

NINTH EDITION

Problem Solving with C++



WALTER SAVITCH

Ninth Edition

PROBLEM SOLVING with **C++**

This page intentionally left blank

Ninth Edition

PROBLEM SOLVING

with

C++

Walter Savitch

UNIVERSITY OF CALIFORNIA, SAN DIEGO

CONTRIBUTOR

Kenrick Mock

UNIVERSITY OF ALASKA, ANCHORAGE

PEARSON

Boston Columbus Indianapolis New York San Francisco Upper Saddle River
Amsterdam Cape Town Dubai London Madrid Milan Munich Paris Montreal Toronto
Delhi Mexico City São Paulo Sydney Hong Kong Seoul Singapore Taipei Tokyo

Editorial Director: *Marcia Horton*
Acquisitions Editor: *Matt Goldstein*
Program Manager: *Kayla Smith-Tarbox*
Editorial Assistant: *Kelsey Loanes*
Marketing Coordinator: *Kathryn Ferranti*
Production Director: *Erin Gregg*
Managing Editor: *Scott Disanno*
Senior Operations Supervisor: *Vincent Scelta*
Operations Specialist: *Linda Sager*
Cover Designer: *Joyce Wells*
Permissions Manager: *Timothy Nicholls*
Image Permissions Manager: *Karen Sanatar*
Media Producer: *Renata Butera*
Media Project Manager: *Wanda Rockwell*
Full-Service Vendor: *Hardik Popli, Cenveo® Publisher Services*
Composition: *Cenveo Publisher Services*
Printer/Binder: *Courier/Westford*
Cover Printer: *Lehigh-Phoenix Color/Hagerstown*

Credits and acknowledgments borrowed from other sources and reproduced, with permission, in this textbook appear on appropriate page within text.

Microsoft® and Windows® are registered trademarks of the Microsoft Corporation in the U.S.A. and other countries. Screen shots and icons reprinted with permission from the Microsoft Corporation. This book is not sponsored or endorsed by or affiliated with the Microsoft Corporation.

Copyright © 2015, 2012, 2009, 2007, 2005, 2003 Pearson Education, Inc. All rights reserved. Manufactured in the United States of America. This publication is protected by Copyright, and permission should be obtained from the publisher prior to any prohibited reproduction, storage in a retrieval system, or transmission in any form or by any means, electronic, mechanical, photocopying, recording, or likewise. To obtain permission(s) to use material from this work, please submit a written request to Pearson Education, Inc., Permissions Department, 501 Boylston Street, Suite 900, Boston, Massachusetts 02116.

Many of the designations by manufacturers and sellers to distinguish their products are claimed as trademarks. Where those designations appear in this book, and the publisher was aware of a trademark claim, the designations have been printed in initial caps or all caps.

Library of Congress Cataloging-in-Publication Data

Savitch, Walter J., 1943-
Problem solving with C++ / Walter Savitch ; contributor, Kenrick Mock. -- Ninth edition.
pages cm
Includes index.
ISBN-13: 978-0-13-359174-3 (alkaline paper)
ISBN-10: 0-13-359174-3 (alkaline paper)
1. C++ (Computer program language) 2. Problem solving. I. Mock, Kenrick. II. Title.
QA76.73.C153S29 2014
005.13'3--dc23

2013048487

10 9 8 7 6 5 4 3 2 1—CW—15 14 13 12 11



www.pearsonhighered.com

ISBN 10: 0-13-359174-3
ISBN 13: 978-0-13-359174-3

Preface

This book is meant to be used in a first course in programming and computer science using the C++ language. It assumes no previous programming experience and no mathematics beyond high school algebra.

If you have used the previous edition of this book, you should read the following section that explains the changes to this ninth edition and then you can skip the rest of this preface. If you are new to this book, the rest of this preface will give you an overview of the book.

Changes to the Ninth Edition

This ninth edition presents the same programming philosophy as the eighth edition. All of the material from the eighth edition remains, but with the following enhancements:

- End-of-chapter programs are now split into Practice Programs and Programming Projects. Practice Programs require a direct application of concepts presented in the chapter and solutions are usually short. Practice Programs are appropriate for laboratory exercises. Programming Projects require additional problem solving and solutions are generally longer than Practice Programs. Programming Projects are appropriate for homework problems.
- Introduction to C++11 in the context of C++98. Examples of C++11 content includes new integer types, the auto type, raw string literals, strong enumerations, `nullptr`, `ranged` for loop, conversion between strings and integers, member initializers, and constructor delegation.
- Additional material on sorting, secure programming (e.g., overflow, array out of bounds), and inheritance.
- Correction of errata.
- Twenty-one new Practice Programs and ten new Programming Projects.
- Ten new VideoNotes for a total of sixty-four VideoNotes. These VideoNotes walk students through the process of both problem solving and coding to help reinforce key programming concepts. An icon appears in the margin of the book when a VideoNote is available regarding the topic covered in the text.

If you are an instructor already using the eighth edition, you can continue to teach your course almost without change.

Flexibility in Topic Ordering

This book was written to allow instructors wide latitude in reordering the material. To illustrate this flexibility, we suggest two alternative ways to order

the topics. There is no loss of continuity when the book is read in either of these ways. To ensure this continuity when you rearrange material, you may need to move sections rather than entire chapters. However, only large sections in convenient locations are moved. To help customize a particular order for any class's needs, the end of this preface contains a dependency chart, and each chapter has a "Prerequisites" section that explains what material needs to be covered before each section in that chapter.

Reordering 1: Earlier Classes

To effectively design classes, a student needs some basic tools such as control structures and function definitions. This basic material is covered in Chapters 1 through 6. After completing Chapter 6, students can begin to write their own classes. One possible reordering of chapters that allows for such early coverage of classes is the following:

Basics: Chapters 1, 2, 3, 4, 5, and 6. This material covers all control structures, function definitions, and basic file I/O. Chapter 3, which covers additional control structures, could be deferred if you wish to cover classes as early as possible.

Classes and namespaces: Chapter 10, Sections 11.1 and 11.2 of Chapter 11, and Chapter 12. This material covers defining classes, friends, overloaded operators, and namespaces.

Arrays, strings and vectors: Chapters 7 and 8

Pointers and dynamic arrays: Chapter 9

Arrays in classes: Sections 11.3 and 11.4 of Chapter 11

Inheritance: Chapter 15

Recursion: Chapter 14 (Alternately, recursion may be moved to later in the course.)

Pointers and linked lists: Chapter 13

Any subset of the following chapters may also be used:

Exception handling: Chapter 16

Templates: Chapter 17

Standard Template Library: Chapter 18

Reordering 2: Classes Slightly Later but Still Early

This version covers all control structures and the basic material on arrays before doing classes, but classes are covered later than the previous ordering and slightly earlier than the default ordering.

Basics: Chapters 1, 2, 3, 4, 5, and 6. This material covers all control structures, function definitions, and the basic file I/O.

Arrays and strings: Chapter 7, Sections 8.1 and 8.2 of Chapter 8

Classes and namespaces: Chapter 10, Sections 11.1 and 11.2 of Chapter 11, and Chapter 12. This material covers defining classes, friends, overloaded operators, and namespaces.

Pointers and dynamic arrays: Chapter 9

Arrays in classes: Sections 11.3 and 11.4 of Chapter 11

Inheritance: Chapter 15

Recursion: Chapter 14. (Alternately, recursion may be moved to later in the course.)

Vectors: Chapter 8.3

Pointers and linked lists: Chapter 13

Any subset of the following chapters may also be used:

Exception handling: Chapter 16

Templates: Chapter 17

Standard Template Library: Chapter 18

Accessibility to Students

It is not enough for a book to present the right topics in the right order. It is not even enough for it to be clear and correct when read by an instructor or other experienced programmer. The material needs to be presented in a way that is accessible to beginning students. In this introductory textbook, I have endeavored to write in a way that students find clear and friendly. Reports from the many students who have used the earlier editions of this book confirm that this style makes the material clear and often even enjoyable to students.

ANSI/ISO C++ Standard

This edition is fully compatible with compilers that meet the latest ANSI/ISO C++ standard. At the time of this writing the latest standard is C++11.

Advanced Topics

Many “advanced topics” are becoming part of a standard CS1 course. Even if they are not part of a course, it is good to have them available in the text as enrichment material. This book offers a number of advanced topics that can be integrated into a course or left as enrichment topics. It gives thorough coverage of C++ templates, inheritance (including virtual functions), exception handling, and the STL (Standard Template Library). Although this book uses libraries and teaches students the importance of libraries, it does not require any nonstandard libraries. This book uses only libraries that are provided with essentially all C++ implementations.

Dependency Chart

The dependency chart on the next page shows possible orderings of chapters and subsections. A line joining two boxes means that the upper box must be covered before the lower box. Any ordering that is consistent with this partial ordering can be read without loss of continuity. If a box contains a section number or numbers, then the box refers only to those sections and not to the entire chapter.

Summary Boxes

Each major point is summarized in a boxed section. These boxed sections are spread throughout each chapter.

Self-Test Exercises

Each chapter contains numerous Self-Test Exercises at strategic points. Complete answers for all the Self-Test Exercises are given at the end of each chapter.



VideoNotes

VideoNotes are designed for teaching students key programming concepts and techniques. These short step-by-step videos demonstrate how to solve problems from design through coding. VideoNotes allow for self-paced instruction with easy navigation including the ability to select, play, rewind, fast-forward, and stop within each VideoNote exercise.

Online Practice and Assessment with MyProgrammingLab

MyProgrammingLab helps students fully grasp the logic, semantics, and syntax of programming. Through practice exercises and immediate, personalized feedback, MyProgrammingLab improves the programming competence of beginning students who often struggle with the basic concepts and paradigms of popular high-level programming languages.

A self-study and homework tool, a MyProgrammingLab course consists of hundreds of small practice problems organized around the structure of this textbook. For students, the system automatically detects errors in the logic and syntax of their code submissions and offers targeted hints that enable students to figure out what went wrong—and why. For instructors, a comprehensive gradebook tracks correct and incorrect answers and stores the code inputted by students for review.

MyProgrammingLab is offered to users of this book in partnership with Turing's Craft, the makers of the CodeLab interactive programming exercise system. For a full demonstration, to see feedback from instructors and students, or to get started using MyProgrammingLab in your course, visit www.myprogramminglab.com.

DISPLAY P.1 Dependency Chart

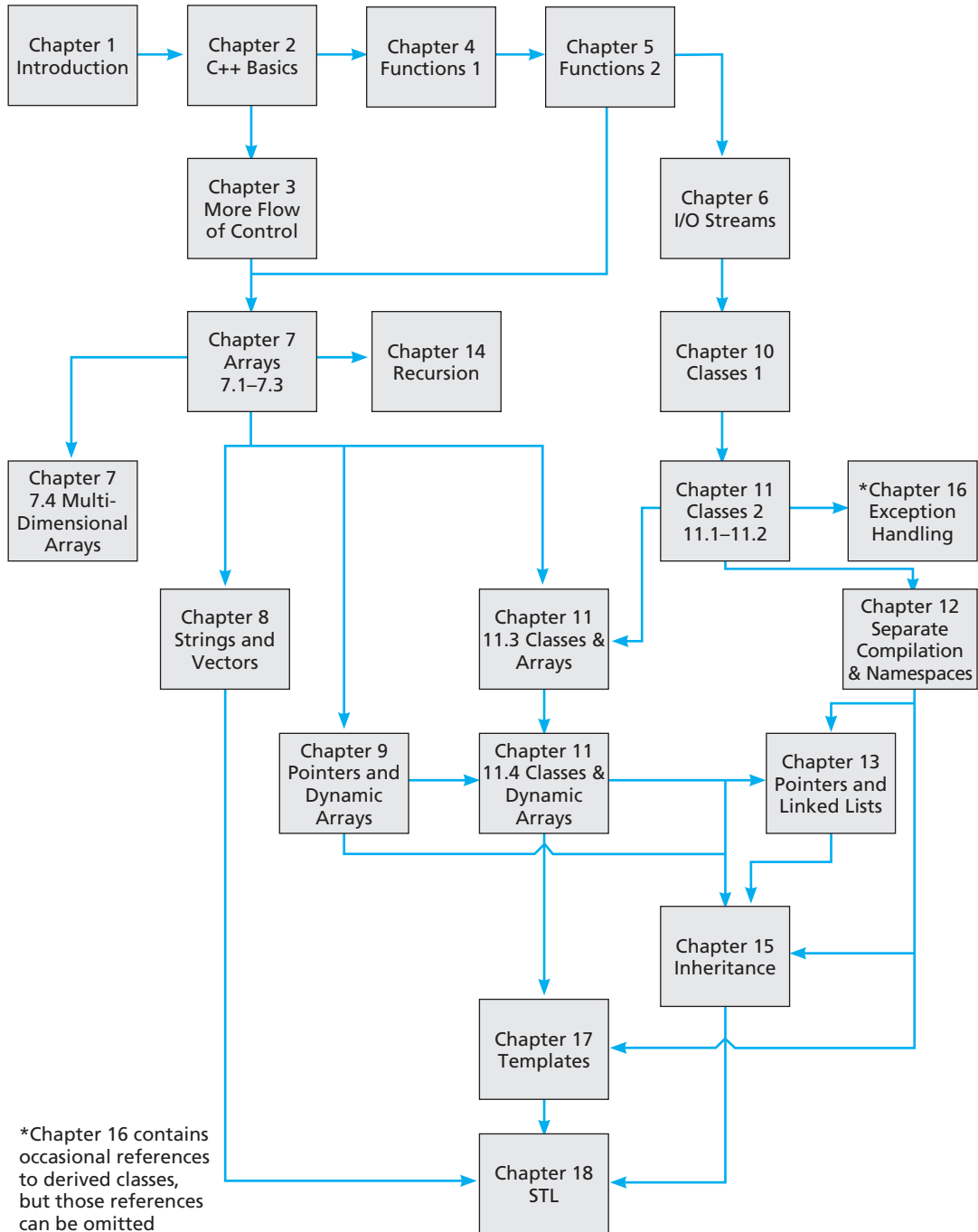

Support Material

There is support material available to all users of this book and additional material available only to qualified instructors.

Materials Available to All Users of this Book

- Source Code from the book
- PowerPoint slides
- VideoNotes

To access these materials, go to:

www.pearsonhighered.com/savitch

Resources Available to Qualified Instructors Only

Visit Pearson Education's instructor resource center at www.pearsonhighered.com/irc to access the following instructor resources:

- Instructor's Resource Guide—including chapter-by-chapter teaching hints, quiz questions with solutions, and solutions to many programming projects
- Test Bank and Test Generator
- PowerPoint Lectures—including programs and art from the text
- Lab Manual

Integrated Development Environment (IDE) Resource Kits

Instructors who adopt this text can order it for students with a kit containing five popular C++ IDEs (Microsoft® Visual Studio 2013 Express Edition, Dev C++, NetBeans, Eclipse, and CodeLite) and access to a Web site containing written and video tutorials for getting started in each IDE. For ordering information, please contact your campus Pearson Education representative.

Contact Us

Your comments, suggestions, questions, and corrections are always welcome. Please e-mail them to savitch.programming.cpp@gmail.com

Acknowledgments

Numerous individuals and groups have provided me with suggestions, discussions, and other help in preparing this textbook. Much of the first edition of this book was written while I was visiting the Computer Science Department at the University of Colorado in Boulder. The remainder of the writing on the first edition and the work on subsequent editions was done in the Computer Science and Engineering Department at the University of California, San Diego (UCSD). I am grateful to these institutions for providing a conducive environment for teaching this material and writing this book.

I extend a special thanks to all the individuals who have contributed critiques or programming projects for this or earlier editions and drafts of this book. In alphabetical order, they are: Alex Feldman, Amber Settle, Andrew Burt, Andrew Haas, Anne Marchant, Barney MacCabe, Bob Holloway, Bob Matthews, Brian R. King, Bruce Johnston, Carol Roberts, Charles Dowling, Claire Bono, Cynthia Martincic, David Feinstein, David Teague, Dennis Heckman, Donald Needham, Doug Cosman, Dung Nguyen, Edward Carr, Eitan M. Gurari, Ethan Munson, Firooz Khosraviyani, Frank Moore, Gilliean Lee, Huzefa Kagdi, James Stepleton, Jeff Roach, Jeffrey Watson, Jennifer Perkins, Jerry Weltman, Joe Faletti, Joel Cohen, John J. Westman, John Marsaglia, John Russo, Joseph Allen, Joseph D. Oldham, Jerrold Grossman, Jesse Morehouse, Karla Chaveau, Ken Rockwood, Larry Johnson, Len Garrett, Linda F. Wilson, Mal Gunasekera, Marianne Lepp, Matt Johnson, Michael Keenan, Michael Main, Michal Sramka, Naomi Shapiro, Nat Martin, Noah Aydin, Nisar Hundewale, Paul J. Kaiser, Paul Kube, Paulo Franca, Richard Borie, Scot Drysdale, Scott Strong, Sheila Foster, Steve Mahaney, Susanne Sherba, Thomas Judson, Walter A. Manrique, Wei Lian Chen, and Wojciech Komornicki.

I extend a special thanks to the many instructors who used early editions of this book. Their comments provided some of the most helpful reviewing that the book received.

Finally, I thank Kenrick Mock who implemented the changes in this edition. He had the almost impossible task of pleasing me, my editor, and his own sensibilities, and he did a superb job of it.

Walter Savitch

This page intentionally left blank

BREAKTHROUGH

To improving results



get with the programming

Through the power of practice and immediate personalized feedback, MyProgrammingLab improves your performance.

MyProgrammingLab™

Learn more at www.myprogramminglab.com

Brief Contents

Table of Location of VideoNotes

Inside front cover and inside back cover

- Chapter 1** Introduction to Computers and C++ Programming 1
- Chapter 2** C++ Basics 39
- Chapter 3** More Flow of Control 111
- Chapter 4** Procedural Abstraction and Functions That Return a Value 181
- Chapter 5** Functions for All Subtasks 251
- Chapter 6** I/O Streams as an Introduction to Objects and Classes 305
- Chapter 7** Arrays 377
- Chapter 8** Strings and Vectors 451
- Chapter 9** Pointers and Dynamic Arrays 507
- Chapter 10** Defining Classes 541
- Chapter 11** Friends, Overloaded Operators, and Arrays in Classes 619

Chapter 12 **Separate Compilation and Namespaces** 703

Chapter 13 **Pointers and Linked Lists** 739

Chapter 14 **Recursion** 789

Chapter 15 **Inheritance** 833

Chapter 16 **Exception Handling** 893

Chapter 17 **Templates** 925

Chapter 18 **Standard Template Library** 957

Appendices

- 1** **C++ Keywords** 1015
- 2** **Precedence of Operators** 1016
- 3** **The ASCII Character Set** 1018
- 4** **Some Library Functions** 1019
- 5** **Inline Functions** 1026
- 6** **Overloading the Array Index
Square Brackets** 1027
- 7** **The `this` Pointer** 1029
- 8** **Overloading Operators as Member
Operators** 1032

Index 1034

Contents

Table of Location of VideoNotes

Inside front cover and inside back cover

Chapter 1 Introduction to Computers and C++ Programming 1

1.1 COMPUTER SYSTEMS 2

Hardware 2
Software 7
High-Level Languages 8
Compilers 9
History Note 12

1.2 PROGRAMMING AND PROBLEM-SOLVING 12

Algorithms 12
Program Design 15
Object-Oriented Programming 16
The Software Life Cycle 17

1.3 INTRODUCTION TO C++ 18

Origins of the C++ Language 18
A Sample C++ Program 19
Pitfall: Using the Wrong Slash in `\n` 23
Programming Tip: Input and Output Syntax 23
Layout of a Simple C++ Program 24
Pitfall: Putting a Space Before the include File Name 26
Compiling and Running a C++ Program 26
Pitfall: Compiling a C++11 program 27
Programming Tip: Getting Your Program to Run 27

1.4 TESTING AND DEBUGGING 29

Kinds of Program Errors 30
Pitfall: Assuming Your Program Is Correct 31

Chapter Summary	32
Answers to Self-Test Exercises	33
Practice Programs	35
Programming Projects	36

Chapter 2 C++ Basics 39

2.1 VARIABLES AND ASSIGNMENTS 40

Variables	40
Names: Identifiers	42
Variable Declarations	44
Assignment Statements	45
<i>Pitfall: Uninitialized Variables</i>	47
<i>Programming Tip: Use Meaningful Names</i>	49

2.2 INPUT AND OUTPUT 50

Output Using <code>cout</code>	50
Include Directives and Namespaces	52
Escape Sequences	53
<i>Programming Tip: End Each Program with a <code>\n</code> or <code>endl</code></i>	55
Formatting for Numbers with a Decimal Point	55
Input Using <code>cin</code>	56
Designing Input and Output	58
<i>Programming Tip: Line Breaks in I/O</i>	58

2.3 DATA TYPES AND EXPRESSIONS 60

The Types <code>int</code> and <code>double</code>	60
Other Number Types	62
C++11 Types	63
The Type <code>char</code>	64
The Type <code>bool</code>	66
Introduction to the Class <code>string</code>	66
Type Compatibilities	68
Arithmetic Operators and Expressions	69
<i>Pitfall: Whole Numbers in Division</i>	72
More Assignment Statements	74

2.4 SIMPLE FLOW OF CONTROL 74

A Simple Branching Mechanism	75
<i>Pitfall: Strings of Inequalities</i>	80
<i>Pitfall: Using <code>=</code> in place of <code>==</code></i>	81
Compound Statements	82

Simple Loop Mechanisms 84
Increment and Decrement Operators 87
Programming Example: Charge Card Balance 89
Pitfall: Infinite Loops 90

2.5 PROGRAM STYLE 93

Indenting 93
Comments 93
Naming Constants 95

Chapter Summary 98
Answers to Self-Test Exercises 98
Practice Programs 103
Programming Projects 105

Chapter 3 More Flow of Control 111

3.1 USING BOOLEAN EXPRESSIONS 112

Evaluating Boolean Expressions 112
Pitfall: Boolean Expressions Convert to int Values 116
Enumeration Types (*Optional*) 119

3.2 MULTIWAY BRANCHES 120

Nested Statements 120
Programming Tip: Use Braces in Nested Statements 121
Multiway *if-else* Statements 123
Programming Example: State Income Tax 125
The *switch* Statement 128
Pitfall: Forgetting a break in a switch Statement 132
Using *switch* Statements for Menus 133
Blocks 135
Pitfall: Inadvertent Local Variables 138

3.3 MORE ABOUT C++ LOOP STATEMENTS 139

The *while* Statements Reviewed 139
Increment and Decrement Operators Revisited 141
The *for* Statement 144
Pitfall: Extra Semicolon in a for Statement 149
What Kind of Loop to Use 150
Pitfall: Uninitialized Variables and Infinite Loops 152
The *break* Statement 153
Pitfall: The break Statement in Nested Loops 154

3.4 DESIGNING LOOPS 155

Loops for Sums and Products 155

Ending a Loop 157

Nested Loops 160

Debugging Loops 162

Chapter Summary 165

Answers to Self-Test Exercises 166

Practice Programs 172

Programming Projects 174

Chapter 4 Procedural Abstraction and Functions That Return a Value 181

4.1 TOP-DOWN DESIGN 182

4.2 PREDEFINED FUNCTIONS 183

Using Predefined Functions 183

Random Number Generation 188

Type Casting 190

Older Form of Type Casting 192

Pitfall: Integer Division Drops the Fractional Part 192

4.3 PROGRAMMER-DEFINED FUNCTIONS 193

Function Definitions 193

Functions That Return a Boolean Value 199

Alternate Form for Function Declarations 199

Pitfall: Arguments in the Wrong Order 200

Function Definition–Syntax Summary 201

More About Placement of Function Definitions 202

Programming Tip: Use Function Calls in Branching Statements 203

4.4 PROCEDURAL ABSTRACTION 204

The Black-Box Analogy 204

Programming Tip: Choosing Formal Parameter Names 207

Programming Tip: Nested Loops 208

Case Study: Buying Pizza 211

Programming Tip: Use Pseudocode 217

4.5 SCOPE AND LOCAL VARIABLES 218

The Small Program Analogy 218

Programming Example: Experimental Pea Patch 221

Global Constants and Global Variables	221
Call-by-Value Formal Parameters Are Local Variables	224
Block Scope	226
Namespaces Revisited	227
<i>Programming Example: The Factorial Function</i>	230

4.6 OVERLOADING FUNCTION NAMES 232

Introduction to Overloading	232
<i>Programming Example: Revised Pizza-Buying Program</i>	235
Automatic Type Conversion	238
Chapter Summary	240
Answers to Self-Test Exercises	240
Practice Programs	245
Programming Projects	247

Chapter 5 Functions for All Subtasks 251

5.1 void FUNCTIONS 252

Definitions of <i>void</i> Functions	252
<i>Programming Example: Converting Temperatures</i>	255
<i>return</i> Statements in <i>void</i> Functions	255

5.2 CALL-BY-REFERENCE PARAMETERS 259

A First View of Call-by-Reference	259
Call-by-Reference in Detail	262
<i>Programming Example: The swap_values Function</i>	267
Mixed Parameter Lists	268
<i>Programming Tip: What Kind of Parameter to Use</i>	269
<i>Pitfall: Inadvertent Local Variables</i>	270

5.3 USING PROCEDURAL ABSTRACTION 273

Functions Calling Functions	273
Preconditions and Postconditions	275
<i>Case Study: Supermarket Pricing</i>	276

5.4 TESTING AND DEBUGGING FUNCTIONS 281

Stubs and Drivers	282
-------------------	-----

5.5 GENERAL DEBUGGING TECHNIQUES 287

Keep an Open Mind	287
Check Common Errors	287

Localize the Error	288
The assert Macro	290
Chapter Summary	292
Answers to Self-Test Exercises	293
Practice Programs	296
Programming Projects	299

Chapter 6 I/O Streams as an Introduction to Objects and Classes 305

6.1 STREAMS AND BASIC FILE I/O 306

Why Use Files for I/O?	307
File I/O	308
Introduction to Classes and Objects	312
<i>Programming Tip: Check Whether a File Was Opened Successfully</i>	314
Techniques for File I/O	316
Appending to a File (<i>Optional</i>)	320
File Names as Input (<i>Optional</i>)	321

6.2 TOOLS FOR STREAM I/O 323

Formatting Output with Stream Functions	323
Manipulators	329
Streams as Arguments to Functions	332
<i>Programming Tip: Checking for the End of a File</i>	332
A Note on Namespaces	335
<i>Programming Example: Cleaning Up a File Format</i>	336

6.3 CHARACTER I/O 338

The Member Functions get and put	338
The putback Member Function (<i>Optional</i>)	342
<i>Programming Example: Checking Input</i>	343
<i>Pitfall: Unexpected '\n' in Input</i>	345
<i>Programming Example: Another new_line Function</i>	347
Default Arguments for Functions (<i>Optional</i>)	348
The eof Member Function	353
<i>Programming Example: Editing a Text File</i>	355
Predefined Character Functions	356
<i>Pitfall: toupper and tolower Return Values</i>	358

Chapter Summary	360
Answers to Self-Test Exercises	361
Practice Programs	368
Programming Projects	370

Chapter 7 Arrays 377

7.1 INTRODUCTION TO ARRAYS 378

Declaring and Referencing Arrays	378
<i>Programming Tip: Use for Loops with Arrays</i>	380
<i>Pitfall: Array Indexes Always Start with Zero</i>	380
<i>Programming Tip: Use a Defined Constant for the Size of an Array</i>	380
Arrays in Memory	382
<i>Pitfall: Array Index Out of Range</i>	383
Initializing Arrays	386
<i>Programming Tip: C++11 Range-Based for Statement</i>	386

7.2 ARRAYS IN FUNCTIONS 389

Indexed Variables as Function Arguments	389
Entire Arrays as Function Arguments	391
The <i>const</i> Parameter Modifier	394
<i>Pitfall: Inconsistent Use of const Parameters</i>	397
Functions That Return an Array	397
<i>Case Study: Production Graph</i>	398

7.3 PROGRAMMING WITH ARRAYS 411

Partially Filled Arrays	411
<i>Programming Tip: Do Not Skimp on Formal Parameters</i>	414
<i>Programming Example: Searching an Array</i>	414
<i>Programming Example: Sorting an Array</i>	417
<i>Programming Example: Bubble Sort</i>	421

7.4 MULTIDIMENSIONAL ARRAYS 424

Multidimensional Array Basics	425
Multidimensional Array Parameters	425
<i>Programming Example: Two-Dimensional Grading Program</i>	427
<i>Pitfall: Using Commas Between Array Indexes</i>	431

Chapter Summary	432
Answers to Self-Test Exercises	433
Practice Programs	437
Programming Projects	439

Chapter 8 Strings and Vectors 451

8.1 AN ARRAY TYPE FOR STRINGS 453

C-String Values and C-String Variables	453
<i>Pitfall:</i> Using = and == with C Strings	456
Other Functions in <code><cstring></code>	458
<i>Pitfall:</i> Copying past the end of a C-string using <code>strcpy</code>	461
C-String Input and Output	464
C-String-to-Number Conversions and Robust Input	466

8.2 THE STANDARD string CLASS 472

Introduction to the Standard Class <code>string</code>	472
I/O with the Class <code>string</code>	475
<i>Programming Tip:</i> More Versions of <code>getline</code>	478
<i>Pitfall:</i> Mixing <code>cin >> variable;</code> and <code>getline</code>	479
String Processing with the Class <code>string</code>	480
<i>Programming Example:</i> Palindrome Testing	484
Converting Between <code>string</code> Objects and C Strings	487
Converting Between Strings and Numbers	488

8.3 VECTORS 489

Vector Basics	489
<i>Pitfall:</i> Using Square Brackets Beyond the Vector Size	492
<i>Programming Tip:</i> Vector Assignment Is Well Behaved	493
Efficiency Issues	493

Chapter Summary	495
Answers to Self-Test Exercises	495
Practice Programs	497
Programming Projects	498

Chapter 9 Pointers and Dynamic Arrays 507

9.1 POINTERS 508

Pointer Variables	509
Basic Memory Management	516

Pitfall: Dangling Pointers 517
Static Variables and Automatic Variables 518
Programming Tip: Define Pointer Types 518

9.2 DYNAMIC ARRAYS 521

Array Variables and Pointer Variables 521
Creating and Using Dynamic Arrays 522
Pointer Arithmetic (*Optional*) 528
Multidimensional Dynamic Arrays (*Optional*) 530

Chapter Summary 532
Answers to Self-Test Exercises 532
Practice Programs 533
Programming Projects 534

Chapter 10 Defining Classes 541

10.1 STRUCTURES 542

Structures for Diverse Data 542
Pitfall: Forgetting a Semicolon in a Structure Definition 547
Structures as Function Arguments 548
Programming Tip: Use Hierarchical Structures 549
Initializing Structures 551

10.2 CLASSES 554

Defining Classes and Member Functions 554
Public and Private Members 559
Programming Tip: Make All Member Variables Private 567
Programming Tip: Define Accessor and Mutator Functions 567
Programming Tip: Use the Assignment Operator with Objects 569
Programming Example: BankAccount Class—Version 1 570
Summary of Some Properties of Classes 574
Constructors for Initialization 576
Programming Tip: Always Include a Default Constructor 584
Pitfall: Constructors with No Arguments 585
Member Initializers and Constructor Delegation in C++11 587

10.3 ABSTRACT DATA TYPES 588

Classes to Produce Abstract Data Types 589
Programming Example: Alternative Implementation of a Class 593

10.4 INTRODUCTION TO INHERITANCE 598

Derived Classes 599

Defining Derived Classes 600

Chapter Summary 604

Answers to Self-Test Exercises 605

Practice Programs 611

Programming Projects 612

**Chapter 11 Friends, Overloaded Operators, and
Arrays in Classes 619****11.1 FRIEND FUNCTIONS 620***Programming Example:* An Equality Function 620

Friend Functions 624

Programming Tip: Define Both Accessor Functions and Friend Functions 626*Programming Tip:* Use Both Member and Nonmember Functions 628*Programming Example:* Money Class (Version 1) 628Implementation of `digit_to_int` (*Optional*) 635*Pitfall:* Leading Zeros in Number Constants 636The `const` Parameter Modifier 638*Pitfall:* Inconsistent Use of `const` 639**11.2 OVERLOADING OPERATORS 643**

Overloading Operators 644

Constructors for Automatic Type Conversion 647

Overloading Unary Operators 649

Overloading `>>` and `<<` 650**11.3 ARRAYS AND CLASSES 660**

Arrays of Classes 660

Arrays as Class Members 664

Programming Example: A Class for a Partially Filled Array 665**11.4 CLASSES AND DYNAMIC ARRAYS 667***Programming Example:* A String Variable Class 668

Destructors 671

Pitfall: Pointers as Call-by-Value Parameters 674

Copy Constructors	675
Overloading the Assignment Operator	680
Chapter Summary	683
Answers to Self-Test Exercises	683
Practice Programs	693
Programming Projects	694

Chapter 12 Separate Compilation and Namespaces 703

12.1 SEPARATE COMPILATION 704

ADTs Reviewed 705

Case Study: DigitalTime—A Class Compiled Separately 706

Using `#ifndef` 715

Programming Tip: Defining Other Libraries 718

12.2 NAMESPACES 719

Namespaces and *using* Directives 719

Creating a Namespace 721

Qualifying Names 724

A Subtle Point About Namespaces (*Optional*) 725

Unnamed Namespaces 726

Programming Tip: Choosing a Name for a Namespace 731

Pitfall: Confusing the Global Namespace and the Unnamed Namespace 732

Chapter Summary 733

Answers to Self-Test Exercises 734

Practice Programs 736

Programming Projects 738

Chapter 13 Pointers and Linked Lists 739

13.1 NODES AND LINKED LISTS 740

Nodes 740

`nullptr` 745

Linked Lists 746

Inserting a Node at the Head of a List 747

Pitfall: Losing Nodes 750

Searching a Linked List 751

Pointers as Iterators 755
Inserting and Removing Nodes Inside a List 755
Pitfall: Using the Assignment Operator with Dynamic Data Structures 757
Variations on Linked Lists 760
Linked Lists of Classes 762

13.2 STACKS AND QUEUES 765

Stacks 765
Programming Example: A Stack Class 766
Queues 771
Programming Example: A Queue Class 772

Chapter Summary 776
Answers to Self-Test Exercises 776
Practice Programs 779
Programming Projects 780

Chapter 14 Recursion 789

14.1 RECURSIVE FUNCTIONS FOR TASKS 791

Case Study: Vertical Numbers 791
A Closer Look at Recursion 797
Pitfall: Infinite Recursion 799
Stacks for Recursion 800
Pitfall: Stack Overflow 802
Recursion Versus Iteration 802

14.2 RECURSIVE FUNCTIONS FOR VALUES 804

General Form for a Recursive Function That Returns a Value 804
Programming Example: Another Powers Function 804

14.3 THINKING RECURSIVELY 809

Recursive Design Techniques 809
Case Study: Binary Search—An Example of Recursive Thinking 810
Programming Example: A Recursive Member Function 818

Chapter Summary 822
Answers to Self-Test Exercises 822
Practice Programs 827
Programming Projects 827

Chapter 15 Inheritance 833

15.1 INHERITANCE BASICS 834

Derived Classes 837

Constructors in Derived Classes 845

Pitfall: Use of Private Member Variables from the Base Class 848

Pitfall: Private Member Functions Are Effectively Not Inherited 850

The *protected* Qualifier 850

Redefinition of Member Functions 853

Redefining Versus Overloading 856

Access to a Redefined Base Function 858

15.2 INHERITANCE DETAILS 859

Functions That Are Not Inherited 859

Assignment Operators and Copy Constructors in Derived Classes 860

Destructors in Derived Classes 861

15.3 POLYMORPHISM 862

Late Binding 863

Virtual Functions in C++ 864

Virtual Functions and Extended Type Compatibility 869

Pitfall: The Slicing Problem 873

Pitfall: Not Using Virtual Member Functions 874

Pitfall: Attempting to Compile Class Definitions Without
Definitions for Every Virtual Member Function 875

Programming Tip: Make Destructors Virtual 875

Chapter Summary 877

Answers to Self-Test Exercises 877

Practice Programs 881

Programming Projects 884

Chapter 16 Exception Handling 893

16.1 EXCEPTION-HANDLING BASICS 895

A Toy Example of Exception Handling 895

Defining Your Own Exception Classes 904

Multiple Throws and Catches 904

Pitfall: Catch the More Specific Exception First 908

Programming Tip: Exception Classes Can Be Trivial 909

Throwing an Exception in a Function 909

Exception Specification 911
Pitfall: Exception Specification in Derived Classes 913

16.2 PROGRAMMING TECHNIQUES FOR EXCEPTION HANDLING 914

When to Throw an Exception 914
Pitfall: Uncaught Exceptions 916
Pitfall: Nested try-catch Blocks 916
Pitfall: Overuse of Exceptions 916
Exception Class Hierarchies 917
Testing for Available Memory 917
Rethrowing an Exception 918

Chapter Summary 918
Answers to Self-Test Exercises 918
Practice Programs 920
Programming Projects 921

Chapter 17 Templates 925

17.1 TEMPLATES FOR ALGORITHM ABSTRACTION 926

Templates for Functions 927
Pitfall: Compiler Complications 931
Programming Example: A Generic Sorting Function 933
Programming Tip: How to Define Templates 937
Pitfall: Using a Template with an Inappropriate Type 938

17.2 TEMPLATES FOR DATA ABSTRACTION 939

Syntax for Class Templates 939
Programming Example: An Array Class 942

Chapter Summary 949
Answers to Self-Test Exercises 949
Practice Programs 953
Programming Projects 953

Chapter 18 Standard Template Library 957

18.1 ITERATORS 959

using Declarations 959
Iterator Basics 960

Programming Tip: Use auto to Simplify Variable Declarations 964

Pitfall: Compiler Problems 964

Kinds of Iterators 966

Constant and Mutable Iterators 970

Reverse Iterators 971

Other Kinds of Iterators 972

18.2 CONTAINERS 973

Sequential Containers 974

Pitfall: Iterators and Removing Elements 978

Programming Tip: Type Definitions in Containers 979

Container Adapters `stack` and `queue` 979

Associative Containers `set` and `map` 983

Programming Tip: Use Initialization, Ranged For, and auto with Containers 990

Efficiency 990

18.3 GENERIC ALGORITHMS 991

Running Times and Big-*O* Notation 992

Container Access Running Times 995

Nonmodifying Sequence Algorithms 997

Container Modifying Algorithms 1001

Set Algorithms 1003

Sorting Algorithms 1004

Chapter Summary 1005

Answers to Self-Test Exercises 1005

Practice Programs 1007

Programming Projects 1008

APPENDICES

1 C++ Keywords 1015

2 Precedence of Operators 1016

3 The ASCII Character Set 1018

4 Some Library Functions 1019

5 Inline Functions 1026

6 Overloading the Array Index Square Brackets 1027

7 The `this` Pointer 1029

8 Overloading Operators as Member Operators 1032

INDEX 1034

Introduction to Computers and C++ Programming **1**

1.1 COMPUTER SYSTEMS 2

Hardware 2
Software 7
High-Level Languages 8
Compilers 9
History Note 12

1.2 PROGRAMMING AND PROBLEM-SOLVING 12

Algorithms 12
Program Design 15
Object-Oriented Programming 16
The Software Life Cycle 17

1.3 INTRODUCTION TO C++ 18

Origins of the C++ Language 18
A Sample C++ Program 19

Pitfall: Using the Wrong Slash in `\n` 23

Programming Tip: Input and Output
Syntax 23

Layout of a Simple C++ Program 24

Pitfall: Putting a Space Before the `include`
File Name 26

Compiling and Running a C++ Program 26

Pitfall: Compiling a C++11 Program 27

Programming Tip: Getting Your Program
to Run 27

1.4 TESTING AND DEBUGGING 29

Kinds of Program Errors 30

Pitfall: Assuming Your Program Is Correct 31



The whole of the development and operation of analysis are now capable of being executed by machinery. . . . As soon as an Analytical Engine exists, it will necessarily guide the future course of science.

CHARLES BABBAGE (1792–1871)

INTRODUCTION

In this chapter we describe the basic components of a computer, as well as the basic technique for designing and writing a program. We then show you a sample C++ program and describe how it works.

1.1 COMPUTER SYSTEMS

A set of instructions for a computer to follow is called a program. The collection of programs used by a computer is referred to as the **software** for that computer. The actual physical machines that make up a computer installation are referred to as **hardware**. As we will see, the hardware for a computer is conceptually very simple. However, computers now come with a large array of software to aid in the task of programming. This software includes editors, translators, and managers of various sorts. The resulting environment is a complicated and powerful system. In this book we are concerned almost exclusively with software, but a brief overview of how the hardware is organized will be useful.

Hardware

There are three main classes of computers: *PCs*, *workstations*, and *mainframes*. A **PC (personal computer)** is a relatively small computer designed to be used by one person at a time. Most home computers are PCs, but PCs are also widely used in business, industry, and science. A **workstation** is essentially a larger and more powerful PC. You can think of it as an “industrial-strength” PC. A **mainframe** is an even larger computer that typically requires some support staff and generally is shared by more than one user. The distinctions between PCs, workstations, and mainframes are not precise, but the terms are commonly used and do convey some very general information about a computer.

A **network** consists of a number of computers connected so that they may share resources such as printers and may share information. A network might contain a number of workstations and one or more mainframes, as well as shared devices such as printers.

For our purposes in learning programming, it will not matter whether you are working on a PC, a mainframe, or a workstation. The basic configuration of the computer, as we will view it, is the same for all three types of computers.

The hardware for most computer systems is organized as shown in Display 1.1. The computer can be thought of as having five main components: the *input device(s)*, the *output device(s)*, the *processor* (also called the *CPU*, for *central processing unit*), the *main memory*, and the *secondary memory*. The processor, main memory, and secondary memory are normally housed in a single cabinet. The processor and main memory form the heart of a computer and can be thought of as an integrated unit. Other components connect to the main memory and operate under the direction of the processor. The arrows in Display 1.1 indicate the direction of information flow.

An **input device** is any device that allows a person to communicate information to the computer. Your primary input devices are likely to be a keyboard and a mouse.

An **output device** is anything that allows the computer to communicate information to you. The most common output device is a display screen, referred to as a *monitor*. Quite often, there is more than one output device. For example, in addition to the monitor, your computer probably is connected to a printer for producing output on paper. The keyboard and monitor are sometimes thought of as a single unit called a *terminal*.

DISPLAY 1.1 Main Components of a Computer

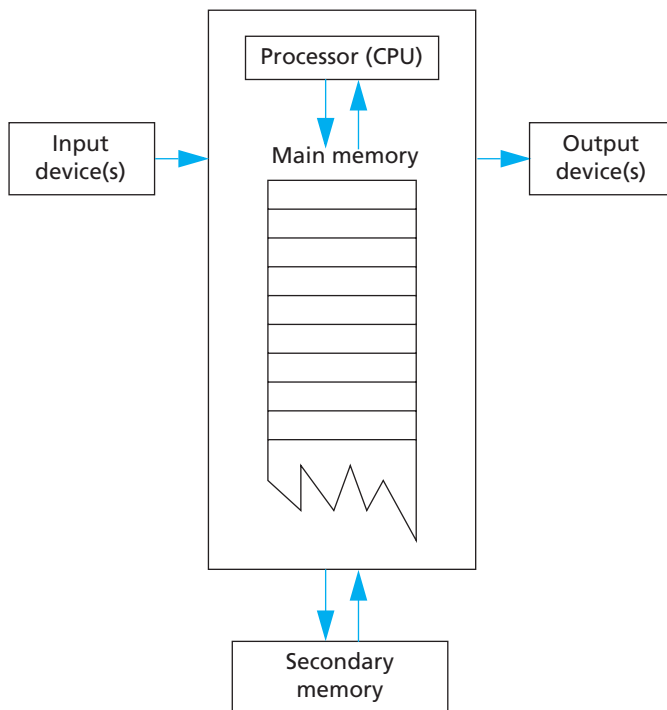

In order to store input and to have the equivalent of scratch paper for performing calculations, computers are provided with *memory*. The program that the computer executes is also stored in this memory. A computer has two forms of memory, called *main memory* and *secondary memory*. The program that is being executed is kept in main memory, and main memory is, as the name implies, the most important memory. **Main memory** consists of a long list of numbered locations called *memory locations*; the number of memory locations varies from one computer to another, ranging from a few thousand to many millions, and sometimes even into the billions. Each memory location contains a string of 0s and 1s. The contents of these locations can change. Hence, you can think of each memory location as a tiny blackboard on which the computer can write and erase. In most computers, all memory locations contain the same number of zero/one digits. A digit that can assume only the values 0 or 1 is called a **binary digit** or a **bit**. The memory locations in most computers contain eight bits (or some multiple of eight bits). An eight-bit portion of memory is called a **byte**, so we can refer to these numbered memory locations as *bytes*. To rephrase the situation, you can think of the computer's main memory as a long list of numbered memory locations called *bytes*. The number that identifies a byte is called its **address**. A data item, such as a number or a letter, can be stored in one of these bytes, and the address of the byte is then used to find the data item when it is needed.

If the computer needs to deal with a data item (such as a large number) that is too large to fit in a single byte, it will use several adjacent bytes to hold the data item. In this case, the entire chunk of memory that holds the data item is still called a **memory location**. The address of the first of the bytes that make up this memory location is used as the address for this larger memory location. Thus, as a practical matter, you can think of the computer's main memory as a long list of memory locations of *varying sizes*. The size of each of these locations is expressed in bytes and the address of the first byte is used as the address (name) of that memory location. Display 1.2 shows a picture of a hypothetical computer's main memory. The sizes of the memory locations are not fixed, but can change when a new program is run on the computer.

Bytes and Addresses

Main memory is divided into numbered locations called **bytes**. The number associated with a byte is called its **address**. A group of consecutive bytes is used as the location for a data item, such as a number or letter. The address of the first byte in the group is used as the address of this larger memory location.

The fact that the information in a computer's memory is represented as 0s and 1s need not be of great concern to you when programming in C++

DISPLAY 1.2 Memory Locations and Bytes

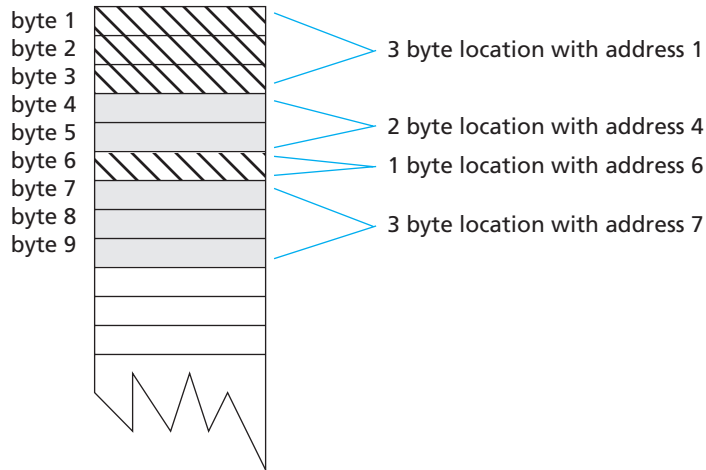

(or in most other programming languages). There is, however, one point about this use of 0s and 1s that will concern us as soon as we start to write programs. The computer needs to interpret these strings of 0s and 1s as numbers, letters, instructions, or other types of information. The computer performs these interpretations automatically according to certain coding schemes. A different code is used for each different type of item that is stored in the computer's memory: one code for letters, another for whole numbers, another for fractions, another for instructions, and so on. For example, in one commonly used set of codes, 01000001 is the code for the letter A and also for the number 65. In order to know what the string 01000001 in a particular location stands for, the computer must keep track of which code is currently being used for that location. Fortunately, the programmer seldom needs to be concerned with such codes and can safely reason as though the locations actually contained letters, numbers, or whatever is desired.

Why Eight?

A **byte** is a memory location that can hold eight bits. What is so special about eight? Why not ten bits? There are two reasons why eight is special. First, eight is a power of 2. (8 is 2^3 .) Since computers use bits, which have only two possible values, powers of 2 are more convenient than powers of 10. Second, it turns out that eight bits (one byte) are required to code a single character (such as a letter or other keyboard symbol).

The memory we have been discussing up until now is the main memory. Without its main memory, a computer can do nothing. However, main memory is only used while the computer is actually following the instructions in a program. The computer also has another form of memory called *secondary memory* or *secondary storage*. (The words *memory* and *storage* are exact synonyms in this context.) **Secondary memory** is the memory that is used for keeping a permanent record of information after (and before) the computer is used. Some alternative terms that are commonly used to refer to secondary memory are *auxiliary memory*, *auxiliary storage*, *external memory*, and *external storage*.

Information in secondary storage is kept in units called **files**, which can be as large or as small as you like. A program, for example, is stored in a file in secondary storage and copied into main memory when the program is run. You can store a program, a letter, an inventory list, or any other unit of information in a file.

Several different kinds of secondary memory can be attached to a single computer. The most common forms of secondary memory are *hard disks*, *diskettes*, *CDs*, *DVDs*, and *removable flash memory drives*. (**Diskettes** are also sometimes referred to as *floppy disks*.) **CDs** (compact discs) used on computers are basically the same as those used to record and play music, while **DVDs** (digital video discs) are the same as those used to play videos. CDs and DVDs for computers can be read-only so that your computer can read, but cannot change, the data on the disc; CDs and DVDs for computers can also be read/write, which can have their data changed by the computer. **Hard disks** are fixed in place and are normally not removed from the disk drive. Diskettes and CDs can be easily removed from the disk drive and carried to another computer. Diskettes and CDs have the advantages of being inexpensive and portable, but hard disks hold more data and operate faster. **Flash drives** have largely replaced diskettes today and store data using a type of memory called flash memory. Unlike main memory, flash memory does not require power to maintain the information stored on the device. Other forms of secondary memory are also available, but this list covers most forms that you are likely to encounter.

Main memory is often referred to as **RAM** or **random access memory**. It is called *random access* because the computer can immediately access the data in any memory location. Secondary memory often requires **sequential access**, which means that the computer must look through all (or at least very many) memory locations until it finds the item it needs.

The **processor** (also known as the **central processing unit**, or **CPU**) is the “brain” of the computer. When a computer is advertised, the computer company tells you what *chip* it contains. The **chip** is the processor. The processor follows the instructions in a program and performs the calculations specified by the program. The processor is, however, a very simple brain. All it can do is follow a set of simple instructions provided by the programmer. Typical processor instructions say things like “Interpret the 0s and 1s as numbers, and then add the number in memory location 37 to the number in memory location 59, and

put the answer in location 43,” or “Read a letter of input, convert it to its code as a string of 0s and 1s, and place it in memory location 1298.” The processor can add, subtract, multiply, and divide and can move things from one memory location to another. It can interpret strings of 0s and 1s as letters and send the letters to an output device. The processor also has some primitive ability to rearrange the order of instructions. Processor instructions vary somewhat from one computer to another. The processor of a modern computer can have as many as several hundred available instructions. However, these instructions are typically all about as simple as those we have just described.

Software

You do not normally talk directly to the computer, but communicate with it through an *operating system*. The **operating system** allocates the computer’s resources to the different tasks that the computer must accomplish. The operating system is actually a program, but it is perhaps better to think of it as your chief servant. It is in charge of all your other servant programs, and it delivers your requests to them. If you want to run a program, you tell the operating system the name of the file that contains it, and the operating system runs the program. If you want to edit a file, you tell the operating system the name of the file and it starts up the editor to work on that file. To most users, the operating system is the computer. Most users never see the computer without its operating system. The names of some common operating systems are *UNIX*, *DOS*, *Linux*, *Windows*, *Mac OS*, *iOS*, and *Android*.

A **program** is a set of instructions for a computer to follow. As shown in Display 1.3, the input to a computer can be thought of as consisting of two parts, a program and some data. The computer follows the instructions in the program and in that way performs some process. The **data** is what we conceptualize as the input to the program. For example, if the program adds two numbers, then the two numbers are the data. In other words, the data is the input to the program, and both the program and the data are input to the computer (usually via the operating system). Whenever we give a computer

DISPLAY 1.3 Simple View of Running a Program

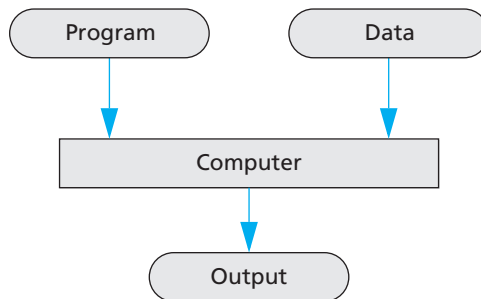

both a program to follow and some data for the program, we are said to be **running the program** on the data, and the computer is said to **execute the program** on the data. The word *data* also has a much more general meaning than the one we have just given it. In its most general sense, it means any information available to the computer. The word is commonly used in both the narrow sense and the more general sense.

High-Level Languages

There are many languages for writing programs. In this text we will discuss the C++ programming language and use it to write our programs. C++ is a high-level language, as are most of the other programming languages you are likely to have heard of, such as C, C#, Java, Python, PHP, Pascal, Visual Basic, FORTRAN, COBOL, Lisp, Scheme, and Ada. **High-level languages** resemble human languages in many ways. They are designed to be easy for human beings to write programs in and to be easy for human beings to read. A high-level language, such as C++, contains instructions that are much more complicated than the simple instructions a computer's processor (CPU) is capable of following.

The kind of language a computer can understand is called a **low-level language**. The exact details of low-level languages differ from one kind of computer to another. A typical low-level instruction might be the following:

```
ADD X Y Z
```

This instruction might mean "Add the number in the memory location called X to the number in the memory location called Y, and place the result in the memory location called Z." The above sample instruction is written in what is called **assembly language**. Although assembly language is almost the same as the language understood by the computer, it must undergo one simple translation before the computer can understand it. In order to get a computer to follow an assembly language instruction, the words need to be translated into strings of 0s and 1s. For example, the word ADD might translate to 0110, the X might translate to 1001, the Y to 1010, and the Z to 1011. The version of the instruction above that the computer ultimately follows would then be:

```
0110 1001 1010 1011
```

Assembly language instructions and their translation into 0s and 1s differ from machine to machine.

Programs written in the form of 0s and 1s are said to be written in **machine language**, because that is the version of the program that the computer (the machine) actually reads and follows. Assembly language and machine language are almost the same thing, and the distinction between them will not be important to us. The important distinction is that between

machine language and high-level languages like C++: Any high-level language program must be translated into machine language before the computer can understand and follow the program.

Compilers

A program that translates a high-level language like C++ to a machine language is called a **compiler**. A compiler is thus a somewhat peculiar sort of program, in that its input or data is some other program, and its output is yet another program. To avoid confusion, the input program is usually called the **source program** or **source code**, and the translated version produced by the compiler is called the **object program** or **object code**. The word **code** is frequently used to mean a program or a part of a program, and this usage is particularly common when referring to object programs. Now, suppose you want to run a C++ program that you have written. In order to get the computer to follow your C++ instructions, proceed as follows. First, run the compiler using your C++ program as data. Notice that in this case, your C++ program is not being treated as a set of instructions. To the compiler, your C++ program is just a long string of characters. The output will be another long string of characters, which is the machine-language equivalent of your C++ program. Next, run this machine-language program on what we normally think of as the data for the C++ program. The output will be what we normally conceptualize as the output of the C++ program. The basic process is easier to visualize if you have two computers available, as diagrammed in Display 1.4. In reality, the entire process is accomplished by using one computer two times.

Compiler

A **compiler** is a program that translates a high-level language program, such as a C++ program, into a machine-language program that the computer can directly understand and execute.

The complete process of translating and running a C++ program is a bit more complicated than what we show in Display 1.4. Any C++ program you write will use some operations (such as input and output routines) that have already been programmed for you. These items that are already programmed for you (like input and output routines) are already compiled and have their object code waiting to be combined with your program's object code to produce a complete machine-language program that can be run on the computer. Another program, called a **linker**, combines the object code for these program pieces with the object code that the compiler produced

from your C++ program. The interaction of the compiler and the linker are diagrammed in Display 1.5. In routine cases, many systems will do this linking for you automatically. Thus, you may not need to worry about linking in many cases.

Linking

The object code for your C++ program must be combined with the object code for routines (such as input and output routines) that your program uses. This process of combining object code is called **linking** and is done by a program called a **linker**. For simple programs, linking may be done for you automatically.

DISPLAY 1.4 Compiling and Running a C++ Program (Basic Outline)

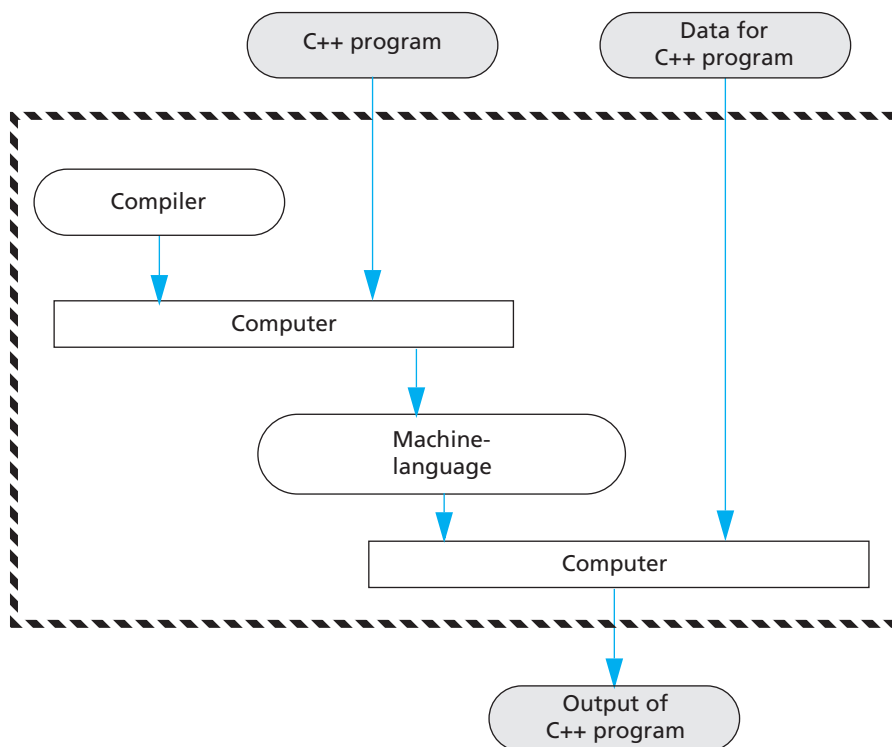

DISPLAY 1.5 Preparing a C++ Program for Running

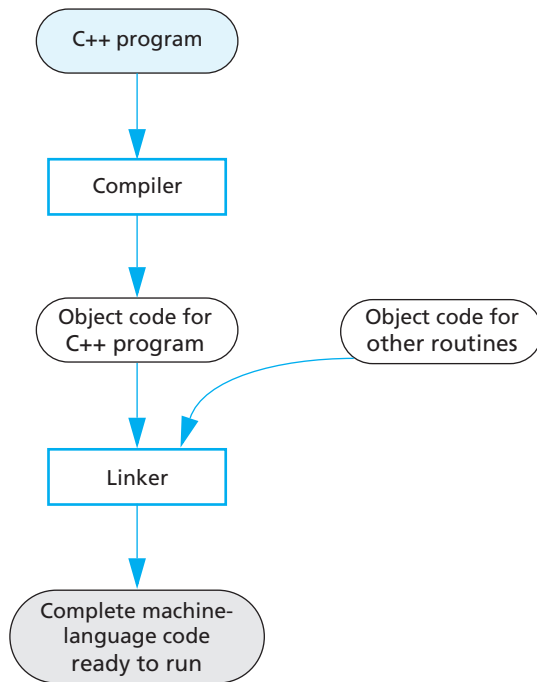
**SELF-TEST EXERCISES**

1. What are the five main components of a computer?
2. What would be the data for a program to add two numbers?
3. What would be the data for a program that assigns letter grades to students in a class?
4. What is the difference between a machine-language program and a high-level language program?
5. What is the role of a compiler?
6. What is a source program? What is an object program?
7. What is an operating system?
8. What purpose does the operating system serve?

9. Name the operating system that runs on the computer you use to prepare programs for this course.
10. What is linking?
11. Find out whether linking is done automatically by the compiler you use for this course.

1.2 PROGRAMMING AND PROBLEM-SOLVING

The Analytical Engine has no pretensions whatever to originate anything. It can do whatever we know how to order it to perform. It can follow analysis; but it has no power of anticipating any analytical relations or truths. Its province is to assist us in making available what we are already acquainted with.

ADA AUGUSTA, *Countess of Lovelace* (1815–1852)

HISTORY NOTE Charles Babbage, Ada Augusta

The first truly programmable computer was designed by **Charles Babbage**, an English mathematician and physical scientist. Babbage began the project sometime before 1822 and worked on it for the rest of his life. Although he never completed the construction of his machine, the design was a conceptual milestone in the history of computing. Much of what we know about Charles Babbage and his computer design comes from the writings of his colleague **Ada Augusta**, the Countess of Lovelace and the daughter of the poet Byron. Ada Augusta is frequently given the title of the first computer programmer. Her comments, quoted in the opening of this section, still apply to the process of solving problems on a computer. Computers are not magic and do not, at least as yet, have the ability to formulate sophisticated solutions to all the problems we encounter. Computers simply do what the programmer orders them to do. The solutions to problems are carried out by the computer, but the solutions are formulated by the programmer. Our discussion of computer programming begins with a discussion of how a programmer formulates these solutions.

In this section we describe some general principles that you can use to design and write programs. These principles are not particular to C++. They apply no matter what programming language you are using.

Algorithms

When learning your first programming language, it is easy to get the impression that the hard part of solving a problem on a computer is translating your ideas into the specific language that will be fed into the computer. This definitely is not the case. The most difficult part of solving a problem on a computer is discovering the method of solution. After you come up with a method of solution, it is routine to translate your method into the required language, be it C++ or some other programming language. It is therefore helpful to temporarily ignore the programming language and to concentrate instead on formulating the steps of the solution and writing them down in plain English, as if the instructions were to be given to a human being rather than a computer. A sequence of instructions expressed in this way is frequently referred to as an *algorithm*.

A sequence of precise instructions which leads to a solution is called an **algorithm**. Some approximately equivalent words are *recipe*, *method*,



▲ Ada Augusta,
Countess of Lovelace and
the first computer programmer



▲ Charles Babbage

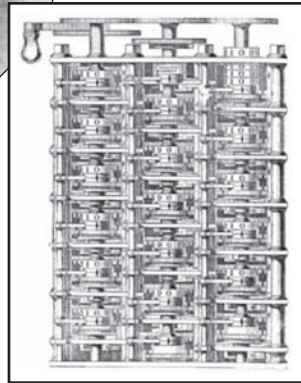

◀ A model of
Babbage's
computer

directions, procedure, and routine. The instructions may be expressed in a programming language or a human language. Our algorithms will be expressed in English and in the programming language C++. A computer program is simply an algorithm expressed in a language that a computer can understand. Thus, the term *algorithm* is more general than the term *program*. However, when we say that a sequence of instructions is an algorithm, we usually mean that the instructions are expressed in English, since if they were expressed in a programming language we would use the more specific term *program*. An example may help to clarify the concept.

Display 1.6 contains an algorithm expressed in English. The algorithm determines the number of times a specified name occurs on a list of names. If the list contains the winners of each of last season's football games and the name is that of your favorite team, then the algorithm determines how many games your team won. The algorithm is short and simple but is otherwise very typical of the algorithms with which we will be dealing.

DISPLAY 1.6 An Algorithm

Algorithm that determines how many times a name occurs in a list of names:

1. Get the list of names.
 2. Get the name being checked.
 3. Set a counter to zero.
 4. Do the following for each name on the list:
Compare the name on the list to the name being checked,
and if the names are the same, then add one to the counter.
 5. Announce that the answer is the number indicated by the counter.
-

The instructions numbered 1 through 5 in our sample algorithm are meant to be carried out in the order they are listed. Unless otherwise specified, we will always assume that the instructions of an algorithm are carried out in the order in which they are given (written down). Most interesting algorithms do, however, specify some change of order, usually a repeating of some instruction again and again such as in instruction 4 of our sample algorithm.

The word *algorithm* has a long history. It derives from the name al-Khwarizmi, a ninth-century Persian mathematician and astronomer. He wrote a famous textbook on the manipulation of numbers and equations. The book was entitled *Kitab al-jabr w'almuqabala*, which can be translated as *Rules for Reuniting and Reducing*. The similar-sounding word *algebra* was derived from the Arabic word *al-jabr*, which appears in the title of the book and which is often translated as *reuniting* or *restoring*. The meanings of the words *algebra* and *algorithm* used to be much more intimately related than they are today. Indeed, until modern times, the word *algorithm* usually referred only to algebraic rules for solving numerical equations. Today, the word *algorithm* can be applied to a wide variety of kinds of instructions for manipulating symbolic as well as numeric data. The properties that qualify a set of instructions as an algorithm now are determined by the nature of the instructions rather than by the things manipulated by the instructions. To qualify as an algorithm, a set of instructions must completely and unambiguously specify the steps to be taken and the order in which they are taken. The person or machine carrying out the algorithm does exactly what the algorithm says, neither more nor less.

Algorithm

An **algorithm** is a sequence of precise instructions that leads to a solution.

Program Design

Designing a program is often a difficult task. There is no complete set of rules, no algorithm to tell you how to write programs. Program design is a creative process. Still, there is the outline of a plan to follow. The outline is given in diagrammatic form in Display 1.7. As indicated there, the entire program design process can be divided into two phases, the *problem-solving phase* and the *implementation phase*. The result of the **problem-solving phase** is an algorithm, expressed in English, for solving the problem. To produce a program in a programming language such as C++, the algorithm is translated into the programming language. Producing the final program from the algorithm is called the **implementation phase**.

The first step is to be certain that the task—what you want your program to do—is completely and precisely specified. Do not take this step lightly. If you do not know exactly what you want as the output of your program, you may be surprised at what your program produces. Be certain that you know what the input to the program will be and exactly what information is supposed to be in the output, as well as what form that information should be in. For example, if the program is a bank accounting program, you must know not only the interest rate but also whether interest is to be compounded annually, monthly, daily, or whatever. If the program is supposed to write poetry, you need to determine whether the poems can be in free verse or must be in iambic pentameter or some other meter.

Many novice programmers do not understand the need to design an algorithm before writing a program in a programming language, such as C++, and so they try to short-circuit the process by omitting the problem-solving phase entirely, or by reducing it to just the problem-definition part. This seems reasonable. Why not “go for the mark” and save time? The answer is that *it does not save time!* Experience has shown that the two-phase process will produce a correctly working program faster. The two-phase process simplifies the algorithm design phase by isolating it from the detailed rules of a programming language such as C++. The result is that the algorithm design process becomes much less intricate and much less prone to error. For even a modest-size program, it can represent the difference between a half day of careful work and several frustrating days of looking for mistakes in a poorly understood program.

The implementation phase is not a trivial step. There are details to be concerned about, and occasionally some of these details can be subtle, but it is much simpler than you might at first think. Once you become familiar with C++ or any other programming language, the translation of an algorithm from English into the programming language becomes a routine task.

As indicated in Display 1.7, testing takes place in both phases. Before the program is written, the algorithm is tested, and if the algorithm is found to be deficient, then the algorithm is redesigned. That desktop testing is performed by mentally going through the algorithm and executing the steps yourself.

DISPLAY 1.7 Program Design Process

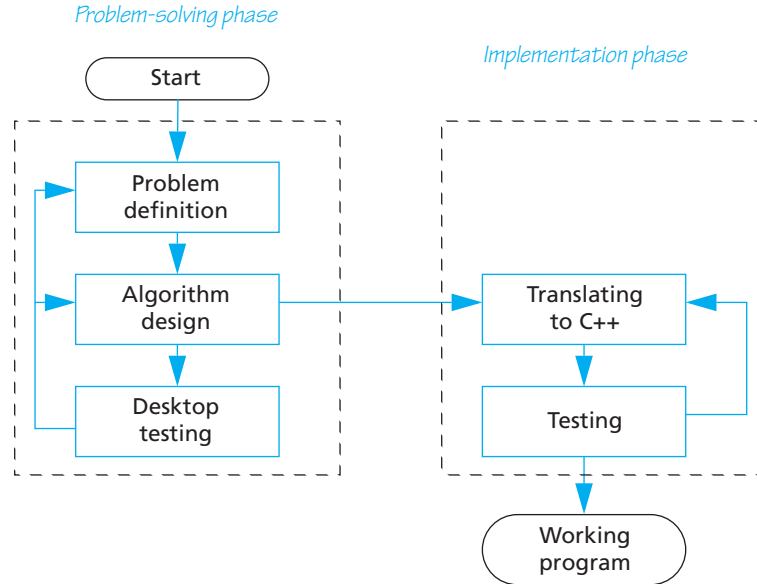

For large algorithms this will require a pencil and paper. The C++ program is tested by compiling it and running it on some sample input data. The compiler will give error messages for certain kinds of errors. To find other types of errors, you must somehow check to see whether the output is correct.

The process diagrammed in Display 1.7 is an idealized picture of the program design process. It is the basic picture you should have in mind, but reality is sometimes more complicated. In reality, mistakes and deficiencies are discovered at unexpected times, and you may have to back up and redo an earlier step. For example, as shown in Display 1.7, testing the algorithm might reveal that the definition of the problem was incomplete. In such a case you must back up and reformulate the definition. Occasionally, deficiencies in the definition or algorithm may not be observed until a program is tested. In that case you must back up and modify the problem definition or algorithm and all that follows them in the design process.

Object-Oriented Programming

The program design process that we outlined in the previous section represents a program as an algorithm (set of instructions) for manipulating some data. That is a correct view, but not always the most productive view. Modern programs are usually designed using a method known as *object-oriented programming*, or **OOP**. In OOP, a program is viewed as a collection

of interacting objects. The methodology is easiest to understand when the program is a simulation program. For example, for a program to simulate a highway interchange, the objects might represent the automobiles and the lanes of the highway. Each object has algorithms that describe how it should behave in different situations. Programming in the OOP style consists of designing the objects and the algorithms they use. When programming in the OOP framework, the term *Algorithm design* in Display 1.7 would be replaced with the phrase *Designing the objects and their algorithms*.

The main characteristics of OOP are *encapsulation*, *inheritance*, and *polymorphism*. Encapsulation is usually described as a form of information hiding or abstraction. That description is correct, but perhaps an easier-to-understand characterization is to say that encapsulation is a form of simplification of the descriptions of objects. Inheritance has to do with writing reusable program code. Polymorphism refers to a way that a single name can have multiple meanings in the context of inheritance. Having made those statements, we must admit that they hold little meaning for readers who have not heard of OOP before. However, we will describe all these terms in detail later in this book. C++ accommodates OOP by providing **classes**, a kind of data type combining both data and algorithms.

The Software Life Cycle

Designers of large software systems, such as compilers and operating systems, divide the software development process into six phases collectively known as the **software life cycle**. The six phases of this life cycle are:

1. Analysis and specification of the task (problem definition)
2. Design of the software (object and algorithm design)
3. Implementation (coding)
4. Testing
5. Maintenance and evolution of the system
6. Obsolescence

We did not mention the last two phases in our discussion of program design because they take place after the program is finished and put into service. However, they should always be kept in mind. You will not be able to add improvements or corrections to your program unless you design it to be easy to read and easy to change. Designing programs so that they can be easily modified is an important topic that we will discuss in detail when we have developed a bit more background and a few more programming techniques. The meaning of obsolescence is obvious, but it is not always easy to accept. When a program is not working as it should and cannot be fixed with a reasonable amount of effort, it should be discarded and replaced with a completely new program.

SELF-TEST EXERCISES

12. An algorithm is approximately the same thing as a recipe, but some kinds of steps that would be allowed in a recipe are not allowed in an algorithm. Which steps in the following recipe would be allowed in an algorithm?

Place 2 teaspoons of sugar in mixing bowl.
Add 1 egg to mixing bowl.
Add 1 cup of milk to mixing bowl.
Add 1 ounce of rum, if you are not driving.
Add vanilla extract to taste.
Beat until smooth.
Pour into a pretty glass.
Sprinkle with nutmeg.

13. What is the first step you should take when creating a program?
14. The program design process can be divided into two main phases. What are they?
15. Explain why the problem-solving phase should not be slighted.

1.3 INTRODUCTION TO C++

Language is the only instrument of science . . .

SAMUEL JOHNSON (1709–1784)

In this section we introduce you to the C++ programming language, which is the programming language used in this book.

Origins of the C++ Language

The first thing that people notice about the C++ language is its unusual name. Is there a C programming language, you might ask? Is there a C- or a C- - language? Are there programming languages named A and B? The answer to most of these questions is no. But the general thrust of the questions is on the mark. There is a B programming language; it was not derived from a language called A, but from a language called BCPL. The C language was derived from the B language, and C++ was derived from the C language. Why are there two pluses in the name C++? As you will see in the next chapter, ++ is an operation in the C and C++ languages, so using ++ produces a nice pun. The languages BCPL and B do not concern us. They are earlier versions of the C programming language. We will start our description of the C++ programming language with a description of the C language.

The C programming language was developed by Dennis Ritchie of AT&T Bell Laboratories in the 1970s. It was first used for writing and maintaining the

UNIX operating system. (Up until that time UNIX systems programs were written either in assembly language or in B, a language developed by Ken Thompson, who is the originator of UNIX.) C is a general-purpose language that can be used for writing any sort of program, but its success and popularity are closely tied to the UNIX operating system. If you wanted to maintain your UNIX system, you needed to use C. C and UNIX fit together so well that soon not just systems programs, but almost all commercial programs that ran under UNIX were written in the C language. C became so popular that versions of the language were written for other popular operating systems; its use is not limited to computers that use UNIX. However, despite its popularity, C is not without its shortcomings.

The C language is peculiar because it is a high-level language with many of the features of a low-level language. C is somewhere in between the two extremes of a very high level language and a low-level language, and therein lies both its strengths and its weaknesses. Like (low-level) assembly language, C language programs can directly manipulate the computer's memory. On the other hand, C has many features of a high-level language, which makes it easier to read and write than assembly language. This makes C an excellent choice for writing systems programs, but for other programs (and in some sense even for systems programs), C is not as easy to understand as other languages; also, it does not have as many automatic checks as some other high-level languages.

To overcome these and other shortcomings of C, Bjarne Stroustrup of AT&T Bell Laboratories developed C++ in the early 1980s. Stroustrup designed C++ to be a better C. Most of C is a subset of C++, and so most C programs are also C++ programs. (The reverse is not true; many C++ programs are definitely not C programs.) Unlike C, C++ has facilities to do *object-oriented programming*, which is a very powerful programming technique described earlier in this chapter. The C++ language continues to evolve. Major new features were added in 2011. This version is referred to as C++11. Minor features are expected in 2014 and major features again in 2017.

A Sample C++ Program

Display 1.8 contains a simple C++ program and the screen display that might be generated when a *user* runs and interacts with this program. The person who runs a program is called the **user**. The output when the program is run is shown in the Sample Dialogue. The text typed in by the user is shown in color to distinguish it from the text output by the program. On the actual screen both texts would look alike. The source code for the program is shown in lines 1–22. The line numbers are shown only for reference. You would not type in the line numbers when entering the program. Keywords with a predefined meaning in C++ are shown in color. These keywords are discussed in Chapter 2. The person who writes the program is called the **programmer**. Do not confuse the roles of the user and the programmer. The user and the programmer might or might not be the same person. For example, if you write and then run a program, you are both the programmer and the user. With professionally produced programs, the programmer (or programmers) and the user are usually different persons.

DISPLAY 1.8 A Sample C++ Program

```
1  #include <iostream>
2  using namespace std;
3  int main( )
4  {
5      int number_of_pods, peas_per_pod, total_peas;
6      cout << "Press return after entering a number.\n";
7      cout << "Enter the number of pods:\n";
8      cin >> number_of_pods;
9      cout << "Enter the number of peas in a pod:\n";
10     cin >> peas_per_pod;
11     total_peas = number_of_pods * peas_per_pod;
12     cout << "If you have ";
13     cout << number_of_pods;
14     cout << " pea pods\n";
15     cout << "and ";
16     cout << peas_per_pod;
17     cout << " peas in each pod, then\n";
18     cout << "you have ";
19     cout << total_peas;
20     cout << " peas in all the pods.\n";
21     return 0;
22 }
```

Sample Dialogue

```
Press return after entering a number.
Enter the number of pods:
10
Enter the number of peas in a pod:
9
If you have 10 pea pods
and 9 peas in each pod, then
you have 90 peas in all the pods.
```

In the next chapter we will explain in detail all the C++ features you need to write programs like the one in Display 1.8, but to give you a feel for how a C++ program works, we will now provide a brief description of how this particular program works. If some of the details are a bit unclear, do not worry. In this section we just want to give you a feel for what a C++ program is.

The beginning and end of our sample program contain some details that need not concern us yet. The program begins with the following lines:

```
#include <iostream>
using namespace std;
int main()
{
```

For now we will consider these lines to be a rather complicated way of saying “The program starts here.”

The program ends with the following two lines:

```
    return 0;
}
```

For a simple program, these two lines simply mean “The program ends here.”

The lines in between these beginning and ending lines are the heart of the program. We will briefly describe these lines, starting with the following line:

```
int number_of_pods, peas_per_pod, total_peas;
```

This line is called a **variable declaration**. This variable declaration tells the computer that `number_of_pods`, `peas_per_pod`, and `total_peas` will be used as names for three *variables*. Variables will be explained more precisely in the next chapter, but it is easy to understand how they are used in this program. In this program the **variables** are used to name numbers. The word that starts this line, `int`, is an abbreviation for the word *integer* and it tells the computer that the numbers named by these variables will be integers. An **integer** is a whole number, like 1, 2, -1, -7, 0, 205, -103, and so forth.

The remaining lines are all instructions that tell the computer to do something. These instructions are called **statements** or **executable statements**. In this program each statement fits on exactly one line. That need not be true, but for very simple programs, statements are usually listed one per line.

Most of the statements begin with either the word `cin` or `cout`. These statements are input statements and output statements. The word `cin`, which is pronounced “see-in,” is used for input. The statements that begin with `cin` tell the computer what to do when information is entered from the keyboard. The word `cout`, which is pronounced “see-out,” is used for output, that is, for sending information from the program to the terminal screen. The letter `c` is there because the language is C++. The arrows, written `<<` or `>>`, tell you the direction that data is moving. The arrows, `<<` and `>>`, are called ‘insert’ and ‘extract,’ or ‘put to’ and ‘get from,’ respectively. For example, consider the line:

```
cout << "Press return after entering a number.\n";
```

This line may be read, ‘put “Press...number.\n” to `cout`’ or simply ‘output “Press...number.\n”’. If you think of the word `cout` as a name for the screen (the output device), then the arrows tell the computer to send the string in quotes to the screen. As shown in the sample dialogue, this causes

the text contained in the quotes to be written to the screen. The `\n` at the end of the quoted string tells the computer to start a new line after writing out the text. Similarly, the next line of the program also begins with `cout`, and that program line causes the following line of text to be written to the screen:

```
Enter the number of pods:
```

The next program line starts with the word `cin`, so it is an input statement. Let's look at that line:

```
cin >> number_of_pods;
```

This line may be read, 'get `number_of_pods` from `cin`' or simply 'input `number_of_pods`'.

If you think of the word `cin` as standing for the keyboard (the input device), then the arrows say that input should be sent from the keyboard to the variable `number_of_pods`. Look again at the sample dialogue. The next line shown has a `10` written in bold. We use bold to indicate something typed in at the keyboard. If you type in the number `10`, then the `10` appears on the screen. If you then press the Return key (which is also sometimes called the *Enter key*), that makes the `10` available to the program. The statement which begins with `cin` tells the computer to send that input value of `10` to the variable `number_of_pods`. From that point on, `number_of_pods` has the value `10`; when we see `number_of_pods` later in the program, we can think of it as standing for the number `10`.

Consider the next two program lines:

```
cout << "Enter the number of peas in a pod:\n";  
cin >> peas_per_pod;
```

These lines are similar to the previous two lines. The first sends a message to the screen asking for a number. When you type in a number at the keyboard and press the Return key, that number becomes the value of the variable `peas_per_pod`. In the sample dialogue, we assume that you type in the number `9`. After you type in `9` and press the Return key, the value of the variable `peas_per_pod` becomes `9`.

The next nonblank program line, shown below, does all the computation that is done in this simple program:

```
total_peas = number_of_pods * peas_per_pod;
```

The asterisk symbol, `*`, is used for multiplication in C++. So this statement says to multiply `number_of_pods` and `peas_per_pod`. In this case, `10` is multiplied by `9` to give a result of `90`. The equal sign says that the variable `total_peas` should be made equal to this result of `90`. This is a special use of the equal sign; its meaning here is different than in other mathematical contexts. It gives the variable on the left-hand side a (possibly new) value; in this case it makes `90` the value of `total_peas`.

The rest of the program is basically more of the same sort of output. Consider the next three nonblank lines:

```
cout << "If you have ";  
cout << number_of_pods;  
cout << " pea pods\n";
```

These are just three more output statements that work basically the same as the previous statements that begin with `cout`. The only thing that is new is the second of these three statements, which says to output the variable `number_of_pods`. When a variable is output, it is the value of the variable that is output. So this statement causes a 10 to be output. (Remember that in this sample run of the program, the variable `number_of_pods` was set to 10 by the user who ran the program.) Thus, the output produced by these three lines is:

```
If you have 10 pea pods
```

Notice that the output is all on one line. A new line is not begun until the special instruction `\n` is sent as output.

The rest of the program contains nothing new, and if you understand what we have discussed so far, you should be able to understand the rest of the program.

PITFALL Using the Wrong Slash in `\n`

When you use a `\n` in a `cout` statement be sure that you use the **backslash**, which is written `\`. If you make a mistake and use `/n` rather than `\n`, the compiler will not give you an error message. Your program will run, but the output will look peculiar. ■

■ **PROGRAMMING TIP** Input and Output Syntax

If you think of `cin` as a name for the keyboard or **input** device and think of `cout` as a name for the screen or the **output** device, then it is easy to remember the direction of the arrows `>>` and `<<`. They point in the direction that data moves. For example, consider the statement:

```
cin >> number_of_pods;
```

In the above statement, data moves from the keyboard to the variable `number_of_pods`, and so the arrow points from `cin` to the variable.

On the other hand, consider the output statement:

```
cout << number_of_pods;
```

In this statement the data moves from the variable `number_of_pods` to the screen, so the arrow points from the variable `number_of_pods` to `cout`. ■

Layout of a Simple C++ Program

The general form of a simple C++ program is shown in Display 1.9. As far as the compiler is concerned, the **line breaks** and **spacing** need not be as shown there and in our examples. The compiler will accept any reasonable pattern of line breaks and indentation. In fact, the compiler will even accept most unreasonable patterns of line breaks and indentation. However, a program should always be laid out so that it is easy to read. Placing the opening brace, {, on a line by itself and also placing the closing brace, }, on a line by itself will make these punctuations easy to find. Indenting each statement and placing each statement on a separate line makes it easy to see what the program instructions are. Later on, some of our statements will be too long to fit on one line and then we will use a slight variant of this pattern for indenting and line breaks. You should follow the pattern set by the examples in this book, or follow the pattern specified by your instructor if you are in a class.

In Display 1.8, the variable declarations are on the line that begins with the word `int`. As we will see in the next chapter, you need not place all your variable declarations at the beginning of your program, but that is a good default location for them. Unless you have a reason to place them somewhere else, place them at the start of your program as shown in Display 1.9 and in the sample program in Display 1.8. The **statements** are the instructions that are followed by the computer. In Display 1.8, the statements are the lines that begin with `cout` or `cin` and the one line that begins with `total_peas` followed by an equal sign. Statements are often called **executable statements**. We will use the terms *statement* and *executable statement* interchangeably. Notice that each of the statements we have seen ends with a semicolon. The semicolon in statements is used in more or less the same way that the period is used in English sentences; it marks the end of a statement.

DISPLAY 1.9 Layout of a Simple C++ Program

```
1  #include <iostream>
2  using namespace std;
3
4  int main()
5  {
6      Variable_Declarations
7
8      Statement_1
9      Statement_2
10     ...
11     Statement_Last
12
13     return 0;
14 }
```

For now you can view the first few lines as a funny way to say “this is the beginning of the program.” But we can explain them in a bit more detail. The first line

```
#include <iostream>
```

is called an **include directive**. It tells the compiler where to find information about certain items that are used in your program. In this case `iostream` is the name of a library that contains the definitions of the routines that handle input from the keyboard and output to the screen; `iostream` is a file that contains some basic information about this library. The linker program that we discussed earlier in this chapter combines the object code for the library `iostream` and the object code for the program you write. For the library `iostream` this will probably happen automatically on your system. You will eventually use other libraries as well, and when you use them, they will have to be named in directives at the start of your program. For other libraries, you may need to do more than just place an `include` directive in your program, but in order to use any library in your program, you will always need to at least place an `include` directive for that library in your program. Directives always begin with the symbol `#`. Some compilers require that directives have no spaces around the `#`, so it is always safest to place the `#` at the very start of the line and not include any space between the `#` and the word `include`.

The following line further explains the `include` directive that we just explained:

```
using namespace std;
```

This line says that the names defined in `iostream` are to be interpreted in the “standard way” (`std` is an abbreviation of *standard*). We will have more to say about this line a bit later in this book.

The third and fourth nonblank lines, shown next, simply say that the main part of the program starts here:

```
int main()  
{
```

The correct term is *main function*, rather than *main part*, but the reason for that subtlety will not concern us until Chapter 4. The braces `{` and `}` mark the beginning and end of the main part of the program. They need not be on a line by themselves, but that is the way to make them easy to find and we will therefore always place each of them on a line by itself.

The next-to-last line

```
return 0;
```

says to “end the program when you get to here.” This line need not be the last thing in the program, but in a very simple program it makes no sense to place it anywhere else. Some compilers will allow you to omit this line and will figure out that the program ends when there are no more statements to

execute. However, other compilers will insist that you include this line, so it is best to get in the habit of including it, even if your compiler is happy without it. This line is called a **return statement** and is considered to be an executable statement because it tells the computer to do something; specifically, it tells the computer to end the program. The number 0 has no intuitive significance to us yet, but must be there; its meaning will become clear as you learn more about C++. Note that even though the return statement says to end the program, you still must add a closing brace, `}`, at the end of the main part of your program.

PITFALL [Putting a Space Before the include File Name](#)

Be certain that you do not have any extra space between the `<` and the `iostream` file name (Display 1.9) or between the end of the file name and the closing `>`. The compiler `include` directive is not very smart: It will search for a file name that starts or ends with a space! The file name will not be found, producing an error that is quite difficult to locate. You should make this error deliberately in a small program, then compile it. Save the message that your compiler produces so you know what the error message means the next time you get that error message. ■



VideoNote
Compiling and Running
a C++ Program

Compiling and Running a C++ Program

In the previous section you learned what would happen if you ran the C++ program shown in Display 1.8. But where is that program and how do you make it run?

You write a C++ program using a text editor in the same way that you write any other document—a term paper, a love letter, a shopping list, or whatever. The program is kept in a file just like any other document you prepare using a text editor. There are different text editors, and the details of how to use them will vary from one to another, so we cannot say too much more about your text editor. You should consult the documentation for your editor.

The way that you compile and run a C++ program also depends on the particular system you are using, so we will discuss these points in only a very general way. You need to learn how to give the commands to compile, link, and run a C++ program on your system. These commands can be found in the manuals for your system and by asking people who are already using C++ on your system. When you give the command to compile your program, this will produce a machine-language translation of your C++ program. This translated version is called the *object code* for your program. The object code must be linked (that is, combined) with the object code for routines (such as input and output routines) that are already written for you. It is likely that this linking will be done automatically, so you do not need to worry about linking. But on some systems, you may be required to make a separate call to the linker. Again, consult your manuals or a local expert. Finally, you give the command to run your program; how you give

that command also depends on the system you are using, so check with the manuals or a local expert.

PITFALL [Compiling a C++11 Program](#)

C++11 (formerly known as C++0x) is the most recent version of the standard of the C++ programming language. It was approved on August 12, 2011 by the International Organization for Standardization. A C++11 compiler is able to compile and run programs written for older versions of C++. However, the C++11 version includes new language features that are not compatible with older C++ compilers. This means that if you have an older C++ compiler then you may not be able to compile and run C++11 programs.

You may also need to specify whether or not to compile against the C++11 standard. For example, g++ 4.7 requires the compiler flag of `-std=c++11` to be added to the command line; otherwise the compiler will assume that the C++ program is written to an older standard. The command line to compile a C++11 program named `testing.cpp` would look like:

```
g++ testing.cpp -std=c++11
```

Check the documentation with your compiler to determine if any special steps are needed to compile C++11 programs and to determine what C++11 language features are supported. ■

■ **PROGRAMMING TIP** [Getting Your Program to Run](#)

Different compilers and different environments might require a slight variation in some details of how you set up a file with your C++ program. Obtain a copy of the program in Display 1.10. It is available for downloading over the Internet. (See the Preface for details.) Alternatively, *very carefully* type in the program yourself. Do not type in the line numbers. Compile the program. If you get an error message, check your typing, fix any typing mistakes, and recompile the file. Once the program compiles with no error messages, try running the program.

If you get the program to compile and run normally, you are all set. You do not need to do anything different from the examples shown in the book. If this program does not compile or does not run normally, then read on. In what follows we offer some hints for dealing with your C++ setup. Once you get this simple program to run normally, you will know what small changes to make to your C++ program files in order to get them to run on your system.

If your program seems to run, but you do not see the output line

```
Testing 1, 2, 3
```

then, in all likelihood, the program probably did give that output, but it disappeared before you could see it. Try adding the following to the end of your program, just before the line `return 0;`; these lines should stop your program to allow you to read the output.

DISPLAY 1.10 Testing Your C++ Setup

```

1  #include <iostream>
2  using namespace std;
3
4  int main( )
5  {
6      cout << "Testing 1, 2, 3\n";
7      return 0;
8  }
9

```

If you cannot compile and run this program, then see the programming tip entitled "Getting Your Program to Run." It suggests some things to do to get your C++ programs to run on your particular computer setup.

Sample Dialogue

```
Testing 1, 2, 3
```

```

char letter;
cout << "Enter a letter to end the program:\n";
cin >> letter;

```

The part in braces should then read as follows:

```

cout << "Testing 1, 2, 3\n";
char letter;
cout << "Enter a letter to end the program:\n";
cin >> letter;
return 0;

```

For now you need not understand these added lines, but they will be clear to you by the end of Chapter 2.

If the program does not compile or run at all, then try changing

```
#include <iostream>
```

by adding `.h` to the end of `iostream`, so it reads as follows:

```
#include <iostream.h>
```

If your program requires `iostream.h` instead of `iostream`, then you have an old C++ compiler and should obtain a more recent compiler.

If your program still does not compile and run normally, try deleting

```
using namespace std;
```

If your program still does not compile and run, then check the documentation for your version of C++ to see if any more "directives" are needed for "console" input/output.

If all this fails, consult your instructor if you are in a course. If you are not in a course or you are not using the course computer, check the documentation for your C++ compiler or check with a friend who has a similar computer setup. The necessary change is undoubtedly very small and, once you find out what it is, very easy.

SELF-TEST EXERCISES

16. If the following statement were used in a C++ program, what would it cause to be written on the screen?

```
cout << "C++ is easy to understand.";
```

17. What is the meaning of `\n` as used in the following statement (which appears in Display 1.8)?

```
cout << "Enter the number of peas in a pod:\n";
```

18. What is the meaning of the following statement (which appears in Display 1.8)?

```
cin >> peas_per_pod;
```

19. What is the meaning of the following statement (which appears in Display 1.8)?

```
total_peas = number_of_pods * peas_per_pod;
```

20. What is the meaning of this directive?

```
#include <iostream>
```

21. What, if anything, is wrong with the following `#include` directives?

- `#include <iostream >`
- `#include < iostream>`
- `#include <iostream>`

1.4 TESTING AND DEBUGGING

"And if you take one from three hundred and sixty-five, what remains?"

"Three hundred and sixty-four, of course."

Humpty Dumpty looked doubtful. "I'd rather see that done on paper," he said.

LEWIS CARROLL, *Through the Looking-Glass*

A mistake in a program is usually called a **bug**, and the process of eliminating bugs is called **debugging**. There is colorful history of how this term came into use. It occurred in the early days of computers, when computer hardware was

extremely sensitive and occupied an entire room. Rear Admiral Grace Murray Hopper (1906–1992) was “the third programmer on the world’s first large-scale digital computer.” (Denise W. Gurer, “Pioneering women in computer science” *CACM* 38(1):45–54, January 1995.) While Hopper was working on the Harvard Mark I computer under the command of Harvard professor Howard H. Aiken, an unfortunate moth caused a relay to fail. Hopper and the other programmers taped the deceased moth in the logbook with the note “First actual case of bug being found.” The logbook is currently on display at the Naval Museum in Dahlgren, Virginia. This was the first documented computer bug. Professor Aiken would come into the facility during a slack time and inquire if any numbers were being computed. The programmers would reply that they were debugging the computer. For more information about Admiral Hopper and other persons in computing, see Robert Slater, *Portraits in Silicon* (MIT Press, 1987). Today, a bug is a mistake in a program. In this section we describe the three main kinds of programming mistakes and give some hints on how to correct them.

Kinds of Program Errors

The compiler will catch certain kinds of mistakes and will write out an error message when it finds a mistake. It will detect what are called **syntax errors**, because they are, by and large, violation of the syntax (that is, the grammar rules) of the programming language, such as omitting a semicolon.

If the compiler discovers that your program contains a syntax error, it will tell you where the error is likely to be and what kind of error it is likely to be. When the compiler says your program contains a syntax error, you can be confident that it does. However, the compiler may be incorrect about either the location or the nature of the error. It does a better job of determining the location of an error, to within a line or two, than it does of determining the source of the error. This is because the compiler is guessing at what you meant to write down and can easily guess wrong. After all, the compiler cannot read your mind. Error messages subsequent to the first one have a higher likelihood of being incorrect with respect to either the location or the nature of the error. Again, this is because the compiler must guess your meaning. If the compiler’s first guess was incorrect, this will affect its analysis of future mistakes, since the analysis will be based on a false assumption.

If your program contains something that is a direct violation of the syntax rules for your programming language, the compiler will give you an **error message**. However, sometimes the compiler will give you only a **warning message**, which indicates that you have done something that is not, technically speaking, a violation of the programming language syntax rules, but that is unusual enough to indicate a likely mistake. When you get a warning message, the compiler is saying, “Are you sure you mean this?” At this stage of your development, you should treat every warning as if it were an error until your instructor approves ignoring the warning.

There are certain kinds of errors that the computer system can detect only when a program is run. Appropriately enough, these are called **run-time errors**. Most computer systems will detect certain run-time errors and output an appropriate error message. Many run-time errors have to do with numeric calculations. For example, if the computer attempts to divide a number by zero, that is normally a run-time error.

If the compiler approved of your program and the program ran once with no run-time error messages, this does not guarantee that your program is correct. Remember, the compiler will only tell you if you wrote a syntactically (that is, grammatically) correct C++ program. It will not tell you whether the program does what you want it to do. Mistakes in the underlying algorithm or in translating the algorithm into the C++ language are called **logic errors**. For example, if you were to mistakenly use the addition sign + instead of the multiplication sign * in the program in Display 1.8, that would be a logic error. The program would compile and run normally but would give the wrong answer. If the compiler approves of your program and there are no run-time errors but the program does not perform properly, then undoubtedly your program contains a logic error. Logic errors are the hardest kind to diagnose, because the computer gives you no error messages to help find the error. It cannot reasonably be expected to give any error messages. For all the computer knows, you may have meant what you wrote.

PITFALL Assuming Your Program Is Correct

In order to test a new program for logic errors, you should run the program on several representative data sets and check its performance on those inputs. If the program passes those tests, you can have more confidence in it, but this is still not an absolute guarantee that the program is correct. It still may not do what you want it to do when it is run on some other data. The only way to justify confidence in a program is to program carefully and so avoid most errors. ■

SELF-TEST EXERCISES

22. What are the three main kinds of program errors?
23. What kinds of errors are discovered by the compiler?
24. If you omit a punctuation symbol (such as a semicolon) from a program, an error is produced. What kind of error?
25. Omitting the final brace } from a program produces an error. What kind of error?

26. Suppose your program has a situation about which the compiler reports a warning. What should you do about it? Give the text's answer and your local answer if it is different from the text's. Identify your answers as the text's or as based on your local rules.
27. Suppose you write a program that is supposed to compute the interest on a bank account at a bank that computes interest on a daily basis, and suppose you incorrectly write your program so that it computes interest on an annual basis. What kind of program error is this?

CHAPTER SUMMARY

The collection of programs used by a computer is referred to as the **software** for that computer. The actual physical machines that make up a computer installation are referred to as **hardware**.

- The five main components of a computer are the input device(s), the output device(s), the processor (CPU), the main memory, and the secondary memory.
- A computer has two kinds of memory: main memory and secondary memory. Main memory is used only while the program is running. Secondary memory is used to hold data that will stay in the computer before and/or after the program is run.
- A computer's main memory is divided into a series of numbered locations called **bytes**. The number associated with one of these bytes is called the **address** of the byte. Often, several of these bytes are grouped together to form a larger memory location. In that case, the address of the first byte is used as the address of this larger memory location.
- A **byte** consists of eight binary digits, each either zero or one. A digit that can only be zero or one is called a **bit**.
- A **compiler** is a program that translates a program written in a high-level language like C++ into a program written in the machine language that the computer can directly understand and execute.
- A sequence of precise instructions that leads to a solution is called an **algorithm**. Algorithms can be written in English or in a programming language, like C++. However, the word *algorithm* is usually used to mean a sequence of instructions written in English (or some other human language, such as Spanish or Arabic).
- Before writing a C++ program, you should design the algorithm (method of solution) that the program will use.
- Programming errors can be classified into three groups: syntax errors, runtime errors, and logic errors. The computer will usually tell you about errors in the first two categories. You must discover logic errors yourself.

- The individual instructions in a C++ program are called **statements**.
- A variable in a C++ program can be used to name a number. (Variables are explained more fully in the next chapter.)
- A statement in a C++ program that begins with `cout <<` is an output statement, which tells the computer to output to the screen whatever follows the `<<`.
- A statement in a C++ program that begins with `cin >>` is an input statement.

Answers to Self-Test Exercises

1. The five main components of a computer are the input device(s), the output device(s), the processor (CPU), the main memory, and the secondary memory.
2. The two numbers to be added.
3. The grades for each student on each test and each assignment.
4. A machine-language program is a low-level language consisting of 0s and 1s that the computer can directly execute. A high-level language is written in a more English-like format and is translated by a compiler into a machine-language program that the computer can directly understand and execute.
5. A compiler translates a high-level language program into a machine-language program.
6. The high-level language program that is input to a compiler is called the source program. The translated machine-language program that is output by the compiler is called the object program.
7. An operating system is a program, or several cooperating programs, but is best thought of as the user's chief servant.
8. An operating system's purpose is to allocate the computer's resources to different tasks the computer must accomplish.
9. Among the possibilities are the Macintosh operating system Mac OS, Windows, VMS, Solaris, SunOS, UNIX (or perhaps one of the UNIX-like operating systems such as Linux). There are many others.
10. The object code for your C++ program must be combined with the object code for routines (such as input and output routines) that your program uses. This process of combining object code is called linking. For simple programs, this linking may be done for you automatically.

11. The answer varies, depending on the compiler you use. Most UNIX and UNIX-like compilers link automatically, as do the compilers in most integrated development environments for Windows and Macintosh operating systems.
12. The following instructions are too vague for use in an algorithm:

```
Add vanilla extract to taste.  
Beat until smooth.  
Pour into a pretty glass.  
Sprinkle with nutmeg.
```

The notions of “to taste,” “smooth,” and “pretty” are not precise. The instruction “sprinkle” is too vague, since it does not specify how much nutmeg to sprinkle. The other instructions are reasonable to use in an algorithm.
13. The first step you should take when creating a program is to be certain that the task to be accomplished by the program is completely and precisely specified.
14. The problem-solving phase and the implementation phase.
15. Experience has shown that the two-phase process produces a correctly working program faster.
16. C++ is easy to understand.
17. The symbols `\n` tell the computer to start a new line in the output so that the next item output will be on the next line.
18. This statement tells the computer to read the next number that is typed in at the keyboard and to send that number to the variable named `peas_per_pod`.
19. This statement says to multiply the two numbers in the variables `number_of_pods` and `peas_per_pod`, and to place the result in the variable named `total_peas`.
20. The `#include <iostream>` directive tells the compiler to fetch the file `iostream`. This file contains declarations of `cin`, `cout`, the insertion (`<<`) and extraction (`>>`) operators for I/O (input and output). This enables correct linking of the object code from the `iostream` library with the I/O statements in the program.
21.
 - a. The extra space after the `iostream` file name causes a *file-not-found* error message.
 - b. The extra space before the `iostream` file name causes a *file-not-found* error message.
 - c. This one is correct.

22. The three main kinds of program errors are syntax errors, run-time errors, and logic errors.
23. The compiler detects syntax errors. There are other errors that are not technically syntax errors that we are lumping with syntax errors. You will learn about these later.
24. A syntax error.
25. A syntax error.
26. The text states that you should take warnings as if they had been reported as errors. You should ask your instructor for the local rules on how to handle warnings.
27. A logic error.

PRACTICE PROGRAMS

Practice Programs can generally be solved with a short program that directly applies the programming principles presented in this chapter.

1. Using your text editor, enter (that is, type in) the C++ program shown in Display 1.8. Be certain to type the first line exactly as shown in Display 1.8. In particular, be sure that the first line begins at the left-hand end of the line with no space before or after the # symbol. Compile and run the program. If the compiler gives you an error message, correct the program and recompile the program. Do this until the compiler gives no error messages. Then run your program.
2. Modify the C++ program you entered in Practice Program 1. Change the program so that it first writes the word Hello to the screen and then goes on to do the same things that the program in Display 1.8 does. You will only have to add one line to the program to make this happen. Recompile the changed program and run it. Then change the program even more. Add one more line that will make the program write the word Good-bye to the screen at the end of the program. Be certain to add the symbols \n to the last output statement so that it reads as follows:

```
cout << "Good-bye\n";
```

(Some systems require that final \n, and your system may be one of them.) Recompile and run the changed program.
3. Further modify the C++ program that you already modified in Practice Program 2. Change the multiplication sign * in your C++ program to a division sign /. Recompile the changed program. Run the program. Enter a 0 input for "number of peas in a pod." Notice the run-time error message due to division by zero.

4. Modify the C++ program that you entered in Practice Program 1. Change the multiplication sign `*` in your C++ program to an addition sign `+`. Recompile and run the changed program. Notice that the program compiles and runs perfectly fine, but the output is incorrect. That is because this modification is a logic error.
5. Modify the C++ program that you entered in Practice Program 1. In this version calculate the total length of fence you would need to enclose a rectangular area that is `width` feet long and `height` feet tall. The program should have variables for `width` and `height` with values entered by the user. Create another variable, `totalLength`, that stores the total length of fence needed (which your program should calculate). Output the total with an appropriate message.
6. The purpose of this exercise is to produce a catalog of typical syntax errors and error messages that will be encountered by a beginner and to continue acquainting you with the programming environment. This exercise should leave you with a knowledge of what error to look for when given any of a number of common error messages.



VideoNote
Solution to Practice
Program 1.6

Your instructor may have a program for you to use for this exercise. If not, you should use a program from one of the previous Practice Programs.

Deliberately introduce errors to the program, compile, record the error and the error message, fix the error, compile again (to be sure you have the program corrected), then introduce another error. Keep the catalog of errors and add program errors and messages to it as you continue through this course.

The sequence of suggested errors to introduce is:

- a. Put an extra space between the `<` and the `iostream` file name.
- b. Omit one of the `<` or `>` symbols in the include directive.
- c. Omit the `int` from `int main()`.
- d. Omit or misspell the word `main`.
- e. Omit one of the `()`; then omit both the `()`.
- f. Continue in this fashion, deliberately misspelling identifiers (`cout`, `cin`, and so on). Omit one or both of the `<<` in the `cout` statement; leave off the ending curly brace `}`.

PROGRAMMING PROJECTS

Programming Projects require more problem-solving than Practice Programs and can usually be solved many different ways. Visit www.myprogramminglab.com to complete many of these Programming Projects online and get instant feedback.

1. Write a C++ program that reads in two integers and then outputs both their sum and their product. One way to proceed is to start with the program in

Display 1.8 and to then modify that program to produce the program for this project. Be certain to type the first line of your program exactly the same as the first line in Display 1.8. In particular, be sure that the first line begins at the left-hand end of the line with no space before or after the # symbol. Also, be certain to add the symbols `\n` to the last output statement in your program. For example, the last output statement might be the following:

```
cout << "This is the end of the program.\n";
```

(Some systems require that final `\n`, and your system may be one of these.)

- Write a program that prints out "CS!" in large block letters inside a border of *s followed by two blank lines then the message Computer Science is Cool Stuff. The output should look as follows:

```
*****
          C C C          S S S S          !!
         C           C      S           S          !!
        C           C      S           S          !!
       C           C      S           S          !!
      C           C      S S S S          !!
     C           C      S           S          !!
    C           C      S           S          !!
   C           C      S           S          !!
  C C C          S S S S          00
*****
Computer Science is Cool Stuff!!!
```

- Write a program that allows the user to enter a number of quarters, dimes, and nickels and then outputs the monetary value of the coins in cents. For example, if the user enters 2 for the number of quarters, 3 for the number of dimes, and 1 for the number of nickels, then the program should output that the coins are worth 85 cents.
- Write a program that allows the user to enter a time in seconds and then outputs how far an object would drop if it is in freefall for that length of time. Assume that the object starts at rest, there is no friction or resistance from air, and there is a constant acceleration of 32 feet per second due to gravity. Use the equation:

$$\text{distance} = \frac{\text{acceleration} \times \text{time}^2}{2}$$

You should first compute the product and then divide the result by 2 (The reason for this will be discussed later in the book).



VideoNote
Solution to Programming
Project 1.3

5. Write a program that inputs a character from the keyboard and then outputs a large block letter "C" composed of that character. For example, if the user inputs the character "X," then the output should look as follows:

```
  X X X
 X   X
X
X
X
X
X
 X   X
X X X
```

C++ Basics 2

2.1 VARIABLES AND ASSIGNMENTS 40

Variables 40
Names: Identifiers 42
Variable Declarations 44
Assignment Statements 45
Pitfall: Uninitialized Variables 47
Programming Tip: Use Meaningful Names 49

2.2 INPUT AND OUTPUT 50

Output Using `cout` 50
Include Directives and Namespaces 52
Escape Sequences 53
Programming Tip: End Each Program with a `\n`
or `endl` 55
Formatting for Numbers with a Decimal Point 55
Input Using `cin` 56
Designing Input and Output 58
Programming Tip: Line Breaks in I/O 58

2.3 DATA TYPES AND EXPRESSIONS 60

The Types `int` and `double` 60
Other Number Types 62
C++11 Types 63

The Type `char` 64
The Type `bool` 66
Introduction to the Class `string` 66
Type Compatibilities 68
Arithmetic Operators and Expressions 69
Pitfall: Whole Numbers in Division 72
More Assignment Statements 74

2.4 SIMPLE FLOW OF CONTROL 74

A Simple Branching Mechanism 75
Pitfall: Strings of Inequalities 80
Pitfall: Using `=` in place of `==` 81
Compound Statements 82
Simple Loop Mechanisms 84
Increment and Decrement Operators 87
Programming Example: Charge Card Balance 89
Pitfall: Infinite Loops 90

2.5 PROGRAM STYLE 93

Indenting 93
Comments 93
Naming Constants 95



Don't imagine you know what a computer terminal is. A computer terminal is not some clunky old television with a typewriter in front of it. It is an interface where the mind and the body can connect with the universe and move bits of it about.

DOUGLAS ADAMS, *Mostly Harmless* (the fifth volume in *The Hitchhiker's Trilogy*)

INTRODUCTION

In this chapter we explain some additional sample C++ programs and present enough details of the C++ language to allow you to write simple C++ programs.

PREREQUISITES

In Chapter 1 we gave a brief description of one sample C++ program. (If you have not read the description of that program, you may find it helpful to do so before reading this chapter.)

2.1 VARIABLES AND ASSIGNMENTS

Once a person has understood the way variables are used in programming, he has understood the quintessence of programming.

E. W. DIJKSTRA, *Notes on Structured Programming*

Programs manipulate data such as numbers and letters. C++ and most other common programming languages use programming constructs known as *variables* to name and store data. Variables are at the very heart of a programming language like C++, so that is where we start our description of C++. We will use the program in Display 2.1 for our discussion and will explain all the items in that program. While the general idea of that program should be clear, some of the details are new and will require some explanation.

Variables

A C++ variable can hold a number or data of other types. For the moment, we will confine our attention to variables that hold only numbers. These variables are like small blackboards on which the numbers can be written. Just as the numbers written on a blackboard can be changed, so too can the number held by a C++ variable be changed. Unlike a blackboard that might possibly contain no number at all, a C++ variable is guaranteed to have some value in it, if only a garbage number left in the computer's memory by some previously run program. The number or other type of data held in a

variable is called its **value**; that is, the value of a variable is the item written on the figurative blackboard. In the program in Display 2.1, `number_of_bars`, `one_weight`, and `total_weight` are variables. For example, when this program is run with the input shown in the sample dialogue, `number_of_bars` has its value set equal to the number 11 with the statement

```
cin >> number_of_bars;
```

Later, the value of the variable `number_of_bars` is changed to 12 when a second copy of the same statement is executed. We will discuss exactly how this happens a little later in this chapter.

Of course, variables are not blackboards. In programming languages, variables are implemented as memory locations. The compiler assigns a memory location (of the kind discussed in Chapter 1) to each variable name in the program. The value of the variable, in a coded form consisting of 0s and 1s, is kept in the memory location assigned to that variable. For example, the three variables in the program shown in Display 2.1 might be assigned the memory locations with addresses 1001, 1003, and 1007. The exact numbers will depend on your computer, your compiler, and a number of other factors. We do not know, or even care, what addresses the compiler will choose for the variables in our program. We can think as though the memory locations were actually labeled with the variable names.

DISPLAY 2.1 A C++ Program (part 1 of 2)

```
1  #include <iostream>
2  using namespace std;
3  int main( )
4  {
5      int number_of_bars;
6      double one_weight, total_weight;
7
8      cout << "Enter the number of candy bars in a package\n";
9      cout << "and the weight in ounces of one candy bar.\n";
10     cout << "Then press return.\n";
11     cin >> number_of_bars;
12     cin >> one_weight;
13
14     total_weight = one_weight * number_of_bars;
15
16     cout << number_of_bars << " candy bars\n";
17     cout << one_weight << " ounces each\n";
18     cout << "Total weight is " << total_weight << " ounces.\n";
19
20     cout << "Try another brand.\n";
21     cout << "Enter the number of candy bars in a package\n";
22     cout << "and the weight in ounces of one candy bar.\n";
```

(continued)

DISPLAY 2.1 A C++ Program (part 2 of 2)

```
23     cout << "Then press return.\n";
24     cin >> number_of_bars;
25     cin >> one_weight;
26
27     total_weight = one_weight * number_of_bars;
28
29     cout << number_of_bars << " candy bars\n";
30     cout << one_weight << " ounces each\n";
31     cout << "Total weight is " << total_weight << " ounces.\n";
32
33     cout << "Perhaps an apple would be healthier.\n";
34
35     return 0;
36 }
```

Sample Dialogue

Enter the number of candy bars in a package and the weight in ounces of one candy bar.

Then press return.

11 2.1

11 candy bars

2.1 ounces each

Total weight is 23.1 ounces.

Try another brand.

Enter the number of candy bars in a package and the weight in ounces of one candy bar.

Then press return.

12 1.8

12 candy bars

1.8 ounces each

Total weight is 21.6 ounces.

Perhaps an apple would be healthier.

Names: Identifiers

The first thing you might notice about the names of the variables in our sample programs is that they are longer than the names normally used for variables in mathematics classes. To make your program easy to understand, you should always use meaningful names for variables. The name of a variable (or other item you might define in a program) is called an **identifier**.

Cannot Get Programs to Run?

If you cannot get your C++ programs to compile and run, read the Programming Tip in Chapter 1 entitled “Getting Your Program to Run.” That section has tips for dealing with variations in C++ compilers and C++ environments.

An identifier must start with either a letter or the underscore symbol, and all the rest of the characters must be letters, digits, or the underscore symbol. For example, the following are all valid identifiers:

```
x x1 x_1 _abc ABC123z7 sum RATE count data2 Big_Bonus
```

All of the previously mentioned names are legal and would be accepted by the compiler, but the first five are poor choices for identifiers, since they are not descriptive of the identifier’s use. None of the following are legal identifiers and all would be rejected by the compiler:

```
12 3X %change data-1 myfirst.c PROG.CPP
```

The first three are not allowed because they do not start with a letter or an underscore. The remaining three are not identifiers because they contain symbols other than letters, digits, and the underscore symbol.

C++ is a **case-sensitive** language; that is, it distinguishes between uppercase and lowercase letters in the spelling of identifiers. Hence the following are three distinct identifiers and could be used to name three distinct variables:

```
rate RATE Rate
```

However, it is not a good idea to use two such variants in the same program, since that might be confusing. Although it is not required by C++, variables are often spelled with all lowercase letters. The predefined identifiers, such as `main`, `cin`, `cout`, and so forth, must be spelled in all lowercase letters. We will see uses for identifiers spelled with uppercase letters later in this chapter.

A C++ identifier can be of any length, although some compilers will ignore all characters after some specified and typically large number of initial characters.

Identifiers

Identifiers are used as names for variables and other items in a C++ program. An identifier must start with either a letter or the underscore symbol, and the remaining characters must all be letters, digits, or the underscore symbol.

There is a special class of identifiers, called **keywords** or **reserved words**, that have a predefined meaning in C++ and that you cannot use as names for variables or anything else. In this book, keywords are written in a different type font like so: *int*, *double*. (And now you know why those words were written in a funny way.) A complete list of keywords is given in Appendix 1.

You may wonder why the other words that we defined as part of the C++ language are not on the list of keywords. What about words like `cin` and `cout`? The answer is that you are allowed to redefine these words, although it would be confusing to do so. These predefined words are not keywords; however, they are defined in libraries required by the C++ language standard. We will discuss libraries later in this book. For now, you need not worry about libraries. Needless to say, using a predefined identifier for anything other than its standard meaning can be confusing and dangerous, and thus should be avoided. The safest and easiest practice is to treat all predefined identifiers as if they were keywords.

Variable Declarations

Every variable in a C++ program must be *declared*. When you **declare** a variable you are telling the compiler—and, ultimately, the computer—what kind of data you will be storing in the variable. For example, the following two declarations from the program in Display 2.1 declare the three variables used in that program:

```
int number_of_bars;  
double one_weight, total_weight;
```

When there is more than one variable in a declaration, the variables are separated by commas. Also, note that each declaration ends with a semicolon.

The word *int* in the first of these two declarations is an abbreviation of the word *integer*. (But in a C++ program you must use the abbreviated form *int*. Do not write out the entire word *integer*.) This line declares the identifier `number_of_bars` to be a variable of *type int*. This means that the value of `number_of_bars` must be a whole number, such as 1, 2, -1, 0, 37, or -288.

The word *double* in the second of these two lines declares the two identifiers `one_weight` and `total_weight` to be variables of *type double*. A variable of *type double* can hold numbers with a fractional part, such as 1.75 or -0.55. The kind of data that is held in a variable is called its **type** and the name for the type, such as *int* or *double*, is called a **type name**.

Every variable in a C++ program must be declared before the variable can be used. There are two natural places to declare a variable: either just before it is used or at the start of the main part of your program right after the lines

```
int main()  
{
```

Do whatever makes your program clearer.

Variable Declarations

All variables must be declared before they are used. The syntax for variable declarations is as follows:

SYNTAX

```
Type_Name Variable_Name_1, Variable_Name_2, ...;
```

EXAMPLES

```
int count, number_of_dragons, number_of_trolls;  
double distance;
```

Variable declarations provide information the compiler needs in order to implement the variables. Recall that the compiler implements variables as memory locations and that the value of a variable is stored in the memory location assigned to that variable. The value is coded as a string of 0s and 1s. Different types of variables require different sizes of memory locations and different methods for coding their values as a string of 0s and 1s. The computer uses one code to encode integers as a string of 0s and 1s. It uses a different code to encode numbers that have a fractional part. It uses yet another code to encode letters as strings of 0s and 1s. The variable declaration tells the compiler—and, ultimately, the computer—what size memory location to use for the variable and which code to use when representing the variable’s value as a string of 0s and 1s.

Syntax

The **syntax** for a programming language (or any other kind of language) is the set of grammar rules for that language. For example, when we talk about the syntax for a variable declaration (as in the box labeled “Variable Declarations”), we are talking about the rules for writing down a well-formed variable declaration. If you follow all the syntax rules for C++, then the compiler will accept your program. Of course, this only guarantees that what you write is legal. It guarantees that your program will do something, but it does not guarantee that your program will do what you want it to do.

Assignment Statements

The most direct way to change the value of a variable is to use an *assignment statement*. An **assignment statement** is an order to the computer saying, “set

the value of this variable to what I have written down.” The following line from the program in Display 2.1 is an example of an assignment statement:

```
total_weight = one_weight * number_of_bars;
```

This assignment statement tells the computer to set the value of `total_weight` equal to the number in the variable `one_weight` multiplied by the number in `number_of_bars`. (As we noted in Chapter 1, `*` is the sign used for multiplication in C++.)

An assignment statement always consists of a variable on the left-hand side of the equal sign and an expression on the right-hand side. An assignment statement ends with a semicolon. The expression on the right-hand side of the equal sign may be a variable, a number, or a more complicated expression made up of variables, numbers, and arithmetic operators such as `*` and `+`. An assignment statement instructs the computer to evaluate (that is, to compute the value of) the expression on the right-hand side of the equal sign and to set the value of the variable on the left-hand side equal to the value of that expression. A few more examples may help to clarify the way these assignment statements work.

You may use any arithmetic operator in place of the multiplication sign. The following, for example, is also a valid assignment statement:

```
total_weight = one_weight + number_of_bars;
```

This statement is just like the assignment statements in our sample program, except that it performs addition rather than multiplication. This statement changes the value of `total_weight` to the sum of the values of `one_weight` and `number_of_bars`. Of course, if you made this change in the program in Display 2.1, the program would give incorrect output, but it would still run.

In an assignment statement, the expression on the right-hand side of the equal sign can simply be another variable. The statement

```
total_weight = one_weight;
```

changes the value of the variable `total_weight` so that it is the same as that of the variable `one_weight`. If you were to use this in the program in Display 2.1, it would give out incorrectly low values for the total weight of a package (assuming there is more than one candy bar in a package), but it might make sense in some other program.

As another example, the following assignment statement changes the value of `number_of_bars` to 37:

```
number_of_bars = 37;
```

A number, like the 37 in this example, is called a **constant**, because unlike a variable, its value cannot change.

Since variables can change value over time and since the assignment operator is one vehicle for changing their values, there is an element of time involved in the meaning of an assignment statement. First, the expression on the right-hand side of the equal sign is evaluated. After that, the value of

the variable on the left side of the equal sign is changed to the value that was obtained from that expression. This means that a variable can meaningfully occur on both sides of an assignment operator. For example, consider the assignment statement

```
number_of_bars = number_of_bars + 3;
```

This assignment statement may look strange at first. If you read it as an English sentence, it seems to say “the `number_of_bars` is equal to the `number_of_bars` plus three.” It may seem to say that, but what it really says is “Make the *new* value of `number_of_bars` equal to the *old* value of `number_of_bars` plus three.” The equal sign in C++ is not used the same way that it is used in English or in simple mathematics.

Assignment Statements

In an assignment statement, first the expression on the right-hand side of the equal sign is evaluated, and then the variable on the left-hand side of the equal sign is set equal to this value.

SYNTAX

```
Variable = Expression;
```

EXAMPLES

```
distance = rate * time;  
count = count + 2;
```

PITFALL Uninitialized Variables

A variable has no meaningful value until a program gives it one. For example, if the variable `minimum_number` has not been given a value either as the left-hand side of an assignment statement or by some other means (such as being given an input value with a `cin` statement), then the following is an error:

```
desired_number = minimum_number + 10;
```

This is because `minimum_number` has no meaningful value, so the entire expression on the right-hand side of the equal sign has no meaningful value. A variable like `minimum_number` that has not been given a value is said to be **uninitialized**. This situation is, in fact, worse than it would be if `minimum_number` had no value at all. An uninitialized variable, like `minimum_number`, will simply have some “garbage value.” The value of an uninitialized variable is determined by whatever pattern of 0s and 1s was left in its memory location by the last program that used that portion of memory. Thus if the program is run twice, an uninitialized

variable may receive a different value each time the program is run. Whenever a program gives different output on *exactly* the same input data and without *any* changes in the program itself, you should suspect an uninitialized variable.

One way to avoid an uninitialized variable is to initialize variables at the same time they are declared. This can be done by adding an equal sign and a value, as follows:

```
int minimum_number = 3;
```

This both declares `minimum_number` to be a variable of type `int` and sets the value of the variable `minimum_number` equal to 3. You can use a more complicated expression involving operations such as addition or multiplication when you initialize a variable inside the declaration in this way. However, a simple constant is what is most often used. You can initialize some, all, or none of the variables in a declaration that lists more than one variable. For example, the following declares three variables and initializes two of them:

```
double rate = 0.07, time, balance = 0.0;
```

C++ allows an alternative notation for initializing variables when they are declared. This alternative notation is illustrated by the following, which is equivalent to the preceding declaration:

```
double rate(0.07), time, balance(0.0);
```

Whether you initialize a variable when it is declared or at some later point in the program depends on the circumstances. Do whatever makes your program the easiest to understand. ■

Initializing Variables in Declarations

You can initialize a variable (that is, give it a value) at the time that you declare the variable.

SYNTAX

```
Type_Name Variable_Name_1 = Expression_for_Value_1,
      Variable_Name_2 = Expression_for_Value_2, . . . ;
```

EXAMPLES

```
int count = 0, limit = 10, fudge_factor = 2;
double distance = 999.99;
```

ALTERNATIVE SYNTAX FOR INITIALIZING IN DECLARATIONS

```
Type_Name Variable_Name_1 (Expression_for_Value_1),
      Variable_Name_2 (Expression_for_Value_2), . . . ;
```

(continued)

EXAMPLES

```
int count(0), limit(10), fudge_factor(2);  
double distance(999.99);
```

PROGRAMMING TIP Use Meaningful Names

Variable names and other names in a program should at least hint at the meaning or use of the thing they are naming. It is much easier to understand a program if the variables have meaningful names. Contrast the following:

```
x = y * z;
```

with the more suggestive:

```
distance = speed * time;
```

The two statements accomplish the same thing, but the second is easier to understand. ■

SELF-TEST EXERCISES

1. Give the declaration for two variables called `feet` and `inches`. Both variables are of type `int` and both are to be initialized to zero in the declaration. Use both initialization alternatives.
2. Give the declaration for two variables called `count` and `distance`. `count` is of type `int` and is initialized to zero. `distance` is of type `double` and is initialized to 1.5.
3. Give a C++ statement that will change the value of the variable `sum` to the sum of the values in the variables `n1` and `n2`. The variables are all of type `int`.
4. Give a C++ statement that will increase the value of the variable `length` by 8.3. The variable `length` is of type `double`.
5. Give a C++ statement that will change the value of the variable `product` to its old value multiplied by the value of the variable `n`. The variables are all of type `int`.
6. Write a program that contains statements that output the value of five or six variables that have been declared, but not initialized. Compile and run the program. What is the output? Explain.

7. Give good variable names for each of the following:
 - a. A variable to hold the speed of an automobile
 - b. A variable to hold the pay rate for an hourly employee
 - c. A variable to hold the highest score in an exam

2.2 INPUT AND OUTPUT

Garbage in means garbage out.

PROGRAMMERS' SAYING

There are several different ways that a C++ program can perform input and output. We will describe what are called *streams*. An **input stream** is simply the stream of input that is being fed into the computer for the program to use. The word *stream* suggests that the program processes the input in the same way no matter where the input comes from. The intuition for the word *stream* is that the program sees only the stream of input and not the source of the stream, like a mountain stream whose water flows past you but whose source is unknown to you. In this section we will assume that the input comes from the keyboard. In Chapter 6 we will discuss how a program can read its input from a file; as you will see there, you can use the same kinds of input statements to read input from a file as those that you use for reading input from the keyboard. Similarly, an **output stream** is the stream of output generated by the program. In this section we will assume the output is going to a terminal screen; in Chapter 6 we will discuss output that goes to a file.

Output Using cout

The values of variables as well as strings of text may be output to the screen using `cout`. There may be any combination of variables and strings to be output. For example, consider the following line from the program in Display 2.1:

```
cout << number_of_bars << " candy bars\n";
```

This statement tells the computer to output two items: the value of the variable `number_of_bars` and the quoted string " candy bars\n". Notice that you do not need a separate copy of the word `cout` for each item output. You can simply list all the items to be output preceding each item to be output with the arrow symbols `<<`. The above single `cout` statement is equivalent to the following two `cout` statements:

```
cout << number_of_bars;  
cout << " candy bars\n";
```

You can include arithmetic expressions in a `cout` statement as shown by the following example, where `price` and `tax` are variables:

```
cout << "The total cost is $" << (price + tax);
```

The parentheses around arithmetic expressions, like `price + tax`, are required by some compilers, so it is best to include them.

The symbol `<` is the same as the “less than” symbol. The two `<` symbols should be typed without any space between them. The arrow notation `<<` is often called the **insertion operator**. The entire `cout` statement ends with a semicolon.

Whenever you have two `cout` statements in a row, you can combine them into a single long `cout` statement. For example, consider the following lines from Display 2.1:

```
cout << number_of_bars << " candy bars\n";
cout << one_weight << " ounces each\n";
```

These two statements can be rewritten as the single following statement, and the program will perform exactly the same:

```
cout << number_of_bars << " candy bars\n" << one_weight
    << " ounces each\n";
```

If you want to keep your program lines from running off the screen, you will have to place such a long `cout` statement on two or more lines. A better way to write the previous long `cout` statement is

```
cout << number_of_bars << " candy bars\n"
    << one_weight << " ounces each\n";
```

You should not break a quoted string across two lines, but otherwise you can start a new line anywhere you can insert a space. Any reasonable pattern of spaces and line breaks will be acceptable to the computer, but the previous example and the sample programs are good models to follow. A good policy is to use one `cout` for each group of output that is intuitively considered a unit. Notice that there is just one semicolon for each `cout`, even if the `cout` statement spans several lines.

Pay particular attention to the quoted strings that are output in the program in Display 2.1. Notice that the strings must be included in double quotes. The double quote symbol used is a single key on your keyboard; do not type two single quotes. Also, notice that the same double quote symbol is used at each end of the string; there are not separate left and right quote symbols.

Also, notice the spaces inside the quotes. The computer does not insert any extra space before or after the items output by a `cout` statement. That is why the quoted strings in the samples often start and/or end with a blank. The blanks keep the various strings and numbers from running together. If all you need is a space and there is no quoted string where you want to insert the space, then use a string that contains only a space, as in the following:

```
cout << first_number << " " << second_number;
```

As we noted in Chapter 1, `\n` tells the computer to start a new line of output. Unless you tell the computer to go to the next line, it will put all the output on the same line. Depending on how your screen is set up, this can

produce anything from arbitrary line breaks to output that runs off the screen. Notice that the `\n` goes inside of the quotes. In C++, going to the next line is considered to be a special character (special symbol) and the way you spell this special character inside a quoted string is `\n`, with no space between the two symbols in `\n`. Although it is typed as two symbols, C++ considers `\n` to be a single character that is called the **new-line character**.

Include Directives and Namespaces

We have started all of our programs with the following two lines:

```
#include <iostream>
using namespace std;
```

These two lines make the library `iostream` available. This is the library that includes, among other things, the definitions of `cin` and `cout`. So if your program uses either `cin` or `cout`, you should have these two lines at the start of the file that contains your program.

The following line is known as an **include directive**. It “includes” the library `iostream` in your program so that you have `cin` and `cout` available:

```
#include <iostream>
```

The operators `cin` and `cout` are defined in a file named `iostream` and the above `include` directive is equivalent to copying that named file into your program. The second line is a bit more complicated to explain.

C++ divides names into **namespaces**. A namespace is a collection of names, such as the names `cin` and `cout`. A statement that specifies a namespace in the way illustrated by the following is called a **using directive**.

```
using namespace std;
```

This particular `using` directive says that your program is using the `std` (“standard”) namespace. This means that the names you use will have the meaning defined for them in the `std` namespace. In this case, the important thing is that when names such as `cin` and `cout` were defined in `iostream`, their definitions said they were in the `std` namespace. So to use names like `cin` and `cout`, you need to tell the compiler you are `using namespace std`;

That is all you need to know (for now) about namespaces, but a brief clarifying remark will remove some of the mystery that might surround the use of `namespace`. The reason that C++ has namespaces at all is because there are so many things to name. As a result, sometimes two or more items receive the same name; that is, a single name can get two different definitions. To eliminate these ambiguities, C++ divides items into collections so that no two items in the same collection (the same namespace) have the same name.

Note that a namespace is not simply a collection of names. It is a body of C++ code that specifies the meaning of some names, such as some definitions and/or declarations. The function of namespaces is to divide all the C++ name

specifications into collections (called *namespaces*) such that each name in a namespace has only one specification (one “definition”) in that namespace. A namespace divides up the names, but it takes a lot of C++ code along with the names.

What if you want to use two items in two different namespaces such that both items have the same name? It can be done and is not too complicated, but that is a topic for later in the book. For now, we do not need to do this.

Some versions of C++ use the following, older form of the include directive (without any `using namespace`):

```
#include <iostream.h>
```

If your programs do not compile or do not run with

```
#include <iostream>
using namespace std;
```

then try using the following line instead of the previous two lines:

```
#include <iostream.h>
```

If your program requires `iostream.h` instead of `iostream`, then you have an old C++ compiler and should obtain a more recent compiler.

Escape Sequences

The backslash, `\`, preceding a character tells the compiler that the character following the `\` does not have the same meaning as the character appearing by itself. Such a sequence is called an **escape sequence**. The sequence is typed in as two characters with no space between the symbols. Several escape sequences are defined in C++.

If you want to put a `\` or a `"` into a string constant, you must escape the ability of the `"` to terminate a string constant by using `\"`, or the ability of the `\` to escape, by using `\\`. The `\\` tells the compiler you mean a real backslash, `\`, not an escape sequence backslash, and `\"` means a real quote, not a string constant end.

A stray `\`, say `\z`, in a string constant will on one compiler simply give back a `z`; on another it will produce an error. The ANSI Standard provides that the unspecified escape sequences have undefined behavior. This means a compiler can do anything its author finds convenient. The consequence is that code that uses undefined escape sequences is not portable. You should not use any escape sequences other than those provided. We list a few here.

new line	<code>\n</code>
horizontal tab	<code>\t</code>
alert	<code>\a</code>
backslash	<code>\\</code>
double quote	<code>\"</code>

Alternately, C++11 supports a format called **raw string literals**, which is convenient if you have many escape characters. In this format use an `R` followed by the string in parentheses. For example, the following line outputs the literal string `"c:\files\"`:

```
cout << R"(c:\files\);
```

If you wish to insert a blank line in the output, you can output the new-line character `\n` by itself:

```
cout << "\n";
```

Another way to output a blank line is to use `endl`, which means essentially the same thing as `"\n"`. So you can also output a blank line as follows:

```
cout << endl;
```

Although `"\n"` and `endl` mean the same thing, they are used slightly differently; `\n` must always be inside of quotes and `endl` should not be placed in quotes.

A good rule for deciding whether to use `\n` or `endl` is the following: If you can include the `\n` at the end of a longer string, then use `\n` as in the following:

```
cout << "Fuel efficiency is "  
    << mpg << " miles per gallon\n";
```

On the other hand, if the `\n` would appear by itself as the short string `"\n"`, then use `endl` instead:

```
cout << "You entered " << number << endl;
```

Starting New Lines in Output

To start a new output line, you can include `\n` in a quoted string, as in the following example:

```
cout << "You have definitely won\n"  
    << "one of the following prizes:\n";
```

Recall that `\n` is typed as two symbols with no space in between the two symbols.

Alternatively, you can start a new line by outputting `endl`. An equivalent way to write the above `cout` statement is as follows:

```
cout << "You have definitely won" << endl  
    << "one of the following prizes:" << endl;
```

■ PROGRAMMING TIP End Each Program with a `\n` or `endl`

It is a good idea to output a new-line instruction at the end of every program. If the last item to be output is a string, then include a `\n` at the end of the string; if not, output an `endl` as the last action in your program. This serves two purposes. Some compilers will not output the last line of your program unless you include a new-line instruction at the end. On other systems, your program may work fine without this final new-line instruction, but the next program that is run will have its first line of output mixed with the last line of the previous program. Even if neither of these problems occurs on your system, putting a new-line instruction at the end will make your programs more portable. ■

Formatting for Numbers with a Decimal Point

When the computer outputs a value of type *double*, the format may not be what you would like. For example, the following simple `cout` statement can produce any of a wide range of outputs:

```
cout << "The price is $" << price << endl;
```

If `price` has the value 78.5, the output might be

```
The price is $78.500000
```

or it might be

```
The price is $78.5
```

or it might be output in the following notation (which we will explain in Section 2.3):

```
The price is $7.850000e01
```

But it is extremely unlikely that the output will be the following, even though this is the format that makes the most sense:

```
The price is $78.50
```

To ensure that the output is in the form you want, your program should contain some sort of instructions that tell the computer how to output the numbers.

There is a “magic formula” that you can insert in your program to cause numbers that contain a decimal point, such as numbers of type *double*, to be output in everyday notation with the exact number of digits after the decimal point that you specify. If you want two digits after the decimal point, use the following magic formula:

```
cout.setf(ios::fixed);  
cout.setf(ios::showpoint);  
cout.precision(2);
```

If you insert the preceding three statements in your program, then any `cout` statement that follows these three statements will output values of type *double* in ordinary notation, with exactly two digits after the decimal point.

For example, suppose the following `cout` statement appears somewhere after this magic formula and suppose the value of `price` is 78.5:

```
cout << "The price is $" << price << endl;
```

The output will then be as follows:

```
The price is $78.50
```

You may use any other nonnegative whole number in place of 2 to specify a different number of digits after the decimal point. You can even use a variable of type `int` in place of the 2. We will explain this magic formula in detail in Chapter 6. For now you should think of this magic formula as one long instruction that tells the computer how you want it to output numbers that contain a decimal point.

If you wish to change the number of digits after the decimal point so that different values in your program are output with different numbers of digits, you can repeat the magic formula with some other number in place of 2. However, when you repeat the magic formula, you only need to repeat the last line of the formula. If the magic formula has already occurred once in your program, then the following line will change the number of digits after the decimal point to 5 for all subsequent values of type `double` that are output:

```
cout.precision(5);
```

Input Using `cin`

You use `cin` for input more or less the same way you use `cout` for output. The syntax is similar, except that `cin` is used in place of `cout` and the arrows point in the opposite direction. For example, in the program in Display 2.1, the variables `number_of_bars` and `one_weight` were filled by the following `cin` statements (shown along with the `cout` statements that tell the user what to do):

Outputting Values of Type `double`

If you insert the following “magic formula” in your program, then all numbers of type `double` (or any other type that allows for digits after the decimal point) will be output in ordinary, everyday notation with two digits after the decimal point:

```
cout.setf(ios::fixed);  
cout.setf(ios::showpoint);  
cout.precision(2);
```

You can use any other nonnegative whole number in place of the 2 to specify a different number of digits after the decimal point. You can even use a variable of type `int` in place of the 2.

```
cout << "Enter the number of candy bars in a package\n";
cout << "and the weight in ounces of one candy bar.\n";
cout << "Then press return.\n";
cin >> number_of_bars;
cin >> one_weight;
```

You can list more than one variable in a single `cin` statement. So the preceding lines could be rewritten to the following:

```
cout << "Enter the number of candy bars in a package\n";
cout << "and the weight in ounces of one candy bar.\n";
cout << "Then press return.\n";
cin >> number_of_bars >> one_weight;
```

If you prefer, the `cin` statement can be written on two lines as follows:

```
cin >> number_of_bars
    >> one_weight;
```

Notice that, as with the `cout` statement, there is just one semicolon for each occurrence of `cin`.

When a program reaches a `cin` statement, it waits for input to be entered from the keyboard. It sets the first variable equal to the first value typed at the keyboard, the second variable equal to the second value typed, and so forth. However, the program does not read the input until the user presses the Return key. This allows the user to backspace and correct mistakes when entering a line of input.

Numbers in the input must be separated by one or more spaces or by a line break. If, for instance, you want to enter the two numbers 12 and 5 and instead you enter the numbers without any space between them, then the computer will think you have entered the single number 125. When you use `cin` statements, the computer will skip over any number of blanks or line breaks until it finds the next input value. Thus, it does not matter whether input numbers are separated by one space or several spaces or even a line break.

cin Statements

A `cin` statement sets variables equal to values typed in at the keyboard.

SYNTAX

```
cin >> Variable_1 >> Variable_2 >> ... ;
```

EXAMPLE

```
cin >> number >> size;
cin >> time_to_go
    >> points_needed;
```

Designing Input and Output

Input and output, or, as it is often called, *I/O*, is the part of the program that the user sees, so the user will not be happy with a program unless the program has well-designed I/O.

When the computer executes a `cin` statement, it expects some data to be typed in at the keyboard. If none is typed in, the computer simply waits for it. The program must tell the user when to type in a number (or other data item). The computer will not automatically ask the user to enter data. That is why the sample programs contain output statements like the following:

```
cout << "Enter the number of candy bars in a package\n";  
cout << "and the weight in ounces of one candy bar.\n";  
cout << "Then press return.\n";
```

These output statements **prompt** the user to enter the input. Your programs should always prompt for input.

When entering input from a terminal, the input appears on the screen as it is typed in. Nonetheless, the program should always write out the input values some time before it ends. This is called **echoing the input**, and it serves as a check to see that the input was read in correctly. Just because the input looks good on the screen when it is typed in does not mean that it was read correctly by the computer. There could be an unnoticed typing mistake or other problem. Echoing input serves as a test of the integrity of the input data.

■ PROGRAMMING TIP Line Breaks in I/O

It is possible to keep output and input on the same line, and sometimes it can produce a nicer interface for the user. If you simply omit a `\n` or `endl` at the end of the last prompt line, then the user's input will appear on the same line as the prompt. For example, suppose you use the following prompt and input statements:

```
cout << "Enter the cost per person: $";  
cin >> cost_per_person;
```

When the `cout` statement is executed, the following will appear on the screen:

```
Enter the cost per person: $
```

When the user types in the input, it will appear on the same line, like this:

```
Enter the cost per person: $1.25
```



SELF-TEST EXERCISES

8. Give an output statement that will produce the following message on the screen:

```
The answer to the question of
Life, the Universe, and Everything is 42.
```

9. Give an input statement that will fill the variable `the_number` (of type `int`) with a number typed in at the keyboard. Precede the input statement with a prompt statement asking the user to enter a whole number.
10. What statements should you include in your program to ensure that, when a number of type `double` is output, it will be output in ordinary notation with three digits after the decimal point?
11. Write a complete C++ program that writes the phrase `Hello world` to the screen. The program does nothing else.
12. Write a complete C++ program that reads in two whole numbers and outputs their sum. Be sure to prompt for input, echo input, and label all output.
13. Give an output statement that produces the new-line character and a tab character.
14. Write a short program that declares and initializes `double` variables `one`, `two`, `three`, `four`, and `five` to the values 1.000, 1.414, 1.732, 2.000, and 2.236, respectively. Then write output statements to generate the following legend and table. Use the tab escape sequence `\t` to line up the columns. If you are unfamiliar with the tab character, you should experiment with it while doing this exercise. A tab works like a mechanical stop on a typewriter. A tab causes output to begin in a next column, usually a multiple of eight spaces away. Many editors and most word processors will have adjustable tab stops. Our output does not.

The output should be:

```
N   Square Root
1   1.000
2   1.414
3   1.732
4   2.000
5   2.236
```

2.3 DATA TYPES AND EXPRESSIONS

They'll never be happy together. He's not her type.

OVERHEARD AT A COCKTAIL PARTY

The Types *int* and *double*

Conceptually, the numbers 2 and 2.0 are the same number. But C++ considers them to be of different types. The whole number 2 is of type *int*; the number 2.0 is of type *double*, because it contains a fraction part (even though the fraction is 0). Once again, the mathematics of computer programming is a bit different from what you may have learned in mathematics classes. Something about the practicalities of computers makes a computer's numbers differ from the abstract definitions of these numbers. The whole numbers in C++ behave as you would expect them to. The type *int* holds no surprises. But values of type *double* are more troublesome. Because it can store only a limited number of significant digits, the computer stores numbers of type *double* as approximate values. Numbers of type *int* are stored as exact values. The precision with which *double* values are stored varies from one computer to another, but you can expect them to be stored with 14 or more digits of accuracy. For most applications this is likely to be sufficient, though subtle problems can occur even in simple cases. Thus, if you know that the values in some variable will always be whole numbers in the range allowed by your computer, it is best to declare the variable to be of type *int*.

Number constants of type *double* are written differently from those of type *int*. Constants of type *int* must not contain a decimal point. Constants of type *double* may be written in either of two forms. The simple form for *double* constants is like the everyday way of writing decimal fractions. When

What Is Doubled?

Why is the type for numbers with a fraction part called *double*? Is there a type called "single" that is half as big? No, but something like that is true. Many programming languages traditionally used two types for numbers with a fractional part. One type used less storage and was very imprecise (that is, it did not allow very many significant digits). The second type used *double* the amount of storage and was therefore much more precise; it also allowed numbers that were larger (although programmers tend to care more about precision than about size). The kind of numbers that used twice as much storage were called

(continued)

double-precision numbers; those that used less storage were called *single-precision*. Following this tradition, the type that (more or less) corresponds to this double-precision type was named *double* in C++. The type that corresponds to single-precision in C++ was called *float*. C++ also has a third type for numbers with a fractional part, which is called *long double*. These types are described in the subsection entitled “Other Number Types.” However, we will rarely use the types *float* and *long double* in this book.

written in this form, a *double* constant must contain a decimal point. There is, however, one thing that constants of type *double* and constants of type *int* have in common: No number in C++ may contain a comma.

The more complicated notation for constants of type *double* is frequently called **scientific notation** or **floating-point notation** and is particularly handy for writing very large numbers and very small fractions. For instance,

$$3.67 \times 10^{17}$$

which is the same as

367000000000000000.0

is best expressed in C++ by the constant 3.67e17. The number

$$5.89 \times 10^{-6}$$

which is the same as

0.00000589

is best expressed in C++ by the constant 5.89e-6. The e stands for *exponent* and means “multiply by 10 to the power that follows.”

This **e notation** is used because keyboards normally have no way to write exponents as superscripts. Think of the number after the e as telling you the direction and number of digits to move the decimal point. For example, to change 3.49e4 to a numeral without an e, you move the decimal point four places to the right to obtain 34900.0, which is another way of writing the same number. If the number after the e is negative, you move the decimal point the indicated number of spaces to the left, inserting extra zeros if need be. So, 3.49e-2 is the same as 0.0349.

The number before the e may contain a decimal point, although it is not required. However, the exponent after the e definitely must *not* contain a decimal point.

Since computers have size limitations on their memory, numbers are typically stored in a limited number of bytes (that is, a limited amount of storage). Hence, there is a limit to how large the magnitude of a number can

be, and this limit is different for different number types. The largest allowable number of type *double* is always much larger than the largest allowable number of type *int*. Most current implementations of C++ will allow values of type *int* as large as 2,147,483,647 and values of type *double* up to about 10^{308} .

Other Number Types

C++ has other numeric types besides *int* and *double*. Some are described in Display 2.2. The various number types allow for different size numbers and for more or less precision (that is, more or fewer digits after the decimal point). In Display 2.2, the values given for memory used, size range, and precision are only one sample set of values, intended to give you a general feel for how the types differ. The values vary from one system to another and may be different on your system.

Although some of these other numeric types are spelled as two words, you declare variables of these other types just as you declare variables of types *int* and *double*. For example, the following declares one variable of type *long double*:

```
long double big_number;
```

The type names *long* and *long int* are two names for the same type. Thus, the following two declarations are equivalent:

```
long big_total;
```

and the equivalent

```
long int big_total;
```

Of course, in any one program, you should use only one of the above two declarations for the variable *big_total*, but it does not matter which one you use. Also, remember that the type name *long* by itself means the same thing as *long int*, not the same thing as *long double*.

The types for whole numbers, such as an *int* and similar types, are called **integer types**. The type for numbers with a decimal point—such as the type *double* and similar types—are called **floating-point types**. They are called *floating-point* because when the computer stores a number written in the usual way, like 392.123, it first converts the number to something like e notation, in this case something like 3.92123e2. When the computer performs this conversion, the decimal point *floats* (that is, moves) to a new position.

You should be aware that there are other numeric types in C++. However, in this book we will use only the types *int*, *double*, and occasionally *long*. For most simple applications, you should not need any types except *int* and *double*. However, if you are writing a program that uses very large whole numbers, then you might need to use the type *long*.

DISPLAY 2.2 Some Number Types

Type Name	Memory Used	Size Range	Precision
<i>short</i> (also called <i>short int</i>)	2 bytes	-32,768 to 32,767	(not applicable)
<i>int</i>	4 bytes	-2,147,483,648 to 2,147,483,647	(not applicable)
<i>long</i> (also called <i>long int</i>)	4 bytes	-2,147,483,648 to 2,147,483,647	(not applicable)
<i>float</i>	4 bytes	approximately 10^{-38} to 10^{38}	7 digits
<i>double</i>	8 bytes	approximately 10^{-308} to 10^{308}	15 digits
<i>long double</i>	10 bytes	approximately 10^{-4932} to 10^{4932}	19 digits

These are only sample values to give you a general idea of how the types differ. The values for any of these entries may be different on your system. Precision refers to the number of meaningful digits, including digits in front of the decimal point. The ranges for the types float, double, and long double are the ranges for positive numbers. Negative numbers have a similar range, but with a negative sign in front of each number.

C++11 Types

The size of integer data types can vary from one machine to another. For example, on a 32-bit machine an integer might be 4 bytes while on a 64-bit machine an integer might be 8 bytes. Sometimes this is problematic if you need to know exactly what range of values can be stored in an integer type. To address this problem, new integer types were added to C++11 that specify exactly the size and whether or not the data type is signed or unsigned. These types are accessible by including `<stdint.h>`. Display 2.3 illustrates some of these number types. In this text we will primarily use the more ambiguous types of `int` and `long`, but consider the C++11 types if you want to specify an exact size.

C++11 also includes a type named `auto` that deduces the type of a variable based on an expression on the right side of the equal sign. For example, the following line of code defines a variable named `x` whose data type matches whatever is computed from "expression":

```
auto x = expression;
```

This feature doesn't buy us much at this point but will save us some long, messy code when we start to work with longer data types that we define ourselves.

DISPLAY 2.3 Some C++11 Fixed Width Integer Types

Type Name	Memory Used	Size Range
int8_t	1 byte	-128 to 127
uint8_t	1 byte	0 to 255
int16_t	2 bytes	-32,768 to 32,767
uint16_t	2 bytes	0 to 65,535
int32_t	4 bytes	-2,147,483,648 to 2,147,483,647
uint32_t	4 bytes	0 to 4,294,967,295
int64_t	8 bytes	-9,223,372,036,854,775,808 to 9,223,372,036,854,775,807
uint64_t	8 bytes	0 to 18,446,744,073,709,551,615
long long	At least 8 bytes	

In the other direction, C++11 also introduces a way to determine the type of a variable or expression. `decltype (expr)` is the declared type of variable or expression `expr` and can be used in declarations:

```
int x = 10;
decltype (x*3.5) y;
```

This code declares `y` to be the same type as `x*3.5`. The expression `x*3.5` is a `double` so `y` is declared as a `double`.



VideoNote
C++11 Fixed Width
Integer Types

The Type *char*

We do not want to give you the impression that computers and C++ are used only for numeric calculations, so we will introduce some nonnumeric types now, though eventually we will see other more complicated nonnumeric types. Values of the type *char*, which is short for *character*, are single symbols such as a letter, digit, or punctuation mark. Values of this type are frequently called *characters* in books and in conversation, but in a C++ program this type must always be spelled in the abbreviated fashion *char*. For example, the variables `symbol` and `letter` of type *char* are declared as follows:

```
char symbol, letter;
```

A variable of type *char* can hold any single character on the keyboard. So, for example, the variable `symbol` could hold an 'A' or a '+' or an 'a'. Note that uppercase and lowercase versions of a letter are considered different characters.

The text in double quotes that are output using `cout` are called *string* values. For example, the following, which occurs in the program in Display 2.1, is a string:

```
"Enter the number of candy bars in a package\n"
```

Be sure to notice that string constants are placed inside of double quotes, while constants of type *char* are placed inside of single quotes. The two kinds of quotes mean different things. In particular, 'A' and "A" mean different things. 'A' is a value of type *char* and can be stored in a variable of type *char*. "A" is a string of characters. The fact that the string happens to contain only one character does *not* make "A" a value of type *char*. Also notice that, for both strings and characters, the left and right quotes are the same.

The use of the type *char* is illustrated in the program shown in Display 2.4. Notice that the user types a space between the first and second initials. Yet the program skips over the blank and reads the letter B as the second input character. When you use *cin* to read input into a variable of type *char*, the computer skips over all blanks and line breaks until it gets to the first nonblank character and reads that nonblank character into the

DISPLAY 2.4 The Type *char*

```
1  #include <iostream>
2  using namespace std;
3  int main( )
4  {
5      char symbol1, symbol2, symbol3;

6      cout << "Enter two initials, without any periods:\n";
7      cin >> symbol1 >> symbol2;
8      cout << "The two initials are:\n";
9      cout << symbol1 << symbol2 << endl;
10     cout << "Once more with a space:\n";
11     symbol3 = ' ';
12     cout << symbol1 << symbol3 << symbol2 << endl;
13     cout << "That's all.";
14     return 0;
15 }
```

Sample Dialogue

```
Enter two initials, without any periods:
J B
The two initials are:
JB
Once more with a space:
J B
That's all.
```

variable. It makes no difference whether there are blanks in the input or not. The program in Display 2.4 will give the same output whether the user types in a blank between initials, as shown in the sample dialogue, or the user types in the two initials without a blank, like so:

```
JB
```

The Type `bool`

The next type we discuss here is the type `bool`. This type was added to the C++ language by the ISO/ANSI (International Standards Organization/American National Standards Organization) committee in 1998. Expressions of type `bool` are called *Boolean* after the English mathematician George Boole (1815–1864), who formulated rules for mathematical logic.

Boolean expressions evaluate to one of the two values, *true* or *false*. Boolean expressions are used in branching and looping statements that we study in Section 2.4. We will say more about Boolean expressions and the type `bool` in that section.

Introduction to the Class `string`

Although C++ lacks a native data type to directly manipulate strings, there is a `string` class that may be used to process strings in a manner similar to the data types we have seen thus far. The distinction between a class and a native data type is discussed in Chapter 10. Further details about the `string` class are discussed in Chapter 8.

To use the `string` class we must first include the `string` library:

```
#include <string>
```

Your program must also contain the following line of code, normally placed at the start of the file:

```
using namespace std;
```

You declare variables of type `string` just as you declare variables of types `int` or `double`. For example, the following declares one variable of type `string` and stores the text "Monday" in it:

```
string day;  
day = "Monday";
```

You may use `cin` and `cout` to read data into strings, as shown in Display 2.5. If you place the '+' symbol between two strings, then this operator concatenates the two strings together to create one longer string. For example, the code:

```
string day, day1, day2;  
day1 = "Monday";
```

```
day2 = "Tuesday";
day = day1 + day2;
```

Results in the concatenated string of:

```
"MondayTuesday"
```

Note that a space is not automatically added between the strings. If you wanted a space between the two days, then a space must be added explicitly:

```
day1 + " " + day2
```

DISPLAY 2.5 The string Class

```
1  #include <iostream>
2  #include <string>
3  using namespace std;
4  int main()
5  {
6      string middle_name, pet_name;
7      string alter_ego_name;
8
9      cout << "Enter your middle name and the name of your pet.\n";
10     cin >> middle_name;
11     cin >> pet_name;
12
13     alter_ego_name = pet_name + " " + middle_name;
14
15     cout << "The name of your alter ego is ";
16     cout << alter_ego_name << "." << endl;
17
18     return 0;
19
20 }
```

Sample Dialogue 1

```
Enter your middle name and the name of your pet.
Parker Pippen
The name of your alter ego is Pippen Parker.
```

Sample Dialogue 2

```
Enter your middle name and the name of your pet.
Parker
Mr. Bojangles
The name of your alter ego is Mr. Parker.
```

When you use `cin` to read input into a `string` variable, the computer only reads until it encounters a *whitespace* character. **Whitespace** characters are all the characters that are displayed as blank spaces on the screen, including the blank or space character, the tab character, and the new-line character `'\n'`. This means that you cannot input a string that contains spaces. This may sometimes cause errors, as indicated in Display 2.5, Sample Dialogue 2. In this case, the user intends to enter "Mr. Bojangles" as the name of the pet, but the string is only read up to "Mr." since the next character is a space. The "Bojangles" string is ignored by this program but would be read next if there was another `cin` statement. Chapter 8 describes a technique to input a string that may include spaces.

Type Compatibilities

As a general rule, you cannot store a value of one type in a variable of another type. For example, most compilers will object to the following:

```
int int_variable;  
int_variable = 2.99;
```

The problem is a type mismatch. The constant 2.99 is of type *double* and the variable `int_variable` is of type *int*. Unfortunately, not all compilers will react the same way to the above assignment statement. Some will issue an error message, some will give only a warning message, and some compilers will not object at all. But even if the compiler does allow you to use this assignment, it will probably give `int_variable` the *int* value 2, not the value 3. Since you cannot count on your compiler accepting this assignment, you should not assign a *double* value to a variable of type *int*.

The same problem arises if you use a variable of type *double* instead of the constant 2.99. Most compilers will also object to the following:

```
int int_variable;  
double double_variable;  
double_variable = 2.00;  
int_variable = double_variable;
```

The fact that the value 2.00 "comes out even" makes no difference. The value 2.00 is of type *double*, not of type *int*. As you will see shortly, you can replace 2.00 with 2 in the preceding assignment to the variable `double_variable`, but even that is not enough to make the assignment acceptable. The variables `int_variable` and `double_variable` are of different types, and that is the cause of the problem.

Even if the compiler will allow you to mix types in an assignment statement, in most cases you should not. Doing so makes your program less portable, and it can be confusing. For example, if your compiler lets you assign 2.99 to a variable of type *int*, the variable will receive the value 2,

rather than 2.99, which can be confusing since the program seems to say the value will be 2.99.

There are some special cases where it is permitted to assign a value of one type to a variable of another type. It is acceptable to assign a value of type *int* to a variable of type *double*. For example, the following is both legal and acceptable style:

```
double double_variable;  
double_variable = 2;
```

The above will set the value of the variable named `double_variable` equal to 2.0.

Although it is usually a bad idea to do so, you can store an *int* value such as 65 in a variable of type *char* and you can store a letter such as 'Z' in a variable of type *int*. For many purposes, the C language considers the characters to be small integers; and perhaps unfortunately, C++ inherited this from C. The reason for allowing this is that variables of type *char* consume less memory than variables of type *int* and so doing arithmetic with variables of type *char* can save some memory. However, it is clearer to use the type *int* when you are dealing with integers and to use the type *char* when you are dealing with characters.

The general rule is that you cannot place a value of one type in a variable of another type—though it may seem that there are more exceptions to the rule than there are cases that follow the rule. Even if the compiler does not enforce this rule very strictly, it is a good rule to follow. Placing data of one type in a variable of another type can cause problems, since the value must be changed to a value of the appropriate type and that value may not be what you would expect.

Values of type *bool* can be assigned to variables of an integer type (*short*, *int*, *long*) and integers can be assigned to variables of type *bool*. However, it is poor style to do this and you should not use these features. For completeness and to help you read other people's code, we do give the details: When assigned to a variable of type *bool*, any nonzero integer will be stored as the value *true*. Zero will be stored as the value *false*. When assigning a *bool* value to an integer variable, *true* will be stored as 1 and *false* will be stored as 0.

Arithmetic Operators and Expressions

In a C++ program, you can combine variables and/or numbers using the arithmetic operators + for addition, - for subtraction, * for multiplication, and / for division. For example, the following assignment statement, which appears in the program in Display 2.1, uses the * operator to multiply the numbers in two variables. (The result is then placed in the variable on the left-hand side of the equal sign.)

```
total_weight = one_weight * number_of_bars;
```

All of the arithmetic operators can be used with numbers of type *int*, numbers of type *double*, and even with one number of each type. However, the type of the value produced and the exact value of the result depends on the types of the numbers being combined. If both operands (that is, both numbers) are of type *int*, then the result of combining them with an arithmetic operator is of type *int*. If one, or both, of the operands is of type *double*, then the result is of type *double*. For example, if the variables `base_amount` and `increase` are of type *int*, then the number produced by the following expression is of type *int*:

```
base_amount + increase
```

However, if one or both of the two variables is of type *double*, then the result is of type *double*. This is also true if you replace the operator `+` with any of the operators `-`, `*`, or `/`.

The type of the result can be more significant than you might suspect. For example, `7.0/2` has one operand of type *double*, namely `7.0`. Hence, the result is the type *double* number `3.5`. However, `7/2` has two operands of type *int* and so it yields the type *int*, which is the result `3`. Even if the result “comes out even,” there is a difference. For example, `6.0/2` has one operand of type *double*, namely `6.0`. Hence, the result is the type *double* number `3.0`, which is only an approximate quantity. However, `6/2` has two operands of type *int*, so it yields the result `3`, which is of type *int* and so is an exact quantity. The division operator is the operator that is affected most severely by the type of its arguments.

When used with one or both operands of type *double*, the division operator, `/`, behaves as you might expect. However, when used with two operands of type *int*, the division operator, `/`, yields the integer part resulting from division. In other words, integer division discards the part after the decimal point. So, `10/3` is `3` (not `3.3333`), `5/2` is `2` (not `2.5`), and `11/3` is `3` (not `3.6666`). Notice that the number is *not rounded*; the part after the decimal point is discarded no matter how large it is.

The operator `%` can be used with operands of type *int* to recover the information lost when you use `/` to do division with numbers of type *int*. When used with values of type *int*, the two operators `/` and `%` yield the two numbers produced when you perform the long division algorithm you learned in grade school. For example, `17` divided by `5` yields `3` with a remainder of `2`. The `/` operation yields the number of times one number “goes into” another. The `%` operation gives the remainder. For example, the statements

```
cout << "17 divided by 5 is " << (17/5) << endl;  
cout << "with a remainder of " << (17%5) << endl;
```

yield the following output:

```
17 divided by 5 is 3  
with a remainder of 2
```

Display 2.6 illustrates how `/` and `%` work with values of type `int`.

DISPLAY 2.6 Integer Division

$\begin{array}{r} 4 \leftarrow 12/3 \\ 3 \overline{) 12} \\ \underline{12} \\ 0 \leftarrow 12\%3 \end{array}$	$\begin{array}{r} 4 \leftarrow 14/3 \\ 3 \overline{) 14} \\ \underline{12} \\ 2 \leftarrow 14\%3 \end{array}$
---	---

When used with negative values of type `int`, the result of the operators `/` and `%` can be different for different implementations of C++. Thus, you should use `/` and `%` with `int` values only when you know that both values are nonnegative.

Any reasonable spacing will do in arithmetic expressions. You can insert spaces before and after operations and parentheses, or you can omit them. Do whatever produces a result that is easy to read.

You can specify the order of operations by inserting parentheses, as illustrated in the following two expressions:

$$(x + y) * z$$

$$x + (y * z)$$

To evaluate the first expression, the computer first adds `x` and `y` and then multiplies the result by `z`. To evaluate the second expression, it multiplies `y` and `z` and then adds the result to `x`. Although you may be used to using mathematical formulas that contain square brackets and various other forms of parentheses, that is not allowed in C++. C++ allows only one kind of parentheses in arithmetic expressions. The other varieties are reserved for other purposes.

If you omit parentheses, the computer will follow rules called **precedence rules** that determine the order in which the operators, such as `+` and `*`, are performed. These precedence rules are similar to rules used in algebra and other mathematics classes. For example,

$$x + y * z$$

is evaluated by first doing the multiplication and then the addition. Except in some standard cases, such as a string of additions or a simple multiplication embedded inside an addition, it is usually best to include the parentheses, even if the intended order of operations is the one dictated by the precedence rules. The parentheses make the expression easier to read and less prone to programmer error. A complete set of C++ precedence rules is given in Appendix 2.

Display 2.7 shows some examples of common kinds of arithmetic expressions and how they are expressed in C++.



VideoNote
Precedence and Arithmetic
Operators

DISPLAY 2.7 Arithmetic Expressions

Mathematical Formula	C++ Expression
$b^2 - 4ac$	<code>b*b - 4*a*c</code>
$x(y + z)$	<code>x*(y + z)</code>
$\frac{1}{x^2 + x + 3}$	<code>1/(x*x + x + 3)</code>
$\frac{a + b}{c - d}$	<code>(a + b)/(c - d)</code>

PITFALL Whole Numbers in Division

When you use the division operator `/` on two whole numbers, the result is a whole number. This can be a problem if you expect a fraction. Moreover, the problem can easily go unnoticed, resulting in a program that looks fine but is producing incorrect output without your even being aware of the problem. For example, suppose you are a landscape architect who charges \$5,000 per mile to landscape a highway, and suppose you know the length of the highway you are working on in feet. The price you charge can easily be calculated by the following C++ statement:

```
total_price = 5000 * (feet/5280.0);
```

This works because there are 5,280 feet in a mile. If the stretch of highway you are landscaping is 15,000 feet long, this formula will tell you that the total price is

```
5000 * (15000/5280.0)
```

Your C++ program obtains the final value as follows: `15000/5280.0` is computed as `2.84`. Then the program multiplies 5000 by `2.84` to produce the value `14200.00`. With the aid of your C++ program, you know that you should charge \$14,200 for the project.

Now suppose the variable `feet` is of type `int`, and you forget to put in the decimal point and the zero, so that the assignment statement in your program reads:

```
total_price = 5000 * (feet/5280);
```

It still looks fine but will cause serious problems. If you use this second form of the assignment statement, you are dividing two values of type `int`, so the result of the division `feet/5280` is `15000/5280`, which is the `int` value `2` (instead of the value `2.84`, which you think you are getting). So the value assigned to `total_cost` is `5000 * 2`, or `10000.00`. If you forget the decimal point, you will charge \$10,000. However, as we have already seen, the correct value is \$14,200. A missing decimal point has cost you \$4,200. Note that this will be true whether the type of `total_price` is `int` or `double`; the damage is done before the value is assigned to `total_price`. ■

SELF-TEST EXERCISES

15. Convert each of the following mathematical formulas to a C++ expression:

$$3x \qquad 3x + y \qquad \frac{x + y}{7} \qquad \frac{3x + y}{z + 2}$$

16. What is the output of the following program lines when embedded in a correct program that declares all variables to be of type *char*?

```
a = 'b';
b = 'c';
c = a;
cout << a << b << c << 'c';
```

17. What is the output of the following program lines when embedded in a correct program that declares *number* to be of type *int*?

```
number = (1/3) * 3;
cout << "(1/3) * 3 is equal to " << number;
```

18. Write a complete C++ program that reads two whole numbers into two variables of type *int* and then outputs both the whole-number part and the remainder when the first number is divided by the second. This can be done using the operators */* and *%*.

19. Given the following fragment that purports to convert from degrees Celsius to degrees Fahrenheit, answer the following questions:

```
double c = 20;
double f;
f = (9/5) * c + 32.0;
```

- What value is assigned to *f*?
 - Explain what is actually happening, and what the programmer likely wanted.
 - Rewrite the code as the programmer intended.
20. What is the output of the following program lines when embedded in a correct program that declares *month*, *day*, *year*, and *date* to be of type *string*?

```
month = "03";
day = "04";
year = "06";
date = month + day + year;
cout << date << endl;
```

More Assignment Statements

There is a shorthand notation that combines the assignment operator (=) and an arithmetic operator so that a given variable can have its value changed by adding, subtracting, multiplying by, or dividing by a specified value. The general form is

$$\text{Variable Op= Expression}$$

which is equivalent to

$$\text{Variable} = \text{Variable Op (Expression)}$$

Op is an operator such as +, *, or /. The *Expression* can be another variable, a constant, or a more complicated arithmetic expression. Following are examples:

Example	Equivalent to:
count += 2;	count = count + 2;
total -= discount;	total = total - discount;
bonus *= 2;	bonus = bonus * 2;
time /= rush_factor;	time = time / rush_factor;
change %= 100;	change = change % 100;
amount *= cnt1 + cnt2;	amount = amount * (cnt1 + cnt2);

2.4 SIMPLE FLOW OF CONTROL

"If you think we're wax-works," he said, "you ought to pay, you know. Wax-works weren't made to be looked at for nothing. Nohow!"

"Contrariwise," added the one marked "DEE," "if you think we're alive, you ought to speak."

LEWIS CARROLL, *Through the Looking-Glass*

The programs you have seen thus far each consist of a simple list of statements to be executed in the order given. However, to write more sophisticated programs, you will also need some way to vary the order in which statements are executed. The order in which statements are executed is often referred to as **flow of control**. In this section we will present two simple ways to add some flow of control to your programs. We will discuss a branching mechanism that lets your program choose between two alternative actions, choosing one or the other depending on the values of variables. We will also present a looping mechanism that lets your program repeat an action a number of times.

A Simple Branching Mechanism

Sometimes it is necessary to have a program choose one of two alternatives, depending on the input. For example, suppose you want to design a program to compute a week's salary for an hourly employee. Assume the firm pays an overtime rate of one-and-one-half times the regular rate for all hours after the first 40 hours worked. As long as the employee works 40 or more hours, the pay is then equal to

$$\text{rate} * 40 + 1.5 * \text{rate} * (\text{hours} - 40)$$

However, if there is a possibility that the employee will work less than 40 hours, this formula will unfairly pay a negative amount of overtime. (To see this, just substitute 10 for hours, 1 for rate, and do the arithmetic. The poor employee will get a negative paycheck.) The correct pay formula for an employee who works less than 40 hours is simply

$$\text{rate} * \text{hours}$$

If both more than 40 hours and less than 40 hours of work are possible, then the program will need to choose between the two formulas. In order to compute the employee's pay, the program action should be

Decide whether or not ($\text{hours} > 40$) is true.

If it is, do the following assignment statement:

$$\text{gross_pay} = \text{rate} * 40 + 1.5 * \text{rate} * (\text{hours} - 40);$$

If it is not, do the following:

$$\text{gross_pay} = \text{rate} * \text{hours};$$

There is a C++ statement that does exactly this kind of branching action. The *if-else* statement chooses between two alternative actions. For example, the wage calculation we have been discussing can be accomplished with the following C++ statement:

```
if (hours > 40)
    gross_pay = rate * 40 + 1.5 * rate * (hours - 40);
else
    gross_pay = rate * hours;
```

A complete program that uses this statement is given in Display 2.8.

Two forms of an *if-else* statement are described in Display 2.9. The first is the simple form of an *if-else* statement; the second form will be discussed in the subsection entitled "Compound Statements." In the first form shown, the two statements may be any executable statements. The *Boolean_Expression* is a test that can be checked to see if it is true or false, that is, to see if it is satisfied or not. For example, the *Boolean_Expression* in the earlier *if-else* statement is

$$\text{hours} > 40$$

When the program reaches the *if-else* statement, exactly one of the two embedded statements is executed. If the *Boolean_Expression* is true (that is, if it is satisfied), then the *Yes_Statement* is executed; if the *Boolean_Expression* is false (that is, if it is not satisfied), then the *No_Statement* is executed. Notice that the *Boolean_Expression* must be enclosed in parentheses. (This is required by the syntax rules for *if-else* statements in C++.) Also notice that an *if-else* statement has two smaller statements embedded in it.

DISPLAY 2.8 An *if-else* Statement (part 1 of 2)

```
1  #include <iostream>
2  using namespace std;
3  int main( )
4  {
5      int hours;
6      double gross_pay, rate;
7      cout << "Enter the hourly rate of pay: $";
8      cin >> rate;
9      cout << "Enter the number of hours worked,\n"
10     << "rounded to a whole number of hours: ";
11     cin >> hours;
12     if (hours > 40)
13         gross_pay = rate * 40 + 1.5 * rate * (hours - 40);
14     else
15         gross_pay = rate * hours;
16
17     cout.setf(ios::fixed);
18     cout.setf(ios::showpoint);
19     cout.precision(2);
20     cout << "Hours = " << hours << endl;
21     cout << "Hourly pay rate = $" << rate << endl;
22     cout << "Gross pay = $" << gross_pay << endl;
23     return 0;
24 }
```

Sample Dialogue 1

```
Enter the hourly rate of pay: $20.00
Enter the number of hours worked,
rounded to a whole number of hours: 30
Hours = 30
Hourly pay rate = $20.00
Gross pay = $600.00
```

(continued)

DISPLAY 2.8 An *if-else* Statement (part 2 of 2)**Sample Dialogue 2**

```

Enter the hourly rate of pay: $10.00
Enter the number of hours worked,
rounded to a whole number of hours: 41
Hours = 41
Hourly pay rate = $10.00
Gross pay = $415.00

```

DISPLAY 2.9 Syntax for an *if-else* Statement**A Single Statement for Each Alternative:**

```

1   if (Boolean_Expression)
2       Yes_Statement
3   else
4       No_Statement

```

A Sequence of Statements for Each Alternative:

```

5   if (Boolean_Expression)
6   {
7       Yes_Statement_1
8       Yes_Statement_2
9       ...
10      Yes_Statement_Last
10   }
12   else
13   {
14       No_Statement_1
15       No_Statement_2
16       ...
17       No_Statement_Last
18   }

```

A **Boolean expression** is any expression that is either true or false. An *if-else* statement always contains a *Boolean_Expression*. The simplest form for a *Boolean_Expression* consists of two expressions, such as numbers or variables, that are compared with one of the comparison operators shown in Display 2.10. Notice that some of the operators are spelled with two symbols: for example, `==`, `!=`, `<=`, `>=`. Be sure to notice that you use a double equal `==` for

DISPLAY 2.10 Comparison Operators

Math Symbol	English	C++ Notation	C++ Sample	Math Equivalent
=	equal to	==	<code>x + 7 == 2 * y</code>	$x + 7 = 2y$
≠	not equal to	!=	<code>ans != 'n'</code>	$ans \neq 'n'$
<	less than	<	<code>count < m + 3</code>	$count < m + 3$
≤	less than or equal to	<=	<code>time <= limit</code>	$time \leq limit$
>	greater than	>	<code>time > limit</code>	$time > limit$
≥	greater than or equal to	>=	<code>age >= 21</code>	$age \geq 21$

the equal sign, and you use the two symbols != for not equal. Such operators should not have any space between the two symbols. The part of the compiler that separates the characters into C++ names and symbols will see the !=, for example, and tell the rest of the compiler that the programmer meant to test for INEQUALITY. When an *if-else* statement is executed, the two expressions being compared are evaluated and compared using the operator. If the comparison turns out to be true, then the first statement is performed. If the comparison fails, then the second statement is executed.

You can combine two comparisons using the “and” operator, which is spelled && in C++. For example, the following Boolean expression is true (that is, is satisfied) provided x is greater than 2 *and* x is less than 7:

```
(2 < x) && (x < 7)
```

When two comparisons are connected using a &&, the entire expression is true, provided both of the comparisons are true (that is, provided both are satisfied); otherwise, the entire expression is false.

You can also combine two comparisons using the “or” operator, which is spelled || in C++. For example, the following is true provided y is less than 0 *or* y is greater than 12:

```
(y < 0) || (y > 12)
```

When two comparisons are connected using a ||, the entire expression is true provided that one or both of the comparisons are true (that is, satisfied); otherwise, the entire expression is false.

Remember that when you use a Boolean expression in an *if-else* statement, the Boolean expression must be enclosed in parentheses. Therefore, an *if-else* statement that uses the && operator and two comparisons is parenthesized as follows:

```
if ( (temperature >= 95) && (humidity >= 90) )
```

```
...
```

The inner parentheses around the comparisons are not required, but they do make the meaning clearer, and we will normally include them.

You can negate any Boolean expression using the `!` operator. If you want to negate a Boolean expression, place the expression in parentheses and place the `!` operator in front of it. For example, `!(x < y)` means “x is *not* less than y.”

The “and” Operator `&&`

You can form a more elaborate Boolean expression by combining two simple tests using the “and” operator `&&`.

SYNTAX (FOR A BOOLEAN EXPRESSION USING `&&`)

```
(Comparison_1) && (Comparison_2)
```

EXAMPLE (WITHIN AN `if-else` STATEMENT)

```
if ( (score > 0) && (score < 10) )
    cout << "score is between 0 and 10\n";
else
    cout << "score is not between 0 and 10.\n";
```

If the value of `score` is greater than 0 and the value of `score` is also less than 10, then the first `cout` statement will be executed; otherwise, the second `cout` statement will be executed.

Since the Boolean expression in an `if-else` statement must be enclosed in parentheses, you should place a second pair of parentheses around the negated expression when it is used in an `if-else` statement. For example, an `if-else` statement might begin as follows:

```
if (!(x < y))
    ...
```

The `!` operator can usually be avoided. For example, our hypothetical `if-else` statement can instead begin with the following, which is equivalent and easier to read:

```
if (x >= y)
    ...
```

We will not have much call to use the `!` operator until later in this book, so we will postpone any detailed discussion of it until then.

Sometimes you want one of the two alternatives in an *if-else* statement to do nothing at all. In C++ this can be accomplished by omitting the *else* part. These sorts of statements are referred to as *if statements* to distinguish them from *if-else* statements. For example, the first of the following two statements is an *if* statement:

```
if (sales >= minimum)
    salary = salary + bonus;
cout << "salary = $" << salary;
```

If the value of *sales* is greater than or equal to the value of *minimum*, the assignment statement is executed and then the following *cout* statement is executed. On the other hand, if the value of *sales* is less than *minimum*, then the embedded assignment statement is not executed, so the *if* statement causes no change (that is, no bonus is added to the base salary), and the program proceeds directly to the *cout* statement.

The "or" Operator ||

You can form a more elaborate Boolean expression by combining two simple tests using the "or" operator `||`.

SYNTAX (FOR A BOOLEAN EXPRESSION USING `||`)

```
(Comparison_1) || (Comparison_2)
```

EXAMPLE (WITHIN AN *if-else* STATEMENT)

```
if ( (x == 1) || (x == y) )
    cout << "x is 1 or x equals y.\n";
else
    cout << "x is neither 1 nor equal to y.\n";
```

If the value of *x* is equal to 1 or the value of *x* is equal to the value of *y* (or both), then the first *cout* statement will be executed; otherwise, the second *cout* statement will be executed.

PITFALL Strings of Inequalities

Do not use a string of inequalities such as the following in your program:

```
if (x < z < y) ←————— Do not do this!
    cout << "z is between x and y.";
```

If you do use this type of expression, your program will probably compile and run, but it will undoubtedly give incorrect output. We will explain why this happens after we learn more details about the C++ language. The same problem will occur with a string of comparisons using any of the comparison operators; the problem is not limited to < comparisons. The correct way to express a string of inequalities is to use the “and” operator `&&` as follows:

```
if ( ( x < z ) && ( z < y ) ) ← correct form
    cout << "z is between x and y.";
```

PITFALL Using = in place of ==

Unfortunately, you can write many things in C++ that you would think are incorrectly formed C++ statements but turn out to have some obscure meaning. This means that if you mistakenly write something that you would expect to produce an error message, you may find out that the program compiles and runs with no error messages, but gives incorrect output. Since you may not realize you wrote something incorrectly, this can cause serious problems. By the time you realize something is wrong, the mistake may be very hard to find. One common mistake is to use the symbol `=` when you mean `==`. For example, consider an *if-else* statement that begins as follows:

```
if ( x = 12 )
    Do_Something
else
    Do_Something_Else
```

Suppose you wanted to test to see if the value of `x` is equal to 12 so that you really meant to use `==` rather than `=`. You might think the compiler will catch your mistake. The expression

```
x = 12
```

is not something that is satisfied or not. It is an assignment statement, so surely the compiler will give an error message. Unfortunately, that is not the case. In C++ the expression `x = 12` is an expression that returns (or has) a value, just like `x + 12` or `2 + 3`. An assignment expression’s value is the value transferred to the variable on the left. For example, the value of `x = 12` is 12. We saw in our discussion of Boolean value compatibility that *int* values may be converted to *true* or *false*. Since 12 is not zero, it is converted to *true*. If you use `x = 12` as the Boolean expression in an *if* statement, the Boolean expression is always *true*, so the first branch (*Do_Something*) is always executed.

This error is very hard to find because it *looks correct*! The compiler can find the error without any special instructions if you put the 12 on the left side of the comparison, as in



VideoNote
Common Bugs with
= and ==

```
    if (12 == x)
        Do_Something;
    else
        Do_Something_Else;
```

Then, the compiler will give an error message if you mistakenly use = instead of ==.

Remember that dropping one of the = in an == is a common error that is not caught by many compilers, is very hard to see, and is almost certainly not what you wanted. In C++, many executable statements can also be used as almost any kind of expression, including as a Boolean expression for an *if-else* statement. If you put an assignment statement where a Boolean expression is expected, the assignment statement will be interpreted as a Boolean expression. Of course the result of the “test” will undoubtedly not be what you intended as the Boolean expression. The *if-else* statement above looks fine at a quick glance and it will compile and run. But, in all likelihood, it will produce puzzling results when it is run. ■

Compound Statements

You will often want the branches of an *if-else* statement to execute more than one statement each. To accomplish this, enclose the statements for each branch between a pair of braces, { and }, as indicated in the second syntax template in Display 2.9 and illustrated in Display 2.11. A list of statements enclosed in a pair of braces is called a **compound statement**. A compound statement is treated as a single statement by C++ and may be used anywhere that a single statement may be used. (Thus, the second syntax template in Display 2.9 is really just a special case of the first one.) Display 2.11 contains two compound statements, embedded in an *if-else* statement.

Syntax rules for *if-else* demand that the Yes statement and No statement be exactly one statement. If more statements are desired for a branch, the statements must be enclosed in braces to convert them to one compound statement. If two or more statements not enclosed by braces are placed between the *if* and the *else*, then the compiler will give an error message.

DISPLAY 2.11 Compound Statements Used With *if-else*

```
1    if (my_score > your_score)
2    {
3        cout << "I win!\n";
4        wager = wager + 100;
5    }
6    else
7    {
8        cout << "I wish these were golf scores.\n";
9        wager = 0;
10   }
```

SELF-TEST EXERCISES

21. Write an *if-else* statement that outputs the word High if the value of the variable `score` is greater than 100 and Low if the value of `score` is at most 100. The variable `score` is of type *int*.
22. Suppose `savings` and `expenses` are variables of type *double* that have been given values. Write an *if-else* statement that outputs the word Solvent, decreases the value of `savings` by the value of `expenses`, and sets the value of `expenses` to 0, provided that `savings` is at least as large as `expenses`. If, however, `savings` is less than `expenses`, the *if-else* statement simply outputs the word Bankrupt and does not change the value of any variables.
23. Write an *if-else* statement that outputs the word Passed provided the value of the variable `exam` is greater than or equal to 60 and the value of the variable `programs_done` is greater than or equal to 10. Otherwise, the *if-else* statement outputs the word Failed. The variables `exam` and `programs_done` are both of type *int*.
24. Write an *if-else* statement that outputs the word Warning provided that either the value of the variable `temperature` is greater than or equal to 100, or the value of the variable `pressure` is greater than or equal to 200, or both. Otherwise, the *if-else* statement outputs the word OK. The variables `temperature` and `pressure` are both of type *int*.
25. Consider a quadratic expression, say
$$x^2 - x - 2$$
Describing where this quadratic is positive (that is, greater than 0), involves describing a set of numbers that are either less than the smaller root (which is -1) or greater than the larger root (which is +2). Write a C++ Boolean expression that is true when this formula has positive values.
26. Consider the quadratic expression
$$x^2 - 4x + 3$$
Describing where this quadratic is negative involves describing a set of numbers that are simultaneously greater than the smaller root (+1) and less than the larger root (+3). Write a C++ Boolean expression that is true when the value of this quadratic is negative.
27. What is the output of the following `cout` statements embedded in these *if-else* statements? You are to assume that these are embedded in a complete correct program. Explain your answer.

```
a. if (0)
    cout << "0 is true";
    else
    cout << "0 is false";
    cout << endl;
b. if (1)
    cout << "1 is true";
    else
    cout << "1 is false";
    cout << endl;
c. if (-1)
    cout << "-1 is true";
    else
    cout << "-1 is false";
    cout << endl;
```

Note: This is an exercise only. This is *not* intended to illustrate programming style you should follow.

Simple Loop Mechanisms

Most programs include some action that is repeated a number of times. For example, the program in Display 2.8 computes the gross pay for one worker. If the company employs 100 workers, then a more complete payroll program would repeat this calculation 100 times. A portion of a program that repeats a statement or group of statements is called a **loop**. The C++ language has a number of ways to create loops. One of these constructions is called a *while* **statement** or *while* **loop**. We will first illustrate its use with a short toy example and then do a more realistic example.

The program in Display 2.12 contains a simple *while* statement shown in color. The portion between the braces, { and }, is called the **body** of the *while* loop; it is the action that is repeated. The statements inside the braces are executed in order, then they are executed again, then again, and so forth until the *while* loop ends. In the first sample dialogue, the body is executed three times before the loop ends, so the program outputs Hello three times. Each repetition of the loop body is called an **iteration** of the loop, and so the first sample dialogue shows three iterations of the loop.

The meaning of a *while* statement is suggested by the English word *while*. The loop is repeated *while the Boolean expression in the parentheses is satisfied*. In Display 2.12 this means that the loop body is repeated as long as the value of the variable `count_down` is greater than 0. Let's consider the first sample dialogue and see how the *while* loop performs. The user types in 3 so the `cin` statement sets the value of `count_down` to 3. Thus, in this case, when the program reaches the *while* statement, it is certainly true that `count_down` is greater than 0, so the statements in the loop body are executed. Every time the loop body is repeated, the following two statements are executed:

DISPLAY 2.12 A *while* Loop

```
1  #include <iostream>
2  using namespace std;
3  int main( )
4  {
5      int count_down;
6      cout << "How many greetings do you want? ";
7      cin >> count_down;
8
9      while (count_down > 0)
10     {
11         cout << "Hello ";
12         count_down = count_down - 1;
13     }
14     cout << endl;
15     cout << "That's all!\n";
16     return 0;
17 }
```

Sample Dialogue 1

```
How many greetings do you want? 3
Hello Hello Hello
That's all!
```

Sample Dialogue 2

```
How many greetings do you want? 1
Hello
That's all!
```

Sample Dialogue 3

```
How many greetings do you want? 0
That's all!
```

*The loop body
is executed
zero times.*

```
cout << "Hello ";
count_down = count_down - 1;
```

Therefore, every time the loop body is repeated, "Hello " is output and the value of the variable `count_down` is decreased by one. After the computer repeats the loop body three times, the value of `count_down` is decreased to 0

DISPLAY 2.13 Syntax of the *while* Statement

A Loop Body with Several Statements:

```

1  while (Boolean_Expression )
2  {
3      Statement_1
4      Statement_2
5      ...
6      Statement_Last
7  }
```

Do NOT put a semicolon here.

body

A Loop Body with a Single Statement:

```

8  while (Boolean_Expression )
9      Statement
```

body

and the program in Display 2.12 and the Boolean expression in parentheses are no longer satisfied. So, this *while* statement ends after repeating the loop body three times.

The syntax for a *while* statement is given in Display 2.13. The *Boolean_Expressions* allowed are exactly the same as the Boolean expressions allowed in an *if-else* statement. Just as in *if-else* statements, the Boolean expression in a *while* statement must be enclosed in parentheses. In Display 2.13 we have given the syntax templates for two cases: the case when there is more than one statement in the loop body and the case when there is just a single statement in the loop body. Note that when there is only a single statement in the loop body, you need not include the braces { and }.

Let's go over the actions performed by a *while* statement in greater detail. When the *while* statement is executed, the first thing that happens is that the Boolean expression following the word *while* is checked. It is either true or false. For example, the comparison

```
count_down > 0
```

is true if the value of `count_down` is positive. If it is false, then no action is taken and the program proceeds to the next statement after the *while* statement. If the comparison is true, then the entire body of the loop is executed. At least one of the expressions being compared typically contains something that might be changed by the loop body, such as the value of `count_down` in the *while* statement in Display 2.12. After the body of the loop is executed, the comparison is again checked. This process is repeated again and again as long as the comparison continues to be true. After each iteration of the loop body, the comparison is again checked and if it is true, then the entire loop body is executed again. When the comparison is no longer true, the *while* statement ends.

The first thing that happens when a *while* statement is executed is that the Boolean expression is checked. If the Boolean expression is not true when the *while* statement begins, then the loop body is never executed. That is exactly what happens in Sample Dialogue 3 of Display 2.12. In many programming situations you want the possibility of executing the loop body zero times. For example, if your *while* loop is reading a list consisting of all the failing scores on an exam and nobody failed the exam, then you want the loop body to be executed zero times.

As we just noted, a *while* loop might execute its loop body zero times, which is often what you want. If, on the other hand, you know that *under all circumstances* your loop body should be executed at least one time, then you can use a *do-while* statement. A *do-while* statement is similar to a *while* statement except that the loop body is always executed at least once. The syntax for a *do-while* statement is given in Display 2.14. A program with a sample *do-while* loop is given in Display 2.15. In that *do-while* loop, as in any *do-while* loop, the first thing that happens is that the statements in the loop body are executed. After that first iteration of the loop body, the *do-while* statement behaves the same as a *while* loop. The Boolean expression is checked. If the Boolean expression is true, the loop body is executed again; the Boolean expression is checked again, and so forth.

Increment and Decrement Operators

We discussed binary operators in the section entitled “Arithmetic Operators and Expressions.” Binary operators have two operands. Unary operators have only one operand. You already know of two unary operators, + and -, as used in the expressions +7 and -7. The C++ language has two other very common unary operators, ++ and --. The ++ operator is called the **increment operator**

DISPLAY 2.14 Syntax of the *do-while* Statement

A Loop Body with Several Statements:

```

1  do
2  {
3      Statement_1
4      Statement_2
5      ...
6      Statement_Last
7  } while (Boolean_Expression);

```

A Loop Body with a Single Statement:

```

8  do
9      Statement
10 while (Boolean_Expression);

```

Do not forget the final semicolon.

DISPLAY 2.15 A *do-while* Loop

```
1  #include <iostream>
2  using namespace std;
3  int main( )
4  {
5      char ans;

6      do
7      {
8          cout << "Hello\n";
9          cout << "Do you want another greeting?\n"
10             << "Press y for yes, n for no,\n"
11             << "and then press return: ";
12         cin >> ans;
13     } while (ans == 'y' || ans == 'Y');
14     cout << "Good-Bye\n";
15     return 0;
16 }
```

Sample Dialogue

```
Hello
Do you want another greeting?
Press y for yes, n for no, and then press return: y
Hello
Do you want another greeting?
Press y for yes, n for no, and then press return: Y
Hello
Do you want another greeting?
Press y for yes, n for no, and then press return: n
Good-Bye
```

and the `--` operator is called the **decrement operator**. They are usually used with variables of type `int`. If `n` is a variable of type `int`, then `n++` increases the value of `n` by one and `n--` decreases the value of `n` by one. So `n++` and `n--` (when followed by a semicolon) are executable statements. For example, the statements

```
int n = 1, m = 7;
n++;
cout << "The value of n is changed to " << n << endl;
m--;
cout << "The value of m is changed to " << m << endl;
```

yield the following output:

```
The value of n is changed to 2
The value of m is changed to 6
```

And now you know where the “++” came from in the name “C++.”

Increment and decrement statements are often used in loops. For example, we used the following statement in the *while* loop in Display 2.12:

```
count_down = count_down - 1;
```

However, most experienced C++ programmers would use the decrement operator rather than the assignment statement, so the entire *while* loop would read as follows:

```
while (count_down > 0)
{
    cout << "Hello ";
    count_down--;
}
```

PROGRAMMING EXAMPLE

Charge Card Balance

Suppose you have a bank charge card with a balance owed of \$50 and suppose the bank charges you 2% per month interest. How many months can you let pass without making any payments before your balance owed will exceed \$100? One way to solve this problem is to simply read each monthly statement and count the number of months that go by until your balance reaches \$100 or more. Better still, you can calculate the monthly balances with a program rather than waiting for the statements to arrive. In this way you will obtain an answer without having to wait so long (and without endangering your credit rating).

After one month the balance would be \$50 plus 2% of \$50, which is \$51. After two months the balance would be \$51 plus 2% of \$51, which is \$52.02. After three months the balance would be \$52.02 plus 2% of \$52.02, and so on. In general, each month increases the balance by 2%. The program could keep track of the balance by storing it in a variable called *balance*. The change in the value of *balance* for one month can be calculated as follows:

```
balance = balance + 0.02 * balance ;
```

If we repeat this action until the value of *balance* reaches (or exceeds) 100.00 and we count the number of repetitions, then we will know the number of months it will take for the balance to reach 100.00. To do this, we need another variable to count the number of times the balance is changed. Let us call this new variable *count*. The final body of our *while* loop will thus contain the following statements:

```
balance = balance + 0.02 * balance;
count++;
```

In order to make this loop perform correctly, we must give appropriate values to the variables `balance` and `count` before the loop is executed. In this case, we can initialize the variables when they are declared. The complete program is shown in Display 2.16.

PITFALL Infinite Loops

A *while* loop or a *do-while* loop does not terminate as long as the Boolean expression after the word *while* is true. This Boolean expression normally contains a variable that will be changed by the loop body, and usually the value of this variable eventually is changed in a way that makes the Boolean expression false and therefore terminates the loop. However, if you make a mistake and write your program so that the Boolean expression is always true, then the loop will run forever. A loop that runs forever is called an **infinite loop**.

First let's describe a loop that does terminate. The following C++ code will write out the positive even numbers less than 12. That is, it will output the numbers 2, 4, 6, 8, and 10, one per line, and then the loop will end.

```
x = 2;
while (x != 12)
{
    cout << x << endl;
    x = x + 2;
}
```

The value of `x` is increased by 2 on each loop iteration until it reaches 12. At that point, the Boolean expression after the word *while* is no longer true, so the loop ends.

Now suppose you want to write out the odd numbers less than 12, rather than the even numbers. You might mistakenly think that all you need do is change the initializing statement to

```
x = 1;
```

but this mistake will create an infinite loop. Because the value of `x` goes from 11 to 13, the value of `x` is never equal to 12, so the loop will never terminate.

This sort of problem is common when loops are terminated by checking a numeric quantity using `==` or `!=`. When dealing with numbers, it is always safer to test for passing a value. For example, the following will work fine as the first line of our *while* loop:

```
while (x < 12)
```

With this change, `x` can be initialized to any number and the loop will still terminate.

A program that is in an infinite loop will run forever unless some external force stops it. Since you can now write programs that contain an infinite loop, it is a good idea to learn how to force a program to terminate. The method for forcing a program to stop varies from system to system. The keystrokes Control-C will terminate a program on many systems. (To type a Control-C, hold down the Control key while pressing the C key.) ■

DISPLAY 2.16 Charge Card Program

```
1  #include <iostream>
2  using namespace std;
3  int main( )
4  {
5      double balance = 50.00;
6      int count = 0;
7      cout << "This program tells you how long it takes\n"
8           << "to accumulate a debt of $100, starting with\n"
9           << "an initial balance of $50 owed.\n"
10          << "The interest rate is 2% per month.\n";
11
12      while (balance < 100.00)
13      {
14          balance = balance + 0.02 * balance;
15          count++;
16      }
17
18      cout << "After " << count << " months,\n";
19      cout.setf(ios::fixed);
20      cout.setf(ios::showpoint);
21      cout.precision(2);
22      cout << "your balance due will be $" << balance << endl;
23      return 0;
24 }
```

Sample Dialogue

```
This program tells you how long it takes
to accumulate a debt of $100, starting with
an initial balance of $50 owed.
The interest rate is 2% per month.
After 36 months,
your balance due will be $101.99
```

SELF-TEST EXERCISES

28. What is the output produced by the following (when embedded in a correct program with `x` declared to be of type `int`)?

```
x = 10;
while (x > 0)
{
    cout << x << endl;
    x = x - 3;
}
```

29. What output would be produced in the previous exercise if the `>` sign were replaced with `<`?

30. What is the output produced by the following (when embedded in a correct program with `x` declared to be of type `int`)?

```
x = 10;
do
{
    cout << x << endl;
    x = x - 3;
} while (x > 0);
```

31. What is the output produced by the following (when embedded in a correct program with `x` declared to be of type `int`)?

```
x = -42;
do
{
    cout << x << endl;
    x = x - 3;
} while (x > 0);
```

32. What is the most important difference between a `while` statement and a `do-while` statement?

33. What is the output produced by the following (when embedded in a correct program with `x` declared to be of type `int`)?

```
x = 10;
while (x > 0)
{
    cout << x << endl;
    x = x + 3;
}
```

34. Write a complete C++ program that outputs the numbers 1 to 20, one per line. The program does nothing else.

2.5 PROGRAM STYLE

In matters of grave importance, style, not sincerity, is the vital thing.

OSCAR WILDE, *The Importance of Being Earnest*

All the variable names in our sample programs were chosen to suggest their use. Our sample programs were laid out in a particular format. For example, the declarations and statements were all indented the same amount. These and other matters of style are of more than aesthetic interest. A program that is written with careful attention to style is easier to read, easier to correct, and easier to change.

Indenting

A program should be laid out so that elements that are naturally considered a group are made to look like a group. One way to do this is to skip a line between parts that are logically considered separate. Indenting can also help to make the structure of the program clearer. A statement within a statement should be indented. In particular, *if-else* statements, *while* loops, and *do-while* loops should be indented either as in our sample programs or in some similar manner.

The braces `{}` determine a large part of the structure of a program. Placing each brace on a line by itself, as we have been doing, makes it easy to find the matching pairs. Notice that we have indented some pairs of braces. When one pair of braces is embedded in another pair, the embedded braces are indented more than the outer braces. Look back at the program in Display 2.16. The braces for the body of the *while* loop are indented more than the braces for the `main` part of the program.

There are at least two schools of thought on where you should place braces. The first, which we use in this book, is to reserve a separate line for each brace. This form is easiest to read. The second school of thought holds that the opening brace for a pair need not be on a line by itself. If used with care, this second method can be effective, and it does save space. The important point is to use a style that shows the structure of the program. The exact layout is not precisely dictated, but you should be consistent within any one program.

Comments

In order to make a program understandable, you should include some explanatory notes at key places in the program. Such notes are called **comments**. C++ and most other programming languages have provisions for including such comments within the text of a program. In C++ the symbols `//` are used to indicate the start of a comment. All of the text between the `//` and the end of the line is a comment. The compiler simply ignores anything that

follows `//` on a line. If you want a comment that covers more than one line, place a `//` on each line of the comment. The symbols `//` are two slashes (without a space between them).

In this book, comments will always be written in italic so that they stand out from the program text. Some text editors indicate comments by showing them in a different color from the rest of the program text.

There is another way to insert comments in a C++ program. Anything between the symbol pair `/*` and the symbol pair `*/` is considered a comment and is ignored by the compiler. Unlike the `//` comments, which require an additional `//` on each line, the `/*` to `*/` comments can span several lines, like so:

```
/*This is a comment that spans  
three lines. Note that there is no comment  
symbol of any kind on the second line.*/
```

Comments of the `/* */` type may be inserted anywhere in a program that a space or line break is allowed. However, they should not be inserted anywhere except where they are easy to read and do not distract from the layout of the program. Usually, comments are only placed at the ends of lines or on separate lines by themselves.

There are differing opinions on which kind of comment is best to use. Either variety (the `//` kind or the `/* */` kind) can be effective if used with care. We will use the `//` kind in this book.

It is difficult to say just how many comments a program should contain. The only correct answer is “just enough,” which of course conveys little to the novice programmer. It will take some experience to get a feel for when it is best to include a comment. Whenever something is important and not obvious, it merits a comment. However, too many comments are as bad as too few. A program that has a comment on each line will be so buried in comments that the structure of the program is hidden in a sea of obvious observations. Comments like the following contribute nothing to understanding and should not appear in a program:

```
distance = speed * time; //Computes the distance traveled
```

Notice the comment given at the start of the program in Display 2.17. All programs should begin with a comment similar to the one shown there. It gives all the essential information about the program: what file the program is in, who wrote the program, how to contact the person who wrote the program, what the program does, the date that the program was last modified, and any other particulars that are appropriate, such as the assignment number, if the program is a class assignment. Exactly what you include in this comment will depend on your particular situation. We will not include such long comments in the programs in the rest of this book, but you should always begin your programs with a similar comment.

DISPLAY 2.17 Comments and Named Constants

```
1 //File Name: health.cpp (Your system may require some suffix other than cpp.)
2 //Author: Your Name Goes Here.
3 //Email Address: you@yourmachine.bla.bla
4 //Assignment Number: 2
5 //Description: Program to determine if the user is ill.
6 //Last Changed: September 23, 2014
7
8 #include <iostream>
9 using namespace std;
10 int main( )
11 {
12     const double NORMAL = 98.6; //degrees Fahrenheit
13     double temperature;
14
15     cout << "Enter your temperature: ";
16     cin >> temperature;
17
18     if (temperature > NORMAL)
19     {
20         cout << "You have a fever.\n";
21         cout << "Drink lots of liquids and get to bed.\n";
22     }
23     else
24     {
25         cout << "You don't have a fever.\n";
26         cout << "Go study.\n";
27     }
28
29     return 0;
30 }
```



Your programs should always begin with a comment similar to this one.

Sample Dialogue

```
Enter your temperature: 98.6
You don't have a fever.
Go study.
```

Naming Constants

There are two problems with numbers in a computer program. The first is that they carry no mnemonic value. For example, when the number 10 is encountered in a program, it gives no hint of its significance. If the program is a banking program, it might be the number of branch offices or the number of teller windows at the main office. In order to understand the program,

you need to know the significance of each constant. The second problem is that when a program needs to have some numbers changed, the changing tends to introduce errors. Suppose that 10 occurs twelve times in a banking program, that four of the times it represents the number of branch offices, and that eight of the times it represents the number of teller windows at the main office. When the bank opens a new branch and the program needs to be updated, there is a good chance that some of the 10s that should be changed to 11 will not be, or some that should not be changed will be. The way to avoid these problems is to name each number and use the name instead of the number within your program. For example, a banking program might have two constants with the names `BRANCH_COUNT` and `WINDOW_COUNT`. Both these numbers might have a value of 10, but when the bank opens a new branch, all you need do in order to update the program is to change the definition of `BRANCH_COUNT`.

How do you name a number in a C++ program? One way is to initialize a variable to that number value, as in the following example:

```
int BRANCH_COUNT = 10;
int WINDOW_COUNT = 10;
```

There is, however, one problem with this method of naming number constants: You might inadvertently change the value of one of these variables. C++ provides a way of marking an initialized variable so that it cannot be changed. If your program tries to change one of these variables, it produces an error condition. To mark a variable declaration so that the value of the variable cannot be changed, precede the declaration with the word *const* (which is an abbreviation of *constant*). For example:

```
const int BRANCH_COUNT = 10;
const int WINDOW_COUNT = 10;
```

If the variables are of the same type, it is possible to combine the previous lines into one declaration, as follows:

```
const int BRANCH_COUNT = 10, WINDOW_COUNT = 10;
```

However, most programmers find that placing each name definition on a separate line is clearer. The word *const* is often called a **modifier**, because it modifies (restricts) the variables being declared.

A variable declared using the *const* modifier is often called a **declared constant**. Writing declared constants in all uppercase letters is not required by the C++ language, but it is standard practice among C++ programmers.

Once a number has been named in this way, the name can then be used anywhere the number is allowed, and it will have exactly the same meaning as the number it names. To change a named constant, you need change only the initializing value in the *const* variable declaration. The meaning of all occurrences of `BRANCH_COUNT`, for instance, can be changed from 10 to 11 simply by changing the initializing value of 10 in the declaration of `BRANCH_COUNT`.

Although unnamed numeric constants are allowed in a program, you should seldom use them. It often makes sense to use unnamed number constants for well-known, easily recognizable, and unchangeable quantities, such as 100 for the number of centimeters in a meter. However, all other numeric constants should be given names in the fashion we just described. This will make your programs easier to read and easier to change.

Display 2.17 contains a simple program that illustrates the use of the declaration modifier *const*.

Naming Constants with the *const* Modifier

When you initialize a variable inside a declaration, you can mark the variable so that the program is not allowed to change its value. To do this, place the word *const* in front of the declaration, as described below:

SYNTAX

```
const Type_Name Variable_Name = Constant;
```

EXAMPLES

```
const int MAX_TRIES = 3;
const double PI = 3.14159;
```

SELF-TEST EXERCISES

35. The following *if-else* statement will compile and run without any problems. However, it is not laid out in a way that is consistent with the other *if-else* statements we have used in our programs. Rewrite it so that the layout (indenting and line breaks) matches the style we used in this chapter.

```
if (x < 0) {x = 7; cout << "x is now positive.";}
else {x = - 7; cout << "x is now negative.";}
```

36. What output would be produced by the following two lines (when embedded in a complete and correct program)?

```
//cout << "Hello from";
cout << "Self-Test Exercise";
```

37. Write a complete C++ program that asks the user for a number of gallons and then outputs the equivalent number of liters. There are 3.78533 liters in a gallon. Use a declared constant. Since this is just an exercise, you need not have any comments in your program.

CHAPTER SUMMARY

- Use meaningful names for variables.
- Be sure to check that variables are declared to be of the correct data type.
- Be sure that variables are initialized before the program attempts to use their value. This can be done when the variable is declared or with an assignment statement before the variable is first used.
- Use enough parentheses in arithmetic expressions to make the order of operations clear.
- Always include a prompt line in a program whenever the user is expected to enter data from the keyboard, and always echo the user's input.
- An *if-else* statement allows your program to choose one of two alternative actions. An *if* statement allows your program to decide whether to perform some one particular action.
- A *do-while* loop always executes its loop body at least once. In some situations, a *while* loop might not execute the body of the loop at all.
- Almost all number constants in a program should be given meaningful names that can be used in place of the numbers. This can be done by using the modifier *const* in a variable declaration.
- Use an indenting, spacing, and line-break pattern similar to the sample programs.
- Insert comments to explain major subsections or any unclear part of a program.

Answers to Self-Test Exercises

1. `int feet = 0, inches = 0;`
`int feet(0), inches(0);`

2. `int count = 0;`
`double distance = 1.5;`

Alternatively, you could use

```
int count(0);  
double distance(1.5);
```

3. `sum = n1 + n2;`

4. `length = length + 8.3;`

5. `product = product * n;`

6. The actual output from a program such as this is dependent on the system and the history of the use of the system.

```
#include <iostream>
using namespace std;
int main()
{
    int first, second, third, fourth, fifth;
    cout << first << " " << second << " " << third
        << " " << fourth << " " << fifth << endl;
    return 0;
}
```

7. There is no unique right answer for this one. Below are possible answers:

- a. speed
- b. pay_rate
- c. highest or max_score

8. `cout << "The answer to the question of\n"`
`<< "Life, the Universe, and Everything is 42.\n";`

9. `cout << "Enter a whole number and press return: ";`
`cin >> the_number;`

10. `cout.setf(ios::fixed);`
`cout.setf(ios::showpoint);`
`cout.precision(3);`

11. `#include <iostream>`
`using namespace std;`
`int main()`
`{`
 `cout << "Hello world\n";`
 `return 0;`
`}`

12. `#include <iostream>`
`using namespace std;`

`int main()`
`{`
 `int n1, n2, sum;`
 `cout << "Enter two whole numbers\n";`
 `cin >> n1 >> n2;`
 `sum = n1 + n2;`
 `cout << "The sum of " << n1 << " and "`
 `<< n2 << " is " << sum << endl;`
 `return 0;`
`}`

13. `cout << endl << "\t";`
14. `#include <iostream>`
`using namespace std;`
- ```

int main()
{
 double one(1.0), two(1.414), three(1.732),
 four(2.0), five(2.236);
 cout << "\tN\tSquare Root\n";
 cout << "\t1\t" << one << endl
 << "\t2\t" << two << endl
 << "\t3\t" << three << endl
 << "\t4\t" << four << endl
 << "\t5\t" << five << endl;
 return 0;
}

```
15.  $3 * x$   
 $3 * x + y$   
 $(x + y) / 7$  Note that  $x + y / 7$  is not correct.  
 $(3 * x + y) / (z + 2)$

16. `bcbc`

17. `(1/3) * 3 is equal to 0`

Since 1 and 3 are of type *int*, the / operator performs integer division, which discards the remainder, so the value of 1/3 is 0, not 0.3333. This makes the value of the entire expression  $0 * 3$ , which of course is 0.

18. `#include <iostream>`  
`using namespace std;`
- ```

int main()
{
    int number1, number2;

    cout << "Enter two whole numbers: ";
    cin >> number1 >> number2;
    cout << number1 << " divided by " << number2
         << " equals " << (number1/number2) << endl
         << "with a remainder of " << (number1%number2)
         << endl;
    return 0;
}

```

19. a. 52.0

- b. $9/5$ has *int* value 1; since numerator and denominator are both *int*, integer division is done; the fractional part is discarded.

```
f = (9.0 / 5) * c + 32.0;
```

or this

```
f = 1.8 * c + 32.0;
```

20. 030406

The strings are concatenated with the + operator.

- ```
21. if (score > 100)
 cout << "High";
else
 cout << "Low";
```

You may want to add `\n` to the end of these quoted strings depending on the other details of the program.

- ```
22. if (savings >= expenses)
{
    savings = savings - expenses;
    expenses = 0;
    cout << "Solvent";
}
else
{
    cout << "Bankrupt";
}
```

You may want to add `\n` to the end of these quoted strings depending on the other details of the program.

- ```
23. if ((exam >= 60) && (programs_done >= 10))
 cout << "Passed";
else
 cout << "Failed";
```

You may want to add `\n` to the end of these quoted strings depending on the other details of the program.

- ```
24. if ( (temperature >= 100) || (pressure >= 200) )
    cout << "Warning";
else
    cout << "OK";
```

You may want to add `\n` to the end of these quoted strings depending on the other details of the program.

- ```
25. (x < -1) || (x > 2)
```

26.  $(1 < x) \ \&\& \ (x < 3)$
27. a. 0 is *false*. In the section on type compatibility, it is noted that the *int* value 0 converts to *false*.  
b. 1 is *true*. In the section on type compatibility, it is noted that a nonzero *int* value converts to *true*.  
c. -1 is *true*. In the section on type compatibility, it is noted that a nonzero *int* value converts to *true*.
28. 10  
7  
4  
1
29. There would be no output, since the Boolean expression  $(x < 0)$  is not satisfied and so the *while* statement ends without executing the loop body.
30. The output is exactly the same as it was for Self-Test Exercise 27.
31. The body of the loop is executed before the Boolean expression is checked, the Boolean expression is false, and so the output is  
-42
32. With a *do-while* statement the loop body is always executed at least once. With a *while* statement there can be conditions under which the loop body is not executed at all.
33. This is an infinite loop. The output would begin with the following and conceptually go on forever:  
10  
13  
16  
19

(Once the value of *x* becomes larger than the largest integer allowed on your computer, the program may stop or exhibit other strange behavior, but the loop is conceptually an infinite loop.)

34. 

```
#include <iostream>
using namespace std;

int main()
{
 int n = 1;
 while (n <= 20)
 {
```

- ```

        cout << n << endl;
        n++;
    }
    return 0;
}

```
35. `if` ($x < 0$)
- ```

{
 x = 7;
 cout << "x is now positive.";
}
else
{
 x = -7;
 cout << "x is now negative.";
}

```
36. The first line is a comment and is not executed. So the entire output is just the following line:

Self-Test Exercise

37. `#include <iostream>`  
`using namespace std;`
- ```

int main()
{
    const double LITERS_PER_GALLON = 3.78533;
    double gallons, liters;

    cout << "Enter the number of gallons:\n";
    cin >> gallons;

    liters = gallons*LITERS_PER_GALLON;
    cout << "There are " << liters << " in "
        << gallons << " gallons.\n";

    return 0;
}

```

PRACTICE PROGRAMS

Practice Programs can generally be solved with a short program that directly applies the programming principles presented in this chapter.

1. A metric ton is 35,273.92 ounces. Write a program that will read the weight of a package of breakfast cereal in ounces and output the weight in metric tons as well as the number of boxes needed to yield 1 metric ton of cereal. Your program should allow the user to repeat this calculation as often as the user wishes.

2. The Babylonian algorithm to compute the square root of a number n is as follows:
 1. Make a *guess* at the answer (you can pick $n/2$ as your initial guess).
 2. Compute $r = n / \textit{guess}$
 3. Set $\textit{guess} = (\textit{guess} + r) / 2$
 4. Go back to step 2 for as many iterations as necessary. The more that steps 2 and 3 are repeated, the closer *guess* will become to the square root of n .

Write a program that inputs a *double* for n and iterates through the Babylonian algorithm 100 times. For a more challenging version, iterate until *guess* is within 1% of the previous guess, and outputs the answer as a *double*.



VideoNote
Solution to Practice
Program 2.3

3. Many treadmills output the speed of the treadmill in miles per hour (mph) on the console, but most runners think of speed in terms of a pace. A common pace is the number of minutes and seconds per mile instead of mph.

Write a program that starts with a quantity in mph and converts the quantity into minutes and seconds per mile. As an example, the proper output for an input of 6.5 mph should be 9 minutes and 13.8 seconds per mile. If you need to convert a *double* to an *int*, which will discard any value after the decimal point, then you may use

```
intValue = static_cast<int>(dblVal);
```

4. Write a program that plays the game of Mad Lib. Your program should prompt the user to enter the following strings:
 - The first or last name of your instructor
 - Your name
 - A food
 - A number between 100 and 120
 - An adjective
 - A color
 - An animal

After the strings are input, they should be substituted into the story below and output to the console.

Dear Instructor [Instructor Name],

I am sorry that I am unable to turn in my homework at this time. First, I ate a rotten [Food], which made me turn [Color] and extremely ill. I came down with a fever of [Number 100-120]. Next, my [Adjective] pet [Animal] must have smelled the remains of the [Food] on my homework, because he ate it. I am currently rewriting my homework and hope you will accept it late.

Sincerely,
[Your Name]

5. The following is a short program that computes the volume of a sphere given the radius. It will compile and run, but it does not adhere to the program style recommended in Section 2.5. Rewrite the program using the style described in the chapter for indentation, adding comments, and appropriately named constants.

```
#include <iostream>
using namespace std;
int main()
{
    double radius, vm;
    cout << "Enter radius of a sphere." << endl; cin >> radius;
    vm = (4.0 / 3.0) * 3.1415 * radius * radius * radius;
    cout << " The volume is " << vm << endl;
    return 0;
}
```

PROGRAMMING PROJECTS

Programming Projects require more problem-solving than Practice Programs and can usually be solved many different ways. Visit www.myprogramminglab.com to complete many of these Programming Projects online and get instant feedback.

1. A government research lab has concluded that an artificial sweetener commonly used in diet soda pop will cause death in laboratory mice. A friend of yours is desperate to lose weight but cannot give up soda pop. Your friend wants to know how much diet soda pop it is possible to drink without dying as a result. Write a program to supply the answer. The input to the program is the amount of artificial sweetener needed to kill a mouse (use 5 grams), the mass of the mouse (use 35 grams), and the weight of the dieter (use 45400 grams for a 100 pound person). Assume that the lethal dose for a mouse is proportional to the lethal dose for the human. A single can of soda pop has a mass of 350 grams. To ensure the safety of your friend, be sure the program requests the weight at which the dieter will stop dieting, rather than the dieter's current weight. Assume that diet

soda contains 1/10th of 1% artificial sweetener. Use a variable declaration with the modifier *const* to give a name to this fraction. You may want to express the percent as the *double* value 0.001. Your program should allow the calculation to be repeated as often as the user wishes.

2. Workers at a particular company have won a 7.6% pay increase retroactive for 6 months. Write a program that takes an employee's previous annual salary as input, and outputs the amount of retroactive pay due the employee, the new annual salary, and the new monthly salary. Use a variable declaration with the modifier *const* to express the pay increase. Your program should allow the calculation to be repeated as often as the user wishes.
3. Modify your program from Programming Project 2 so that it calculates the retroactive salary for a worker for any number of months, instead of just 6 months. The number of months is entered by the user.
4. Negotiating a consumer loan is not always straightforward. One form of loan is the discount installment loan, which works as follows. Suppose a loan has a face value of \$1,000, the interest rate is 15%, and the duration is 18 months. The interest is computed by multiplying the face value of \$1,000 by 0.15, to yield \$150. That figure is then multiplied by the loan period of 1.5 years to yield \$225 as the total interest owed. That amount is immediately deducted from the face value, leaving the consumer with only \$775. Repayment is made in equal monthly installments based on the face value. So the monthly loan payment will be \$1,000 divided by 18, which is \$55.56. This method of calculation may not be too bad if the consumer needs \$775 dollars, but the calculation is a bit more complicated if the consumer needs \$1,000. Write a program that will take three inputs: the amount the consumer needs to receive, the interest rate, and the duration of the loan in months. The program should then calculate the face value required in order for the consumer to receive the amount needed. It should also calculate the monthly payment. Your program should allow the calculations to be repeated as often as the user wishes.
5. Write a program that determines whether a meeting room is in violation of fire law regulations regarding the maximum room capacity. The program will read in the maximum room capacity and the number of people attending the meeting. If the number of people is less than or equal to the maximum room capacity, the program announces that it is legal to hold the meeting and tells how many additional people may legally attend. If the number of people exceeds the maximum room capacity, the program announces that the meeting cannot be held as planned due to fire regulations and tells how many people must be excluded in order to meet the fire regulations. For a harder version, write your program so that it allows the calculation to be repeated as often as the user wishes. If this is a class exercise, ask your instructor whether you should do this harder version.

6. An employee is paid at a rate of \$16.78 per hour for the first 40 hours worked in a week. Any hours over that are paid at the overtime rate of one-and-one-half times that. From the worker's gross pay, 6% is withheld for Social Security tax, 14% is withheld for federal income tax, 5% is withheld for state income tax, and \$10 per week is withheld for union dues. If the worker has three or more dependents, then an additional \$35 is withheld to cover the extra cost of health insurance beyond what the employer pays. Write a program that will read in the number of hours worked in a week and the number of dependents as input and will then output the worker's gross pay, each withholding amount, and the net take-home pay for the week. For a harder version, write your program so that it allows the calculation to be repeated as often as the user wishes. If this is a class exercise, ask your instructor whether you should do this harder version.
7. It is difficult to make a budget that spans several years, because prices are not stable. If your company needs 200 pencils per year, you cannot simply use this year's price as the cost of pencils 2 years from now. Because of inflation the cost is likely to be higher than it is today. Write a program to gauge the expected cost of an item in a specified number of years. The program asks for the cost of the item, the number of years from now that the item will be purchased, and the rate of inflation. The program then outputs the estimated cost of the item after the specified period. Have the user enter the inflation rate as a percentage, like 5.6 (percent). Your program should then convert the percent to a fraction, like 0.056, and should use a loop to estimate the price adjusted for inflation. (*Hint*: This is similar to computing interest on a charge card account, which was discussed in this chapter.)
8. You have just purchased a stereo system that cost \$1,000 on the following credit plan: no down payment, an interest rate of 18% per year (and hence 1.5% per month), and monthly payments of \$50. The monthly payment of \$50 is used to pay the interest and whatever is left is used to pay part of the remaining debt. Hence, the first month you pay 1.5% of \$1,000 in interest. That is \$15 in interest. So, the remaining \$35 is deducted from your debt, which leaves you with a debt of \$965.00. The next month you pay interest of 1.5% of \$965.00, which is \$14.48. Hence, you can deduct \$35.52 (which is \$50 - \$14.48) from the amount you owe. Write a program that will tell you how many months it will take you to pay off the loan, as well as the total amount of interest paid over the life of the loan. Use a loop to calculate the amount of interest and the size of the debt after each month. (Your final program need not output the monthly amount of interest paid and remaining debt, but you may want to write a preliminary version of the program that does output these values.) Use a variable to count the number of loop iterations and hence the number of months until the debt is zero. You may want to use other variables as well. The last payment may be less than \$50. Do not forget the interest on the last payment. If you owe \$50, then your

monthly payment of \$50 will not pay off your debt, although it will come close. One month's interest on \$50 is only 75 cents.

9. Write a program that reads in ten whole numbers and that outputs the sum of all the numbers greater than zero, the sum of all the numbers less than zero (which will be a negative number or zero), and the sum of all the numbers, whether positive, negative, or zero. The user enters the ten numbers just once each and the user can enter them in any order. Your program should not ask the user to enter the positive numbers and the negative numbers separately.
10. Modify your program from Programming Project 9 so that it outputs the sum of all positive numbers, the average of all positive numbers, the sum of all nonpositive numbers, the average of all nonpositive numbers, the sum of all positive and nonpositive numbers, and the average of all numbers entered.
11. Sound travels through air as a result of collisions between the molecules in the air. The temperature of the air affects the speed of the molecules, which in turn affects the speed of sound. The velocity of sound in dry air can be approximated by the formula:

$$\text{velocity} \approx 331.3 + 0.61 \times T_c$$

where T_c is the temperature of the air in degrees Celsius and the velocity is in meters/second.

Write a program that allows the user to input a starting and an ending temperature. Within this temperature range, the program should output the temperature and the corresponding velocity in 1° increments. For example, if the user entered 0 as the start temperature and 2 as the end temperature, then the program should output

```
At 0 degrees Celsius the velocity of sound is 331.3 m/s
At 1 degrees Celsius the velocity of sound is 331.9 m/s
At 2 degrees Celsius the velocity of sound is 332.5 m/s
```

12. Many private water wells produce only 1 or 2 gallons of water per minute. One way to avoid running out of water with these low-yield wells is to use a holding tank. A family of four will use about 250 gallons of water per day. However, there is a "natural" water holding tank in the casing (that is, the hole) of the well itself. A deeper well stores more water that can be pumped out for household use. But how much water will be available?

Write a program that allows the user to input the radius of the well casing in inches (a typical well will have a 3-inch radius) and the depth of the well in feet (assume water will fill this entire depth, although in



practice that will not be true since the static water level will generally be 50 feet or more below the ground surface). The program should output the number of gallons stored in the well casing. For your reference, the volume of a cylinder is $\pi r^2 h$, where r is the radius and h is the height, and 1 cubic foot = 7.48 gallons of water.

For example, a 300-foot-well full of water with a radius of 3 inches for the casing holds about 441 gallons of water—plenty for a family of four and no need to install a separate holding tank.

13. The Harris–Benedict equation estimates the number of calories your body needs to maintain your weight if you do no exercise. This is called your basal metabolic rate, or BMR.

The formula for the calories needed for a woman to maintain her weight is

$$\text{BMR} = 655 + (4.3 \times \text{weight in pounds}) + (4.7 \times \text{height in inches}) - (4.7 \times \text{age in years})$$

The formula for the calories needed for a man to maintain his weight is

$$\text{BMR} = 66 + (6.3 \times \text{weight in pounds}) + (12.9 \times \text{height in inches}) - (6.8 \times \text{age in years})$$

A typical chocolate bar will contain around 230 calories. Write a program that allows the user to input his or her weight in pounds, height in inches, age in years, and the character M for male and F for female. The program should then output the number of chocolate bars that should be consumed to maintain one's weight for the appropriate sex of the specified weight, height, and age.

14. Write a program that calculates the total grade for N classroom exercises as a percentage. The user should input the value for N followed by each of the N scores and totals. Calculate the overall percentage (sum of the total points earned divided by the total points possible) and output it as a percentage. Sample input and output is shown below.

How many exercises to input? 3

Score received for exercise 1: 10

Total points possible for exercise 1: 10

Score received for exercise 2: 7

Total points possible for exercise 2: 12

Score received for exercise 3: 5

Total points possible for exercise 3: 8

Your total is 22 out of 30, or 73.33%.

15. It is important to consider the effect of thermal expansion when building a structure that must withstand changes in temperature. For example, a metal beam will expand in hot temperatures. The additional stress could cause the structure to fail. Similarly, a material will contract in cold temperatures. The linear change in length of a material if it is allowed to freely expand is described by the following equation:

$$L_{\Delta} = \alpha L_0 T_{\Delta}$$

Here, L_0 is the initial length of the material in meters, L_{Δ} is the displacement in meters, T_{Δ} is the change in temperature in Celsius, and α is a coefficient for linear expansion.

Write a program that inputs α , L_{Δ} , and T_{Δ} , then calculates and outputs the linear displacement. If the displacement is positive then output that "The material will expand by" the displacement in meters. If the displacement is negative then output that "The material will contract by" the displacement in meters. You shouldn't output the displacement as a negative number. Here are some values for α for different materials.

Aluminum	2.31×10^{-5}
Copper	1.70×10^{-5}
Glass	8.50×10^{-6}
Steel	1.20×10^{-5}

More Flow of Control 3

3.1 USING BOOLEAN EXPRESSIONS 112

Evaluating Boolean Expressions 112
Pitfall: Boolean Expressions Convert to *int* Values 116
Enumeration Types (*Optional*) 119

3.2 MULTIWAY BRANCHES 120

Nested Statements 120
Programming Tip: Use Braces in Nested Statements 121
Multiway *if-else* Statements 123
Programming Example: State Income Tax 125
The *switch* Statement 128
Pitfall: Forgetting a *break* in a *switch* Statement 132
Using *switch* Statements for Menus 133
Blocks 135
Pitfall: Inadvertent Local Variables 138

3.3 MORE ABOUT C++ LOOP STATEMENTS 139

The *while* Statements Reviewed 139
Increment and Decrement Operators Revisited 141
The *for* Statement 144
Pitfall: Extra Semicolon in a *for* Statement 149
What Kind of Loop to Use 150
Pitfall: Uninitialized Variables and Infinite Loops 152
The *break* Statement 153
Pitfall: The *break* Statement in Nested Loops 154

3.4 DESIGNING LOOPS 155

Loops for Sums and Products 155
Ending a Loop 157
Nested Loops 160
Debugging Loops 162



When you come to a fork in the road, take it.

ATTRIBUTED TO YOGI BERRA

INTRODUCTION

The order in which the statements in your program are performed is called **flow of control**. The *if-else* statement, the *while* statement, and the *do-while* statement are three ways to specify flow of control. This chapter explores some new ways to use these statements and introduces two new statements called the *switch* statement and the *for* statement, which are also used for flow of control. The actions of an *if-else* statement, a *while* statement, or a *do-while* statement are controlled by Boolean expressions. We begin by discussing Boolean expressions in more detail.

PREREQUISITES

This chapter uses material from Chapter 2.

3.1 USING BOOLEAN EXPRESSIONS

“Contrariwise,” continued Tweedledee. “If it was so, it might be; and if it were so, it would be; but as it isn’t, it ain’t. That’s logic.”

LEWIS CARROLL, *Through the Looking-Glass*

Evaluating Boolean Expressions

A **Boolean expression** is an expression that can be thought of as being *true* or *false* (that is, *true* if satisfied or *false* if not satisfied). Thus far you have used Boolean expressions as the test condition in *if-else* statements and as the controlling expression in loops, such as a *while* loop. However, a Boolean expression has an independent identity apart from any *if-else* statement or loop statement you might use it in. The C++ type *bool* provides you the ability to declare variables that can carry the values *true* and *false*.

A Boolean expression can be evaluated in the same way that an arithmetic expression is evaluated. The only difference is that an arithmetic expression uses operations such as +, *, and / and produces a number as the final result, whereas a Boolean expression uses relational operations such as == and < and Boolean operations such as &&, ||, and ! to produce one of the two values *true* and *false* as the final result. Note that ==, !=, <, <=, and so forth operate on pairs of any built-in type to produce a Boolean value *true* or *false*.

If you understand the way Boolean expressions are evaluated, you will be able to write and understand complex Boolean expressions and be able to use Boolean expressions for the value returned by a function.

First let's review evaluating an arithmetic expression; the same technique will work to evaluate Boolean expressions. Consider the following arithmetic expression:

$$(x + 1) * (x + 3)$$

Assume that the variable x has the value 2. To evaluate this arithmetic expression, you evaluate the two sums to obtain the numbers 3 and 5, then you combine these two numbers 3 and 5 using the $*$ operator to obtain 15 as the final value. Notice that in performing this evaluation, you do not multiply the expressions $(x + 1)$ and $(x + 3)$. Instead, you multiply the values of these expressions. You use 3; you do not use $(x + 1)$. You use 5; you do not use $(x + 3)$.

The computer evaluates Boolean expressions the same way. Subexpressions are evaluated to obtain values, each of which is either *true* or *false*. These individual values of *true* or *false* are then combined according to the rules in the tables shown in Display 3.1. For example, consider the Boolean expression

$$!((y < 3) \ || \ (y > 7))$$

which might be the controlling expression for an *if-else* statement or a *while* statement. Suppose the value of y is 8. In this case, $(y < 3)$ evaluates to *false* and $(y > 7)$ evaluates to *true*, so the Boolean expression above is equivalent to

$$!(false \ || \ true)$$

Consulting the tables for $||$ (which is labeled **OR** in Display 3.1), the computer sees that the expression inside the parentheses evaluates to *true*. Thus, the computer sees that the entire expression is equivalent to

$$!(true)$$

Consulting the tables again, the computer sees that $!(true)$ evaluates to *false*, and so it concludes that *false* is the value of the original Boolean expression.

Almost all the examples we have constructed thus far have been fully parenthesized to show exactly how each $\&\&$, $||$, and $!$ is used to construct an expression. Parentheses are not always required. If you omit parentheses, the default precedence is as follows: perform $!$ first, then evaluate relational operators such as $<$, then evaluate $\&\&$, and then evaluate $||$. However, it is a good practice to include most parentheses in order to make the expression easier to understand. One place where parentheses can safely be omitted is a simple string of $\&\&$'s or $||$'s (but not a mixture of the two). The following expression is acceptable in terms of both the C++ compiler and readability:

$$(temperature > 90) \ \&\& \ (humidity > 0.90) \ \&\& \ (pool_gate == OPEN)$$

DISPLAY 3.1 Truth Tables

AND				
<i>Exp_1</i>	<i>Exp_2</i>	<i>Exp_1 && Exp_2</i>		
<i>true</i>	<i>true</i>	<i>true</i>		
<i>true</i>	<i>false</i>	<i>false</i>		
<i>false</i>	<i>true</i>	<i>false</i>		
<i>false</i>	<i>false</i>	<i>false</i>		

NOT	
<i>Exp</i>	<i>!(Exp)</i>
<i>true</i>	<i>false</i>
<i>false</i>	<i>true</i>

OR		
<i>Exp_1</i>	<i>Exp_2</i>	<i>Exp_1 Exp_2</i>
<i>true</i>	<i>true</i>	<i>true</i>
<i>true</i>	<i>false</i>	<i>true</i>
<i>false</i>	<i>true</i>	<i>true</i>
<i>false</i>	<i>false</i>	<i>false</i>

Since the relational operations `>` and `==` are evaluated before the `&&` operation, you could omit the parentheses in the expression above and it would have the same meaning, but including some parentheses makes the expression easier to read.

When parentheses are omitted from an expression, the computer groups items according to rules known as **precedence rules**. Some of the precedence rules for C++ are given in Display 3.2. If one operation is evaluated before another, the operation that is evaluated first is said to have **higher precedence**. Binary operations of equal precedence are evaluated in left-to-right order. Unary operations of equal precedence are evaluated in right-to-left order. A complete set of precedence rules is given in Appendix 2.

Notice that the precedence rules include both arithmetic operators such as `+` and `*` as well as Boolean operators such as `&&` and `||`. This is because many expressions combine arithmetic and Boolean operations, as in the following simple example:

$$(x + 1) > 2 \ || \ (x + 1) < -3$$

If you check the precedence rules given in Display 3.2, you will see that this expression is equivalent to

$$((x + 1) > 2) \ || \ ((x + 1) < -3)$$

because `>` and `<` have higher precedence than `||`. In fact, you could omit all the parentheses in the expression above and it would have the same meaning,

DISPLAY 3.2 Precedence Rules

The unary operators `+`, `-`, `++`, `--`, and `!`

The binary arithmetic operations `*`, `/`, `%`

The binary arithmetic operations `+`, `-`

The Boolean operations `<`, `>`, `<=`, `>=`

The Boolean operations `==`, `!=`

The Boolean operations `&&`

The Boolean operations `||`

Highest precedence
(done first)



Lowest precedence
(done last)

although it would be harder to read. Although we do not advocate omitting all the parentheses, it might be instructive to see how such an expression is interpreted using the precedence rules. Here is the expression without any parentheses:

```
x + 1 > 2 || x + 1 < -3
```

The precedence rules say first apply the unary `-`, then apply the `+` signs, then do the `>` and the `<`, and finally do the `||`, which is exactly what the fully parenthesized version says to do.

The preceding description of how a Boolean expression is evaluated is basically correct, but in C++, the computer actually takes an occasional shortcut when evaluating a Boolean expression. Notice that in many cases you need to evaluate only the first of two subexpressions in a Boolean expression. For example, consider the following:

```
(x >= 0) && (y > 1)
```

If `x` is negative, then `(x >= 0)` is *false*, and as you can see in the tables in Display 3.1, when one subexpression in an `&&` expression is *false*, then the whole expression is *false*, no matter whether the other expression is *true* or *false*. Thus, if we know that the first expression is *false*, there is no need to evaluate the second expression. A similar thing happens with `||` expressions. If the first of two expressions joined with the `||` operator is *true*, then you know the entire expression is *true*, no matter whether the second expression is *true* or *false*. The C++ language uses this fact to sometimes save itself the trouble of evaluating the second subexpression in a logical expression connected with an `&&` or an `||`. C++ first evaluates the leftmost of the two expressions joined by an `&&` or an `||`. If that gives it enough information to determine the final value of the expression (independent of the value of the second expression), then C++ does not bother to evaluate the second expression. This method of evaluation is called **short-circuit evaluation**.

Some languages, other than C++, use **complete evaluation**. In complete evaluation, when two expressions are joined by an `&&` or an `||`, both subexpressions are always evaluated and then the truth tables are used to obtain the value of the final expression.

Both short-circuit evaluation and complete evaluation give the same answer, so why should you care that C++ uses short-circuit evaluation? Most of the time you need not care. As long as both subexpressions joined by the `&&` or the `||` have a value, the two methods yield the same result. However, if the second subexpression is undefined, you might be happy to know that C++ uses short-circuit evaluation.

Let's look at an example that illustrates this point. Consider the following statement:

```
if ( (kids != 0) && ((pieces/kids) >= 2) )
    cout << "Each child may have two pieces!";
```

If the value of `kids` is not zero, this statement involves no subtleties. However, suppose the value of `kids` is zero and consider how short-circuit evaluation handles this case. The expression `(kids != 0)` evaluates to *false*, so there would be no need to evaluate the second expression. Using short-circuit evaluation, C++ says that the entire expression is *false*, *without bothering to evaluate the second expression*. This prevents a run-time error, since evaluating the second expression would involve dividing by zero.

C++ sometimes uses integers as if they were Boolean values. In particular, C++ converts the integer 1 to *true* and converts the integer 0 to *false*. The situation is even a bit more complicated than simply using 1 for *true* and 0 for *false*. The compiler will treat any nonzero number as if it were the value *true* and will treat 0 as if it were the value *false*. As long as you make no mistakes in writing Boolean expressions, this conversion causes no problems and you usually need not even be aware of it. However, when you are debugging, it might help to know that the compiler is happy to combine integers using the Boolean operators `&&`, `||`, and `!`.

Boolean (*bool*) values are *true* and *false*

In C++, a Boolean expression evaluates to the *bool* value *true* when it is satisfied and to the *bool* value *false* when it is not satisfied.

PITFALL Boolean Expressions Convert to *int* Values

Suppose you want to use a Boolean expression in an *if-else* statement, and you want it to be *true* provided that time has not yet run out (in some game or process). To phrase it a bit more precisely, suppose you want to use a Boolean expression in an *if-else* statement and you want it to be *true* provided the value of a variable `time` of type *int* is not greater than the value

of a variable called `limit`. You might write the following (where *Something* and *Something_Else* are some C++ statements):

```
if (!time > limit)           ← Wrong for what we want
    Something
else
    Something_Else
```

This sounds right if you read it out loud: “not time greater than `limit`.” The Boolean expression is wrong, however, and unfortunately, the compiler will not give you an error message. We have been bitten by the precedence rules of C++. The compiler will instead apply the precedence rules from Display 3.2 and interpret your Boolean expression as the following:

```
(!time) > limit
```

This looks like nonsense, and intuitively it is nonsense. If the value of `time` is, for example, 36, what could possibly be the meaning of `(!time)`? After all, that is equivalent to “not 36.” But in C++, any nonzero integer converts to *true* and 0 is converted to *false*. Thus, `!36` is interpreted as “not *true*” and so it evaluates to *false*, which is in turn converted back to 0 because we are comparing to an *int*.

What we want as the value of this Boolean expression and what C++ gives us are not the same. If `time` has a value of 36 and `limit` has a value of 60, you want the displayed Boolean expression above to evaluate to *true* (because it is *not true* that `time > limit`). Unfortunately, the Boolean expression instead evaluates as follows: `(!time)` evaluates to *false*, which is converted to 0, so the entire Boolean expression is equivalent to

```
0 > limit
```

That in turn is equivalent to `0 > 60`, because 60 is the value of `limit`. This evaluates to *false*. Thus, the above logical expression evaluates to *false*, when you want it to evaluate to *true*.

There are two ways to correct this problem. One way is to use the `!` operator correctly. When using the operator `!`, be sure to include parentheses around the argument. The correct way to write the preceding Boolean expression is as follows:

```
if (!(time > limit))
    Something
else
    Something_Else
```

Another way to correct this problem is to completely avoid using the `!` operator. For example, the following is also correct and easier to read:

```
if (time <= limit)
    Something
else
    Something_Else
```

Avoid using “not” You can almost always avoid using the `!` operator, and some programmers advocate avoiding it as much as possible. They say that just as *not* in English can make things not undifficult to read, so too can the “not” operator `!` make C++ programs difficult to read. There is no need to be obsessive in avoiding the `!` operator, but before using it, you should see if you can express the same thing more clearly without using the `!` operator. ■

The Type *bool* Is New

Older versions of C++ have no type *bool*, but instead use the integers 1 and 0 for *true* and *false*. If you have an older version of C++ that does not have the type *bool*, you should obtain a new compiler.

SELF-TEST EXERCISES

- Determine the value, *true* or *false*, of each of the following Boolean expressions, assuming that the value of the variable `count` is 0 and the value of the variable `limit` is 10. Give your answer as one of the values *true* or *false*.
 - `(count == 0) && (limit < 20)`
 - `count == 0 && limit < 20`
 - `(limit > 20) || (count < 5)`
 - `!(count == 12)`
 - `(count == 1) && (x < y)`
 - `(count < 10) || (x < y)`
 - `!(((count < 10) || (x < y)) && (count >= 0))`
 - `((limit/count) > 7) || (limit < 20)`
 - `(limit < 20) || ((limit/count) > 7)`
 - `((limit/count) > 7) && (limit < 0)`
 - `(limit < 0) && ((limit/count) > 7)`
 - `(5 && 7) + (!6)`
- Name two kinds of statements in C++ that alter the order in which actions are performed. Give some examples.
- In college algebra we see numeric intervals given as

$$2 < x < 3$$

In C++ this interval does not have the meaning you may expect. Explain and give the correct C++ Boolean expression that specifies that `x` lies between 2 and 3.

4. Does the following sequence produce division by zero?

```
j = -1;
if ((j > 0) && (1/(j + 1) > 10))
    cout << i << endl;
```

Enumeration Types (*Optional*)

An **enumeration type** is a type whose values are defined by a list of constants of type *int*. An enumeration type is very much like a list of declared constants.

When defining an enumeration type, you can use any *int* values and can have any number of constants defined in an enumeration type. For example, the following enumeration type defines a constant for the length of each month:

```
enum MonthLength { JAN_LENGTH = 31, FEB_LENGTH = 28,
MAR_LENGTH = 31, APR_LENGTH = 30, MAY_LENGTH = 31,
JUN_LENGTH = 30, JUL_LENGTH = 31, AUG_LENGTH = 31,
SEP_LENGTH = 30, OCT_LENGTH = 31, NOV_LENGTH = 30,
DEC_LENGTH = 31 };
```

As this example shows, two or more named constants in an enumeration type can receive the same *int* value.

If you do not specify any numeric values, the identifiers in an enumeration-type definition are assigned consecutive values beginning with 0. For example, the type definition

```
enum Direction { NORTH = 0, SOUTH = 1, EAST = 2, WEST = 3 };
```

is equivalent to

```
enum Direction { NORTH, SOUTH, EAST, WEST };
```

The form that does not explicitly list the *int* values is normally used when you just want a list of names and do not care about what values they have.

If you initialize only some enumeration constant to some values, say

```
enum MyEnum { ONE = 17, TWO, THREE, FOUR = -3, FIVE };
```

then ONE takes the value 17, TWO takes the next *int* value 18, THREE takes the next value 19, FOUR takes -3, and FIVE takes the next value, -2.

In short, the default for the first enumeration constant is 0. The rest increase by 1 unless you set one or more of the enumeration constants.

C++11 introduced a new version of enumerations called *strong enums* or *enum classes* that avoids some problems of conventional enums. For example, you may not want an enum to act as an integer. Additionally, enums are global in scope so you can't have the same enum value twice. To define a strong enum, add the word `class` after `enum`. You can qualify an enum value by providing the enum name followed by two colons followed by the value. For example:

```
enum class Days { Sun, Mon, Tue, Wed };
enum class Weather { Rain, Sun };
```

```
Days d = Days::Tue;
Weather w = Weather::Sun;
```

The variables `d` and `w` are not integers so we can't treat them as such. For example, it would be illegal to check `if (d == 0)` whereas this is legal in a traditional enum. It is legal to check `if (d == Days::Sun)`.

3.2 MULTIWAY BRANCHES

"Would you tell me, please, which way I ought to go from here?"

"That depends a good deal on where you want to get to," said the Cat.

LEWIS CARROLL, *Alice in Wonderland*

Any programming construct that chooses one from a number of alternative actions is called a **branching mechanism**. The *if-else* statement chooses between two alternatives. In this section we will discuss methods for choosing from among more than two alternatives.

Nested Statements

As you have seen, *if-else* statements and *if* statements contain smaller statements within them. Thus far we have used compound statements and simple statements such as assignment statements as these smaller substatements, but there are other possibilities. In fact, any statement at all can be used as a subpart of an *if-else* statement, of an *if* statement, of a *while* statement, or of a *do-while* statement. This is illustrated in Display 3.3. The statement in that display has three levels of nesting, as indicated by the boxes. Two `cout` statements are nested within an *if-else* statement, and that *if-else* statement is nested within an *if* statement.

When nesting statements, you normally indent each level of nested substatements. In Display 3.3 there are three levels of nesting, so there are

DISPLAY 3.3 An *if-else* Statement Within an *if* Statement

```

1  if (count > 0)
2      if (score > 5)
3          cout << "count > 0 and score > 5\n";
4      else
5          cout << "count > 0 and score <= 5\n";
```

three levels of indenting. Both `cout` statements are indented the same amount because they are both at the same level of nesting. Later in this chapter, you will see some specific cases where it makes sense to use other indenting patterns, but unless there is some rule to the contrary, you should indent each level of nesting as illustrated in Display 3.3.

■ PROGRAMMING TIP Use Braces in Nested Statements

Suppose we want to write an *if-else* statement to use in an onboard computer monitoring system for a racing car. This part of the program warns the driver when fuel is low but tells the driver to bypass pit stops if the fuel tank is close to full. In all other situations the program gives no output so as not to distract the driver. We design the following pseudocode:

If the fuel gauge is below 3/4 full, then:

 Check whether the fuel gauge is below 1/4 full and issue a low fuel warning if it is.

Otherwise (that is, if fuel gauge is over 3/4 full):

 Output a statement telling the driver not to stop.

If we are not being too careful, we might implement the pseudocode as follows:

```
if (fuel_gauge_reading < 0.75)
    if (fuel_gauge_reading < 0.25)
        cout << "Fuel very low. Caution!\n";
else
    cout << "Fuel over 3/4. Don't stop now!\n";
```

Read text to see what is wrong with this.

This implementation looks fine, and it is indeed a correctly formed C++ statement that the compiler will accept and that will run with no error messages. However, it does not implement the pseudocode. Notice that this statement has two occurrences of *if* and only one *else*. The compiler must decide which *if* gets paired with the one *else*. We have nicely indented this nested statement to show that the *else* should be paired with the first *if*, but the compiler does not care about indenting. To the compiler, the preceding nested statement is the same as the following version, which differs only in how it is indented:

```
if (fuel_gauge_reading < 0.75)
    if (fuel_gauge_reading < 0.25)
        cout << "Fuel very low. Caution!\n";
else
    cout << "Fuel over 3/4. Don't stop now!\n";
```

Unfortunately for us, the compiler will use the second interpretation and will pair the one *else* with the second *if* rather than the first *if*. This is sometimes called the **dangling *else* problem**; it is illustrated by the program in Display 3.4.

The compiler always pairs an *else* with the nearest previous *if* that is not already paired with some *else*. But, do not try to work within this rule. Ignore

DISPLAY 3.4 The Importance of Braces

```

1 //Illustrates the importance of using braces in if-else statements.
2 #include <iostream>
3 using namespace std;
4 int main( )
5 {
6     double fuel_gauge_reading;
7
8     cout << "Enter fuel gauge reading: ";
9     cin >> fuel_gauge_reading;
10
11     cout << "First with braces:\n";
12     if (fuel_gauge_reading < 0.75)
13     {
14         if (fuel_gauge_reading < 0.25)
15             cout << "Fuel very low. Caution!\n";
16     }
17     else
18     {
19         cout << "Fuel over 3/4. Don't stop now!\n";
20     }
21
22     cout << "Now without braces:\n";
23     if (fuel_gauge_reading < 0.75)
24         if (fuel_gauge_reading < 0.25)
25             cout << "Fuel very low. Caution!\n";
26     else
27         cout << "Fuel over 3/4. Don't stop now!\n";
28
29     return 0;
30 }
```

This indenting is nice, but is not what the computer follows.

Sample Dialogue 1

```

Enter fuel gauge reading: 0.1
First with braces:
Fuel very low. Caution!
Now without braces:
Fuel very low. Caution!
```

Braces make no difference in this case, but see Dialogue 2.

Sample Dialogue 2

```

Enter fuel gauge reading: 0.5
First with braces:
Now without braces:
Fuel over 3/4. Don't stop now!
```

There should be no output here, and thanks to braces, there is none.

Incorrect output from the version without braces.

the rule! Change the rules! You are the boss! Always tell the compiler what you want it to do and the compiler will then do what you want. How do you tell the compiler what you want? You use braces. Braces in nested statements are like parentheses in arithmetic expressions. The braces tell the compiler how to group things, rather than leaving them to be grouped according to default conventions, which may or may not be what you want. To avoid problems and to make your programs easier to read, place braces, { and }, around substatements in *if-else* statements, as we have done in the first *if-else* statement in Display 3.4.

rule for
pairing *else*'s
with *if*'s

For very simple substatements, such as a single assignment statement or a single `cout` statement, you can safely omit the braces. In Display 3.4, the braces around the following substatement (within the first *if-else* statement) are not needed:

```
cout << "Fuel over 3/4. Don't stop now!\n";
```

However, even in these simple cases, the braces can sometimes aid readability. Some programmers advocate using braces around even the simplest substatements when they occur within *if-else* statements, which is what we have done in the first *if-else* statement in Display 3.4. ■

Multiway *if-else* Statements

An *if-else* statement is a two-way branch. It allows a program to choose one of two possible actions. Often you will want to have a three- or four-way branch so that your program can choose between more than two alternative actions. You can implement such multiway branches by nesting *if-else* statements. By way of example, suppose you are designing a game-playing program in which the user must guess the value of some number. The number can be in a variable named `number`, and the guess can be in a variable named `guess`. If you wish to give a hint after each guess, you might design the following pseudocode:

```
Output "Too high." when guess > number.
Output "Too low." when guess < number.
Output "Correct!" when guess == number.
```

Any time a branching action is described as a list of mutually exclusive conditions and corresponding actions, as in this example, it can be implemented by using a nested *if-else* statement. For example, this pseudocode translates to the following code:

```
if (guess > number)
    cout << "Too high.";
else if (guess < number)
    cout << "Too low.";
else if (guess == number)
    cout << "Correct!";
```

The indenting pattern used here is slightly different from what we have advocated previously. If we followed our indenting rules, we would produce something like the following:

```

if (guess > number)
    cout << "Too high.";
else
    if (guess < number)
        cout << "Too low.";
    else
        if (guess == number)
            cout << "Correct!";

```

*Use the previous
indenting pattern
rather than this one.*

This is one of those rare cases in which you should not follow our general guidelines for indenting nested statements. The reason is that by lining up all the *else*'s, you also line up all the condition/action pairs and so make the layout of the program reflect your reasoning. Another reason is that even for not-too-deeply nested *if-else* statements, you can quickly run out of space on your page!

Since the conditions are mutually exclusive, the last *if* in the nested *if-else* statement above is superfluous and can be omitted, but it is sometimes best to include it in a comment as follows:

```

if (guess > number)
    cout << "Too high.";
else if (guess < number)
    cout << "Too low.";
else //(guess == number)
    cout << "Correct!";

```

You can use this form of multiple-branch *if-else* statement even if the conditions are not mutually exclusive. Whether the conditions are mutually exclusive or not, the computer will evaluate the conditions in the order in which they appear until it finds the first condition that is *true* and then it will execute the action corresponding to this condition. If no condition is *true*, no action is taken. If the statement ends with a plain *else* without any *if*, then the last statement is executed when all the conditions are *false*.

Multiway *if-else* Statement

SYNTAX

```

if (Boolean_Expression_1)
    Statement_1
else if (Boolean_Expression_2)
    Statement_2
    .
    .
    .
else if (Boolean_Expression_n)
    Statement_n
else
    Statement_For_All_Other_Possibilities

```

(continued)

EXAMPLE>

```

if ((temperature <-10) && (day == SUNDAY))
    cout << "Stay home.";
else if (temperature <-10) //and day != SUNDAY
    cout << "Stay home, but call work.";
else if (temperature <= 0) //and temperature >= -10
    cout << "Dress warm.";
else //temperature > 0
    cout << "Work hard and play hard.";

```

The Boolean expressions are checked in order until the first *true* Boolean expression is encountered, and then the corresponding statement is executed. If none of the Boolean expressions is *true*, then the *Statement_For_All_Other_Possibilities* is executed.

PROGRAMMING EXAMPLE**State Income Tax**

Display 3.5 contains a program that uses a multiway *if-else* statement. The program takes the taxpayer's net income rounded to a whole number of dollars and computes the state income tax due on this net income. This state computes tax according to the following rate schedule:

1. No tax is paid on the first \$15,000 of net income.
2. A tax of 5 percent is assessed on each dollar of net income from \$15,001 to \$25,000.
3. A tax of 10 percent is assessed on each dollar of net income over \$25,000.

The program defined in Display 3.5 uses a multiway *if-else* statement with one action for each of these three cases. The condition for the second case is actually more complicated than it needs to be. The computer will not get to the second condition unless it has already tried the first condition and found it to be *false*. Thus, you know that whenever the computer tries the second condition, it will know that `net_income` is greater than 15000. Hence, you can replace the line

```
else if ((net_income > 15000) && (net_income <= 25000))
```

with the following, and the program will perform exactly the same:

```
else if (net_income <= 25000)
```

DISPLAY 3.5 Multiway *if-else* Statement

```
1 //Program to compute state income tax.
2 #include <iostream>
3 using namespace std;
4
5 //This program outputs the amount of state income tax due computed
6 //as follows: no tax on income up to $15,000; 5% on income between
7 // $15,001 and $25,000; 10% on income over $25,000.
8
9 int main( )
10 {
11     int net_income;
12     double tax_bill;
13     double five_percent_tax, ten_percent_tax;
14
15
16     cout << "Enter net income (rounded to whole dollars) $";
17     cin >> net_income;
18
19     if (net_income <= 15000)
20         tax_bill = 0;
21     else if ((net_income > 15000) && (net_income <= 25000))
22         //5% of amount over $15,000
23         tax_bill = (0.05 * (net_income - 15000));
24     else //net_income > $25,000
25     {
26         //five_percent_tax = 5% of income from $15,000 to $25,000.
27         five_percent_tax = 0.05 * 10000;
28         //ten_percent_tax = 10% of income over $25,000.
29         ten_percent_tax = 0.10 * (net_income - 25000);
30         tax_bill = (five_percent_tax + ten_percent_tax);
31     }
32
33     cout.setf(ios::fixed);
34     cout.setf(ios::showpoint);
35     cout.precision(2);
36     cout << "Net income = $" << net_income << endl
37         << "Tax bill = $" << tax_bill << endl;
38
39     return 0;
40 }
```

Sample Dialogue

```
Enter net income (rounded to whole dollars) $25100
Net income = $25100.00
Tax bill = $510.00
```

SELF-TEST EXERCISES

5. What output will be produced by the following code, when embedded in a complete program?

```
int x = 2;
cout << "Start\n";
if (x <= 3)
    if (x != 0)
        cout << "Hello from the second if.\n";
    else
        cout << "Hello from the else.\n";
cout << "End\n";

cout << "Start again\n";
if (x > 3)
    if (x != 0)
        cout << "Hello from the second if.\n";
    else
        cout << "Hello from the else.\n";
cout << "End again\n";
```

6. What output will be produced by the following code, when embedded in a complete program?

```
int extra = 2;
if (extra < 0)
    cout << "small";
else if (extra == 0)
    cout << "medium";
else
    cout << "large";
```

7. What would be the output in Self-Test Exercise 6 if the assignment were changed to the following?

```
int extra = -37;
```

8. What would be the output in Self-Test Exercise 6 if the assignment were changed to the following?

```
int extra = 0;
```

9. What output will be produced by the following code, when embedded in a complete program?

```
int x = 200;
cout << "Start\n";
if (x < 100)
    cout << "First Output.\n";
```

```

else if (x > 10)
    cout << "Second Output.\n";
else
    cout << "Third Output.\n";
cout << "End\n";

```

10. What would be the output in Self-Test Exercise 9 if the Boolean expression $(x > 10)$ were changed to $(x > 100)$?
11. What output will be produced by the following code, when embedded in a complete program?

```

int x = SOME_CONSTANT;
cout << "Start\n";
if (x < 100)
    cout << "First Output.\n";
else if (x > 100)
    cout << "Second Output.\n";
else
    cout << x << endl;
cout << "End\n";

```

SOME_CONSTANT is a constant of type *int*. Assume that neither "First Output" nor "Second Output" is output. So, you know the value of *x* is output.

12. Write a multiway *if-else* statement that classifies the value of an *int* variable *n* into one of the following categories and writes out an appropriate message:

$n < 0$ or $0 \leq n \leq 100$ or $n > 100$

13. Given the following declaration and output statement, assume that this has been embedded in a correct program and is run. What is the output?

```

enum Direction { N, S, E, W };
//...
cout << W << " " << E << " " << S << " " << N << endl;

```

14. Given the following declaration and output statement, assume that this has been embedded in a correct program and is run. What is the output?

```

enum Direction { N = 5, S = 7, E = 1, W };
// ...
cout << W << " " << E << " " << S << " " << N << endl;

```

The *switch* Statement

You have seen *if-else* statements used to construct multiway branches. The ***switch*** statement is another kind of C++ statement that also implements

multiway branches. A sample *switch* statement is shown in Display 3.6. This particular *switch* statement has four regular branches and a fifth branch for illegal input. The variable *grade* determines which branch is executed. There is one branch for each of the grades 'A', 'B', and 'C'. The grades 'D' and 'F' cause the same branch to be taken, rather than having a separate action for each of 'D' and 'F'. If the value of *grade* is any character other than 'A', 'B', 'C', 'D', or 'F', then the *cout* statement after the identifier *default* is executed.

DISPLAY 3.6 A *switch* Statement (part 1 of 2)

```
1 //Program to illustrate the switch statement.
2 #include <iostream>
3 using namespace std;
4 int main( )
5 {
6     char grade;
7     cout << "Enter your midterm grade and press Return: ";
8     cin >> grade;
9     switch (grade)
10    {
11        case 'A':
12            cout << "Excellent. "
13                << "You need not take the final.\n";
14            break;
15        case 'B':
16            cout << "Very good. ";
17            grade = 'A';
18            cout << "Your midterm grade is now "
19                << grade << endl;
20            break;
21        case 'C':
22            cout << "Passing.\n";
23            break;
24        case 'D':
25        case 'F':
26            cout << "Not good. "
27                << "Go study.\n";
28            break;
29        default:
30            cout << "That is not a possible grade.\n";
31    }
32    cout << "End of program.\n";
33    return 0;
34 }
```

(continued)

DISPLAY 3.6 A *switch* Statement (part 2 of 2)

Sample Dialogue 1

```
Enter your midterm grade and press Return: A
Excellent. You need not take the final.
End of program.
```

Sample Dialogue 2

```
Enter your midterm grade and press Return: B
Very good. Your midterm grade is now A.
End of program.
```

Sample Dialogue 3

```
Enter your midterm grade and press Return: D
Not good. Go study.
End of program.
```

Sample Dialogue 4

```
Enter your midterm grade and press Return: E
That is not a possible grade.
End of program.
```



VideoNote
switch Statement Example

The syntax and preferred indenting pattern for the *switch* statement are shown in the sample *switch* statement in Display 3.6 and in the box entitled “*switch* Statement.”

When a *switch* statement is executed, one of a number of different branches is executed. The choice of which branch to execute is determined by a **controlling expression** given in parentheses after the keyword *switch*. The controlling expression in the sample *switch* statement shown in Display 3.6 is of type *char*. The controlling expression for a *switch* statement must always return either a *bool* value, an *enum* constant, one of the integer types, or a character. When the *switch* statement is executed, this controlling expression is evaluated and the computer looks at the constant values given after the various occurrences of the *case* identifiers. If it finds a constant that equals the value of the controlling expression, it executes the code for that *case*. For example, if the expression evaluates to 'B', then it looks for the following and executes the statements that follow this line:

```
case 'B':
```

Notice that the constant is followed by a colon. Also note that you cannot have two occurrences of *case* with the same constant value after them, since that would be an ambiguous instruction.

A **break statement** consists of the keyword *break* followed by a semicolon. When the computer executes the statements after a *case* label, it continues until it reaches a *break* statement. When the computer encounters a *break* statement, the *switch* statement ends. If you omit the *break* statements, then after executing the code for one *case*, the computer will go on to execute the code for the next *case*.

Note that you can have two *case* labels for the same section of code. In the *switch* statement in Display 3.6, the same action is taken for the values 'D' and 'F'. This technique can also be used to allow for both upper- and lowercase letters. For example, to allow both lowercase 'a' and uppercase 'A' in the program in Display 3.6, you can replace

```
case 'A':
    cout << "Excellent. "
        << "You need not take the final.\n";
    break;
```

with the following:

```
case 'A':
case 'a':
    cout << "Excellent. "
        << "You need not take the final.\n";
    break;
```

Of course, the same can be done for all the other letters.

If no *case* label has a constant that matches the value of the controlling expression, then the statements following the *default* label are executed. You need not have a *default* section. If there is no *default* section and no match is found for the value of the controlling expression, then nothing happens when the *switch* statement is executed. However, it is safest to always have a *default* section. If you think your *case* labels list all possible outcomes, then you can put an error message in the *default* section. This is what we did in Display 3.6.

switch Statement

SYNTAX

```
switch (Controlling_Expression)
{
    case Constant_1:
        Statement_Sequence_1
        break;
```

(continued)

```

    case Constant_2:
        Statement_Sequence_2
        break;
    .
    .
    .
    case Constant_n:
        Statement_Sequence_n
        break;
    default:
        Default_Statement_Sequence
}

```

EXAMPLE

```

int vehicle_class;
cout << "Enter vehicle class: ";
cin >> vehicle_class;

switch (vehicle_class)
{
    case 1:
        cout << "Passenger car.";
        toll = 0.50;
        break;
    case 2:
        cout << "Bus.";
        toll = 1.50;
        break;
    case 3:
        cout << "Truck.";
        toll = 2.00;
        break;
    default:
        cout << "Unknown vehicle class!";
}

```

If you forget this break, then passenger cars will pay \$1.50.

PITFALL Forgetting a *break* in a *switch* Statement

If you forget a *break* in a *switch* statement, the compiler will not issue an error message. You will have written a syntactically correct *switch* statement, but it will not do what you intended it to do. Consider the *switch* statement in the box entitled “*switch* Statement.” If a *break* statement were omitted, as indicated by the arrow, then when the variable `vehicle_class` has the value 1, the case labeled

```

case 1:

```

would be executed as desired, but then the computer would go on to also execute the next *case*. This would produce a puzzling output that says the vehicle is a passenger car and then later says it is a bus; moreover, the final value of `to11` would be 1.50, not 0.50 as it should be. When the computer starts to execute a *case*, it does not stop until it encounters either a *break* or the end of the *switch* statement. ■

Using *switch* Statements for Menus

The multiway *if-else* statement is more versatile than the *switch* statement, and you can use a multiway *if-else* statement anywhere you can use a *switch* statement. However, sometimes the *switch* statement is clearer. For example, the *switch* statement is perfect for implementing *menus*.

DISPLAY 3.7 A Menu (part 1 of 2)

```

1 //Program to give out homework assignment information.
2 #include <iostream>
3 using namespace std;
4
5
6 int main( )
7 {
8     int choice;
9
10    do
11    {
12        cout << endl
13            << "Choose 1 to see the next homework assignment.\n"
14            << "Choose 2 for your grade on the last assignment.\n"
15            << "Choose 3 for assignment hints.\n"
16            << "Choose 4 to exit this program.\n"
17            << "Enter your choice and press Return: ";
18        cin >> choice;
19
20        switch(choice)
21        {
22            case 1:
23                //code to display the next assignment on screen would go here.
24                break;
25            case 2:
26                //code to ask for a student number and give the corresponding
27                //grade would go here.
28                break;
29            case 3:
30                //code to display a hint for the current assignment would go

```

(continued)

DISPLAY 3.7 A Menu (part 2 of 2)

```
31         //here.  
32         break;  
33     case 4:  
34         cout << "End of Program.\n";  
35         break;  
36     default:  
37         cout << "Not a valid choice.\n"  
38             << "Choose again.\n";  
39     }  
40 } while (choice != 4);  
41  
42 return 0;  
43 }
```

Sample Dialogue

Choose 1 to see the next homework assignment.
Choose 2 for your grade on the last assignment.
Choose 3 for assignment hints.
Choose 4 to exit this program.
Enter your choice and press Return: 3

Assignment hints:
Analyze the problem.
Write an algorithm in pseudocode.
Translate the pseudocode into a C++ program.

Choose 1 to see the next homework assignment.
Choose 2 for your grade on the last assignment.
Choose 3 for assignment hints.
Choose 4 to exit this program.
Enter your choice and press Return: 4
End of Program.

*The exact
output will
depend on the
code inserted
into the switch
statement.*

A *menu* in a restaurant presents a list of alternatives for a customer to choose from. A **menu** in a computer program does the same thing: It presents a list of alternatives on the screen for the user to choose from. Display 3.7 shows the outline of a program designed to give students information on homework assignments. The program uses a menu to let the student choose which information she or he wants. A more readable way to implement the menu actions is through functions. Functions are discussed in Chapter 4.

Blocks

Each branch of a *switch* statement or of an *if-else* statement is a separate subtask. As indicated in the previous Programming Tip, it is often best to make the action of each branch a function call. That way the subtask for each branch can be designed, written, and tested separately. On the other hand, sometimes the action of one branch is so simple that you can just make it a compound statement. Occasionally, you may want to give this compound statement its own local variables. For example, consider the program in Display 3.8. It calculates the final bill for a specified number of items at a given price. If the sale is a wholesale transaction, then no sales tax is charged (presumably because the tax will be paid when the items are resold to retail buyers). If, however, the sale is a retail transaction, then sales tax must be added. An *if-else* statement is used to produce different calculations for wholesale and retail purchases. For the retail purchase, the calculation uses a temporary variable called `subtotal`, and so that variable is declared within the compound statement for that branch of the *if-else* statement.

As shown in Display 3.8, the variable `subtotal` is declared within a compound statement. If we wanted to, we could have used the variable name `subtotal` for something else outside of the compound statement in which it is declared. A variable that is declared inside a compound statement is *local* to the compound statement. Local variables are created when the compound statement is executed and are destroyed when the compound statement is completed. In other words, **local variables** exist only within the compound statement in which they are declared. Within a compound statement, you can use all the variables declared outside of the compound statement, as well as the local variables declared inside the compound statement.

DISPLAY 3.8 Block with a Local Variable (part 1 of 2)

```
1 //Program to compute bill for either a wholesale or a retail purchase.
2 #include <iostream>
3 using namespace std;
4
5
6 int main( )
7 {
8     const double TAX_RATE = 0.05; //5% sales tax
9     char sale_type;
10    int number;
11    double price, total;
12
13    cout << "Enter price $";
14    cin >> price;
```

(continued)

DISPLAY 3.8 Block with a Local Variable (part 2 of 2)

```
15     cout << "Enter number purchased: ";
16     cin >> number;
17     cout << "Type W if this is a wholesale purchase.\n"
18         << "Type R if this is a retail purchase.\n"
19         << "Then press Return.\n";
20     cin >> sale_type;
21
22     if ((sale_type == 'W') || (sale_type == 'w'))
23     {
24         total = price * number;
25     }
26     else if ((sale_type == 'R') || (sale_type == 'r'))
27     {
28         double subtotal; ← Local to the block
29         subtotal = price * number;
30         total = subtotal + subtotal * TAX_RATE;
31     }
32     else
33     {
34         cout << "Error in input.\n";
35     }
36     cout.setf(ios::fixed);
37     cout.setf(ios::showpoint);
38     cout.precision(2);
39     cout << number << " items at $" << price << endl;
40     cout << "Total Bill = $" << total;
41     if ((sale_type == 'R') || (sale_type == 'r'))
42         cout << " including sales tax.\n";
43
44     return 0;
45 }
```

Sample Dialogue

```
Enter price: $10.00
Enter number purchased: 2
Type W if this is a wholesale purchase.
Type R if this is a retail purchase.
Then press Return.
R
2 items at $10.00
Total Bill = $21.00 including sales tax.
```

A compound statement with declarations is more than a simple compound statement, so it has a special name. A compound statement that contains variable declarations is usually called a **block**, and the variables declared within the block are said to be **local to the block** or to **have the block as their scope**. (A plain old compound statement that does not contain any variable declarations is also called a block. Any code enclosed in braces is called a block.)

In Chapter 4 we will show how to define functions. The body of a function definition is also a block. There is no standard name for a block that is not the body of a function. However, we want to talk about these kinds of blocks, so let us create a name for them. Let's call a block a **statement block** when it is not the body of a function (and not the body of the main part of a program).

Statement blocks can be nested within other statement blocks, and basically the same rules about local variable names apply to these nested statement blocks as those we have already discussed, but applying the rules can be tricky when statement blocks are nested. A better rule is to not nest statement blocks. Nested statement blocks make a program hard to read. If you feel the need to nest statement blocks, instead make some of the statement blocks into function definitions and use function calls rather than nested statement blocks. In fact, statement blocks of any kind should be used sparingly. In most situations, a function call is preferable to a statement block. For completeness, we include the scope rule for nested blocks in the accompanying summary box.

Blocks

A **block** is some C++ code enclosed in braces. The variables declared in a block are local to the block and so the variable names can be used outside of the block for something else (such as being reused as the name for a different variable).

Scope Rule for Nested Blocks

If an identifier is declared as a variable in each of two blocks, one within the other, then these are two different variables with the same name. One variable exists only within the inner block and cannot be accessed outside of the inner block. The other variable exists only in the outer block and cannot be accessed in the inner block. The two variables are distinct, so changes made to one of these variables will have no effect on the other of these two variables.

PITFALL Inadvertent Local Variables

When you declare a variable within a pair of braces, { }, that variable becomes a local variable for the block enclosed in the pair. This is true whether you wanted the variable to be local or not. If you want a variable to be available outside of the braces, then you must declare it outside of the braces. ■

SELF-TEST EXERCISES

15. What output will be produced by the following code, when embedded in a complete program?

```
int first_choice = 1;
switch (first_choice + 1)
{
    case 1:
        cout << "Roast beef\n";
        break;
    case 2:
        cout << "Roast worms\n";
        break;
    case 3:
        cout << "Chocolate ice cream\n";
    case 4:
        cout << "Onion ice cream\n";
        break;
    default:
        cout << "Bon appetit!\n";
}
```

16. What would be the output in Self-Test Exercise 15 if the first line were changed to the following?

```
int first_choice = 3;
```

17. What would be the output in Self-Test Exercise 15 if the first line were changed to the following?

```
int first_choice = 2;
```

18. What would be the output in Self-Test Exercise 15 if the first line were changed to the following?

```
int first_choice = 4;
```

19. What output is produced by the following code, when embedded in a complete program?

```

int number = 22;
{
    int number = 42;
    cout << number << " ";
}
cout << number;

```

20. Though we urge you not to program using this style, we are providing an exercise that uses nested blocks to help you understand the scope rules. Give the output that this code fragment would produce if embedded in an otherwise complete, correct program.

```

{
    int x = 1;
    cout << x << endl;
    {
        cout << x << endl;
        int x = 2;
        cout << x << endl;
        {
            cout << x << endl;
            int x = 3;
            cout << x << endl;
        }
        cout << x << endl;
    }
    cout << x << endl;
}

```

3.3 MORE ABOUT C++ LOOP STATEMENTS

*It is not true that life is one damn thing after another—
It's one damn thing over and over.*

EDNA ST. VINCENT MILLAY, *Letter to Arthur Darison Ficke, October 24, 1930*

A **loop** is any program construction that repeats a statement or sequence of statements a number of times. The simple *while* loops and *do-while* loops that we have already seen are examples of loops. The statement (or group of statements) to be repeated in a loop is called the **body** of the loop, and each repetition of the loop body is called an **iteration** of the loop. The two main design questions when constructing loops are: What should the loop body be? How many times should the loop body be iterated?

The *while* Statements Reviewed

The syntax for the *while* statement and its variant, the *do-while* statement, is reviewed in Display 3.9. The important difference between the two types of loops

involves *when* the controlling Boolean expression is checked. When a *while* statement is executed, the Boolean expression is checked *before* the loop body is executed. If the Boolean expression evaluates to *false*, then the body is not executed at all. With a *do-while* statement, the body of the loop is executed first and the Boolean expression is checked *after* the loop body is executed. Thus, the *do-while* statement always executes the loop body at least once. After this start-up, the *while* loop and the *do-while* loop behave very much the same. After each iteration of the loop body, the Boolean expression is again checked; if it is *true*, then the loop is iterated again. If it has changed from *true* to *false*, then the loop statement ends.

DISPLAY 3.9 Syntax of the *while* Statement and *do-while* Statement

A *while* Statement with a Single Statement Body

```
while (Boolean_Expression)
    Statement ← Body
```

A *while* Statement with a Multistatement Body

```
while (Boolean_Expression)
{
    Statement_1
    Statement_2
    .
    .
    Statement_Last
}
```

Body

A *do-while* Statement with a Single Statement Body

```
do
    Statement ← Body
while (Boolean_Expression);
```

A *do-while* Statement with a Multistatement Body

```
do
{
    Statement_1
    Statement_2
    .
    .
    Statement_Last
} while (Boolean_Expression);
```

Body

The first thing that happens when a *while* loop is executed is that the controlling Boolean expression is evaluated. If the Boolean expression evaluates to *false* at that point, then the body of the loop is never executed. It may seem pointless to execute the body of a loop zero times, but that is sometimes the desired action. For example, a *while* loop is often used to sum a list of numbers, but the list could be empty. To be more specific, a checkbook balancing program might use a *while* loop to sum the values of all the checks you have written in a month—but you might take a month’s vacation and write no checks at all. In that case, there are zero numbers to sum and so the loop is iterated zero times.

executing the
body zero times

Increment and Decrement Operators Revisited

You have used the increment operator as a statement that increments the value of a variable by 1. For example, the following will output 42 to the screen:

```
int number = 41;
number++;
cout << number;
```

Thus far we have always used the increment operator as a statement. But the increment operator is also an operator, just like the + and ? operators. An expression like `number++` also returns a value, so `number++` can be used in an arithmetic expression such as

increment
operator in
expressions

```
2 * (number++)
```

The expression `number++` first returns the value of the variable `number`, and *then* the value of `number` is increased by 1. For example, consider the following code:

```
int number = 2;
int value_produced = 2 * (number++);
cout << value_produced << endl;
cout << number << endl;
```

This code will produce the following output:

```
4
3
```

Notice the expression `2 * (number++)`. When C++ evaluates this expression, it uses the value that `number` has *before* it is incremented, not the value that it has after it is incremented. Thus, the value produced by the expression `number++` is 2, even though the increment operator changes the value of `number` to 3. This may seem strange, but sometimes it is just what you want. And, as you are about to see, if you want an expression that behaves differently, you can have it.

The expression `v++` evaluates to the value of the variable `v`, and *then* the value of the variable `v` is incremented by 1. If you reverse the order and place

the `++` in front of the variable, the order of these two actions is reversed. The expression `++v` first increments the value of the variable `v` and then returns this increased value of `v`. For example, consider the following code:

```
int number = 2;
int value_produced = 2 * (++number);
cout << value_produced << endl;
cout << number << endl;
```

This code is the same as the previous piece of code except that the `++` is before the variable, so this code produces the following output:

```
6
3
```

Notice that the two increment operators `number++` and `++number` have the same effect on a variable `number`: They both increase the value of `number` by 1. But the two expressions evaluate to different values. Remember, if the `++` is *before* the variable, then the incrementing is done *before* the value is returned; if the `++` is *after* the variable, then the incrementing is done *after* the value is returned.

The program in Display 3.10 uses the increment operator in a *while* loop to count the number of times the loop body is repeated. One of the main uses of the increment operator is to control the iteration of loops in ways similar to what is done in Display 3.10.

DISPLAY 3.10 The Increment Operator as an Expression (part 1 of 2)

```
1 //Calorie-counting program.
2 #include <iostream>
3 using namespace std;
4
5 int main( )
6 {
7     int number_of_items, count,
8         calories_for_item, total_calories;
9
10    cout << "How many items did you eat today? ";
11    cin >> number_of_items;
12
13    total_calories = 0;
14    count = 1;
15    cout << "Enter the number of calories in each of the\n"
16         << number_of_items << " items eaten:\n";
17
18    while (count++ <= number_of_items)
```

(continued)

DISPLAY 3.10 The Increment Operator as an Expression (part 2 of 2)

```

19     {
20         cin >> calories_for_item;
21         total_calories = total_calories
22                             + calories_for_item;
23     }
24
25     cout << "Total calories eaten today = "
26           << total_calories << endl;
27     return 0;
28 }
29

```

Sample Dialogue

```

How many items did you eat today?
7
Enter the number of calories in each of the
7 items eaten:
300 60 1200 600 150 1 120
Total calories eaten today = 2431

```

Everything we said about the increment operator applies to the decrement operator as well, except that the value of the variable is decreased by 1 rather than increased by 1. For example, consider the following code:

decrement
operator

```

int number = 8;
int value_produced = number--;
cout << value_produced << endl;
cout << number << endl;

```

This produces the output

```

8
7

```

On the other hand, the code

```

int number = 8;
int value_produced = --number;
cout << value_produced << endl;
cout << number << endl;

```

produces the output

```

7
7

```

`++` and `--` can only be used with variables

`number--` returns the value of `number` and then decrements `number`; on the other hand, `--number` first decrements `number` and then returns the value of `number`.

You cannot apply the increment and decrement operators to anything other than a single variable. Expressions such as `(x + y)++`, `--(x + y)`, `5++`, and so forth are all illegal in C++.

SELF-TEST EXERCISES

21. What is the output of the following (when embedded in a complete program)?

```
int count = 3;
while (count-- > 0)
    cout << count << " ";
```

22. What is the output of the following (when embedded in a complete program)?

```
int count = 3;
while (--count > 0)
    cout << count << " ";
```

23. What is the output of the following (when embedded in a complete program)?

```
int n = 1;
do
    cout << n << " ";
while (n++ <= 3);
```

24. What is the output of the following (when embedded in a complete program)?

```
int n = 1;
do
    cout << n << " ";
while (++n <= 3);
```

The *for* Statement

The *while* statement and the *do-while* statement are all the loop mechanisms you absolutely need. In fact, the *while* statement alone is enough. However, there is one sort of loop that is so common that C++ includes a special statement for this. In performing numeric calculations, it is common to do a calculation with the number 1, then with the number 2, then with 3, and so forth, until some last value is reached. For example, to add 1 through 10, you

want the computer to perform the following statement ten times, with the value of `n` equal to 1 the first time and with `n` increased by 1 each subsequent time:

```
sum = sum + n;
```

The following is one way to accomplish this with a *while* statement:

```
sum = 0;
n = 1;
while (n <= 10)
{
    sum = sum + n;
    n++;
}
```

Although a *while* loop will do here, this sort of situation is just what the **for statement** (also called the **for loop**) was designed for. The following *for* statement will neatly accomplish the same task:

```
sum = 0;
for (n = 1; n <= 10; n++)
    sum = sum + n;
```

Let's look at this *for* statement piece by piece.

First, notice that the *while* loop version and the *for* loop version are made by putting together the same pieces: They both start with an assignment statement that sets the variable `sum` equal to 0. In both cases, this assignment statement for `sum` is placed before the loop statement itself begins. The loop statements themselves are both made from the pieces.

```
n = 1; n <= 10; n++ and sum = sum + n;
```

These pieces serve the same function in the *for* statement as they do in the *while* statement. The *for* statement is simply a more compact way of saying the same thing. Although other things are possible, we will only use *for* statements to perform loops controlled by one variable. In our example, that would be the variable `n`. With the equivalence of the previous two loops to guide us, let's go over the rules for writing a *for* statement.

A *for* statement begins with the keyword *for* followed by three things in parentheses that tell the computer what to do with the controlling variable. The beginning of a *for* statement looks like the following:

```
for (Initialization_Action; Boolean_Expression; Update_Action)
```

The first expression tells how the variable is initialized, the second gives a Boolean expression that is used to check for when the loop should end, and the last expression tells how the loop control variable is updated after each iteration of the loop body. For example, the above *for* loop begins

```
for (n = 1; n <= 10; n++)
```

The `n = 1` says that `n` is initialized to 1. The `n <= 10` says the loop will continue to iterate the body as long as `n` is less than or equal to 10. The last expression, `n++`, says that `n` is incremented by 1 after each time the loop body is executed.

The three expressions at the start of a *for* statement are separated by two, and only two, semicolons. Do not succumb to the temptation to place a semicolon after the third expression. (The technical explanation is that these three things are expressions, not statements, and so do not require a semicolon at the end.)

Display 3.11 shows the syntax of a *for* statement and also describes the action of the *for* statement by showing how it translates into an equivalent *while* statement. Notice that in a *for* statement, as in the corresponding *while* statement, the stopping condition is tested before the first loop iteration. Thus, it is possible to have a *for* loop whose body is executed zero times.

DISPLAY 3.11 The *for* Statement (part 1 of 2)

for Statement

SYNTAX

```
1  for (Initialization_Action; Boolean_Expression; Update_Action)
2      Body_Statement
```

EXAMPLE

```
1  for (number = 100; number >= 0; number--)
2      cout << number
3      << " bottles of beer on the shelf.\n";
```

Equivalent *while* Loop

EQUIVALENT SYNTAX

```
1  Initialization_Action;
2  while (Boolean_Expression)
3  {
4      Body_Statement
5      Update_Action;
6  }
```

EQUIVALENT EXAMPLE

```
1  number = 100;
2  while (number >= 0)
```

(continued)

DISPLAY 3.11 The *for* Statement (part 2 of 2)

```
3   {
4       cout << number
5           << " bottles of beer on the shelf.\n";
6       number--;
7   }
```

Output

```
100 bottles of beer on the shelf.
99 bottles of beer on the shelf.
.
.
.
0 bottles of beer on the shelf.
```

Display 3.12 shows a sample *for* statement embedded in a complete (although very simple) program. The *for* statement in Display 3.12 is similar to the one discussed above, but it has one new feature. The variable *n* is declared when it is initialized to 1. So, the declaration of *n* is inside the *for* statement. The initializing action in a *for* statement can include a variable declaration. When a variable is used only within the *for* statement, this can be the best place to declare the variable. However, if the variable is also used outside of the *for* statement, then it is best to declare the variable outside of the *for* statement.

declaring
variables within
a *for* statement

The ANSI C++ standard requires that a C++ compiler claiming compliance with the standard treat any declaration in a *for* loop initializer as if it were local to the body of the loop. Earlier C++ compilers did not do this. You should determine how your compiler treats variables declared in a *for* loop initializer. In the interests of portability, you should not write code that depends on this behavior. The ANSI C++ standard requires that variables declared in the initialization expression of a *for* loop be local to the block of the *for* loop. The next generation of C++ compilers will likely comply with this rule, but compilers presently available may or may not comply.

Our description of a *for* statement was a bit less general than what is allowed. The three expressions at the start of a *for* statement may be any C++ expressions and therefore they may involve more (or even fewer!) than one variable. However, our *for* statements will always use only a single variable in these expressions.

In the *for* statement in Display 3.12, the body was the simple assignment statement

```
sum = sum + n;
```

DISPLAY 3.12 A for Statement

```

1 //Illustrates a for loop.
2 #include <iostream>
3 using namespace std;
4
5 int main( )
6 {
7     int sum = 0;
8
9     for (int n = 1; n <= 10; n++) //Note that the variable n is a local
10        sum = sum + n;           //variable of the body of the for loop!
11
12     cout << "The sum of the numbers 1 to 10 is "
13          << sum << endl;
14     return 0;
15 }

```

Initializing action
Repeat the loop as long as this is true.
Done after each loop body iteration

Output

```
The sum of the numbers 1 to 10 is 55
```

DISPLAY 3.13 for Loop with a Multistatement Body**SYNTAX**

```

for (Initialization_Action; Boolean_Expression; Update_Action)
{
    Statement_1
    Statement_2
    .
    .
    Statement_Last
}

```

Body

EXAMPLE

```

for (int number = 100; number >= 0; number--)
{
    cout << number
         << " bottles of beer on the shelf.\n";
    if (number > 0)
        cout << "Take one down and pass it around.\n";
}

```

The body may be any statement at all. In particular, the body may be a compound statement. This allows us to place several statements in the body of a *for* loop, as shown in Display 3.13.

Thus far, you have seen *for* loops that increase the loop control variable by 1 after each loop iteration, and you have seen *for* loops that decrease the loop control variable by 1 after each loop iteration. There are many more possible kinds of variable updates. The variable can be incremented or decremented by 2 or 3 or any number. If the variable is of type *double*, it can be incremented or decremented by a fractional amount. All of the following are legitimate *for* loops:

more possible
update actions

```
int n;
for (n = 1; n <= 10; n = n + 2)
    cout << "n is now equal to " << n << endl;

for (n = 0; n > -100; n = n - 7)
    cout << "n is now equal to " << n << endl;

for (double size = 0.75; size <= 5; size = size + 0.05)
    cout << "size is now equal to " << size << endl;
```

The update need not even be an addition or subtraction. Moreover, the initialization need not simply set a variable equal to a constant. You can initialize and change a loop control variable in just about any way you wish. For example, the following demonstrates one more way to start a *for* loop:

```
for (double x = pow(y, 3.0); x > 2.0; x = sqrt(x))
    cout << "x is now equal to " << x << endl;
```

PITFALL Extra Semicolon in a *for* Statement

Do not place a semicolon after the closing parentheses at the beginning of a *for* loop. To see what can happen, consider the following *for* loop:

```
for (int count = 1; count <= 10; count++); ← Problem
    cout << "Hello\n";                    semicolon
```

If you did not notice the extra semicolon, you might expect this *for* loop to write Hello to the screen ten times. If you do notice the semicolon, you might expect the compiler to issue an error message. Neither of those things happens. If you embed this *for* loop in a complete program, the compiler will not complain. If you run the program, only one Hello will be output instead of ten Hellos. What is happening? To answer that question, we need a little background.

One way to create a statement in C++ is to put a semicolon after something. If you put a semicolon after *x++*, you change the expression

x++

into the statement

```
x++;
```

If you place a semicolon after nothing, you still create a statement. Thus, the semicolon by itself is a statement, which is called the **empty statement** or the **null statement**. The empty statement performs no action, but it is still a statement. Therefore, the following is a complete and legitimate *for* loop, whose body is the empty statement:

```
for (int count = 1; count <= 10; count++);
```

This *for* loop is indeed iterated ten times, but since the body is the empty statement, nothing happens when the body is iterated. This loop does nothing, and it does nothing ten times!

Now let's go back and consider the *for* loop code labeled *Problem semicolon*. Because of the extra semicolon, that code begins with a *for* loop that has an empty body, and as we just discussed, that *for* loop accomplishes nothing. After the *for* loop is completed, the following *cout* statement is executed and writes Hello to the screen one time:

```
cout << "Hello\n";
```

You will eventually see some uses for *for* loops with empty bodies, but at this stage, such a *for* loop is likely to be just a careless mistake. ■

What Kind of Loop to Use

When designing a loop, the choice of which C++ loop statement to use is best postponed to the end of the design process. First design the loop using pseudocode, then translate the pseudocode into C++ code. At that point it will be easy to decide what type of C++ loop statement to use.

If the loop involves a numeric calculation using a variable that is changed by equal amounts each time through the loop, use a *for* loop. In fact, whenever you have a loop for a numeric calculation, you should consider using a *for* loop. It will not always be suitable, but it is often the clearest and easiest loop to use for numeric calculations.

In most other cases, you should use a *while* loop or a *do-while* loop; it is fairly easy to decide which of these two to use. If you want to insist that the loop body will be executed at least once, you may use a *do-while* loop. If there are circumstances for which the loop body should not be executed at all, then you must use a *while* loop. A common situation that demands a *while* loop is reading input when there is a possibility of no data at all. For example, if the program reads in a list of exam scores, there may be cases of students who have taken no exams, and hence the input loop may be faced with an empty list. This calls for a *while* loop.

SELF-TEST EXERCISES

25. What is the output of the following (when embedded in a complete program)?

```
for (int count = 1; count < 5; count++)
    cout << (2 * count) << " ";
```

26. What is the output of the following (when embedded in a complete program)?

```
for (int n = 10; n > 0; n = n - 2)
{
    cout << "Hello ";
    cout << n << endl;
}
```

27. What is the output of the following (when embedded in a complete program)?

```
for (double sample = 2; sample > 0; sample = sample - 0.5)
    cout << sample << " ";
```

28. For each of the following situations, tell which type of loop (*while*, *do-while*, or *for*) would work best:

- Summing a series, such as $1/2 + 1/3 + 1/4 + 1/5 + \dots + 1/10$.
- Reading in the list of exam scores for one student.
- Reading in the number of days of sick leave taken by employees in a department.
- Testing a function to see how it performs for different values of its arguments.

29. Rewrite the following loops as *for* loops.

a.

```
int i = 1;
while (i <= 10)
{
    if (i < 5 && i != 2)
        cout << 'X';
    i++;
}
```

b.

```
int i = 1;
while (i <= 10)
```

```

    {
        cout << 'X';
        i = i + 3;
    }

```

```

c. long m = 100;
   do
   {
       cout << 'X';
       m = m + 100;
   } while (m < 1000);

```

30. What is the output of this loop? Identify the connection between the value of *n* and the value of the variable *log*.

```

int n = 1024;
int log = 0;
for (int i = 1; i < n; i = i * 2)
    log++;
cout << n << " " << log << endl;

```

31. What is the output of this loop? Comment on the code.

```

int n = 1024;
int log = 0;
for (int i = 1; i < n; i = i * 2);
    log++;
cout << n << " " << log << endl;

```

32. What is the output of this loop? Comment on the code.

```

int n = 1024;
int log = 0;
for (int i = 0; i < n; i = i * 2)
    log++;
cout << n << " " << log << endl;

```

PITFALL Uninitialized Variables and Infinite Loops

When we first introduced simple *while* and *do-while* loops in Chapter 2, we warned you of two pitfalls associated with loops. We said that you should be sure all variables that need to have a value in the loop are initialized (that is, given a value) before the loop is executed. This seems obvious when stated in the abstract, but in practice it is easy to become so concerned with designing a loop that you forget to initialize variables before the loop. We also said that you should be careful to avoid infinite loops. Both of these cautions apply equally well to *for* loops. ■

The *break* Statement

You have already used the *break* statement as a way of ending a *switch* statement. This same *break* statement can be used to exit a loop. Sometimes you want to exit a loop before it ends in the normal way. For example, the loop might contain a check for improper input and if some improper input is encountered, then you may want to simply end the loop. The code in Display 3.14 reads a list of negative numbers and computes their sum as the value of the variable *sum*. The loop ends normally provided the user types in ten negative numbers. If the user forgets a minus sign, the computation is ruined and the loop ends immediately when the *break* statement is executed.

DISPLAY 3.14 A *break* Statement in a Loop (part 1 of 2)

```

1 //Sums a list of ten negative numbers.
2 #include <iostream>
3 using namespace std;
4
5 int main( )
6 {
7     int number, sum = 0, count = 0;
8     cout << "Enter 10 negative numbers:\n";
9
10     while (++count <= 10)
11     {
12         cin >> number;
13
14         if (number >= 0)
15         {
16             cout << "ERROR: positive number"
17                 << " or zero was entered as the\n"
18                 << count << "th number! Input ends "
19                 << "with the " << count << "th number.\n"
20                 << count << "th number was not added in.\n";
21             break;
22         }
23
24         sum = sum + number;
25     }
26
27     cout << sum << " is the sum of the first "
28         << (count - 1) << " numbers.\n";
29
30     return 0;
31 }
```

(continued)

DISPLAY 3.14 A *break* Statement in a Loop (part 2 of 2)**Sample Dialogue**

```
Enter 10 negative numbers:  
-1 -2 -3 4 -5 -6 -7 -8 -9 -10  
ERROR: positive number or zero was entered as the  
4th number! Input ends with the 4th number.  
4th number was not added in.  
-6 is the sum of the first 3 numbers.
```

The *break* Statement

The *break* statement can be used to exit a loop statement. When the *break* statement is executed, the loop statement ends immediately and execution continues with the statement following the loop statement. The *break* statement may be used in any form of loop—in a *while* loop, in a *do-while* loop, or in a *for* loop. This is the same *break* statement that we have already used in *switch* statements.

PITFALL The *break* Statement in Nested Loops

A *break* statement ends only the innermost loop that contains it. If you have a loop within a loop and a *break* statement in the inner loop, then the *break* statement will end only the inner loop. ■

SELF-TEST EXERCISES

33. What is the output of the following (when embedded in a complete program)?

```
int n = 5;  
while (--n > 0)  
{  
    if (n == 2)  
        break;  
    cout << n << " ";  
}  
cout << "End of Loop.";
```

34. What is the output of the following (when embedded in a complete program)?

```
int n = 5;
while (--n > 0)
{
    if (n == 2)
        exit(0);
    cout << n << " ";
}
cout << "End of Loop.";
```

35. What does a *break* statement do? Where is it legal to put a *break* statement?

3.4 DESIGNING LOOPS

Round and round she goes, and where she stops nobody knows.

TRADITIONAL CARNIVAL BARKER'S CALL

When designing a loop, you need to design three things:

1. The body of the loop
2. The initializing statements
3. The conditions for ending the loop

We begin with a section on two common loop tasks and show how to design these three elements for each of the two tasks.

Loops for Sums and Products

Many common tasks involve reading in a list of numbers and computing their sum. If you know how many numbers there will be, such a task can easily be accomplished by the following pseudocode. The value of the variable `this_many` is the number of numbers to be added. The sum is accumulated in the variable `sum`.

```
sum = 0;
repeat the following this_many times:
    cin >> next;
    sum = sum + next;
end of loop.
```

This pseudocode is easily implemented as the following *for* loop:

```
int sum = 0;
for (int count = 1; count <= this_many; count++)
```

```

{
    cin >> next;
    sum = sum + next;
}

```

Notice that the variable `sum` is expected to have a value when the following loop body statement is executed:

```
sum = sum + next;
```

Since `sum` must have a value the very first time this statement is executed, `sum` must be initialized to some value before the loop is executed. In order to determine the correct initializing value for `sum`, think about what you want to happen after one loop iteration. After adding in the first number, the value of `sum` should be that number. That is, the first time through the loop the value of `sum + next` should equal `next`. To make this true, the value of `sum` must be initialized to 0.

Repeat “This Many Times”

A `for` statement can be used to produce a loop that repeats the loop body a predetermined number of times.

PSEUDOCODE

Repeat the following *this_many* times:
Loop_Body

EQUIVALENT `for` STATEMENT

```
for (int count = 1; count <= this_many; count++)
    Loop_Body
```

EXAMPLE

```
for (int count = 1; count <= 3; count++)
    cout << "Hip, Hip, Hurray\n";
```

You can form the **product** of a list of numbers in a way that is similar to how we formed the sum of a list of numbers. The technique is illustrated by the following code:

```

int product = 1;
for (int count = 1; count <= this_many; count++)
{
    cin >> next;
    product = product * next;
}

```

The variable `product` must be given an initial value. Do not assume that all variables should be initialized to zero. If `product` were initialized to 0, then it would still be zero after the loop above has finished. As indicated in the C++ code shown earlier, the correct initializing value for `product` is 1. To see that 1 is the correct initial value, notice that the first time through the loop this will leave `product` equal to the first number read in, which is what you want.

Ending a Loop

There are four commonly used methods for terminating an **input loop**. We will discuss them in order.

1. List headed by size
2. Ask before iterating
3. List ended with a sentinel value
4. Running out of input

If your program can determine the size of an input list beforehand, either by asking the user or by some other method, you can use a “repeat n times” loop to read input exactly n times, where n is the size of the list. This method is called **list headed by size**.

The second method for ending an input loop is simply to ask the user, after each loop iteration, whether or not the loop should be iterated again. For example:

```
sum = 0;
cout << "Are there any numbers in the list? (Type\n"
      << "Y and Return for Yes, N and Return for No): ";
char ans;
cin >> ans;
while ((ans == 'Y') || (ans == 'y'))
{
    cout << "Enter number: ";
    cin >> number;
    sum = sum + number;
    cout << "Are there any more numbers? (Type\n"
          << "Y for Yes, N for No. End with Return.): ";
    cin >> ans;
}
```

However, for reading in a long list, this is very tiresome to the user. Imagine typing in a list of 100 numbers this way. The user is likely to progress from happy to sarcastic and then to angry and frustrated. When reading in a long list, it is preferable to include only one stopping signal, which is the method we discuss next.

Perhaps the nicest way to terminate a loop that reads a list of values from the keyboard is with a *sentinel value*. A **sentinel value** is one that is somehow distinct from all the possible values on the list being read in and so can be used to signal the end of the list. For example, if the loop reads in a list of positive numbers, then a negative number can be used as a sentinel value to indicate the end of the list. A loop such as the following can be used to add a list of nonnegative numbers:

```
cout << "Enter a list of nonnegative integers.\n"
      << "Place a negative integer after the list.\n";
sum = 0;
cin >> number;
while (number >= 0)
{
    sum = sum + number;
    cin >> number;
}
```

Notice that the last number in the list is read but is not added into `sum`. To add the numbers 1, 2, and 3, the user appends a negative number to the end of the list like so:

```
1 2 3 -1
```

The final `-1` is read in but not added into the sum.

To use a sentinel value this way, you must be certain there is at least one value of the data type in question that definitely will not appear on the list of input values and thus can be used as the sentinel value. If the list consists of integers that might be any value whatsoever, then there is no value left to serve as the sentinel value. In this situation, you must use some other method to terminate the loop.

When reading input from a file, you can use a sentinel value, but a more common method is to simply check to see if all the input in the file has been read and to end the loop when there is no more input left to be read. This method of ending an input loop is discussed in Chapter 6 in the Programming Tip section entitled “Checking for the End of a File” and in the section entitled “The eof Member Function.”

The techniques we gave for ending an input loop are all special cases of more general techniques that can be used to end loops of any kind. The more general techniques are as follows:

- Count-controlled loops
- Ask before iterating
- Exit on a flag condition

A **count-controlled loop** is any loop that determines the number of iterations before the loop begins and then iterates the loop body that many times. The list-headed-by-size technique that we discussed for input loops is an example of a count-controlled loop. All of our “repeat this many times” loops are count-controlled loops.

We already discussed the **ask-before-iterating** technique. You can use it for loops other than input loops, but the most common use for this technique is for processing input.

Earlier in this section we discussed input loops that end when a sentinel value is read. In our example, the program read nonnegative integers into a variable called `number`. When `number` received a negative value, that indicated the end of the input; the negative value was the sentinel value. This is an example of a more general technique known as **exit on a flag condition**. A variable that changes value to indicate that some event has taken place is often called a **flag**. In our example input loop, the flag was the variable `number`; when it becomes negative, that indicates that the input list has ended.

Ending a file input loop by running out of input is another example of the exit-on-a-flag technique. In this case the flag condition is determined by the system. The system keeps track of whether or not input reading has reached the end of a file.

A flag can also be used to terminate loops other than input loops. For example, the following sample loop can be used to find a tutor for a student. Students in the class are numbered starting with 1. The loop checks each student number to see if that student received a high grade and stops the loop as soon as a student with a high grade is found. For this example, a grade of 90 or more is considered high. The code `compute_grade(n)` is a call to a user-defined function. In this case, the function will execute some code that will compute a numeric value from 0 to 100 that corresponds to student `n`'s grade. The numeric value then is copied into the variable `grade`. Chapter 4 discusses functions in more detail.

```
int n = 1;
grade = compute_grade(n);
while (grade < 90)
{
    n++;
    grade = compute_grade(n);
}
cout << "Student number " << n << " may be a tutor.\n"
     << "This student has a score of " << grade << endl;
```

In this example, the variable `grade` serves as the flag.

The previous loop indicates a problem that can arise when designing loops. What happens if no student has a score of 90 or better? The answer depends on the definition for the function `compute_grade`. If `grade` is defined for all positive integers, it could be an infinite loop. Even worse, if `grade` is defined to be, say, 100 for all arguments `n` that are not students, then it may try to make a tutor out of a nonexistent student. In any event, something will go wrong. If there is a danger of a loop turning into an infinite loop or even a danger of it iterating more times than is sensible, then you should include a check to see that the loop is not iterated too many times. For example, a better condition for our example loop is the following, where the variable `number_of_students` has been set equal to the number of students in the class:

```

int n = 1;
grade = compute_grade(n);
while ((grade < 90) && (n < number_of_students))
{
    n++;
    grade = compute_grade(n);
}
if (grade >= 90)
    cout << "Student number " << n << " may be a tutor.\n"
        << "This student has a score of " << grade << endl;
else
    cout << "No student has a high score.";

```



VideoNote
Nested Loop Example

Nested Loops

The program in Display 3.15 was designed to help track the reproduction rate of the green-necked vulture, an endangered species. In the district where this vulture survives, conservationists annually perform a count of the number of eggs in green-necked vulture nests. The program in Display 3.15 takes the reports of each of the conservationists in the district and calculates the total number of eggs contained in all the nests they observed.

Each conservationist's report consists of a list of numbers. Each number is the count of the number of eggs observed in one green-necked vulture nest. The program reads in the report of one conservationist and calculates the total number of eggs found by this conservationist. The list of numbers for each conservationist has a negative number added to the end of the list. This serves as a sentinel value. The program loops through the number of reports and calculates the total number of eggs found for each report.

The body of a loop may contain any kind of statement, so it is possible to have loops nested within loops (as well as eggs nested within nests). The program in Display 3.15 contains a loop within a loop. The nested loop in Display 3.15 is executed once for each value of count from 1 to number_of_reports. For each such iteration of the outer *for* loop there is one complete execution of the inner *while* loop. In Chapter 4 we'll use subroutines to make the program in Display 3.15 more readable.

DISPLAY 3.15 Explicitly Nested Loops (part 1 of 2)

```

1 //Determines the total number of green-necked vulture eggs
2 //counted by all conservationists in the conservation district.
3 #include <iostream>
4 using namespace std;
5
6 int main()
7 {
8     cout << "This program tallies conservationist reports\n"
9         << "on the green-necked vulture.\n"

```

(continued)

DISPLAY 3.15 Explicitly Nested Loops (*part 2 of 2*)

```

10     << "Each conservationist's report consists of\n"
11     << "a list of numbers. Each number is the count of\n"
12     << "the eggs observed in one"
13     << "green-necked vulture nest.\n"
14     << "This program then tallies"
15     << "the total number of eggs.\n";
16
17     int number_of_reports;
18     cout << "How many conservationist reports are there? ";
19     cin >> number_of_reports;
20
21     int grand_total = 0, subtotal, count;
22     for (count = 1; count <= number_of_reports; count++)
23     {
24         cout << endl << "Enter the report of "
25             << "conservationist number " << count << endl;
26         cout << "Enter the number of eggs in each nest.\n"
27             << "Place a negative integer at the end of your list.\n";"
28         subtotal = 0;
29         int next;
30         cin >> next;
31         while (next >= 0)
32         {
33             subtotal = subtotal + next;
34             cin >> next;
35         }
36         cout << "Total egg count for conservationist "
37             << " number " << count << " is "
38             << subtotal << endl;
39         grand_total = grand_total + subtotal;
40     }
41
42     cout << endl << "Total egg count for all reports = "
43         << grand_total << endl;
44
45     return 0;
46 }

```

SELF-TEST EXERCISES

36. Write a loop that will write the word Hello to the screen ten times (when embedded in a complete program).
37. Write a loop that will read in a list of even numbers (such as 2, 24, 8, 6) and compute the total of the numbers on the list. The list is ended with a sentinel value. Among other things, you must decide what would be a good sentinel value to use.

38. Predict the output of the following nested loops:

```
int n, m;
for (n = 1; n <= 10; n++)
    for (m = 10; m >= 1; m-)
        cout << n << " times " << m
            << " = " << n * m << endl;
```

Debugging Loops

No matter how carefully a program is designed, mistakes will still sometimes occur. In the case of loops, there is a pattern to the kinds of mistakes programmers most often make. Most loop errors involve the first or last iteration of the loop. If you find that your loop does not perform as expected, check to see if the loop is iterated one too many or one too few times. Loops that iterate one too many or one too few times are said to have an **off-by-one error**; these errors are among the most common loop bugs. Be sure you are not confusing less-than with less-than-or-equal-to. Be sure you have initialized the loop correctly. Remember that a loop may sometimes need to be iterated zero times and check that your loop handles that possibility correctly.

Infinite loops usually result from a mistake in the Boolean expression that controls the stopping of the loop. Check to see that you have not reversed an inequality, confusing less-than with greater-than. Another common source of infinite loops is terminating a loop with a test for equality, rather than something involving greater-than or less-than. With values of type *double*, testing for equality does not give meaningful answers, since the quantities being compared are only approximate values. Even for values of type *int*, equality can be a dangerous test to use for ending a loop, since there is only one way that it can be satisfied.

First, localize the problem

If you check and recheck your loop and can find no error, but your program still misbehaves, then you will need to do some more sophisticated testing. First, make sure that the mistake is indeed in the loop. Just because the program is performing incorrectly does not mean the bug is where you think it is. If your program is divided into functions, it should be easy to determine the approximate location of the bug or bugs.

Once you have decided that the bug is in a particular loop, you should watch the loop change the value of variables while the program is running. This way you can see what the loop is doing and thus see what it is doing wrong. Watching the value of a variable change while the program is running is called **tracing** the variable. Many systems have debugging utilities that allow you to easily trace variables without making any changes to your program. If your system has such a debugging utility, it would be well worth your effort to learn how to use it. If your system does not have a debugging utility, you can trace a variable by placing a temporary `cout` statement in the loop body; that way the value of the variable will be written to the screen on each loop iteration.

For example, consider the following piece of program code, which needs to be debugged:

```
int next = 2, product = 1;
while (next < 5)
{
    next++;
    product = product * next;
}
//The variable product contains
//the product of the numbers 2 through 5.
```

The comment at the end of the loop tells what the loop is supposed to do, but we have tested it and know that it gives the variable `product` an incorrect value. We need to find out what is wrong. To help us debug this loop, we trace the variables `next` and `product`. If you have a debugging utility, you could use it. If you do not have a debugging facility, you can trace the variables by inserting a `cout` statement as follows:

```
int next = 2, product = 1;
while (next < 5)
{
    next++;
    product = product * next;
    cout << "next = " << next
         << " product = " << product << endl;
}
}
```

When we trace the variables `product` and `next`, we find that after the first loop iteration, the values of `product` and `next` are both 3. It is then clear to us that we have multiplied only the numbers 3 through 5 and have missed multiplying by 2.

There are at least two good ways to fix this bug. The easiest fix is to initialize the variable `next` to 1, rather than 2. That way, when `next` is incremented the first time through the loop, it will receive the value 2 rather than 3. Another way to fix the loop is to place the increment after the multiplication, as follows:

```
int next = 2, product = 1;
while (next < 5)
{
    product = product * next;
    next++;
}
}
```

Let's assume we fix the bug by moving the statement `next++` as indicated above. After we add this fix, we are not yet done. We must test this revised code. When we test it, we will see that it still gives an incorrect result. If we again trace variables, we will discover that the loop stops after multiplying by 4, and never multiplies by 5. This tells us that the Boolean expression should now use a less-than-or-equal sign, rather than a less-than sign. Thus, the correct code is

```
int next = 2, product = 1;
while (next <= 5)
{
    product = product * next;
    next++;
}
```

Every change
requires retesting

Every time you change a program, you should retest the program. Never assume that your change will make the program correct. Just because you found one thing to correct does not mean you have found all the things that need to be corrected. Also, as illustrated by this example, when you change one part of your program to make it correct, that change may require you to change some other part of the program as well.

Testing a Loop

Every loop should be tested with inputs that cause each of the following loop behaviors (or as many as are possible): zero iterations of the loop body, one iteration of the loop body, the maximum number of iterations of the loop body, and one less than the maximum number of iterations of the loop body. (This is only a minimal set of test situations. You should also conduct other tests that are particular to the loop you are testing.)

The techniques we have developed will help you find the few bugs that may find their way into a well-designed program. However, no amount of debugging can convert a poorly designed program into a reliable and readable one. If a program or algorithm is very difficult to understand or performs very poorly, do not try to fix it. Instead, throw it away and start over. This will result in a program that is easier to read and that is less likely to contain hidden errors. What may not be so obvious is that by throwing out the poorly designed code and starting over, you will produce a working program faster than if you try to repair the old code. It may seem like wasted effort to throw out all the code that you worked so hard on, but that is the most efficient way to proceed. The work that went into the discarded code is not wasted. The lessons you learned by writing it will help you to design a better program faster than if you started with no experience. The bad code itself is unlikely to help at all.

Debugging a Very Bad Program

If your program is very bad, do not try to debug it. Instead, throw it out and start over.

SELF-TEST EXERCISES

39. What does it mean to trace a variable? How do you trace a variable?
40. What is an off-by-one loop error?
41. You have a fence that is to be 100 meters long. Your fence posts are to be placed every 10 feet. How many fence posts do you need? Why is the presence of this problem in a programming book not as silly as it might seem? What problem that programmers have does this question address?

CHAPTER SUMMARY

- Boolean expressions are evaluated similarly to the way arithmetic expressions are evaluated.
- Most modern compilers have a *bool* type having the values *true* and *false*.
- You can write a function so that it returns a value of *true* or *false*. A call to such a function can be used as a Boolean expression in an *if-else* statement or anywhere else that a Boolean expression is permitted.
- One approach to solving a task or subtask is to write down conditions and corresponding actions that need to be taken under each condition. This can be implemented in C++ as a multiway *if-else* statement.
- A *switch* statement is a good way to implement a menu for the user of your program.
- A **block** is a compound statement that contains variable declarations. The variables declared in a block are local to the block. Among other uses, blocks can be used for the action in one branch of a multiway branch statement, such as a multiway *if-else* statement.
- A *for* loop can be used to obtain the equivalent of the instruction “repeat the loop body *n* times.”
- There are four commonly used methods for terminating an input loop: list headed by size, ask before iterating, list ended with a sentinel value, and running out of input.
- It is usually best to design loops in pseudocode that does not specify a choice of C++ looping mechanism. Once the algorithm has been designed, the choice of which C++ loop statement to use is usually clear.
- One way to simplify your reasoning about nested loops is to make the loop body a function call.

- Always check loops to be sure that the variables used by the loop are properly initialized before the loop begins.
- Always check loops to be certain they are not iterated one too many or one too few times.
- When debugging loops, it helps to trace key variables in the loop body.
- If a program or algorithm is very difficult to understand or performs very poorly, do not try to fix it. Instead, throw it away and start over.

Answers to Self-Test Exercises

1. a. *true*.
- b. *true*. Note that expressions (a) and (b) mean exactly the same thing. Because the operators `==` and `<` have higher precedence than `&&`, you do not need to include the parentheses. The parentheses do, however, make it easier to read. Most people find the expression in (a) easier to read than the expression in (b), even though they mean the same thing.
- c. *true*.
- d. *true*.
- e. *false*. Since the value of the first subexpression (`count == 1`) is *false*, you know that the entire expression is *false* without bothering to evaluate the second subexpression. Thus, it does not matter what the values of `x` and `y` are. This is called *short-circuit evaluation*, which is what C++ does.
- f. *true*. Since the value of the first subexpression (`count < 10`) is *true*, you know that the entire expression is *true* without bothering to evaluate the second subexpression. Thus, it does not matter what the values of `x` and `y` are. This is called *short-circuit evaluation*, which is what C++ does.
- g. *false*. Notice that the expression in (g) includes the expression in (f) as a subexpression. This subexpression is evaluated using short-circuit evaluation as we described for (f). The entire expression in (g) is equivalent to

```
!( (true || (x < y)) && true )
```

which in turn is equivalent to `!(true && true)`, and that is equivalent to `!(true)`, which is equivalent to the final value of *false*.

- h. This expression produces an error when it is evaluated because the first subexpression `((limit/count) > 7)` involves a division by zero.

- i. *true*. Since the value of the first subexpression $(limit < 20)$ is *true*, you know that the entire expression is *true* without bothering to evaluate the second subexpression. Thus, the second subexpression

$$((limit/count) > 7)$$

is never evaluated and so the fact that it involves a division by zero is never noticed by the computer. This is short-circuit evaluation, which is what C++ does.

- j. This expression produces an error when it is evaluated because the first subexpression $((limit/count) > 7)$ involves a division by zero.
- k. *false*. Since the value of the first subexpression $(limit < 0)$ is *false*, you know that the entire expression is *false* without bothering to evaluate the second subexpression. Thus, the second subexpression

$$((limit/count) > 7)$$

is never evaluated and so the fact that it involves a division by zero is never noticed by the computer. This is short-circuit evaluation, which is what C++ does.

- l. If you think this expression is nonsense, you are correct. The expression has no intuitive meaning, but C++ converts the *int* values to *bool* values and then evaluates the *&&* and *!* operations. Thus, C++ will evaluate this mess. Recall that in C++, any nonzero integer converts to *true*, and 0 converts to *false*. C++ will evaluate

$$(5 \ \&\& \ 7) + (!6)$$

as follows: In the expression $(5 \ \&\& \ 7)$, the 5 and 7 convert to *true*. *true* *&&* *true* evaluates to *true*, which C++ converts to 1. In $(!6)$, the 6 is converted to *true*, so $!(true)$ evaluates to *false*, which C++ converts to 0. The entire expression thus evaluates to $1 + 0$, which is 1. The final value is thus 1. C++ will convert the number 1 to *true*, but the answer has little intuitive meaning as *true*; it is perhaps better to just say the answer is 1.

There is no need to become proficient at evaluating these nonsense expressions, but doing a few will help you to understand why the compiler does not give you an error message when you make the mistake of incorrectly mixing numeric and Boolean operators in a single expression.

2. To this point we have studied branching statements, iteration statements, and function call statements. Examples of branching statements we have studied are *if* and *if-else* statements. Examples of iteration statements are *while* and *do-while* statements.

3. The expression `2 < x < 3` is legal. It does not mean `(2 < x) && (x < 3)` as many would wish. It means `(2 < x) < 3`. Since `(2 < x)` is a Boolean expression, its value is either *true* or *false*, which converts to 1 or 0, so that `2 < x < 3` is always *true*. The output is "true" regardless of the value of `x`.
4. No. The Boolean expression `j > 0` is *false* (`j` was just assigned `-1`). The `&&` uses short-circuit evaluation, which does not evaluate the second expression if the truth value can be determined from the first expression. The first expression is *false*, so the entire expression evaluates to *false* without evaluating the second expression. So, there is no division by zero.
5.

```
Start
Hello from the second if.
End
Start again
End again
```
6.

```
large
```
7.

```
small
```
8.

```
medium
```
9.

```
Start
Second Output
End
```
10. The statements are the same whether the second Boolean expression is `(x > 10)` or `(x > 100)`. So, the output is the same as in Self-Test Exercise 9.
11.

```
Start
100
End
```
12. Both of the following are correct:

```
if (n < 0)
    cout << n << " is less than zero.\n";
else if ((0 <= n) && (n <= 100))
    cout << n << " is between 0 and 100 (inclusive).\n";
else if (n > 100)
    cout << n << " is larger than 100.\n";
```

and

```
if (n < 0)
    cout << n << " is less than zero.\n";
```

```

else if (n <= 100)
    cout << n << " is between 0 and 100 (inclusive).\n";
else
    cout << n << " is larger than 100.\n";

```

13. *enum* constants are given default values starting at 0, unless otherwise assigned. The constants increment by 1. The output is 3 2 1 0.
14. *enum* constants are given values as assigned. Unassigned constants increment the previous value by 1. The output is 2 1 7 5.

15. Roast worms

16. Onion ice cream

17. Chocolate ice cream
Onion ice cream

(This is because there is no *break* statement in *case 3*.)

18. Bon appetit!

19. 42 22

20. It helps to slightly change the code fragment to understand to which declaration each usage resolves.

```

{
    int x1 = 1; // output in this column
    cout << x1 << endl; // 1<cr>
    {
        cout << x1 << endl; // 1<cr>
        int x2 = 2;
        cout << x2 << endl; // 2<cr>
        {
            cout << x2 << endl; // 2<cr>
            int x3 = 3;
            cout << x3 << endl; // 3<cr>
        }
        cout << x2 << endl; // 2<cr>
    }
    cout << x1 << endl; // 1<cr>
}

```

Here *<cr>* indicates that the output starts a new line.

21. 2 1 0

22. 2 1

23. 1 2 3 4
24. 1 2 3
25. 2 4 6 8
26. Hello 10
Hello 8
Hello 6
Hello 4
Hello 2
27. 2.000000 1.500000 1.000000 0.500000
28. a. A *for* loop
b. and c. Both require a *while* loop since the input list might be empty.
c. A *do-while* loop can be used since at least one test will be performed.
29. a.

```
for (int i = 1; i <= 10; i++)
    if (i < 5 && i != 2)
        cout << 'X';
```

b.

```
for (i = 1; i <= 10; i = i + 3)
    cout << 'X';
```

c.

```
cout << 'X'; //necessary to keep output the same. Note
//also the change in initialization of m
for (long m = 200; m < 1000; m = m + 100)
    cout << 'X';
```
30. The output is 1024 10. The second number is the base 2 log of the first number.
31. The output is: 1024 1. The ';' after the *for* is probably a pitfall error.
32. This is an infinite loop. Consider the update expression $i = i * 2$. It cannot change i because its initial value is 0, so it leaves i at its initial value, 0.
33. 4 3 End of Loop
34. 4 3
- Notice that since the `exit` statement ends the program, the phrase End of Loop is not output.
35. A *break* statement is used to exit a loop (a *while*, *do-while*, or *for* statement) or to terminate a case in a *switch* statement. A *break* is not legal anywhere else in a C++ program. Note that if the loops are nested, a *break* statement only terminates one level of the loop.

36.

```
for (int count = 1; count <= 10; count++)
    cout << "Hello\n";
```

37. You can use any odd number as a sentinel value.

```
int sum = 0, next;
cout << "Enter a list of even numbers. Place an\n"
    << "odd number at the end of the list.\n";
cin >> next;
while ((next % 2) == 0)
{
    sum = sum + next;
    cin >> next;
}
```

38. The output is too long to reproduce here. The pattern is as follows:

```
1 times 10 = 10
1 times 9 = 9
.
.
.
1 times 1 = 1
2 times 10 = 20
2 times 9 = 18
.
.
.
2 times 1 = 2
3 times 10 = 30
.
.
.
```

39. *Tracing a variable* means watching a program variable change value while the program is running. This can be done with special debugging facilities or by inserting temporary output statements in the program.

40. Loops that iterate the loop body one too many or one too few times are said to have an off-by-one error.

41. Off-by-one errors abound in problem solving, not just writing loops. Typical reasoning from those who do not think carefully is

10 posts = 100 feet of fence / 10 feet between posts

This, of course, will leave the last 10 feet of fence without a post. You need 11 posts to provide 10 between-the-post 10-foot intervals to get 100 feet of fence.

PRACTICE PROGRAMS

Practice Programs can generally be solved with a short program that directly applies the programming principles presented in this chapter.

1. Write a program to score the paper-rock-scissor game. Each of two users types in either P, R, or S. The program then announces the winner as well as the basis for determining the winner: Paper covers rock, Rock breaks scissors, Scissors cut paper, or Nobody wins. Be sure to allow the users to use lowercase as well as uppercase letters. Your program should include a loop that lets the user play again until the user says she or he is done.
2. Write a program to compute the interest due, total amount due, and the minimum payment for a revolving credit account. The program accepts the account balance as input, then adds on the interest to get the total amount due. The rate schedules are the following: The interest is 1.5 percent on the first \$1,000 and 1 percent on any amount over that. The minimum payment is the total amount due if that is \$10 or less; otherwise, it is \$10 or 10 percent of the total amount owed, whichever is larger. Your program should include a loop that lets the user repeat this calculation until the user says she or he is done.
3. Write an astrology program. The user types in a birthday, and the program responds with the sign and horoscope for that birthday. The month may be entered as a number from 1 to 12. Then enhance your program so that if the birthday is only one or two days away from an adjacent sign, the program announces that the birthday is on a “cusp” and also outputs the horoscope for that nearest adjacent sign. This program will have a long multiway branch. Make up a horoscope for each sign. Your program should include a loop that lets the user repeat this calculation until the user says she or he is done.

The horoscope signs and dates are:

Aries	March 21–April 19
Taurus	April 20–May 20
Gemini	May 21–June 21
Cancer	June 22–July 22
Leo	July 23–August 22
Virgo	August 23–September 22
Libra	September 23–October 22
Scorpio	October 23–November 21
Sagittarius	November 22–December 21
Capricorn	December 22–January 19
Aquarius	January 20–February 18
Pisces	February 19–March 20

4. Horoscope Signs of the same Element are most compatible. There are 4 Elements in astrology, and 3 Signs in each: FIRE (Aries, Leo, Sagittarius), EARTH (Taurus, Virgo, Capricorn), AIR (Gemini, Libra, Aquarius), WATER (Cancer, Scorpio, Pisces).

According to some astrologers, you are most comfortable with your own sign and the other two signs in your Element. For example, Aries would be most comfortable with other Aries and the two other FIRE signs, Leo and Sagittarius.

Modify your program from Practice Program 3 to also display the name of the signs that will be compatible for the birthday.

5. Write a program that finds and prints all of the prime numbers between 3 and 100. A prime number is a number such that 1 and itself are the only numbers that evenly divide it (for example, 3, 5, 7, 11, 13, 17, ...).

One way to solve this problem is to use a doubly nested loop. The outer loop can iterate from 3 to 100 while the inner loop checks to see if the counter value for the outer loop is prime. One way to see if number n is prime is to loop from 2 to $n - 1$ and if any of these numbers evenly divides n , then n cannot be prime. If none of the values from 2 to $n - 1$ evenly divides n , then n must be prime. (Note that there are several easy ways to make this algorithm more efficient.)

6. Buoyancy is the ability of an object to float. Archimedes' principle states that the buoyant force is equal to the weight of the fluid that is displaced by the submerged object. The buoyant force can be computed by

$$F_b = V \times \gamma$$

where F_b is the buoyant force, V is the volume of the submerged object, and γ is the specific weight of the fluid. If F_b is greater than or equal to the weight of the object, then it will float, otherwise it will sink.

Write a program that inputs the weight (in pounds) and radius (in feet) of a sphere and outputs whether the sphere will sink or float in water. Use $\gamma = 62.4 \text{ lb/ft}^3$ as the specific weight of water. The volume of a sphere is computed by $(4/3)\pi r^3$.

7. Write a program that finds the temperature that is the same in both Celsius and Fahrenheit. The formula to convert from Celsius to Fahrenheit is

$$\text{Fahrenheit} = \frac{(9 \times \text{Celsius})}{5} + 32$$

Your program should create two integer variables for the temperature in Celsius and Fahrenheit. Initialize the temperature to 100 degrees Celsius. In a loop, decrement the Celsius value and compute the corresponding temperature in Fahrenheit until the two values are the same.

Since you are working with integer values, the formula may not give an exact result for every possible Celsius temperature. This will not affect your solution to this particular problem.

PROGRAMMING PROJECTS

Programming Projects require more problem-solving than Practice Programs and can usually be solved many different ways. Visit www.myprogramminglab.com to complete many of these Programming Projects online and get instant feedback.

1. Write a program that computes the cost of a long-distance call. The cost of the call is determined according to the following rate schedule:
 - a. Any call started between 8:00 am and 6:00 pm, Monday through Friday, is billed at a rate of \$0.40 per minute.
 - b. Any call starting before 8:00 am or after 6:00 pm, Monday through Friday, is charged at a rate of \$0.25 per minute.
 - c. Any call started on a Saturday or Sunday is charged at a rate of \$0.15 per minute.

The input will consist of the day of the week, the time the call started, and the length of the call in minutes. The output will be the cost of the call. The time is to be input in 24-hour notation, so the time 1:30 pm is input as

13:30

The day of the week will be read as one of the following pairs of character values, which are stored in two variables of type *char*:

Mo Tu We Th Fr Sa Su

Be sure to allow the user to use either uppercase or lowercase letters or a combination of the two. The number of minutes will be input as a value of type *int*. (You can assume that the user rounds the input to a whole number of minutes.) Your program should include a loop that lets the user repeat this calculation until the user says she or he is done.

2. (This Project requires that you know some basic facts about complex numbers, so it is only appropriate if you have studied complex numbers in some mathematics class.)

Write a C++ program that solves a quadratic equation to find its roots. The roots of a quadratic equation

$$ax^2 + bx + c = 0$$

(where *a* is not zero) are given by the formula

$$(-b \pm \text{sqrt}(b^2 - 4ac)) / 2a$$

The value of the discriminant ($b^2 - 4ac$) determines the nature of roots. If the value of the discriminant is zero, then the equation has a single real root. If the value of the discriminant is positive then the equation has two real roots. If the value of the discriminant is negative, then the equation has two complex roots.

The program takes values of a , b , and c as input and outputs the roots. Be creative in how you output complex roots. Include a loop that allows the user to repeat this calculation for new input values until the user says she or he wants to end the program.

3. Write a program that accepts a year written as a four-digit Arabic (ordinary) numeral and outputs the year written in Roman numerals. Important Roman numerals are V for 5, X for 10, L for 50, C for 100, D for 500, and M for 1,000. Recall that some numbers are formed by using a kind of subtraction of one Roman “digit”; for example, IV is 4 produced as V minus I, XL is 40, CM is 900, and so on. A few sample years: MCM is 1900, MCML is 1950, MCMLX is 1960, MCMXL is 1940, MCMLXXXIX is 1989. Assume the year is between 1000 and 3000. Your program should include a loop that lets the user repeat this calculation until the user says she or he is done.
4. Write a program that scores a blackjack hand. In blackjack, a player receives from two to five cards. The cards 2 through 10 are scored as 2 through 10 points each. The face cards—jack, queen, and king—are scored as 10 points. The goal is to come as close to a score of 21 as possible without going over 21. Hence, any score over 21 is called “busted.” The ace can count as either 1 or 11, whichever is better for the user. For example, an ace and a 10 can be scored as either 11 or 21. Since 21 is a better score, this hand is scored as 21. An ace and two 8s can be scored as either 17 or 27. Since 27 is a “busted” score, this hand is scored as 17.

The user is asked how many cards she or he has, and the user responds with one of the integers 2, 3, 4, or 5. The user is then asked for the card values. Card values are 2 through 10, jack, queen, king, and ace. A good way to handle input is to use the type *char* so that the card input 2, for example, is read as the character '2', rather than as the number 2. Input the values 2 through 9 as the characters '2' through '9'. Input the values 10, jack, queen, king, and ace as the characters 't', 'j', 'q', 'k', and 'a'. (Of course, the user does not type in the single quotes.) Be sure to allow upper- as well as lowercase letters as input.

After reading in the values, the program should convert them from character values to numeric card scores, taking special care for aces. The output is either a number between 2 and 21 (inclusive) or the word Busted. You are likely to have one or more long multiway branches that use a *switch* statement or nested *if-else* statement. Your program should include a loop that lets the user repeat this calculation until the user says she or he is done.

5. Interest on a loan is paid on a declining balance, and hence a loan with an interest rate of, say, 14 percent can cost significantly less than 14 percent of the balance. Write a program that takes a loan amount and interest rate as input and then outputs the monthly payments and balance of the loan until the loan is paid off. Assume that the monthly payments are one-twentieth of the original loan amount, and that any amount in excess of the interest is credited toward decreasing the balance due. Thus, on a loan of \$20,000, the payments would be \$1,000 a month. If the interest rate is 10 percent, then each month the interest is one-twelfth of 10 percent of the remaining balance. The first month, $(10 \text{ percent of } \$20,000)/12$, or \$166.67, would be paid in interest, and the remaining \$833.33 would decrease the balance to \$19,166.67. The following month the interest would be $(10 \text{ percent of } \$19,166.67)/12$, and so forth. Also have the program output the total interest paid over the life of the loan.

Finally, determine what simple annualized percentage of the original loan balance was paid in interest. For example, if \$1,000 was paid in interest on a \$10,000 loan and it took 2 years to pay off, then the annualized interest is \$500, which is 5 percent of the \$10,000 loan amount. Your program should allow the user to repeat this calculation as often as desired.

6. The Fibonacci numbers F_n are defined as follows. F_0 is 1, F_1 is 1, and

$$F_{i+2} = F_i + F_{i+1}$$

$i = 0, 1, 2, \dots$. In other words, each number is the sum of the previous two numbers. The first few Fibonacci numbers are 1, 1, 2, 3, 5, and 8. One place that these numbers occur is as certain population growth rates. If a population has no deaths, then the series shows the size of the population after each time period. It takes an organism two time periods to mature to reproducing age, and then the organism reproduces once every time period. The formula applies most straightforwardly to asexual reproduction at a rate of one offspring per time period.

Assume that the green crud population grows at this rate and has a time period of 5 days. Hence, if a green crud population starts out as 10 pounds of crud, then in 5 days there is still 10 pounds of crud; in 10 days there is 20 pounds of crud, in 15 days 30 pounds, in 20 days 50 pounds, and so forth. Write a program that takes both the initial size of a green crud population (in pounds) and a number of days as input, and that outputs the number of pounds of green crud after that many days. Assume that the population size is the same for 4 days and then increases every fifth day. Your program should allow the user to repeat this calculation as often as desired.

7. The value e^x can be approximated by the sum

$$1 + x + x^2/2! + x^3/3! + \dots + x^n/n!$$

Write a program that takes a value x as input and outputs this sum for n taken to be each of the values 1 to 100. The program should also output e^x calculated using the predefined function `exp`. The function `exp` is a predefined function such that `exp(x)` returns an approximation to the value e^x . The function `exp` is in the library with the header file `cmath`. Your program should repeat the calculation for new values of x until the user says she or he is through.

Use variables of type `double` to store the factorials or you are likely to produce integer overflow (or arrange your calculation to avoid any direct calculation of factorials). 100 lines of output might not fit comfortably on your screen. Output the 100 output values in a format that will fit all 100 values on the screen. For example, you might output 10 lines with 10 values on each line.

8. An approximate value of pi can be calculated using the series given below:

$$\text{pi} = 4 [1 - 1/3 + 1/5 - 1/7 + 1/9 \dots + ((-1)^n)/(2n + 1)]$$

Write a C++ program to calculate the approximate value of pi using this series. The program takes an input n that determines the number of terms in the approximation of the value of pi and outputs the approximation. Include a loop that allows the user to repeat this calculation for new values n until the user says she or he wants to end the program.

9. The following problem is sometimes called “The Monty Hall Game Show Problem.” You are a contestant on a game show and have won a shot at the grand prize. Before you are three closed doors. Behind one door is a brand new car. Behind the other two doors are consolation prizes. The location of the prizes is randomly selected. The game show host asks you to select a door, and you pick one. However, before revealing the contents behind your door, the game show host reveals one of the other doors with a consolation prize. At this point, the game show host asks if you would like to stick with your original choice or switch your choice to the other closed door. What choice should you make to optimize your chances of winning the car? Does it matter whether you stick with your original choice or switch doors?

Write a simulation program to solve the game show problem. Your program should make 10,000 simulated runs through the problem, randomly selecting locations for the prize, and then counting the number of times the car was won when sticking with the original choice, and counting the number of times the car was won when switching doors. Output the estimated probability of winning for both strategies. Be sure that your program exactly simulates the process of selecting the door, revealing one, and then switching. Do not make assumptions about the actual solution (for example, simply assuming that there is a $1/3$ or $1/2$ chance of getting the prize).

Appendix 4 gives library functions for generating random numbers. A more detailed description is provided in Chapter 4.



VideoNote
Solution to Programming
Project 3.9

10. Repeat Programming Project 13 from Chapter 2 but in addition ask the user if he or she is:
- Sedentary
 - Somewhat active (exercise occasionally)
 - Active (exercise 3–4 days per week)
 - Highly active (exercise every day)

If the user answers “Sedentary,” then increase the calculated BMR by 20 percent. If the user answers “Somewhat active,” then increase the calculated BMR by 30 percent. If the user answers “Active,” then increase the calculated BMR by 40 percent. Finally, if the user answers “Highly active,” then increase the calculated BMR by 50 percent. Output the number of chocolate bars based on the new BMR value.

11. The keypad on your oven is used to enter the desired baking temperature and is arranged like the digits on a phone:

1	2	3
4	5	6
7	8	9
	0	

Unfortunately the circuitry is damaged and the digits in the leftmost column no longer function. In other words, the digits 1, 4, and 7 do not work. If a recipe calls for a temperature that can't be entered, then you would like to substitute a temperature that can be entered. Write a program that inputs a desired temperature. The temperature must be between 0 and 999 degrees. If the desired temperature does not contain 1, 4, or 7, then output the desired temperature. Otherwise, compute the next largest and the next smallest temperature that does not contain 1, 4, or 7 and output both.

For example, if the desired temperature is 450, then the program should output 399 and 500. Similarly, if the desired temperature is 375, then the program should output 380 and 369.

12. The game of “23” is a two-player game that begins with a pile of 23 toothpicks. Players take turns, withdrawing either 1, 2, or 3 toothpicks at a time. The player to withdraw the last toothpick loses the game. Write a human vs. computer program that plays “23”. The human should always move first. When it is the computer's turn, it should play according to the following rules:
- If there are more than 4 toothpicks left, then the computer should withdraw $4 - X$ toothpicks, where X is the number of toothpicks the human withdrew on the previous turn.



VideoNote
Solution to Programming
Project 3.11

- If there are 2 to 4 toothpicks left, then the computer should withdraw enough toothpicks to leave 1.
- If there is 1 toothpick left, then the computer has to take it and loses.

When the human player enters the number of toothpicks to withdraw, the program should perform input validation. Make sure that the entered number is between 1 and 3 and that the player is not trying to withdraw more toothpicks than exist in the pile.

13. Holy digits Batman! The Riddler is planning his next caper somewhere on Pennsylvania Avenue. In his usual sporting fashion, he has left the address in the form of a puzzle. The address on Pennsylvania is a four-digit number where:
- All four digits are different
 - The digit in the thousands place is three times the digit in the tens place
 - The number is odd
 - The sum of the digits is 27

Write a program that uses a loop (or loops) to find the address where the Riddler plans to strike.

This page intentionally left blank

Procedural Abstraction and Functions That Return a Value **4**

4.1 TOP-DOWN DESIGN 182

4.2 PREDEFINED FUNCTIONS 183

Using Predefined Functions 183
Random Number Generation 188
Type Casting 190
Older Form of Type Casting 192
Pitfall: Integer Division Drops the
Fractional Part 192

4.3 PROGRAMMER-DEFINED FUNCTIONS 193

Function Definitions 193
Functions That Return a Boolean Value 199
Alternate Form for Function Declarations 199
Pitfall: Arguments in the Wrong Order 200
Function Definition–Syntax Summary 201
More About Placement of Function Definitions 202
Programming Tip: Use Function Calls in Branching
Statements 203

4.4 PROCEDURAL ABSTRACTION 204

The Black-Box Analogy 204
Programming Tip: Choosing Formal Parameter
Names 207

Programming Tip: Nested Loops 208
Case Study: Buying Pizza 211
Programming Tip: Use Pseudocode 217

4.5 SCOPE AND LOCAL VARIABLES 218

The Small Program Analogy 218
Programming Example: Experimental
Pea Patch 221
Global Constants and Global Variables 221
Call-by-Value Formal Parameters Are Local
Variables 224
Block Scope 226
Namespaces Revisited 227
Programming Example: The Factorial Function 230

4.6 OVERLOADING FUNCTION NAMES 232

Introduction to Overloading 232
Programming Example: Revised Pizza-Buying
Program 235
Automatic Type Conversion 238



There was a most ingenious Architect who had contrived a new method for building Houses, by beginning at the Roof, and working downward to the Foundation.

JONATHAN SWIFT, *Gulliver's Travels*

INTRODUCTION

A program can be thought of as consisting of subparts, such as obtaining the input data, calculating the output data, and displaying the output data. C++, like most programming languages, has facilities to name and code each of these subparts separately. In C++ these subparts are called *functions*. In this chapter we present the basic syntax for one of the two main kinds of C++ functions—namely those designed to compute a single value. We also discuss how these functions can aid in program design. We begin with a discussion of a fundamental design principle.

PREREQUISITES

You should read Chapter 2 and at least look through Chapter 1 before reading this chapter.

4.1 TOP-DOWN DESIGN

Remember that the way to write a program is to first design the method that the program will use and to write out this method in English, as if the instructions were to be followed by a human clerk. As we noted in Chapter 1, this set of instructions is called an *algorithm*. A good plan of attack for designing the algorithm is to break down the task to be accomplished into a few subtasks, decompose each of these subtasks into smaller subtasks, and so forth. Eventually, the subtasks become so small that they are trivial to implement in C++. This method is called **top-down design**. (The method is also sometimes called **stepwise refinement**, or more graphically, **divide and conquer**.)

Using the top-down method, you design a program by breaking the program's task into subtasks and solving these subtasks by subalgorithms. Preserving this top-down structure in your C++ program makes the program easier to understand, easier to change if need be, and, as will become apparent, easier to write, test, and debug. C++, like most programming languages, has facilities to include separate subparts inside of a program. In other programming languages these subparts are called *subprograms*, *procedures*, or *methods*. In C++ these subparts are called **functions**.

One of the advantages of using functions to divide a programming task into subtasks is that the program becomes easier to understand, test, debug, and maintain. Additionally, dividing the task allows different people to work on the different subtasks. When producing a very large program, such as a compiler or office-management system, this sort of teamwork is needed if the program is to be produced in a reasonable amount of time. We will begin our discussion of functions by showing you how to use functions that were written by somebody else.

4.2 PREDEFINED FUNCTIONS

C++ comes with libraries of predefined functions that you can use in your programs. Before we show you how to define functions, we will first show you how to use some functions that are already defined for you.

Using Predefined Functions

We will use the `sqrt` function to illustrate how you use predefined functions. The `sqrt` function calculates the square root of a number. (The square root of a number is the number that, when multiplied by itself, will produce the number you started out with. For example, the square root of 9 is 3 because 3^2 is equal to 9.) The function `sqrt` starts with a number, such as 9.0, and computes its square root, in this case 3.0. The value the function starts out with is called its **argument**. The value it computes is called the **value returned**. Some functions may have more than one argument, but no function has more than one value returned. If you think of the function as being similar to a small program, then the arguments are analogous to the input and the value returned is analogous to the output.

The syntax for using functions in your program is simple. To set a variable named `the_root` equal to the square root of 9.0, you can use the following assignment statement:

```
the_root = sqrt(9.0);
```

The expression `sqrt(9.0)` is called a **function call** (or if you want to be fancy you can also call it a **function invocation**). An argument in a function call can be a constant, such as 9.0, or a variable, or a more complicated expression. A function call is an expression that can be used like any other expression. You can use a function call wherever it is legal to use an expression of the type specified for the value returned by the function. For example, the value returned by `sqrt` is of type *double*. Thus, the following is legal (although perhaps stingy):

```
bonus = sqrt(sales)/10;
```

`sales` and `bonus` are variables that would normally be of type *double*. The function call `sqrt(sales)` is a single item, just as if it were enclosed in parentheses. Thus, this assignment statement is equivalent to

```
bonus = (sqrt(sales))/10;
```

You can also use a function call directly in a `cout` statement, as in the following:

```
cout << "The side of a square with area " << area
      << " is " << sqrt(area);
```

Display 4.1 contains a complete program that uses the predefined function `sqrt`. The program computes the size of the largest square dog house that can be built for the amount of money the user is willing to spend. The program asks the user for an amount of money and then determines how many square feet of floor space can be purchased for that amount of money. That calculation yields an area in square feet for the floor area of the dog house. The function `sqrt` yields the length of one side of the dog house floor.

Notice that there is another new element in the program in Display 4.1:

```
#include <cmath>
```

Function Call

A function call is an expression consisting of the function name followed by arguments enclosed in parentheses. If there is more than one argument, the arguments are separated by commas. A function call is an expression that can be used like any other expression of the type specified for the value returned by the function.

SYNTAX

```
Function_Name(Argument_List)
```

where the *Argument_List* is a comma-separated list of arguments:

```
Argument_1, Argument_2, . . . , Argument_Last
```

EXAMPLES

```
side = sqrt(area);
cout << "2.5 to the power 3.0 is "
      << pow(2.5, 3.0);
```

That line looks very much like the line

```
#include <iostream>
```

and, in fact, these two lines are the same sort of thing. As we noted in Chapter 2, such lines are called **include directives**. The name inside the angular brackets `<>` is the name of a file known as a **header file**. A header file for a library provides

DISPLAY 4.1 A Function Call

```
1 //Computes the size of a dog house that can be purchased
2 //given the user's budget.
3 #include <iostream>
4 #include <cmath>
5 using namespace std;
6
7 int main( )
8 {
9     const double COST_PER_SQ_FT = 10.50;
10    double budget, area, length_side;
11
12    cout << "Enter the amount budgeted for your dog house $";
13    cin >> budget;
14
15    area = budget / COST_PER_SQ_FT;
16    length_side = sqrt(area);
17
18    cout.setf(ios::fixed);
19    cout.setf(ios::showpoint);
20    cout.precision(2);
21    cout << "For a price of $" << budget << endl
22         << "I can build you a luxurious square dog house\n"
23         << "that is " << length_side
24         << " feet on each side.\n";
25
26    return 0;
27 }
```

Sample Dialogue

```
Enter the amount budgeted for your dog house: $25.00
For a price of $25.00
I can build you a luxurious square dog house
that is 1.54 feet on each side.
```

the compiler with certain basic information about the library, and an `include` directive delivers this information to the compiler. This enables the linker to find object code for the functions in the library so that it can correctly link the library to your program. For example, the library `iostream` contains the definitions of `cin` and `cout`, and the header file for the `iostream` library is called `iostream`. The `math` library contains the definition of the function `sqrt` and a number of other mathematical functions, and the header file for this library is `cmath`. If your program uses a predefined function from some library, then it must contain a directive that names the header file for that library, such as the following:

```
#include <cmath>
```

Be sure to follow the syntax illustrated in our examples. Do not forget the symbols `<` and `>`; they are the same symbols as the less-than and greater-than symbols. There should be no space between the `<` and the filename, nor between the filename and the `>`. Also, some compilers require that directives have no spaces around the `#`, so it is always safest to place the `#` at the very start of the line and not to put any space between the `#` and the word `include`. These `# include` directives are normally placed at the beginning of the file containing your program.

As we noted before, the directive

```
#include <iostream>
```

requires that you also use the following *using* directive:

```
using namespace std;
```

This is because the definitions of names like `cin` and `cout`, which are given in `iostream`, define those names to be part of the `std` namespace. This is true of most standard libraries. If you have an `include` directive for a standard library such as

```
#include <cmath>
```

then you probably need the *using* directive:

```
using namespace std;
```

There is no need to use multiple copies of this *using* directive when you have multiple `include` directives.

*#include may
not be enough*

Usually, all you need to do to use a library is to place an `include` directive and a *using* directive for that library in the file with your program. If things work with just the `include` directive and the *using* directive, you need not worry about doing anything else. However, for some libraries on some systems, you may need to give additional instructions to the compiler or to explicitly run a linker program to link in the library. Early C and C++ compilers did not automatically search all libraries for linking. The details vary from one system to another, so you will have to check your manual or a local expert to see exactly what is necessary.

Some people will tell you that `include` directives are not processed by the compiler, but are processed by a **preprocessor**. They're right, but the difference is more of a word game than anything that need concern you. On almost all compilers the preprocessor is called automatically when you compile your program.

A few predefined functions are described in Display 4.2; more predefined functions are described in Appendix 4. Notice that the absolute value functions `abs` and `labs` are in the library with header file `cstdlib`, so any program that uses either of these functions must contain the following directive:

```
#include <cstdlib>
```

All the other functions listed are in the library with header file `cmath`, just like `sqrt`.

Also notice that there are three absolute value functions. If you want to produce the absolute value of a number of type `int`, you use `abs`; if you want to produce the absolute value of a number of type `long`, you use `labs`; and if you want to produce the absolute value of a number of type `double`, you use `fabs`. To complicate things even more, `abs` and `labs` are in the library with header file `cstdlib`, while `fabs` is in the library with header file `cmath`. `fabs` is an abbreviation for *floating-point absolute value*. Recall that numbers with a fraction after the decimal point, such as numbers of type `double`, are often called *floating-point numbers*.

Another example of a predefined function is `pow`, which is in the library with header file `cmath`. The function `pow` can be used to do exponentiation in C++. For example, if you want to set a variable `result` equal to x^y , you can use the following:

```
result = pow(x, y);
```

DISPLAY 4.2 Some Predefined Functions

Name	Description	Type of Arguments	Type of Value Returned	Example	Value	Library Header
<code>sqrt</code>	square root	<code>double</code>	<code>double</code>	<code>sqrt(4.0)</code>	2.0	<code>cmath</code>
<code>pow</code>	powers	<code>double</code>	<code>double</code>	<code>pow(2.0, 3.0)</code>	8.0	<code>cmath</code>
<code>abs</code>	absolute value for <code>int</code>	<code>int</code>	<code>int</code>	<code>abs(-7)</code> <code>abs(7)</code>	7 7	<code>cstdlib</code>
<code>labs</code>	absolute value for <code>long</code>	<code>long</code>	<code>long</code>	<code>labs(-70000)</code> <code>labs(70000)</code>	70000 70000	<code>cstdlib</code>
<code>fabs</code>	absolute value for <code>double</code>	<code>double</code>	<code>double</code>	<code>fabs(-7.5)</code> <code>fabs(7.5)</code>	7.5 7.5	<code>cmath</code>
<code>ceil</code>	ceiling (round up)	<code>double</code>	<code>double</code>	<code>ceil(3.2)</code> <code>ceil(3.9)</code>	4.0 4.0	<code>cmath</code>
<code>floor</code>	floor (round down)	<code>double</code>	<code>double</code>	<code>floor(3.2)</code> <code>floor(3.9)</code>	3.0 3.0	<code>cmath</code>
<code>srand</code>	Seed random number generator	<code>none</code>	<code>none</code>	<code>srand()</code>	<code>none</code>	<code>cstdlib</code>
<code>rand</code>	Random number	<code>none</code>	<code>int</code>	<code>rand()</code>	0-RAND_MAX	<code>cstdlib</code>

Hence, the following three lines of program code will output the number 9.0 to the screen, because $(3.0)^{2.0}$ is 9.0:

```
double result, x = 3.0, y = 2.0;
result = pow(x, y);
cout << result;
```

Arguments have
a type

Notice that the above call to `pow` returns 9.0, not 9. The function `pow` always returns a value of type `double`, not of type `int`. Also notice that the function `pow` requires two arguments. A function can have any number of arguments. Moreover, every argument position has a specified type and the argument used in a function call should be of that type. In many cases, if you use an argument of the wrong type, then some automatic type conversion will be done for you by C++. However, the results may not be what you intended. When you call a function, you should use arguments of the type specified for that function. One exception to this caution is the automatic conversion of arguments from type `int` to type `double`. In many situations, including calls to the function `pow`, you can safely use an argument of type `int` when an argument of type `double` is specified.

Restrictions
on pow

Many implementations of `pow` have a restriction on what arguments can be used. In these implementations, if the first argument to `pow` is negative, then the second argument must be a whole number. Since you probably have enough other things to worry about when learning to program, it might be easiest and safest to use `pow` only when the first argument is nonnegative.

Random Number Generation

Random and
pseudorandom
numbers

Games and simulation programs often require the generation of random numbers. C++ has a predefined function to generate *pseudorandom numbers*. A pseudorandom number is one that appears to be random but is really determined by a predictable formula. For example, here is the formula for a very simple pseudorandom number generator that specifies the i^{th} random number R_i based on the previously generated random number R_{i-1} :

$$R_i = (R_{i-1} \times 7) \% 11$$

Let's set the initial "seed," $R_0 = 1$. The first time we fetch a "random" number we compute R_1 with the formula:

$$R_1 = (R_0 \times 7) \% 11 = (1 \times 7) \% 11 = 7 \% 11 = 7$$

The second time we fetch a "random" number we compute R_2 with:

$$R_2 = (R_1 \times 7) \% 11 = (7 \times 7) \% 11 = 49 \% 11 = 5$$

The third time we fetch a "random" number we compute R_3 with:

$$R_3 = (R_2 \times 7) \% 11 = (5 \times 7) \% 11 = 35 \% 11 = 2$$

and so on.



VideoNote
Random Number
Generation

As you can see, each successive value seems random unless we know the formula. This is why they are called pseudorandom. This particular function would not be a very good pseudorandom number generator because it would repeat numbers rather quickly. The random number generator in C++ varies depending upon the library implementation but uses the same basic idea as our simple generator with some enhancements to achieve a random uniform distribution.

We can get a different sequence of random numbers if we start with a different seed value. In the example, the seed always started at 1. However, if the seed is initialized with a number that changes, such as the time on the computer's clock, then we will likely get a different sequence of random numbers every time we run the program.

To seed C++'s random number generator use the predefined method `srand`. It returns no value and takes as input an unsigned integer that is the initial seed value. To always seed the random number generator with the value 35, we would use:

```
srand(35);
```

To vary the random number sequence every time the program is executed, we can seed the random number generator with the time of day. Invoking the predefined function `time(0)` returns the number of seconds that have elapsed since January 1, 1970¹ on most systems. The `time` function requires you to include the `ctime` library.

```
#include <cstdlib>
#include <ctime>
...
srand(time(0));
```

We can get a random number by calling the function `rand`, which will return an integer in the range 0 to `RAND_MAX`. `RAND_MAX` is a constant defined in `cstdlib` and is guaranteed to be 32767 or higher. Usually, a number between 0 and `RAND_MAX` is not what is desired, in which case the random number can be scaled by modulus and addition. For example, to simulate rolling a six-sided die we could use the following:

```
int die = (rand() % 6) + 1;
```

The random number modulo 6 gives us a number between 0 and 5. Adding 1 results in a random integer that is in the range from 1 to 6.

It is important to seed the random number generator only once. A common error is to invoke `srand` every time a random number is generated. If both `srand` and `rand` are placed in a loop, then the likely result is a sequence of identical numbers, because the computer runs quickly enough that the time value will probably not change for repeated calls to `srand`.

¹The number of seconds elapsed since January 1, 1970 is known as Unix time.

Division may
require the
type `double`

Type Casting

Recall that `9/2` is integer division and evaluates to 4, not 4.5. If you want division to produce an answer of type `double` (that is, including the fractional part after the decimal point), then at least one of the two numbers in the division must be of type `double`. For example, `9/2.0` evaluates to 4.5. If one of the two numbers is given as a constant, you can simply add a decimal point and a zero to one (or both) numbers, and the division will then produce a value that includes the digits after the decimal point.

But what if both of the operands in a division are variables, as in the following?

```
int total_candy, number_of_people;
double candy_per_person;
<The program somehow sets the value of total_candy to 9
and the value of number_of_people to 2.
It does not matter how the program does this.>
candy_per_person = total_candy/number_of_people;
```

Unless you convert the value in one of the variables `total_candy` or `number_of_people` to a value of type `double`, then the result of the division will be 4, not 4.5 as it should be. The fact that the variable `candy_per_person` is of type `double` does not help. The value of 4 obtained by division will be converted to a value of type `double` before it is stored in the variable `candy_per_person`, but that will be too late. The 4 will be converted to 4.0 and the final value of `candy_per_person` will be 4.0, not 4.5. If one of the quantities in the division were a constant, you could add a decimal point and a zero to convert the constant to type `double`, but in this case both quantities are variables. Fortunately, there is a way to convert from type `int` to type `double` that you can use with either a constant or a variable.

In C++ you can tell the computer to convert a value of type `int` to a value of type `double`. The way that you write “Convert the value 9 to a value of type `double`” is

```
static_cast<double>(9)
```

The notation `static_cast<double>` is a kind of predefined function that converts a value of some other type, such as 9, to a value of type `double`, in this case 9.0. An expression such as `static_cast<double>(9)` is called a **type cast**. You can use a variable or other expression in place of the 9. You can use other type names besides `double` to obtain a type cast to some type other than `double`, but we will postpone that topic until later.

For example, in the following we use a type cast to change the type of 9 from `int` to `double` and so the value of answer is set to 4.5:

```
double answer;
answer = static_cast<double>(9)/2;
```

Type casting applied to a constant, such as 9, can make your code easier to read, since it makes your intended meaning clearer. But type casting applied

to constants of type *int* does not give you any additional power. You can use 9.0 instead of `static_cast<double>(9)` when you want to convert 9 to a value of type *double*. However, if the division involves only variables, then type casting may be your only sensible alternative. Using type casting, we can rewrite our earlier example so that the variable `candy_per_person` receives the correct value of 4.5, instead of 4.0; in order to do this, the only change we need is the replacement of `total_candy` with `static_cast<double>(total_candy)`, as shown in what follows:

```
int total_candy, number_of_people;
double candy_per_person;
<The program somehow sets the value of total_candy to 9
  and the value of number_of_people to 2.
  It does not matter how the program does this.>
candy_per_person =
    static_cast<double>(total_candy)/number_of_people;
```

Notice the placement of parentheses in the type casting used in the code. You want to do the type casting before the division so that the division operator is working on a value of type *double*. If you wait until after the division is completed, then the digits after the decimal point are already lost. If you mistakenly use the following for the last line of the previous code, then the value of `candy_per_person` will be 4.0, not 4.5.

Warning!

```
candy_per_person =
    static_cast<double>(total_candy/number_of_people); //WRONG!
```

A Function to Convert from *int* to *double*

The notation `static_cast<double>` can be used as a predefined function and will convert a value of some other type to a value of type *double*. For example, `static_cast<double>(2)` returns 2.0. This is called **type casting**. (Type casting can be done with types other than *double*, but until later in this book, we will do type casting only with the type *double*.)

SYNTAX

```
static_cast<double>(Expression_of_Type_int)
```

EXAMPLE

```
int total_pot, number_of_winners;
double your_winnings;
. . .
your_winnings =
    static_cast<double>(total_pot)/number_of_winners;
```

double used
as a function

Older Form of Type Casting

The use of `static_cast<double>`, as we discussed in the previous section, is the preferred way to perform a type cast. However, older versions of C++ used a different notation for type casting. This older notation simply uses the type name as if it were a function name, so `double(9)` returns 9.0. Thus, if `candy_per_person` is a variable of type `double`, and if both `total_candy` and `number_of_people` are variables of type `int`, then the following two assignment statements are equivalent:

```
candy_per_person =
    static_cast<double>(total_candy)/number_of_people;
```

and

```
candy_per_person =
    double(total_candy)/number_of_people;
```

Although `static_cast<double>(total_candy)` and `double(total_candy)` are more or less equivalent, you should use the `static_cast<double>` form, since the form `double(total_candy)` may be discontinued in later versions of C++.

PITFALL Integer Division Drops the Fractional Part

In integer division, such as computing $11/2$, it is easy to forget that $11/2$ gives 5, not 5.5. The result is the next-lower integer. For example,

```
double d;
d = 11/2;
```

Here, the division is done using integer divide; the result of the division is 5, which is converted to `double`, then assigned to `d`. The fractional part is not generated. Observe that the fact that `d` is of type `double` does not change the division result. The variable `d` receives the value 5.0, not 5.5. ■

SELF-TEST EXERCISES

- Determine the value of each of the following arithmetic expressions:

<code>sqrt(16.0)</code>	<code>sqrt(16)</code>	<code>pow(2.0, 3.0)</code>
<code>pow(2, 3)</code>	<code>pow(2.0, 3)</code>	<code>pow(1.1, 2)</code>
<code>abs(3)</code>	<code>abs(-3)</code>	<code>abs(0)</code>
<code>fabs(-3.0)</code>	<code>fabs(-3.5)</code>	<code>fabs(3.5)</code>
<code>ceil(5.1)</code>	<code>ceil(5.8)</code>	<code>floor(5.1)</code>
<code>floor(5.8)</code>	<code>pow(3.0, 2)/2.0</code>	<code>pow(3.0, 2)/2</code>
<code>7/abs(-2)</code>	<code>(7 + sqrt(4.0))/3.0</code>	<code>sqrt(pow(3, 2))</code>

2. Convert each of the following mathematical expressions to a C++ arithmetic expression:

$$\begin{array}{ccc} \sqrt{x + y} & x^{y+7} & \sqrt{\text{area} + \text{fudge}} \\ \frac{\sqrt{\text{time} + \text{tide}}}{\text{nobody}} & \frac{-b + \sqrt{b^2 - 4ac}}{2a} & |x - y| \end{array}$$

3. Write a complete C++ program to compute and output the square root of PI; PI is approximately 3.14159. The `const double` PI is predefined in `cmath`. You are encouraged to use this predefined constant.
4. Write and compile short programs to test the following issues:
- Determine whether your compiler will allow the `#include <iostream>` anywhere on the line, or if the `#` needs to be flush with the left margin.
 - Determine whether your compiler will allow space between the `#` and the `include`.

4.3 PROGRAMMER-DEFINED FUNCTIONS

A custom-tailored suit always fits better than one off the rack.

MY UNCLE, *The Tailor*

In the previous section we told you how to use predefined functions. In this section we tell you how to define your own functions.

Function Definitions

You can define your own functions, either in the same file as the `main` part of your program or in a separate file so that the functions can be used by several different programs. The definition is the same in either case, but for now, we will assume that the function definition will be in the same file as the `main` part of your program.

Display 4.3 contains a sample function definition in a complete program that demonstrates a call to the function. The function is called `total_cost`. The function takes two arguments—the price for one item and number of items for a purchase. The function returns the total cost, including sales tax, for that many items at the specified price. The function is called in the same way a predefined function is called. The description of the function, which the programmer must write, is a bit more complicated.

The description of the function is given in two parts that are called the *function declaration* and the *function definition*. The **function declaration** (also known as the **function prototype**) describes how the function is called. C++ requires that either the complete function definition

DISPLAY 4.3 A Function Definition

```

1  #include <iostream>
2  using namespace std;
3
4  double total_cost(int number_par, double price_par);
5  //Computes the total cost, including 5% sales tax,
6  //on number_par items at a cost of price_par each.
7
8  int main( )
9  {
10     double price, bill;
11     int number;
12
13     cout << "Enter the number of items purchased: ";
14     cin >> number;
15     cout << "Enter the price per item $";
16     cin >> price;
17
18     bill = total_cost(number, price);
19
20     cout.setf(ios::fixed);
21     cout.setf(ios::showpoint);
22     cout.precision(2);
23     cout << number << " items at "
24         << "$" << price << " each.\n"
25         << "Final bill, including tax, is $" << bill
26         << endl;
27
28     return 0;
29 }
30
31 double total_cost(int number_par, double price_par)
32 {
33     const double TAX_RATE = 0.05; //5% sales tax
34     double subtotal;
35
36     subtotal = price_par * number_par;
37     return (subtotal + subtotal * TAX_RATE);
38 }

```

function declaration

function call

function heading

function body

function definition

Sample Dialogue

```

Enter the number of items purchased: 2
Enter the price per item: $10.10
2 items at $10.10 each.
Final bill, including tax, is $21.21

```

or the function declaration appears in the code before the function is called. The function declaration for the function `total_cost` is in color at the top of Display 4.3 and is reproduced here:

```
double total_cost(int number_par, double price_par);
```

The function declaration tells you everything you need to know in order to write a call to the function. It tells you the name of the function, in this case `total_cost`. It tells you how many arguments the function needs and what type the arguments should be; in this case, the function `total_cost` takes two arguments, the first one of type `int` and the second one of type `double`. The identifiers `number_par` and `price_par` are called *formal parameters*. A **formal parameter** is used as a kind of blank, or place holder, to stand in for the argument. When you write a function declaration, you do not know what the arguments will be, so you use the formal parameters in place of the arguments. The names of the formal parameters can be any valid identifiers, but for a while we will end our formal parameter names with `_par` so that it will be easier for us to distinguish them from other items in a program. Notice that a function declaration ends with a semicolon.

The first word in a function declaration specifies the **type of the value returned** by the function. Thus, for the function `total_cost`, the type of the value returned is `double`.

As you can see, the function call in Display 4.3 satisfies all the requirements given by its function declaration. Let's take a look. The function call is in the following line:

```
bill = total_cost(number, price);
```

The function call is the expression on the right-hand side of the equal sign. The function name is `total_cost`, and there are two arguments: The first argument is of type `int`, the second argument is of type `double`, and since the variable `bill` is of type `double`, it looks like the function returns a value of type `double` (which it does). All that detail is determined by the function declaration.

The compiler does not care whether there's a comment along with the function declaration, but you should always include a comment that explains what value is returned by the function.

Function Declaration

A **function declaration** tells you all you need to know to write a call to the function. A function declaration is required to appear in your code prior to a call to a function whose definition has not yet appeared. Function declarations are normally placed before the main part of your program.

(continued)

SYNTAX

```
Type_Returned Function_Name(Parameter_List); ← Do not forget
Function_Declaration_Comment this semicolon.
```

where the *Parameter_List* is a comma-separated list of parameters:

```
Type_1 Formal_Parameter_1, Type_2 Formal_Parameter_2, ...
..., Type_LastFormal_Parameter_Last
```

EXAMPLE

```
double total_weight(int number, double weight_of_one);
//Returns the total weight of number items that
//each weigh weight_of_one.
```

In Display 4.3 the function definition is in color at the bottom of the display. A **function definition** describes how the function computes the value it returns. If you think of a function as a small program within your program, then the function definition is like the code for this small program. In fact, the syntax for the definition of a function is very much like the syntax for the main part of a program. A function definition consists of a *function header* followed by a *function body*. The **function header** is written the same way as the function declaration, except that the header does *not* have a semicolon at the end. This makes the header a bit repetitious, but that's OK.

Although the function declaration tells you all you need to know to write a function call, it does not tell you what value will be returned. The value returned is determined by the statements in the *function body*. The **function body** follows the function header and completes the function definition. The function body consists of declarations and executable statements enclosed within a pair of braces. Thus, the function body is just like the body of the main part of a program. When the function is called, the argument values are plugged in for the formal parameters and then the statements in the body are executed. The value returned by the function is determined when the function executes a *return* statement. (The details of this “plugging in” will be discussed in a later section.)

A **return statement** consists of the keyword *return* followed by an expression. The function definition in Display 4.3 contains the following *return* statement:

```
return (subtotal + subtotal * TAX_RATE);
```

When this *return* statement is executed, the value of the following expression is returned as the value of the function call:

```
(subtotal + subtotal * TAX_RATE)
```

The parentheses are not needed. The program will run exactly the same if the *return* statement is written as follows:

```
return subtotal + subtotal * TAX_RATE;
```

However, on larger expressions, the parentheses make the *return* statement easier to read. For consistency, some programmers advocate using these parentheses even on simple expressions. In the function definition in Display 4.3, there are no statements after the *return* statement, but if there were, they would not be executed. When a *return* statement is executed, the function call ends.

A Function Is Like a Small Program

To understand functions, keep the following three points in mind:

- A function definition is like a small program and calling the function is the same thing as running this “small program.”
- A function uses formal parameters, rather than `cin`, for input. The arguments to the function are the input and they are plugged in for the formal parameters.
- A function (of the kind discussed in this chapter) does not normally send any output to the screen, but it does send a kind of “output” back to the program. The function returns a value, which is like the “output” for the function. The function uses a *return* statement instead of a `cout` statement for this “output.”

Let’s see exactly what happens when the following function call is executed in the program shown in Display 4.3:

```
bill = total_cost(number, price);
```

First, the values of the arguments `number` and `price` are plugged in for the formal parameters; that is, the values of the arguments `number` and `price` are substituted in for `number_par` and `price_par`. In the Sample Dialogue, `number` receives the value 2 and `price` receives the value 10.10. So 2 and 10.10 are substituted for `number_par` and `price_par`, respectively. This substitution process is known as the **call-by-value mechanism**, and the formal parameters are often referred to as **call-by-value formal parameters**, or simply as **call-by-value parameters**. There are three things that you should note about this substitution process:

1. It is the values of the arguments that are plugged in for the formal parameters. If the arguments are variables, the values of the variables, not the variables themselves, are plugged in.
2. The first argument is plugged in for the first formal parameter in the parameter list, the second argument is plugged in for the second formal parameter in the list, and so forth.

Anatomy of a
function call

- When an argument is plugged in for a formal parameter (for instance, when 2 is plugged in for `number_par`), the argument is plugged in for *all* instances of the formal parameter that occur in the function body (for instance, 2 is plugged in for `number_par` each time it appears in the function body).

The entire process involved in the function call shown in Display 4.3 is described in detail in Display 4.4.

DISPLAY 4.4 Details of a Function Call

```

int main()
{
    double price, bill;
    int number;

    cout << "Enter the number of items purchased: ";
    cin >> number;
    cout << "Enter the price per item $";
    cin >> price;

    bill = total_cost (number, price);
    cout.setf (ios::fixed);
    cout.setf (ios::showpoint);
    cout.precision(2);
    cout << number << " items at "
         << "$" << price << " each.\n"
         << "Final bill, including tax, is $" << bill
         << endl;
    return 0;
}

double total_cost (int number_par, double price_par)
{
    const double TAX_RATE = 0.05; //5% sales tax
    double subtotal;

    subtotal = price_par * number_par;
    return (subtotal + subtotal * TAX_RATE);
}

```

1. Before the function is called, values of the variables **number** and **price** are set to 2 and 10.10, by cin statements (as you can see the Sample Dialogue in Display 4.3)

2. The function call executes and the value of **number** (which is 2) plugged in for **number_par** and value of **price** (which is 10.10) plugged in for **price_par**.

3. The body of the function executes with **number_par** set to 2 and **price_par** set to 10.10, producing the value 20.20 in subtotal.

4. When the return statement is executed, the value of the expression after return is evaluated and returned by the function. In this case, (**subtotal** + **subtotal** * **TAX_RATE**) is (20.20 + 20.20*0.05) or 21.21.

5. The value 21.21 is returned to where the function was invoked. The result is that **total_cost(number, price)** is replaced by the return value of 21.21. The value of **bill** (on the left-hand side of the equal sign) is set equal to 21.21 when the statement **bill = total_cost (number, price);** finally ends.

Functions That Return a Boolean Value

A function may return a *bool* value. Such a function can be used in a Boolean expression to control an *if-else* statement or to control a loop statement, or it can be used anywhere else that a Boolean expression is allowed. The returned type for such a function should be the type *bool*.

A call to a function that returns a Boolean value of *true* or *false* can be used anywhere that a Boolean expression is allowed. This can often make a program easier to read. By means of a function declaration, you can associate a complex Boolean expression with a meaningful name and use the name as a Boolean expression in an *if-else* statement or anywhere else that a Boolean expression is allowed. For example, the statement

```
if (((rate >= 10) && (rate < 20)) || (rate == 0))
{
    ...
}
```

can be made to read

```
if (appropriate(rate))
{
    ...
}
```

provided that the following function has been defined:

```
bool appropriate(int rate)
{
    return (((rate >= 10) && (rate < 20)) || (rate == 0));
}
```

Alternate Form for Function Declarations

You are not required to list formal parameter names in a function declaration. The following two function declarations are equivalent:

```
double total_cost(int number_par, double price_par);
```

and

```
double total_cost(int, double);
```

We will always use the first form so that we can refer to the formal parameters in the comment that accompanies the function declaration. However, you will often see the second form in manuals that describe functions.²

²All C++ needs to link to your program to the library for your function is the function name and sequence of types of the formal parameters. The formal parameter names are important only to the function definition. However, programs should communicate to programmers as well as to compilers. It is frequently very helpful in understanding a function to use the name that the programmer attaches to the function's data.

This alternate form applies only to function declarations. *Function headers must always list the formal parameter names.*

PITFALL Arguments in the Wrong Order

When a function is called, the computer substitutes the first argument for the first formal parameter, the second argument for the second formal parameter, and so forth. It does not check for reasonableness. If you confuse the order of the arguments in a function call, the program will not do what you want it to do. In order to see what can go wrong, consider the program in Display 4.5. The programmer who wrote that program carelessly reversed the order of the arguments in the call to the function `grade`. The function call should have been

```
letter_grade = grade(score, need_to_pass);
```

This is the only mistake in the program. Yet, some poor student has been mistakenly failed in a course because of this careless mistake. The function `grade` is so simple that you might expect this mistake to be discovered by the programmer when the program is tested. However, if `grade` were a more complicated function, the mistake might easily go unnoticed.

If the type of an argument does not match the formal parameter, then the compiler may give you a warning message. Unfortunately, not all compilers will give such warning messages. Moreover, in a situation like the one in

DISPLAY 4.5 Incorrectly Ordered Arguments (part 1 of 2)

```

1 //Determines user's grade. Grades are Pass or Fail.
2 #include <iostream>
3 using namespace std;
4
5 char grade(int received_par, int min_score_par);
6 //Returns 'P' for passing, if received_par is
7 //min_score_par or higher. Otherwise returns 'F' for failing.
8
9 int main( )
10 {
11     int score, need_to_pass;
12     char letter_grade;
13
14     cout << "Enter your score"
15          << " and the minimum needed to pass:\n";
16     cin >> score >> need_to_pass;
17
18     letter_grade = grade(need_to_pass, score);
19

```

(continued)

DISPLAY 4.5 Incorrectly Ordered Arguments (*part 2 of 2*)

```
20     cout << "You received a score of " << score << endl
21         << "Minimum to pass is " << need_to_pass << endl;
22
23     if (letter_grade == 'P')
24         cout << "You Passed. Congratulations!\n";
25     else
26         cout << "Sorry. You failed.\n";
27
28     cout << letter_grade
29         << " will be entered in your record.\n";
30
31     return 0;
32 }
33
34 char grade(int received_par, int min_score_par)
35 {
36     if (received_par >= min_score_par)
37         return 'P';
38     else
39         return 'F';
40 }
```

Sample Dialogue

Enter your score and the minimum needed to pass:

98 60

You received a score of 98

Minimum to pass is 60

Sorry. You failed.

F will be entered in your record.

Display 4.5, no compiler will complain about the ordering of the arguments, because the function argument types will match the formal parameter types no matter what order the arguments are in. ■

Function Definition–Syntax Summary

Function declarations are normally placed before the main part of your program and function definitions are normally placed after the main part of your program (or, as we will see later in this book, in a separate file). Display 4.6 gives a summary of the syntax for a function declaration and definition. There is actually a bit more freedom than that display indicates. The declarations and executable statements in the function definition can be intermixed, as



VideoNote
Programmer-Defined
Function Example

long as each variable is declared before it is used. The rules about intermixing declarations and executable statements in a function definition are the same as they are for the main part of a program. However, unless you have reason to do otherwise, it is best to place the declarations first, as indicated in Display 4.6.

Since a function does not return a value until it executes a *return* statement, a function must contain one or more *return* statements in the body of the function. A function definition may contain more than one *return* statement. For example, the body of the code might contain an *if-else* statement, and each branch of the *if-else* statement might contain a different *return* statement, as illustrated in Display 4.5.

Spacing and line breaks

Any reasonable pattern of spaces and line breaks in a function definition will be accepted by the compiler. However, you should use the same rules for indenting and laying out a function definition as you use for the main part of a program. In particular, notice the placement of braces `{}` in our function definitions and in Display 4.6. The opening and closing braces that mark the ends of the function body are each placed on a line by themselves. This sets off the function body.

More About Placement of Function Definitions

We have discussed where function definitions and function declarations are normally placed. Under normal circumstances these are the best locations for the function declarations and function definitions. However, the compiler will accept programs with the function definitions and function declarations in certain other locations. A more precise statement of the rules is as follows:

DISPLAY 4.6 Syntax for a Function That Returns a Value

Function Declaration

```
Type_Returned Function_Name(Parameter_List);
Function_Declaration_Comment
```

Function Definition

```
Type_Returned Function_Name(Parameter_List) ← function header
{
    Declaration_1
    Declaration_2
    . . .
    Declaration_Last
    Executable_Statement_1
    Executable_Statement_2
    . . .
    Executable_Statement_Last } ← Must include one or more return statements.
```

body

Each function call must be preceded by either a function declaration for that function or the definition of the function. For example, if you place all of your function definitions before the `main` part of the program, then you need not include any function declarations. Knowing this more general rule will help you to understand C++ programs you see in some other books, but you should follow the example of the programs in this book. The style we are using sets the stage for learning how to build your own libraries of functions, which is the style that most C++ programmers use.

■ PROGRAMMING TIP Use Function Calls in Branching Statements

The `switch` statement and the multiway `if-else` statement allow you to place several different statements in each branch. However, doing so can make the `switch` statement or `if-else` statement difficult to read. Look at the `switch` statement in Display 3.7. Each of the branches for choices 1, 2, and 3 could be a single function call. This makes the layout of the `switch` statement and the overall structure of the program clear. If we had instead placed all the code for each branch in the `switch` statement, instead of in the function definitions, then the `switch` statement would be an incomprehensible sea of C++ statements. In fact, the `switch` statement would not even fit on one screen. ■

SELF-TEST EXERCISES

5. What is the output produced by the following program?

```
#include <iostream>
using namespace std;
char mystery(int first_par, int second_par);
int main()
{
    cout << mystery(10, 9) << "ow\n";
    return 0;
}

char mystery(int first_par, int second_par)
{
    if (first_par >= second_par)
        return 'W';
    else
        return 'H';
}
```

6. Write a function declaration and a function definition for a function that takes three arguments, all of type *int*, and that returns the sum of its three arguments.
7. Write a function declaration and a function definition for a function that takes one argument of type *int* and one argument of type *double*, and that returns a value of type *double* that is the average of the two arguments.
8. Write a function declaration and a function definition for a function that takes one argument of type *double*. The function returns the character value 'P' if its argument is positive and returns 'N' if its argument is zero or negative.
9. Carefully describe the call-by-value parameter mechanism.
10. List the similarities and differences between use of a predefined (that is, library) function and a user-defined function.
11. Write a function definition for a function called `in_order` that takes three arguments of type *int*. The function returns *true* if the three arguments are in ascending order; otherwise, it returns *false*. For example, `in_order(1, 2, 3)` and `in_order(1, 2, 2)` both return *true*, while `in_order(1, 3, 2)` returns *false*.
12. Write a function definition for a function called `even` that takes one argument of type *int* and returns a *bool* value. The function returns *true* if its one argument is an even number; otherwise, it returns *false*.
13. Write a function definition for a function `is_digit` that takes one argument of type *char* and returns a *bool* value. The function returns *true* if the argument is a decimal digit; otherwise, it returns *false*.
14. Write a function definition for a function `is_root_of` that takes two arguments of type *int* and returns a *bool* value. The function returns *true* if the first argument is the square root of the second; otherwise, it returns *false*.

4.4 PROCEDURAL ABSTRACTION

The cause is hidden, but the result is well known.

OVID, *Metamorphoses IV*

The Black-Box Analogy

A person who uses a program should not need to know the details of how the program is coded. Imagine how miserable your life would be if you had

to know and remember the code for the compiler you use. A program has a job to do, such as compile your program or check the spelling of words in your paper. You need to know *what* the program's job is so that you can use the program, but you do not (or at least should not) need to know *how* the program does its job. A function is like a small program and should be used in a similar way. A programmer who uses a function in a program needs to know *what* the function does (such as calculate a square root or convert a temperature from degrees Fahrenheit to degrees Celsius) but should not need to know *how* the function accomplishes its task. This is often referred to as treating the function like a *black box*.

Calling something a **black box** is a figure of speech intended to convey the image of a physical device that you know how to use but whose method of operation is a mystery, because it is enclosed in a black box and you cannot see inside the box (and cannot pry it open!). If a function is well designed, the programmer can use the function as if it were a black box. All the programmer needs to know is that if he or she puts appropriate arguments into the black box, then an appropriate returned value will come out of the black box. Designing a function so that it can be used as a black box is sometimes called **information hiding** to emphasize that the programmer acts as if the body of the function were hidden from view.

Display 4.7 contains the function declaration and two different definitions for a function named `new_balance`. As the function declaration comment explains, the function `new_balance` calculates the new balance in a bank account when simple interest is added. For instance, if an account starts with \$100, and 4.5 percent interest is posted to the account, then the new balance is \$104.50. Hence, the following code will change the value of `vacation_fund` from 100.00 to 104.50:

```
vacation_fund = 100.00;  
vacation_fund = new_balance(vacation_fund, 4.5);
```

It does not matter which of the implementations of `new_balance` shown in Display 4.7 that a programmer uses. The two definitions produce functions that return exactly the same values. We may as well place a black box over the body of the function definition so that the programmer does not know which implementation is being used. In order to use the function `new_balance`, all the programmer needs to read is the function declaration and the accompanying comment.

Writing and using functions as if they were black boxes is also called **procedural abstraction**. When programming in C++ it might make more sense to call it *functional abstraction*. However, *procedure* is a more general term than *function*. Computer scientists use the term *procedure* for all "function-like" sets of instructions, and so they use the term *procedural abstraction*. The term *abstraction* is intended to convey the idea that when you use a function as a black box, you are abstracting away the details of the code contained in the function body. You can call this technique *the black-box principle* or *the principle*

DISPLAY 4.7 Definitions That Are Black-Box Equivalent

Function Declaration

```
1  double new_balance(double balance_par, double rate_par);
2  //Returns the balance in a bank account after
3  //posting simple interest. The formal parameter balance_par is
4  //the old balance. The formal parameter rate_par is the interest rate.
5  //For example, if rate_par is 5.0, then the interest rate is 5 percent
6  //and so new_balance(100, 5.0) returns 105.00.
```

Definition 1

```
double new_balance(double balance_par, double rate_par)
{
    double interest_fraction, interest;

    interest_fraction = rate_par/100;
    interest = interest_fraction * balance_par;
    return (balance_par + interest);
}
```

Definition 2

```
double new_balance(double balance_par, double rate_par)
{
    double interest_fraction, updated_balance;

    interest_fraction = rate_par/100;
    updated_balance = balance_par * (1 + interest_fraction);
    return updated_balance;
}
```

of *procedural abstraction* or *information hiding*. The three terms mean the same thing. Whatever you call this principle, the important point is that you should use it when designing and writing your function definitions.

Procedural Abstraction

When applied to a function definition, the principle of **procedural abstraction** means that your function should be written so that it can be used like a **black box**. This means that the programmer who uses the function should not need to look at the body of the function definition

(continued)

to see how the function works. The function declaration and the accompanying comment should be all the programmer needs to know in order to use the function. To ensure that your function definitions have this important property, you should strictly adhere to the following rules:

HOW TO WRITE A BLACK-BOX FUNCTION DEFINITION (THAT RETURNS A VALUE)

- The function declaration comment should tell the programmer any and all conditions that are required of the arguments to the function and should describe the value that is returned by the function when called with these arguments.
- All variables used in the function body should be declared in the function body. (The formal parameters do not need to be declared, because they are listed in the function declaration.)

■ PROGRAMMING TIP Choosing Formal Parameter Names

The principle of procedural abstraction says that functions should be self-contained modules that are designed separately from the rest of the program. On large programming projects, a different programmer may be assigned to write each function. The programmer should choose the most meaningful names he or she can find for formal parameters. The arguments that will be substituted for the formal parameters may well be variables in the `main` part of the program. These variables should also be given meaningful names, often chosen by someone other than the programmer who writes the function definition. This makes it likely that some or all arguments will have the same names as some of the formal parameters. This is perfectly acceptable. No matter what names are chosen for the variables that will be used as arguments, these names will not produce any confusion with the names used for formal parameters. After all, the functions will use only the values of the arguments. When you use a variable as a function argument, the function takes only the value of the variable and disregards the variable name.

Now that you know you have complete freedom in choosing formal parameter names, we will stop placing a `"_par"` at the end of each formal parameter name. For example, in Display 4.8 we have rewritten the definition for the function `total_cost` from Display 4.3 so that the formal parameters are named `number` and `price` rather than `number_par` and `price_par`. If you replace the function declaration and definition of the function `total_cost` that appear in Display 4.3 with the versions in Display 4.8, then the program will perform in exactly the same way, even though there will be formal parameters named `number` and `price` and there will be variables in the `main` part of the program that are also named `number` and `price`.

DISPLAY 4.8 Simpler Formal Parameter Names

Function Declaration

```
1  double total_cost(int number, double price);
2  //Computes the total cost, including 5 percent sales tax,
3  //on number items at a cost of price each.
```

Function Definition

```
1  double total_cost(int number, double price)
2  {
3      const double TAX_RATE = 0.05; //5 percent sales tax
4      double subtotal;
5      subtotal = price * number;
6      return (subtotal + subtotal * TAX_RATE);
7  }
```

PROGRAMMING TIP Nested Loops

When you see nested loops in your code, then you should consider whether or not to apply the principle of procedural abstraction. Consider the explicitly nested loops in Display 3.15 that computed the total number of green-necked vulture eggs counted by all conservationists. We can make this code more readable by moving the loops into procedure calls, as shown in Display 4.9.

The two versions of our program for totaling green-necked vulture eggs are equivalent. Both programs produce the same dialogue with the user. However, most people find the version in Display 4.9 easier to understand because the loop body is a function call. When considering the outer loop, you should think of computing the subtotal for one conservationist's report as a single operation and not think of it as a loop. ■

Make a Loop Body a Function Call

Whenever you have a loop nested within a loop, or any other complex computation included in a loop body, make the loop body a function call. This way you can separate the design of the loop body from the design of the rest of the program. This divides your programming task into two smaller subtasks.

DISPLAY 4.9 Nicely Nested Loops (part 1 of 3)

```
1 //Determines the total number of green-necked vulture eggs
2 //counted by all conservationists in the conservation district.
3 #include <iostream>
4 using namespace std;
5
6
7 int get_one_total();
8 //Precondition: User will enter a list of egg counts
9 //followed by a negative number.
10 //Postcondition: returns a number equal to the sum of all the egg counts.
11
12 int main( )
13 {
14     cout << "This program tallies conservationist reports\n"
15         << "on the green-necked vulture.\n"
16         << "Each conservationist's report consists of\n"
17         << "a list of numbers. Each number is the count of\n"
18         << "the eggs observed in one"
19         << " green-necked vulture nest.\n"
20         << "This program then tallies"
21         << " the total number of eggs.\n";
22
23     int number_of_reports;
24     cout << "How many conservationist reports are there? ";
25     cin >> number_of_reports;
26
27     int grand_total = 0, subtotal, count;
28     for (count = 1; count <= number_of_reports; count++)
29     {
30         cout << endl << "Enter the report of "
31             << "conservationist number " << count << endl;
32         subtotal = get_one_total();
33         cout << "Total egg count for conservationist "
34             << " number " << count << " is "
35             << subtotal << endl;
36         grand_total = grand_total + subtotal;
37     }
38
39     cout << endl << "Total egg count for all reports = "
40         << grand_total << endl;
41
42     return 0;
43 }
44
45
```

(continued)

DISPLAY 4.9 Nicely Nested Loops (*part 2 of 3*)

```
46 //Uses iostream:
47 int get_one_total()
48 {
49     int total;
50     cout << "Enter the number of eggs in each nest.\n"
51          << "Place a negative integer"
52          << " at the end of your list.\n";
53
54     total = 0;
55     int next;
56     cin >> next;
57     while (next >= 0)
58     {
59         total = total + next;
60         cin >> next;
61     }
62     return total;
63 }
```

Sample Dialogue

This program tallies conservationist reports on the green-necked vulture. Each conservationist's report consists of a list of numbers. Each number is the count of the eggs observed in one green-necked vulture nest. This program then tallies the total number of eggs. How many conservationist reports are there? 3

Enter the report of conservationist number 1
Enter the number of eggs in each nest.
Place a negative integer at the end of your list.
1 0 0 2 -1
Total egg count for conservationist number 1 is 3

Enter the report of conservationist number 2
Enter the number of eggs in each nest.
Place a negative integer at the end of your list.
0 3 1 -1
Total egg count for conservationist number 2 is 4

Enter the report of conservationist number 3
Enter the number of eggs in each nest.

(continued)

DISPLAY 4.9 Nicely Nested Loops (*part 3 of 3*)

```
Place a negative integer at the end of your list.  
-1  
Total egg count for conservationist number 3 is 0  
  
Total egg count for all reports = 7
```

CASE STUDY Buying Pizza

The large “economy” size of an item is not always a better buy than the smaller size. This is particularly true when buying pizzas. Pizza sizes are given as the diameter of the pizza in inches. However, the quantity of pizza is determined by the area of the pizza, and the area is not proportional to the diameter. Most people cannot easily estimate the difference in area between a 10-inch pizza and a 12-inch pizza and so cannot easily determine which size is the best buy—that is, which size has the lowest price per square inch. In this case study we will design a program that compares two sizes of pizza to determine which is the better buy.

Problem Definition

The precise specification of the program input and output are as follows:

Input

The input will consist of the diameter in inches and the price for each of two sizes of pizza.

Output

The output will give the cost per square inch for each of the two sizes of pizza and will tell which is the better buy, that is, which has the lowest cost per square inch. (If they are the same cost per square inch, we will consider the smaller one to be the better buy.)

Analysis of the Problem

We will use top-down design to divide the task to be solved by our program into the following subtasks:

Subtask 1: Get the input data for both the small and large pizzas.

Subtask 2: Compute the price per square inch for the small pizza.

Subtask 3: Compute the price per square inch for the large pizza.

Subtask 4: Determine which is the better buy.

Subtask 5: Output the results.

Notice subtasks 2 and 3. They have two important properties:

Subtasks 2
and 3

1. They are exactly the same task. The only difference is that they use different data to do the computation. The only things that change between subtask 2 and subtask 3 are the size of the pizza and its price.
2. The result of subtask 2 and the result of subtask 3 are each a single value: the price per square inch of the pizza.

When to define a function

Whenever a subtask takes some values, such as some numbers, and returns a single value, it is natural to implement the subtask as a function. Whenever two or more such subtasks perform the same computation, they can be implemented as the same function called with different arguments each time it is used. We therefore decide to use a function called `unitprice` to compute the price per square inch of a pizza. The function declaration and explanatory comment for this function will be as follows:

```
double unitprice(int diameter, double price);
//Returns the price per square inch of a pizza. The formal
//parameter named diameter is the diameter of the pizza in
//inches. The formal parameter named price is the price of
//the pizza.
```

Algorithm Design

Subtask 1

Subtask 1 is straightforward. The program will simply ask for the input values and store them in four variables, which we will call `diameter_small`, `diameter_large`, `price_small`, and `price_large`.

Subtasks 4 and 5

Subtask 4 is routine. To determine which pizza is the best buy, we just compare the cost per square inch of the two pizzas using the less-than operator. Subtask 5 is a routine output of the results.

Subtasks 2 and 3

Subtasks 2 and 3 are implemented as calls to the function `unitprice`. Next, we design the algorithm for this function. The hard part of the algorithm is determining the area of the pizza. Once we know the area, we can easily determine the price per square inch using division, as follows:

```
price/area
```

where `area` is a variable that holds the area of the pizza. This expression will be the value returned by the function `unitprice`. But we still need to formulate a method for computing the area of the pizza.

A pizza is basically a circle (made up of bread, cheese, sauce, and so forth). The area of a circle (and hence of a pizza) is πr^2 , where r is the radius of the circle and π is the number called “pi,” which is approximately equal to 3.14159. The radius is one half of the diameter.

The algorithm for the function `unitprice` can be outlined as follows:

Algorithm Outline for the Function `unitprice`

1. Compute the radius of the pizza.
2. Compute the area of the pizza using the formula πr^2 .
3. Return the value of the expression `(price/area)`.

We will give this outline a bit more detail before translating it into C++ code. We will express this more detailed version of our algorithm in *pseudocode*. **Pseudocode** is a mixture of C++ and ordinary English. Pseudocode allows us to make our algorithm precise without worrying about the details of C++ syntax. We can then easily translate our pseudocode into C++ code. In our pseudocode, *radius* and *area* will be variables for holding the values indicated by their names.

Pseudocode for the Function `unitprice`

```
radius = one half of diameter;
area =  $\pi$  * radius * radius;
return (price/area);
```

That completes our algorithm for `unitprice`. We are now ready to convert our solutions to subtasks 1 through 5 into a complete C++ program.

Coding

Coding subtask 1 is routine, so we next consider subtasks 2 and 3. Our program can implement subtasks 2 and 3 by the following two calls to the function `unitprice`:

```
unitprice_small = unitprice(diameter_small, price_small);
unitprice_large = unitprice(diameter_large, price_large);
```

where `unitprice_small` and `unitprice_large` are two variables of type *double*. One of the benefits of a function definition is that you can have multiple calls to the function in your program. This saves you the trouble of repeating the same (or almost the same) code. But we still must write the code for the function `unitprice`.

When we translate our pseudocode into C++ code, we obtain the following for the body of the function `unitprice`:

```
{//First draft of the function body for unitprice
  const double PI = 3.14159;
  double radius, area;

  radius = diameter/2;
  area = PI * radius * radius;
  return (price/area);
}
```

Notice that we made `PI` a named constant using the modifier *const*. Also, notice the following line from the code:

```
radius = diameter/2;
```

This is just a simple division by 2, and you might think that nothing could be more routine. Yet, as written, this line contains a serious mistake. We want the division to produce the radius of the pizza including any fraction.

For example, if we are considering buying the “bad luck special,” which is a 13-inch pizza, then the radius is 6.5 inches. But the variable `diameter` is of type `int`. The constant `2` is also of type `int`. Thus, as we saw in Chapter 2, this line would perform integer division and would compute the radius $13/2$ to be 6 instead of the correct value of 6.5, and we would have disregarded a half inch of pizza radius. In all likelihood, this would go unnoticed, but the result could be that millions of subscribers to the Pizza Consumers Union could be wasting their money by buying the wrong size pizza. This is not likely to produce a major worldwide recession, but the program would be failing to accomplish its goal of helping consumers find the best buy. In a more important program, the result of such a simple mistake could be disastrous.

How do we fix this mistake? We want the division by 2 to be regular division that includes any fractional part in the answer. That form of division requires that at least one of the arguments to the division operator `/` must be of type `double`. We can use type casting to convert the constant `2` to a value of type `double`. Recall that `static_cast<double>(2)`, which is called a *type casting*, converts the `int` value `2` to a value of type `double`. Thus, if we replace `2` by `static_cast<double>(2)`, that will change the second argument in the division from type `int` to type `double`, and the division will then produce the result we want. The rewritten assignment statement is

```
radius = diameter/static_cast<double>(2);
```

The complete corrected code for the function definition of `unitprice`, along with the rest of the program, is shown in Display 4.10.

The type cast `static_cast<double>(2)` returns the value `2.0`, so we could have used the constant `2.0` in place of `static_cast<double>(2)`. Either way, the function `unitprice` will return the same value. However, by using `static_cast<double>(2)`, we make it conspicuously obvious that we want to do the version of division that includes the fractional part in its answer. If we instead used `2.0`, then when revising or copying the code, we can easily make the mistake of changing `2.0` to `2`, and that would produce a subtle problem.

We need to make one more remark about the coding of our program. As you can see in Display 4.10, when we coded tasks 4 and 5, we combined these two tasks into a single section of code consisting of a sequence of `cout` statements followed by an `if-else` statement. When two tasks are very simple and are closely related, it sometimes makes sense to combine them into a single task.

Program Testing

Just because a program compiles and produces answers that look right does not mean the program is correct. In order to increase your confidence in your program, you should test it on some input values for which you know the correct answer by some other means, such as working out the answer with paper and pencil or by using a handheld calculator. For example, it does not make sense to buy a 2-inch pizza, but it can still be used as

DISPLAY 4.10 Buying Pizza (part 1 of 2)

```

1 //Determines which of two pizza sizes is the best buy.
2 #include <iostream>
3 using namespace std;
4
5 double unitprice (int diameter, double price);
6 //Returns the price per square inch of a pizza. The formal
7 //parameter named diameter is the diameter of the pizza in inches.
8 //The formal parameter named price is the price of the pizza.
9
10 int main( )
11 {
12     int diameter_small, diameter_large;
13     double price_small, unitprice_small,
14         price_large, unitprice_large;
15
16     cout << "Welcome to the Pizza Consumers Union.\n";
17     cout << "Enter diameter of a small pizza (in inches): ";
18     cin >> diameter_small;
19     cout << "Enter the price of a small pizza: $";
20     cin >> price_small;
21     cout << "Enter diameter of a large pizza (in inches): ";
22     cin >> diameter_large;
23     cout << "Enter the price of a large pizza: $";
24     cin >> price_large;
25
26     unitprice_small = unitprice(diameter_small, price_small);
27     unitprice_large = unitprice(diameter_large, price_large);
28
29     cout.setf(ios::fixed);
30     cout.setf(ios::showpoint);
31     cout.precision(2);
32     cout << "Small pizza:\n"
33         << "Diameter = " << diameter_small << " inches\n"
34         << "Price = $" << price_small
35         << " Per square inch = $" << unitprice_small << endl
36         << "Large pizza:\n"
37         << "Diameter = " << diameter_large << " inches\n"
38         << "Price = $" << price_large
39         << " Per square inch = $" << unitprice_large << endl;
40     if (unitprice_large < unitprice_small)
41         cout << "The large one is the better buy.\n";
42     else
43         cout << "The small one is the better buy.\n";
44
45     cout << "Buon Appetito!\n";
46     return 0;

```

(continued)

DISPLAY 4.10 Buying Pizza (part 2 of 2)

```
47  }
48
49  double unitprice(int diameter, double price)
50  {
51      const double PI = 3.14159;
52      double radius, area;
53
54      radius = diameter/static_cast<double>(2);
55      area = PI * radius * radius;
56      return (price/area);
57  }
58
```

Sample Dialogue

```
Welcome to the Pizza Consumers Union.
Enter diameter of a small pizza (in inches): 10
Enter the price of a small pizza: $7.50
Enter diameter of a large pizza (in inches): 13
Enter the price of a large pizza: $14.75
Small pizza:
Diameter = 10 inches
Price = $7.50 Per square inch = $0.10
Large pizza:
Diameter = 13 inches
Price = $14.75 Per square inch = $0.11
The small one is the better buy.
Buon Appetito!
```

an easy test case for this program. It is an easy test case because it is easy to compute the answer by hand. Let's calculate the cost per square inch of a 2-inch pizza that sells for \$3.14. Since the diameter is 2 inches, the radius is 1 inch. The area of a pizza with radius 1 is $3.14159 * 1^2$, which is 3.14159. If we divide this into the price of \$3.14, we find that the price per square inch is $3.14/3.14159$, which is approximately \$1.00. Of course, this is an absurd size for a pizza and an absurd price for such a small pizza, but it is easy to determine the value that the function `unitprice` should return for these arguments.

Having checked your program on this one case, you can have more confidence in it, but you still cannot be certain your program is correct. An incorrect program can sometimes give the correct answer, even though it will give incorrect answers on some other inputs. You may have

tested an incorrect program on one of the cases for which the program happens to give the correct output. For example, suppose we had not caught the mistake we discovered when coding the function `unitprice`. Suppose we mistakenly used 2 instead of `static_cast<double>(2)` in the following line:

```
radius = diameter/static_cast<double>(2);
```

So that line reads as follows:

```
radius = diameter/2;
```

As long as the pizza diameter is an even number, like 2, 8, 10, or 12, the program gives the same answer whether we divide by 2 or by `static_cast<double>(2)`. It is unlikely that it would occur to you to be sure to check both even- and odd-size pizzas. However, if you test your program on several different pizza sizes, then there is a better chance that your test cases will contain samples of the relevant kinds of data.

■ PROGRAMMING TIP Use Pseudocode

Algorithms are typically expressed in *pseudocode*. **Pseudocode** is a mixture of C++ (or whatever programming language you are using) and ordinary English (or whatever human language you are using). Pseudocode allows you to state your algorithm precisely without having to worry about all the details of C++ syntax. When the C++ code for a step in your algorithm is obvious, there is little point in stating it in English. When a step is difficult to express in C++, the algorithm will be clearer if the step is expressed in English. You can see an example of pseudocode in the previous case study, where we expressed our algorithm for the function `unitprice` in pseudocode. ■

SELF-TEST EXERCISES

15. What is the purpose of the comment that accompanies a function declaration?
16. What is the principle of procedural abstraction as applied to function definitions?
17. What does it mean when we say the programmer who uses a function should be able to treat the function like a black box? (*Hint*: This question is very closely related to the previous question.)
18. Carefully describe the process of program testing.

19. Consider two possible definitions for the function `unitprice`. One is the definition given in Display 4.10. The other definition is the same except that the type cast `static_cast<double>(2)` is replaced with the constant `2.0`; in other words, the line

```
radius = diameter/static_cast<double>(2);
```

is replaced with the line

```
radius = diameter/2.0;
```

Are these two possible function definitions black-box equivalent?

4.5 SCOPE AND LOCAL VARIABLES

He was a local boy, not known outside his home town.

COMMON SAYING

In the last section we advocated using functions as if they were black boxes. In order to define a function so that it can be used as a black box, you often need to give the function variables of its own that do not interfere with the rest of your program. The variables that “belong to” a function are called *local variables*. As we will see, these variables simply conform to the scope rule for nested blocks described in Chapter 3. In this section we take another look at scoping with an emphasis on local variables and how to use them.

The Small Program Analogy

Look back at the program in Display 4.1. It includes a call to the predefined function `sqrt`. We did not need to know anything about the details of the function definition for `sqrt` in order to use this function. In particular, we did not need to know what variables were declared in the definition of `sqrt`. A function that you define is no different. Variable declarations in function definitions that you write are as separate as those in the function definitions for the predefined functions. Variable declarations within a function definition are the same as if they were variable declarations in another program. If you declare a variable in a function definition and then declare another variable of the same name in the `main` part of your program (or in the body of some other function definition), then these two variables are two different variables, even though they have the same name. Let’s look at a program that does have a variable in a function definition with the same name as another variable in the program.

The program in Display 4.11 has two variables named `average_pea`; one is declared and used in the function definition for the function `est_total`, and the other is declared and used in the `main` part of the program. The variable

DISPLAY 4.11 Local Variables (part 1 of 2)

```

1 //Computes the average yield on an experimental pea growing patch.
2 #include <iostream>
3 using namespace std;
4
5 double est_total(int min_peas, int max_peas, int pod_count);
6 //Returns an estimate of the total number of peas harvested.
7 //The formal parameter pod_count is the number of pods.
8 //The formal parameters min_peas and max_peas are the minimum
9 //and maximum number of peas in a pod.
10
11 int main( ) This variable named average_pea is
12 { local to the main part of the program.
13     int max_count, min_count, pod_count;
14     double average_pea, yield;
15
16     cout << "Enter minimum and maximum number of peas in a pod: ";
17     cin >> min_count >> max_count;
18     cout << "Enter the number of pods: ";
19     cin >> pod_count;
20     cout << "Enter the weight of an average pea (in ounces): ";
21     cin >> average_pea;
22
23     yield =
24         est_total(min_count, max_count, pod_count) * average_pea;
25
26     cout.setf(ios::fixed);
27     cout.setf(ios::showpoint);
28     cout.precision(3);
29     cout << "Min number of peas per pod = " << min_count << endl
30         << "Max number of peas per pod = " << max_count << endl
31         << "Pod count = " << pod_count << endl
32         << "Average pea weight = "
33         << average_pea << " ounces" << endl
34         << "Estimated average yield = " << yield << " ounces"
35         << endl;
36
37     return 0;
38 }
39
40 double est_total(int min_peas, int max_peas, int pod_count)
41 {
42     double average_pea; This variable named average_pea
43 is local to the function est_total.
44     average_pea = (max_peas + min_peas)/2.0;
45     return (pod_count * average_pea);
46 }

```

(continued)

DISPLAY 4.11 Local Variables (part 2 of 2)*Sample Dialogue*

```
Enter minimum and maximum number of peas in a pod: 4 6
Enter the number of pods: 10
Enter the weight of an average pea (in ounces): 0.5
Min number of peas per pod = 4
Max number of peas per pod = 6
Pod count = 10
Average pea weight = 0.500 ounces
Estimated average yield = 25.000 ounces
```

average_pea in the function definition for `est_total` and the variable `average_pea` in the main part of the program are two different variables. It is the same as if the function `est_total` were a predefined function. The two variables named `average_pea` will not interfere with each other any more than two variables in two completely different programs would. When the variable `average_pea` is given a value in the function call to `est_total`, this does not change the value of the variable in the main part of the program that is also named `average_pea`. (The details of the program in Display 4.11, other than this coincidence of names, are explained in the Programming Example section that follows this section.)

Variables that are declared within the body of a function definition are said to be **local to that function** or to have that function as their **scope**. Variables that are defined within the main body of the program are said to be **local to the main part of the program** or to have the main part of the program as their **scope**. There are other kinds of variables that are not local to any function or to the main part of the program, but we will have no use for such variables. Every variable we will use is either local to a function definition or local to the main part of the program. When we say that a variable is a **local variable** without any mention of a function and without any mention of the main part of the program, we mean that the variable is local to some function definition.

Local Variables

Variables that are declared within the body of a function definition are said to be **local to that function** or to have that function as their **scope**. Variables that are declared within the main part of the program are said to be **local to the main part of the program** or to have the main part of the program as their **scope**. When we say that a variable is a **local variable** without any mention of a function and without any mention of the main part of the

(continued)

program, we mean that the variable is local to some function definition. If a variable is local to a function, then you can have another variable with the same name that is declared in the main part of the program or in another function definition, and these will be two different variables, even though they have the same name.

PROGRAMMING EXAMPLE

Experimental Pea Patch

The program in Display 4.11 gives an estimate for the total yield on a small garden plot used to raise an experimental variety of peas. The function `est_total` returns an estimate of the total number of peas harvested. The function `est_total` takes three arguments. One argument is the number of pea pods that were harvested. The other two arguments are used to estimate the average number of peas in a pod. Different pea pods contain differing numbers of peas, so the other two arguments to the function are the smallest and the largest number of peas that were found in any one pod. The function `est_total` averages these two numbers and uses this average as an estimate for the average number of peas in a pod.

Global Constants and Global Variables

As we noted in Chapter 2, you can and should name constant values using the `const` modifier. For example, in Display 4.10 we used the following declaration to give the name `PI` to the constant 3.14159:

```
const double PI = 3.14159;
```

In Display 4.3, we used the `const` modifier to give a name to the rate of sales tax with the following declaration:

```
const double TAX_RATE = 0.05; //5 percent sales tax
```

As with our variable declarations, we placed these declarations for naming constants inside the body of the functions that used them. This worked out fine because each named constant was used by only one function. However, it can easily happen that more than one function uses a named constant. In that case you can place the declaration for naming a constant at the beginning of your program, outside of the body of all the functions and outside the body of the main part of your program. The named constant is then said to be a **global named constant** and the named constant can be used in any function definition that follows the constant declaration.

Display 4.12 shows a program with an example of a global named constant. The program asks for a radius and then computes both the area of

DISPLAY 4.12 A Global Named Constant *(part 1 of 2)*

```
1 //Computes the area of a circle and the volume of a sphere.
2 //Uses the same radius for both calculations.
3 #include <iostream>
4 #include <cmath>
5 using namespace std;
6
7 const double PI = 3.14159;
8
9 double area(double radius);
10 //Returns the area of a circle with the specified radius.
11
12 double volume(double radius);
13 //Returns the volume of a sphere with the specified radius.
14
15 int main( )
16 {
17     double radius_of_both, area_of_circle, volume_of_sphere;
18
19     cout << "Enter a radius to use for both a circle\n"
20          << "and a sphere (in inches): ";
21     cin >> radius_of_both;
22
23     area_of_circle = area(radius_of_both);
24     volume_of_sphere = volume(radius_of_both);
25
26     cout << "Radius = " << radius_of_both << " inches\n"
27          << "Area of circle = " << area_of_circle
28          << " square inches\n"
29          << "Volume of sphere = " << volume_of_sphere
30          << " cubic inches\n";
31
32     return 0;
33 }
34
35 double area(double radius)
36 {
37     return (PI * pow(radius, 2));
38 }
39
40 double volume(double radius)
41 {
42     return ((4.0/3.0) * PI * pow(radius, 3));
43 }
```

(continued)

DISPLAY 4.12 A Global Named Constant (part 2 of 2)

Sample Dialogue

```
Enter a radius to use for both a circle
and a sphere (in inches): 2
Radius = 2 inches
Area of circle = 12.5664 square inches
Volume of sphere = 33.5103 cubic inches
```

a circle and the volume of a sphere with that radius. The programmer who wrote that program looked up the formulas for computing those quantities and found the following:

$$\begin{aligned}\text{area} &= \pi \times (\text{radius})^2 \\ \text{volume} &= (4/3) \times \pi \times (\text{radius})^3\end{aligned}$$

Both formulas include the constant π , which is approximately equal to 3.14159. The symbol π is the Greek letter called “pi.” In previous programs we have used the following declaration to produce a named constant called `PI` to use when we convert such formulas to C++ code:

```
const double PI = 3.14159;
```

In the program in Display 4.12 we use the same declaration but place it near the beginning of the file so that it defines a global named constant that can be used in all the function bodies.

The compiler allows you wide latitude with regard to where you place the declarations for your global named constants, but to aid readability you should place all your `include` directives together, all your global named constant declarations together in another group, and all your function declarations together. We will follow standard practice and place all our global named constant declarations after our `include` directives and before our function declarations.

Placing all named constant declarations at the start of your program can aid readability even if the named constant is used by only one function. If the named constant might need to be changed in a future version of your program, it will be easier to find if it is at the beginning of the program. For example, placing the constant declaration for the sales tax rate at the beginning of an accounting program will make it easy to revise the program should the tax rate increase.

It is possible to declare ordinary variables, without the `const` modifier, as **global variables**, which are accessible to all function definitions in the file. This is done the same way that it is done for global named constants,



except that the modifier *const* is not used in the variable declaration. However, there is seldom any need to use such global variables. Moreover, global variables can make a program harder to understand and maintain, so we will not use any global variables. Once you have had more experience designing programs, you may choose to occasionally use global variables.

Call-by-Value Formal Parameters Are Local Variables

Formal parameters are more than just blanks that are filled in with the argument values for the function. Formal parameters are actually variables that are local to the function definition, so they can be used just like a local variable that is declared in the function definition. Earlier in this chapter we described the call-by-value mechanism that handles the arguments in a function call. We can now define this mechanism for “plugging in arguments” in more detail. When a function is called, the formal parameters for the function (which are local variables) are initialized to the values of the arguments. This is the precise meaning of the phrase “plugged in for the formal parameters” that we have been using. Typically, a formal parameter is used only as a kind of blank, or place holder, that is filled in by the value of its corresponding argument; occasionally, however, a formal parameter is used as a variable whose value is changed. In this section we will give one example of a formal parameter used as a local variable.

The program in Display 4.13 is the billing program for the law offices of Dewey, Cheatham, and Howe. Notice that, unlike other law firms, the firm of Dewey, Cheatham, and Howe does not charge for any time less than a quarter of an hour. That is why it’s called “the law office with a heart.” If they work for 1 hour and 14 minutes, they only charge for 4 quarter hours, not 5 quarter hours as other firms do; so you would pay only \$600 for the consultation.

DISPLAY 4.13 Formal Parameter Used as a Local Variable (part 1 of 2)

```
1 //Law office billing program.
2 #include <iostream>
3 using namespace std;
4
5 const double RATE = 150.00; //Dollars per quarter hour.
6
7 double fee(int hours_worked, int minutes_worked);
8 //Returns the charges for hours_worked hours and
9 //minutes_worked minutes of legal services.
10
11 int main( )
12 {
13     int hours, minutes;
14     double bill;
15
```

(continued)

DISPLAY 4.13 Formal Parameter Used as a Local Variable (*part 2 of 2*)

```

16     cout << "Welcome to the offices of\n"
17         << "Dewey, Cheatham, and Howe.\n"
18         << "The law office with a heart.\n"
19         << "Enter the hours and minutes"
20         << " of your consultation:\n";
21     cin >> hours >> minutes;
22
23     bill = fee(hours, minutes);
24
25     cout.setf(ios::fixed);
26     cout.setf(ios::showpoint);
27     cout.precision(2);
28     cout << "For " << hours << " hours and " << minutes
29         << " minutes, your bill is $" << bill << endl;
30
31     return 0;
32 }
33
34 double fee(int hours_worked, int minutes_worked)
35 {
36     int quarter_hours;
37
38     minutes_worked = hours_worked * 60 + minutes_worked;
39     quarter_hours = minutes_worked/15;
40     return (quarter_hours * RATE);
41 }

```

*The value of minutes
is not changed by the
call to fee.*

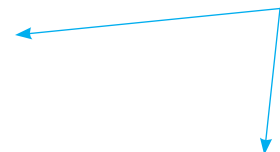

*minutes_worked is
a local variable
initialized to the
value of minutes.*

Sample Dialogue

```

Welcome to the offices of
Dewey, Cheatham, and Howe.
The law office with a heart.
Enter the hours and minutes of your consultation:
2 45
For 2 hours and 45 minutes, your bill is $1650.00

```

Notice the formal parameter `minutes_worked` in the definition of the function `fee`. It is used as a variable and has its value changed by the following line, which occurs within the function definition:

```
minutes_worked = hours_worked * 60 + minutes_worked;
```

Formal parameters are local variables just like the variables you declare within the body of a function. However, you should not add a variable

**Do not add a
declaration for a
formal parameter**

declaration for the formal parameters. Listing the formal parameter `minutes_worked` in the function declaration also serves as the variable declaration. The following is the *wrong way* to start the function definition for `fee` as it declares `minutes_worked` twice:

```
double fee(int hours_worked, int minutes_worked)
{
    int quarter_hours;
    int minutes_worked;
    . . .
}
```

Do NOT do this!

Block Scope

The scope of a local variable refers to the part of a program that can directly access that variable and is sometimes referred to as *local scope*. Similarly, global identifiers declared at the beginning of your program, outside of the body of all the functions, are sometimes referred to as having *global scope*. Despite their differences, local and global identifiers are really examples of *block scope* described in Chapter 3. A block is some C++ code enclosed in braces, with the exception of the “global block,” which is an implied outermost block that encompasses all code. The scope rule states that identifiers declared within their block are local to that block and accessible only from the point they are defined to the end of their block. Blocks are commonly nested. For example, the braces of the `main` function defines a block and a `for` loop inside `main` defines a nested block.

The program outlined in Display 4.14 doesn’t compute anything interesting but illustrates the scope of identifiers declared in different blocks. In this example, the constant `GLOBAL_CONST` has global scope, along with the functions `function1` and `main`, because they are declared outside the body of all functions. This allows us to access `GLOBAL_CONST` from both `main` and `function1`.

The `main` function declares the variables `x` and `d` that are local to `main`. Their scope extends to the end of `main`’s block. Similarly, the function `function1` has a parameter `param` and a local variable `y` that have scope extending to the end of `function1`. Neither of these variables is directly accessible from outside their scope. The scope of local variables and parameters really uses the same rule of block scope, but in this case the block refers to the function in which the variables or parameters are declared.

The `for` loop in Display 4.14 illustrates the scope of a nested block. The variable `i` is declared inside the `for` loop and thus only has scope to the end of the loop block. Attempts to reference `i` anywhere outside its scope, even if we are still inside `main` (for example, on line 17) would result in a compiler error.

You can think of variables as being created when their scope begins and destroyed when their scope ends. For example, the local variable `y` in Display 4.14 is created and initialized to `GLOBAL_CONST` every time `function1` is called. If code on line 23 changed the value stored in `y`, then these changes would be

DISPLAY 4.14 Local, Global, and Block Scope

Block Scope Revisited

```

1  #include <iostream>
2  using namespace std;
3
4  const double GLOBAL_CONST = 1.0;
5
6  int function1(int param);
7
8  int main()
9  {
10     int x;
11     double d = GLOBAL_CONST;
12
13     for (int i = 0; i < 10; i++)
14     {
15         x = function1(i);
16     }
17     return 0;
18 }
19
20 int function1(int param)
21 {
22     double y = GLOBAL_CONST;
23     ...
24     return 0;
25 }
```

Local and Global scope are examples of Block scope.
A variable can be directly accessed only within its scope.

Block scope:
Variable **i** has
scope from
lines 13-16

Local scope to
main: Variable
x has scope
from lines
10-18 and
variable **d** has
scope from
lines 11-18

Global scope:
The constant
GLOBAL_CONST
has scope from
lines 4-25 and
the function
function1
has scope from
lines 6-25

Local scope to **function1**:
Variable **param**
has scope from lines 20-25
and variable **y** has scope
from lines 22-25

lost when the function exits and *y* goes out of scope because the variable *y* is destroyed. A repeat call to `function1` will not recall the previous value of *y*, but rather a new *y* will be created.

In addition to block scope there is also namespace scope and class scope. Class scope is discussed in Chapter 10 and namespace scope in Chapter 12. C++ also defines function prototype scope, which refers to the line of scope for parameters defined in a function prototype. Finally, C++ supports function scope, which is used for labels. Labels are a remnant from the C language and are used with `goto` statements. Their use is generally shunned because they can result in logic that is difficult to follow, whereas the same task can be performed by loops in an understandable fashion.

Namespaces Revisited

Thus far, we have started all of our programs with the following two lines:

```

#include <iostream>
using namespace std;
```

However, the start of the file is not always the best location for the line

```
using namespace std;
```

We will eventually be using more namespaces than just `std`. In fact, we may be using different namespaces in different function definitions. If you place the directive

```
using namespace std;
```

inside the brace `{` that starts the body of a function definition, then the *using* directive applies to only that function definition. This will allow you to use two different namespaces in two different function definitions, even if the two function definitions are in the same file and even if the two namespaces have some name(s) with different meanings in the two different namespaces.

Placing a *using* directive inside a function definition is analogous to placing a variable declaration inside a function definition. If you place a variable definition inside a function definition, the variable is local to the function; that is, the meaning of the variable declaration is confined to the function definition. If you place a *using* directive inside a function definition, the *using* directive is local to the function definition; in other words, the meaning of the *using* directive is confined to the function definition.

It will be some time before we use any namespace other than `std` in a *using* directive, but it will be good practice to start placing these *using* directives where they should go. In Display 4.15 we have rewritten the program in Display 4.12 with the *using* directives where they should be placed. The program in Display 4.15 will behave exactly the same as the one in Display 4.12. In this particular case, the difference is only one of style, but when you start to use more namespaces, the difference will affect how your programs perform.

DISPLAY 4.15 Using Namespaces (part 1 of 2)

```

1  //Computes the area of a circle and the volume of a sphere.
2  //Uses the same radius for both calculations.
3  #include <iostream>
4  #include <cmath>
5
6  const double PI = 3.14159;
7
8  double area(double radius);
9  //Returns the area of a circle with the specified radius.
10
11 double volume(double radius);
12 //Returns the volume of a sphere with the specified radius.
```

(continued)

DISPLAY 4.15 Using Namespaces *(part 2 of 2)*

```

13
14     int main( )
15     {
16         using namespace std;
17
18         double radius_of_both, area_of_circle, volume_of_sphere;
19
20         cout << "Enter a radius to use for both a circle\n"
21              << "and a sphere (in inches): ";
22         cin >> radius_of_both;
23
24         area_of_circle = area(radius_of_both);
25         volume_of_sphere = volume(radius_of_both);
26
27         cout << "Radius = " << radius_of_both << " inches\n"
28              << "Area of circle = " << area_of_circle
29              << " square inches\n"
30              << "Volume of sphere = " << volume_of_sphere
31              << " cubic inches\n";
32
33         return 0;
34     }
35
36
37     double area(double radius)
38     {
39         using namespace std;
40
41         return (PI * pow(radius, 2));
42     }
43
44     double volume(double radius)
45     {
46         using namespace std;
47
48         return ((4.0/3.0) * PI * pow(radius, 3));
49     }

```

The sample dialogue for this program would be the same as the one for the program in Display 4.12.

SELF-TEST EXERCISES

20. If you use a variable in a function definition, where should you declare the variable? In the function definition? In the main part of the program? Any place that is convenient?

21. Suppose a function named `Function1` has a variable named `sam` declared within the definition of `Function1`, and a function named `Function2` also has a variable named `sam` declared within the definition of `Function2`. Will the program compile (assuming everything else is correct)? If the program will compile, will it run (assuming that everything else is correct)? If it runs, will it generate an error message when run (assuming everything else is correct)? If it runs and does not produce an error message when run, will it give the correct output (assuming everything else is correct)?
22. The following function is supposed to take as arguments a length expressed in feet and inches and return the total number of inches in that many feet and inches. For example, `total_inches(1,2)` is supposed to return 14, because 1 foot and 2 inches is the same as 14 inches. Will the following function perform correctly? If not, why not?

```
double total_inches(int feet, int inches)
{
    inches = 12 * feet + inches;
    return inches;
}
```

23. Write a function declaration and function definition for a function called `read_filter` that has no parameters and that returns a value of type `double`. The function `read_filter` prompts the user for a value of type `double` and reads the value into a local variable. The function returns the value read provided this value is greater than or equal to zero and returns zero if the value read is negative.

PROGRAMMING EXAMPLE

The Factorial Function

Display 4.16 contains the function declaration and definition for a commonly used mathematical function known as the *factorial* function. In mathematics texts, the factorial function is usually written $n!$ and is defined to be the product of all the integers from 1 to n . In traditional mathematical notation, you can define $n!$ as follows:

$$n! = 1 \times 2 \times 3 \times \dots \times n$$

In the function definition we perform the multiplication with a *while* loop. Note that the multiplication is performed in the reverse order to what you might expect. The program multiplies by n , then $n - 1$, then $n - 2$, and so forth.

DISPLAY 4.16 Factorial Function

Function Declaration

```

1  int factorial(int n);
2  //Returns factorial of n.
3  //The argument n should be nonnegative.

```

Function Definition

```

1  int factorial(int n)
2  {
3      int product = 1;
4      while (n > 0)
5      {
6          product = n * product;
7          n--; ← formal parameter n
8      }                                     used as a local
9                                          variable
10     return product;
11 }

```

The function definition for `factorial` uses two local variables: `product`, which is declared at the start of the function body, and the formal parameter `n`. Since a formal parameter is a local variable, we can change its value. In this case we change the value of the formal parameter `n` with the decrement operator `n--`. (The decrement operator was discussed in Chapter 2.)

Formal parameter
used as a local
variable

Each time the body of the loop is executed, the value of the variable `product` is multiplied by the value of `n`, and then the value of `n` is decreased by one using `n--`. If the function `factorial` is called with 3 as its argument, then the first time the loop body is executed the value of `product` is 3, the next time the loop body is executed the value of `product` is $3 * 2$, the next time the value of `product` is $3 * 2 * 1$, and then the `while` loop ends. Thus, the following will set the variable `x` equal to 6 which is $3 * 2 * 1$:

```
x = factorial(3);
```

Notice that the local variable `product` is initialized to the value 1 when the variable is declared. (This way of initializing a variable when it is declared was introduced in Chapter 2.) It is easy to see that 1 is the correct initial value for the variable `product`. To see that this is the correct initial value for `product`, note that after executing the body of the `while` loop the first time, we want the value of `product` to be equal to the (original) value of the formal parameter `n`; if `product` is initialized to 1, then this will be what happens.

4.6 OVERLOADING FUNCTION NAMES

"...—and that shows that there are three hundred and sixty-four days when you might get un-birthday presents—"

"Certainly," said Alice.

"And only one for birthday presents, you know. There's glory for you!"

"I don't know what you mean by 'glory,'" Alice said.

Humpty Dumpty smiled contemptuously, "Of course you don't—till I tell you. I mean 'there's a nice knock-down argument for you!'"

"But 'glory' doesn't mean 'a nice knock-down argument,'" Alice objected.

"When I use a word," Humpty Dumpty said, in rather a scornful tone, "it means just what I choose it to mean—neither more nor less."

"The question is," said Alice, "whether you can make words mean so many different things."

"The question is," said Humpty Dumpty, "which is to be master—that's all."

LEWIS CARROLL, *Through the Looking-Glass*

C++ allows you to give two or more different definitions to the same function name, which means you can reuse names that have strong intuitive appeal across a variety of situations. For example, you could have three functions called `max`: one that computes the largest of two numbers, another that computes the largest of three numbers, and yet another that computes the largest of four numbers. When you give two (or more) function definitions for the same function name, that is called **overloading** the function name. Overloading does require some extra care in defining your functions and should not be used unless it will add greatly to your program's readability. But when it is appropriate, overloading can be very effective.

Introduction to Overloading

Suppose you are writing a program that requires you to compute the average of two numbers. You might use the following function definition:

```
double ave(double n1, double n2)
{
    return ((n1 + n2)/2.0);
}
```

Now suppose your program also requires a function to compute the average of three numbers. You might define a new function called `ave3` as follows:

```
double ave3(double n1, double n2, double n3)
{
    return ((n1 + n2 + n3)/3.0);
}
```

This will work, and in many programming languages you have no choice but to do something like this. Fortunately, C++ allows for a more elegant solution. In C++ you can simply use the same function name `ave` for both functions; you can use the following function definition in place of the function definition `ave3`:

```
double ave(double n1, double n2, double n3)
{
    return ((n1 + n2 + n3)/3.0);
}
```

DISPLAY 4.17 Overloading a Function Name

```
1 //Illustrates overloading the function name ave.
2 #include <iostream>
3
4 double ave(double n1, double n2);
5 //Returns the average of the two numbers n1 and n2.
6
7 double ave(double n1, double n2, double n3);
8 //Returns the average of the three numbers n1, n2, and n3.
9
10 int main( )
11 {
12     using namespace std;
13     cout << "The average of 2.0, 2.5, and 3.0 is "
14          << ave(2.0, 2.5, 3.0) << endl;
15
16     cout << "The average of 4.5 and 5.5 is "
17          << ave(4.5, 5.5) << endl;
18
19     return 0;
20 }
21
22 double ave(double n1, double n2)
23 {
24     return ((n1 + n2)/2.0);
25 }
26
27 double ave(double n1, double n2, double n3)
28 {
29     return ((n1 + n2 + n3)/3.0);
30 }
31
32
```

two arguments

three arguments

Output

```
The average of 2.0, 2.5, and 3.0 is 2.50000
The average of 4.5 and 5.5 is 5.00000
```

The function name `ave` now has two definitions. This is an example of overloading. In this case we have overloaded the function name `ave`. In Display 4.17 we have embedded these two function definitions for `ave` into a complete sample program. Be sure to notice that each function definition has its own function declaration.

Overloading is a great idea. It makes a program easier to read, and it saves you from going crazy trying to think up a new name for a function just because you already used the most natural name in some other function definition. But how does the compiler know which function definition to use when it encounters a call to a function name that has two or more definitions? The compiler cannot read a programmer's mind. In order to tell which function definition to use, the compiler checks the number of arguments and the types of the arguments in the function call. In the program in Display 4.17, one of the functions called `ave` has two arguments and the other has three arguments. To tell which definition to use, the compiler simply counts the number of arguments in the function call. If there are two arguments, it uses the first definition. If there are three arguments, it uses the second definition.

Determining
which definition
applies

Whenever you give two or more definitions to the same function name, the various function definitions must have different specifications for their arguments; that is, any two function definitions that have the same function name must use different numbers of formal parameters or use formal parameters of different types (or both). Notice that when you overload a function name, the function declarations for the two different definitions must differ in their formal parameters. *You cannot overload a function name by giving two definitions that differ only in the type of the value returned.*

Overloading a Function Name

If you have two or more function definitions for the same function name, that is called **overloading**. When you overload a function name, the function definitions must have different numbers of formal parameters or some formal parameters of different types. When there is a function call, the compiler uses the function definition whose number of formal parameters and types of formal parameters match the arguments in the function call.

Overloading is not really new to you. You saw a kind of overloading in Chapter 2 with the division operator `/`. If both operands are of type `int`, as in `13/2`, then the value returned is the result of integer division, in this case 6. On the other hand, if one or both operands are of type `double`, then the value returned is the result of regular division; for example, `13/2.0` returned the value 6.5. There are two definitions for the division operator `/`, and the two

definitions are distinguished not by having different numbers of operands, but rather by requiring operands of different types. The difference between overloading of / and overloading function names is that the compiler has already done the overloading of / but you program the overloading of the function name. We will see in a later chapter how to overload operators such as +, -, and so on.

PROGRAMMING EXAMPLE

Revised Pizza-Buying Program

The Pizza Consumers Union has been very successful with the program that we wrote for it in Display 4.10. In fact, now everybody always buys the pizza that is the best buy. One disreputable pizza parlor used to make money by fooling consumers into buying the more expensive pizza, but our program has put an end to their evil practices. However, the owners wish to continue their despicable behavior and have come up with a new way to fool consumers. They now offer both round pizzas and rectangular pizzas. They know that the program we wrote cannot deal with rectangularly shaped pizzas, so they hope they can again confuse consumers. We need to update our program so that we can foil their nefarious scheme. We want to change the program so that it can compare a round pizza and a rectangular pizza.

The changes we need to make to our pizza evaluation program are clear: We need to change the input and output a bit so that it deals with two different shapes of pizzas. We also need to add a new function that can compute the cost per square inch of a rectangular pizza. We could use the following function definition in our program so that we can compute the unit price for a rectangular pizza:

```
double unitprice_rectangular
    (int length, int width, double price)
{
    double area = length * width;
    return (price/area);
}
```

However, this is a rather long name for a function; in fact, it's so long that we needed to put the function heading on two lines. That is legal, but it would be nicer to use the same name, `unitprice`, for both the function that computes the unit price for a round pizza and for the function that computes the unit price for a rectangular pizza. Since C++ allows overloading of function names, we can do this. Having two definitions for the function `unitprice` will pose no problems to the compiler because the two functions will have different numbers of arguments. Display 4.18 shows the program we obtained when we modified our pizza evaluation program to allow us to compare round pizzas with rectangular pizzas.

DISPLAY 4.18 Overloading a Function Name (part 1 of 2)

```
1 //Determines whether a round pizza or a rectangular pizza is the best buy.
2 #include <iostream>
3
4 double unitprice(int diameter, double price);
5 //Returns the price per square inch of a round pizza.
6 //The formal parameter named diameter is the diameter of the pizza
7 //in inches. The formal parameter named price is the price of the pizza.
8
9 double unitprice(int length, int width, double price);
10 //Returns the price per square inch of a rectangular pizza
11 //with dimensions length by width inches.
12 //The formal parameter price is the price of the pizza.
13
14 int main( )
15 {
16     using namespace std;
17     int diameter, length, width;
18     double price_round, unit_price_round,
19     price_rectangular, unitprice_rectangular;
20
21     cout << "Welcome to the Pizza Consumers Union.\n";
22     cout << "Enter the diameter in inches"
23         << " of a round pizza: ";
24     cin >> diameter;
25     cout << "Enter the price of a round pizza: $";
26     cin >> price_round;
27     cout << "Enter length and width in inches\n"
28         << "of a rectangular pizza: ";
29     cin >> length >> width;
30     cout << "Enter the price of a rectangular pizza: $";
31     cin >> price_rectangular;
32
33     unitprice_rectangular =
34         unitprice(length, width, price_rectangular);
35     unit_price_round = unitprice(diameter, price_round);
36
37     cout.setf(ios::fixed);
38     cout.setf(ios::showpoint);
39     cout.precision(2);
40     cout << endl
41         << "Round pizza: Diameter = "
42         << diameter << " inches\n"
43         << "Price = $" << price_round
44         << " Per square inch = $" << unit_price_round
45         << endl
46         << "Rectangular pizza: Length = "
47         << length << " inches\n"
```

(continued)

DISPLAY 4.18 Overloading a Function Name (*part 2 of 2*)

```

48         << "Rectangular pizza: Width = "
49         << width << " inches\n"
50         << "Price = $" << price_rectangular
51         << " Per square inch = $" << unitprice_rectangular
52         << endl;
53
54         if (unit_price_round < unitprice_rectangular)
55             cout << "The round one is the better buy.\n";
56         else
57             cout << "The rectangular one is the better buy.\n";
58
59         cout << "Buon Appetito!\n";
60         return 0;
61     }
62
63     double unitprice(int diameter, double price)
64     {
65         const double PI = 3.14159;
66         double radius, area;
67
68         radius = diameter/static_cast<double>(2);
69         area = PI * radius * radius;
70         return (price/area);
71     }
72
73     double unitprice(int length, int width, double price)
74     {
75         double area = length * width;
76         return (price/area);
77     }

```

Sample Dialogue

```

Welcome to the Pizza Consumers Union.
Enter the diameter in inches of a round pizza: 10
Enter the price of a round pizza: $8.50
Enter length and width in inches of a rectangular pizza: 6 4
Enter the price of a rectangular pizza: $7.55

Round pizza: Diameter = 10 inches
Price = $8.50 Per square inch = $0.11
Rectangular pizza: Length = 6 inches
Rectangular pizza: Width = 4 inches
Price = $7.55 Per square inch = $0.31
The round one is the better buy.
Buon Appetito!

```

Automatic Type Conversion

Suppose that the following function definition occurs in your program and that you have *not* overloaded the function name `mpg` (so this is the only definition of a function called `mpg`).

```
double mpg(double miles, double gallons)
//Returns miles per gallon.
{
    return (miles/gallons);
}
```

If you call the function `mpg` with arguments of type `int`, then C++ will automatically convert any argument of type `int` to a value of type `double`. Hence, the following will output 22.5 miles per gallon to the screen:

```
cout << mpg(45, 2) << " miles per gallon";
```

C++ converts the 45 to 45.0 and the 2 to 2.0, then performs the division 45.0/2.0 to obtain the value returned, which is 22.5.

Interaction of
overloading and
type conversion

If a function requires an argument of type `double` and you give it an argument of type `int`, C++ will automatically convert the `int` argument to a value of type `double`. This is so useful and natural that we hardly give it a thought. However, overloading can interfere with this automatic type conversion. Let's look at an example.

Now, suppose you had (foolishly) overloaded the function name `mpg` so that your program also contained the following definition of `mpg` (as well as the previous one):

```
int mpg(int goals, int misses)
//Returns the Measure of Perfect Goals
//which is computed as (goals - misses).
{
    return (goals - misses);
}
```

In a program that contains both of these definitions for the function name `mpg`, the following will (unfortunately) output 43 miles per gallon (since 43 is 45 - 2):

```
cout << mpg(45, 2) << " miles per gallon";
```

When C++ sees the function call `mpg(45, 2)`, which has two arguments of type `int`, C++ *first* looks for a function definition of `mpg` that has two formal parameters of type `int`. If it finds such a function definition, C++ uses that function definition. C++ does not convert an `int` argument to a value of type `double` unless that is the only way it can find a matching function definition.

The `mpg` example illustrates one more point about overloading. You should not use the same function name for two unrelated functions. Such careless use of function names is certain to eventually produce confusion.

SELF-TEST EXERCISES

24. Suppose you have two function definitions with the following function declarations:

```
double score(double time, double distance);
int score(double points);
```

Which function definition would be used in the following function call and why would it be the one used? (*x* is of type *double*.)

```
final_score = score(x);
```

25. Suppose you have two function definitions with the following function declarations:

```
double the_answer(double data1, double data2);
double the_answer(double time, int count);
```

Which function definition would be used in the following function call and why would it be the one used? (*x* and *y* are of type *double*.)

```
x = the_answer(y, 6.0);
```

26. Suppose you have two function definitions with the function declarations given in Self-Test Exercise 25. Which function definition would be used in the following function call and why would it be the one used?

```
x = the_answer(5, 6);
```

27. Suppose you have two function definitions with the function declarations given in Self-Test Exercise 25. Which function definition would be used in the following function call and why would it be the one used?

```
x = the_answer(5, 6.0);
```

28. This question has to do with the Programming Example “Revised Pizza-Buying Program.” Suppose the evil pizza parlor that is always trying to fool customers introduces a square pizza. Can you overload the function `unitprice` so that it can compute the price per square inch of a square pizza as well as the price per square inch of a round pizza? Why or why not?

29. Look at the program in Display 4.18. The `main` function contains the `using` directive:

```
using namespace std;
```

Why doesn't the method `unitprice` contain this `using` directive?

CHAPTER SUMMARY

- A good plan of attack for designing the algorithm for a program is to break down the task to be accomplished into a few subtasks, then decompose each subtask into smaller subtasks, and so forth until the subtasks are simple enough that they can easily be implemented as C++ code. This approach is called **top-down design**.
- A function that returns a value is like a small program. The arguments to the function serve as the input to this “small program” and the value returned is like the output of the “small program.”
- When a subtask for a program takes some values as input and produces a single value as its only result, then that subtask can be implemented as a function.
- A function should be defined so that it can be used as a black box. The programmer who uses the function should not need to know any details about how the function is coded. All the programmer should need to know is the function declaration and the accompanying comment that describes the value returned. This rule is sometimes called the **principle of procedural abstraction**.
- A variable that is declared in a function definition is said to be **local to the function**.
- Global named constants are declared using the *const* modifier. Declarations for global named constants are normally placed at the start of a program after the *include* directives and before the function declarations.
- Call-by-value formal parameters (which are the only kind of formal parameter discussed in this chapter) are variables that are local to the function. Occasionally, it is useful to use a formal parameter as a local variable.
- When you have two or more function definitions for the same function name, that is called **overloading** the function name. When you overload a function name, the function definitions must have different numbers of formal parameters or some formal parameters of different types.

Answers to Self-Test Exercises

- | | | | |
|----|-----|-----|------|
| 1. | 4.0 | 4.0 | 8.0 |
| | 8.0 | 8.0 | 1.21 |
| | 3 | 3 | 0 |
| | 3.0 | 3.5 | 3.5 |
| | 6.0 | 6.0 | 5.0 |
| | 5.0 | 4.5 | 4.5 |
| | 3 | 3.0 | 3.0 |

2. `sqrt(x + y)`
`pow(x, y + 7)`
`sqrt(area + fudge)`
`sqrt(time + tide)/nobody`
`(-b + sqrt(b * b - 4 * a * c))/(2 * a)`
`abs(x - y)` or `labs(x - y)` or `fabs(x - y)`
3. *//Computes the square root of 3.14159.*
`#include <iostream>`
`#include <cmath>//provides sqrt and PI.`
`using namespace std;`
`int main()`
`{`
`cout << "The square root of " << PI`
`<< sqrt(PI) << endl;`
`return 0;`
`}`
4. a. *//To determine whether the compiler will tolerate*
//spaces before the # in the #include:
`#include <iostream>`
`using namespace std;`
`int main()`
`{`
`cout << "hello world" << endl;`
`return 0;`
`}`
- b. *//To determine if the compiler will allow spaces*
//between the # and include in the #include:
`# include<iostream>`
`using namespace std;`
//The rest of the program can be identical to the above.
5. Wow
6. The function declaration is:

```
int sum(int n1, int n2, int n3);  

//Returns the sum of n1, n2, and n3.
```

The function definition is:

```
int sum(int n1, int n2, int n3)  

{  

    return (n1 + n2 + n3);  

}
```

7. The function declaration is:

```
double ave(int n1, double n2);
//Returns the average of n1 and n2.
```

The function definition is:

```
double ave(int n1, double n2)
{
    return ((n1 + n2)/2.0);
}
```

8. The function declaration is:

```
char positive_test(double number);
//Returns 'P' if number is positive.
//Returns 'N' if number is negative or zero.
```

The function definition is:

```
char positive_test(double number)
{
    if (number > 0)
        return 'P';
    else
        return 'N';
}
```

9. Suppose the function is defined with arguments, say param1 and param2. The function is then called with corresponding arguments arg1 and arg2. The values of the arguments are “plugged in” for the corresponding formal parameters, arg1 into param1, arg2 into param2. The formal parameters are then used in the function.

10. Predefined (library) functions usually require that you #include a header file. For a programmer-defined function, the programmer puts the code for the function either into the file with the main part of the program or in another file to be compiled and linked to the main program.

11. `bool in_order(int n1, int n2, int n3)`
- ```
{
 return ((n1 <= n2) && (n2 <= n3));
}
```

12. `bool even(int n)`
- ```
{
    return ((n % 2) == 0);
}
```

13. `bool` is `digit(char ch)`

```
{  
    return ('0' <= ch) && (ch <= '9');  
}
```
14. `bool` is `is_root_of(int root_candidate, int number)`

```
{  
    return (number == root_candidate * root_candidate);  
}
```
15. The comment explains what value the function returns and gives any other information that you need to know in order to use the function.
16. The principle of procedural abstraction says that a function should be written so that it can be used like a black box. This means that the programmer who uses the function need not look at the body of the function definition to see how the function works. The function declaration and accompanying comment should be all the programmer needs to know in order to use the function.
17. When we say that the programmer who uses a function should be able to treat the function like a black box, we mean the programmer should not need to look at the body of the function definition to see how the function works. The function declaration and accompanying comment should be all the programmer needs to know in order to use the function.
18. In order to increase your confidence in your program, you should test it on input values for which you know the correct answers. Perhaps you can calculate the answers by some other means, such as pencil and paper or hand calculator.
19. Yes, the function would return the same value in either case, so the two definitions are black-box equivalent.
20. If you use a variable in a function definition, you should declare the variable in the body of the function definition.
21. Everything will be fine. The program will compile (assuming everything else is correct). The program will run (assuming that everything else is correct). The program will not generate an error message when run (assuming everything else is correct). The program will give the correct output (assuming everything else is correct).
22. The function will work fine. That is the entire answer, but here is some additional information: The formal parameter `inches` is a call-by-value parameter and, as discussed in the text, it is therefore a local variable. Thus, the value of the argument will not be changed.

23. The function declaration is:

```
double read_filter();
//Reads a number from the keyboard. Returns the number
//read provided it is >= 0; otherwise returns zero.
```

The function definition is:

```
//uses iostream
double read_filter()
{
    using namespace std;
    double value_read;
    cout << "Enter a number:\n";
    cin >> value_read;

    if (value_read >= 0)
        return value_read;
    else
        return 0.0;
}
```

24. The function call has only one argument, so it would use the function definition that has only one formal parameter.
25. The function call has two arguments of type *double*, so it would use the function corresponding to the function declaration with two arguments of type *double* (that is, the first function declaration).
26. The second argument is of type *int* and the first argument would be automatically converted to type *double* by C++ if needed, so it would use the function corresponding to the function declaration with the first argument of type *double* and the second argument of type *int* (that is, the second function declaration).
27. The second argument is of type *double* and the first argument would be automatically converted to type *double* by C++ if needed, so it would use the function corresponding to the function declaration with two arguments of type *double* (that is, the first function declaration).
28. This cannot be done (at least not in any nice way). The natural ways to represent a square and a round pizza are the same. Each is naturally represented as one number, which is the diameter for a round pizza and the length of a side for a square pizza. In either case the function `unitprice` would need to have one formal parameter of type *double* for the price and one formal parameter of type *int* for the size (either radius or side). Thus, the two function declarations would have the same number and types of formal parameters. (Specifically, they would both have one formal

parameter of type *double* and one formal parameter of type *int*.) Thus, the compiler would not be able to decide which definition to use. You can still defeat this evil pizza parlor's strategy by defining two functions, but they will need to have different names.

29. The definition of `unitprice` does not do any input or output and so does not use the library `iostream`. In `main` we needed the `using` directive because `cin` and `cout` are defined in `iostream` and those definitions place `cin` and `cout` in the `std` namespace.

PRACTICE PROGRAMS

Practice Programs can generally be solved with a short program that directly applies the programming principles presented in this chapter.

1. A liter is 0.264179 gallons. Write a program that will read in the number of liters of gasoline consumed by the user's car and the number of miles traveled by the car and will then output the number of miles per gallon the car delivered. Your program should allow the user to repeat this calculation as often as the user wishes. Define a function to compute the number of miles per gallon. Your program should use a globally defined constant for the number of liters per gallon.
2. Modify your program from Practice Program 1 so that it will take input data for two cars and output the number of miles per gallon delivered by each car. Your program will also announce which car has the best fuel efficiency (highest number of miles per gallon).
3. The price of stocks is sometimes given to the nearest eighth of a dollar; for example, $297/8$ or $891/2$. Write a program that computes the value of the user's holding of one stock. The program asks for the number of shares of stock owned, the whole-dollar portion of the price, and the fraction portion. The fraction portion is to be input as two *int* values, one for the numerator and one for the denominator. The program then outputs the value of the user's holdings. Your program should allow the user to repeat this calculation as often as the user wishes and will include a function definition that has three *int* arguments consisting of the whole-dollar portion of the price and the two integers that make up the fraction part. The function returns the price of one share of stock as a single number of type *double*.
4. Write a program to gauge the rate of inflation for the past year. The program asks for the price of an item (such as a hot dog or a 1-carat diamond) both one year ago and today. It estimates the inflation rate as the difference in price divided by the year-ago price. Your program should allow the user to repeat this calculation as often as the user wishes. Define a function to compute the rate of inflation. The inflation rate should be a value of type *double* giving the rate as a percent, for example 5.3 for 5.3 percent.

5. Enhance your program from the previous Practice Program by having it also print out the estimated price of the item in one and in two years from the time of the calculation. The increase in cost over one year is estimated as the inflation rate times the price at the start of the year. Define a second function to determine the estimated cost of an item in one year, given the current price of the item and the inflation rate as arguments.
6. Write a function declaration for a function that computes interest on a credit card account balance. The function takes arguments for the initial balance, the monthly interest rate, and the number of months for which interest must be paid. The value returned is the interest due. Do not forget to compound the interest—that is, to charge interest on the interest due. The interest due is added into the balance due, and the interest for the next month is computed using this larger balance. Use a *while* loop that is similar to (but need not be identical to) the one shown in Display 2.14. Embed the function in a program that reads the values for the interest rate, initial account balance, and number of months, then outputs the interest due. Embed your function definition in a program that lets the user compute interest due on a credit account balance. The program should allow the user to repeat the calculation until the user says he or she wants to end the program.
7. The gravitational attractive force between two bodies with masses m_1 and m_2 separated by a distance d is given by:

$$F = \frac{Gm_1m_2}{d^2}$$

where G is the universal gravitational constant:

$$G = 6.673 \times 10^{-8} \left(\frac{cm^3}{g \times sec^2} \right)$$

Write a function definition that takes arguments for the masses of two bodies and the distance between them and that returns the gravitational force. Since you will use the preceding formula, the gravitational force will be in dynes. One dyne equals

$$\left(\frac{g \times cm}{sec^2} \right)$$

You should use a globally defined constant for the universal gravitational constant. Embed your function definition in a complete program that computes the gravitational force between two objects given suitable inputs. Your program should allow the user to repeat this calculation as often as the user wishes.

8. That we are “blessed” with several absolute value functions is an accident of history. C libraries were already available when C++ arrived; they could be easily used, so they were not rewritten using function overloading. You are to find all the absolute value functions you can and rewrite all of them



VideoNote
Solution to Practice
Program 4.7

overloading the `abs` function name. At a minimum, you should have the `int`, `long`, `float`, and `double` types represented.

9. Write an overloaded function `max` that takes either two or three parameters of type `double` and returns the largest of them.

PROGRAMMING PROJECTS

Programming Projects require more problem-solving than Practice Programs and can usually be solved many different ways. Visit www.myprogramminglab.com to complete many of these Programming Projects online and get instant feedback.

1. Write a program that computes the annual after-tax cost of a new house for the first year of ownership. The cost is computed as the annual mortgage cost minus the tax savings. The input should be the price of the house and the down payment. The annual mortgage cost can be estimated as 3 percent of the initial loan balance credited toward paying off the loan principal plus 6 percent of the initial loan balance in interest. The initial loan balance is the price minus the down payment. Assume a 35 percent marginal tax rate and assume that interest payments are tax deductible. So, the tax savings is 35 percent of the interest payment. Your program should use at least two function definitions and should allow the user to repeat this calculation as often as the user wishes.
2. Write a program that asks for the user's height, weight, and age, and then computes clothing sizes according to the formulas:
 - Hat size = weight in pounds divided by height in inches and all that multiplied by 2.9.
 - Jacket size (chest in inches) = height times weight divided by 288 and then adjusted by adding 1/8 of an inch for each 10 years over age 30. (Note that the adjustment only takes place after a full 10 years. So, there is no adjustment for ages 30 through 39, but 1/8 of an inch is added for age 40.)
 - Waist in inches = weight divided by 5.7 and then adjusted by adding 1/10 of an inch for each 2 years over age 28. (Note that the adjustment only takes place after a full 2 years. So, there is no adjustment for age 29, but 1/10 of an inch is added for age 30.)

Use functions for each calculation. Your program should allow the user to repeat this calculation as often as the user wishes.

3. Modify your program from Programming Project 2 so that it also calculates the user's jacket and waist sizes after 10 years.
4. Write a program that outputs the lyrics for the song "Ninety-Nine Bottles of Beer on the Wall." Your program should print the number of bottles in English, not as a number. For example:

Ninety-nine bottles of beer on the wall,
 Ninety-nine bottles of beer,
 Take one down, pass it around,
 Ninety-eight bottles of beer on the wall.
 ...
 One bottle of beer on the wall,
 One bottle of beer,
 Take one down, pass it around,
 Zero bottles of beer on the wall.

Design your program with a function that takes as an argument an integer between 0 and 99 and returns a string that contains the integer value in English. Your function should not have 100 different *if-else* statements! Instead, use % and / to extract the tens and ones digits to construct the English string. You may need to test specifically for values such as 0, 10–19, etc.

5. To maintain one's body weight, an adult human needs to consume enough calories daily to (1) meet the basal metabolic rate (energy required to breathe, maintain body temperature, etc.), (2) account for physical activity such as exercise, and (3) account for the energy required to digest the food that is being eaten. For an adult that weighs P pounds, we can estimate these caloric requirements using the following formulas:

A. Basal metabolic rate: $\text{Calories required} = 70 * (P / 2.2)^{0.756}$

B. Physical activity: $\text{Calories required} = 0.0385 * \text{Intensity} * P * \text{Minutes}$

Here, *Minutes* is the number of minutes spent during the physical activity, and *Intensity* is a number that estimates the intensity of the activity. Here are some sample numbers for the range of values:

Activity	Intensity
Running 10 mph:	17
Running 6 mph:	10
Basketball:	8
Walking 1 mph:	1

C. Energy to digest food: $\text{calories required} = \text{TotalCaloriesConsumed} * 0.1$

In other words, 10 percent of the calories we consume goes towards digestion.

Write a function that computes the calories required for the basal metabolic rate, taking as input a parameter for the person's weight. Write another function that computes the calories required for physical activity, taking as input parameters for the intensity, weight, and minutes spent exercising.

Use these functions in a program that inputs a person's weight, an estimate for the intensity of physical activity, the number of minutes spent performing the physical activity, and the number of calories in one serving of your favorite food. The program should then calculate and output how many servings of that food should be eaten per day to maintain the person's current weight at the specified activity level. The computation should include the energy that is required to digest food.

You can find estimates of the caloric content of many foods on the Web. For example, a double cheeseburger has approximately 1000 calories.

6. You have invented a vending machine capable of deep frying twinkies. Write a program to simulate the vending machine. It costs \$3.50 to buy a deep-fried twinkie, and the machine only takes coins in denominations of a dollar, quarter, dime, or nickel. Write code to simulate a person putting money into the vending machine by repeatedly prompting the user for the next coin to be inserted. Output the total entered so far when each coin is inserted. When \$3.50 or more is added, the program should output "Enjoy your deep-fried twinkie" along with any change that should be returned. Use top-down design to determine appropriate functions for the program.
7. Your time machine is capable of going forward in time up to 24 hours. The machine is configured to jump ahead in minutes. To enter the proper number of minutes into your machine, you would like a program that can take a start time (in hours, minutes, and a Boolean indicating AM or PM) and a future time (in hours, minutes, and a Boolean indicating AM or PM) and calculate the difference in minutes between the start and future time.

A time is specified in your program with three variables:

```
int hours, minutes;  
bool isAM;
```

For example, to represent 11:50 PM, you would store:

```
hours = 11  
minutes = 50  
isAM = false;
```

This means that you need six variables to store a start and future time.

Write a program that allows the user to enter a start time and a future time. Include a function named `computeDifference` that takes the six variables as parameters that represent the start time and future time. Your function should return, as an `int`, the time difference in minutes. For example, given a start time of 11:59 AM and a future time of 12:01 PM, your program should compute 2 minutes as the time difference. Given a start time of 11:59 AM and a future time of 11:58 AM, your program should compute 1439 minutes as the time difference (23 hours and 59 minutes).

You may need “AM” or “PM” from the user’s input by reading in two character values. (Display 2.3 illustrates character input.) Characters can be compared just like numbers. For example, if the variable `a_char` is of type `char`, then `(a_char == 'A')` is a Boolean expression that evaluates to true if `a_char` contains the letter A.



VideoNote
Solution to Programming
Project 4.8

8. Do Programming Project 11 from Chapter 3 except write a function named `containsDigit` that determines if a number contains a particular digit. The header should look like:

```
bool containsDigit(int number, int digit);
```

If `number` contains `digit`, then the function should return `true`. Otherwise, the function should return `false`. Your program should use this function to find the closest numbers that can be entered on the keypad.

9. Your sports league uses the following lottery system to select draft picks for the four worst teams in the league:

- The last place team gets 20 balls in an urn.
- The second-to-last place team gets 10 balls in the urn.
- The third-to-last place team gets 6 balls in the urn
- The fourth-to-last place team gets 4 balls in the urn.

To determine the first pick in the draft a ball is selected at random. The team owning that ball gets the first pick. The ball is then put back in the urn.

To determine the second pick in the draft a ball is selected at random. If the ball belongs to the team that got the first pick then it is put back in and the process repeats until a ball is selected that does not belong to the first pick.

To determine subsequent picks in the draft the process repeats until a ball is selected that belongs to a team that has not already been chosen.

Write a function that takes as input which of the four teams have already been granted picks, simulates selecting a ball from the urn according to the lottery rules, and returns the team that belongs to the selected ball. You get to choose how to design your function to perform these actions. Write a `main` function that outputs the draft order (e.g., a possible order is: second-to-last picks 1, last place picks 2, third-to-last picks 3, and fourth-to-last picks 4). If you change the random seed then the order should differ if you run the program multiple times.

For a slightly harder version of the problem, allow the user to input the names of the four teams. The program should then output the team names in the draft order.

Functions for All Subtasks 5

5.1 *void* FUNCTIONS 252

Definitions of *void* Functions 252

Programming Example: Converting Temperatures 255

return Statements in *void* Functions 255

5.2 CALL-BY-REFERENCE PARAMETERS 259

A First View of Call-by-Reference 259

Call-by-Reference in Detail 262

Programming Example: The `swap_values` Function 267

Mixed Parameter Lists 268

Programming Tip: What Kind of Parameter to Use 269

Pitfall: Inadvertent Local Variables 270

5.3 USING PROCEDURAL ABSTRACTION 273

Functions Calling Functions 273

Preconditions and Postconditions 275

Case Study: Supermarket Pricing 276

5.4 TESTING AND DEBUGGING FUNCTIONS 281

Stubs and Drivers 282

5.5 GENERAL DEBUGGING TECHNIQUES 287

Keep an Open Mind 287

Check Common Errors 287

Localize the Error 288

The `assert` Macro 290



Everything is possible.

COMMON MAXIM

INTRODUCTION

The top-down design strategy discussed in Chapter 4 is an effective way to design an algorithm for a program. You divide the program's task into subtasks and then implement the algorithms for these subtasks as functions. Thus far, we have seen how to define functions that start with the values of some arguments and return a single value as the result of the function call. A subtask that computes a single value is a very important kind of subtask, but it is not the only kind. In this chapter we will complete our description of C++ functions and present techniques for designing functions that perform other kinds of subtasks.

PREREQUISITES

You should read Chapters 2 through 4 before reading this chapter.

5.1 *void* FUNCTIONS

void functions
return no value

Subtasks are implemented as functions in C++. The functions discussed in Chapter 4 always return a single value, but there are other forms of subtasks. A subtask might produce several values or it might produce no values at all. In C++, a function must either return a single value or return no values at all. As we will see later in this chapter, a subtask that produces several different values is usually (and perhaps paradoxically) implemented as a function that returns no value. For the moment, however, let us avoid that complication and focus on subtasks that intuitively produce no values at all, and let us see how these subtasks are implemented. A function that returns no value is called a *void* function. For example, one typical subtask for a program is to output the results of some calculation. This subtask produces output on the screen, but it produces no values for the rest of the program to use. This kind of subtask would be implemented as a *void* function.

Definitions of *void* Functions

In C++ a *void* function is defined in almost the same way as a function that returns a value. For example, the following is a *void* function that outputs the result of a calculation that converts a temperature expressed in Fahrenheit

degrees to a temperature expressed in Celsius degrees. The actual calculation would be done elsewhere in the program. This *void* function implements only the subtask for outputting the results of the calculation. For now, we do not need to worry about how the calculation will be performed.

```
void show_results(double f_degrees, double c_degrees)
{
    using namespace std;
    cout.setf(ios::fixed);
    cout.setf(ios::showpoint);
    cout.precision(1);
    cout << f_degrees
         << " degrees Fahrenheit is equivalent to\n"
         << c_degrees << " degrees Celsius.\n";
    return;
}
```

As this function definition illustrates, there are only two differences between a function definition for a *void* function and the function definitions we discussed in Chapter 4. One difference is that we use the keyword *void* where we would normally specify the type of the value to be returned. This tells the compiler that this function will not return any value. The name *void* is used as a way of saying “no value is returned by this function.” The second difference is that the *return* statement does not contain an expression for a value to be returned, because, after all, there is no value returned. The syntax is summarized in Display 5.1.

Function
definition

A *void* function call is an executable statement. For example, our function `show_results` might be called as follows:

Function call

```
show_results(32.5, 0.3);
```

If this statement were executed in a program, it would cause the following to appear on the screen:

```
32.5 degrees Fahrenheit is equivalent to
0.3 degrees Celsius.
```

Notice that the function call ends with a semicolon, which tells the compiler that the function call is an executable statement.

When a *void* function is called, the arguments are substituted for the formal parameters and the statements in the function body are executed. For example, a call to the *void* function `show_results`, which we gave earlier in this section, will cause some output to be written to the screen. One way to think of a call to a *void* function is to imagine that the body of the function definition is copied into the program in place of the function call. When the function is called, the arguments are substituted for the formal parameters, and then it is just as if the body of the function were lines in the program.

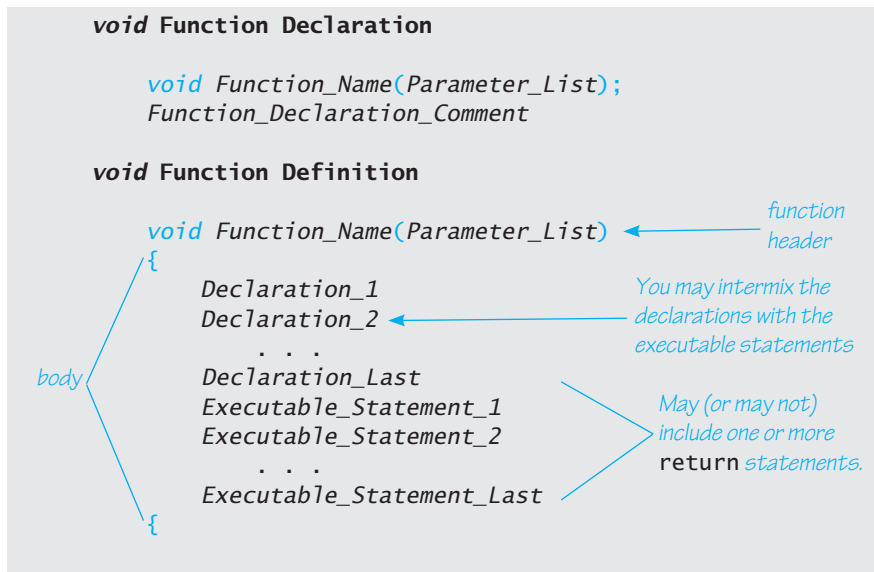
DISPLAY 5.1 Syntax for a *void* Function Definition**Functions with no arguments**

It is perfectly legal, and sometimes useful, to have a function with no arguments. In that case, there simply are no formal parameters listed in the function declaration and no arguments are used when the function is called. For example, the *void* function `initialize_screen`, defined next, simply sends a new line command to the screen:

```
void initialize_screen()
{
    using namespace std;
    cout << endl;
    return;
}
```

If your program includes the following call to this function as its first executable statement, then the output from the previously run program will be separated from the output for your program:

```
initialize_screen();
```

Be sure to notice that even when there are no parameters to a function, you still must include the parentheses in the function declaration and in a call to the function. The next programming example shows these two sample *void* functions in a complete program.

PROGRAMMING EXAMPLE

Converting Temperatures

The program in Display 5.2 takes a Fahrenheit temperature as input and outputs the equivalent Celsius temperature. A Fahrenheit temperature *F* can be converted to an equivalent Celsius temperature *C* as follows:

$$C = (5/9)(F - 32)$$

The function `celsius` shown in Display 5.2 uses this formula to do the temperature conversion.

return Statements in *void* Functions

Both *void* functions and functions that return a value can have *return* statements. In the case of a function that returns a value, the *return* statement specifies the value returned. In the case of a *void* function, the *return* statement simply ends the function call. As we saw in the previous chapter, every function that returns a value must end by executing a *return* statement. However, a *void* function need not contain a *return* statement. If it does not contain a *return* statement, it will end after executing the code in the function body. It is as if there were an implicit *return* statement just before the final closing brace `}` at the end of the function body. For example, the functions `initialize_screen` and `show_results` in Display 5.2 would perform exactly the same if we omitted the *return* statements from their function definitions.

void functions and *return* statements

The fact that there is an implicit *return* statement before the final closing brace in a function body does not mean that you never need a *return* statement in a *void* function. For example, the function definition in Display 5.3 might be used as part of a restaurant management program. That function outputs instructions for dividing a given amount of ice cream among the people at a table. If there are no people at the table (that is, if `number` equals 0), then the *return* statement within the *if* statement terminates the function call and avoids a division by zero. If `number` is not 0, then the function call ends when the last `cout` statement is executed at the end of the function body.

By now you may have guessed that the `main` part of a program is actually the definition of a function called `main`. When the program is run, the function `main` is automatically called and it, in turn, may call other functions. Although it may seem that the *return* statement in the `main` part of a program should be optional, officially it is not. Technically, the `main` part of a program is a function that returns a value of type `int`, so it requires a *return* statement. However, the function `main` is used as if it were a *void* function. Treating the `main` part of your program as a function that returns an integer may sound

The `main` part of a program is a function

DISPLAY 5.2 *void Functions (part 1 of 2)*

```

1 //Program to convert a Fahrenheit temperature to a Celsius temperature.
2 #include <iostream>
3
4 void initialize_screen( );
5 //Separates current output from
6 //the output of the previously run program.
7
8 double celsius(double fahrenheit);
9 //Converts a Fahrenheit temperature
10 //to a Celsius temperature.
11
12 void show_results(double f_degrees, double c_degrees);
13 //Displays output. Assumes that c_degrees
14 //Celsius is equivalent to f_degrees Fahrenheit.
15
16 int main( )
17 {
18     using namespace std;
19     double f_temperature, c_temperature;
20
21     initialize_screen( );
22     cout << "I will convert a Fahrenheit temperature"
23          << " to Celsius.\n"
24          << "Enter a temperature in Fahrenheit: ";
25     cin >> f_temperature;
26
27     c_temperature = celsius(f_temperature);
28
29     show_results(f_temperature, c_temperature);
30     return 0;
31 }
32
33 //Definition uses iostream:
34 void initialize_screen( )
35 {
36     using namespace std;
37     cout << endl;
38     return; ← This return is optional.
39 }
40 double celsius(double fahrenheit)
41 {
42     return ((5.0/9.0)*(fahrenheit - 32));
43 }
44 //Definition uses iostream:
45 void show_results(double f_degrees, double c_degrees)
46 {

```

(continued)

DISPLAY 5.2 void Functions (part 2 of 2)

```

47     using namespace std;
48     cout.setf(ios::fixed);
49     cout.setf(ios::showpoint);
50     cout.precision(1);
51     cout << f_degrees
52         << " degrees Fahrenheit is equivalent to\n"
53         << c_degrees << " degrees Celsius.\n";
54     return; ← This return is optional.
55 }

```

Sample Dialogue

```

I will convert a Fahrenheit temperature to Celsius.
Enter a temperature in Fahrenheit: 32.5
32.5 degrees Fahrenheit is equivalent to
0.3 degrees Celsius.

```

DISPLAY 5.3 Use of return in a void Function**Function Declaration**

```

1     void ice_cream_division(int number, double total_weight);
2     //Outputs instructions for dividing total_weight ounces of
3     //ice cream among number customers.
4     //If number is 0, nothing is done.

```

Function Definition

```

1     //Definition uses iostream:
2     void ice_cream_division(int number, double total_weight)
3     {
4         using namespace std;
5         double portion;
6
7         if (number == 0)
8             return; ← If number is 0, then the
9                             function execution ends here.
10        portion = total_weight/number;
11        cout.setf(ios::fixed);
12        cout.setf(ios::showpoint);
13        cout.precision(2);
14        cout << "Each one receives "
15            << portion << " ounces of ice cream." << endl;

```

crazy, but that's the tradition. It might be best to continue to think of the main part of the program as just "the main part of the program" and not worry about this minor detail.¹

SELF-TEST EXERCISES

1. What is the output of the following program?

```
#include <iostream>
void friendly();
void shy(int audience_count);
int main()
{
    using namespace std;
    friendly();
    shy(6);
    cout << "One more time:\n";
    shy(2);
    friendly();
    cout << "End of program.\n";
    return 0;
}

void friendly()
{
    using namespace std;
    cout << "Hello\n";
}

void shy(int audience_count)
{
    using namespace std;
    if (audience_count < 5)
        return;
    cout << "Goodbye\n";
}
```

2. Are you required to have a *return* statement in a *void* function definition?
3. Suppose you omitted the *return* statement in the function definition for `initialize_screen` in Display 5.2. What effect would it have on the program? Would the program compile? Would it run? Would the program behave any differently? What about the *return* statement in the function

¹ The C++ Standard says that you can omit the *return 0* in the main part, but many compilers still require it.

definition for `show_results` in that same program? What effect would it have on the program if you omitted the `return` statement in the definition of `show_results`? What about the `return` statement in the function definition for `celsius` in that same program? What effect would it have on the program if you omitted the `return` statement in the definition of `celsius`?

4. Write a definition for a `void` function that has three arguments of type `int` and that outputs to the screen the product of these three arguments. Put the definition in a complete program that reads in three numbers and then calls this function.
5. Does your compiler allow `void main()` and `int main()`? What warnings are issued if you have `int main()` and do not supply a `return 0;` statement? To find out, write several small test programs and perhaps ask your instructor or a local guru.
6. Is a call to a `void` function used as a statement or is it used as an expression?

5.2 CALL-BY-REFERENCE PARAMETERS

When a function is called, its arguments are substituted for the formal parameters in the function definition, or to state it less formally, the arguments are “plugged in” for the formal parameters. There are different mechanisms used for this substitution process. The mechanism we used in Chapter 4, and thus far in this chapter, is known as the *call-by-value* mechanism. The second main mechanism for substituting arguments is known as the *call-by-reference* mechanism.

A First View of Call-by-Reference

The call-by-value mechanism that we used until now is not sufficient for certain subtasks. For example, one common subtask is to obtain one or more input values from the user. Look back at the program in Display 5.2. Its tasks are divided into four subtasks: initialize the screen, obtain the Fahrenheit temperature, compute the corresponding Celsius temperature, and output the results. Three of these four subtasks are implemented as the functions `initialize_screen`, `celsius`, and `show_results`. However, the subtask of obtaining the input is implemented as the following four lines of code (rather than as a function call):

```
cout << "I will convert a Fahrenheit temperature"
      << " to Celsius.\n"
      << "Enter a temperature in Fahrenheit: ";
cin >> f_temperature;
```

The subtask of obtaining the input should be accomplished by a function call. To do this with a function call, we will use a call-by-reference parameter.

A function for obtaining input should set the values of one or more variables to values typed in at the keyboard, so the function call should have one or more variables as arguments and should change the values of these argument variables. With the call-by-value formal parameters that we have used until now, an argument in a function call can be a variable, but the function takes only the value of the variable and does not change the variable in any way. With a call-by-value formal parameter only the value of the argument is substituted for the formal parameter. For an input function, we want the variable (not the value of the variable) to be substituted for the formal parameter. The call-by-reference mechanism works in just this way. With a **call-by-reference** formal parameter (also called simply a **reference** parameter), the corresponding argument in a function call must be a variable and this argument variable is substituted for the formal parameter. It is as if the argument variable were literally copied into the body of the function definition in place of the formal parameter. After the argument is substituted in, the code in the function body is executed and this code can change the value of the argument variable.

A call-by-reference parameter must be marked in some way so that the compiler will know it from a call-by-value parameter. The way that you indicate a call-by-reference parameter is to attach the ampersand sign, `&`, to the end of the type name in the formal parameter list in both the function declaration and the header of the function definition. For example, the following function definition has one formal parameter, `f_variable`, and that formal parameter is a call-by-reference parameter:

```
void get_input (double& f_variable)
{
    using namespace std;
    cout << "I will convert a Fahrenheit temperature"
         << " to Celsius.\n"
         << "Enter a temperature in Fahrenheit: ";
    cin >> f_variable;
}
```

In a program that contains this function definition, the following function call sets the variable `f_temperature` equal to a value read from the keyboard:

```
get_input(f_temperature);
```

Using this function definition, we could easily rewrite the program shown in Display 5.2 so that the subtask of reading the input is accomplished by this function call. However, rather than rewrite an old program, let's look at a completely new program.

Display 5.4 demonstrates call-by-reference parameters. The program doesn't do very much. It just reads in two numbers and writes the same numbers out, but in the reverse order. The parameters in the functions `get_numbers` and `swap_values` are call-by-reference parameters. The input is performed by the function call

```
get_numbers(first_num, second_num);
```

DISPLAY 5.4 Call-by-Reference Parameters

```

1 //Program to demonstrate call-by-reference parameters.
2 #include <iostream>
3 void get_numbers(int& input1, int& input2);
4 //Reads two integers from the keyboard.
5 void swap_values(int& variable1, int& variable2);
6 //Interchanges the values of variable1 and variable2.
7 void show_results(int output1, int output2);
8 //Shows the values of variable1 and variable2, in that order.
9 int main( )
10 {
11     int first_num = 0, second_num = 0;
12
13     get_numbers(first_num, second_num);
14     swap_values(first_num, second_num);
15     show_results(first_num, second_num);
16     return 0;
17 }
18 //Uses iostream:
19 void get_numbers (int& input1, int& input2)
20 {
21     using namespace std;
22     cout << "Enter two integers: ";
23     cin >> input1
24         >> input2;
25 }
26 void swap_values(int& variable1, int& variable2)
27 {
28     int temp;
29     temp = variable1;
30     variable1 = variable2;
31     variable2 = temp;
32 }
33 //Uses iostream:
34 void show_results(int output1, int output2)
35 {
36     using namespace std;
37     cout << "In reverse order the numbers are: "
38         << output1 << " " << output2 << endl;
39 }

```

Sample Dialogue

```

Enter two integers: 5 10
In reverse order the numbers are: 10 5

```

The values of the variables `first_num` and `second_num` are set by this function call. After that, the following function call reverses the values in the two variables `first_num` and `second_num`:

```
swap_values(first_num, second_num);
```

In the next few subsections we describe the call-by-reference mechanism in more detail and also explain the particular functions used in Display 5.4.

Call-by-Reference in Detail

In most situations, the call-by-reference mechanism works as if the name of the variable given as the function argument were literally substituted for the call-by-reference formal parameter. However, the process is a bit more subtle than that. In some situations, this subtlety is important, so we need to examine more details of this call-by-reference substitution process.

Recall that program variables are implemented as memory locations. The compiler assigns one memory location to each variable. For example, when the program in Display 5.4 is compiled, the variable `first_num` might be assigned location 1010, and the variable `second_num` might be assigned 1012. For purposes of this example, consider these variables to be stored at these memory locations. In other words, after executing the line

```
int first_num = 0, second_num = 0;
```

the value 0 will be stored at memory locations 1010 and 1012. The arrows in the diagram below point to the memory locations referenced by the variables.

Memory Location	Value	
...		
1008		
1010	0	← <i>first_num</i>
1012	0	← <i>second_num</i>
1014		
...		

Next, consider the following function declaration from Display 5.4:

```
void get_numbers(int& input1, int& input2);
```

The call-by-reference formal parameters `input1` and `input2` are place holders for the actual arguments used in a function call.

Call-by-Reference

To make a formal parameter a **call-by-reference** parameter, append the **ampersand sign &** to its type name. The corresponding argument in a call to the function should then be a variable, not a constant or other expression. When the function is called, the corresponding variable argument (not its value) will be substituted for the formal parameter. Any change made to the formal parameter in the function body will be made to the argument variable when the function is called. The exact details of the substitution mechanisms are given in the text of this chapter.

EXAMPLE (OF CALL-BY-REFERENCE PARAMETERS IN A FUNCTION DECLARATION):

```
void get_data(int& first_in, double& second_in);
```

Now consider a function call like the following from the same display:

```
get_numbers(first_num, second_num);
```

When the function call is executed, the function is not given values stored in `first_num` and `second_num`. Instead, it is given the memory locations associated with each name. In this example, the locations are

```
1010
1012
```

which are the locations assigned to the argument variables `first_num` and `second_num`, in that order. It is these memory locations that are associated with the formal parameters. The first memory location is associated with the first formal parameter, the second memory location is associated with the second formal parameter, and so forth. In our example `input1` is the first parameter, so it gets the same memory location as `first_num`. The second parameter is `input2` and it gets the same memory location as `second_num`. Diagrammatically, the correspondence is

	Memory Location	Value	
	...		
	1008		
<i>input1</i> →	1010	0	← <i>first_num</i>
<i>input2</i> →	1012	0	← <i>second_num</i>
	1014		
	...		

When the function statements are executed, whatever the function body says to do to a formal parameter is actually done to the variable in the memory location associated with that formal parameter. In this case, the instructions in the body of the function `get_numbers` say that a value should be stored in the formal parameter `input1` using a `cin` statement, and so that value is stored in the variable in memory location 1010 (which happens to be where the variable `first_num` is stored). Similarly, the instructions in the body of the function `get_numbers` say that a value should then be stored in the formal parameter `input2` using a `cin` statement, and so that value is stored in the variable in memory location 1012 (which happens to be where the variable `second_num` is stored). Thus, whatever the function instructs the computer to do to `input1` and `input2` is actually done to the variables `first_num` and `second_num`. For example, if the user enters 5 and 10 as in Display 5.4, then the result is

	Memory Location	Value	
	...		
	1008		
<i>input1</i> →	1010	5	← <i>first_num</i>
<i>input2</i> →	1012	10	← <i>second_num</i>
	1014		
	...		

When the function `get_numbers` exits, the variables `input1` and `input2` go out of scope and are lost. This means we can no longer retrieve the data values at 1010 and 1012 through the variables `input1` and `input2`. However, the data still exists in memory location 1010 and 1012 and is accessible through the variables `first_num` and `second_num` within the scope of the main function. These details of how the call-by-reference mechanism works in this function call to `get_numbers` are described in Display 5.5.

It may seem that there is an extra level of detail, or at least an extra level of verbiage. If `first_num` is the variable with memory location 1010, why do we insist on saying “the variable at memory location 1010” instead of simply saying “`first_num`”? This extra level of detail is needed if the arguments and formal parameters contain some confusing coincidence of names. For example, the function `get_numbers` has formal parameters named `input1` and `input2`. Suppose you want to change the program in Display 5.4 so that it uses the function `get_numbers` with arguments that are also named `input1` and `input2`, and suppose that you want to do something less than obvious. Suppose you want the first number typed in to be stored in a variable named `input2`, and the second

DISPLAY 5.5 Behavior of Call-by-Reference Arguments (part 1 of 2)

Anatomy of a Function Call from Display 5.4 Using Call-by-Reference Arguments

- 0 Assume the variables `first_num` and `second_num` have been assigned the following memory address by the compiler:

```
first_num  —> 1010
second_num —> 1012
```

(We do not know what addresses are assigned and the results will not depend on the actual addresses, but this will make the process very concrete and thus perhaps easier to follow.)

- 1 In the program in Display 5.4, the following function call begins executing:

```
get_numbers(first_num, second_num);
```

- 2 The function is told to use the memory location of the variable `first_num` in place of the formal parameter `input1` and the memory location of the `second_num` in place of the formal parameter `input2`. The effect is the same as if the function definition were rewritten to the following (which is not legal C++ code, but does have a clear meaning to us):

```
void get_numbers(int& <the variable at memory location 1010>,
                 int& <the variable at memory location 1012>)
{
    using namespace std;
    cout << "Enter two integers: ";
    cin >> <the variable at memory location 1010>
        >> <the variable at memory location 1012>;
}
```

Anatomy of the Function Call in Display 5.4 (concluded)

Since the variables in locations 1010 and 1012 are `first_num` and `second_num`, the effect is thus the same as if the function definition were rewritten to the following:

```
void get_numbers(int& first_num, int& second_num)
{
    using namespace std;
    cout << "Enter two integers: ";
    cin >> first_num
        >> second_num;
}
```

- 3 The body of the function is executed. The effect is the same as if the following were executed:

(continued)

DISPLAY 5.5 Behavior of Call-by-Reference Arguments (*part 2 of 2*)

```
{
    using namespace std;
    cout << "Enter two integers: ";
    cin >> first_num
        >> second_num;
}
```

- 4 When the `cin` statement is executed, the values of the variables `first_num` and `second_num` are set to the values typed in at the keyboard. (If the dialogue is as shown in Display 5.4, then the value of `first_num` is set to 5 and the value of `second_num` is set to 10.)
- 5 When the function call ends, the variables `first_num` and `second_num` retain the values that they were given by the `cin` statement in the function body. (If the dialogue is as shown in Display 5.4, then the value of `first_num` is 5 and the value of `second_num` is 10 at the end of the function call.)

number typed in to be stored in the variable named `input1`—perhaps because the second number will be processed first, or because it is the more important number. Now, let's suppose that the variables `input1` and `input2`, which are declared in the main part of your program, have been assigned memory locations 1014 and 1016. The function call could be as follows:

```
int input1, input 2;
get_numbers(input2, input1);
```

*Notice the order
of the arguments*

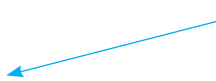

In this case if you say “`input1`,” we do not know whether you mean the variable named `input1` that is declared in the main part of your program or the formal parameter `input1`. However, if the variable `input1` declared in the main part of your program is assigned memory location 1014, the phrase “the variable at memory location 1014” is unambiguous. Let's go over the details of the substitution mechanisms in this case.

In this call the argument corresponding to the formal parameter `input1` is the variable `input2`, and the argument corresponding to the formal parameter `input2` is the variable `input1`. This can be confusing to us, but it produces no problem at all for the computer, since the computer never does actually “substitute `input2` for `input1`” or “substitute `input1` for `input2`.” The computer simply deals with memory locations. The computer substitutes “the variable at memory location 1016” for the formal parameter `input1`, and “the variable at memory location 1014” for the formal parameter `input2`.

PROGRAMMING EXAMPLE**The swap_values Function**

The function `swap_values` defined in Display 5.4 interchanges the values stored in two variables. The description of the function is given by the following function declaration and accompanying comment:

```
void swap_values(int& variable1, int& variable2);
//Interchanges the values of variable1 and variable2.
```

To see how the function is supposed to work, assume that the variable `first_num` has the value 5 and the variable `second_num` has the value 10 and consider the function call:

```
swap_values(first_num, second_num);
```

After this function call, the value of `first_num` will be 10 and the value of `second_num` will be 5.

As shown in Display 5.4, the definition of the function `swap_values` uses a local variable called `temp`. This local variable is needed. You might be tempted to think the function definition could be simplified to the following:

```
void swap_values(int& variable1, int& variable2)
{
    variable1 = variable2;
    variable2 = variable1;
}
```



This does not work!

To see that this alternative definition cannot work, consider what would happen with this definition and the function call

```
swap_values(first_num, second_num);
```

The variables `first_num` and `second_num` are substituted for the formal parameters `variable1` and `variable2` so that, with this incorrect function definition, the function call is equivalent to the following:

```
first_num = second_num;
second_num = first_num;
```

This code does not produce the desired result. The value of `first_num` is set equal to the value of `second_num`, just as it should be. But then, the value of `second_num` is set equal to the changed value of `first_num`, which is now the original value of `second_num`. Thus the value of `second_num` is not changed at all. (If this is unclear, go through the steps with specific values for the variables `first_num` and `second_num`.) What the function needs to do is to save the original value of `first_num` so that value is not lost. This is what the local variable `temp` in the correct function definition is used for. That correct definition is the one in Display 5.4. When that correct version is used and

the function is called with the arguments `first_num` and `second_num`, the function call is equivalent to the following code, which works correctly:

```
temp = first_num;
first_num = second_num;
second_num = temp;
```

Parameters and Arguments

All the different terms that have to do with parameters and arguments can be confusing. However, if you keep a few simple points in mind, you will be able to easily handle these terms.

1. The **formal parameters** for a function are listed in the function declaration and are used in the body of the function definition. A formal parameter (of any sort) is a kind of blank or place holder that is filled in with something when the function is called.
2. An **argument** is something that is used to fill in a formal parameter. When you write down a function call, the arguments are listed in parentheses after the function name. When the function call is executed, the arguments are “plugged in” for the formal parameters.
3. The terms *call-by-value* and *call-by-reference* refer to the mechanism that is used in the “plugging in” process. In the **call-by-value** method, only the value of the argument is used. In this call-by-value mechanism, the formal parameter is a local variable that is initialized to the value of the corresponding argument. In the **call-by-reference** mechanism, the argument is a variable and the entire variable is used. In the call-by-reference mechanism, the argument variable is substituted for the formal parameter so that any change that is made to the formal parameter is actually made to the argument variable.

Mixed Parameter Lists

Whether a formal parameter is a call-by-value parameter or a call-by-reference parameter is determined by whether there is an ampersand attached to its type specification. If the ampersand is present, then the formal parameter is a call-by-reference parameter. If there is no ampersand associated with the formal parameter, then it is a call-by-value parameter.

It is perfectly legitimate to mix call-by-value and call-by-reference formal parameters in the same function. For example, the first and last of the formal parameters in the following function declaration are call-by-reference parameters and the middle one is a call-by-value parameter:

```
void good_stuff(int& par1, int par2, double& par3);
```

Call-by-reference parameters are not restricted to *void* functions. You can also use them in functions that return a value. Thus, a function with a call-by-reference parameter could both change the value of a variable given as an argument and return a value.

■ PROGRAMMING TIP What Kind of Parameter to Use

Display 5.6 illustrates the differences between how the compiler treats call-by-value and call-by-reference formal parameters. The parameters `par1_value` and `par2_ref` are both assigned a value inside the body of the function definition. But since they are different kinds of parameters, the effect is different in the two cases.

`par1_value` is a call-by-value parameter, so it is a local variable. When the function is called as follows

```
do_stuff(n1, n2);
```

the local variable `par1_value` is initialized to the value of `n1`. That is, the local variable `par1_value` is initialized to 1 and the variable `n1` is then ignored by the function. As you can see from the sample dialogue, the formal parameter `par1_value` (which is a local variable) is set to 111 in the function body and this value is output to the screen. However, the value of the argument `n1` is not changed. As shown in the sample dialogue, `n1` has retained its value of 1.

DISPLAY 5.6 Comparing Argument Mechanisms (part 1 of 2)

```

1 //Illustrates the difference between a call-by-value
2 //parameter and a call-by-reference parameter.
3 #include <iostream>
4 void do_stuff(int par1_value, int& par2_ref);
5 //par1_value is a call-by-value formal parameter and
6 //par2_ref is a call-by-reference formal parameter.
7 int main( )
8 {
9     using namespace std;
10    int n1, n2;
11
12    n1 = 1;
13    n2 = 2;
14    do_stuff(n1, n2);
15    cout << "n1 after function call = " << n1 << endl;
16    cout << "n2 after function call = " << n2 << endl;
17    return 0;
18 }
19 void do_stuff(int par1_value, int& par2_ref)
20 {
21    using namespace std;
```

(continued)



VideoNote
Call by Reference and Call
by Value

DISPLAY 5.6 Comparing Argument Mechanisms (*part 2 of 2*)

```
22     par1_value = 111;
23     cout << "par1_value in function call = "
24           << par1_value << endl;
25     par2_ref = 222;
26     cout << "par2_ref in function call = "
27           << par2_ref << endl;
28 }
```

Sample Dialogue

```
par1_value in function call = 111
par2_ref in function call = 222
n1 after function call = 1
n2 after function call = 222
```

On the other hand, `par2_ref` is a call-by-reference parameter. When the function is called, the variable argument `n2` (not just its value) is substituted for the formal parameter `par2_ref`. So that when the following code is executed:

```
par2_ref = 222;
```

it is the same as if the following were executed:

```
n2 = 222;
```

Thus, the value of the variable `n2` is changed when the function body is executed, so as the dialogue shows, the value of `n2` is changed from 2 to 222 by the function call.

If you keep in mind the lesson of Display 5.6, it is easy to decide which parameter mechanism to use. If you want a function to change the value of a variable, then the corresponding formal parameter must be a call-by-reference formal parameter and must be marked with the ampersand sign, `&`. In all other cases, you can use a call-by-value formal parameter. ■

PITFALL Inadvertent Local Variables

If you want a function to change the value of a variable, the corresponding formal parameter must be a call-by-reference parameter and must have the ampersand, `&`, attached to its type. If you carelessly omit the ampersand, the function will have a call-by-value parameter where you meant to have a call-by-reference parameter, and when the program is run, you will discover that the function call does not change the value of the corresponding argument. This is because a formal call-by-value parameter is a local variable, so if it has its value changed in the function, then as with any local variable, that change has no effect outside of the function body. This is a logic error that can be very difficult to see because it looks right.

For example, the program in Display 5.7 is identical to the program in Display 5.4, except that the ampersands were mistakenly omitted from the function `swap_values`. As a result, the formal parameters `variable1` and `variable2` are local variables. The argument variables `first_num` and `second_num` are never substituted in for `variable1` and `variable2`; `variable1` and `variable2` are instead initialized to the values of `first_num` and `second_num`. Then, the values of `variable1` and `variable2` are interchanged, but the values of `first_num` and `second_num` are left unchanged. The omission of two ampersands has made the program completely wrong, yet it looks almost identical to the correct program and will compile and run without any error messages. ■

DISPLAY 5.7 Inadvertent Local Variable

```

1  //Program to demonstrate call-by-reference parameters.
2  #include <iostream>
3  void get_numbers(int& input1, int& input2);
4  //Reads two integers from the keyboard.
5  void swap_values(int variable1, int variable2);
6  //Interchanges the values of variable1 and variable2.
7  void show_results(int output1, int output2);
8  //Shows the values of variable1 and variable2, in that order.
9  int main( )
10 {
11     int first_num, second_num;
12     get_numbers(first_num, second_num);
13     swap_values(first_num, second_num);
14     show_results(first_num, second_num);
15     return 0;
16 }
17 void swap_values(int variable1, int variable2)
18 {
19     int temp;
20     temp = variable1;
21     variable1 = variable2;
22     variable2 = temp;
23 }
24
25 <The definitions of get_numbers and
    show_results are the same as in Display 5.4.>

```

forgot the & here

forgot the & here

inadvertent local variables

Sample Dialogue

```

Enter two integers: 5 10
In reverse order the numbers are: 5 10

```

SELF-TEST EXERCISES

7. What is the output of the following program?

```
#include <iostream>
void figure_me_out(int& x, int y, int& z);
int main()
{
    using namespace std;
    int a, b, c;
    a = 10;
    b = 20;
    c = 30;
    figure_me_out(a, b, c);
    cout << a << " " << b << " " << c;
    return 0;
}

void figure_me_out(int& x, int y, int& z)
{
    using namespace std;
    cout << x << " " << y << " " << z << endl;
    x = 1;
    y = 2;
    z = 3;
    cout << x << " " << y << " " << z << endl;
}
```

8. What would be the output of the program in Display 5.4 if you omit the ampersands, &, from the first parameter in the function declaration and function heading of `swap_values`? The ampersand is not removed from the second parameter.
9. What would be the output of the program in Display 5.6 if you change the function declaration for the function `do_stuff` to the following and you change the function header to match, so that the formal parameter `par2_ref` is changed to a call-by-value parameter:
- ```
void do_stuff(int par1_value, int par2_ref);
```
10. Write a `void` function definition for a function called `zero_both` that has two reference parameters, both of which are variables of type `int`, and sets the values of both variables to 0.
11. Write a `void` function definition for a function called `add_tax`. The function `add_tax` has two formal parameters: `tax_rate`, which is the amount of sales tax expressed as a percentage, and `cost`, which is the cost of an item before tax. The function changes the value of `cost` so that it includes sales tax.

12. Can a function that returns a value have a call-by-reference parameter?  
May a function have both call-by-value and call-by-reference parameters?

## 5.3 USING PROCEDURAL ABSTRACTION

*My memory is so bad, that many times I forget my own name!*

MIGUEL DE CERVANTES SAAVEDRA, *Don Quixote*

Recall that the principle of procedural abstraction says that functions should be designed so that they can be used as black boxes. For a programmer to use a function effectively, all the programmer should need to know is the function declaration and the accompanying comment that says what the function accomplishes. The programmer should not need to know any of the details contained in the function body. In this section we discuss a number of topics that deal with this principle in more detail.

### Functions Calling Functions

A function body may contain a call to another function. The situation for these sorts of function calls is exactly the same as it would be if the function call had occurred in the `main` function of the program; the only restriction is that the function declaration should appear before the function is used. If you set up your programs as we have been doing, this will happen automatically, since all function declarations come before the `main` function and all function definitions come after the `main` function. Although you may include a function call within the definition of another function, you cannot place the definition of one function within the body of another function definition.

Display 5.8 shows an enhanced version of the program shown in Display 5.4. The program in Display 5.4 always reversed the values of the variables `first_num` and `second_num`. The program in Display 5.8 reverses these variables only some of the time. The program in Display 5.8 uses the function `order` to reorder the values in these variables so as to ensure that

```
first_num <= second_num
```

If this condition is already true, then nothing is done to the variables `first_num` and `second_num`. If, however, `first_num` is greater than `second_num`, then the function `swap_values` is called to interchange the values of these two variables. This testing for order and exchanging of variable values all takes place within the body of the function `order`. Thus, the function `swap_values` is called within the body of the function `order`. This presents no special problems. Using the principle of procedural abstraction, we think of the function `swap_values` as performing an action (namely, interchanging the values of two variables); this action is the same no matter where it occurs.



**DISPLAY 5.8** Function Calling Another Function (part 1 of 2)

```
1 //Program to demonstrate a function calling another function.
2 #include <iostream>
3
4 void get_input(int& input1, int& input2);
5 //Reads two integers from the keyboard.
6
7 void swap_values(int& variable1, int& variable2);
8 //Interchanges the values of variable1 and variable2.
9
10 void order(int& n1, int& n2);
11 //Orders the numbers in the variables n1 and n2
12 //so that after the function call n1 <= n2.
13
14 void give_results(int output1, int output2);
15 //Outputs the values in output1 and output2.
16 //Assumes that output1 <= output2
17
18 int main()
19 {
20 int first_num, second_num;
21
22 get_input(first_num, second_num);
23 order(first_num, second_num);
24 give_results(first_num, second_num);
25 return 0;
26 }
27
28 //Uses iostream:
29 void get_input(int& input1, int& input2)
30 {
31 using namespace std;
32 cout << "Enter two integers: ";
33 cin >> input1 >> input2;
34 }
35
36 void swap_values(int& variable1, int& variable2)
37 {
38 int temp;
39
40 temp = variable1;
41 variable1 = variable2;
42 variable2 = temp;
43 }
44
```

(continued)

**DISPLAY 5.8** Function Calling Another Function (part 2 of 2)

```

45 void order(int& n1, int& n2)
46 {
47 if (n1 > n2)
48 swap_values(n1, n2);
49 }
50
51 //Uses iostream:
52 void give_results(int output1, int output2)
53 {
54 using namespace std;
55 cout << "In increasing order the numbers are: "
56 << output1 << " " << output2 << endl;
57 }

```

*These function definitions can be in any order.*

**Sample Dialogue**

```

Enter two integers: 10 5
In increasing order the numbers are: 5 10

```

**Preconditions and Postconditions**

One good way to write a function declaration comment is to break it down into two kinds of information, called a precondition and a postcondition. The **precondition** states what is assumed to be true when the function is called. The function should not be used and cannot be expected to perform correctly unless the precondition holds. The **postcondition** describes the effect of the function call; that is, the postcondition tells what will be true after the function is executed in a situation in which the precondition holds. For a function that returns a value, the postcondition will describe the value returned by the function. For a function that changes the value of some argument variables, the postcondition will describe all the changes made to the values of the arguments.

For example, the function declaration comment for the function `swap_values` shown in Display 5.8 can be put into this format as follows:

```

void swap_values(int& variable1, int& variable2);
//Precondition: variable1 and variable2 have been given
//values.
//Postcondition: The values of variable1 and variable2
//have been interchanged.

```

The comment for the function `celsius` from Display 5.2 can be put into this format as follows:

```

double celsius(double fahrenheit);
//Precondition: fahrenheit is a temperature expressed

```

```
//in degrees Fahrenheit.
//Postcondition: Returns the equivalent temperature
//expressed in degrees Celsius.
```

When the only postcondition is a description of the value returned, programmers often omit the word `postcondition`. A common and acceptable alternative form for the previous function declaration comments is the following:

```
//Precondition: fahrenheit is a temperature expressed
//in degrees Fahrenheit.
//Returns the equivalent temperature expressed in
//degrees Celsius.
```

Another example of preconditions and postconditions is given by the following function declaration:

```
void post_interest(double& balance, double rate);
//Precondition: balance is a nonnegative savings
//account balance.rate is the interest rate
//expressed as a percent, such as 5 for 5%.
//Postcondition: The value of balance has been
//increased by rate percent.
```

You do not need to know the definition of the function `post_interest` in order to use this function, so we have given only the function declaration and accompanying comment.

Preconditions and postconditions are more than a way to summarize a function's actions. They should be the first step in designing and writing a function. When you design a program, you should specify what each function does before you start designing how the function will do it. In particular, the function declaration comments and the function declaration should be designed and written down before starting to design the function body. If you later discover that your specification cannot be realized in a reasonable way, you may need to back up and rethink what the function should do, but by clearly specifying what you think the function should do, you will minimize both design errors and wasted time writing code that does not fit the task at hand.

Some programmers prefer not to use the words `precondition` and `postcondition` in their function comments. However, whether you use the words or not, your function comment should always contain the precondition and postcondition information.

## **CASE STUDY** Supermarket Pricing

---

This case study solves a very simple programming task. It may seem that it contains more detail than is needed for such a simple task. However, if you see the design elements in the context of a simple task, you can concentrate on learning them without the distraction of any side issues. Once you learn the

techniques that are illustrated in this simple case study, you can apply these same techniques to much more complicated programming tasks.

### **Problem Definition**

We have been commissioned by the Quick-Shop supermarket chain to write a program that will determine the retail price of an item given suitable input. Their pricing policy is that any item that is expected to sell in one week or less is marked up 5 percent, and any item that is expected to stay on the shelf for more than one week is marked up 10 percent over the wholesale price. Be sure to notice that the low markup of 5 percent is used for up to 7 days and that at 8 days the markup changes to 10 percent. It is important to be precise about exactly when a program should change from one form of calculation to a different one.

As always, we should be sure we have a clear statement of the input required and the output produced by the program.

### **Input**

The input will consist of the wholesale price of an item and the expected number of days until the item is sold.

### **Output**

The output will give the retail price of the item.

### **Analysis of the Problem**

Like many simple programming tasks, this one breaks down into three main subtasks:

1. Input the data.
2. Compute the retail price of the item.
3. Output the results.

These three subtasks will be implemented by three functions. The three functions are described by their function declarations and accompanying comments, which are given below. Note that only those items that are changed by the functions are call-by-reference parameters. The remaining formal parameters are call-by-value parameters.

```
void get_input(double& cost, int& turnover);
//Precondition: User is ready to enter values correctly.
//Postcondition: The value of cost has been set to the
//wholesale cost of one item. The value of turnover has been
//set to the expected number of days until the item is sold.

double price(double cost, int turnover);
//Precondition: cost is the wholesale cost of one item.
//turnover is the expected number of days
//until sale of the item.
//Returns the retail price of the item.
```

```

void give_output(double cost, int turnover, double price);
//Precondition: cost is the wholesale cost of one item;
//turnover is the expected time until sale of the item;
//price is the retail price of the item.
//Postcondition: The values of cost, turnover, and price have
//been written to the screen.

```

Now that we have the function headings, it is trivial to write the main part of our program:

```

int main()
{
 double wholesale_cost, retail_price;
 int shelf_time;

 get_input(wholesale_cost, shelf_time);
 retail_price = price(wholesale_cost, shelf_time);
 give_output(wholesale_cost, shelf_time, retail_price);
 return 0;
}

```

Even though we have not yet written the function bodies and have no idea of how the functions work, we can write the above code that uses the functions. That is what is meant by the principle of procedural abstraction. The functions are treated like black boxes.

### Algorithm Design

The implementations of the functions `get_input` and `give_output` are straightforward. They simply consist of a few `cin` and `cout` statements. The algorithm for the function `price` is given by the following pseudocode:

```

if turnover ≤ 7 days then
 return (cost +5% of cost);
else
 return (cost +10% of cost);

```

### Coding

There are three constants used in this program: a low markup figure of 5 percent, a high markup figure of 10 percent, and an expected shelf stay of 7 days as the threshold above which the high markup is used. Since these constants might need to be changed to update the program should the company decide to change its pricing policy, we declare global named constants at the start of our program for each of these three numbers. The declarations with the `const` modifier are the following:

```

const double LOW_MARKUP = 0.05; //5%
const double HIGH_MARKUP = 0.10; //10%
const int THRESHOLD = 7; //Use HIGH_MARKUP if do not
//expect to sell in 7 days or less

```

The body of the function `price` is a straightforward translation of our algorithm from pseudocode to C++ code:

```

{
 if (turnover <= THRESHOLD)
 return (cost + (LOW_MARKUP * cost));
 else
 return (cost + (HIGH_MARKUP * cost));
}

```

The complete program is shown in Display 5.9.

### DISPLAY 5.9 Supermarket Pricing (part 1 of 2)

---

```

1 //Determines the retail price of an item according to
2 //the pricing policies of the Quick-Shop supermarket chain.
3 #include <iostream>
4 const double LOW_MARKUP = 0.05; //5%
5 const double HIGH_MARKUP = 0.10; //10%
6 const int THRESHOLD = 7; //Use HIGH_MARKUP if not expected
7 //to sell in 7 days or less.
8 void introduction();
9 //Postcondition: Description of program is written on the screen.
10 void get_input(double& cost, int& turnover);
11 //Precondition: User is ready to enter values correctly.
12 //Postcondition: The value of cost has been set to the
13 //wholesale cost of one item. The value of turnover has been
14 //set to the expected number of days until the item is sold.
15 double price(double cost, int turnover);
16 //Precondition: cost is the wholesale cost of one item.
17 //turnover is the expected number of days until sale of the item.
18 //Returns the retail price of the item.
19 void give_output(double cost, int turnover, double price);
20 //Precondition: cost is the wholesale cost of one item; turnover is the
21 //expected time until sale of the item; price is the retail price of the item.
22 //Postcondition: The values of cost, turnover, and price have been
23 //written to the screen.
24 int main()
25 {
26 double wholesale_cost, retail_price;
27 int shelf_time;
28 introduction();
29 get_input(wholesale_cost, shelf_time);
30 retail_price = price(wholesale_cost, shelf_time);
31 give_output(wholesale_cost, shelf_time, retail_price);
32 return 0;
33 }
34 //Uses iostream:
35 void introduction()

```

(continued)

**DISPLAY 5.9 Supermarket Pricing** (part 2 of 2)

---

```
36 {
37 using namespace std;
38 cout<< "This program determines the retail price for\n"
39 << "an item at a Quick-Shop supermarket store.\n";
40 }
41 //Uses iostream:
42 void get_input(double& cost, int& turnover)
43 {
44 using namespace std;
45 cout << "Enter the wholesale cost of item: $";
46 cin >> cost;
47 cout << "Enter the expected number of days until sold: ";
48 cin >> turnover;
49 }
50 //Uses iostream:
51 void give_output(double cost, int turnover, double price)
52 {
53 using namespace std;
54 cout.setf(ios::fixed);
55 cout.setf(ios::showpoint);
56 cout.precision(2);
57 cout << "Wholesale cost = $" << cost << endl
58 << "Expected time until sold = "
59 << turnover << " days" << endl
60 << "Retail price = $" << price << endl;
61 }
62 //Uses defined constants LOW_MARKUP, HIGH_MARKUP, and THRESHOLD:
63 double price(double cost, int turnover)
64 {
65 if (turnover <= THRESHOLD)
66 return (cost + (LOW_MARKUP * cost));
67 else
68 return (cost + (HIGH_MARKUP * cost));
69 }
70 }
```

---

**Sample Dialogue**

```
This program determines the retail price for an item at a Quick-Shop
supermarket store. Enter the wholesale cost of item: $1.21
Enter the expected number of days until sold: 5
Wholesale cost = $1.21
Expected time until sold = 5 days
Retail price = $1.27
```

---

### Program Testing

An important technique in testing a program is to test all kinds of input. There is no precise definition of what we mean by a “kind” of input, but in practice, it is often easy to decide what kinds of input data a program deals with. In the case of our supermarket program, there are two main kinds of input: input that uses the low markup of 5 percent and input that uses the high markup of 10 percent. Thus, we should test at least one case in which the item is expected to remain on the shelf for less than 7 days and at least one case in which the item is expected to remain on the shelf for more than 7 days.

Test all kinds of input

Another testing strategy is to test boundary values. Unfortunately, boundary value is another vague concept. An input (test) value is a boundary value if it is a value at which the program changes behavior. For example, in our supermarket program, the program’s behavior changes at an expected shelf stay of 7 days. Thus, 7 is a boundary value; the program behaves differently for a number of days that is less than or equal to 7 than it does for a number of days that is greater than 7. Hence, we should test the program on at least one case in which the item is expected to remain on the shelf for exactly 7 days. Normally, you should also test input that is one step away from the boundary value as well, since you can easily be off by one in deciding where the boundary is. Hence, we should test our program on input for an item that is expected to remain on the shelf for 6 days, an item that is expected to remain on the shelf for 7 days, and an item that is expected to remain on the shelf for 8 days. (This is in addition to the test inputs described in the previous paragraph, which should be well below and well above 7 days.)

Test boundary values

## SELF-TEST EXERCISES

13. Can a function definition appear inside the body of another function definition?
14. Can a function definition contain a call to another function?
15. Rewrite the function declaration comment for the function order shown in Display 5.8 so that it is expressed in terms of preconditions and postconditions.
16. Give a precondition and a postcondition for the predefined function `sqrt`, which returns the square root of its argument.

## 5.4 TESTING AND DEBUGGING FUNCTIONS

*“I beheld the wretch—the miserable monster whom I had created.”*

MARY WOLLSTONECRAFT SHELLEY, *Frankenstein*



## Stubs and Drivers

Each function should be designed, coded, and tested as a separate unit from the rest of the program. This is the essence of the top-down design strategy. When you treat each function as a separate unit, you transform one big task into a series of smaller, more manageable tasks. But how do you test a function outside of the program for which it is intended? You write a special program to do the testing. For example, Display 5.10 shows a program to test the function `get_input`, which was used in the program in Display 5.9.

### DISPLAY 5.10 Driver Program (part 1 of 2)

---

```

1 //Driver program for the function get_input.
2 #include <iostream>
3
4 void get_input(double& cost, int& turnover);
5 //Precondition: User is ready to enter values correctly.
6 //Postcondition: The value of cost has been set to the
7 //wholesale cost of one item. The value of turnover has been
8 //set to the expected number of days until the item is sold.
9
10 int main()
11 {
12 using namespace std;
13 double wholesale_cost;
14 int shelf_time;
15 char ans;
16
17 cout.setf(ios::fixed);
18 cout.setf(ios::showpoint);
19 cout.precision(2);
20 do
21 {
22 get_input(wholesale_cost, shelf_time);
23
24 cout << "Wholesale cost is now $"
25 << wholesale_cost << endl;
26 cout << "Days until sold is now "
27 << shelf_time << endl;
28
29 cout << "Test again?"
30 << " (Type y for yes or n for no): ";
31 cin >> ans;
32 cout << endl;
33 } while (ans == 'y' || ans == 'Y');
34
35 return 0;
36 }
```

(continued)

**DISPLAY 5.10 Driver Program (part 2 of 2)**

---

```
37 //Uses iostream:
38 void get_input(double& cost, int& turnover)
39 {
40 using namespace std;
41 cout << "Enter the wholesale cost of item: $";
42 cin >> cost;
43 cout << "Enter the expected number of days until sold: ";
44 cin >> turnover;
45 }
```

---

**Sample Dialogue**

```
Enter the wholesale cost of item: $123.45
Enter the expected number of days until sold: 67
Wholesale cost is now $123.45
Days until sold is now 67
Test again? (Type y for yes or n for no): y

Enter the wholesale cost of item: $9.05
Enter the expected number of days until sold: 3
Wholesale cost is now $9.05
Days until sold is now 3
Test again? (Type y for yes or n for no): n
```

---

Programs like this one are called **driver** programs. These driver programs are temporary tools and can be quite minimal. They need not have fancy input routines. They need not perform all the calculations the final program will perform. All they need do is obtain reasonable values for the function arguments in as simple a way as possible—typically from the user—then execute the function and show the result. A loop, as in the program shown in Display 5.10, will allow you to retest the function on different arguments without having to rerun the program.

If you test each function separately, you will find most of the mistakes in your program. Moreover, you will find out which functions contain the mistakes. If you were to test only the entire program, you would probably find out if there were a mistake but may have no idea where the mistake is. Even worse, you may think you know where the mistake is but be wrong.

Once you have fully tested a function, you can use it in the driver program for some other function. Each function should be tested in a program in which it is the only untested function. However, it's fine to use a fully tested function when testing some other function. If a bug is found, you know the bug is in the untested function. For example, after fully testing the function `get_input` with the driver program in Display 5.10, you can use `get_input` as the input routine in driver programs to test the remaining functions.

It is sometimes impossible or inconvenient to test a function without using some other function that has not yet been written or has not yet been tested. In this case, you can use a simplified version of the missing or untested function. These simplified functions are called **stubs**. These stubs will not necessarily perform the correct calculation, but they will deliver values that suffice for testing, and they are simple enough that you can have confidence in their performance. For example, the program in Display 5.11 is designed to test the function `give_output` from Display 5.9 as well as the basic layout of the program. This program uses the function `get_input`, which we already

### DISPLAY 5.11 Program with a Stub (part 1 of 2)

---

```

1 //Determines the retail price of an item according to
2 //the pricing policies of the Quick-Shop supermarket chain.
3 #include <iostream>

4 void introduction();
5 //Postcondition: Description of program is written on the screen.

6 void get_input(double& cost, int& turnover);
7 //Precondition: User is ready to enter values correctly.
8 //Postcondition: The value of cost has been set to the
9 //wholesale cost of one item. The value of turnover has been
10 //set to the expected number of days until the item is sold.

11 double price(double cost, int turnover);
12 //Precondition: cost is the wholesale cost of one item.
13 //turnover is the expected number of days until sale of the item.
14 //Returns the retail price of the item.

15 void give_output(double cost, int turnover, double price);
16 //Precondition: cost is the wholesale cost of one item; turnover is the
17 //expected time until sale of the item; price is the retail price of the item.
18 //Postcondition: The values of cost, turnover, and price have been
19 //written to the screen.

20 int main()
21 {
22 double wholesale_cost, retail_price;
23 int shelf_time;

24 introduction();
25 get_input(wholesale_cost, shelf_time);
26 retail_price = price(wholesale_cost, shelf_time);
27 give_output(wholesale_cost, shelf_time, retail_price);
28 return 0;
29 }
```

(continued)

**DISPLAY 5.11 Program with a Stub (part 2 of 2)**

```

30 //Uses iostream:
31 void introduction() ← fully tested
32 { function
33 using namespace std;
34 cout << "This program determines the retail price for\n"
35 << "an item at a Quick-Shop supermarket store.\n";
36 }
37 //Uses iostream:
38 void get_input(double& cost, int& turnover) ← fully tested
39 { function
40 using namespace std;
41 cout << "Enter the wholesale cost of item: $";
42 cin >> cost;
43 cout << "Enter the expected number of days until sold: ";
44 cin >> turnover;
45 }
46 //Uses iostream:
47 void give_output(double cost, int turnover, double price) ← function
48 { being tested
49 using namespace std;
50 cout.setf(ios::fixed);
51 cout.setf(ios::showpoint);
52 cout.precision(2);
53 cout << "Wholesale cost = $" << cost << endl
54 << "Expected time until sold = "
55 << turnover << " days" << endl
56 << "Retail price= $" << price << endl;
57 }
58 //This is only a stub:
59 double price(double cost, int turnover) ← stub
60 {
61 return 9.99; //Not correct, but good enough for some testing.
62 }

```

**Sample Dialogue**

```

This program determines the retail price for
an item at a Quick-Shop supermarket store.
Enter the wholesale cost of item: $1.21
Enter the expected number of days until sold: 5
Wholesale cost = $1.21
Expected time until sold = 5 days
Retail price = $9.99

```

fully tested using the driver program shown in Display 5.10. This program also includes the function `initialize_screen`, which we assume has been tested in a driver program of its own, even though we have not bothered to show that simple driver program. Since we have not yet tested the function `price`, we have used a stub to stand in for it. Notice that we could use this program before we have even written the function `price`. This way we can test the basic program layout before we fill in the details of all the function definitions.

Using a program outline with stubs allows you to test and then “flesh out” the basic program outline, rather than write a completely new program to test each function. For this reason, a program outline with stubs is usually the most efficient method of testing. A common approach is to use driver programs to test some basic functions, like the input and output functions, and then use a program with stubs to test the remaining functions. The stubs are replaced by functions one at a time: One stub is replaced by a complete function and tested; once that function is fully tested, another stub is replaced by a full function definition, and so forth until the final program is produced.

### The Fundamental Rule for Testing Functions

Every function should be tested in a program in which every other function in that program has already been fully tested and debugged.

## SELF-TEST EXERCISES

17. What is the fundamental rule for testing functions? Why is this a good way to test functions?
18. What is a driver program?
19. Write a driver program for the function introduction shown in Display 5.11.
20. Write a driver program for the function `add_tax` from Self-Test Exercise 11.
21. What is a stub?
22. Write a stub for the function whose function declaration is given next. Do not write a whole program, only the stub that would go in a program. (*Hint*: It will be very short.)

```
double rain_prob(double pressure, double humidity,
 double temp);
//Precondition: pressure is the barometric
```

```
//pressure in inches of mercury,
//humidity is the relative humidity as a percent, and
//temp is the temperature in degrees Fahrenheit.
//Returns the probability of rain, which is a number
//between 0 and 1.
//0 means no chance of rain. 1 means rain is 100%
//certain.
```

## 5.5 GENERAL DEBUGGING TECHNIQUES



Careful testing through the use of stubs and drivers can detect a large number of bugs that may exist in a program. However, examination of the code and the output of test cases may be insufficient to track down many logic errors. In this case, there are a number of general debugging techniques that you may employ.

### Keep an Open Mind

Examine the system as a whole and don't assume that the bug occurs in one particular place. If the program is giving incorrect output values, then you should examine the source code, different test cases for the input and output values, and the logic behind the algorithm itself. For example, consider the code to determine price for the supermarket example in Display 5.9. If the wrong price is displayed, the error might simply be that the input values were different from those you were expecting in the test case, leading to an apparently incorrect program.

Some novice programmers will "randomly" change portions of the code hoping that it will fix the error. Avoid this technique at all costs! Sometimes this approach will work for the first few simple programs that you write. However, it will almost certainly fail for larger programs and will often introduce new errors to the program. Make sure that you understand what logical impact a change to the code will make before committing the modification.

Finally, if allowed by your instructor, you could show the program to someone else. A fresh set of eyes can sometimes quickly pinpoint an error that you have been missing. Taking a break and returning to the problem a few hours later or the next day can also sometimes help in discovering an error.

### Check Common Errors

One of the first mistakes you should look for are common errors that are easy to make, as described throughout the textbook in the Pitfall and Programming Tip sections. Examples of sources for common errors include (1) uninitialized variables, (2) off-by-one errors, (3) exceeding a data boundary, (4) automatic type conversion, and (5) using = instead of ==.

## Localize the Error

Determining the precise cause and location of a bug is one of the first steps to fixing the error. Examining the input and output behavior for different test cases is one way to localize the error. A related technique is to add `cout` statements to strategic locations in the program that print out the values for critical variables. The `cout` statements also serve to show what code the program is executing. This is the strategy of tracing variables that was described in Chapter 3 for loops, but it can be used even when there are no loops present in the code.

For example, consider the code in Display 5.12 that is intended to convert a temperature from Fahrenheit to Celsius using the formula

$$C = \frac{5(F - 32)}{9}$$

When this program is executed with an input of 100 degrees Fahrenheit, the output is "Temperature in Celsius is 0". This is obviously incorrect, as the correct answer is 37.8 degrees Celsius.

To track down the error we can print out the value of critical variables. In this case, something appears to be wrong with the conversion formula, so we try a two-step approach. In the first step we compute  $(\text{Fahrenheit} - 32)$  and in the second step we compute  $(5 / 9)$  and then output both values. This

### DISPLAY 5.12 Temperature Conversion Program with a Bug

---

```
1 #include <iostream>
2 using namespace std;
3
4 int main()
5 {
6 double fahrenheit;
7 double celsius;
8
9 cout << "Enter temperature in Fahrenheit." << endl;
10 cin >> fahrenheit;
11 celsius = (5 / 9) * (fahrenheit - 32);
12 cout << "Temperature in Celsius is " << celsius << endl;
13
14 return 0;
15 }
```

---

#### Sample Dialogue

```
Enter temperature in Fahrenheit.
100
Temperature in Celsius is 0
```

---

is illustrated in Display 5.13. We have also commented out the original line of code by placing `//` at the beginning of the line. This tells the compiler to ignore the original line of code but still leave it in the program for our reference. If we ever wish to restore the code, we simply remove the `//` instead of having to type the line in again if it was deleted.

By examining the result of the `cout` statements we have now identified the precise location of the bug. In this case, the conversion factor is not computed correctly. Since we are setting the conversion factor to  $5 / 9$ ,

### DISPLAY 5.13 Debugging with `cout` Statements

---

```
1 #include <iostream>
2 using namespace std;
3
4 int main()
5 {
6 double fahrenheit;
7 double celsius;
8
9 cout << "Enter temperature in Fahrenheit." << endl;
10 cin >> fahrenheit;
11
12 // Comment out original line of code but leave it
13 // in the program for our reference
14 // celsius = (5 / 9) * (fahrenheit - 32);
15
16 // Add cout statements to verify (5 / 9) and (fahrenheit - 32)
17 // are computed correctly
18 double conversionFactor = 5 / 9;
19 double tempFahrenheit = (fahrenheit - 32);
20
21 cout << "fahrenheit - 32 = " << tempFahrenheit << endl;
22 cout << "conversionFactor = " << conversionFactor << endl;
23 celsius = conversionFactor * tempFahrenheit;
24 cout << "Temperature in Celsius is " << celsius << endl;
25
26 return 0;
27 }
```

*code that is commented out*

*debugging with cout statements*

#### Sample Dialogue

```
Enter temperature in Fahrenheit.
100
fahrenheit - 32 = 68
conversionFactor = 0
Temperature in Celsius is 0
```

---



this instructs the compiler to compute the division of two integers, which results in zero. The simple fix is to perform floating-point division instead of integer division by changing one of the operands to a floating-point type, for example:

```
double conversionFactor = 5.0 / 9;
```

Once the bug has been identified we can now remove or comment out the debug code and return to a corrected version of the original program by modifying the line that computes the formula to the following:

```
celsius = (5.0 / 9) * (fahrenheit - 32);
```

Adding debugging code and introducing `cout` statements is a simple technique that works in almost any programming environment. However, it can sometimes be tedious to add a large number of `cout` statements to a program. Moreover, the output of the `cout` statements may be long or difficult to interpret, and the introduction of debugging code might even introduce new errors. Many compilers and integrated developing environments include a separate program, a **debugger**, that allows the programmer to stop execution of the program at a specific line of code called a breakpoint and step through the execution of the code one line at a time. As the debugger steps through the code, the programmer can inspect the contents of variables and even manually change the values stored in those variables. No `cout` statements are necessary to view the values of critical variables. The interface, commands, and capabilities of debuggers vary among C++ compilers, so check your user manual or check with your instructor for help on how to use these features.

## The `assert` Macro

In Section 5.3 we discussed the concept of preconditions and postconditions for subroutines. The `assert` macro is a tool to ensure that the expected conditions are true at the location of the `assert` statement. If the condition is not met, then the program will display an error message and abort. To use `assert`, first include the definition of `assert` in your program with the following include statement:

```
#include <cassert>
```

To use `assert`, add the following line of code at the location where you would like to enforce the assertion with a boolean expression that should evaluate to true:

```
assert(boolean_expression);
```

The `assert` statement is a macro, which is a construct similar to a function. As an example, consider a subroutine that uses Newton's method to calculate the square root of a number  $n$ :

$$\text{sqrt}_{i+1} = \frac{1}{2} \left( \text{sqrt}_i + \frac{n}{\text{sqrt}_i} \right)$$

Here  $\text{sqrt}_0 = 1$  and  $\text{sqrt}_i$  approaches the square root of  $n$  as  $i$  approaches infinity. A subroutine that implements this algorithm requires that  $n$  be a positive number and that the number of iterations we will repeat the calculation is also a positive number. We can guarantee this condition by adding `assert` to the subroutine as shown below:

```
// Approximates the square root of n using Newton's
// Iteration.
// Precondition: n is positive, num_iterations is positive
// Postcondition: returns the square root of n
double newton_sqrtroot(double n, int num_iterations)
{
 double answer = 1;
 int i = 0;

 assert((n > 0) && (num_iterations > 0));
 while (i < num_iterations)
 {
 answer = 0.5 * (answer + n / answer);
 i++;
 }
 return answer;
}
```

If we try to execute this subroutine with any negative parameters, then the program will abort and display the assertion that failed. The `assert` statement can be used in a similar manner for any assertion that you would like to enforce and is an excellent technique for defensive programming.

If you are going to distribute your program, you might not want the executable program to include the `assert` statements, since users could then get error messages that they might not understand. If you have added many `assert` statements to your code, it can be tedious to remove them all. Fortunately, you can disable all `assert` macros by adding the following line to the beginning of your program, before the `include` statement for `<cassert>` as follows:

```
#define NDEBUG
#include <cassert>
```

If you later change your program and need to debug it again, you can turn the `assert` statements back on by deleting the line `#define NDEBUG` (or commenting it out).

## SELF-TEST EXERCISES

23. If computing the statement:  $x = (x * y / z)$ ; how can you use the `assert` macro to avoid division by zero?
24. What is a debugger?
25. What general techniques can you use to determine the source of an error?

## CHAPTER SUMMARY

- All subtasks in a program can be implemented as functions, either as functions that return a value or as *void* functions.
- A **formal parameter** is a kind of place holder that is filled in with a function **argument** when the function is called. There are two methods of performing this substitution, call-by-value and call-by-reference.
- In the **call-by-value** substitution mechanism, the value of an argument is substituted for its corresponding formal parameter. In the **call-by-reference** substitution mechanism, the argument should be a variable and the entire variable is substituted for the corresponding argument.
- The way to indicate a call-by-reference parameter in a function definition is to attach the ampersand sign, `&`, to the type of the formal parameter.
- An argument corresponding to a call-by-value parameter cannot be changed by a function call. An argument corresponding to a call-by-reference parameter can be changed by a function call. If you want a function to change the value of a variable, then you must use a call-by-reference parameter.
- A good way to write a function declaration comment is to use a precondition and a postcondition. The **precondition** states what is assumed to be true when the function is called. The **postcondition** describes the effect of the function call; that is, the postcondition tells what will be true after the function is executed in a situation in which the precondition holds.
- Every function should be tested in a program in which every other function in that program has already been fully tested and debugged.
- A **driver program** is a program that does nothing but test a function.
- A simplified version of a function is called a **stub**. A stub is used in place of a function definition that has not yet been tested (or possibly not even written) so that the rest of the program can be tested.
- A debugger, strategic placement of `cout` statements, and the `assert` macro are tools that can help you debug a program.

## Answers to Self-Test Exercises

1. 

```
Hello
Goodbye
One more time:
Hello
End of program.
```
2. No, a *void* function definition need not contain a *return* statement. A *void* function definition may contain a *return* statement, but one is not required.
3. Omitting the *return* statement in the function definition for `initialize_screen` in Display 5.2 would have absolutely no effect on how the program behaves. The program will compile, run, and behave exactly the same. Similarly, omitting the *return* statement in the function definition for `show_results` also will have no effect on how the program behaves. However, if you omit the *return* statement in the function definition for `celsius`, that will be a serious error that will keep the program from running. The difference is that the functions `initialize_screen` and `show_results` are *void* functions, but `celsius` is not a *void* function.
4. 

```
#include <iostream>

void product_out(int n1, int n2, int n3);
int main()
{
 using namespace std;
 int num1, num2, num3;
 cout << "Enter three integers: ";
 cin >> num1 >> num2 >> num3;
 product_out(num1, num2, num3);
 return 0;
}

void product_out(int n1, int n2, int n3)
{
 using namespace std;
 cout << "The product of the three numbers "
 << n1 << ", " << n2 << ", and "
 << n3 << " is " << (n1 * n2 * n3) << endl;
}

```
5. These answers are system dependent.
6. A call to a *void* function followed by a semicolon is a statement. A call to a function that returns a value is an expression.

7. `10 20 30`  
`1 2 3`  
`1 20 3`
8. Enter two integers: `5 10`  
 In reverse order the numbers are: `5 5` ← *different*
9. `par1_value in function call = 111`  
`par2_ref in function call = 222`  
`n1 after function call = 1`  
`n2 after function call = 2` ← *different*

10. `void zero_both(int& n1, int& n2)`

```
{
 n1 = 0;
 n2 = 0;
}
```

11. `void add_tax(double tax_rate, double& cost)`

```
{
 cost = cost + (tax_rate/100.0) * cost;
}
```

The division by 100 is to convert a percent to a fraction. For example, 10% is 10/100.0 or 1/10th of the cost.

12. Yes, a function that returns a value can have a call-by-reference parameter. Yes, a function can have a combination of call-by-value and call-by-reference parameters.
13. No, a function definition cannot appear inside the body of another function definition.
14. Yes, a function definition can contain a call to another function.
15. `void order(int& n1, int& n2);`  
*//Precondition: The variables n1 and n2 have values.*  
*//Postcondition: The values in n1 and n2 have been*  
*//ordered so that n1 <= n2.*
16. `double sqrt(double n);`  
*//Precondition: n >= 0.*  
*//Returns the squareroot of n.*

You can rewrite the second comment line to the following if you prefer, but the previous version is the usual form used for a function that returns a value:

```
//Postcondition: Returns the squareroot of n.
```

17. The fundamental rule for testing functions is that every function should be tested in a program in which every other function in that program has already been fully tested and debugged. This is a good way to test a function because if you follow this rule, then when you find a bug, you will know which function contains the bug.
18. A driver program is a program written for the sole purpose of testing a function.

19. `#include <iostream>`

```

void introduction();
//Postcondition: Description of program is written on
//the screen.
int main()
{
 using namespace std;
 introduction();
 cout << "End of test.\n";
 return 0;
}
//Uses iostream:
void introduction()
{
 using namespace std;
 cout << "This program determines the retail price for\n"
 << "an item at a Quick-Shop supermarket store.\n";
}

```

20. *//Driver program for the function add\_tax.*

```

#include <iostream>

void add_tax(double tax_rate, double& cost);
//Precondition: tax_rate is the amount of sales tax as
//a percentage and cost is the cost of an item before
//tax.
//Postcondition: cost has been changed to the cost of
//the item after adding sales tax.

int main()
{
 using namespace std;
 double cost, tax_rate;
 char ans;
 cout.setf(ios::fixed);
 cout.setf(ios::showpoint);
 cout.precision(2);
 do
 {
 cout << "Enter cost and tax rate:\n";

```

```

 cin >> cost >> tax_rate;
 add_tax(tax_rate, cost);

 cout << "After call to add_tax\n"
 << "tax_rate is " << tax_rate << endl
 << "cost is " << cost << endl;

 cout << "Test again?"
 << " (Type y for yes or n for no): ";
 cin >> ans;
 cout << endl;
 } while (ans == 'y' || ans == 'Y');

 return 0;
}

void add_tax(double tax_rate, double& cost)
{
 cost = cost + (tax_rate/100.0) * cost;
}

```

21. A stub is a simplified version of a function that is used in place of the function so that other functions can be tested.
22. //THIS IS JUST A STUB.  

```

double rain_prob(double pressure, double humidity, double temp)
{
 return 0.25; //Not correct, but good enough for some testing.
}

```
23. `assert(z != 0)`.
24. A debugger is a tool that allows the programmer to set breakpoints, step through the code line by line, and inspect or modify the value of variables.
25. Keeping an open mind, adding `cout` statements to narrow down the cause of the error, using a debugger, searching for common errors, and devising a variety of tests are a few techniques that you can use to debug a program.

## PRACTICE PROGRAMS

*Practice Programs can generally be solved with a short program that directly applies the programming principles presented in this chapter.*

1. Write a function that computes the average and standard deviation of four scores. The standard deviation is defined to be the square root of the average of the four values:  $(s_i - a)^2$ , where  $a$  is average of the four scores  $s_1$ ,  $s_2$ ,  $s_3$ , and  $s_4$ . The function will have six parameters and will call two other

- functions. Embed the function in a driver program that allows you to test the function again and again until you tell the program you are finished.
2. Write a program that reads in a length in feet and inches and outputs the equivalent length in meters and centimeters. Use at least three functions: one for input, one or more for calculating, and one for output. Include a loop that lets the user repeat this computation for new input values until the user says he or she wants to end the program. There are 0.3048 meters in a foot, 100 centimeters in a meter, and 12 inches in a foot.
  3. Write a program like that of the previous exercise that converts from meters and centimeters into feet and inches. Use functions for the subtasks.
  4. (You should do the previous two Practice Programs before doing this one.) Write a program that combines the functions in the previous two Practice Programs. The program asks the user if he or she wants to convert from feet and inches to meters and centimeters or from meters and centimeters to feet and inches. The program then performs the desired conversion. Have the user respond by typing the integer 1 for one type of conversion and 2 for the other conversion. The program reads the user's answer and then executes an *if-else* statement. Each branch of the *if-else* statement will be a function call. The two functions called in the *if-else* statement will have function definitions that are very similar to the programs for the previous two Practice Programs. Thus, they will be function definitions that call other functions in their function bodies. Include a loop that lets the user repeat this computation for new input values until the user says he or she wants to end the program.
  5. Write a program that reads in a weight in pounds and ounces and outputs the equivalent weight in kilograms and grams. Use at least three functions: one for input, one or more for calculating, and one for output. Include a loop that lets the user repeat this computation for new input values until the user says he or she wants to end the program. There are 2.2046 pounds in a kilogram, 1000 grams in a kilogram, and 16 ounces in a pound.
  6. Write a program like that of the previous exercise that converts from kilograms and grams into pounds and ounces. Use functions for the subtasks.
  7. (You should do the previous two Practice Programs before doing this one.) Write a program that combines the functions of the previous two Practice Programs. The program asks the user if he or she wants to convert from pounds and ounces to kilograms and grams or from kilograms and grams to pounds and ounces. The program then performs the desired conversion. Have the user respond by typing the integer 1 for one type of conversion and 2 for the other. The program reads the user's answer and then executes an *if-else* statement. Each branch of the *if-else* statement



VideoNote  
Solution to Practice  
Program 5.5



will be a function call. The two functions called in the `if-else` statement will have function definitions that are very similar to the programs for the previous two Practice Programs. Thus, they will be function definitions that call other functions in their function bodies. Include a loop that lets the user repeat this computation for new input values until the user says he or she wants to end the program.

8. (You need to do Practice Programs 4 and 7 before doing this one.) Write a program that combines the functions of Practice Programs 4 and 7. The program asks the user if he or she wants to convert lengths or weights. If the user chooses lengths, then the program asks the user if he or she wants to convert from feet and inches to meters and centimeters or from meters and centimeters to feet and inches. If the user chooses weights, a similar question about pounds, ounces, kilograms, and grams is asked. The program then performs the desired conversion. Have the user respond by typing the integer 1 for one type of conversion and 2 for the other. The program reads the user's answer and then executes an `if-else` statement. Each branch of the `if-else` statement will be a function call. The two functions called in the `if-else` statement will have function definitions that are very similar to the programs for Practice Programs 4 and 7. Thus, these functions will be function definitions that call other functions in their function bodies; however, they will be very easy to write by adapting the programs you wrote for Practice Programs 4 and 7.

Notice that your program will have `if-else` statements embedded inside of `if-else` statements, but only in an indirect way. The outer `if-else` statement will include two function calls as its two branches. These two function calls will each in turn include an `if-else` statement, but you need not think about that. They are just function calls and the details are in a black box that you create when you define these functions. If you try to create a four-way branch, you are probably on the wrong track. You should only need to think about two-way branches (even though the entire program does ultimately branch into four cases). Include a loop that lets the user repeat this computation for new input values until the user says he or she wants to end the program.

9. The area of an arbitrary triangle can be computed using the formula

$$\text{area} = \sqrt{s(s-a)(s-b)(s-c)}$$

where  $a$ ,  $b$ , and  $c$  are the lengths of the sides, and  $s$  is the semiperimeter.

$$s = (a + b + c)/2$$

Write a `void` function that computes the area and perimeter (*not the semiperimeter*) of a triangle based on the length of the sides. The function should use five parameters—three value parameters that provide the lengths of the edges and two reference parameters that store the computed area

and perimeter. Make your function robust. Note that not all combinations of  $a$ ,  $b$ , and  $c$  produce a triangle. Your function should produce correct results for legal data and reasonable results for illegal combinations.

## PROGRAMMING PROJECTS

*Programming Projects require more problem-solving than Practice Programs and can usually be solved many different ways. Visit [www.myprogramminglab.com](http://www.myprogramminglab.com) to complete many of these Programming Projects online and get instant feedback.*

1. Write a program that converts from 24-hour notation to 12-hour notation. For example, it should convert 14:25 to 2:25 PM. The input is given as two integers. There should be at least three functions, one for input, one to do the conversion, and one for output. Record the AM/PM information as a value of type char, 'A' for AM and 'P' for PM. Thus, the function for doing the conversions will have a call-by-reference formal parameter of type char to record whether it is AM or PM. (The function will have other parameters as well.) Include a loop that lets the user repeat this computation for new input values again and again until the user says he or she wants to end the program.
2. Write a program that requests the current time and a waiting time as two integers for the number of hours and the number of minutes to wait. The program then outputs what the time will be after the waiting period. Use 24-hour notation for the times. Include a loop that lets the user repeat this calculation for additional input values until the user says she or he wants to end the program.
3. Modify your program for Programming Project 2 so that it uses 12-hour notation, such as 3:45 PM.
4. Write a program that tells what coins to give out for any amount of change from 1 cent to 99 cents. For example, if the amount is 86 cents, the output would be something like the following:

```
86 cents can be given as
3 quarter(s) 1 dime(s) and 1 penny(pennies)
```

Use coin denominations of 25 cents (quarters), 10 cents (dimes), and 1 cent (pennies). Do not use nickel and half-dollar coins. Your program will use the following function (among others):

```
void compute_coins(int coin_value, int& num, int& amount_left);
//Precondition: 0 < coin_value < 100; 0 <= amount_left < 100.
//Postcondition: num has been set equal to the maximum number
//of coins of denomination coin_value cents that can be obtained
//from amount_left. Additionally, amount_left has been decreased
//by the value of the coins, that is, decreased by
//num * coin_value.
```

For example, suppose the value of the variable `amount_left` is 86. Then, after the following call, the value of `number` will be 3 and the value of `amount_left` will be 11 (because if you take 3 quarters from 86 cents, that leaves 11 cents):

```
compute_coins(25, number, amount_left);
```

Include a loop that lets the user repeat this computation for new input values until the user says he or she wants to end the program. (*Hint:* Use integer division and the `%` operator to implement this function.)

5. In cold weather, meteorologists report an index called the windchill factor, that takes into account the wind speed and the temperature. The index provides a measure of the chilling effect of wind at a given air temperature. Windchill may be approximated by the formula:

$$W = 13.12 + 0.6215 * t - 11.37 * v^{0.16} + 0.3965 * t * v^{0.16}$$

where

$v$  = wind speed in m/sec

$t$  = temperature in degrees Celsius:  $t \leq 10$

$W$  = windchill index (in degrees Celsius)

Write a function that returns the windchill index. Your code should ensure that the restriction on the temperature is not violated. Look up some weather reports in back issues of a newspaper in your university library and compare the windchill index you calculate with the result reported in the newspaper.

6. In the land of Puzzlevania, Aaron, Bob, and Charlie had an argument over which one of them was the greatest puzzler of all time. To end the argument once and for all, they agreed on a duel to the death. Aaron is a poor shooter and only hits his target with a probability of  $1/3$ . Bob is a bit better and hits his target with a probability of  $1/2$ . Charlie is an expert marksman and never misses. A hit means a kill and the person hit drops out of the duel.

To compensate for the inequities in their marksmanship skills, it is decided that the contestants would fire in turns starting with Aaron, followed by Bob, and then by Charlie. The cycle would repeat until there was one man standing. And that man would be remembered as the greatest puzzler of all time.

- a. Write a function to simulate a single shot. It should use the following declaration:

```
void shoot(bool& targetAlive, double accuracy);
```

This would simulate someone shooting at `targetAlive` with the given accuracy by generating a random number between 0 and 1. If the random



number is less than accuracy, then the target is hit and `targetAlive` should be set to false. Chapter 4 illustrates how to generate random numbers.

For example, if Bob is shooting at Charlie, this could be invoked as:

```
shoot(charlieAlive, 0.5);
```

Here, `charlieAlive` is a Boolean variable that indicates if Charlie is alive. Test your function using a driver program before moving on to step b.

- b. An obvious strategy is for each man to shoot at the most accurate shooter still alive on the grounds that this shooter is the deadliest and has the best chance of hitting back. Write a second function named `startDuel` that uses the `shoot` function to simulate an entire duel using this strategy. It should loop until only one contestant is left, invoking the `shoot` function with the proper target and probability of hitting the target according to who is shooting. The function should return a variable that indicates who won the duel.
  - c. In your main function, invoke the `startDuel` function 1000 times in a loop, keeping track of how many times each contestant wins. Output the probability that each contestant will win when everyone uses the strategy of shooting at the most accurate shooter left alive.
  - d. A counterintuitive strategy is for Aaron to intentionally miss on his first shot. Thereafter, everyone uses the strategy of shooting at the most accurate shooter left alive. This strategy means that Aaron is guaranteed to live past the first round, since Bob and Charlie will fire at each other. Modify the program to accommodate this new strategy and output the probability of winning for each contestant.
7. Write a program that inputs a date (for example, July 4, 2008) and outputs the day of the week that corresponds to that date. The following algorithm is from [http://en.wikipedia.org/wiki/Calculating\\_the\\_day\\_of\\_the\\_week](http://en.wikipedia.org/wiki/Calculating_the_day_of_the_week). The implementation will require several functions.

```
bool isLeapYear(int year);
```

This function should return `true` if `year` is a leap year and `false` if it is not. Here is pseudocode to determine a leap year:

```
leap_year = (year divisible by 400) or (year divisible by 4 and
 year not divisible by 100)
int getCenturyValue(int year);
```

This function should take the first two digits of the year (that is, the century), divide by 4, and save the remainder. Subtract the remainder from 3

and return this value multiplied by 2. For example, the year 2008 becomes:  $(20/4) = 5$  with a remainder of 0.  $3 - 0 = 3$ . Return  $3 * 2 = 6$ .

```
int getYearValue(int year);
```

This function computes a value based on the years since the beginning of the century. First, extract the last two digits of the year. For example, 08 is extracted for 2008. Next, factor in leap years. Divide the value from the previous step by 4 and discard the remainder. Add the two results together and return this value. For example, from 2008 we extract 08. Then  $(8/4) = 2$  with a remainder of 0. Return  $2 + 8 = 10$ .

```
int getMonthValue(int month, int year);
```

This function should return a value based on the table below and will require invoking the `isLeapYear` function.

| Month     | Return Value                 |
|-----------|------------------------------|
| January   | 0 (6 if year is a leap year) |
| February  | 3 (2 if year is a leap year) |
| March     | 3                            |
| April     | 6                            |
| May       | 1                            |
| June      | 4                            |
| July      | 6                            |
| August    | 2                            |
| September | 5                            |
| October   | 0                            |
| November  | 3                            |
| December  | 5                            |

Finally, to compute the day of the week, compute the sum of the date's day plus the values returned by `getMonthValue`, `getYearValue`, and `getCenturyValue`. Divide the sum by 7 and compute the remainder. A remainder of 0 corresponds to Sunday, 1 corresponds to Monday, etc.,

up to 6, which corresponds to Saturday. For example, the date July 4, 2008 should be computed as  $(\text{day of month}) + (\text{getMonthValue}) + (\text{getYearValue}) + (\text{getCenturyValue}) = 4 + 6 + 10 + 6 = 26$ .  $26/7 = 3$  with a remainder of 5. The fifth day of the week corresponds to Friday.

Your program should allow the user to enter any date and output the corresponding day of the week in English.

This program should include a `void` function named `getInput` that prompts the user for the date and returns the month, day, and year using pass-by-reference parameters. You may choose to have the user enter the date's month as either a number (1–12) or a month name.

8. Complete the previous Programming Project and create a top-level function named `dayOfWeek` with the header:

```
int dayOfWeek(int month, int day, int year);
```

The function should encapsulate the necessary logic to return the day of the week of the specified date as an `int` (Sunday = 0, Monday = 1, etc.) You should add validation code to the function that tests if any of the inputs are invalid. If so, the function should return `-1` as the day of the week. In your main function write a test driver that checks if `dayOfWeek` is returning the correct values. Your set of test cases should include at least two cases with invalid inputs.

*This page intentionally left blank*

# I/O Streams as an Introduction to Objects and Classes

# 6

## 6.1 STREAMS AND BASIC FILE I/O 306

Why Use Files for I/O? 307

File I/O 308

Introduction to Classes and Objects 312

*Programming Tip:* Check Whether a File Was  
Opened Successfully 314

Techniques for File I/O 316

Appending to a File (*Optional*) 320

File Names as Input (*Optional*) 321

## 6.2 TOOLS FOR STREAM I/O 323

Formatting Output with Stream Functions 323

Manipulators 329

Streams as Arguments to Functions 332

*Programming Tip:* Checking for the  
End of a File 332

A Note on Namespaces 335

*Programming Example:* Cleaning Up a File  
Format 336

## 6.3 CHARACTER I/O 338

The Member Functions `get` and `put` 338

The `putback` Member Function (*Optional*) 342

*Programming Example:* Checking Input 343

*Pitfall:* Unexpected '\n' in Input 345

*Programming Example:* Another *new\_line*  
Function 347

Default Arguments for Functions (*Optional*) 348

The `eof` Member Function 353

*Programming Example:* Editing a Text File 355

Predefined Character Functions 356

*Pitfall:* `toupper` and `tolower` Return Values 358



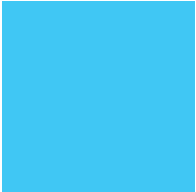

*Fish say, they have their stream and pond; But is there anything beyond?*

RUPERT BROOKE, "Heaven" (1913)

*As a leaf is carried by a stream, whether the stream ends in a lake or in the sea, so too is the output of your program carried by a stream not knowing if the stream goes to the screen or to a file.*

WASHROOM WALL OF A COMPUTER SCIENCE DEPARTMENT (1995)

---

## INTRODUCTION

I/O refers to program input and output. Input can be taken from the keyboard or from a file. Similarly, output can be sent to the screen or to a file. This chapter explains how you can write your programs to take input from a file and send output to another file.

Input is delivered to your program via a C++ construct known as a *stream*, and output from your program is delivered to the output device via a stream. Streams are our first examples of *objects*. An object is a special kind of variable that has its own special-purpose functions that are, in a sense, attached to the variable. The ability to handle objects is one of the language features that sets C++ apart from earlier programming languages. In this chapter we tell you what streams are and explain how to use them for program I/O. In the process of explaining streams, we will introduce you to the basic ideas about what objects are and about how objects are used in a program.

## PREREQUISITES

This chapter uses the material from Chapters 2 through 5.

## 6.1 STREAMS AND BASIC FILE I/O

*Good Heavens! For more than forty years I have been speaking prose without knowing it.*

MOLIÈRE, *Le Bourgeois Gentilhomme*

You are already using files to store your programs. You can also use files to store input for a program or to receive output from a program. The files used for program I/O are the same kind of files you use to store your programs. Streams, which we discuss next, allow you to write programs that handle file input and keyboard input in a unified way and that handle file output and screen output in a unified way.

A **stream** is a flow of characters (or other kind of data). If the flow is into your program, the stream is called an **input stream**. If the flow is out of your program, the stream is called an **output stream**. If the input

stream flows from the keyboard, then your program will take input from the keyboard. If the input stream flows from a file, then your program will take its input from that file. Similarly, an output stream can go to the screen or to a file.

Although you may not realize it, you have already been using streams in your programs. The `cin` that you have already used is an input stream connected to the keyboard, and `cout` is an output stream connected to the screen. These two streams are automatically available to your program, as long as it has an `include` directive that names the header file `iostream`. You can define other streams that come from or go to files; once you have defined them, you can use them in your program in the same way you use the streams `cin` and `cout`.

`cin` and `cout` are streams

For example, suppose your program defines a stream called `in_stream` that comes from some file. (We'll tell you how to define it shortly.) You can then fill an `int` variable named `the_number` with a number from this file by using the following in your program:

```
int the_number;
in_stream >> the_number;
```

Similarly, if your program defines an output stream named `out_stream` that goes to another file, then you can output the value of this variable to this other file. The following will output the string "the\_number is" followed by the contents of the variable `the_number` to the output file that is connected to the stream `out_stream`:

```
out_stream << "the_number is" << the_number << endl;
```

Once the streams are connected to the desired files, your program can do file I/O the same way it does I/O using the keyboard and screen.

## Why Use Files for I/O?

The keyboard input and screen output we have used so far deal with temporary data. When the program ends, the data typed in at the keyboard and the data left on the screen go away. Files provide you with a way to store data permanently. The contents of a file remain until a person or program changes the file. If your program sends its output to a file, the output file will remain after the program has finished running. An input file can be used over and over again by many programs without the need to type in the data separately for each program.

Permanent storage

The input and output files used by your program are the same kind of files that you read and write with an editor, such as the editor you use to write your programs. This means you can create an input file for your program or read an output file produced by your program whenever it's convenient for you, as opposed to having to do all your reading and writing while the program is running.

Files also provide you with a convenient way to deal with large quantities of data. When your program takes its input from a large input file, the program receives a lot of data without making the user do a lot of typing.

## File I/O

When your program takes input from a file, it is said to be **reading** from the file; when your program sends output to a file, it is said to be **writing** to the file. There are other ways of reading input from a file, but the method we will use reads the file from the beginning to the end (or as far as the program gets before ending). Using this method, your program is not allowed to back up and read anything in the file a second time. This is exactly what happens when the program takes input from the keyboard, so this should not seem new or strange. (As we will see, the program can reread a file starting from the beginning of the file, but this is “starting over,” not “backing up.”) Similarly, for the method we present here, your program writes output into a file starting at the beginning of the file and proceeding forward. It is not allowed to back up and change any output that it has previously written to the file. This is exactly what happens when your program sends output to the screen. You can send more output to the screen, but you cannot back up and change the screen output. The way that you get input from a file into your program or send output from your program into a file is to connect the program to the file by means of a stream.

A stream is a variable

In C++, a stream is a special kind of variable known as an *object*. We will discuss objects in the next section, but we will first describe how your program can use stream objects to do simple file I/O. If you want to use a stream to get input from a file (or give output to a file), you must declare the stream and you must connect the stream to the file.

You can think of the file that a stream is connected to as the value of the stream. You can disconnect a stream from one file and connect it to another file, so you can change the value of these stream variables. However, you must use special functions that apply only to streams in order to perform these changes. You *cannot* use a stream variable in an assignment statement the way that you can use a variable of type *int* or *char*. Although streams are variables, they are unusual sorts of variables.

Declaring streams ifstream and ofstream

The streams `cin` and `cout` are already declared for you, but if you want a stream to connect to a file, you must declare it just as you would declare any other variable. The type for input-file stream variables is named `ifstream` (for “input-file stream”). The type for output-file stream variables is named `ofstream` (for “output-file stream”). Thus, you can declare `in_stream` to be an input stream for a file and `out_stream` to be an output stream for another file as follows:

```
ifstream in_stream;
ofstream out_stream;
```

The types `ifstream` and `ofstream` are defined in the library with the header file `fstream`, and so any program that declares stream variables in this way must contain the following directive (normally near the beginning of the file):

```
#include <fstream>
```

When using the types `ifstream` and `ofstream`, your program must also contain the following, normally either at the start of the file or at the start of the function body that uses the types `ifstream` or `ofstream`:

```
using namespace std;
```

Stream variables, such as `in_stream` and `out_stream` declared earlier, must each be **connected to** a file. This is called **opening the file** and is done with a function named `open`. For example, suppose you want the input stream `in_stream` connected to the file named `infile.dat`. Your program must then contain the following before it reads any input from this file:

```
in_stream.open("infile.dat");
```

This may seem like rather strange syntax for a function call. We will have more to say about this peculiar syntax in the next section. For now, just notice a couple of details about how this call to `open` is written. First, the stream variable name and a dot (that is, a period) is placed before the function named `open`, and the file name is given as an argument to `open`. Also notice that the file name is given in quotes. The file name that is given as an argument is the same as the name you would use for the file if you wanted to write in it using the editor. If the input file is in the same directory as your program, you probably can simply give the name of the file in the manner just described. In some situations you might also need to specify the directory that contains the file. The details about specifying directories varies from one system to another. If you need to specify a directory, ask your instructor or some other local expert to explain the details.

Once you have declared an input stream variable and connected it to a file using the `open` function, your program can take input from the file using the extraction operator `>>`. For example, the following reads two input numbers from the file connected to `in_stream` and places them in the variables `one_number` and `another_number`:

```
int one_number, another_number;
in_stream >> one_number >> another_number;
```

An output stream is opened (that is, connected to a file) in the same way as just described for input streams. For example, the following declares the output stream `out_stream` and connects it to the file named `outfile.dat`:

```
ofstream out_stream;
out_stream.open("outfile.dat");
```

Connecting a  
stream to a file  
open

When used with a stream of type `ofstream`, the member function `open` will create the output file if it does not already exist. If the output file does already exist, the member function `open` will discard the contents of the file so that the output file is empty after the call to `open`.

After a file is connected to the stream `out_stream` with a call to `open`, the program can send output to that file using the insertion operator `<<`. For example, the following writes two strings and the contents of the variables `one_number` and `another_number` to the file that is connected to the stream `out_stream` (which in this example is the file named `outfile.dat`):

```
out_stream << "one_number = " << one_number
<< " another_number = " << another_number;
```

Notice that when your program is dealing with a file, it is as if the file had two names. One is the usual name for the file that is used by the operating system. This name is called the **external file name**. In our sample code the external file names were `infile.dat` and `outfile.dat`. The external file name is in some sense the “real name” for the file. It is the name used by the operating system. The conventions for spelling these external file names vary from one system to another; you will need to learn these conventions from your instructor or from some other local expert. The names `infile.dat` and `outfile.dat` that we used in our examples might or might not look like file names on your system. You should name your files following whatever conventions your system uses. Although the external file name is the real name for the file, it is typically used only once in a program. The external file name is given as an argument to the function `open`, but *after the file is opened, the file is always referred to by naming the stream that is connected to the file*. Thus, within your program, the stream name serves as a second name for the file.

The sample program in Display 6.1 reads three numbers from one file and writes their sum, as well as some text, to another file.

### A File Has Two Names

Every input and every output file used by your program has two names. The **external file name** is the real name of the file, but it is used only in the call to the function `open`, which connects the file to a stream. After the call to `open`, you always use the stream name as the name of the file.

Every file should be closed when your program is finished getting input from the file or sending output to the file. Closing a file disconnects the stream from the file. A file is closed with a call to the function `close`. The following lines from the program in Display 6.1 illustrate how to use the function `close`:

```
in_stream.close();
out_stream.close();
```

Notice that the function `close` takes no arguments. If your program ends normally but without closing a file, the system will automatically close the file for you. However, it is good to get in the habit of closing files for at least two reasons. First, the system will only close files for you if your program ends in a normal fashion. If your program ends abnormally due to an error, the file will not be closed and may be left in a corrupted state. If your program closes files as soon as it is finished with them, file corruption is less likely. A second reason for closing a file is that you may want your program to send output to a file and later read that output back into the program. To do this, your program should close the file after it is finished writing to the file, and then your program should connect the file to an input stream using the function

### DISPLAY 6.1 Simple File Input/Output

```

1 //Reads three numbers from the file infile.dat, sums the numbers,
2 //and writes the sum to the file outfile.dat.
3 //(A better version of this program will be given in Display 6.2.)
4 #include <fstream>
5 int main()
6 {
7 using namespace std;
8 ifstream in_stream;
9 ofstream out_stream;
10
11 in_stream.open("infile.dat");
12 out_stream.open("outfile.dat");
13 int first, second, third;
14 in_stream >> first >> second >> third;
15 out_stream << "The sum of the first 3\n"
16 << "numbers in infile.dat\n"
17 << "is " << (first + second + third)
18 << endl;
19 in_stream.close();
20 out_stream.close();
21 return 0;
22 }
```

#### infile.dat

(Not changed by program.)

|   |
|---|
| 1 |
| 2 |
| 3 |
| 4 |

#### outfile.dat

(After program is run.)

|                                                         |
|---------------------------------------------------------|
| The sum of the first 3<br>numbers in infile.dat<br>is 6 |
|---------------------------------------------------------|

There is no output to the screen and no input from the keyboard.

open. (It is possible to open a file for both input and output, but this is done in a slightly different way and we will not be discussing this alternative.)

## Introduction to Classes and Objects

The streams `in_stream` and `out_stream` discussed in the last section and the predefined streams `cin` and `cout` are objects. An **object** is a variable that has functions as well as data associated with it. For example, the streams `in_stream` and `out_stream` both have a function named `open` associated with them. Two sample calls of these functions, along with the declarations of the objects `in_stream` and `out_stream`, are given below:

```
ifstream in_stream;
ofstream out_stream;
in_stream.open("infile.dat");
out_stream.open("outfile.dat");
```

There is a reason for this peculiar notation. The function named `open` that is associated with the object `in_stream` is a different function from the function named `open` that is associated with the object `out_stream`. One function opens a file for input, and the other opens a file for output. Of course, these two functions are similar. They both “open files.” When we give two functions the same name, it is because the two functions have some intuitive similarity. However, these two functions named `open` are different functions, even if they may be only slightly different. When the compiler sees a call to a function named `open`, it must decide which of these two functions named `open` you mean. The compiler determines this by looking at the name of the object that precedes the dot, in this case, either `in_stream` or `out_stream`. A function that is associated with an object is called a **member function**. So, for example, `open` is a member function of the object `in_stream`, and another function named `open` is a member of the object `out_stream`.

As we have just seen, different objects can have different member functions. These functions may have the same names, as was true of the functions named `open`, or they may have completely different names. The type of an object determines which member functions the object has. If two objects are of the same type, they may have different values, but they will have the same member functions. For example, suppose you declare the following stream objects:

```
ifstream in_stream, in_stream2;
ofstream out_stream, out_stream2;
```

The functions `in_stream.open` and `in_stream2.open` are the same function. Similarly, `out_stream.open` and `out_stream2.open` are the same function (but they are different from the functions `in_stream.open` and `in_stream2.open`).

A type whose variables are objects—such as `ifstream` and `ofstream`—is called a **class**. Since the member functions for an object are completely determined by its class (that is, by its type), these functions are called *member functions of the class* (as well as being called *members of the object*). For example, the class `ifstream` has a member function called `open`, and the class `ofstream`

has a different member function called `open`. The class `ofstream` also has a member function named `precision`, but the class `ifstream` has no member function named `precision`. You have already been using the member function `precision` with the stream `cout`, but we will discuss it in more detail later.

When you call a member function in a program, you always specify an object, usually by writing the object name and a dot before the function name, as in the following example:

```
in_stream.open("infile.dat");
```

One reason for naming the object is that the function can have some effect on the object. In the preceding example, the call to the function `open` connects the file `infile.dat` to the stream `in_stream`, so it needs to know the name of this stream.

In a function call, such as

```
in_stream.open("infile.dat");
```

the dot is called the **dot operator** and the object named before the dot is referred to as the **calling object**. In some ways the calling object is like an additional argument to the function—the function can change the calling object as if it were an argument—but the calling object plays an even larger role in the function call. The calling object determines the meaning of the function name. The compiler uses the type of the calling object to determine the meaning of the function name. For example, in the earlier call to `open`, the type of the object `in_stream` determines the meaning of the function name `open`.

Calling a member function

### Calling a Member Function

#### SYNTAX

```
Calling_Object.Member_Function_Name(Argument_List);
```

*Dot Operator*

#### EXAMPLES

```
in_stream.open("infile.dat");
out_stream.open("outfile.dat");
out_stream.precision(2);
```

The meaning of the *Member\_Function\_Name* is determined by the class of (that is, the type of) the *Calling\_Object*.

### Classes and Objects

An **object** is a variable that has functions associated with it. These functions are called **member functions**. A **class** is a type whose variables are objects. The object's class (that is, the type of the object) determines which member functions the object has.





VideoNote  
Objects and File I/O  
Streams

The function name `close` is analogous to `open`. The classes `ifstream` and `ofstream` each have a member function named `close`. They both “close files,” but they close them in different ways because the files were opened and were manipulated in different ways. We will be discussing more member functions for the classes `ifstream` and `ofstream` later in this chapter.

### ■ PROGRAMMING TIP Check Whether a File Was Opened Successfully

A call to `open` can be unsuccessful for a number of reasons. For example, if you open an input file and there is no file with the external name that you specify, then the call to `open` will fail. When this happens, you might not receive an error message and your program might simply proceed to do something unexpected. Thus, you should always follow a call to `open` with a test to see whether the call to `open` was successful and end the program (or take some other appropriate action) if the call to `open` was unsuccessful.

The member  
function `fail`

You can use the member function named `fail` to test whether a stream operation has failed. There is a `fail` member function for each of the classes `ifstream` and `ofstream`. The `fail` function takes no arguments and returns a `bool` value. A call to the function `fail` for a stream named `in_stream` would be as follows:

```
in_stream.fail()
```

This is a Boolean expression that can be used to control a *while* loop or an *if-else* statement.

You should place a call to `fail` immediately after each call to `open`; if the call to `open` fails, the function `fail` will return *true* (that is, the Boolean expression will be satisfied). For example, if the following call to `open` fails, then the program will output an error message and end; if the call succeeds, the `fail` function returns *false*, so the program will continue.

```
in_stream.open("stuff.dat");
if (in_stream.fail())
{
 cout << "Input file opening failed.\n";
 exit(1); ← Ends the program
}
```

`fail` is a member function, so it is called using the stream name and a dot. Of course, the call to `in_stream.fail` refers only to a call to `open` of the form `in_stream.open`, and not to any call to the function `open` made with any other stream as the calling object.

The `exit` statement shown earlier has nothing to do with classes and has nothing directly to do with streams, but it is often used in this context. The `exit` statement causes your program to end immediately. The `exit` function returns its argument to the operating system. To use the `exit` statement, your program must contain the following `include` directive:

```
#include <cstdlib>
```

When using `exit`, your program must also contain the following, normally either at the start of the file or at the start of the function body that uses `exit`:

```
using namespace std;
```

The function `exit` is a predefined function that takes a single integer argument. By convention, 1 is used as the argument if the call to `exit` was due to an error, and 0 is used otherwise.<sup>1</sup> For our purposes, it makes no difference what integer you use, but it pays to follow this convention since it is important in more advanced programming.

### The `exit` Statement

The `exit` statement is written

```
exit(Integer_Value);
```

When the `exit` statement is executed, the program ends immediately. Any `Integer_Value` may be used, but by convention, 1 is used for a call to `exit` that is caused by an error, and 0 is used in other cases. The `exit` statement is a call to the function `exit`, which is in the library with header file named `cstdlib`. Therefore, any program that uses the `exit` statement must contain the following directives:

```
#include <cstdlib>
using namespace std;
```

(These directives need not be given one immediately after the other. They are placed in the same locations as similar directives we have seen.)

---

<sup>1</sup>UNIX and Windows use 1 for error and 0 for success, but other operating systems may reverse this convention. You should ask your instructor what values to use.

Display 6.2 contains the program from Display 6.1 rewritten to include tests to see if the input and output files were opened successfully. It processes files in exactly the same way as the program in Display 6.1. In particular, assuming that the file `infile.dat` exists and has the contents shown in Display 6.1, the program in Display 6.2 will create the file `outfile.dat` that is shown in Display 6.1. However, if there were something wrong and one of the calls to open failed, then the program in Display 6.2 would end and send an appropriate error message to the screen. For example, if there were no file named `infile.dat`, then the call to `in_stream.open` would fail, the program would end, and an error message would be written to the screen.

Notice that we used `cout` to output the error message; this is because we want the error message to go to the screen, as opposed to going to a file. Since this program uses `cout` to output to the screen (as well as doing file I/O), we have added an `include` directive for the header file `iostream`. (Actually, your program does not need to have `#include <iostream>` when the program has `#include <fstream>`, but it causes no problems to include it, and it reminds you that the program is using screen output in addition to file I/O.)

## Techniques for File I/O

As we already noted, the operators `>>` and `<<` work the same for streams connected to files as they do for `cin` and `cout`. However, the programming style for file I/O is different from that for I/O using the screen and keyboard. When reading input from the keyboard, you should prompt for input and echo the input, like this:

```
cout << "Enter the number: ";
cin >> the_number;
cout << "The number you entered is " << the_number;
```

When your program takes its input from a file, you should not include such prompt lines or echoing of input, because there is nobody there to read and respond to the prompt and echo. When reading input from a file, you must be certain the data in the file is exactly the kind of data the program expects. Your program then simply reads the input file assuming that the data it needs will be there when it is requested. If `in_file` is a stream variable that is connected to an input file and you wish to replace the previous keyboard/screen I/O shown with input from the file connected to `in_file`, then you would replace those three lines with the following line:

```
in_file >> the_number;
```

You may have any number of streams opened for input or for output. Thus, a single program can take input from the keyboard and also take input from one or more files. The same program could send output to the screen and

to one or more files. Alternatively, a program could take all of its input from the keyboard and send output to both the screen and a file. Any combination of input and output streams is allowed. Most of the examples in this book will use `cin` and `cout` to do I/O using the keyboard and screen, but it is easy to modify these programs so that the program takes its input from a file and/or sends its output to a file.

## DISPLAY 6.2 File I/O with Checks on open

---

```
1 //Reads three numbers from the file infile.dat, sums the numbers,
2 //and writes the sum to the file outfile.dat.
3 #include <fstream>
4 #include <iostream>
5 #include <cstdlib>
6 int main()
7 {
8 using namespace std;
9 ifstream in_stream;
10 ofstream out_stream;
11 in_stream.open("infile.dat");
12 if (in_stream.fail())
13 {
14 cout << "Input file opening failed.\n";
15 exit(1);
16 }
17 out_stream.open("outfile.dat");
18 if (out_stream.fail())
19 {
20 cout << "Output file opening failed.\n";
21 exit(1);
22 }
23 int first, second, third;
24 in_stream >> first >> second >> third;
25 out_stream << "The sum of the first 3\n"
26 << "numbers in infile.dat\n"
27 << "is " << (first + second +third)
28 << endl;
29 in_stream.close();
30 out_stream.close();
31 return 0;
32 }
```

---

### Screen Output (If the file `infile.dat` does not exist)

```
Input file opening failed.
```

---

### Summary of File I/O Statements

In this sample the input comes from a file with the directory name `infile.dat`, and the output goes to a file with the directory name `outfile.dat`.

- Place the following **include** directives in your program file:

```
#include <fstream> ← For file I/O
#include <iostream> ← For cout
#include <cstdlib> ← For exit
```

- Choose a stream name for the input stream (for example, **in\_stream**), and declare it to be a variable of type **ifstream**. Choose a stream name for the output file (for example, **out\_stream**), and declare it to be of type **ofstream**:

```
using namespace std;
ifstream in_stream;
ofstream out_stream;
```

- Connect each stream to a file using the member function **open** with the external file name as an argument. Remember to use the member function **fail** to test that the call to **open** was successful:

```
in_stream.open("infile.dat");
if (in_stream.fail())
{
 cout << "Input file opening failed.\n";
 exit(1);
}
out_stream.open("outfile.dat");
if (out_stream.fail())
{
 cout << "Output file opening failed.\n";
 exit(1);
}
```

- Use the stream **in\_stream** to get input from the file **infile.dat** just like you use **cin** to get input from the keyboard. For example:

```
in_stream >> some_variable >> some_other_variable;
```

- Use the stream **out\_stream** to send output to the file **outfile.dat** just like you use **cout** to send output to the screen. For example:

```
out_stream << "some_variable = "
 << some_variable << endl;
```

- Close the streams using the function **close**:

```
in_stream.close();
out_stream.close();
```

## SELF-TEST EXERCISES

1. Suppose you are writing a program that uses a stream called `fin` that will be connected to an input file, and a stream called `fout` that will be connected to an output file. How do you declare `fin` and `fout`? What `include` directive, if any, do you need to place in your program file?
2. Suppose you are continuing to write the program discussed in the previous exercise and you want it to take its input from the file `stuff1.dat` and send its output to the file `stuff2.dat`. What statements do you need to place in your program in order to connect the stream `fin` to the file `stuff1.dat` and to connect the stream `fout` to the file `stuff2.dat`? Be sure to include checks to make sure that the openings were successful.
3. Suppose that you are still writing the same program that we discussed in the previous two exercises and you reach the point at which you no longer need to get input from the file `stuff1.dat` and no longer need to send output to the file `stuff2.dat`. How do you close these files?
4. Suppose you want to change the program in Display 6.1 so that it sends its output to the screen instead of the file `outfile.dat`. (The input should still come from the file `infile.dat`.) What changes do you need to make to the program?
5. What `include` directive do you need to place in your program file if your program uses the function `exit`?
6. Continuing Self-Test Exercise 5, what does `exit(1)` do with its argument?
7. Suppose `b1a` is an object, `dobedo` is a member function of the object `b1a`, and `dobedo` takes one argument of type `int`. How do you write a call to the member function `dobedo` of the object `b1a` using the argument 7?
8. What characteristics of files do ordinary program variables share? What characteristics of files are different from ordinary variables in a program?
9. Name at least three member functions associated with an `iostream` object, and give examples of usage of each.
10. A program has read half of the lines in a file. What must the program do to the file to enable reading the first line a second time?
11. In the text it says "a file has two names." What are the two names? When is each name used?

## Appending to a File (Optional)

When sending output to a file, your code must first use the member function `open` to open a file and connect it to a stream of type `ofstream`. The way we have done that thus far (with a single argument for the file name) always gives an empty file. If a file with the specified name already exists, its old contents are lost. There is an alternative way to open a file so that the output from your program will be appended to the file after any data already in the file.

To append your output to a file named `important.txt`, you would use a two-argument version of `open`, as illustrated by the following:

```
ofstream outStream;
outStream.open("important.txt", ios::app);
```

If the file `important.txt` does not exist, this will create an empty file with that name to receive your program's output, but if the file already exists, then all the output from your program will be appended to the end of the file so that old data in the file is not lost. This is illustrated in Display 6.3.

### DISPLAY 6.3 Appending to a File (Optional) (part 1 of 2)

---

```
1 //Appends data to the end of the file data.txt.
2 #include <fstream>
3 #include <iostream>
4
5 int main()
6 {
7 using namespace std;
8
9 cout << "Opening data.txt for appending.\n";
10 ofstream fout;
11 fout.open("data.txt", ios::app);
12 if (fout.fail())
13 {
14 cout << "Input file opening failed.\n";
15 exit(1);
16 }
17
18 fout << "5 6 pick up sticks.\n"
19 << "7 8 ain't C++ great!\n";
20
21 fout.close();
22 cout << "End of appending to file.\n";
23
24 return 0;
25 }
```

(continued)

### DISPLAY 6.3 Appending to a File (Optional) (part 2 of 2)

---

#### Sample Dialogue

| <b>data.txt</b><br>(Before program is run.)       | <b>data.txt</b><br>(After program is run.)                                                 |
|---------------------------------------------------|--------------------------------------------------------------------------------------------|
| <pre>1 2 buckle my shoe. 3 4 shut the door.</pre> | <pre>1 2 buckle my shoe. 3 4 shut the door. 5 6 pick up sticks. 7 8 ain't C++ great!</pre> |

---

#### Screen Output

```
Opening data.txt for appending.
End of appending to file.
```

---

The second argument `ios::app` is a special constant that is defined in `iostream` and so requires the following `include` directive:

```
#include <iostream>
```

Your program should also include the following, normally either at the start of the file or at the start of the function body that uses `ios::app`:

```
using namespace std;
```

#### File Names as Input (Optional)

Thus far, we have written the literal file names for our input and output files into the code of our programs. We did this by giving the file name as the argument to a call to the function `open`, as in the following example:

```
in_stream.open("infile.dat");
```

This can sometimes be inconvenient. For example, the program in Display 6.2 reads numbers from the file `infile.dat` and outputs their sum to the file `outfile.dat`. If you want to perform the same calculation on the numbers in another file named `infile2.dat` and write the sum of these numbers to another file named `outfile2.dat`, then you must change the file names in the two calls to the member function `open` and then recompile your program. A preferable alternative is to write your program so that it asks the user to type in the names of the input and output files. This way your program can use different files each time it is run.



### Appending to a File

If you want to append data to a file so that it goes after any existing contents of the file, open the file as follows.

#### SYNTAX

```
Output_Stream.open(File_Name, ios::app);
```

#### EXAMPLE

```
ofstream outStream;
outStream.open("important.txt", ios::app);
```

A file name is a *string* and we will not discuss string handling in detail until Chapter 8. However, it is easy to learn enough about strings so that you can write programs that accept a file name as input. A **string** is just a sequence of characters. We have already used string values in output statements such as the following:

```
cout << "This is a string.";
```

We have also used string values as arguments to the member function `open`. Whenever you write a literal string, as in the `cout` statement shown, you must place the string in double quotes.

In order to read a file name into your program, you need a variable that is capable of holding a string. We discuss the details of strings in Chapter 8, but for now we will cover just enough to store a file name. A variable to hold a string value is declared as in the following example:

```
char file_name[16];
```

This declaration is the same as if you had declared the variable to be of type *char*, except that the variable name is followed by an integer in square brackets that specifies the maximum number of characters you can have in a string stored in the variable. This number must be one greater than the maximum number of characters in the string value. So, in our example, the variable `file_name` can contain any string that contains 15 or fewer characters. The name `file_name` can be replaced by any other identifier (that is not a keyword), and the number 16 can be replaced by any other positive integer.

You can input a string value to a string variable the same way that you input values of other types. For example, consider the following piece of code:

```
cout << "Enter the file name (maximum of 15 characters):\n";
cin >> file_name;
cout << "OK, I will edit the file " << file_name << endl;
```

A possible dialogue for this code is

```
Enter the file name (maximum of 15 characters):
myfile.dat
OK, I will edit the file myfile.dat
```

Once your program has read the name of a file into a string variable, such as the variable `file_name`, it can use this string variable as the argument to the member function `open`. For example, the following will connect the input-file stream `in_stream` to the file whose name is stored in the variable `file_name` (and will use the member function `fail` to check whether the opening was successful):

String variables  
as arguments to  
`open`

```
ifstream in_stream;
in_stream.open(file_name);
if (in_stream.fail())
{
 cout << "Input file opening failed.\n";
 exit(1);
}
```

Note that when you use a string variable as an argument to the member function `open`, you do not use any quotes.

In Display 6.4 we have rewritten the program in Display 6.2 so that it takes its input from and sends its output to whatever files the user specifies. The input and output file names are read into the string variables `in_file_name` and `out_file_name` and then these variables are used as the arguments in calls to the member function `open`. Notice the declaration of the string variables. You must include a number in square brackets after each string variable name, as we did in Display 6.4.

String variables are not ordinary variables and cannot be used in all the ways you can use ordinary variables. In particular, you cannot use an assignment statement to change the value of a string variable.

Warning!

## 6.2 TOOLS FOR STREAM I/O

*You shall see them on a beautiful quarto page, where a neat rivulet of text shall meander through a meadow of margin.*

RICHARD BRINSLEY SHERIDAN, *The School for Scandal*

### Formatting Output with Stream Functions

The layout of a program's output is called the **format** of the output. In C++ you can control the format with commands that determine such details as the number of spaces between items and the number of digits after the decimal point. You already used three output formatting instructions when you learned the formula for outputting dollar amounts of money in the usual way (not in

**DISPLAY 6.4 Inputting a File Name (Optional)** *(part 1 of 2)*

```
1 //Reads three numbers from the file specified by the user, sums the numbers,
2 //and writes the sum to another file specified by the user.
3 #include <fstream>
4 #include <iostream>
5 #include <cstdlib>
6
7 int main()
8 {
9 using namespace std;
10 char in_file_name[16], out_file_name[16];
11 ifstream in_stream;
12 ofstream out_stream;
13
14 cout << "I will sum three numbers taken from an input\n"
15 << "file and write the sum to an output file.\n";
16 cout << "Enter the input file name (maximum of 15 characters):\n";
17 cin >> in_file_name;
18 cout << "Enter the output file name (maximum of 15 characters):\n";
19 cin >> out_file_name;
20 cout << "I will read numbers from the file "
21 << in_file_name << " and\n"
22 << "place the sum in the file "
23 << out_file_name << endl;
24
25 in_stream.open(in_file_name);
26 if (in_stream.fail())
27 {
28 cout << "Input file opening failed.\n";
29 exit(1);
30 }
31
32 out_stream.open(out_file_name);
33 if (out_stream.fail())
34 {
35 cout << "Output file opening failed.\n";
36 exit(1);
37 }
38 int first, second, third;
39 in_stream >> first >> second >> third;
40 out_stream << "The sum of the first 3\n"
41 << "numbers in " << in_file_name << endl
42 << "is " << (first + second + third)
43 << endl;
44
45 in_stream.close();
```

*(continued)*

**DISPLAY 6.4** Inputting a File Name (Optional) (part 2 of 2)

```

46 out_stream.close();
47
48 cout << "End of Program.\n";
49 return 0;
50 }

```

**numbers.dat**

(Not changed by program.)

```

1
2
3
4

```

**sum.dat**

(After program is run.)

```

The sum of the first 3
numbers in numbers.dat
is 6

```

**Sample Dialogue**

```

I will sum three numbers taken from an input
file and write the sum to an output file.
Enter the input file name (maximum of 15 characters):
numbers.dat
Enter the output file name (maximum of 15 characters):
sum.dat
I will read numbers from the file numbers.dat and
place the sum in the file sum.dat
End of Program.

```

e-notation) with two digits after the decimal point. Before outputting amounts of money, you inserted the following “magic formula” into your program:

```

cout.setf(ios::fixed);
cout.setf(ios::showpoint);
cout.precision(2);

```

Now that you’ve learned about object notation for streams, we can explain this magic formula and a few other formatting commands.

The first thing to note is that you can use these formatting commands on any output stream. If your program is sending output to a file that is connected to an output stream called `out_stream`, you can use these same commands to ensure that numbers with a decimal point will be written in the way we normally write amounts of money. Just insert the following in your program:

```

out_stream.setf(ios::fixed);

```

```
out_stream.setf(ios::showpoint);
out_stream.precision(2);
```

To explain this magic formula, we will consider the instructions in reverse order.

Every output stream has a member function named `precision`. When your program executes a call to `precision` such as the previous one for the stream `out_stream`, then from that point on in your program, any number with a decimal point that is output to that stream will be written with a total of two significant figures, or with two digits after the decimal point, depending on when your compiler was written. The following is some possible output from a compiler that sets two significant digits:

```
23. 2.2e7 2.2 6.9e-1 0.00069
```

The following is some possible output from a compiler that sets two digits after the decimal point:

```
23.56 2.26e7 2.21 0.69 0.69e-4
```

In this book, we assume the compiler sets two digits after the decimal point.

A call to `precision` applies only to the stream named in the call. If your program has another output stream named `out_stream_two`, then the call to `out_stream.precision` affects the output to the stream `out_stream` but has no effect on the stream `out_stream_two`. Of course, you can also call `precision` with the stream `out_stream_two`; you can even specify a different number of digits for the numbers output to the stream `out_stream_two`, as in the following:

```
out_stream_two.precision(3);
```

The other formatting instructions in our magic formula are a bit more complicated than the member function `precision`. We now discuss these other instructions. The following are two calls to the member function `setf` with the stream `out_stream` as the calling object:

```
out_stream.setf(ios::fixed);
out_stream.setf(ios::showpoint);
```

`setf` is an abbreviation for *set flags*. A **flag** is an instruction to do something in one of two possible ways. If a flag is given as an argument to `setf`, then the flag tells the computer to write output to that stream in some specific way. What it causes the stream to do depends on the flag.

In the previous example, there are two calls to the function `setf`, and these two calls set the two flags `ios::fixed` and `ios::showpoint`. The flag `ios::fixed` causes the stream to output numbers of type *double* in what is called **fixed-point notation**, which is a fancy phrase for the way we normally write numbers. If the flag `ios::fixed` is set (by a call to `setf`), then all floating-point numbers (such as numbers of type *double*) that are output to that stream will be written in ordinary everyday notation, rather than e-notation.

**DISPLAY 6.5** Formatting Flags for `setf`

| Flag                         | Meaning                                                                                                                                                                                                                                                                                                                                                                 | Default |
|------------------------------|-------------------------------------------------------------------------------------------------------------------------------------------------------------------------------------------------------------------------------------------------------------------------------------------------------------------------------------------------------------------------|---------|
| <code>ios::fixed</code>      | If this flag is set, floating-point numbers are not written in e-notation. (Setting this flag automatically unsets the flag <code>ios::scientific</code> .)                                                                                                                                                                                                             | Not set |
| <code>ios::scientific</code> | If this flag is set, floating-point numbers are written in e-notation. (Setting this flag automatically unsets the flag <code>ios::fixed</code> .) If neither <code>ios::fixed</code> nor <code>ios::scientific</code> is set, then the system decides how to output each number.                                                                                       | Not set |
| <code>ios::showpoint</code>  | If this flag is set, a decimal point and trailing zeros are always shown for floating-point numbers. If it is not set, a number with all zeros after the decimal point might be output without the decimal point and following zeros.                                                                                                                                   | Not set |
| <code>ios::showpos</code>    | If this flag is set, a plus sign is output before positive integer values.                                                                                                                                                                                                                                                                                              | Not set |
| <code>ios::right</code>      | If this flag is set and some field-width value is given with a call to the member function <code>width</code> , then the next item output will be at the right end of the space specified by <code>width</code> . In other words, any extra blanks are placed <i>before</i> the item output. (Setting this flag automatically unsets the flag <code>ios::left</code> .) | Set     |
| <code>ios::left</code>       | If this flag is set and some field-width value is given with a call to the member function <code>width</code> , then the next item output will be at the left end of the space specified by <code>width</code> . In other words, any extra blanks are placed <i>after</i> the item output. (Setting this flag automatically unsets the flag <code>ios::right</code> .)  | Not set |

The flag `ios::showpoint` tells the stream to always include a decimal point in floating-point numbers, such as numbers of type *double*. So if the number to be output has a value of 2.0, then it will be output as 2.0 and not simply as 2; that is, the output will include the decimal point even if all the digits after the decimal point are 0. Some common flags and the actions they cause are described in Display 6.5.

Another useful flag is `ios::showpos`. If this flag is set for a stream, then positive numbers output to that stream will be written with the plus sign in front of them. If you want a plus sign to appear before positive numbers, insert the following:

```
cout.setf(ios::showpos);
```

Minus signs appear before negative numbers without setting any flags.

One very commonly used formatting function is `width`. For example, consider the following call to `width` made by the stream `cout`:

```
cout << "Start Now";
cout.width(4);
cout << 7 << endl;
```

This code causes the following line to appear on the screen:

```
Start Now 7
```

This output has exactly three spaces between the letter 'w' and the number 7. The `width` function tells the stream how many spaces to use when giving an item as output. In this case the item (namely, the number 7) occupies only one space, and `width` said to use four spaces, so three of the spaces are blank. If the output requires more space than you specified in the argument to `width`, then as much additional space as is needed will be used. The entire item is always output, no matter what argument you give to `width`.

A call to `width` applies only to the next item that is output. If you want to output 12 numbers, using four spaces to output each number, then you must call `width` 12 times. If this becomes a nuisance, you may prefer to use the manipulator `setw` that is described in the next subsection.

Any flag that is set may be unset. To unset a flag, you use the function `unsetf`. For example, the following will cause your program to stop including plus signs on positive integers that are output to the stream `cout`:

```
cout.unsetf(ios::showpos);
```

### Flag Terminology

Why are the arguments to `setf`, such as `ios::showpoint`, called *flags*? And what is meant by the strange notation `ios::?`

The word **flag** is used for something that can be turned on or off. The origin of the term apparently comes from some phrase similar to “when the flag is up, do it.” Or perhaps the term was “when the flag is down, do it.” Moreover, apparently nobody can recall what the exact originating phrase was because programmers now say “when the flag is set” and that does not conjure up any picture. In any event, when the flag `ios::showpoint` is set (that is, when it is an argument to `setf`), the stream that called the `setf` function will behave as described in Display 6.5; when any other flag is set (that is, is given as an argument to `setf`), that signals the stream to behave as Display 6.5 specifies for that flag.

The explanation for the notation `ios::?` is rather mundane for such exotic notation. The `ios` indicates that the meaning of terms such as `fixed` or `showpoint` is the meaning that they have when used with an input or output stream. The notation `::` means “use the meaning of what follows the `::` in the context of what comes before the `::`.” We will say more about this `::` notation later in this book.

## Manipulators

A **manipulator** is a function that is called in a nontraditional way. In turn, the manipulator function calls a member function. Manipulators are placed after the insertion operator `<<`, just as if the manipulator function call were an item to be output. Like traditional functions, manipulators may or may not have arguments. We have already seen one manipulator, `endl`. In this subsection we will discuss two manipulators called `setw` and `setprecision`.

The manipulator `setw` and the member function `width` (which you have already seen) do exactly the same thing. You call the `setw` manipulator by writing it after the insertion operator `<<`, as if it were to be sent to the output stream, and this in turn calls the member function `width`. For example, the following outputs the numbers 10, 20, and 30, using the field widths specified:

```
cout << "Start" << setw(4) << 10
<< setw(4) << 20 << setw(6) << 30;
```

The preceding statement will produce the following output:

```
Start 10 20 30
```

(There are two spaces before the 10, two spaces before the 20, and four spaces before the 30.)

The manipulator `setprecision` does exactly the same thing as the member function `precision` (which you have already seen). However, a call to `setprecision` is written after the insertion operator `<<`, in a manner similar to how you call the `setw` manipulator. For example, the following outputs the numbers listed using the number of digits after the decimal point that are indicated by the call to `setprecision`:

```
cout.setf(ios::fixed);
cout.setf(ios::showpoint);
cout << "$" << setprecision(2) << 10.3 << endl
<< "$" << 20.5 << endl;
```

The statement above will produce the following output:

```
$10.30
$20.50
```

When you set the number of digits after the decimal point using the manipulator `setprecision`, then just as was the case with the member function `precision`, the setting stays in effect until you reset it to some other number by another call to either `setprecision` or `precision`.

To use either of the manipulators `setw` or `setprecision`, you must include the following directive in your program:

```
#include <iomanip>
```

Your program should also include the following:

```
using namespace std;
```



## SELF-TEST EXERCISES

12. What output will be produced when the following lines are executed (assuming the lines are embedded in a complete and correct program with the proper `include` directives)?

```
cout << "*";
cout.width(5);
cout << 123
 << "*" << 123 << "*" << endl;
cout << "*" << setw(5) << 123
 << "*" << 123 << "*" << endl;
```

13. What output will be produced when the following lines are executed (assuming the lines are embedded in a complete and correct program with the proper `include` directives)?

```
cout << "*" << setw(5) << 123;
cout.setf(ios::left);
cout << "*" << setw(5) << 123;
cout.setf(ios::right);
cout << "*" << setw(5) << 123 << "*" << endl;
```

14. What output will be produced when the following lines are executed (assuming the lines are embedded in a complete and correct program with the proper `include` directives)?

```
cout << "*" << setw(5) << 123 << "*"
 << 123 << "*" << endl;
cout.setf(ios::showpos);
cout << "*" << setw(5) << 123 << "*"
 << 123 << "*" << endl;
cout.unsetf(ios::showpos);
cout.setf(ios::left);
cout << "*" << setw(5) << 123 << "*"
 << setw(5) << 123 << "*" << endl;
```

15. What output will be sent to the file `stuff.dat` when the following lines are executed (assuming the lines are embedded in a complete and correct program with the proper `include` directives)?

```
ofstream fout;
fout.open("stuff.dat");
fout << "*" << setw(5) << 123 << "*"
 << 123 << "*" << endl;
fout.setf(ios::showpos);
fout << "*" << setw(5) << 123 << "*"
 << 123 << "*" << endl;
```

```
fout.unsetf(ios::showpos);
fout.setf(ios::left);
fout << "*" << setw(5) << 123 << "*"
 << setw(5) << 123 << "*" << endl;
```

16. What output will be produced when the following line is executed (assuming the line is embedded in a complete and correct program with the proper include directives)?

```
cout << "*" << setw(3) << 12345 << "*" << endl;
```

17. In formatting output, the following flag constants are used with the stream member function `setf`. What effect does each have?

- a. `ios::fixed`
- b. `ios::scientific`
- c. `ios::showpoint`
- d. `ios::showpos`
- e. `ios::right`
- f. `ios::left`

18. Here is a code segment that reads input from `infile.dat` and sends output to `outfile.dat`. What changes are necessary to make the output go to the screen? (The input is still to come from `infile.dat`.)

```
//Problem for Self Test. Copies three int numbers
//between files.
#include <fstream>
int main()
{
 using namespace std;

 ifstream instream;
 ofstream ostream;

 instream.open("infile.dat");
 ostream.open("outfile.dat");
 int first, second, third;
 instream >> first >> second >> third;
 ostream << "The sum of the first 3" << endl
 << "numbers in infile.dat is " << endl
 << (first + second + third) << endl;
 instream.close();
 ostream.close();
 return 0;
}
```

Stream parameters must be call-by-reference

## Streams as Arguments to Functions

A stream can be an argument to a function. The only restriction is that the function formal parameter must be call-by-reference. A stream parameter cannot be a call-by-value parameter. For example, the function `make_neat` in Display 6.6 has two stream parameters: one is of type `ifstream` and is for a stream connected to an input file; another is of type `ofstream` and is for a stream connected to an output file. We will discuss the other features of the program in Display 6.6 in the next two subsections.

### ■ PROGRAMMING TIP Checking for the End of a File

*That's all there is, there isn't any more.*

ETHEL BARRYMORE (1879–1959)

When you write a program that takes its input from a file, you will often want the program to read all the data in the file. For example, if the file contains numbers, you might want your program to calculate the average of all the numbers in the file. Since you might run the program with different data files at different times, the program cannot assume it knows how many numbers are in the file. You would like to write your program so that it keeps reading numbers from the file until there are no more numbers left to be read. If `in_stream` is a stream connected to the input file, then the algorithm for computing this average can be stated as follows:

```
double next, sum = 0;
int count = 0;
while (There are still numbers to be read)
{
 in_stream >> next;
 sum = sum + next;
 count++;
}
```

*The average is  $\text{sum} / \text{count}$ .*

This algorithm is already almost all C++ code, but we still must express the following test in C++:

*(There are still numbers to be read)*

Even though it may not look correct at first, one way to express the aforementioned test is the following:

```
(in_stream >> next)
```

The previous algorithm can thus be rewritten as the following C++ code (plus one last line in pseudocode that is not the issue here):

**DISPLAY 6.6** Formatting Output (part 1 of 2)

```

1 //Illustrates output formatting instructions.
2 //Reads all the numbers in the file rawdata.dat and writes the numbers
3 //to the screen and to the file neat.dat in a neatly formatted way.
4 #include <iostream>
5 #include <fstream>
6 #include <cstdlib>
7 #include <iomanip>
8 using namespace std;
9 void make_neat(istream& messy_file, ostream& neat_file,
10 int number_after_decimalpoint, int field_width);
11 //Precondition: The streams messy_file and neat_file have been connected
12 //to files using the function open.
13 //Postcondition: The numbers in the file connected to messy_file have been
14 //written to the screen and to the file connected to the stream neat_file.
15 //The numbers are written one per line, in fixed-point notation (that is, not in
16 //e-notation), with number_after_decimalpoint digits after the decimal point;
17 //each number is preceded by a plus or minus sign and each number is in a field
18 //of width field_width. (This function does not close the file.)
19 int main()
20 {
21 ifstream fin;
22 ofstream fout;
23
24 fin.open("rawdata.dat");
25 if (fin.fail())
26 {
27 cout << "Input file opening failed.\n";
28 exit(1);
29 }
30 fout.open("neat.dat");
31 if (fout.fail())
32 {
33 cout << "Output file opening failed.\n";
34 exit(1);
35 }
36 make_neat(fin, fout, 5, 12);
37
38 fin.close();
39 fout.close();
40
41 cout << "End of program.\n";
42 return 0;
43 }
44
45

```

*Needed for setw*  
*Stream parameters must be call-by-reference.*

(continued)

**DISPLAY 6.6 Formatting Output** (part 2 of 2)

```

46 //Uses iostream, fstream, and iomanip:
47 void make_neat(ifstream& messy_file, ofstream& neat_file,
48 int number_after_decimalpoint, int field_width)
49 {
50 neat_file.setf(ios::fixed); ← Not in e-notation
51 neat_file.setf(ios::showpoint); ← Show decimal point
52 neat_file.setf(ios::showpos); ← Show + sign
53 neat_file.precision(number_after_decimalpoint);
54 cout.setf(ios::fixed);
55 cout.setf(ios::showpoint);
56 cout.setf(ios::showpos);
57 cout.precision(number_after_decimalpoint);
58
59 double next;
60 while (messy_file >> next) ← Satisfied if there is a
61 { next number to read
62 cout << setw(field_width) << next << endl;
63 neat_file << setw(field_width) << next << endl;
64 }
65 }

```

**rawdata.dat**

(Not changed by program.)

|                |             |
|----------------|-------------|
| 10.37          | -9.89897    |
| 2.313          | -8.950 15.0 |
| 7.33333        | 92.8765     |
| -1.237568432e2 |             |

**neat.dat**

(After program is run.)

|            |
|------------|
| +10.37000  |
| -9.89897   |
| +2.31300   |
| -8.95000   |
| +15.00000  |
| +7.33333   |
| +92.87650  |
| -123.75684 |

**Screen Output**

|                 |
|-----------------|
| +10.37000       |
| -9.89897        |
| +2.31300        |
| -8.95000        |
| +15.00000       |
| +7.33333        |
| +92.87650       |
| -123.75684      |
| End of program. |

```
double next, sum = 0;
int count = 0;
while (in_stream >> next)
{
 sum = sum + next;
 count++;
}
The average is sum / count.
```

Notice that the loop body is not identical to what it was in our pseudocode. Since `in_stream >> next` is now in the Boolean expression, it is no longer in the loop body.

This loop may look a bit peculiar, because `in_stream >> next` is both the way you input a number from the stream `in_stream` and the controlling Boolean expression for the *while* loop. An expression involving the extraction operator `>>` is simultaneously both an action and a Boolean condition.<sup>2</sup> It is an instruction to take one input number from the input stream, and it is also a Boolean expression that is either satisfied or not. If there is another number to be input, then the number is read and the Boolean expression is satisfied, so the body of the loop is executed one more time. If there are no more numbers to be read in, then nothing is input and the Boolean expression is not satisfied, so the loop ends. In this example the type of the input variable `next` was *double*, but this method of checking for the end of the file works the same way for other data types, such as *int* and *char*. ■

## A Note on Namespaces

We have tried to keep our *using* directives local to a function definition. This is an admirable goal, but now we have a problem—functions whose parameter type is in a namespace. In our immediate examples we need the stream type names that are in the namespace `std`. Thus, we need a *using* directive (or something) outside of the function definition body so that C++ will understand the parameter type names, such as `ifstream`. The easiest fix is to simply place one *using* directive at the start of the file (after the `include` directives). We have done this in Display 6.6.

Placing a single *using* directive at the start of a file is the easiest solution to our problem, but many experts would not consider it the best solution, since it would not allow the use of two namespaces that have names in common, and that is the whole purpose of namespaces. At this point we are

---

<sup>2</sup> Technically, the Boolean condition works this way: The overloading of operator `>>` for the input stream classes is done with functions associated with the stream. This function is named `operator >>`. The return value of this operator function is an input stream reference (`istream&` or `ifstream&`). A function is provided that automatically converts the stream reference to a *bool* value. The resulting value is *true* if the stream is able to extract data, and *false* otherwise.

only using the namespace `std`,<sup>3</sup> so there is no problem. In Chapter 12, we will teach you another way around this problem with parameters and namespaces. This other approach will allow you to use any kinds of multiple namespaces.

Many programmers prefer to place *using* directives at the start of the program file. For example, consider the following *using* directive:

```
using namespace std;
```

Many of the programs in this book do not place this *using* directive at the start of the program file. Instead, this *using* directive is placed at the start of each function definition that needs the namespace `std` (immediately after the opening brace). An example of this is shown in Display 6.3. An even better example is shown in Display 5.11. All of the programs that have appeared so far in this book, and almost all programs that follow, would behave exactly the same if there were just one *using* directive for the namespace `std` and that one *using* directive were placed immediately after the `include` directives, as in Display 6.6. For the namespace `std`, the *using* directive can safely be placed at the start of the file (in almost all cases). For some other namespaces, a single *using* directive will not always suffice, but you will not see any of these cases for some time.

We advocate placing the *using* directives inside function definitions (or inside some other small units of code) so that it does not interfere with any other possible *using* directives. This trains you to use namespaces correctly in preparation for when you write more complicated code later in your programming career. In the meantime, we sometimes violate this rule ourselves when following the rule becomes too burdensome to the other issues we are discussing. If you are taking a course, do whatever your instructor requires. Otherwise, you have some latitude in where you place your *using* directives.

## PROGRAMMING EXAMPLE

### Cleaning Up a File Format

The program in Display 6.6 takes its input from the file `rawdata.dat` and writes its output, in a neat format, both to the screen and to the file `neat.dat`. The program copies numbers from the file `rawdata.dat` to the file `neat.dat`, but it uses formatting instructions to write them in a neat way. The numbers are written one per line in a field of width 12, which means that each number is preceded by enough blanks so that the blanks plus the number occupy 12 spaces. The numbers are written in ordinary notation; that is, they are not written in e-notation. Each number is written with five digits after the decimal

---

<sup>3</sup> We are actually using two namespaces: the namespace `std` and a namespace called the global namespace, which is a namespace that consists of all names that are not in some other namespace. But this technical detail is not a big issue to us now.

point and with a plus or minus sign. The output to the screen is the same as the output to the file `neat.dat`, except that the screen output has one extra line that announces that the program is ending. The program uses a function, named `make_neat`, that has formal parameters for the input-file stream and the output-file stream.

## SELF-TEST EXERCISES

19. What output will be produced when the following lines are executed, assuming the file `list.dat` contains the data shown (and assuming the lines are embedded in a complete and correct program with the proper `include` directives)?

```
ifstream ins;
ins.open("list.dat");
int count = 0, next;
while (ins >> next)
{
 count++;
 cout << next << endl;
}
ins.close();
cout << count;
```

The file `list.dat` contains the following three numbers (and nothing more)

|   |   |
|---|---|
| 1 | 2 |
| 3 |   |

20. Write the definition for a `void` function called `to_screen`. The function `to_screen` has one formal parameter called `file_stream`, which is of type `ifstream`. The precondition and postcondition for the function are as follows:

```
//Precondition: The stream file_stream has been connected
//to a file with a call to the member function open. The
//file contains a list of integers (and nothing else).
//Postcondition: The numbers in the file connected to
//file_stream have been written to the screen one per line.
//(This function does not close the file.)
```

21. (This exercise is for those who have studied the optional section entitled "File Names as Input.") Suppose you are given the following string variable declaration and input statement:



```
#include <iostream>
using namespace std;
// ...
char name[21];
cout >> name;
```

Suppose this code segment is embedded in a correct program. What is the longest name that can be entered into the string variable `name`?

## 6.3 CHARACTER I/O

*Polonius: What do you read, my lord?*

*Hamlet: Words, words, words.*

WILLIAM SHAKESPEARE, *Hamlet*

All data is input and output as character data. When your program outputs the number 10, it is really the two characters '1' and '0' that are output. Similarly, when the user wants to type in the number 10, he or she types in the character '1' followed by the character '0'. Whether the computer interprets this 10 as two characters or as the number 10 depends on how your program is written. But, however your program is written, the computer hardware is always reading the characters '1' and '0', not the number 10. This conversion between characters and numbers is usually done automatically so that you need not think about such detail. Sometimes, however, all this automatic help gets in the way. Therefore, C++ provides some low-level facilities for input and output of character data. These low-level facilities include no automatic conversions. This allows you to bypass the automatic facilities and do input/output in absolutely any way you want. You could even write input and output functions that read and write numbers in Roman numeral notation, if you wanted to be so perverse.

### The Member Functions `get` and `put`

The function `get` allows your program to read in one character of input and store it in a variable of type `char`. Every input stream, whether it is an input-file stream or the stream `cin`, has `get` as a member function. We will describe `get` as a member function of the stream `cin`, but it behaves in exactly the same way for input-file streams as it does for `cin`, so you can apply all that we say about `get` to input-file streams as well as to the stream `cin`.

Before now, we have used `cin` with the extraction operator `>>` in order to read a character of input (or any other input, for that matter). When you use the extraction operator `>>`, as we have been doing, some things are done for you automatically, such as skipping blanks. With the member function `get`, nothing is done automatically. If you want, for example, to skip over blanks using `cin.get`, you must write code to read and discard the blanks.

The member function `get` takes one argument, which should be a variable of type `char`. That argument receives the input character that is read from the input stream. For example, the following reads in the next input character from the keyboard and stores it in the variable `next_symbol`:

```
char next_symbol;
cin.get(next_symbol);
```

It is important to note that your program can read any character in this way. If the next input character is a blank, this code will not skip over the blank, but will read the blank and set the value of `next_symbol` equal to the blank character. If the next character is the new-line character `'\n'`, that is, if the program has just reached the end of an input line, then the call to `cin.get` shown earlier sets the value of `next_symbol` equal to `'\n'`.

Reading blanks  
and `'\n'`

Although we write it as two symbols, `'\n'` is just a single character in C++. With the member function `get`, the character `'\n'` can be input and output just like any other character. For example, suppose your program contains the following code:

```
char c1, c2, c3;
cin.get(c1);
cin.get(c2);
cin.get(c3);
```

and suppose you type in the following two lines of input to be read by this code:

```
AB
CD
```

That is, suppose you type `AB` followed by Return and then `CD` followed by Return. As you would expect, the value of `c1` is set to `'A'` and the value of `c2` is set to `'B'`. That's nothing new. But when this code fills the variable `c3`, things are different from what they would be if you had used the extraction operator `>>` instead of the member function `get`. When this code is executed on the input we showed, the value of `c3` is set to `'\n'`; that is, the value of `c3` is set equal to the new-line character. The variable `c3` is not set equal to `'C'`.

One thing you can do with the member function `get` is to have your program detect the end of a line. The following loop will read a line of input and stop after passing the new-line character `'\n'`. Then, any subsequent input will be read from the beginning of the next line. For this first example, we have simply echoed the input, but the same technique would allow you to do whatever you want with the input:

Detecting the end  
of an input line

```
cout << "Enter a line of input and I will echo it:\n";
char symbol;
do
{
 cin.get(symbol);
```

```

 cout << symbol;
} while (symbol != '\n');
cout << "That's all for this demonstration.";

```

This loop will read any line of input and echo it exactly, including blanks. The following is a sample dialogue produced by this code:

```

Enter a line of input and I will echo it:
Do Be Do 1 2 34
Do Be Do 1 2 34
That's all for this demonstration.

```

Notice that the new-line character '\n' is both read and output. Since '\n' is output, the string that begins with the word "That 's" is on a new line.

### The Member Function `get`

Every input stream has a member function named `get` that can be used to read one character of input. Unlike the extraction operator `>>`, `get` reads the next input character, no matter what that character is. In particular, `get` reads a blank or the new-line character '\n' if either of these is the next input character. The function `get` takes one argument, which should be a variable of type *char*. When `get` is called, the next input character is read and the argument variable (called *Char\_Variable* below) has its value set equal to this input character.

#### SYNTAX

```
Input_Stream.get(Char_Variable);
```

#### EXAMPLE

```
char next_symbol;
cin.get(next_symbol);
```

If you wish to use `get` to read from a file, you use an input-file stream in place of the stream `cin`. For example, if `in_stream` is an input stream for a file, then the following reads one character from the input file and places the character in the *char* variable `next_symbol`:

```
in_stream.get(next_symbol);
```

Before you can use `get` with an input-file stream such as `in_stream`, your program must first connect the stream to the input file with a call to `open`.

(continued)

### '\n' and "\n"

'\n' and "\n" sometimes seem like the same thing. In a `cout` statement, they produce the same effect, but they cannot be used interchangeably in all situations. '\n' is a value of type *char* and can be stored in a variable of type *char*. On the other hand, "\n" is a string that happens to be made up of exactly one character. Thus, "\n" is not of type *char* and cannot be stored in a variable of type *char*.

The member function `put` is analogous to the member function `get` except that it is used for output rather than input. `put` allows your program to output one character. The member function `put` takes one argument, which should be an expression of type *char*, such as a constant or a variable of type *char*. The value of the argument is output to the stream when the function is called. For example, the following outputs the letter 'a' to the screen:

```
cout.put('a');
```

The function `cout.put` does not allow you to do anything you could not do by using the methods we discussed previously, but we include it for completeness.

If your program uses `cin.get` or `cout.put`, then just as with other uses of `cin` and `cout`, your program should include the following directive:

```
#include <iostream>
```

Similarly, if your program uses `get` for an input-file stream or `put` for an output-file stream, then just as with any other file I/O, your program should contain the following directive:

```
#include <fstream>
```

### The Member Function `put`

Every output stream has a member function named `put`, which takes one argument which should be an expression of type *char*. When the member function `put` is called, the value of its argument (called *Char\_Expression* below) is output to the output stream.

#### SYNTAX

```
Output_Stream.put(Char_Expression);
```

(continued)

**EXAMPLES**

```
cout.put(next_symbol);
cout.put('a');
```

If you wish to use `put` to output to a file, you use an output-file stream in place of the stream `cout`. For example, if `out_stream` is an output stream for a file, then the following will output the character 'Z' to the file connected to `out_stream`:

```
out_stream.put('Z');
```

Before you can use `put` with an output-file stream, such as `out_stream`, your program must first connect the stream to the output file with a call to the member function `open`.

When using either of these `include` directives, your program must also include the following:

```
using namespace std;
```

### The `putback` Member Function (*Optional*)

Sometimes your program needs to know the next character in the input stream. However, after reading the next character, it might turn out that you do not want to process that character and so you would like to simply put it back in the input stream. For example, if you want your program to read up to *but not including* the first blank it encounters in an input stream, then your program must read that first blank in order to know when to stop reading—but then that blank is no longer in the stream. Some other part of your program might need to read and process this blank. There are a number of ways to deal with this sort of situation, but the easiest is to use the member function `putback`. The function `putback` is a member of every input stream. It takes one argument of type `char` and it places the value of that argument back in the input stream. The argument can be any expression that evaluates to a value of type `char`.

For example, the following code will read characters from the file connected to the input stream `fin` and write them to the file connected to the output stream `fout`. The code reads characters up to, but not including, the first blank it encounters.

```
fin.get(next);
while (next != ' ')
{
 fout.put(next);
 fin.get(next);
}
fin.putback(next);
```

Notice that after this code is executed, the blank that was read is still in the input stream `fin`, because the code puts it back after reading it.

Notice that `putback` places a character in an *input* stream, while `put` places a character in an *output* stream. The character that is put back into the input stream with the member function `putback` need not be the last character read; it can be any character you wish. If you put back a character other than the last character read, the text in the input file will not be changed by `putback`, although your program will behave as if the text in the input file had been changed.

## PROGRAMMING EXAMPLE

### Checking Input

If a user enters incorrect input, the entire run of the program can become worthless. To ensure that your program is not hampered by incorrect input, you should use input functions that allow the user to reenter input until the input is correct. The function `get_int` in Display 6.7 asks the user whether the input is correct and asks for a new value if the user says the input is incorrect. The program in Display 6.7 is just a driver program to test the function `get_int`, but the function, or one very similar to it, can be used in just about any kind of program that takes its input from the keyboard.

Notice the call to the function `new_line( )`. The function `new_line` reads all the characters on the remainder of the current line but does nothing with them. This amounts to discarding the remainder of the line. Thus, if the user types in `No`, then the program reads the first letter, which is `N`, and then calls the function `new_line`, which discards the rest of the input line. This means that if the user types `75` on the next input line, as shown in the sample dialogue, the program will read the number `75` and will not attempt to read the letter `o` in the word `No`. If the program did not include a call to the function `new_line`, then the next item read would be the `o` in the line containing `No` instead of the number `75` on the following line.

### DISPLAY 6.7 Checking Input (part 1 of 2)

```

1 //Program to demonstrate the functions new_line and get_input.
2 #include <iostream>
3 using namespace std;
4
5 void new_line();
6 //Discards all the input remaining on the current input line.
7 //Also discards the '\n' at the end of the line.
8 //This version works only for input from the keyboard.
9
10 void get_int(int& number);
11 //Postcondition: The variable number has been

```

(continued)

**DISPLAY 6.7** Checking Input (part 2 of 2)

---

```
12 //given a value that the user approves of.
13
14
15 int main()
16 {
17 int n;
18
19 get_int(n);
20 cout << "Final value read in = " << n << endl
21 << "End of demonstration.\n";
22 return 0;
23 }
24
25
26 //Uses iostream:
27 void new_line()
28 {
29 char symbol;
30 do
31 {
32 cin.get(symbol);
33 } while (symbol != '\n');
34 }
35 //Uses iostream:
36 void get_int(int& number)
37 {
38 char ans;
39 do
40 {
41 cout << "Enter input number: ";
42 cin >> number;
43 cout << "You entered " << number
44 << ". Is that correct? (yes/no): ";
45 cin >> ans;
46 new_line();
47 } while ((ans != 'Y') && (ans != 'y'));
48 }
```

---

**Sample Dialogue**

```
Enter input number: 57
You entered 57. Is that correct? (yes/no): No
Enter input number: 75
You entered 75. Is that correct? (yes/no): yes
Final value read in = 75
End of demonstration.
```

---

Notice the Boolean expression that ends the *do-while* loop in the function `get_int`. If the input is not correct, the user is supposed to type No (or some variant such as no), which will cause one more iteration of the loop. However, rather than checking to see if the user types a word that starts with 'N', the *do-while* loop checks to see if the first letter of the user's response is *not* equal to 'Y' (and not equal to the lowercase version of 'Y'). As long as the user makes no mistakes and responds with some form of Yes or No, but never with anything else, then checking for No or checking for not being Yes are the same thing. However, since the user might respond in some other way, checking for not being Yes is safer. To see why this is safer, suppose the user makes a mistake in entering the input number. The computer echoes the number and asks if it is correct. The user should type in No, but suppose the user makes a mistake and types in Bo, which is not unlikely since 'B' is right next to 'N' on the keyboard. Since 'B' is not equal to 'Y', the body of the *do-while* loop will be executed, and the user will be given a chance to reenter the input.

When in doubt,  
enter the input  
again

But, what happens if the correct response is Yes and the user mistakenly enters something that begins with a letter other than 'Y' or 'y'? In that case, the loop should not iterate, but it does iterate one extra time. This is a mistake, but not nearly as bad a mistake as the one discussed in the last paragraph. It means the user must type in the input number one extra time, but it does not waste the entire run of the program. When checking input, it is better to risk an extra loop iteration than to risk proceeding with incorrect input.

### **PITFALL** Unexpected '\n' in Input

When using the member function `get`, you must account for every character of input, even the characters you do not think of as being symbols, such as blanks and the new-line character '\n'. A common problem when using `get` is forgetting to dispose of the '\n' that ends every input line. If there is a new-line character in the input stream that is not read (and usually discarded), then when your program next expects to read a "real" symbol using the member function `get`, it will instead read the character '\n'. To clear the input stream of any leftover '\n' characters, you can use the function `new_line`, which we defined in Display 6.7. Let's look at a concrete example.

It is legal to mix the different forms of `cin`. For example, the following is legal:

```
cout << "Enter a number:\n";
int number;
cin >> number;
cout << "Now enter a letter:\n";
char symbol;
cin.get(symbol);
```

However, this mixing can produce problems, as illustrated by the following dialogue:



```
Enter a number:
21
Now enter a letter:
A
```

With this dialogue, the value of `number` will be 21, as you expect. However, if you expect the value of the variable `symbol` to be 'A', you will be disappointed. The value given to `symbol` is '\n'. After reading the number 21, the next character in the input stream is the new-line character, '\n', and so that is read next. Remember, `get` does not skip over line breaks and spaces. (In fact, depending on what is in the rest of the program, you may not even get a chance to type in the A. Once the variable `symbol` is filled with the character '\n', the program proceeds to whatever statement is next in the program. If the next statement sends output to the screen, the screen will be filled with output before you get a chance to type in the A.)

Either of the following rewritings of the previous code will cause the previous dialogue to fill the variable `number` with 21 and fill the variable `symbol` with 'A':

```
cout << "Enter a number:\n";
int number;
cin >> number;
cout << "Now enter a letter:\n";
char symbol;
cin >> symbol;
```

Alternatively, you can use the function `new_line`, defined in Display 6.7, as follows:

```
cout << "Enter a number:\n";
int number;
cin >> number;
new_line();
cout << "Now enter a letter:\n";
char symbol;
cin.get(symbol);
```

As this second rewrite indicates, you can mix the two forms of `cin` and have your program work correctly, but it does require some extra care. ■

### Making Stream Parameters Versatile

If you want to define a function that takes an input stream as an argument and you want that argument to be `cin` in some cases and an input-file stream in other cases, then use a formal parameter of type `istream` (without an `f`). However, an input-file stream, even if used as an argument of type `istream`, must still be declared to be of type `ifstream` (with an `f`).

*(continued)*

Similarly, if you want to define a function that takes an output stream as an argument and you want that argument to be `cout` in some cases and an output-file stream in other cases, then use a formal parameter of type `ostream`. However, an output-file stream, even if used as an argument of type `ostream`, must still be declared to be of type `ofstream`. You cannot open or close a stream parameter of type `istream` or `ostream`. Open these objects before passing them to your function and close them after the call.

## PROGRAMMING EXAMPLE

### Another `new_line` Function

As another example of how you can make a stream function more versatile, consider the function `new_line` in Display 6.7. That function works only for input from the keyboard, which is input from the predefined stream `cin`. The function `new_line` in Display 6.7 has no arguments. Below we have rewritten the function `new_line` so that it has a formal parameter of type `istream` for the input stream:

```
//Uses istream:
void new_line(istream& in_stream)
{
 char symbol;
 do
 {
 in_stream.get(symbol);
 } while (symbol != '\n');
}
```

Now, suppose your program contains this new version of the function `new_line`. If your program is taking input from an input stream called `fin` (which is connected to an input file), the following will discard all the input left on the line currently being read from the input file:

```
new_line(fin);
```

On the other hand, if your program is also reading some input from the keyboard, the following will discard the remainder of the input line that was typed in at the keyboard:

```
new_line(cin);
```

If your program has only the rewritten version of `new_line` above, which takes a stream argument such as `fin` or `cin`, you must always give the stream name, even if the stream name is `cin`. But thanks to overloading, you can have both versions of the function `new_line` in the same program: the version with

Using both  
versions of  
`new_line`

no arguments that is given in Display 6.7 and the version with one argument of type `istream` that we just defined. In a program with both definitions of `new_line`, the following two calls are equivalent:

```
new_line(cin);
```

and

```
new_line();
```

You do not really need two versions of the function `new_line`. The version with one argument of type `istream` can serve all your needs. However, many programmers find it convenient to have a version with no arguments for keyboard input, since keyboard input is used so frequently.



## Default Arguments for Functions (*Optional*)

An alternative to having two versions of the `new_line` function is to use **default arguments**. In the following code, we have rewritten the `new_line` function a third time:

```
//Uses iostream:
void new_line(istream& in_stream = cin)
{
 char symbol;
 do
 {
 in_stream.get(symbol);
 } while (symbol != '\n');
}
```

If we call this function as

```
new_line();
```

the formal parameter takes the default argument `cin`. If we call this as

```
new_line(fin);
```

the formal parameter takes the argument provided in the call to `fin`. This facility is available to us with any argument type and any number of arguments.

If some parameters are provided default arguments and some are not, the formal parameters with default arguments must all be together at the end of the argument list. If you provide several defaults and several nondefault arguments, the call may provide either as few arguments as there are nondefault arguments or more arguments, up to the number of parameters. The arguments will be applied to the parameters without default arguments in order, and then will be applied to the parameters with default arguments up to the number of parameters.

Here is an example:

```
//To test default argument behavior
//Uses iostream
void default_args(int arg1, int arg2, int arg3 = -3,
 int arg4 = -4)
{
 cout << arg1 << ' ' << arg2 << ' ' << arg3 << ' ' << arg4
 << endl;
}

```

Calls to this may be made with two, three, or four arguments. For example, the call

```
default_args(5, 6);
```

supplies the nondefault arguments and uses the two default arguments. The output is

```
5 6 -3 -4
```

Next, consider

```
default_args(6, 7, 8);
```

This call supplies the nondefault arguments and the first default argument, and the last argument uses the default. This call gives the following output:

```
6 7 8 -4
```

The call

```
default_args(5, 6, 7, 8);
```

assigns all the arguments from the argument list and gives the following output:

```
5 6 7 8
```

## SELF-TEST EXERCISES

22. Suppose *c* is a variable of type *char*. What is the difference between the following two statements?

```
cin >> c;
```

and

```
cin.get(c);
```

23. Suppose `c` is a variable of type `char`. What is the difference between the following two statements?

```
cout << c;
```

and

```
cout.put(c);
```

24. (This question is for those who have read the optional section “The `putback` Member Function.”) The `putback` member function “puts back” a symbol into an input stream. Does the symbol that is put back have to be the last symbol input from the stream? For example, if your program reads an ‘a’ from the input stream, can it use the `putback` function to put back a ‘b’, or can it only put back an ‘a’?

25. Consider the following code (and assume that it is embedded in a complete and correct program and then run):

```
char c1, c2, c3, c4;
cout << "Enter a line of input:\n";
cin.get(c1);
cin.get(c2);
cin.get(c3);
cin.get(c4);
cout << c1 << c2 << c3 << c4 << "END OF OUTPUT";
```

If the dialogue begins as follows, what will be the next line of output?

```
Enter a line of input:
a b c d e f g
```

26. Consider the following code (and assume that it is embedded in a complete and correct program and then run):

```
char next;
int count = 0;
cout << "Enter a line of input:\n";
cin.get(next);
while (next != '\n')
{
 if ((count % 2) == 0)
 cout << next;
 count++;
 cin.get(next);
}
```

*True if count is even* ←

If the dialogue begins as follows, what will be the next line of output?

```
Enter a line of input:
abcdef gh
```

27. Suppose that the program described in Self-Test Exercise 26 is run and the dialogue begins as follows (instead of beginning as shown in Self-Test Exercise 26). What will be the next line of output?

```
Enter a line of input:
0 1 2 3 4 5 6 7 8 9 10 11
```

28. Consider the following code (and assume that it is embedded in a complete and correct program and then run):

```
char next;
int count = 0;
cout << "Enter a line of input:\n";
cin >> next;
while (next != '\n')
{
 if ((count % 2) == 0)
 cout << next;
 count++;
 cin >> next;
}
```

If the dialogue begins as follows, what will be the next line of output?

```
Enter a line of input:
0 1 2 3 4 5 6 7 8 9 10 11
```

29. Define a function called `copy_char` that takes one argument that is an input stream. When called, `copy_char` will read one character of input from the input stream given as its argument and will write that character to the screen. You should be able to call your function using either `cin` or an input-file stream as the argument to your function `copy_char`. (If the argument is an input-file stream, then the stream is connected to a file before the function is called, so `copy_char` will not open or close any files.) For example, the first of the following two calls to `copy_char` will copy a character from the file `stuff.dat` to the screen, and the second will copy a character from the keyboard to the screen:

```
ifstream fin;
fin.open("stuff.dat");
copy_char(fin);
copy_char(cin);
```

30. Define a function called `copy_line` that takes one argument that is an input stream. When called, `copy_line` reads one line of input from the input stream given as its argument and writes that line to the screen. You should be able to call your function using either `cin` or an input-file stream as the argument to your function `copy_line`. (If the argument

is an input-file stream, then the stream is connected to a file before the function is called, so `copy_line` will not open or close any files.) For example, the first of the following two calls to `copy_line` will copy a line from the file `stuff.dat` to the screen, and the second will copy a line from the keyboard to the screen:

```
ifstream fin;
fin.open("stuff.dat");
copy_line(fin);
copy_line(cin);
```

31. Define a function called `send_line` that takes one argument that is an output stream. When called, `send_line` reads one line of input from the keyboard and outputs the line to the output stream given as its argument. You should be able to call your function using either `cout` or an output-file stream as the argument to your function `send_line`. (If the argument is an output-file stream, then the stream is connected to a file before the function is called, so `send_line` will not open or close any files.) For example, the first of the following calls to `send_line` copies a line from the keyboard to the file `morestuff.dat`, and the second copies a line from the keyboard to the screen:

```
ofstream fout;
fout.open("morestuff.dat");
cout << "Enter 2 lines of input:\n";
send_line(fout);
send_line(cout);
```

32. (This exercise is for those who have studied the optional section on default arguments.) What output does the following function provide in response to the following calls?

```
void func(double x, double y = 1.1, double z = 2.3)
{
 cout << x << " " << y << " " << z << endl;
}
```

Calls:

- `func(2.0);`
  - `func(2.0, 3.0);`
  - `func(2.0, 3.0, 4.0);`
33. (This exercise is for those who have studied the optional section on default arguments.) Write several functions that overload the function name to get the same effect as all the calls in the default function arguments in the previous Self-Test Exercise.

## The eof Member Function

Every input-file stream has a member function called `eof` that can be used to determine when all of the file has been read and there is no more input left for the program. This is the second technique we have presented for determining when a program has read everything in a file.

The letters `eof` stand for *end of file*, and `eof` is normally pronounced by saying the three letters e-o-f. The function `eof` takes no arguments, so if the input stream is called `fin`, then a call to the function `eof` is written

```
fin.eof()
```

This is a Boolean expression that can be used to control a *while* loop, a *do-while* loop, or an *if-else* statement. This expression is satisfied (that is, is *true*) if the program has read past the end of the input file; otherwise, the expression above is not satisfied (that is, is *false*).

Since we usually want to test that we are *not* at the end of a file, a call to the member function `eof` is typically used with a *not* in front of it. Recall that in C++ the symbol `!` is used to express *not*. For example, consider the following statement:

`eof` is usually used with "not"

```
if (! fin.eof())
 cout << "Not done yet.";
else
 cout << "End of the file.";
```

The Boolean expression after the *if* means "not at the end of the file connected to `fin`." Thus, the *if-else* statement above will output the following to the screen:

```
Not done yet.
```

provided the program has not yet read past the end of the file that is connected to the stream `fin`. The *if-else* statement will output the following, if the program has read beyond the end of the file:

```
End of the file.
```

As another example of using the `eof` member function, suppose that the input stream `in_stream` has been connected to an input file with a call to `open`. Then the entire contents of the file can be written to the screen with the following *while* loop:

Ending an input loop with the `eof` function

```
in_stream.get(next);
while (! in_stream.eof())
{
 cout << next;
 in_stream.get(next);
}

```

If you prefer, you can use `cout.put(next)` here.



This *while* loop reads each character from the input file into the *char* variable next using the member function `get`, and then writes the character to the screen. After the program has passed the end of the file, the value of `in_stream.eof( )` changes from *false* to *true*. So,

```
(! in_stream.eof())
```

changes from *true* to *false* and the loop ends.

Notice that `in_stream.eof( )` does not become *true* until the program attempts to read one character beyond the end of the file. For example, suppose the file contains the following (without any new-line after the `c`):

```
ab
c
```

This is actually the following list of four characters:

```
ab<the new-line character '\n'>c
```

This loop reads an 'a' and writes it to the screen, then reads a 'b' and writes it to the screen, then reads the new-line character '\n' and writes it to the screen, and then reads a 'c' and writes it to the screen. At that point the loop will have read all the characters in the file. However, `in_stream.eof( )` will still be *false*. The value of `in_stream.eof( )` will not change from *false* to *true* until the program tries to read one more character. That is why the *while* loop ends with `in_stream.get(next)`. The loop needs to read one extra character in order to end the loop.

There is a special end-of-file marker at the end of a file. The member function `eof` does not change from *false* to *true* until this end-of-file marker is read. That's why the example *while* loop could read one character beyond what you think of as the last character in the file. However, this end-of-file marker is not an ordinary character and should not be manipulated like an ordinary character. You can read this end-of-file marker but you should not write it out again. If you write out the end-of-file marker, the result is unpredictable. The system automatically places this end-of-file marker at the end of each file for you.

The next Programming Example uses the `eof` member function to determine when the program has read the entire input file.

Deciding how to  
test for the end  
of an input file

You now have two methods for detecting the end of a file. You can use the `eof` member function or you can use the method we described in the Programming Tip entitled "Checking for the End of a File." In most situations you can use either method, but many programmers use the two different methods in different situations. If you do not have any other reason to prefer one of these two methods, then use the following general rule: Use the `eof` member function when you are treating the input as text and reading the input with the `get` member function; use the other method when you are processing numeric data.

## SELF-TEST EXERCISES

34. Suppose `ins` is a file input stream that has been connected to a file with the member function `open`. Suppose your program has just read the last character in the file. At this point, would `ins.eof( )` evaluate to *true* or *false*?
35. Write the definition for a *void* function called `text_to_screen` that has one formal parameter called `file_stream` that is of type `ifstream`. The precondition and postcondition for the function are as follows:

```
//Precondition: The stream file_stream has been connected
//to a file with a call to the member function open.
//Postcondition: The contents of the file connected to
//file_stream have been copied to the screen character by
//character, so that the screen output is the same as the
//contents of the text in the file.
//(This function does not close the file.)
```

## PROGRAMMING EXAMPLE

### Editing a Text File

The program discussed here is a very simple example of text editing applied to files. It might be used by a software firm to update its advertising literature. The firm has been marketing compilers for the C programming language and has recently introduced a line of C++ compilers. This program can be used to automatically generate C++ advertising material from the existing C advertising material. The program takes its input from a file that contains advertising copy that says good things about C and writes similar advertising copy about C++ in another file. The file that contains the C advertising copy is called `cad.dat`, and the new file that receives the C++ advertising copy is called `cp1usad.dat`. The program is shown in Display 6.8.

The program simply reads every character in the file `cad.dat` and copies the characters to the file `cp1usad.dat`. Every character is copied unchanged, except that when the uppercase letter 'C' is read from the input file, the program writes the string "C++" to the output file. This program assumes that whenever the letter 'C' occurs in the input file, it names the C programming language; thus, this change is exactly what is needed to produce the updated advertising copy.

Notice that the line breaks are preserved when the program reads characters from the input file and writes the characters to the output file. The new-line character '\n' is treated just like any other character. It is read from the input file with the member function `get`, and it is written to the output file using the insertion operator `<<`. We must use the member function `get` to

read the input. If we instead use the extraction operator `>>` to read the input, the program would skip over all the whitespace, which means that none of the blanks and none of the new-line characters `'\n'` would be read from the input file, so they would not be copied to the output file.

Also notice that the member function `eof` is used to detect the end of the input file and end the *while* loop.

## Predefined Character Functions

In text processing, you often want to convert lowercase letters to uppercase or vice versa. The predefined function `toupper` can be used to convert a lowercase letter to an uppercase letter. For example, `toupper('a')` returns `'A'`. If the argument to the function `toupper` is anything other than a lowercase letter, then `toupper` simply returns the argument unchanged. So `toupper('A')` also returns `'A'`. The function `tolower` is similar except that it converts an uppercase letter to its lowercase version.

The functions `toupper` and `tolower` are in the library with the header file `cctype`, so any program that uses these functions, or any other functions in this library, must contain the following `include` directive:

```
#include <cctype>
```

### DISPLAY 6.8 Editing a File of Text (part 1 of 2)

```
1 //Program to create a file called cplusplus.dat that is identical to the file
2 //cad.dat, except that all occurrences of 'C' are replaced by "C++".
3 //Assumes that the uppercase letter 'C' does not occur in cad.dat except
4 //as the name of the C programming language.
5 #include <fstream>
6 #include <iostream>
7 #include <cstdlib>
8 using namespace std;
9 void add_plus_plus(ifstream& in_stream, ofstream& out_stream);
10 //Precondition: in_stream has been connected to an input file with open.
11 //out_stream has been connected to an output file with open.
12 //Postcondition: The contents of the file connected to in_stream have been
13 //copied into the file connected to out_stream, but with each 'C' replaced
14 //by "C++". (The files are not closed by this function.)
15 int main()
16 {
17 ifstream fin;
18 ofstream fout;
19 cout << "Begin editing files.\n";
20 fin.open("cad.dat");
21 if (fin.fail())
22 {
```

(continued)

**DISPLAY 6.8** Editing a File of Text (part 2 of 2)

```

23 cout << "Input file opening failed.\n";
24 exit(1);
25 }
26 fout.open("cplusad.dat");
27 if (fout.fail())
28 {
29 cout << "Output file opening failed.\n";
30 exit(1);
31 }
32 add_plus_plus(fin, fout);
33 fin.close();
34 fout.close();
35 cout << "End of editing files.\n";
36 return 0;
37 }
38
39 void add_plus_plus(ifstream& in_stream, ofstream& out_stream)
40 {
41 char next;
42 in_stream.get(next);
43 while (! in_stream.eof())
44 {
45 if (next == 'C')
46 out_stream << "C++";
47 else
48 out_stream << next;
49 in_stream.get(next);
50 }
51 }

```

**cad.dat**

(Not changed by program.)

C is one of the world's most modern programming languages.  
There is no language as versatile as C, and C is fun to use.

**cplusad.dat**

(After program is run.)

C++ is one of the world's most modern programming languages.  
There is no language as versatile as C++, and C++ is fun to use.

**Screen Output**

Begin editing files.  
End of editing files.

Display 6.9 contains descriptions of some of the most commonly used functions in the library `cctype`.

The function `isspace` returns *true* if its argument is a *whitespace* character. If the argument to `isspace` is not a whitespace character, then `isspace` returns *false*. Thus, `isspace(' ')` returns *true* and `isspace('a')` returns *false*.

For example, the following code reads a sentence terminated with a period and echoes the string with all whitespace characters replaced with the symbol '-':

```
char next;
do
{
 cin.get(next);
 if (isspace(next)) ← True if the character in
 next is whitespace
 cout << '-';
 else
 cout << next;
} while (next != '.');
```

For example, if the code above is given the following input:

```
Ahhdo be do.
```

then it will produce the following output:

```
Ahhdo--be--do.
```

## **PITFALL** toupper and tolower Return Values

In many ways, C++ considers characters to be whole numbers, similar to the numbers of type *int*. Each character is assigned a number, and when the character is stored in a variable of type *char*, it is this number that is placed in the computer's memory. In C++ you can use a value of type *char* as a number—for example, by placing it in a variable of type *int*. You can also store a number of type *int* in a variable of type *char* (provided the number is not too large). Thus, the type *char* can be used as the type for characters or as a type for small whole numbers.

Usually you need not be concerned with this detail and can simply think of values of type *char* as being characters and not worry about their use as numbers. However, when using the functions in `cctype`, this detail can be important. The functions `toupper` and `tolower` actually return values of type *int* rather than values of type *char*; that is, they return the number corresponding to the character we think of them as returning, rather than the character itself. Thus, the following will not output the letter 'A', but will instead output the number that is assigned to 'A':

```
cout << toupper('a');
```

**DISPLAY 6.9** Some Predefined Character Functions in `cctype`

| Function                       | Description                                                                                                                                     | Example                                                                                                                                                                                   |
|--------------------------------|-------------------------------------------------------------------------------------------------------------------------------------------------|-------------------------------------------------------------------------------------------------------------------------------------------------------------------------------------------|
| <code>toupper(Char_Exp)</code> | Returns the uppercase version of <i>Char_Exp</i> .                                                                                              | <pre>char c = toupper('a'); cout &lt;&lt; c; <b>Outputs:</b> A</pre>                                                                                                                      |
| <code>tolower(Char_Exp)</code> | Returns the lowercase version of <i>Char_Exp</i> .                                                                                              | <pre>char c = tolower('A'); cout &lt;&lt; c; <b>Outputs:</b> a</pre>                                                                                                                      |
| <code>isupper(Char_Exp)</code> | Returns <i>true</i> provided <i>Char_Exp</i> is an uppercase letter; otherwise, returns <i>false</i> .                                          | <pre>if (isupper(c))     cout &lt;&lt; c &lt;&lt;         &lt;&lt; " isuppercase."; else     cout &lt;&lt; c         &lt;&lt; " is not uppercase.";</pre>                                 |
| <code>islower(Char_Exp)</code> | Returns <i>true</i> provided <i>Char_Exp</i> is a lowercase letter; otherwise, returns <i>false</i> .                                           | <pre>char c = 'a'; if (islower(c))     cout &lt;&lt; c &lt;&lt;&lt;&lt; " islowercase."; <b>Outputs:</b> a is lowercase.</pre>                                                            |
| <code>isalpha(Char_Exp)</code> | Returns <i>true</i> provided <i>Char_Exp</i> is a letter of the alphabet; otherwise, returns <i>false</i> .                                     | <pre>char c = '\$'; if (isalpha(c))     cout &lt;&lt; c &lt;&lt; " is a letter."; else     cout &lt;&lt; c         &lt;&lt;" is not a letter."; <b>Outputs:</b> \$ is not a letter.</pre> |
| <code>isdigit(Char_Exp)</code> | Returns <i>true</i> provided <i>Char_Exp</i> is one of the digits '0' through '9'; otherwise, returns <i>false</i> .                            | <pre>if (isdigit('3'))     cout &lt;&lt; "It's a digit."; else     cout &lt;&lt; "It's not a digit."; <b>Outputs:</b> It's a digit.</pre>                                                 |
| <code>isspace(Char_Exp)</code> | Returns <i>true</i> provided <i>Char_Exp</i> is a whitespace character, such as the blank or new-line symbol; otherwise, returns <i>false</i> . | <pre>//Skips over one "word" and //sets c equal to the first //whitespace character after //the "word": do {     cin.get(c); } while (! isspace(c));</pre>                                |

In order to get the computer to treat the value returned by `toupper` or `tolower` as a value of type `char` (as opposed to a value of type `int`), you need to indicate that you want a value of type `char`. One way to do this is to place the value returned in a variable of type `char`. The following will output the character 'A', which is usually what we want:

```
char c = toupper('a'); ← Places 'A' in the
cout << c; variable c
```

Another way to get the computer to treat the value returned by `toupper` or `tolower` as a value of type `char` is to use a type cast as follows:

```
cout << static_cast<char>(toupper('a'));
```

(Type casts were discussed in Chapter 4 in the section “Type Casting.”) ■

## SELF-TEST EXERCISES

36. Consider the following code (and assume that it is embedded in a complete and correct program and then run):

```
cout << "Enter a line of input:\n";
char next;
do
{
 cin.get(next);
 cout << next;
} while ((! isdigit(next)) && (next != '\n'));
cout << "<END OF OUTPUT";
```

If the dialogue begins as follows, what will be the next line of output?

```
Enter a line of input:
I'll see you at 10:30 AM.
```

37. Write some C++ code that will read a line of text and echo the line with all uppercase letters deleted.

## CHAPTER SUMMARY

- A stream of type `ifstream` can be connected to a file with a call to the member function `open`. Your program can then take input from that file.
- A stream of type `ofstream` can be connected to a file with a call to the member function `open`. Your program can then send output to that file.
- You should use the member function `fail` to check whether a call to `open` was successful.

- An **object** is a variable that has functions associated with it. These functions are called **member functions**. A **class** is a type whose variables are objects. A stream is an example of an object. The types `ifstream` and `ofstream` are examples of classes.
- The following is the syntax you use when you write a call to a member function of an object:

```
Calling_Object.Member_Function_Name(Argument_List);
```

An example with the stream `cout` as the calling object and `precision` as the member function is the following:

```
cout.precision(2);
```

- Stream member functions, such as `width`, `setf`, and `precision`, can be used to format output. These output functions work the same for the stream `cout`, which is connected to the screen, and for output streams connected to files.
- Every input stream has a member function named `get` that can be used to read one character of input. The member function `get` does not skip over whitespace. Every output stream also has a member function named `put` that can be used to write one character to the output stream.
- The member function `eof` can be used to test for when a program has reached the end of an input file. The member function `eof` works well for text processing. However, when processing numeric data, you might prefer to test for the end of a file by using the other method we discussed in this chapter.
- A function may have formal parameters of a stream type, but they must be call-by-reference parameters; they cannot be call-by-value parameters. The type `ifstream` can be used for an input-file stream, and the type `ofstream` can be used for an output-file stream. (See the next summary point for other type possibilities.)
- If you use `istream` (spelled without the `f`) as the type for an input-stream parameter, then the argument corresponding to that formal parameter can be either the stream `cin` or an input-file stream of type `ifstream` (spelled with the `f`). If you use `ostream` (spelled without the `f`) as the type for an output stream parameter, then the argument corresponding to that formal parameter can be either the stream `cout` or an output-file stream of type `ofstream` (spelled with the `f`).

## Answers to Self-Test Exercises

1. The streams `fin` and `fout` are declared as follows:

```
ifstream fin;
ofstream fout;
```



The `include` directive that goes at the top of your file is

```
#include <fstream>
```

Your code also needs the following:

```
using namespace std;
```

2. `fin.open("stuff1.dat");`

```
if (fin.fail())
{
 cout << "Input file opening failed.\n";
 exit(1);
}
```

`fout.open("stuff2.dat");`

```
if (fout.fail())
{
 cout << "Output file opening failed.\n";
 exit(1);
}
```

3. `fin.close( );`

`fout.close( );`

4. You need to replace the stream `out_stream` with the stream `cout`. Note that you do not need to declare `cout`, you do not need to call `open` with `cout`, and you do not need to close `cout`.

5. `#include <cstdlib>`

Your code also needs the following:

```
using namespace std;
```

6. The `exit(1)` function returns the argument to the operating system. By convention, the operating system uses a 1 as an indication of error status and 0 as an indication of success. What is actually done is system-dependent.

7. `bla.dobedo(7);`

8. Both files and program variables store values and can have values retrieved from them. Program variables exist only while the program runs, whereas files may exist before a program is run and may continue to exist after a program stops. In short, files may be permanent; variables are not. Files provide the ability to store large quantities of data, whereas program variables do not provide quite so large a store.

9. We have seen the `open`, `close`, and `fail` member functions at this point. The following illustrate their use.

```

int c;
ifstream in;
ofstream out;
in.open("in.dat");
if (in.fail())
{
 cout << "Input file opening failed.\n";
 exit(1);
}
in >> c;

out.open("out.dat");
if (out.fail())
{
 cout << "Output file opening failed.\n";
 exit(1);
}
out << c;

out.close();
in.close();

```

10. This is the “starting over” the text describes at the beginning of this chapter. The file must be closed and opened again. This action puts the read position at the start of the file, ready to be read again.
11. The two names are the *external file name* and the *stream name*. The external file name is the one used by the operating system. It is the real name of the file, but it is used only in the call to the function `open`, which connects the file to a stream. The stream name is a stream variable (typically of type `ifstream` or `ofstream`). After the call to `open`, your program always uses the stream name as the name of the file.

12. `* 123*123*`  
`* 123*123*`

Each of the spaces contains exactly two blank characters. Notice that a call to `width` or call to `setw` only lasts for one output item.

13. `* 123*123 * 123*`

Each of the spaces consists of exactly two blank characters.

14. `* 123*123*`  
`* +123*+123*`  
`*123 *123 *`

There is just one space between the `*` and the `+` on the second line. Each of the other spaces contains exactly two blank characters.

15. The output to the file `stuff.dat` will be exactly the same as the output given in the answer to Exercise 14.

16. `*12345*`

Notice that the entire integer is output even though this requires more space than was specified by `setw`.

17. a. `ios::fixed`. Setting this flag causes floating-point numbers not to be displayed in e-notation, that is, not in scientific notation. Setting this flag unsets `ios::scientific`.
- b. `ios::scientific`. Setting this flag causes floating-point numbers to be displayed in e-notation, that is, in scientific notation. Setting this flag unsets `ios::fixed`.
- c. `ios::showpoint`. Setting this flag causes the decimal point and trailing zeros to be always displayed.
- d. `ios::showpos`. Setting this flag causes a plus sign to be output before positive integer values.
- e. `ios::right`. Setting this flag causes subsequent output to be placed at the right end of any field that is set with the `width` member function. That is, any extra blanks are put before the output. Setting this flag unsets `ios::left`.
- f. `ios::left`. Setting this flag causes subsequent output to be placed at the left end of any field that is set with the `width` member function. That is, any extra blanks are put after the output. Setting this flag unsets `ios::right`.

18. You need to replace `ostream` with `cout` and delete the `open` and `close` calls for `ostream`. You do not need to declare `cout`, `open cout`, or `close cout`. The `#include <fstream>` directive has all the `iostream` members you need for screen I/O, though it does no harm, and may make the program clearer, to `#include <iostream>`.

19. 

```
1
2
3
3
```

20. 

```
void to_screen(istream& file_stream)
{
 int next;
 while (file_stream >> next)
 cout << next << endl;
}
```

21. The maximum number of characters that can be typed in for a string variable is one less than the declared size. Here the value is 20.
22. The statement
- ```
cin >> c;
```
- reads the next *nonwhite* character, whereas
- ```
cin.get(c);
```
- reads the next character whether the character is nonwhite or not.
23. The two statements are equivalent. Both of the statements output the value of the variable *c*.
24. The character that is “put back” into the input stream with the member function `putback` need not be the last character read. If your program reads an 'a' from the input stream, it can use the `putback` function to put back a 'b'. (The text in the input file will not be changed by `putback`, although your program will behave as if the text in the input file had been changed.)

25. The complete dialogue is

```
Enter a line of input:
a b c d e f g
a b END OF OUTPUT
```

26. The complete dialogue is

```
Enter a line of input:
abcdef gh
ace h
```

Note that the output is simply every other character of the input, and note that the blank is treated just like any other character.

27. The complete dialogue is

```
Enter a line of input:
0 1 2 3 4 5 6 7 8 9 10 11
01234567891 1
```

Be sure to note that only the '1' in the input string 10 is output. This is because `cin.get` is reading characters, not numbers, and so it reads the input 10 as the two characters, '1' and '0'. Since this code is written to echo only every other character, the '0' is not output. Since the '0' is not output, the next character, which is a blank, is output, and so there is one blank in the output. Similarly, only one of the two '1' characters in 11 is output. If this is unclear, write the input on a sheet of paper and use a small square for the blank character. Then, cross out every other character; the output shown above is what is left.

28. This code contains an infinite loop and will continue as long as the user continues to give it input. The Boolean expression (`next != '\n'`) is always *true* because `next` is filled via the statement

```
cin >> next;
```

and this statement always skips the new-line character `'\n'` (as well as any blanks). The code will run and if the user gives no additional input, the dialogue will be as follows:

```
Enter a line of input:
0 1 2 3 4 5 6 7 8 9 10 11
0246811
```

Notice that the code in Self-Test Exercise 27 used `cin.get`, so it reads every character, *whether the character is a blank or not*, and then it outputs every other character. So the code in Self-Test Exercise 27 outputs every other character even if the character is a blank. On the other hand, the code in this Self-Test Exercise uses `cin` and `>>`, so it *skips over all blanks* and considers only nonblank characters (which in this case are the digits '0' through '9'). Thus, this code outputs every other *nonblank* character. The two '1' characters in the output are the first character in the input 10 and the first character in the input 11.

29. `void copy_char(istream& source_file)`
- ```
{
    char next;
    source_file.get(next);
    cout << next;
}
```
30. `void copy_line(istream& source_file)`
- ```
{
 char next;
 do
 {
 source_file.get(next);
 cout << next;
 } while (next != '\n');
}
```
31. `void send_line(ostream& target_stream)`
- ```
{
    char next;
    do
    {
        cin.get(next);
        target_stream << next;
    } while (next != '\n');
}
```

32. a. 2.0 1.1 2.3
 b. 2.0 3.0 2.3
 c. 2.0 3.0 4.0

33. One set of functions follows:

```
void func(double x)
{
    double y = 1.1;
    double z = 2.3;
    cout << x << " " << y << " " << z << endl;
}
void func(double x, double y)
{
    double z = 2.3;
    cout << x << " " << y << " " << z << endl;
}
void func(double x, double y, double z)
{
    cout << x << " " << y << " " << z << endl;
}
```

34. It would evaluate to *false*. Your program must attempt to read one more character (beyond the last character) before it changes to *true*.

```
35. void text_to_screen(ifstream& file_stream)
{
    char next;
    file_stream.get(next);
    while (! file_stream.eof( ))
    {
        cout << next;
        file_stream.get(next);
    }
}
```

If you prefer, you can use `cout.put(next);` instead of `cout << next;`.

36. The complete dialogue is as follows:

```
Enter a line of input:
I'll see you at 10:30 AM.
I'll see you at 1 <END OF OUTPUT
```

```
37. cout << "Enter a line of input:\n";
char next;
do
{
    cin.get(next);
    if (!isupper(next))
        cout << next;
} while (next != '\n');
```

Note that you should use `!isupper(next)` and not use `islower(next)`. This is because `islower(next)` is *false* if `next` contains a character that is not a letter (such as the blank or comma symbol).

PRACTICE PROGRAMS

Practice Programs can generally be solved with a short program that directly applies the programming principles presented in this chapter.

1. Write a program that will search a file of numbers of type `int` and write the largest and the smallest numbers to the screen. The file contains nothing but numbers of type `int` separated by blanks or line breaks. If this is being done as a class assignment, obtain the file name from your instructor.
2. Write a program that takes its input from a file of numbers of type `double` and outputs the average of the numbers in the file to the screen. The file contains nothing but numbers of type `double` separated by blanks and/or line breaks. If this is being done as a class assignment, obtain the file name from your instructor.
3. a. Compute the median of a data file. The median is the number that has the same number of data elements greater than the number as there are less than the number. For purposes of this problem, you are to assume that the data is *sorted* (that is, is in increasing order). The median is the middle element of the file if there are an odd number of elements, or the average of the two middle elements if the file has an even number of elements. You will need to open the file, count the elements, close the file and calculate the location of the middle of the file, open the file again (recall the “start over” discussion in this chapter), count up to the file entries you need, and calculate the middle.

If your instructor has assigned this problem, ask for a data file to test your program with. Otherwise, construct several files on your own, including one with an even number of data points, increasing, and one with an odd number, also increasing.

- b. For a sorted file, a quartile is one of three numbers: The first has one-fourth the data values less than or equal to it, one-fourth the data values between the first and second numbers, one-fourth the data points between the second and the third, and one-fourth above the third quartile. Find the three quartiles for the data file you used for part (a).

(Hint: You should recognize that having done part (a) you have one-third of your job done—you have the second quartile already. You also should recognize that you have done almost all the work toward finding the other two quartiles as well.)

4. Write a program that takes its input from a file of numbers of type *double*. The program outputs to the screen the average and standard deviation of the numbers in the file. The file contains nothing but numbers of type *double* separated by blanks and/or line breaks. The standard deviation of a list of numbers $n_1, n_2, n_3,$ and so forth is defined as the square root of the average of the following numbers:

$$(n_1 - a)^2, (n_2 - a)^2, (n_3 - a)^2, \text{ and so forth}$$

The number a is the average of the numbers $n_1, n_2, n_3,$ and so forth. If this is being done as a class assignment, obtain the file name from your instructor.

(*Hint:* Write your program so that it first reads the entire file and computes the average of all the numbers, and then closes the file, then reopens the file and computes the standard deviation.)

5. Write a program that gives and takes advice on program writing. The program starts by writing a piece of advice to the screen and asking the user to type in a different piece of advice. The program then ends. The next person to run the program receives the advice given by the person who last ran the program. The advice is kept in a file, and the contents of the file change after each run of the program. You can use your editor to enter the initial piece of advice in the file so that the first person who runs the program receives some advice. Allow the user to type in advice of any length so that it can be any number of lines long. The user is told to end his or her advice by pressing the Return key two times. Your program can then test to see that it has reached the end of the input by checking to see when it reads two consecutive occurrences of the character '\n'.
6. Write a program that reads text from one file and writes an edited version of the same text to another file. The edited version is identical to the unedited version except that every string of two or more consecutive blanks is replaced by a single blank. Thus, the text is edited to remove any extra blank characters. Your program should define a function that is called with the input- and output-file streams as arguments. If this is being done as a class assignment, obtain the file names from your instructor.
7. Write a program that merges the numbers in two files and writes all the numbers into a third file. Your program takes input from two different files and writes its output to a third file. Each input file contains a list of numbers of type *int* in sorted order from the smallest to the largest. After the program is run, the output file will contain all the numbers in the two input files in one longer list in sorted order from smallest to largest. Your program should define a function that is called with the two input-file streams and the output-file stream as three arguments. If this is being done as a class assignment, obtain the file names from your instructor.

PROGRAMMING PROJECTS

Programming Projects require more problem-solving than Practice Programs and can usually be solved many different ways. Visit www.myprogramminglab.com to complete many of these Programming Projects online and get instant feedback.

1. Write a program to generate personalized junk mail. The program takes input both from an input file and from the keyboard. The input file contains the text of a letter, except that the name of the recipient is indicated by the three characters #N#. The program asks the user for a name and then writes the letter to a second file but with the three letters #N# replaced by the name. The three-letter string #N# will occur exactly once in the letter.

(Hint: Have your program read from the input file until it encounters the three characters #N#, and have it copy what it reads to the output file as it goes. When it encounters the three letters #N#, it then sends output to the screen asking for the name from the keyboard. You should be able to figure out the rest of the details. Your program should define a function that is called with the input- and output-file streams as arguments. If this is being done as a class assignment, obtain the file names from your instructor.)

Harder version (using material in the optional section “File Names as Input”): Allow the string #N# to occur any number of times in the file. In this case, the name is stored in two string variables. For this version, assume that there is a first name and last name but no middle names or initials.

2. Write a program to compute numeric grades for a course. The course records are in a file that will serve as the input file. The input file is in exactly the following format: Each line contains a student’s last name, then one space, then the student’s first name, then one space, then ten quiz scores all on one line. The quiz scores are whole numbers and are separated by one space. Your program will take its input from this file and send its output to a second file. The data in the output file will be the same as the data in the input file except that there will be one additional number (of type *double*) at the end of each line. This number will be the average of the student’s ten quiz scores. If this is being done as a class assignment, obtain the file names from your instructor. Use at least one function that has file streams as all or some of its arguments.
3. Enhance the program you wrote for Programming Project 2 in all of the following ways.
 - a. The list of quiz scores on each line will contain ten or fewer quiz scores. (If there are fewer than ten quiz scores, that means the student missed one or more quizzes.) The average score is still the sum of the quiz scores divided by 10. This amounts to giving the student a 0 for any missed quiz.

- b. The output file will contain a line (or lines) at the beginning of the file explaining the output. Use formatting instructions to make the layout neat and easy to read.
- c. After placing the desired output in an output file, your program will close all files and then copy the contents of the “output” file to the “input” file so that the net effect is to change the contents of the input file.

Use at least two functions that have file streams as all or some of their arguments. If this is being done as a class assignment, obtain the file names from your instructor.

4. Write a program that will compute the average word length (average number of characters per word) for a file that contains some text. A word is defined to be any string of symbols that is preceded and followed by one of the following at each end: a blank, a comma, a period, the beginning of a line, or the end of a line. Your program should define a function that is called with the input-file stream as an argument. This function should also work with the stream `cin` as the input stream, although the function will not be called with `cin` as an argument in this program. If this is being done as a class assignment, obtain the file names from your instructor.
5. Write a program that will correct a C++ program that has errors in which operator, `<<` or `>>`, it uses with `cin` and `cout`. The program replaces each (incorrect) occurrence of

```
cin <<
```

with the corrected version

```
cin >>
```

and each (incorrect) occurrence of

```
cout >>
```

with the corrected version

```
cout <<
```

For an easier version, assume that there is always exactly one blank space between any occurrence of `cin` and a following `<<`, and similarly assume that there is always exactly one blank space between each occurrence of `cout` and a following `>>`.

For a harder version, allow for the possibility that there may be any number of blanks, even zero blanks, between `cin` and `<<` and between `cout` and `>>`. In this harder case, the replacement corrected version has only one blank between the `cin` or `cout` and the following operator. The program to be corrected is in one file and the corrected version is output

to a second file. Your program should define a function that is called with the input- and output-file streams as arguments.

If this is being done as a class assignment, obtain the file names from your instructor and ask your instructor whether you should do the easier version or the harder version.

(*Hint:* Even if you are doing the harder version, you will probably find it easier and quicker to first do the easier version and then modify your program so that it performs the harder task.)

6. Write a program that allows the user to type in any one-line question and then answers that question. The program will not really pay any attention to the question, but will simply read the question line and discard all that it reads. It always gives one of the following answers:

```
I'm not sure, but I think you will find the answer in Chapter #N.
That's a good question.
If I were you, I would not worry about such things.
That question has puzzled philosophers for centuries.
I don't know. I'm just a machine.
Think about it and the answer will come to you.
I used to know the answer to that question, but I've forgotten it.
The answer can be found in a secret place in the woods.
```

These answers are stored in a file (one answer per line), and your program simply reads the next answer from the file and writes it out as the answer to the question. After your program has read the entire file, it simply closes the file, reopens the file, and starts down the list of answers again.

Whenever your program outputs the first answer, it should replace the two symbols #N with a number between 1 and 18 (including the possibility of 1 and 18). In order to choose a number between 1 and 18, your program should initialize a variable to 18 and decrease the variable's value by 1 each time it outputs a number so that the chapter numbers count backward from 18 to 1. When the variable reaches the value 0, your program should change its value back to 18. Give the number 17 the name `NUMBER_OF_CHAPTERS` with a global named constant declaration using the `const` modifier.

(*Hint:* Use the function `new_line` defined in this chapter.)

7. This project is the same as Programming Project 6, except that in this project your program will use a more sophisticated method for choosing the answer to a question. When your program reads a question, it counts the number of characters in the question and stores the number in a variable named `count`. It then responds with answer number `count % ANSWERS`. The first answer in the file is answer number 0, the next is answer number 1, then 2, and so forth. `ANSWERS` is defined in a constant declaration, as shown next, so that it is equal to the number of answers in the answer file:

```
const int ANSWERS = 8;
```

This way you can change the answer file so that it contains more or fewer answers and you need change only the constant declaration to make your program work correctly for a different number of possible answers. Assume that the answer listed first in the file will always be the following, even if the answer file is changed:

I'm not sure, but I think you will find the answer in Chapter #N.

When replacing the two characters #N with a number, use the number $(\text{count} \% \text{NUMBER_OF_CHAPTERS} + 1)$, where `count` is the variable discussed above, and `NUMBER_OF_CHAPTERS` is a global named constant defined to be equal to the number of chapters in this book.

8. This program numbers the lines found in a text file. Write a program that reads text from a file and outputs each line to the screen and to another file preceded by a line number. Print the line number at the start of the line and right-adjusted in a field of three spaces. Follow the line number with a colon, then one space, then the text of the line. You should get a character at a time and write code to ignore leading blanks on each line. You may assume that the lines are short enough to fit within a line on the screen. Otherwise, allow default printer or screen output behavior if the line is too long (that is, wrap or truncate).

A somewhat harder version determines the number of spaces needed in the field for the line numbers by counting lines before processing the lines of the file. This version of the program should insert a new line after the last complete word that will fit within a 72-character line.

9. Write a program that computes all of the following statistics for a file and outputs the statistics to both the screen and to another file: the total number of occurrences of characters in the file, the total number of non-whitespace characters in the file, and the total number of occurrences of letters in the file.
10. The text file `babynames2012.txt`, which is included in the source code for this book and is available online from the book's Web site, contains a list of the 1000 most popular boy and girl names in the United States for the year 2012 as compiled by the Social Security Administration.

This is a space-delimited file of 1000 entries in which the rank is listed first, followed by the corresponding boy name and girl name. The most popular names are listed first and the least popular names are listed last. For example, the file begins with

```
1 Jacob Sophia  
2 Mason Emma  
3 Ethan Isabella
```

This indicates that Jacob is the most popular boy name and Sophia is the most popular girl name. Mason is the second most popular boy name and Emma is the second most popular girl name.

Write a program that allows the user to input a name. The program should then read from the file and search for a matching name among the girls and boys. If a match is found, it should output the rank of the name. The program should also indicate if there is no match.

For example, if the user enters the name "Justice," then the program should output:

```
Justice is ranked 519 in popularity among boys.  
Justice is ranked 518 in popularity among girls.
```

If the user enters the name "Walter," then the program should output:

```
Walter is ranked 376 in popularity among boys.  
Walter is not ranked among the top 1000 girl names.
```



VideoNote
Solution to Programming
Project 6.11

11. To complete this problem you must have a computer that is capable of viewing Scalable Vector Graphics (SVG) files. Your Web browser may already be able to view these files. To test to see if your browser can display SVG files, type in the `rectLine.svg` file below and see if you can open it in your Web browser. If your Web browser cannot view the file, then you can search on the Web and download a free SVG viewer.

The graphics screen to draw an image uses a coordinate system in which $(0, 0)$ is located in the upper-left corner. The x coordinate increases to the right, and the y coordinate increases to the bottom. Consequently, coordinate $(100, 0)$ would be located 100 pixels directly toward the right from the upper-left corner, and coordinate $(0, 100)$ would be located 100 pixels directly toward the bottom from the upper-left corner. This is illustrated in the figure below.

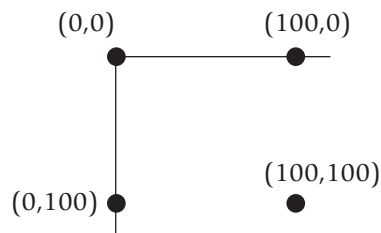

The SVG format defines a graphics image using XML. The specification for the image is stored in a text file and can be displayed by an SVG viewer. Here is a sample SVG file that draws two rectangles and a line. To view it, save it to a text file with the ".svg" extension, such as `rectLine.svg`, and open it with your SVG viewer.

```

<?xml version="1.0" standalone="no"?>
<!DOCTYPE svg PUBLIC "-//W3C//DTD SVG 1.1//EN"
"http://www.w3.org/Graphics/SVG/1.1/DTD/svg11.dtd">
<svg width="500" height="500"
xmlns="http://www.w3.org/2000/svg">

<rect x="20" y="20" width="50" height="250"
style="fill:blue;"/>
<rect x="75" y="100" width="150" height="50"
style="fill:rgb(0,255,0);"/>
<line x1="0" y1="0" x2="300" y2="300"
style="stroke:purple;stroke-width:2"/>

</svg>

```

For purposes of this problem, you can ignore the first five lines and the last line and consider them “boilerplate” that must be inserted to properly create the image.

The lines that begins with `<rect x="20"...` draw a blue rectangle whose upper-left corner is at coordinate (20, 20) and whose width is 50 pixels and height is 250 pixels.

The lines that begin with `<rect x="75"...` draw a green rectangle (RGB color value of 0,255,0 is all green) whose upper-left corner is at coordinate (75, 100) and whose width is 150 pixels and height is 50 pixels.

Finally, the `<line>` tag draws a purple line from (0, 0) to (300, 300) with a width of 2.

Based on this example, write a program that inputs four nonnegative integer values and creates the SVG file that displays a simple bar chart that depicts the integer values. Your program should scale the values so they are always drawn with a maximum height of 400 pixels. For example, if your input values to graph were 20, 40, 60, and 120, you might generate a SVG file that would display as follows:

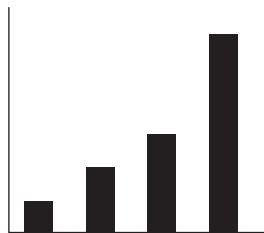

12. Refer to Programming Project 11 for information about the SVG format. Shown below is another example that illustrates how to draw circles, ellipses, and multiple lines:

```

<?xml version="1.0" standalone="no"?>
<!DOCTYPE svg PUBLIC "-//W3C//DTD SVG 1.1//EN"
"http://www.w3.org/Graphics/SVG/1.1/DTD/svg11.dtd">
<svg width="500" height="500"
xmlns="http://www.w3.org/2000/svg">

<circle cx="100" cy="50" r="30"
stroke="green" stroke-width="3" fill="gold"/>

<ellipse cx="100" cy="200" rx="50" ry="100"
style="fill:purple;stroke:black;stroke-width:2"/>

<polyline points="10,10 40,40 20,100 120,140"
style="fill-opacity:0;stroke:red;stroke-width:2"/>

</svg>

```

The `<circle>` tag draws a circle centered at (100, 50) with radius 30 and pen width of 3. It is filled in with gold and has a border in green.

The `<ellipse>` tag draws an ellipse centered at (100, 200) with x radius of 50 and y radius of 100. It is filled using purple with a black border.

The `<polyline>` tag draws a red line from (10, 10) to (40, 40) to (20, 100) to (120, 140). The fill-opacity is set to 0, making the fill of the polygon transparent.

Based on these examples and those presented in Project 18, write a program that creates an SVG image that draws a picture of your professor. It can be somewhat abstract and simple. If you wish to draw a fancier image, you can research the SVG picture format; there are additional tags that can draw using filters, gradients, and polygons.

13. Write a program that prompts the user to input the name of a text file and then outputs the number of words in the file. You can consider a “word” to be any text that is surrounded by whitespace (for example, a space, carriage return, newline) or borders the beginning or end of the file.
14. The following is an old word puzzle: “Name a common word, besides tremendous, stupendous and horrendous, that ends in dous.” If you think about this for a while, it will probably come to you. However, we can also solve this puzzle by reading a text file of English words and outputting the word if it contains “dous” at the end. The text file “words.txt” contains 87,314 English words, including the word that completes the puzzle. This file is available online with the source code for the book. Write a program that reads each word from the text file and outputs only those containing “dous” at the end to solve the puzzle.

Arrays

7

7.1 INTRODUCTION TO ARRAYS 378

Declaring and Referencing Arrays 378

Programming Tip: Use **for** Loops with Arrays 380

Pitfall: Array Indexes Always Start with Zero 380

Programming Tip: Use a Defined *Constant* for the Size of an Array 380

Arrays in Memory 382

Pitfall: Array Index Out of Range 383

Initializing Arrays 386

Programming Tip: C++11 Range-Based **for** Statement 386

7.2 ARRAYS IN FUNCTIONS 389

Indexed Variables as Function Arguments 389

Entire Arrays as Function Arguments 391

The **const** Parameter Modifier 394

Pitfall: Inconsistent Use of **const** Parameters 397

Functions That Return an Array 397

Case Study: Production Graph 398

7.3 PROGRAMMING WITH ARRAYS 411

Partially Filled Arrays 411

Programming Tip: Do Not Skimp on Formal Parameters 414

Programming Example: Searching an Array 414

Programming Example: Sorting an Array 417

Programming Example: Bubble Sort 421

7.4 MULTIDIMENSIONAL ARRAYS 424

Multidimensional Array Basics 425

Multidimensional Array Parameters 425

Programming Example: Two-Dimensional Grading Program 427

Pitfall: Using Commas Between Array Indexes 431



It is a capital mistake to theorize before one has data.

SIR ARTHUR CONAN DOYLE, *Scandal in Bohemia* (Sherlock Holmes)

INTRODUCTION

An array is used to process a collection of data all of which is of the same type, such as a list of temperatures or a list of names. This chapter introduces the basics of defining and using arrays in C++ and presents many of the basic techniques used when designing algorithms and programs that use arrays.

PREREQUISITES

This chapter uses material from Chapters 2 through 6.

7.1 INTRODUCTION TO ARRAYS

Suppose we wish to write a program that reads in five test scores and performs some manipulations on these scores. For instance, the program might compute the highest test score and then output the amount by which each score falls short of the highest. The highest score is not known until all five scores are read in. Hence, all five scores must be retained in storage so that after the highest score is computed each score can be compared to it.

To retain the five scores, we will need something equivalent to five variables of type *int*. We could use five individual variables of type *int*, but five variables are hard to keep track of, and we may later want to change our program to handle 100 scores; certainly, 100 variables are impractical. An array is the perfect solution. An **array** behaves like a list of variables with a uniform naming mechanism that can be declared in a single line of simple code. For example, the names for the five individual variables we need might be `score[0]`, `score[1]`, `score[2]`, `score[3]`, and `score[4]`. The part that does not change—in this case, `score`—is the name of the array. The part that can change is the integer in the square brackets, [].

Declaring and Referencing Arrays

In C++, an array consisting of five variables of type *int* can be declared as follows:

```
int score[5];
```

This declaration is like declaring the following five variables to all be of type *int*:

```
score[0], score[1], score[2], score[3], score[4]
```

The individual variables that together make up the array are referred to in a variety of different ways. We will call them **indexed variables**, though they are also sometimes called **subscripted variables** or **elements** of the array. The number in square brackets is called an **index** or a **subscript**. In C++, indexes are numbered starting with 0, not with 1 or any other number except 0. The number of indexed variables in an array is called the **declared size** of the array, or sometimes simply the **size** of the array. When an array is declared, the size of the array is given in square brackets after the array name. The indexed variables are then numbered (also using square brackets), starting with 0 and ending with the integer that is one less than the size of the array.

In our example, the indexed variables were of type *int*, but an array can have indexed variables of any type. For example, to declare an array with indexed variables of type *double*, simply use the type name *double* instead of *int* in the declaration of the array. All the indexed variables for one array are, however, of the same type. This type is called the **base type** of the array. Thus, in our example of the array *score*, the base type is *int*.

You can declare arrays and regular variables together. For example, the following declares the two *int* variables *next* and *max* in addition to the array *score*:

```
int next, score[5], max;
```

An indexed variable like *score[3]* can be used anywhere that an ordinary variable of type *int* can be used.

Do not confuse the two ways to use the square brackets [] with an array name. When used in a declaration, such as

```
int score[5];
```

the number enclosed in the square brackets specifies how many indexed variables the array has. When used anywhere else, the number enclosed in the square brackets tells which indexed variable is meant. For example, *score[0]* through *score[4]* are indexed variables.

The index inside the square brackets need not be given as an integer constant. You can use any expression in the square brackets as long as the expression evaluates to one of the integers 0 through the integer that is one less than the size of the array. For example, the following will set the value of *score[3]* equal to 99:

```
int n = 2;  
score[n + 1] = 99;
```

Although they may look different, *score[n+1]* and *score[3]* are the same indexed variable in the code above. That is because *n + 1* evaluates to 3.

The identity of an indexed variable, such as *score[i]*, is determined by the value of its index, which in this instance is *i*. Thus, you can write programs

that say things such as “do such and such to the *i*th indexed variable,” where the value of *i* is computed by the program. For example, the program in Display 7.1 reads in scores and processes them in the way we described at the start of this chapter.

■ PROGRAMMING TIP Use *for* Loops with Arrays

The second *for* loop in Display 7.1 illustrates a common way to step through an array using a *for* loop:

```
for (i = 0; i < 5; i++)
    cout << score[i] << " off by "
        << (max - score[i]) << endl;
```

The *for* statement is ideally suited to array manipulations. ■

PITFALL Array Indexes Always Start with Zero

The indexes of an array always start with 0 and end with the integer that is one less than the size of the array. ■

■ PROGRAMMING TIP Use a Defined *Constant* for the Size of an Array

Look again at the program in Display 7.1. It only works for classes that have exactly five students. Most classes do not have exactly five students. One way to make a program more versatile is to use a defined constant for the size of each array. For example, the program in Display 7.1 could be rewritten to use the following defined constant:

```
const int NUMBER_OF_STUDENTS = 5;
```

The line with the array declaration would then be

```
int i, score[NUMBER_OF_STUDENTS], max;
```

Of course, all places that have a 5 for the size of the array should also be changed to have `NUMBER_OF_STUDENTS` instead of 5. If these changes are made to the program (or better still, if the program had been written this way in the first place), then the program can be rewritten to work for any number of students by simply changing the one line that defines the constant `NUMBER_OF_STUDENTS`. Note that on many compilers you cannot use a variable for the array size, such as the following:

```
cout << "Enter number of students:\n";
cin >> number;
int score[number]; //ILLEGAL ON MANY COMPILERS!
```

DISPLAY 7.1 Program Using an Array

```
1 //Reads in 5 scores and shows how much each
2 //score differs from the highest score.
3 #include <iostream>

4 int main( )
5 {
6     using namespace std;
7     int i, score[5], max;

8     cout << "Enter 5 scores:\n";
9     cin >> score[0];
10    max = score[0];
11    for (i = 1; i < 5; i++)
12    {
13        cin >> score[i];
14        if (score[i] > max)
15            max = score[i];
16        //max is the largest of the values score[0],..., score[i].
17    }

18    cout << "The highest score is " << max << endl
19         << "The scores and their\n"
20         << "differences from the highest are:\n";
21    for (i = 0; i < 5; i++)
22        cout << score[i] << " off by "
23            << (max - score[i]) << endl;

24    return 0;
25 }
```

Sample Dialogue

```
Enter 5 scores:
5 9 2 10 6
The highest score is 10
The scores and their
differences from the highest are:
5 off by 5
9 off by 1
2 off by 8
10 off by 0
6 off by 4
```

Some but not all compilers will allow you to specify an array size with a variable in this way. However, for the sake of portability you should not do so, even if your compiler permits it. (In Chapter 9 we will discuss a different kind of array whose size can be determined when the program is run. ■

Arrays in Memory

Before discussing how arrays are represented in a computer's memory, let's first see how a simple variable, such as a variable of type *int* or *double*, is represented in the computer's memory. A computer's memory consists of a list of numbered locations called bytes.¹ The number of a byte is known as its address. A simple variable is implemented as a portion of memory consisting of some number of consecutive bytes. The number of bytes is determined by the type of the variable. Thus, a simple variable in memory is described by two pieces of information: an **address** in memory (giving the location of the first byte for that variable) and the type of the variable, which tells how many bytes of memory the variable requires. When we speak of the address of a variable, it is this address we are talking about. When your program stores a value in the variable, what really happens is that the value (coded as 0s and 1s) is placed in those bytes of memory that are assigned to that variable. Similarly, when a variable is given as a (call-by-reference) argument to a function, it is the address of the variable that is actually given to the calling function. Now let's move on to discuss how arrays are stored in memory.

Array indexed variables are represented in memory the same way as ordinary variables, but with arrays there is a little more to the story. The locations of the various array indexed variables are always placed next to one another in memory. For example, consider the following:

```
int a[6];
```

When you declare this array, the computer reserves enough memory to hold six variables of type *int*. Moreover, the computer always places these variables one after the other in memory. The computer then remembers the address of indexed variable `a[0]`, but it does not remember the address of any other indexed variable. When your program needs the address of some other indexed variable, the computer calculates the address for this other indexed variable from the address of `a[0]`. For example, if you start at the address of `a[0]` and count past enough memory for three variables of type *int*, then you will be at the address of `a[3]`. To obtain the address of `a[3]`, the computer starts with the address of `a[0]` (which is a number). The computer then adds the number of bytes needed to hold three variables of type *int* to the number for the address of `a[0]`. The result is the address of `a[3]`. This implementation is diagrammed in Display 7.2.

Many of the peculiarities of arrays in C++ can be understood only in terms of these details about memory. For example, in the next Pitfall section, we use these details to explain what happens when your program uses an illegal array index.

¹ A byte consists of 8 bits, but the exact size of a byte is not important to this discussion.

Array Declaration

SYNTAX

```
Type_Name Array_Name[Declared_Size];
```

EXAMPLES

```
int big_array[100];  
double a[3];  
double b[5];  
char grade[10], one_grade;
```

An array declaration, of the form shown, will define *Declared_Size* indexed variables, namely, the indexed variables *Array_Name*[0] through *Array_Name*[*Declared_Size*-1]. Each indexed variable is a variable of type *Type_Name*.

The array *a* consists of the indexed variables *a*[0], *a*[1], and *a*[2], all of type *double*. The array *b* consists of the indexed variables *b*[0], *b*[1], *b*[2], *b*[3], and *b*[4], also all of type *double*. You can combine array declarations with the declaration of simple variables such as the variable *one_grade* shown above.

PITFALL Array Index Out of Range

The most common programming error made when using arrays is attempting to reference a nonexistent array index. For example, consider the following array declaration:

```
int a[6];
```

When using the array *a*, every index expression must evaluate to one of the integers 0 through 5. For example, if your program contains the indexed variable *a*[*i*], the *i* must evaluate to one of the six integers 0, 1, 2, 3, 4, or 5. If *i* evaluates to anything else, that is an error. When an index expression evaluates to some value other than those allowed by the array declaration, the index is said to be out of range or simply **illegal**. On most systems, the result of an illegal array index is that your program will do something wrong, possibly disastrously wrong, and will do so without giving you any warning.

Attackers have also exploited this type of error to break into software. An out-of-range programming error could potentially compromise the entire system, so take great care to avoid this error. In 2011, the Common Weakness Enumeration (CWE)/SANS Institute identified this type of error as the third most dangerous programmer error.



VideoNote
Array Walkthrough

DISPLAY 7.2 An Array in Memory

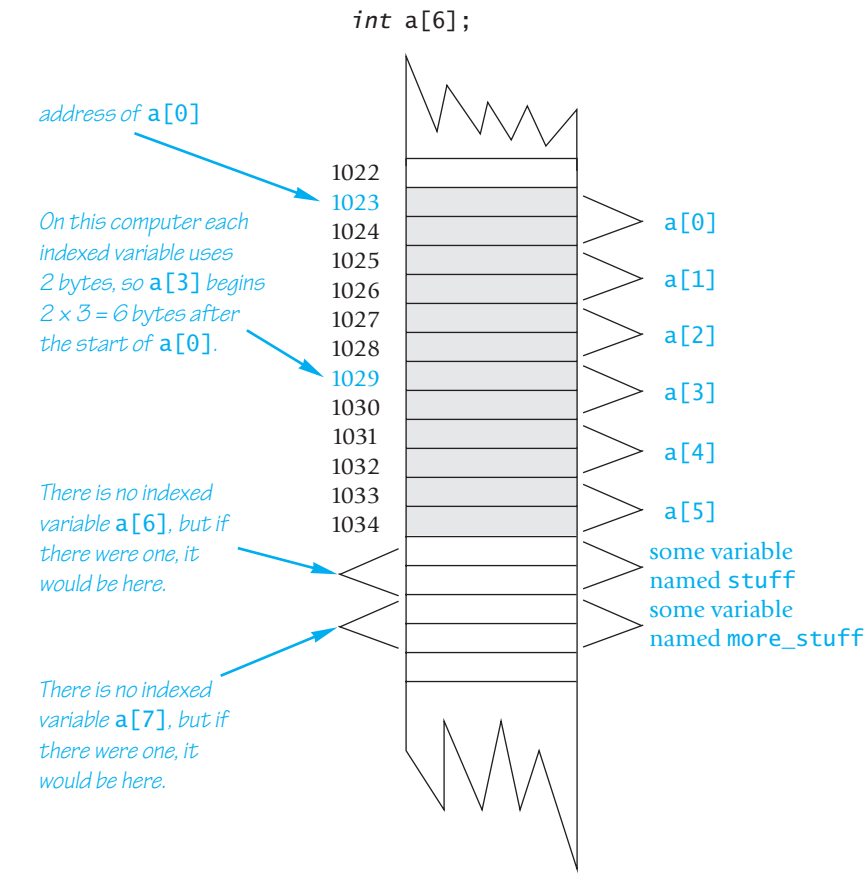

For example, suppose your system is typical, the array `a` is declared as shown, and your program contains the following:

```
a[i] = 238;
```

Now, suppose the value of `i`, unfortunately, happens to be 7. The computer proceeds as if `a[7]` were a legal indexed variable. The computer calculates the address where `a[7]` would be (if only there were an `a[7]`), and places the value 238 in that location in memory. However, there is no indexed variable `a[7]`, and the memory that receives this 238 probably belongs to some other variable, maybe a variable named `more_stuff`. So the value of `more_stuff` has been unintentionally changed. The situation is illustrated in Display 7.2.

Array indexes get out of range most commonly at the first or last iteration of a loop that processes the array. So, it pays to carefully check all array processing loops to be certain that they begin and end with legal array indexes.

It may sound simple to keep the array indexes within a valid range. In practice it is more difficult, because there are often subtle or unanticipated ways to change an index variable. For example, consider the following code that inputs some numbers into an array:

```
int num;
int a[10];

cout << "How many numbers? (max of 10)" << endl;
cin >> num;
for (int i = 0; i <= num; i++)
{
    cout << "Enter number " << i << endl;
    cin >> a[i];
}
```

This program suffers from two errors. First, the loop has an off-by-one error. By starting at index 0 and continuing up to and including `num` the loop will input `num+1` numbers instead of `num` numbers. As long as a value less than ten is entered for `num` then you might not notice the problem. The program won't crash because the numbers will all be entered with the addition of one extra number which still fits in the array. However, if 10 is entered for `num` then the eleventh number will be stored at index `a[10]` which is one off the end of the array. To fix this problem the loop should be written as:

```
for (int i = 0; i < num; i++)
```

Another problem is the lack of input validation. A malicious or mischievous user could enter 100 as the number of values to enter; the loop would then simply execute 100 times and input data well past the end of the array (the program may crash before looping 100 times as numbers past the end of the array could cause mischief). To address this problem we can validate that the user's input is within valid range:

```
cout << "How many numbers? (max of 10)" << endl;
cin >> num;
cout << num << endl;
if (num <= 10)
{
    for (int i = 0; i < num; i++)
    {
        cout << "Enter number " << i << endl;
        cin >> a[i];
    }
}
```

Even this modified version has the potential for error. If a value is entered for `num` that exceeds its maximum size then there is the possibility for overflow. For example, on most systems a signed short can only store a number up

to +32767. Entering a larger value results in overflow which could store 0 or a negative value in `num`. Although the `for` loop will not run if `num` is zero or negative the program would erroneously pass the `if` statement. We explore this type of error again in Chapter 8. ■

Initializing Arrays

An array can be initialized when it is declared. When initializing the array, the values for the various indexed variables are enclosed in braces and separated with commas. For example,

```
int children[3] = {2, 12, 1};
```

This declaration is equivalent to the following code:

```
int children[3];
children[0] = 2;
children[1] = 12;
children[2] = 1;
```

If you list fewer values than there are indexed variables, those values will be used to initialize the first few indexed variables, and the remaining indexed variables will be initialized to a 0 of the array base type. In this situation, indexed variables not provided with initializers are initialized to 0. However, arrays with no initializers and other variables declared within a function definition, including the `main` function of a program, are not initialized. Although array indexed variables (and other variables) may sometimes be automatically initialized to 0, you cannot and should not count on it.

If you initialize an array when it is declared, you can omit the size of the array, and the array will automatically be declared to have the minimum size needed for the initialization values. For example, the following declaration

```
int b[ ] = {5, 12, 11};
```

is equivalent to

```
int b[3] = {5, 12, 11};
```

■ PROGRAMMING TIP C++11 Range-Based for Statement

C++11 includes a new type of `for` loop, the range-based `for` loop, that simplifies iteration over every element in an array. The syntax is shown below:

```
for (datatype varname : array)
{
    // varname is successively set to each element in the array
}
```



For example:

```
int arr[] = {2, 4, 6, 8};
for (int x : arr)
    cout << x;
cout << endl;
```

This will output: 2468

When defining the variable that will iterate through the array we can use the same modifiers that are available when defining a parameter for a function. The example we used above for variable `x` is equivalent to pass-by-value. If we change `x` inside the loop it doesn't change the array. We could define `x` as pass by reference using `&` and then changes to `x` will be made to the array. We could also use `const` to indicate that the variable can't be changed. The example below increments every element in the array and then outputs them. We used the auto datatype in the output loop to automatically determine the type of element inside the array.

```
int arr[] = {2, 4, 6, 8};
for (int& x : arr)
    x++;
for (auto x : arr)
    cout << x;
cout << endl;
```

This will output: 3579. The range-based for loop is especially convenient when iterating over vectors, which are introduced in Chapter 8, and iterating over containers, which are discussed in Chapter 18. ■

SELF-TEST EXERCISES

1. Describe the difference in the meaning of `int a[5]` and the meaning of `a[4]`. What is the meaning of the `[5]` and `[4]` in each case?
2. In the array declaration

```
double score[5];
```

state the following:

- a. The array name
- b. The base type
- c. The declared size of the array
- d. The range of values that an index for this array can have
- e. One of the indexed variables (or elements) of this array

3. Identify any errors in the following array declarations.

- `int x[4] = { 8, 7, 6, 4, 3 };`
- `int x[] = { 8, 7, 6, 4 };`
- `const int SIZE = 4;`
- `int x[SIZE];`

4. What is the output of the following code?

```
char symbol[3] = {'a', 'b', 'c'};
for (int index = 0; index < 3; index++)
    cout << symbol[index];
```

5. What is the output of the following code?

```
double a[3] = {1.1, 2.2, 3.3};
cout << a[0] << " " << a[1] << " " << a[2] << endl;
a[1] = a[2];
cout << a[0] << " " << a[1] << " " << a[2] << endl;
```

6. What is the output of the following code?

```
int i, temp[10];
for (i = 0; i < 10; i++)
    temp[i] = 2 * i;
for (i = 0; i < 10; i++)
    cout << temp[i] << " ";
cout << endl;
for (i = 0; i < 10; i = i + 2)
    cout << temp[i] << " ";
```

7. What is wrong with the following piece of code?

```
int sample_array[10];
for (int index = 1; index <= 10; index++)
    sample_array[index] = 3 * index;
```

8. Suppose we expect the elements of the array `a` to be ordered so that

$$a[0] \leq a[1] \leq a[2] \leq \dots$$

However, to be safe we want our program to test the array and issue a warning in case it turns out that some elements are out of order. The following code is supposed to output such a warning, but it contains a bug. What is it?

```
double a[10];
<Some code to fill the array a goes here.>
```

```

for (int index = 0; index < 10; index++)
    if (a[index] > a[index + 1])
        cout << "Array elements " << index << " and "
            << (index + 1) << " are out of order.";

```

9. Write some C++ code that will fill an array *a* with 20 values of type *int* read in from the keyboard. You need not write a full program, just the code to do this, but do give the declarations for the array and for all variables.
10. Suppose you have the following array declaration in your program:

```
int your_array[7];
```

Also, suppose that in your implementation of C++, variables of type *int* use 2 bytes of memory. When you run your program, how much memory will this array consume? Suppose that when you run your program, the system assigns the memory address 1000 to the indexed variable *your_array[0]*. What will be the address of the indexed variable *your_array[3]*?

7.2 ARRAYS IN FUNCTIONS

You can use both array indexed variables and entire arrays as arguments to functions. We first discuss array indexed variables as arguments to functions.

Indexed Variables as Function Arguments

An indexed variable can be an argument to a function in exactly the same way that any variable can be an argument. For example, suppose a program contains the following declarations:

```
int i, n, a[10];
```

If *my_function* takes one argument of type *int*, then the following is legal:

```
my_function(n);
```

Since an indexed variable of the array *a* is also a variable of type *int*, just like *n*, the following is equally legal:

```
my_function(a[3]);
```

There is one subtlety that does apply to indexed variables used as arguments. For example, consider the following function call:

```
my_function(a[i]);
```

If the value of *i* is 3, then the argument is *a[3]*. On the other hand, if the value of *i* is 0, then this call is equivalent to the following:

```
my_function(a[0]);
```

The indexed expression is evaluated in order to determine exactly which indexed variable is given as the argument.

Display 7.3 contains an example of indexed variables used as function arguments. The program shown gives five additional vacation days to each of three employees in a small business. The program is extremely simple, but it does illustrate how indexed variables are used as arguments to functions. Notice the function `adjust_days`. This function has a formal parameter called `old_days` that is of type `int`. In the main body of the program, this function is called with the argument `vacation[number]` for various values of `number`. Notice that there was nothing special about the formal parameter `old_days`. It is just an ordinary formal parameter of type `int`, which is the base type of the array `vacation`. In Display 7.3 the indexed variables are call-by-value arguments. The same remarks apply to call-by-reference arguments. An indexed variable can be a call-by-value argument or a call-by-reference argument.

DISPLAY 7.3 Indexed Variable as an Argument (part 1 of 2)

```

1 //Illustrates the use of an indexed variable as an argument.
2 //Adds 5 to each employee's allowed number of vacation days.
3 #include <iostream>
4 const int NUMBER_OF_EMPLOYEES = 3;

5 int adjust_days(int old_days);
6 //Returns old_days plus 5.

7 int main( )
8 {
9     using namespace std;
10    int vacation[NUMBER_OF_EMPLOYEES], number;
11    cout << "Enter allowed vacation days for employees 1"
12         << " through " << NUMBER_OF_EMPLOYEES << ":\n";
13    for (number = 1; number <= NUMBER_OF_EMPLOYEES; number++)
14        cin >> vacation[number - 1];
15    for (number = 0; number < NUMBER_OF_EMPLOYEES; number++)
16        vacation[number] = adjust_days(vacation[number]);
17    cout << "The revised number of vacation days are:\n";
18    for (number = 1; number <= NUMBER_OF_EMPLOYEES; number++)
19        cout << "Employee number " << number
20             << " vacation days = " << vacation[number-1] << endl;
21    return 0;
22 }

23 int adjust_days(int old_days)
24 {
25     return (old_days + 5);
26 }
```

(continued)

DISPLAY 7.3 Indexed Variable as an Argument (part 2 of 2)

Sample Dialogue

Enter allowed vacation days for employees 1 through 3:

10 20 5

The revised number of vacation days are:

Employee number 1 vacation days = 15

Employee number 2 vacation days = 25

Employee number 3 vacation days = 10

SELF-TEST EXERCISES

11. Consider the following function definition:

```
void tripler(int& n)
{
    n = 3*n;
}
```

Which of the following are acceptable function calls?

```
int a[3] = {4, 5, 6}, number = 2;
tripler(number);
tripler(a[2]);
tripler(a[3]);
tripler(a[number]);
tripler(a);
```

12. What (if anything) is wrong with the following code? The definition of `tripler` is given in Self-Test Exercise 11.

```
int b[5] = {1, 2, 3, 4, 5};
for (int i = 1; i <= 5; i++)
    tripler(b[i]);
```

Entire Arrays as Function Arguments

A function can have a formal parameter for an entire array so that when the function is called, the argument that is plugged in for this formal parameter is an entire array. However, a formal parameter for an entire array is neither a call-by-value parameter nor a call-by-reference parameter; it is a new kind of formal parameter referred to as an **array parameter**. Let's start with an example.



The function defined in Display 7.4 has one array parameter, `a`, which will be replaced by an entire array when the function is called. It also has one ordinary call-by-value parameter (`size`) that is assumed to be an integer value equal to the size of the array. This function fills its array argument (that is, fills all the array's indexed variables) with values typed in from the keyboard, and then the function outputs a message to the screen telling the index of the last array index used.

The formal parameter `int a[]` is an array parameter. The square brackets, with no index expression inside, are what C++ uses to indicate an array parameter. An array parameter is not quite a call-by-reference parameter, but for most practical purposes it behaves very much like a call-by-reference parameter. Let's go through this example in detail to see how an array argument works in this case. (An **array argument** is, of course, an array that is plugged in for an array parameter, such as `a[]`.)

When the function `fill_up` is called it must have two arguments: The first gives an array of integers, and the second should give the declared size of the array. For example, the following is an acceptable function call:

```
int score[5], number_of_scores = 5;
fill_up(score, number_of_scores);
```

This call to `fill_up` will fill the array `score` with five *integers* typed in at the keyboard. Notice that the formal parameter `a[]` (which is used in the function declaration and the heading of the function definition) is given with square brackets, but no index expression. (You may insert a number inside the square brackets for an array parameter, but the compiler will simply

DISPLAY 7.4 Function with an Array Parameter

Function Declaration

```
1 void fill_up(int a[], int size);
2 //Precondition: size is the declared size of the array a.
3 //The user will type in size integers.
4 //Postcondition: The array a is filled with size integers
5 //from the keyboard.
```

Function Definition

```
1 //Uses iostream:
2 void fill_up(int a[], int size)
3 {
4     using namespace std;
5     cout << "Enter " << size << " numbers:\n";
6     for (int i = 0; i < size; i++)
7         cin >> a[i];
8     size--;
9     cout << "The last array index used is " << size << endl;
10 }
```

ignore the number, so we do not use such numbers in this book.) On the other hand, the argument given in the function call (`score` in this example) is given without any square brackets or any index expression. What happens to the array argument `score` in this function call? Very loosely speaking, the argument `score` is plugged in for the formal array parameter `a` in the body of the function, and then the function body is executed. Thus, the function call

```
fill_up(score, number_of_scores);
```

is equivalent to the following code:

```
{
    using namespace std;
    size = 5;
    cout << "Enter " << size << " numbers:\n";
    for (int i = 0; i < size; i++)
        cin >> score[i];
    size--;
    cout << "The last array index used is " << size << endl;
}
```

5 is the value of number_of_scores

The formal parameter `a` is a different kind of parameter from the ones we have seen before now. The formal parameter `a` is merely a placeholder for the argument `score`. When the function `fill_up` is called with `score` as the array argument, the computer behaves as if `a` were replaced with the corresponding argument `score`. *When an array is used as an argument in a function call, any action that is performed on the array parameter is performed on the array argument, so the values of the indexed variables of the array argument can be changed by the function.* If the formal parameter in the function body is changed (for example, with a `cin` statement), then the array argument will be changed.

So far it looks like an array parameter is simply a call-by-reference parameter for an array. That is close to being true, but an array parameter is slightly different from a call-by-reference parameter. To help explain the difference, let's review some details about arrays.

Recall that an array is stored as a contiguous chunk of memory. For example, consider the following declaration for the array `score`:

```
int score[5];
```

When you declare this array, the computer reserves enough memory to hold five variables of type `int`, which are stored one after the other in the computer's memory. The computer does not remember the addresses of each of these five indexed variables; it remembers only the address of indexed variable `score[0]`. For example, when your program needs `score[3]`, the computer calculates the address of `score[3]` from the address of `score[0]`. The computer knows that `score[3]` is located three `int` variables past `score[0]`. Thus, to obtain the address of `score[3]`, the computer takes the address of `score[0]` and adds a number that represents the amount of memory used by three `int` variables; the result is the address of `score[3]`.

[Arrays in memory](#)

Array argument

Viewed this way, an array has three parts: the address (location in memory) of the first indexed variable, the base type of the array (which determines how much memory each indexed variable uses), and the size of the array (that is, the number of indexed variables). When an array is used as an array argument to a function, only the first of these three parts is given to the function. When an array argument is plugged in for its corresponding formal parameter, all that is plugged in is the address of the array's first indexed variable. The base type of the array argument must match the base type of the formal parameter, so the function also knows the base type of the array. However, the array argument does not tell the function the size of the array. When the code in the function body is executed, the computer knows where the array starts in memory and how much memory each indexed variable uses, but (unless you make special provisions) it does not know how many indexed variables the array has. That is why it is critical that you always have another *int* argument telling the function the size of the array. That is also why an array parameter is not the same as a call-by-reference parameter. You can think of an array parameter as a weak form of call-by-reference parameter in which everything about the array is told to the function except for the size of the array.²

Different size array arguments can be plugged in for the same array parameter

These array parameters may seem a little strange, but they have at least one very nice property as a direct result of their seemingly strange definition. This advantage is best illustrated by again looking at our example of the function `fill_up` given in Display 7.4. *That same function can be used to fill an array of any size*, as long as the base type of the array is *int*. For example, suppose you have the following array declarations:

```
int score[5], time[10];
```

The first of the following calls to `fill_up` fills the array `score` with five values and the second fills the array `time` with ten values:

```
fill_up(score, 5);  
fill_up(time, 10);
```

You can use the same function for array arguments of different sizes because the size is a separate argument.

The *const* Parameter Modifier

When you use an array argument in a function call, the function can change the values stored in the array. This is usually fine. However, in a complicated function definition, you might write code that inadvertently changes one or more of the values stored in an array, even though the array should not be changed at all. As a precaution, you can tell the compiler that you do not

² If you have heard of pointers, this will sound like pointers, and indeed an array argument is passed by passing a pointer to its first (zeroth) index variable. We will discuss this in Chapter 9. If you have not yet learned about pointers, you can safely ignore this footnote.

intend to change the array argument, and the computer will then check to make sure your code does not inadvertently change any of the values in the array. To tell the compiler that an array argument should not be changed by your function, you insert the modifier *const* before the array parameter for that argument position. An array parameter that is modified with a *const* is called a **constant array parameter**.

For example, the following function outputs the values in an array but does not change the values in the array:

```
void show_the_world(int a[ ], int size_of_a)
//Precondition: size_of_a is the declared size of the array a.
//All indexed variables of a have been given values.
//Postcondition: The values in a have been written
//to the screen.
{
    cout << "The array contains the following values:\n";
    for (int i = 0; i < size_of_a; i++)
        cout << a[i] << " ";
    cout << endl;
}
```

This function will work fine. However, as an added safety measure you can add the modifier *const* to the function heading as follows:

```
void show_the_world(const int a[ ], int size_of_a)
```

With the addition of this modifier *const*, the computer will issue an error message if your function definition contains a mistake that changes any of the

Array Formal Parameters and Arguments

An argument to a function may be an entire array, but an argument for an entire array is neither a call-by-value argument nor a call-by-reference argument. It is a new kind of argument known as an **array argument**. When an array argument is plugged in for an **array parameter**, all that is given to the function is the address in memory of the first indexed variable of the array argument (the one indexed by 0). The array argument does not tell the function the size of the array. Therefore, when you have an array parameter to a function, you normally must also have another formal parameter of type *int* that gives the size of the array (as in the example below).

An array argument is like a call-by-reference argument in the following way: If the function body changes the array parameter, then when the function is called, that change is actually made to the array argument. Thus, a function can change the values of an array argument (that is, can change the values of its indexed variables).

(continued)

The syntax for a function declaration with an array parameter is as follows:

SYNTAX

```
Type_Returned Function_Name(..., Base_Type Array_
Name[],...);
```

EXAMPLE

```
void sum_array(double& sum, double a[ ], int size);
```

values in the array argument. For example, the following is a version of the function `show_the_world` that contains a mistake that inadvertently changes the value of the array argument. Fortunately, this version of the function definition includes the modifier `const`, so that an error message will tell us that the array `a` is changed. This error message will help to explain the mistake:

```
void show_the_world(const int a[ ], int size_of_a)
//Precondition: size_of_a is the declared size of the array a.
//All indexed variables of a have been given values.
//Postcondition: The values in a have been written
//to the screen.
{
    cout << "The array contains the following values:\n";
    for (int i = 0; i < size_of_a; a[i]++)
        cout << a[i] << " ";
    cout << endl;
}
```

Mistake, but the compiler will not catch it unless you use the const modifier.

If we had not used the `const` modifier in this function definition and if we made the mistake shown, the function would compile and run with no error messages. However, the code would contain an infinite loop that continually increments `a[0]` and writes its new value to the screen.

The problem with this incorrect version of `show_the_world` is that the wrong item is incremented in the `for` loop. The indexed variable `a[i]` is incremented, but it should be the index `i` that is incremented. In this incorrect version, the index `i` starts with the value 0 and that value is never changed. But `a[i]`, which is the same as `a[0]`, is incremented. When the indexed variable `a[i]` is incremented, that changes a value in the array, and since we included the modifier `const`, the computer will issue a warning message. That error message should serve as a clue to what is wrong.

You normally have a function declaration in your program in addition to the function definition. When you use the `const` modifier in a function definition, you must also use it in the function declaration so that the function heading and the function declaration are consistent.

The modifier *const* can be used with any kind of parameter, but it is normally used only with array parameters and call-by-reference parameters for classes, which are discussed in Chapter 11.

PITFALL Inconsistent Use of *const* Parameters

The *const* parameter modifier is an all-or-nothing proposition. If you use it for one array parameter of a particular type, then you should use it for every other array parameter that has that type and that is not changed by the function. The reason has to do with function calls within function calls. Consider the definition of the function `show_difference`, which is given below along with the declaration of a function used in the definition:

```
double compute_average(int a[ ], int number_used);
//Returns the average of the elements in the first number_used
//elements of the array a. The array a is unchanged.

void show_difference(const int a[ ], int number_used)
{
    double average = compute_average(a, number_used);
    cout << "Average of the " << number_used
         << " numbers = " << average << endl
         << "The numbers are:\n";
    for (int index = 0; index < number_used; index++)
        cout << a[index] << " differs from average by "
             << (a[index] - average) << endl;
}
```

This code will generate an error message or warning message with most compilers. The function `compute_average` does not change its parameter `a`. However, when the compiler processes the function definition for `show_difference`, it will think that `compute_average` does (or at least might) change the value of its parameter `a`. This is because, when it is translating the function definition for `show_difference`, all the compiler knows about the function `compute_average` is the function declaration for `compute_average`, and the function declaration does not contain a *const* to tell the compiler that the parameter `a` will not be changed. Thus, if you use *const* with the parameter `a` in the function `show_difference`, then you should also use the modifier *const* with the parameter `a` in the function `compute_average`. The function declaration for `compute_average` should be as follows:

```
double compute_average(const int a[ ], int number_used); ■
```

Functions That Return an Array

A function may not return an array in the same way that it returns a value of type *int* or *double*. There is a way to obtain something more or less

equivalent to a function that returns an array. The thing to do is to return a pointer to the array. However, we have not yet covered pointers. We will discuss returning a pointer to an array when we discuss the interaction of arrays and pointers in Chapter 9. Until then, you have no way to write a function that returns an array.

CASE STUDY Production Graph

In this case study we use arrays in the top-down design of a program. We use both indexed variables and entire arrays as arguments to the functions for subtasks.

Problem Definition

The Apex Plastic Spoon Manufacturing Company has commissioned us to write a program that will display a bar graph showing the productivity of each of its four manufacturing plants for any given week. Plants keep separate production figures for each department, such as the teaspoon department, soup spoon department, plain cocktail spoon department, colored cocktail spoon department, and so forth. Moreover, each plant has a different number of departments. For example, only one plant manufactures colored cocktail spoons. The input is entered plant-by-plant and consists of a list of numbers giving the production for each department in that plant. The output will consist of a bar graph in the following form:

```
Plant #1 *****
Plant #2 *****
Plant #3 *****
Plant #4 *****
```

Each asterisk represents 1000 units of output.

We decide to read in the input separately for each department in a plant. Since departments cannot produce a negative number of spoons, we know that the production figure for each department will be nonnegative. Hence, we can use a negative number as a sentinel value to mark the end of the production numbers for each plant.

Since output is in units of 1000, it must be scaled by dividing it by 1000. This presents a problem since the computer must display a whole number of asterisks. It cannot display 1.6 asterisks for 1600 units. We will thus round to the nearest 1000th. Thus, 1600 will be the same as 2000 and will produce two asterisks. A precise statement of the program's input and output is as follows.

Input

There are four manufacturing plants numbered 1 through 4. The following input is given for each of the four plants: a list of numbers giving the production for each department in that plant. The list is terminated with a negative number that serves as a sentinel value.

Output

A bar graph showing the total production for each plant. Each asterisk in the bar graph equals 1000 units. The production of each plant is rounded to the nearest 1000 units.

Analysis of the Problem

We will use an array called `production`, which will hold the total production for each of the four plants. In C++, array indexes always start with 0. But since the plants are numbered 1 through 4, rather than 0 through 3, we will not use the plant number as the array index. Instead, we will place the total production for plant number n in the indexed variable `production[n-1]`. The total output for plant number 1 will be held in `production[0]`, the figures for plant 2 will be held in `production[1]`, and so forth.

Since the output is in thousands of units, the program will scale the values of the array elements. If the total output for plant number 3 is 4040 units, then the value of `production[2]` will initially be set to 4040. This value of 4040 will then be scaled to 4 so that the value of `production[2]` is changed to 4, and four asterisks will be output in the graph to represent the output for plant number 3.

The task for our program can be divided into the following subtasks:

Subtasks

- `input_data`: Read the input data for each plant and set the value of the indexed variable `production[plant_number-1]` equal to the total production for that plant, where `plant_number` is the number of the plant.
- `scale`: For each `plant_number`, change the value of the indexed variable `production[plant_number - 1]` to the correct number of asterisks.
- `graph`: Output the bar graph.

The entire array `production` will be an argument for the functions that carry out these subtasks. As is usual with an array parameter, this means we must have an additional formal parameter for the size of the array, which in this case is the same as the number of plants. We will use a defined constant for the number of plants, and this constant will serve as the size of the array `production`. The main part of our program, together with the function declarations for the functions that perform the subtasks and the defined constant for the number of plants, is shown in Display 7.5. Notice that, since there is no reason to change the array parameter to the function `graph`, we have made that array parameter a constant parameter by adding the `const` parameter modifier. The material in Display 7.5 is the outline for our program, and if it is in a separate file, that file can be compiled so that we can check for any syntax errors in this outline before we go on to define the functions corresponding to the function declarations shown.

Having compiled the file shown in Display 7.5, we are ready to design the implementation of the functions for the three subtasks. For each of these three functions, we will design an algorithm, write the code for the function, and test the function before we go on to design the next function.

Algorithm Design for `input_data`

The function declaration and descriptive comment for the function `input_data` is shown in Display 7.5. As indicated in the body of the `main` part of our program (also shown in Display 7.5), when `input_data` is called, the formal array parameter `a` will be replaced with the array `production`, and since the last plant number is the same as the number of plants, the formal parameter `last_plant_number` will be replaced by `NUMBER_OF_PLANTS`. The algorithm for `input_data` is straightforward:

For `plant_number` equal to each of 1, 2, through `last_plant_number` do the following:

Read in all the data for plant whose number is `plant_number`.

Sum the numbers.

Set `production[plant_number - 1]` equal to that total.

Coding for `input_data`

The algorithm for the function `input_data` translates to the following code:

```
//Uses iostream:
void input_data(int a[ ], int last_plant_number)
{
    using namespace std;
    for (int plant_number = 1;
         plant_number <= last_plant_number; plant_number++)
    {
        cout << endl
              << "Enter production data for plant number "
              << plant_number << endl;
        get_total(a[plant_number - 1]);
    }
}
```

The code is routine since all the work is done by the function `get_total`, which we still need to design. But before we move on to discuss the function `get_total`, let's observe a few things about the function `input_data`. Notice that we store the figures for plant number `plant_number` in the indexed variable with index `plant_number-1`; this is because arrays always start with index 0, while the plant numbers start with 1. Also, notice that we use an indexed variable for the argument to the function `get_total`. The function `get_total` really does all the work for the function `input_data`.

The function `get_total` does all the input work for one plant. It reads the production figures for that plant, sums the figures, and stores the total in the indexed variable for that plant. But `get_total` does not need to know that its argument is an indexed variable. To a function such as `get_total`, an indexed variable is just like any other variable of type `int`. Thus, `get_total` will have an ordinary call-by-reference parameter of type `int`. That means that

DISPLAY 7.5 Outline of the Graph Program

```

1  //Reads data and displays a bar graph showing productivity for each plant.
2  #include <iostream>
3  const int NUMBER_OF_PLANTS = 4;
4
5  void input_data(int a[], int last_plant_number);
6  //Precondition: last_plant_number is the declared size of the array a.
7  //Postcondition: For plant_number = 1 through last_plant_number:
8  //a[plant_number - 1] equals the total production for plant number plant_number.
9
10 void scale(int a[], int size);
11 //Precondition: a[0] through a[size - 1] each has a nonnegative value.
12 //Postcondition: a[i] has been changed to the number of 1000s (rounded to
13 //an integer) that were originally in a[i], for all i such that 0 <= i <= size - 1.
14
15 void graph(const int asterisk_count[], int last_plant_number);
16 //Precondition: asterisk_count[0] through asterisk_count[last_plant_number - 1]
17 //have nonnegative values.
18 //Postcondition: A bar graph has been displayed saying that plant
19 //number N has produced asterisk_count[N - 1] 1000s of units, for each N such that
20 //1 <= N <= last_plant_number
21
22 int main( )
23 {
24     using namespace std;
25     int production[NUMBER_OF_PLANTS];
26
27     cout << "This program displays a graph showing\n"
28          << "production for each plant in the company.\n";
29
30     input_data(production, NUMBER_OF_PLANTS);
31     scale(production, NUMBER_OF_PLANTS);
32     graph(production, NUMBER_OF_PLANTS);
33
34     return 0;
35 }
36

```

`get_total` is just an ordinary input function like others that we have seen before we discussed arrays. The function `get_total` reads in a list of numbers ended with a sentinel value, sums the numbers as it reads them in, and sets the value of its argument, which is a variable of type `int`, equal to this sum. There is nothing new to us in the function `get_total`. Display 7.6 shows the function definitions for both `get_total` and `input_data`. The functions are embedded in a simple test program.

Testing input_data

Every function should be tested in a program in which it is the only untested function. The function `input_data` includes a call to the function `get_total`. Therefore, we should test `get_total` in a driver program of its own. Once `get_total` has been completely tested, we can use it in a program, like the one in Display 7.6, to test the function `input_data`.

When testing the function `input_data`, we should include tests with all possible kinds of production figures for a plant. We should include a plant that has no production figures (as we did for plant 4 in Display 7.6); we should include a test for a plant with only one production figure (as we did for plant 3 in Display 7.6); and we should include a test for a plant with more than one production figure (as we did for plants 1 and 2 in Display 7.6). We should test for both nonzero and zero production figures, which is why we included a 0 in the input list for plant 2 in Display 7.6.

Algorithm Design for scale

The function `scale` changes the value of each indexed variable in the array `production` so that it shows the number of asterisks to print out. Since there should be one asterisk for every 1000 units of production, the value of each indexed variable must be divided by 1000.0. Then to get a whole number of asterisks, this number is rounded to the nearest integer. This method can be used to scale the values in any array `a` of any size, so the function declaration for `scale`, shown in Display 7.5 and repeated here, is stated in terms of an arbitrary array `a` of some arbitrary size:

```
void scale(int a[ ], int size);
//Precondition: a[0] through a[size - 1] each has a
//nonnegative value.
//Postcondition: a[i] has been changed to the number of 1000s
//(rounded to an integer) that were originally in a[i], for
//all i such that 0 <= i <= size - 1.
```

When the function `scale` is called, the array parameter `a` will be replaced by the array `production`, and the formal parameter `size` will be replaced by `NUMBER_OF_PLANTS` so that the function call looks like the following:

```
scale(production, NUMBER_OF_PLANTS);
```

The algorithm for the function `scale` is as follows:

```
for (int index = 0; index < size; index++)
```

Divide the value of `a[index]` by 1000 and round the result to the nearest whole number; the result is the new value of `a[index]`.

Coding for scale

The algorithm for `scale` translates into the C++ code given next, where `round` is a function we still need to define. The function `round` takes one argument of type `double` and returns a type `int` value that is the integer nearest to its argument; that is, the function `round` will round its argument to the nearest whole number.

DISPLAY 7.6 Test of Function `input_data` (part 1 of 3)

```

1 //Tests the function input_data.
2 #include <iostream>
3 const int NUMBER_OF_PLANTS = 4;
4
5 void input_data(int a[], int last_plant_number);
6 //Precondition: last_plant_number is the declared size of the array a.
7 //Postcondition: For plant_number = 1 through last_plant_number:
8 //a[plant_number-1] equals the total production for plant number plant_number.
9
10 void get_total(int& sum);
11 //Reads nonnegative integers from the keyboard and
12 //places their total in sum.
13
14 int main( )
15 {
16     using namespace std;
17     int production[NUMBER_OF_PLANTS];
18     char ans;
19
20     do
21     {
22         input_data(production, NUMBER_OF_PLANTS);
23         cout << endl
24             << "Total production for each"
25             << " of plants 1 through 4:\n";
26         for (int number = 1; number <= NUMBER_OF_PLANTS; number++)
27             cout << production[number - 1] << " ";
28
29         cout << endl
30             << "Test Again?(Type y or n and Return): ";
31         cin >> ans;
32     } while ( (ans != 'N') && (ans != 'n') );
33
34     cout << endl;
35
36     return 0;
37 }
38 //Uses iostream:
39 void input_data(int a[], int last_plant_number)
40 {
41     using namespace std;
42     for (int plant_number = 1;
43         plant_number <= last_plant_number; plant_number++)
44     {
45         cout << endl
46             << "Enter production data for plant number "

```

(continued)

DISPLAY 7.6 Test of Function `input_data` (part 2 of 3)

```

47         << plant_number << endl;
48         get_total(a[plant_number - 1]);
49     }
50 }
51
52
53 //Uses iostream:
54 void get_total(int& sum)
55 {
56     using namespace std;
57     cout << "Enter number of units produced by each department.\n"
58          << "Append a negative number to the end of the list.\n";
59
60     sum = 0;
61     int next;
62     cin >> next;
63     while (next >= 0)
64     {
65         sum = sum + next;
66         cin >> next;
67     }
68
69     cout << "Total = " << sum << endl;
70 }

```

Sample Dialogue

```

Enter production data for plant number 1
Enter number of units produced by each department.
Append a negative number to the end of the list.

```

```
1 2 3 -1
```

```
Total = 6
```

```

Enter production data for plant number 2
Enter number of units produced by each department.
Append a negative number to the end of the list.

```

```
0 2 3 -1
```

```
Total = 5
```

```

Enter production data for plant number 3
Enter number of units produced by each department.
Append a negative number to the end of the list.

```

```
2 -1
```

```
Total = 2
```

(continued)

DISPLAY 7.6 Test of Function input_data (part 3 of 3)

```

Enter production data for plant number 4
Enter number of units produced by each department.
Append a negative number to the end of the list.
-1
Total = 0

Total production for each of plants 1 through 4:
6 5 2 0
Test Again?(Type y or n and Return): n

```

```

void scale(int a[], int size)
{
    for (int index = 0; index < size; index++)
        a[index] = round(a[index]/1000.0 );
}

```

Notice that we divided by 1000.0, not by 1000 (without the decimal point). If we had divided by 1000, we would have performed integer division. For example, 2600/1000 would give the answer 2, but 2600/1000.0 gives the answer 2.6. It is true that we want an integer for the final answer after rounding, but we want 2600 divided by 1000 to produce 3, not 2, when it is rounded to a whole number.

We now turn to the definition of the function `round`, which rounds its argument to the nearest integer. For example, `round(2.3)` returns 2, and `round(2.6)` returns 3. The code for the function `round`, as well as that for `scale`, is given in Display 7.7. The code for `round` may require a bit of explanation.

The function `round` uses the predefined function `floor` from the library with the header file `cmath`. The function `floor` returns the whole number just below its argument. For example, `floor(2.1)` and `floor(2.9)` both return 2. To see that `round` works correctly, let's look at some examples. Consider `round(2.4)`. The value returned is

```
floor(2.4 + 0.5)
```

which is `floor(2.9)`, and that is 2.0. In fact, for any number that is greater than or equal to 2.0 and strictly less than 2.5, that number plus 0.5 will be less than 3.0, and so `floor` applied to that number plus 0.5 will return 2.0. Thus, `round` applied to any number that is greater than or equal to 2.0 and strictly less than 2.5 will return 2. (Since the function declaration for `round` specifies that the type for the value returned is `int`, the computed value of 2.0 is type cast to the integer value 2 without a decimal point using `static_cast<int>`.)

Now consider numbers greater than or equal to 2.5, for example, 2.6. The value returned by the call `round(2.6)` is

```
floor(2.6 + 0.5)
```

DISPLAY 7.7 The Function scale

```
1 //Demonstration program for the function scale.
2 #include <iostream>
3 #include <cmath>
4
5 void scale(int a[], int size);
6 //Precondition: a[0] through a[size - 1] each has a nonnegative value.
7 //Postcondition: a[i] has been changed to the number of 1000s (rounded to
8 //an integer) that were originally in a[i], for all i such that 0 <= i <= size - 1.
9
10 int round(double number);
11 //Precondition: number >= 0.
12 //Returns number rounded to the nearest integer.
13
14 int main( )
15 {
16     using namespace std;
17     int some_array[4], index;
18     cout << "Enter 4 numbers to scale: ";
19     for (index = 0; index < 4; index++)
20         cin >> some_array[index];
21     scale(some_array, 4);
22     cout << "Values scaled to the number of 1000s are: ";
23     for (index = 0; index < 4; index++)
24         cout << some_array[index] << " ";
25     cout << endl;
26     return 0;
27 }
28
29 void scale(int a[], int size)
30 {
31     for (int index = 0; index < size; index++)
32         a[index] = round(a[index]/1000.0);
33 }
34
35 //Uses cmath:
36 int round(double number)
37 {
38     using namespace std;
39     return static_cast<int>(floor(number + 0.5));
40 }
```

Sample Dialogue

```
Enter 4 numbers to scale: 2600 999 465 3501
Values scaled to the number of 1000s are: 3 1 0 4
```

which is `floor(3.1)` and that is 3.0. In fact, for any number that is greater than or equal to 2.5 and less than or equal to 3.0, that number plus 0.5 will be greater than 3.0. Thus, `round` called with any number that is greater than or equal to 2.5 and less than or equal to 3.0 will return 3.

Thus, `round` works correctly for all arguments between 2.0 and 3.0. Clearly, there is nothing special about arguments between 2.0 and 3.0. A similar argument applies to all nonnegative numbers. So, `round` works correctly for all nonnegative arguments.

Testing `scale`

Display 7.7 contains a demonstration program for the function `scale`, but the testing programs for the functions `round` and `scale` should be more elaborate than this simple program. In particular, they should allow you to retest the tested function several times rather than just once. We will not give the complete testing programs, but you should first test `round` (which is used by `scale`) in a driver program of its own, and then test `scale` in a driver program. The program to test `round` should test arguments that are 0, arguments that round up (like 2.6), and arguments that round down like 2.3. The program to test `scale` should test a similar variety of values for the elements of the array.

The Function graph

The complete program for producing the desired bar graph is shown in Display 7.8. We have not taken you step-by-step through the design of the function `graph` because it is quite straightforward.

DISPLAY 7.8 Production Graph Program (part 1 of 3)

```

1 //Reads data and displays a bar graph showing productivity for each plant.
2 #include <iostream>
3 #include <cmath>
4 const int NUMBER_OF_PLANTS = 4;
5 void input_data(int a[], int last_plant_number);
6 //Precondition: last_plant_number is the declared size of the array a.
7 //Postcondition: For plant_number = 1 through last_plant_number:
8 //a[plant_number - 1] equals the total production for plant number plant_number.
9 void scale(int a[], int size);
10 //Precondition: a[0] through a[size - 1] each has a nonnegative value.
11 //Postcondition: a[i] has been changed to the number of 1000s (rounded to
12 //an integer) that were originally in a[i], for all i such that 0 <= i <= size - 1.
13 void graph(const int asterisk_count[], int last_plant_number);
14 //Precondition: asterisk_count[0] through asterisk_count[last_plant_number - 1]
15 //have nonnegative values.
16 //Postcondition: A bar graph has been displayed saying that plant
17 //number N has produced asterisk_count[N - 1] 1000s of units, for each N such that
18 //1 <= N <= last_plant_number

```

(continued)

DISPLAY 7.8 Production Graph Program (part 2 of 3)

```

19 void get_total(int& sum);
20 //Reads nonnegative integers from the keyboard and
21 //places their total in sum.
22 int round(double number);
23 //Precondition: number >= 0.
24 //Returns number rounded to the nearest integer.
25 void print_asterisks(int n);
26 //Prints n asterisks to the screen.
27 int main( )
28 {
29     using namespace std;
30     int production[NUMBER_OF_PLANTS];
31     cout << "This program displays a graph showing\n"
32           << "production for each plant in the company.\n";
33     input_data(production, NUMBER_OF_PLANTS);
34     scale(production, NUMBER_OF_PLANTS);
35     graph(production, NUMBER_OF_PLANTS);
36     return 0;
37 }
38 //Uses iostream:
39 void input_data(int a[], int last_plant_number)
    <The rest of the definition of input_data is given in Display 7.6.>
40 //Uses iostream:
41 void get_total(int& sum)
    <The rest of the definition of get_total is given in Display 7.6.>
42 void scale(int a[], int size)
    <The rest of the definition of scale is given in Display 7.7.>
43 //Uses cmath:
44 int round(double number)
    <The rest of the definition of round is given in Display 7.7.>
45 //Uses iostream:
46 void graph(const int asterisk_count[], int last_plant_number)
47 {
48     using namespace std;
49     cout << "\nUnits produced in thousands of units:\n";
50     for (int plant_number = 1;
51          plant_number <= last_plant_number; plant_number++)
52     {
53         cout << "Plant #" << plant_number << " ";
54         print_asterisks(asterisk_count[plant_number - 1]);
55         cout << endl;
56     }
57 }

```

(continued)

DISPLAY 7.8 Production Graph Program (*part 3 of 3*)

```
58 //Uses iostream:
59 void print_asterisks(int n)
60 {
61     using namespace std;
62     for (int count = 1; count <= n; count++)
63         cout << "*";
64 }
```

Sample Dialogue

```
This program displays a graph showing
production for each plant in the company.
Enter production data for plant number 1
Enter number of units produced by each department.
Append a negative number to the end of the list.
2000 3000 1000 -1
Total = 6000

Enter production data for plant number 2
Enter number of units produced by each department.
Append a negative number to the end of the list.
2050 3002 1300 -1
Total = 6352

Enter production data for plant number 3
Enter number of units produced by each department.
Append a negative number to the end of the list.
5000 4020 500 4348 -1
Total = 13868

Enter production data for plant number 4
Enter number of units produced by each department.
Append a negative number to the end of the list.
2507 6050 1809 -1
Total = 10366

Units produced in thousands of units: Plant #1 *****
Plant #2 *****
Plant #3 *****
Plant #4 *****
```

SELF-TEST EXERCISES

13. Write a function definition for a function called `one_more`, which has a formal parameter for an array of integers and increases the value of each array element by one. Add any other formal parameters that are needed.

14. Consider the following function definition:

```
void too2(int a[ ], int how_many)
{
    for (int index = 0; index < how_many; index++)
        a[index] = 2;
}
```

Which of the following are acceptable function calls?

```
int my_array[29];
too2(my_array, 29);
too2(my_array, 10);
too2(my_array, 55);
"Hey too2. Please, come over here."
int your_array[100];
too2(your_array, 100);
too2(my_array[3], 29);
```

15. Insert `const` before any of the following array parameters that can be changed to constant array parameters:

```
void output(double a[], int size);
//Precondition: a[0] through a[size - 1] have values.
//Postcondition: a[0] through a[size - 1] have been
//written out.

void drop_odd(int a[ ], int size);
//Precondition: a[0] through a[size - 1] have values.
//Postcondition: All odd numbers in a[0] through
//a[size - 1] have been changed to 0.
```

16. Write a function named `out_of_order` that takes as parameters an array of `double s` and an `int` parameter named `size` and returns a value of type `int`. This function will test this array for being out of order, meaning that the array violates the following condition:

$$a[0] \leq a[1] \leq a[2] \leq \dots$$

The function returns `-1` if the elements are not out of order; otherwise, it will return the index of the first element of the array that is out of order. For example, consider the declaration

```
double a[10] = {1.2, 2.1, 3.3, 2.5, 4.5,  
              7.9, 5.4, 8.7, 9.9, 1.0};
```

In this array, `a[2]` and `a[3]` are the first pair out of order, and `a[3]` is the first element out of order, so the function returns 3. If the array were sorted, the function would return -1.

7.3 PROGRAMMING WITH ARRAYS

Never trust to general impressions, my boy, but concentrate yourself upon details.

SIR ARTHUR CONAN DOYLE, *A Case of Identity* (Sherlock Holmes)

In this section we discuss partially filled arrays and give a brief introduction to sorting and searching of arrays. This section includes no new material about the C++ language, but does include more practice with C++ array parameters.

Partially Filled Arrays

Often the exact size needed for an array is not known when a program is written, or the size may vary from one run of the program to another. One common and easy way to handle this situation is to declare the array to be of the largest size the program could possibly need. The program is then free to use as much or as little of the array as is needed.

Partially filled arrays require some care. The program must keep track of how much of the array is used and must not reference any indexed variable that has not been given a value. The program in Display 7.9 illustrates this point. The program reads in a list of golf scores and shows how much each score differs from the average. This program will work for lists as short as one score, as long as ten scores, and for any length in between. The scores are stored in the array `score`, which has ten indexed variables, but the program uses only as much of the array as it needs. The variable `number_used` keeps track of how many elements are stored in the array. The elements (that is, the scores) are stored in positions `score[0]` through `score[number_used - 1]`.

The details are very similar to what they would be if `number_used` were the declared size of the array and the entire array were used. In particular, the variable `number_used` usually must be an argument to any function that manipulates the partially filled array. Since the argument `number_used` (when used properly) can often ensure that the function will not reference an illegal array index, this sometimes (but not always) eliminates the need for an argument that gives the declared size of the array. For example, the functions `show_difference` and `compute_average` use the argument `number_used` to ensure that only legal array indexes are used. However, the function `fill_array` needs to know the maximum declared size for the array so that it does not overflow the array.

DISPLAY 7.9 Partially Filled Array (part 1 of 2)

```

1 //Shows the difference between each of a list of golf scores and their average.
2 #include <iostream>
3 const int MAX_NUMBER_SCORES = 10;
4 void fill_array(int a[], int size, int& number_used);
5 //Precondition: size is the declared size of the array a.
6 //Postcondition: number_used is the number of values stored in a.
7 //a[0] through a[number_used - 1] have been filled with
8 //nonnegative integers read from the keyboard.
9 double compute_average(const int a[], int number_used);
10 //Precondition: a[0] through a[number_used - 1] have values; number_used > 0.
11 //Returns the average of numbers a[0] through a[number_used - 1].
12 void show_difference(const int a[], int number_used);
13 //Precondition: The first number_used indexed variables of a have values.
14 //Postcondition: Gives screen output showing how much each of the first
15 //number_used elements of a differs from their average.
16 int main( )
17 {
18     using namespace std;
19     int score[MAX_NUMBER_SCORES], number_used;
20     cout << "This program reads golf scores and shows\n"
21          << "how much each differs from the average.\n";
22
23     cout << "Enter golf scores:\n";
24     fill_array(score, MAX_NUMBER_SCORES, number_used);
25     show_difference(score, number_used);
26
27     return 0;
28 }
29 //Uses iostream:
30 void fill_array(int a[], int size, int& number_used)
31 {
32     using namespace std;
33     cout << "Enter up to " << size << " nonnegative whole numbers.\n"
34          << "Mark the end of the list with a negative number.\n";
35     int next, index = 0;
36     cin >> next;
37     while ((next >= 0) && (index < size))
38     {
39         a[index] = next;
40         index++;
41         cin >> next;
42     }
43     number_used = index;
44 }

```

(continued)

DISPLAY 7.9 Partially Filled Array (part 2 of 2)

```
44  double compute_average(const int a[], int number_used)
45  {
46      double total = 0;
47      for (int index = 0; index < number_used; index++)
48          total = total + a[index];
49      if (number_used > 0)
50      {
51          return (total/number_used);
52      }
53      else
54      {
55          using namespace std;
56          cout << "ERROR: number of elements is 0 in compute_average.\n"
57               << "compute_average returns 0.\n";
58          return 0;
59      }
60  }

61  void show_difference(const int a[], int number_used)
62  {
63      using namespace std;
64      double average = compute_average(a, number_used);
65      cout << "Average of the " << number_used
66           << " scores = " << average << endl
67           << "The scores are:\n";
68      for (int index = 0; index < number_used; index++)
69          cout << a[index] << " differs from average by "
70              << (a[index] - average) << endl;
71  }
```

Sample Dialogue

```
This program reads golf scores and shows
how much each differs from the average.
Enter golf scores:
Enter up to 10 nonnegative whole numbers.
Mark the end of the list with a negative number.
69 74 68 -1

Average of the 3 scores = 70.3333
The scores are:
69 differs from average by -1.33333
74 differs from average by 3.66667
68 differs from average by -2.33333
```

■ PROGRAMMING TIP Do Not Skimp on Formal Parameters

Notice the function `fill_array` in Display 7.9. When `fill_array` is called, the declared array size `MAX_NUMBER_SCORES` is given as one of the arguments, as shown in the following function call from Display 7.9:

```
fill_array(score, MAX_NUMBER_SCORES, number_used);
```

You might protest that `MAX_NUMBER_SCORES` is a globally defined constant and so could be used in the definition of `fill_array` without the need to make it an argument. You would be correct, and if we did not use `fill_array` in any program other than the one in Display 7.9, we could get by without making `MAX_NUMBER_SCORES` an argument to `fill_array`. However, `fill_array` is a generally useful function that you may want to use in several different programs. We do in fact also use the function `fill_array` in the program in Display 7.10, discussed in the next subsection. In the program in Display 7.10, the argument for the declared array size is a different named global constant. If we had written the global constant `MAX_NUMBER_SCORES` into the body of the function `fill_array`, we would not have been able to reuse the function in the program in Display 7.10. ■

PROGRAMMING EXAMPLE

Searching an Array

A common programming task is to search an array for a given value. For example, the array may contain the student numbers for all students in a given course. To tell whether a particular student is enrolled, the array is searched to see if it contains the student's number. The program in Display 7.10 fills an array and then searches the array for values specified by the user. A real application program would be much more elaborate, but this shows all the essentials of the sequential search algorithm. The sequential search algorithm is the most straightforward searching algorithm you could imagine: The program looks at the array elements in the order first to last to see if the target number is equal to any of the array elements.

In Display 7.10, the function `search` is used to search the array. When searching an array, you often want to know more than simply whether or not the target value is in the array. If the target value is in the array, you often want to know the index of the indexed variable holding that target value, since the index may serve as a guide to some additional information about the target value. Therefore, we designed the function `search` to return an index giving the location of the target value in the array, provided the target value is, in fact, in the array. If the target value is not in the array, `search` returns `-1`. Let's look at the function `search` in a little more detail.

The function `search` uses a *while* loop to check the array elements one after the other to see whether any of them equals the target value. The variable

DISPLAY 7.10 Searching an Array (part 1 of 2)

```

1 //Searches a partially filled array of nonnegative integers.
2 #include <iostream>
3 const int DECLARED_SIZE = 20;
4 void fill_array(int a[], int size, int& number_used);
5 //Precondition: size is the declared size of the array a.
6 //Postcondition: number_used is the number of values stored in a.
7 //a[0] through a[number_used - 1] have been filled with
8 //nonnegative integers read from the keyboard.
9 int search(const int a[], int number_used, int target);
10 //Precondition: number_used is <= the declared size of a.
11 //Also, a[0] through a[number_used - 1] have values.
12 //Returns the first index such that a[index] == target,
13 //provided there is such an index; otherwise, returns -1.
14 int main( )
15 {
16     using namespace std;
17     int arr[DECLARED_SIZE], list_size, target;
18     fill_array(arr, DECLARED_SIZE, list_size);
19     char ans;
20     int result;
21     do
22     {
23         cout << "Enter a number to search for: ";
24         cin >> target;
25         result = search(arr, list_size, target);
26         if (result == -1)
27             cout << target << " is not on the list.\n";
28         else
29             cout << target << " is stored in array position "
30              << result << endl
31              << "(Remember: The first position is 0.)\n";
32         cout << "Search again?(y/n followed by Return): ";
33         cin >> ans;
34     } while ((ans != 'n') && (ans != 'N'));
35     cout << "End of program.\n";
36     return 0;
37 }
38 //Uses iostream:
39 void fill_array(int a[], int size, int& number_used)

```

<The rest of the definition of fill_array is given in Display 7.9.>

40

(continued)

DISPLAY 7.10 Searching an Array (part 2 of 2)

```
41  int search(const int a[], int number_used, int target)
42  {
43
44      int index = 0;
45      bool found = false;
46      while ((!found) && (index < number_used))
47          if (target == a[index])
48              found = true;
49          else
50              index++;
51
52      if (found)
53          return index;
54      else
55          return -1;
56  }
```

Sample Dialogue

```
Enter up to 20 nonnegative whole numbers.
Mark the end of the list with a negative number.
10 20 30 40 50 60 70 80 -1
Enter a number to search for: 10
10 is stored in array position 0.
(Remember: The first position is 0.)
Search again?(y/n followed by Return): y
Enter a number to search for: 40
40 is stored in array position 3.
(Remember: The first position is 0.)
Search again?(y/n followed by Return): y
Enter a number to search for: 42
42 is not on the list.
Search again?(y/n followed by Return): n
End of program.
```

found is used as a flag to record whether or not the target element has been found. If the target element is found in the array, found is set to *true*, which in turn ends the *while* loop.

Even if we used `fill_array` in only one program, it can still be a good idea to make the declared array size an argument to `fill_array`. Displaying the declared size of the array as an argument reminds us that the function needs this information in a critically important way.

PROGRAMMING EXAMPLE**Sorting an Array**

One of the most widely encountered programming tasks, and certainly the most thoroughly studied, is sorting a list of values, such as a list of sales figures that must be sorted from lowest to highest or from highest to lowest, or a list of words that must be sorted into alphabetical order. In this section we describe a function called `sort` that sorts a partially filled array of numbers so that they are ordered from smallest to largest.

The procedure `sort` has one array parameter `a`. The array `a` will be partially filled, so there is an additional formal parameter called `number_used`, which tells how many array positions are used. Thus, the declaration and precondition for the function `sort` is

```
void sort(int a[], int number_used);
//Precondition: number_used <= declared size of the array a.
//Array elements a[0] through a[number_used - 1] have values.
```

The function `sort` rearranges the elements in array `a` so that after the function call is completed the elements are sorted as follows:

$$a[0] \leq a[1] \leq a[2] \leq \dots \leq a[\text{number_used} - 1]$$

The algorithm we use to do the sorting is called selection sort. It is one of the easiest of the sorting algorithms to understand.

One way to design an algorithm is to rely on the definition of the problem. In this case the problem is to sort an array `a` from smallest to largest. That means rearranging the values so that `a[0]` is the smallest, `a[1]` the next smallest, and so forth. That definition yields an outline for the selection sort algorithm:

```
for (int index = 0; index < number_used; index++)
    Place the indexth smallest element in a[index]
```

There are many ways to realize this general approach. The details could be developed using two arrays and copying the elements from one array to the other in sorted order, but one array should be both adequate and economical. Therefore, the function `sort` uses only the one array containing the values to be sorted. The function `sort` rearranges the values in the array `a` by interchanging pairs of values. Let us go through a concrete example so that you can see how the algorithm works.

Consider the array shown in Display 7.11. The algorithm will place the smallest value in `a[0]`. The smallest value is the value in `a[3]`. So the algorithm interchanges the values of `a[0]` and `a[3]`. The algorithm then looks for the next smallest element. The value in `a[0]` is now the smallest element and so the next smallest element is the smallest of the remaining elements `a[1]`, `a[2]`, `a[3]`, ..., `a[9]`. In the example in Display 7.11, the next smallest element is in `a[5]`, so the algorithm interchanges the values of `a[1]` and `a[5]`. This positioning of the second smallest element is illustrated in the fourth and fifth array pictures in Display 7.11. The algorithm then positions the third smallest element, and so forth.

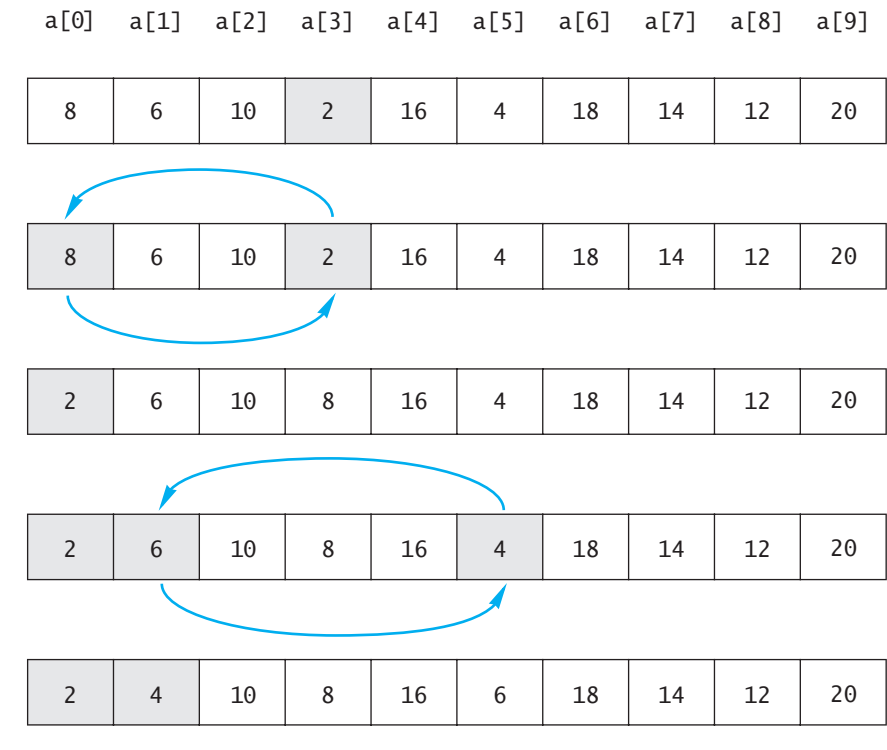

VideoNote
Selection Sort Walkthrough

DISPLAY 7.11 Selection Sort

As the sorting proceeds, the beginning array elements are set equal to the correct sorted values. The sorted portion of the array grows by adding elements one after the other from the elements in the unsorted end of the array. Notice that the algorithm need not do anything with the value in the last indexed variable, `a[9]`. That is because once the other elements are positioned correctly, `a[9]` must also have the correct value. After all, the correct value for `a[9]` is the smallest value left to be moved, and the only value left to be moved is the value that is already in `a[9]`.

The definition of the function `sort`, included in a demonstration program, is given in Display 7.12. `sort` uses the function `index_of_smallest` to find the index of the smallest element in the unsorted end of the array, and then it does an interchange to move this element down into the sorted part of the array.

The function `swap_values`, shown in Display 7.12, is used to interchange the values of indexed variables. For example, the following call will interchange the values of `a[0]` and `a[3]`:

```
swap_values(a[0], a[3]);
```

The function `swap_values` was explained in Chapter 5.

DISPLAY 7.12 *Sorting an Array (part 1 of 2)*

```

1 //Tests the procedure sort.
2 #include <iostream>

3 void fill_array(int a[], int size, int&number_used);
4 //Precondition: size is the declared size of the array a.
5 //Postcondition: number_used is the number of values stored in a.
6 //a[0] through a[number_used - 1] have been filled with
7 //nonnegative integers read from the keyboard.

8 void sort(int a[], int number_used);
9 //Precondition: number_used <= declared size of the array a.
10 //The array elements a[0] through a[number_used - 1] have values.
11 //Postcondition: The values of a[0] through a[number_used - 1] have
12 //been rearranged so that a[0] <= a[1] <= ... <= a[number_used - 1].

13 void swap_values(int &v1, int &v2);
14 //Interchanges the values of v1 and v2.

15 int index_of_smallest(const int a[], int start_index, int number_used);
16 //Precondition: 0 <= start_index < number_used. Referenced array elements have
17 //values.
18 //Returns the index i such that a[i] is the smallest of the values
19 //a[start_index], a[start_index + 1], ..., a[number_used - 1].

20 int main( )
21 {
22     using namespace std;
23     cout << "This program sorts numbers from lowest to highest.\n";

24     int sample_array[10], number_used;
25     fill_array(sample_array, 10, number_used);
26     sort(sample_array, number_used);

27     cout << "In sorted order the numbers are:\n";
28     for (int index = 0; index < number_used; index++)
29         cout << sample_array[index] << " ";
30     cout << endl;

31     return 0;
32 }

33 //Uses iostream:
34 void fill_array(int a[], int size, int&number_used)

```

<The rest of the definition of fill_array is given in Display 7.9.>

```

35 void sort(int a[], int number_used)
36 {
37     int index_of_next_smallest;
38     for (int index = 0; index < number_used - 1; index++)

```

(continued)

DISPLAY 7.12 *Sorting an Array (part 2 of 2)*

```

39     {//Place the correct value in a[index]:
40         index_of_next_smallest =
41             index_of_smallest(a, index, number_used);
42         swap_values(a[index], a[index_of_next_smallest]);
43         //a[0] <= a[1] <=...<= a[index] are the smallest of the original array
44         //elements. The rest of the elements are in the remaining positions.
45     }
46 }
47
48 void swap_values(int& v1, int& v2)
49 {
50     int temp;
51     temp = v1;
52     v1 = v2;
53     v2 = temp;
54 }
55
56 int index_of_smallest(const int a[], int start_index, int number_used)
57 {
58     int min = a[start_index],
59         index_of_min = start_index;
60     for (int index = start_index + 1; index < number_used; index++)
61         if (a[index] < min)
62             {
63                 min = a[index];
64                 index_of_min = index;
65                 //min is the smallest of a[start_index] through a[index]
66             }
67     return index_of_min;
68 }
69 }

```

Sample Dialogue

This program sorts numbers from lowest to highest.

Enter up to 10 nonnegative whole numbers.

Mark the end of the list with a negative number.

80 30 50 70 60 90 20 30 40 -1

In sorted order the numbers are:

20 30 30 40 50 60 70 80 90

PROGRAMMING EXAMPLE**Bubble Sort**VideoNote
Bubble Sort Walkthrough

The selection sort algorithm that we just described is not the only way to sort an array. In fact, computer scientists have devised scores of sorting algorithms! Some of these algorithms are more efficient than others and some work only for particular types of data. Bubble sort is a simple and general sorting algorithm that is similar to selection sort.

If we use bubble sort to sort an array in ascending order, then the largest value is successively “bubbled” toward the end of the array. For example, if we start with an unsorted array consisting of the following integers:

Initial array: {3, 10, 9, 2, 5}

Then after the first pass we will have moved the largest value, 10, to the end of the array:

After first pass: {3, 9, 2, 5, 10}

The second pass will move the second largest value, 9, to the second to last index of the array:

After second pass: {3, 2, 5, 9, 10}

The third pass will move the third largest value, 5, to the third to last index of the array (where it already is):

After third pass: {2, 3, 5, 9, 10}

The fourth pass will move the fourth largest value, 3, to the fourth to last index of the array (where it already is):

After fourth pass: {2, 3, 5, 9, 10}

At this point the algorithm is done. The remaining number at the beginning of the array doesn’t need to be examined since it is the only number left and must be the smallest. To design a program based on bubble sort note that we are placing the largest item at index `length-1`, the second largest item at `length-2`, the next at `length-3`, etc. This corresponds to a loop that starts at index `length-1` of the array and counts down to index 1 of the array. We don’t need to include index 0 since that will contain the smallest element. One way to implement the loop is with the following code, where variable `i` corresponds to the target index:

```
for (int i = length-1; i > 0; i--)
```

The “bubble” part of bubble sort happens inside each iteration of this loop. The bubble step consists of another loop that moves the largest number toward the index `i` in the array. First, the largest number between index 0 and

index i will be bubbled up to index i . We start the bubbling procedure by comparing the number at index 0 with the number at index 1. If the number at index 0 is larger than the number at index 1 then the values are swapped so we end up with the largest number at index 1. If the number at index 0 is less than or equal to the number at index 1 then nothing happens. Starting with the following unsorted array:

Initial array: {3, 10, 9, 2, 5}

Then the first step of the bubbling procedure will compare 3 to 10. Since $10 > 3$ nothing happens and the end result is the number 10 is at index 1:

After step 1: {3, 10, 9, 2, 5}

The procedure is repeated for successively larger values until we reach i . The second step will compare the numbers at index 1 and 2, which is values 10 and 9. Since 10 is larger than 9 we swap the numbers resulting in the following:

After step 2: {3, 9, 10, 2, 5}

The process is repeated two more times:

After step 3: {3, 9, 2, 10, 5}

After step 4: {3, 9, 2, 5, 10}

This ends the first iteration of the bubble sort algorithm. We have bubbled the largest number to the end of the array. The next iteration would bubble the second largest number to the second to last position, and so forth, where variable i represents the target index for the bubbled number. If we use variable j to reference the index of the bubbled item then our loop code looks like this:

```
for (int i = length-1; i > 0; i--)
    for (int j = 0; j < i; j++)
```

Inside the loop we must compare the items at index j and index $j+1$. The largest should be moved into index $j+1$. The completed algorithm is shown below and a complete example in Display 7.13.

```
for (int i = length-1; i > 0; i--)
    for (int j = 0; j < i; j++)
        if (arr[j] > arr[j+1])
        {
            int temp = arr[j+1];
            arr[j+1] = arr[j];
            arr[j] = temp;
        }
```

DISPLAY 7.13 Bubble Sort Program

```
1 //DISPLAY 7.13 Bubble Sort Program
2 //Sorts an array of integers using Bubble Sort.
3 #include <iostream>
4
5 void bubblesort(int arr[], int length);
6 //Precondition: length <= declared size of the array arr.
7 //The array elements arr[0] through a[length - 1] have values.
8 //Postcondition: The values of arr[0] through arr[length - 1] have
9 //been rearranged so that arr[0] <= a[1] <= ... <= arr[length - 1].
10
11 int main()
12 {
13     using namespace std;
14     int a[] = {3, 10, 9, 2, 5, 1};
15
16     bubblesort(a, 6);
17     for (int i=0; i<6; i++)
18     {
19         cout << a[i] << " ";
20     }
21     cout << endl;
22     return 0;
23 }
24
25 void bubblesort(int arr[], int length)
26 {
27     // Bubble largest number toward the right
28     for (int i = length-1; i > 0; i--)
29         for (int j = 0; j < i; j++)
30             if (arr[j] > arr[j+1])
31             {
32                 // Swap the numbers
33                 int temp = arr[j+1];
34                 arr[j+1] = arr[j];
35                 arr[j] = temp;
36             }
37 }
```

Sample Dialogue

```
1 2 3 5 9 10
```



SELF-TEST EXERCISES

17. Write a program that will read up to ten nonnegative integers into an array called `number_array` and then write the integers back to the screen. For this exercise you need not use any functions. This is just a toy program and can be very minimal.

18. Write a program that will read up to ten letters into an array and write the letters back to the screen in the reverse order. For example, if the input is

abcd.

then the output should be

dcba

Use a period as a sentinel value to mark the end of the input. Call the array `letter_box`. For this exercise you need not use any functions. This is just a toy program and can be very minimal.

19. Following is the declaration for an alternative version of the function search defined in Display 7.12. In order to use this alternative version of the search function, we would need to rewrite the program slightly, but for this exercise all you need to do is to write the function definition for this alternative version of search.

```
bool search(const int a[], int number_used,
            int target, int& where);
//Precondition: number_used is <= the declared size of the
//array a; a[0] through a[number_used - 1] have values.
//Postcondition: If target is one of the elements a[0]
//through a[number_used - 1], then this function returns
//true and sets the value of where so that a[where] ==
//target; otherwise this function returns false and the
//value of where is unchanged.
```

7.4 MULTIDIMENSIONAL ARRAYS

Two indexes are better than one.

FOUND ON THE WALL OF A COMPUTER SCIENCE DEPARTMENT RESTROOM

C++ allows you to declare arrays with more than one index. In this section we describe these multidimensional arrays.

Multidimensional Array Basics

It is sometimes useful to have an array with more than one index, and this is allowed in C++. The following declares an array of characters called `page`. The array `page` has two indexes: The first index ranges from 0 to 29, and the second from 0 to 99.

```
char page[30][100];
```

The indexed variables for this array each have two indexes. For example, `page[0][0]`, `page[15][32]`, and `page[29][99]` are three of the indexed variables for this array. Note that each index must be enclosed in its own set of square brackets. As was true of the one-dimensional arrays we have already seen, each indexed variable for a multidimensional array is a variable of the base type.

An array may have any number of indexes, but perhaps the most common number of indexes is two. A two-dimensional array can be visualized as a two-dimensional display with the first index giving the row and the second index giving the column. For example, the array indexed variables of the two-dimensional array `page` can be visualized as follows:

```
page[0][0], page[0][1], ..., page[0][99]
page[1][0], page[1][1], ..., page[1][99]
page[2][0], page[2][1], ..., page[2][99]
      .
      .
      .
page[29][0], page[29][1], ..., page[29][99]
```

You might use the array `page` to store all the characters on a page of text that has 30 lines (numbered 0 through 29) and 100 characters on each line (numbered 0 through 99).

In C++, a two-dimensional array, such as `page`, is actually an array of arrays. The example array `page` is actually a one-dimensional array of size 30, whose base type is a one-dimensional array of characters of size 100. Normally, this need not concern you, and you can usually act as if the array `page` is actually an array with two indexes (rather than an array of arrays, which is harder to keep track of). There is, however, at least one situation where a two-dimensional array looks very much like an array of arrays, namely, when you have a function with an array parameter for a two-dimensional array, which is discussed in the next subsection.

A multidimensional array is an array of arrays

Multidimensional Array Parameters

The following declaration of a two-dimensional array is actually declaring a one-dimensional array of size 30, whose base type is a one-dimensional array of characters of size 100:

Multidimensional Array Declaration

SYNTAX

```
Type Array_Name[Size_Dim_1][Size_Dim_2]...[Size_Dim_Last];
```

EXAMPLES

```
char page[30][100];
int matrix[2][3];
double three_d_picture[10][20][30];
```

An array declaration, of the form shown, defines one indexed variable for each combination of array indexes. For example, the second of the sample declarations defines the following six indexed variables for the array `matrix`:

```
matrix[0][0], matrix[0][1], matrix[0][2],
matrix[1][0], matrix[1][1], matrix[1][2]
```

```
char page[30][100];
```

Viewing a two-dimensional array as an array of arrays will help you to understand how C++ handles parameters for multidimensional arrays. For example, the following function takes an array argument, like `page`, and prints it to the screen:

```
void display_page(const char p[][100], int size_dimension_1)
{
    for (int index1 = 0; index1 < size_dimension_1; index1++)
        { //Printing one line:
            for (int index2 = 0; index2 < 100; index2++)
                cout << p[index1][index2];
            cout << endl;
        }
}
```

Notice that with a two-dimensional array parameter, the size of the first dimension is not given, so we must include an `int` parameter to give the size of this first dimension. (As with ordinary arrays, the compiler will allow you to specify the first dimension by placing a number within the first pair of square brackets. However, such a number is only a comment; the compiler ignores any such number.) The size of the second dimension (and all other dimensions if there are more than two) is given after the array parameter, as shown for the parameter

```
const char p[ ][100]
```

Multidimensional Array Parameters

When a multidimensional array parameter is given in a function heading or function declaration, the size of the first dimension is not given, but the remaining dimension sizes must be given in square brackets. Since the first dimension size is not given, you usually need an additional parameter of type *int* that gives the size of this first dimension. Below is an example of a function declaration with a two-dimensional array parameter *p*:

```
void get_page(char p[][100], int size_dimension_1);
```

If you realize that a multidimensional array is an array of arrays, then this rule begins to make sense. Since the two-dimensional array parameter

```
const char p[ ][100]
```

is a parameter for an array of arrays, the first dimension is really the index of the array and is treated just like an array index for an ordinary, one-dimensional array. The second dimension is part of the description of the base type, which is an array of characters of size 100.

PROGRAMMING EXAMPLE

Two-Dimensional Grading Program

Display 7.14 contains a program that uses a two-dimensional array, named *grade*, to store and then display the grade records for a small class. The class has four students and includes three quizzes. Display 7.15 illustrates how the array *grade* is used to store data. The first array index is used to designate a student, and the second array index is used to designate a quiz. Since the students and quizzes are numbered starting with 1 rather than 0, we must subtract 1 from the student number and subtract 1 from the quiz number to obtain the indexed variable that stores a particular quiz score. For example, the score that student number 4 received on quiz number 1 is recorded in *grade*[3][0].

Our program also uses two ordinary one-dimensional arrays. The array *st_ave* will be used to record the average quiz score for each of the students. For example, the program will set *st_ave*[0] equal to the average of the quiz scores received by student 1, *st_ave*[1] equal to the average of the quiz scores received by student 2, and so forth. The array *quiz_ave* will be used to record the average score for each quiz. For example, the program will set *quiz_ave*[0] equal to the average of all the student scores for quiz 1, *quiz_ave*[1] will record the average

DISPLAY 7.14 Two-Dimensional Array (part 1 of 3)

```
1 //Reads quiz scores for each student into the two-dimensional array grade (but
2 //the input code is not shown in this display). Computes the average score
3 //for each student and the average score for each quiz. Displays the quiz scores
4 //and the averages.
5 #include <iostream>
6 #include <iomanip>
7 const int NUMBER_STUDENTS = 4, NUMBER_QUIZZES = 3;
8
9 void compute_st_ave(const int grade[][NUMBER_QUIZZES], double st_ave[]);
10 //Precondition: Global constants NUMBER_STUDENTS and NUMBER_QUIZZES
11 //are the dimensions of the array grade. Each of the indexed variables
12 //grade[st_num - 1, quiz_num - 1] contains the score for student st_num on quiz
13 //quiz_num.
14 //Postcondition: Each st_ave[st_num - 1] contains the average for student
15 //number stu_num.
16
17 void compute_quiz_ave(const int grade[][NUMBER_QUIZZES], double quiz_ave[]);
18 //Precondition: Global constants NUMBER_STUDENTS and NUMBER_QUIZZES
19 //are the dimensions of the array grade. Each of the indexed variables
20 //grade[st_num - 1, quiz_num - 1] contains the score for student st_num on quiz
21 //quiz_num.
22 //Postcondition: Each quiz_ave[quiz_num - 1] contains the average for quiz number
23 //quiz_num.
24
25 void display(const int grade[][NUMBER_QUIZZES],
26 const double st_ave[], const double quiz_ave[]);
27 //Precondition: Global constants NUMBER_STUDENTS and NUMBER_QUIZZES are the
28 //dimensions of the array grade. Each of the indexed variables grade[st_num - 1,
29 //quiz_num - 1] contains the score for student st_num on quiz quiz_num. Each
30 //st_ave[st_num - 1] contains the average for student stu_num. Each
31 //quiz_ave[quiz_num - 1] contains the average for quiz number quiz_num.
32 //Postcondition: All the data in grade, st_ave, and quiz_ave has been output.
33
34 int main( )
35 {
36     using namespace std;
37     int grade[NUMBER_STUDENTS][NUMBER_QUIZZES];
38     double st_ave[NUMBER_STUDENTS];
39     double quiz_ave[NUMBER_QUIZZES];
40
```

<The code for filling the array grade goes here, but is not shown.>

(continued)

DISPLAY 7.14 Two-Dimensional Array (part 2 of 3)

```

41     compute_st_ave(grade, st_ave);
42     compute_quiz_ave(grade, quiz_ave);
43     display(grade, st_ave, quiz_ave);
44     return 0;
45 }

46 void compute_st_ave(const int grade[][NUMBER_QUIZZES], double st_ave[])
47 {
48     for (int st_num = 1; st_num <= NUMBER_STUDENTS; st_num++)
49     {//Process one st_num:
50         double sum = 0;
51         for (int quiz_num = 1; quiz_num <= NUMBER_QUIZZES; quiz_num++)
52             sum = sum + grade[st_num - 1][quiz_num - 1];
53         //sum contains the sum of the quiz scores for student number st_num.
54         st_ave[st_num - 1] = sum/NUMBER_QUIZZES;
55         //Average for student st_num is the value of st_ave[st_num-1]
56     }
57 }

58
59
60 void compute_quiz_ave(const int grade[][NUMBER_QUIZZES], double quiz_ave[])
61 {
62     for (int quiz_num = 1; quiz_num <= NUMBER_QUIZZES; quiz_num++)
63     {//Process one quiz (for all students):
64         double sum = 0;
65         for (int st_num = 1; st_num <= NUMBER_STUDENTS; st_num++)
66             sum = sum + grade[st_num - 1][quiz_num - 1];
67         //sum contains the sum of all student scores on quiz number quiz_num.
68         quiz_ave[quiz_num - 1] = sum/NUMBER_STUDENTS;
69         //Average for quiz quiz_num is the value of quiz_ave[quiz_num - 1]
70     }
71 }

72
73
74 //Uses iostream and iomanip:
75 void display(const int grade[][NUMBER_QUIZZES],
76             const double st_ave[], const double quiz_ave[])
77 {
78     using namespace std;
79     cout.setf(ios::fixed);
80     cout.setf(ios::showpoint);
81     cout.precision(1);
82     cout << setw(10) << "Student"
83          << setw(5) << "Ave"
84          << setw(15) << "Quizzes\n";
85     for (int st_num = 1; st_num <= NUMBER_STUDENTS; st_num++)
86     {//Display for one st_num:

```

(continued)

DISPLAY 7.14 Two-Dimensional Array (part 3 of 3)

```

87     cout << setw(10) << st_num
88         << setw(5) << st_ave[st_num - 1] << " ";
89     for (int quiz_num = 1; quiz_num <= NUMBER_QUIZZES; quiz_num++)
90         cout << setw(5) << grade[st_num - 1][quiz_num - 1];
91     cout << endl;
92 }

93     cout << "Quiz averages = ";
94     for (int quiz_num = 1; quiz_num <= NUMBER_QUIZZES; quiz_num++)
95         cout << setw(5) << quiz_ave[quiz_num - 1];
96     cout << endl;
97 }
```

Sample Dialogue

<The dialogue for filling the array grade is not shown.>

Student	Ave	Quizzes		
1	10.0	10	10	10
2	1.0	2	0	1
3	7.7	8	6	9
4	7.3	8	4	10
Quiz averages =	7.0	5.0	7.5	

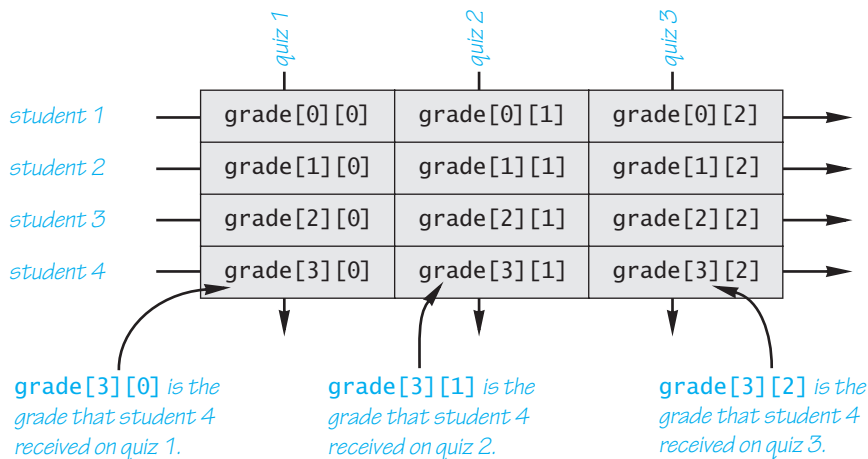
DISPLAY 7.15 The Two-Dimensional Array grade

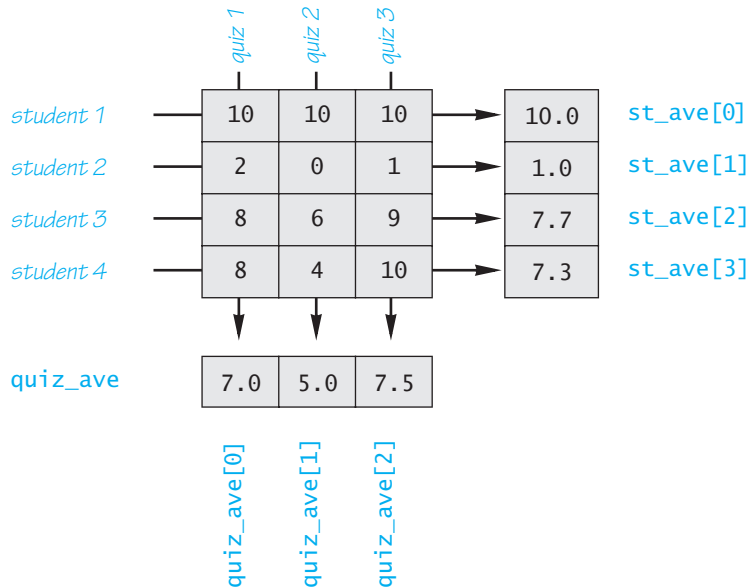
DISPLAY 7.16 The Two-Dimensional Array grade (Another View)

score for quiz 2, and so forth. Display 7.16 illustrates the relationship between the arrays `grade`, `st_ave`, and `quiz_ave`. In that display, we have shown some sample data for the array `grade`. This data, in turn, determines the values that the program stores in `st_ave` and in `quiz_ave`. Display 7.16 also shows these values, which the program computes for `st_ave` and `quiz_ave`.

The complete program for filling the array `grade` and then computing and displaying both the student averages and the quiz averages is shown in Display 7.14. In that program we have declared array dimensions as global named constants. Since the procedures are particular to this program and could not be reused elsewhere, we have used these globally defined constants in the procedure bodies, rather than having parameters for the size of the array dimensions. Since it is routine, the display does not show the code that fills the array.

PITFALL Using Commas Between Array Indexes

Note that in Display 7.14 we wrote an indexed variable for the two-dimensional array `grade` as `grade[st_num - 1][quiz_num - 1]` with two pairs of square brackets. In some other programming languages it would be written with one pair of brackets and commas as follows: `grade[st_num - 1, quiz_num - 1]`; this is incorrect in C++. If you use `grade[st_num - 1, quiz_num - 1]` in C++ you are unlikely to get any error message, but it is incorrect usage and will cause your program to misbehave. ■

SELF-TEST EXERCISES

20. What is the output produced by the following code?

```
int my_array[4][4], index1, index2;
for (index1 = 0; index1 < 4; index1++)
    for (index2 = 0; index2 < 4; index2++)
        my_array[index1][index2] = index2;
for (index1 = 0; index1 < 4; index1++)
{
    for (index2 = 0; index2 < 4; index2++)
        cout << my_array[index1][index2] << " ";
    cout << endl;
}
```

21. Write code that will fill the array `a` (declared below) with numbers typed in at the keyboard. The numbers will be input five per line, on four lines (although your solution need not depend on how the input numbers are divided into lines).

```
int a[4][5];
```

22. Write a function definition for a *void* function called `echo` such that the following function call will echo the input described in Self-Test Exercise 21 and will echo it in the same format as we specified for the input (that is, four lines of five numbers per line):

```
echo(a, 4);
```

CHAPTER SUMMARY

- An array can be used to store and manipulate a collection of data that is all of the same type.
- The indexed variables of an array can be used just like any other variables of the base type of the array.
- A *for* loop is a good way to step through the elements of an array and perform some program action on each indexed variable.
- The most common programming error made when using arrays is attempting to access a nonexistent array index. Always check the first and last iterations of a loop that manipulates an array to make sure it does not use an index that is illegally small or illegally large.
- An array formal parameter is neither a call-by-value parameter nor a call-by-reference parameter, but a new kind of parameter. An array parameter is similar to a call-by-reference parameter in that any change that is made to the formal parameter in the body of the function will be made to the array argument when the function is called.

- The indexed variables for an array are stored next to each other in the computer's memory so that the array occupies a contiguous portion of memory. When the array is passed as an argument to a function, only the address of the first indexed variable (the one numbered 0) is given to the calling function. Therefore, a function with an array parameter usually needs another formal parameter of type *int* to give the size of the array.
- When using a partially filled array, your program needs an additional variable of type *int* to keep track of how much of the array is being used.
- To tell the compiler that an array argument should not be changed by your function, you can insert the modifier *const* before the array parameter for that argument position. An array parameter that is modified with a *const* is called a **constant array parameter**.
- If you need an array with more than one index, you can use a multidimensional array, which is actually an array of arrays.

Answers to Self-Test Exercises

1. The statement `int a[5];` is a declaration, where 5 is the number of array elements. The expression `a[4]` is an access into the array defined by the previous statement. The access is to the element having index 4, which is the fifth (and last) array element.
2. a. score
b. double
c. 5
d. 0 through 4
e. Any of `score[0]`, `score[1]`, `score[2]`, `score[3]`, `score[4]`
3. a. One too many initializers
b. Correct. The array size is 4.
c. Correct. The array size is 4.
4. abc
5. 1.1 2.2 3.3
1.1 3.3 3.3

(Remember that the indexes start with 0, not 1.)
6. 2 4 6 8 10 12 14 16 18 0 4 8 12 16

7. The indexed variables of `sample_array` are `sample_array[0]` through `sample_array[9]`, but this piece of code tries to fill `sample_array[1]` through `sample_array[10]`. The index 10 in `sample_array[10]` is out of range.
8. There is an index out of range. When `index` is equal to 9, `index + 1` is equal to 10, so `a[index + 1]`, which is the same as `a[10]`, has an illegal index. The loop should stop with one less iteration. To correct the code, change the first line of the `for` loop to

```
for (int index = 0; index < 9; index++)
```

9. `int i, a[20];`

```
cout << "Enter 20 numbers:\n";
```

```
for (i = 0; i < 20; i++)
    cin >> a[i];
```

10. The array will consume 14 bytes of memory. The address of the indexed variable `your_array[3]` is 1006.
11. The following function calls are acceptable:

```
tripler(number);
tripler(a[2]);
tripler(a[number]);
```

The following function calls are incorrect:

```
tripler(a[3]);
tripler(a);
```

The first one has an illegal index. The second has no indexed expression at all. You cannot use an entire array as an argument to `tripler`, as in the second call. The section "Entire Arrays as Function Arguments" discusses a different situation in which you can use an entire array as an argument.

12. The loop steps through indexed variables `b[1]` through `b[5]`, but 5 is an illegal index for the array `b`. The indexes are 0, 1, 2, 3, and 4. The correct version of the code is:

```
int b[5] = {1, 2, 3, 4, 5};
for (int i = 0; i < 5; i++)
    tripler(b[i]);
```

13. `void one_more(int a[], int size)`
//Precondition: size is the declared size of the array a.
//a[0] through a[size - 1] have been given values.
//Postcondition: a[index] has been increased by 1
//for all indexed variables of a.
 {

```

    for (int index = 0; index < size; index++)
        a[index] = a[index] + 1;
}

```

14. The following function calls are all acceptable:

```

too2(my_array, 29);
too2(my_array, 10);
too2(your_array, 100);

```

The call

```
too2(my_array, 10);
```

is legal, but will fill only the first ten indexed variables of `my_array`. If that is what is desired, the call is acceptable.

The following function calls are all incorrect:

```

too2(my_array, 55);
"Hey too2. Please, come over here."
too2(my_array[3], 29);

```

The first of these is incorrect because the second argument is too large. The second is incorrect because it is missing a final semicolon (and for other reasons). The third one is incorrect because it uses an indexed variable for an argument where it should use the entire array.

15. You can make the array parameter in `output` a constant parameter, since there is no need to change the values of any indexed variables of the array parameter. You cannot make the parameter in `drop_odd` a constant parameter because it may have the values of some of its indexed variables changed.

```

void output(const double a[ ], int size);
//Precondition: a[0] through a[size - 1] have values.
//Postcondition: a[0] through a[size - 1] have been
//written out.

```

```

void drop_odd(int a[], int size);
//Precondition: a[0] through a[size - 1] have values.
//Postcondition: All odd numbers in a[0] through
//a[size - 1] have been changed to 0.

```

16. `int out_of_order(double array[], int size)`
- ```

{
 for (int i = 0; i < size - 1; i++)
 if (array[i] > array[i+1]) //fetch a[i+1] for each i.
 return i+1;
 return -1;
}

```

```
17. #include <iostream>
 using namespace std;
 const int DECLARED_SIZE = 10;

 int main()
 {
 cout << "Enter up to ten nonnegative integers.\n"
 << "Place a negative number at the end.\n";
 int number_array[DECLARED_SIZE], next, index = 0;
 cin >> next;
 while ((next >= 0) && (index < DECLARED_SIZE))
 {
 number_array[index] = next;
 index++;
 cin >> next;
 }

 int number_used = index;
 cout << "Here they are back at you:";
 for (index = 0; index < number_used; index++)
 cout << number_array[index] << " ";
 cout << endl;
 return 0;
 }

18. #include <iostream>
 using namespace std;
 const int DECLARED_SIZE = 10;

 int main()
 {
 cout << "Enter up to ten letters"
 << " followed by a period:\n";
 char letter_box[DECLARED_SIZE], next;
 int index = 0;
 cin >> next;
 while ((next != '.') && (index < DECLARED_SIZE))
 {
 letter_box[index] = next;
 index++;
 cin >> next;
 }
 int number_used = index;
 cout << "Here they are backwards:\n";
 for(index = number_used - 1; index >= 0; index--)
 cout << letter_box[index];
 cout << endl;
 return 0;
 }
```

- ```

19. bool search(const int a[ ], int number_used,
               int target, int& where)
{
    int index = 0;
    bool found = false;
    while ((!found) && (index < number_used))
        if (target == a[index])
            found = true;
        else
            index++;
    //If target was found, then
    //found == true and a[index] == target.
    if (found)
        where = index;
    return found;
}

```
20. 0 1 2 3
0 1 2 3
0 1 2 3
0 1 2 3
- ```

21. int a[4][5];
 int index1, index2;
 for (index1 = 0; index1 < 4; index1++)
 for (index2 = 0; index2 < 5; index2++)
 cin >> a[index1][index2];

```
- ```

22. void echo(const int a[][5], int size_of_a)
    //Outputs the values in the array a on size_of_a lines
    //with 5 numbers per line.
    {
        for (int index1 = 0; index1 < size_of_a; index1++)
        {
            for (int index2 = 0; index2 < 5; index2++)
                cout << a[index1][index2] << " ";
            cout << endl;
        }
    }

```

PRACTICE PROGRAMS

Practice Programs can generally be solved with a short program that directly applies the programming principles presented in this chapter.

1. Write a function named `firstLast2` that takes as input an array of integers and an integer that specifies how many entries are in the array. The function should return `true` if the array starts or ends with the digit 2. Otherwise it should return `false`. Test your function with arrays of different length and

with the digit 2 at the beginning of the array, end of the array, middle of the array, and missing from the array.

2. Write a function named `countNum2s` that takes as input an array of integers and an integer that specifies how many entries are in the array. The function should return the number of 2's in the array. Test your function with arrays of different length and with varying number of 2's.
3. Write a function named `swapFrontBack` that takes as input an array of integers and an integer that specifies how many entries are in the array. The function should swap the first element in the array with the last element in the array. The function should check if the array is empty to prevent errors. Test your function with arrays of different length and with varying front and back numbers.
4. The following code creates a small phone book. An array is used to store a list of names and another array is used to store the phone numbers that go with each name. For example, Michael Myers' phone number is 333-8000 and Ash Williams' phone number is 333-2323. Write the function `lookupName` so the code properly looks up and returns the phone number for the input target name.

```
int main()
{
    using namespace std;
    string names[] = {"Michael Myers",
                    "Ash Williams",
                    "Jack Torrance",
                    "Freddy Krueger"};
    string phoneNumbers[] = {"333-8000", "333-2323",
                             "333-6150", "339-7970"};
    string targetName, targetPhone;
    char c;
    do
    {
        cout << "Enter a name to find the "
              << "corresponding phone number."
              << endl;
        getline(cin, targetName);
        targetPhone = lookupName(targetName,
                                names, phoneNumbers, 4);
        if (targetPhone.length() > 0)
            cout << "The number is: "
                 << targetPhone << endl;
        else
            cout << "Name not found. "
                 << endl;
        cout << "Look up another name? (y/n)"
              << endl;
    }
```

```
    cin >> c;
    cin.ignore();
} while (c == 'y');
return 0;
}
```

PROGRAMMING PROJECTS

Programming Projects require more problem-solving than Practice Programs and can usually be solved many different ways. Visit www.myprogramminglab.com to complete many of these Programming Projects online and get instant feedback.

Projects 7 through 11 can be written more elegantly using structures or classes. Projects 12 through 15 are meant to be written using multidimensional arrays and do not require structures or classes. See Chapters 10 and 11 for information on defining classes and structures.

1. There are three versions of this project.

Version 1 (all interactive). Write a program that reads in the average monthly rainfall for a city for each month of the year and then reads in the actual monthly rainfall for each of the previous 12 months. The program then prints out a nicely formatted table showing the rainfall for each of the previous 12 months as well as how much above or below average the rainfall was for each month. The average monthly rainfall is given for the months January, February, and so forth, in order. To obtain the actual rainfall for the previous 12 months, the program first asks what the current month is and then asks for the rainfall figures for the previous 12 months. The output should correctly label the months.

There are a variety of ways to deal with the month names. One straightforward method is to code the months as integers and then do a conversion before doing the output. A large *switch* statement is acceptable in an output function. The month input can be handled in any manner you wish, as long as it is relatively easy and pleasant for the user.

After you have completed this program, produce an enhanced version that also outputs a graph showing the average rainfall and the actual rainfall for each of the previous 12 months. The graph should be similar to the one shown in Display 7.8, except that there should be two bar graphs for each month and they should be labeled as the average rainfall and the rainfall for the most recent month. Your program should ask the user whether she or he wants to see the table or the bar graph and then should display whichever format is requested. Include a loop that allows the user to see either format as often as the user wishes until the user requests that the program end.

Version 2 (combines interactive and file output). For a more elaborate version, also allow the user to request that the table and graph be output to a file. The file name is entered by the user. This program does everything that the Version 1 program does but has this added feature. To read a file name, you must use material presented in the optional section of Chapter 5 entitled “File Names as Input.”

Version 3 (all I/O with files). This version is like Version 1 except that input is taken from a file and the output is sent to a file. Since there is no user to interact with, there is no loop to allow repeating the display; both the table and the graph are output to the same file. If this is a class assignment, ask your instructor for instructions on what file names to use.

- Hexadecimal numerals are integers written in base 16. The 16 digits used are ‘0’ through ‘9’ plus ‘a’ for the “digit 10”, ‘b’ for the “digit 11”, ‘c’ for the “digit 12”, ‘d’ for the “digit 13”, ‘e’ for the “digit 14”, and ‘f’ for the “digit 15”. For example, the hexadecimal numeral d is the same as base 10 numeral 13 and the hexadecimal numeral 1d is the same as the base 10 numeral 29. Write a C++ program to perform addition of two hexadecimal numerals each with up to 10 digits. If the result of the addition is more than 10 digits long, then simply give the output message “Addition Overflow” and not the result of the addition. Use arrays to store hexadecimal numerals as arrays of characters. Include a loop to repeat this calculation for new numbers until the user says she or he wants to end the program.
- Write a function called `delete_repeats` that has a partially filled array of characters as a formal parameter and that deletes all repeated letters from the array. Since a partially filled array requires two arguments, the function will actually have two formal parameters: an array parameter and a formal parameter of type `int` that gives the number of array positions used. When a letter is deleted, the remaining letters are moved forward to fill in the gap. This will create empty positions at the end of the array so that less of the array is used. Since the formal parameter is a partially filled array, a second formal parameter of type `int` will tell how many array positions are filled. This second formal parameter will be a call-by-reference parameter and will be changed to show how much of the array is used after the repeated letters are deleted.

For example, consider the following code:

```
char a[10];  
a[0] = 'a';  
a[1] = 'b';  
a[2] = 'a';  
a[3] = 'c';  
int size = 4;  
delete_repeats(a, size);
```

After this code is executed, the value of `a[0]` is 'a', the value of `a[1]` is 'b', the value of `a[2]` is 'c', and the value of `size` is 3. (The value of `a[3]`



is no longer of any concern, since the partially filled array no longer uses this indexed variable.)

You may assume that the partially filled array contains only lowercase letters. Embed your function in a suitable test program.

4. The standard deviation of a list of numbers is a measure of how much the numbers deviate from the average. If the standard deviation is small, the numbers are clustered close to the average. If the standard deviation is large, the numbers are scattered far from the average. The standard deviation, S , of a list of N numbers x is defined as follows:

$$S = \sqrt{\frac{\sum_{i=1}^N (x_i - \bar{x})^2}{N}}$$

where \bar{x} is the average of the N numbers x_1, x_2, \dots . Define a function that takes a partially filled array of numbers as its arguments and returns the standard deviation of the numbers in the partially filled array. Since a partially filled array requires two arguments, the function will actually have two formal parameters: an array parameter and a formal parameter of type *int* that gives the number of array positions used. The numbers in the array will be of type *double*. Embed your function in a suitable test program.

5. Write a program that reads in a list of integers into an array with base type *int*. Provide the facility to either read this array from the keyboard or from a file, at the user's option. If the user chooses file input, the program should request a file name. You may assume that there are fewer than 50 entries in the array. Your program determines how many entries there are. The output is to be a two-column list. The first column is a list of the distinct array elements; the second column is the count of the number of occurrences of each element. The list should be sorted on entries in the first column, largest to smallest.

For example, for the input

```
-12 3 -12 4 1 1 -12 1 -1 1 2 3 4 2 3 -12
```

the output should be

N	Count
4	2
3	3
2	2
1	4
-1	1
-12	4

6. The text discusses the selection sort. We propose a different “sort” routine, the insertion sort. This routine is in a sense the opposite of the selection sort in that it picks up successive elements from the array and *inserts* each of these into the correct position in an already sorted subarray (at one end of the array we are sorting).

The array to be sorted is divided into a sorted subarray and to-be-sorted subarray. Initially, the sorted subarray is empty. Each element of the to-be-sorted subarray is picked and inserted into its correct position in the sorted subarray.

Write a function and a test program to implement the selection sort. Thoroughly test your program.

Example and hints: The implementation involves an outside loop that selects successive elements in the to-be-sorted subarray and a nested loop that inserts each element in its proper position in the sorted subarray.

Initially, the sorted subarray is empty, and the to-be-sorted subarray is all of the array:

a[0]	a[1]	a[2]	a[3]	a[4]	a[5]	a[6]	a[7]	a[8]	a[9]
8	6	10	2	16	4	18	14	12	10

Pick the first element, a[0] (that is, 8), and place it in the first position. The inside loop has nothing to do in this first case. The array and subarrays look like this:

sorted	to-be-sorted								
a[0]	a[1]	a[2]	a[3]	a[4]	a[5]	a[6]	a[7]	a[8]	a[9]
8	6	10	2	16	4	18	14	12	10

The first element from the to-be-sorted subarray is a[1], which has value 6. Insert this into the sorted subarray in its proper position. These are out of order, so the inside loop must swap values in position 0 and position 1. The result is as follows:

sorted	to-be-sorted								
a[0]	a[1]	a[2]	a[3]	a[4]	a[5]	a[6]	a[7]	a[8]	a[9]
6	8	10	2	16	4	18	14	10	12

Note that the sorted subarray has grown by one entry.

Repeat the process for the first to-be-sorted subarray entry, $a[2]$, finding a place where $a[2]$ can be placed so that the subarray remains sorted. Since $a[2]$ is already in place—that is, it is larger than the largest element in the sorted subarray—the inside loop has nothing to do. The result is as follows:

sorted			to-be-sorted						
$a[0]$	$a[1]$	$a[2]$	$a[3]$	$a[4]$	$a[5]$	$a[6]$	$a[7]$	$a[8]$	$a[9]$
6	8	10	2	16	4	18	14	10	12

Again, pick the first to-be-sorted array element, $a[3]$. This time the inside loop has to swap values until the value of $a[3]$ is in its proper position. This involves some swapping:

sorted				to-be-sorted					
$a[0]$	$a[1]$	$a[2]$	$a[3]$	$a[4]$	$a[5]$	$a[6]$	$a[7]$	$a[8]$	$a[9]$
6	8	10<--->2		16	4	18	14	10	12

sorted				to-be-sorted					
$a[0]$	$a[1]$	$a[2]$	$a[3]$	$a[4]$	$a[5]$	$a[6]$	$a[7]$	$a[8]$	$a[9]$
6	8<--->2		10	16	4	18	14	10	12

sorted				to-be-sorted					
$a[0]$	$a[1]$	$a[2]$	$a[3]$	$a[4]$	$a[5]$	$a[6]$	$a[7]$	$a[8]$	$a[9]$
6<--->2		8	10	16	4	18	14	10	12

The result of placing the 2 in the sorted subarray is

sorted				to-be-sorted					
$a[0]$	$a[1]$	$a[2]$	$a[3]$	$a[4]$	$a[5]$	$a[6]$	$a[7]$	$a[8]$	$a[9]$
2	6	8	10	16	4	18	14	10	12

The algorithm continues in this fashion until the to-be-sorted array is empty and the sorted array has all the original array's elements.

7. An array can be used to store large integers one digit at a time. For example, the integer 1234 could be stored in the array `a` by setting `a[0]` to 1, `a[1]` to 2, `a[2]` to 3, and `a[3]` to 4. However, for this exercise you might find it more useful to store the digits backward, that is, place 4 in `a[0]`, 3 in `a[1]`, 2 in `a[2]`, and 1 in `a[3]`.

In this exercise you will write a program that reads in two positive integers that are 20 or fewer digits in length and then outputs the sum of the two numbers. Your program will read the digits as values of type `char` so that the number 1234 is read as the four characters '1', '2', '3', and '4'. After they are read into the program, the characters are changed to values of type `int`. The digits will be read into a partially filled array, and you might find it useful to reverse the order of the elements in the array after the array is filled with data from the keyboard. (Whether or not you reverse the order of the elements in the array is up to you. It can be done either way, and each way has its advantages and disadvantages.)

Your program will perform the addition by implementing the usual paper-and-pencil addition algorithm. The result of the addition is stored in an array of size 20, and the result is then written to the screen. If the result of the addition is an integer with more than the maximum number of digits (that is, more than 20 digits), then your program should issue a message saying that it has encountered "integer overflow." You should be able to change the maximum length of the integers by changing only one globally defined constant. Include a loop that allows the user to continue to do more additions until the user says the program should end.

8. Write a program that will read a line of text and output a list of all the letters that occur in the text together with the number of times each letter occurs in the line. End the line with a period that serves as a sentinel value. The letters should be listed in the following order: the most frequently occurring letter, the next most frequently occurring letter, and so forth. Use two arrays, one to hold integers and one to hold letters. You may assume that the input uses all lowercase letters. For example, the input

do be do bo.

should produce output similar to the following:

Letter	Number of Occurrences
o	3
d	2
b	2
e	1

Your program will need to sort the arrays according to the values in the integer array. This will require that you modify the function `sort` given in Display 7.12. You cannot use `sort` to solve this problem without changing the function. If this is a class assignment, ask your instructor if input/output should be done with the keyboard and screen or if it should be done with files. If it is to be done with files, ask your instructor for instructions on file names.

9. Write a program to score five-card poker hands into one of the following categories: nothing, one pair, two pairs, three of a kind, straight (in order, with no gaps), flush (all the same suit, for example, all spades), full house (one pair and three of a kind), four of a kind, straight flush (both a straight and a flush). Use two arrays, one to hold the value of the card and one to hold the suit. Include a loop that allows the user to continue to score more hands until the user says the program should end.
10. Write a program that will allow two users to play tic-tac-toe. The program should ask for moves alternately from player X and player O. The program displays the game positions as follows:

```
1 2 3
4 5 6
7 8 9
```

The players enter their moves by entering the position number they wish to mark. After each move, the program displays the changed board. A sample board configuration is as follows:

```
X X O
4 5 6
O 8 9
```

11. Write a program to assign passengers seats in an airplane. Assume a small airplane with seat numbering as follows:

```
1 A B C D
2 A B C D
3 A B C D
4 A B C D
5 A B C D
6 A B C D
7 A B C D
```

The program should display the seat pattern, with an X marking the seats already assigned. For example, after seats 1A, 2B, and 4C are taken, the display should look like this:

```
1 X B C D
2 A X C D
3 A B C D
```

```
4 A B X D
5 A B C D
6 A B C D
7 A B C D
```

After displaying the seats available, the program prompts for the seat desired, the user types in a seat, and then the display of available seats is updated. This continues until all seats are filled or until the user signals that the program should end. If the user types in a seat that is already assigned, the program should say that that seat is occupied and ask for another choice.

12. Write a program that accepts input like the program in Display 7.8 and that outputs a bar graph like the one in that display except that your program will output the bars vertically rather than horizontally. A two-dimensional array may be useful.
13. The mathematician John Horton Conway invented the “Game of Life.” Though not a “game” in any traditional sense, it provides interesting behavior that is specified with only a few rules. This project asks you to write a program that allows you to specify an initial configuration. The program follows the rules of LIFE to show the continuing behavior of the configuration.

LIFE is an organism that lives in a discrete, two-dimensional world. While this world is actually unlimited, we don’t have that luxury, so we restrict the array to 80 characters wide by 22 character positions high. If you have access to a larger screen, by all means use it.

This world is an array with each cell capable of holding one LIFE cell. Generations mark the passing of time. Each generation brings births and deaths to the LIFE community. The births and deaths follow the following set of rules.

- We define each cell to have eight *neighbor* cells. The neighbors of a cell are the cells directly above, below, to the right, to the left, diagonally above to the right and left, and diagonally below to the right and left.
- If an occupied cell has zero or one neighbors, it dies of *loneliness*. If an occupied cell has more than three neighbors, it dies of *overcrowding*.
- If an empty cell has exactly three occupied neighbor cells, there is a *birth* of a new cell to replace the empty cell.
- Births and deaths are instantaneous and occur at the changes of generation. A cell dying for whatever reason may help cause birth, but a newborn cell cannot resurrect a cell that is dying, nor will a cell’s death prevent the death of another, say, by reducing the local population.

Notes: Some configurations grow from relatively small starting configurations. Others move across the region. It is recommended that for text output

you use a rectangular array of *char* with 80 columns and 22 rows to store the LIFE world's successive generations. Use an asterisk *** to indicate a living cell, and use a blank to indicate an empty (or dead) cell. If you have a screen with more rows than that, by all means make use of the whole screen.

Examples:

```
***
```

becomes

```
*
```

```
*
```

```
*
```

then becomes

```
***
```

again, and so on.

Suggestions: Look for stable configurations. That is, look for communities that repeat patterns continually. The number of configurations in the repetition is called the *period*. There are configurations that are fixed, which continue without change. A possible project is to find such configurations.

Hints: Define a *void* function named *generation* that takes the array we call *world*, an 80-column by 22-row array of *char*, which contains the initial configuration. The function scans the array and modifies the cells, marking the cells with births and deaths in accord with the rules listed earlier. This involves examining each cell in turn, either killing the cell, letting it live, or, if the cell is empty, deciding whether a cell should be born. There should be a function *display* that accepts the array *world* and displays the array on the screen. Some sort of time delay is appropriate between calls to *generation* and *display*. To do this, your program should generate and display the next generation when you press Return. You are at liberty to automate this, but automation is not necessary for the program.

14. Redo (or do for the first time) Programming Project 10 from Chapter 6. Your program should first load all boy names and girl names from the file into separate arrays. Search for the target name from the arrays, not directly from the file.
15. Redo (or do for the first time) Programming Project 11 from Chapter 6. Your program should not be hard-coded to create a bar chart of exactly four integers, but should be able to graph an array of up to 100 integers. Scale the graph appropriately in the horizontal and vertical dimensions so the bar chart fits within a 400 by 400 pixel area. You can impose the constraint that all integers in the array are nonnegative. Use the sentinel value of -1 to indicate the end of the values to draw in the bar chart. For example, to

create the bar chart with values 20, 40, 60, and 120, your program would operate on the array:

```
a[0] = 20
a[1] = 40
a[2] = 60
a[3] = 120
a[4] = -1
```

Test your program by creating several bar charts with different values and up to 100 entries and view the resulting SVG files to ensure that they are drawn correctly.

16. A common memory matching game played by young children is to start with a deck of cards that contains identical pairs. For example, given six cards in the deck, two might be labeled "1," two might be labeled "2," and two might be labeled "3." The cards are shuffled and placed face down on the table. The player then selects two cards that are face down, turns them face up, and if they match they are left face up. If the two cards do not match, they are returned to their original position face down. The game continues in this fashion until all cards are face up.

Write a program that plays the memory matching game. Use 16 cards that are laid out in a 4 X 4 square and are labeled with pairs of numbers from 1 to 8. Your program should allow the player to specify the cards that she would like to select through a coordinate system.

For example, suppose the cards are in the following layout:

	1	2	3	4
1	8	*	*	*
2	*	*	*	*
3	*	8	*	*
4	*	*	*	*

All of the cards are face down except for the pair 8, which has been located at coordinates (1, 1) and (2, 3). To hide the cards that have been temporarily placed face up, output a large number of newlines to force the old board off the screen.

(Hint: Use a two-dimensional array for the arrangement of cards and another two-dimensional array that indicates if a card is face up or face down. Write a function that "shuffles" the cards in the array by repeatedly selecting two cards at random and swapping them. Random number generation is described in Chapter 4.)

17. Your swim school has two swimming instructors, Jeff and Anna. Their current schedules are shown below. An "X" denotes a 1-hour time slot that is occupied with a lesson.

Jeff	Monday	Tuesday	Wednesday	Thursday
11-12	X	X		
12-1		X	X	X
1-2		X	X	
2-3	X	X	X	

Anna	Monday	Tuesday	Wednesday	Thursday
11-12	X	X		X
12-1		X		X
1-2	X	X		
2-3	X		X	X

Write a program with array(s) capable of storing the schedules. Create a main menu that allows the user to mark a time slot as busy or free for either instructor. Also, add an option to output the schedules to the screen. Next, add an option to output all time slots available for individual lessons (slots when at least one instructor is free). Finally, add an option to output all time slots available for group lessons (when both instructors are free).

18. Modify Programming Project 17 by adding menu options to load and save the schedules from a file.
19. Traditional password entry schemes are susceptible to “shoulder surfing” in which an attacker watches an unsuspecting user enter their password or PIN number and uses it later to gain access to the account. One way to combat this problem is with a randomized challenge-response system. In these systems, the user enters different information every time based on a secret in response to a randomly generated challenge. Consider the following scheme in which the password consists of a five-digit PIN number (00000 to 99999). Each digit is assigned a random number that is 1, 2, or 3. The user enters the random numbers that correspond to their PIN instead of their actual PIN numbers.

For example, consider an actual PIN number of 12345. To authenticate the user would be presented with a screen such as:

```
PIN:    0 1 2 3 4 5 6 7 8 9
NUM:    3 2 3 1 1 3 2 2 1 3
```

The user would enter 23113 instead of 12345. This doesn't divulge the password even if an attacker intercepts the entry because 23113 could correspond to other PIN numbers, such as 69440 or 70439. The next time the user logs in, a different sequence of random numbers would be generated, such as:

```
PIN:    0 1 2 3 4 5 6 7 8 9
NUM:    1 1 2 3 1 2 2 3 3 3
```

Your program should simulate the authentication process. Store an actual PIN number in your program. The program should use an array to assign random numbers to the digits from 0 to 9. Output the random digits to the screen, input the response from the user, and output whether or not the user's response correctly matches the PIN number.

20. The Social Security Administration maintains an actuarial life table that contains the probability that a person in the United States will die (<http://www.ssa.gov/OACT/STATS/table4c6.html>). The death probabilities from this table for 2009 are stored in the file `LifeDeathProbability.txt` and it is included on the website for the book. There are three values for each row, the age, death probability for a male, and death probability for a female. For example, the first five lines are:

```
0 0.006990 0.005728
1 0.000447 0.000373
2 0.000301 0.000241
3 0.000233 0.000186
4 0.000177 0.000150
```

This says that a 3 year old female has a 0.000186 chance of dying.

Write a program that reads the data into arrays from the file. Next, let the user enter his or her sex and age. The program should simulate to what age the user will live by starting with the death probability for the user's current age and sex. Generate a random number between 0-1; if this number is less than or equal to the death probability then predict that the user will live to the current age. If the random number is greater than the death probability then increase the age by one and repeat the calculation with a new random number for the next probability value.

If the simulation reaches age 120 then stop and predict that the user will live to 120. This program is merely a simulation and will give different results each time it is run, assuming you change the seed for the random number generator.

Strings and Vectors 8

8.1 AN ARRAY TYPE FOR STRINGS 453

C-String Values and C-String Variables 453

Pitfall: Using = and == with C Strings 456

Other Functions in `<cstring>` 458

Pitfall: Copying past the end of a C-string using `strcpy` 461

C-String Input and Output 464

C-String-to-Number Conversions and Robust Input 466

8.2 THE STANDARD `string` CLASS 472

Introduction to the Standard Class `string` 472

I/O with the Class `string` 475

Programming Tip: More Versions of `getline` 478

Pitfall: Mixing `cin >> variable;` and `getline` 479

String Processing with the Class `string` 480

Programming Example: Palindrome Testing 484

Converting between `string` Objects and C Strings 487

Converting Between Strings and Numbers 488

8.3 VECTORS 489

Vector Basics 489

Pitfall: Using Square Brackets Beyond the Vector Size 492

Programming Tip: Vector Assignment Is Well Behaved 493

Efficiency Issues 493



Polonius: What do you read my lord?

Hamlet: Words, words, words.

WILLIAM SHAKESPEARE, *Hamlet*

INTRODUCTION

This chapter discusses two topics that use arrays or are related to arrays: strings and vectors. Although strings and vectors are very closely related, this relationship is not always obvious, and no one of these topics depends on the other. The topics of strings and vectors can be covered in either order.

Sections 8.1 and 8.2 present two types whose values represent strings of characters, such as "Hello". One type, discussed in Section 8.1, is just an array with base type *char* that stores strings of characters in the array and marks the end of the string with the null character '\0'. This is the older way of representing strings, which C++ inherited from the C programming language. These sorts of strings are called C strings. Although C strings are an older way of representing strings, it is difficult to do any sort of string processing in C++ without at least passing contact with C strings. For example, quoted strings, such as "Hello", are implemented as C strings in C++.

The ANSI/ISO C++ standard includes a more modern string-handling facility in the form of the class `string`. The class `string` is the second string type that we will discuss in this chapter and is covered in Section 8.2.

Vectors can be thought of as arrays that can grow (and shrink) in length while your program is running. In C++, once your program creates an array, it cannot change the length of the array. Vectors serve the same purpose as arrays except that they can change length while the program is running.

PREREQUISITES

Sections 8.1 and 8.2, which cover strings, and Section 8.3 which covers vectors, are independent of each other. If you wish to cover vectors before strings, that is fine.

Section 8.1 on C strings uses material from Chapters 2 through 6, and Sections 7.1, 7.2, and 7.3 of Chapter 7. Section 8.2 on the string class uses Section 8.1 and material from Chapters 2 through 6 and Sections 7.1, 7.2, and 7.3 of Chapter 7. Section 8.3 on vectors uses material from Chapters 2 through 6 and Sections 7.1, 7.2, and 7.3 of Chapter 7.

8.1 AN ARRAY TYPE FOR STRINGS

In everything one must consider the end.

JEAN DE LA FONTAINE, FABLES, BOOK III (1668)

In this section we describe one way to represent strings of characters, which C++ has inherited from the C language. In Section 8.2 we describe a string class that is a more modern way to represent strings. Although the string type described here may be a bit “old-fashioned,” it is still widely used and is an integral part of the C++ language.

C-String Values and C-String Variables

One way to represent a string is as an array with base type *char*. If the string is “Hello”, it is handy to represent it as an array of characters with six indexed variables: five for the five letters in “Hello” plus one for the character ‘\0’, which serves as an end marker. The character ‘\0’ is called the **null character** and is used as an end marker because it is distinct from all the “real” characters. The end marker allows your program to read the array one character at a time and know that it should stop reading when it reads the end marker ‘\0’. A string stored in this way (as an array of characters terminated with ‘\0’) is called a **C string**.

We write ‘\0’ with two symbols when we write it in a program, but just like the new-line character ‘\n’, the character ‘\0’ is really only a single character value. Like any other character value, ‘\0’ can be stored in one variable of type *char* or one indexed variable of an array of characters.

The Null Character, ‘\0’

The null character, ‘\0’, is used to mark the end of a C string that is stored in an array of characters. When an array of characters is used in this way, the array is often called a C-string variable. Although the null character ‘\0’ is written using two symbols, it is a single character that fits in one variable of type *char* or one indexed variable of an array of characters.

You have already been using C strings. In C++, a literal string, such as “Hello”, is stored as a C string, although you seldom need to be aware of this detail.

A **C-string variable** is just an array of characters. Thus, the following array declaration provides us with a C-string variable capable of storing a C-string value with nine or fewer characters:

```
char s[10];
```

The 10 is for the nine letters in the string plus the null character ‘\0’ to mark the end of the string.

A C-string variable is a partially filled array of characters. Like any other partially filled array, a C-string variable uses positions starting at indexed variable 0 through as many as are needed. However, a C-string variable does not use an *int* variable to keep track of how much of the array is currently being used. *Instead, a string variable places the special symbol '\0' in the array immediately after the last character of the C string.* Thus, if *s* contains the string "Hi Mom!", then the array elements are filled as shown here:

s[0]	s[1]	s[2]	s[3]	s[4]	s[5]	s[6]	s[7]	s[8]	s[9]
H	I		M	o	m	!	\0	?	?

The character '\0' is used as a sentinel value to mark the end of the C string. If you read the characters in the C string starting at indexed variable *s*[0], proceed to *s*[1], and then to *s*[2], and so forth, you know that when you encounter the symbol '\0', you have reached the end of the C string. Since the symbol '\0' always occupies one element of the array, the length of the longest string that the array can hold is 1 less than the size of the array.

C-string variables
vs. arrays of
characters

The thing that distinguishes a C-string variable from an ordinary array of characters is that a C-string variable must contain the null character '\0' at the end of the C-string value. This is a distinction in how the array is used rather than a distinction about what the array is. *A C-string variable is an array of characters, but it is used in a different way.*

C-String Variable Declaration

A **C-string variable** is the same thing as an array of characters, but it is used differently. A C-string variable is declared to be an array of characters in the usual way.

SYNTAX

```
char Array_Name[Maximum_C_string_Size + 1];
```

EXAMPLE

```
char my_c_string[11];
```

The + 1 allows for the null character '\0', which terminates any C string stored in the array. For example, the C-string variable `my_c_string` in the example can hold a C string that is ten or fewer characters long.

Initializing
C-string variables

You can initialize a C-string variable when you declare it, as illustrated by the following example:

```
char my_message[20] = "Hi there.";
```

Notice that the C string assigned to the C-string variable need not fill the entire array.

When you initialize a C-string variable, you can omit the array size. C++ will automatically make the size of the C-string variable 1 more than the length of the quoted string. (The one extra indexed variable is for '\0'.) For example,

```
char short_string[] = "abc";
```

is equivalent to

```
char short_string[4] = "abc";
```

Be sure you do not confuse the following initializations:

```
char short_string[] = "abc";
```

and

```
char short_string[] = {'a', 'b', 'c'};
```

They are *not equivalent*. The first of these two possible initializations places the null character '\0' in the array after the characters 'a', 'b', and 'c'. The second one does not put a '\0' anywhere in the array.

Initializing a C-String Variable

A C-string variable can be initialized when it is declared, as illustrated by the following example:

```
char your_string[11] = "Do Be Do";
```

Initializing in this way automatically places the null character, '\0', in the array at the end of the C string specified.

If you omit the number inside the square brackets, [], then the C-string variable will be given a size one character longer than the length of the C string. For example, the following declares `my_string` to have nine indexed variables (eight for the characters of the C string "Do Be Do" and one for the null character '\0'):

```
char my_string[] = "Do Be Do";
```

A C-string variable is an array, so it has **indexed variables** that can be used just like those of any other array. For example, suppose your program contains the following C-string variable declaration:

```
char our_string[5] = "Hi";
```

With `our_string` declared as shown previously, your program has the following indexed variables: `our_string[0]`, `our_string[1]`, `our_string[2]`, `our_string[3]`, and `our_string[4]`. For example, the following will change

the C-string value in `our_string` to a C string of the same length consisting of all 'X' characters:

```
int index = 0;
while (our_string[index] != '\0')
{
    our_string[index] = 'X';
    index++;
}
```

Do not destroy
the '\0'

When manipulating these indexed variables, you should be very careful not to replace the null character '\0' with some other value. If the array loses the value '\0', it will no longer behave like a C-string variable. For example, the following will change the array `happy_string` so that it no longer contains a C string:

```
char happy_string[7] = "DoBeDo";
happy_string[6] = 'Z';
```

After this code is executed, the array `happy_string` will still contain the six letters in the C-string "DoBeDo", but `happy_string` will no longer contain the null character '\0' to mark the end of the C string. Many string-manipulating functions depend critically on the presence of '\0' to mark the end of the C-string value.

As another example, consider the previous *while* loop that changed characters in the C-string variable `our_string`. That *while* loop changes characters until it encounters a '\0'. If the loop never encounters a '\0', then it could change a large chunk of memory to some unwanted values, which could make your program do strange things. As a safety feature, it would be wise to rewrite that *while* loop as follows, so that if the null character '\0' is lost, the loop will not inadvertently change memory locations beyond the end of the array:

```
int index = 0;
while ( (our_string[index] != '\0') && (index < SIZE) )
{
    our_string[index] = 'X';
    index++;
}
```

`SIZE` is a defined constant equal to the declared size of the array `our_string`.

PITFALL Using = and == with C Strings

C-string values and C-string variables are not like values and variables of other data types, and many of the usual operations do not work for C strings. You cannot use a C-string variable in an assignment statement using `=`. If you use `==` to test C strings for equality, you will not get the result you expect. The reason for these problems is that C strings and C-string variables are arrays.

Assigning a value to a C-string variable is not as simple as it is for other kinds of variables. The following is illegal:

Assigning a
C-string value

```
char a_string[10];
a_string = "Hello";
```

Illegal! ←

Although you can use the equal sign to assign a value to a C-string variable when the variable is declared, you cannot do it anywhere else in your program. Technically, a use of the equal sign in a declaration, as in

```
char happy_string[7] = "DoBeDo";
```

is an initialization, not an assignment. If you want to assign a value to a C-string variable, you must do something else.

There are a number of different ways to assign a value to a C-string variable. The easiest way is to use the predefined function `strcpy` as shown:

```
strcpy(a_string, "Hello");
```

This will set the value of `a_string` equal to "Hello". Unfortunately, this version of the function `strcpy` does not check to make sure the copying does not exceed the size of the string variable that is the first argument.

Many, but not all, versions of C++ also have a safer version of `strcpy`. This safer version is spelled `strncpy` (with an `n`). The function `strncpy` takes a third argument that gives the maximum number of characters to copy. For example:

```
char another_string[10];
strncpy(another_string, a_string_variable, 9);
```

With this `strncpy` function, at most nine characters (leaving room for `'\0'`) will be copied from the C-string variable `a_string_variable`, no matter how long the string in `a_string_variable` may be.

You also cannot use the operator `==` in an expression to test whether two C strings are the same. (Things are actually much worse than that. You can use `==` with C strings, but it does not test for the C strings being equal. So if you use `==` to test two C strings for equality, you are likely to get incorrect results, but no error message!) To test whether two C strings are the same, you can use the predefined function `strcmp`. For example:

Testing C strings
for equality

```
if (strcmp(c_string1, c_string2))
    cout << "The strings are NOT the same.";
else
    cout << "The strings are the same.";
```

Note that the function `strcmp` works differently than you might guess. The comparison is true if the strings do not match. The function `strcmp` compares the characters in the C-string arguments a character at a time. If at any point the numeric encoding of the character from `c_string1` is less than the numeric encoding of the corresponding character from `c_string2`, the testing stops,

and a negative number is returned. If the character from `c_string1` is greater than the character from `c_string2`, then a positive number is returned. (Some implementations of `strcmp` return the difference of the character encodings, but you should not depend on that.) If the C strings are the same, a 0 is returned. The ordering relationship used for comparing characters is called **lexicographic order**. The important point to note is that if both strings are all in uppercase or all in lowercase, then lexicographic order is just alphabetic order.

We see that `strcmp` returns a negative value, a positive value, or zero, depending on whether the C strings compare lexicographically as less, greater, or equal. If you use `strcmp` as a Boolean expression in an *if* or a looping statement to test C strings for equality, then the nonzero value will be converted to *true* if the strings are different, and the zero will be converted to *false*. Be sure that you remember this inverted logic in your testing for C-string equality. C++ compilers that are compliant with the standard have a safer version of `strcmp` that has a third argument that gives the maximum number of characters to compare.

The functions `strcpy` and `strcmp` are in the library with the header file `<cstring>`, so to use them you would insert the following near the top of the file:

```
#include <cstring>
```

The functions `strcpy` and `strcmp` do not require the following or anything similar (although other parts of your program are likely to require it):¹

```
using namespace std;
```

The `<cstring>` Library

You do not need any `include` directive or `using` directive in order to declare and initialize C strings. However, when processing C strings, you inevitably will use some of the predefined string functions in the library `<cstring>`. So, when using C strings, you will normally give the following `include` directive near the beginning of the file with your code:

```
#include <cstring>
```

Other Functions in `<cstring>`

Display 8.1 contains a few of the most commonly used functions from the library with the header file `<cstring>`. To use them, you insert the following near the top of the file:

```
#include <cstring>
```

¹ As you will see in Chapter 12, the definitions of `strcpy` and `strcmp`, and all other string functions in `<cstring>`, are placed in the global namespace, not in the `std` namespace, and so no `using` directive is required.

DISPLAY 8.1 Some Predefined C-String Functions in <cstring>

Function	Description	Cautions
<code>strcpy(Target_String_Var, Src_String)</code>	Copies the C-string value <i>Src_String</i> into the C-string variable <i>Target_String_Var</i> .	Does not check to make sure <i>Target_String_Var</i> is large enough to hold the value <i>Src_String</i> .
<code>strncpy(Target_String_Var, Src_String, Limit)</code>	The same as the two-argument <code>strcpy</code> except that at most <i>Limit</i> characters are copied.	If <i>Limit</i> is chosen carefully, this is safer than the two-argument version of <code>strcpy</code> . Not implemented in all versions of C++.
<code>strcat(Target_String_Var, Src_String)</code>	Concatenates the C-string value <i>Src_String</i> onto the end of the C string in the C-string variable <i>Target_String_Var</i> .	Does not check to see that <i>Target_String_Var</i> is large enough to hold the result of the concatenation.
<code>strncat(Target_String_Var, Src_String, Limit)</code>	The same as the two-argument <code>strcat</code> except that at most <i>Limit</i> characters are appended.	If <i>Limit</i> is chosen carefully, this is safer than the two-argument version of <code>strcat</code> . Not implemented in all versions of C++.
<code>strlen(Src_String)</code>	Returns an integer equal to the length of <i>Src_String</i> . (The null character, '\0', is not counted in the length.)	
<code>strcmp(String_1, String_2)</code>	Returns 0 if <i>String_1</i> and <i>String_2</i> are the same. Returns a value < 0 if <i>String_1</i> is less than <i>String_2</i> . Returns a value > 0 if <i>String_1</i> is greater than <i>String_2</i> (that is, returns a nonzero value if <i>String_1</i> and <i>String_2</i> are different). The order is lexicographic.	If <i>String_1</i> equals <i>String_2</i> , this function returns 0, which converts to <i>false</i> . Note that this is the reverse of what you might expect it to return when the strings are equal.
<code>strncmp(String_1, String_2, Limit)</code>	The same as the two-argument <code>strcmp</code> except that at most <i>Limit</i> characters are compared.	If <i>Limit</i> is chosen carefully, this is safer than the two-argument version of <code>strcmp</code> . Not implemented in all versions of C++.

Like the functions `strcpy` and `strcmp`, all the other functions in `<cstring>` also do not require the following or anything similar (although other parts of your program are likely to require it):¹

```
using namespace std;
```

We have already discussed `strcpy` and `strcmp`. The function `strlen` is easy to understand and use. For example, `strlen("dobedo")` returns 6 because there are six characters in "dobedo".

The function `strcat` is used to concatenate two C strings, that is, to form a longer string by placing the two shorter C strings end-to-end. The first argument must be a C-string variable. The second argument can be anything that evaluates to a C-string value, such as a quoted string. The result is placed in the C-string variable that is the first argument. For example, consider the following:

```
char string_var[20] = "The rain";  
strcat(string_var, "in Spain");
```

This code will change the value of `string_var` to "The rainin Spain". As this example illustrates, you need to be careful to account for blanks when concatenating C strings.

If you look at the table in Display 8.1, you will see that safer, three-argument versions of the functions `strcpy`, `strcat`, and `strcmp` are available in many, but not all, versions of C++. Also, note that these three-argument versions are spelled with an added letter n: `strncpy`, `strncat`, and `strncmp`.

C-String Arguments and Parameters

A C-string variable is an array, so a C-string parameter to a function is simply an array parameter.

As with any array parameter, whenever a function changes the value of a C-string parameter, it is safest to include an additional *int* parameter giving the declared size of the C-string variable.

On the other hand, if a function only uses the value in a C-string argument but does not change that value, then there is no need to include another parameter to give either the declared size of the C-string variable or the amount of the C-string variable array that is filled. The null character `'\0'` can be used to detect the end of the C-string value that is stored in the C-string variable.

PITFALL Copying Past the End of a CString Using strcpyVideoNote
Dangers of strcpy

A common error in C and C++ is to copy a larger Cstring to a smaller Cstring using strcpy. This is dangerous because the strcpy function doesn't put any bounds on how much data to copy. It will simply copy everything from the source string to the target string until the null character is encountered. If the source is larger than the target then data will be copied past the memory allocated for the target string. Here is a simple example where we could have problems:

```
void copyString(char source[])
{
    char target[5];
    strcpy(target, source);
    // If this was more than an example we would presumably
    // use the target string in some way here
}
```

Quite simply, if the source Cstring is larger than five characters then this code will copy data into whatever happens to be stored past the target array, likely causing your program to crash or do unpredictable things. It could even open up your system to attack by malicious users. This has been such a serious problem that some compilers will not compile code that uses strcpy unless you override the warning. Assuming your compiler does allow you to use strcpy, one way to fix the problem is to only copy the Cstring if it is less than five characters long. Consider the following attempt to avoid exceeding the size of the Cstring:

```
void copyString(char source[])
{
    char target[5];
    signed char length; // Can hold -128 to +127
    length = strlen(source);
    if (length < 5)
        strcpy(target, source);
}
```

In this version we might use a signed char to store the length of the Cstring. This may seem reasonable since we are only creating an array of size 5 and a signed char can store values up to +127. This version will work fine for small source strings. But what if we input a source string that is 145 characters long? strlen will return 145, but this number is too large to store in a signed char. This causes overflow and results in a negative value copied into length. As a result the program enters the if statement and erroneously copies the source data to the target array. To avoid this problem we should make length an int (the same size returned by strlen), use strncpy to cap the maximum copy length, or use the string class described in the next section. ■

SELF-TEST EXERCISES

1. Which of the following declarations are equivalent?

```
char string_var[10] = "Hello";
char string_var[10] = {'H', 'e', 'l', 'l', 'o', '\0'};
char string_var[10] = {'H', 'e', 'l', 'l', 'o'};
char string_var[6] = "Hello";
char string_var[] = "Hello";
```

2. What C string will be stored in `singing_string` after the following code is run?

```
char singing_string[20] = "DoBeDo";
strcat(singing_string, " to you");
```

Assume that the code is embedded in a complete and correct program and that an `include` directive for `<cstring>` is in the program file.

3. What (if anything) is wrong with the following code?

```
char string_var[] = "Hello";
strcat(string_var, " and Good-bye.");
cout << string_var;
```

Assume that the code is embedded in a complete program and that an `include` directive for `<cstring>` is in the program file.

4. Suppose the function `strlen` (which returns the length of its string argument) was not already defined for you. Give a function definition for `strlen`. Note that `strlen` has only one argument, which is a C string. Do not add additional arguments; they are not needed.
5. What is the maximum length of a string that can be placed in the string variable declared by the following declaration? Explain.

```
char s[6];
```

6. How many characters are in each of the following character and string constants?
- `'\n'`
 - `'n'`
 - `"Mary"`
 - `"M"`
 - `"Mary\n"`

7. Since character strings are just arrays of `char`, why does the text caution you not to confuse the following declaration and initialization?

```
char short_string[] = "abc";
char short_string[] = {'a', 'b', 'c'};
```

8. Given the following declaration and initialization of the string variable, write a loop to assign 'X' to all positions of this string variable, keeping the length the same.

```
char our_string[15] = "Hi there!";
```

9. Given the declaration of a C-string variable, where SIZE is a defined constant:

```
char our_string[SIZE];
```

The C-string variable `our_string` has been assigned in code not shown here. For correct C-string variables, the following loop reassigns all positions of `our_string` the value 'X', leaving the length the same as before. Assume this code fragment is embedded in an otherwise complete and correct program. Answer the questions following this code fragment:

```
int index = 0;
while (our_string[index] != '\0')
{
    our_string[index] = 'X';
    index++;
}
```

- a. Explain how this code can destroy the contents of memory beyond the end of the array.
 - b. Modify this loop to protect against inadvertently changing memory beyond the end of the array.
10. Write code using a library function to copy the string constant "Hello" into the string variable declared below. Be sure to include the necessary header file to get the declaration of the function you use.

```
char a_string[10];
```

11. What string will be output when this code is run? (Assume, as always, that this code is embedded in a complete, correct program.)

```
char song[10] = "I did it ";
char franks_song[20];
strcpy( franks_song, song );
strcat( franks_song, "my way!");
cout << franks_song << endl;
```

12. What is the problem (if any) with this code?

```
char a_string[20] = "How are you? ";
strcat(a_string, "Good, I hope.");
```

C-String Input and Output

C strings can be output using the insertion operator `<<`. In fact, we have already been doing so with quoted strings. You can use a C-string variable in the same way; for example,

```
cout << news << "Wow.\n";
```

where `news` is a C-string variable.

It is possible to fill a C-string variable using the input operator `>>`, but there is one thing to keep in mind. As for all other types of data, all whitespace (blanks, tabs, and line breaks) are skipped when C strings are read this way. Moreover, each reading of input stops at the next space or line break. For example, consider the following code:

```
char a[80], b[80];  
cout << "Enter some input:\n";  
cin >> a >> b;  
cout << a << b << "END OF OUTPUT\n";
```

When embedded in a complete program, this code produces a dialogue like the following:

```
Enter some input:  
Do bedo to you!  
Dobedo END OF OUTPUT
```

The C-string variables `a` and `b` each receive only one word of the input: `a` receives the C-string value "Do" because the input character following Do is a blank; `b` receives "be" because the input character following be is a blank.

If you want your program to read an entire line of input, you can use the extraction operator `>>` to read the line one word at a time. This can be tedious and it still will not read the blanks in the line. There is an easy way to read an entire line of input and place the resulting C string into a C-string variable: Just use the predefined member function `getline`, which is a member function of every input stream (such as `cin` or a file input stream). The function `getline` has two arguments. The first argument is a C-string variable to receive the input and the second is an integer that typically is the declared size of the C-string variable. The second argument tells the maximum number of array elements in the C-string variable that `getline` will be allowed to fill with characters. For example, consider the following code:

```
char a[80];  
cout << "Enter some input:\n";  
cin.getline(a, 80);  
cout << a << "END OF OUTPUT\n";
```

When embedded in a complete program, this code produces a dialogue like the following:

```
Enter some input:
Do be do to you!
Do be do to you!END OF OUTPUT
```

With the function `cin.getline`, the entire line is read. The reading ends when the line ends, even though the resulting C string may be shorter than the maximum number of characters specified by the second argument.

When `getline` is executed, the reading stops after the number of characters given by the second argument have been filled in the C-string array, even if the end of the line has not been reached. For example, consider the following code:

```
char short_string[5];
cout << "Enter some input:\n";
cin.getline(short_string, 5);
cout << short_string << "END OF OUTPUT\n";
```

When embedded in a complete program, this code produces a dialogue like the following:

```
Enter some input:
dobe dowap
dobeEND OF OUTPUT
```

Notice that four, not five, characters are read into the C-string variable `short_string`, even though the second argument is 5. This is because the null character `'\0'` fills one array position. Every C string is terminated with the null character when it is stored in a C-string variable, and this always consumes one array position.

The C-string input and output techniques we illustrated for `cout` and `cin` work the same way for input and output with files. The input stream `cin` can be replaced by an input stream that is connected to a file. The output stream `cout` can be replaced by an output stream that is connected to a file. (File I/O is discussed in Chapter 6.)

getline

The member function `getline` can be used to read a line of input and place the C string of characters on that line into a C-string variable.

SYNTAX

```
cin.getline(String_Var, Max_Characters + 1);
```

One line of input is read from the stream *Input_Stream*, and the resulting C string is placed in *String_Var*. If the line is more than *Max_Characters* long, then only the first *Max_Characters* on the line

(continued)

are read. (The +1 is needed because every C string has the null character '\0' added to the end of the C string and so the string stored in *String_Var* is 1 longer than the number of characters read in.)

EXAMPLE

```
char one_line[80];
cin.getline(one_line, 80);
```

(You can use an input stream connected to a text file in place of *cin*.)

SELF-TEST EXERCISES

13. Consider the following code (and assume it is embedded in a complete and correct program and then run):

```
char a[80], b[80];
cout << "Enter some input:\n";
cin >> a >> b;
cout << a << '-' << b << "END OF OUTPUT\n";
```

If the dialogue begins as follows, what will be the next line of output?

Enter some input:

```
The
    time is now.
```

14. Consider the following code (and assume it is embedded in a complete and correct program and then run):

```
char my_string[80];
cout << "Enter a line of input:\n";
cin.getline(my_string, 6);
cout << my_string << "<END OF OUTPUT";
```

If the dialogue begins as follows, what will be the next line of output?

Enter a line of input:

```
May the hair on your toes grow long and curly.
```

C-String-to-Number Conversions and Robust Input

The C string "1234" and the number 1234 are not the same things. The first is a sequence of characters; the second is a number. In everyday life, we

write them the same way and blur this distinction, but in a C++ program this distinction cannot be ignored. If you want to do arithmetic, you need 1234, not "1234". If you want to add a comma to the numeral for one thousand two hundred thirty four, then you want to change the C string "1234" to the C string "1,234". When designing numeric input, it is often useful to read the input as a string of characters, edit the string, and then convert the string to a number. For example, if you want your program to read an amount of money, the input may or may not begin with a dollar sign. If your program is reading percentages, the input may or may not have a percent sign at the end. If your program reads the input as a string of characters, it can store the string in a C-string variable and remove any unwanted characters, leaving only a C string of digits. Your program then needs to convert this C string of digits to a number, which can easily be done with the predefined function `atoi`.

The function `atoi` takes one argument that is a C string and returns the *int* value that corresponds to that C string. For example, `atoi("1234")` returns the integer 1234. If the argument does not correspond to an *int* value, then `atoi` returns 0. For example, `atoi("#37")` returns 0, because the character '#' is not a digit. You pronounce `atoi` as "A to I," which is an

C-String-to-Number Functions

The functions `atoi`, `atol`, and `atof` can be used to convert a C string of digits to the corresponding numeric value. The functions `atoi` and `atol` convert C strings to integers. The only difference between `atoi` and `atol` is that `atoi` returns a value of type *int* whereas `atol` returns a value of type *long*. The function `atof` converts a C string to a value of type *double*. If the C-string argument (to either function) is such that the conversion cannot be made, then the function returns zero. For example

```
int x = atoi("657");
```

sets the value of `x` to 657, and

```
double y = atof("12.37");
```

sets the value of `y` to 12.37.

Any program that uses `atoi` or `atof` must contain the following directive:

```
#include <cstdlib>
```

abbreviation of “alphabetic to integer.” The function `atoi` is in the library with header file `cstdlib`, so any program that uses it must contain the following directive:

```
#include <cstdlib>
```

If your numbers are too large to be values of type `int`, you can convert them from C strings to values of type `long`. The function `atol` performs the same conversion as the function `atoi` except that `atol` returns values of type `long` and thus can accommodate larger integer values (on systems where this is a concern).

Display 8.2 contains the definition of a function called `read_and_clean` that reads a line of input and discards all characters other than the digits '0' through '9'. The function then uses the function `atoi` to convert the “cleaned-up” C string of digits to an integer value. As the demonstration program indicates, you can use this function to read money amounts and it will not matter whether the user included a dollar sign or not. Similarly, you can read percentages and it will not matter whether the user types in a percent sign or not. Although the output makes it look as if the function `read_and_clean` simply removes some symbols, more than that is happening. The value produced is a true `int` value that can be used in a program as a number; it is not a C string of characters.

The function `read_and_clean` shown in Display 8.2 will delete any nondigits from the string typed in, but it cannot check that the remaining digits will yield the number the user has in mind. The user should be given a chance to look at the final value and see whether it is correct. If the value is not correct, the user should be given a chance to reenter the input. In Display 8.3 we have used the function `read_and_clean` in another function called `get_int`, which will accept anything the user types and will allow the user to reenter the input until she or he is satisfied with the number that is computed from the input string. It is a very robust input procedure. (The function `get_int` is an improved version of the function of the same name given in Display 6.7.)

The functions `read_and_clean` in Display 8.2 and `get_int` in Display 8.3 are samples of the various input functions you can design by reading numeric input as a string value. Programming Project 3 at the end of this chapter asks you to define a function similar to `get_int` that reads in a number of type `double`, as opposed to a number of type `int`. To write that function, it would be nice to have a predefined function that converts a string value to a number of type `double`. Fortunately, the predefined function `atof`, which is also in the library with header file `cstdlib`, does just that. For example, `atof ("9.99")` returns the value 9.99 of type `double`. If the argument does not correspond to a number of type `double`, then `atof` returns 0.0. You pronounce `atof` as “A to F,” which is an abbreviation of “alphabetic to floating point.” Recall that numbers with a decimal point are often called *floating-point* numbers because of the way the computer handles the decimal point when storing these numbers in memory.

DISPLAY 8.2 C Strings to Integers (part 1 of 2)

```

1 //Demonstrates the function read_and_clean.
2 #include <iostream>
3 #include <cstdlib>
4 #include <cctype>
5
6 void read_and_clean(int& n);
7 //Reads a line of input. Discards all symbols except the digits. Converts
8 //the C string to an integer and sets n equal to the value of this integer.
9
10 void new_line( );
11 //Discards all the input remaining on the current input line.
12 //Also discards the '\n' at the end of the line.
13
14 int main( )
15 {
16     using namespace std;
17     int n;
18     char ans;
19     do
20     {
21         cout << "Enter an integer and press Return: ";
22         read_and_clean(n);
23         cout << "That string converts to the integer " << n <<endl;
24         cout << "Again? (yes/no): ";
25         cin >> ans;
26         new_line( );
27     } while ( (ans != 'n') && (ans != 'N') );
28     return 0;
29 }
30 //Uses iostream, cstdlib, and ctype:
31 void read_and_clean(int& n)
32 {
33     using namespace std;
34     const int ARRAY_SIZE = 6;
35     char digit_string[ARRAY_SIZE];
36
37     char next;
38     cin.get(next);
39     int index = 0;
40     while (next != '\n')
41     {
42         if ((isdigit(next)) && (index < ARRAY_SIZE - 1))
43         {
44             digit_string[index] = next;
45             index++;
46         }

```

(continued)

DISPLAY 8.2 C Strings to Integers (part 2 of 2)

```

47     cin.get(next);
48     }
49     digit_string[index] = '\0';
50     n = atoi(digit_string);
51     }
52     //Uses iostream:
53     void new_line( )
54     {
55         using namespace std;
        <The rest of the definition of new_line is given in Display 6.7.>

```

Sample Dialogue

```

Enter an integer and press Return: $ 100
That string converts to the integer 100
Again? (yes/no): yes
Enter an integer and press Return: 100
That string converts to the integer 100
Again? (yes/no): yes
Enter an integer and press Return: 99%
That string converts to the integer 99
Again? (yes/no): yes
Enter an integer and press Return: 23% &&5 *12
That string converts to the integer 23512
Again? (yes/no): no

```

DISPLAY 8.3 Robust Input Function (part 1 of 2)

```

1     //Demonstration program for improved version of get_int.
2     #include <iostream>
3     #include <cstdlib>
4     #include <cctype>

5     void read_and_clean(int& n);
6     //Reads a line of input. Discards all symbols except the digits. Converts
7     //the C string to an integer and sets n equal to the value of this integer.

8     void new_line( );
9     //Discards all the input remaining on the current input line.
10    //Also discards the '\n' at the end of the line.

11    void get_int(int& input_number);
12    //Gives input_number a value that the user approves of.

```

(continued)

DISPLAY 8.3 Robust Input Function (part 2 of 2)

```

13  int main( )
14  {
15      using namespace std;
16      int input_number;
17      get_int(input_number);
18      cout << "Final value read in = " <<input_number<<endl;
19      return 0;
20  }

21  //Uses iostream and read_and_clean:
22  void get_int(int& input_number)
23  {
24      using namespace std;
25      char ans;
26      do
27      {
28          cout << "Enter input number: ";
29          read_and_clean(input_number);
30          cout << "You entered " <<input_number
31              << " Is that correct? (yes/no): ";
32          cin >> ans;
33          new_line( );
34      } while ((ans != 'y') && (ans != 'Y'));
35  }

36  //Uses iostream, cstdlib, and ctype:
37  void read_and_clean(int& n)

```

<The rest of the definition of read_and_clean is given in Display 8.2.>

```

38  //Uses iostream:
39  void new_line( )

```

<The rest of the definition of new_line is given in Display 8.2.>

Sample Dialogue

```

Enter input number: $57
You entered 57 Is that correct? (yes/no): no
Enter input number: $77*5xa
You entered 775 Is that correct? (yes/no): no
Enter input number: 77
You entered 77 Is that correct? (yes/no): no
Enter input number: $75
You entered 75 Is that correct? (yes/no): yes
Final value read in = 75

```

8.2 THE STANDARD `string` CLASS

I try to catch every sentence, every word you and I say, and quickly lock all these sentences and words away in my literary storehouse because they might come in handy.

ANTON CHEKHOV, *The Seagull*

In Section 8.1, we introduced C strings. These C strings were simply arrays of characters terminated with the null character `'\0'`. In order to manipulate these C strings, you needed to worry about all the details of handling arrays. For example, when you want to add characters to a C string and there is not enough room in the array, you must create another array to hold this longer string of characters. In short, C strings require the programmer to keep track of all the low-level details of how the C strings are stored in memory. This is a lot of extra work and a source of programmer errors. The latest ANSI/ISO standard for C++ specified that C++ must now also have a class `string` that allows the programmer to treat strings as a basic data type without needing to worry about implementation details. In this section we introduce you to this `string` type.

Introduction to the Standard Class `string`

The class `string` is defined in the library whose name is also `<string>`, and the definitions are placed in the `std` namespace. So, in order to use the class `string`, your code must contain the following (or something more or less equivalent):

```
#include <string>
using namespace std;
```

+ operator does concatenation

The class `string` allows you to treat string values and string expressions very much like values of a simple type. You can use the `=` operator to assign a value to a string variable, and you can use the `+` sign to concatenate two strings. For example, suppose `s1`, `s2`, and `s3` are objects of type `string` and both `s1` and `s2` have string values. Then `s3` can be set equal to the concatenation of the string value in `s1` followed by the string value in `s2` as follows:

```
s3 = s1 + s2;
```

There is no danger of `s3` being too small for its new string value. If the sum of the lengths of `s1` and `s2` exceeds the capacity of `s3`, then more space is automatically allocated for `s3`.

As we noted earlier in this chapter, quoted strings are really C strings and so they are not literally of type `string`. However, C++ provides automatic type casting of quoted strings to values of type `string`. So, you can use quoted strings as if they were literal values of type `string`, and we (and most others) will often refer to quoted strings as if they were values of type `string`. For example,

```
s3 = "Hello Mom!";
```

sets the value of the string variable `s3` to a string object with the same characters as in the C string `"Hello Mom!"`.

The class `string` has a default constructor that initializes a `string` object to the empty string. The class `string` also has a second constructor that takes one argument that is a standard C string and so can be a quoted string. This second constructor initializes the `string` object to a value that represents the same string as its C-string argument. For example,

```
string phrase;  
string noun("ants");
```

The first line declares the string variable `phrase` and initializes it to the empty string. The second line declares `noun` to be of type `string` and initializes it to a string value equivalent to the C string `"ants"`. Most programmers when talking loosely would say that “`noun` is initialized to `"ants"`,” but there really is a type conversion here. The quoted string `"ants"` is a C string, not a value of type `string`. The variable `noun` receives a string value that has the same characters as `"ants"` in the same order as `"ants"`, but the string value is not terminated with the null character `'\0'`. In fact, in theory at least, you do not know or care whether the string value of `noun` is even stored in an array, as opposed to some other data structure.

There is an alternate notation for declaring a string variable and invoking a constructor. The following two lines are exactly equivalent:

```
string noun("ants");  
string noun = "ants";
```

These basic details about the class `string` are illustrated in Display 8.4. Note that, as illustrated there, you can output `string` values using the operator `<<`.

Consider the following line from Display 8.4:

```
phrase = "I love " + adjective + " " + noun + "!";
```

C++ must do a lot of work to allow you to concatenate strings in this simple and natural fashion. The string constant `"I love"` is not an object of type `string`. A string constant like `"I love"` is stored as a C string (in other words, as a null-terminated array of characters). When C++ sees `"I love"` as an argument to `+`, it finds the definition (or overloading) of `+` that applies to a value such as `"I love"`. There are overloadings of the `+` operator that have a C string on the left and a string on the right, as well as the reverse of this positioning. There is even a version that has a C string on both sides of the `+` and produces a `string` object as the value returned. Of course, there is also the overloading you expect, with the type `string` for both operands.

C++ did not really need to provide all those overloading cases for `+`. If these overloadings were not provided, C++ would look for a constructor that could perform a type conversion to convert the C string `"I love"` to a value for which `+` did apply. In this case, the constructor with the one C-string parameter would perform just such a conversion. However, the extra overloadings are presumably more efficient.

The class `string` is often thought of as a modern replacement for C strings. However, in C++ you cannot easily avoid also using C strings when you program with the class `string`.

Converting
C-string constants
to the type
`string`

DISPLAY 8.4 Program Using the Class string

```
1 //Demonstrates the standard class string.
2 #include <iostream>
3 #include <string>
4 using namespace std;

5 int main( )
6 {
7     string phrase;
8     string adjective("fried"), noun("ants");
9     string wish = "Bon appetit!";

10     phrase = "I love " + adjective + " " + noun + "!";
11     cout << phrase << endl
12         << wish << endl;

13     return 0;
14 }
```

Initialized to the empty string

Two ways of initializing a string variable

Sample Dialogue

```
I love fried ants!
Bon appetit!
```

The Class string

The class `string` can be used to represent values that are strings of characters. The class `string` provides more versatile string representation than the C strings discussed in Section 8.1.

The class `string` is defined in the library that is also named `<string>`, and its definition is placed in the `std` namespace. So, programs that use the class `string` should contain the following (or something more or less equivalent):

```
#include <string>
using namespace std;
```

The class `string` has a default constructor that initializes the `string` object to the empty string and a constructor that takes a C string as an argument and initializes the `string` object to a value that represents the string given as the argument. For example:

```
string s1, s2("Hello");
```

I/O with the Class `string`

You can use the insertion operator `<<` and `cout` to output `string` objects just as you do for data of other types. This is illustrated in Display 8.4. Input with the class `string` is a bit more subtle.

The extraction operator `>>` and `cin` work the same for `string` objects as for other data, but remember that the extraction operator ignores initial whitespace and stops reading when it encounters more whitespace. This is as true for strings as it is for other data. For example, consider the following code;

```
string s1, s2;
cin >> s1;
cin >> s2;
```

If the user types in

```
May the hair on your toes grow long and curly!
```

then `s1` will receive the value "May" with any leading (or trailing) whitespace deleted. The variable `s2` receives the string "the". Using the extraction operator `>>` and `cin`, you can only read in words; you cannot read in a line or other string that contains a blank. Sometimes this is exactly what you want, but sometimes it is not at all what you want.

If you want your program to read an entire line of input into a variable of type `string`, you can use the function `getline`. The syntax for using `getline` with `string` objects is a bit different from what we described for C strings in Section 8.1. You do not use `cin.getline`; instead, you make `cin` the first argument to `getline`.² (Thus, this version of `getline` is not a member function.)

```
string line;
cout << "Enter a line of input:\n";
getline(cin, line);
cout << line << "END OF OUTPUT\n";
```

When embedded in a complete program, this code produces a dialogue like the following:

```
Enter some input:
Do bedo to you!
Do bedo to you!END OF OUTPUT
```

If there were leading or trailing blanks on the line, then they too would be part of the `string` value read by `getline`. This version of `getline` is in the

² This is a bit ironic, since the class `string` was designed using more modern object-oriented techniques, and the notation it uses for `getline` is the old fashioned, less object-oriented notation. This is an accident of history. This `getline` function was defined after the `iostream` library was already in use, so the designers had little choice but to make this `getline` a stand-alone function.

library `<string>`. You can use a stream object connected to a text file in place of `cin` to do input from a file using `getline`.

You cannot use `cin` and `>>` to read in a blank character. If you want to read one character at a time, you can use `cin.get`, which we discussed in Chapter 6. The function `cin.get` reads values of type `char`, not of type `string`, but it can be helpful when handling `string` input. Display 8.5 contains a program that illustrates both `getline` and `cin.get` used for `string` input. The significance of the function `new_line` is explained in the Pitfall subsection entitled “??”

DISPLAY 8.5 Program Using the Class `string` (part 1 of 2)

```

1  //Demonstrates getline and cin.get.
2  #include <iostream>
3  #include <string>

4  void new_line( );

5  int main( )
6  {
7      using namespace std;
8
9      string first_name, last_name, record_name;
10     string motto = "Your records are our records.";

11     cout << "Enter your first and last name:\n";
12     cin >> first_name>>last_name;
13     new_line( );

14     record_name = last_name + ", " + first_name;
15     cout << "Your name in our records is: ";
16     cout << record_name<<endl;

17     cout << "Our motto is\n"
18         << motto <<endl;
19     cout << "Please suggest a better (one-line) motto:\n";
20     getline(cin, motto);
21     cout << "Our new motto will be:\n";
22     cout << motto <<endl;

23     return 0;
24 }
25
26 //Uses iostream:
27 void new_line( )
28 {
29     using namespace std;
30
```

(continued)

DISPLAY 8.5 Program Using the Class string (part 2 of 2)

```
31     char next_char;  
32     do  
33     {  
34         cin.get(next_char);  
35     } while (next_char != '\n');  
36 }
```

Sample Dialogue

```
Enter your first and last name:  
B'Elanna Torres  
Your name in our records is: Torres, B'Elanna  
Our motto is  
Your records are our records.  
Please suggest a better (one-line) motto:  
Our records go where no records dared to go before.  
Our new motto will be:  
Our records go where no records dared to go before.
```

I/O with string Objects

You can use the insertion operator `<<` with `cout` to output `string` objects. You can input a string with the extraction operator `>>` and `cin`. When using `>>` for input, the code reads in a string delimited with whitespace. You can use the function `getline` to input an entire line of text into a string object.

EXAMPLES

```
string greeting("Hello"), response, next_word;  
cout << greeting << endl;  
getline(cin, response);  
cin >> next_word;
```

SELF-TEST EXERCISES

15. Consider the following code (and assume that it is embedded in a complete and correct program and then run):

```
string s1, s2;
```

```
cout << "Enter a line of input:\n";
cin >> s1 >> s2;
cout << s1 << "*" << s2 << "<END OF OUTPUT";
```

If the dialogue begins as follows, what will be the next line of output?

```
Enter a line of input:
A string is a joy forever!
```

16. Consider the following code (and assume that it is embedded in a complete and correct program and then run):

```
string s;
cout << "Enter a line of input:\n";
getline(cin, s);
cout << s << "<END OF OUTPUT";
```

If the dialogue begins as follows, what will be the next line of output?

```
Enter a line of input:
A string is a joy forever!
```

■ PROGRAMMING TIP More Versions of `getline`

So far, we have described the following way of using `getline`:

```
string line;
cout << "Enter a line of input:\n";
getline(cin, line);
```

This version stops reading when it encounters the end-of-line marker `'\n'`. There is a version that allows you to specify a different character to use as a stopping signal. For example, the following will stop when the first question mark is encountered:

```
string line;
cout << "Enter some input:\n";
getline(cin, line, '?');
```

It makes sense to use `getline` as if it were a *void* function, but it actually returns a reference to its first argument, which is `cin` in the code above. Thus, the following will read a line of text into `s1` and a string of nonwhitespace characters into `s2`:

```
string s1, s2;
getline(cin, s1) >> s2;
```

The invocation `getline (cin,s1)` returns a reference to `cin`, so that after the invocation of `getline`, the next thing to happen is equivalent to

```
cin >> s2;
```

This kind of use of `getline` seems to have been designed for use in a C++ quiz show rather than to meet any actual programming need, but it can come in handy sometimes. ■

PITFALL `Mixing cin >> variable; and getline`

Take care in mixing input using `cin >> variable;` with input using `getline`. For example, consider the following code:

```
int n;
string line;
cin >> n;
getline(cin, line);
```



VideoNote
Example using `cin` and
`getline` with the `string`
class

getline for Objects of the Class string

The `getline` function for `string` objects has two versions:

```
istream& getline(istream& ins, string& str_var,
                char delimiter);
```

and

```
istream& getline(istream& ins, string& str_var);
```

The first version of this function reads characters from the `istream` object given as the first argument (always `cin` in this chapter), inserting the characters into the `string` variable `str_var` until an instance of the delimiter character is encountered. The delimiter character is removed from the input and discarded. The second version uses `'\n'` for the default value of `delimiter`; otherwise, it works the same.

These `getline` functions return their first argument (always `cin` in this chapter), but they are usually used as if they were *void* functions.

When this code reads the following input, you might expect the value of `n` to be set to 42 and the value of `line` to be set to a `string` value representing "Hello hitchhiker.":

```
42
Hello hitchhiker.
```

However, while `n` is indeed set to the value of 42, `line` is set equal to the empty `string`. What happened?

Using `cin >> n` skips leading whitespace on the input, but leaves the rest of the line, in this case just `'\n'`, for the next input. A statement like

```
cin >> n;
```

always leaves something on the line for a following `getline` to read (even if it is just the `'\n'`). In this case, the `getline` sees the `'\n'` and stops reading, so `getline` reads an empty string. If you find your program appearing to mysteriously ignore input data, see if you have mixed these two kinds of input. You may need to use either the `new_line` function from Display 8.5 or the function `ignore` from the library `iostream`. For example,

```
cin.ignore(1000, '\n');
```

With these arguments, a call to the `ignore` member function will read and discard the entire rest of the line up to and including the `'\n'` (or until it discards 1000 characters if it does not find the end of the line after 1000 characters).

There can be other baffling problems with programs that use `cin` with both `>>` and `getline`. Moreover, these problems can come and go as you move from one C++ compiler to another. When all else fails, or if you want to be certain of portability, you can resort to character-by-character input using `cin.get`.

These problems can occur with any of the versions of `getline` that we discuss in this chapter. ■

String Processing with the Class `string`

The class `string` allows you to perform the same operations that you can perform with the C strings we discussed in Section 8.1 and more. You can access the characters in a `string` object in the same way that you access array elements, so `string` objects have all the advantages of arrays of characters plus a number of advantages that arrays do not have, such as automatically increasing their capacity. If `last_name` is the name of a `string` object, then `last_name[i]` gives access to the `i`th character in the string represented by `last_name`. This use of array square brackets is illustrated in Display 8.6.

Display 8.6 also illustrates the member function `length`. Every `string` object has a member function named `length` that takes no arguments and returns the length of the string represented by the `string` object. Thus, not only can a `string` object be used like an array but the `length` member function makes it behave like a partially filled array that automatically keeps track of how many positions are occupied.

When used with an object of the class `string`, the array square brackets do not check for illegal indexes. If you use an illegal index (that is, an index that is greater than or equal to the length of the string in the object), then the results are unpredictable but are bound to be bad. You may just get strange behavior without any error message that tells you that the problem is an illegal index value.

There is a member function named `at` that does check for illegal index values. This member function behaves basically the same as the square brackets, except for two points: You use function notation with `at`, so instead

DISPLAY 8.6 A string Object Can Behave Like an Array

```

1  //Demonstrates using a string object as if it were an array.
2  #include <iostream>
3  #include <string>
4  using namespace std;
5
6  int main( )
7  {
8      string first_name, last_name;
9
10     cout << "Enter your first and last name:\n";
11     cin >> first_name>>last_name;
12
13     cout << "Your last name is spelled:\n";
14     int i;
15     for (i = 0; i <last_name.length( ); i++)
16     {
17         cout << last_name[i] << " ";
18         last_name[i] = '-';
19     }
20     cout << endl;
21     for (i = 0; i <last_name.length( ); i++)
22         cout << last_name[i] << " "; //Places a "-" under each letter.
23     cout << endl;
24
25     cout << "Good day " << first_name << endl;
26     return 0;
27 }

```

Sample Dialogue

```

Enter your first and last name:
John Crichton
Your last name is spelled:
C r i c h t o n
- - - - -
Good day John

```

of `a[i]`, you use `a.at(i)`; and the `at` member function checks to see if `i` evaluates to an illegal index. If the value of `i` in `a.at(i)` is an illegal index, then you should get a run-time error message telling you what is wrong. In the following two example code fragments, the attempted access is out of range, yet the first of these probably will not produce an error message, although it will be accessing a nonexistent indexed variable:

```

string str("Mary");
cout << str[6] << endl;

```

The second example, however, will cause the program to terminate abnormally, so you at least know that something is wrong:

```
string str("Mary");
cout << str.at(6) << endl;
```

But be warned that some systems give very poor error messages when `str.at(i)` has an illegal index `i`.

You can change a single character in the string by assigning a `char` value to the indexed variable, such as `str[i]`. This may also be done with the member function `at`. For example, to change the third character in the string object `str` to 'X', you can use either of the following code fragments:

```
str.at(2) = 'X';
```

or

```
str[2] = 'X';
```

As in an ordinary array of characters, character positions for objects of type `string` are indexed starting with 0, so the third character in a `string` is in index position 2.

Display 8.7 gives a partial list of the member functions of the class `string`. In many ways, objects of the class `string` are better behaved than the C strings we introduced in Section 8.1. In particular, the `==` operator on objects of the `string` class returns a result that corresponds to our intuitive notion of strings being equal—namely, it returns `true` if the two strings contain the same characters in the same order, and returns `false` otherwise. Similarly, the comparison operators `<`, `>`, `<=`, `>=` compare string objects using lexicographic ordering. (Lexicographic ordering is alphabetic ordering using the order of symbols given in the ASCII character set in Appendix 3. If the strings consist of all letters and are both either all uppercase or all lowercase letters, then for this case lexicographic ordering is the same as everyday alphabetical ordering.)

DISPLAY 8.7 Member Functions of the Standard Class `string` (part 1 of 2)

Example	Remarks
Constructors	
<code>string str;</code>	Default constructor creates empty string object <code>str</code> .
<code>string str("sample");</code>	Creates a string object with data "sample".
<code>string str (a_string);</code>	Creates a string object <code>str</code> that is a copy of <code>a_string</code> ; <code>a_string</code> is an object of the class <code>string</code> .

(continued)

DISPLAY 8.7 Member Functions of the Standard Class `string` (part 2 of 2)**Accessors**

<code>str[i]</code>	Returns read/write reference to character in <code>str</code> at index <code>i</code> . Does not check for illegal index.
<code>str.at(i)</code>	Returns read/write reference to character in <code>str</code> at index <code>i</code> . Same as <code>str[i]</code> , but this version checks for illegal index.
<code>str.substr(position, length)</code>	Returns the substring of the calling object starting at <code>position</code> and having <code>length</code> characters.
<code>str.length()</code>	Returns the length of <code>str</code> .

Assignment/Modifiers

<code>str1 = str2;</code>	Initializes <code>str1</code> to <code>str2</code> 's data.
<code>str1 += str2;</code>	Character data of <code>str2</code> is concatenated to the end of <code>str1</code> .
<code>str.empty()</code>	Returns true if <code>str</code> is an empty string; false otherwise.
<code>str1 + str2</code>	Returns a string that has <code>str2</code> 's data concatenated to the end of <code>str1</code> 's data.
<code>str.insert(pos, str2);</code>	Inserts <code>str2</code> into <code>str</code> beginning at position <code>pos</code> .
<code>str.erase(pos, length);</code>	Removes substring of size <code>length</code> , starting at position <code>pos</code> .

Comparison

<code>str1 == str2</code> <code>str1 != str2</code>	Compare for equality or inequality; returns a Boolean value.
<code>str1 < str2</code> <code>str1 > str2</code>	Four comparisons. All are lexicographical comparisons.
<code>str1 <= str2</code> <code>str1 >= str2</code>	

Finds

<code>str.find(str1)</code>	Returns index of the first occurrence of <code>str1</code> in <code>str</code> . If <code>str1</code> is not found, then the special value <code>string::npos</code> is returned.
<code>str.find(str1, pos)</code>	Returns index of the first occurrence of string <code>str1</code> in <code>str</code> ; the search starts at position <code>pos</code> .
<code>str.find_first_of(str1, pos)</code>	Returns the index of the first instance in <code>str</code> of any character in <code>str1</code> , starting the search at position <code>pos</code> .
<code>str.find_first_not_of(str1, pos)</code>	Returns the index of the first instance in <code>str</code> of any character not in <code>str1</code> , starting the search at position <code>pos</code> .

PROGRAMMING EXAMPLE Palindrome Testing

A palindrome is a string that reads the same front to back as it does back to front. The program in Display 8.8 tests an input string to see if it is a palindrome. Our palindrome test will disregard all spaces and punctuations and will consider upper- and lowercase versions of a letter to be the same when deciding if something is a palindrome. Some palindrome examples are as follows:

```
Able was I ere I saw Elba.
I Love Me, Vol. I.
Madam, I'm Adam.
A man, a plan, a canal, Panama.
Rats live on no evil star.
radar
deed
mom
racecar
```

The `remove_punct` function is of interest in that it uses the string member functions `substr` and `find`. The member function `substr` extracts a substring of the calling object, given the position and length of the desired substring.

DISPLAY 8.8 Palindrome Testing Program (part 1 of 3)

```
1 //Test for palindrome property.
2 #include <iostream>
3 #include <string>
4 #include <cctype>
5 using namespace std;
6 void swap (char& v1, char& v2);
7 //Interchanges the values of v1 and v2.
8 string reverse(const string& s);
9 //Returns a copy of s but with characters in reverse order.
10 string remove_punct(const string& s, const string& punct);
11 //Returns a copy of s with any occurrences of characters
12 //in the string punct removed.
13 string make_lower(const string& s);
14 //Returns a copy of s that has all uppercase
15 //characters changed to lowercase, other characters unchanged.
16 bool is_pal(const string& s);
17 //Returns true if s is a palindrome, false otherwise.
18 int main( )
19 {
20     string str;
```

(continued)

DISPLAY 8.8 Palindrome Testing Program (part 2 of 3)

```

21     cout << "Enter a candidate for palindrome test\n"
22         << "followed by pressing Return.\n";
23     getline(cin, str);
24     if (is_pal(str))
25         cout << "\"" <<str + "\" is a palindrome.";
26     else
27         cout << "\"" <<str + "\" is not a palindrome.";
28     cout << endl;
29     return 0;
30 }
31
32 void swap(char& v1, char& v2)
33 {
34     char temp = v1;
35     v1 = v2;
36     v2 = temp;
37 }
38
39 string reverse(const string& s)
40 {
41     int start = 0;
42     int end = s.length( );
43     string temp(s);
44
45     while (start < end)
46     {
47         end--;
48         swap(temp[start], temp[end]);
49         start++;
50     }
51     return temp;
52 }
53 //Uses <cctype> and <string>
54 string make_lower(const string& s)
55 {
56     string temp(s);
57     for (int i = 0; i < s.length( ); i++)
58         temp[i] = tolower(s[i]);
59     return temp;
60 }
61 string remove_punct(const string& s, const string& punct)
62 {
63     string no_punct; //initialized to empty string
64     int s_length = s.length( );
65     int punct_length = punct.length( );

```

(continued)

DISPLAY 8.8 Palindrome Testing Program (part 3 of 3)

```

66     for (int i = 0; i < s_length; i++)
67     {
68         string a_char = s.substr(i,1); //A one-character string
69         int location = punct.find(a_char, 0);
70         //Find location of successive characters
71         //of src in punct.
72         if (location < 0 || location >= punct_length)
73             no_punct = no_punct + a_char; //a_char not in punct, so keep it
74     }
75     return no_punct;
76 }
77
78 //uses functions make_lower, remove_punct
79 bool is_pal(const string& s)
80 {
81     stringpunct (",;:?!'\ " "); //includes a blank
82     string str(s);
83     str = make_lower(str);
84     string lower_str = remove_punct(str, punct);
85     return (lower_str == reverse(lower_str));
86 }

```

Sample Dialogue

Enter a candidate for palindrome test
followed by pressing Return.

Madam, I'm Adam.

"Madam, I'm Adam." is a palindrome.

Sample Dialogue

Enter a candidate for palindrome test
followed by pressing Return.

Radar

"Radar" is a palindrome.

Sample Dialogue

Enter a candidate for palindrome test
followed by pressing Return.

Am I a palindrome?

"Am I a palindrome?" is not a palindrome.

The first three lines of `remove_punct` declare variables for use in the function. The *for* loop runs through the characters of the parameters one at a time and tries to find them in the `punct` string. To do this, a string that is the substring of `s`, of length 1 at each character position, is extracted. The position of this substring in the `punct` string is determined using the `find` member function. If this one-character string is not in the `punct` string, then the one-character string is concatenated to the `no_punct` string that is to be returned.

= and == Are Different for strings and C Strings

The operators `=`, `==`, `!=`, `<`, `>`, `<=`, `>=`, when used with the standard C++ type `string`, produce results that correspond to our intuitive notion of how strings compare. They do not misbehave as they do with the C strings, as we discussed in Section 8.1

SELF-TEST EXERCISES

17. Consider the following code:

```
string s1, s2("Hello");
cout << "Enter a line of input:\n";
cin >> s1;
if (s1 == s2)
    cout << "Equal\n";
else
    cout << "Not equal\n";
```

If the dialogue begins as follows, what will be the next line of output?

```
Enter a line of input:
Hello friend!
```

18. What is the output produced by the following code?

```
string s1, s2("Hello");
s1 = s2;
s2[0] = 'J';
cout << s1 << " " << s2;
```

Converting Between string Objects and C Strings

You have already seen that C++ will perform an automatic type conversion to allow you to store a C string in a variable of type `string`. For example, the following will work fine:

```
char a_c_string[] = "This is my C string.";
string string_variable;
string_variable = a_c_string;
```

However, the following will produce a compiler error message:

```
a_c_string = string_variable; //ILLEGAL
```

The following is also illegal:

```
strcpy(a_c_string, string_variable); //ILLEGAL
```

`strcpy` cannot take a `string` object as its second argument, and there is no automatic conversion of `string` objects to C strings, which is the problem we cannot seem to get away from.

To obtain the C string corresponding to a `string` object, you must perform an explicit conversion. This can be done with the `string` member function `c_str()`. The correct version of the copying we have been trying to do is the following:

```
strcpy(a_c_string, string_variable.c_str( )); //Legal;
```

Note that you need to use the `strcpy` function to do the copying. The member function `c_str()` returns the C string corresponding to the `string` calling object. As we noted earlier in this chapter, the assignment operator does not work with C strings. So, just in case you thought the following might work, we should point out that it too is illegal.

```
a_c_string = string_variable.c_str( ); //ILLEGAL
```

Converting Between Strings and Numbers

Prior to C++11 it was a bit complicated to convert between strings and numbers, but in C++11 it is simply a matter of calling a function. Use `stof`, `stod`, `stoi`, or `stol` to convert a string to a float, double, int, or long, respectively. Use `to_string` to convert a numeric type to a string. These functions are illustrated in the following example:

```
int i;
double d;
string s;
i = stoi("35"); // Converts the string "35" to an integer 35
d = stod("2.5"); // Converts the string "2.5" to the double 2.5
s = to_string(d*2); // Converts the double 5.0 to a string
                    "5.0000"
cout << i << " " << d << " " << s << endl;
```

The output is 35 2.5 5.0000

8.3 VECTORS

"Well, I'll eat it," said Alice, "and if it makes me grow larger, I can reach the key; and if it makes me grow smaller, I can creep under the door; so either way I'll get into the garden...."

LEWIS CARROLL, *Alice's Adventures in Wonderland*

Vectors can be thought of as arrays that can grow (and shrink) in length while your program is running. In C++, once your program creates an array, it cannot change the length of the array. Vectors serve the same purpose as arrays except that they can change length while the program is running. Vectors are part of a standard C++ library known as the STL (Standard Template Library), which we cover in more detail in Chapter 18.

You need not read the previous sections of this chapter before covering this section.

Vector Basics

Like an array, a vector has a base type, and like an array, a vector stores a collection of values of its base type. However, the syntax for a vector type and a vector variable declaration are different from the syntax for arrays.

You declare a variable `v` for a vector with base type `int` as follows:

```
vector<int> v;
```

Declaring a vector variable

The notation `vector<Base_Type>` is a **template class**, which means you can plug in any type for `Base_Type` and that will produce a class for vectors with that base type. You can think of this as specifying the base type for a vector in the same sense as you specify a base type for an array. You can use any type, including class types, as the base type for a vector. The notation `vector<int>` is a class name, and so the previous declaration of `v` as a vector of type `vector<int>` includes a call to the default constructor for the class `vector<int>`, which creates a vector object that is empty (has no elements).

Vector elements are indexed starting with 0, the same as arrays. The array square brackets notation can be used to read or change these elements, just as with an array. For example, the following changes the value of the `i`th element of the vector `v` and then outputs that changed value. (`i` is an `int` variable.)

```
v[i] = 42;
cout << "The answer is " << v[i];
```

There is, however, a restriction on this use of the square brackets notation with vectors that is unlike the same notation used with arrays. You can use `v[i]` to change the value of the `i`th element. However, you cannot initialize the `i`th element using `v[i]`; you can only change an element that has already been given some value. To add an element to an index position of a vector for the first time, you would normally use the member function `push_back`.

You add elements to a vector in order of positions, first at position 0, then position 1, then 2, and so forth. The member function `push_back` adds an element in the next available position. For example, the following gives initial values to elements 0, 1, and 2 of the vector `sample`:

```
vector<double> sample;
sample.push_back(0.0);
sample.push_back(1.1);
sample.push_back(2.2);
```

In C++11 we can initialize a vector the same way we initialize an array:

```
vector <double> sample = {0.0, 1.1, 2.2};
```

The number of elements in a vector is called the **size** of the vector. The member function `size` can be used to determine how many elements are in a vector. For example, after the previously shown code is executed, `sample.size()` returns 3. You can write out all the elements currently in the vector `sample` as follows:

```
for (int i = 0; i < sample.size( ); i++)
    cout << sample[i] << endl;
```

The function `size` returns a value of type *unsigned int*, not a value of type *int*. (The type *unsigned int* allows only nonnegative integer values.) This returned value should be automatically converted to type *int* when it needs to be of type *int*, but some compilers may warn you that you are using an *unsigned int* where an *int* is required. If you want to be very safe, you can always apply a type cast to convert the returned *unsigned int* to an *int* or, in cases like this *for* loop, use a loop control variable of type *unsigned int* as follows:

```
for (unsigned int i = 0; i < sample.size( ); i++)
    cout << sample[i] << endl;
```

Equivalently, we could use the ranged *for* loop:

```
for (auto i : sample)
    cout << i << endl;
```

A simple demonstration illustrating some basic vector techniques is given in Display 8.9.

There is a vector constructor that takes one integer argument and will initialize the number of positions given as the argument. For example, if you declare `v` as follows:

```
vector<int> v(10);
```

then the first ten elements are initialized to 0, and `v.size()` would return 10. You can then set the value of the *i*th element using `v[i]` for values of *i* equal to 0 through 9. In particular, the following could immediately follow the declaration:

```
for (unsigned int i = 0; i < 10; i++)
    v[i] = i;
```

DISPLAY 8.9 Using a Vector

```
1  #include <iostream>
2  #include <vector>
3  using namespace std;

4  int main( )
5  {
6      vector<int> v;
7      cout << "Enter a list of positive numbers.\n"
8           << "Place a negative number at the end.\n";

9      int next;
10     cin >> next;
11     while (next > 0)
12     {
13         v.push_back(next);
14         cout << next << " added. ";
15         cout << "v.size( ) = " <<v.size( ) <<endl;
16         cin >> next;
17     }

18     cout << "You entered:\n";
19     for (unsigned int i = 0; i <v.size( ); i++)
20         cout << v[i] << " ";
21     cout << endl;

22     return 0;
23 }
```

Sample Dialogue

```
Enter a list of positive numbers.
Place a negative number at the end.
2 4 6 8 -1
2 added. v.size( ) = 1
4 added. v.size( ) = 2
6 added. v.size( ) = 3
8 added. v.size( ) = 4
You entered:
2 4 6 8
```

To set the i th element, for i greater than or equal to 10, you would use `push_back`.

When you use the constructor with an integer argument, vectors of numbers are initialized to the zero of the number type. If the vector base type is a class type, the default constructor is used for initialization.

The vector definition is given in the library `vector`, which places it in the `std` namespace. Thus, a file that uses vectors would include the following (or something similar):

```
#include <vector>
using namespace std;
```

PITFALL Using Square Brackets Beyond the Vector Size

If `v` is a vector and `i` is greater than or equal to `v.size()`, then the element `v[i]` does not yet exist and needs to be created by using `push_back` to add elements up to and including position `i`. If you try to set `v[i]` for `i` greater than or equal to `v.size()`, as in

```
v[i] = n;
```

then you may or may not get an error message, but your program will undoubtedly misbehave at some point. ■

Vectors

Vectors are used very much like arrays are used, but a vector does not have a fixed size. If it needs more capacity to store another element, its capacity is automatically increased. Vectors are defined in the library `<vector>`, which places them in the `std` namespace. Thus, a file that uses vectors would include the following (or something similar):

```
#include <vector>
using namespace std;
```

The vector class for a given *Base_Type* is written `vector<Base_Type>`. Two sample vector declarations are

```
vector<int> v; //default constructor
              //producing an empty vector.
vector<Aclass> record(20); //vector constructor
                          //for Aclass to initialize 20
                          elements.
```

Elements are added to a vector using the member function `push_back`, as illustrated below:

```
v.push_back(42);
```

Once an element position has received its first element, either with `push_back` or with a constructor initialization, that element position can then be accessed using square bracket notation, just like an array element.

■ PROGRAMMING TIP Vector Assignment Is Well Behaved

The assignment operator with vectors does an element-by-element assignment to the vector on the left-hand side of the assignment operator (increasing capacity if needed and resetting the size of the vector on the left-hand side of the assignment operator). Thus, provided the assignment operator on the base type makes an independent copy of the element of the base type, then the assignment operator on the vector will make an independent copy.

Note that for the assignment operator to produce a totally independent copy of the vector on the right-hand side of the assignment operator requires that the assignment operator on the base type make completely independent copies. The assignment operator on a vector is only as good (or bad) as the assignment operator on its base type. (Details on overloading the assignment operator for classes that need it are given in Chapter 11.) ■

Efficiency Issues

At any point in time a vector has a **capacity**, which is the number of elements for which it currently has memory allocated. The member function `capacity()` can be used to find out the capacity of a vector. Do not confuse the capacity of a vector with the *size* of a vector. The *size* is the number of elements in a vector, while the *capacity* is the number of elements for which there is memory allocated. Typically, the capacity is larger than the *size*, and the capacity is always greater than or equal to the *size*.

Whenever a vector runs out of capacity and needs room for an additional member, the capacity is automatically increased. The exact amount of the increase is implementation-dependent but always allows for more capacity than is immediately needed. A commonly used implementation scheme is for the capacity to double whenever it needs to increase. Since increasing capacity is a complex task, this approach of reallocating capacity in large chunks is more efficient than allocating numerous small chunks.

Size and Capacity

The **size** of a vector is the number of elements in the vector. The **capacity** of a vector is the number of elements for which it currently has memory allocated. For a vector `v`, the size and capacity can be recovered with the member functions `v.size()` and `v.capacity()`.

You can completely ignore the capacity of a vector and that will have no effect on what your program does. However, if efficiency is an issue, you might want to manage capacity yourself and not simply accept the default behavior of doubling capacity whenever more is needed. You can use the member function `reserve` to explicitly increase the capacity of a vector. For example,

```
v.reserve(32);
```

sets the capacity to at least 32 elements, and

```
v.reserve(v.size( ) + 10);
```

sets the capacity to at least 10 more than the number of elements currently in the vector. Note that you can rely on `v.reserve` to increase the capacity of a vector, but it does not necessarily decrease the capacity of a vector if the argument is smaller than the current capacity.

You can change the size of a vector using the member function `resize`. For example, the following resizes a vector to 24 elements:

```
v.resize(24);
```

If the previous size was less than 24, then the new elements are initialized as we described for the constructor with an integer argument. If the previous size was greater than 24, then all but the first 24 elements are lost. The capacity is automatically increased if need be. Using `resize` and `reserve`, you can shrink the size and capacity of a vector when there is no longer any need for some elements or some capacity.

SELF-TEST EXERCISES

19. Is the following program legal? If so, what is the output?

```
#include <iostream>
#include <vector>
using namespace std;

int main( )
{
    vector<int> v(10);
    int i;

    for (i = 0; i < v.size( ); i++)
        v[i] = i;

    vector<int> copy;
    copy = v;
    v[0] = 42;

    for (i = 0; i < copy.size( ); i++)
        cout << copy[i] << " ";
    cout << endl;

    return 0;
}
```

20. What is the difference between the size and the capacity of a vector?

CHAPTER SUMMARY

- A C-string variable is the same thing as an array of characters, but it is used in a slightly different way. A string variable uses the null character '\0' to mark the end of the string stored in the array.
- C-string variables usually must be treated like arrays, rather than simple variables of the kind we used for numbers and single characters. In particular, you cannot assign a C-string value to a C-string variable using the equal sign, =, and you cannot compare the values in two C-string variables using the == operator. Instead, you must use special C-string functions to perform these tasks.
- The ANSI/ISO standard <string> library provides a fully featured class called `string` that can be used to represent strings of characters.
- Objects of the class `string` are better behaved than C strings. In particular, the assignment and equal operators, = and ==, have their intuitive meaning when used with objects of the class `string`.
- Vectors can be thought of as arrays that can grow (and shrink) in length while your program is running.

Answers to Self-Test Exercises

1. The following two are equivalent to each other (but not equivalent to any others):

```
char string_var[10] = "Hello";  
char string_var[10] = {'H', 'e', 'l', 'l', 'o', '\0'};
```

The following two are equivalent to each other (but not equivalent to any others):

```
char string_var[6] = "Hello";  
char string_var[] = "Hello";
```

The following is not equivalent to any of the others:

```
char string_var[10] = {'H', 'e', 'l', 'l', 'o'};
```

2. "DoBeDo to you"
3. The declaration means that `string_var` has room for only six characters (including the null character '\0'). The function `strcat` does not check that there is room to add more characters to `string_var`, so `strcat` will write all the characters in the string "and Good-bye." into memory, even though that requires more memory than has been assigned to `string_var`. This means memory that should not be changed will be changed. The net effect is unpredictable, but bad.

4. If `strlen` were not already defined for you, you could use the following definition:

```
int strlen(const char str[])
//Precondition: str contains a string value terminated
//with '\0'.
//Returns the number of characters in the string str (not
//counting '\0').
{
    int index = 0;
    while (str[index] != '\0')
        index++;
    return index;
}
```

5. The maximum number of characters is five because the sixth position is needed for the null terminator ('\0').
6. a. 1
b. 1
c. 5 (including the '\0')
d. 2 (including the '\0')
e. 6 (including the '\0')

7. These are *not equivalent*. The first of these places the null character '\0' in the array after the characters 'a', 'b', and 'c'. The second only assigns the successive positions 'a', 'b', and 'c' but *does not put a '\0' anywhere*.

```
8. int index = 0;
while ( our_string[index] != '\0' )
{
    our_string[index] = 'X';
    index++;
}
```

9. a. If the C-string variable does not have a null terminator, '\0', the loop can run beyond memory allocated for the C string, destroying the contents of memory there. To protect memory beyond the end of the array, change the *while* condition as shown in (b).

b. `while (our_string[index] != '\0' && index < SIZE)`

```
10. #include <cstring>
//needed to get the declaration of strcpy
...
strcpy(a_string, "Hello");
```

11. I did it my way!

12. The string "good, I hope." is too long for `a_string`. A chunk of memory that doesn't belong to the array `a_string` will be overwritten.

13. Enter some input:

```
The
    time is now.
The-timeEND OF OUTPUT
```

14. The complete dialogue is as follows:

```
Enter a line of input:
May the hair on your toes grow long and curly.
May t<END OF OUTPUT
```

15. A*string<END OF OUTPUT

16. A string is a joy forever!<END OF OUTPUT

17. The complete dialogue is

```
Enter a line of input:
Hello friend!
Equal
```

Remember, `cin` stops reading when it reaches a whitespace character such as a blank.

18. Hello Jello

19. The program is legal. The output is

```
0 1 2 3 4 5 6 7 8 9
```

Note that changing `v` does not change `copy`. A true independent copy is made with the assignment

```
copy = v;
```

20. The `size` is the number of elements in a vector, whereas the `capacity` is the number of elements for which there is memory allocated. Typically, the `capacity` is larger than the `size`.

PRACTICE PROGRAMS

Practice Programs can generally be solved with a short program that directly applies the programming principles presented in this chapter.

1. Create a `Cstring` variable that contains a name, age, and title. Each field is separated by a space. For example, the string might contain "Bob 45 Programmer" or any other name/age/title in the same format. Assume the name, age, and title have no spaces themselves. Write a program using only functions from `cstring` (not the class `string`) that can extract the name, age, and title into separate variables. Test your program with a variety of names, ages, and titles.

2. Repeat Practice Program 1 except use the class `string` to extract the fields, not the `cstring` functions.
3. Write a program that inputs a first and last name, separated by a space, into a `string` variable. Use the `string` functions to output the first and last initial. Embed your code into a *do-while* loop. At the end of the loop ask the user if he or she would like to repeat the program. Input the user's choice into a `char` using `cin`. If the character is 'y' then repeat the program, otherwise exit. Beware of the pitfall with newlines when `cin` is mixed with `getline`.
4. Write a function named `firstLast2` that takes as input a vector of integers. The function should return *true* if the vector starts or ends with the digit 2. Otherwise it should return *false*. Test your function with vectors of different length and with the digit 2 at the beginning of the vector, end of the vector, middle of the vector, and missing from the vector.
5. Write a function named `swapFrontBack` that takes as input a vector of integers. The function should swap the first element in the vector with the last element in the vector. The function should check if the vector is empty to prevent errors. Test your function with vectors of different length and with varying front and back numbers.
6. Do Practice Program 7.4 except change the program to use vectors of strings instead of arrays of strings.
7. Write a program that inputs two string variables, `first` and `last`, each of which the user should enter with his or her name. First, convert both strings to all lowercase. Your program should then create a new string that contains the full name in Pig Latin with the first letter capitalized for the first and last name. The rules to convert a word into Pig Latin are as follows:

If the first letter is a consonant, move it to the end and add "ay" to the end.

If the first letter is a vowel, add "way" to the end.

For example, if the user inputs "Erin" for the first name and "Jones" for the last name, then the program should create a new string with the text "Erinway Onesjay" and print it.

PROGRAMMING PROJECTS

Programming Projects require more problem-solving than Practice Programs and can usually be solved many different ways. Visit www.myprogramminglab.com to complete many of these Programming Projects online and get instant feedback.

1. Write a program that reads in a sentence of up to 100 characters and outputs the sentence with spacing corrected and with letters corrected for



capitalization. In other words, in the output sentence, all strings of two or more blanks should be compressed to a single blank. The sentence should start with an uppercase letter but should contain no other uppercase letters. Do not worry about proper names; if their first letters are changed to lowercase, that is acceptable. Treat a line break as if it were a blank, in the sense that a line break and any number of blanks are compressed to a single blank. Assume that the sentence ends with a period and contains no other periods. For example, the input

```
the   Answer to life, the Universe, and  everything
IS 42.
```

should produce the following output:

```
The answer to life, the universe, and everything is 42.
```

- Write a program that will read in a line of text and output the number of words in the line and the number of occurrences of each letter. Define a word to be any string of letters that is delimited at each end by either whitespace, a period, a comma, or the beginning or end of the line. You can assume that the input consists entirely of letters, whitespace, commas, and periods. When outputting the number of letters that occur in a line, be sure to count upper- and lowercase versions of a letter as the same letter. Output the letters in alphabetical order and list only those letters that do occur in the input line. For example, the input line

```
I say Hi.
```

should produce output similar to the following:

```
3 words
1 a
1 h
2 i
1 s
1 y
```

- Give the function definition for the function with the following function declaration. Embed your definition in a suitable test program.

```
void get_double(double& input_number);
//Postcondition: input_number is given a value
//that the user approves of.
```

You can assume that the user types in the input in normal everyday notation, such as 23.789, and does not use e-notation to type in the number. Model your definition after the definition of the function `get_int` given in Display 8.3 so that your function reads the input as characters, edits the string of characters, and converts the resulting string to a number of type `double`. You will need to define a function like

`read_and_clean` that is more sophisticated than the one in Display 8.2, since it must cope with the decimal point. This is a fairly easy project. For a more difficult project, allow the user to enter the number in either the normal everyday notation, as discussed above, or in e-notation. Your function should decide whether or not the input is in e-notation by reading the input, *not* by asking the user whether she or he will use e-notation.

4. Write a program that reads a person's name in the following format: first name, then middle name or initial, and then last name. The program then outputs the name in the following format:

`Last_Name, First_Name Middle_Initial.`

For example, the input

`Mary Average User`

should produce the output:

`User, Mary A.`

The input

`Mary A. User`

should also produce the output:

`User, Mary A.`

Your program should work the same and place a period after the middle initial even if the input did not contain a period. Your program should allow for users who give no middle name or middle initial. In that case, the output, of course, contains no middle name or initial. For example, the input

`Mary User`

should produce the output

`User, Mary`

If you are using C strings, assume that each name is at most 20 characters long. Alternatively, use the class `string`.

(*Hint:* You may want to use three string variables rather than one large string variable for the input. You may find it easier to *not* use `getline`.)

5. Write a program that reads in a line of text and replaces all four-letter words with the word "love". For example, the input string

`I hate you, you dodo!`

should produce the output

```
I love you, you love!
```

Of course, the output will not always make sense. For example, the input string

```
John will run home.
```

should produce the output

```
Love love run love.
```

If the four-letter word starts with a capital letter, it should be replaced by "Love", not by "love". You need not check capitalization, except for the first letter of a word. A word is any string consisting of the letters of the alphabet and delimited at each end by a blank, the end of the line, or any other character that is not a letter. Your program should repeat this action until the user says to quit.

6. Write a program that reads in a line of text and outputs the line with all the digits in all integer numbers replaced with 'x'. For example,

Input:

```
My userID is john17 and my 4 digit pin is 1234 which is secret.
```

Output:

```
My userID is john17 and my x digit pin is xxxx which is secret.
```

Note that if a digit is part of a word, then the digit is not changed to an 'x'. For example, note that john17 is NOT changed to johnxx. Include a loop that allows the user to repeat this calculation again until the user says she or he wants to end the program.

7. Write a program that can be used to train the user to use less sexist language by suggesting alternative versions of sentences given by the user. The program will ask for a sentence, read the sentence into a string variable, and replace all occurrences of masculine pronouns with gender-neutral pronouns. For example, it will replace "he" with "she or he". Thus, the input sentence

```
See an adviser, talk to him, and listen to him.
```

should produce the following suggested changed version of the sentence:

```
See an adviser, talk to her or him, and listen to her or him.
```

Be sure to preserve uppercase letters for the first word of the sentence. The pronoun "his" can be replaced by "her (s)"; your program need

not decide between "her" and "hers". Allow the user to repeat this for more sentences until the user says she or he is done.

This will be a long program that requires a good deal of patience. Your program should not replace the string "he" when it occurs inside another word, such as "here". A word is any string consisting of the letters of the alphabet and delimited at each end by a blank, the end of the line, or any other character that is not a letter. Allow your sentences to be up to 100 characters long.

8. Write a sorting function that is similar to Display 7.12 in Chapter 7 except that it has an argument for a vector of *ints* rather than an array. This function will not need a parameter like `number_used` as in Display 7.12, since a vector can determine the number used with the member function `size()`. This sort function will have only this one parameter, which will be of a vector type. Use the selection sort algorithm (which was used in Display 7.12).
9. Redo Programming Project 6 from Chapter 7, but this time use vectors instead of arrays. (It may help to do the previous Programming Project first.)
10. Redo Programming Project 5 from Chapter 7, but this time use vectors instead of arrays. You should do either Programming Project 8 or 9 before doing this one. However, you will need to write your own (similar) sorting code for this project rather than using the sorting function from Programming Project 7 or 8 with no changes.
11. Your country is at war and your enemies are using a secret code to communicate with each other. You have managed to intercept a message that reads as follows:

```
:mmZ\dxZmx]Zpgy
```

The message is obviously encrypted using the enemy's secret code. You have just learned that their encryption method is based upon the ASCII code. Appendix 3 shows the ASCII character set. Individual characters in a string are encoded using this system. For example, the letter "A" is encoded using the number 65 and "B" is encoded using the number 66.

Your enemy's secret code takes each letter of the message and encrypts it as follows:

```
If (OriginalChar + Key > 126) then
    EncryptedChar = 32 + ((OriginalChar + Key) - 127)
Else
    EncryptedChar = (OriginalChar + Key)
```

For example, if the enemy uses `Key = 10` then the message "Hey" would be encrypted as:

Character	ASCII code
H	72
e	101
y	121

Encrypted H = $(72 + 10) = 82 = R$ in ASCII

Encrypted e = $(101 + 10) = 111 = o$ in ASCII

Encrypted y = $32 + ((121 + 10) - 127) = 36 = \$$ in ASCII

Consequently, "Hey" would be transmitted as "Ro\$."

Write a program that decrypts the intercepted message. The ASCII codes for the unencrypted message are limited to the visible ASCII characters. You only know that the key used is a number between 1 and 100. Your program should try to decode the message using all possible keys between 1 and 100. When you try the valid key, the message will make sense. For all other keys, the message will appear as gibberish.

- Write a program that inputs a time from the console. The time should be in the format "HH:MM AM" or "HH:MM PM". Hours may be one or two digits, for example, "1:10 AM" or "11:30 PM". Your program should include a function that takes a string parameter containing the time. This function should convert the time into a four-digit military time based on a 24-hour clock. For example, "1:10 AM" would output "0110 hours", "11:30 PM" would output "2330 hours", and "12:15 AM" would output "0015 hours". The function may either write the time to the console or return a string to be written to the console by the main function.
- The XML (eXtensible Markup Language) is a common format used to structure and store data on the Web. The following is a small sample XML file that could be used to store names in an address book. Type it in using a text editor and save it to a file named `address.xml` (or find it at the accompanying website).

```
<?xml version="1.0"?>
<address_book>
  <contact>
    <name>George Clooney</name>
    <street>1042 El Camino Real</street>
    <city>Beverly Hills</city>
    <state>CA</state>
    <zip>90214</zip>
  </contact>
  <contact>
    <name>Cathy Pearl</name>
    <street>405 A St.</street>
```

```

        <city>Palmdale</city>
        <state>CA</state>
        <zip>93352</zip>
    </contact>
    <contact>
        <name>Paris Hilton</name>
        <street>200 S. Elm St.</street>
        <city>Beverly Hills</city>
        <state>CA</state>
        <zip>90212</zip>
    </contact>
    <contact>
        <name>Wendy Jones</name>
        <street>982 Boundary Ave.</street>
        <city>Palmdale</city>
        <state>CA</state>
        <zip>93354</zip>
    </contact>
</address_book>

```

The sample file contains four contacts. The `<>` tag denotes the start of a field and the `</>` tag denotes the end of the field.

- a. You are hosting a party in Palmdale, CA. Write a program that reads in the `address.xml` file and outputs the names and addresses of everyone in Palmdale. Your program shouldn't output any of the tag information, just the address content.
- b. You would like to send an advertising flyer to everyone in zip codes 90210 through 90214. Write a program that reads in the `address.xml` file and outputs the names and addresses of everyone whose zip code falls within the specified range.

You may assume that each contact in the address file has the same structure and the same fields. However, your solution should be able to handle an input file with any number of contacts and should not assume that the fields within each contact are in the same order.

14. Given the following header:

```
vector<string> split(string target, string delimiter);
```

implement the function `split` so that it returns a vector of the strings in `target` that are separated by the string `delimiter`. For example:

```
split("10,20,30", ",")
```

should return a vector with the strings "10", "20", and "30". Similarly,

```
split("do re mi fa so la ti do", " ")
```



should return a vector with the strings "do", "re", "mi", "fa", "so", "la", "ti", and "do".

15. Write a function that determines if two strings are anagrams. The function should not be case sensitive and should disregard any punctuation or spaces. Two strings are anagrams if the letters can be rearranged to form each other. For example, "Eleven plus two" is an anagram of "Twelve plus one." Each string contains one "v", three "e's", two "l's", etc. Test your function with several strings that are anagrams and non-anagrams. You may use either the `string` class or a C-style string.
16. In many races competitors wear an RFID tag on their shoe or bib. When the racer crosses a sensor a computer logs the racer's number along with the current time. Sensors can be placed along the course to accurately calculate the racer's finish time or pace and also to verify that the racer crossed key checkpoints. Consider such a system in use for a half marathon running race, which is 13.1 miles. In this problem there are only three sensors: at the start, at the 7 mile point, and at the finish line.

Here is sample data for three racers. The first line is the gun time in the 24 hour time format (HH MM SS). The gun time is when the race begins. Subsequent lines are recorded by sensors and contain the sensor ID (0=start, 1=midpoint, 2=finish) followed by the racer's number followed by the time stamp. The start time may be different than the gun time because sometimes it takes a racer a little while to get to the starting line when there is a large pack.

```
08 00 00
0,100,08 00 00
0,132,08 00 03
0,182,08 00 15
1,100,08 50 46
1,182,08 51 15
1,132,08 51 18
2,132,09 34 16
2,100,09 35 10
2,182,09 45 15
```

Create a text file with a sample race log. Write a program that reads the log data into array(s) or vector(s). The program should then allow a user to enter a racer's number and it should output the racer's overall finish place, race split times in minutes/mile for each split (i.e. the time between sensors), and the overall race time and overall race pace.

For a more challenging version modify your program so that it works with an arbitrary number of sensors placed at different locations along the course instead of just 3 locations. You will need to specify the mile marker for each sensor.

17. Based on the log file described in Programming Project 16 write a program to detect cheating. This could occur if:
- A racer misses a sensor, which is a sign that the racer may have taken a shortcut.
 - A race split is suspiciously fast, which is a sign that the racer may have hopped in a vehicle. In this case, a race split faster than 4:30 per mile can be considered suspicious.

The output should be a list of suspected cheaters along with the reason for suspicion.



Pointers and Dynamic Arrays **9**

9.1 POINTERS 508

Pointer Variables 509

Basic Memory Management 516

Pitfall: Dangling Pointers 517

Static Variables and Automatic Variables 518

Programming Tip: Define Pointer Types 518

9.2 DYNAMIC ARRAYS 521

Array Variables and Pointer Variables 521

Creating and Using Dynamic Arrays 522

Pointer Arithmetic (*Optional*) 528

Multidimensional Dynamic Arrays (*Optional*) 530

Chapter Summary 532

Answers to Self-Test Exercises 532

Practice Programs 533

Programming Projects 534



Memory is necessary for all the operations of reason.

BLAISE PASCAL, *Pensées*

INTRODUCTION

A *pointer* is a construct that gives you more control of the computer's memory. This chapter shows how pointers are used with arrays and introduces a new form of array called a *dynamic array*. Dynamic arrays are arrays whose size is determined while the program is running, rather than being fixed when the program is written.

PREREQUISITES

Section 9.1, which covers the basics of pointers, uses material from Chapters 2 through 6. It does not require any of the material from Chapters 7 or 8. Section 9.2, which covers dynamic arrays, uses material from Section 9.1, and Chapters 2 through 7. It does not require any of the material from Chapter 8.

9.1 POINTERS

Do not mistake the pointing finger for the moon.

ZEN SAYING

A **pointer** is the memory address of a variable. Recall that the computer's memory is divided into numbered memory locations (called bytes) and that variables are implemented as a sequence of adjacent memory locations. Recall also that sometimes the C++ system uses these memory addresses as names for the variables. If a variable is implemented as, say, three memory locations, then the address of the first of these memory locations is sometimes used as a name for that variable. For example, when the variable is used as a call-by-reference argument, it is this address, not the identifier name of the variable, that is passed to the calling function.

An address that is used to name a variable in this way (by giving the address in memory where the variable starts) is called a *pointer* because the address can be thought of as "pointing" to the variable. The address "points" to the variable because it identifies the variable by telling *where* the variable is, rather than telling what the variable's name is. A variable that is, say, at location number 1007 can be pointed out by saying "it's the variable over there at location 1007."

You have already been using pointers in a number of situations. As we noted in the previous paragraph, when a variable is a call-by-reference argument in a function call, the function is given this argument variable in the form of a pointer to the variable. This is an important and powerful use for pointers, but it is done automatically for you by the C++ system. In this chapter, we show you how to write programs that manipulate pointers in any way you want, rather than relying on the system to manipulate the pointers for you.

Pointer Variables

A pointer can be stored in a variable. However, even though a pointer is a memory address and a memory address is a number, you cannot store a pointer in a variable of type *int* or *double* without type casting. A variable to hold a pointer must be declared to have a pointer type. For example, the following declares *p* to be a pointer variable that can hold one pointer that points to a variable of type *double*:

```
double *p;
```

The variable *p* can hold pointers to variables of type *double*, but it cannot normally contain a pointer to a variable of some other type, such as *int* or *char*. Each variable type requires a different pointer type.

In general, to declare a variable that can hold pointers to other variables of a specific type, you declare the pointer variable just as you would declare an ordinary variable of that type, but you place an asterisk in front of the variable name. For example, the following declares the variables *p1* and *p2* so that they can hold pointers to variables of type *int*; it also declares two ordinary variables, *v1* and *v2*, of type *int*:

```
int *p1, *p2, v1, v2;
```

There must be an asterisk before *each* of the pointer variables. If you omit the second asterisk in the previous declaration, then *p2* will not be a pointer variable; it will instead be an ordinary variable of type *int*. The asterisk is the same symbol you have been using for multiplication, but in this context it has a totally different meaning.

When discussing pointers and pointer variables, we usually speak of *pointing* rather than of *addresses*. When a pointer variable, such as *p1*, contains the address of a variable, such as *v1*, the pointer variable is said to *point to the variable* *v1* or to be *a pointer to the variable* *v1*.

Pointer variables, like *p1* and *p2* declared earlier, can contain pointers to variables like *v1* and *v2*. You can use the operator *&* to determine the address of a variable, and you can then assign that address to a pointer variable. For example, the following will set the variable *p1* equal to a pointer that points to the variable *v1*:

```
p1 = &v1;
```

Declaring pointer variables

Pointer Variable Declarations

A variable that can hold pointers to other variables of type *Type_Name* is declared similarly to the way you declare a variable of type *Type_Name*, except that you place an asterisk at the beginning of the variable name.

SYNTAX

```
Type_Name *Variable_Name1, *Variable_Name2, . . . ;
```

EXAMPLE

```
double *pointer1, *pointer2;
```

Addresses and Numbers

A pointer is an address, and an address is an integer, but a pointer is not an integer. That is not crazy. That is abstraction! C++ insists that you use a pointer as an address and that you not use it as a number. A pointer is not a value of type *int* or of any other numeric type. You normally cannot store a pointer in a variable of type *int*. If you try, most C++ compilers will give you an error message or a warning message. Also, you cannot perform the normal arithmetic operations on pointers. (You can perform a kind of addition and a kind of subtraction on pointers, but they are not the usual integer addition and subtraction.)

You now have two ways to refer to *v1*: You can call it *v1* or you can call it “the variable pointed to by *p1*.” In C++, the way that you say “the variable pointed to by *p1*” is **p1*. This is the same asterisk that we used when we declared *p1*, but now it has yet another meaning. When the asterisk is used in this way, it is often called the **dereferencing operator**, and the pointer variable is said to be **dereferenced**.

Putting these pieces together can produce some surprising results. Consider the following code:

```
v1 = 0;  
p1 = &v1;  
*p1 = 42;  
cout << v1 << endl;  
cout << *p1 << endl;
```

This code outputs the following to the screen:

```
42  
42
```

As long as `p1` contains a pointer that points to `v1`, then `v1` and `*p1` refer to the same variable. So when you set `*p1` equal to 42, you are also setting `v1` equal to 42.

The symbol `&` that is used to obtain the address of a variable is the same symbol that you use in function declarations to specify a call-by-reference parameter. This use is not a coincidence. Recall that a call-by-reference argument is implemented by giving the address of the argument to the calling function. So, these two uses of the symbol `&` are very much the same. However, the usages are slightly different and we will consider them to be two different (although very closely related) usages of the symbol `&`.

The * and & Operators

The `*` operator in front of a pointer variable produces the variable it points to. When used this way, the `*` operator is called the **dereferencing operator**.

The operator `&` in front of an ordinary variable produces the address of that variable; that is, produces a pointer that points to the variable. The `&` operator is called the **address-of operator**.

For example, consider the declarations

```
double *p, v;
```

The following sets the value of `p` so that `p` points to the variable `v`:

```
p = &v;
```

`*p` produces the variable pointed to by `p`, so after the assignment above, `*p` and `v` refer to the same variable. For example, the following sets the value of `v` to 9.99, even though the name `v` is never explicitly used:

```
*p = 9.99;
```

You can assign the value of one pointer variable to another pointer variable. This copies an address from one pointer variable to another pointer variable. For example, if `p1` is still pointing to `v1`, then the following will set `p2` so that it also points to `v1`:

```
p2 = p1;
```

Provided we have not changed `v1`'s value, the following also outputs a 42 to the screen:

```
cout << *p2;
```

Pointers in
assignment
statements

Be sure that you do not confuse

```
p1 = p2;
```

and

```
*p1 = *p2;
```

When you add the asterisk, you are not dealing with the pointers `p1` and `p2`, but with the variables that the pointers are pointing to. This is illustrated in Display 9.1.

Since a pointer can be used to refer to a variable, your program can manipulate variables even if the variables have no identifiers to name them. The operator `new` can be used to create variables that have no identifiers to serve as their names. These nameless variables are referred to via pointers. For example, the following creates a new variable of type `int` and sets the pointer variable `p1` equal to the address of this new variable (that is, `p1` points to this new, nameless variable):

```
p1 = new int;
```

This new, nameless variable can be referred to as `*p1` (that is, as the variable pointed to by `p1`). You can do anything with this nameless variable that you can do with any other variable of type `int`. For example, the following reads a value of type `int` from the keyboard into this nameless variable, adds 7 to the value, then outputs this new value:

```
cin >> *p1;
*p1 = *p1 + 7;
cout << *p1;
```

DISPLAY 9.1 Uses of the Assignment Operator

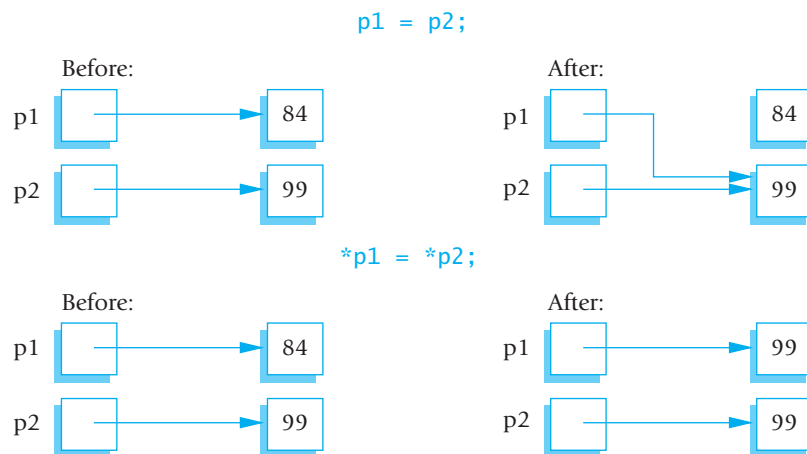

The *new* operator produces a new, nameless variable and returns a pointer that points to this new variable. You specify the type for this new variable by writing the type name after the *new* operator. Variables that are created using the *new* operator are called **dynamic variables** because they are created and destroyed while the program is running. The program in Display 9.2 demonstrates some simple operations on pointers and dynamic variables. Display 9.3 illustrates the working of the program in Display 9.2. In Display 9.3, variables are represented as boxes and the value of the variable is written inside the box. We have not shown the actual numeric addresses in the pointer variables. The actual numbers are not important. What is important is that the number is the address of some particular variable. So, rather than use the actual number of the address, we have merely indicated the address with an arrow that points to the variable with that address. For example, in illustration (b) in Display 9.3, p1 contains the address of a variable that has a question mark written in it.

DISPLAY 9.2 Basic Pointer Manipulations (part 1 of 2)

```

1 //Program to demonstrate pointers and dynamic variables.
2 #include <iostream>
3 using namespace std;
4
5 int main( )
6 {
7     int *p1, *p2;
8
9     p1 = new int;
10    *p1 = 42;
11    p2 = p1;
12    cout<< "*p1 == " << *p1 << endl;
13    cout<< "*p2 == " << *p2 << endl;
14
15    *p2 = 53;
16    cout<< "**p1 == " << *p1 << endl;
17    cout<< "**p2 == " << *p2 << endl;
18
19    p1 = new int;
20    *p1 = 88;
21    cout<< "*p1 == " << *p1 << endl;
22    cout<< "*p2 == " << *p2 << endl;
23    cout<< "Hope you got the point of this example!\n";
24    return 0;
25 }
```

(continued)

DISPLAY 9.2 Basic Pointer Manipulations (*part 2 of 2*)**Sample Dialogue**

```
*p1 == 42
*p2 == 42
*p1 == 53
*p2 == 53
*p1 == 88
*p2 == 53
Hope you got the point of this example!
```

Pointer Variables Used with =

If `p1` and `p2` are pointer variables, then the statement

```
p1 = p2;
```

changes `p1` so that it points to the same thing that `p2` is currently pointing to.

The `new` Operator

The `new` operator creates a new dynamic variable of a specified type and returns a pointer that points to this new variable. For example, the following creates a new dynamic variable of type `MyType` and leaves the pointer variable `p` pointing to this new variable:

```
MyType *p;
p = new MyType;
```

The C++ standard specifies that if there is not sufficient memory available to create the new variable, then the `new` operator, by default, terminates the program.¹

¹ Technically, the `new` operator throws an exception, which, if not caught, terminates the program. It is possible to “catch” the exception or install a new handler, but these topics are not covered until Chapter 16.

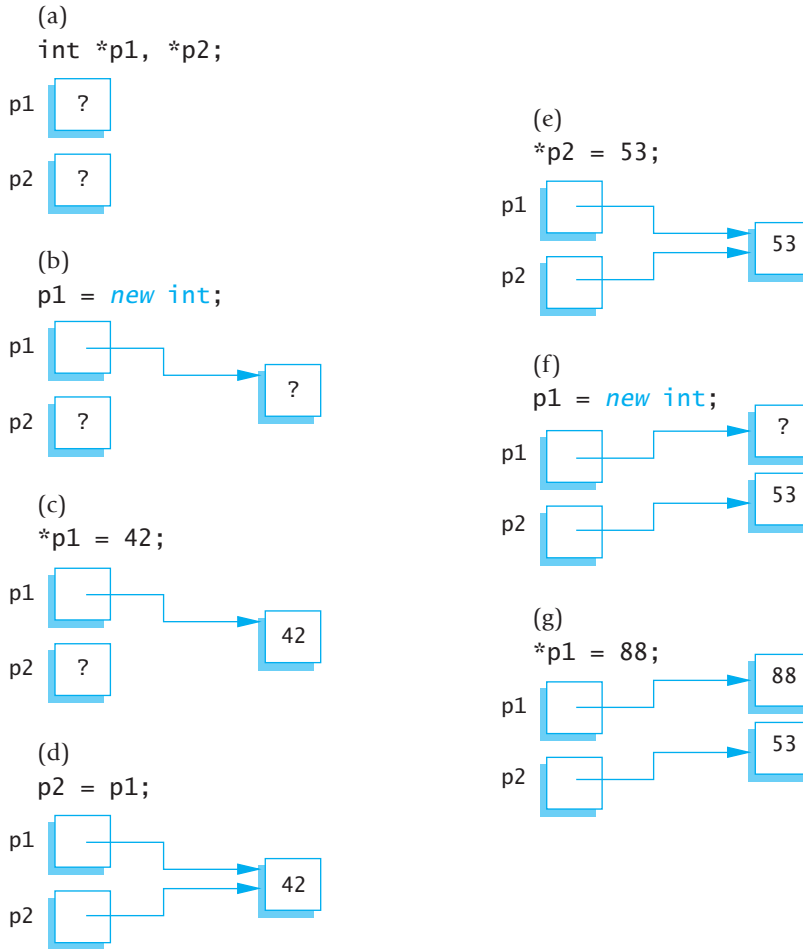
DISPLAY 9.3 Explanation of Display 9.2**SELF-TEST EXERCISES**

1. Explain the concept of a pointer in C++.
2. What unfortunate misinterpretation can occur with the following declaration?
`int* int_ptr1, int_ptr2;`
3. Give at least two uses of the `*` operator. State what the `*` is doing, and name the use of the `*` that you present.

4. What is the output produced by the following code?

```
int *p1, *p2;
p1 = new int;
p2 = new int;
*p1 = 10;
*p2 = 20;
cout << *p1 << " " << *p2 << endl;
p1 = p2;
cout << *p1 << " " << *p2 << endl;
*p1 = 30;
cout << *p1 << " " << *p2 << endl;
```

How would the output change if you were to replace

```
*p1 = 30;
```

with the following?

```
*p2 = 30;
```

5. What is the output produced by the following code?

```
int *p1, *p2;
p1 = new int;
p2 = new int;
*p1 = 10;
*p2 = 20;
cout << *p1 << " " << *p2 << endl;
*p1 = *p2; //This is different from Exercise 4
cout << *p1 << " " << *p2 << endl;
*p1 = 30;
cout << *p1 << " " << *p2 << endl;
```

Basic Memory Management

A special area of memory, called the **freestore**, is reserved for dynamic variables. Any new dynamic variable created by a program consumes some of the memory in the freestore.² If your program creates too many dynamic variables, it will consume all of the memory in the freestore. If this happens, any additional calls to *new* will fail.

The size of the freestore varies by computer and implementation of C++. It is typically large, and a modest program is not likely to use all the memory in the freestore. However, even on modest programs it is a good practice to recycle any freestore memory that is no longer needed. If your program no

² The freestore is also sometimes called the *heap*.

longer needs a dynamic variable, the memory used by that dynamic variable can be recycled. The *delete* operator eliminates a dynamic variable and returns the memory that the dynamic variable occupied to the freestore so that the memory can be reused. Suppose that *p* is a pointer variable that is pointing to a dynamic variable. The following will destroy the dynamic variable pointed to by *p* and return the memory used by the dynamic variable to the freestore:

```
delete p;
```

After this call to *delete*, the value of *p* is undefined and *p* should be treated like an uninitialized variable.

The *delete* Operator

The *delete* operator eliminates a dynamic variable and returns the memory that the dynamic variable occupied to the freestore. The memory can then be reused to create new dynamic variables. For example, the following eliminates the dynamic variable pointed to by the pointer variable *p*:

```
delete p;
```

After a call to *delete*, the value of the pointer variable, like *p* above, is undefined. (A slightly different version of *delete*, discussed later in this chapter, is used when the dynamic variable is an array.)

PITFALL Dangling Pointers

When you apply *delete* to a pointer variable, the dynamic variable it is pointing to is destroyed. At that point, the value of the pointer variable is undefined, which means that you do not know where it is pointing, nor what the value is where it is pointing. Moreover, if some other pointer variable was pointing to the dynamic variable that was destroyed, then this other pointer variable is also undefined. These undefined pointer variables are called **dangling pointers**. If *p* is a dangling pointer and your program applies the dereferencing operator *** to *p* (to produce the expression **p*), the result is unpredictable and usually disastrous. Before you apply the dereferencing operator *** to a pointer variable, you should be certain that the pointer variable points to some variable. ■

Static Variables and Automatic Variables

Variables created with the *new* operator are called **dynamic variables**, because they are created and destroyed while the program is running. When compared with these dynamic variables, ordinary variables seem static, but the terminology used by C++ programmers is a bit more involved than that, and ordinary variables are not called *static variables*.

The ordinary variables we have been using in previous chapters are not really static. If a variable is local to a function, then the variable is created by the C++ system when the function is called and is destroyed when the function call is completed. Since the main part of a program is really just a function called `main`, this is even true of the variables declared in the main part of your program. (Since the call to `main` does not end until the program ends, the variables declared in `main` are not destroyed until the program ends, but the mechanism for handling local variables is the same for `main` as it is for any other function.) The ordinary variables that we have been using (that is, the variables declared within `main` or within some other function definition) are called **automatic variables** (not to be confused with variables defined of type `auto`), because their dynamic properties are controlled automatically for you; they are automatically created when the function in which they are declared is called and automatically destroyed when the function call ends. We will usually call these variables **ordinary variables**, but other books call them *automatic variables*.

There is one other category of variables, namely, **global variables**. Global variables are variables that are declared outside of any function definition (including being outside of `main`). We discussed global variables briefly in Chapter 4. As it turns out, we have no need for global variables and have not used them.

■ PROGRAMMING TIP Define Pointer Types

You can define a pointer type name so that pointer variables can be declared like other variables without the need to place an asterisk in front of each pointer variable. For example, the following defines a type called `IntPtr`, which is the type for pointer variables that contain pointers to *int* variables:

```
typedef int* IntPtr;
```

Thus, the following two pointer variable declarations are equivalent:

```
IntPtr p;
```

and

```
int *p;
```

You can use *typedef* to define an alias for any type name or definition. For example, the following defines the type name *Kilometers* to mean the same thing as the type name *double*:

```
typedef double Kilometers;
```

Once you have given this type definition, you can define a variable of type *double* as follows:

```
Kilometers distance;
```

Renaming existing types this way can occasionally be useful. However, our main use of *typedef* will be to define types for pointer variables.

There are two advantages to using defined pointer type names, such as *IntPtr* defined earlier. First, it avoids the mistake of omitting an asterisk. Remember, if you intend *p1* and *p2* to be pointers, then the following is a mistake:

```
int *p1, p2;
```

Since the *** was omitted from the *p2*, the variable *p2* is just an ordinary *int* variable, not a pointer variable. If you get confused and place the *** on the *int*, the problem is the same but is more difficult to notice. C++ allows you to place the *** on the type name, such as *int**, so that the following is legal:

```
int* p1, p2;
```

Although this line is legal, it is misleading. It looks like both *p1* and *p2* are pointer variables, but in fact only *p1* is a pointer variable; *p2* is an ordinary *int* variable. As far as the C++ compiler is concerned, the *** that is attached to the identifier *int* may as well be attached to the identifier *p1*. One correct way to declare both *p1* and *p2* to be pointer variables is

```
int *p1, *p2;
```

An easier and less error-prone way to declare both *p1* and *p2* to be pointer variables is to use the defined type name *IntPtr* as follows:

```
IntPtr p1, p2;
```

The second advantage of using a defined pointer type, such as *IntPtr*, is seen when you define a function with a call-by-reference parameter for a pointer variable. Without the defined pointer type name, you would need to include both an *** and an *&* in the function declaration for the function, and the details can get confusing. If you use a type name for the pointer type, then a call-by-reference parameter for a pointer type involves no complications. You define a call-by-reference parameter for a defined pointer type just like you define any other call-by-reference parameter. Here's a sample:

```
void sample_function(IntPtr& pointer_variable);
```



Type Definitions

You can assign a name to a type definition and then use the type name to declare variables. This is done with the keyword *typedef*. These type definitions are normally placed outside of the body of the main part of your program (and outside the body of other functions). We will use type definitions to define names for pointer types, as shown in the example below.

SYNTAX

```
typedef Known_Type_Definition New_Type_Name;
```

EXAMPLE

```
typedef int* IntPtr;
```

The type name `IntPtr` can then be used to declare pointers to dynamic variables of type `int`, as in the following:

```
IntPtr pointer1, pointer2;
```

SELF-TEST EXERCISES

6. Suppose a dynamic variable were created as follows:

```
char *p;  
p = new char;
```

Assuming that the value of the pointer variable `p` has not changed (so it still points to the same dynamic variable), how can you destroy this new dynamic variable and return the memory it uses to the freestore so that the memory can be reused to create new dynamic variables?

7. Write a definition for a type called `NumberPtr` that will be the type for pointer variables that hold pointers to dynamic variables of type `int`. Also, write a declaration for a pointer variable called `my_point` that is of type `NumberPtr`.
8. Describe the action of the `new` operator. What does the operator `new` return?

9.2 DYNAMIC ARRAYS

In this section you will see that array variables are actually pointer variables. You will also find out how to write programs with dynamic arrays. A **dynamic array** is an array whose size is not specified when you write the program, but is determined while the program is running.

Array Variables and Pointer Variables

In Chapter 7 we described how arrays are kept in memory. At that point we had not learned about pointers, so we discussed arrays in terms of memory addresses. But, a memory address is a pointer. So, in C++ an array variable is actually a pointer variable that points to the first indexed variable of the array. Given the following two variable declarations, `p` and `a` are the same kind of variable:

```
int a[10];
typedef int* IntPtr;
IntPtr p;
```

The fact that `a` and `p` are the same kind of variable is illustrated in Display 9.4. Since `a` is a pointer that points to a variable of type `int` (namely the variable `a[0]`), the value of `a` can be assigned to the pointer variable `p` as follows:

```
p = a;
```

After this assignment, `p` points to the same memory location that `a` points to. So, `p[0]`, `p[1]`, ... `p[9]` refer to the indexed variables `a[0]`, `a[1]`, ... `a[9]`. The square bracket notation you have been using for arrays applies to pointer variables as long as the pointer variable points to an array in memory. After this assignment, you can treat the identifier `p` as if it were an array identifier. You can also treat the identifier `a` as if it were a pointer variable, but there is one important reservation. *You cannot change the pointer value in an array variable, such as `a`.* You might be tempted to think the following is legal, but it is not:

```
IntPtr p2;
...//p2 is given some pointer value.
a = p2;//ILLEGAL. You cannot assign a different address to a.
```

Display 9.5 illustrates the working of the program in Display 9.4. As in Display 9.3, variables are represented as boxes and the value of the variable is written inside the box. An arrow indicates a pointer or reference to another memory location, in this case, the first element of the array.

DISPLAY 9.4 Arrays and Pointer Variables

```
1 //Program to demonstrate that an array variable is a kind of pointer variable.
2 #include <iostream>
3 using namespace std;
4
5 typedef int* IntPtr;
6
7 int main( )
8 {
9     IntPtr p;
10    int a[10];
11    int index;
12
13    for (index = 0; index < 10; index++)
14        a[index] = index;
15
16    p = a;
17
18    for (index = 0; index < 10; index++)
19        cout << p[index] << " ";
20    cout << endl;
21
22    for (index = 0; index < 10; index++)
23        p[index] = p[index] + 1;
24
25    for (index = 0; index < 10; index++)
26        cout << a[index] << " ";
27    cout << endl;
28
29    return 0;
30 }
```

Note that changes to the array p are also changes to the array a.

Output

```
0 1 2 3 4 5 6 7 8 9
1 2 3 4 5 6 7 8 9 10
```

Creating and Using Dynamic Arrays

One problem with the kinds of arrays you have used thus far is that you must specify the size of the array when you write the program—but you may not know what size array you need until the program is run. For example, an array might hold a list of student identification numbers, but the size of the class may be different each time the program is run. With the kinds of arrays you have used thus far, you must estimate the largest possible size you may need

DISPLAY 9.5 Explanation of Display 9.4

(a)

```
IntPtr p;
int a[10];
```



(b)

```
for (index = 0; index < 10; index++)
    a[index] = index;
```

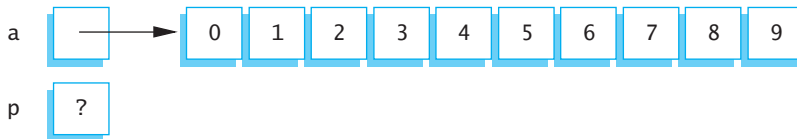

(c)

```
p = a;
```

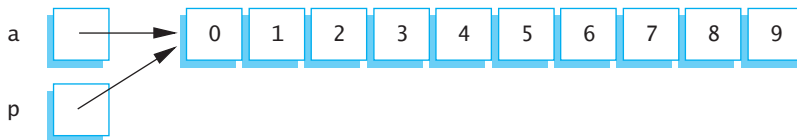

```
for (index=0; index < 10; index++)
    cout << p[index] << " ";
```

```
Output 0 1 2 3 4 5 6 7 8 9
```

Iterating through `p` is the same as iterating through `a`

(d)

```
for (index = 0; index < 10; index++)
    p[index] = p[index] + 1;
```

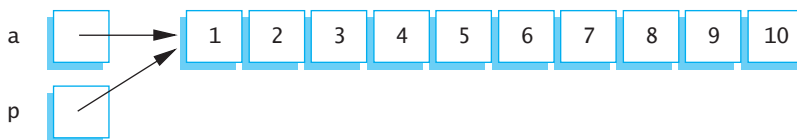

```
for (index=0; index < 10; index++)
    cout << a[index] << " ";
```

```
Output 1 2 3 4 5 6 7 8 9 10
```

Iterating through `a` is the same as iterating through `p`

Creating a dynamic array

for the array and hope that size is large enough. There are two problems with this. First, you may estimate too low, and then your program will not work in all situations. Second, since the array might have many unused positions, this can waste computer memory. Dynamic arrays avoid these problems. If your program uses a dynamic array for student identification numbers, then the size of the class can be entered as input to the program and the dynamic array can be created to be exactly that size.

Dynamic arrays are created using the *new* operator. The creation and use of dynamic arrays is surprisingly simple. Since array variables are pointer variables, you can use the *new* operator to create dynamic variables that are arrays and treat these dynamic array variables as if they were ordinary arrays. For example, the following creates a dynamic array variable with ten array elements of type *double*:

```
typedef double* DoublePtr;
DoublePtr p;
p = new double [10];
```

To obtain a dynamic array of elements of any other type, simply replace *double* with the desired type. To obtain a dynamic array variable of any other size, simply replace 10 with the desired size.

There are also a number of less obvious things to notice about this example. First, the pointer type that you use for a pointer to a dynamic array is the same as the pointer type you would use for a single element of the array. For instance, the pointer type for an array of elements of type *double* is the same as the pointer type you would use for a simple variable of type *double*. The pointer to the array is actually a pointer to the first indexed variable of the array. In the previous example, an entire array with ten indexed variables is created and the pointer *p* is left pointing to the first of these ten indexed variables.

Also notice that when you call *new*, the size of the dynamic array is given in square brackets after the type, which in this example is the type *double*. This tells the computer how much storage to reserve for the dynamic array. If you omit the square brackets and the 10, the computer will allocate enough storage for only one variable of type *double*, rather than for an array of ten indexed variables of type *double*. As illustrated in Display 9.6, you can use an *int* variable in place of the constant 10 so that the size of the dynamic array can be read into the program.

The program in Display 9.6 sorts a list of numbers. This program works for lists of any size because it uses a dynamic array to hold the numbers. The size of the array is determined when the program is run. The user is asked how many numbers there will be, and then the *new* operator creates a dynamic array of that size. The size of the dynamic array is given by the variable *array_size*.

Notice the *delete* statement, which destroys the dynamic array variable *a* in Display 9.6. Since the program is about to end anyway, we did not really need this *delete* statement; however, if the program went on to do other

DISPLAY 9.6 A Dynamic Array (part 1 of 2)

```

1 //Sorts a list of numbers entered at the keyboard.
2 #include <iostream>
3 #include <cstdlib>
4 #include <cstdlibdef>
5
6 typedef int* IntArrayPtr;
7
8 void fill_array(int a[], int size); ← Ordinary array
9 //Precondition: size is the size of the array a. parameters
10 //Postcondition: a[0] through a[size- 1] have been
11 //filled with values read from the keyboard.
12
13 void sort(int a[], int size); ←
14 //Precondition: size is the size of the array a.
15 //The array elements a[0] through a[size-1] have values.
16 //Postcondition: The values of a[0] through a[size-1] have been rearranged
17 //so that a[0] <= a[1] <= ... <= a[size-1].
18
19 int main( )
20 {
21     using namespace std;
22     cout << "This program sorts numbers from lowest to highest.\n";
23
24     int array_size;
25     cout << "How many numbers will be sorted? ";
26     cin >> array_size;
27
28     IntArrayPtr a;
29     a = new int[array_size];
30
31     fill_array(a, array_size);
32     sort(a, array_size);
33
34     cout << "In sorted order the numbers are:\n";
35     for (int index = 0; index < array_size; index++)
36         cout << a[index] << " ";
37     cout << endl;
38
39     delete [] a; ← The dynamic array a is
40                                     used like an ordinary array.
41     return 0;
42 }
43
44 //Uses the library iostream:
45 void fill_array(int a[], int size)
46 {

```

(continued)

DISPLAY 9.6 A Dynamic Array (part 2 of 2)

```
47     using namespace std;
48     cout << "Enter " << size << " integers.\n";
49     for (int index = 0; index < size; index++)
50         cin >> a[index];
51 }
52
53 void sort(int a[], int size)
```

<Any implementation of `sort` may be used. This may or may not require some additional function definitions. The implementation need not even know that `sort` will be called with a dynamic array. For example, you can use the implementation in Display 7.12 (with suitable adjustments to parameter names).>

things with dynamic variables, you would want such a `delete` statement so that the memory used by this dynamic array is returned to the freestore. The `delete` statement for a dynamic array is similar to the `delete` statement you saw earlier, except that with a dynamic array you must include an empty pair of square brackets, like so:

```
delete [] a;
```

The square brackets tell C++ that a dynamic array variable is being eliminated, so the system checks the size of the array and removes that many indexed variables. If you omit the square brackets, you would be telling the computer to eliminate only one variable of type `int`. For example,

```
delete a;
```

is not legal, but the error is not detected by most compilers. The ANSI C++ standard says that what happens when you do this is “undefined.” That means the author of the compiler can have this do anything that is convenient—convenient for the compiler writer, not for you. Even if it does something useful, you have no guarantee that either the next version of that compiler or any other compiler you compile this code with will do the same thing. The moral is simple: Always use the

```
delete [] array_ptr;
```

syntax when you are deleting memory that was allocated with something like

```
array_ptr = new MyType[37];
```

You create a dynamic array with a call to `new` using a pointer, such as the pointer `a` in Display 9.6. After the call to `new`, you should not assign any other pointer value to this pointer variable, because that can confuse the system when the memory for the dynamic array is returned to the freestore with a call to `delete`.

How to Use a Dynamic Array

- **Define a pointer type:** Define a type for pointers to variables of the same type as the elements of the array. For example, if the dynamic array is an array of *double*, you might use the following:

```
typedef double* DoubleArrayPtr;
```

- **Declare a pointer variable:** Declare a pointer variable of this defined type. The pointer variable will point to the dynamic array in memory and will serve as the name of the dynamic array.

```
DoubleArrayPtr a;
```

- **Call new:** Create a dynamic array using the *new* operator:

```
a = new double[array_size];
```

The size of the dynamic array is given in square brackets as in the example above. The size can be given using an *int* variable or other *int* expression. In the example above, *array_size* can be a variable of type *int* whose value is determined while the program is running.

- **Use like an ordinary array:** The pointer variable, such as *a*, is used just like an ordinary array. For example, the indexed variables are written in the usual way: *a[0]*, *a[1]*, and so forth. The pointer variable should not have any other pointer value assigned to it, but should be used like an array variable.
- **Call delete[]:** When your program is finished with the dynamic variable, use *delete* and empty square brackets along with the pointer variable to eliminate the dynamic array and return the storage that it occupies to the freestore for reuse. For example:

```
delete [] a;
```

Dynamic arrays are created using *new* and a pointer variable. When your program is finished using a dynamic array, you should return the array memory to the freestore with a call to *delete*. Other than that, a dynamic array can be used just like any other array.

SELF-TEST EXERCISES

9. Write a type definition for pointer variables that will be used to point to dynamic arrays. The array elements are to be of type *char*. Call the type *CharArray*.

10. Suppose your program contains code to create a dynamic array as follows:

```
int *entry;
entry = new int[10];
```

so that the pointer variable `entry` is pointing to this dynamic array. Write code to fill this array with ten numbers typed in at the keyboard.

11. Suppose your program contains code to create a dynamic array as in Self-Test Exercise 10, and suppose the pointer variable `entry` has not had its (pointer) value changed. Write code to destroy this new dynamic array and return the memory it uses to the freestore.
12. What is the output of the following code fragment? The code is assumed to be embedded in a correct and complete program.

```
int a[10];
int *p = a;
int i;
for (i = 0; i < 10; i++)
    a[i] = i;

for (i = 0; i < 10; i++)
    cout << p[i] << " ";
cout << endl;
```

13. What is the output of the following code fragment? The code is assumed to be embedded in a correct and complete program.

```
int array_size = 10;
int *a;
a = new int [array_size];
int *p = a;
int i;
for (i = 0; i < array_size; i++)
    a[i] = i;
p[0] = 10;

for (i = 0; i < array_size; i++)
    cout << a[i] << " ";
cout << endl;
```

Pointer Arithmetic (Optional)

There is a kind of arithmetic you can perform on pointers, but it is an arithmetic of addresses, not an arithmetic of numbers. For example, suppose your program contains the following code:

```
typedef double* DoublePtr;
DoublePtr d;
d = new double[10];
```

After these statements, `d` contains the address of the indexed variable `d[0]`. The expression `d + 1` evaluates to the address of `d[1]`, `d + 2` is the address of `d[2]`, and so forth. Notice that although the value of `d` is an address and an address is a number, `d+1` does not simply add 1 to the number in `d`. If a variable of type *double* requires 8 bytes (eight memory locations) and `d` contains the address 2001, then `d+1` evaluates to the memory address 2009. Of course, the type *double* can be replaced by any other type and then pointer addition moves in units of variables for that type.

This pointer arithmetic gives you an alternative way to manipulate arrays. For example, if `array_size` is the size of the dynamic array pointed to by `d`, then the following will output the contents of the dynamic array:

```
for (int i = 0; i < array_size; i++)
    cout << *(d + i) << " ";
```

This code is equivalent to the following:

```
for(int i = 0; i < array_size; i++)
    cout << d[i] << " ";
```

You may not perform multiplication or division of pointers. All you can do is add an integer to a pointer, subtract an integer from a pointer, or subtract two pointers of the same type. When you subtract two pointers, the result is the number of indexed variables between the two addresses. Remember, for subtraction of two pointer values, these values must point into the same array! It makes little sense to subtract a pointer that points into one array from another pointer that points into a different array. You can use the increment and decrement operators `++` and `--`. For example, `d++` will advance the value of `d` so that it contains the address of the next indexed variable, and `d--` will change `d` so that it contains the address of the previous indexed variable.



VideoNote
Dynamic Arrays and Pointer
Arithmetic

SELF-TEST EXERCISES

These exercises apply to the optional section on pointer arithmetic.

14. What is the output of the following code fragment? The code is assumed to be embedded in a correct and complete program.

```
int array_size = 10;
int *a;
a = new int[array_size];
int i;
for (i = 0; i < array_size; i++)
    *(a + i) = i;
for (i = 0; i < array_size; i++)
    cout << a[i] << " ";
cout << endl;
```

15. What is the output of the following code fragment? The code is assumed to be embedded in a correct and complete program.

```

int array_size = 10;
int *a;
a = new int[array_size];
int i;
for (i = 0; i < array_size; i++)
    a[i] = i;
while (*a < 9)
{
    a++;
    cout << *a << " ";
}
cout << endl;

```

Multidimensional Dynamic Arrays (Optional)

You can have multidimensional dynamic arrays. You just need to remember that multidimensional arrays are arrays of arrays, or arrays of arrays of arrays, or so forth. For example, to create a two-dimensional dynamic array, you must remember that it is an array of arrays. To create a two-dimensional array of integers, you first create a one-dimensional dynamic array of pointers of type *int**, which is the type for a one-dimensional array of *ints*. Then you create a dynamic array of *ints* for each indexed variable of the array of pointers.

A type definition may help to keep things straight. The following is the variable type for an ordinary one-dimensional dynamic array of *ints*:

```
typedef int* IntArrayPtr;
```

To obtain a 3-by-4 array of *ints*, you want an array whose base type is *IntArrayPtr*. For example:

```
IntArrayPtr *m = new IntArrayPtr[3];
```

This is an array of three pointers, each of which can name a dynamic array of *ints*, as follows:

```

for (int i = 0; i < 3; i++)
    m[i] = new int[4];

```

The resulting array *m* is a 3-by-4 dynamic array. A simple program to illustrate this is given in Display 9.7.

Be sure to notice the use of *delete* in Display 9.7. Since the dynamic array *m* is an array of arrays, each of the arrays created with *new* in the *for* loop must be returned to the freestore manager with a call to *delete[]*;

then, the array `m` itself must be returned to the freestore with another call to `delete[]`. There must be one call to `delete[]` for each call to `new` that created an array. (Since the program ends right after the calls to `delete[]`, we could safely omit these calls, but we wanted to illustrate their usage.)

DISPLAY 9.7 A Two-Dimensional Dynamic Array (part 1 of 2)

```

1  #include <iostream>
2  using namespace std;
3
4  typedef int* IntArrayPtr;
5
6  int main( )
7  {
8      int d1, d2;
9      cout << "Enter the row and column dimensions of the array:\n";
10     cin >> d1 >> d2;
11
12     IntArrayPtr *m = new IntArrayPtr[d1];
13     int i, j;
14     for (i = 0; i < d1; i++)
15         m[i] = new int[d2];
16     //m is now a d1 by d2 array.
17
18     cout << "Enter " << d1 << " rows of "
19           << d2 << " integers each:\n";
20     for (i = 0; i < d1; i++)
21         for (j = 0; j < d2; j++)
22             cin >> m[i][j];
23
24     cout << "Echoing the two-dimensional array:\n";
25     for (i = 0; i < d1; i++)
26     {
27         for (j = 0; j < d2; j++)
28             cout << m[i][j] << " ";
29         cout << endl;
30     }
31     for (i = 0; i < d1; i++)
32         delete[] m[i];
33     delete[] m;
34
35     return 0;
36 }

```

Note that there must be one call to `delete[]` for each call to `new` that created an array. (These calls to `delete[]` are not really needed, since the program is ending, but in another context it could be important to include them.)

(continued)

DISPLAY 9.7 A Two-Dimensional Dynamic Array (*part 2 of 2*)*Sample Dialogue*

```
Enter the row and column dimensions of the array:
3 4
Enter 3 rows of 4 integers each:
1 2 3 4
5 6 7 8
9 0 1 2
Echoing the two-dimensional array:
1 2 3 4
5 6 7 8
9 0 1 2
```

CHAPTER SUMMARY

- A **pointer** is a memory address, so a pointer provides a way to indirectly name a variable by naming the address of the variable in the computer's memory.
- **Dynamic variables** are variables that are created (and destroyed) while a program is running.
- Memory for dynamic variables is in a special portion of the computer's memory called the **freestore**. When a program is finished with a dynamic variable, the memory used by the dynamic variable can be returned to the freestore for reuse; this is done with a *delete* statement.
- A **dynamic array** is an array whose size is determined when the program is running. A dynamic array is implemented as a dynamic variable of an array type.

Answers to Self-Test Exercises

1. A pointer is the memory address of a variable.
2. To the unwary, or to the neophyte, this looks like two objects of type pointer to *int*, that is, *int**. Unfortunately, the *** binds to the *identifier*, not to the type (that is, not to the *int*). The result is that this declaration declares *int_ptr1* to be an *int* pointer, while *int_ptr2* is just an ordinary *int* variable.

```
3. int *p; //This declares a pointer variable that can
           //hold a pointer to an int variable.
   *p = 17; //Here, * is the dereference operator.
           //This assigns 17 to the memory location pointed to by p.
```

```
4. 10 20
   20 20
   30 30
```

If you replace `*p1 = 30;` with `*p2 = 30;`, the output would be the same.

```
5. 10 20
   20 20
   30 20
```

```
6. delete p;
```

```
7. typedef int* NumberPtr;
   NumberPtr my_point;
```

8. The *new* operator takes a type for its argument. *new* allocates space on the freestore of an appropriate size for a variable of the type of the argument. It returns a pointer to that memory (that is, a pointer to that new dynamic variable), provided there is enough available memory in the freestore. If there is not enough memory available in the freestore, your program ends.

```
9. typedef char* CharArray;
```

```
10. cout << "Enter 10 integers:\n";
     for (int i = 0; i < 10; i++)
         cin >> entry[i];
```

```
11. delete [] entry;
```

```
12. 0 1 2 3 4 5 6 7 8 9
```

```
13. 10 1 2 3 4 5 6 7 8 9
```

```
14. 0 1 2 3 4 5 6 7 8 9
```

```
15. 1 2 3 4 5 6 7 8 9
```

PRACTICE PROGRAMS

Practice Programs can generally be solved with a short program that directly applies the programming principles presented in this chapter.

1. In the C programming language there is no pass-by-reference syntax to pass a variable by reference to a function. Instead a variable is passed by pointer (just to be confusing, sometimes passing by pointer is referred to as pass by reference). This Practice Program asks you to do the same thing as C, which in

practice would be simpler to implement using C++'s reference parameter syntax. Here is the header for a function that takes as input a pointer to an integer:

```
void addOne(int *ptrNum)
```

Complete the function so it adds one to the integer referenced by `ptrNum`. Write a `main` function where an integer variable is defined, give it an initial value, call `addOne`, and output the variable. It should be incremented by 1.

- Write a program that asks the user to input an integer named `numDoubles`. Create a dynamic array that can store `numDoubles` doubles and make a loop that allows the user to enter a double into each array entry. Loop through the array, calculate the average, and output it. Delete the memory allocated to your dynamic array before exiting.
- This Practice Program requires that you read the optional section about pointer arithmetic. Complete the function `isPalindrome` so that it returns `true` if the string `cstr` is a palindrome (the same backwards as forwards) and `false` if it is not. The function uses the `cstring` library.

```
bool isPalindrome(char* cstr)
{
    char* front = cstr;
    char* back = cstr + strlen(cstr)-1;

    while (front < back)
    {
        // Complete code here
    }
    return true;
}
```

Here is a sample `main` function for quick and dirty testing:

```
int main()
{
    char s1[50] = "neveroddeven";
    char s2[50] = "not a palindrome";
    cout << isPalindrome(s1) << endl; // true
    cout << isPalindrome(s2) << endl; // false
    return 0;
}
```

PROGRAMMING PROJECTS

Programming Projects require more problem-solving than Practice Programs and can usually be solved many different ways. Visit www.myprogramminglab.com to complete many of these Programming Projects online and get instant feedback.

- Do Programming Project 7 in Chapter 7 using a dynamic array. In this version of the problem, use dynamic arrays to store the digits in each large

- integer. Allow an arbitrary number of digits instead of capping the number of digits at 20.
- Do Programming Project 3 in Chapter 7. In this version of the problem, return a new dynamic array where all repeated letters are deleted instead of modifying the partially filled array. Don't forget to free the memory allocated for these returned dynamic arrays when the data is no longer needed.
 - Do Programming Project 11 in Chapter 7 using a dynamic array (or arrays). In this version, your program will ask the user how many rows the plane has and will handle that many rows (and so not always assume the plane has 7 rows as it did in Programming Project 11 of Chapter 7).
 - Write a function that takes a C string as an input parameter and reverses the string. The function should use two pointers, *front* and *rear*. The *front* pointer should initially reference the first character in the string, and the *rear* pointer should initially reference the last character in the string. Reverse the string by swapping the characters referenced by *front* and *rear*, then increment *front* to point to the next character and decrement *rear* to point to the preceding character, and so on, until the entire string is reversed. Write a main program to test your function on various strings of both even and odd length.
 - You run four computer labs. Each lab contains computer stations that are numbered as shown in the table below:

Lab Number	Computer Station Numbers
1	1–5
2	1–6
3	1–4
4	1–3

Each user has a unique five-digit ID number. Whenever a user logs on, the user's ID, lab number, and the computer station number are transmitted to your system. For example, if user 49193 logs onto station 2 in lab 3, then your system receives (49193, 2, 3) as input data. Similarly, when a user logs off a station, then your system receives the lab number and computer station number.

Write a computer program that could be used to track, by lab, which user is logged onto which computer. For example, if user 49193 is logged into station 2 in lab 3 and user 99577 is logged into station 1 of lab 4, then your system might display the following:

```
Lab Number Computer Stations
1          1: empty 2: empty 3: empty 4: empty 5: empty
2          1: empty 2: empty 3: empty 4: empty 5: empty 6: empty
3          1: empty 2: 49193 3: empty 4: empty
4          1: 99577 2: empty 3: empty
```

Create a menu that allows the administrator to simulate the transmission of information by manually typing in the login or logoff data. Whenever someone logs in or out, the display should be updated. Also write a search option so that the administrator can type in a user ID and the system will output what lab and station number that user is logged into, or “None” if the user ID is not logged into any computer station.

You should use a fixed array of length 4 for the labs. Each array entry points to a dynamic array that stores the user login information for each respective computer station.

The structure is shown in the figure below. This structure is sometimes called a ragged array since the columns are of unequal length.

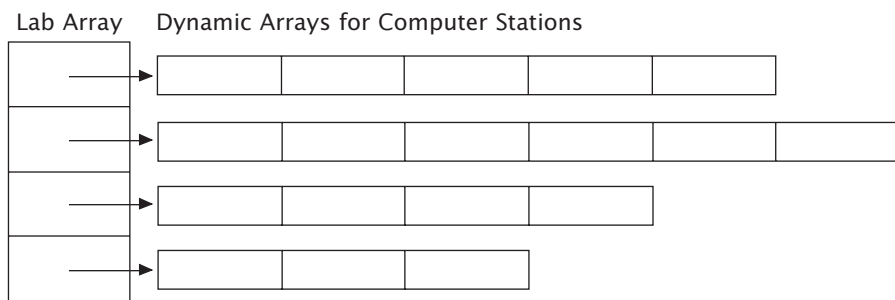

VideoNote
Solution to Programming
Project 9.6

- One problem with dynamic arrays is that once the array is created using the new operator, the size cannot be changed. For example, you might want to add or delete entries from the array as you can with a vector. This project asks you to create functions that use dynamic arrays to emulate the behavior of a vector.

First, write a program that creates a dynamic array of five strings. Store five names of your choice into the dynamic array. Next, complete the following two functions:

```
string* addEntry(string *dynamicArray, int &size, string
                newEntry);
```

This function should create a new dynamic array one element larger than `dynamicArray`, copy all elements from `dynamicArray` into the new array, add the new entry onto the end of the new array, increment `size`, delete `dynamicArray`, and return the new dynamic array.

```
string* deleteEntry(string *dynamicArray, int &size, string
                   entryToDelete);
```

This function should search `dynamicArray` for `entryToDelete`. If not found, the request should be ignored and the unmodified `dynamicArray`

returned. If found, create a new dynamic array one element smaller than `dynamicArray`. Copy all elements except `entryToDelete` into the new array, delete `dynamicArray`, decrement `size`, and return the new dynamic array.

Test your functions by adding and deleting several names to the array while outputting the contents of the array. You will have to assign the array returned by `addEntry` or `deleteEntry` back to the dynamic array variable in your `main` function.

7. What if C++ had no built-in facility for two-dimensional arrays? It is possible to emulate them yourself with wrapper functions around a one-dimensional array. The basic idea is shown below. Consider the following two-dimensional array:

```
int matrix[2][3];
```

It can be visualized as a table:

<code>matrix[0][0]</code>	<code>matrix[0][1]</code>	<code>matrix[0][2]</code>
<code>matrix[1][0]</code>	<code>matrix[1][1]</code>	<code>matrix[1][2]</code>

The two-dimensional array can be mapped to storage in a one-dimensional array where each row is stored in consecutive memory locations (your compiler actually does something very similar to map two-dimensional arrays to memory).

```
int matrix1D[6];
```

<code>matrix[0][0]</code>	<code>matrix1D[0][1]</code>	<code>matrix1D[0][2]</code>	<code>matrix1D[1][0]</code>	<code>matrix1D[1][1]</code>	<code>matrix1D[1][2]</code>
---------------------------	-----------------------------	-----------------------------	-----------------------------	-----------------------------	-----------------------------

Here, the mapping is as follows:

```
matrix[0][0] would be stored in matrix1D[0]
matrix[0][1] would be stored in matrix1D[1]
matrix[0][2] would be stored in matrix1D[2]
matrix[1][0] would be stored in matrix1D[3]
matrix[1][1] would be stored in matrix1D[4]
matrix[1][2] would be stored in matrix1D[5]
```

Based on this idea, complete the definitions for the following functions:

```
int* create2DArray(int rows, int columns);
```

This creates a one-dimensional dynamic array to emulate a two-dimensional array and returns a pointer to the one-dimensional dynamic array.

rows is the number of rows desired in the two-dimensional array.
 columns is the number of columns desired in the two-dimensional array.

Return value: a pointer to a one-dimensional dynamic array large enough to hold a two-dimensional array of size rows * columns.

Note that `int ptr = create2DArray(2,3);` would create an array analogous to that created by `int ptr[2][3];`

```
void set(int *arr, int rows, int columns,
        int desired_row, int desired_column, int val);
```

This stores val into the emulated two-dimensional array at position desired_row, desired_column. The function should print an error message and exit if the desired indices are invalid.

arr is the one-dimensional array used to emulate a two-dimensional array.

rows is the total number of rows in the two-dimensional array.

columns is the total number of columns in the two-dimensional array.

desired_row is the zero-based index of the row the caller would like to access.

desired_column is the zero-based index of the column the caller would like to access.

val is the value to store at desired_row and desired_column.

```
int get(int *arr, int rows, int columns,
        int desired_row, int desired_column);
```

This returns the value in the emulated two-dimensional array at position desired_row, desired_column. The function should print an error message and exit if the desired indices are invalid.

arr is the one-dimensional array used to emulate a two-dimensional array.

rows is the total number of rows in the two-dimensional array.

columns is the total number of columns in the two-dimensional array.

desired_row is the zero-based index of the row the caller would like to access.

desired_column is the zero-based index of the column the caller would like to access.

Create a suitable test program that invokes all three functions.

- Write a program that outputs a histogram of student grades for an assignment. The program should input each student's grade as an integer

and store the grade in a vector (covered in Chapter 8). Grades should be entered until the user enters -1 for a grade. The program should then scan through the vector and compute the histogram. In computing the histogram, the minimum value of a grade is 0 but your program should determine the maximum value entered by the user. Use a dynamic array to store the histogram. Output the histogram to the console. For example, if the input is:

```
20
30
4
20
30
30
-1
```

Then the output should be:

```
Number of 4's: 1
Number of 20's: 2
Number of 30's: 3
```

This page intentionally left blank

Defining Classes 10

10.1 STRUCTURES 542

Structures for Diverse Data 542

Pitfall: Forgetting a Semicolon in a Structure Definition 547

Structures as Function Arguments 548

Programming Tip: Use Hierarchical Structures 549

Initializing Structures 551

10.2 CLASSES 554

Defining Classes and Member Functions 554

Public and Private Members 559

Programming Tip: Make All Member Variables Private 567

Programming Tip: Define Accessor and Mutator Functions 567

Programming Tip: Use the Assignment Operator with Objects 569

Programming Example: BankAccount Class—Version 1 570

Summary of Some Properties of Classes 574

Constructors for Initialization 576

Programming Tip: Always Include a Default Constructor 584

Pitfall: Constructors with No Arguments 585

Member Initializers and Constructor Delegation in C++11 587

10.3 ABSTRACT DATA TYPES 588

Classes to Produce Abstract Data Types 589

Programming Example: Alternative Implementation of a Class 593

10.4 INTRODUCTION TO INHERITANCE 598

Derived Classes 599

Defining Derived Classes 600



*“The time has come,” the Walrus said,
“To talk of many things:
Of shoes—and ships—and sealing wax—
Of cabbages—and kings—”*

LEWIS CARROLL, *Through the Looking-Glass*

INTRODUCTION

In Chapter 6 you learned how to use classes and objects, but not how to define classes. In this chapter we will show you how to define your own classes. A class is a data type. You can use the classes you define in the same way you use the predefined data types, such as *int*, *char*, and *ifstream*. However, unless you define your classes the right way, they will not be as well behaved as the predefined data types. Thus, we spend a good deal of time explaining what makes for a good class definition and give you some techniques to help you define your classes in a way that is consistent with modern programming practices.

Before we introduce classes, we will first present *structures* (also known as *structs*). When used in the way we present them here, a structure is a kind of simplified class and structures will prove to be a stepping-stone to understanding classes.

PREREQUISITES

This chapter uses material from Chapters 2 through 6.

10.1 STRUCTURES

As we said in Chapter 6, an object is a variable that has member functions, and a class is a data type whose variables are objects. Thus, the definition of a class should be a data type definition that describes two things: (1) what kinds of values the variables can hold and (2) what the member functions are. We will approach class definitions in two steps. We will first tell you how to give a type definition for a *structure*. A structure (of the kind discussed here) can be thought of as an object without any member functions. After you learn about structures, it will be a natural extension to define classes.

Structures for Diverse Data

Sometimes it is useful to have a collection of values of different types and to treat the collection as a single item. For example, consider a bank certificate of deposit, which is often called a CD. A CD is a bank account that does not allow withdrawals for a specified number of months. A CD naturally has

three pieces of data associated with it: the account balance, the interest rate for the account, and the term, which is the number of months until maturity. The first two items can be represented as values of type *double*, and the number of months can be represented as a value of type *int*. Display 10.1 shows the definition of a structure called *CDAccount* that can be used for this kind of account. The definition is embedded in a complete program that demonstrates this structure type definition. As you can see from the sample dialogue, this particular bank specializes in short-term CDs, so the term will always be 12 or fewer months. Let's look at how this sample structure is defined and used.

The structure definition is as follows:

```
struct CDAccount
{
    double balance;
    double interest_rate;
    int term; //months until maturity
};
```

The keyword *struct* announces that this is a structure type definition. The identifier *CDAccount* is the name of the structure type. The name of a structure type is called the **structure tag**. The tag can be any legal identifier (but not a keyword). Although this convention is not required by the C++ language, structure tags are usually spelled with a mix of uppercase and lowercase letters, beginning with an uppercase letter. The identifiers declared inside the braces, {}, are called **member names**. As illustrated in this example, a structure type definition ends with both a brace, }, and a semicolon.

A structure definition is usually placed outside of any function definition (in the same way that globally defined constant declarations are placed outside of all function definitions). The structure type is then available to all the code that follows the structure definition.

Once a structure type definition has been given, the structure type can be used just like the predefined types *int*, *char*, and so forth. For example, the following will declare two variables, named *my_account* and *your_account*, both of type *CDAccount*:

```
CDAccount my_account, your_account;
```

A structure variable can hold values just like any other variable can hold values. A **structure value** is a collection of smaller values called **member values**. There is one member value for each member name declared in the structure definition. For example, a value of the type *CDAccount* is a collection of three member values: two of type *double* and one of type *int*. The member values that together make up the structure value are stored in *member variables*, which we discuss next.

Each structure type specifies a list of member names. In Display 10.1 the structure *CDAccount* has the three member names *balance*, *interest_rate*,

Where to place
a structure
definition

DISPLAY 10.1 A Structure Definition (part 1 of 2)

```
1 //Program to demonstrate the CDAccount structure type.
2 #include <iostream>
3 using namespace std;
4 //Structure for a bank certificate of deposit:
5 struct CDAccount
6 {
7     double balance;
8     double interest_rate;
9     int term; //months until maturity
10 };
11
12
13 void get_data(CDAccount& the_account);
14 //Postcondition: the_account.balance and the_account.interest_rate
15 //have been given values that the user entered at the keyboard.
16
17
18 int main( )
19 {
20     CDAccount account;
21     get_data(account);
22
23     double rate_fraction, interest;
24     rate_fraction = account.interest_rate / 100.0;
25     interest = account.balance * rate_fraction * (account.term / 12.0);
26     account.balance = account.balance + interest;
27
28     cout.setf(ios::fixed);
29     cout.setf(ios::showpoint);
30     cout.precision(2);
31     cout << "When your CD matures in "
32           << account.term << " months,\n"
33           << "it will have a balance of $"
34           << account.balance << endl;
35     return 0;
36 }
37
38 //Uses iostream:
39 void get_data(CDAccount& the_account)
40 {
41     cout << "Enter account balance: $";
42     cin >> the_account.balance;
43     cout << "Enter account interest rate: ";
44     cin >> the_account.interest_rate;
45     cout << "Enter the number of months until maturity\n"
46           << "(must be 12 or fewer months): ";
47     cin >> the_account.term;
48 }
```

(continued)

DISPLAY 10.1 A Structure Definition (part 2 of 2)

Sample Dialogue

```
Enter account balance: $100.00
Enter account interest rate: 10.0
Enter the number of months until maturity
(must be 12 or fewer months): 6
When your CD matures in 6 months,
it will have a balance of $105.00
```

and term. Each of these member names can be used to pick out one smaller variable that is a part of the larger structure variable. These smaller variables are called **member variables**. Member variables are specified by giving the name of the structure variable followed by a dot (that is, followed by a period) and then the member name. For example, if `account` is a structure variable of type `CDAccount` (as declared in Display 10.1), then the structure variable `account` has the following three member variables:

```
account.balance
account.interest_rate
account.term
```

The first two member variables are of type *double*, and the last is of type *int*. These member variables can be used just like any other variables of those types. For example, the member variables above can be given values with the following three assignment statements:

```
account.balance = 1000.00;
account.interest_rate = 4.7;
account.term = 11;
```

The result of these three statements is diagrammed in Display 10.2. Member variables can be used in all the ways that ordinary variables can be used. For example, the following line from the program in Display 10.1 will add the value contained in the member variable `account.balance` and the value contained in the ordinary variable `interest` and will then place the result in the member variable `account.balance`:

```
account.balance = account.balance + interest;
```

Notice that you specify a member variable for a structure variable by using the dot operator in the same way you used it in Chapter 6, where the dot operator was used to specify a member function of a class. The only difference is that in the case of structures, the members are variables rather than functions.

DISPLAY 10.2 Member Values

1	<code>struct CDAccount</code>				
2	{				
3	<code>double balance;</code>				
4	<code>double interest_rate;</code>				
5	<code>int term; //months until maturity</code>				
6	};				
7	<code>int main()</code>				
8	{				
9	<code>CDAccount account;</code>	balance	<table border="1" style="display: inline-table; text-align: center;"><tr><td>?</td></tr></table>	?	} account
?					
10	<code>...</code>	interest_rate	<table border="1" style="display: inline-table; text-align: center;"><tr><td>?</td></tr></table>	?	
?					
11		term	<table border="1" style="display: inline-table; text-align: center;"><tr><td>?</td></tr></table>	?	
?					
12					
13	<code>account.balance = 1000.00;</code>	balance	<table border="1" style="display: inline-table; text-align: center;"><tr><td>1000.00</td></tr></table>	1000.00	} account
1000.00					
14		interest_rate	<table border="1" style="display: inline-table; text-align: center;"><tr><td>?</td></tr></table>	?	
?					
15		term	<table border="1" style="display: inline-table; text-align: center;"><tr><td>?</td></tr></table>	?	
?					
16	<code>account.interest_rate = 4.7;</code>	balance	<table border="1" style="display: inline-table; text-align: center;"><tr><td>1000.00</td></tr></table>	1000.00	} account
1000.00					
17		interest_rate	<table border="1" style="display: inline-table; text-align: center;"><tr><td>4.7</td></tr></table>	4.7	
4.7					
18		term	<table border="1" style="display: inline-table; text-align: center;"><tr><td>?</td></tr></table>	?	
?					
19	<code>account.term = 11;</code>	balance	<table border="1" style="display: inline-table; text-align: center;"><tr><td>1000.00</td></tr></table>	1000.00	} account
1000.00					
20		interest_rate	<table border="1" style="display: inline-table; text-align: center;"><tr><td>4.7</td></tr></table>	4.7	
4.7					
21		term	<table border="1" style="display: inline-table; text-align: center;"><tr><td>11</td></tr></table>	11	
11					
22					

Reusing member names

Two or more structure types may use the same member names. For example, it is perfectly legal to have the following two type definitions in the same program:

```
struct FertilizerStock
{
    double quantity;
    double nitrogen_content;
};
```

and

```
struct CropYield
{
    int quantity;
    double size;
};
```

This coincidence of names will produce no problems. For example, if you declare the following two structure variables:

```
FertilizerStock super_grow;  
CropYield apples;
```

then the quantity of `super_grow` fertilizer is stored in the member variable `super_grow.quantity` and the quantity of apples produced is stored in the member variable `apples.quantity`. The dot operator and the structure variable specify which quantity is meant in each instance.

A structure value can be viewed as a collection of member values. Viewed this way, a structure value is many different values. A structure value can also be viewed as a single (complex) value (which just happens to be made up of member values). Since a structure value can be viewed as a single value, structure values and structure variables can be used in the same ways that you use simple values and simple variables of the predefined types such as `int`. In particular, you can assign structure values using the equal sign. For example, if `apples` and `oranges` are structure variables of the type `CropYield` defined earlier, then the following is perfectly legal:

```
apples = oranges;
```

This assignment statement is equivalent to:

```
apples.quantity = oranges.quantity;  
apples.size = oranges.size;
```

Structure
variables in
assignment
statements

PITFALL [Forgetting a Semicolon in a Structure Definition](#)

When you add the final brace, `}`, to a structure definition, it feels like the structure definition is finished, but it is not. You must also place a semicolon after that final brace. There is a reason for this, even though the reason is a feature that we will have no occasion to use. A structure definition is more than a definition. It can also be used to declare structure variables. You are allowed to list structure variable names between that final brace and that final semicolon. For example, the following defines a structure called `WeatherData` and declares two structure variables, `data_point1` and `data_point2`, both of type `WeatherData`:

```
struct WeatherData  
{  
    double temperature;  
    double wind_velocity;  
} data_point1, data_point2;
```

However, as we said, we will always separate a structure definition and the declaration of variables of that structure type, so our structure definitions will always have a semicolon immediately after the final brace. ■

The Dot Operator

The **dot operator** is used to specify a member variable of a structure variable.

SYNTAX

Structure_Variable_Name.*Member_Variable_Name*



```
struct StudentRecord
{
    int student_number;
    char grade;
};

int main()
{
    StudentRecord your_record;
    your_record.student_number = 2001;
    your_record.grade = 'A';
}
```

Some writers call the dot operator the *structure member access operator* although we will not use that term.

Structures as Function Arguments

A function can have call-by-value parameters of a structure type and/or call-by-reference parameters of a structure type. The program in Display 10.1, for example, includes a function named `get_data` that has a call-by-reference parameter with the structure type `CDAccount`.

Functions can
return structures

A structure type can also be the type for the value returned by a function. For example, the following defines a function that takes three appropriate arguments and returns a value of type `CDAccount`:

```
CDAccount shrink_wrap(double the_balance,
                     double the_rate, int the_term)
{
    CDAccount temp;
    temp.balance = the_balance;
    temp.interest_rate = the_rate;
    temp.term = the_term;
    return temp;
}
```

Notice the local variable `temp` of type `CDAccount`; `temp` is used to build up a complete structure value, which is then returned by the function. Once you

have defined the function `shrink_wrap`, you can give a value to a variable of type `CDAccount` as illustrated by the following:

```
CDAccount new_account;  
new_account = shrink_wrap(10000.00, 5.1, 11);
```

■ PROGRAMMING TIP Use Hierarchical Structures

Sometimes it makes sense to have structures whose members are themselves smaller structures. For example, a structure type called `PersonInfo`, which can be used to store a person's height, weight, and birth date, can be defined as follows:

Structures within structures

```
struct Date  
{  
    int month;  
    int day;  
    int year;  
};  
  
struct PersonInfo  
{  
    double height; //in inches  
    int weight; //in pounds  
    Date birthday;  
};
```

A structure variable of type `PersonInfo` is declared in the usual way:

```
PersonInfo person1;
```

If the structure variable `person1` has had its value set to record a person's birth date, then the year the person was born can be output to the screen as follows:

```
cout << person1.birthday.year;
```

The way to read such expressions is left to right, and very carefully. Starting at the left end, `person1` is a structure variable of type `PersonInfo`. To obtain the member variable with the name `birthday`, use the dot operator as follows:

```
person1.birthday
```

This member variable is itself a structure variable of type `Date`. Thus, this member variable has member variables itself. A member variable of the structure variable `person1.birthday` is obtained by adding a dot and the member variable name, such as `year`, which produces the expression `person1.birthday.year` shown previously. ■

Simple Structure Types

You define a **structure type** as shown below. The *Structure_Tag* is the name of the structure type.

SYNTAX

```
struct Structure_Tag
{
    Type_1 Member_Variable_Name_1;
    Type_2 Member_Variable_Name_2;
    .
    .
    .
    Type_Last Member_Variable_Name_Last;
}; ← Do not forget this semicolon.
```

EXAMPLE

```
struct Automobile
{
    int year;
    int doors;
    double horse_power;
    char model;
};
```

Although we will not use this feature, you can combine member names of the same type into a single list separated by commas. For example, the following is equivalent to the previous structure definition:

```
struct Automobile
{
    int year, doors;
    double horse_power;
    char model;
};
```

Variables of a structure type can be declared in the same way as variables of other types. For example:

```
Automobile my_car, your_car;
```

The member variables are specified using the **dot operator**. For example,

```
my_car.year, my_car.doors, my_car.horse_power, and
my_car.model.
```

Initializing Structures

You can initialize a structure at the time that it is declared. To give a structure variable a value, you follow it by an equal sign and a list of the member values enclosed in braces. For example, the following definition of a structure type for a date was given in the previous subsection:

```
struct Date
{
    int month;
    int day;
    int year;
};
```

Once the type `Date` is defined, you can declare and initialize a structure variable called `due_date` as follows:

```
Date due_date = {12, 31, 2004};
```

Be sure to notice that the initializing values must be given in the order that corresponds to the order of member variables in the structure type definition. In this example, `due_date.month` receives the first initializing value of 12, `due_date.day` receives the second value of 31, and `due_date.year` receives the third value of 2004.

It is an error if there are more initializers than `struct` members. If there are fewer initializer values than `struct` members, the provided values are used to initialize data members, in order. Each data member without an initializer is initialized to a zero value of an appropriate type for the variable.

SELF-TEST EXERCISES

1. Given the following structure and structure variable declaration:

```
struct TermAccount
{
    double balance;
    double interest_rate;
    int term;
    char initial1;
    char initial2;
};
TermAccount account;
```

what is the type of each of the following? Mark any that are not correct.

- a. `account.balance`
- b. `account.interest_rate`

- c. `TermAccount.term`
- d. `savings_account.initial1`
- e. `account.initial2`
- f. `account`

2. Consider the following type definition:

```
struct ShoeType
{
    char style;
    double price;
};
```

Given this structure type definition, what will be the output produced by the following code?

```
ShoeType shoe1, shoe2;
shoe1.style = 'A';
shoe1.price = 9.99;
cout << shoe1.style << " $" << shoe1.price << endl;
shoe2 = shoe1;

shoe2.price = shoe2.price/9;
cout << shoe2.style << " $" << shoe2.price << endl;
```

3. What is the error in the following structure definition? What is the message your compiler gives for this error? State what the error is, in your own words.

```
struct Stuff
{
    int b;
    int c;
}
int main( )
{
    Stuff x;
    //other code
}
```

4. Given the following *struct* definition:

```
struct A
{
    int member_b;
    int member_c;
};
```

declare `x` to have this structure type. Initialize the members of `x`, `member_b` and `member_c`, to the values 1 and 2, respectively.

(*Note:* This requests an initialization, not an assignment of the members. This distinction is important and will be made in a later chapter.)

5. Here is an initialization of a structure type. Tell what happens with each initialization. Note any problems with these initializations.

```
struct Date
{
    int month;
    int day;
    int year;
};
```

- `Date due_date = {12, 21};`
 - `Date due_date = {12, 21, 20, 22};`
 - `Date due_date = {12, 21, 20, 22};`
 - `Date due_date = {12, 21, 22};`
6. Write a definition for a structure type for records consisting of a person's wage rate, accrued vacation (which is some whole number of days), and status (which is either hourly or salaried). Represent the status as one of the two `char` values 'H' and 'S'. Call the type `EmployeeRecord`.

7. Give a function definition corresponding to the following function declaration. (The type `ShoeType` is given in Self-Test Exercise 2.)

```
void read_shoe_record(ShoeType& new_shoe);
//Fills new_shoe with values read from the keyboard.
```

8. Give a function definition corresponding to the following function declaration. (The type `ShoeType` is given in Self-Test Exercise 2.)

```
ShoeType discount(ShoeType old_record);
//Returns a structure that is the same as its argument,
//but with the price reduced by 10%.
```

9. Give the structure definition for a type named `StockRecord` that has two member variables, one named `shoe_info` of the type `ShoeType` given in Self-Test Exercise 2 and one named `arrival_date` of type `Date` given in Self-Test Exercise 5.
10. Declare a variable of type `StockRecord` (given in the previous exercise) and write a statement that will set the year of the arrival date to 2006.

10.2 CLASSES

I don't care to belong to any club that will accept me as a member.

GROUCHO MARX, *The Groucho Letters*

Defining Classes and Member Functions

A **class** is a data type whose variables are objects. In Chapter 6 we described an **object** as a variable that has member functions as well as the ability to hold data values.¹ Thus, within a C++ program, the definition of a class should be a data type definition that describes what kinds of values the variables can hold and also what the member functions are. A structure definition describes some of these things. A structure is a defined type that allows you to define values of the structure type by defining member variables. To obtain a class from a structure, all you need to do is add some member functions.

A sample class definition is given in the program shown in Display 10.3. The type `DayOfYear` defined there is a class definition for objects whose values are dates, such as January 1 or July 4. These values can be used to record holidays, birthdays, and other special dates. In this definition of `DayOfYear`, the month is recorded as an `int` value, with 1 standing for January, 2 standing for February, and so forth. The day of the month is recorded in a second `int` member variable. The class `DayOfYear` has one member function called `output`, which has no arguments and outputs the month and day values to the screen. Let's look at the definition for the class `DayOfYear` in detail.

A member
function

The definition of the class `DayOfYear` is shown near the top of Display 10.3. For the moment, ignore the line that contains the keyword `public`. This line simply says that the member variables and functions have no restriction on them. We will explain this line later in this chapter. The rest of the definition of the class `DayOfYear` is very much like a structure definition, except that it uses the keyword `class` instead of `struct` and it lists the member function `output` (as well as the member variables `month` and `day`). Notice that the member function `output` is listed by giving only its function declaration. The definitions for the member functions are given elsewhere. (In a C++ class definition, you can intermix the ordering of the member variables and member functions in any way you wish, but the style we will follow has a tendency to list the member functions before the member variables.) Objects (that is, variables) of a class type are declared in the same way as variables of the predefined types and in the same way as structure variables.

¹The object is actually the value of the variable rather than the variable itself, but since we use the variable to name the value it holds, we can simplify our discussion by ignoring this nicety and talking as if the variable and its value were the same thing.

DISPLAY 10.3 Class with a Member Function (part 1 of 2)

```

1  //Program to demonstrate a very simple example of a class.
2  //A better version of the class DayOfYear will be given in
   Display 10.4.
3  #include <iostream>
4  using namespace std;

5  class DayOfYear
6  {
7  public:
8      void output( ); ← Member function declaration
9      int month;
10     int day;
11 };

12 int main( )
13 {
14     DayOfYear today, birthday;

15     cout << "Enter today's date:\n";
16     cout << "Enter month as a number: ";
17     cin >> today.month;
18     cout << "Enter the day of the month: ";
19     cin >> today.day;
20     cout << "Enter your birthday:\n";
21     cout << "Enter month as a number: ";
22     cin >> birthday.month;
23     cout << "Enter the day of the month: ";
24     cin >> birthday.day;

25     cout << "Today's date is ";
26     today.output( ); ← Calls to the member
27     cout << "Your birthday is "; ← function output
28     birthday.output( );

29     if (today.month == birthday.month
30         && today.day == birthday.day)
31         cout << "Happy Birthday!\n";
32     else
33         cout << "Happy Unbirthday!\n";
34     return 0;
35 }

36 //Uses iostream:
37 void DayOfYear::output( )
38 {
39     cout << "month = " << month
40     << ", day = " << day << endl;
41 }

```

(continued)

DISPLAY 10.3 Class with a Member Function (part 2 of 2)

Sample Dialogue

```
Enter today's date:
Enter month as a number: 10
Enter the day of the month: 15
Enter your birthday:
Enter month as a number: 2
Enter the day of the month: 21
Today's date is month = 10, day = 15
Your birthday is month = 2, day = 21
Happy Unbirthday!
```

Calling member functions

Member functions for classes that you define are called in the same way as we described in Chapter 6 for predefined classes. For example, the program in Display 10.3 declares two objects of type `DayOfYear` in the following way:

```
DayOfYear today, birthday;
```

The member function `output` is called with the object `today` as follows:

```
today.output();
```

and the member function `output` is called with the object `birthday` as follows:

```
birthday.output();
```

Encapsulation

Combining a number of items, such as variables and functions, into a single package, such as an object of some class, is called **encapsulation**.

Defining member functions

When a member function is defined, the definition must include the class name because there may be two or more classes that have member functions with the same name. In Display 10.3 there is only one class definition, but in other situations you may have many class definitions, and each class may have a member function called `output`. The definition for the member function `output` of the class `DayOfYear` is shown in Display 10.3. The definition is similar to an ordinary function definition, but there are some differences.

The heading of the function definition for the member function `output` is as follows:

```
void DayOfYear::output()
```

The operator `::` is called the **scope resolution operator**, and it serves a purpose similar to that of the dot operator. Both the dot operator and the scope resolution operator are used to tell what a member function is a member of. However, the scope resolution operator `::` is used with a class name, whereas the dot operator is used with objects (that is, with class variables). The scope resolution operator consists of two colons with no space between them. The class name that precedes the scope resolution operator is often called a **type qualifier**, because it specializes (“qualifies”) the function name to one particular type.

Look at the definition of the member function `DayOfYear::output` given in Display 10.3. Notice that in the function definition of `DayOfYear::output`, we used the member names `month` and `day` by themselves without first giving the object and dot operator. That is not as strange as it may at first appear. At this point we are simply defining the member function `output`. This definition of `output` will apply to all objects of type `DayOfYear`, but at this point we do not know the names of the objects of type `DayOfYear` that we will use, so we cannot give their names. When the member function is called, as in

```
today.output();
```

all the member names in the function definition are specialized to the name of the calling object. So the function call above is equivalent to the following:

```
{
    cout << "month = " << today.month
         << ", day = " << today.day << endl;
}
```

In the function definition for a member function, you can use the names of all members of that class (both the data members and the function members) without using the dot operator.

Member variables
in function
definitions

Member Function Definition

A member function is defined the same way as any other function except that the *Class_Name* and the scope resolution operator `::` are given in the function heading.

SYNTAX

```
Returned_Type Class_Name::Function_Name(Parameter_List)
{
    Function_Body_Statements
}
```

(continued)

EXAMPLE

```
//Uses iostream:  
void DayOfYear::output()  
{  
    cout << "month = " << month  
        << ", day = " << day << endl;  
}
```

The class definition for the example class `DayOfYear` above is given in Display 10.3, where `month` and `day` are defined as the names of member variables for the class `DayOfYear`. Note that `month` and `day` are not preceded by an object name and dot.

The Dot Operator and the Scope Resolution Operator

Both the dot operator and the scope resolution operator are used with member names to specify what thing they are members of. For example, suppose you have declared a class called `DayOfYear` and you declare an object called `today` as follows:

```
DayOfYear today;
```

You use the **dot operator** to specify a member of the object `today`. For example, `output` is a member function for the class `DayOfYear` (defined in Display 10.3), and the following function call will output the data values stored in the object `today`:

```
today.output();
```

You use the **scope resolution operator** `::` to specify the class name when giving the function definition for a member function. For example, the heading of the function definition for the member function `output` would be as follows:

```
void DayOfYear::output()
```

Remember, the scope resolution operator `::` is used with a class name, whereas the dot operator is used with an object of that class.

SELF-TEST EXERCISES

11. Below we have redefined the class `DayOfYear` from Display 10.3 so that it now has one additional member function called `input`. Write an appropriate definition for the member function `input`.

```
class DayOfYear
{
public:
    void input();
    void output();
    int month;
    int day;
};
```

12. Given the following class definition, write an appropriate definition for the member function `set`:

```
class Temperature
{
public:
    void set(double new_degrees, char new_scale);
    //Sets the member variables to the values given as
    //arguments.

    double degrees;
    char scale; // 'F' for Fahrenheit or 'C' for Celsius.
};
```

13. Carefully distinguish between the meaning and use of the dot operator and the scope resolution operator `::`.

Public and Private Members

The predefined types such as `double` are not implemented as C++ classes, but the people who wrote your C++ compiler did design some way to represent values of type `double` in your computer. It is possible to implement the type `double` in many different ways. In fact, different versions of C++ do implement the type `double` in slightly different ways, but if you move your C++ program from one computer to another with a different implementation of the type `double`, your program should still work correctly.² Classes are types that you define, and the types that you define should behave as well as the predefined types. You can build a library of your own class type definitions and use your types as if they were predefined types. For example, you could place each class definition in a separate file and copy it into any program that uses the type.

² Sometimes this ideal is not quite realized, but in the ideal world it should be realized, and at least for simple programs, it is realized even in the imperfect world that we live in.

Your class definitions should separate the rules for using the class and the details of the class implementation in as strong a way as was done for the predefined types. If you change the implementation of a class (for example, by changing some details in the definition of a member function in order to make function calls run faster), then you should not need to change any of the other parts of your programs. In order to realize this ideal, we need to describe one more feature of class definitions.

Look back at the definition of the type `DayOfYear` given in Display 10.3. The type `DayOfYear` is designed to hold values that represent dates such as birthdays and holidays. We chose to represent these dates as two integers, one for the month and one for the day of the month. We might later decide to change the representation of the month from one variable of type `int` to three variables of type `char`. In this changed version, the three characters would be an abbreviation of the month's name. For example, the three `char` values 'J', 'a', and 'n' would represent the month January. However, whether you use a single member variable of type `int` to record the month or three member variables of type `char` is an implementation detail that need not concern a programmer who uses the type `DayOfYear`. Of course, if you change the way the class `DayOfYear` represents the month, then you must change the implementation of the member function `output`—but that is all you should need to change. You should not need to change any other part of a program that uses your class definition for `DayOfYear`. Unfortunately, the program in Display 10.3 does not meet this ideal. For example, if you replace the one member variable named `month` with three member variables of type `char`, then there will be no member variable named `month`, so you must change those parts of the program that perform input and also change the *if-else* statement.

With an ideal class definition, you should be able to change the details of how the class is implemented and the only things you should need to change in any program that uses the class are the definitions of the member functions. In order to realize this ideal, you must have enough member functions so that you never need to access the member variables directly, but access them only through the member functions. Then, if you change the member variables, you need change only the definitions of the member functions to match your changes to the member variables, and nothing else in your programs need change. In Display 10.4 we have redefined the class `DayOfYear` so that it has enough member functions to do everything we want our programs to do, and so the program does not need to directly reference any member variables. If you look carefully at the program in Display 10.4, you will see that the only place the member variable names `month` and `day` are used is in the definitions of the member functions. There is no reference to `today.month`, `today.day`, `bach_birthday.month`, nor `bach_birthday.day` anywhere outside of the definitions of member functions.

The program in Display 10.4 has one new feature that is designed to ensure that no programmer who uses the class `DayOfYear` will ever

DISPLAY 10.4 Class with Private Members (part 1 of 2)

```

1  //Program to demonstrate the class DayOfYear.
2  #include <iostream>
3  using namespace std;
4  class DayOfYear
5  {
6  public:
7      void input( );
8      void output( );
9
10     void set(int new_month, int new_day);
11     //Precondition: new_month and new_day form a possible date.
12     //Postcondition: The date is reset according to the arguments.
13
14     int get_month( );
15     //Returns the month, 1 for January, 2 for February, etc.
16
17     int get_day( );
18     //Returns the day of the month.
19 private:
20     void check_date( );
21     int month;
22     int day;
23 };
24
25 int main( )
26 {
27     DayOfYear today, bach_birthday;
28     cout << "Enter today's date:\n";
29     today.input( );
30     cout << "Today's date is ";
31     today.output( );
32
33     bach_birthday.set(3, 21);
34     cout << "J. S. Bach's birthday is ";
35     bach_birthday.output( );
36
37     if (today.get_month( ) == bach_birthday.get_month( ) &&
38         today.get_day( ) == bach_birthday.get_day( ) )
39         cout << "Happy Birthday Johann Sebastian!\n";
40     else
41         cout << "Happy Unbirthday Johann Sebastian!\n";
42     return 0;
43 }
44 //Uses iostream:
45 void DayOfYear::input( )
46 {
47     cout << "Enter the month as a number: ";

```

This is an improved version of the class DayOfYear that we gave in Display 10.3.

Private member function

Private member variables

(continued)

DISPLAY 10.4 Class with Private Members (part 2 of 2)

```

42     cin >> month;
43     cout << "Enter the day of the month: ";
44     cin >> day;
45     check_date( );
46 }
47
48 void DayOfYear::output( )
    <The rest of the definition of DayOfYear::output is
    given in Display 10.3.>
49
50 void DayOfYear::set(int new_month, int new_day)
51 {
52     month = new_month;
53     day = new_day;
54     check_date();
55 }
56
57 void DayOfYear::check_date( )
58 {
59     if ((month < 1) || (month > 12) || (day < 1) || (day > 31))
60     {
61         cout << "Illegal date. Aborting program.\n";
62         exit(1);
63     }
64 }
65
66 int DayOfYear::get_month( )
67 {
68     return month;
69 }
70
71 int DayOfYear::get_day( )
72 {
73     return day;
74 }

```

Private members may be used in member function definitions (but not elsewhere).

A better definition of the member function **input** would ask the user to reenter the date if the user enters an incorrect date.

The member function **check_date** does not check for all illegal dates, but it would be easy to make the check complete by making it longer. See Self-Test Exercise 14.

The function **exit** is discussed in Chapter 6. It ends the program.

Sample Dialogue

```

Enter today's date:
Enter the month as a number: 3
Enter the day of the month: 21
Today's date is month = 3, day = 21
J. S. Bach's birthday is month = 3, day = 21
Happy Birthday Johann Sebastian!

```

directly reference any of its member variables. Notice the line in the definition of the class `DayOfYear` that contains the keyword `private`. All the member variable names that are listed after this line are **private members**, which means that they cannot be directly accessed in the program except within the definition of a member function. If you try to access one of these member variables in the `main` part of your program or in the definition of some function that is not a member function of this particular class, the compiler will give you an error message. If you insert the keyword `private` and a colon in the list of member variables and member functions, all the members that follow the label `private:` will be private members. The variables that follow the label `private:` will be **private member variables**, and the functions that follow it will be **private member functions**.

All the member variables for the class `DayOfYear` defined in Display 10.4 are private members. A private member variable may be used in the definition of any of the member functions, but nowhere else. For example, with this changed definition of the class `DayOfYear`, the following two assignments are no longer permitted in the `main` part of the program:

```
DayOfYear today; //This line is OK.
today.month = 12; //ILLEGAL
today.day = 25; //ILLEGAL
```

Any reference to these private variables is illegal (except in the definition of member functions). Since this new definition makes `month` and `day` private member variables, the following are also illegal in the `main` part of any program that declares `today` to be of type `DayOfYear`:

```
cout << today.month; //ILLEGAL
cout << today.day; //ILLEGAL
if (today.month == 1) //ILLEGAL
    cout << "January";
```

Once you make a member variable a private member variable, there is then no way to change its value (or to reference the member variable in any other way) except by using one of the member functions. This is a severe restriction, but it is usually a wise restriction to impose. Programmers find that it usually makes their code easier to understand and easier to update if they make all member variables private.

It may seem that the program in Display 10.4 does not really disallow direct access to the private member variables, since they can be changed using the member function `DayOfYear::set`, and their values can be discovered using the member functions `DayOfYear::get_month` and `DayOfYear::get_day`. While that is almost true for the program in Display 10.4, it might not be so true if we changed the implementation of how we represented the month and/or day in our dates. For example, suppose we change the type definition of `DayOfYear` to the following:

```

class DayOfYear
{
public:
    void input();
    void output();

    void set(int new_month, int new_day);
    //Precondition: new_month and new_day form a possible date.
    //Postcondition: The date is reset according to the
    //arguments.

    int get_month();
    //Returns the month, 1 for January, 2 for February, etc.

    int get_day();
    //Returns the day of the month.
private:
    void DayOfYear::check_date( );
    char first_letter; //of month
    char second_letter; //of month
    char third_letter; //of month
    int day;
};

```

It would then be slightly more difficult to define the member functions, but they could be redefined so that they would behave *exactly* as they did before. For example, the definition of the function `get_month` might start as follows:

```

int DayOfYear::get_month()
{
    if (first_letter == 'J' && second_letter == 'a'
        && third_letter == 'n')
        return 1;
    if (first_letter == 'F' && second_letter == 'e'
        && third_letter == 'b')
        return 2;
    ...
}

```

This approach would be rather tedious, but not difficult.

Also notice that the member functions `DayOfYear::set` and `DayOfYear::input` check to make sure the member variables `month` and `day` are set to legal values. This is done with a call to the member function `DayOfYear::check_date`. If the member variables `month` and `day` were public instead of private, then these member variables could be set to any values, including illegal values. By making the member variables private and manipulating them only via member functions, we can ensure that the member variables are never set to illegal or meaningless values. (In Self-Test Exercise 14 you are asked to redefine the member function `DayOfYear::check_date` so that it does a complete check for illegal dates.)

It is also possible to make a member function private. Like a private member variable, a private member function can be used in the definition of any other member function, but nowhere else, such as in the main part of a program that uses the class type. For example, the member function `DayOfYear::check_date` in Display 10.4 is a private member function. The normal practice is to make a member function private if you only expect to use that member function as a helping function in the definitions of the member functions.

The keyword *public* is used to indicate **public members** the same way that the keyword *private* is used to indicate private members. For example, for the class `DayOfYear` defined in Display 10.4, all the member functions except `DayOfYear::check_date` are public members (and all the member variables are private members). A public member can be used in the main body of your program or in the definition of any function, even a nonmember function.

You can have any number of occurrences of *public* and *private* in a class definition. Every time you insert the label

public:

the list of members changes from private to public. Every time you insert the label

private:

the list of members changes back to being private members. For example, the member function `do_something_else` and the member variable `more_stuff` in the following structure definition are private members, while the other four members are all public:

```
class SampleClass
{
public:
    void do_something();
    int stuff;
private:
    void do_something_else();
    char more_stuff;
public:
    double do_yet_another_thing();
    double even_more_stuff;
};
```

If you list members at the start of your class definition and do not insert either *public:* or *private:* before these first members, then they will be private members. However, it is a good idea to always explicitly label each group of members as either *public* or *private*.



VideoNote
Class Scope, Public and
Private Members

Classes and Objects

A **class** is a type whose variables are **objects**. These objects can have both member variables and member functions. The syntax for a class definition is as follows.

SYNTAX

```
class Class_Name
{
public:
    Member_Specification_1
    Member_Specification_2
    .
    .
    .
    Member_Specification_n
private:
    Member_Specification_n+1
    Member_Specification_n+2
    .
    .
};
```

Each *Member_Specification_i* is either a member variable declaration or a member function declaration. (Additional *public* and *private* sections are permitted.)

EXAMPLE

```
class Bicycle
{
public:
    char get_color();
    int number_of_speeds();
    void set(int the_speeds, char the_color);
private:
    int speeds;
    char color;
};
```

Once a class is defined, an object (which is just a variable of the class type) can be declared in the same way as variables of any other type. For example, the following declares two objects of type `Bicycle`:

```
Bicycle my_bike, your_bike;
```

■ PROGRAMMING TIP Make All Member Variables Private

When defining a class, the normal practice is to make all member variables private. This means that the member variables can only be accessed or changed using the member functions. Much of this chapter is dedicated to explaining how and why you should define classes in this way. ■

■ PROGRAMMING TIP Define Accessor and Mutator Functions

The operator `==` can be used to test two values of a simple type to see if they are equal. Unfortunately, the predefined operator `==` does not automatically apply to objects. In Chapter 11 we will show you how you can make the operator `==` apply to the objects of the classes you define. Until then, you will not be able to use the equality operator `==` with objects (nor can you use it with structures). This can produce some complications. When defining a class, the preferred style is to make all member variables private. Thus, in order to test two objects to see if they represent the same value, you need some way to access the values of the member variables (or something equivalent to the values of the member variables). This allows you to test for equality by testing the values of each pair of corresponding member variables. To do this in Display 10.4, we used the member functions `get_month` and `get_day` in the *if-else* statement.

Member functions, such as `get_month` and `get_day`, that allow you to find out the values of the private member variables are called **accessor functions**. Given the techniques you have learned to date, it is important to always include a complete set of accessor functions with each class definition so that you can test objects for equality. The accessor functions need not literally return the values of each member variable, but they must return something equivalent to those values. In Chapter 11 we will develop a more elegant method to test two objects for equality, but even after you learn that technique, it will still be handy to have accessor functions.

Member functions, such as `set` in Display 10.4, that allow you to change the values of the private member variables are called **mutator functions**. It is important to always include mutator functions with each class definition so that you can change the data stored in an object.

Accessor and Mutator Functions

Member functions that allow you to find out the values of the private member variables of a class are called **accessor functions**. The accessor functions need not literally return the values of each member variable, but they must return something equivalent to those values. Although this is not required by the C++ language, the names of accessor functions normally include the word `get`.

(continued)

Member functions that allow you to change the values of the private member variables of a class are called **mutator functions**. Although this is not required by the C++ language, the names of mutator functions normally include the word `set`.

It is important to always include accessor and mutator functions with each class definition so that you can change the data stored in an object.

SELF-TEST EXERCISES

14. The private member function `DayOfYear::check_date` in Display 10.4 allows some illegal dates to get through, such as February 30. Redefine the member function `DayOfYear::check_date` so that it ends the program whenever it finds any illegal date. Allow February to contain 29 days, so you account for leap years. (*Hint*: This is a bit tedious and the function definition is a bit long, but it is not very difficult.)
15. Suppose your program contains the following class definition:

```
class Automobile
{
public:
    void set_price(double new_price);
    void set_profit(double new_profit);
    double get_price();
private:
    double price;
    double profit;
    double get_profit();
};
```

and suppose the main part of your program contains the following declaration and that the program somehow sets the values of all the member variables to some values:

```
Automobile hyundai, jaguar;
```

Which of the following statements are then allowed in the main part of your program?

```
hyundai.price = 4999.99;
jaguar.set_price(30000.97);
double a_price, a_profit;
a_price = jaguar.get_price();
a_profit = jaguar.get_profit();
a_profit = hyundai.get_profit();
```

```
if (hyundai == jaguar)
    cout << "Want to swap cars?";
hyundai = jaguar;
```

16. Suppose you change Self-Test Exercise 15 so that the definition of the class `Automobile` omits the line that contains the keyword `private`. How would this change your answer to the question in Self-Test Exercise 15?
17. Explain what `public:` and `private:` do in a class definition. In particular, explain why we do not just make everything `public:` and save difficulty in access.
18. a. How many `public:` sections are required in a class for the class to be useful?
 - b. How many `private:` sections are required in a class?
 - c. What kind of section do you have between the opening `{` and the first `public:` or `private:` section label of a class?
 - d. What kind of section do you have between the opening `{` and the first `public:` or `private:` section label of a structure?

■ PROGRAMMING TIP Use the Assignment Operator with Objects

It is perfectly legal to use the assignment operator `=` with objects or with structures. For example, suppose the class `DayOfYear` is defined as shown in Display 10.4 so that it has two private member variables named `month` and `day`, and suppose that the objects `due_date` and `tomorrow` are declared as follows:

```
DayOfYear due_date, tomorrow;
```

The following is then perfectly legal (provided the member variables of the object `tomorrow` have already been given values):

```
due_date = tomorrow;
```

The previous assignment is equivalent to the following:

```
due_date.month = tomorrow.month;
due_date.day = tomorrow.day;
```

Moreover, this is true even though the member variables named `month` and `day` are private members of the class `DayOfYear`.³ ■

³ In Chapter 11 we see situations in which the assignment operator `=` should be redefined (overloaded) for a class.

PROGRAMMING EXAMPLE**BankAccount Class—Version 1**

Display 10.5 contains a class definition for a bank account that illustrates all of the points about class definitions you have seen thus far. This type of bank account allows you to withdraw your money at any time, so it has no term as did the type `CDAccount` that you saw earlier. A more important difference is that the class `BankAccount` has member functions for all the operations you would expect to use in a program. Objects of the class `BankAccount` have two private member variables: one to record the account balance and one to record the interest rate. Let's discuss some of features of the class `BankAccount`.

First, notice that the class `BankAccount` has a private member function called `fraction`. Since `fraction` is a private member function, it cannot be called in the body of `main` or in the body of any function that is not a member function of the class `BankAccount`. The function `fraction` can only be called in the definitions of other member functions of the class `BankAccount`. The only reason we have this (or any) private member function is to aid us in defining other member functions for the same class. In our definition of the class `BankAccount`, we included the member function `fraction` so that we could use it in the definition of the function `update`. The function `fraction` takes one argument that is a percentage figure, like `10.0` for `10.0%`, and converts it to a fraction, like `0.10`. That allows us to compute the amount of interest on the account at the given percentage. If the account contains \$100.00 and the interest rate is 10%, then the interest is equal to \$100 times `0.10`, which is \$10.00.

When you call a public member function, such as `update`, in the main body of your program, you must include an object name and a dot, as in the following line from Display 10.5:

```
account1.update();
```

One member
function calling
another

However, when you call a private member function (or any other member function) within the definition of another member function, you use only the member function name without any calling object or dot operator. For example, the following definition of the member function `BankAccount::update` includes a call to `BankAccount::fraction` (as shown in Display 10.5):

```
void BankAccount::update()
{
    balance = balance + fraction(interest_rate) * balance;
}
```

The calling object for the member function `fraction` and for the member variables `balance` and `interest_rate` are determined when the function `update` is called. For example, the meaning of

```
account1.update();
```

is the following:

DISPLAY 10.5 The BankAccount Class (part 1 of 3)

```

1  //Program to demonstrate the class BankAccount.
2  #include <iostream>
3  using namespace std;

4  //Class for a bank account:
5  class BankAccount
6  {
7  public:
8      void set(int dollars, int cents, double rate);
9          //Postcondition: The account balance has been set to $dollars.cents;
10         //The interest rate has been set to rate percent.
11
12         void set(int dollars, double rate);
13             //Postcondition: The account balance has been set to $dollars.00.
14             //The interest rate has been set to rate percent.
15
16         void update( );
17             //Postcondition: One year of simple interest has been
18             //added to the account balance.
19
20         double get_balance( );
21             //Returns the current account balance.
22
23         double get_rate( );
24             //Returns the current account interest rate as a percentage.
25
26         void output(ostream& outs);
27             //Precondition: If outs is a file output stream, then
28             //outs has already been connected to a file.
29             //Postcondition: Account balance and interest rate have
30             //been written to the stream outs.
31 private:
32         double balance;
33         double interest_rate;
34
35         double fraction(double percent);
36             //Converts a percentage to a fraction. For example, fraction(50.3)
37             //returns 0.503.
38 };
39
40 int main( )
41 {
42     BankAccount account1, account2;
43     cout << "Start of Test:\n";
44     account1.set(123, 99, 3.0);
45     cout << "account1 initial statement:\n";
46     account1.output(cout);
47     account1.set(100, 5.0);

```

The member function set is overloaded.

Calls to the overloaded member function set

(continued)

DISPLAY 10.5 The BankAccount Class (part 2 of 3)

```

42     cout << "account1 with new setup:\n";
43     account1.output(cout);

44     account1.update( );
45     cout << "account1 after update:\n";
46     account1.output(cout);

47     account2 = account1;
48     cout << "account2:\n";
49     account2.output(cout);
50     return 0;
51 }
52
53 void BankAccount::set(int dollars, int cents, double rate)
54 {
55     if ((dollars < 0) || (cents < 0) || (rate < 0))
56     {
57         cout << "Illegal values for money or interest rate.\n";
58         exit(1);
59     }

60     balance = dollars + 0.01*cents;
61     interest_rate = rate;
62 }
63
64 void BankAccount::set(int dollars, double rate)
65 {
66     if ((dollars < 0) || (rate < 0))
67     {
68         cout << "Illegal values for money or interest rate.\n";
69         exit(1);
70     }

71     balance = dollars;
72     interest_rate = rate;
73 }
74
75 void BankAccount::update( )
76 {
77     balance = balance + fraction(interest_rate)*balance;
78 }
79
80 double BankAccount::fraction(double percent_value)
81 {
82     return (percent_value / 100.0);
83 }
84

```

Definitions of overloaded member function set

In the definition of a member function, you call another member function like this.

(continued)

DISPLAY 10.5 The BankAccount Class (part 3 of 3)

```

85     double BankAccount::get_balance( )
86     {
87         return balance;
88     }
89
90     double BankAccount::get_rate( )
91     {
92         return interest_rate;
93     }
94
95     //Uses ostream:
96     void BankAccount::output(ostream& outs)
97     {
98         outs.setf(ios::fixed);
99         outs.setf(ios::showpoint);
100        outs.precision(2);
101        outs << "Account balance $" << balance << endl;
102        outs << "Interest rate " << interest_rate << "%" << endl;
103    }

```

Stream parameter that can be replaced either with cout or with a file output stream

Sample Dialogue

```

Start of Test:
account1 initial statement:
Account balance $123.99
Interest rate 3.00%
account1 with new setup:
Account balance $100.00
Interest rate 5.00%
account1 after update:
Account balance $105.00
Interest rate 5.00%
account2:
Account balance $105.00
Interest rate 5.00%

```

```

{
    account1.balance = account1.balance +
        account1.fraction(account1.interest_rate) * account1.balance;
}

```

Notice that the call to the member function `fraction` is handled in the same way in this regard as the references to the member variables.

Input/output stream arguments

Like the classes we discussed earlier, the class `BankAccount` has a member function that outputs the data information stored in the object. In this program we are sending output to the screen. However, we want to write this class definition so that it can be copied into other programs and used unchanged in those other programs. Since some other program may want to send output to a file, we have given the member function `output` a formal parameter of type `ostream` so that the function `output` can be called with an argument that is either the stream `cout` or a file output stream. In the sample program we want the output to go to the screen, so the first function call to the member function `output` has the form

```
account1.output(cout);
```

Other calls to `output` also use `cout` as the argument, so all output is sent to the screen. If you want the output to go to a file instead, then you must first connect the file to an output stream, as we discussed in Chapter 6. If the file output stream is called `fout` and is connected to a file, then the following would write the data information for the object `account1` to this file rather than to the screen:

```
account1.output(fout);
```

Overloading member functions

The value of an object of type `BankAccount` represents a bank account that has some balance and pays some interest rate. The balance and interest rate can be set with the member function `set`. Notice that we have overloaded the member function named `set` so that there are two versions of `set`. One version has three formal parameters, and the other has only two formal parameters. Both versions have a formal parameter of type `double` for the interest rate, but the two versions of `set` use different formal parameters to set the account balance. One version has two formal parameters to set the balance, one for the dollars and one for the cents in the account balance. The other version has only a single formal parameter, which gives the number of dollars in the account and assumes that the number of cents is zero. This second version of `set` is handy, since most people open an account with some “even” amount of money, such as \$1,000 and no cents. Notice that this overloading is nothing new. A member function is overloaded in the same way as an ordinary function is overloaded.

Summary of Some Properties of Classes

Classes have all of the properties that we described for structures plus all the properties associated with member functions. The following is a list of some points to keep in mind when using classes.

- Classes have both member variables and member functions.
- A member (either a member variable or a member function) may be either public or private.

- Normally, all the member variables of a class are labeled as private members.
- A private member of a class cannot be used except within the definition of another member function of the same class.
- The name of a member function for a class may be overloaded just like the name of an ordinary function.
- A class may use another class as the type for a member variable.
- A function may have formal parameters whose types are classes. (See Self-Test Exercises 19 and 20.)
- A function may return an object; that is, a class may be the type for the value returned by a function. (See Self-Test Exercise 21.)

Structures Versus Classes

Structures are normally used with all member variables being public and having no member functions. However, in C++ a structure can have private member variables and both public and private member functions. Aside from some notational differences, a C++ structure can do anything a class can do. Having said this and satisfied the “truth in advertising” requirement, we advocate that you forget this technical detail about structures. If you take this technical detail seriously and use structures in the same way that you use classes, then you have two names (with different syntax rules) for the same concept. On the other hand, if you use structures as we described them, then you will have a meaningful difference between structures (as you use them) and classes, and your usage will be the same as that of most other programmers.

SELF-TEST EXERCISES

19. Give a definition for the function with the following function declaration. The class `BankAccount` is defined in Display 10.5.

```
double difference(BankAccount account1, BankAccount account2);  
//Precondition: account1 and account2 have been given values  
 //(that is, their member variables have been given values).  
//Returns the balance in account1 minus the balance in  
account2.
```
20. Give a definition for the function with the following function declaration. The class `BankAccount` is defined in Display 10.5. (*Hint: It's easy if you use a member function.*)

```
void double_update(BankAccount& the_account);
//Precondition: the_account has previously been given a value
//(that is, its member variables have been given values).
//Postcondition: The account balance has been changed so that
//two years' interest has been posted to the account.
```

21. Give a definition for the function with the following function declaration. The class `BankAccount` is defined in Display 10.5.

```
BankAccount new_account(BankAccount old_account);
//Precondition: old_account has previously been given a value
//(that is, its member variables have been given values).
//Returns the value for a new account that has a balance of zero
//and the same interest rate as the old_account.
```

For example, after this function is defined, a program could contain the following:

```
BankAccount account3, account4;
account3.set(999, 99, 5.5);
account4 = new_account(account3);
account4.output(cout);
```

This would produce the following output:

```
Account balance $0.00
Interest rate 5.50%
```

Constructors for Initialization

You often want to initialize some or all the member variables for an object when you declare the object. As we will see later in this book, there are other initializing actions you might also want to take, but initializing member variables is the most common sort of initialization. C++ includes special provisions for such initializations. When you define a class, you can define a special kind of member function known as a **constructor**. A constructor is a member function that is automatically called when an object of that class is declared. A constructor is used to initialize the values of member variables and to do any other sort of initialization that may be needed. You can define a constructor the same way that you define any other member function, except for two points:

1. A constructor must have the same name as the class. For example, if the class is named `BankAccount`, then any constructor for this class must be named `BankAccount`.
2. A constructor definition cannot return a value. Moreover, no return type, not even `void`, can be given at the start of the function declaration or in the function header.

For example, suppose we wanted to add a constructor for initializing the balance and interest rate for objects of type `BankAccount` shown in Display 10.5. The class definition could be as follows. (We have omitted some of the comments to save space, but they should be included.)

```
class BankAccount
{
public:
    BankAccount(int dollars, int cents, double rate);
    //Initializes the account balance to $dollars.cents and
    //initializes the interest rate to rate percent.

    void set(int dollars, int cents, double rate);
    void set(int dollars, double rate);
    void update();

    double get_balance();
    double get_rate();
    void output(ostream& outs);
private:
    double balance;
    double interest_rate;
    double fraction(double percent);
};
```

Notice that the constructor is named `BankAccount`, which is the name of the class. Also notice that the function declaration for the constructor `BankAccount` does not start with `void` or with any other type name. Finally, notice that the constructor is placed in the public section of the class definition. Normally, you should make your constructors public member functions. If you were to make all your constructors private members, then you would not be able to declare any objects of that class type, which would make the class completely useless.

With the redefined class `BankAccount`, two objects of type `BankAccount` can be declared and initialized as follows:

```
BankAccount account1(10, 50, 2.0), account2(500, 0, 4.5);
```

Assuming that the definition of the constructor performs the initializing action that we promised, the previous declaration will declare the object `account1`, set the value of `account1.balance` to 10.50, and set the value of `account1.interest_rate` to 2.0. Thus, the object `account1` is initialized so that it represents a bank account with a balance of \$10.50 and an interest rate of 2.0%. Similarly, `account2` is initialized so that it represents a bank account with a balance of \$500.00 and an interest rate of 4.5%. What happens is that the object `account1` is declared and then the constructor `BankAccount` is called with the three arguments 10, 50, and 2.0. Similarly, `account2` is declared and then the constructor `BankAccount` is called with the arguments 500, 0, and 4.5. The result is conceptually equivalent to the following (although you cannot write it this way in C++):

```

BankAccount account1, account2; //PROBLEMS--BUT FIXABLE
account1.BankAccount(10, 50, 2.0); //VERY ILLEGAL
account2.BankAccount(500, 0, 4.5); //VERY ILLEGAL

```

As the comments indicate, you cannot place those three lines in your program. The first line can be made to be acceptable, but the two calls to the constructor `BankAccount` are illegal. A constructor cannot be called in the same way as an ordinary member function is called. Still, it is clear what we want to happen when we write those three lines, and that happens automatically when you declare the objects `account1` and `account2` as follows:

```
BankAccount account1(10, 50, 2.0), account2(500, 0, 4.5);
```

The definition of a constructor is given in the same way as any other member function. For example, if you revise the definition of the class `BankAccount` by adding the constructor just described, you need to also add the following definition of the constructor:

```

BankAccount::BankAccount(int dollars, int cents, double rate)
{
    if ((dollars < 0) || (cents < 0) || (rate < 0))
    {
        cout << "Illegal values for money or interest rate.\n";
        exit(1);
    }
    balance = dollars + 0.01*cents;
    interest_rate = rate;
}

```

Since the class and the constructor function have the same name, the name `BankAccount` occurs twice in the function heading: The `BankAccount` before the scope resolution operator `::` is the name of the class, and the `BankAccount` after the scope resolution operator is the name of the constructor function. Also notice that no return type is specified in the heading of the constructor definition, not even the type `void`. Aside from these points, a constructor can be defined in the same way as an ordinary member function.

You can overload a constructor name like `BankAccount::BankAccount`, just as you can overload any other member function name, such as we did with `BankAccount::set` in Display 10.5. In fact, constructors usually are overloaded so that objects can be initialized in more than one way. For example, in Display 10.6 we have redefined the class `BankAccount` so that it has three versions of its constructor. This redefinition overloads the constructor name `BankAccount` so that it may have three arguments (as we just discussed), two arguments, or no arguments.

For example, suppose you give only two arguments when you declare an object of type `BankAccount`, as in the following example:

```
BankAccount account1(100, 2.3);
```

Then the object `account1` is initialized so that it represents an account with a balance of \$100.00 and an interest rate of 2.3%.

On the other hand, if no arguments are given, as in the following example,

```
BankAccount account2;
```

then the object is initialized to represent an account with a balance of \$0.00 and an interest rate of 0.0%. Notice that when the constructor has no arguments, you do not include any parentheses in the object declaration. The following is incorrect:

```
BankAccount account2(); //WRONG! DO NOT DO THIS!
```

In some cases, you can omit mutator member functions such as `set` once you have a good set of constructor definitions. You can use the overloaded constructor `BankAccount` in Display 10.6 to create a new `BankAccount` object with the values of your choice. However, invoking the constructor will create a new object, so if you want to change the existing member variables in the object, then you should use a mutator function.

DISPLAY 10.6 Class with Constructors (part 1 of 3)

```
1 //Program to demonstrate the class BankAccount.
2 #include <iostream>
3 using namespace std;
4 //Class for a bank account:
5 class BankAccount
6 {
7 public:
8     BankAccount(int dollars, int cents, double rate);
9     //Initializes the account balance to $dollars.cents and
10    //initializes the interest rate to rate percent.
11
12    BankAccount(int dollars, double rate);
13    //Initializes the account balance to $dollars.00 and
14    //initializes the interest rate to rate percent.
15
16    BankAccount( );
17    //Initializes the account balance to $0.00
18    //and the interest rate to 0.0%.
19
20    void set(int dollars, int cents, double rate);
21    //Postcondition: The account balance has been set to $dollars.cents;
22    //The interest rate has been set to rate percent.
23
24    void set(int dollars, double rate);
25    //Postcondition: The account balance has been set to $dollars.00.
26    //The interest rate has been set to rate percent.
27
28    void update( );
```

This definition of `BankAccount` is an improved version of the class `BankAccount` given in Display 10.5.

(continued)

DISPLAY 10.6 Class with Constructors (part 2 of 3)

```

24     //Postcondition: One year of simple interest has been added
25     //to the account balance.
26     double get_balance( );
27     //Returns the current account balance.
28     double get_rate( );
29     //Returns the current account interest rate as a percentage.
30     void output(ostream& outs);
31     //Precondition: If outs is a file output stream, then
32     //outs has already been connected to a file.
33     //Postcondition: Account balance and interest rate
34     //have been written to the stream outs.
35 private:
36     double balance;
37     double interest_rate;
38     double fraction(double percent);
39     //Converts a percentage to a fraction. For example, fraction(50.3)
40     //returns 0.503.
41 };
42 int main( )
43 {
44     BankAccount account1(100, 2.3), account2;
45     cout << "account1 initialized as follows:\n";
46     account1.output(cout);
47     cout << "account2 initialized as follows:\n";
48     account2.output(cout);
49     account1 = BankAccount(999, 99, 5.5);
50     cout << "account1 reset to the following:\n";
51     account1.output(cout);
52     return 0;
53 }
54 BankAccount::BankAccount(int dollars, int cents, double rate)
55 {
56     if ((dollars < 0) || (cents < 0) || (rate < 0))
57     {
58         cout << "Illegal values for money or interest rate.\n";
59         exit(1);
60     }
61     balance = dollars + 0.01 * cents;
62     interest_rate = rate;
63 }
64 BankAccount::BankAccount(int dollars, double rate)
65 {

```

This declaration causes a call to the default constructor. Notice that there are no parentheses.

An explicit call to the constructor `BankAccount::BankAccount`

(continued)

DISPLAY 10.6 Class with Constructors (part 3 of 3)

```
66     if ((dollars < 0) || (rate < 0))
67     {
68         cout << "Illegal values for money or interest rate.\n";
69         exit(1);
70     }
71     balance = dollars;
72     interest_rate = rate;
73 }
74 BankAccount::BankAccount( ) : balance(0), interest_rate(0.0)
75 {
76     //Body intentionally empty
77 }
```

<Definitions of the other member functions are the same as in Display 10.5.

Screen Output

```
account1 initialized as follows:
Account balance $100.00
Interest rate 2.30%
account2 initialized as follows:
Account balance $0.00
Interest rate 0.00%
account1 reset to the following:
Account balance $999.99
Interest rate 5.50%
```

Constructor

A **constructor** is a member function of a class that has the same name as the class. A constructor is called automatically when an object of the class is declared. Constructors are used to initialize objects. A constructor must have the same name as the class of which it is a member.

The constructor with no parameters in Display 10.6 deserves some extra discussion since it contains something we have not seen before. For reference, we reproduce the defining of the constructor with no parameters:

```

BankAccount::BankAccount() : balance(0), interest_rate(0.0)
{
    //Body intentionally empty
}

```

The new element, which is shown on the first line, is the part that starts with a single colon. This part of the constructor definition is called the **initialization section**. As this example shows, the initialization section goes after the parentheses that ends the parameter list and before the opening brace of the function body. The initialization section consists of a colon followed by a list of some or all the member variables separated by commas. Each member variable is followed by its initializing value in parentheses. This constructor definition is completely equivalent to the following way of writing the definition:

```

BankAccount::BankAccount( )
{
    balance = 0;
    interest_rate = 0.0;
}

```

The function body in a constructor definition with an initialization section need not be empty. For example, the following definition of the two-parameter constructor is equivalent to the one given in Display 10.6:

```

BankAccount::BankAccount(int dollars, double rate)
    : balance(dollars), interest_rate(rate)
{
    if ((dollars < 0) || (rate < 0))
    {
        cout << "Illegal values for money or interest rate.\n";
        exit(1);
    }
}

```

Notice that the initializing values can be given in terms of the constructor parameters.

Constructor Initialization Section

Some or all of the member variables in a class can (optionally) be initialized in the **constructor initialization section** of a constructor definition. The constructor initialization section goes after the parentheses that end the parameter list and before the opening brace of the function body. The initialization section consists of a colon followed by a list of some or all the member variables separated by commas. Each member variable is followed by its initializing value in parentheses. The example given below uses a constructor initialization section and is equivalent to the three-parameter constructor given in Display 10.6.

(continued)

EXAMPLE

```

BankAccount::BankAccount(int dollars, int cents,
                        double rate)
    : balance(dollars + 0.01*cents), interest_rate(rate)
{
    if ((dollars < 0) || (cents < 0) || (rate < 0))
    {
        cout <<
            "Illegal values for money or interest rate.\n";
        exit(1);
    }
}

```

Notice that the initializing values can be given in terms of the constructor parameters.

Calling a Constructor

A constructor is called automatically when an object is declared, but you must give the arguments for the constructor when you declare the object. A constructor can also be called explicitly in order to create a new object for a class variable.

SYNTAX (for an object declaration when you have constructors)

```
Class_Name Object_Name(Arguments_for_Constructor);
```

EXAMPLE

```
BankAccount account1(100, 2.3);
```

SYNTAX (for an explicit constructor call)

```
Object = Constructor_Name(Arguments_For_Constructor);
```

EXAMPLE

```
account1 = BankAccount(200, 3.5);
```

A constructor must have the same name as the class of which it is a member. Thus, in the syntax descriptions above, *Class_Name* and *Constructor_Name* are the same identifier.

Initializers can also be specified if the object is created as a dynamic variable.

```
BankAccount *myAcct; myAcct = new BankAccount (300, 4.2);
```

A constructor is called automatically whenever you declare an object of the class type, but it can also be called again after the object has been declared. This allows you to conveniently set all the members of an object. The technical details are as follows. Calling the constructor creates an anonymous object with new values. An anonymous object is an object that is not named (as yet) by any variable. The anonymous object can be assigned to the named object (that is, to the class variable). For example, the following line of code is a call to the constructor `BankAccount` that creates an anonymous object with a balance of \$999.99 and interest rate of 5.5%. This anonymous object is assigned to object `account1` so that it too represents an account with a balance of \$999.99 and an interest rate of 5.5%:

```
account1 = BankAccount(999, 99, 5.5);
```

As you might guess from the notation, a constructor behaves like a function that returns an object of its class type. However, since a call to a constructor always creates a new object and a call to a set member function merely changes the values of existing member variables, a call to set may be a more efficient way to change the values of member variables than a call to a constructor. Thus, for efficiency reasons or if you need to change the values of member variables without creating a new object, you may wish to have both the set member functions and the constructors in your class definition.

■ PROGRAMMING TIP Always Include a Default Constructor

C++ does not always generate a default constructor for the classes you define. If you give no constructor, the compiler will generate a default constructor that does nothing. This constructor will be called if class objects are declared. On the other hand, if you give at least one constructor definition for a class, then the C++ compiler will generate no other constructors. Every time you declare an object of that type, C++ will look for an appropriate constructor definition to use. If you declare an object without using arguments for the constructor, C++ will look for a default constructor, and if you have not defined a default constructor, none will be there for it to find.

For example, suppose you define a class as follows:

```
class SampleClass
{
public:
    SampleClass(int parameter1, double parameter2);
    void do_stuff();
private:
    int data1;
    double data2;
};
```

Constructor that requires two arguments

You should recognize the following as a legal way to declare an object of type `SampleClass` and call the constructor for that class:

```
SampleClass my_object(7, 7.77);
```

However, you may be surprised to learn that the following is illegal:

```
SampleClass your_object;
```

The compiler interprets this declaration as including a call to a constructor with no arguments, but there is no definition for a constructor with zero arguments. You must either add two arguments to the declaration of `your_object` or add a constructor definition for a constructor with no arguments.

A constructor that can be called with no arguments is called a **default constructor**, since it applies in the default case where you declare an object without specifying any arguments. Since it is likely that you will sometimes want to declare an object without giving any constructor arguments, you should always include a default constructor. The following redefined version of `SampleClass` includes a default constructor:

```
class SampleClass
{
public:
    SampleClass(int parameter1, double parameter2);
    SampleClass();           Default constructor
    void do_stuff();
private:                    ←
    int data1;
    double data2;
};
```

If you redefine the class `SampleClass` in this manner, then the previous declaration of `your_object` would be legal.

If you do not want the default constructor to initialize any member variables, you can simply give it an empty body when you implement it. The following constructor definition is perfectly legal. It does nothing when called except make the compiler happy:

```
SampleClass::SampleClass()
{
    //Do nothing.
}
```

Note that if a class is created as a dynamic variable using the `new` operator then the default constructor is invoked. ■

PITFALL Constructors with No Arguments

If a constructor for a class called `BankAccount` has two formal parameters, you declare an object and give the arguments to the constructor as follows:

```
BankAccount account1(100, 2.3);
```

To call the constructor with no arguments, you would naturally think that you would declare the object as follows:

```
BankAccount account2(); //THIS WILL CAUSE PROBLEMS.
```

After all, when you call a function that has no arguments, you include a pair of empty parentheses. However, this is wrong for a constructor. Moreover, it may not produce an error message, since it does have an unintended meaning. The compiler will think that this code is the function declaration for a function called `account2` that takes no arguments and returns a value of type `BankAccount`.

Do not include parentheses when you declare an object and want C++ to use the constructor with no arguments. The correct way to declare `account2` using the constructor with no arguments is as follows:

```
BankAccount account2;
```

However, if you explicitly call a constructor in an assignment statement, you do use the parentheses. If the definitions and declarations are as in Display 10.6, then the following will set the account balance for `account1` to \$0.00 and set the interest rate to 0.0%:

```
account1 = BankAccount();
```

Constructors with No Arguments

When you declare an object and want the constructor with zero arguments to be called, you do not include any parentheses. For example, to declare an object and pass two arguments to the constructor, you might do the following:

```
BankAccount account1(100, 2.3);
```

However, if you want the constructor with zero arguments to be used, declare the object as follows:

```
BankAccount account1;
```

You do *not* declare the object as follows:

```
BankAccount account1(); //INCORRECT DECLARATION
```

(The problem is that this syntax declares a function named `account1` that returns a `BankAccount` object and has no parameters.)



Member Initializers and Constructor Delegation in C++11

C++11 supports a feature called *member initialization* that is present in most object-oriented programming languages. This feature allows you to set default values for member variables. When an object is created the member variables are automatically initialized to the specified values. Consider the following definition and implementation of the `Coordinate` class:

```
class Coordinate
{
public:
    Coordinate();
    Coordinate(int x);
    Coordinate(int x, int y);
    int getX();
    int getY();
private:
    int x=1;
    int y=2;
};
Coordinate::Coordinate()
{ }
Coordinate::Coordinate(int xval) : x(xval)
{ }
Coordinate::Coordinate(int xval, int yval) : x(xval), y(yval)
{ }
int Coordinate::getX()
{
    return x;
}
int Coordinate::getY()
{
    return y;
}
```

If we create a `Coordinate` object, then member variable `x` will be set to 1 and member variable `y` will be set to 2 by default. These values can be overridden if we invoke a constructor that explicitly sets the variable. In the snippet below, the default values for `x` and `y` are set for `c1`, but for `c2` the default value is only set for `y` because `x` is explicitly set to the input argument:

```
Coordinate c1, c2(10);
cout << c1.getX() << " " << c1.getY() << endl; // Outputs 1 2
cout << c2.getX() << " " << c2.getY() << endl; // Outputs 10 2
```

A related feature supported by C++11 is *constructor delegation*. Simply put, this allows one constructor to call another constructor. For example, we could modify the implementation of the default constructor so it invokes the constructor with two parameters:



VideoNote
Default Initialization
of Member Variables

```
Coordinate::Coordinate() : Coordinate(99,99)
{ }
```

The object defined by `Coordinate c1;` will invoke the default constructor which will in turn invoke the constructor to set `x` to 99 and `y` to 99.

SELF-TEST EXERCISES

22. Suppose your program contains the following class definition (along with definitions of the member functions):

```
class YourClass
{
public:
    YourClass(int new_info, char more_new_info);
    YourClass();
    void do_stuff();
private:
    int information;
    char more_information;
};
```

Which of the following are legal?

```
YourClass an_object(42, 'A');
YourClass another_object;
YourClass yet_another_object();
an_object = YourClass(99, 'B');
an_object = YourClass();
an_object = YourClass;
```

23. How would you change the definition of the class `DayOfYear` in Display 10.4 so that it has two versions of an (overloaded) constructor? One version should have two `int` formal parameters (one for the month and one for the day) and should set the private member variables to represent that month and day. The other should have no formal parameters and should set the date represented to January 1. Do this without using a constructor initialization section in either constructor.
24. Redo the previous exercise, but this time use a constructor initialization section to initialize all member functions in each constructor.

10.3 ABSTRACT DATA TYPES

We all know — the Times knows — but we pretend we don't.

VIRGINIA WOOLF, *Monday or Tuesday*

A data type, such as the type *int*, has certain specified values, such as 0, 1, -1, 2, and so forth. You tend to think of the data type as being these values, but the operations on these values are just as important as the values. Without the operations, you could do nothing of interest with the values. The operations for the type *int* consist of +, -, *, /, %, and a few other operators and predefined library functions. You should not think of a data type as being simply a collection of values. A **data type** consists of a collection of values together with a set of basic operations defined on those values.

A data type is called an **abstract data type** (abbreviated ADT) if the programmers who use the type do not have access to the details of how the values and operations are implemented. The predefined types, such as *int*, are abstract data types (ADTs). You do not know how the operations, such as + and *, are implemented for the type *int*. Even if you did know, you would not use this information in any C++ program.

Programmer-defined types, such as the structure types and class types, are not automatically ADTs. Unless they are defined and used with care, programmer-defined types can be used in unintuitive ways that make a program difficult to understand and difficult to modify. The best way to avoid these problems is to make sure all the data types that you define are ADTs. The way that you do this in C++ is to use classes, but not every class is an ADT. To make it an ADT you must define the class in a certain way, and that is the topic of the next subsection.

Classes to Produce Abstract Data Types

A class is a type that you define, as opposed to the types, such as *int* and *char*, that are already defined for you. A value for a class type is the set of values of the member variables. For example, a value for the type *BankAccount* in Display 10.6 consists of two numbers of type *double*. For easy reference, we repeat the class definition (omitting only the comments):

```
class BankAccount
{
public:
    BankAccount(int dollars, int cents, double rate);
    BankAccount(int dollars, double rate);
    BankAccount();
    void set(int dollars, int cents, double rate);
    void set(int dollars, double rate);
    void update();
    double get_balance();
    double get_rate();
    void output(ostream& outs);
private:
    double balance;
    double interest_rate;
    double fraction(double percent);
};
```

The programmer who uses the type `BankAccount` need not know how you implemented the definition of `BankAccount::update` or any of the other member functions. The function definition for the member function `BankAccount::update` that we used is as follows:

```
void BankAccount::update()
{
    balance = balance + fraction(interest_rate) * balance;
}
```

However, we could have dispensed with the private function `fraction` and implemented the member function `update` with the following slightly more complicated formula:

```
void BankAccount::update()
{
    balance = balance + (interest_rate / 100.0) * balance;
}
```

The programmer who uses the class `BankAccount` need not be concerned with which implementation of `update` we used, since both implementations have the same effect.

Similarly, the programmer who uses the class `BankAccount` need not be concerned about how the values of the class are implemented. We chose to implement the values as two values of type `double`. If `vacation_savings` is an object of type `BankAccount`, the value of `vacation_savings` consists of the two values of type `double` stored in the following two member variables:

```
vacation_savings.balance
vacation_savings.interest_rate
```

However, you do not want to think of the value of the object `vacation_savings` as two numbers of type `double`, such as $1.3546e + 2$ and 4.5 . You want to think of the value of `vacation_savings` as the single entry

```
Account balance $135.46
Interest rate 4.50%
```

That is why our implementation of `BankAccount::output` writes the class value in this format.

The fact that we chose to implement this `BankAccount` value as the two `double` values $1.3546e + 2$ and 4.5 is an implementation detail. We could instead have implemented this `BankAccount` value as the two `int` values 135 and 46 (for the dollars and cents part of the balance) and the single value 0.045 of type `double`. The value 0.045 is simply 4.5% converted to a fraction, which might be a more useful way to implement a percentage figure. After all, in order to compute interest on the account we convert a percentage to just such a fraction. With this alternative implementation of the class `BankAccount`, the public members would remain unchanged but the private members would change to the following:

```

class BankAccount
{
public:
    <This part is exactly the same as before>
private:
    int dollars_part;
    int cents_part;
    double interest_rate;
    double fraction(double percent);
};

```

We would need to change the member function definitions to match this change, but that is easy to do. For example, the function definitions for `get_balance` and one version of the constructor could be changed to the following:

```

double BankAccount::get_balance()
{
    return (dollars_part + 0.01 * cents_part);
}

BankAccount::BankAccount(int dollars, int cents, double rate)
{
    if ((dollars < 0) || (cents < 0) || (rate < 0))
    {
        cout << "Illegal values for money or interest rate.\n";
        exit(1);
    }
    dollars_part = dollars;
    cents_part = cents;
    interest_rate = rate;
}

```

Similarly, each of the other member functions could be redefined to accommodate this new way of storing the account balance and the interest rate.

Notice that even though the user may think of the account balance as a single number, that does not mean the implementation has to be a single number of type *double*. You have just seen that it could, for example, be two numbers of type *int*. The programmer who uses the type `BankAccount` need not know any of this detail about how the values of the type `BankAccount` are implemented.

These comments about the type `BankAccount` illustrate the basic technique for defining a class so that it will be an abstract data type. In order to define a class so that it is an abstract data type, you need to separate the specification of how the type is used by a programmer from the details of how the type is implemented. The separation should be so complete that you can change the implementation of the class without needing to make any changes in any program that uses the class ADT. One way to ensure this separation is to follow these rules:

[How to write an ADT](#)

1. Make all the member variables private members of the class.
2. Make each of the basic operations that the programmer needs a public member function of the class, and fully specify how to use each such public member function.
3. Make any helping functions private member functions.

In Chapters 11 and 12 you will learn some alternative approaches to defining ADTs, but these three rules are one common way to ensure that a class is an abstract data type.

The **interface** of an ADT tells you how to use the ADT in your program. When you define an ADT as a C++ class, the interface consists of the public member functions of the class along with the comments that tell you how to use these public member functions. The interface of the ADT should be all you need to know in order to use the ADT in your program.

The **implementation** of the ADT tells how this interface is realized as C++ code. The implementation of the ADT consists of the private members of the class and the definitions of both the public and private member functions. Although you need the implementation in order to run a program that uses the ADT, you should not need to know anything about the implementation in order to write the rest of a program that uses the ADT; that is, you should not need to know anything about the implementation in order to write the main part of the program and to write any nonmember functions used by the main part of the program. The situation is similar to what we advocated for ordinary function definitions in Chapters 4 and 5. The implementation of an ADT, like the implementation of an ordinary function, should be thought of as being in a black box that you cannot see inside.

In Chapter 12 you will learn how to place the interface and implementation of an ADT in files separate from each other and separate from the programs that use the ADT. That way a programmer who uses the ADT literally does not see the implementation. Until then, we will place all of the details about our ADT classes in the same file as the main part of our program, but we still think of the interface (given in the public section of the class definitions) and the implementation (the private section of the class definition and the member function definitions) as separate parts of the ADT. We will strive to write our ADTs so that the user of the ADT need only know about the interface of the ADT and need not know anything about the implementation. To be sure you are defining your ADTs this way, simply make sure that if you change the implementation of your ADT, your program will still work without your needing to change any other part of the program. This is illustrated in the next Programming Example.

The most obvious benefit you derive from making your classes ADTs is that you can change the implementation without needing to change the other parts of your program. But ADTs provide more benefits than that. If you make your classes ADTs, you can divide work among different programmers,

Separate
interface and
implementation



VideoNote
Separate Interface and
Implementation

with one programmer designing and writing the ADT and other programmers using the ADT. Even if you are the only programmer working on a project, you have divided one larger task into two smaller tasks, which makes your program easier to design and easier to debug.

PROGRAMMING EXAMPLE

Alternative Implementation of a Class

Display 10.7 contains the alternative implementation of the ADT class `BankAccount` discussed in the previous subsection. In this version, the data for a bank account is implemented as three member values: one for the dollars part of the account balance, one for the cents part of the account balance, and one for the interest rate.

Notice that, although both the implementation in Display 10.6 and the implementation in Display 10.7 each have a member variable called `interest_rate`, the value stored is slightly different in the two implementations. If the account pays interest at a rate of 4.7%, then in the implementation in Display 10.6 (which is basically the same as the one in Display 10.5), the value of `interest_rate` is 4.7. However, in the implementation in Display 10.7, the value of `interest_rate` would be 0.047. This alternative implementation, shown in Display 10.7, stores the interest rate as a fraction rather than as a percentage figure. The basic difference in this new implementation is that when an interest rate is set, the function `fraction` is used to immediately convert the interest rate to a fraction. Hence, in this new implementation the private member function `fraction` is used in the definitions of constructors, but it is not needed in the definition of the member function `update` because the value in the member variable `interest_rate` has already been converted to a fraction. In the old implementation (shown in Display 10.5 and Display 10.6), the situation was just the reverse. In the old implementation, the private member function `fraction` was not used in the definition of constructors, but was used in the definition of `update`.

Although we have changed the private members of the class `BankAccount`, we have not changed anything in the public section of the class definition. The public member functions have the same function declarations and they behave exactly as they did in the old version of the ADT class given in Display 10.6. For example, although this new implementation stores a percentage such as 4.7% as the fraction 0.047, the member function `get_rate` still returns the value 4.7, just as it would for the old implementation in Display 10.5. Similarly, the member function `get_balance` returns a single value of type `double`, which gives the balance as a number with a decimal point, just as it did in the old implementation in Display 10.5. This is true even though the balance is now stored in two member variables of type `int`, rather than in a single member variable of type `double` (as in the old versions).

The public interface is not changed

DISPLAY 10.7 Alternative BankAccount Class Implementation (part 1 of 4)

```

1 //Demonstrates an alternative implementation of the class BankAccount.
2 #include <iostream>
3 #include <cmath>
4 using namespace std;
5 //Class for a bank account:
6 class BankAccount
7 {
8 public:
9     BankAccount(int dollars, int cents, double rate);
10    //Initializes the account balance to $dollars.cents and
11    //initializes the interest rate to rate percent.
12
13    BankAccount(int dollars, double rate);
14    //Initializes the account balance to $dollars.00 and
15    //initializes the interest rate to rate percent.
16
17    BankAccount( );
18    //Initializes the account balance to $0.00 and the
19    //interest rate to 0.0%.
20
21    void set(int dollars, int cents, double rate);
22    //Postcondition: The account balance has been set to $dollars.cents;
23    //The interest rate has been set to rate percent.
24
25    void set(int dollars, double rate);
26    //Postcondition: The account balance has been set to $dollars.00.
27    //The interest rate has been set to rate percent.
28
29    void update( );
30    //Postcondition: One year of simple interest has been
31    //added to the account balance.
32
33    double get_balance( );
34    //Returns the current account balance.
35
36    double get_rate( );
37    //Returns the current account interest rate as a percentage.
38
39    void output(ostream& outs);
40    //Precondition: If outs is a file output stream, then
41    //outs has already been connected to a file.
42    //Postcondition: Account balance and interest rate
43    //have been written to the stream outs.
44 private:
45     int dollars_part;
46     int cents_part;
47     double interest_rate;
48     //Expressed as a fraction, for example, 0.057 for 5.7%

```

Notice that the public members of **BankAccount** look and behave exactly the same as in Display 10.6

(continued)

DISPLAY 10.7 Alternative BankAccount Class Implementation (part 2 of 4)

```

41     double fraction(double percent);
42     //Converts a percentage to a fraction. For example, fraction(50.3)
43     //returns 0.503.
44     double percent(double fraction_value); ← New
45     //Converts a fraction to a percentage. For example, percent(0.503)
46     //returns 50.3.
47 };
48 int main( )
49 {
50     BankAccount account1(100, 2.3), account2;
51
52     cout << "account1 initialized as follows:\n";
53     account1.output(cout);
54     cout << "account2 initialized as follows:\n";
55     account2.output(cout);
56
57     account1 = BankAccount(999, 99, 5.5);
58     cout << "account1 reset to the following:\n";
59     account1.output(cout);
60     return 0;
61 }
62 BankAccount::BankAccount(int dollars, int cents, double rate)
63 {
64     if ((dollars < 0) || (cents < 0) || (rate < 0))
65     {
66         cout << "Illegal values for money or interest rate.\n";
67         exit(1);
68     }
69     dollars_part = dollars;
70     cents_part = cents;
71     interest_rate = fraction(rate);
72 }
73 BankAccount::BankAccount(int dollars, double rate)
74 {
75     if ((dollars < 0) || (rate < 0))
76     {
77         cout << "Illegal values for money or interest rate.\n";
78         exit(1);
79     }
80     dollars_part = dollars;
81     cents_part = 0;
82     interest_rate = fraction(rate);
83 }
84 BankAccount::BankAccount( ) : dollars_part(0), cents_part(0), interest_rate(0.0)
85

```

Since the body of `main` is identical to that in Display 10.6, the screen output is also identical to that in Display 10.6

In the old implementation of this ADT, the private member function `fraction` was used in the definition of `update`. In this implementation, `fraction` is instead used in the definition of constructors and in the set function.

(continued)

DISPLAY 10.7 Alternative BankAccount Class Implementation (part 3 of 4)

```

86  {
87      //Body intentionally empty.
88  }
89  double BankAccount::fraction(double percent_value)
90  {
91      return (percent_value/100.0);
92  }
93  //Uses cmath:
94  void BankAccount::update( )
95  {
96      double balance = get_balance( );
97      balance = balance + interest_rate * balance;
98      dollars_part = static_cast<int>(floor(balance));
99      cents_part = static_cast<int>(floor((balance - dollars_part)*100));
100 }
101 double BankAccount::get_balance( )
102 {
103     return (dollars_part + 0.01 * cents_part);
104 }
105 double BankAccount::percent(double fraction_value)
106 {
107     return (fraction_value * 100);
108 }
109 double BankAccount::get_rate( )
110 {
111     return percent(interest_rate);
112 }
113 //Uses iostream:
114 void BankAccount::output(ostream& outs)
115 {
116     outs.setf(ios::fixed);
117     outs.setf(ios::showpoint);
118     outs.precision(2);
119     outs << "Account balance $" << get_balance( ) << endl;
120     outs << "Interest rate " << get_rate( ) << "%" << endl;
121 }
122 void BankAccount::set(int dollars, int cents, double rate)
123 {
124     if ((dollars < 0) || (cents < 0) || (rate < 0))
125     {
126         cout << "Illegal values for money or interest rate.\n";
127         exit(1);
128     }

```

The new definitions of `get_balance` and `get_rate` ensure that the output will still be in the correct units.

(continued)

DISPLAY 10.7 Alternative BankAccount Class Implementation (part 4 of 4)

```
129     dollars_part = dollars;
130     cents_part = cents;
131     interest_rate = fraction(rate);
132 }
133 void BankAccount::set(int dollars, double rate)
134 {
135     if ((dollars < 0) || (rate < 0))
136     {
137         cout << "Illegal values for money or interest rate.\n";
138         exit(1);
139     }
140     dollars_part = dollars;
141     interest_rate = fraction(rate);
142 }
```

Notice that there is an important difference between how you treat the public member functions and how you treat the private member functions. If you want to preserve the interface of an ADT class so that any programs that use it need not change (other than changing the definitions of the class and its member functions), then you must leave the public member function declarations unchanged. However, you are free to add, delete, or change any of the private member functions. In this example, we have added one additional private function called `percent`, which is the inverse of the function `fraction`. The function `fraction` converts a percentage to a fraction, and the function `percent` converts a fraction back to a percentage. For example, `fraction(4.7)` returns 0.047, and `percent(0.047)` returns 4.7.

Changing private member functions

Information Hiding

We discussed information hiding when we introduced functions in Chapter 3. We said that **information hiding**, as applied to functions, means that you should write your functions so that they could be used as black boxes, that is, so that the programmer who uses the function need not know any details about how the function is implemented. This principle means that all the programmer who uses a function needs to know is the function declaration and the accompanying comment that explains how to use the function. The use of private member variables and private member functions in the definition of an abstract data type is another way to implement information hiding, but now we apply the principle to data values as well as to functions.

SELF-TEST EXERCISES

25. When you define an ADT as a C++ class, should you make the member variables public or private? Should you make the member functions public or private?
26. When you define an ADT as a C++ class, what items are considered part of the interface for the ADT? What items are considered part of the implementation for the ADT?
27. Suppose your friend defines an ADT as a C++ class in the way we described in Section 10.3. You are given the task of writing a program that uses this ADT. That is, you must write the `main` part of the program as well as any nonmember functions that are used in the `main` part of the program. The ADT is very long and you do not have a lot of time to write this program. What parts of the ADT do you need to read and what parts can you safely ignore?
28. Redo the three- and two-parameter constructors in Display 10.7 so that all member variables are set using a constructor initialization section.

10.4 INTRODUCTION TO INHERITANCE

One of the most powerful features of C++ is the use of *derived classes*. The word *inheritance* is just another name for the topic of derived classes. When we say that one class was derived from another class, we mean that the derived class was obtained from the other class by adding features. For example, suppose we define a class for vehicles that has member variables to record the vehicle's number of wheels and maximum number of occupants. The class also has accessor and mutator functions. Imagine that we then define a class for automobiles that has member variables and functions just like the ones in the class of vehicles. In addition, our automobile class would have added member variables for such things as the amount of fuel in the fuel tank and the license plate number and would also have some added member functions. Instead of repeating the definitions of the member variables and functions of the class of vehicles within the class of automobiles, we could use C++'s inheritance mechanism and let the automobile class inherit all the member variables and functions of the class for vehicles.

Inheritance allows you to define a general class and then later define more specialized classes that add some new details to the existing general class. This saves work because the more specialized, or derived, class inherits all the properties of the general class and you, the programmer, need only program the new features. This section will first introduce the notion of inheritance and a derived class and then we briefly describe how to create your own derived

classes. Details of inheritance are left to Chapter 15. It may take a while before you are completely comfortable with the idea of a derived class, but you easily can learn enough about derived classes to start using them in some simple, and very useful, ways.

Derived Classes

Consider the `BankAccount` class defined in Display 10.7. This class keeps track of an amount and interest rate for a bank account—fairly generic features that apply to any interest-bearing account. If we would like to implement more specific types of bank accounts, then there is a natural hierarchy for grouping the account types. Display 10.8 depicts a part of this hierarchical arrangement for bank accounts, checking accounts, money market accounts, savings accounts, and Certificate of Deposit (CD) accounts. In the hierarchy, `BankAccount` is the most general type of account; more specific types of accounts are shown underneath. An arrow points from a specific account type to a more general account type. In addition to representing different types of bank accounts, each box also corresponds to a class that we can implement in C++.

For example, a checking account does everything a bank account can do (store an amount and interest rate) but in addition allows customers to make deposits and write checks. Similarly, a savings account does everything a bank account can do but in addition allows customers to make deposits and withdrawals. Unlike a checking account, a savings account may not allow customers to write checks. Since both checking accounts and savings accounts are types of bank accounts they are shown in Display 10.8 directly underneath the `BankAccount` class. When we say that some class A is a **derived class** of some other class B, it means that class A has all the features of class B but it also has *added features*. The convention for indicating this relationship in a diagram is to draw an unfilled arrow from the specific to the more general class. For example, in Display 10.8 the `CheckingAccount` and `SavingsAccount` classes are derived classes of the `BankAccount` class.

DISPLAY 10.8 A Class Hierarchy

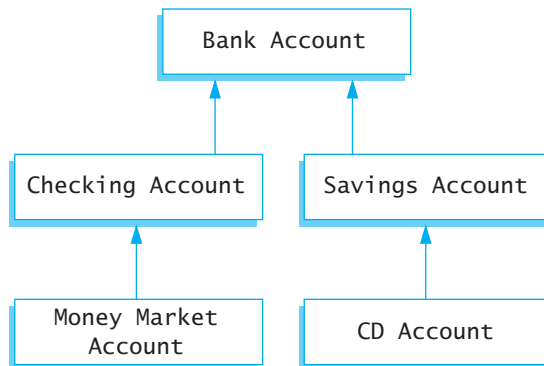

In C++, some class **A** can be a derived class of some other class **B**, which in turn can be a derived class of some other class **C**, and so on. For example, a CD account is similar to a savings account except the funds and any accrued interest must not be withdrawn until after a “maturity” date. If the funds are withdrawn prior to the maturity date, then there is a penalty. Due to these restrictions, a CD account normally accrues interest at a higher rate than a savings account. In the hierarchy, this is shown by deriving `CDAccount` from `SavingsAccount`. Similarly, a money market account is a special type of checking account in which the customer normally has a limit on the number of checks that can be written, along with higher minimum balances, but pays a higher interest rate. In the hierarchy, this is shown by deriving `MoneyMarketAccount` from `CheckingAccount`.

Derived classes are often discussed using the metaphor of inheritance and family relationships. If class **B** is a derived class of class **A**, then class **B** is called a **child** of class **A** and class **A** is called a **parent** of class **B**. The parent class is also referred to as the **base** class. The derived class is said to **inherit** the member functions of its parent class. For example, every convertible inherits the fact that it has four wheels from the class of all automobiles. This is why the topic of derived classes is often called *inheritance*.

Defining Derived Classes

If we want to create a class to represent a savings account, we could start by making a copy of the `BankAccount` class and renaming it to `SavingsAccount`. We would need to add new public member functions to deposit and withdraw funds. While this approach would work, it would be very inefficient, because the `SavingsAccount` class would duplicate most of the functionality in the `BankAccount` class. Not only does this waste memory space, it also becomes more difficult to make modifications. For example, if we later decide to change the `update()` function to accrue interest daily instead of annually, then we would have two places to make the change: in the `SavingsAccount` class and also in the `BankAccount` class. These problems can be solved by defining the `SavingsAccount` class as a derived class of the `BankAccount` class. The `SavingsAccount` class then can share member variables and functions defined in the `BankAccount` class. We specify this relationship when defining the derived class by adding a colon followed by the keyword `public` and the name of the parent or base class:

```
class SavingsAccount : public BankAccount
{
public:
    SavingsAccount(int dollars, int cents, double rate);
    <Other constructors would normally go here>
    void deposit(int dollars, int cents);
    void withdraw(int dollars, int cents);
private:
};
```

The colon separates the derived class, `SavingsAccount`, from the parent class, `BankAccount`

Notice that we only defined functions and data that specifically relate to savings accounts, in this case, functions to deposit and withdraw money. We don't need to redefine all of the variables and functions relating to bank accounts—such as storing the interest rate, dollars, cents, or defining the `update()` function—because those members will be inherited from the `BankAccount` class and are automatically created when we construct a `SavingsAccount` object. For example, if we create a `SavingsAccount` object, we could invoke the following functions:

```
SavingsAccount account(100, 50, 5.5);
account.deposit(10,25);
account.output(cout);
```

*Invoking a function in
the derived class,*

*Invoking a function in the
parent class, **BankAccount***

In this example, inheritance allowed us to reuse code defined in the parent class from the context of the derived class. Moreover, if we later change one of `BankAccount`'s functions—such as `update()`—then the new code automatically will be used from the context of its derived classes when the program is recompiled and linked. An implementation of the `SavingsAccount` class along with a main function to test the `deposit` and `withdraw` functions is given in Display 10.9. For simplicity, we have left verification out of the `deposit` and `withdraw` functions, for example, checking for negative amounts, but you should be able to add them easily with some *if* statements.

Once the `SavingsAccount` class is defined we can go one step further and derive more specialized classes from the `SavingsAccount`. For example, to define the `CD` account class we need a new private member variable to store the days until maturity and define functions to access this variable:

```
class CDAccount : public SavingsAccount
{
public:
    CDAccount(int dollars, int cents, double rate,
             int days_to_maturity);
    <Other constructors would normally go here>
    int get_days_to_maturity( );
    //Returns the number of days until the CD matures
    void decrement_days_to_maturity( );
    //Subtracts one from the days_to_maturity variable
private:
    int days_to_maturity; //Days until the CD matures
};
```

Once again, we only defined functions and data that specifically relate to CD accounts, in this case, storing and manipulating the number of days to maturity. We don't need to redefine all of the variables and functions relating to bank accounts or savings accounts because those members will be inherited from the parent classes. For example, once the functions in the `CDAccount` class are implemented, we could invoke the following functions from the `CDAccount`, `SavingsAccount`, or `BankAccount` classes given a `CDAccount` object:

DISPLAY 10.9 A SavingsAccount Derived Class (part 1 of 2)

<Everything from Display 10.6 should be inserted here except for the main function.>

```

1  class SavingsAccount : public BankAccount
2  {
3  public:
4      SavingsAccount(int dollars, int cents, double rate);
5      //Other constructors would go here
6      void deposit(int dollars, int cents);
7      //Adds $dollars.cents to the account balance
8      void withdraw(int dollars, int cents);
9      //Subtracts $dollars.cents from the account balance
10 private:
11 };
12
13 int main( )
14 {
15     SavingsAccount account(100, 50, 5.5);
16     account.output(cout);
17     cout << endl;
18     cout << "Depositing $10.25." << endl;
19     account.deposit(10,25);
20     account.output(cout);
21     cout << endl;
22     cout << "Withdrawing $11.80." << endl;
23     account.withdraw(11,80);
24     account.output(cout);
25     cout << endl;
26     return 0;
27 }
28 SavingsAccount::SavingsAccount(int dollars, int cents, double rate):
29     BankAccount(dollars, cents, rate)
30 {
31     //deliberately empty
32 }
33
34 void SavingsAccount::deposit(int dollars, int cents)
35 {
36     double balance = get_balance();
37     balance += dollars;
38     balance += (static_cast<double>(cents) / 100);
39     int new_dollars = static_cast<int>(balance);
40     int new_cents = static_cast<int>((balance - new_dollars) * 100);

```

The colon indicates that the class SavingsAccount is derived from the class BankAccount

Only new member functions or variables need to be defined

The SavingsAccount constructor invokes the BankAccount constructor. Note the preceding colon.

The deposit function adds the new amount to the balance and changes the member variables via the set function

(continued)

DISPLAY 10.9 A SavingsAccount Derived Class (part 2 of 2)

```

39     set(new_dollars, new_cents, get_rate());
40 }
41 void SavingsAccount::withdraw(int dollars, int cents)
42 {
43     double balance = get_balance();
44     balance -= dollars;
45     balance -= (static_cast<double>(cents) / 100);
46     int new_dollars = static_cast<int>(balance);
47     int new_cents = static_cast<int>((balance - new_dollars) * 100);
48     set(new_dollars, new_cents, get_rate());
49 }

```

The `withdraw` function subtracts the amount from the balance and changes the member variables via the `set` function

Screen Output

```

Account balance $100.50
Interest rate 5.50%
Depositing $10.25.
Account balance $110.75
Interest rate 5.50%
Withdrawing $11.80.
Account balance $98.95
Interest rate 5.50%

```

```

//Create a new CD with $1000, 6% interest, 180 days to maturity
CDAccount newCD(1000, 0, 6.0, 180);
newCD.deposit(100,50);
days_to_maturity = newCD.get_days_to_maturity( );
//Returns 180
balance = newCD.get_balance( );
//Returns 1100.50

```

Invoking a function in SavingsAccount

Invoking a function in CDAccount

Invoking a function in BankAccount

This short example has only scratched the surface of what is possible using inheritance. Additional details are described in Chapter 15. While it does take some effort to learn how to effectively design classes using inheritance, the effort will pay off in the long run. You will end up writing less code that is easier to understand and maintain than code that does not use inheritance.

SELF-TEST EXERCISES

29. How does inheritance support code reuse and make code easier to maintain?
30. Can a derived class directly access by name a private member variable of the parent class?
31. Suppose the class `SportsCar` is a derived class of a class `Automobile`. Suppose also that the class `Automobile` has public member functions named `accelerate` and `addGas`. Will an object of the class `SportsCar` have member functions named `accelerate` and `addGas`?

CHAPTER SUMMARY

- A structure can be used to combine data of different types into a single (compound) data value.
- A class can be used to combine data and functions into a single (compound) object.
- A member variable or a member function for a class may be either public or private. If it is public, it can be used outside of the class. If it is private, it can be used only in the definition of another member function in the class.
- A function may have formal parameters of a class or structure type. A function may return values of a class or structure type.
- A member function for a class can be overloaded in the same way as ordinary functions are overloaded.
- A **constructor** is a member function of a class that is called automatically when an object of the class is declared. A constructor must have the same name as the class of which it is a member.
- A data type consists of a collection of values together with a set of basic operations defined on these values.
- A data type is called an **abstract data type** (abbreviated **ADT**) if a programmer who uses the type does not need to know any of the details about how the values and operations for that type are implemented.
- One way to implement an abstract data type in C++ is to define a class with all member variables being private and with the operations implemented as public member functions.
- Inheritance refers to a parent/child relationship between classes. The child or derived class inherits members from the parent class.

Answers to Self-Test Exercises

1. a. *double*
 b. *double*
 c. illegal—cannot use `struct` tag instead of a structure variable
 d. illegal—`savings_account` undeclared
 e. *char*
 f. *TermAccount*
2. A \$9.99
 A \$1.11
3. Many compilers give poor error messages. Surprisingly, the error message from `g++` is quite informative.

```
g++ -fsyntax-only c10testq3.cc
c10testq3.cc:8: semicolon missing after declaration of
'Stuff'
c10testq3.cc:8: extraneous 'int' ignored
c10testq3.cc:8: semicolon missing after declaration of
'struct Stuff'
```

4. `A x = {1,2};`
5. a. Too few initializers, not a syntax error. After initialization, `due_date.month == 12`, `due_date.day == 21`, `due_date.year == 0`. Member variables not provided an initializer are initialized to a zero of appropriate type.
 b. Correct after initialization: `12 == due_date.month`, `21 == due_date.day`, `2022 == due_date.year`.
 c. Error: too many initializers.
 d. May be a design error, that is, an error in intent. The author of the code provides only two digits for the date initializer. There should be four digits used for the year because a program using two-digit dates could fail in ways that vary from amusing to disastrous at the turn of the century.

6. `struct EmployeeRecord`

```
{
    double wage_rate;
    int vacation;
    char status;
};
```

7. `void read_shoe_record(ShoeType& new_shoe)`

```
{
```

```

        cout << "Enter shoe style (one letter): ";
        cin >> new_shoe.style;
        cout << "Enter shoe price $";
        cin >> new_shoe.price;
    }

```

8. `ShoeType discount(ShoeType old_record)`

```

{
    ShoeType temp;
    temp.style = old_record.style;
    temp.price = 0.90 * old_record.price;
    return temp;
}

```

9. `struct StockRecord`

```

{
    ShoeType shoe_info;
    Date arrival_date;
};

```

10. `StockRecord aRecord;`

```

aRecord.arrival_date.year = 2006;

```

11. `void DayOfYear::input()`

```

{
    cout << "Enter month as a number: ";
    cin >> month;
    cout << "Enter the day of the month: ";
    cin >> day;
}

```

12. `void Temperature::set(double new_degrees, char new_scale)`

```

{
    degrees = new_degrees;
    scale = new_scale;
}

```

13. Both the dot operator and the scope resolution operator are used with member names to specify the class or struct of which the member name is a member. If class `DayOfYear` is as defined in Display 10.3 and `today` is an object of the class `DayOfYear`, then the member `month` may be accessed with the dot operator: `today.month`. When we give the definition of a member function, the scope resolution operator is used to tell the compiler that this function is the one declared in the class whose name is given before the scope resolution operator.

14. `void DayOfYear::check_date()`
- ```

{
 if ((month < 1) || (month > 12)
 || (day < 1) || (day > 31))
 {
 cout << "Illegal date. Aborting program.\n";
 exit(1);
 }
 if (((month == 4) || (month == 6) || (month == 9)
 || (month == 11))
 && (day == 31))
 {
 cout << "Illegal date. Aborting program.\n";
 exit(1);
 }
 if ((month == 2) && (day > 29))
 {
 cout << "Illegal date. Aborting program.\n";
 exit(1);
 }
}

```
15. `hyundai.price = 4999.99; //ILLEGAL. price is private.`
- ```

jaguar.set_price(30000.97); //LEGAL
double a_price, a_profit; //LEGAL
a_price = jaguar.get_price(); //LEGAL
a_profit = jaguar.get_profit(); //ILLEGAL. get_profit is private.
a_profit = hyundai.get_profit(); //ILLEGAL. get_profit is private.
if (hyundai == jaguar) //ILLEGAL. Cannot use == with classes.
    cout << "Want to swap cars?";
hyundai = jaguar; //LEGAL

```
16. After the change, they would all be legal except for the following, which is still illegal:
- ```

if (hyundai == jaguar) //ILLEGAL. Cannot use == with classes.
 cout << "Want to swap cars?";

```
17. `private` restricts access to function definitions to member functions of the same class. This restricts any change of `private` variables to functions provided by the class author. The class author is then in control of these changes to the `private` data, preventing inadvertent corruption of the class data.
18. a. Only one. The compiler warns if you have no `public:` members in a class (or `struct` for that matter).
- b. None; we normally expect to find at least one `private:` section in a class.

- c. In a class, such a section is by default a `private`: section.
- d. In a `struct`, such a section is by default a `public`: section.

19. A possible correct answer is as follows:

```
double difference(BankAccount account1, BankAccount account2)
{
 return (account1.get_balance() - account2.get_balance());
}
```

Note that the following is not correct, because `balance` is a private member.

```
double difference(BankAccount account1, BankAccount account2)
{
 return (account1.balance - account2.balance); //ILLEGAL
}
```

20. `void` double\_update(BankAccount& the\_account)

```
{
 the_account.update();
 the_account.update();
}
```

Note that since this is not a member function, you must give the object name and dot operator when you call `update`.

21. `BankAccount` new\_account(`BankAccount` old\_account)

```
{
 BankAccount temp;
 temp.set(0, old_account.get_rate());
 return temp;
}
```

```
22. YourClass an_object(42, 'A'); //LEGAL
YourClass another_object; //LEGAL
YourClass yet_another_object(); //PROBLEM
an_object = YourClass(99, 'B'); //LEGAL
an_object = YourClass(); //LEGAL
an_object = YourClass; //ILLEGAL
```

The statement marked `//PROBLEM` is not, strictly speaking, illegal, but it does not mean what you might think it means. If you mean this to be a declaration of an object called `yet_another_object`, then it is wrong. It is a correct function declaration for a function called `yet_another_object` that takes zero arguments and that returns a value of type `YourClass`, but that is not the intended meaning. As a practical matter, you can probably consider it illegal. The correct way to declare an object called

yet\_another\_object so that it will be initialized with the default constructor is as follows:

```
YourClass yet_another_object;
```

23. The modified class definition is as follows:

```
class DayOfYear
{
public:
 DayOfYear(int the_month, int the_day);
 //Precondition: the_month and the_day form a
 //possible date. Initializes the date according to
 //the arguments.
 DayOfYear();
 //Initializes the date to January first.
 void input();
 void output();
 int get_month();
 //Returns the month, 1 for January, 2 for February, etc.
 int get_day();
 //Returns the day of the month.
private:
 void check_date();
 int month;
 int day;
};
```

Notice that we have omitted the member function set, since the constructors make set unnecessary. You must also add the following function definitions (and delete the function definition for DayOfYear::set):

```
DayOfYear::DayOfYear(int the_month, int the_day)
{
 month = the_month;
 day = the_day;
 check_date();
}
DayOfYear::DayOfYear()
{
 month = 1;
 day = 1;
}
```

24. The class definition is the same as in the previous exercise. The constructor definitions would change to the following:

```
DayOfYear::DayOfYear(int the_month, int the_day)
 : month(the_month), day(the_day)
```



```

 {
 check_date();
 }
 DayOfYear::DayOfYear() : month(1), day(1)
 {
 //Body intentionally empty.
 }

```

25. The member variables should all be private. The member functions that are part of the interface for the ADT (that is, the member functions that are operations for the ADT) should be public. You may also have auxiliary helping functions that are used only in the definitions of other member functions. These auxiliary functions should be private.
26. All the declarations of private member variables are part of the implementation. (There should be no public member variables.) All the function declarations for public member functions of the class (which are listed in the class definitions) as well as the explanatory comments for these function declarations are part of the interface. All the function declarations for private member functions are part of the implementation. All member function definitions (whether the function is public or private) are part of the implementation.
27. You need to read only the interface parts. That is, you need to read only the function declarations for public members of the class (which are listed in the class definitions) as well as the explanatory comments for these function declarations. You need not read any of the function declarations of the private member functions, the declarations of the private member variables, the definitions of the public member functions, or the definitions of the private member functions.
28. `BankAccount::BankAccount(int dollars, int cents, double rate) : dollars_part(dollars), cents_part(cents), interest_rate(fraction(rate))`
- ```

{
    if ((dollars < 0) || (cents < 0) || (rate < 0))
    {
        cout << "Illegal values for money or interest rate.\n";
        exit(1);
    }
}

BankAccount::BankAccount(int dollars, double rate)
    : dollars_part(dollars), cents_part(0),
      interest_rate(fraction(rate))
{
    if ((dollars < 0) || (rate < 0))

```

```
{  
    cout << "Illegal values for money or interest rate.\n";  
    exit(1);  
}
```

29. Functions and data defined for the parent class can be made available in the derived class, eliminating the need to redefine the functions and data again in the derived class. This enhances maintainability because there is now no duplication of code among multiple classes and hence only a single location in the code that may be subject to change. Additionally, inheritance provides a clean way to isolate code that is only applicable to a derived class. Since such code only appears in the definition of the derived class, it is usually easier to read.
30. No, but a derived class can indirectly access a private member variable of the parent class through a public function.
31. Yes, the derived class will have access to the same functions. In Chapter 15 we will discuss how we can make the functions do different things for an object of class `SportsCar` versus an object of class `Automobile`.

PRACTICE PROGRAMS

Practice Programs can generally be solved with a short program that directly applies the programming principles presented in this chapter.

1. Redefine `CDAccount` from Display 10.1 so that it is a class rather than a structure. Use the same member variables as in Display 10.1 but make them private. Include member functions for each of the following: one to return the initial balance, one to return the balance at maturity, one to return the interest rate, and one to return the term. Include a constructor that sets all of the member variables to any specified values, as well as a default constructor. Embed your class definition in a test program.
2. Redo your definition of the class `CDAccount` from Practice Program 1 so that it has the same interface but a different implementation. The new implementation is in many ways similar to the second implementation for the class `BankAccount` given in Display 10.7. Your new implementation for the class `CDAccount` will record the balance as two values of type `int`: one for the dollars and one for the cents. The member variable for the interest rate will store the interest rate as a fraction rather than as a percentage. For example, an interest rate of 4.3% will be stored as the value 0.043 of type `double`. Store the term in the same way as in Display 10.1.
3. Define a class for a type called `CounterType`. An object of this type is used to count things, so it records a count that is a nonnegative whole number. Include a default constructor that sets the counter to zero and a constructor



VideoNote
Solution to Practice
Program 10.1

with one argument that sets the counter to the value specified by its argument. Include member functions to increase the count by 1 and to decrease the count by 1. Be sure that no member function allows the value of the counter to become negative. Also, include a member function that returns the current count value and one that outputs the count to a stream. The member function for doing output will have one formal parameter of type `ostream` for the output stream that receives the output. Embed your class definition in a test program.

PROGRAMMING PROJECTS

Programming Projects require more problem-solving than Practice Programs and can usually be solved many different ways. Visit www.myprogramminglab.com to complete many of these Programming Projects online and get instant feedback.

1. Write a grading program for a class with the following grading policies:
 - a. There are two quizzes, each graded on the basis of 10 points.
 - b. There is one midterm exam and one final exam, each graded on the basis of 100 points.
 - c. The final exam counts for 50 percent of the grade, the midterm counts for 25 percent, and the two quizzes together count for a total of 25 percent. (Do not forget to normalize the quiz scores. They should be converted to a percent before they are averaged in.)

Any grade of 90 or more is an A, any grade of 80 or more (but less than 90) is a B, any grade of 70 or more (but less than 80) is a C, any grade of 60 or more (but less than 70) is a D, and any grade below 60 is an F.

The program will read in the student's scores and output the student's record, which consists of two quiz and two exam scores as well as the student's average numeric score for the entire course and the final letter grade. Define and use a structure for the student record. If this is a class assignment, ask your instructor if input/output should be done with the keyboard and screen or if it should be done with files. If it is to be done with files, ask your instructor for instructions on file names.

2. Redo Programming Project 1 (or do it for the first time), but this time make the student record type a class type rather than a structure type. The student record class should have member variables for all the input data described in Programming Project 1 and a member variable for the student's weighted average numeric score for the entire course as well as a member variable for the student's final letter grade. Make all member variables private. Include member functions for each of the following: member functions to set each of the member variables to values given as an argument(s) to the function, member functions to retrieve the data from each of the

member variables, a *void* function that calculates the student's weighted average numeric score for the entire course and sets the corresponding member variable, and a *void* function that calculates the student's final letter grade and sets the corresponding member variable.

3. Define a class called `Month` that is an abstract data type for a month. Your class will have one member variable of type *int* to represent a month (1 for January, 2 for February, and so forth). Include all the following member functions: a constructor to set the month using the first three letters in the name of the month as three arguments, a constructor to set the month using an integer as an argument (1 for January, 2 for February, and so forth), a default constructor, an input function that reads the month as an integer, an input function that reads the month as the first three letters in the name of the month, an output function that outputs the month as an integer, an output function that outputs the month as the first three letters in the name of the month, and a member function that returns the next month as a value of type `Month`. The input and output functions will each have one formal parameter for the stream. Embed your class definition in a test program.
4. Redefine the implementation of the class `Month` described in Programming Project 3 (or do the definition for the first time, but do the implementation as described here). This time the month is implemented as three member variables of type *char* that store the first three letters of the name of the month. Embed your definition in a test program.
5. (In order to do this project you must have first done either Programming Project 3 or Project 4.) Rewrite the program in Display 10.4, but use the class `Month` that you defined in Project 3 or Project 4 as the type for the member variable to record the month. (You may define the class `Month` either as described in Project 3 or as described in Project 4.) Redefine the member function `output` so that it has one formal parameter of type `ostream` for the output stream. Modify the program so that everything that is output to the screen is *also* output to a file. This means that all output statements will occur twice: once with the argument `cout` and once with an output-stream argument. If you are in a class, obtain the file name from your instructor. The input will still come from the keyboard. Only the output will be sent to a file.
6. My mother always took a little red counter to the grocery store. The counter was used to keep a tally of the amount of money she would have spent so far on that visit to the store, if she bought all the items in her basket. There was a four-digit display, increment buttons for each digit, and a reset button. There was an overflow indicator that came up red if more money was entered than the \$99.99 it would register. (This was a long time ago.)

Write and implement the member functions of a class `Counter` that simulates and slightly generalizes the behavior of this grocery store

counter. The constructor should create a `Counter` object that can count up to the constructor's argument. That is, `Counter(9999)` should provide a counter that can count up to 9999. A newly constructed counter displays a reading of 0. The member function `void reset();` sets the counter's number to 0. The member functions `void incr1();` increments the units digit by 1, `void incr10();` increments the tens digit by 1, and `void incr100();` and `void incr1000();` increment the next two digits, respectively. Accounting for any carry when you increment should require no further action than adding an appropriate number to the private data member. A member function `bool overflow();` detects overflow. (Overflow is the result of incrementing the counter's private data member beyond the maximum entered at counter construction.)

Use this class to provide a simulation of my mother's little red clicker. Even though the display is an integer, in the simulation, the rightmost (lower-order) two digits are always thought of as cents and tens of cents, the next digit is dollars, and the fourth digit is tens of dollars.

Provide keys for cents, dimes, dollars, and tens of dollars. Unfortunately, no choice of keys seems particularly mnemonic. One choice is to use the keys `asdf`: a for cents, followed by a digit 1 to 9; s for dimes, followed by digits 1 to 9; d for dollars, followed by a digit 1 to 9; and f for tens of dollars, again followed by a digit 1 to 9. Each entry (one of `asdf` followed by 1 to 9) is followed by pressing the Return key. Any overflow is reported after each operation. Overflow can be requested by pressing the o key.

7. Write a `rational` number class. This problem will be revisited in Chapter 11, where operator overloading will make the problem much easier. For now we will use member functions `add`, `sub`, `mul`, `div`, and `less` that each carry out the operations `+`, `-`, `*`, `/`, and `<`. For example, `a + b` will be written `a.add(b)`, and `a < b` will be written `a.less(b)`.

Define a class for rational numbers. A rational number is a "ratio-nal" number, composed of two integers with division indicated. The division is not carried out, it is only indicated, as in $1/2$, $2/3$, $15/32$, $65/4$, $16/5$. You should represent rational numbers by two `int` values, numerator and denominator.

A principle of abstract data type construction is that constructors must be present to create objects with any legal values. You should provide constructors to make objects out of pairs of `int` values; this is a constructor with two `int` parameters. Since every `int` is also a rational number, as in $2/1$ or $17/1$, you should provide a constructor with a single `int` parameter.

Provide member functions `input` and `output` that take an `istream` and `ostream` argument, respectively, and `fetch` or `write` rational numbers in the form $2/3$ or $37/51$ to or from the keyboard (and to or from a file).

Provide member functions `add`, `sub`, `mul`, and `div` that return a rational value. Provide a function `less` that returns a *bool* value. These functions should do the operation suggested by the name. Provide a member function `neg` that has no parameters and returns the negative of the calling object.

Provide a `main` function that thoroughly tests your class implementation. The following formulas will be useful in defining functions.

$$\begin{aligned} a/b + c/d &= (a * d + b * c) / (b * d) \\ a/b - c/d &= (a * d - b * c) / (b * d) \\ (a/b) * (c/d) &= (a * c) / (b * d) \\ (a/b) / (c/d) &= (a * d) / (c * b) \\ -(a/b) &= (-a/b) \\ (a/b) < (c/d) &\text{ means } (a * d) < (c * b) \\ (a/b) == (c/d) &\text{ means } (a * d) == (c * b) \end{aligned}$$

Let any sign be carried by the numerator; keep the denominator positive.

- Define a class called `Odometer` that will be used to track fuel and mileage for an automotive vehicle. Include private member variables to track the miles driven and the fuel efficiency of the vehicle in miles per gallon. The class should have a constructor that initializes these values to zero. Include a member function to reset the odometer to zero miles, a member function to set the fuel efficiency, a member function that accepts miles driven for a trip and adds it to the odometer's total, and a member function that returns the number of gallons of gasoline that the vehicle has consumed since the odometer was last reset.

Use your class with a test program that creates several trips with different fuel efficiencies.

- Redo Programming Project 7 from Chapter 5 (or do it for the first time), but this time use a class to encapsulate the date. Use private member variables to store the day, month, and year along with an appropriate constructor and member functions to get and set the data. Create a public function that returns the day of the week. All helper functions should be declared private. Embed your class definition in a suitable test program.
- The U.S. Postal Service printed a bar code on every envelope that represented a five- (or more) digit zip code using a format called POSTNET (this format was deprecated in favor of a new system, OneCode, in 2009). The bar code consists of long and short bars as shown:



For this program, we will represent the bar code as a string of digits. The digit 1 represents a long bar, and the digit 0 represents a short bar. Therefore, the bar code would be represented in our program as

```
110100101000101011000010011
```

The first and last digits of the bar code are always 1. Removing these leaves 25 digits. If these 25 digits are split into groups of 5 digits each, we have

```
10100  10100  01010  11000  01001
```

Next, consider each group of 5 digits. There will always be exactly two 1s in each group of digits. Each digit stands for a number. From left to right, the digits encode the values 7, 4, 2, 1, and 0. Multiply the corresponding value with the digit and compute the sum to get the final encoded digit for the zip code. The table below shows the encoding for 10100.

Bar Code Digits	1	0	1	0	0
Value	7	4	2	1	0
Product of Digit * Value	7	0	2	0	0

Zip Code Digit = $7 + 0 + 2 + 0 + 0 = 9$

Repeat this for each group of 5 digits and concatenate to get the complete zip code. There is one special value. If the sum of a group of 5 digits is 11, then this represents the digit 0 (this is necessary because with two digits per group it is not possible to represent zero). The zip code for the sample bar code decodes to 99504. Although the POSTNET scheme may seem unnecessarily complex, its design allows machines to detect if errors have been made in scanning the zip code.

Write a zip code class that encodes and decodes 5-digit bar codes used by the U.S. Postal Service on envelopes. The class should have two constructors. The first constructor should input the zip code as an integer, and the second constructor should input the zip code as a bar code string consisting of 0s and 1s, as described above. Although you have two ways to input the zip code, internally, the class should store the zip code using only one format (you may choose to store it as a bar code string or as a zip code number). The class should also have at least two public member functions, one to return the zip code as an integer, and the other to return the zip code in bar code format as a string. All helper functions should be

declared private. Embed your class definition in a suitable test program. Your program should print an error message if an invalid bar code is passed to the constructor.

11. Consider a class `Movie` that contains information about a movie. The class has the following attributes:

- The movie name
- The MPAA rating (for example, G, PG, PG-13, R)
- The number of people that have rated this movie as a 1 (Terrible)
- The number of people that have rated this movie as a 2 (Bad)
- The number of people that have rated this movie as a 3 (OK)
- The number of people that have rated this movie as a 4 (Good)
- The number of people that have rated this movie as a 5 (Great)

Implement the class with accessor and mutator functions for the movie name and MPAA rating. Write a function `addRating` that takes an integer as an input parameter. The function should verify that the parameter is a number between 1 and 5, and if so, increment the number of people rating the movie that match the input parameter. For example, if 3 is the input parameter, then the number of people that rated the movie as a 3 should be incremented by 1. Write another function, `getAverage`, that returns the average value for all of the movie ratings. Finally, add a constructor that allows the programmer to create the object with a specified name and MPAA rating. The number of people rating the movie should be set to 0 in the constructor.

Test the class by writing a `main` function that creates at least two movie objects, adds at least five ratings for each movie, and outputs the movie name, MPAA rating, and average rating for each movie object.

This page intentionally left blank

Friends, Overloaded Operators, and Arrays in Classes

11

11.1 FRIEND FUNCTIONS 620

Programming Example: An Equality Function 620

Friend Functions 624

Programming Tip: Define Both Accessor Functions and Friend Functions 626

Programming Tip: Use Both Member and Nonmember Functions 628

Programming Example: Money Class (Version 1) 628

Implementation of `digit_to_int` (*Optional*) 635

Pitfall: Leading Zeros in Number Constants 636

The `const` Parameter Modifier 638

Pitfall: Inconsistent Use of `const` 639

11.2 OVERLOADING OPERATORS 643

Overloading Operators 644

Constructors for Automatic Type Conversion 647

Overloading Unary Operators 649

Overloading `>>` and `<<` 650

11.3 ARRAYS AND CLASSES 660

Arrays of Classes 660

Arrays as Class Members 664

Programming Example: A Class for a Partially Filled Array 665

11.4 CLASSES AND DYNAMIC ARRAYS 667

Programming Example: A String Variable Class 668

Destructors 671

Pitfall: Pointers as Call-by-Value Parameters 674

Copy Constructors 675

Overloading the Assignment Operator 680



Give us the tools, and we'll finish the job.

WINSTON CHURCHILL, *Radio Broadcast, February 9, 1941*

INTRODUCTION

This chapter teaches you more techniques for defining functions and operators for classes, including overloading common operators such as `+`, `*`, and `/` so that they can be used with the classes you define in the same way that they are used with the predefined types such as `int` and `double`.

PREREQUISITES

This chapter uses material from Chapters 2 through 10.

11.1 FRIEND FUNCTIONS

Trust your friends.

COMMON ADVICE

Until now we have implemented class operations, such as input, output, accessor functions, and so forth, as member functions of the class, but for some operations, it is more natural to implement the operations as ordinary (nonmember) functions. In this section, we discuss techniques for defining operations on objects as nonmember functions. We begin with a simple example.

PROGRAMMING EXAMPLE

An Equality Function

In Chapter 10, we developed a class called `DayOfYear` that records a date, such as January 1 or July 4, that might be a holiday or birthday or some other annual event. We gave progressively better versions of the class. The final version was produced in Self-Test Exercise 23 of Chapter 10. In Display 11.1, we repeat this final version of the class `DayOfYear` and have enhanced the class one more time by adding a function called `equal` that can test two objects of type `DayOfYear` to see if their values represent the same date.

DISPLAY 11.1 Equality Function (part 1 of 3)

```
1 //Program to demonstrate the function equal. The class DayOfYear
2 //is the same as in Self-Test Exercises 23-24 in Chapter 10.
3 #include <iostream>
4 using namespace std;

5 class DayOfYear
6 {
7 public:
8     DayOfYear(int the_month, int the_day);
9     //Precondition: the_month and the_day form a
10    //possible date. Initializes the date according
11    //to the arguments.

12    DayOfYear( );
13    //Initializes the date to January first.

14    void input( );

15    void output( );

16    int get_month( );
17    //Returns the month, 1 for January, 2 for February, etc.

18    int get_day( );
19    //Returns the day of the month.
20 private:
21    void check_date( );
22    int month;
23    int day;
24 };
25
26 bool equal(DayOfYear date1, DayOfYear date2);
27 //Precondition: date1 and date2 have values.
28 //Returns true if date1 and date2 represent the same date;
29 //otherwise, returns false.
30
31 int main( )
32 {
33     DayOfYear today, bach_birthday(3, 21);
34
35     cout << "Enter today's date:\n";
36     today.input( );
37     cout << "Today's date is ";
38     today.output( );
39
40     cout << "J. S. Bach's birthday is ";
```

(continued)

DISPLAY 11.1 Equality Function (part 2 of 3)

```

41     bach_birthday.output( );
42
43     if (equal(today, bach_birthday))
44         cout << "Happy Birthday Johann Sebastian!\n";
45     else
46         cout << "Happy Unbirthday Johann Sebastian!\n";
47     return 0;
48 }
49
50 bool equal(DayOfYear date1, DayOfYear date2)
51 {
52     return ( date1.get_month( ) == date2.get_month( ) &&
53             date1.get_day( ) == date2.get_day( ) );
54 }
55
56 DayOfYear::DayOfYear(int the_month, int the_day)
57     : month(the_month), day(the_day)
58 {
59     check_date();
60 }
61
62 int DayOfYear::get_month( )
63 {
64     return month;
65 }
66
67 int DayOfYear::get_day( )
68 {
69     return day;
70 }
71
72 //Uses iostream:
73 void DayOfYear::input( )
74 {
75     cout << "Enter the month as a number: ";
76     cin >> month;
77     cout << "Enter the day of the month: ";
78     cin >> day;
79 }
80
81 //Uses iostream:
82 void DayOfYear::output( )
83 {
84     cout << "month = " << month
85         << ", day = " << day << endl;
86 }

```

Omitted function and constructor definitions are as in Chapter 10, Self-Test Exercises 14 and 24, but those details are not needed for what we are doing here.

(continued)

DISPLAY 11.1 Equality Function (part 3 of 3)

Sample Dialogue

```
Enter today's date:  
Enter the month as a number: 3  
Enter the day of the month: 21  
Today's date is month = 3, day = 21  
J. S. Bach's birthday is month = 3, day = 21  
Happy Birthday Johann Sebastian!
```

Suppose `today` and `bach_birthday` are two objects of type `DayOfYear` that have been given values representing some dates. You can test to see if they represent the same date with the following Boolean expression:

```
equal(today, bach_birthday)
```

This call to the function `equal` returns `true` if `today` and `bach_birthday` represent the same date. In Display 11.1 this Boolean expression is used to control an *if-else* statement.

The definition of the function `equal` is straight forward. Two dates are equal if they represent the same month and the same day of the month. The definition of `equal` uses accessor functions `get_month` and `get_day` to compare the months and the days represented by the two objects.

Notice that we did not make the function `equal` a member function. It would be possible to make `equal` a member function of the class `DayOfYear`, but `equal` compares *two* objects of type `DayOfYear`. If you make `equal` a member function, you must decide whether the calling object should be the first date or the second date. Rather than arbitrarily choosing one of the two dates as the calling object, we instead treated the two dates in the same way. We made `equal` an ordinary (nonmember) function that takes two dates as its arguments.

SELF-TEST EXERCISE

1. Write a function definition for a function called `before` that takes two arguments of the type `DayOfYear`, which is defined in Display 11.1. The function returns a `bool` value and returns `true` if the first argument represents a date that comes before the date represented by the second argument; otherwise, the function returns `false`; for example, January 5 comes before February 2.

Friend Functions

If your class has a full set of accessor functions, you can use the accessor functions to define a function to test for equality or to do any other kind of computing that depends on the private member variables. However, although this may give you access to the private member variables, it may not give you efficient access to them. Look again at the definition of the function `equal` given in Display 11.1. To read the month, it must make a call to the accessor function `get_month`. To read the day, it must make a call to the accessor function `get_day`. This works, but the code would be simpler and more efficient if we could just access the member variables.

A simpler and more efficient definition of the function `equal` given in Display 11.1 would be as follows:

```
bool equal(DayOfYear date1, DayOfYear date2)
{
    return (date1.month == date2.month &&
           date1.day == date2.day);
}
```

There is just one problem with this definition: It's illegal! It's illegal because the member variables `month` and `day` are private members of the class `DayOfYear`. Private member variables (and private member functions) cannot normally be referenced in the body of a function unless the function is a member function, and `equal` is not a member function of the class `DayOfYear`. But there is a way to give a nonmember function the same access privileges as a member function. If we make the function `equal` a *friend* of the class `DayOfYear`, then the previous definition of `equal` will be legal.

Friends can access private members

A **friend function** of a class is not a member function of the class, but a friend function has access to the private members of that class just as a member function does. A friend function can directly read the value of a member variable and can even directly change the value of a member variable, for example, with an assignment statement that has a private member variable on one side of the assignment operator. To make a function a friend function, you must name it as a friend in the class definition. For example, in Display 11.2 we have rewritten the definition of the class `DayOfYear` so that the function `equal` is a friend of the class. You make a function a friend of a class by listing the function declaration in the definition of the class and placing the keyword `friend` in front of the function declaration.

A friend is not a member

A friend function is added to a class definition by listing its function declaration, just as you would list the declaration of a member function, except that you precede the function declaration by the keyword `friend`. However, a friend is not a member function; rather, it really is an ordinary function with extraordinary access to the data members of the class. The friend is defined and called exactly like the ordinary function it is. In particular, the function definition for `equal` shown in Display 11.2 does

DISPLAY 11.2 Equality Function as a Friend

```

1 //Demonstrates the function equal.
2 //In this version equal is a friend of the class DayOfYear.
3 #include <iostream>
4 using namespace std;
5
6 class DayOfYear
7 {
8 public:
9     friend bool equal(DayOfYear date1, DayOfYear date2);
10    //Precondition: date1 and date2 have values.
11    //Returns true if date1 and date2 represent the same date;
12    //otherwise, returns false.
13
14    DayOfYear(int the_month, int the_day);
15    //Precondition: the_month and the_day form a
16    //possible date. Initializes the date according
17    //to the arguments.
18
19    DayOfYear( );
20    //Initializes the date to January first.
21
22    void input( );
23
24    void output( );
25
26    int get_month( );
27    //Returns the month, 1 for January, 2 for February, etc.
28
29    int get_day( );
30    //Returns the day of the month.
31 private:
32    void check_date( );
33    int month;
34    int day;
35 };
36
37 int main( )
38 {

```

<The main part of the program is the same as in Display 11.1.>

```

33 }
34
35 bool equal(DayOfYear date1, DayOfYear date2)
36 {
37     return (date1.month == date2.month &&
38            date1.day == date2.day);
39 }
40

```

Note that the private member variables **month** and **day** can be accessed by name.

<The rest of this display, including the Sample Dialogue, is the same as in Display 11.1.>

not include the qualifier `DayOfYear::` in the function heading. Also, the `equal` function is not called by using the dot operator. The function `equal` takes objects of type `DayOfYear` as arguments the same way that any other nonmember function would take arguments of any other type. However, a friend function definition can access the private member variables and private member functions of the class by name, so it has the same access privileges as a member function.

■ PROGRAMMING TIP Define Both Accessor Functions and Friend Functions

It may seem that if you make all your basic functions friends of a class, then there is no need to include accessor and mutator functions in the class. After all, friend functions have access to the private member variables and so do not need accessor or mutator functions. This is not entirely wrong. It is true that if you made all the functions in the world friends of a class, you would not need accessor or mutator functions. However, making all functions friends is not practical.

In order to see why you still need accessor functions, consider the example of the class `DayOfYear` given in Display 11.2. You might use this class in another program, and that other program might very well want to do something with the month part of a `DayOfYear` object. For example, the program might want to calculate how many months there are remaining in the year. Specifically, the `main` part of the program might contain the following:

```
DayOfYear today;
cout << "enter today's date: \n";
today.input();
cout << "There are " << (12 - today.get_month())
    << " months left in this year.\n";
```

You cannot replace `today.get_month()` with `today.month` because `month` is a private member of the class. You need the accessor function `get_month`.

You have just seen that you definitely need to include accessor functions in your class. Other cases require mutator functions. You may think that, because you usually need accessor and mutator functions, you do not need friends. In a sense, that is true. Notice that you could define the function `equal` either as a friend without using accessor functions (Display 11.2) or not as a friend and use accessor functions (as in Display 11.1). In most situations, the only reason to make a function a friend is to make the definition of the function simpler and more efficient; but sometimes, that is reason enough.

Friend Functions

A **friend function** of a class is an ordinary function except that it has access to the private members of objects of that class. To make a function a friend of a class, you must list the function declaration for the friend function in the class definition. The function declaration is preceded by the keyword *friend*. The function declaration may be placed in either the private section or the public section, but it will be a public function in either case, so it is clearer to list it in the public section.

SYNTAX (of a class definition with friend functions)

```
class Class_Name
{
public:
    friend Declaration_for_Friend_Function_1
    friend Declaration_for_Friend_Function_2
        .
        .
        .
    Member_Function_Declarations
private:
    Private_Member_Declarations
};
```

You need not list the friend functions first. You can intermix the order of these function declarations.

EXAMPLE

```
class FuelTank
{
public:
    friend double need_to_fill(FuelTank tank);
    //Precondition: Member variables of tank have values.
    //Returns the number of liters needed to fill tank.
    FuelTank(double the_capacity, double the_level);
    FuelTank();
    void input();
    void output();
private:
    double capacity;//in liters
    double level;
};
```

A friend function is *not* a member function. A friend function is defined and called the same way as an ordinary function. You do not use the dot operator in a call to a friend function and you do not use a type qualifier in the definition of a friend function.

■ PROGRAMMING TIP Use Both Member and Nonmember Functions

Member functions and friend functions serve a very similar role. In fact, sometimes it is not clear whether you should make a particular function a friend of your class or a member function of the class. In most cases, you can make a function either a member function or a friend and have it perform the same task in the same way. There are, however, places where it is better to use a member function and places where it is better to use a friend function (or even a plain old function that isn't a friend, like the version of `equal` in Display 11.1). A simple rule to help you decide between member functions and nonmember functions is the following:

- Use a member function if the task being performed by the function involves only one object.
- Use a nonmember function if the task being performed involves more than one object. For example, the function `equal` in Display 11.1 (and Display 11.2) involves two objects, so we made it a nonmember (friend) function.

Whether you make a nonmember function a friend function or use accessor and mutator functions is a matter of efficiency and personal taste. As long as you have enough accessor and mutator functions, either approach will work.

The choice of whether to use a member or nonmember function is not always as simple as the above two rules. With more experience, you will discover situations in which it pays to violate those rules. A more accurate but harder to understand rule is to use member functions if the task is intimately related to a single object; use a nonmember function when the task involves more than one object and the objects are used symmetrically. However, this more accurate rule is not clear-cut, and the two simple rules given above will serve as a reliable guide until you become more sophisticated in handling objects. ■

PROGRAMMING EXAMPLE

Money Class (Version 1)

Display 11.3 contains the definition of a class called `Money`, which represents amounts of U.S. currency. The value is implemented as a single integer value that represents the amount of money as if it were converted to all pennies. For example, \$9.95 would be stored as the value 995. Since we use an integer to represent the amount of money, the amount is represented as an exact quantity. We did not use a value of type `double` because values of type `double` are stored as approximate values and we want our money amounts to be exact quantities.

This integer for the amount of money (expressed as all cents) is stored in a member variable named `all_cents`. We could use `int` for the type of the

member variable `all_cents`, but with some compilers that would severely limit the amounts of money we could represent. In some implementations of C++, only 2 bytes are used to store the `int` type.¹ The result of the 2-byte implementation is that the largest value of type `int` is only slightly larger than 32000, but 32000 cents represents only \$320, which is a fairly small amount of money. Since we may want to deal with amounts of money much larger than \$320, we have used `long` for the type of the member variable `all_cents`. C++ compilers that implement the `int` type in 2 bytes usually implement the type `long` in 4 bytes. Values of type `long` are integers just like the values of the type `int`, except that the 4-byte `long` implementation enables the largest allowable value of type `long` to be much larger than the largest allowable value of type `int`. On most systems the largest allowable value of type `long` is 2 billion or larger. (The type `long` is also called `long int`. The two names `long` and `long int` refer to the same type.)

The class `Money` has two operations that are friend functions: `equal` and `add` (which are defined in Display 11.3). The function `add` returns a `Money` object whose value is the sum of the values of its two arguments. A function call of the form `equal(amount1, amount2)` returns `true` if the two objects `amount1` and `amount2` have values that represent equal amounts of money.

Notice that the class `Money` reads and writes amounts of money as we normally write amounts of money, such as \$9.95 or -\$9.95. First, consider the member function `input` (also defined in Display 11.3). That function first reads a single character, which should be either the dollar sign ('\$') or the minus sign ('-'). If this first character is the minus sign, then the function remembers that the amount is negative by setting the value of the variable `negative` to `true`. It then reads an additional character, which should be the dollar sign. On the other hand, if the first symbol is not '-', then `negative` is set equal to `false`. At this point the negative sign (if any) and the dollar sign have been read. The function `input` then reads the number of dollars as a value of type `long` and places the number of dollars in the local variable named `dollars`. After reading the dollars part of the input, the function `input` reads the remainder of the input as values of type `char`; it reads in three characters, which should be a decimal point and two digits.

(You might be tempted to define the member function `input` so that it reads the decimal point as a value of type `char` and then reads the number of cents as a value of type `int`. This is not done because of the way that some C++ compilers treat leading zeros. As explained in the Pitfall section entitled "Leading Zeros in Number Constants," many compilers still in use do not read numbers with leading zeros as you would like them to, so an amount like \$7.09 may be read incorrectly if your C++ code were to read the 09 as a value of type `int`.)

¹ See Chapter 2 for details. Display 2.2 has a description of data types as most recent compilers implement them.

DISPLAY 11.3 Money Class—Version 1 (part 1 of 4)

```
1 //Program to demonstrate the class Money.
2 #include <iostream>
3 #include <cstdlib>
4 #include <cctype>
5 using namespace std;

6 //Class for amounts of money in U.S. currency.
7 class Money
8 {
9 public:
10 friend Money add(Money amount1, Money amount2);
11 //Precondition: amount1 and amount2 have been given values.
12 //Returns the sum of the values of amount1 and amount2.

13 friend bool equal(Money amount1, Money amount2);
14 //Precondition: amount1 and amount2 have been given values.
15 //Returns true if the amount1 and amount2 have the same value;
16 //otherwise, returns false.

17 Money(long dollars, int cents);
18 //Initializes the object so its value represents an amount with the
19 //dollars and cents given by the arguments. If the amount is negative,
20 //then both dollars and cents must be negative.

21 Money(long dollars);
22 //Initializes the object so its value represents $dollars.00.

23 Money( );
24 //Initializes the object so its value represents $0.00.

25 double get_value( );
26 //Precondition: The calling object has been given a value.
27 //Returns the amount of money recorded in the data of the calling object.

28 void input(istream& ins);
29 //Precondition: If ins is a file input stream, then ins has already been
30 //connected to a file. An amount of money, including a dollar sign, has been
31 //entered in the input stream ins. Notation for negative amounts is -$100.00.
32 //Postcondition: The value of the calling object has been set to
33 //the amount of money read from the input stream ins.

34 void output(ostream& outs);
35 //Precondition: If outs is a file output stream, then outs has already been
36 //connected to a file.
37 //Postcondition: A dollar sign and the amount of money recorded
38 //in the calling object have been sent to the output stream outs.
39 private:
40 long all_cents;
41 };
```

(continued)

DISPLAY 11.3 Money Class—Version 1 (part 2 of 4)

```

42  int digit_to_int(char c);
43  //Function declaration for function used in the definition of Money::input:
44  //Precondition: c is one of the digits '0' through '9'.
45  //Returns the integer for the digit; for example, digit_to_int ('3') returns 3.

46  int main( )
47  {
48      Money your_amount, my_amount(10, 9), our_amount;
49      cout << "Enter an amount of money: ";
50      your_amount.input(cin);
51      cout << "Your amount is ";
52      your_amount.output(cout);
53      cout << endl;
54      cout << "My amount is ";
55      my_amount.output(cout);
56      cout << endl;

57      if (equal(your_amount, my_amount))
58          cout << "We have the same amounts.\n";
59      else
60          cout << "One of us is richer.\n";
61      our_amount = add(your_amount, my_amount);
62      your_amount.output(cout);
63      cout << " + ";
64      my_amount.output(cout);
65      cout << " equals ";
66      our_amount.output(cout);
67      cout << endl;
68      return 0;
69  }
70  Money add(Money amount1, Money amount2)
71  {
72      Money temp;
73
74      temp.all_cents = amount1.all_cents + amount2.all_cents;
75      return temp;
76  }
77
78  bool equal(Money amount1, Money amount2)
79  {
80      return (amount1.all_cents == amount2.all_cents);
81  }
82
83  Money::Money(long dollars, int cents)
84  {
85      if (dollars * cents < 0) //If one is negative and one is positive

```

(continued)

DISPLAY 11.3 Money Class—Version 1 (part 3 of 4)

```

86     {
87         cout << "Illegal values for dollars and cents.\n";
88         exit(1);
89     }
90     all_cents = dollars * 100 + cents;
91 }
92
93 Money::Money(long dollars) : all_cents(dollars * 100)
94 {
95     //Body intentionally blank.
96 }
97
98 Money::Money( ) : all_cents(0)
99 {
100    //Body intentionally blank.
101 }
102
103 double Money::get_value( )
104 {
105     return (all_cents * 0.01);
106 }
107 //Uses iostream, ctype, cstdlib:
108 void Money::input(istream& ins)
109 {
110     char one_char, decimal_point, digit1, digit2;
111     //digits for the amount of cents
112     long dollars;
113     int cents;
114     bool negative;//set to true if input is negative.
115
116     ins >> one_char;
117     if (one_char == ' ')
118     {
119         negative = true;
120         ins >> one_char; //read '$'
121     }
122     else
123         negative = false;
124     //if input is legal, then one_char == '$'
125
126     ins >> dollars >> decimal_point >> digit1 >> digit2;
127
128     if (one_char != '$' || decimal_point != '.'
129         || !isdigit(digit1) || !isdigit(digit2))

```

(continued)

DISPLAY 11.3 Money Class—Version 1 (part 4 of 4)

```

130     {
131         cout << "Error illegal form for money input\n";
132         exit(1);
133     }
134     cents = digit_to_int(digit1) * 10 + digit_to_int(digit2);
135
136     all_cents = dollars * 100 + cents;
137     if (negative)
138         all_cents = -all_cents;
139 }
140
141 //Uses cstdlib and iostream:
142 void Money::output(ostream& outs)
143 {
144     long positive_cents, dollars, cents;
145     positive_cents = labs(all_cents);
146     dollars = positive_cents / 100;
147     cents = positive_cents % 100;
148
149     if (all_cents < 0)
150         outs << "-$" << dollars << '.';
151     else
152         outs << "$" << dollars << '.';
153
154     if (cents < 10)
155         outs << '0';
156     outs << cents;
157 }
158
159 int digit_to_int(char c)
160 {
161     return (static_cast<int>(c) - static_cast<int>('0'));
162 }
163

```

Sample Dialogue

```

Enter an amount of money: $123.45
Your amount is $123.45
My amount is $10.09
One of us is richer.
$123.45 + $10.09 equals $133.54

```

The following assignment statement converts the two digits that make up the cents part of the input amount to a single integer, which is stored in the local variable `cents`:

```
cents = digit_to_int(digit1) * 10 + digit_to_int(digit2);
```

After this assignment statement is executed, the value of `cents` is the number of cents in the input amount.

The helping function `digit_to_int` takes an argument that is a digit, such as '3', and converts it to the corresponding *int* value, such as 3. We need this helping function because the member function `input` reads the two digits for the number of cents as two values of type *char*, which are stored in the local variables `digit1` and `digit2`. However, once the digits are read into the computer, we want to use them as numbers. Therefore, we use the function `digit_to_int` to convert a digit such as '3' to a number such as 3. The definition of the function `digit_to_int` is given in Display 11.3. You can simply take it on faith that this definition does what it is supposed to do and treat the function as a black box. All you need to know is that `digit_to_int('0')` returns 0, `digit_to_int('1')` returns 1, and so forth. However, it is not too difficult to see how this function works, so you may want to read the optional section that follows this one. It explains the implementation of `digit_to_int`.

Once the local variables `dollars` and `cents` are set to the number of dollars and the number of cents in the input amount, it is easy to set the member variable `all_cents`. The following assignment statement sets `all_cents` to the correct number of cents:

```
all_cents = dollars * 100 + cents;
```

However, this always sets `all_cents` to a positive amount. If the amount of money is negative, then the value of `all_cents` must be changed from positive to negative. This is done with the following statement:

```
if (negative)
    all_cents = -all_cents;
```

The member function `output` (Display 11.3) calculates the number of dollars and the number of cents from the value of the member variable `all_cents`. It computes the number of dollars and the number of cents using integer division by 100. For example, if `all_cents` has a value of 995 (cents), then the number of dollars is $995/100$, which is 9, and the number of cents is $995\%100$, which is 95. Thus, \$9.95 would be the value output when the value of `all_cents` is 995 (cents).

The definition for the member function `output` needs to make special provisions for outputting negative amounts of money. The result of integer division with negative numbers does not have a standard definition and can vary from one implementation to another. To avoid this problem, we have taken the absolute value of the number in `all_cents` before performing

division. To compute the absolute value we use the predefined function `labs`. The function `labs` returns the absolute value of its argument, just like the function `abs`, but `labs` takes an argument of type `long` and returns a value of type `long`. The function `labs` is in the library with header file `cstdlib`, just like the function `abs`. (Some versions of C++ do not include `labs`. If your implementation of C++ does not include `labs`, you can easily define the function for yourself.)

Implementation of `digit_to_int` (Optional)

The definition of the function `digit_to_int` from Display 11.3 is reproduced here:

```
int digit_to_int(char c)
{
    return (static_cast<int>(c) - static_cast<int>('0'));
}
```

At first glance, the formula for the value returned may seem a bit strange, but the details are not too complicated. The digit to be converted—for example, '3'—is the parameter `c`, and the returned value will turn out to be the corresponding `int` value—in this example, 3. As we pointed out in Chapters 2 and 6, values of type `char` are implemented as numbers. Unfortunately, the number implementing the digit '3', for example, is not the number 3. The type cast `static_cast<int>(c)` produces the number that implements the character `c` and converts this number to the type `int`. This changes `c` from the type `char` to a number of type `int` but, unfortunately, not to the number we want. For example, `static_cast<int>('3')` is not 3, but is some other number. We need to convert `static_cast<int>(c)` to the number corresponding to `c` (for example, '3' to 3). So let's see how we must adjust `static_cast<int>(c)` to get the number we want.

We know that the digits are in order. So `static_cast<int>('0') + 1` is equal to `static_cast<int>('1')`; `static_cast<int>('1') + 1` is equal to `static_cast<int>('2')`; `static_cast<int>('2') + 1` is equal to `static_cast<int>('3')`, and so forth. Knowing that the digits are in this order is all we need to know in order to see that `digit_to_int` returns the correct value. If `c` is '0', the value returned is

$$\text{static_cast<int>(c) - static_cast<int>('0')}$$

which is

$$\text{static_cast<int>('0') - static_cast<int>('0')}$$

So `digit_to_int('0')` returns 0.

Now let's consider what happens when `c` has the value '1'. The value returned is then `static_cast<int>(c) - static_cast<int>('0')`, which is `static_cast<int>('1') - static_cast<int>('0')`. That equals (`static_`

`cast<int>('0') + 1) - static_cast<int>('0')`, and that, in turn, equals `static_cast<int>('0') - static_cast<int>('0') + 1`. Since `static_cast<int>('0') - static_cast<int>('0')` is 0, this result is $0 + 1$, or 1. You can check the other digits, '2' through '9', for yourself; each digit produces a number that is 1 larger than the previous digit.

PITFALL Leading Zeros in Number Constants

The following are the object declarations given in the main part of the program in Display 11.3:

```
Money your_amount, my_amount(10, 9), our_amount;
```

The two arguments in `my_amount(10,9)` represent \$10.09. Since we normally write cents in the format “.09,” you might be tempted to write the object declaration as `my_amount(10,09)`. However, this will cause problems. In mathematics, the numerals 9 and 09 represent the same number. However, some C++ compilers use a leading zero to signal a different kind of numeral, so in C++ the constants 9 and 09 are not necessarily the same number. With some compilers, a leading zero means that the number is written in base 8 rather than base 10. Since base 8 numerals do not use the digit 9, the constant 09 does not make sense in C++. The constants 00 through 07 should work correctly, since they mean the same thing in base 8 and in base 10, but some systems in some contexts will have trouble even with 00 through 07.

The ANSI C++ standard provides that input should default to being interpreted as decimal, regardless of the leading 0. The GNU project C++ compiler, g++, and Microsoft’s VC++ compiler do comply with the standard, and so they do not have a problem with leading zeros. Most compiler vendors track the ANSI standard and thus should be compliant with the ANSI C++ standard, and so this problem with leading zeros should eventually go away. You should write a small program to test this on your compiler. ■

SELF-TEST EXERCISES

2. What is the difference between a friend function for a class and a member function for the class?
3. Suppose you wish to add a friend function to the class `DayOfYear` defined in Display 11.2. This friend function will be named `after` and will take two arguments of the type `DayOfYear`. The function returns `true` if the first argument represents a date that comes after the date represented by the second argument; otherwise, the function returns `false`. For example, February 2 comes after January 5. What do you need to add to the definition of the class `DayOfYear` in Display 11.2?

4. Suppose you wish to add a friend function for subtraction to the class `Money` defined in Display 11.3. What do you need to add to the description of the class `Money` that we gave in Display 11.3? The subtraction function should take two arguments of type `Money` and return a value of type `Money` whose value is the value of the first argument minus the value of the second argument.
5. Notice the member function `output` in the class definition of `Money` given in Display 11.3. In order to write a value of type `Money` to the screen, you call `output` with `cout` as an argument. For example, if `purse` is an object of type `Money`, then to output the amount of money in `purse` to the screen, you write the following in your program:

```
purse.output(cout);
```

It might be nicer not to have to list the stream `cout` when you send output to the screen.

Rewrite the class definition for the type `Money` given in Display 11.3. The only change is that this rewritten version overloads the function name `output` so that there are two versions of `output`. One version is just like the one shown in Display 11.3; the other version of `output` takes no arguments and sends its output to the screen. With this rewritten version of the type `Money`, the following two calls are equivalent:

```
purse.output(cout);
```

and

```
purse.output();
```

but the second is simpler. Note that since there will be two versions of the function `output`, you can still send output to a file. If `outs` is an output file stream that is connected to a file, then the following will output the money in the object `purse` to the file connected to `outs`:

```
purse.output(outs);
```

6. Notice the definition of the member function `input` of the class `Money` given in Display 11.3. If the user enters certain kinds of incorrect input, the function issues an error message and ends the program. For example, if the user omits a dollar sign, the function issues an error message. However, the checks given there do not catch all kinds of incorrect input. For example, negative amounts of money are supposed to be entered in the form `-$9.95`, but if the user mistakenly enters the amount in the form `$-9.95`, then the `input` will not issue an error message and the value of the `Money` object will be set to an incorrect value. What amount will the member function `input` read if the user mistakenly enters `$-9.95`? How might you add additional checks to catch most errors caused by such a misplaced minus sign?

7. The Pitfall section entitled “Leading Zeros in Number Constants” suggests that you write a short program to test whether a leading 0 will cause your compiler to interpret input numbers as base-8 numerals. Write such a program.

The `const` Parameter Modifier

A call-by-reference parameter is more efficient than a call-by-value parameter. A call-by-value parameter is a local variable that is initialized to the value of its argument, so when the function is called there are two copies of the argument. With a call-by-reference parameter, the parameter is just a placeholder that is replaced by the argument, so there is only one copy of the argument. For parameters of simple types, such as `int` or `double`, the difference in efficiency is negligible, but for class parameters the difference in efficiency can sometimes be important. Thus, it can make sense to use a call-by-reference parameter rather than a call-by-value parameter for a class, even if the function does not change the parameter.

If you are using a call-by-reference parameter and your function does not change the value of the parameter, you can mark the parameter so that the compiler knows that the parameter should not be changed. To do so, place the modifier `const` before the parameter type. The parameter is then called a **constant parameter**. For example, consider the class `Money` defined in Display 11.3. The `Money` parameters for the friend function `add` can be made into constant parameters as follows:

```
class Money
{
public:
    friend Money add(const Money& amount1, const Money& amount2);
    //Precondition: amount1 and amount2 have been given values.
    //Returns the sum of the values of amount1 and amount2.
    ...
}
```

When you use constant parameters, the modifier `const` must be used in both the function declaration and in the heading of the function definition, so with the change in the class definition above, the function definition for `add` would begin as follows:

```
Money add(const Money& amount1, const Money& amount2)
{
    ...
}
```

The remainder of the function definition would be the same as in Display 11.3.

Constant parameters are a form of automatic error checking. If your function definition contains a mistake that causes an inadvertent change to the constant parameter, then the computer will issue an error message.

The parameter modifier `const` can be used with any kind of parameter; however, it is normally used only for call-by-reference parameters for classes (and occasionally for certain other parameters whose corresponding arguments are large).

Call-by-reference parameters are replaced with arguments when a function is called, and the function call may (or may not) change the value of the argument. When you have a call to a member function, the calling object behaves very much like a call-by-reference parameter. When you have a call to a member function, that function call can change the value of the calling object. For example, consider the following, where the class `Money` is as in Display 11.3:

const with
member functions

```
Money m;
m.input(cin);
```

When the object `m` is declared, the value of the member variable `all_cents` is initialized to 0. The call to the member function `input` changes the value of the member variable `all_cents` to a new value determined by what the user types in. Thus, the call `m.input(cin)` changes the value of `m`, just as if `m` were a call-by-reference argument.

The modifier *const* applies to calling objects in the same way that it applies to parameters. If you have a member function that should not change the value of a calling object, you can mark the function with the *const* modifier; the computer will then issue an error message if your function code inadvertently changes the value of the calling object. In the case of a member function, the *const* goes at the end of the function declaration, just before the final semicolon, as shown here:

```
class Money
{
public:
    ...
    void output(ostream& outs) const;
    ...
}
```

The modifier *const* should be used in both the function declaration and the function definition, so the function definition for `output` would begin as follows:

```
void Money::output(ostream& outs) const
{
    ...
}
```

The remainder of the function definition would be the same as in Display 11.3.

PITFALL Inconsistent Use of *const*

Use of the *const* modifier is an all-or-nothing proposition. If you use *const* for one parameter of a particular type, then you should use it for every other parameter that has that type and that is not changed by the function call; moreover, if the type is a class type, then you should also use the *const* modifier for every member function that does not change the value of its calling object. The reason has to do with function calls within function calls. For example, consider the following definition of the function `guarantee`:



```
void guarantee(const Money& price)
{
    cout << "If not satisfied, we will pay you\n"
          << "double your money back.\n"
          << "That's a refund of $"
          << (2 * price.get_value()) << endl;
}
```

If you do *not* add the *const* modifier to the function declaration for the member function `get_value`, then the function `guarantee` will give an error message on most compilers. The member function `get_value` does not change the calling object `price`. However, when the compiler processes the function definition for `guarantee`, it will think that `get_value` does (or at least might) change the value of `price`. This is because when it is translating the function definition for `guarantee`, all that the compiler knows about the member function `get_value` is the function declaration for `get_value`; if the function declaration does not contain a *const*, which tells the compiler that the calling object will not be changed, then the compiler assumes that the calling object will be changed. Thus, if you use the modifier *const* with parameters of type `Money`, then you should also use *const* with all `Money` member functions that do not change the value of their calling object. In particular, the function declaration for the member function `get_value` should include a *const*.

In Display 11.4 we have rewritten the definition of the class `Money` given in Display 11.3, but this time we have used the *const* modifier where appropriate. The definitions of the member and friend functions would be the same as they are in Display 11.3, except that the modifier *const* must be used in function headings so that the headings match the function declarations shown in Display 11.4. ■

***const* Parameter Modifier**

If you place the modifier *const* before the type for a call-by-reference parameter, the parameter is called a **constant parameter**. (The heading of the function definition should also have a *const* so that it matches the function declaration.) When you add the *const*, you are telling the compiler that this parameter should not be changed. If you make a mistake in your definition of the function so that it does change the constant parameter, then the computer will give an error message. Parameters of a class type that are not changed by the function ordinarily should be constant call-by-reference parameters, rather than call-by-value parameters.

(continued)

If a member function does not change the value of its calling object, then you can mark the function by adding the *const* modifier to the function declaration. If you make a mistake in your definition of the function so that it does change the calling object and the function is marked with *const*, then the computer will give an error message. The *const* is placed at the end of the function declaration, just before the final semicolon. The heading of the function definition should also have a *const* so that it matches the function declaration.

EXAMPLE

```
class Sample
{
public:
    Sample();
    friend int compare(const Sample& s1, const Sample& s2);
    void input();
    void output() const;
private:
    int stuff;
    double more_stuff;
};
```

Use of the *const* modifier is an all-or-nothing proposition. You should use the *const* modifier whenever it is appropriate for a class parameter and whenever it is appropriate for a member function of the class. If you do not use *const* every time that it is appropriate for a class, then you should never use it for that class.

DISPLAY 11.4 The Class Money with Constant Parameters (part 1 of 2)

```
1 //Class for amounts of money in U.S. currency.
2 class Money
3 {
4 public:
5     friend Money add(const Money& amount1, const Money& amount2);
6     //Precondition: amount1 and amount2 have been given values.
7     //Returns the sum of the values of amount1 and amount2.
8
9     friend bool equal(const Money& amount1, const Money& amount2);
10    //Precondition: amount1 and amount2 have been given values.
11    //Returns true if amount1 and amount2 have the same value;
12    //otherwise, returns false.
13
14    Money(long dollars, int cents);
```

(continued)

DISPLAY 11.4 The Class Money with Constant Parameters (part 2 of 2)

```

13     //Initializes the object so its value represents an amount with the
14     //dollars and cents given by the arguments. If the amount is negative,
15     //then both dollars and cents must be negative.
16     Money(long dollars);
17     //Initializes the object so its value represents $dollars.00.
18     Money( );
19     //Initializes the object so its value represents $0.00.
20     double get_value( ) const;
21     //Precondition: The calling object has been given a value.
22     //Returns the amount of money recorded in the data of the calling object.
23     void input(istream& ins);
24     //Precondition: If ins is a file input stream, then ins has already been
25     //connected to a file. An amount of money, including a dollar sign, has been
26     //entered in the input stream ins. Notation for negative amounts is -$100.00.
27     //Postcondition: The value of the calling object has been set to
28     //the amount of money read from the input stream ins.
29     void output(ostream& outs) const;
30     //Precondition: If outs is a file output stream, then outs has already been
31     //connected to a file.
32     //Postcondition: A dollar sign and the amount of money recorded
33     //in the calling object have been sent to the output stream outs.
34 private:
35     long all_cents;
36 };

```

SELF-TEST EXERCISES

8. Give the complete definition of the member function `get_value` that you would use with the definition of `Money` given in Display 11.4.
9. Why would it be incorrect to add the modifier `const`, as shown here, to the function declaration for the member function `input` of the class `Money` given in Display 11.4?

```

class Money
{
    ...
public:
    void input(istream& ins) const;
    ...

```

10. What are the differences and the similarities between a call-by-value parameter and a call-by-`const`-reference parameter? Function declarations that illustrate these are

```
void call_by_value(int x);
void call_by_const_reference(const int& x);
```

11. Given the following definitions:

```
const int x = 17;
class A
{
public:
    A();
    A(int x);
    int f() const;
    int g(const A& x);
private:
    int i;
};
```

Each of the three *const* keywords is a promise to the compiler that the compiler will enforce. What is the promise in each case?

11.2 OVERLOADING OPERATORS

He's a smooth operator.

LINE FROM A SONG BY SADE (WRITTEN BY SADE ADU AND RAY ST. JOHN)

Earlier in this chapter, we showed you how to make the function `add` a friend of the class `Money` and use it to add two objects of type `Money` (Display 11.3). The function `add` is adequate for adding objects, but it would be nicer if you could simply use the usual `+` operator to add values of type `Money`, as in the last line of the following code:

```
Money total, cost, tax;
cout << "Enter cost and tax: ";
cost.input(cin);
tax.input(cin);
total = cost + tax;
```

instead of having to use the slightly more awkward

```
total = add(cost, tax);
```

Recall that an operator, such as `+`, is really just a function except that the syntax for how it is used is slightly different from that of an ordinary function. In an ordinary function call, the arguments are placed in parentheses after the function name, as in the following:

```
add(cost, tax)
```

With a (binary) operator, the arguments are placed on either side of the operator, as shown here:

```
cost + tax
```

A function can be overloaded to take arguments of different types. An operator is really a function, so an operator can be overloaded. The way you overload an operator, such as `+`, is basically the same as the way you overload a function name. In this section we show you how to overload operators in C++.

Overloading Operators

You can overload the operator `+` (and many other operators) so that it will accept arguments of a class type. The difference between overloading the `+` operator and defining the function `add` (given in Display 11.3) involves only a slight change in syntax. The definition of the overloaded operator `+` is basically the same as the definition of the function `add`. The only differences are that you use the name `+` instead of the name `add` and you precede the `+` with the keyword *operator*. In Display 11.5 we have rewritten the type `Money` to include the overloaded operator `+` and we have embedded the definition in a small demonstration program.

The class `Money`, as defined in Display 11.5, also overloads the `==` operator so that `==` can be used to compare two objects of type `Money`. If `amount1` and `amount2` are two objects of type `Money`, we want the expression

```
amount1 == amount2
```

to return the same value as the following Boolean expression:

```
amount1.all_cents == amount2.all_cents
```

As shown in Display 11.5, this is the value returned by the overloaded operator `==`.

You can overload most, but not all, operators. The operator need not be a friend of a class, but you will often want it to be a friend. Check the box entitled “Rules on Overloading Operators” for some technical details on when and how you can overload an operator.

Operator Overloading

A (binary) operator, such as `+`, `-`, `/`, `%`, and so forth, is simply a function that is called using a different syntax for listing its arguments. With an operator, the arguments are listed before and after the operator; with a function, the arguments are listed in parentheses after the function name. An operator definition is written similarly to a function definition, except that the operator definition includes the reserved word *operator* before the operator name. The predefined operators, such as `+` and so forth, can be overloaded by giving them a new definition for a class type.

An operator may be a friend of a class although this is not required. An example of overloading the `+` operator as a friend is given in Display 11.5.

DISPLAY 11.5 Overloading Operators (part 1 of 2)

```

1 //Program to demonstrate the class Money. (This is an improved version of
2 //the class Money that we gave in Display 11.3 and rewrote in Display 11.4.)
3 #include <iostream>
4 #include <cstdlib>
5 #include <cctype>
6 using namespace std;
7
8 //Class for amounts of money in U.S. currency.
9 class Money
10 {
11 public:
12     friend Money operator +(const Money& amount1, const Money& amount2);
13     //Precondition: amount1 and amount2 have been given values.
14     //Returns the sum of the values of amount1 and amount2.
15
16     friend bool operator ==(const Money& amount1, const Money& amount2);
17     //Precondition: amount1 and amount2 have been given values.
18     //Returns true if amount1 and amount2 have the same value;
19     //otherwise, returns false.
20
21     Money(long dollars, int cents);
22     Money(long dollars);
23     Money( );
24     double get_value( ) const;
25     void input(istream& ins);
26     void output(ostream& outs) const;
27 private:
28     long all_cents;
29 };

```

Some comments from Display 11.4 have been omitted to save space in this book, but they should be included in a real program.

<Any extra function declarations from Display 11.3 go here.>

```

28 int main( )
29 {
30     Money cost(1, 50), tax(0, 15), total;
31     total = cost + tax;
32     cout << "cost = ";
33     cost.output(cout);
34     cout << endl;
35     cout << "tax = ";
36     tax.output(cout);
37     cout << endl;
38     cout << "total bill = ";
39     total.output(cout);
40     cout << endl;

```

(continued)

DISPLAY 11.5 Overloading Operators (part 2 of 2)

```
41     if (cost == tax)
42         cout << "Move to another state.\n";
43     else
44         cout << "Things seem normal.\n";
45     return 0;
46 }
47
48 Money operator +(const Money& amount1, const Money& amount2)
49 {
50     Money temp;
51     temp.all_cents = amount1.all_cents + amount2.all_cents;
52     return temp;
53 }
54
55 bool operator ==(const Money& amount1, const Money& amount2)
56 {
57     return (amount1.all_cents == amount2.all_cents);
58 }
59
```

<The definitions of the member functions are the same as in Display 11.3 except that *const* is added to the function headings in various places so that the function headings match the function declarations in the preceding class definition. No other changes are needed in the member function definitions. The bodies of the member function definitions are identical to those in Display 11.3>

Output

```
cost = $1.50
tax = $0.15
total bill = $1.65
Things seem normal.
```

SELF-TEST EXERCISES

12. What is the difference between a (binary) operator and a function?
13. Suppose you wish to overload the operator `<` so that it applies to the type `Money` defined in Display 11.5. What do you need to add to the description of `Money` given in Display 11.5?

14. Suppose you wish to overload the operator `<=` so that it applies to the type `Money` defined in Display 11.5. What do you need to add to the description of `Money` given in Display 11.5?
15. Is it possible using operator overloading to change the behavior of `+` on integers? Why or why not?

Rules on Overloading Operators

- When overloading an operator, at least one argument of the resulting overloaded operator must be of a class type.
- An overloaded operator can be, but does not have to be, a friend of a class; the operator function may be a member of the class or an ordinary (non-friend) function. (Overloading an operator as a class member is discussed in Appendix 8.)
- You cannot create a new operator. All you can do is overload existing operators, such as `+`, `-`, `*`, `/`, `%`, and so forth.
- You cannot change the number of arguments that an operator takes. For example, you cannot change `%` from a binary to a unary operator when you overload `%`; you cannot change `++` from a unary to a binary operator when you overload it.
- You cannot change the precedence of an operator. An overloaded operator has the same precedence as the ordinary version of the operator. For example, `x*y+z` always means `(x*y)+z`, even if `x`, `y`, and `z` are objects and the operators `+` and `*` have been overloaded for the appropriate classes.
- The following operators cannot be overloaded: the dot operator (`.`), the scope resolution operator (`::`), and the operators `.*` and `?:`, which are not discussed in this book.
- Although the assignment operator `=` can be overloaded so that the default meaning of `=` is replaced by a new meaning, this must be done in a different way from what is described here. Overloading `=` is discussed in the section “Overloading the Assignment Operator” later in this chapter. Some other operators, including `[]` and `->`, also must be overloaded in a way that is different from what is described in this chapter. The operators `[]` and `->` are discussed later in this book.

Constructors for Automatic Type Conversion

If your class definition contains the appropriate constructors, the system will perform certain type conversions automatically. For example, if your program contains the definition of the class `Money` given in Display 11.5, you could use the following in your program:

```

Money base_amount(100, 60), full_amount;
full_amount = base_amount + 25;
full_amount.output(cout);

```

The output will be

```
$125.60
```

The code above may look simple and natural enough, but there is one subtle point. The 25 (in the expression `base_amount + 25`) is not of the appropriate type. In Display 11.5 we only overloaded the operator `+` so that it could be used with two values of type `Money`. We did not overload `+` so that it could be used with a value of type `Money` and an integer. The constant 25 is an integer and is not of type `Money`. The constant 25 can be considered to be of type `int` or of type `long`, but 25 cannot be used as a value of type `Money` unless the class definition somehow tells the system how to convert an integer to a value of type `Money`. The only way that the system knows that 25 means \$25.00 is that we included a constructor that takes a single argument of type `long`. When the system sees the expression

```
base_amount + 25
```

it first checks to see if the operator `+` has been overloaded for the combination of a value of type `Money` and an integer. Since there is no such overloading, the system next looks to see if there is a constructor that takes a single argument that is an integer. If it finds a constructor that takes a single-integer argument, it uses that constructor to convert the integer 25 to a value of type `Money`. The constructor with one argument of type `long` tells the system how to convert an integer, such as 25, to a value of type `Money`. The one-argument constructor says that 25 should be converted to an object of type `Money` whose member variable `all_cents` is equal to 2500; in other words, the constructor converts 25 to an object of type `Money` that represents \$25.00. (The definition of the constructor is in Display 11.3.)

Note that this type conversion will not work unless there is a suitable constructor. For example, the type `Money` (Display 11.5) has no constructor that takes an argument of type `double`, so the following is illegal and would produce an error message if you were to put it in a program that declares `base_amount` and `full_amount` to be of type `Money`:

```
full_amount = base_amount + 25.67;
```

To make this use of `+` legal, you could change the definition of the class `Money` by adding another constructor. The function declaration for the constructor you need to add is the following:

```

class Money
{
public:
    . . .

```

```
Money(double amount);
//Initializes the object so its value represents $amount.
. . .
```

Writing the definition for this new constructor is Self-Test Exercise 16.

These automatic type conversions (produced by constructors) seem most common and compelling with overloaded numeric operators such as + and -. However, these automatic conversions apply in exactly the same way to arguments for ordinary functions, arguments for member functions, and arguments for other overloaded operators.

SELF-TEST EXERCISE

16. Give the definition for the constructor discussed at the end of the previous section. The constructor is to be added to the class Money in Display 11.5. The definition begins as follows:

```
Money::Money(double amount)
{
```

Overloading Unary Operators

In addition to the binary operators, such as + in $x+y$, there are also unary operators, such as the operator - when it is used to mean negation. In the following statement, the unary operator - is used to set the value of a variable x equal to the negative of the value of the variable y :

```
x = -y;
```

The increment and decrement operators ++ and -- are other examples of unary operators.

You can overload unary operators as well as binary operators. For example, you can redefine the type Money given in Display 11.5 so that it has both a unary and a binary operator version of the subtraction/negation operator -. The redone class definition is given in Display 11.6. Suppose your program contains this class definition and the following code:

```
Money amount1(10), amount2(6), amount3;
```

Then the following sets the value of amount3 to amount1 minus amount2:

```
amount3 = amount1 - amount2;
```

The following will, then, output \$4.00 to the screen:

```
amount3.output(cout);
```

On the other hand, the following will set amount3 equal to the negative of amount1:

```
amount3 = -amount1;
```

The following will, then, output -\$10.00 to the screen:

```
amount3.output(cout);
```

You can overload the ++ and -- operators in ways similar to the way we overloaded the negation operator in Display 11.6. The overloading definition will apply to the operator when it is used in prefix position, as in ++x and --x. The postfix versions of ++ and --, as in x++ and x--, are handled in a different manner, but we will not discuss these postfix versions. (Hey, you can't learn everything in a first course!)

Overloading >> and <<

<< is an operator

The insertion operator << that we used with cout is a binary operator like the binary operators + or -. For example, consider the following:

```
cout << "Hello out there.\n";
```

The operator is <<, the first operand is the output stream cout, and the second operand is the string value "Hello out there.\n". You can change either of these operands. If fout is an output stream of type ofstream and fout has been connected to a file with a call to open, then you can replace cout with fout and the string will instead be written to the file connected to fout. Of course, you can also replace the string "Hello out there.\n" with another string, a variable, or a number. Since the insertion operator << is an operator, you should be able to overload it just as you overload operators such as + and -. This is true, but there are a few more details to worry about when you overload the input and output operators >> and <<.

Overloading <<

In our previous definitions of the class Money, we used the member function output to output values of type Money (Displays 11.3 through 11.6). This is adequate, but it would be nicer if we could simply use the insertion operator << to output values of type Money as in the following:

```
Money amount(100);
cout << "I have " << amount << " in my purse.\n";
```

instead of having to use the member function output as shown here:

```
Money amount(100);
cout << "I have ";
amount.output(cout);
cout << " in my purse.\n";
```

One problem in overloading the operator << is deciding what value should be returned when << is used in an expression like the following:

```
cout << amount
```

DISPLAY 11.6 Overloading a Unary Operator

```

1  //Class for amounts of money in U.S. currency.
2  class Money
3  {
4  public:
5      friend Money operator +(const Money& amount1, const Money& amount2);
6
7      friend Money operator -(const Money& amount1, const Money& amount2);
8      //Precondition: amount1 and amount2 have been given values.
9      //Returns amount1 minus amount2.
10
11     friend Money operator -(const Money& amount);
12     //Precondition: amount has been given a value.
13     //Returns the negative of the value of amount.
14
15     friend bool operator ==(const Money& amount1, const Money& amount2);
16
17     Money(long dollars, int cents);
18     Money(long dollars);
19     Money( );
20
21     double get_value( ) const;
22
23     void input(istream& ins);
24     void output(ostream& outs) const;
25 private:
26     long all_cents;
27 };

```

This is an improved version of the class `Money` given in Display 11.5.

We have omitted the `include` directives and some of the comments, but you should include them in your programs.

<Any additional function declarations as well as the main part of the program go here.>

```

22 Money operator -(const Money& amount1, const Money& amount2)
23 {
24     Money temp;
25     temp.all_cents = amount1.all_cents - amount2.all_cents;
26     return temp;
27 }
28 Money operator -(const Money& amount)
29 {
30     Money temp;
31     temp.all_cents = -amount.all_cents;
32     return temp;
33 }

```

<The other function definitions are the same as in Display 11.5.>

The two operands in this expression are `cout` and `amount`, and evaluating the expression should cause the value of `amount` to be written to the screen. But if `<<` is an operator like `+` or `*`, then the expression above should also return some value. After all, expressions with other operands, such as `n1 + n2`, return values. But what does `cout << amount` return? To obtain the answer to that question, we need to look at a more complicated expression involving `<<`.

Chains of `<<`

Let's consider the following expression, which involves evaluating a chain of expressions using `<<`:

```
cout << "I have " << amount << " in my purse.\n";
```

If you think of the operator `<<` as being analogous to other operators, such as `+`, then the above should be (and in fact is) equivalent to the following:

```
((cout << "I have ") << amount) << " in my purse.\n";
```

What value should `<<` return in order to make sense of this expression? The first thing evaluated is the subexpression:

```
(cout << "I have ")
```

If things are to work out, then the subexpression had better return `cout` so that the computation can continue as follows:

```
(cout << amount) << " in my purse.\n";
```

And if things are to continue to work out, `(cout << amount)` had better also return `cout` so that the computation can continue as follows:

```
cout << " in my purse.\n";
```

`<<` returns a stream

This is illustrated in Display 11.7. The operator `<<` should return its first argument, which is a stream of type `ostream`.

Thus, the declaration for the overloaded operator `<<` (to use with the class `Money`) should be as follows:

```
class Money
{
public:
    . . .
    friend ostream& operator <<(ostream& outs, const
                               Money& amount);
    //Precondition: If outs is a file output stream, then outs
    //has already been connected to a file.
    //Postcondition: A dollar sign and the amount of money
    //recorded in the calling object have been sent to the output
    //stream outs.
    . . .
}
```

Once we have overloaded the insertion (output) operator `<<`, we will no longer need the member function `output` and thus can delete `output` from

DISPLAY 11.7 << as an Operator

```

1   cout << "I have " << amount << " in my purse.\n";
2
3   means the same as
4
5   ((cout << "I have ") << amount) << " in my purse.\n";
6
7   and is evaluated as follows:
8
9   First evaluate (cout << "I have "), which returns cout:
10  ((cout << "I have ") << amount) << " in my purse.\n";
11
12  and the string "I have" is output.
13
14  (cout << amount) << " in my purse.\n";
15
16
17  Then evaluate (cout << amount), which returns cout:
18
19  (cout << amount) << " in my purse.\n";
20
21  and the value of amount is output.
22
23  cout << " in my purse.\n";
24
25
26  Then evaluate cout << " in my purse.\n", which returns cout:
27
28  cout << " in my purse.\n";
29
30  and the string "in my purse.\n" is output.
31
32  Since there are no more << operators, the process ends.

```

our definition of the class Money. The definition of the overloaded operator << is very similar to the member function output. In outline form, the definition for the overloaded operator is as follows:

```

ostream& operator <<(ostream& outs, const Money& amount)
{
    <This part is the same as the body of Money::output
    that is given in Display 11.3 (except that all_cents
    is replaced with amount.all_cents).>
    return outs;
}

```

<< and >> return a reference

Returning a reference

There is one thing left to explain in the previous function declaration and definition for the overloaded operator <<. What is the meaning of the & in the returned type `ostream&`? The easiest answer is that *whenever an operator (or a function) returns a stream, you must add an & to the end of the name for the returned type*. That simple rule will allow you to overload the operators << and >>. However, although that is a good working rule that will allow you to write your class definitions and programs, it is not very satisfying. You do not need to know what that & really means, but if we explain it, that will remove some of the mystery from the rule that tells you to add an &.

When you add an & to the name of a returned type, you are saying that the operator (or function) returns a *reference*. All the functions and operators we have seen thus far return values. However, if the returned type is a stream, you cannot simply return the value of the stream. In the case of a stream, the value of the stream is an entire file or the keyboard or the screen, and it may not make sense to return those things. Thus, you want to return only the stream itself rather than the value of the stream. When you add an & to the name of a returned type, you are saying that the operator (or function) returns a **reference**, which means that you are returning the object itself, as opposed to the value of the object.

The extraction operator >> is overloaded in a way that is analogous to what we described for the insertion operator <<. However, with the extraction (input) operator >>, the second argument will be the object that receives the input value, so the second parameter must be an ordinary call-by-reference parameter. In outline form, the definition for the overloaded extraction operator >> is as follows:

```
istream& operator >>(istream& ins, Money& amount)
{
    <This part is the same as the body of
    Money::input given in Display 11.3 (except that
    all_cents is replaced with amount.all_cents).>
    return ins;
}
```

The complete definitions of the overloaded operators << and >> are given in Display 11.8, where we have rewritten the class `Money` yet again. This time we have rewritten the class so that the operators << and >> are overloaded to allow us to use these operators with values of type `Money`.

Overloading >> and <<

The input and output operators >> and << can be overloaded just like any other operators. The value returned must be the stream. The type for the value returned must have the & symbol added to the end of the type name. The function declarations and beginnings of the function definitions are as shown on the next page. See Display 11.8 for an example.

(continued)

FUNCTION DECLARATIONS

```

class Class_Name
{
public:
    . . .

    friend ostream& operator >>(istream& Parameter_1,
                                Class_Name& Parameter_2);

    friend ostream& operator <<(ostream& Parameter_3,
                                const Class_Name&
                                Parameter_4);

    . . .

```

Parameter for the stream (points to Parameter_1)

Parameter for the object to receive the input (points to Parameter_2)

DEFINITIONS

```

ostream& operator >>(istream& Parameter_1,
                    Class_Name& Parameter_2)
{
    . . .
}

ostream& operator <<(ostream& Parameter_3,
                    const Class_Name& Parameter_4)
{
    . . .

```

DISPLAY 11.8 Overloading << and >> (part 1 of 4)

```

1 //Program to demonstrate the class Money
2 #include <iostream>
3 #include <fstream>
4 #include <cstdlib>
5 #include <cctype>
6 using namespace std;
7
8 //Class for amounts of money in U.S. currency.
9 class Money
10 {
11 public:
12     friend Money operator +(const Money& amount1, const Money& amount2);
13     friend Money operator -(const Money& amount1, const Money& amount2);
14     friend Money operator -(const Money& amount);

```

*This is an improved version of the class **Money** that we gave in Display 11.6.*

Although we have omitted some of the comments from Displays 11.5 and 11.6, you should include them.

(continued)

DISPLAY 11.8 Overloading << and >> (part 2 of 4)

```

15     friend bool operator ==(const Money& amount1, const Money& amount2);
16     Money(long dollars, int cents);
17     Money(long dollars);
18     Money( );
19     double get_value( ) const;
20     friend istream& operator >>(istream& ins, Money& amount);
21     //Overloads the >> operator so it can be used to input values of type Money.
22     //Notation for inputting negative amounts is as in -$100.00.
23     //Precondition: If ins is a file input stream, then ins has already been
24     //connected to a file.
25     friend ostream& operator <<(ostream& outs, const Money& amount);
26     //Overloads the << operator so it can be used to output values of type Money.
27     //Precedes each output value of type Money with a dollar sign.
28     //Precondition: If outs is a file output stream,
29     //then outs has already been connected to a file.
30 private:
31     long all_cents;
32 };
33 int digit_to_int(char c);
34 //Used in the definition of the overloaded input operator >>.
35 //Precondition: c is one of the digits '0' through '9'.
36 //Returns the integer for the digit; for example, digit_to_int('3') returns 3.
37
38 int main( )
39 {
40     Money amount;
41     ifstream in_stream;
42     ofstream out_stream;
43
44     in_stream.open("infile.dat");
45     if (in_stream.fail( ))
46     {
47         cout << "Input file opening failed.\n";
48         exit(1);
49     }
50
51     out_stream.open("outfile.dat");
52     if (out_stream.fail( ))
53     {
54         cout << "Output file opening failed.\n";
55         exit(1);
56     }

```

(continued)

DISPLAY 11.8 Overloading << and >> (part 3 of 4)

```

57
58     in_stream >> amount;
59     out_stream << amount
60         << " copied from the file infile.dat.\n";
61     cout << amount
62         << " copied from the file infile.dat.\n";
63
64     in_stream.close( );
65     out_stream.close( );
66
67     return 0;
68 }
69 //Uses iostream, ctype, cstdlib:
70 istream& operator >>(istream& ins, Money& amount)
71 {
72     char one_char, decimal_point,
73         digit1, digit2; //digits for the amount of cents
74     long dollars;
75     int cents;
76     bool negative;//set to true if input is negative.
77
78     ins >> one_char;
79     if (one_char == '-')
80     {
81         negative = true;
82         ins >> one_char; //read '$'
83     }
84     else
85         negative = false;
86     //if input is legal, then one_char == '$'
87
88     ins >> dollars >> decimal_point >> digit1 >> digit2;
89
90     if (one_char != '$' || decimal_point != '.'
91         || !isdigit(digit1) || !isdigit(digit2))
92     {
93         cout << "Error illegal form for money input\n";
94         exit(1);
95     }
96
97     cents = digit_to_int(digit1) * 10 + digit_to_int(digit2);
98
99     amount.all_cents = dollars * 100 + cents;
100    if (negative)
101        amount.all_cents = -amount.all_cents;
102    return ins;
103 }

```

(continued)

DISPLAY 11.8 Overloading << and >> (part 4 of 4)

```
100  int digit_to_int(char c)
101  {
102      return ( static_cast<int>(c) - static_cast<int>('0') );
103  }

104  //Uses cstdlib and iostream:
105  ostream& operator <<(ostream& outs, const Money& amount)
106  {
107      long positive_cents, dollars, cents;
108      positive_cents = labs(amount.all_cents);
109      dollars = positive_cents/100;
110      cents = positive_cents%100;
111
112      if (amount.all_cents < 0)
113          outs << "- $" << dollars << '.';
114      else
115          outs << "$" << dollars << '.';
116
117      if (cents < 10)
118          outs << '0';
119      outs << cents;
120
121      return outs;
122  }
123
```

<The definitions of the member functions and other overloaded operators go here. See Displays 11.3, 11.4, 11.5, and 11.6 for the definitions.>

infile.dat

(Not changed by program.)

```
$1.11 $2.22
$3.33
```

outfile.dat

(After program is run.)

```
$1.11 copied from the file infile.dat.
```

Screen Output

```
$1.11 copied from the file infile.dat.
```

SELF-TEST EXERCISES

17. Here is a definition of a class called `Pairs`. Objects of type `Pairs` can be used in any situation where ordered pairs are needed. Your task is to write implementations of the overloaded operator `>>` and the overloaded operator `<<` so that objects of class `Pairs` are to be input and output in the form `(5,6)(5,-4)(-5,4)` or `(-5,-6)`. You need not implement any constructor or other member, and you need not do any input format checking.

```
#include <iostream>
using namespace std;
class Pairs
{
public:
    Pairs( );
    Pairs(int first, int second);
    //other members and friends
    friend ostream& operator >>(ostream& ins, Pairs& second);
    friend ostream& operator <<(ostream& outs, const Pairs& second);
private:
    int f;
    int s;
};
```

18. Following is the definition for a class called `Percent`. Objects of type `Percent` represent percentages such as 10% or 99%. Give the definitions of the overloaded operators `>>` and `<<` so that they can be used for input and output with objects of the class `Percent`. Assume that input always consists of an integer followed by the character `'%'`, such as 25%. All percentages are whole numbers and are stored in the `int` member variable named `value`. You do not need to define the other overloaded operators and do not need to define the constructor. You only have to define the overloaded operators `>>` and `<<`.

```
#include <iostream>
using namespace std;
class Percent
{
public:
    friend bool operator ==(const Percent& first,
                           const Percent& second);

    friend bool operator <(const Percent& first,
                           const Percent& second);

    Percent();
    Percent(int percent_value);
```

```

    friend istream& operator >>(istream& ins,
                               Percent& the_object);

    //Overloads the >> operator to input values of type
    //Percent.
    //Precondition: If ins is a file input stream, then ins
    //has already been connected to a file.

    friend ostream& operator <<(ostream& outs,
                                const Percent& a_percent);
    //Overloads the << operator for output values of type
    //Percent.
    //Precondition: If outs is a file output stream, then
    //outs has already been connected to a file.
private:
    int value;
};

```

11.3 ARRAYS AND CLASSES

You can combine arrays, structures, and classes to form intricately structured types such as arrays of structures, arrays of classes, and classes with arrays as member variables. In this section we discuss a few simple examples to give you an idea of the possibilities.

Arrays of Classes

The base type of an array may be any type, including types that you define, such as structure and class types. If you want each indexed variable to contain items of different types, make the array an array of structures. For example, suppose you want an array to hold ten weather data points, where each data point is a wind velocity and a wind direction (north, south, east, or west). You might use the following type definition and array declaration:

```

struct WindInfo
{
    double velocity; //in miles per hour
    char direction; //'N', 'S', 'E', or 'W'
};

WindInfo data_point[10];

```

To fill the array `data_point`, you could use the following *for* loop:

```

int i;
for (i = 0; i < 10; i++)

```

```

{
    cout << "Enter velocity for "
          << i << " numbered data point: ";
    cin >> data_point[i].velocity;
    cout << "Enter direction for that data point"
          << " (N, S, E, or W): ";
    cin >> data_point[i].direction;
}

```

The way to read an expression such as `data_point[i].velocity` is left to right and very carefully. First, `data_point` is an array. So, `data_point[i]` is the *i*th indexed variable of this array. An indexed variable of this array is of type `WindInfo`, which is a structure with two member variables named `velocity` and `direction`. So, `data_point[i].velocity` is the member variable named `velocity` for the *i*th array element. Less formally, `data_point[i].velocity` is the wind velocity for the *i*th data point. Similarly, `data_point[i].direction` is the wind direction for the *i*th data point.

The ten data points in the array `data_point` can be written to the screen with the following *for* loop:

```

for (i = 0; i < 10; i++)
    cout << "Wind data point number " << i << ": \n"
          << data_point[i].velocity
          << " miles per hour\n"
          << "direction " << data_point[i].direction
          << endl;

```

Display 11.9 contains the definition for a class called `Money`. Objects of the class `Money` are used to represent amounts of money in U.S. currency. The definitions of the member functions, member operations, and friend functions for this class can be found in Displays 11.3 through 11.8 and in the answer to Self-Test Exercise 13. You can have arrays whose base type is the type `Money`. A simple example is given in Display 11.9. That program reads in a list of five amounts of money and computes how much each amount differs from the largest of the five amounts. Notice that an array whose base type is a class is treated basically the same as any other array. In fact, the program in Display 11.9 is very similar to the program in Display 7.1, except that in Display 11.9 the base type is a class.

When an array of classes is declared, the default constructor is called to initialize the indexed variables, so it is important to have a default constructor for any class that will be the base type of an array. An array of classes is manipulated just like an array with a simple base type like `int` or `double`. For example, the difference between each amount and the largest amount is stored in an array named `difference`, as follows:

```

Money difference[5];
for (i = 0; i < 5; i++)
    difference[i] = max - amount[i];

```

Constructor call

DISPLAY 11.9 Program Using an Array of Money Objects *(part 1 of 2)*

```

1  //This is the definition for the class Money.
2  //Values of this type are amounts of money in U.S. currency.
3  #include <iostream>
4  using namespace std;
5
6  class Money
7  {
8  public:
9      friend Money operator +(const Money& amount1, const Money& amount2);
10     //Returns the sum of the values of amount1 and amount2.
11
12     friend Money operator -(const Money& amount1, const Money& amount2);
13     //Returns amount1 minus amount2.
14
15     friend Money operator -(const Money& amount);
16     //Returns the negative of the value of amount.
17
18     friend bool operator ==(const Money& amount1, const Money& amount2);
19     //Returns true if amount1 and amount2 have the same value; false otherwise.
20
21     friend bool operator <(const Money& amount1, const Money& amount2);
22     //Returns true if amount1 is less than amount2; false otherwise.
23
24     Money(long dollars, int cents);
25     //Initializes the object so its value represents an amount with
26     //the dollars and cents given by the arguments. If the amount
27     //is negative, then both dollars and cents should be negative.
28
29     Money(long dollars);
30     //Initializes the object so its value represents $dollars.00.
31
32     Money( );
33     //Initializes the object so its value represents $0.00.
34
35     double get_value( ) const;
36     //Returns the amount of money recorded in the data portion of the calling
37     //object.
38
39     friend istream& operator >>(istream& ins, Money& amount);
40     //Overloads the >> operator so it can be used to input values of type
41     //Money. Notation for inputting negative amounts is as in - $100.00.
42     //Precondition: If ins is a file input stream, then ins has already been
43     //connected to a file.
44
45     friend ostream& operator <<(ostream& outs, const Money& amount);
46     //Overloads the << operator so it can be used to output values of type
47     //Money. Precedes each output value of type Money with a dollar sign.
48     //Precondition: If outs is a file output stream, then outs has already been
49     //connected to a file.
50
51 private:
52     long all_cents;
53 };

```

(continued)

DISPLAY 11.9 Program Using an Array of Money Objects (part 2 of 2)

<The definitions of the member functions and the overloaded operators goes here.>

```

44 //Reads in 5 amounts of money and shows how much each
45 //amount differs from the largest amount.
46 int main( )
47 {
48     Money amount[5], max;
49     int i;
50     cout << "Enter 5 amounts of money:\n";
51     cin >> amount[0];
52     max = amount[0];
53     for (i = 1; i < 5; i++)
54     {
55         cin >> amount[i];
56         if (max < amount[i])
57             max = amount[i];
58         //max is the largest of amount[0], . . . , amount[i].
59     }
60     Money difference[5];
61     for (i = 0; i < 5; i++)
62         difference[i] = max - amount[i];
63     cout << "The highest amount is " << max << endl;
64     cout << "The amounts and their\n"
65           << "differences from the largest are:\n";
66     for (i = 0; i < 5; i++)
67     {
68         cout << amount[i] << " off by "
69             << difference[i] << endl;
70     }
71     return 0;
72 }

```

Sample Dialogue

```

Enter 5 amounts of money:
$5.00 $10.00 $19.99 $20.00 $12.79
The highest amount is $20.00
The amounts and their
differences from the largest are:
$5.00 off by $15.00
$10.00 off by $10.00
$19.99 off by $0.01
$20.00 off by $0.00
$12.79 off by $7.21

```

SELF-TEST EXERCISES

19. Give a type definition for a structure called `Score` that has two member variables called `home_team` and `opponent`. Both member variables are of type `int`. Declare an array called `game` that is an array with ten elements of type `Score`. The array `game` might be used to record the scores of each of ten games for a sports team.
20. Write a program that reads in five amounts of money, doubles each amount, and then writes out the doubled values to the screen. Use one array with `Money` as the base type. (*Hint*: Use Display 11.9 as a guide, but this program will be simpler than the one in Display 11.9.)

Arrays as Class Members

You can have a structure or class that has an array as a member variable. For example, suppose you are a speed swimmer and want a program to keep track of your practice times for various distances. You can use the structure `my_best` (of the type `Data` given next) to record a distance (in meters) and the times (in seconds) for each of ten practice tries swimming that distance:

```
struct Data
{
    double time[10];
    int distance;
};

Data my_best;
```

The structure `my_best`, declared above, has two member variables: One, named `distance`, is a variable of type `int` (to record a distance); the other, named `time`, is an array of ten values of type `double` (to hold times for ten practice tries at the specified distance). To set the distance equal to 20 (meters), you can use the following:

```
my_best.distance = 20;
```

You can set the ten array elements with values from the keyboard as follows:

```
cout << "Enter ten times (in seconds):\n";
for (int i = 0; i < 10; i++)
    cin >> my_best.time[i];
```

The expression `my_best.time[i]` is read left to right: `my_best` is a structure; `my_best.time` is the member variable named `time`. Since `my_best.time` is an array, it makes sense to add an index. So, the expression `my_best.time[i]` is the *i*th indexed variable of the array `my_best.time`. If you use a class rather than a structure type, then you can do all your array manipulations with member functions and avoid such confusing expressions. This is illustrated in the following Programming Example.

PROGRAMMING EXAMPLE**A Class for a Partially Filled Array**

Display 11.10 shows the definition for a class called `TemperatureList`, whose objects are lists of temperatures. You might use an object of type `TemperatureList` in a program that does weather analysis. The list of temperatures is kept in the member variable `list`, which is an array. Since this array will typically be only partially filled, a second member variable, called `size`, is used to keep track of how much of the array is used. The value of `size` is the number of indexed variables of the array `list` that are being used to store values.

An object of type `TemperatureList` is declared like an object of any other type. For example, the following declares `my_data` to be an object of type `TemperatureList`:

```
TemperatureList my_data;
```

This declaration calls the default constructor with the new object `my_data`, and so the object `my_data` is initialized so that the member variable `size` has the value 0, indicating an empty list.

Once you have declared an object such as `my_data`, you can add an item to the list of temperatures (that is, to the member array `list`) with a call to the member function `add_temperature` as follows:

```
my_data.add_temperature(77);
```

In fact, this is the only way you can add a temperature to the list `my_data`, since the array `list` is a private member variable. Notice that when you add an item with a call to the member function `add_temperature`, the function call first tests to see if the array `list` is full and adds the value only if the array is not full.

The class `TemperatureList` is very specialized. The only things you can do with an object of the class `TemperatureList` are to initialize the list so it is empty, add items to the list, check if the list is full, and output the list. To output the temperatures stored in the object `my_data` (declared previously), the call would be as follows:

```
cout << my_data;
```

With the class `TemperatureList` you cannot delete a temperature from the list (array) of temperatures. You can, however, erase the entire list and start over with an empty list by calling the default constructor, as follows:

```
my_data = TemperatureList();
```

The type `TemperatureList` uses almost no properties of temperatures. You could define a similar class for lists of pressures or lists of distances or lists of any other data expressed as values of type `double`. To save yourself the trouble of defining all these different classes, you could define a single class that represents an arbitrary list of values of type `double` without specifying what the values represent.

DISPLAY 11.10 Program for a Class with an Array Member (part 1 of 2)

```

1  //This is a definition for the class
2  //TemperatureList. Values of this type are lists of Fahrenheit temperatures.
3
4  #include <iostream>
5  #include <cstdlib>
6  using namespace std;
7
8  const int MAX_LIST_SIZE = 50;
9
10 class TemperatureList
11 {
12 public:
13     TemperatureList( );
14     //Initializes the object to an empty list.
15
16     void add_temperature(double temperature);
17     //Precondition: The list is not full.
18     //Postcondition: The temperature has been added to the list.
19
20     bool full( ) const;
21     //Returns true if the list is full; false otherwise.
22
23     friend ostream& operator <<(ostream& outs,
24         const TemperatureList& the_object);
25     //Overloads the << operator so it can be used to output values of
26     //type TemperatureList. Temperatures are output one per line.
27     //Precondition: If outs is a file output stream, then outs
28     //has already been connected to a file.
29 private:
30     double list[MAX_LIST_SIZE]; //of temperatures in Fahrenheit
31     int size; //number of array positions filled
32 };
33
34 //This is the implementation for the class TemperatureList.
35
36 TemperatureList::TemperatureList( ) : size(0)
37 {
38     //Body intentionally empty.
39 }
40 void TemperatureList::add_temperature(double temperature)
41 { //Uses iostream and cstdlib:
42     if ( full( ) )
43     {
44         cout << "Error: adding to a full list.\n";
45         exit(1);
46     }

```

(continued)

DISPLAY 11.10 Program for a Class with an Array Member (part 2 of 2)

```

47     else
48     {
49         list[size] = temperature;
50         size = size + 1;
51     }
52 }

53 bool TemperatureList::full( ) const
54 {
55     return (size == MAX_LIST_SIZE);
56 }

57 //Uses iostream:
58 ostream& operator <<(ostream& outs, const TemperatureList& the_object)
59 {
60     for (int i = 0; i < the_object.size; i++)
61         outs << the_object.list[i] << " F\n";
62     return outs;
63 }

```

SELF-TEST EXERCISES

21. Change the class `TemperatureList` given in Display 11.10 by adding a member function called `get_size`, which takes no arguments and returns the number of temperatures on the list.
22. Change the type `TemperatureList` given in Display 11.10 by adding a member function called `get_temperature`, which takes one `int` argument that is an integer greater than or equal to 0 and strictly less than `MAX_LIST_SIZE`. The function returns a value of type `double`, which is the temperature in that position on the list. So, with an argument of 0, `get_temperature` returns the first temperature; with an argument of 1, it returns the second temperature, and so forth. Assume that `get_temperature` will not be called with an argument that specifies a location on the list that does not currently contain a temperature.

11.4 CLASSES AND DYNAMIC ARRAYS

With all appliances and means to boot.

WILLIAM SHAKESPEARE, *King Henry IV, Part III*

A dynamic array can have a base type that is a class. A class can have a member variable that is a dynamic array. You can combine the techniques you

learned about classes and the techniques you learned about dynamic arrays in just about any way. There are a few more things to worry about when using classes and dynamic arrays, but the basic techniques are the ones that you have already used. Let's start with an example.

PROGRAMMING EXAMPLE

A String Variable Class

In Chapter 8 we showed you how to define array variables to hold C strings. In the previous section you learned how to define dynamic arrays so that the size of the array can be determined when your program is run. In this example we will define a class called `StringVar` whose objects are string variables. An object of the class `StringVar` will be implemented using a dynamic array whose size is determined when your program is run. So objects of type `StringVar` will have all the advantages of dynamic arrays, but they will also have some additional features. We will define `StringVar`'s member functions so that if you try to assign a string that is too long to an object of type `StringVar`, you will get an error message. The version we define here provides only a small collection of operations for manipulating string objects. In Programming Project 1 you are asked to enhance the class definition by adding more member functions and overloaded operators.

Since you could use the standard class `string`, as discussed in Chapter 8, you do not really need the class `StringVar`, but it will be a good exercise to design and code it.

Constructors

The definition for the type `StringVar` is given in Display 11.11. One constructor for the class `StringVar` takes a single argument of type `int`. This argument determines the maximum allowable length for a string value stored in the object. A default constructor creates an object with a maximum allowable length of 100. Another constructor takes an array argument that contains a C string of the kind discussed in Chapter 8. Note that this means the argument to this constructor can be a quoted string. This constructor initializes the object so that it can hold any string whose length is less than or equal to the length of its argument, and it initializes the object's string value to a copy of the value of its argument. For the moment, ignore the constructor that is labeled *Copy constructor*. Also ignore the member function named `~StringVar`. Although it may look like one, `~StringVar` is not a constructor. We will discuss these two new kinds of member functions in later subsections. The meanings of the remaining member functions for the class `StringVar` are straight forward.

Size of string value

A simple demonstration program is given in Display 11.11. Two objects, `your_name` and `our_name`, are declared within the definition of the function `conversation`. The object `your_name` can contain any string that is `max_name_size` or fewer characters long. The object `our_name` is initialized to the string value "Borg" and can have its value changed to any other string of length 4 or less.

DISPLAY 11.11 Program Using the StringVar Class (part 1 of 2)

```

1  //This is the definition for the class StringVar
2  //whose values are strings. An object is declared as follows.
3  //Note that you use (max_size), not [max_size]
4  //StringVar the_object(max_size);
5  //where max_size is the longest string length allowed.
6  #include <iostream>
7  using namespace std;
8
9  class StringVar
10 {
11 public:
12     StringVar(int size);
13     //Initializes the object so it can accept string values up to size
14     //in length. Sets the value of the object equal to the empty string.
15
16     StringVar( );
17     //Initializes the object so it can accept string values of length 100
18     //or less. Sets the value of the object equal to the empty string.
19
20     StringVar(const char a[]);
21     //Precondition: The array a contains characters terminated with '\0'.
22     //Initializes the object so its value is the string stored in a and
23     //so that it can later be set to string values up to strlen(a) in length.
24
25     StringVar(const StringVar& string_object);
26     //Copy constructor.
27
28     ~StringVar( );
29     //Returns all the dynamic memory used by the object to the freestore.
30
31     int length( ) const;
32     //Returns the length of the current string value.
33
34     void input_line(istream& ins);
35     //Precondition: If ins is a file input stream, then ins has been
36     //connected to a file.
37     //Action: The next text in the input stream ins, up to '\n', is copied
38     //to the calling object. If there is not sufficient room, then
39     //only as much as will fit is copied.
40
41     friend ostream& operator <<(ostream& outs, const StringVar& the_string);
42     //Overloads the << operator so it can be used to output values
43     //of type StringVar
44     //Precondition: If outs is a file output stream, then outs
45     //has already been connected to a file.

```

(continued)

DISPLAY 11.11 Program Using the StringVar Class (part 2 of 2)

```
45  private:
46      char *value; //pointer to dynamic array that holds the string value.
47      int max_length; //declared max length of any string value.
48  };
49
50
51  <The definitions of the member functions and overloaded operators go here>
52
53  //Program to demonstrate use of the class StringVar.
54
55  void conversation(int max_name_size);
56  //Carries on a conversation with the user.
57
58  int main( )
59  {
60      using namespace std;
61      conversation(30); ← Memory is returned to the freestore
62      cout << "End of demonstration.\n";
63      return 0;
64  }
65
66  //This is only a demonstration function:
67  void conversation(int max_name_size)
68  {
69      using namespace std;
70
71      StringVar your_name(max_name_size, our_name("Borg"));
72
73      cout << "What is your name?\n";
74      your_name.input_line(cin);
75      cout << "We are " << our_name << endl;
76      cout << "We will meet again " << your_name << endl;
77  }
```

Determines the size of the dynamic array

Sample Dialogue

```
What is your name?
Kathryn Janeway
We are Borg
We will meet again Kathryn Janeway
End of demonstration
```

As we indicated at the beginning of this subsection, the class `StringVar` is implemented using a dynamic array. The implementation is shown in Display 11.12. When an object of type `StringVar` is declared, a constructor is called to initialize the object. The constructor uses the *new* operator to create a new dynamic array of characters for the member variable `value`. The string value is stored in the array `value` as an ordinary string value, with `'\0'` used to mark the end of the string. Notice that the size of this array is not determined until the object is declared, at which point the constructor is called and the argument to the constructor determines the size of the dynamic array. As illustrated in Display 11.11, this argument can be a variable of type *int*. Look at the declaration of the object `your_name` in the definition of the function `conversation`. The argument to the constructor is the call-by-value parameter `max_name_size`. Recall that a call-by-value parameter is a local variable, so `max_name_size` is a variable. Any *int* variable may be used as the argument to the constructor in this way.

The implementation of the member functions `length`, `input_line`, and the overloaded output operator `<<` are all straightforward. In the next few subsections we discuss the function `~StringVar` and the constructor labeled *Copy constructor*.

Implementation

Destructors

There is one problem with dynamic variables. They do not go away unless your program makes a suitable call to `delete`. Even if the dynamic variable was created using a local pointer variable and the local pointer variable goes away at the end of a function call, the dynamic variable will remain unless there is a call to `delete`. If you do not eliminate dynamic variables with calls to `delete`, they will continue to occupy memory space, which may cause your program to abort because it used up all the memory in the freestore. Moreover, if the dynamic variable is embedded in the implementation of a class, the programmer who uses the class does not know about the dynamic variable and cannot be expected to perform the call to `delete`. In fact, since the data members are normally private members, the programmer normally *cannot* access the needed pointer variables and so *cannot* call `delete` with these pointer variables. To handle this problem, C++ has a special kind of member function called a *destructor*.

A **destructor** is a member function that is called automatically when an object of the class passes out of scope. This means that if your program contains a local variable that is an object with a destructor, then when the function call ends, the destructor is called automatically. If the destructor is defined correctly, the destructor calls `delete` to eliminate all the dynamic variables created by the object. This may be done with a single call to `delete` or it may require several calls to `delete`. You might also want your destructor to perform some other cleanup details as well, but returning memory to the freestore is the main job of the destructor.



VideoNote
Arrays of Classes using
Dynamic Arrays

The member function `~StringVar` is the destructor for the class `StringVar` shown in Display 11.11. Like a constructor, a destructor always has the same name as the class it is a member of, but the destructor has the tilde symbol, `~`, at the beginning of its name (so you can tell that it is a destructor and not a constructor). Like a constructor, a destructor has no type for the value returned, not even the type `void`. A destructor has no parameters. Thus, a class can have only one destructor; you cannot overload the destructor for a class. Otherwise, a destructor is defined just like any other member function.

Notice the definition of the destructor `~StringVar` given in Display 11.12. `~StringVar` calls `delete` to eliminate the dynamic array pointed to by the member pointer variable `value`. Look again at the function conversation in the sample program shown in Display 11.11. The local variables `your_name` and `our_name` both create dynamic arrays. If this class did not have a destructor, then after the call to `conversation` has ended, these dynamic arrays would still be occupying memory, even though they are useless to the program. This would not be a problem here because the sample program ends soon after the call to `conversation` is completed; but if you wrote a program that made repeated calls to functions like `conversation`, and if the class `StringVar` did not have a suitable destructor, then the function calls could consume all the memory in the freestore and your program would then end abnormally.

DISPLAY 11.12 Implementation of `StringVar` (part 1 of 2)

```

1  //This is the implementation of the class StringVar.
2  //The definition for the class StringVar is in Display 11.11.
3  #include <cstdlib>
4  #include <cstring>
5  #include <string>
6
7  //Uses cstdlib and cstring:
8  StringVar::StringVar(int size) : max_length(size)
9  {
10     value = new char[max_length + 1]; //+1 is for '\0'.
11     value[0] = '\0';
12 }
13
14 //Uses cstring and cstdlib:
15 StringVar::StringVar( ) : max_length(100)
16 {
17     value = new char[max_length + 1]; //+1 is for '\0'.
18     value[0] = '\0';
19 }
20
21 //Uses cstring, cstring, and cstdlib:
22 StringVar::StringVar(const char a[]) : max_length(strlen(a))
23 {
24     value = new char[max_length + 1]; //+1 is for '\0'.

```

(continued)

DISPLAY 11.12 Implementation of StringVar (part 2 of 2)

```

25     strcpy(value, a);
26 }
27 //Uses cstring, cstdint, and cstdlib:
28 StringVar::StringVar(const StringVar& string_object)
29     : max_length(string_object.length( ))
30 {
31     value = new char[max_length + 1]; //+1 is for '\0'.
32     strcpy(value, string_object.value);
33 }
34 StringVar::~StringVar( )
35 {
36     delete [] value;
37 }
38
39 //Uses cstring:
40 int StringVar::length( ) const
41 {
42     return strlen(value);
43 }
44
45 //Uses iostream:
46 void StringVar::input_line(istream& ins)
47 {
48     ins.getline(value, max_length + 1);
49 }
50
51 //Uses iostream:
52 ostream& operator <<(ostream& outs, const StringVar& the_string)
53 {
54     outs << the_string.value;
55     return outs;
56 }

```

Copy constructor (discussed later in this chapter)

Destructor

Destructor

A **destructor** is a member function of a class that is called automatically when an object of the class goes out of scope. Among other things, this means that if an object of the class type is a local variable for a function, then the destructor is automatically called as the last action before the function call ends. Destructors are used to eliminate any dynamic variables that have been created by the object so that the memory occupied by these dynamic variables is returned to the freestore. Destructors may perform other cleanup tasks as well. The name of a destructor must consist of the tilde symbol, ~, followed by the name of the class.

PITFALL Pointers as Call-by-Value Parameters

When a call-by-value parameter is of a pointer type, its behavior can be subtle and troublesome. Consider the function call shown in Display 11.13. The parameter `temp` in the function `sneaky` is a call-by-value parameter, and hence it is a local variable. When the function is called, the value of `temp` is set to the value of the argument `p` and the function body is executed. Since `temp` is a local variable, no changes to `temp` should go outside of the function `sneaky`. In particular, the value of the pointer variable `p` should not be changed. Yet the sample dialogue makes it look as if the value of the pointer variable `p` had changed. Before the call to the function `sneaky`, the value of `*p` was 77, and after the call to `sneaky` the value of `*p` is 99. What has happened?

DISPLAY 11.13 A Call-by-Value Pointer Parameter (part 1 of 2)

```

1  //Program to demonstrate the way call-by-value parameters
2  //behave with pointer arguments.
3  #include <iostream>
4  using namespace std;
5
6  typedef int* IntPtr;
7
8  void sneaky(IntPtr temp);
9
10 int main( )
11 {
12     IntPtr p;
13
14     p = new int;
15     *p = 77;
16     cout << "Before call to function *p == "
17          << *p << endl;
18
19     sneaky(p);
20
21     cout << "After call to function *p == "
22          << *p << endl;
23
24     return 0;
25 }
26 void sneaky(IntPtr temp)
27 {
28     *temp = 99;
29     cout << "Inside function call *temp == "
30          << *temp << endl;
31 }

```

(continued)

DISPLAY 11.13 A Call-by-Value Pointer Parameter (part 2 of 2)**Sample Dialogue**

```

Before call to function *p == 77
Inside function call *temp == 99
After call to function *p == 99

```

The situation is diagrammed in Display 11.14. Although the sample dialogue may make it look as if `p` were changed, the value of `p` was not changed by the function call to `sneaky`. Pointer `p` has two things associated with it: `p`'s pointer value and the value stored where `p` points. Now, the value of `p` is a pointer (that is, a memory address). After the call to `sneaky`, the variable `p` contains the same pointer value (that is, the same memory address). The call to `sneaky` has changed the value of the variable pointed to by `p`, but it has not changed the value of `p` itself.

If the parameter type is a class or structure type that has member variables of a pointer type, the same kind of surprising changes can occur with call-by-value arguments of the class type. However, for class types, you can avoid (and control) these surprise changes by defining a *copy constructor*, as described in the next subsection. ■

Copy Constructors

A **copy constructor** is a constructor that has one parameter that is of the same type as the class. The one parameter must be a call-by-reference parameter, and normally the parameter is preceded by the *const* parameter modifier, so it is a constant parameter. In all other respects, a copy constructor is defined in the same way as any other constructor and can be used just like other constructors.

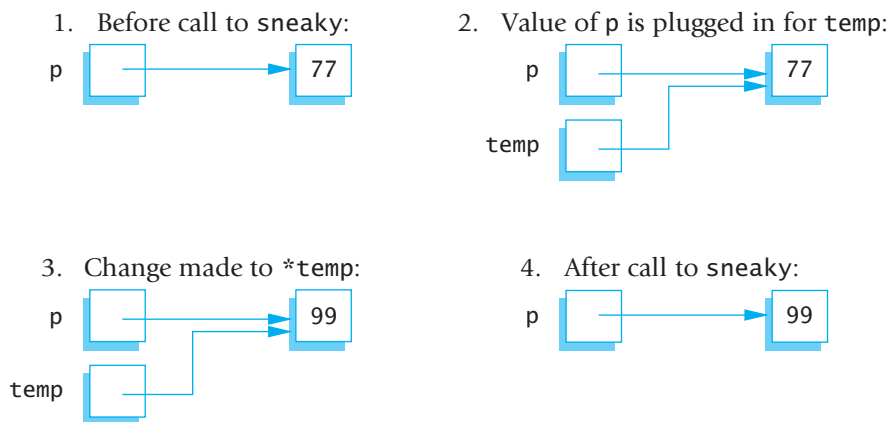
DISPLAY 11.14 The Function Call `sneaky(p);`

Called when an object is declared

For example, a program that uses the class `StringVar` defined in Display 11.11 might contain the following:

```
StringVar line(20), motto("Constructors can help.");
cout << "Enter a string of length 20 or less:\n";
line.input_line(cin);
StringVar temp(line); //Initialized by the copy constructor.
```

The constructor used to initialize each of the three objects of type `StringVar` is determined by the type of the argument given in parentheses after the object's name. The object `line` is initialized with the constructor that has a parameter of type `int`; the object `motto` is initialized by the constructor that has a parameter of type `const char a[]`. Similarly, the object `temp` is initialized by the constructor that has one argument of type `const StringVar&`. When used in this way, a copy constructor is being used just like any other constructor.

A copy constructor should be defined so that the object being initialized becomes a complete, independent copy of its argument. So, in the declaration

```
StringVar temp(line);
```

the member variable `temp.value` is not simply set to the same value as `line.value`; that would produce two pointers pointing to the same dynamic array. The definition of the copy constructor is shown in Display 11.12. Note that in the definition of the copy constructor, a new dynamic array is created and the contents of one dynamic array are copied to the other dynamic array. Thus, in the previous declaration, `temp` is initialized so that its string value is equal to the string value of `line`, but `temp` has a separate dynamic array. Thus, any change that is made to `temp` has no effect on `line`.

As you have seen, a copy constructor can be used just like any other constructor. A copy constructor is also called automatically in certain other situations. Roughly speaking, whenever C++ needs to make a copy of an object, it automatically calls the copy constructor. In particular, the copy constructor is called automatically in three circumstances: (1) when a class object is declared and is initialized by another object of the same type, (2) when a function returns a value of the class type, and (3) whenever an argument of the class type is "plugged in" for a call-by-value parameter. In this case, the copy constructor defines what is meant by "plugging in."

To see why you need a copy constructor, let's see what would happen if we did not define a copy constructor for the class `StringVar`. Suppose we did not include the copy constructor in the definition of the class `StringVar` and suppose we used a call-by-value parameter in a function definition, for example:

```
void show_string(StringVar the_string)
{
    cout << "The string is: "
         << the_string << endl;
}
```

Call-by-value parameters

Why a copy constructor is needed

Consider the following code, which includes a function call:

```
StringVar greeting("Hello");
show_string(greeting);
cout << "After call: " << greeting << endl;
```

Assuming there is no copy constructor, things proceed as follows: When the function call is executed, the value of `greeting` is copied to the local variable `the_string`, so `the_string.value` is set equal to `greeting.value`. But these are pointer variables, so during the function call, `the_string.value` and `greeting.value` point to the same dynamic array, as follows:

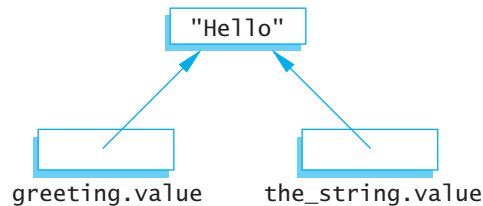

When the function call ends, the destructor for `StringVar` is called to return the memory used by `the_string` to the freestore. The definition of the destructor contains the following statement:

```
delete [] value;
```

Since the destructor is called with the object `the_string`, this statement is equivalent to:

```
delete [] the_string.value;
```

which changes the picture to the following:

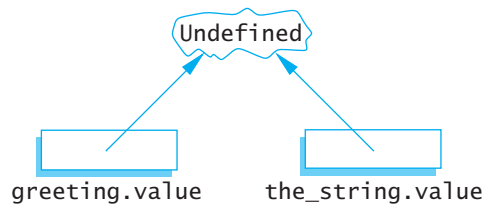

Since `greeting.value` and `the_string.value` point to the same dynamic array, deleting `the_string.value` is the same as deleting `greeting.value`. Thus, `greeting.value` is undefined when the program reaches the statement

```
cout << "After call: " << greeting << endl;
```

This `cout` statement is therefore undefined. The `cout` statement may by chance give you the output you want, but sooner or later the fact that `greeting.value` is undefined will produce problems. One major problem occurs when the object `greeting` is a local variable in some function. In this case the destructor will be called with `greeting` when the function call ends. That destructor call will be equivalent to

```
delete [] greeting.value;
```

But, as we just saw, the dynamic array pointed to by `greeting.value` has already been deleted once, and now the system is trying to delete it a second time. Calling `delete` twice to delete the same dynamic array (or other variable created with `new`) can produce a serious system error that can cause your program to crash.

That was what would happen if there were no copy constructor. Fortunately, we included a copy constructor in our definition of the class `StringVar`, so the copy constructor is called automatically when the following function call is executed:

```
StringVar greeting("Hello");
show_string(greeting);
```

The copy constructor defines what it means to “plug in” the argument `greeting` for the call-by-value parameter `the_string`, so that now the picture is as follows:

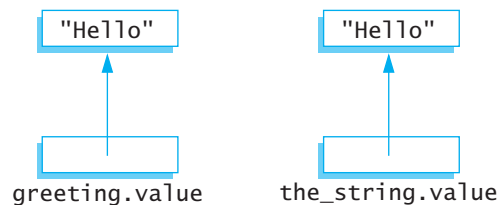

Thus, any change that is made to `the_string.value` has no effect on the argument `greeting`, and there are no problems with the destructor. If the destructor is called for `the_string` and then called for `greeting`, each call to the destructor deletes a different dynamic array.

Returned value

When a function returns a value of a class type, the copy constructor is called automatically to copy the value specified by the return statement. If there is no copy constructor, then problems similar to what we described for value parameters will occur.

When you need a copy constructor

If a class definition involves pointers and dynamically allocated memory using the `new` operator, then you need to include a copy constructor. Classes that do not involve pointers or dynamically allocated memory do not need a copy constructor.

Assignment statements

Contrary to what you might expect, the copy constructor is *not* called when you set one object equal to another using the assignment operator.² However, if you do not like what the default assignment operator does, you can redefine the assignment operator in the way described in the subsection entitled “Overloading the Assignment Operator.”

² C++ makes a careful distinction between initialization (the three cases where the copy constructor is called) and assignment. Initialization uses the copy constructor to create a new object; the assignment operator takes an existing object and modifies it so that it is an identical copy (in all but location) of the right-hand side of the assignment.

Copy Constructor

A **copy constructor** is a constructor that has one call-by-reference parameter that is of the same type as the class. The one parameter must be a call-by-reference parameter. Normally, the parameter is also a constant parameter, that is, preceded by the *const* parameter modifier. The copy constructor for a class is called automatically whenever a function returns a value of the class type. The copy constructor is also called automatically whenever an argument is “plugged in” for a call-by-value parameter of the class type. A copy constructor can also be used in the same ways as other constructors.

Any class that uses pointers and the *new* operator should have a copy constructor.

The Big Three

The **copy constructor**, the **=operator**, and the **destructor** are called the **big three** because experts say that if you need to define any of them, then you need to define all three. If any of these is missing, the compiler will create it, but it may not behave as you want. So it pays to define them yourself. The copy constructor and overloaded =operator that the compiler generates for you will work fine if all member variables are of predefined types such as *int* and *double*, but they may misbehave on classes that have class or pointer member variables. For any class that uses pointers and the *new* operator, it is safest to define your own copy constructor, overloaded =, and destructor.

= must be a member

SELF-TEST EXERCISES

23. If a class is named `MyClass` and it has a constructor, what is the constructor named? If `MyClass` has a destructor, what is the destructor named?
24. Suppose you change the definition of the destructor in Display 11.12 to the following. How would the sample dialogue in Display 11.11 change?

```
StringVar::~~StringVar()
{
    cout << endl
         << "Good-bye cruel world! The short life of\n"
         << "this dynamic array is about to end.\n";
    delete [] value;
}
```

25. The following is the first line of the copy constructor definition for the class `StringVar`. The identifier `StringVar` occurs three times and means something slightly different each time. What does it mean in each of the three cases?

```
StringVar::StringVar(const StringVar& string_object)
```

26. Answer these questions about destructors.
- What is a destructor and what must the name of a destructor be?
 - When is a destructor called?
 - What does a destructor actually do?
 - What should a destructor do?

Overloading the Assignment Operator

Suppose `string1` and `string2` are declared as follows:

```
StringVar string1(10), string2(20);
```

The class `StringVar` was defined in Displays 11.11 and 11.12. If `string2` has somehow been given a value, then the following assignment statement is defined, but its meaning may not be what you would like it to be:

```
string1 = string2;
```

As usual, this predefined version of the assignment statement copies the value of each of the member variables of `string2` to the corresponding member variables of `string1`, so the value of `string1.max_length` is changed to be the same as `string2.max_length` and the value of `string1.value` is changed to be the same as `string2.value`. But this can cause problems with `string1` and probably even cause problems for `string2`.

The member variable `string1.value` contains a pointer, and the assignment statement sets this pointer equal to the same value as `string2.value`. Thus, both `string1.value` and `string2.value` point to the same place in memory. If you change the string value in `string1`, you will therefore also change the string value in `string2`. If you change the string value in `string2`, you will change the string value in `string1`.

In short, the predefined assignment statement does not do what we would like an assignment statement to do with objects of type `StringVar`. Using the predefined version of the assignment operator with the class `StringVar` can only cause problems. The way to fix this is to overload the assignment operator `=` so that it does what we want it to do with objects of the class `StringVar`.

The assignment operator cannot be overloaded in the way we have overloaded other operators, such as `<<` and `+`. When you overload the assignment operator, it must be a member of the class; it cannot be a friend of the class. To add an overloaded version of the assignment operator to the class `StringVar`, the definition of `StringVar` should be changed to the following:



VideoNote
Overloading = and == for
a Class

```

class StringVar
{
public:
    void operator =(const StringVar& right_side);
    //Overloads the assignment operator = to copy a string
    //from one object to another.
    <The rest of the definition of the class can be the same as in
    Display 11.11.>

```

The assignment operator is then used just as you always use the assignment operator. For example, consider the following:

```
string1 = string2;
```

In this call, `string1` is the calling object and `string2` is the argument to the member operator `=`.

Calling object
for =

The definition of the assignment operator can be as follows:

```

//The following is acceptable, but
//we will give a better definition:
void StringVar::operator =(const StringVar& right_side)
{
    int new_length = strlen(right_side.value);
    if ((new_length) > max_length)
        new_length = max_length;

    for (int i = 0; i < new_length; i++)
        value[i] = right_side.value[i];
    value[new_length] = '\0';
}

```

Notice that the length of the string in the object on the right side of the assignment operator is checked. If it is too long to fit in the object on the left side of the assignment operator (which is the calling object), then only as many characters as will fit are copied to the object receiving the string. But suppose you do not want to lose any characters in the copying process. To fit in all the characters, you can create a new, larger dynamic array for the object on the left-hand side of the assignment operator. You might try to redefine the assignment operator as follows:

```

//This version has a bug:
void StringVar::operator =(const StringVar& right_side)
{
    delete [] value;
    int new_length = strlen(right_side.value);
    max_length = new_length;
    value = new char[max_length + 1];
    for (int i = 0; i < new_length; i++)
        value[i] = right_side.value[i];
    value[new_length] = '\0';
}

```

This version has a problem when used in an assignment with the same object on both sides of the assignment operator, like the following:

```
my_string = my_string;
```

When this assignment is executed, the first statement executed is

```
delete [] value;
```

But the calling object is `my_string`, so this means

```
delete [] my_string.value;
```

So, the string value in `my_string` is deleted and the pointer `my_string.value` is undefined. The assignment operator has corrupted the object `my_string`, and this run of the program is probably ruined.

One way to fix this bug is to first check whether there is sufficient room in the dynamic array member of the object on the left-hand side of the assignment operator and to delete the array only if extra space is needed. Our final definition of the overloaded assignment operator does just such a check:

```
//This is our final version:
void StringVar::operator =(const StringVar& right_side)
{
    int new_length = strlen(right_side.value);
    if (new_length > max_length)
    {
        delete [] value;
        max_length = new_length;
        value = new char[max_length + 1];
    }
    for (int i = 0; i < new_length; i++)
        value[i] = right_side.value[i];
    value[new_length] = '\0';
}
```

For many classes, the obvious definition for overloading the assignment operator does not work correctly when the same object is on both sides of the assignment operator. You should always check this case and be careful to write your definition of the overloaded assignment operator so that it also works in this case.

SELF-TEST EXERCISE

27. a. Explain carefully why no overloaded assignment operator is needed when the only data consists of built-in types.
- b. Same as part (a) for a copy constructor.
- c. Same as part (a) for a destructor.

CHAPTER SUMMARY

- A **friend** function of a class is an ordinary function except that it has access to the private members of the class, just like the member functions do.
- If your classes each have a full set of accessor and mutator functions, then the only reason to make a function a friend is to make the definition of the friend function simpler and more efficient, but that is often reason enough.
- A parameter of a class type that is not changed by the function should normally be a constant parameter.
- Operators, such as + and ==, can be overloaded so they can be used with objects of a class type that you define.
- When overloading the >> or << operators, the type returned should be a stream type and must be a reference, which is indicated by appending an & to the name of the returned type.
- The base type of an array can be a structure or class type. A structure or class can have an array as a member variable.
- A **destructor** is a special kind of member function for a class. A destructor is called automatically when an object of the class passes out of scope. The main reason for destructors is to return memory to the freestore so the memory can be reused.
- A **copy constructor** is a constructor that has a single argument that is of the same type as the class. If you define a copy constructor, it will be called automatically whenever a function returns a value of the class type and whenever an argument is “plugged in” for a call-by-value parameter of the class type. Any class that uses pointers and the operator *new* should have a copy constructor.
- The assignment operator = can be overloaded for a class so that it behaves as you wish for that class. However, it must be overloaded as a member of the class; it cannot be overloaded as a friend. Any class that uses pointers and the operator *new* should overload the assignment operator for use with that class.

Answers to Self-Test Exercises

1.

```
bool before(DayOfYear date1, DayOfYear date2)
{
    return ((date1.get_month() < date2.get_month())
        || (date1.get_month() == date2.get_month()
            && date1.get_day ( ) < date2.get_day ( )));
}
```

The previous Boolean expression says that `date1` is before `date2`, provided the month of `date1` is before the month of `date2` or that the months are the same and the day of `date1` is before the day of `date2`.

2. A friend function and a member function are alike in that they both can use any member of the class (either public or private) in their function definition. However, a friend function is defined and used just like an ordinary function; the dot operator is not used when you call a friend function, and no type qualifier is used when you define a friend function. A member function, on the other hand, is called using an object name and the dot operator. Also, a member function definition includes a type qualifier consisting of the class name and the scope resolution operator `::`.
3. The modified definition of the class `DayOfYear` is shown below. The part in color is new. We have omitted some comments to save space, but all the comments shown in Display 11.2 should be included in this definition.

```
class DayOfYear
{
public:
    friend bool equal(DayOfYear date1, DayOfYear date2);
    friend bool after(DayOfYear date1, DayOfYear date2);
    //Precondition: date1 and date2 have values.
    //Returns true if date1 follows date2 on the calendar;
    //otherwise, returns false.

    DayOfYear(int the_month, int the_day);
    DayOfYear();
    void input();
    void output();
    int get_month();
    int get_day();
private:
    void check_date( );
    int month;
    int day;
};
```

You also must add the following definition of the function after:

```
bool after(DayOfYear date1, DayOfYear date2)
{
    return ((date1.month > date2.month) ||
            ((date1.month == date2.month) && (date1.day > date2.day)))
}
```

4. The modified definition of the class `Money` is shown here. The part in color is new. We have omitted some comments to save space, but all the comments shown in Display 11.3 should be included in this definition.

```

class Money
{
public:
    friend Money subtract(Money amount1, Money amount2);
    //Precondition: amount1 and amount2 have values.
    //Returns amount1 minus amount2.

    friend bool equal(Money amount1, Money amount2);
    Money(long dollars, int cents);
    Money(long dollars);
    Money();
    double get_value();
    void input(istream& ins);
    void output(ostream& outs);
private:
    long all_cents;
};

```

You also must add the following definition of the function `subtract`:

```

Money subtract(Money amount1, Money amount2)
{
    Money temp;
    temp.all_cents = amount1.all_cents
        - amount2.all_cents;
    return temp;
}

```

5. The modified definition of the class `Money` is shown here. The part in color is new. We have omitted some comments to save space, but all the comments shown in Display 11.3 should be included in this definition.

```

class Money
{
public:
    friend Money add(Money amount1, Money amount2);
    friend bool equal(Money amount1, Money amount2);
    Money(long dollars, int cents);
    Money(long dollars);
    Money();
    double get_value();
    void input(istream& ins);

    void output(ostream& outs);
    //Precondition: If outs is a file output stream, then
    //outs has already been connected to a file.
    //Postcondition: A dollar sign and the amount of money
    //recorded in the calling object has been sent to the
    //output stream outs.

```

```

void output();
//Postcondition: A dollar sign and the amount of money
//recorded in the calling object has been output to the
//screen.
private:
    long all_cents;
};

```

You also must add the following definition of the function name `output`. (The old definition of `output` stays, so that there are two definitions of `output`.)

```

void Money::output()
{
    output(cout);
}

```

The following longer version of the function definition also works:

```

//Uses cstdlib and iostream
void Money::output()
{
    long positive_cents, dollars, cents;
    positive_cents = labs(all_cents);
    dollars = positive_cents/100;
    cents = positive_cents%100;

    if (all_cents < 0)
        cout << "-$" << dollars << '.';
    else
        cout << "$" << dollars << '.';

    if (cents < 10)
        cout << '0';
    cout << cents;
}

```

You can also overload the member function `input` so that a call like

```

purse.input();

```

means the same as

```

purse.input(cin);

```

And, of course, you can combine this enhancement with the enhancements from previous Self-Test Exercises to produce one highly improved class `Money`.

6. If the user enters `$-9.95` (instead of `-$9.95`), the function `input` will read the `'$'` as the value of `one_char`, the `-9` as the value of `dollars`, the `'.'` as the value of `decimal_point`, and the `'9'` and `'5'` as the values of `digit1` and `digit2`. That means it will set `dollars` equal to `-9` and `cents` equal

to 95 and so set the amount equal to a value that represents $-\$9.00$ plus 0.95 , which is $-\$8.05$. One way to catch this problem is to test if the value of `dollars` is negative (since the value of `dollars` should be an absolute value). To do this, rewrite the error message portion as follows:

```
if (one_char != '$' || decimal_point != '.'
    || !isdigit(digit1) || !isdigit(digit2)
    || dollars < 0) ← New
{
    cout << "Error illegal form for money input\n";
    exit(1);
}
```

This code still will not give an error message for incorrect input with zero dollars as in $\$-0.95$. However, with the material we have learned thus far, a test for this case, while certainly possible, would significantly complicate the code and make it harder to read.

```
7. #include <iostream>
   using namespace std;
   int main( )
   {
       int x;
       cin >> x;
       cout << x << endl;
       return 0;
   }
```

If the compiler interprets input with a leading 0 as a base-8 numeral, then with input data 077, the output should be 63. The output should be 77 if the compiler does not interpret data with a leading 0 as indicating base 8.

8. The only change from the version given in Display 11.3 is that the modifier *const* is added to the function heading, so the definition is

```
double Money::get_value() const
{
    return (all_cents * 0.01);
}
```

9. The member function `input` changes the value of its calling object, and so the compiler will issue an error message if you add the *const* modifier.
10. *Similarities*: Each parameter call protects the caller's argument from change. *Differences*: The call-by-value makes a copy of the caller's argument, so it uses more memory than a call-by-constant-reference.
11. In the `const int x = 17;` declaration, the *const* keyword promises the compiler that code written by the author will not change the value of `x`.

In the `int f() const;` declaration, the `const` keyword is a promise to the compiler that code written by the author to implement function `f` will not change anything in the calling object.

In the `int g(const A& x);` declaration, the `const` keyword is a promise to the compiler that code written by the class author will not change the argument plugged in for `x`.

12. The difference between a (binary) operator (such as `+`, `*`, `/`, and so forth) and a function involves the syntax of how they are called. In a function call, the arguments are given in parentheses after the function name. With an operator, the arguments are given before and after the operator. Also, you must use the reserved word *operator* in the declaration and in the definition of an overloaded operator.
13. The modified definition of the class `Money` is shown here. The part in color is new. We have omitted some comments to save space, but all the comments shown in Display 11.5 should be included in this definition.

```
class Money
{
public:
    friend Money operator +(const Money& amount1,
                           const Money& amount2);
    friend bool operator ==(const Money& amount1,
                            const Money& amount2);
    friend bool operator <(const Money& amount1,
                           const Money& amount2);
    //Precondition: amount1 and amount2 have been given
    //values.
    //Returns true if amount1 is less than amount2;
    //otherwise, returns false.
    Money(long dollars, int cents);
    Money(long dollars);
    Money();
    double get_value() const;
    void input(istream& ins);
    void output(ostream& outs) const;
private:
    long all_cents;
};
```

You also must add the following definition of the overloaded operator `<`:

```
bool operator <(const Money& amount1,
               const Money& amount2)
{
    return (amount1.all_cents < amount2.all_cents);
}
```

14. The modified definition of the class `Money` is shown here. The part in color is new. We have omitted some comments to save space, but all the comments shown in Display 11.5 should be included in this definition. We have included the changes from the previous exercises in this answer, since it is natural to use the overloaded `<` operator in the definition of the overloaded `<=` operator.

```

class Money
{
public:
    friend Money operator +(const Money& amount1,
                           const Money& amount2);
    friend bool operator ==(const Money& amount1,
                            const Money& amount2);
    friend bool operator <(const Money& amount1,
                           const Money& amount2);
    //Precondition: amount1 and amount2 have been given
    //values.
    //Returns true if amount1 is less than amount2;
    //otherwise, returns false.
    friend bool operator <=(const Money& amount1,
                            const Money& amount2);
    //Precondition: amount1 and amount2 have been given
    //values.
    //Returns true if amount1 is less than or equal to
    //amount2; otherwise, returns false.
    Money(long dollars, int cents);
    Money(long dollars);
    Money();
    double get_value() const;
    void input(istream& ins);
    void output(ostream& outs) const;
private:
    long all_cents;
};

```

You also must add the following definition of the overloaded operator `<=` (as well as the definition of the overloaded operator `<` given in the previous exercise):

```

bool operator <=(const Money& amount1,
                 const Money& amount2)
{
    return ((amount1.all_cents < amount2.all_cents)
           || (amount1.all_cents == amount2.all_cents));
}

```

15. When overloading an operator, at least one of the arguments to the operator must be of a class type. This prevents changing the behavior of `+` for integers. Actually, this requirement prevents changing the effect of any operator on any built-in type.

```

16. //Uses cmath (for floor):
Money::Money(double amount)
{
    all_cents = floor(amount * 100);
}

```

This definition simply discards any amount that is less than one cent. For example, it converts 12.34999 to the integer 1234, which represents the amount \$12.34. It is possible to define the constructor to instead do other things with any fraction of a cent.

```

17. istream& operator >>(istream& ins, Pairs& second)
{
    char ch;
    ins >> ch;          //discard initial '('
    ins >> second.f;
    ins >> ch;          //discard comma ', '
    ins >> second.s;
    ins >> ch;          //discard final ')'
    return ins;
}

ostream& operator <<(ostream& outs, const Pairs& second)
{
    outs << '(';
    outs << second.f;
    outs << ','; //You might prefer ", "
                //to get an extra space
    outs << second.s;
    outs << ')';
    return outs;
}

18. //Uses iostream:
istream& operator >>(istream& ins, Percent& the_object)
{
    char percent_sign;
    ins >> the_object.value;
    ins >> percent_sign; //Discards the % sign.
    return ins;
}

//Uses iostream:
ostream& operator <<(ostream& outs,
    const Percent& a_percent)
{
    outs << a_percent.value << '%';
    return outs;
}

```

19. `struct` Score

```
{
    int home_team;
    int opponent;
};
Score game[10];
```

20. *//Reads in 5 amounts of money, doubles each amount, //and outputs the results.*
`#include <iostream>`

<The definitions for the Money class go here>

```
int main()
{
    using namespace std;
    Money amount[5];
    int i;
    cout << "Enter 5 amounts of money:\n";
    for (i = 0; i < 5; i++)
        cin >> amount[i];
    for (i = 0; i < 5; i++)
        amount[i] = amount[i] + amount[i];
    cout << "After doubling, the amounts are:\n";
    for (i = 0; i < 5; i++)
        cout << amount[i] << " ";
    cout << endl;
    return 0;
}
```

(You cannot use `2 * amount[i]`, since `*` has not been overloaded for operands of type `Money`.)

21. See answer 22.

22. This answer combines the answers to this and the previous Self-Test Exercise. The class definition would change to the following. (We have deleted some comments from Display 11.10 to save space, but you should include them in your answer.)

```
class TemperatureList
{
public:
    TemperatureList();

    int get_size( ) const;
    //Returns the number of temperatures on the list.

    void add_temperature(double temperature);

    double get_temperature(int position) const;
```

```

//Precondition: 0 <= position < get_size( ).
//Returns the temperature that was added in position
//specified. The first temperature that was added is
//in position 0.

bool full() const;

friend ostream& operator <<(ostream& outs,
const TemperatureList& the_object);
private:
double list[MAX_LIST_SIZE]; //of temperatures in
//Fahrenheit
int size; //number of array positions filled
};

```

You also need to add the following member function definitions:

```

int TemperatureList::get_size() const
{
return size;
}

//Uses iostream and cstdlib:
double TemperatureList::get_temperature (int position) const
{
if ((position >= size) || (position < 0))
{
cout << "Error:"
<< " reading an empty list position.\n";
exit(1);
}
else
return (list[position]);
}

```

23. The *constructor* is named `MyClass`, the same name as the name of the class. The *destructor* is named `~MyClass`.
24. The dialogue would change to the following:

```

What is your name?
Kathryn Janeway
We are Borg
We will meet again Kathryn Janeway
Good-bye cruel world! The short life of
this dynamic array is about to end.
Good-bye cruel world! The short life of
this dynamic array is about to end.
End of demonstration

```

25. The `StringVar` before the `::` is the name of the class. The `StringVar` right after the `::` is the name of the member function. (Remember, a constructor is a member function that has the same name as the class.) The `StringVar` inside the parentheses is the type for the parameter `string_object`.
26. a. A destructor is a member function of a class. A destructor's name always begins with a tilde, `~`, followed by the class name.
 b. A destructor is called when a class object goes out of scope.
 c. A destructor actually does whatever the class author programs it to do!
 d. A destructor is supposed to delete dynamic variables that have been allocated by constructors for the class. Destructors may also do other cleanup tasks.
27. In the case of the assignment operator `=` and the copy constructor, if there are only built-in types for data, the default copy mechanism is exactly what you want, so the default works fine. In the case of the destructor, no dynamic memory allocation is done (no pointers), so the default do-nothing action is again what you want.

PRACTICE PROGRAMS

Practice Programs can generally be solved with a short program that directly applies the programming principles presented in this chapter.

1. Modify the definition of the class `Money` shown in Display 11.8 so that all of the following are added:
 - a. The operators `<`, `<=`, `>`, and `>=` have each been overloaded to apply to the type `Money`. (*Hint*: See Self-Test Exercise 13.)
 - b. The following member function has been added to the class definition. (We show the function declaration as it should appear in the class definition. The definition of the function itself will include the qualifier `Money::`.)

```
Money percent(int percent_figure) const;
//Returns a percentage of the money amount in the
//calling object. For example, if percent_figure is 10,
//then the value returned is 10% of the amount of
//money represented by the calling object.
```

For example, if `purse` is an object of type `Money` whose value represents the amount \$100.10, then the call

```
purse.percent(10);
```

returns 10% of \$100.10; that is, it returns a value of type `Money` that represents the amount \$10.01.

- Self-Test Exercise 17 asked you to overload the operator `>>` and the operator `<<` for a class `Pairs`. Complete and test this exercise. Implement the default constructor and the constructors with one and two `int` parameters. The one-parameter constructor should initialize the first member of the pair; the second member of the pair is to be 0.

Overload binary operator `+` to add pairs according to the rule

$$(a, b) + (c, d) = (a + c, b + d)$$

Overload operator `-` analogously.

Overload operator `*` on `Pairs` and `int` according to the rule

$$(a, b) * c = (a * c, b * c)$$

Write a program to test all the member functions and overloaded operators in your class definition.

- Self-Test Exercise 18 asked you to overload the operator `>>` and the operator `<<` for a class `Percent`. Complete and test this exercise. Implement the default constructor and the constructor with one `int` parameter. Overload the `+` and `-` operators to add and subtract percents. Also, overload the `*` operator to allow multiplication of a percent by an integer.

Write a program to test all the member functions and overloaded operators in your class definition.

PROGRAMMING PROJECTS

Programming Projects require more problem-solving than Practice Programs and can usually be solved many different ways. Visit www.myprogramminglab.com to complete many of these Programming Projects online and get instant feedback.

- In Chapter 8 we discussed vectors, which are like arrays that can grow in size. Suppose that vectors were not defined in C++. Define a class called `VectorDouble` that is like a class for a vector with base type `double`. Your class `VectorDouble` will have a private member variable for a dynamic array of `doubles`. It will also have two member variables of type `int`; one called `max_count` for the size of the dynamic array of `doubles`; and one called `count` for the number of array positions currently holding values. (`max_count` is the same as the capacity of a vector; `count` is the same as the size of a vector.)

If you attempt to add an element (a value of type `double`) to the vector object of the class `VectorDouble` and there is no more room, then a new dynamic array with twice the capacity of the old dynamic array is created and the values of the old dynamic array are copied to the new dynamic array.

Your class should have all of the following:

- Three constructors: a default constructor that creates a dynamic array for 50 elements, a constructor with one *int* argument for the number of elements in the initial dynamic array, and a copy constructor.
 - A destructor.
 - A suitable overloading of the assignment operator =.
 - A suitable overloading of the equality operator ==. To be equal, the values of *count* and the *count* array elements must be equal, but the values of *max_count* need not be equal.
 - Member functions *push_back*, *capacity*, *size*, *reserve*, and *resize* that behave the same as the member functions of the same names for vectors.
 - Two member functions to give your class the same utility as the square brackets: *value_at(i)*, which returns the value of the *i*th element in the dynamic array; and *change_value_at(d, i)*, which changes the *double* value at the *i*th element of the dynamic array to *d*. Enforce suitable restrictions on the arguments to *value_at* and *change_value_at*. (Your class will not work with the square brackets. It can be made to work with square brackets, but we have not covered the material which tells you how to do that.)
2. Define a class for rational numbers. A rational number is a number that can be represented as the quotient of two integers. For example, $1/2$, $3/4$, $64/2$, and so forth are all rational numbers. (By $1/2$, etc., we mean the everyday meaning of the fraction, not the integer division this expression would produce in a C++ program.) Represent rational numbers as two values of type *int*, one for the numerator and one for the denominator. Call the class `Rational`.

Include a constructor with two arguments that can be used to set the member variables of an object to any legitimate values. Also include a constructor that has only a single parameter of type *int*; call this single parameter *whole_number* and define the constructor so that the object will be initialized to the rational number *whole_number*/1. Also include a default constructor that initializes an object to 0 (that is, to 0/1).

Overload the input and output operators `>>` and `<<`. Numbers are to be input and output in the form $1/2$, $15/32$, $300/401$, and so forth. Note that the numerator, the denominator, or both may contain a minus sign, so $-1/2$, $15/32$, and $-300/-401$ are also possible inputs. Overload all of the following operators so that they correctly apply to the type `Rational`: `==`, `<`, `<=`, `>`, `>=`, `+`, `-`, `*`, and `/`. Also write a test program to test your class.

(Hints: Two rational numbers a/b and c/d are equal if $a*d$ equals $c*b$. If b and d are *positive* rational numbers, a/b is less than c/d provided $a*d$ is less than $c*b$. You should include a function to normalize the values stored so that, after normalization, the denominator is positive and the numerator and denominator are as small as possible. For example, after normalization $4/-8$ would be represented the same as $-1/2$. You should also write a test program to test your class.)

3. Define a class for complex numbers. A complex number is a number of the form

$$a + b * i$$

where, for our purposes, a and b are numbers of type *double*, and i is a number that represents the quantity $\sqrt{-1}$. Represent a complex number as two values of type *double*. Name the member variables *real* and *imaginary*. (The variable for the number that is multiplied by i is the one called *imaginary*.) Call the class *Complex*.

Include a constructor with two parameters of type *double* that can be used to set the member variables of an object to any values. Also include a constructor that has only a single parameter of type *double*; call this parameter *real_part* and define the constructor so that the object will be initialized to $\text{real_part} + 0*i$. Also include a default constructor that initializes an object to 0 (that is, to $0 + 0*i$). Overload all of the following operators so that they correctly apply to the type *Complex*: `==`, `+`, `-`, `*`, `>>`, and `<<`. You should write a test program to test your class.

(Hints: To add or subtract two complex numbers, you add or subtract the two member variables of type *double*. The product of two complex numbers is given by the following formula:

$$(a + b*i)*(c + d*i) == (a*c - b*d) + (a*d + b*c)*i$$

In the interface file, you should define a constant i as follows:

```
const Complex i(0, 1);
```

This defined constant i will be the same as the i discussed earlier.

```
delete p;
```

4. Enhance the definition of the class *StringVar* given in Displays 11.11 and 11.12 by adding all of the following:

- Member function *copy_piece*, which returns a specified substring;
- member function *one_char*, which returns a specified single character; and
- member function *set_char*, which changes a specified character

- An overloaded version of the `==` operator (note that only the string values have to be equal; the values of `max_length` need not be the same)
- An overloaded version of `+` that performs concatenation of strings of type `StringVar`
- An overloaded version of the extraction operator `>>` that reads one word (as opposed to `input_line`, which reads a whole line)

If you did the section on overloading the assignment operator, then add it as well. Also write a suitable test program and thoroughly test your class definition.

5. Define a class called `Text` whose objects store lists of words. The class `Text` will be just like the class `StringVar` except that the class `Text` will use a dynamic array with base type `StringVar` rather than base type `char` and will mark the end of the array with a `StringVar` object consisting of a single blank, rather than using `'\0'` as the end marker. Intuitively, an object of the class `Text` represents some text consisting of words separated by blanks. Enforce the restriction that the array elements of type `StringVar` contain no blanks (except for the end marker elements of type `StringVar`).

Your class `Text` will have member functions corresponding to all the member functions of `StringVar`. The constructor with an argument of type `const char a[]` will initialize the `Text` object in the same way as described below for `input_line`. If the C-string argument contains the new-line symbol `'\n'`, that is considered an error and ends the program with an error message.

The member function `input_line` will read blank separated strings and store each string in one element of the dynamic array with base type `StringVar`. Multiple blank spaces are treated the same as a single blank space. When outputting an object of the class `Text`, insert one blank between each value of type `StringVar`. You may either assume that no tab symbols are used or you can treat the tab symbols the same as a blank; if this is a class assignment, ask your instructor how you should treat the tab symbol.

Add the enhancements described in Programming Project 6. The overloaded version of the extraction operator `>>` will fill only one element of the dynamic array.

6. Using dynamic arrays, implement a polynomial class with polynomial addition, subtraction, and multiplication.

Discussion: A variable in a polynomial does very little other than act as a placeholder for the coefficients. Hence, the only interesting thing

about polynomials is the array of coefficients and the corresponding exponent. Think about the polynomial

$$x^3 + x + 1$$

One simple way to implement the polynomial class is to use an array of *doubles* to store the coefficients. The index of the array is the exponent of the corresponding term. Where is the term in x^3 in the previous example? If a term is missing, then it simply has a zero coefficient.

There are techniques for representing polynomials of high degree with many missing terms. These use so-called sparse polynomial techniques. Unless you already know these techniques, or learn very quickly, don't use them.

Provide a default constructor, a copy constructor, and a parameterized constructor that enable an arbitrary polynomial to be constructed. Also supply an overloaded operator = and a destructor.

Provide these operations:

- polynomial + polynomial
- constant + polynomial
- polynomial + constant
- polynomial - polynomial
- constant - polynomial
- polynomial - constant
- polynomial * polynomial
- constant * polynomial
- polynomial * constant

Supply functions to assign and extract coefficients, indexed by exponent.

Supply a function to evaluate the polynomial at a value of type *double*.

You should decide whether to implement these functions as members, friends, or stand-alone functions.

7. Write a checkbook balancing program. The program will read in the following for all checks that were not cashed as of the last time you balanced your checkbook: the number of each check, the amount of the check, and whether or not it has been cashed. Use an array with a class base type. The class should be a class for a check. There should be three member variables to record the check number, the check amount, and whether or not the check was cashed. The class for a check will have a member variable of type *Money* (as defined in Display 19) to record the check amount. So, you will have a class used within

a class. The class for a check should have accessor and mutator functions as well as constructors and functions for both input and output of a check.

In addition to the checks, the program also reads all the deposits, as well as the old and the new account balance. You may want another array to hold the deposits. The new account balance should be the old balance plus all deposits, minus all checks that have been cashed.

The program outputs the total of the checks cashed, the total of the deposits, what the new balance should be, and how much this figure differs from what the bank says the new balance is. It also outputs two lists of checks: the checks cashed since the last time you balanced your checkbook and the checks still not cashed. Display both lists of checks in sorted order from lowest to highest check number.

If this is a class assignment, ask your instructor if input/output should be done with the keyboard and screen or if it should be done with files. If it is to be done with files, ask your instructor for instructions on file names.

8. Define a class called `List` that can hold a list of values of type *double*. Model your class definition after the class `TemperatureList` given in Display 11.10, but your class `List` will make no reference to temperatures when it outputs values. The values may represent any sort of data items as long as they are of type *double*. Include the additional features specified in Self-Test Exercises 21 and 22. Change the member function names so that they do not refer to temperature.

Add a member function called `get_last` that takes no arguments and returns the last item on the list. The member function `get_last` does not change the list, and it should not be called if the list is empty. Add another member function called `delete_last` that deletes the last element on the list. The member function `delete_last` is a *void* function. Note that when the last element is deleted, the member variable `size` must be adjusted. If `delete_last` is called with an empty list as the calling object, the function call has no effect. Design a program to thoroughly test your definition for the class `List`.

9. Define a class called `StringSet` that will be used to store a set of STL strings. Use an array or a vector to store the strings. Create a constructor that takes as an input parameter an array of strings for the initial values in the set. Then write member functions to add a string to the set, remove a string from the set, clear the entire set, return the number of strings in the set, and output all strings in the set. Overload the `+` operator so that it returns the union of two `StringSet` objects. Also overload the `*` operator so that it returns the intersection of two `StringSet` objects. Write a program to test all member functions and overloaded operators in your class.

10. This programming project requires you to complete Programming Project 9 first.

The field of information retrieval is concerned with finding relevant electronic documents based upon a query. For example, given a group of keywords (the query), a search engine retrieves Web pages (documents) and displays them sorted by relevance to the query. This technology requires a way to compare a document with the query to see which is most relevant to the query.

A simple way to make this comparison is to compute the binary cosine coefficient. The coefficient is a value between 0 and 1, where 1 indicates that the query is very similar to the document and 0 indicates that the query has no keywords in common with the document. This approach treats each document as a set of words. For example, given the following sample document:

“Chocolate ice cream, chocolate milk, and chocolate bars are delicious.”

This document would be parsed into keywords where case is ignored and punctuation discarded and turned into the set containing the words {chocolate, ice, cream, milk, and, bars, are, delicious}. An identical process is performed on the query to turn it into a set of strings. Once we have a query Q represented as a set of words and a document D represented as a set of words, the similarity between Q and D is computed by:

$$Sim = \frac{|Q \cap D|}{\sqrt{|Q|} \sqrt{|D|}}$$

Modify the `StringSet` from Programming Project 12 by adding an additional member function that computes the similarity between the current `StringSet` and an input parameter of type `StringSet`. The `sqrt` function is in the `cmath` library.

Create two text files on your disk named `Document1.txt` and `Document2.txt`. Write some text content of your choice in each file, but make sure that each file contains different content. Next, write a program that allows the user to input from the keyboard a set of strings that represents a query. The program should then compare the query to both text files on the disk and output the similarity to each one using the binary cosine coefficient. Test your program with different queries to see if the similarity metric is working correctly.

11. Redo Programming Project 6 from Chapter 9 (or do it for the first time), but this time encapsulate the dynamic array and array size within a class. The class should have public member functions `addEntry` and `deleteEntry`. Make the array and size variables private. This will require

adding functions for getting and setting specific items in the array as well as returning the current size of the array. Add a destructor that frees up the memory allocated to the dynamic array. Also, add a copy constructor and overload the assignment operator so that the dynamic array is properly copied from the object on the right-hand side of the assignment to the object on the left-hand side. Embed your class in a suitable test program.

12. To combat election fraud, your city is instituting a new voting procedure. The ballot has a letter associated with every selection a voter may make. A sample ballot is shown.



VideoNote
Solution to Programming
Project 11.12

1. VOTE FOR MAYOR
 - A. Pincher, Penny
 - B. Dover, Skip
 - C. Perman, Sue

2. PROPOSITION 17
 - D. YES
 - E. NO

3. MEASURE 1
 - F. YES
 - G. NO

4. MEASURE 2
 - H. YES
 - I. NO

After submitting the ballot, every voter receives a receipt that has a unique ID number and a record of the voting selections. For example, a voter who submits a ballot for Sue Perman, Yes on Proposition 17, No on Measure 1, and Yes on Measure 2 might receive a receipt with

ID 4925 : CDGH

The next day the city posts all votes on its Web page sorted by ID number. This allows a voter to confirm their submission and allows anyone to count the vote totals for themselves. A sample list for the sample ballot is shown.

ID	VOTES
4925	CDGH
4926	AEGH
4927	CDGI
4928	BEGI
4929	ADFH

Write a program that reads the posted voting list from a file and outputs the percent of votes cast for each ballot item. You may assume that the file does not have any header lines. The first line will contain a voter ID and a string representing votes. Define a class named `Voter` that stores an individual's voting record. The class should have a constructor that takes as input a string of votes (for example, "CDGH"), a voter ID, and accessor function(s) that return the person's ID and vote for a specific question. Store each `Voter` instance in an array or vector. Your program should iterate over the array to compute and output the percent of votes cast for each candidate, proposition, and measure. It should then prompt the user to enter a voter ID, iterate over the list again to find the object with that ID, and print his or her votes.

13. Repeat Programming Project 11 from Chapter 10 but use an array to store the movie ratings instead of separate variables. All changes should be internal to the class so the main function to test the class should run identically with either the old `Movie` class or the new `Movie` class that uses an array member variable.

Next, modify the main function so that instead of creating separate variables for each `Movie` object, an array of at least four `Movie` objects is created with sample data. Loop through the array and output the name, MPA rating, and average rating for each of the four movies.

14. Do Programming Project 16 from Chapter 8 except use a `Racer` class to store information about each race participant. The class should store the racer's name, bib number, finishing position, and all of his or her split times as recorded by the RFID sensors. You can choose appropriate structures to store this information. Include appropriate functions to access or change the racer's information, along with a constructor. Make an array or vector of `Racer` objects to store the entire race results.

The racer's name should come from a separate text file. The information for this file is collected before the race when the participant registers for the event. Listed below is a sample file:

```
100,Bill Rodgers  
132, Frank Shorter  
182,Joan Benoit
```

Separate Compilation and Namespaces

12

12.1 SEPARATE COMPILATION 704

ADTs Reviewed 705

Case Study: `DigitalTime`—A Class Compiled Separately 706

Using `#ifndef` 715

Programming Tip: Defining Other Libraries 718

12.2 NAMESPACES 719

Namespaces and `using` Directives 719

Creating a Namespace 721

Qualifying Names 724

A Subtle Point About Namespaces (*Optional*) 725

Unnamed Namespaces 726

Programming Tip: Choosing a Name for a Namespace 731

Pitfall: Confusing the Global Namespace and the Unnamed Namespace 732



*From mine own library with volumes that
I prize above my dukedom.*

WILLIAM SHAKESPEARE, *The Tempest*

INTRODUCTION

This chapter covers two topics that have to do with how you organize a C++ program into separate parts. Section 12.1 on separate compilation discusses how a C++ program can be distributed across a number of files so that when some parts of the program change, only those parts need to be recompiled. The separate parts can also be more easily reused in other applications.

Section 12.2 discusses namespaces, which we introduced briefly in Chapter 2. Namespaces are a way of allowing you to reuse the names of classes, functions, and other items by qualifying the names to indicate different uses. Namespaces divide your code into sections so that the different sections may reuse the same names with differing meanings. Namespaces allow a kind of local meaning for names that is more general than local variables.

PREREQUISITES

This chapter uses material from Chapters 2 through 6 and 10 through 11.

12.1 SEPARATE COMPILATION

Your "if " is the only peacemaker; much virtue in "if."

WILLIAM SHAKESPEARE, *As You Like It*

C++ has facilities for dividing a program into parts that are kept in separate files, compiled separately, and then linked together when (or just before) the program is run. You can place the definition for a class (and its associated function definitions) in files that are separate from the programs that use the class. That way you can build up a library of classes so that many programs can use the same class. You can compile the class once and then use it in many different programs, just like you use the predefined libraries (such as those with header files `iostream` and `cstdlib`). Moreover, you can define the class itself in two files so that the specification of what the class does is separate from how the class is implemented. If your class is defined following the guidelines we have been giving you and you change only the implementation of the class, then you need only recompile the file with the class implementation. The other files, including the files with the programs that use the class, need not be changed or even recompiled. In this section, we tell you how to carry out this separate compilation of classes.

ADTs Reviewed

Recall that an ADT (abstract data type) is a class that has been defined so as to separate the interface and the implementation of the class. All your class definitions should be ADTs. In order to define a class so that it is an ADT, you need to separate the specification of how the class is used by a programmer from the details of how the class is implemented. The separation should be so complete that you can change the implementation without needing to change any program that uses the class in any way. The way to ensure this separation can be summarized in three rules:

1. Make all the member variables private members of the class.
2. Make each of the basic operations for the ADT (the class) either a public member function of the class, a friend function, an ordinary function, or an overloaded operator. Group the class definition and the function and operator declarations together. This group, along with its accompanying comments, is called the **interface** for the ADT. Fully specify how to use each such function or operator in a comment given with the class or with the function or operator declaration.
3. Make the implementation of the basic operations unavailable to the programmer who uses the abstract data type. The **implementation** consists of the function definitions and overloaded operator definitions (along with any helping functions or other additional items these definitions require).

In C++, the best way to ensure that you follow these rules is to place the interface and the implementation of the ADT class in separate files. As you might guess, the file that contains the interface is often called the **interface file**, and the file that contains the implementation is called the **implementation file**. The exact details of how to set up, compile, and use these files will vary slightly from one version of C++ to another, but the basic scheme is the same in all versions of C++. In particular, the details of what goes into the files are the same in all systems. The only things that vary are what commands you use to compile and link these files. The details about what goes into these files are illustrated in the next Case Study.

An ADT class has private member variables. Private member variables (and private member functions) present a problem to our basic philosophy of placing the interface and the implementation of an ADT in separate files. The public part of the class definition for an ADT is part of the interface for the ADT, but the private part is part of the implementation. This is a problem because C++ will not allow you to split the class definition across two files. Thus, some sort of compromise is needed. The only sensible compromise, and the one we use, is to place the entire class definition in the interface file. Since a programmer who is using the ADT class cannot use any of the private members of the class, the private members will, in effect, still be hidden from the programmer.

Private members
are part of the
implementation.

ADT

A data type is called an abstract data type (abbreviated ADT) if the programmers who use the type do not have access to the details of how the values and operations are implemented. All the classes that you define should be ADTs. An ADT class is a class that is defined following good programming practices that separate the interface and implementation of the class. (Any nonmember basic operations for the class such as overloaded operators are considered part of the ADT, even though they may not be officially part of the class definition.)

CASE STUDY *DigitalTime*—A Class Compiled Separately

Display 12.1 contains the interface file for an ADT class called `DigitalTime`. `DigitalTime` is a class whose values are times of day, such as 9:30. Only the public members of the class are part of the interface. The private members are part of the implementation, even though they are in the interface file. The label *private*: warns you that these private members are not part of the public interface. Everything that a programmer needs to know in order to use the ADT `DigitalTime` is explained in the comment at the start of the file and in the comments in the public section of the class definition. This interface tells the programmer how to use the two versions of the member function named `advance`, the constructors, and the overloaded operators `=`, `>>`, and `<<`. The member function named `advance`, the overloaded operators, and the assignment statement are the only ways that a programmer can manipulate objects and values of this class. As noted in the comment at the top of the interface file, this ADT class uses 24-hour notation, so, for instance, 1:30 PM is input and output as 13:30. This and the other details you must know in order to effectively use the class `DigitalTime` are included in the comments given with the member functions.

We have placed the interface in a file named `dtime.h`. The suffix `.h` indicates that this is a header file. An interface file is always a header file and therefore always ends with the suffix `.h`. Any program that uses the class `DigitalTime` must contain an include directive like the following, which names this file:

```
#include "dtime.h"
```

When you write an include directive, you must indicate whether the header file is a predefined header file that is provided for you or is a header file that you wrote. If the header file is predefined, write the header file name in angular brackets, like `<iostream>`. If the header file is one that you wrote, then write the header file name in quotes, like `"dtime.h"`. This distinction tells the compiler where to look for the header file. If the header file name is

DISPLAY 12.1 Interface File for DigitalTime

```

1 //Header file dtime.h: This is the INTERFACE for the class DigitalTime.
2 //Values of this type are times of day. The values are input and output in
3 //24-hour notation, as in 9:30 for 9:30 AM and 14:45 for 2:45 PM.
4 #include <iostream>
5 using namespace std;
6 class DigitalTime
7 {
8 public:
9     friend bool operator ==(const DigitalTime& time1, const DigitalTime& time2);
10    //Returns true if time1 and time2 represent the same time;
11    //otherwise, returns false.
12
13    DigitalTime(int the_hour, int the_minute);
14    //Precondition: 0 <= the_hour <= 23 and 0 <= the_minute <= 59.
15    //Initializes the time value to the_hour and the_minute.
16
17    DigitalTime( );
18    //Initializes the time value to 0:00 (which is midnight).
19
20    void advance(int minutes_added);
21    //Precondition: The object has a time value.
22    //Postcondition: The time has been changed to minutes_added minutes later.
23
24    void advance(int hours_added, int minutes_added);
25    //Precondition: The object has a time value.
26    //Postcondition: The time value has been advanced
27    //hours_added hours plus minutes_added minutes.
28
29    friend istream& operator >>(istream& ins, DigitalTime& the_object);
30    //Overloads the >> operator for input values of type DigitalTime.
31    //Precondition: If ins is a file input stream, then ins has already been
32    //connected to a file.
33
34    friend ostream& operator <<(ostream& outs, const DigitalTime& the_object);
35    //Overloads the << operator for output values of type DigitalTime.
36    //Precondition: If outs is a file output stream, then outs has already been
37    //connected to a file.
38 private:
39     int hour;
40     int minute;
41 };

```

For the definition of the types `istream` and `ostream`, which are used as parameter types

This is part of the implementation. It is not part of the interface. The word `private` indicates that this is not part of the public interface.

in angular brackets, the compiler looks wherever the predefined header files are kept in your implementation of C++. If the header file name is in quotes, the compiler looks in the current directory or wherever programmer-defined header files are kept on your system.

Any program that uses our `DigitalTime` class must contain the previous include directive that names the header file `dtime.h`. That is enough to

allow you to compile the program but is not enough to allow you to run the program. In order to run the program, you must write (and compile) the definitions of the member functions and the overloaded operators. We have placed these function and operator definitions in another file, which is called the **implementation file**. Although it is not required by most compilers, it is traditional to give the interface file and the implementation file the same name. The two files do, however, end in different suffixes. We have placed the interface for our ADT class in the file named `dtime.h` and the implementation for our ADT class in a file named `dtime.cpp`. The suffix you use for the implementation file depends on your version of C++. Use the same suffix for the implementation file as you normally use for files that contain C++ programs. If your program files end in `.cxx`, then you would use `.cxx` in place of `.cpp`. If your program files end in `.CPP`, then your implementation files will end in `.CPP` instead of `.cpp`. We are using `.cpp` since most compilers accept `.cpp` as the suffix for a C++ source code file. The implementation file for our `DigitalTime` ADT class is given in Display 12.2. After we explain how the various files for our ADT interact with each other, we will return to Display 12.2 and discuss the details of the definitions in this implementation file.

In order to use the ADT class `DigitalTime` in a program, the program must contain the include directive

```
#include "dtime.h"
```

Notice that both the implementation file and the program file must contain this include directive that names the interface file. The file that contains the program (that is, the file that contains the main part of the program) is often called the **application file** or **driver file**. Display 12.3 contains an application file with a very simple program that uses and demonstrates the `DigitalTime` ADT class.

The exact details on how you run this complete program, which is contained in three files, depend on what system you are using. However, the basic details are the same for all systems. You must compile the implementation file, and you must compile the application file that contains the main part of your program. You do not compile the interface file, which in this example is the file `dtime.h` given in Display 12.1. You do not need to compile the interface file because the compiler thinks the contents of this interface file are already contained in each of the other two files. Recall that both the implementation file and the application file contain the directive

```
#include "dtime.h"
```

Compiling your program automatically invokes a preprocessor that reads this include directive and replaces it with the text in the file `dtime.h`. Thus, the compiler sees the contents of `dtime.h`, and so the file `dtime.h` does not need to be compiled separately. (In fact, the compiler sees the contents of `dtime.h` twice: once when you compile the implementation file and once when you compile the application file.) This copying of the file `dtime.h` is

DISPLAY 12.2 Implementation File for DigitalTime (part 1 of 3)

```

1 //Implementation file dtime.cpp (Your system may require some
2 //suffix other than .cpp): This is the IMPLEMENTATION of the ADT DigitalTime.
3 //The interface for the class DigitalTime is in the header file dtime.h.
4 #include <iostream>
5 #include <cctype>
6 #include <cstdlib>
7 #include "dtime.h"
8 using namespace std;

9 //These FUNCTION DECLARATIONS are for use in the definition of
10 //the overloaded input operator >>:
11 void read_hour(istream& ins, int& the_hour);
12 //Precondition: Next input in the stream ins is a time in 24-hour notation,
13 //like 9:45 or 14:45.
14 //Postcondition: the_hour has been set to the hour part of the time.
15 //The colon has been discarded and the next input to be read is the minute.
16 void read_minute(istream& ins, int& the_minute);
17 //Reads the minute from the stream ins after read_hour has read the hour.
18 int digit_to_int(char c);
19 //Precondition: c is one of the digits '0' through '9'.
20 //Returns the integer for the digit; for example, digit_to_int('3') returns 3.
21 bool operator ==(const DigitalTime& time1, const DigitalTime& time2)
22 {
23     return (time1.hour == time2.hour && time1.minute == time2.minute);
24 }
25 //Uses iostream and cstdlib:
26 DigitalTime::DigitalTime(int the_hour, int the_minute)
27 {
28     if (the_hour < 0 || the_hour > 23 || the_minute < 0 || the_minute > 59)
29     {
30         cout << "Illegal argument to DigitalTime constructor.";
31         exit(1);
32     }
33
34     else
35     {
36         hour = the_hour;
37         minute = the_minute;
38     }
39 }
40 DigitalTime::DigitalTime( ) : hour(0), minute(0)
41 {
42     //Body intentionally empty.
43 }
44

```

(continued)

DISPLAY 12.2 Implementation File for DigitalTime (part 2 of 3)

```
45 void DigitalTime::advance(int minutes_added)
46 {
47     int gross_minutes = minute + minutes_added;
48     minute = gross_minutes % 60;
49
50     int hour_adjustment = gross_minutes / 60;
51     hour = (hour + hour_adjustment) % 24;
52 }
53
54 void DigitalTime::advance(int hours_added, int minutes_added)
55 {
56     hour = (hour + hours_added) % 24;
57     advance(minutes_added);
58 }
59
60 //Uses iostream:
61 ostream& operator <<(ostream& outs, const DigitalTime& the_object)
62 {
63     outs << the_object.hour << ':';
64     if (the_object.minute < 10)
65         outs << '0';
66     outs << the_object.minute;
67     return outs;
68 }
69
70 //Uses iostream:
71 istream& operator >>(istream& ins, DigitalTime& the_object)
72 {
73     read_hour(ins, the_object.hour);
74     read_minute(ins, the_object.minute);
75     return ins;
76 }
77
78 int digit_to_int(char c)
79 {
80     return (static_cast <int>(c) - static_cast <int>('0'));
81 }
82
83 //Uses iostream, ctype, and cstdlib:
84 void read_minute(istream& ins, int& the_minute)
85 {
86     char c1, c2;
87     ins >> c1 >> c2;
88
89     if (!(isdigit(c1) && isdigit(c2)))
```

(continued)

DISPLAY 12.2 Implementation File for DigitalTime (part 3 of 3)

```
90     {
91         cout<< "Error illegal input to read_minute\n";
92         exit(1);
93     }
94
95     the_minute = (digit_to_int(c1) * 10) + digit_to_int(c2);
96
97     if (the_minute < 0 || the_minute > 59)
98     {
99         cout<< "Error illegal input to read_minute\n";
100        exit(1);
101    }
102 }
103
104 //Uses iostream, ctype, and cstdlib:
105 void read_hour(istream& ins, int& the_hour)
106 {
107     char c1, c2;
108     ins >> c1 >> c2;
109     if ( !( isdigit(c1) && (isdigit(c2) || c2 == ':' ) ) )
110     {
111         cout<< "Error illegal input to read_hour\n";
112         exit(1);
113     }
114
115     if (isdigit(c1) && c2 == ':')
116     {
117         the_hour = digit_to_int(c1);
118     }
119     else //(isdigit(c1) && isdigit(c2))
120     {
121         the_hour = (digit_to_int(c1) * 10) + digit_to_int(c2);
122         ins >> c2; //discard ':'
123         if (c2 != ':')
124         {
125             cout<< "Error illegal input to read_hour\n";
126             exit(1);
127         }
128     }
129     if (the_hour < 0 || the_hour > 23)
130     {
131         cout<< "Error illegal input to read_hour\n";
132         exit(1);
133     }
134 }
```

DISPLAY 12.3 Application File Using DigitalTime

```
1 //Application file timedemo.cpp (your system may require some suffix
2 //other than .cpp): This program demonstrates use of the class DigitalTime.
3 #include <iostream>
4 #include "dtime.h"
5 using namespace std;
6
7 int main( )
8 {
9     DigitalTime clock, old_clock;
10
11     cout<< "Enter the time in 24-hour notation: ";
12     cin>> clock;
13
14     old_clock = clock;
15     clock.advance(15);
16     if (clock == old_clock)
17         cout << "Something is wrong.";
18     cout << "You entered " << old_clock << endl;
19     cout << "15 minutes later the time will be "
20         << clock << endl;
21
22     clock.advance(2, 15);
23     cout << "2 hours and 15 minutes after that\n"
24         << "the time will be "
25         << clock << endl;
26
27     return 0;
28 }
```

Sample Dialogue

```
Enter the time in 24-hour notation: 11:15
You entered 11:15
15 minutes later the time will be 11:30
2 hours and 15 minutes after that
the time will be 13:45
```

only a conceptual copying. The compiler acts as if the contents of `dtime.h` were copied into each file that has the include directive. However, if you look in that file after it is compiled, you will only find the include directive; you will not find the contents of the file `dtime.h`.

Once the implementation file and the application file are compiled, you still need to connect these files so that they can work together. This is called

linking the files and is done by a separate utility called a **linker**. The details for how you call the linker depend on what system you are using. After the files are linked, you can run your program. (Often the linking is done automatically as part of the process of running the program.)

This process sounds complicated, but many systems have facilities that manage much of this detail for you automatically or semiautomatically. On any system, the details quickly become routine.

Displays 12.1, 12.2, and 12.3 contain one complete program divided into pieces and placed in three different files. You could instead combine the contents of these three files into one file and then compile and run this one file without all this fuss about include directives and linking separate files. Why bother with three separate files? There are several advantages to dividing your program into separate files. Since you have the definition and the implementation of the class `DigitalTime` in files separate from the application file, you can use this class in many different programs without needing to rewrite the definition of the class in each of the programs. Moreover, you need to compile the implementation file only once, no matter how many programs use the class `DigitalTime`. But there are more advantages than that. Since you have separated the interface from the implementation of your `DigitalTime` ADT class, you can change the implementation file and will not need to change any program that uses the ADT. In fact, you will not even need to recompile the program. If you change the implementation file, you only need to recompile the implementation file and to relink the files. Saving a bit of recompiling time is nice, but the big advantage is not having to rewrite code. You can use the ADT class in many programs without writing the class code into each program. You can change the implementation of the ADT class and you need not rewrite any part of any program that uses the class.

Why separate files?

Defining a Class in Separate Files: A Summary

You can define a class and place the definition of the class and the implementation of its member functions in separate files. You can then compile the class separately from any program that uses the class, and you can use this same class in any number of different programs. The class and the program that uses the class are placed in three files as follows:

1. Put the definition of the class in a header file called the **interface file**. The name of this header file ends in `.h`. The interface file also contains the declarations for any functions and overloaded operators that define basic operations for the class but that are not listed in the class definition. Include comments that explain how all these functions and operators are used.

(continued)

2. The definitions of all the functions and overloaded operators mentioned in step 1 (whether they are members or friends or neither) are placed in another file called the **implementation file**. This file must contain an include directive that names the interface file described above. This include directive uses quotes around the file name, as in the following example:

```
#include "dtime.h"
```

The interface file and the implementation file traditionally have the same name, but end in different suffixes. The interface file ends in `.h`. The implementation file ends in the same suffix that you use for files that contain a complete C++ program. The implementation file is compiled separately before it is used in any program.

3. When you want to use the class in a program, place the main part of the program (and any additional function definitions, constant declarations, and so on) in another file called an **application file**. This file also must contain an include directive naming the interface file, as in the following example:

```
#include "dtime.h"
```

The application file is compiled separately from the implementation file. You can write any number of these application files to use with one pair of interface and implementation files. To run an entire program, you must first link the object code that is produced by compiling the application file and the object code that is produced by compiling the implementation file. (On some systems the linking may be done automatically or semiautomatically.)

Implementation details

Now that we have explained how the various files in our ADT class and program are used, let's discuss the implementation of our ADT class (Display 12.2) in more detail. Most of the implementation details are straightforward, but there are two things that merit comment. Notice that the member function name `advance` is overloaded so that it has two function definitions. Also notice that the definition for the overloaded extraction (input) operator `>>` uses two "helping functions" called `read_hour` and `read_minute` and these two helping functions themselves use a third helping function called `digit_to_int`. Let's discuss these points.

The class `DigitalTime` (Displays 12.1 and 12.2) has two member functions called `advance`. One version takes a single argument, which is an integer giving the number of minutes to advance the time. The other version takes two arguments, one for a number of hours and one for a number of minutes, and advances the time by that number of hours plus that number of minutes. Notice that the definition of the two-argument version of `advance` includes a call to the one-argument version of `advance`. Look at the definition of the two-argument version that is given in Display 12.2. First the time is

advanced by `hours_added` hours, and then the single-argument version of `advance` is used to advance the time by an additional `minutes_added` minutes. At first this may seem strange, but it is perfectly legal. The two functions named `advance` are two different functions that, as far as the compiler is concerned, coincidentally happen to have the same name. The situation is no different in this regard than it would be if one of the two versions of the overloaded function `advance` had been called `another_advance`.

Now let's discuss the helping functions. The helping functions `read_hour` and `read_minute` read the input one character at a time and then convert the input to integer values that are placed in the member variables `hour` and `minute`. The functions `read_hour` and `read_minute` read the hour and minute one digit at a time, so they are reading values of type `char`. This is more complicated than reading the input as `int` values, but it allows us to perform error checking to see whether the input is correctly formed and to issue an error message if the input is not well formed. These helping functions `read_hour` and `read_minute` use another helping function named `digit_to_int`, which is the same as the `digit_to_int` function we used in our definition of the class `Money` in Displays 11.3. The function `digit_to_int` converts a digit, such as `'3'`, to a number, such as `3`.

Reusable Components

An ADT class developed and coded into separate files is a software component that can be used again and again in a number of different programs. **Reusability**, such as the reusability of these ADT classes, is an important goal to strive for when designing software components. A reusable component saves effort because it does not need to be redesigned, recoded, and retested for every application. A reusable component is also likely to be more reliable than a component that is used only once—for two reasons. First, you can afford to spend more time and effort on a component if it will be used many times. Second, if the component is used again and again, it is tested again and again. Every use of a software component is a test of that component. Using a software component many times in a variety of contexts is one of the best ways to discover any remaining bugs in the software.

Using `#ifndef`

We have given you a method for placing a program in three files: two for the interface and implementation of a class, and one for the application part of the program. A program can be kept in more than three files. For example, a program might use several classes, and each class might be kept in a separate pair of files.



Suppose you have a program spread across a number of files and more than one file has an include directive for a class interface file such as the following:

```
#include "dtime.h"
```

Under these circumstances, you can have files that include other files, and these other files may in turn include yet other files. This can easily lead to a situation in which a file, in effect, contains the definitions in `dtime.h` more than once. C++ does not allow you to define a class more than once, even if the repeated definitions are identical. Moreover, if you are using the same header file in many different projects, it becomes close to impossible to keep track of whether you included the class definition more than once. To avoid this problem, C++ provides a way of marking a section of code to say “if you have already included this stuff once before, do not include it again.” The way this is done is quite intuitive, although the notation may look a bit weird until you get used to it. We will go through an example, explaining the details as we go.

The following directive “defines” `DTIME_H`:

```
#define DTIME_H
```

What this means is that the compiler’s preprocessor puts `DTIME_H` on a list to indicate that `DTIME_H` has been seen. *Defines* is perhaps not the best word for this, since `DTIME_H` is not defined to mean anything but is merely put on a list. The important point is that you can use another directive to test whether or not `DTIME_H` has been defined and so test whether or not a section of code has already been processed. You can use any (nonkeyword) identifier in place of `DTIME_H`, but you will see that there are standard conventions for which identifier you should use.

The following directive tests to see whether or not `DTIME_H` has been defined:

```
#ifndef DTIME_H
```

If `DTIME_H` has already been defined, then everything between this directive and the first occurrence of the following directive is skipped:

```
#endif
```

(An equivalent way to state this, which may clarify the way the directives are spelled, is the following: If `DTIME_H` is *not* defined, then the compiler processes everything up to the next `#endif`. That *not* is why there is an `n` in `#ifndef`. This may lead you to wonder whether there is a `#ifdef` directive as well as a `#ifndef` directive. There is, and it has the obvious meaning, but we will have no occasion to use `#ifdef`.

Now consider the following code:

```
#ifndef DTIME_H
#define DTIME_H
<a class definition>
#endif
```

If this code is in a file named `dttime.h`, then no matter how many times your program contains

```
#include "dttime.h"
```

the class will be defined only one time.

The first time

```
#include "dttime.h"
```

is processed, the flag `DTIME_H` is defined and the class is defined. Now, suppose the compiler again encounters

```
#include "dttime.h"
```

When the include directive is processed this second time, the directive

```
#ifndef DTIME_H
```

says to skip everything up to

```
#endif
```

and so the class is not defined again.

In Display 12.4 we have rewritten the header file `dttime.h` shown in Display 12.1, but this time we used these directives to prevent multiple definitions. With the version of `dttime.h` shown in Display 12.4, if a file contains the following include directive more than once, the class `DigitalTime` will still be defined only once:

```
#include "dttime.h"
```

DISPLAY 12.4 Avoiding Multiple Definitions of a Class

```
1 //Header file dttime.h: This is the INTERFACE for the class DigitalTime.
2 //Values of this type are times of day. The values are input and output in
3 //24-hour notation, as in 9:30 for 9:30 AM and 14:45 for 2:45 PM.
4 #ifndef DTIME_H
5 #define DTIME_H
6 #include <iostream>
7 using namespace std;
8 class DigitalTime
9 {
10
11     <The definition of the class DigitalTime is the same as in Display 12.1.>
12 };
13
14 #endif//DTIME_H
```

You may use some other identifier in place of `DTIME_H`, but the normal convention is to use the name of the file written in all uppercase letters with the underscore used in place of the period. You should follow this convention so that others can more easily read your code and so that you do not have to remember the flag name. This way the flag name is determined automatically and there is nothing arbitrary to remember.

These same directives can be used to skip over code in files other than header files, but we will not have occasion to use these directives except in header files.

■ PROGRAMMING TIP Defining Other Libraries

You need not define a class in order to use separate compilation. If you have a collection of related functions that you want to make into a library of your own design, you can place the function declarations and accompanying comments in a header file and the function definitions in an implementation file, just as we outlined for ADT classes. After that, you can use this library in your programs the same way you would use a class that you placed in separate files. ■

SELF-TEST EXERCISES

1. Suppose that you are defining an ADT class and that you then use this class in a program. You want to separate the class and program parts into separate files as described in this chapter. Specify whether each of the following should be placed in the interface file, implementation file, or application file:
 - a. The class definition
 - b. The declaration for a function that is to serve as an ADT operation, but that is neither a member nor a friend of the class
 - c. The declaration for an overloaded operator that is to serve as an ADT operation, but that is neither a member nor a friend of the class
 - d. The definition for a function that is to serve as an ADT operation, but that is neither a member nor a friend of the class
 - e. The definition for a friend function that is to serve as an ADT operation
 - f. The definition for a member function
 - g. The definition for an overloaded operator that is to serve as an ADT operation, but that is neither a member nor a friend of the class
 - h. The definition for an overloaded operator that is to serve as an ADT operation and that is a friend of the class
 - i. The main part of your program

2. Which of the following files has a name that ends in `.h`: the interface file for a class, the implementation file for the class, or the application file that uses the class?
3. When you define a class in separate files, there is an interface file and an implementation file. Which of these files needs to be compiled? (Both? Neither? Only one? If so, which one?)
4. Suppose you define a class in separate files and use the class in a program. Now suppose you change the class implementation file. Which of the following files, if any, need to be recompiled: the interface file, the implementation file, or the application file?
5. Suppose you want to change the implementation of the class `DigitalTime` given in Displays 12.1 and 12.2. Specifically, you want to change the way the time is recorded. Instead of using the two private variables `hour` and `minute`, you want to use a single (private) `int` variable, which will be called `minutes`. In this new implementation, the private variable `minutes` will record the time as the number of minutes since the time 0:00 (that is, since midnight). So 1:30 is recorded as 90 minutes, since it is 90 minutes past midnight. Describe how you need to change the interface and implementation files shown in Displays 12.1 and 12.2. You need not write out the files in their entirety; just indicate what items you need to change and how, in a very general way, you would change them.
6. What is the difference between an ADT you define in C++ and a class you define in C++?

12.2 NAMESPACES

*What's in a name? That which we call a rose
By any other name would smell as sweet.*

WILLIAM SHAKESPEARE, *Romeo and Juliet*

When a program uses different classes and functions written by different programmers, there is a possibility that two programmers will use the same name for two different things. Namespaces are a way to deal with this problem. A namespace is a collection of name definitions, such as class definitions and variable declarations.

Namespaces and *using* Directives

We have already been using the namespace that is named `std`. The `std` namespace contains all the names defined in the standard library files (such

as `iostream` and `cstdlib`) that you use. For example, when you place the following at the start of a file,

```
#include <iostream>
```

that places all of the name definitions (for names like `cin` and `cout`) into the `std` namespace. Your program does not know about names in the `std` namespace unless you specify that it is using the `std` namespace. So far, the only way we know how to specify the `std` namespace (or any namespace) is with the following sort of *using* directive:

```
using namespace std;
```

A good way to see why you might want to include this *using* directive is to think about why you might want to *not* include it. If you do not include this *using* directive for the namespace `std`, then you can define `cin` and `cout` to have some meaning other than their standard meaning. (Perhaps you want to redefine `cin` and `cout` because you want them to behave a bit differently from the standard versions.) Their standard meaning is in the `std` namespace, and without the *using* directive (or something like it), your code knows nothing about the `std` namespace, and therefore, as far as your code is concerned, the only definitions of `cin` and `cout` are whatever definitions you give them.

Every bit of code you write is in some namespace. If you do not place the code in some specific namespace, then the code is in a namespace known as the **global namespace**. So far, we have not placed any code we wrote in any namespace, so all of our code has been in the global namespace. The global namespace does not have a *using* directive because you are always using the global namespace. You could say that there is always an implicit automatic *using* directive that says you are using the global namespace.

Note that you can be using more than one namespace at the same time. For example, we are always using the global namespace and we are usually using the `std` namespace. What happens if a name is defined in two namespaces and you are using both namespaces? This results in an error (either a compiler error or a run-time error, depending on the exact details). You can have the same name defined in two different namespaces, but if that is true, then you can only use one of those namespaces at a time.¹ However, this does not mean you cannot use the two namespaces in the same program. You can use them each at different times in the same program.

For example, suppose `ns1` and `ns2` are two namespaces, and suppose `my_function` is a *void* function with no arguments that is defined in both namespaces but defined in different ways in the two namespaces. The following is then legal:

¹As you will see later in this chapter, there are ways to use two namespaces at the same time even if they contain the same name, but that is a subtle point that does not yet concern us.

```
{
    using namespace ns1;
    my_function( );
}
{
    using namespace ns2;
    my_function( );
}
```

The first invocation would use the definition of `my_function` given in the namespace `ns1`, and the second invocation would use the definition of `my_function` given in the namespace `ns2`.

Recall that a block is a list of statements, declarations, and possibly other code, enclosed in braces `{}`. A *using* directive at the start of a block applies only to that block. So the first *using* directive applies only in the first block, and the second *using* directive applies only in the second block. The usual way of phrasing this is to say that the **scope** of the `ns1` namespace is the first block, while the scope of the `ns2` namespace is the second block. Note that because of this scope rule, we are able to use two conflicting namespaces in the same program (such as in a program that contains the two blocks we discussed in the previous paragraph).

When you use a *using* directive in a block, it is typically the block consisting of the body of a function definition. If you place a *using* directive at the start of a file (as we have usually done so far), then the *using* directive applies to the entire file. A *using* directive should normally be placed near the start of a file or the start of a block.

Scope Rule for *using* Directives

The scope of a *using* directive is the block in which it appears (more precisely, from the location of the *using* directives to the end of the block). If the *using* directive is outside of all blocks, then it applies to all of the file that follows the *using* directive.

Creating a Namespace

In order to place some code in a namespace, you simply place it in a namespace grouping of the following form:

```
namespace Name_Space_Name
{
    Some_Code
}
```

When you include one of these groupings in your code, you are said to place the names defined in *Some_Code* into the namespace *Name_Space_Name*. These

names (really the definitions of these names) can be made available with the *using* directive:

```
using namespace Name_Space_Name;
```

For example, the following, taken from Display 12.5, places a function declaration in the namespace `savitch1`:

```
namespace savitch1
{
    void greeting( );
}
```

If you look again at Display 12.5, you see that the definition of the function `greeting` is also placed in namespace `savitch1`. That is done with the following additional namespace grouping:

```
namespace savitch1
{
    void greeting( )
    {
        cout << "Hello from namespace savitch1.\n";
    }
}
```

Note that you can have any number of these namespace groupings for a single namespace. In Display 12.5, we used two namespace groupings for namespace `savitch1` and two other groupings for namespace `savitch2`.

Every name defined in a namespace is available inside the namespace grouping, but the names can also be made available to code outside of the namespace. That function declaration and function definition in the namespace `savitch1` can be made available with the *using* directive:

```
using namespace savitch1
```

as illustrated in Display 12.5.

DISPLAY 12.5 Namespace Demonstration (part 1 of 2)

```
1  #include <iostream>
2  using namespace std;
3
4  namespace savitch1
5  {
6      void greeting( );
7  }
8
9  namespace savitch2
10 {
11     void greeting( );
12 }
```

(continued)

DISPLAY 12.5 Namespace **Demonstration** (part 2 of 2)

```

13
14     void big_greeting( );
15
16     int main( )
17     {
18         {
19             using namespace savitch2; ← Names in this block use
20             greeting( );              definitions in namespaces
21         }                             savitch2, std, and the
22                                     global namespace.
23
24         {
25             using namespace savitch1; ← Names in this block use
26             greeting( );              definitions in namespaces
27         }                             savitch1, std, and the
28                                     global namespace.
29     big_greeting( );
30     return 0; ← Names out here use only definitions
31 }                                       in namespace std and the
32                                     global namespace.
33 namespace savitch1
34 {
35     void greeting( )
36     {
37         cout << "Hello from namespace savitch1.\n";
38     }
39 }
40
41 namespace savitch2
42 {
43     void greeting( )
44     {
45         cout<< "Greetings from namespace savitch2.\n";
46     }
47 }
48
49 void big_greeting( )
50 {
51     cout<< "A Big Global Hello!\n";
52 }

```

Sample Dialogue

```

Greetings from namespace savitch2.
Hello from namespace savitch1.
A Big Global Hello!

```

SELF-TEST EXERCISES

7. Consider the program shown in Display 12.5. Could we use the name `greeting` in place of `big_greeting`?
8. In Self-Test Exercise 7, we saw that you could *not* add a definition for the following function (to the global namespace):

```
void greeting( );
```

Can you add a definition for the following function declaration to the global namespace?

```
void greeting(int how_many);
```

9. Can a namespace have more than one namespace grouping?

Qualifying Names

Suppose you are faced with the following situation: You have two namespaces, `ns1` and `ns2`. You want to use the function `fun1` defined in `ns1` and the function `fun2` defined in namespace `ns2`. The complication is that both `ns1` and `ns2` define a function `my_function`. (Assume all functions in this discussion take no arguments, so overloading does not apply.) It would not be a good idea to use the following:

```
using namespace ns1;
using namespace ns2;
```

This would provide conflicting definitions for `my_function`.

What you need is a way to say you are using `fun1` in namespace `ns1` and `fun2` in namespace `ns2` and nothing else in the namespaces `ns1` and `ns2`. The following are called *using declarations*, and they are your answer:

```
using ns1::fun1;
using ns2::fun2;
```

A *using* declaration of the form

```
using Name_Space::One_Name
```

makes (the definition of) the name *One_Name* from the namespace *Name_Space* available, but does not make any other names in *Name_Space* available.

Note that you have seen the scope resolution operator, `::`, before. For example, in Display 12.2 we had the following function definition:

```
void DigitalTime::advance(int hours_added, int minutes_added)
{
    hour = (hour + hours_added) % 24;
    advance(minutes_added);
}
```

In this case the `::` means that we are defining the function `advance` for the class `DigitalTime`, as opposed to any other function named `advance` in any other class. Similarly,

```
using ns1::fun1;
```

means we are using the function named `fun1` as defined in the namespace `ns1`, as opposed to any other definition of `fun1` in any other namespace.

Now suppose that you intend to use the name `fun1` as defined in the namespace `ns1`, but you intend to use it only one time (or a small number of times). You can then name the function (or other item) using the name of the namespace and the scope resolution operator as in the following:

```
ns1::fun1( );
```

This form is often used when specifying a parameter type. For example, consider

```
int get_number(std::istream input_stream)
. . .
```

In the function `get_number`, the parameter `input_stream` is of type `istream`, where `istream` is defined as in the `std` namespace. If this use of the type name `istream` is the only name you need from the `std` namespace (or if all the names you need are similarly qualified with `std::`), then you do *not* need

```
using namespace std;
```

A Subtle Point About Namespaces (Optional)

There are two differences between a `using` declaration, such as

```
using std::cout;
```

and a `using` directive, such as

```
using namespace std;
```

The differences are as follows:

1. A `using` declaration (like `using std::cout;`) makes only one name in the namespace available to your code, while a `using` directive (like `using namespace std;`) makes all the names in a namespace available.
2. A `using` declaration introduces a name (like `cout`) into your code so that no other use of the name can be made. However, a `using` directive only potentially introduces the names in the namespace.

Point 1 is pretty obvious. Point 2 has some subtleties. For example, suppose the namespaces `ns1` and `ns2` both provide definitions for `my_function` but have no other name conflicts. Then the following will produce no problems:

```
using namespace ns1;
using namespace ns2;
```

provided that (within the scope of these directives) the conflicting name `my_function` is never used in your code. On the other hand, the following is illegal, even if the function `my_function` is never used:

```
using ns1::my_function;
using ns2::my_function;
```

Sometimes this subtle point can be important, but it does not impinge on most routine code.

SELF-TEST EXERCISES

- Write the function declaration for a `void` function named `wow`. The function `wow` has two parameters, the first of type `speed` as defined in the `speedway` namespace and the second of type `speed` as defined in the `indy500` namespace.
- Consider the following function declarations from the definition of the class `Money` in Display 11.4.

```
void input(istream& ins);
void output(ostream& outs) const;
```

Rewrite these function declarations so that they do not need to be preceded by

```
using namespace std;
```

(You do not need to look back at Display 11.4 to do this.)

Unnamed Namespaces

Our definition of the class `DigitalTime` in Displays 12.1 and 12.2 used three helping functions: `digit_to_int`, `read_hour`, and `read_minute`. These helping functions are part of the implementation for the ADT class `DigitalTime`, so we placed their definitions in the implementation file (Display 12.2). However, this does not really hide these three functions. We would like these functions to be local to the implementation file for the class `DigitalTime`. However, as we have done it, they are not. In particular, we cannot define another function with the name `digit_to_int` (or `read_hour` or `read_minute`) in an application program that uses the class `DigitalTime`. This violates the principle of information hiding. To truly hide these helping functions and make them local to the implementation file for `DigitalTime`, we need to place them in a special namespace called the *unnamed namespace*.

A **compilation unit** is a file, such as a class implementation file, along with all the files that are `#included` in the file, such as the interface header file for the class. Every compilation unit has an **unnamed namespace**. A namespace grouping for the unnamed namespace is written in the same way as any other namespace, but no name is given, as in the following example:

```
namespace
{
    void sample_function( )
        :
        :
        :
} //unnamed namespace
```

All the names defined in the unnamed namespace are local to the compilation unit, and thus the names can be reused for something else outside the compilation unit. For example, Displays 12.6 and 12.7 show a rewritten (and our final) version of the interface and implementation file for the class `DigitalTime`. Note that the helping functions (`read_hour`, `read_minute`, and `digit_to_int`) are all in the unnamed namespace and therefore are local to the compilation unit. As illustrated in Display 12.8, the names in the unnamed namespace can be reused for something else outside the compilation unit. In Display 12.8 the function name `read_hour` is reused for another different function in the application program.

DISPLAY 12.6 Placing a Class in a Namespace—Header File

```
1 //Header file dtime.h: This is the interface for the class DigitalTime.
2 //Values of this type are times of day. The values are input and output in
3 //24-hour notation, as in 9:30 for 9:30 AM and 14:45 for 2:45 PM.
4
5 #ifndef DTIME_H
6 #define DTIME_H
7
8 #include <iostream>
9 using namespace std;
10
11 namespace dtimesavitch
12 {
13
14     class DigitalTime
15     {
16
17         <The definition of the class DigitalTime is the same as in Display 12.1.>
18     };
19 } //end dtimesavitch
20 #endif //DTIME_H
```

One grouping for the namespace `dtimesavitch`.
Another grouping for the namespace `dtimesavitch` is in the implementation file `dtime.cpp`.

DISPLAY 12.7 Placing a Class in a Namespace—Implementation File (part 1 of 2)

```

1  //Implementation file dtime.cpp (your system may require some
2  //suffix other than .cpp): This is the IMPLEMENTATION of the ADT DigitalTime.
3  //The interface for the class DigitalTime is in the header file dtime.h.
4  #include <iostream>
5  #include <cctype>
6  #include <cstdlib>
7  #include "dtime.h"
8  using namespace std;
9
10 namespace ← One grouping for the unnamed
11 {           namespace
12     //These function declarations are for use in the definition of
13     //the overloaded input operator >>:
14
15     void read_hour(istream& ins, int& the_hour);
16     //Precondition: Next input in the stream ins is a time in 24-hour notation,
17     //like 9:45 or 14:45.
18     //Postcondition: the_hour has been set to the hour part of the time.
19     //The colon has been discarded and the next input to be read is the minute.
20
21     void read_minute(istream& ins, int& the_minute);
22     //Reads the minute from the stream ins after read_hour has read the hour.
23
24     int digit_to_int(char c);
25     //Precondition: c is one of the digits '0' through '9'.
26     //Returns the integer for the digit; for example, digit_to_int('3')
27     //returns 3.
28 } //unnamed namespace
29
30 namespace dtimesavitch ← One grouping for the namespace dtimesavitch.
31 {           Another grouping is in the file dtime.h.
32
33     bool operator ==(const DigitalTime& time1, const DigitalTime& time2)
34     <The rest of the definition of == is the same as in Display 12.2.>
35
36     DigitalTime::DigitalTime( )
37     <The rest of the definition of this constructor is the same as in Display 12.2.>
38
39     DigitalTime::DigitalTime(int the_hour, int the_minute)
40     <The rest of the definition of this constructor is the same as in Display 12.2.>
41     void DigitalTime::advance(int minutes_added)
42     <The rest of the definition of this advance function is the same as in Display 12.2.>
43
44     void DigitalTime::advance(int hours_added, int minutes_added)
45     <The rest of the definition of this advance function is the same as in Display 12.2.>

```

(continued)

DISPLAY 12.7 Placing a Class in a Namespace—Implementation File (part 2 of 2)

```

42     ostream& operator <<(ostream& outs, const DigitalTime& the_object)
    <The rest of the definition of << is the same as in Display 12.2.>
43
44     //Uses iostream and functions in the unnamed namespace:
45     istream& operator >>(istream& ins, DigitalTime& the_object)
46     {
47         read_hour(ins, the_object.hour);           Functions defined in the unnamed
48         read_minute(ins, the_object.minute);       namespace are local to this com-
49         return ins;                                 ilation unit (this file and included
50     }                                               files). They can be used anywhere
51 } //dtimesavitch                                   in this file, but have no meaning
52                                                    outside this compilation unit.
53
54 namespace ← Another grouping for the
55 {                                                  unnamed namespace.
56     int digit_to_int(char c)
    <The rest of the definition of digit_to_int is the same as in Display 12.2.>
57
58     void read_minute(istream& ins, int& the_minute)
    <The rest of the definition of read_minute is the same as in Display 12.2.>
59
60     void read_hour(istream& ins, int& the_hour)
    <The rest of the definition of read_hour is the same as in Display 12.2.>
61
62 }//unnamed namespace

```

If you look again at the implementation file in Display 12.8, you will see that the helping functions `digit_to_int`, `read_hour`, and `read_minute` are used outside the unnamed namespace without any namespace qualifier. Any name defined in the unnamed namespace can be used without qualification anywhere in the compilation unit. (Of course, this needed to be so, since the unnamed namespace has no name to use for qualifying its names.)

It is interesting to note how unnamed namespaces interact with the C++ rule that you cannot have two definitions of a name (in the same namespace). There is one unnamed namespace in each compilation unit. It is easily possible for compilation units to overlap. For example, both the implementation file for a class and an application program using the class would normally include the header file (interface file) for the class. Thus, the header file is in two compilation units and hence participates in two unnamed namespaces. As dangerous as this sounds, it will normally produce no problems as long as each compilation unit's namespace makes sense when considered by itself. For example, if a name is defined in the unnamed namespace in the header file, it cannot be defined again in the unnamed namespace in either the implementation file or the application file. So, a name conflict is avoided.

DISPLAY 12.8 Placing a Class in a Namespace—Application Program (part 1 of 2)

```

1  //This is the application file: timedemo.cpp. This program
2  //demonstrates hiding the helping functions in an unnamed namespace.
3
4  #include <iostream>
5  #include "dtime.h"
6
7  void read_hour(int& the_hour);
8
9  int main( )
10 {
11     using namespace std;
12
13     using namespace dtimesavitch;
14
15     int the_hour;
16     read_hour(the_hour);
17
18     DigitalTime clock(the_hour, 0), old_clock;
19
20     old_clock = clock;
21     clock.advance(15);
22     if (clock == old_clock)
23         cout << "Something is wrong.";
24     cout << "You entered " << old_clock << endl;
25     cout << "15 minutes later, the time will be "
26         << clock; << endl;
27
28     clock.advance(2, 15);
29     cout << "2 hours and 15 minutes after that\n"
30         << "the time will be "
31         << clock; << endl;
32
33     return 0;
34 }
35 void read_hour(int& the_hour)
36 {
37     using namespace std;
38
39     cout << "Let's play a time game.\n"
40         << "Let's pretend the hour has just changed.\n"
41         << "You may write midnight as either 0 or 24,\n"
42         << "but I will always write it as 0.\n"
43         << "Enter the hour as a number (0 to 24): ";
44     cin >> the_hour;
45     if (the_hour == 24)
46         the_hour = 0;
47 }

```

If you place the using directives here, then the program behavior will be the same.

This is a different function `read_hour` than the one in the implementation file `dtime.cpp` (shown in Display 12.7).

(continued)

DISPLAY 12.8 Placing a Class in a Namespace—Application Program (part 2 of 2)**Sample Dialogue**

```
Let's play a time game.
Let's pretend the hour has just changed.
You may write midnight as either 0 or 24,
but I will always write it as 0.
Enter the hour as a number (0 to 24): 11
You entered 11:00
15 minutes later the time will be 11:15
2 hours and 15 minutes after that
the time will be 13:30
```

PROGRAMMING TIP Choosing a Name for a Namespace

It is a good idea to include your last name or some other unique string in the names of your namespaces so as to reduce the chance that somebody else will use the same namespace name as you do. With multiple programmers writing code for the same project, it is important that namespaces that are meant to be distinct really do have distinct names. Otherwise, you can easily have multiple definitions of the same names in the same scope. That is why we included the name `savitch` in the namespace `dtimesavitch` in Display 12.7. ■

Unnamed Namespace

You can use the **unnamed namespace** to make a definition local to a compilation unit (that is, to a file and its included files). Each compilation unit has one unnamed namespace. All the identifiers defined in the unnamed namespace are local to the compilation unit. You place a definition in the unnamed namespace by placing it in a namespace grouping with no namespace name, as shown in the following:

```
namespace
{
    Definition_1
    Definition_2
    .
    .
    .
    Definition_Last
}
```

You can use any name in the unnamed namespace without a qualifier anywhere in the compilation unit. See Displays 12.6 and 12.7 for a complete example.

PITFALL **Confusing the Global Namespace and the Unnamed Namespace**

Do not confuse the global namespace with the unnamed namespace. If you do not put a name definition in a namespace grouping, then it is in the global namespace. To put a name definition in the unnamed namespace, you must put it in a namespace grouping that starts as follows, without a name:

```
namespace
{
```

Both names in the global namespace and names in the unnamed namespace may be accessed without a qualifier. However, names in the global namespace have global scope (all the program files), while names in an unnamed namespace are local to a compilation unit.

This confusion between the global namespace and the unnamed namespace does not arise very much in writing code, since there is a tendency to think of names in the global namespace as being “in no namespace,” even though that is not technically correct. However, the confusion can easily arise when discussing code. ■

SELF-TEST EXERCISES

12. Would the program in Display 12.8 behave any differently if you replaced the *using* directive

```
using namespace dtimesavitch;
```

with the following *using* declaration?

```
using dtimesavitch::DigitalTime;
```

13. What is the output produced by the following program?

```
#include <iostream>
using namespace std;

namespace sally
{
    void message( );
}

namespace
{
    void message( );
}

int main( )
{
    {
        message( );
```

```

        using sally::message;
        message( );
    }

    message( );
    return 0;
}
namespace sally
{
    void message( )
    {
        cout << "Hello from Sally.\n";
    }
}
namespace
{
    void message( )
    {
        cout << "Hello from unnamed.\n";
    }
}

```

14. In Display 12.7 there are two groupings for the unnamed namespace: one for the helping function declarations and one for the helping function definitions. Can we eliminate the grouping for the helping function declarations? If so, how can we do it?

CHAPTER SUMMARY

- In C++, abstract data types (ADTs) are implemented as classes with all member variables private and with the operations implemented as public member and nonmember functions and overloaded operators.
- You can define an ADT as a class and place the definition of the class and the implementation of its member functions in separate files. You can then compile the ADT class separately from any program that uses it and you can use this same ADT class in any number of different programs.
- A namespace is a collection of name definitions, such as class definitions and variable declarations.
- There are three ways to use a name from a namespace: by making all the names in the namespace available with a *using* directive, by making the single name available by a *using* declaration for the one name, or by qualifying the name with the name of the namespace and the scope resolution operator.
- You place a definition in a namespace by placing it in a namespace grouping for that namespace.
- The unnamed namespace can be used to make a name definition local to a compilation unit.

Answers to Self-Test Exercises

1. Parts (a), (b), and (c) go in the interface file; parts (d) through (h) go in the implementation file. (All the definitions of ADT operations of any sort go in the implementation file.) Part (i) (that is, the `main` part of your program) goes in the application file.
2. The name of the interface file ends in `.h`.
3. Only the implementation file needs to be compiled. The interface file does not need to be compiled.
4. Only the implementation file needs to be recompiled. You do, however, need to relink the files.
5. You need to delete the private member variables `hour` and `minute` from the interface file shown in Display 12.1 and replace them with the member variable `minutes` (with an `s`). You do not need to make any other changes in the interface file. In the implementation file, you need to change the definitions of all the constructors and other member functions, as well as the definitions of the overloaded operators, so that they work for this new way of recording time. (In this case, you do not need to change any of the helping functions `read_hour`, `read_minute`, or `digit_to_int`, but that might not be true for some other class or even some other reimplementation of this class.) For example, the definition of the overloaded operator `>>` could be changed to the following:

```
istream& operator >>(istream& ins, DigitalTime& the_object)
{
    int input_hour, input_minute;
    read_hour(ins, input_hour);
    read_minute(ins, input_minute);
    the_object.minutes = input_minute + (60 * input_hour);
    return ins;
}
```

You need not change any application files for programs that use the class. However, since the interface file is changed (as well as the implementation file), you will need to recompile any application files, and of course you will need to recompile the implementation file.

6. The short answer is that an ADT is simply a class that you defined following good programming practices of separating the interface from the implementation. Also, when we describe a class as an ADT, we consider the nonmember basic operations such as overloaded operators to be part of the ADT, even though they are not technically speaking part of the C++ class.

7. No. If you replace `big_greeting` with `greeting`, then you will have a definition for the name `greeting` in the global namespace. There are parts of the program where all the name definitions in the namespace `savitch1` and all the name definitions in the global namespace are simultaneously available. In those parts of the program, there would be two distinct definitions for

```
void greeting( );
```

8. Yes, the additional definition would cause no problems. This is because overloading is always allowed. When, for example, the namespaces `savitch1` and the global namespace are available, the function name `greeting` would be overloaded. The problem in Self-Test Exercise 7 was that there would sometimes be two definitions of the function name `greeting` with the same parameter lists.
9. Yes, a namespace can have any number of groupings. For example, the following are two groupings for the namespace `savitch1` that appear in Display 12.5:

```
namespace savitch1
{
    void greeting( );
}

namespace savitch1
{
    void greeting( )
    {
        cout << "Hello from namespace savitch1.\n";
    }
}
```

10. `void wow(speedway::speed s1, indy500::speed s2);`
11. `void input(std::istream& ins);`
`void output(std::ostream& outs) const;`
12. The program would behave exactly the same.
13. Hello from unnamed. Hello from Sally. Hello from unnamed.
14. Yes, you can eliminate the grouping for the helping function declarations, as long as the grouping with the helping function definitions occurs before the helping functions are used. For example, you could remove the namespace with the helping function declarations and move the grouping with the helping function definitions to just before the namespace grouping for the namespace `dtimesavitch`.

PRACTICE PROGRAMS

Practice Programs can generally be solved with a short program that directly applies the programming principles presented in this chapter.

1. Add the following member function to the ADT class `DigitalTime` defined in Displays 12.1 and 12.2:

```
void DigitalTime::interval_since(const DigitalTime& a_previous_time,
                                int& hours_in_interval, int& minutes_in_interval) const
```

This function computes the time interval between two values of type `DigitalTime`. One of the values of type `DigitalTime` is the object that calls the member function `interval_since`, and the other value of type `DigitalTime` is given as the first argument. For example, consider the following code:

```
DigitalTime current(5, 45), previous(2, 30);
int hours, minutes;
current.interval_since(previous, hours, minutes);
cout << "The time interval between " << previous
     << " and " << current << endl
     << "is " << hours << " hours and "
     << minutes << " minutes.\n";
```

In a program that uses your revised version of the `DigitalTime` ADT, this code should produce the following output:

```
The time interval between 2:30 and 5:45
is 3 hours and 15 minutes.
```

Allow the time given by the first argument to be later in the day than the time of the calling object. In this case, the time given as the first argument is assumed to be on the previous day. You should also write a program to test this revised ADT class.

2. Do Self-Test Exercise 5 in full detail. Write out the complete ADT class, including interface and implementation files. Also write a program to test your ADT class.
3. Redo Practice Programs 1 from Chapter 11, but this time define the `Money` ADT class in separate files for the interface and implementation so that the implementation can be compiled separately from any application program.
4. Redo Practice Programs 2 from Chapter 11, but this time define the `Pairs` ADT class in separate files for the interface and implementation so that the implementation can be compiled separately from any application program.



5. This Practice Program explores how the unnamed namespace works. Listed below are snippets from a program to perform input validation for a username and password. The code to input and validate the username is in a file separate from the code to input and validate the password.

File `user.cpp`:

```
namespace Authenticate
{
    void inputUserName()
    {
        do
        {
            cout << "Enter your username (8 letters only)" << endl;
            cin >> username;
        } while (!isValid());
    }
    string getUsername()
    {
        return username;
    }
}
```

Define the `username` variable and the `isValid()` function in the unnamed namespace so the code will compile. The `isValid()` function should return `true` if `username` contains exactly eight letters. Generate an appropriate header file for this code.

Repeat the same steps for the file `password.cpp`, placing the `password` variable and the `isValid()` function in the unnamed namespace. In this case, the `isValid()` function should return `true` if the input password has at least eight characters including at least one nonletter:

File `password.cpp`:

```
namespace Authenticate
{
    void inputPassword()
    {
        do
        {
            cout << "Enter your password (at least 8 characters " <<
                "and at least one nonletter)" << endl;
            cin >> password;
        } while (!isValid());
    }
    string getPassword()
    {
        return password;
    }
}
```

At this point you should have two functions named `isValid()`, each in different unnamed namespaces. Place the following main function in an appropriate place. The program should compile and run.

```
int main()
{
    inputUserName();
    inputPassword();
    cout << "Your username is " << getUsername() <<
         " and your password is: " <<
         getPassword() << endl;
    return 0;
}
```

Test the program with several invalid usernames and passwords.

PROGRAMMING PROJECTS

Programming Projects require more problem-solving than Practice Programs and can usually be solved many different ways. Visit www.myprogramminglab.com to complete many of these Programming Projects online and get instant feedback.

1. Redo (or do for the first time) Practice Program 3 from Chapter 11. Define your ADT class in separate files so that it can be compiled separately.
2. Redo (or do for the first time) Programming Project 2 from Chapter 11. Define your ADT class in separate files so that it can be compiled separately.
3. Redo (or do for the first time) Programming Project 9 from Chapter 11. Define your ADT class in separate files so that it can be compiled separately. Put the main function in its own file separate from the ADT files.

Pointers and Linked Lists

13

13.1 NODES AND LINKED LISTS 740

Nodes 740

`nullptr` 745

Linked Lists 746

Inserting a Node at the Head of a List 747

Pitfall: Losing Nodes 750

Searching a Linked List 751

Pointers as Iterators 755

Inserting and Removing Nodes Inside a List 755

*Pitfall: Using the Assignment Operator with
Dynamic Data Structures* 757

Variations on Linked Lists 760

Linked Lists of Classes 762

13.2 STACKS AND QUEUES 765

Stacks 765

Programming Examples: A Stack Class 766

Queues 771

Programming Examples: A Queue Class 772

Chapter Summary 776

Answers to Self-Test Exercises 776

Practice Programs 779

Programming Projects 780

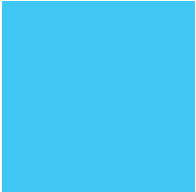

*If somebody there chanced to be
Who loved me in a manner true
My heart would point him out to me
And I would point him out to you.*

GILBERT AND SULLIVAN, *Ruddigore*

INTRODUCTION

A *linked list* is a list constructed using pointers. A linked list is not fixed in size, but can grow and shrink while your program is running. This chapter shows you how to define and manipulate linked lists, which will serve to introduce you to a new way of using pointers.

PREREQUISITES

This chapter uses material from Chapters 2 through 12.

13.1 NODES AND LINKED LISTS

Useful dynamic variables are seldom of a simple type such as *int* or *double*, but are normally of some complex type such as an array, *struct*, or class type. You saw that dynamic variables of an array type can be useful. Dynamic variables of a *struct* or class type can also be useful, but in a different way. Dynamic variables that are either *structs* or classes normally have one or more member variables that are pointer variables which connect them to other dynamic variables. For example, one such structure, which happens to contain a shopping list, is diagrammed in Display 13.1.

Nodes

A structure like the one shown in Display 13.1 consists of items that we have drawn as boxes connected by arrows. The boxes are called **nodes** and the arrows represent pointers. Each of the nodes in Display 13.1 contains a string, an integer, and a pointer that can point to other nodes of the same type. Note that pointers point to the entire node, not to the individual items (such as 10 or "rolls") that are inside the node.

Nodes are implemented in C++ as *structs* or classes. For example, the *struct* type definitions for a node of the type shown in Display 13.1, along with the type definition for a pointer to such nodes, can be as follows:

```
struct ListNode  
{  
    string item;
```

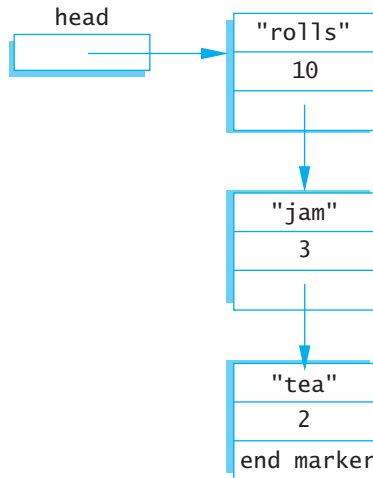
DISPLAY 13.1 Nodes and Pointers

```

    int count;
    ListNode *link;
};
typedef ListNode* ListNodePtr;

```

The order of the type definitions is important. The definition of `ListNode` must come first, since it is used in the definition of `ListNodePtr`.

The box labeled `head` in Display 13.1 is not a node, but is a pointer variable that can point to a node. The pointer variable `head` is declared as follows:

```
ListNodePtr head;
```

Even though we have ordered the type definitions to avoid some illegal forms of circularity, the definition of the `struct` type `ListNode` is still blatantly circular. The definition uses the type name `ListNode` to define the member variable `link`. There is nothing wrong with this particular circularity, and it is allowed in C++. One indication that this definition is not logically inconsistent is the fact that you can draw pictures, like Display 13.1, that represent such structures.

We now have pointers inside of `structs` and have these pointers pointing to `structs` that contain pointers, and so forth. In such situations the syntax can sometimes get involved, but in all cases the syntax follows those few rules we have described for pointers and `structs`. As an illustration, suppose the declarations are as above, the situation is as

diagrammed in Display 13.1, and you want to change the number in the first node from 10 to 12. One way to accomplish this is with the following statement:

```
(*head).count = 12;
```

The expression on the left side of the assignment operator may require a bit of explanation. The variable `head` is a pointer variable. So, the expression `*head` is the thing it points to, namely the node (dynamic variable) containing "rolls" and the integer 10. This node, referred to by `*head`, is a *struct*, and the member variable of this *struct*, which contains a value of type *int*, is called `count`, and so `(*head).count` is the name of the *int* variable in the first node. The parentheses around `*head` are not optional. You want the dereferencing operator `*` to be performed before the dot operator. However, the dot operator has higher precedence than the dereferencing operator `*`, and so without the parentheses, the dot operator would be performed first (and that would produce an error). In the next paragraph, we will describe a shortcut notation that can avoid this worry about parentheses.

C++ has an operator that can be used with a pointer to simplify the notation for specifying the members of a *struct* or a class. The **arrow operator** `->` combines the actions of a dereferencing operator `*` and a dot operator to specify a member of a dynamic *struct* or object that is pointed to by a given pointer. For example, the assignment statement above for changing the number in the first node can be written more simply as

```
head->count = 12;
```

This assignment statement and the previous one mean the same thing, but this one is the form normally used.

The string in the first node can be changed from "rolls" to "bagels" with the following statement:

```
head->item = "bagels";
```

The result of these changes to the first node in the list is diagrammed in Display 13.2. Look at the pointer member in the last node in the lists shown in Display 13.2. This last node has the word `NULL` written where there should be a pointer. In Display 13.1 we filled this position with the phrase "end marker," but "end marker" is not a C++ expression. In C++ programs we use the constant `NULL` as an end marker to signal the end of a linked list. `NULL` is a special defined constant that is part of the C++ language (provided as part of the required C++ libraries).

`NULL` is typically used for two different (but often coinciding) purposes. It is used to give a value to a pointer variable that otherwise would not have any value. This prevents an inadvertent reference to memory, since `NULL` is not

DISPLAY 13.2 Accessing Node Data

```
head->count = 12;
head->item = "bagels";
```

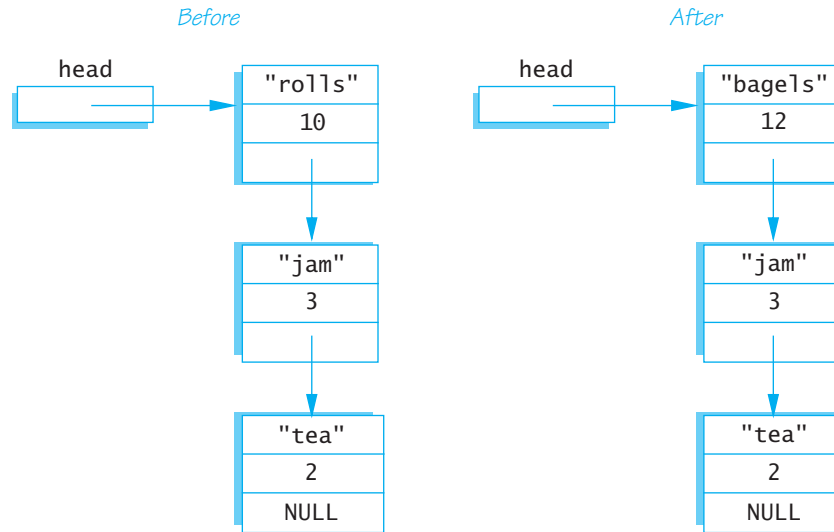

the address of any memory location. The second category of use is that of an end marker. A program can step through the list of nodes as shown in Display 13.2, and when the program reaches the node that contains NULL, it knows that it has come to the end of the list.

The constant NULL is actually the number 0, but we prefer to think of it and spell it as NULL. That makes it clear that you mean this special-purpose value that you can assign to pointer variables. The definition of the identifier NULL is in a number of the standard libraries, such as `<iostream>` and `<cstdlib>`, so you should use an `include` directive with either `<iostream>` or `<cstdlib>` (or other suitable library) when you use NULL. No `using` directive is needed in order to make NULL available to your program code. In particular, it does not require `using namespace std;`, although other things in your code are likely to require something like `using namespace std;`¹

NULL is 0

¹ The details are as follows: The definition of NULL is handled by the C++ preprocessor, which replaces NULL with 0. Thus, the compiler never actually sees "NULL" and so there are no namespace issues, and no `using` directive is needed.

The Arrow Operator ->

The arrow operator `->` specifies a member of a *struct* (or a member of a class object) that is pointed to by a pointer variable. The syntax is as follows:

```
Pointer_Variable->Member_Name
```

The above refers to a member of the *struct* or object pointed to by the *Pointer_Variable*. Which member it refers to is given by the *Member_Name*.

For example, suppose you have the following definition:

```
struct Record
{
    int number;
    char grade;
};
```

The following creates a dynamic variable of type *Record* and sets the member variables of the dynamic *struct* variable to 2001 and 'A':

```
Record *p;
p = new Record;
p->number = 2001;
p->grade = 'A';
```

A pointer can be set to NULL using the assignment operator, as in the following, which declares a pointer variable called *there* and initializes it to NULL:

```
double *there = NULL;
```

The constant NULL can be assigned to a pointer variable of any pointer type.

NULL

NULL is a special constant value that is used to give a value to a pointer variable that would not otherwise have a value. NULL can be assigned to a pointer variable of any type. The identifier NULL is defined in a number of libraries, including the library with header file `<cstdlib>` and the library with header file `<iostream>`. The constant NULL is actually the number 0, but we prefer to think of it and spell it as NULL.

`nullptr`

The fact that the constant `NULL` is actually the number 0 leads to an ambiguity problem. Consider the overloaded function below:

```
void func(int *p);
void func(int i);
```

Which function will be invoked if we call `func(NULL)`? Since `NULL` is the number 0, both are equally valid. C++11 resolves this problem by introducing a new constant, `nullptr`. `nullptr` is not the integer zero, but it is a literal constant used to represent a null pointer. Use `nullptr` anywhere you would have used `NULL` for a pointer. For example, we can write:

```
double *there = nullptr;
```

nullptr

`nullptr` is a special constant value that is used the same way as `NULL`, but it can only be assigned to a **pointer**. It is not the number 0. Use `nullptr` to differentiate between a null pointer and the number 0. `nullptr` was introduced in C++11.

SELF-TEST EXERCISES

- Suppose your program contains the following type definitions:

```
struct Box
{
    string name;
    int number;
    Box *next;
};

typedef Box* BoxPtr;
```

What is the output produced by the following code?

```
BoxPtr head;
head = new Box;
head->name = "Sally";
head->number = 18;
cout << (*head).name << endl;
cout << head->name << endl;
cout << (*head).number << endl;
cout << head->number << endl;
```

2. Suppose that your program contains the type definitions and code given in Self-Test Exercise 1. That code creates a node that contains the string "Sally" and the number 18. What code would you add in order to set the value of the member variable next of this node equal to NULL?
3. Suppose that your program contains the type definitions and code given in Self-Test Exercise 1. Assuming that the value of the pointer variable head has not been changed, how can you destroy the dynamic variable pointed to by head and return the memory it uses to the freestore so that it can be reused to create new dynamic variables?
4. Given the following structure definition:

```
struct ListNode
{
    string item;
    int count;
    ListNode *link;
};
ListNode *head = new ListNode;
```

write code to assign the string "Wilbur's brother Orville" to the member item of the node pointed to by head.

Linked Lists

Lists such as those shown in Display 13.2 are called *linked lists*. A **linked list** is a list of nodes in which each node has a member variable that is a pointer that points to the next node in the list. The first node in a linked list is called the **head**, which is why the pointer variable that points to the first node is named head. Note that the pointer named head is not itself the head of the list but only points to the head of the list. The last node has no special name, but it does have a special property. The last node has NULL as the value of its member pointer variable. To test to see whether a node is the last node, you need only test to see if the pointer variable in the node is equal to NULL.

Our goal in this section is to write some basic functions for manipulating linked lists. For variety, and to simplify the notation, we will use a simpler type of node than that used in Display 13.2. These nodes will contain only an integer and a pointer. The node and pointer type definitions that we will use are as follows:

```
struct Node
{
    int data;
    Node *link;
};

typedef Node* NodePtr;
```

As a warm-up exercise, let's see how we might construct the start of a linked list with nodes of this type. We first declare a pointer variable, called `head`, that will point to the head of our linked list:

```
NodePtr head;
```

To create our first node, we use the operator `new` to create a new dynamic variable that will become the first node in our linked list.

```
head = new Node;
```

We then give values to the member variables of this new node:

```
head->data = 3;
head->link = NULL;
```

Notice that the pointer member of this node is set equal to `NULL`. That is because this node is the last node in the list (as well as the first node in the list). At this stage, our linked list looks like this:

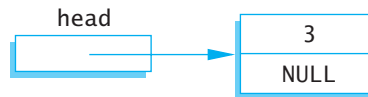

Our one-node list was built in a purely ad hoc way. To have a larger linked list, your program must be able to add nodes in a systematic way. We next describe one simple way to insert nodes in a linked list.

Inserting a Node at the Head of a List

In this subsection we assume that our linked list already contains one or more nodes, and we develop a function to add another node. The first parameter for the insertion function will be a call-by-reference parameter for a pointer variable that points to the head of the linked list, that is, a pointer variable that points to the first node in the linked list. The other parameter will give the number to be stored in the new node. The function declaration for our insertion function is as follows:

```
void head_insert(NodePtr& head, int the_number);
```

Linked Lists as Arguments

You should always keep one pointer variable pointing to the head of a linked list. This pointer variable is a way to name the linked list. When you write a function that takes a linked list as an argument, this pointer (which points to the head of the linked list) can be used as the linked list argument.

To insert a new node into the linked list, our function will use the *new* operator to create a new node. The data is then copied into the new node, and the new node is inserted at the head of the list. When we insert nodes this way, the new node will be the first node in the list (that is, the head node) rather than the last node. Since dynamic variables have no names, we must use a local pointer variable to point to this node. If we call the local pointer variable `temp_ptr`, the new node can be referred to as `*temp_ptr`. The complete process can be summarized as follows:

Pseudocode for `head_insert` Function

1. Create a new dynamic variable pointed to by `temp_ptr`. (This new dynamic variable is the new node. This new node can be referred to as `*temp_ptr`.)
2. Place the data in this new node.
3. Make the link member of this new node point to the head node (first node) of the original linked list.
4. Make the pointer variable named `head` point to the new node.

Display 13.3 contains a diagram of this algorithm. Steps 2 and 3 in the diagram can be expressed by these C++ assignment statements:

```
temp_ptr->link = head;
head = temp_ptr;
```

The complete function definition is given in Display 13.4.

DISPLAY 13.3 Adding a Node to a Linked List (part 1 of 2)

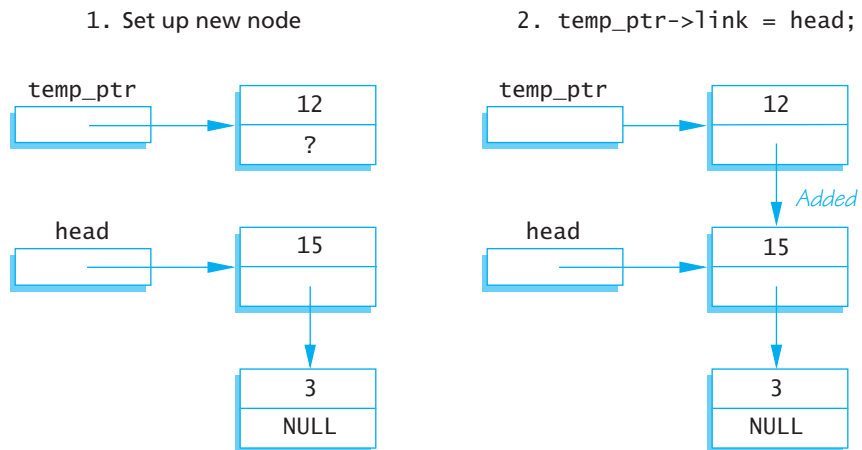

(continued)

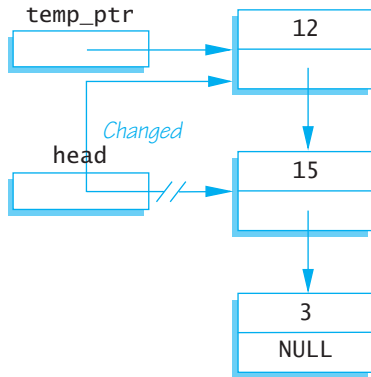
DISPLAY 13.3 Adding a Node to a Linked List (part 2 of 2)3. `head = temp_ptr;`

4. After function call

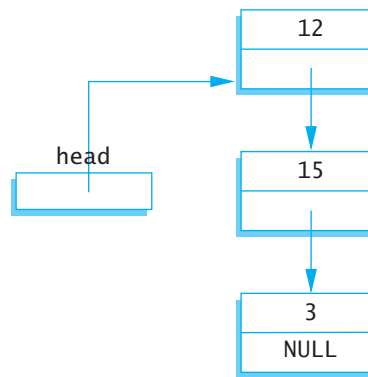
**DISPLAY 13.4 Function to Add a Node at the Head of a Linked List****Function Declaration**

```

1  struct Node
2  {
3      int data;
4      Node *link;
5  };
6
7  typedef Node* NodePtr;
8
9  void head_insert(NodePtr& head, int the_number);
10 //Precondition: The pointer variable head points to
11 //the head of a linked list.
12 //Postcondition: A new node containing the_number
13 //has been added at the head of the linked list.

```

Function Definition

```

1  void head_insert(NodePtr& head, int the_number)
2  {
3      NodePtr temp_ptr;
4      temp_ptr = new Node;
5
6      temp_ptr->data = the_number;
7
8      temp_ptr->link = head;
9      head = temp_ptr;
10 }

```

You will want to allow for the possibility that a list contains nothing. For example, a shopping list might have nothing in it because there is nothing to buy this week. A list with nothing in it is called an **empty list**. A linked list is named by naming a pointer that points to the head of the list, but an empty list has no head node. To specify an empty list, you use the pointer `NULL`. If the pointer variable `head` is supposed to point to the head node of a linked list and you want to indicate that the list is empty, then you set the value of `head` as follows:

```
head = NULL;
```

Whenever you design a function for manipulating a linked list, you should always check to see if it works on the empty list. If it does not, you may be able to add a special case for the empty list. If you cannot design the function to apply to the empty list, then your program must be designed to handle empty lists some other way or to avoid them completely. Fortunately, the empty list can often be treated just like any other list. For example, the function `head_insert` in Display 13.4 was designed with nonempty lists as the model, but a check will show that it works for the empty list as well.

PITFALL **Losing Nodes**

You might be tempted to write the function definition for `head_insert` (Display 13.4) using the pointer variable `head` to construct the new node, instead of using the local pointer variable `temp_ptr`. If you were to try, you might start the function as follows:

```
head = new Node;  
head->data = the_number;
```

At this point the new node is constructed, contains the correct data, and is pointed to by the pointer `head`, all as it is supposed to be. All that is left to do is to attach the rest of the list to this node by setting the pointer member given below so that it points to what was formerly the first node of the list:

```
head->link
```

Display 13.5 shows the situation when the new data value is 12. That illustration reveals the problem. If you were to proceed in this way, there would be nothing pointing to the node containing 15. Since there is no named pointer pointing to it (or to a chain of pointers ending with that node), there is no way the program can reference this node. The node below this node is also lost. A program cannot make a pointer point to either of these nodes, nor can it access the data in these nodes, nor can it do anything else to the nodes. It simply has no way to refer to the nodes.

Such a situation ties up memory for the duration of the program. A program that loses nodes is sometimes said to have a “memory leak.” A significant memory leak can result in the program running out of memory, causing abnormal termination. Worse, a memory leak (lost nodes) in an

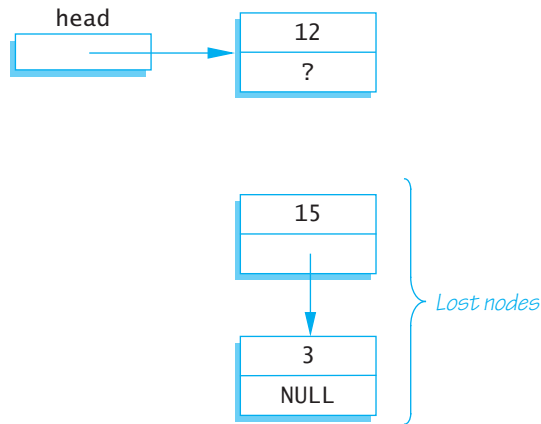
DISPLAY 13.5 Lost Nodes

ordinary user's program can cause the operating system to crash. To avoid such lost nodes, the program must always keep some pointer pointing to the head of the list, usually the pointer in a pointer variable like head. ■

Searching a Linked List

Next we will design a function to search a linked list in order to locate a particular node. We will use the same node type, called *Node*, that we used in the previous subsections. (The definition of the node and pointer types is given in Display 13.4.) The function we design will have two arguments: for the linked list and the integer we want to locate. The function will return a pointer that points to the first node which contains that integer. If no node contains the integer, the function will return the pointer *NULL*. This way, our program can test to see whether the integer is on the list by checking to see if the function returns a pointer value that is not equal to *NULL*. The function declaration and header comment for our function is as follows:

```
NodePtr search(NodePtr head, int target);
//Precondition: The pointer head points to the head of
//a linked list. The pointer variable in the last node
//is NULL. If the list is empty, then head is NULL.
//Returns a pointer that points to the first node that
//contains the target. If no node contains the target,
//the function returns NULL.
```

We will use a local pointer variable, called *here*, to move through the list looking for the target. The only way to move around a linked list, or any other data structure made up of nodes and pointers, is to follow the pointers. So we will start with *here* pointing to the first node and move the pointer from node to node following the pointer out of each node. This technique is

diagrammed in Display 13.6. Since empty lists present some minor problems that would clutter our discussion, we will at first assume that the linked list contains at least one node. Later we will come back and make sure the algorithm works for the empty list as well. This search technique yields the following algorithm:

Pseudocode for search Function

Make the pointer variable here point to the head node (that is, first node) of the linked list.

```

while (here is not pointing to a node containing target
      and here is not pointing to the last node)
{
    Make here point to the next node in the list.
}
if (the node pointed to by here contains target)
    return here;
else
    return NULL;

```

In order to move the pointer here to the next node, we must think in terms of the named pointers we have available. The next node is the one pointed to by the pointer member of the node currently pointed to by here. The pointer member of the node currently pointed to by here is given by the expression

```
here->link
```

To move here to the next node, we want to change here so that it points to the node that is pointed to by the above-named pointer (member) variable. Hence, the following will move the pointer here to the next node in the list:

```
here = here->link;
```

Putting these pieces together yields the following refinement of the algorithm pseudocode:

Preliminary Version of the Code for the search Function

```

here = head;

while (here->data != target && here->link != NULL)
    here = here->link;

if (here->data == target)
    return here;
else
    return NULL;

```

Notice the Boolean expression in the *while* statement. We test to see if here is not pointing to the last node by testing to see if the member variable here->link is not equal to NULL.

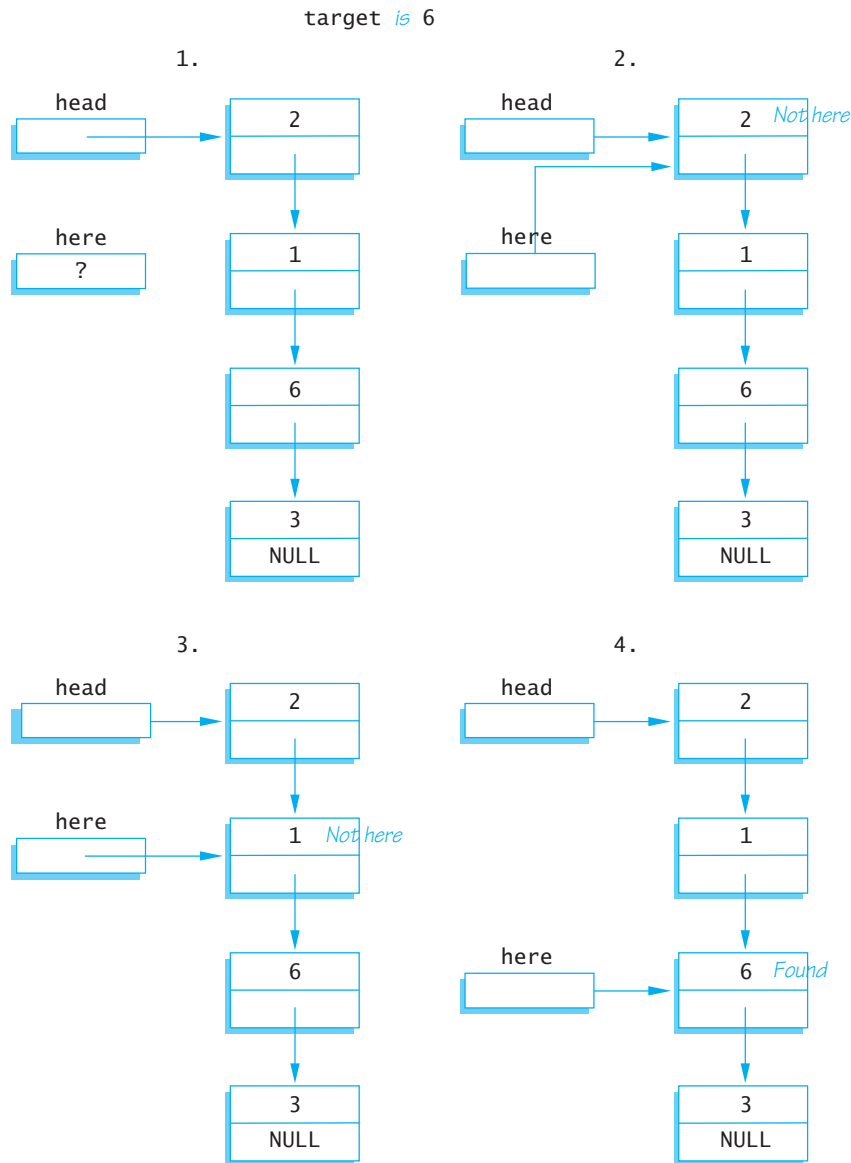
DISPLAY 13.6 Searching a Linked List

We still must go back and take care of the empty list. If we check our code, we find that there is a problem with the empty list. If the list is empty, then `here` is equal to `NULL` and hence the following expressions are undefined:

```
here->data
here->link
```

When here is NULL, it is not pointing to any node, so there is no member named data nor any member named link. Hence, we make a special case of the empty list. The complete function definition is given in Display 13.7.

DISPLAY 13.7 Function to Locate a Node in a Linked List

Function Declaration

```

1  struct Node
2  {
3      int data;
4      Node *link;
5  };
6
7  typedef Node* NodePtr;
8
9  NodePtr search(NodePtr head, int target);
10 //Precondition: The pointer head points to the head of
11 //a linked list. The pointer variable in the last node
12 //is NULL. If the list is empty, then head is NULL.
13 //Returns a pointer that points to the first node that
14 //contains the target. If no node contains the target,
15 //the function returns NULL.
```

Function Definition

```

1  //Uses cstddef:
2  NodePtr search(NodePtr head, int target)
3  {
4      NodePtr here = head;
5
6      if (here == NULL)
7      {
8          return NULL;
9      }
10     else
11     {
12         while (here->data != target &&
13             here->link != NULL)
14             here = here->link;
15
16         if (here->data == target)
17             return here;
18         else
19             return NULL;
20     }
21 }
```

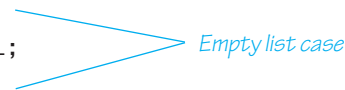

Pointers as Iterators

An **iterator** is a construct that allows you to cycle through the data items stored in a data structure so that you can perform whatever action you want on each data item. An iterator can be an object of some iterator class or something simpler, such as an array index or a pointer. Pointers provide a simple example of an iterator. In fact, a pointer is the prototypical example of an iterator. The basic ideas can be easily seen in the context of linked lists. You can use a pointer as an iterator by moving through the linked list one node at a time starting at the head of the list and cycling through all the nodes in the list. The general outline is as follows:

```
Node_Type *iter;
for (iter = head; iter != NULL; iter = iter->link)
    Do whatever you want with the node pointed to by iter;
```

where *head* is a pointer to the head node of the linked list and *link* is the name of the member variable of a node that points to the next node in the list.

For example, to output the data in all the nodes in a linked list of the kind we have been discussing, you could use

```
NodePtr iter; //Equivalent to: Node *iter;
for (iter = head; iter != NULL; iter = iter->link)
    cout << (iter->data);
```

The definition of `Node` and `NodePtr` are given in Display 13.7.

Inserting and Removing Nodes Inside a List

We next design a function to insert a node at a specified place in a linked list. If you want the nodes in some particular order, such as numeric order or alphabetical order, you cannot simply insert the node at the beginning or end of the list. We will therefore design a function to insert a node after a specified node in the linked list. We assume that some other function or program part has correctly placed a pointer called *after_me* pointing to some node in the linked list. We want the new node to be placed after the node pointed to by *after_me*, as illustrated in Display 13.8. The same technique works for nodes with any kind of data, but to be concrete, we are using the same type of nodes as in previous subsections. The type definitions are given in Display 13.7. The function declaration for the function we want to define is:

```
void insert(NodePtr after_me, int the_number);
//Precondition: after_me points to a node in a linked list.
//Postcondition: A new node containing the_number
//has been added after the node pointed to by after_me.
```

A new node is set up the same way it was in the function `head_insert` in Display 13.4. The difference between this function and that one is that we now wish to insert the node not at the head of the list, but after the node

Inserting in the
middle of a list

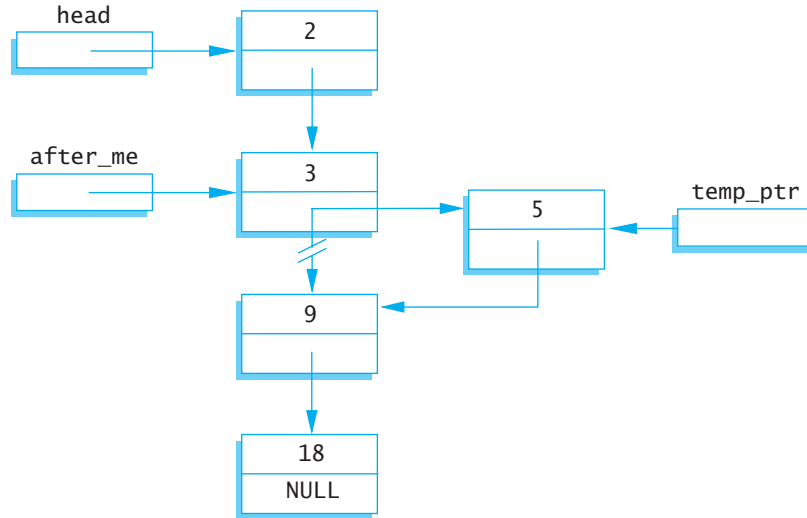
DISPLAY 13.8 Inserting in the Middle of a Linked List

pointed to by `after_me`. The way to do the insertion is shown in Display 13.8 and is expressed as follows in C++ code:

```
//add a link from the new node to the list:
temp_ptr->link = after_me->link;
//add a link from the list to the new node:
after_me->link = temp_ptr;
```

The order of these two assignment statements is critical. In the first assignment we want the pointer value `after_me->link` *before it is changed*. The complete function is given in Display 13.9.

Insertion at the ends

If you go through the code for the function `insert`, you will see that it works correctly even if the node pointed to by `after_me` is the last node in the list. However, `insert` will not work for inserting a node at the beginning of a linked list. The function `head_insert` given in Display 13.4 can be used to insert a node at the beginning of a list.

Comparison to arrays

By using the function `insert` you can maintain a linked list in numerical order or alphabetical order or other ordering. You can “squeeze” a new node into the correct position by simply adjusting two pointers. This is true no matter how long the linked list is or where in the list you want the new data to go. If you instead used an array, much, and in extreme cases all, of the array would have to be copied in order to make room for a new value in the correct spot. Despite the overhead involved in positioning the pointer `after_me`, inserting into a linked list is frequently more efficient than inserting into an array.

Removing a node

Removing a node from a linked list is also quite easy. Display 13.10 illustrates the method. Once the pointers `before` and `discard` have

DISPLAY 13.9 Function to Add a Node in the Middle of a Linked List

Function Declaration

```

1  struct Node
2  {
3      int data;
4      Node *link;
5  };
6
7  typedef Node* NodePtr;
8
9  void insert(NodePtr after_me, int the_number);
10 //Precondition: after_me points to a node in a linked
11 //list.
12 //Postcondition: A new node containing the_number
13 //has been added after the node pointed to by after_me.
```

Function Definition

```

1  void insert(NodePtr after_me, int the_number)
2  {
3      NodePtr temp_ptr;
4      temp_ptr = new Node;
5
6      temp_ptr->data = the_number;
7
8      temp_ptr->link = after_me->link;
9      after_me->link = temp_ptr;
10 }
```

been positioned, all that is required to remove the node is the following statement:

```
before->link = discard->link;
```

This is sufficient to remove the node from the linked list. However, if you are not using this node for something else, you should destroy it and return the memory it uses to the freestore; you can do this with a call to *delete* as follows:

```
delete discard;
```

PITFALL Using the Assignment Operator with Dynamic Data Structures

If *head1* and *head2* are pointer variables and *head1* points to the head node of a linked list, the following will make *head2* point to the same head node and hence the same linked list:

```
head2 = head1;
```

DISPLAY 13.10 Removing a Node

1. Position the pointer `discard` so that it points to the node to be deleted, and position the pointer `before` so that it points to the node before the one to be deleted.
2. `before->link = discard->link;`

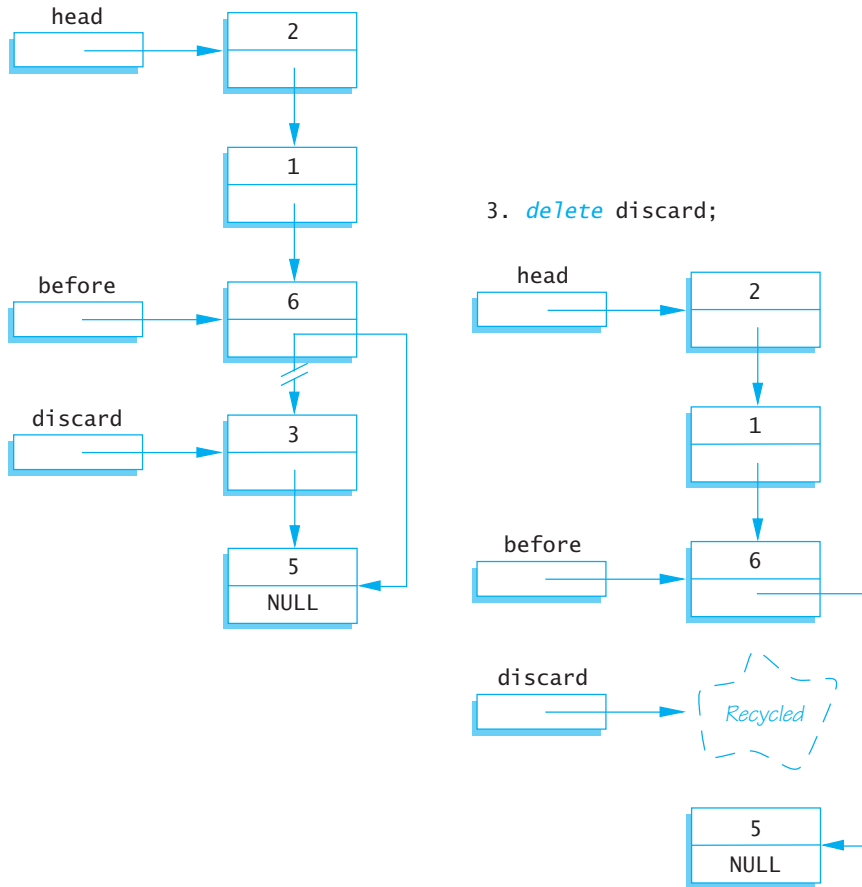

However, you must remember that there is only one linked list, not two. If you change the linked list pointed to by `head1`, then you will also change the linked list pointed to by `head2`, because they are the same linked list.

If `head1` points to a linked list and you want `head2` to point to a second, identical *copy* of this linked list, the assignment statement above will not work. Instead, you must copy the entire linked list node by node. Alternatively, you can overload the assignment operator `=` so that it means whatever you want it to mean. Overloading `=` is discussed in the subsection of Chapter 11 entitled "Overloading the Assignment Operator." ■

SELF-TEST EXERCISES

5. Write type definitions for the nodes and pointers in a linked list. Call the node type `NodeType` and call the pointer type `PointerType`. The linked lists will be lists of letters.
6. A linked list is normally given by giving a pointer that points to the first node in the list, but an empty list has no first node. What pointer value is normally used to represent an empty list?
7. Suppose your program contains the following type definitions and pointer variable declarations:

```
struct Node
{
    double data;
    Node *next;
};

typedef Node* Pointer;
Pointer p1, p2;
```

Suppose `p1` points to a node of this type that is on a linked list. Write code that will make `p1` point to the next node on this linked list. (The pointer `p2` is for the next exercise and has nothing to do with this exercise.)

8. Suppose your program contains type definitions and pointer variable declarations as in Self-Test Exercise 7. Suppose further that `p2` points to a node of type `Node` that is on a linked list and is not the last node on the list. Write code that will delete the node *after* the node pointed to by `p2`. After this code is executed, the linked list should be the same, except that there will be one less node on the linked list. (*Hint*: You might want to declare another pointer variable to use.)
9. Choose an answer and explain it.

For a large array and large list holding the same type objects, inserting a new object at a known location into the middle of a linked list compared with insertion in an array is

- a. More efficient
- b. Less efficient
- c. About the same
- d. Dependent on the size of the two lists

Variations on Linked Lists

In this subsection we give you a hint of the many data structures that can be created using nodes and pointers. We briefly describe two additional data structures, the doubly linked list and the binary tree.

An ordinary linked list allows you to move down the list in only one direction (following the links). A node in a **doubly linked list** has two links, one link that points to the next node and one that points to the previous node. Diagrammatically, a doubly linked list looks like the sample list in Display 13.11. The node class for a doubly linked list could be as follows:

```
struct Node
{
    int data;
    Node *forward_link;
    Node *back_link;
};
```

Rather than a single pointer to the head node, a doubly linked list normally has a pointer to each of the two end nodes. You can call these pointers *front* and *back*, although the choice of which is *front* and which is *back* is arbitrary. The definitions of constructors and some of the functions in the doubly linked list class will have to change (from the singly linked case) to accommodate the extra link.

A **tree** is a data structure that is structured as shown in Display 13.12. In particular, in a tree you can reach any node from the top (root) node by some path that follows the links. Note that there are no cycles in a tree. If you follow the links, you eventually get to an "end." Note that each node has two links that point

DISPLAY 13.11 A Doubly Linked List

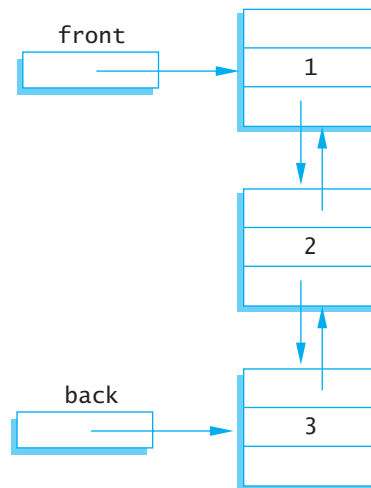

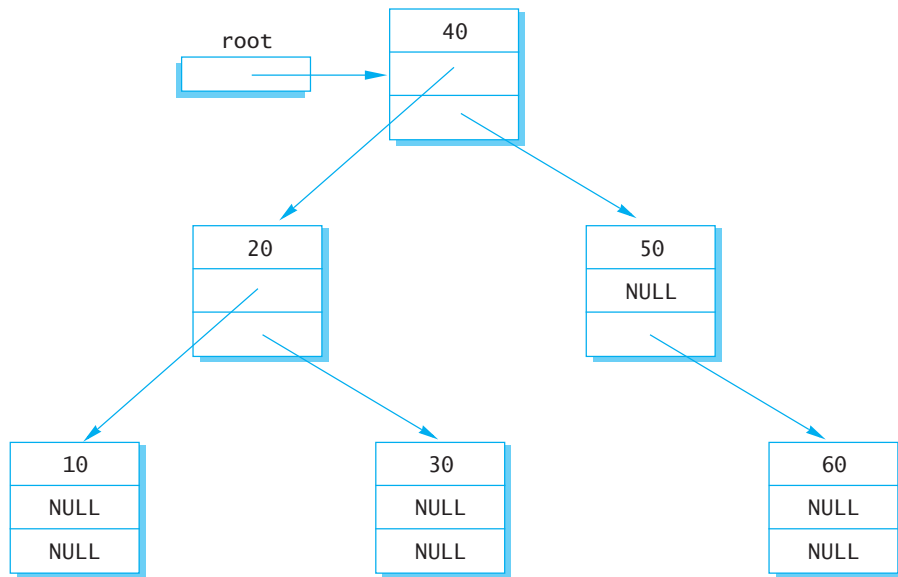
DISPLAY 13.12 A Binary Tree

to other nodes (or the value NULL). This sort of tree is called a **binary tree**, because each node has exactly two links. There are other kinds of trees with different numbers of links in the nodes, but the binary tree is the most common case.

A tree is not a form of linked list, but does use links (pointers) in ways that are similar to how they are used in linked lists. The definition of the node type for a binary tree is essentially the same as what it is for a doubly linked list, but the two links are usually named using some form of the words *left* and *right*. The following is a node type that can be used for constructing a binary tree:

```

struct TreeNode
{
    int data;
    TreeNode *left_link;
    TreeNode *right_link;
};
  
```

In Display 13.12, the pointer named *root* points to the **root node** (“top node”). The root node serves a purpose similar to that of the head node in an ordinary linked list (Display 13.10). Any node in the tree can be reached from the root node by following the links.

The term *tree* may seem like a misnomer. The root is at the top of the tree and the branching structure looks more like a root branching structure than a tree branching structure. The secret to the terminology is to turn the picture (Display 13.12) upside down. The picture then does resemble the branching structure of a tree and the root node is where the tree’s root would begin. The

nodes at the ends of the branches with both link instance variables set to NULL are known as **leaf nodes**, a terminology that may now make some sense.

Although we do not have room to pursue the topic in this book, binary trees can be used to efficiently store and retrieve data.

Linked Lists of Classes

In the preceding examples we created linked lists by using a struct to hold the contents of a node within the list. It is possible to create the same data structures using a class instead of a struct. The logic is identical except the syntax of using and defining a class should be substituted in place of that for a struct.

Displays 13.13 and 13.14 illustrate how to define a Node class. The data variables are declared *private* using the principle of information hiding, and *public* methods have been created to access the data value and next node in the link. Display 13.15 creates a short list of five nodes by inserting new nodes



VideoNote
Walkthrough of Linked
Lists of Classes

DISPLAY 13.13 Interface File for a Node Class

```

1  //This is the header file for Node.h. This is the interface for
2  //a node class that behaves similarly to the struct defined
3  //in Display 13.4
4  namespace linkedlistofclasses
5  {
6      class Node
7      {
8      public:
9          Node( );
10         Node(int value, Node *next);
11         //Constructors to initialize a node
12
13         int getData( ) const;
14         //Retrieve value for this node
15
16         Node *getLink( ) const;
17         //Retrieve next Node in the list
18
19         void setData(int value);
20         //Use to modify the value stored in the list
21
22         void setLink(Node *next);
23         //Use to change the reference to the next node
24
25     private:
26         int data;
27         Node *link;
28     };
29     typedef Node* NodePtr;
30 } //linkedlistofclasses
31 //Node.h

```

DISPLAY 13.14 Implementation File for a Node Class

```

1  //This is the implementation file Node.cpp.
2  //It implements logic for the Node class. The interface
3  //file is in the header file Node.h
4  #include <iostream>
5  #include "Node.h"
6
7  namespace linkedlistofclasses
8  {
9      Node::Node( ) : data(0), link(NULL)
10     {
11         //deliberately empty
12     }
13
14     Node::Node(int value, Node *next) : data(value), link(next)
15     {
16         //deliberately empty
17     }
18
19     //Accessor and Mutator methods follow
20
21     int Node::getData( ) const
22     {
23         return data;
24     }
25
26     Node* Node::getLink( ) const
27     {
28         return link;
29     }
30
31     void Node::setData(int value)
32     {
33         data = value;
34     }
35
36     void Node::setLink(Node *next)
37     {
38         link = next;
39     }
40 } //linkedlistofclasses
41 //Node.cpp

```

DISPLAY 13.15 Program Using the Node Class (part 1 of 3)

```

1  //This program demonstrates the creation of a linked list
2  //using the Node class. Five nodes are created, output, then
3  //destroyed.

```

(continued)

DISPLAY 13.15 Program Using the Node Class (part 2 of 3)

```
4  #include <iostream>
5  #include "Node.h"
6
7  using namespace std;
8  using namespace linkedlistofclasses;
9
10 //This function inserts a new node onto the head of the list
11 //and is a class-based version of the same function defined
12 //in Display 13.4.
13 void head_insert(NodePtr& head, int the_number)
14 {
15     NodePtr temp_ptr;
16     //The constructor sets temp_ptr->link to head and
17     //sets the data value to the_number
18     temp_ptr = new Node(the_number, head);
19     head = temp_ptr;
20 }
21
22 int main()
23 {
24     NodePtr head, tmp;
25
26     //Create a list of nodes 4 -> 3 -> 2 -> 1 -> 0
27     head = new Node(0, NULL);
28     for (int i = 1; i < 5; i++)
29     {
30         head_insert(head, i);
31     }
32     //Iterate through the list and display each value
33     tmp = head;
34     while (tmp != NULL)
35     {
36         cout << tmp->getData() << endl;
37         tmp = tmp->getLink();
38     }
39     //Delete all nodes in the list before exiting
40     //the program.
41     tmp = head;
42     while (tmp != NULL)
43     {
44         NodePtr nodeToDelete = tmp;
45         tmp = tmp->getLink();
46         delete nodeToDelete;
47     }
48     return 0;
49 }
```

(continued)

DISPLAY 13.15 Program Using the Node Class (part 3 of 3)**Sample Dialogue**

```
4
3
2
1
0
```

onto the front of the list. The `head_insert` function is logically identical to the same function defined in Display 13.4 except the constructor defined for the `Node` class is used to set the data.

13.2 STACKS AND QUEUES

But many who are first now will be last, and many who are last now will be first.

MATTHEW 19:30

Linked lists have many applications. In this section we give two samples of what they can be used for. We use linked lists to give implementations of two data structures known as a *stack* and a *queue*. In this section we always use regular linked lists and not doubly linked lists.

Stacks

A *stack* is a data structure that retrieves data in the reverse of the order in which the data is stored. Suppose you place the letters 'A', 'B', and then 'C' in a stack. When you take these letters out of the stack, they will be removed in the order 'C', 'B', and then 'A'. This use of a stack is diagrammed in Display 13.16. As shown

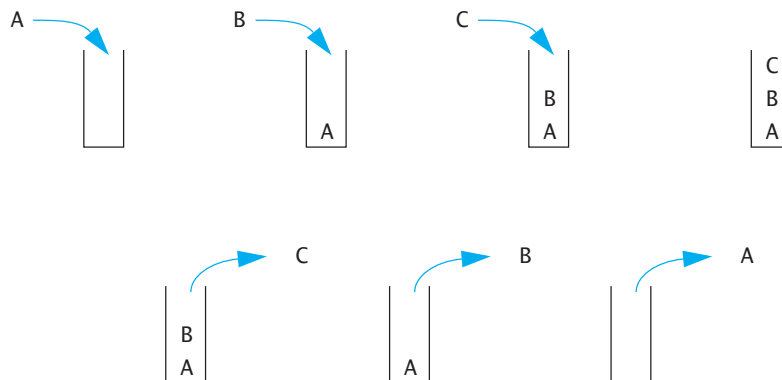
DISPLAY 13.16 A Stack

there, you can think of a stack as a hole in the ground. In order to get something out of the stack, you must first remove the items on top of the one you want. For this reason a stack is often called a *last-in/first-out* (LIFO) data structure.

Stacks are used for many language processing tasks. In Chapter 14 we will discuss how the computer system uses a stack to keep track of C++ function calls. However, here we will do only one very simple application. Our goal in this example is to show you how you can use the linked list techniques to implement specific data structures; a stack is one simple example of the use of linked lists. You need not read Chapter 14 to understand this example.

PROGRAMMING EXAMPLE

A Stack Class

The interface for our Stack class is given in Display 13.17. This particular stack is used to store data of type *char*. You can define a similar stack to store data of any other type. There are two basic operations you can perform on a stack: adding an item to the stack and removing an item from the stack. Adding an item is called *pushing* the item onto the stack, and so we called the member function that

DISPLAY 13.17 Interface File for a Stack Class (part 1 of 2)

```

1 //This is the header file stack.h. This is the interface for the class Stack,
2 //which is a class for a stack of symbols.
3 #ifndef STACK_H
4 #define STACK_H
5 namespace stacksavitch
6 {
7     struct StackFrame
8     {
9         char data;
10        StackFrame *link;
11    };
12    typedef StackFrame* StackFramePtr;
13    class Stack
14    {
15    public:
16        Stack( );
17        //Initializes the object to an empty stack.
18        Stack(const Stack& a_stack);
19        //Copy constructor.
20        ~Stack( );
21        //Destroys the stack and returns all the memory to the freestore.

```

(continued)

DISPLAY 13.17 Interface File for a Stack Class (part 2 of 2)

```

22     void push(char the_symbol);
23     //Postcondition: the_symbol has been added to the stack.
24     char pop( );
25     //Precondition: The stack is not empty.
26     //Returns the top symbol on the stack and removes that
27     //top symbol from the stack.
28     bool empty( ) const;
29     //Returns true if the stack is empty. Returns false otherwise.
30     private:
31         StackFramePtr top;
32     };
33 }//stacksavitch
34 #endif //STACK_H

```

does this push. Removing an item from a stack is called *poping* the item off the stack, and so we called the member function that does this pop.

The names push and pop derive from another way of visualizing a stack. A stack is analogous to a mechanism that is sometimes used to hold plates in a cafeteria. The mechanism stores plates in a hole in the countertop. There is a spring underneath the plates with its tension adjusted so that only the top plate protrudes above the countertop. If this sort of mechanism were used as a stack data structure, the data would be written on plates (which might violate some health laws, but still makes a good analogy). To add a plate to the stack, you put it on top of the other plates, and the weight of this new plate *pushes* down the spring. When you remove a plate, the plate below it *pops* into view.

Display 13.18 shows a simple program that illustrates how the Stack class is used. This program reads a word one letter at a time and places the letters in a stack. The program then removes the letters one by one and writes them to

Application
program

DISPLAY 13.18 Program Using the Stack Class (part 1 of 2)

```

1 //Program to demonstrate use of the Stack class.
2 #include <iostream>
3 #include "stack.h"
4 using namespace std;
5 using namespace stacksavitch;
6
7 int main( )
8 {

```

(continued)

DISPLAY 13.18 Program Using the Stack Class (part 2 of 2)

```

9     stack s;
10    char next, ans;
11
12    do
13    {
14        cout << "Enter a word: ";
15        cin.get(next);
16        while (next != '\n')
17        {
18            s.push(next);
19            cin.get(next);
20        }
21
22        cout << "Written backward that is: ";
23        while ( ! s.empty( ) )
24            cout << s.pop( );
25        cout << endl;
26
27        cout << "Again?(y/n): ";
28        cin >> ans;
29        cin.ignore(10000, '\n');
30    } while (ans != 'n' && ans != 'N');
31
32    return 0;
33 }

```

<The ignore member of cin is discussed in Chapter 8. It discards input remaining on the current input line up to 10,000 characters or until a return is entered. It also discards the return ('\n') at the end of the line.>

Sample Dialogue

```

Enter a word: straw
Written backward that is: warts
Again?(y/n): y
Enter a word: C++
Written backward that is: ++C
Again?(y/n): n

```

the screen. Because data is removed from a stack in the reverse of the order in which it enters the stack, the output shows the word written backward.

Implementation

As shown in Display 13.19, our Stack class is implemented as a linked list in which the head of the list serves as the top of the stack. The member variable top is a pointer that points to the head of the linked list.

DISPLAY 13.19 Implementation of the Stack Class (part 1 of 2)

```

1  //This is the implementation file stack.cpp.
2  //This is the implementation of the class Stack.
3  //The interface for the class Stack is in the header file stack.h.
4  #include <iostream>
5  #include <cstddef>
6  #include "stack.h"
7  using namespace std;
8
9  namespace stacksavitch
10 {
11     //Uses cstddef:
12     Stack::Stack( ) : top(NULL)
13     {
14         //Body intentionally empty.
15     }
16
17     Stack::Stack(const Stack& a_stack)
18
19         <The definition of the copy constructor is Self-Test Exercise 11.>
20
21     Stack::~Stack( )
22     {
23         char next;
24         while (! empty( ))
25             next = pop( ); //pop calls delete.
26     }
27
28     //Uses cstddef:
29     bool Stack::empty( ) const
30     {
31         return (top == NULL);
32     }
33
34     void Stack::push(char the_symbol)
35
36         <The rest of the definition is Self-Test Exercise 10.>
37
38     //Uses iostream:
39     char Stack::pop( )
40     {
41         if (empty( ))
42         {
43             cout << "Error: popping an empty stack.\n";
44             exit(1);
45         }
46     }

```

(continued)

DISPLAY 13.19 Implementation of the Stack Class (*part 2 of 2*)

```

41         char result = top->data;
42
43         StackFramePtr temp_ptr;
44         temp_ptr = top;
45         top = top->link;
46
47         delete temp_ptr;
48
49         return result;
50     }
51 } //stacksavitch

```

Writing the definition of the member function `push` is Self-Test Exercise 10. However, we have already given the algorithm for this task. The code for the `push` member function is essentially the same as the function `head_insert` shown in Display 13.4, except that in the member function `push` we use a pointer named `top` in place of a pointer named `head`.

An empty stack is just an empty linked list, so an empty stack is implemented by setting the pointer `top` equal to `NULL`. Once you realize that `NULL` represents the empty stack, the implementations of the default constructor and of the member function `empty` are obvious.

The definition of the copy constructor is a bit complicated but does not use any techniques we have not already discussed. The details are left to Self-Test Exercise 11.

The `pop` member function first checks to see if the stack is empty. If the stack is not empty, it proceeds to remove the top character in the stack. It sets the local variable `result` equal to the top symbol on the stack. That is done as follows:

```
char result = top->data;
```

After the symbol in the top node is saved in the variable `result`, the pointer `top` is moved to the next node on the linked list, effectively removing the top node from the list. The pointer `top` is moved with the following statement:

```
top = top->link;
```

However, before the pointer `top` is moved, a temporary pointer, called `temp_ptr`, is positioned so that it points to the node that is about to be removed from the list. The node can then be removed with the following call to `delete`:

```
delete temp_ptr;
```

Each node that is removed from the linked list by the member function `pop` is destroyed with a call to `delete`. Thus, all that the destructor needs to do is remove each item from the stack with a call to `pop`. Each node will then have its memory returned to the freestore.

SELF-TEST EXERCISES

10. Give the definition of the member function `push` of the class `Stack` described in Display 13.17.
11. Give the definition of the copy constructor for the class `Stack` described in Display 13.17.

Queues

A stack is a last-in/first-out data structure. Another common data structure is a **queue**, which handles data in a first-in/first-out (FIFO) fashion. A queue behaves exactly the same as a line of people waiting for a bank teller or other service. The people are served in the order they enter the line (the queue). The operation of a queue is diagrammed in Display 13.20.

A queue can be implemented with a linked list in a manner that is similar to our implementation of the `Stack` class. However, a queue needs a pointer at both the head of the list and at the other the end of the linked list, since action takes place in both locations. It is easier to remove a node from the head of a linked list than from the other end of the linked list. So, our implementation will remove a node from the head of the list (which we will now call the **front** of the list) and we will add nodes to the other end of the list, which we will now call the **back** of the list (or the back of the queue).

Queue

A **queue** is a first-in/first-out data structure; that is, the data items are removed from the queue in the same order that they were added to the queue.

DISPLAY 13.20 A Queue

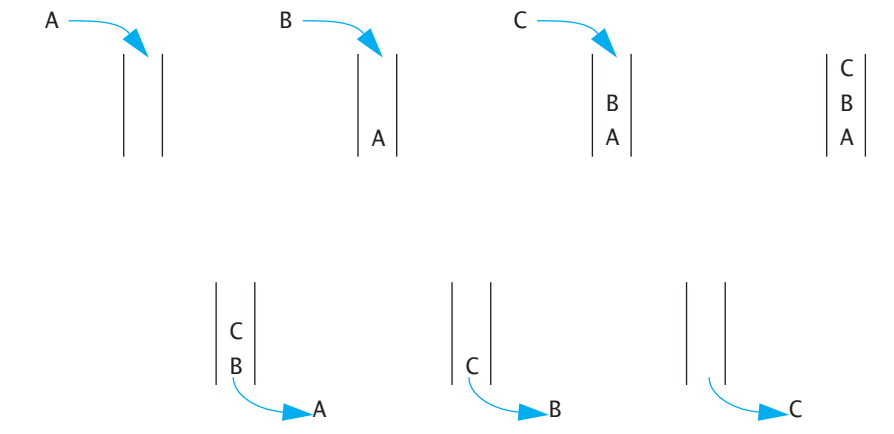

PROGRAMMING EXAMPLE**A Queue Class**

The interface for our queue class is given in Display 13.21. This particular queue is used to store data of type *char*. You can define a similar queue to store data of any other type. There are two basic operations you can perform on a queue: adding an item to the end of the queue and removing an item from the front of the queue.

DISPLAY 13.21 Interface File for a Queue Class

```

1  //This is the header file queue.h. This is the interface for the class Queue,
2  //which is a class for a queue of symbols.
3  #ifndef QUEUE_H
4  #define QUEUE_H
5  namespace queuesavitch
6  {
7      struct QueueNode
8      {
9          char data;
10         QueueNode *link;
11     };
12     typedef QueueNode* QueueNodePtr;
13
14     class Queue
15     {
16     public:
17         Queue();
18         //Initializes the object to an empty queue.
19         Queue(const Queue& aQueue);
20         ~Queue();
21         void add(char item);
22         //Postcondition: item has been added to the back of the queue.
23         char remove();
24         //Precondition: The queue is not empty.
25         //Returns the item at the front of the queue and
26         //removes that item from the queue.
27         bool empty() const;
28         //Returns true if the queue is empty. Returns false otherwise.
29     private:
30         QueueNodePtr front; //Points to the head of a linked list.
31                             //Items are removed at the head
32         QueueNodePtr back; //Points to the node at the other end of the
33                             //linked list. Items are added at this end.
34     };
35 }//queuesavitch
36 #endif //QUEUE_H

```

Display 13.22 shows a simple program that illustrates how the queue class is used. This program reads a word one letter at a time and places the letters in a queue. The program then removes the letters one by one and writes them to the screen. Because data is removed from a queue in the order in which it enters the queue, the output shows the letters in the word in the same order that the user entered them. It is good to contrast this application of a queue with a similar application using a stack that we gave in Display 13.18.

Application
program

DISPLAY 13.22 Program Using the Queue Class (part 1 of 2)

```

1 //Program to demonstrate use of the Queue class.
2 #include <iostream>
3 #include "queue.h"
4 using namespace std;
5 using namespace queuesavitch;
6
7 int main()
8 {
9     Queue q;
10    char next, ans;
11
12    do
13    {
14        cout << "Enter a word: ";
15        cin.get(next);
16        while (next != '\n')
17        {
18            q.add(next);
19            cin.get(next);
20        }
21
22        cout << "You entered:: ";
23        while ( ! q.empty() )
24            cout << q.remove();
25        cout << endl;
26
27        cout << "Again?(y/n): ";
28        cin >> ans;
29        cin.ignore(10000, '\n');
30    } while (ans != 'n' && ans != 'N');
31
32    return 0;
33 }
```

<The ignore member of cin is discussed in Chapter 8. It discards input remaining on the current input line up to 10,000 characters or until a return is entered. It also discards the return ('\n') at the end of the line.>

(continued)

DISPLAY 13.22 Program Using the Queue Class (part 2 of 2)*Sample Dialogue*

```

Enter a word: straw
You entered: straw
Again?(y/n): y
Enter a word: C++
You entered: C++
Again?(y/n): n

```

Implementation

As shown in Displays 13.21 and 13.23, our queue class is implemented as a linked list in which the head of the list serves as the front of the queue. The member variable `front` is a pointer that points to the head of the linked list. Nodes are removed at the head of the linked list. The member variable `back` is a pointer that points to the node at the other end of the linked list. Nodes are added at this end of the linked list.

An empty queue is just an empty linked list, so an empty queue is implemented by setting the pointers `front` and `back` equal to `NULL`. The rest of the details of the implementation are similar to things we have seen before.

DISPLAY 13.23 Implementation of the Queue Class (part 1 of 3)

```

1  //This is the implementation file queue.cpp.
2  //This is the implementation of the class Queue.
3  //The interface for the class Queue is in the header file queue.h.
4  #include <iostream>
5  #include <cstdlib>
6  #include <cstddef>
7  #include "queue.h"
8  using namespace std;
9
10 namespace queuesavitch
11 {
12     //Uses cstddef:
13     Queue::Queue() : front(NULL), back(NULL)
14     {
15         //Intentionally empty.
16     }
17
18     Queue::Queue(const Queue& aQueue)
19         <The definition of the copy constructor is Self-Test Exercise 12.>

```

(continued)

DISPLAY 13.23 Implementation of the Queue Class (part 2 of 3)

```

20
21     Queue::~Queue()
22         <The definition of the destructor is Self-Test Exercise 13.>
23
24     //Uses cstdint:
25     bool Queue::empty() const
26     {
27         return (back == NULL); //front == NULL would also work
28     }
29
30     //Uses cstdint:
31     void Queue::add(char item)
32     {
33         if (empty())
34         {
35             front = new QueueNode;
36             front->data = item;
37             front->link = NULL;
38             back = front;
39         }
40
41         else
42         {
43             QueueNodePtr temp_ptr;
44             temp_ptr = new QueueNode;
45             temp_ptr->data = item;
46             temp_ptr->link = NULL;
47             back->link = temp_ptr;
48             back = temp_ptr;
49         }
50     }
51
52     //Uses cstdlib and iostream:
53     char Queue::remove()
54     {
55         if (empty())
56         {
57             cout << "Error: Removing an item from an empty queue.\n";
58             exit(1);
59         }
60
61         char result = front->data;
62
63         QueueNodePtr discard;
64         discard = front;
65         front = front->link;

```

(continued)

DISPLAY 13.23 Implementation of the Queue Class (part 3 of 3)

```

66         if (front == NULL) //if you removed the last node
67             back = NULL;
68
69         delete discard;
70
71         return result;
72     }
73 }//queuesavitch

```

SELF-TEST EXERCISES

12. Give the definition of the copy constructor for the class Queue described in Display 13.21.
13. Give the definition of the destructor for the class Queue described in Display 13.21.

CHAPTER SUMMARY

- A node is a *struct* or class object that has one or more member variables that are pointer variables. These nodes can be connected by their member pointer variables to produce data structures that can grow and shrink in size while your program is running.
- A linked list is a list of nodes in which each node contains a pointer to the next node in the list.
- The end of a linked list (or other linked data structure) is indicated by setting the pointer member variable equal to NULL or `nullptr`.
- A stack is a first-in/last-out data structure. A stack can be implemented using a linked list.
- A queue is a first-in/first-out data structure. A queue can be implemented using a linked list.

Answers to Self-Test Exercises

1. Sally
Sally
18
18

Note that `(*head).name` and `head->name` mean the same thing. Similarly, `(*head).number` and `head->number` mean the same thing

2. The best answer is

```
head->next = NULL;
```

However, the following is also correct:

```
(*head).next = NULL;
```

3. `delete` head;

4. `head->item = "Wilbur's brother Orville";`

5. `struct` NodeType

```
{
    char data;
    NodeType *link;
};

typedef NodeType* PointerType;
```

6. The pointer value NULL is used to indicate an empty list.

7. `p1 = p1-> next;`

8. Pointer discard;

```
discard = p2->next;
//discard now points to the node to be deleted.
p2->next = discard->next;
```

This is sufficient to delete the node from the linked list. However, if you are not using this node for something else, you should destroy the node with a call to `delete` as follows:

```
delete discard;
```

9. a. Inserting a new item at a known location into a large linked list is more efficient than inserting into a large array. If you are inserting into a list, you have about five operations, most of which are pointer assignments, regardless of the list size. If you insert into an array, on the average you have to move about half the array entries to insert a data item.

For small lists, the answer is (c), about the same.

10. `//Uses cstddef:`

```
void Stack::push(char the_symbol)
{
    StackFramePtr temp_ptr;
    temp_ptr = new StackFrame;
```



```

    temp_ptr->data = the_symbol;
    temp_ptr->link = top;
    top = temp_ptr;
}

```

11. *//Uses cstdint:*

```

Stack::Stack(const Stack& a_stack)
{
    if (a_stack.top == NULL)
        top = NULL;
    else
    {
        StackFramePtr temp = a_stack.top; //temp moves
        //through the nodes from top to bottom of
        //a_stack.
        StackFramePtr end; //Points to end of the new stack.

        end = new StackFrame;
        end->data = temp->data;
        top = end;
        //First node created and filled with data.
        //New nodes are now added AFTER this first node.

        temp = temp->link;
        while (temp != NULL)
        {
            end->link = new StackFrame;
            end = end->link;
            end->data = temp->data;
            temp = temp->link;
        }
        end->link = NULL;
    }
}

```

12. *//Uses cstdint:*

```

Queue::Queue(const Queue&aQueue)
{
    if (aQueue.empty( ))
        front = back = NULL;
    else
    {
        QueueNodePtr temp_ptr_old = aQueue.front;
        //temp_ptr_old moves through the nodes
        //from front to back of aQueue.
        QueueNodePtr temp_ptr_new;
        //temp_ptr_new is used to create new nodes.

        back = new QueueNode;
        back->data = temp_ptr_old->data;
    }
}

```

```

back->link = NULL;
front = back;
//First node created and filled with data.
//New nodes are now added AFTER this first node.

temp_ptr_old = temp_ptr_old->link;
//temp_ptr_old now points to second
//node or NULL if there is no second node.

while (temp_ptr_old != NULL)
{
    temp_ptr_new = new QueueNode;
    temp_ptr_new->data = temp_ptr_old->data;
    temp_ptr_new->link = NULL;
    back->link = temp_ptr_new;
    back = temp_ptr_new;
    temp_ptr_old = temp_ptr_old->link;
}
}
}

```

```

13. Queue::~~Queue( )
{
    char next;
    while (! empty( ))
        next = remove( );//remove calls delete.
}

```

PRACTICE PROGRAMS

Practice Programs can generally be solved with a short program that directly applies the programming principles presented in this chapter.

1. The following program creates a linked list with three names:

```

#include <iostream>
#include <string>
using namespace std;

struct Node
{
    string name;
    Node *link;
};

typedef Node* NodePtr;

int main()
{
    NodePtr listPtr, tempPtr;

```

```

        listPtr = new Node;
        listPtr->name = "Emily";

        tempPtr = new Node;
        tempPtr->name = "James";
        listPtr->link = tempPtr;

        tempPtr->link = new Node;
        tempPtr = tempPtr->link;
        tempPtr->name = "Joules";
        tempPtr->link = NULL;

        return 0;
    }

```

Add code to the main function that:

- a. Outputs in order all names in the list.
 - b. Inserts the name "Joshua" in the list after "James" then outputs the modified list.
 - c. Deletes the node with "Joules" then outputs the modified list.
 - d. Deletes all nodes in the list.
2. Re-do Practice Program 1, but instead of a struct, use a class named Node. Your class should have appropriate member functions to set the name and the link to the next node in the list. You might also consider adding a constructor that can set the name and link.

PROGRAMMING PROJECTS

Programming Projects require more problem-solving than Practice Programs and can usually be solved many different ways. Visit www.myprogramminglab.com to complete many of these Programming Projects online and get instant feedback.

1. Write a *void* function that takes a linked list of integers and reverses the order of its nodes. The function will have one call-by-reference parameter that is a pointer to the head of the list. After the function is called, this pointer will point to the head of a linked list that has the same nodes as the original list, but in the reverse of the order they had in the original list. Note that your function will neither create nor destroy any nodes. It will simply rearrange nodes. Place your function in a suitable test program.
2. Write a function called `merge_lists` that takes two call-by-reference arguments that are pointer variables that point to the heads of linked lists of values of type *int*. The two linked lists are assumed to be sorted so that the number at the head is the smallest number, the number in the next node is

the next smallest, and so forth. The function returns a pointer to the head of a new linked list that contains all of the nodes in the original two lists. The nodes in this longer list are also sorted from smallest to largest values. Note that your function will neither create nor destroy any nodes. When the function call ends, the two pointer variable arguments should have the value NULL.

3. Design and implement a class whose objects represent polynomials. The polynomial

$$a_n x^n + a_{n-1} x^{n-1} + \dots + a_0$$

will be implemented as a linked list. Each node will contain an *int* value for the power of *x* and an *int* value for the corresponding coefficient. The class operations should include addition, subtraction, multiplication, and evaluation of a polynomial. Overload the operators +, -, and * for addition, subtraction, and multiplication.

Evaluation of a polynomial is implemented as a member function with one argument of type *int*. The evaluation member function returns the value obtained by plugging in its argument for *x* and performing the indicated operations. Include four constructors: a default constructor, a copy constructor, a constructor with a single argument of type *int* that produces the polynomial that has only one constant term that is equal to the constructor argument, and a constructor with two arguments of type *int* that produces the one-term polynomial whose coefficient and exponent are given by the two arguments. (In the notation above, the polynomial produced by the one-argument constructor is of the simple form consisting of only a_0 . The polynomial produced by the two-argument constructor is of the slightly more complicated form $a_n x^n$.) Include a suitable destructor. Include member functions to input and output polynomials.

When the user inputs a polynomial, the user types in the following:

$$a_n x^n + a_{n-1} x^{n-1} + \dots + a_0$$

However, if a coefficient a_i is zero, the user may omit the term $a_i x^i$. For example, the polynomial

$$3x^4 + 7x^2 + 5$$

can be input as

$$3x^4 + 7x^2 + 5$$

It could also be input as

$$3x^4 + 0x^3 + 7x^2 + 0x^1 + 5$$

If a coefficient is negative, a minus sign is used in place of a plus sign, as in the following examples:

$$3x^5 - 7x^3 + 2x^1 - 8$$

$$-7x^4 + 5x^2 + 9$$

A minus sign at the front of the polynomial, as in the second of the two examples, applies only to the first coefficient; it does not negate the entire polynomial. Polynomials are output in the same format. In the case of output, the terms with zero coefficients are not output.

To simplify input, you can assume that polynomials are always entered one per line and that there will always be a constant term a_0 . If there is no constant term, the user enters 0 for the constant term, as in the following:

$$12x^8 + 3x^2 + 0$$

4. In this project you will redo Programming Project 8 from Chapter 11 using a linked list instead of an array. As noted there, this is a linked list of *double* items. This fact may imply changes in some of the member functions. The members are as follows: a default constructor; a member function named `add_item` to add a *double* to the list; a test for a full list that is a Boolean-valued function named `full()`; and a *friend* function overloading the insertion operator `<<`.
5. A harder version of Programming Project 4 would be to write a class named `List`, similar to Project 4, but with all the following member functions:
 - Default constructor, `List()`;
 - `double List::front()`; , which returns the first item in the list
 - `double List::back()`; , which returns the last item in the list
 - `double List::current()`; , which returns the “current” item
 - `void List::advance()`; , which advances the item that `current()` returns
 - `void List::reset()`; to make `current()` return the first item in the list
 - `void List::insert(double after_me, double insert_me)`; , which inserts `insert_me` into the list after `after_me` and increments the *private*: variable `count`.
 - `int size()`; , which returns the number of items in the list
 - *friend* `istream& operator<<(istream& ins, double write_me)`;

The private data members should include the following:

```
node* head;
node* current;
int count;
```

and possibly one more pointer.

You will need the following *struct* (outside the list class) for the linked list nodes:

```
struct node
{
    double item;
    node *next;
};
```

Incremental development is essential to all projects of any size, and this is no exception. Write the definition for the `List` class, but do not implement any members yet. Place this class definition in a file `list.h`. Then `#include "list.h"` in a file that contains `int main(){}.` Compile your file. This will find syntax errors and many typographical errors that would cause untold difficulty if you attempted to implement members without this check. Then you should implement and compile one member at a time, until you have enough to write test code in your main function.

- In an ancient land, the beautiful princess Eve had many suitors. She decided on the following procedure to determine which suitor she would marry. First, all of the suitors would be lined up one after the other and assigned numbers. The first suitor would be number 1, the second number 2, and so on up to the last suitor, number n . Starting at the first suitor she would then count three suitors down the line (because of the three letters in her name) and the third suitor would be eliminated from winning her hand and removed from the line. Eve would then continue, counting three more suitors, and eliminate every third suitor. When she reached the end of the line she would continue counting from the beginning.

For example, if there were six suitors then the elimination process would proceed as follows:

123456	initial list of suitors, start counting from 1
12456	suitor 3 eliminated, continue counting from 4
1245	suitor 6 eliminated, continue counting from 1
125	suitor 4 eliminated, continue counting from 5
15	suitor 2 eliminated, continue counting from 5
1	suitor 5 eliminated, 1 is the lucky winner

Write a program that creates a circular linked list of nodes to determine which position you should stand in to marry the princess if there are n suitors. A circular linked list is a linked list where the link field of the last node in the list refers to the node that is the head of the list. Your program should simulate the elimination process by deleting the node that corresponds to the suitor that is eliminated for each step in the process. Consider the possibility that you may need to delete the "head" node in the list.



VideoNote
Solution to Programming
Project 13.6

7. Redo (or do for the first time) Programming Project 5 from Chapter 9. However, instead of a dynamic array to store the list of user IDs for each computer station, use a linked list. The node for the lists should contain the station number and user ID of the person logged in on that station. If nobody is logged on to a computer station, then no entry should exist in the linked list for that computer station.
8. Modify or rewrite the Queue class (Display 13.21 through 13.23) to simulate customer arrivals at the Department of Motor Vehicles (DMV) counter. As customers arrive, they are given a ticket number starting at 1 and incrementing with each new customer. When a customer service agent is free, the customer with the next ticket number is called. This system results in a FIFO queue of customers ordered by ticket number. Write a program that implements the queue and simulates customers entering and leaving the queue. Input into the queue should be the ticket number and a timestamp when the ticket was entered into the queue. A ticket and its corresponding timestamp is removed when a customer service agent handles the next customer. Your program should save the length of time the last three customers spent waiting in the queue. Every time a ticket is removed from the queue, update these times and output the average of the last three customers as an estimate of how long it will take until the next customer is handled. If nobody is in the queue, output that the line is empty.

Code to compute a timestamp based on the computer's clock is given below. The `time(NULL)` function returns the number of seconds since January 1, 1970, on most implementations of C++:

```
#include <ctime>
...
int main()
{
    long seconds;
    seconds = static_cast<long>(time(NULL));
    cout << "Seconds since 1/1/1970: " << seconds << endl;
    return 0;
}
```

Sample execution is shown here:

The line is empty.

Enter '1' to simulate a customer's arrival, '2' to help the next customer, or '3' to quit.

1

Customer 1 entered the queue at time 100000044.

Enter '1' to simulate a customer's arrival, '2' to help the next customer, or '3' to quit.

1

Customer 2 entered the queue at time 100000049.

Enter '1' to simulate a customer's arrival, '2' to help the next customer, or '3' to quit.

1

Customer 3 entered the queue at time 100000055.
Enter '1' to simulate a customer's arrival, '2' to help the next customer, or '3' to quit.

2

Customer 1 is being helped at time 100000069. Wait time = 25 seconds.

The estimated wait time for customer 2 is 25 seconds.

Enter '1' to simulate a customer's arrival, '2' to help the next customer, or '3' to quit.

2

Customer 2 is being helped at time 100000076. Wait time = 27 seconds.

The estimated wait time for customer 3 is 26 seconds.

Enter '1' to simulate a customer's arrival, '2' to help the next customer, or '3' to quit.

1

Customer 4 entered the queue at time 100000080.

Enter '1' to simulate a customer's arrival, '2' to help the next customer, or '3' to quit.

2

Customer 3 is being helped at time 100000099. Wait time = 44 seconds.

The estimated wait time for customer 4 is 32 seconds.

9. The following figure is called a *graph*. The circles are called *nodes*, and the lines are called *edges*. An edge connects two nodes. You can interpret the graph as a maze of rooms and passages. The nodes can be thought of as rooms, and an edge connects one room to another. Note that each node has at most four edges in the graph.



VideoNote
Solution to Programming
Project 13.9

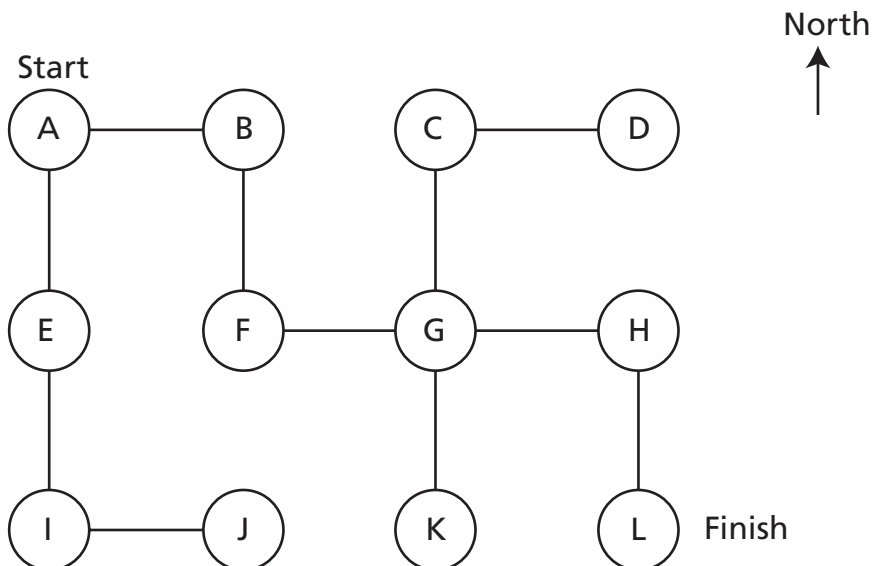

Write a program that implements the maze using nodes and pointers. Each node in the graph will correspond to a node in your code that is implemented in the form of a class or struct. The edges correspond to bidirectional links that point from one node to another. Start the user in node A. The user's goal is to reach the finish in node L. The program should output possible moves in the north, south, east, or west direction. Sample execution is shown here.

You are in room A of a maze of twisty little passages, all alike.
You can go (E)ast, (S)outh, or (Q)uit.

E

You are in room B of a maze of twisty little passages, all alike.
You can go (W)est, (S)outh, or (Q)uit.

S

You are in room F of a maze of twisty little passages, all alike.
You can go (E)ast, (N)orth, or (Q)uit.

E

10. Reverse Polish Notation (RPN), or postfix notation, is a format to specify mathematical expressions. In RPN, the operator comes after the operands instead of the normal format in which the operator is between the operands (this is called *infix* notation). Starting with an empty stack, a RPN calculator can be implemented with the following rules:

- If a number is input, push it on the stack.
- If "+" is input, then pop the last two operands off the stack, add them, and push the result on the stack.
- If "-" is input then pop value1, pop value2, then push value2-value1 on the stack.
- If "*" is input, then pop the last two operands off the stack, multiply them, and push the result on the stack
- If "/" is input then pop value1, pop value2, then push value2/value1 on the stack
- If "q" is input, then stop inputting values, print out the top of the stack, and exit the program

Modify the Stack class given in Section 13.2 to store integers instead of characters. Use the modified stack to implement a RPN calculator. Output an appropriate error message if there are not two operands on the stack when given an operator. Here is a sample input and output that is equivalent to $((10 - (2 + 3)) * 2)/5$:

```
10
2
3
+
```

(continued)

```
-
2
*
5
/
q
```

The top of the stack is: 2

11. You should complete the Programming Project 10 before attempting this one. Write a program that converts a fully parenthesized mathematical infix expression into an equivalent postfix expression and then evaluates the postfix expression. A fully parenthesized expression is one in which parentheses surround every operator and its operands. Starting with an empty stack of strings to store operators and an empty queue of strings to store the postfix expression, the conversion can be implemented with the following rules:
- If "(" is input, then ignore it.
 - If a number is input, then add it to the queue.
 - If an operator (either "*", "+", "-", or "/") is input, then push it on the stack.
 - If ")" is input, then pop the operator from the stack and add it to the queue.
 - If "q" is input, then exit.

When the final operator is popped from the stack, the queue contains the equivalent postfix expression. Use your solution from Programming Project 10 to evaluate it. You will need to convert a string object to an integer. Use the `c_str()` function to convert the string to a C string, and then use the `atoi` function to convert the C string into an integer. Refer to Chapter 8 for details.

Sample output is shown below for $((10 - (2 + 3)) * 2)$, which translates to the postfix expression `10 2 3 + - 2 *`:

```
(
(
10
-
(
2
+
3
)
)
*
2
)
q
```

The expression evaluates to 10

This page intentionally left blank



Recursion 14

14.1 RECURSIVE FUNCTIONS FOR TASKS 791

Case Study: Vertical Numbers 791

A Closer Look at Recursion 797

Pitfall: Infinite Recursion 799

Stacks for Recursion 800

Pitfall: Stack Overflow 802

Recursion Versus Iteration 802

14.2 RECURSIVE FUNCTIONS FOR VALUES 804

General Form for a Recursive Function That Returns a Value 804

Programming Example: Another Powers Function 804

14.3 THINKING RECURSIVELY 809

Recursive Design Techniques 809

Case Study: Binary Search—An Example of Recursive Thinking 810

Programming Example: A Recursive Member Function 818



After a lecture on cosmology and the structure of the solar system, William James was accosted by a little old lady.

"Your theory that the sun is the center of the solar system, and the earth is a ball which rotates around it has a very convincing ring to it, Mr. James, but it's wrong. I've got a better theory," said the little old lady.

"And what is that, madam?" inquired James politely.

"That we live on a crust of earth which is on the back of a giant turtle."

Not wishing to demolish this absurd little theory by bringing to bear the masses of scientific evidence he had at his command, James decided to gently dissuade his opponent by making her see some of the inadequacies of her position.

"If your theory is correct, madam," he asked, "what does this turtle stand on?"

"You're a very clever man, Mr. James, and that's a very good question," replied the little old lady, "but I have an answer to it. And it is this: the first turtle stands on the back of a second, far larger, turtle, who stands directly under him."

"But what does this second turtle stand on?" persisted James patiently.

To this the little old lady crowed triumphantly. "It's no use, Mr. James—it's turtles all the way down."

J. R. ROSS, *Constraints on Variables in Syntax*

INTRODUCTION

You have encountered a few cases of circular definitions that worked out satisfactorily. The most prominent examples are the definitions of certain C++ statements. For example, the definition of a *while* statement says that it can contain other (smaller) statements. Since one of the possibilities for these smaller statements is another *while* statement, there is a kind of circularity in that definition. The definition of the *while* statement, if written out in complete detail, will contain a reference to *while* statements. In mathematics, this kind of circular definition is called a recursive definition. In C++, a function may be defined in terms of itself in the same way. To put it more precisely, a function definition may contain a call to itself. In such cases, the function is said to be recursive. This chapter discusses recursion in C++ and more generally discusses recursion as a programming and problem-solving technique.

PREREQUISITES

Sections 14.1 and 14.2 use material only from Chapters 2 through 5. Section 14.3 uses material from Chapters 2 through 7 and 10.

14.1 RECURSIVE FUNCTIONS FOR TASKS

I remembered too that night which is at the middle of the Thousand and One Nights when Scheherazade (through a magical oversight of the copyist) begins to relate word for word the story of the Thousand and One Nights, establishing the risk of coming once again to the night when she must repeat it, and thus to infinity.

JORGE LUIS BORGES, *The Garden of Forking Paths*

When you are writing a function to solve a task, one basic design technique is to break the task into subtasks. Sometimes it turns out that at least one of the subtasks is a smaller example of the same task. For example, if the task is to search an array for a particular value, you might divide this into the subtask of searching the first half of the array and the subtask of searching the second half of the array. The subtasks of searching the halves of the array are “smaller” versions of the original task. Whenever one subtask is a smaller version of the original task to be accomplished, you can solve the original task using a recursive function. It takes a little training to easily decompose problems this way, but once you learn the technique, it can be one of the quickest ways to design an algorithm, and, ultimately, a C++ function. We begin with a simple case study to illustrate this technique.

Recursion

In C++, a function definition may contain a call to the function being defined. In such cases, the function is said to be **recursive**.

CASE STUDY Vertical Numbers

In this case study we design a recursive *void* function that writes numbers to the screen with the digits written vertically, so that, for example, 1984 would be written as



```
1
9
8
4
```

Problem Definition

The declaration and header comment for our function is as follows:

```
void write_vertical(int n);
//Precondition: n >= 0.
//Postcondition: The number n is written to the screen
//vertically with each digit on a separate line.
```

Algorithm Design

One case is very simple. If n , the number to be written out, is only one digit long, then just write out the number. As simple as it is, this case is still important, so let's keep track of it.

Simple Case: If $n < 10$, then write the number n to the screen.

Now let's consider the more typical case in which the number to be written out consists of more than one digit. Suppose you want to write the number 1234 vertically so that the result is

```
1
2
3
4
```

One way to decompose this task into two subtasks is the following:

1. Output all the digits except the last digit like so:

```
1
2
3
```

2. Output the last digit, which in this example is 4.

Subtask 1 is a smaller version of the original task, so we can implement this subtask with a recursive call. Subtask 2 is just the simple case we listed earlier. Thus, an outline of our algorithm for the function `write_vertical` with parameter n is given by the following pseudocode:

```
if (n < 10)
{
    cout << n << endl;
}
else //n is two or more digits long:
{
    write_vertical(the number n with the last digit removed);
    cout << the last digit of n << endl;
}
```

Recursive subtask

In order to convert this pseudocode into the code for a C++ function, all we need to do is translate the following two pieces of pseudocode into C++ expressions:

the number n with the last digit removed

and

the last digit of n

These expressions can easily be translated into C++ expressions using the integer division operators `/` and `%` as follows:

```
n / 10 //the number n with the last digit removed
n % 10 //the last digit of n
```

For example, `1234 / 10` evaluates to 123, and `1234 % 10` evaluates to 4.

Several factors influenced our selection of the two subtasks we used in this algorithm. One was that we could easily compute the argument for the recursive call to `write_vertical` (shown in color) that we used in the pseudocode. The number `n` with the last digit removed is easily computed as `n/10`. As an alternative, you might have been tempted to divide the subtasks as follows:

1. Output the first digit of `n`.
2. Output the number `n` with the first digit removed.

This is a perfectly valid decomposition of the task into subtasks, and it can be implemented recursively. However, it is difficult to calculate the result of removing the first digit from a number, while it is easy to calculate the result of removing the last digit from a number.

Another reason for choosing these sorts of decompositions is that one of the subcases does not involve a recursive call. A successful definition of a recursive function always includes at least one case that does not involve a recursive call (as well as one or more cases that do involve at least one recursive call). This aspect of the recursive algorithm is discussed in the subsections that follow this case study.

Coding

We can now put all the pieces together to produce the recursive function `write_vertical` shown in Display 14.1. In the next subsection we will explain more details of how recursion works in this example.

DISPLAY 14.1 A Recursive Output Function (part 1 of 2)

```
1 //Program to demonstrate the recursive function write_vertical.
2 #include <iostream>
3 using namespace std;
4
5 void write_vertical(int n);
6 //Precondition: n >= 0.
7 //Postcondition: The number n is written to the screen vertically
8 //with each digit on a separate line.
9
10 int main( )
11 {
12     cout<< "write_vertical(3):" <<endl;
13     write_vertical(3);
14
```

(continued)

DISPLAY 14.1 A Recursive Output Function (*part 2 of 2*)

```
15     cout<< "write_vertical(12):" <<endl;
16     write_vertical(12);
17
18     cout<< "write_vertical(123):" <<endl;
19     write_vertical(123);
20
21     return 0;
22 }
23
24 //uses iostream:
25 void write_vertical(int n)
26 {
27     if (n < 10)
28     {
29         cout << n << endl;
30     }
31     else //n is two or more digits long:
32     {
33         write_vertical(n / 10);
34         cout << (n % 10) << endl;
35     }
36 }
```

Sample Dialogue

```
write_vertical(3):
3
write_vertical(12):
1
2
write_vertical(123):
1
2
3
```

Tracing a Recursive Call

Let's see exactly what happens when the following function call is made:

```
write_vertical(123);
```

When this function call is executed, the computer proceeds just as it would with any function call. The argument 123 is substituted for the parameter *n* in the function definition, and the body of the function is executed. After the substitution of 123 for *n*, the code to be executed is as follows:

```

if (123 < 10)
{
    cout << 123 << endl;
}
else //n is two or more digits long:
{
    write_vertical(123 / 10); ← Computation will
    cout << (123 % 10) << endl; stop here until the
}                                     recursive call returns.

```

Since 123 is not less than 10, the logical expression in the *if-else* statement is *false*, so the *else* part is executed. However, the *else* part begins with the following function call:

```
write_vertical(n / 10);
```

which (since *n* is equal to 123) is the call

```
write_vertical(123 / 10);
```

which is equivalent to

```
write_vertical(12);
```

When execution reaches this recursive call, the current function computation is placed in suspended animation and this recursive call is executed. When this recursive call is finished, the execution of the suspended computation will return to this point, and the suspended computation will continue from this point.

The recursive call

```
write_vertical(12);
```

is handled just like any other function call. The argument 12 is substituted for the parameter *n* and the body of the function is executed. After substituting 12 for *n*, there are two computations, one suspended and one active, as follows:

<pre> if (123 < 10) { cout << 123 << endl; } else // { wri cout } </pre>	<pre> if (12 < 10) { cout << 12 << endl; } else //n is two or more digits long: { write_vertical(12 / 10); ← Computation will stop cout << (12 % 10) << endl; here until the recursive } call returns. </pre>
---	--

Since 12 is not less than 10, the Boolean expression in the *if-else* statement is *false* and so the *else* part is executed. However, as you already saw, the *else* part begins with a recursive call. The argument for the recursive call is *n* / 10, which

in this case is equivalent to $12 / 10$. So this second computation of the function `write_vertical` is suspended and the following recursive call is executed:

```
write_vertical(12/ 10);
```

which is equivalent to

```
write_vertical(1);
```

At this point there are two suspended computations waiting to resume and the computer begins to execute this new recursive call, which is handled just like all the previous recursive calls. The argument `1` is substituted for the parameter `n`, and the body of the function is executed. At this point, the computation looks like the following:

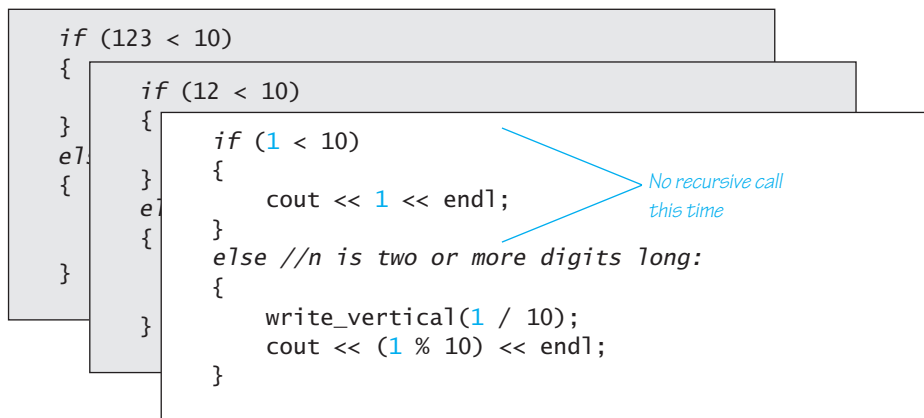

Output the digit 1

When the body of the function is executed this time, something different happens. Since `1` is less than `10`, the Boolean expression in the `if-else` statement is `true`, so the statement before the `else` is executed. That statement is simply a `cout` statement that writes the argument `1` to the screen, and so the call `write_vertical(1)` writes `1` to the screen and ends without any recursive call.

When the call `write_vertical(1)` ends, the suspended computation that is waiting for it to end resumes where that suspended computation left off, as shown by the following:

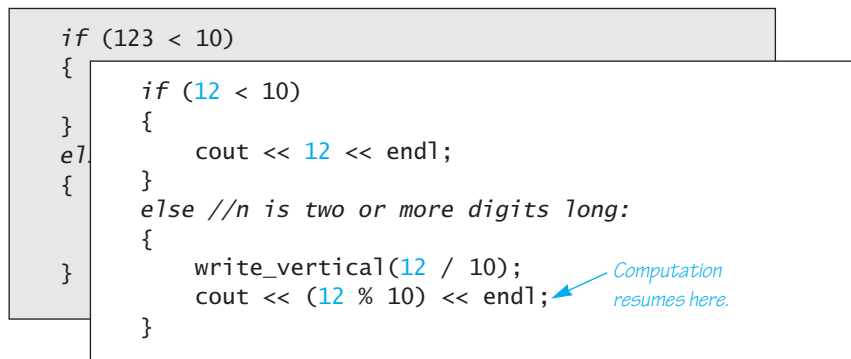

When this suspended computation resumes, it executes a `cout` statement that outputs the value `123 % 10`, which is 2. That ends that computation, but there is yet another suspended computation waiting to resume. When this last suspended computation resumes, the situation is as follows:

Output the
digit 2

```

if (123 < 10)
{
    cout << 123 << endl;
}
else //n is two or more digits long:
{
    write_vertical(123 / 10);
    cout << (123 % 10) << endl; ← Computation
                                resumes here.
}

```

When this last suspended computation resumes, it outputs the value `123 % 10`, which is 3, and the execution of the original function call ends. And, sure enough, the digits 1, 2, and 3 have been written to the screen one per line, in that order.

Output the digit 3

A Closer Look at Recursion

The definition of the function `write_vertical` uses recursion. Yet we did nothing new or different in evaluating the function call `write_vertical(123)`. We treated it just like any of the function calls we saw in previous chapters. We just substituted the argument 123 for the parameter `n` and then executed the code in the body of the function definition. When we reached the recursive call

```
write_vertical(123 / 10);
```

we simply repeated this process one more time.

The computer keeps track of recursive calls in the following way. When a function is called, the computer plugs in the arguments for the parameter(s) and begins to execute the code. If it should encounter a recursive call, then it temporarily stops its computation. This is because it must know the result of the recursive call before it can proceed. It saves all the information it needs to continue the computation later on and proceeds to evaluate the recursive call. When the recursive call is completed, the computer returns to finish the outer computation.

How recursion
works

The C++ language places no restrictions on how recursive calls are used in function definitions. However, in order for a recursive function definition to be useful, it must be designed so that any call of the function must ultimately terminate with some piece of code that does not depend on recursion. The function may call itself, and that recursive call may call the function again.

How recursion
ends

The process may be repeated any number of times. However, the process will not terminate unless eventually one of the recursive calls does not depend on recursion. The general outline of a successful recursive function definition is as follows:

- One or more cases in which the function accomplishes its task by using recursive calls to accomplish one or more smaller versions of the task.
- One or more cases in which the function accomplishes its task without the use of any recursive calls. These cases without any recursive calls are called **base cases** or **stopping cases**.

Often, an *if-else* statement determines which of the cases will be executed. A typical scenario is for the original function call to execute a case that includes a recursive call. That recursive call may in turn execute a case that requires another recursive call. For some number of times each recursive call produces another recursive call, but eventually one of the stopping cases should apply. *Every call of the function must eventually lead to a stopping case, or else the function call will never end because of an infinite chain of recursive calls.* (In practice, a call that includes an infinite chain of recursive calls will usually terminate abnormally rather than actually running forever.)

The most common way to ensure that a stopping case is eventually reached is to write the function so that some (positive) numeric quantity is decreased on each recursive call and to provide a stopping case for some “small” value. This is how we designed the function `write_vertical` in Display 14.1. When the function `write_vertical` is called, that call produces a recursive call with a smaller argument. This continues with each recursive call producing another recursive call until the argument is less than 10. When the argument is less than 10, the function call ends without producing any more recursive calls and the process works its way back to the original call and then ends.

General Form of a Recursive Function Definition

The general outline of a successful recursive function definition is as follows:

- One or more cases that include one or more recursive calls to the function being defined. These recursive calls should solve “smaller” versions of the task performed by the function being defined.
- One or more cases that include no recursive calls. These cases without any recursive calls are called **base cases** or **stopping cases**.

PITFALL Infinite Recursion

In the example of the function `write_vertical` discussed in the previous subsections, the series of recursive calls eventually reached a call of the function that did not involve recursion (that is, a stopping case was reached). If, on the other hand, every recursive call produces another recursive call, then a call to the function will, in theory, run forever. This is called **infinite recursion**. In practice, such a function will typically run until the computer runs out of resources and the program terminates abnormally. Phrased another way, a recursive definition should not be “recursive all the way down.” Otherwise, like the lady’s explanation of the universe given at the start of this chapter, a call to the function will never end, except perhaps in frustration.

Examples of infinite recursion are not hard to come by. The following is a syntactically correct C++ function definition, which might result from an attempt to define an alternative version of the function `write_vertical`:

```
void new_write_vertical(int n)
{
    new_write_vertical(n / 10);
    cout << (n % 10) << endl;
}
```

If you embed this definition in a program that calls this function, the compiler will translate the function definition to machine code and you can execute the machine code. Moreover, the definition even has a certain reasonableness to it. It says that to output the argument to `new_write_vertical`, first output all but the last digit and then output the last digit. However, when called, this function will produce an infinite sequence of recursive calls. If you call `new_write_vertical(12)`, that execution will stop to execute the recursive call `new_write_vertical (12/10)`, which is equivalent to `new_write_vertical(1)`. The execution of that recursive call will, in turn, stop to execute the recursive call

```
new_write_vertical(1/10);
```

which is equivalent to

```
new_write_vertical(0);
```

That, in turn, will stop to execute the recursive call `new_write_vertical (0/10)`; which is also equivalent to

```
new_write_vertical(0);
```

and that will produce another recursive call to again execute the same recursive function call `new_write_vertical(0)`; and so on, forever. Since the definition of `new_write_vertical` has no stopping case, the process will proceed forever (or until the computer runs out of resources). ■

SELF-TEST EXERCISES

1. What is the output of the following program?

```
#include <iostream>
using namespace std;
void cheers(int n);

int main()
{
    cheers(3);
    return 0;
}

void cheers(int n)
{
    if (n == 1)
    {
        cout << "Hurray\n";
    }
    else
    {
        cout << "Hip ";
        cheers(n - 1);
    }
}
```

2. Write a recursive *void* function that has one parameter which is a positive integer and that writes out that number of asterisks '*' to the screen all on one line.
3. Write a recursive *void* function that has one parameter, which is a positive integer. When called, the function writes its argument to the screen backward. That is, if the argument is 1234, it outputs the following to the screen:
4321
4. Write a recursive *void* function that takes a single *int* argument *n* and writes the integers 1, 2, . . . , *n*.
5. Write a recursive *void* function that takes a single *int* argument *n* and writes integers *n*, *n*-1, . . . , 3, 2, 1. (*Hint*: Notice that you can get from the code for Self-Test Exercise 4 to that for Self-Test Exercise 5, or vice versa, by an exchange of as little as two lines.)

Stacks for Recursion

In order to keep track of recursion, and a number of other things, most computer systems make use of a structure called a *stack*. A **stack** is a very specialized kind of memory structure that is analogous to a stack of paper. In

this analogy there is an inexhaustible supply of extra blank sheets of paper. To place some information in the stack, it is written on one of these sheets of paper and placed on top of the stack of papers. To place more information in the stack, a clean sheet of paper is taken, the information is written on it, and this new sheet of paper is placed on top of the stack. In this straightforward way, more and more information may be placed on the stack.

Getting information out of the stack is also accomplished by a very simple procedure. The top sheet of paper can be read, and when it is no longer needed, it is thrown away. There is one complication: Only the top sheet of paper is accessible. In order to read, say, the third sheet from the top, the top two sheets must be thrown away. Since the last sheet that is put on the stack is the first sheet taken off the stack, a stack is often called a **last-in/first-out (LIFO)** memory structure.

Using a stack, the computer can easily keep track of recursion. Whenever a function is called, a new sheet of paper is taken. The function definition is copied onto this sheet of paper, and the arguments are plugged in for the function parameters. Then the computer starts to execute the body of the function definition. When it encounters a recursive call, it stops the computation it is doing on that sheet in order to compute the recursive call. But before computing the recursive call, it saves enough information so that, when it does finally complete the recursive call, it can continue the stopped computation. This saved information is written on a sheet of paper and placed on the stack. A new sheet of paper is used for the recursive call. The computer writes a second copy of the function definition on this new sheet of paper, plugs in the arguments for the function parameters, and starts to execute the recursive call. When it gets to a recursive call within the recursively called copy, it repeats the process of saving information on the stack and using a new sheet of paper for the new recursive call. This process is illustrated in the earlier subsection entitled "Tracing a Recursive Call." Even though we did not call it a stack in that section, the illustrations of computations placed one on top of the other demonstrate the actions of the stack.

This process continues until some recursive call to the function completes its computation without producing any more recursive calls. When that happens, the computer turns its attention to the top sheet of paper on the stack. This sheet contains the partially completed computation that is waiting for the recursive computation that just ended. So, it is possible to proceed with that suspended computation. When that suspended computation ends, the computer discards that sheet of paper, and the suspended computation that is below it on the stack becomes the computation on top of the stack. The computer turns its attention to the suspended computation that is now on the top of the stack, and so forth. The process continues until the computation on the bottom sheet is completed. Depending on how many recursive calls are made and how the function definition is written, the stack may grow and shrink in any fashion. Notice that the sheets in the stack can only be accessed in a last-in/first-out fashion, but that is exactly what is needed to keep track of recursive calls. Each suspended version is waiting for the completion of the version directly above it on the stack.



Needless to say, computers do not have stacks of paper of this kind. This is just an analogy. The computer uses portions of memory rather than pieces of paper. The contents of one of these portions of memory (“sheets of paper”) is called an **activation frame**. These activation frames are handled in the last-in/first-out manner we just discussed. (The activation frames do not contain a complete copy of the function definition, but merely reference a single copy of the function definition. However, an activation frame contains enough information to allow the computer to act as if the frame contained a complete copy of the function definition.)

Stack

A **stack** is a *last-in/first-out* memory structure. The first item referenced or removed from a stack is always the last item entered into the stack. Stacks are used by computers to keep track of recursion (and for other purposes).

PITFALL Stack Overflow

There is always some limit to the size of the stack. If there is a long chain in which a function makes a recursive call to itself, and that call results in another recursive call, and that call produces yet another recursive call, and so forth, then each recursive call in this chain will cause another activation frame to be placed on the stack. If this chain is too long, then the stack will attempt to grow beyond its limit. This is an error condition known as a **stack overflow**. If you receive an error message that says *stack overflow*, it is likely that some function call has produced an excessively long chain of recursive calls. One common cause of stack overflow is infinite recursion. If a function is recursing infinitely, then it will eventually try to make the stack exceed any stack size limit. ■

Recursion Versus Iteration

Recursion is not absolutely necessary. In fact, some programming languages do not allow it. Any task that can be accomplished using recursion can also be done in some other way without using recursion. For example, Display 14.2 contains a nonrecursive version of the function given in Display 14.1. The nonrecursive version of a function typically uses a loop (or loops) of some sort in place of recursion. For that reason, the nonrecursive version is usually referred to as an **iterative version**. If the definition of the function `write_vertical` given in Display 14.1 is replaced by the version given in Display 14.2, then the output will be the same. As is true in this case, a recursive version of a function can sometimes be much simpler than an iterative version.

DISPLAY 14.2 Iterative Version of the Function in Display 14.1

```

1  //Uses iostream:
2  void write_vertical(int n)
3  {
4      int tens_in_n = 1;
5      int left_end_piece = n;
6      while (left_end_piece > 9)
7          {
8              left_end_piece = left_end_piece/10;
9              tens_in_n = tens_in_n * 10;
10         }
11     //tens_in_n is a power of ten that has the same number
12     //of digits as n. For example, if n is 2345, then
13     //tens_in_n is 1000.
14
15     for (int power_of_10 = tens_in_n;
16         power_of_10 > 0; power_of_10 = power_of_10/10)
17     {
18         cout << (n/power_of_10) <<endl;
19         n = n % power_of_10;
20     }
21 }
```

A recursively written function will usually run slower and use more storage than an equivalent iterative version. Although the iterative version of `write_vertical` given in Display 14.2 looks like it uses more storage and does more computing than the recursive version in Display 14.1, the two versions of `write_vertical` actually use comparable storage and do comparable amounts of computing. In fact, the recursive version may use more storage and run somewhat slower, because the computer must do a good deal of work manipulating the stack in order to keep track of the recursion. However, since the system does all this for you automatically, using recursion can sometimes make your job as a programmer easier and can sometimes produce code that is easier to understand. As you will see in the examples in this chapter and in the Self-Test Exercises and Programming Projects, sometimes a recursive definition is simpler and clearer; other times, an iterative definition is simpler and clearer.

SELF-TEST EXERCISES

6. If your program produces an error message that says *stack overflow*, what is a likely source of the error?
7. Write an iterative version of the function `cheers` defined in Self-Test Exercise 1.

8. Write an iterative version of the function defined in Self-Test Exercise 2.
9. Write an iterative version of the function defined in Self-Test Exercise 3.
10. Trace the recursive solution you made to Self-Test Exercise 4.
11. Trace the recursive solution you made to Self-Test Exercise 5.

14.2 RECURSIVE FUNCTIONS FOR VALUES

To iterate is human, to recurse divine.

ANONYMOUS

General Form for a Recursive Function That Returns a Value

The recursive functions you have seen thus far are all *void* functions, but recursion is not limited to *void* functions. A recursive function can return a value of any type. The technique for designing recursive functions that return a value is basically the same as for *void* functions. An outline for a successful recursive function definition that returns a value is as follows.

- One or more cases in which the value returned is computed in terms of calls to the same function (that is, using recursive calls). As was the case with *void* functions, the arguments for the recursive calls should intuitively be “smaller.”
- One or more cases in which the value returned is computed without the use of any recursive calls. These cases without any recursive calls are called **base cases** or **stopping cases** (just as they were with *void* functions).

This technique is illustrated in the next Programming Example.

PROGRAMMING EXAMPLE

Another Powers Function

In Chapter 4 we introduced the predefined function `pow` that computes powers. For example, `pow(2.0, 3.0)` returns $2.0^3.0$, so the following sets the variable `x` equal to 8.0:

```
double x = pow(2.0, 3.0);
```

The function `pow` takes two arguments of type *double* and returns a value of type *double*. Display 14.3 contains a recursive definition for a function that is similar but that works with the type *int* rather than *double*. This new function is called `power`. For example, the following will set the value of `y` equal to 8, since 2^3 is 8:

```
int y = power(2, 3);
```

DISPLAY 14.3 The Recursive Function `power`

```

1  //Program to demonstrate the recursive function power.
2  #include <iostream>
3  #include <cstdlib>
4  using namespace std;

5  int power(int x, int n);
6  //Precondition: n >= 0.
7  //Returns x to the power n.

8  int main( )
9  {
10     for (int n = 0; n < 4; n++)
11         cout << "3 to the power " << n
12            << " is " << power(3, n) << endl;

13     return 0;
14 }

15 //uses iostream and cstdlib:
16 int power(int x, int n)
17 {
18     if (n < 0)
19     {
20         cout << "Illegal argument to power.\n";
21         exit(1);
22     }

23     if (n > 0)
24         return ( power(x, n - 1) * x);
25     else // n == 0
26         return (1);
27 }

```

Sample Dialogue

```

3 to the power 0 is 1
3 to the power 1 is 3
3 to the power 2 is 9
3 to the power 3 is 27

```

Our main reason for defining the function `power` is to have a simple example of a recursive function, but there are situations in which the function `power` would be preferable to the function `pow`. The function `pow` returns values of type *double*, which are only approximate quantities. The function `power` returns values of type *int*, which are exact quantities. In some situations, you might need the additional accuracy provided by the function `power`.

The definition of the function `power` is based on the following formula:

$$x^n \text{ is equal to } x^{n-1} * x$$

Translating this formula into C++ says that the value returned by `power(x, n)` should be the same as the value of the expression

$$\text{power}(x, n - 1) * x$$

The definition of the function `power` given in Display 14.3 does return this value for `power(x, n)`, provided $n > 0$. The case where n is equal to 0 is the stopping case. If n is 0, then `power(x, n)` simply returns 1 (since x^0 is 1).

Let's see what happens when the function `power` is called with some sample values. First consider the following simple expression:

```
power(2, 0)
```

When the function is called, the value of x is set equal to 2, the value of n is set equal to 0, and the code in the body of the function definition is executed. Since the value of n is a legal value, the *if-else* statement is executed. Since this value of n is not greater than 0, the *return* statement after the *else* is used, so the function call returns 1. Thus, the following would set the value of y equal to 1:

```
int y = power(2, 0);
```

Now let's look at an example that involves a recursive call. Consider the expression

```
power(2, 1)
```

When the function is called, the value of x is set equal to 2, the value of n is set equal to 1, and the code in the body of the function definition is executed. Since this value of n is greater than 0, the following *return* statement is used to determine the value returned:

```
return ( power(x, n - 1) * x );
```

which in this case is equivalent to

```
return ( power(2, 0) * 2 );
```

At this point the computation of `power(2,1)` is suspended, a copy of this suspended computation is placed on the stack, and the computer then starts a new function call to compute the value of `power(2,0)`. As you have already seen, the value of `power(2,0)` is 1. After determining the value of `power(2,0)`, the computer replaces the expression `power(2,0)` with its value of 1 and resumes the suspended computation. The resumed computation determines the final value for `power(2,1)` from the *return* statement above as follows:

```
power(2, 0) * 2 is 1 * 2, which is 2.
```

Thus, the final value returned for `power(2,1)` is 2. The following would therefore set the value of z equal to 2:

```
int z = power(2, 1);
```

Larger numbers for the second argument will produce longer chains of recursive calls. For example, consider the statement

```
cout << power(2, 3);
```

The value of `power(2, 3)` is calculated as follows:

```
power(2, 3) is power(2, 2) * 2
power(2, 2) is power(2, 1) * 2
power(2, 1) is power(2, 0) * 2
power(2, 0) is 1 (stopping case)
```

When the computer reaches the stopping case, `power(2,0)`, there are three suspended computations. After calculating the value returned for the stopping case, it resumes the most recently suspended computation to determine the value of `power(2,1)`. After that, the computer completes each of the other suspended computations, using each value computed as a value to plug into another suspended computation, until it reaches and completes the computation for the original call, `power(2,3)`. The details of the entire computation are illustrated in Display 14.4.

DISPLAY 14.4 Evaluating the Recursive Function Call `power(2, 3)`

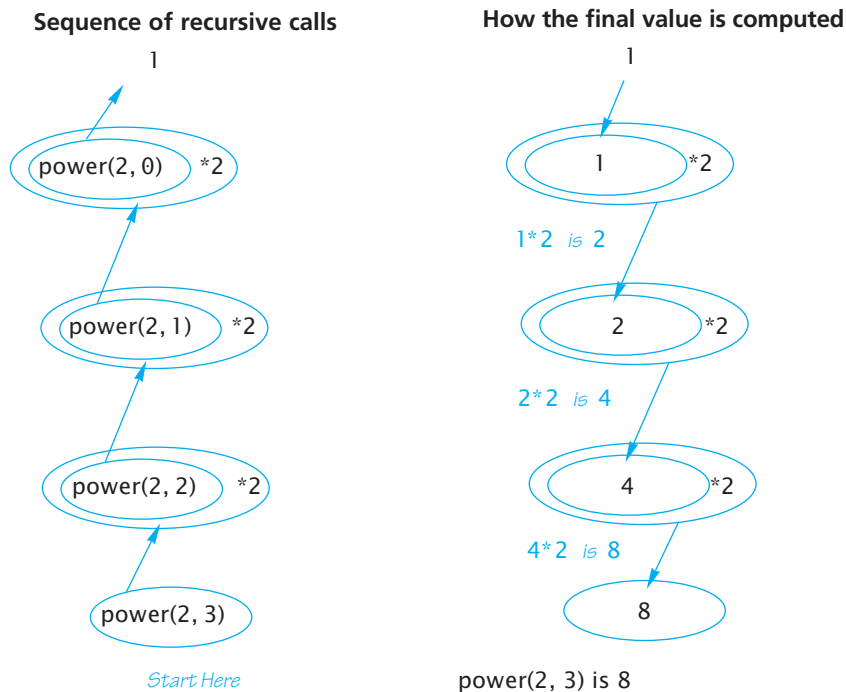

SELF-TEST EXERCISES

12. What is the output of the following program?

```
#include <iostream>
using namespace std;
int mystery(int n);
//Precondition n >= 1.

int main()
{
    cout << mystery(3);
    return 0;
}
int mystery(int n)
{
    if (n <= 1)
        return 1;
    else
        return ( mystery(n - 1) + n );
}
```

13. What is the output of the following program? What well-known mathematical function is rose?

```
#include <iostream>
using namespace std;
int rose(int n);
//Precondition: n >= 0.

int main()
{
    cout << rose(4);
    return 0;
}
int rose(int n)
{
    if (n <= 0)
        return 1;
    else
        return ( rose(n - 1) * n );
}
```

14. Redefine the function power so that it also works for negative exponents. In order to do this, you will also have to change the type of the value returned to *double*. The function declaration and header comment for the redefined version of power is as follows:

```
double power(int x, int n);
```

```
//Precondition: If n < 0, then x is not 0.
//Returns x to the power n.
```

(Hint: x^{-n} is equal to $1/(x^n)$.)

14.3 THINKING RECURSIVELY

There are two kinds of people in the world: those who divide the world into two kinds of people and those who do not.

ANONYMOUS

Recursive Design Techniques

When defining and using recursive functions you do not want to be continually aware of the stack and the suspended computations. The power of recursion comes from the fact that you can ignore that detail and let the computer do the bookkeeping for you. Consider the example of the function `power` in Display 14.3. The way to think of the definition of `power` is as follows:

```
power(x, n) returns power (x, n - 1) * x
```

Since x^n is equal to $x^{n-1} * x$, this is the correct value to return, provided that the computation will always reach a stopping case and will correctly compute the stopping case. So, after checking that the recursive part of the definition is correct, all you need check is that the chain of recursive calls will always reach a stopping case and that the stopping case always returns the correct value.

When you design a recursive function, you need not trace out the entire sequence of recursive calls for the instances of that function in your program. If the function returns a value, all that you need do is confirm that the following three properties are satisfied:

Criteria for functions that return a value

1. There is no infinite recursion. (A recursive call may lead to another recursive call and that may lead to another and so forth, but every such chain of recursive calls eventually reaches a stopping case.)
2. Each stopping case returns the correct value for that case.
3. For the cases that involve recursion: *If* all recursive calls return the correct value, *then* the final value returned by the function is the correct value.

For example, consider the function `power` in Display 14.3:

1. *There is no infinite recursion:* The second argument to `power(x,n)` is decreased by 1 in each recursive call, so any chain of recursive calls must eventually reach the case `power(x,0)`, which is the stopping case. Thus, there is no infinite recursion.

2. *Each stopping case returns the correct value for that case:* The only stopping case is `power(x, 0)`. A call of the form `power(x, 0)` always returns 1, and the correct value for x^0 is 1. So the stopping case returns the correct value.
3. *For the cases that involve recursion—if all recursive calls return the correct value, then the final value returned by the function is the correct value:* The only case that involves recursion is when $n > 1$. When $n > 1$, `power(x, n)` returns

$$\text{power}(x, n - 1) * x$$

To see that this is the correct value to return, note that: if `power(x, n-1)` returns the correct value, then `power(x, n-1)` returns x^{n-1} and so `power(x, n)` returns

$$x^{n-1} * x, \text{ which is } x^n$$

and that is the correct value for `power(x, n)`.

That's all you need to check in order to be sure that the definition of `power` is correct. (This technique is known as *mathematical induction*, a concept that you may have heard about in a mathematics class. However, you do not need to be familiar with the term in order to use this technique.)

We gave you three criteria to use in checking the correctness of a recursive function that returns a value. Basically, the same rules can be applied to a recursive *void* function. If you show that your recursive *void* function definition satisfies the following three criteria, then you will know that your *void* function performs correctly:

Criteria for *void* functions

1. There is no infinite recursion.
2. Each stopping case performs the correct action for that case.
3. For each of the cases that involve recursion: *If* all recursive calls perform their actions correctly, *then* the entire case performs correctly.

CASE STUDY Binary Search—An Example of Recursive Thinking

In this case study we develop a recursive function that searches an array to find out whether it contains a specified value. For example, the array may contain a list of numbers for credit cards that are no longer valid. A store clerk needs to search the list to see if a customer's card is valid or invalid. In Chapter 7 (Display 7.10) we discussed a simple method for searching an array by simply checking every array element. In this section we will develop a method that is much faster for searching a sorted array.

The indexes of the array `a` are the integers 0 through `final_index`. In order to make the task of searching the array easier, we assume that the array is sorted. Hence, we know the following:

$$a[0] \leq a[1] \leq a[2] \leq \dots \leq a[\text{final_index}]$$

When searching an array, you are likely to want to know both whether the value is in the list and, if it is, where it is in the list. For example, if we are searching for a credit card number, then the array index may serve as a record number. Another array indexed by these same indexes may hold a phone number or other information to use for reporting the suspicious card. Hence, if the sought-after value is in the array, we will want our function to tell where that value is in the array.

Problem Definition

We will design our function to use two call-by-reference parameters to return the outcome of the search. One parameter, called *found*, will be of type *bool*. If the value is found, then *found* will be set to *true*. If the value is found, then another parameter, called *location*, will be set to the index of the value found. If we use *key* to denote the value being searched for, the task to be accomplished can be formulated precisely as follows:

Precondition: *a[0]* through *a[final_index]* are sorted in increasing order.

Postcondition: if *key* is not one of the values *a[0]* through *a[final_index]*, then *found == false*; otherwise, *a[location] == key* and *found == true*.

Algorithm Design

Now let us proceed to produce an algorithm to solve this task. It will help to visualize the problem in very concrete terms. Suppose the list of numbers is so long that it takes a book to list them all. This is in fact how invalid credit card numbers are distributed to stores that do not have access to computers. If you are a clerk and are handed a credit card, you must check to see if it is on the list and hence invalid.

How would you proceed? Open the book to the middle and see if the number is there. If it is not and it is smaller than the middle number, then work backward toward the beginning of the book. If the number is larger than the middle number, you work your way toward the end of the book. This idea produces our first draft of an algorithm:

```
found = false; //so far.
mid = approximate midpoint between 0 and final_index;
if (key == a[mid])
{
    found = true;
    location = mid;
}
else if (key < a[mid])
    search a[0] through a[mid - 1];
else if (key > a[mid])
    search a[mid + 1] through a[final_index];
```

Algorithm—first
version

Since the searchings of the shorter lists are smaller versions of the very task we are designing the algorithm to perform, this algorithm naturally lends

itself to the use of recursion. The smaller lists can be searched with recursive calls to the algorithm itself.

Our pseudocode is a bit too imprecise to be easily translated into C++ code. The problem has to do with the recursive calls. There are two recursive calls shown:

```
search a[0] through a[mid - 1];
```

and

```
search a[mid + 1] through a[final_index];
```

More parameters

To implement these recursive calls, we need two more parameters. A recursive call specifies that a subrange of the array is to be searched. In one case it is the elements indexed by 0 through mid-1. In the other case it is the elements indexed by mid+1 through final_index. The two extra parameters will specify the first and last indexes of the search, so we will call them first and last. Using these parameters for the lowest and highest indexes, instead of 0 and final_index, we can express the pseudocode more precisely as follows:

Algorithm—first refinement

```
To search a[first] through a[last] do the following:
found = false; //so far.
mid = approximate midpoint between first and last;
if (key == a[mid])
{
    found = true;
    location = mid;
}
else if (key < a[mid])
    search a[first] through a[mid - 1];
else if (key > a[mid])
    search a[mid + 1] through a[last];
```

To search the entire array, the algorithm would be executed with first set equal to 0 and last set equal to final_index. The recursive calls will use other values for first and last. For example, the first recursive call would set first equal to 0 and last equal to the calculated value mid-1.

Stopping case algorithm—final version

As with any recursive algorithm, we must ensure that our algorithm ends rather than producing infinite recursion. If the sought-after number is found on the list, then there is no recursive call and the process terminates, but we need some way to detect when the number is not on the list. On each recursive call, the value of first is increased or the value of last is decreased. If they ever pass each other and first actually becomes larger than last, then we will know that there are no more indexes left to check and that the number key is not in the array. If we add this test to our pseudocode, we obtain a complete solution as shown in Display 14.5.

Coding

Now we can routinely translate the pseudocode into C++ code. The result is shown in Display 14.6. The function search is an implementation of the recursive algorithm given in Display 14.5. A diagram of how the function performs on a sample array is given in Display 14.7.

DISPLAY 14.5 Pseudocode for Binary Search

```
int a[Some_Size_Value];
```

Algorithm to search a[first] through a[last]

```
1 //Precondition:
2 //a[first]<= a[first + 1] <= a[first + 2] <= ... <= a[last]
```

To locate the value key:

```
1 if (first > last) //A stopping case
2     found = false;
3 else
4     {
5         mid = approximate midpoint between first and last;
6         if (key == a[mid]) //A stopping case
7             {
8                 found = true;
9                 location = mid;
10            }
11        else if key < a[mid] //A case with recursion
12            search a[first] through a[mid - 1];
13        else if key > a[mid] //A case with recursion
14            search a[mid + 1] through a[last];
15    }
```

DISPLAY 14.6 Recursive Function for Binary Search (part 1 of 2)

```
1 //Program to demonstrate the recursive function for binary search.
2 #include <iostream>
3 using namespace std;
4 const int ARRAY_SIZE = 10;
5
6
7 void search(const int a[], int first, int last,
8            int key, bool& found, int& location);
9 //Precondition: a[first] through a[last] are sorted in increasing order.
10 //Postcondition: if key is not one of the values a[first] through a[last],
11 //then found == false; otherwise, a[location] == key and found == true.
12
13
14 int main( )
15 {
16     int a[ARRAY_SIZE];
17     const int final_index = ARRAY_SIZE - 1;
18
```

(continued)

DISPLAY 14.6 Recursive Function for Binary Search (part 2 of 2)

<This portion of the program contains some code to fill and sort the array a. The exact details are irrelevant to this example.>

```
19     int key, location;
20     bool found;
21     cout << "Enter number to be located: ";
22     cin >> key;
23     search(a, 0, final_index, key, found, location);
24
25     if (found)
26         cout << key << " is in index location "
27             << location << endl;
28     else
29         cout << key << " is not in the array." << endl;
30
31     return 0;
32 }
33 void search(const int a[], int first, int last,
34            int key, bool& found, int& location)
35 {
36     int mid;
37     if (first > last)
38     {
39         found = false;
40     }
41     else
42     {
43         mid = (first + last)/2;
44
45         if (key == a[mid])
46         {
47             found = true;
48             location = mid;
49         }
50         else if (key < a[mid])
51         {
52             search(a, first, mid -1, key, found, location);
53         }
54         else if (key > a[mid])
55         {
56             search(a, mid + 1, last, key, found, location);
57         }
58     }
59 }
```

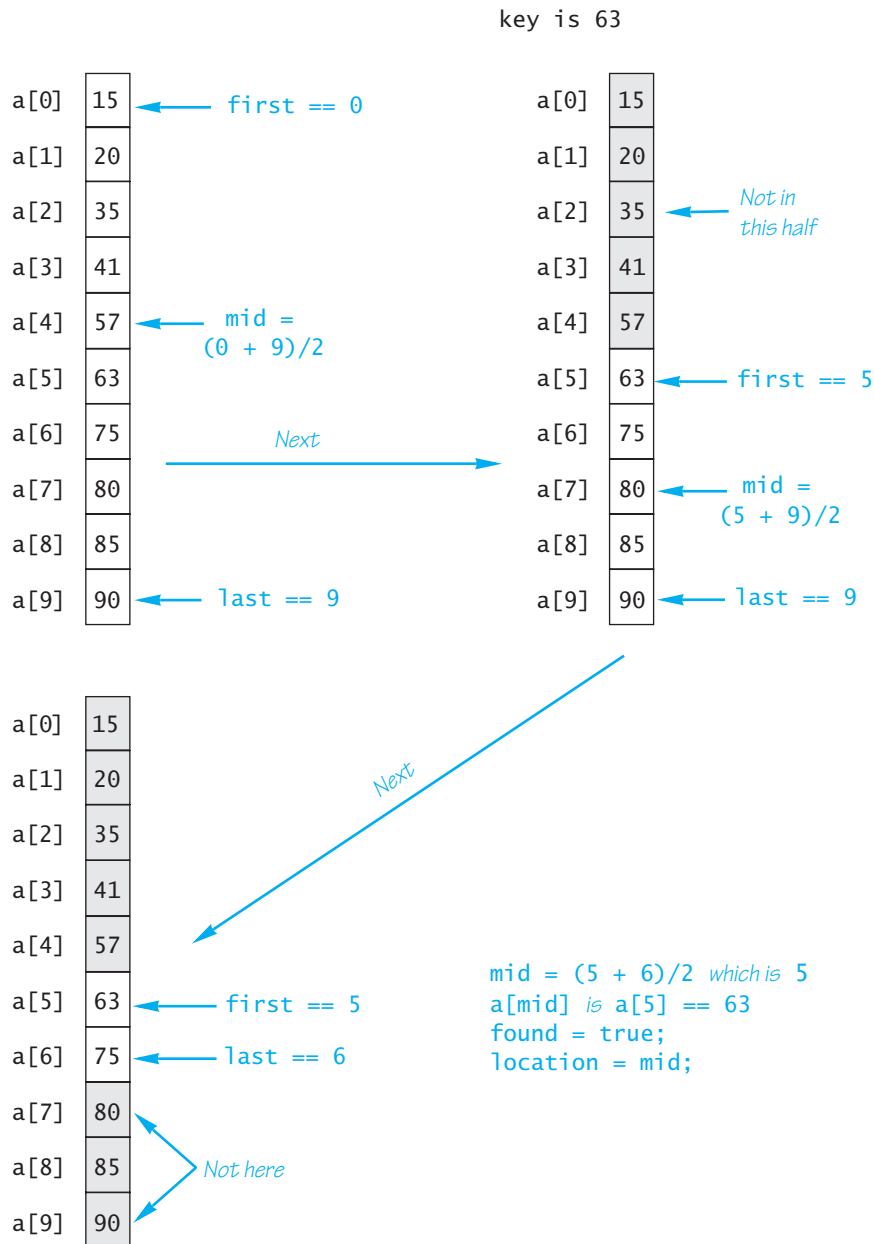
DISPLAY 14.7 Execution of the Function search

Solve a more general problem

Notice that the function `search` solves a more general problem than the original task. Our goal was to design a function to search an entire array. Yet the function will let us search any interval of the array by specifying the index bounds `first` and `last`. This is common when designing recursive functions. Frequently, it is necessary to solve a more general problem in order to be able to express the recursive algorithm. In this case, we only wanted the answer in the case where `first` and `last` are set equal to 0 and `final_index`. However, the recursive calls will set them to values other than 0 and `final_index`.

Checking the Recursion

In the subsection entitled “Recursive Design Techniques,” we gave three criteria that you should check to ensure that a recursive *void* function definition is correct. Let’s check these three things for the function `search` given in Display 14.6.

1. *There is no infinite recursion:* On each recursive call, the value of `first` is increased or the value of `last` is decreased. If the chain of recursive calls does not end in some other way, then eventually the function will be called with `first` larger than `last`, and that is a stopping case.
2. *Each stopping case performs the correct action for that case:* There are two stopping cases: when `first > last` and when `key==a[mid]`. Let’s consider each case.

If `first > last`, there are no array elements between `a[first]` and `a[last]`, and so `key` is not in this segment of the array. (Nothing is in this segment of the array!) So, if `first > last`, the function `search` correctly sets `found` equal to *false*.

If `key==a[mid]`, the algorithm correctly sets `found` equal to *true* and `location` equal to `mid`. Thus, both stopping cases are correct.

3. *For each of the cases that involve recursion, if all recursive calls perform their actions correctly, then the entire case performs correctly:* There are two cases in which there are recursive calls: when `key < a[mid]` and when `key > a[mid]`. We need to check each of these two cases.

First suppose `key < a[mid]`. In this case, since the array is sorted, we know that if `key` is anywhere in the array, then `key` is one of the elements `a[first]` through `a[mid-1]`. Thus, the function need only search these elements, which is exactly what the recursive call

```
search(a, first, mid - 1, key, found, location);
```

does. So if the recursive call is correct, then the entire action is correct.

Next, suppose `key > a[mid]`. In this case, since the array is sorted, we know that if `key` is anywhere in the array, then `key` is one of the elements `a[mid+1]` through `a[last]`. Thus, the function need search only these elements, which is exactly what the recursive call

```
search(a, mid + 1, last, key, found, location);
```

does. So if the recursive call is correct, then the entire action is correct. Thus, in both cases the function performs the correct action (assuming that the recursive calls perform the correct action).

The function `search` passes all three of our tests, so it is a good recursive function definition.

Efficiency

The binary search algorithm is extremely fast compared to an algorithm that simply tries all array elements in order. In the binary search, you eliminate about half the array from consideration right at the start. You then eliminate a quarter, then an eighth of the array, and so forth. These savings add up to a dramatically fast algorithm. For an array of 100 elements, the binary search will never need to compare more than 7 array elements to the key. A simple serial search could compare as many as 100 array elements to the key and on the average will compare about 50 array elements to the key. Moreover, the larger the array is, the more dramatic the savings will be. On an array with 1000 elements, the binary search will need to compare only about 10 array elements to the key value, as compared to an average of 500 for the simple serial search algorithm.

An iterative version of the function `search` is given in Display 14.8. On some systems, the iterative version will run more efficiently than the recursive version. The algorithm for the iterative version was derived by mirroring the recursive version. In the iterative version, the local variables `first` and `last` mirror the roles of the parameters in the recursive version, which are also named `first` and `last`. As this example illustrates, it often makes sense to derive a recursive algorithm even if you expect to later convert it to an iterative algorithm.

Iterative version

DISPLAY 14.8 Iterative Version of Binary Search (part 1 of 2)

Function Declaration

```
1 void search(const int a[], int low_end, int high_end,
2 int key, bool& found, int& location);
3 //Precondition: a[low_end] through a[high_end] are sorted in increasing
4 //order.
5 //Postcondition: If key is not one of the values a[low_end] through
6 //a[high_end], then found == false; otherwise, a[location] == key and
7 //found == true.
```

Function Definition

```
1 void search(const int a[], int low_end, int high_end,
2 int key, bool& found, int& location)
3 {
4 int first = low_end;
5 int last = high_end;
```

(continued)

DISPLAY 14.8 Iterative Version of Binary Search (part 2 of 2)

```
6     int mid;
7
8     found = false; //so far
9     while ( (first <= last) && !(found) )
10    {
11        mid = (first + last)/2;
12        if (key == a[mid])
13        {
14            found = true;
15            location = mid;
16        }
17        else if (key < a[mid])
18        {
19            last = mid -1;
20        }
21        else if (key > a[mid])
22        {
23            first = mid + 1;
24        }
25    }
26 }
```

PROGRAMMING EXAMPLE**A Recursive Member Function**

A member function of a class can be recursive. Member functions can use recursion in the same way that ordinary functions do. Display 14.9 contains an example of a recursive member function. The class `BankAccount` used in that display is the same as the class named `BankAccount` that was defined in Display 10.6, except that we have overloaded the member function name `update`. The first version of `update` has no arguments and posts one year of simple interest to the bank account balance. The other (new) version of `update` takes an `int` argument that is some number of years. This member function updates the account by posting the interest for that many years. The new version of `update` is recursive; has one parameter, called `years`; and uses the following algorithm:

If the number of years is 1, then *//Stopping case*:

 call the other function named `update` (the one with no arguments).

If the number of years is greater than 1, then *//Recursive case*:

 make a recursive call to post `years-1` worth of interest, and then call the other function called `update` (the one with no arguments) to post one more year's worth of interest.

DISPLAY 14.9 A Recursive Member Function (part 1 of 2)

```

1  //Program to demonstrate the recursive member function update(years).
2  #include <iostream>
3  using namespace std;
4
5  //Class for a bank account:
6  class BankAccount
7  {
8  public:
9      BankAccount(int dollars, int cents, double rate);
10     //Initializes the account balance to $dollars.cents and
11     //initializes the interest rate to rate percent.
12
13     BankAccount(int dollars, double rate);
14     //Initializes the account balance to $dollars.00 and
15     //initializes the interest rate to rate percent.
16
17     BankAccount( );
18     //Initializes the account balance to $0.00 and
19     //initializes the interest rate to 0.0%.
20
21     void update( );
22     //Postcondition: One year of simple interest
23     //has been added to the account balance.
24
25     void update(int years);
26     //Postcondition: Interest for the number of years given has been added to the
27     //account balance. Interest is compounded annually.
28
29     double get_balance( );
30     //Returns the current account balance.
31
32     double get_rate( );
33     //Returns the current account interest rate as a percentage.
34
35     void output(ostream& outs);
36     //Precondition: If outs is a file output stream, then outs has already
37     //been connected to a file.
38     //Postcondition: Balance & interest rate have been written to the stream outs.
39 private:
40     double balance;
41     double interest_rate;
42     double fraction(double percent); //Converts a percentage to a fraction.
43 };
44
45 int main( )
46 {
47     BankAccount your_account(100, 5);
48     your_account.update(10);
49     cout.setf(ios::fixed);

```

The class `BankAccount` in this program is an improved version of the class `BankAccount` given in Display 10.6.

Two different functions with the same name

(continued)

DISPLAY 14.9 A Recursive Member Function (part 2 of 2)

```

42     cout.setf(ios::showpoint);
43     cout.precision(2);
44     cout << "If you deposit $100.00 at 5% interest, then\n"
45         << "in ten years your account will be worth $"
46         << your_account.get_balance( ) << endl;
47     return 0;
48 }
49
50 void BankAccount::update( )
51 {
52     balance = balance + fraction(interest_rate)*balance;
53 }
54
55 void BankAccount::update(int years)
56 {
57     if (years == 1)
58     {
59         update( );
60     }
61     else if (years > 1)
62     {
63         update(years - 1);
64         update( );
65     }
66 }

```

Overloading (that is, calls to another function with the same name)

Recursive function call

<Definitions of the other member functions are given in Display 10.5 and Display 10.6, but you need not read those definitions in order to understand this example.>

Sample Dialogue

If you deposit \$100.00 at 5% interest, then
in ten years your account will be worth \$162.89

It is easy to see that this algorithm produces the desired result by checking the three points given in the subsection entitled “Recursive Design Techniques.”

1. *There is no infinite recursion:* Each recursive call reduces the number of years by 1 until the number of years eventually becomes 1, which is the stopping case. So there is no infinite recursion.
2. *Each stopping case performs the correct action for that case:* The one stopping case is when `years==1`. This case produces the correct action, since it simply calls the other overloaded member function called `update`, and we checked the correctness of that function in Chapter 10.

3. *For the cases that involve recursion, if all recursive calls perform correctly, then the entire case performs correctly:* The recursive case—that is, `years>1`—works correctly, because if the recursive call correctly posts `years-1` worth of interest, then all that is needed is to post one additional year's worth of interest and the call to the overloaded zero-argument version of `update` will correctly post one year's worth of interest. Thus, *if the recursive call performs the correct action, then the entire action for the case of `years>1` will be correct.*

In this example, we have overloaded `update` so that there are two different functions named `update`: one that takes no arguments and one that takes a single argument. Do not confuse the calls to the two functions named `update`. These are two different functions that, as far as the compiler is concerned, just coincidentally happen to have the same name. When the definition of the function `update` with one argument includes a call to the version of `update` that takes no arguments, that is not a recursive call. Only the call to the version of `update` with the *exact* same function declaration is a recursive call. To see what is involved here, note that we could have named the version of `update` that takes no argument `post_one_year()`, instead of naming it `update()`, and then the definition of the recursive version of `update` would read as follows:

Overloading

```
void BankAccount::update(int years)
{
    if (years == 1)
    {
        post_one_year();
    }
    else if (years > 1)
    {
        update(years - 1);
        post_one_year();
    }
}
```

Recursion and Overloading

Do not confuse recursion and overloading. When you overload a function name, you are giving two different functions the same name. If the definition of one of these two functions includes a call to the other, that is not recursion. In a recursive function definition, the definition of the function includes a call to the *exact* same function with the *exact same definition*, not to some other function that coincidentally uses the same name. It is not too serious an error if you confuse overloading and recursion, since they are both legal. It is simply a question of getting the terminology straight so that you can communicate clearly with other programmers and so that you understand the underlying processes.

SELF-TEST EXERCISES

15. Write a recursive function definition for the following function:

```
int squares(int n);
//Precondition: n >= 1
//Returns the sum of the squares of numbers 1 through n.
```

For example, `squares(3)` returns 14 because $1^2 + 2^2 + 3^2$ is 14.

16. Write an iterative version of the one-argument member function `BankAccount::update(int years)` that is described in Display 14.9.

CHAPTER SUMMARY

- If a problem can be reduced to smaller instances of the same problem, then a recursive solution is likely to be easy to find and implement.
- A recursive algorithm for a function definition normally contains two kinds of cases: one or more cases that include at least one recursive call and one or more stopping cases in which the problem is solved without any recursive calls.
- When writing a recursive function definition, always confirm that the function will not produce infinite recursion.
- When you define a recursive function, use the three criteria given in the subsection “Recursive Design Techniques” to confirm that the function is correct.
- When you design a recursive function to solve a task, it is often necessary to solve a more general problem than the given task. This may be required to allow for the proper recursive calls, since the smaller problems may not be exactly the same problem as the given task. For example, in the binary search problem, the task was to search an entire array, but the recursive solution is an algorithm to search any portion of the array (either all of it or a part of it).

Answers to Self-Test Exercises

1. Hip Hip Hurray
2.

```
void stars(int n)
{
    cout << '*';
    if (n > 1)
        stars(n - 1);
}
```

The following is also correct but is more complicated:

```
void stars(int n)
{
    if (n <= 1)
    {
        cout << '*';
    }
    else
    {
        stars(n - 1);
        cout << '*';
    }
}
```

3. `void backward(int n)`

```
{
    if (n < 10)
    {
        cout << n;
    }
    else
    {
        cout << (n % 10); //write last digit
        backward(n / 10); //write the other digits backward
    }
}
```

4. and 5. The answer to 4 is `write_up(int n);`. The answer to 5 is `write_down(int n);`.

```
#include <iostream>
using namespace std;
void write_down(int n)
{
    if (n >= 1)
    {
        cout << n << " ";
        write_down(n - 1);
    }
}
```

```
void write_up(int n)
{
    if (n >= 1)
    {
        write_up(n - 1);
        cout << n << " ";
    }
}
```

```

//testing code for both #4 and #5
int main()
{
    cout << "calling write_up(" << 10 << ")\n";
    write_up(10);
    cout << endl;
    cout << "calling write_down(" << 10 << ")\n";
    write_down(10);
    cout << endl;
    return 0;
}
/* Test results
calling write_up(10)
1 2 3 4 5 6 7 8 9 10
calling write_down(10)
10 9 8 7 6 5 4 3 2 1
*/

```

6. An error message that says *stack overflow* is telling you that the computer has attempted to place more activation frames on the stack than are allowed on your system. A likely cause of this error message is infinite recursion.

7. `void` cheers(`int` n)

```

{
    while (n > 1)
    {
        cout << "Hip ";
        n--;
    }
    cout << "Hurray\n";
}

```

8. `void` stars(`int` n)

```

{
    for (int count = 1; count <= n; count++)
        cout << '*';
}

```

9. `void` backward(`int` n)

```

{
    while (n >= 10)
    {
        cout << (n % 10); //write last digit
        n = n / 10; //discard the last digit
    }
    cout << n;
}

```

10. Trace for Exercise 4: If $n = 3$, the code to be executed is

```
if ( 3 >= 1 )
{
    write_up( 3 - 1 );
    cout << 3 << " ";
}
}
```

On the next recursion, $n = 2$; the code to be executed is

```
if ( 2 >= 1 )
{
    write_up( 2 - 1 );
    cout << 2 << " ";
}
}
```

On the next recursion, $n = 1$ and the code to be executed is

```
if ( 1 >= 1 )
{
    write_up( 1 - 1 );
    cout << 1 << " ";
}
}
```

On the final recursion, $n = 0$ and the code to be executed is

```
if ( 0 >= 1 ) // condition false, body skipped
{
    // skipped
}
}
```

The recursions unwind; the output (obtained while recursion was winding up) is 1 2 3.

11. Trace for Exercise 5: If $n = 3$, the code to be executed is

```
if ( 3 >= 1 )
{
    cout << 3 << " ";
    write_down(3 - 1);
}
}
```

Next recursion, $n = 2$, the code to be executed is

```
if ( 2 >= 1 )
{
    cout << 2 << " ";
    write_down(2 - 1)
}
}
```

Next recursion, $n = 1$, the code to be executed is

```
if ( 1 >= 1 )
```



```

    {
        cout << 1 << " ";
        write_down(1 - 1)
    }

```

Final recursion, $n = 0$, and the "true" clause is not executed:

```

if (0 >= 1 ) // condition false
{
    // this clause is skipped
}

```

The output is 3 2 1.

12. 6

13. The output is 24. The function is the factorial function, usually written $n!$ and defined as follows:

$n!$ is equal to $n * (n - 1) * (n - 2) * \dots * 1$

14. //Uses *iostream* and *cstdlib*:

```

double power(int x, int n)
{
    if (n < 0 && x == 0)
    {
        cout << "Illegal argument to power.\n";
        exit(1);
    }

    if (n < 0)
        return ( 1/power(x, -n));
    else if (n > 0)
        return ( power(x, n - 1)*x );
    else // n == 0
        return (1.0);
}

```

15. *int* squares(*int* n)

```

{
    if (n <= 1)
        return 1;
    else
        return ( squares(n - 1) + n * n );
}

```

16. *void* BankAccount::update(*int* years)

```

{
    for (int count = 1; count <= years; count++)
        update( );
}

```

PRACTICE PROGRAMS

Practice Programs can generally be solved with a short program that directly applies the programming principles presented in this chapter.

1. Write a recursive function definition for a function that has one parameter n of type `int` and that returns the n th Fibonacci number. See Programming Project 6 in Chapter 3 for the definition of Fibonacci numbers. Embed the function in a program and test it.
2. Write a recursive version of the function `index_of_smallest` that was used in the sorting program in Display 7.12 of Chapter 7. Embed the function in a program and test it.
3. Write a recursive version of the search function in Display 7.10 of Chapter 7.
4. There are n people in a room, where n is an integer greater than or equal to 2. Each person shakes hands once with every other person. What is the total number of handshakes in the room? Write a recursive function to solve this problem, with the following header:

```
int handshake(int n)
```

where `handshake(n)` returns the total number of handshakes for n people in the room. To get you started, if there are only one or two people in the room, then:

```
handshake(1) = 0
handshake(2) = 1
```

5. Write a recursive function that returns `true` if an input string is a palindrome and `false` if it is not. You can do this by checking if the first character equals the last character, and if so, make a recursive call with the input string minus the first and last characters. You will have to define a suitable stopping condition. Test your function with several palindromes and non-palindromes.



VideoNote
Solution to Practice
Program 14.4

PROGRAMMING PROJECTS

Programming Projects require more problem-solving than Practice Programs and can usually be solved many different ways. Visit www.myprogramminglab.com to complete many of these Programming Projects online and get instant feedback.

1. The formula for computing the number of ways of choosing r different things from a set of n things is the following:

$$C(n, r) = n! / (r! * (n - r)!)$$

The factorial function $n!$ is defined by

$$n! = n * (n - 1) * (n - 2) * \dots * 1$$

Discover a recursive version of this formula and write a recursive function that computes the value of the formula. Embed the function in a program and test it.

- Write a recursive function that has an argument that is an array of characters and two arguments that are bounds on array indexes. The function should reverse the order of those entries in the array whose indexes are between the two bounds. For example, if the array is

```
a[0] == 'A' a[1] == 'B' a[2] == 'C' a[3] == 'D' a[4] == 'E'
```

and the bounds are 1 and 4, then after the function is run the array elements should be

```
a[0] == 'A' a[1] == 'E' a[2] == 'D' a[3] == 'C' a[4] == 'B'
```

Embed the function in a program and test it. After you have fully debugged this function, define another function that takes a single argument which is an array that contains a string value and that reverses the spelling of the string value in the array argument. This function will include a call to the recursive definition you did for the first part of this project. Embed this second function in a program and test it.

- Write an iterative version of the recursive function in Programming Project 1. Embed it in a program and test it.
- Write a recursive function to sort an array of integers into ascending order using the following idea: Place the smallest element in the first position, then sort the rest of the array by a recursive call. This is a recursive version of the selection sort algorithm discussed in Chapter 7. (*Note:* Simply taking the program from Chapter 7 and plugging in a recursive version of `index_of_smallest` will not suffice. The function to do the sorting must itself be recursive and not merely use a recursive function.)
- Towers of Hanoi: There is a story about Buddhist monks who are playing this puzzle with 64 stone disks. The story claims that when the monks finish moving the disks from one post to a second via the third post, time will end.

A stack of n disks of decreasing size is placed on one of three posts. The task is to move the disks one at a time from the first post to the second. To do this, any disk can be moved from any post to any other post, subject to the rule that you can never place a larger disk over a smaller disk. The (spare) third post is provided to make the solution possible. Your task is to write a recursive function that describes instructions for a solution to



this problem. We don't have graphics available, so you should output a sequence of instructions that will solve the problem.

(*Hint:* If you could move up $n-1$ of the disks from the first post to the third post using the second post as a spare, the last disk could be moved from the first post to the second post. Then by using the same technique (whatever that may be) you can move the $n-1$ disks from the third post to the second post, using the first disk as a spare. There! You have the puzzle solved. You only have to decide what the nonrecursive case is, what the recursive case is, and when to output instructions to move the disks.)

6. The game of "Jump It" consists of a board with n positive integers in a row, except for the first column, which always contains 0. These numbers represent the cost to enter each column. Here is a sample game board where n is 6:

0	3	80	6	57	10
---	---	----	---	----	----

The object of the game is to move from the first column to the last column with the lowest total cost. The number in each column represents the cost to enter that column. You always start the game in the first column and have two types of moves. You can either move to the adjacent column or jump over the adjacent column to land two columns over. The cost of a game is the sum of the costs of the columns visited.

In the board shown above, there are several ways to get to the end. Starting in the first column, our cost so far is 0. We could jump to 80, then jump to 57, then move to 10 for a total cost of $80 + 57 + 10 = 147$. However, a cheaper path would be to move to 3, jump to 6, then jump to 10, for a total cost of $3 + 6 + 10 = 19$.

Write a recursive solution to this problem that computes the lowest cost of the game and outputs this value for an arbitrarily large game board represented as an array. Your program doesn't have to output the actual sequence of jumps, only the lowest cost of this sequence. After making sure that your solution works on small arrays, test it on boards of larger and larger values of n to get a feel for the scalability and efficiency of your solution.

7. Suppose we can buy chocolate bars from the vending machine for \$1 each. Inside every chocolate bar is a coupon. We can redeem 7 coupons for 1 chocolate bar from the machine. We would like to know how many chocolate bars can be eaten, including those redeemed via coupon, if we have n dollars.

For example, if we have \$20, then we can initially buy 20 chocolate bars. This gives us 20 coupons. We can redeem 14 coupons for 2 additional chocolate bars. These two additional chocolate bars have 2 more coupons,

so we now have a total of 8 coupons when added to the 6 left over from the original purchase. This gives us enough to redeem for 1 final chocolate bar. As a result we now have 23 chocolate bars and 2 leftover coupons.

Write a recursive solution to this problem that inputs from the user the number of dollars to spend on chocolate bars and outputs how many chocolate bars you can collect after spending all your money and redeeming as many coupons as possible. Your recursive function will be based upon the number of coupons owned.

8. Some problems require finding all permutations (different orderings) of a set of items. For a set of n items $\{ a_1, a_2, a_3, \dots, a_n \}$ there are $n!$ permutations. For example, given the set $\{1, 2, 3\}$ there are six permutations:

$\{3, 2, 1\}$ $\{2, 3, 1\}$ $\{2, 1, 3\}$ $\{3, 1, 2\}$ $\{1, 3, 2\}$ $\{1, 2, 3\}$

Write a recursive function that generates all the permutations of a set of numbers. The general outline of a solution is given here, but the implementation is up to you. The program will require storing a set of permutations of numbers that you can implement in many ways (for example, linked lists of nodes, linked lists of vectors, arrays, etc.) Your program should call the recursive function with sets of several different sizes, printing the resulting set of permutations for each.

One solution is to first leave out the n th item in the set. Recursively find all permutations using the set of $(n-1)$ items. If we insert the n th item into each position for all of these permutations, then we get a new set of permutations that includes the n th item. The base case is when there is only one item in the set, in which case the solution is simply the permutation with the single item.

For example, consider finding all permutations of $\{1, 2, 3\}$. We leave the 3 out and recursively find all permutations of the set $\{1, 2\}$. This consists of the permutations:

$\{1, 2\}$ $\{2, 1\}$

Next we insert the 3 into every position for these permutations. For the first permutation, we insert the 3 in the front, between 1 and 2, and after 2. For the second permutation, we insert the 3 in the front, between 2 and 1, and after 1:

$\{3, 1, 2\}$ $\{1, 3, 2\}$ $\{1, 2, 3\}$ $\{3, 2, 1\}$ $\{2, 3, 1\}$ $\{2, 1, 3\}$

The resulting six permutations comprise all permutations of the set $\{1, 2, 3\}$.

9. The word ladder game was invented by Lewis Carroll in 1877. The idea is to begin with a start word and change one letter at a time until arriving at an end word. Each word along the way must be an English word.

For example, starting from FISH you can make a word ladder to MAST through the following ladder:

FISH, WISH, WASH, MASH, MAST

Write a program that uses recursion to find the word ladder given a start word and an end word, or determines if no word ladder exists. Use the file `words.txt` that is available online with the source code for the book as your dictionary of valid words. This file contains 87314 words. Your program does not need to find the shortest word ladder between words, any word ladder will do if one exists.

This page intentionally left blank

Inheritance 15

15.1 INHERITANCE BASICS 834

Derived Classes 837

Constructors in Derived Classes 845

Pitfall: Use of Private Member Variables from the Base Class 848

Pitfall: Private Member Functions Are Effectively Not Inherited 850

The *protected* Qualifier 850

Redefinition of Member Functions 853

Redefining Versus Overloading 856

Access to a Redefined Base Function 858

15.2 INHERITANCE DETAILS 859

Functions That Are Not Inherited 859

Assignment Operators and Copy Constructors in Derived Classes 860

Destructors in Derived Classes 861

15.3 POLYMORPHISM 862

Late Binding 863

Virtual Functions in C++ 864

Virtual Functions and Extended Type Compatibility 869

Pitfall: The Slicing Problem 873

Pitfall: Not Using Virtual Member Functions 874

Pitfall: Attempting to Compile Class Definitions Without Definitions for Every Virtual Member Function 875

Programming Tip: Make Destructors Virtual 875



With all appliances and means to boot.

WILLIAM SHAKESPEARE, *King Henry IV, Part III*

INTRODUCTION

Object-oriented programming is a popular and powerful programming technique. Among other things, it provides for a new dimension of abstraction known as *inheritance*. This means that a very general form of a class can be defined and compiled. Later, more specialized versions of that class can be defined and can inherit all the properties of the previous class. Facilities for inheritance are available in all versions of C++.

PREREQUISITES

Section 15.1 uses material from Chapters 2 to 8 and 10 to 12. Sections 15.2 and 15.3 use material from Chapters 9 and 13 in addition to Chapters 2 to 8, 10 to 12, and Section 15.1.

15.1 INHERITANCE BASICS

If there is anything that we wish to change in the child, we should first examine it and see whether it is not something that could better be changed in ourselves.

CARL GUSTAV JUNG, *The Integration of the Personality*

One of the most powerful features of C++ is the use of inheritance to derive one class from another. **Inheritance** is the process by which a new class—known as a **derived class**—is created from another class, called the **base class**. A derived class automatically has all the member variables and functions that the base class has and can have additional member functions and/or additional member variables.

In Chapter 10, we noted that saying that class D is derived from another class B means that class D has all the features of class B and some extra, added features as well. When a class D is derived from a class B, we say that B is the base class and D is the derived class. We also say that D is the **child class** and B is the **parent class**.¹

¹ Some authors speak of a *subclass* D and *superclass* B instead of derived class D and base class B. However, we have found the terms *derived class* and *base class* to be less confusing. We only mention this in an effort to help you to read other texts.

As an example to illustrate the usefulness of inheritance, imagine that you've set up a home automation system where your garage door and furnace thermostat are networked and accessible from your computer. You would like to control and interrogate the status of these devices (e.g., door is open, thermostat set to 80 degrees) from your computer. This would be much easier to accomplish if there was a consistent interface for these disparate devices. Inheritance lets us do this while providing a way to organize our code without duplication.

First, consider the general concept of a device in the home automation system. Every device must have a model and serial number. Perhaps every device also has a way to query its status. We could model this with a `Device` class that has variables for the model and serial number, and a function for the status. The idea is that this class contains functions and properties that are common to every possible device.

Second, consider the garage door. This is a specific type of device in the automation system. In addition to having a model, serial number, and way to query its status like every other device, the garage door device also has a specific function to open or close the door. We can model the garage door with a `DoorDevice` class. We will need to add an `openClose()` function to this class. The `DoorDevice` class is also where we would know how to return the status of the device. At the level of the generic `Device` class we don't have the needed information to return the status of a specific device because at that level we don't even know what kind of device we are working with. While we need to add functions to `DoorDevice` for the status and to open/close the door, it would be nice if we didn't have to duplicate the variables and code to manipulate the model and serial number that we wrote for the `Device` class.

Similarly, the thermostat device will also have a model, serial number, and way to query its status in addition to a function to set the temperature. We can define a `ThermostatDevice` class with functions to set the temperature and return the status of the device, but it would be nice if we didn't again have to duplicate the variables and code to manipulate the model and serial number that we wrote for the `Device` class!

We can solve this problem with inheritance. In this case, `DoorDevice` "IS-A" `Device` and `ThermostatDevice` "IS-A" `Device`. By defining `DoorDevice` and `ThermostatDevice` as derived classes from `Device`, then these classes (if the programmer specifies it) have access to the model and serial number defined in `Device` and we don't need to re-write any code in the `Device` class that deals with these variables. At the same time we can add specific code that is unique to our derived classes. The relationship between these classes is illustrated in Display 15.1.

Once the inheritance relationship is defined, then if we create an object of type `DoorDevice` or `ThermostatDevice` we will have access to functions and variables defined in `Device`. For example, if `thermostat` is a variable of type `ThermostatDevice` then we could access `thermostat.model` if `model` is a

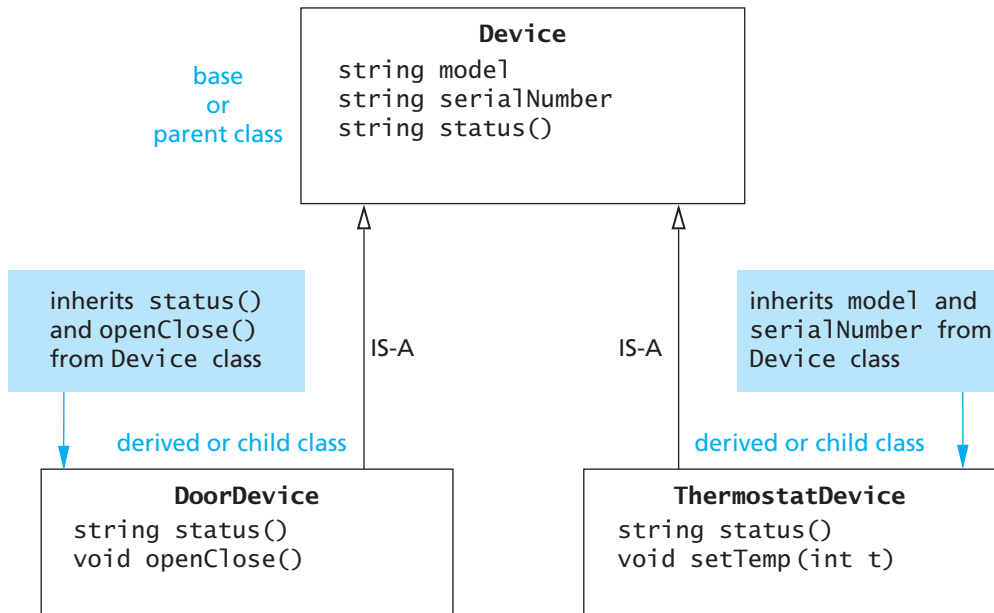
DISPLAY 15.1 Example Inheritance Hierarchy for Home Automation Devices

An object of type `DoorDevice` or `ThermostatDevice` includes functions and variables defined in `Device`, such as `model` and `serialNumber`.

The `status()` function can be *overridden*. If a `DoorDevice` object is treated like a `Device` object, then calling `status()` will invoke `DoorDevice`'s `status()` function, not `Device`'s `status()` function. This is necessary when the `Device` class doesn't know what to return as a status and only the derived classes can return the information.

public string variable in the `Device` class. This saves us the work of redefining the code and variables from the `Device` class.

We can specify the `status()` function to behave a bit differently. When we define the same function in both the base and derived classes then we will see later in the chapter that we have two options: *redefine* the function or *override* the function. In this case we want to override the function. If we had an object `thermostat` of type `ThermostatDevice`, but then treat `thermostat` instead like it is of type `Device` (for example, by passing `thermostat` to a function where the parameter is defined to be of type `Device`), then invoking `status()` will call the definition associated with `ThermostatDevice` rather than the definition associated with `Device`. This behavior is important in this case because the `Device` class doesn't know what to return as the status! This topic is explored in more detail in section 15.3.

For another example where inheritance can be applied, consider the CD account in Chapter 10. We discussed how a CD account is a more specialized version of a savings account. By deriving the class `CDAccount` from `SavingsAccount`, we automatically inherit all of the `SavingsAccount` public functions and variables when we create a `CDAccount` object. C++ uses inheritance in predefined classes as well. In using streams for file I/O, the predefined class `ifstream` is derived from the (predefined) class `istream` by adding member functions such as `open` and `close`. The stream `cin` belongs to the class of all input streams (that is, the class `istream`), but it does not belong to the class of input-file streams (that is, does not belong to `ifstream`), partly because it lacks the member functions `open` and `close` of the derived class `ifstream`.

Derived Classes

Suppose we are designing a record-keeping program that has records for salaried employees and hourly employees. There is a natural hierarchy for grouping these classes. These are all classes of people who share the property of being employees.

Employees who are paid an hourly wage are one subset of employees. Another subset consists of employees who are paid a fixed wage each month or each week. Although the program may not need any type corresponding to the set of all employees, thinking in terms of the more general concept of employees can be useful. For example, all employees have names and Social Security numbers, and the member functions for setting and changing names and Social Security numbers will be the same for salaried and hourly employees.

Within C++ you can define a class called `Employee` that includes all employees, whether salaried or hourly, and then use this class to define classes for hourly employees and salaried employees. Displays 15.2 and 15.3 show one possible definition for the class `Employee`.

You can have an (undifferentiated) `Employee` object, but our reason for defining the class `Employee` is so that we can define derived classes for different kinds of employees. In particular, the function `print_check` will always have its definition changed in derived classes so that different kinds of employees can have different kinds of checks. This is reflected in the definition of the function `print_check` for the class `Employee` (Display 15.3). It makes little sense to print a check for such an (undifferentiated) `Employee`. We know nothing about this employee's salary details. Consequently, we implemented the function `print_check` of the class `Employee` so that the program stops with an error message if `print_check` is called for a base class `Employee` object. As you will see, derived classes will have enough information to redefine the function `print_check` to produce meaningful employee checks.

A class that is derived from the class `Employee` will automatically have all the member variables of the class `Employee` (`name`, `ssn`, and `net_pay`). A class that is derived from the class `Employee` will also have all the member functions of the class `Employee`, such as `print_check`, `get_name`, `set_name`, and the other

DISPLAY 15.2 Interface for the Base Class Employee

```
1 //This is the header file employee.h.
2 //This is the interface for the class Employee.
3 //This is primarily intended to be used as a base class to derive
4 //classes for different kinds of employees.
5 #ifndef EMPLOYEE_H
6 #define EMPLOYEE_H

7 #include <string>
8 using namespace std;

9 namespace employeessavitch
10 {

11     class Employee
12     {
13     public:
14         Employee( );
15         Employee(string the_name, string the_ssn);
16         string get_name( ) const;
17         string get_ssn( ) const;
18         double get_net_pay( ) const;
19         void set_name(string new_name);
20         void set_ssn(string new_ssn);
21         void set_net_pay(double new_net_pay);
22         void print_check( ) const;
23     private:
24         string name;
25         string ssn;
26         double net_pay;
27     };

28 } //employeessavitch

29 #endif //EMPLOYEE_H
```

member functions listed in Display 15.2. This is usually expressed by saying that the derived class **inherits** the member variables and member functions.

The interface files with the class definitions of two derived classes of the class `Employee` are given in Displays 15.4 (`HourlyEmployee`) and 15.5 (`SalariedEmployee`). We have placed the class `Employee` and the two derived classes in the same namespace. C++ does not require that they be in the same namespace, but since they are related classes, it makes sense to put them there. We will first discuss the derived class `HourlyEmployee` given in Display 15.4.

Note that the definition of a derived class begins like any other class definition but adds a colon, the reserved word *public*, and the name of the

DISPLAY 15.3 Implementation for the Base Class `Employee` (part 1 of 2)

```
1 //This is the file: employee.cpp.
2 //This is the implementation for the class Employee.
3 //The interface for the class Employee is in the header file employee.h.
4 #include <string>
5 #include <cstdlib>
6 #include <iostream>
7 #include "employee.h"
8 using namespace std;

9 namespace employeessavitch
10 {
11     Employee::Employee() : name("No name yet"), ssn("No number yet"), net_pay(0)
12     {
13         //deliberately empty
14     }

15     Employee::Employee(string the_name, string the_number)
16         : name(the_name), ssn(the_number), net_pay(0)
17     {
18         //deliberately empty
19     }

20     string Employee::get_name() const
21     {
22         return name;
23     }

24     string Employee::get_ssn() const
25     {
26         return ssn;
27     }

28
29     double Employee::get_net_pay() const
30     {
31         return net_pay;
32     }

33     void Employee::set_name(string new_name)
34     {
35         name = new_name;
36     }
37     void Employee::set_ssn(string new_ssn)
38     {
39         ssn = new_ssn;
40     }
```

(continued)

DISPLAY 15.3 Implementation for the Base Class Employee (part 2 of 2)

```

41     void Employee::set_net_pay (double new_net_pay)
42     {
43         net_pay = new_net_pay;
44     }

45     void Employee::print_check( ) const
46     {
47         cout << "\nERROR: print_check FUNCTION CALLED FOR AN \n"
48             << "UNDIFFERENTIATED EMPLOYEE. Aborting the program.\n"
49             << "Check with the author of the program about this bug.\n";
50         exit(1);
51     }

52 }//employeessavitch

```

DISPLAY 15.4 Interface for the Derived Class HourlyEmployee (part 1 of 2)

```

1 //This is the header file hourlyemployee.h.
2 //This is the interface for the class HourlyEmployee.
3 #ifndef HOURLYEMPLOYEE_H
4 #define HOURLYEMPLOYEE_H

5 #include <string>
6 #include "employee.h"

7 using namespace std;
8 namespace employeessavitch
9 {

10     class HourlyEmployee : public Employee
11     {
12     public:
13         HourlyEmployee( );
14         HourlyEmployee(string the_name, string the_ssn,
15             double the_wage_rate, double the_hours);
16         void set_rate(double new_wage_rate);
17         double get_rate( ) const;
18         void set_hours(double hours_worked);
19         double get_hours( ) const;

```

(continued)

DISPLAY 15.4 Interface for the Derived Class `HourlyEmployee` (part 2 of 2)

```

20     void print_check( );
21     private:
22         double wage_rate;
23         double hours;
24     };

25 } //employeessavitch

26 #endif //HOURLY_EMPLOYEE_H

```

You only list the declaration of an inherited member function if you want to change the definition of the function.

DISPLAY 15.5 Interface for the Derived Class `SalariedEmployee`

```

1 //This is the header file salariedemployee.h.
2 //This is the interface for the class SalariedEmployee.
3 #ifndef SALARIEDEMPLOYEE_H
4 #define SALARIEDEMPLOYEE_H

5 #include <string>
6 #include "employee.h"

7 using namespace std;

8 namespace employeessavitch
9 {

10     class SalariedEmployee : public Employee
11     {
12     public:
13         SalariedEmployee( );
14         SalariedEmployee (string the_name, string the_ssn,
15                             double the_weekly_salary);
16         double get_salary( ) const;
17         void set_salary(double new_salary);
18         void print_check( );
19     private:
20         double salary;//weekly
21     };

22 } //employeessavitch

23 #endif //SALARIEDEMPLOYEE_H

```

base class to the first line of the class definition, as in the following (from Display 15.4):

```
class HourlyEmployee : public Employee
{
```

By using the keyword `public` the derived class (such as `HourlyEmployee`) automatically receives all the public member variables and member functions of the base class (such as `Employee`). We can also add additional member variables and member functions to the derived class.

The definition of the class `HourlyEmployee` does not mention the member variables `name`, `ssn`, and `net_pay`, but every object of the class `HourlyEmployee` has member variables named `name`, `ssn`, and `net_pay`. These member variables are inherited from the class `Employee`. The class `HourlyEmployee` declares two additional member variables named `wage_rate` and `hours`. Thus, every object of the class `HourlyEmployee` has five member variables named `name`, `ssn`, `net_pay`, `wage_rate`, and `hours`. Note that the definition of a derived class (such as `HourlyEmployee`) only lists the added member variables. The member variables defined in the base class are not mentioned. They are provided automatically to the derived class.

Just as it inherits the member variables of the class `Employee`, the class `HourlyEmployee` inherits all the member functions from the class `Employee`. So, the class `HourlyEmployee` inherits the member functions `get_name`, `get_ssn`, `get_net_pay`, `set_name`, `set_ssn`, `set_net_pay`, and `print_check` from the class `Employee`.

In addition to the inherited member variables and member functions, a derived class can add new member variables and new member functions. The new member variables and the declarations for the new member functions are listed in the class definition. For example, the derived class `HourlyEmployee` adds the two member variables `wage_rate` and `hours`, and it adds the new member functions named `set_rate`, `get_rate`, `set_hours`, and `get_hours`. This is shown in Display 15.4. Note that you do not give the declarations of the inherited member functions except for those whose definitions you want to change, which is the reason we list only the member function `print_check` from the base class `Employee`. For now, do not worry about the details of the constructor definition for the derived class. We will discuss constructors in the next subsection.

In the implementation file for the derived class, such as the implementation of `HourlyEmployee` in Display 15.6, you give the definitions of all the added member functions. Note that you do not give definitions for the inherited member functions unless the definition of the member function is changed in the derived class, a point we discuss next.

The definition of an inherited member function can be changed in the definition of a derived class so that it has a meaning in the derived class that is different from what it is in the base class. This is called **redefining** the inherited member function. For example, the member function `print_check()` is redefined in the definition of the derived class `HourlyEmployee`. To redefine a

DISPLAY 15.6 Implementation for the Derived Class HourlyEmployee
(part 1 of 2)

```
1  //This is the file: hourlyemployee.cpp
2  //This is the implementation for the class HourlyEmployee.
3  //The interface for the class HourlyEmployee is in
4  //the header file hourlyemployee.h.
5  #include <string>
6  #include <iostream>
7  #include "hourlyemployee.h"
8  using namespace std;

9  namespace employeessavitch
10 {

11     HourlyEmployee::HourlyEmployee( ) : Employee( ), wage_rate(0), hours(0)
12     {
13         //deliberately empty
14     }

15     HourlyEmployee::HourlyEmployee(string the_name, string the_number,
16                                     double the_wage_rate, double the_hours)
17     : Employee(the_name, the_number), wage_rate(the_wage_rate), hours(the_hours)
18     {
19         //deliberately empty
20     }

21     void HourlyEmployee::set_rate(double new_wage_rate)
22     {
23         wage_rate = new_wage_rate;
24     }

25     double HourlyEmployee::get_rate( ) const
26     {
27         return wage_rate;
28     }

29     void HourlyEmployee::set_hours(double hours_worked)
30     {
31         hours = hours_worked;
32     }

33     double HourlyEmployee::get_hours( ) const
34     {
35         return hours;
36     }
```

(continued)

DISPLAY 15.6 Implementation for the Derived Class `HourlyEmployee` (part 2 of 2)

```

37     void HourlyEmployee::print_check( )
38     {
39         set_net_pay (hours * wage_rate);

40         cout << "\n_____ \n";
41         cout << "Pay to the order of " << get_name( ) << endl;
42         cout << "The sum of " << get_net_pay( ) << " Dollars\n";
43         cout << "_____ \n";
44         cout << "Check Stub: NOT NEGOTIABLE\n";
45         cout << "Employee Number: " << get_ssn( ) << endl;
46         cout << "Hourly Employee. \nHours worked: " << hours
47             << " Rate: " << wage_rate << " Pay: " << get_net_pay( ) << endl;
48         cout << "_____ \n";
49     }

50 } //employeessavitch

```

We have chosen to set `net_pay` as part of the `print_check` function since that is the question. But note that C++ allows us to drop the `const` in the function `print_check` when we redefine it in a derived class.

member function definition, simply list it in the class definition and give it a new definition, just as you would do with a member function that is added in the derived class. This is illustrated by the redefined function `print_check()` of the class `HourlyEmployee` (Displays 15.4 and 15.6).

`SalariedEmployee` is another example of a derived class of the class

Parent and Child Classes

When discussing derived classes, it is common to use terminology derived from family relationships. A base class is often called a **parent class**.

A derived class is then called a **child class**. This makes the language of inheritance very smooth. For example, we can say that a child class inherits member variables and member functions from its parent class.

This analogy is often carried one step further. A class that is a parent of a parent of another class (or some other number of "parent of" iterations) is often called an **ancestor class**. If class A is an ancestor of class B, then class B is often called a **descendant** of class A.

Inherited Members

A derived class automatically has all the member variables and all the ordinary member functions of the base class. (As discussed later in this chapter, there are some specialized member functions, such as constructors, that are not automatically inherited.) These members from the base class are said to be **inherited**. These inherited member functions and inherited member variables are, with one exception, not mentioned in the definition of the derived class, but they are automatically members of the derived class. As explained in the text, you do mention an inherited member function in the definition of the derived class if you want to change the definition of the inherited member function.

Employee. The interface for the class `SalariedEmployee` is given in Display 15.5. An object declared to be of type `SalariedEmployee` has all the member functions and member variables of `Employee` and the new members given in the definition of the class `SalariedEmployee`. This is true even though the class `SalariedEmployee` lists none of the inherited variables and only lists one function from the class `Employee`, namely, the function `print_check`, which will have its definition changed in `SalariedEmployee`. The class `SalariedEmployee`, nonetheless, has the three member variables `name`, `ssn`, and `net_pay`, as well as the member variable `salary`. Notice that you do not have to declare the member variables and member functions of the class `Employee`, such as `name` and `set_name`, in order for a `SalariedEmployee` to have these members. The class `SalariedEmployee` gets these inherited members automatically without the programmer doing anything.

Note that the class `Employee` has all the code that is common to the two classes `HourlyEmployee` and `SalariedEmployee`. This saves you the trouble of writing identical code two times, once for the class `HourlyEmployee` and once for the class `SalariedEmployee`. Inheritance allows you to reuse the code in the class `Employee`.

Constructors in Derived Classes

A constructor in a base class is not inherited in the derived class, but you can invoke a constructor of the base class within the definition of a derived class constructor, and that is all you need or normally want. A constructor for a derived class uses a constructor from the base class in a special way. A constructor for the base class initializes all the data inherited from the base class. Thus, a constructor for a derived class begins with an invocation of a constructor for the base class.

There is a special syntax for invoking the base class constructor that is

illustrated by the constructor definitions for the class `HourlyEmployee` given in Display 15.6. In what follows we have reproduced (with minor changes in the line breaks to make it fit the text column) one of the constructor definitions for the class `HourlyEmployee` taken from that display:

```
HourlyEmployee::HourlyEmployee(string the_name,
    string the_number, double the_wage_rate,
    double the_hours)
    : Employee(the_name, the_number),
      wage_rate(the_wage_rate), hours(the_hours)
{
    //deliberately empty
}
```

The portion after the colon is the initialization section of the constructor definition for the constructor `HourlyEmployee::HourlyEmployee`. The part `Employee(the_name, the_number)` is an invocation of the two-argument constructor for the base class `Employee`. Note that the syntax for invoking the base class constructor is analogous to the syntax used to set member variables: The entry `wage_rate(the_wage_rate)` sets the value of the member variable `wage_rate` to `the_wage_rate`; the entry `Employee(the_name, the_number)` invokes the base class constructor `Employee` with the arguments `the_name` and `the_number`. Since all the work is done in the initialization section, the body of the constructor definition is empty.

Here we reproduce the other constructor for the class `HourlyEmployee` from Display 15.6:

```
HourlyEmployee::HourlyEmployee( ) : Employee( ), wage_rate(0),
    hours(0)
{
    //deliberately empty
}
```

In this constructor definition the default (zero-argument) version of the base class constructor is called to initialize the inherited member variables. You should always include an invocation of one of the base class constructors in the initialization section of a derived class constructor.

If a constructor definition for a derived class does not include an invocation of a constructor for the base class, then the default (zero-argument) version of the base class constructor will be invoked automatically. So, the following definition of the default constructor for the class `HourlyEmployee` (with `Employee()` omitted) is equivalent to the version we just discussed:

```
HourlyEmployee::HourlyEmployee( ) : wage_rate(0), hours(0)
{
    //deliberately empty
}
```

However, we prefer to always explicitly include a call to a base class

An Object of a Derived Class Has More Than One Type

In everyday experience an hourly employee is an employee. In C++ the same sort of thing holds. Since `HourlyEmployee` is a derived class of the class `Employee`, every object of the class `HourlyEmployee` can be used anywhere an object of the class `Employee` can be used. In particular, you can use an argument of type `HourlyEmployee` when a function requires an argument of type `Employee`. You can assign an object of the class `HourlyEmployee` to a variable of type `Employee`. (But be warned: You cannot assign a plain old `Employee` object to a variable of type `HourlyEmployee`. After all, an `Employee` is not necessarily an `HourlyEmployee`.) Of course, the same remarks apply to any base class and its derived class. You can use an object of a derived class anywhere that an object of its base class is allowed.

More generally, an object of a class type can be used anywhere that an object of any of its ancestor classes can be used. If class `Child` is derived from class `Ancestor` and class `Grandchild` is derived from class `Child`, then an object of class `Grandchild` can be used anywhere an object of class `Child` can be used, and the object of class `Grandchild` can also be used anywhere that an object of class `Ancestor` can be used.

constructor, even if it would be invoked automatically.

A derived class object has all the member variables of the base class. When a derived class constructor is called, these member variables need to be allocated memory and should be initialized. This allocation of memory for the inherited member variables must be done by a constructor for the base class, and the base class constructor is the most convenient place to initialize these inherited member variables. That is why you should always include a call to one of the base class constructors when you define a constructor for a derived class. If you do not include a call to a base class constructor (in the initialization section of the definition of a derived class constructor), then the default (zero-argument) constructor of the base class is called automatically. (If there is no default constructor for the base class, that is an error condition.)

The call to the base class constructor is the first action taken by a derived class constructor. Thus, if class `B` is derived from class `A` and class `C` is derived from class `B`, then when an object of the class `C` is created, first a constructor for the class `A` is called, then a constructor for `B` is called, and finally the remaining actions of the `C` constructor are taken.

Constructors in Derived Classes

A derived class does not inherit the constructors of its base class. However, when defining a constructor for the derived class, you can and should include a call to a constructor of the base class (within the initialization section of the constructor definition).

If you do not include a call to a constructor of the base class, then the default (zero-argument) constructor of the base class will automatically be called when the derived class constructor is called.

PITFALL Use of Private Member Variables from the Base Class

An object of the class `HourlyEmployee` (Displays 15.4 and 15.6) inherits a member variable called `name` from the class `Employee` (Displays 15.2 and 15.3). For example, the following code would set the value of the member variable `name` of the object `joe` to “Josephine”. (This code also sets the member variable `ssn` to “123-45-6789” and both the `wage_rate` and `hours` to 0.)

```
HourlyEmployee joe(“Josephine”, “123-45-6789”, 0, 0);
```

If you want to change `joe.name` to “Mighty-Joe”, you can do so as follows:

```
joe.set_name(“Mighty-Joe”);
```

But you must be a bit careful about how you manipulate inherited member variables such as `name`. The member variable `name` of the class `HourlyEmployee` was inherited from the class `Employee`, but the member variable `name` is a private member variable in the definition of the class `Employee`. That means that `name` can be directly accessed only within the definition of a member function in the class `Employee`. A member variable (or member function) that is private in a base class is not accessible *by name* in the definition of a member function for *any other class, not even in a member function definition of a derived class*. Thus, although the class `HourlyEmployee` does have a member variable named `name` (inherited from the base class `Employee`), it is illegal to directly access the member variable `name` in the definition of any member function in the class definition of `HourlyEmployee`.

For example, the following are the first few lines from the body of the member function `HourlyEmployee::print_check` (taken from Display 15.6):

```
void HourlyEmployee::print_check( )
{
    set_net_pay(hours * wage_rate);

    cout << “\n_____ \n”;
    cout << “Pay to the order of “ << get_name( ) << endl;
    cout << “The sum of “ << get_net_pay( ) << “ Dollars\n”;
```

You might have wondered why we needed to use the member function `set_net_pay` to set the value of the `net_pay` member variable. You might be tempted to rewrite the start of the member function definition as follows:

```
void HourlyEmployee::print_check( )
{
    net_pay = hours * wage_rate; //Illegal use of net_pay
```

As the comment indicates, this will not work. The member variable `net_pay` is a private member variable in the class `Employee`, and although a derived class like `HourlyEmployee` inherits the variable `net_pay`, it cannot access it directly. It must use some public member function to access the member variable `net_pay`. The correct way to accomplish the definition of `print_check` in the class `HourlyEmployee` is the way we did it in Display 15.6 (and part of which was displayed earlier).

The fact that `name` and `net_pay` are inherited variables that are private in the base class also explains why we needed to use the accessor functions `get_name` and `get_net_pay` in the definition of `HourlyEmployee::print_check` instead of simply using the variable names `name` and `net_pay`. You cannot mention a private inherited member variable by name. You must instead use public accessor and mutator member functions (such as `get_name` and `set_name`) that were defined in the base class. (Recall that an *accessor function* is a function that allows you to access member variables of a class, and a *mutator function* is one that allows you to change member variables of a class. Accessor and mutator functions were covered in Chapter 10.)

The fact that a private member variable of a base class cannot be accessed in the definition of a member function of a derived class often seems wrong to people. After all, if you are an hourly employee and you want to change your name, nobody says, “Sorry name is a private member variable of the class `Employee`.” After all, if you are an hourly employee, you are also an employee. In Java, this is also true; an object of the class `HourlyEmployee` is also an object of the class `Employee`. However, the laws on the use of private member variables and member functions must be as we described, or else their privacy would be compromised. If private member variables of a class were accessible in member function definitions of a derived class, then anytime you wanted to access a private member variable, you could simply create a derived class and access it in a member function of that class, which would mean that all private member variables would be accessible to anybody who wanted to put in a little extra effort. This adversarial scenario illustrates the problem, but the big problem is unintentional errors, not intentional subversion. If private member variables of a class were accessible in member function definitions of a derived class, then the member variables might be changed by mistake or in inappropriate ways. (Remember, accessor and mutator functions can guard against inappropriate changes to member variables.)

We will discuss one possible way to get around this restriction on private member variables of the base class in the subsection entitled “The *protected* Qualifier” a bit later in this chapter. ■

PITFALL Private Member Functions Are Effectively Not Inherited

As we noted in the previous Pitfall section, a member variable (or member function) that is private in a base class is not directly accessible outside of the interface and implementation of the base class, *not even in a member function definition for a derived class*. Note that private member functions are just like private variables in terms of not being directly available. But in the case of member functions, the restriction is more dramatic. A private variable can be accessed indirectly via an accessor or mutator member function. A private member function is simply not available. It is just as if the private member function were not inherited.

This should not be a problem. Private member functions should just be used as helping functions, and so their use should be limited to the class in which they are defined. If you want a member function to be used as a helping member function in a number of inherited classes, then it is not *just* a helping function, and you should make the member function public. ■

The *protected* Qualifier

As you have seen, you cannot access a private member variable or private member function in the definition or implementation of a derived class. There is a classification of member variables and functions that allows them to be accessed by name in a derived class but not anywhere else, such as in some class that is not a derived class. If you use the qualifier *protected*, rather than *private* or *public*, before a member variable or member function of a class, then for any class or function other than a derived class, the effect is the same as if the member variable were labeled *private*; however, in a derived class the variable can be accessed by name.

For example, consider the class `HourlyEmployee` that was derived from the base class `Employee`. We were required to use accessor and mutator member functions to manipulate the inherited member variables in the definition of `HourlyEmployee::print_check`. If all the private member variables in the class `Employee` were labeled with the keyword *protected* instead of *private*, the definition of `HourlyEmployee::print_check` in the derived class `Employee` could be simplified to the following:

```
void HourlyEmployee::print_check( )
//Only works if the member variables of Employee are marked
//protected instead of private.
{
    net_pay = hours * wage_rate;

    cout << "\n_____ \n";
    cout << "Pay to the order of " << name << endl;
```

```

cout << "The sum of " << net_pay << " Dollars\n";
cout << "-----\n";
cout << "Check Stub: NOT NEGOTIABLE\n";
cout << "Employee Number: " << ssn << endl;
cout << "Hourly Employee. \nHours worked: " << hours
    << " Rate: " << wage_rate << " Pay: " << net_pay
    << endl;
cout << "-----\n";
}

```

In the derived class `HourlyEmployee`, the inherited member variables `name`, `net_pay`, and `ssn` can be accessed by name, provided they are marked as *protected* (as opposed to *private*) in the base class `Employee`. However, in any class that is not derived from the class `Employee`, these member variables are treated as if they were marked *private*.

Member variables that are protected in the base class act as though they were also marked *protected* in any derived class. For example, suppose you define a derived class `PartTimeHourlyEmployee` of the class `HourlyEmployee`. The class `PartTimeHourlyEmployee` inherits all the member variables of the class `HourlyEmployee`, including the member variables that `HourlyEmployee` inherits from the class `Employee`. So, the class `PartTimeHourlyEmployee` will have the member variables `net_pay`, `name`, and `ssn`. If these member variables were marked *protected* in the class `Employee`, then they can be used by name in the definitions of functions of the class `PartTimeHourlyEmployee`. Except for derived classes (and derived classes of derived classes, etc.), a member variable that is marked *protected* is treated the same as if it were marked *private*.

We include a discussion of *protected* member variables primarily because you will see them used and should be familiar with them. Many, but not all, programming authorities say it is bad style to use *protected* member variables. They say it compromises the principle of hiding the class implementation and that all member variables should be marked *private*. If all member variables are marked *private*, the inherited member variables cannot be accessed by name in derived class function definitions. However, this is not as bad as it sounds. The inherited *private* member variables can be accessed indirectly by invoking inherited functions that either read or change the *private* inherited variables. Since authorities differ, you will have to make your own decision on whether or not to use protected members.

Protected Members

If you use the qualifier *protected*, rather than *private* or *public*, before a member variable of a class, then for any class or function other than a derived class (or a derived class of a derived class, etc.), the

(continued)

situation is the same as if the member variable were labeled *private*. However, in the definition of a member function of a derived class, the variable can be accessed by name. Similarly, if you use the qualifier *protected* before a member function of a class, then for any class or function other than a derived class (or a derived class of a derived class, etc.), that is the same as if the member function were labeled *private*. However, in the definition of a member function of a derived class the *protected* function can be used.

Inherited *protected* members are inherited in the derived class as if they were marked *protected* in the derived class. In other words, if a member is marked as *protected* in a base class, then it can be accessed by name in the definitions of all descendant classes, not just in those classes directly derived from the base class.

SELF-TEST EXERCISES

1. Is the following program legal (assuming appropriate `#include` and `using` directives are added)?

```
void show_employee_data(const Employee object);

int main( )
{
    HourlyEmployee joe("Mighty Joe",
                       "123-45-6789", 20.50, 40);
    SalariedEmployee boss("Mr. Big Shot",
                          "987-65-4321", 10500.50);
    show_employee_data(joe);
    show_employee_data(boss);

    return 0;
}

void show_employee_data(const Employee object)
{
    cout << "Name: " << object.get_name( ) << endl;
    cout << "Social Security Number: "
         << object.get_ssn( ) << endl;
}
```

2. Give a definition for a class `SmartBut` that is a derived class of the base class `Smart`, which we reproduce for you here. Do not bother with `#include` directives or namespace details.

```

class Smart
{
public:
    Smart( );
    void print_answer( ) const;
protected:
    int a;
    int b;
};

```

This class should have an additional data field, *crazy*, that is of type *bool*, one additional member function that takes no arguments and returns a value of type *bool*, and suitable constructors. The new function is named *is_crazy*. You do not need to give any implementations, just the class definition.

3. Is the following a legal definition of the member function *is_crazy* in the derived class *SmartBut* discussed in Self-Test Exercise 2? Explain your answer. (Remember, the question asks if it is legal, not if it is a sensible definition.)

```

bool SmartBut::is_crazy( ) const
{
    if (a > b)
        return false;
    else
        return true;
}

```

Redefinition of Member Functions

In the definition of the derived class *HourlyEmployee* (Display 15.4), we gave the declarations for the new member functions *set_rate*, *get_rate*, *set_hours*, and *get_hours*. We also gave the function declaration for only one of the member functions inherited from the class *Employee*. The inherited member functions whose function declarations were not given (such as *set_name* and *set_ssn*) are inherited unchanged. They have the same definition in the class *HourlyEmployee* as they do in the base class *Employee*. When you define a derived class like *HourlyEmployee*, you list only the function declarations for the inherited member functions whose definitions you want to change to have a different definition in the derived class. If you look at the implementation of the class *HourlyEmployee*, given in Display 15.6, you will see that we have redefined the inherited member function *print_check*. The class *SalariedEmployee* also gives a new definition to the member function *print_check*, as shown in Display 15.7. Moreover, the two classes give different definitions from each other. The function *print_check* is **redefined** in the derived classes.

Redefining an Inherited Function

A derived class inherits all the member functions (and member variables as well) that belong to the base class. However, if a derived class requires a different implementation for an inherited member function, the function may be redefined in the derived class. When a member function is redefined, you must list its declaration in the definition of the derived class even though the declaration is the same as in the base class. If you do not wish to redefine a member function that is inherited from the base class, then it is not listed in the definition of the derived class.

DISPLAY 15.7 Implementation for the Derived Class `SalariedEmployee` (part 1 of 2)

```

1  //This is the file salariedemployee.cpp.
2  //This is the implementation for the class SalariedEmployee.
3  //The interface for the class SalariedEmployee is in
4  //the header file salariedemployee.h.
5  #include <iostream>
6  #include <string>
7  #include "salariedemployee.h"
8  using namespace std;

9  namespace employeessavitch
10 {
11     SalariedEmployee::SalariedEmployee( ) : Employee( ), salary(0)
12     {
13         //deliberately empty
14     }
15     SalariedEmployee::SalariedEmployee(string the_name, string the_number,
16         double the_weekly_salary)
17         : Employee(the_name, the_number), salary(the_weekly_salary)
18     {
19         //deliberately empty
20     }

21     double SalariedEmployee::get_salary( ) const
22     {
23         return salary;
24     }

25     void SalariedEmployee::set_salary(double new_salary)
26     {
27         salary = new_salary;
28     }

```

(continued)

DISPLAY 15.7 Implementation for the Derived Class SalariedEmployee (part 2 of 2)

```

29     void SalariedEmployee::print_check( )
30     {
31         set_net_pay(salary);
32         cout << "\n-----\n";
33         cout << "Pay to the order of " << get_name( ) << endl;
34         cout << "The sum of " << get_net_pay( ) << " Dollars\n";
35         cout << "-----\n";
36         cout << "Check Stub NOT NEGOTIABLE \n";

37     void SalariedEmployee::print_check( )
38     {
39         set_net_pay(salary);
40         cout << "\n-----\n";
41         cout << "Pay to the order of " << get_name( ) << endl;
42         cout << "The sum of " << get_net_pay( ) << " Dollars\n";
43         cout << "-----\n";
44         cout << "Check Stub NOT NEGOTIABLE \n";
45         cout << "Employee Number: " << get_ssn( ) << endl;
46         cout << "Salaried Employee. Regular Pay: "
47             << salary << endl;
48         cout << "-----\n";
49     }
50 } //employeessavitch

```

Display 15.8 gives a demonstration program that illustrates the use of the derived classes HourlyEmployee and SalariedEmployee.

DISPLAY 15.8 Using Derived Classes (part 1 of 2)

```

1     #include <iostream>
2     #include "hourlyemployee.h"
3     #include "salariedemployee.h"
4     using std::cout;
5     using std::endl;
6     using namespace employeessavitch;

7     int main( )
8     {
9         HourlyEmployee joe;
10        joe.set_name("Mighty Joe");
11        joe.set_ssn("123-45-6789");
12        joe.set_rate(20.50);
13        joe.set_hours(40);

```

(continued)

DISPLAY 15.8 Using Derived Classes (part 2 of 2)

```

14     cout << "Check for " << joe.get_name( )
15         << " for " << joe.get_hours( ) << " hours.\n";
16     joe.print_check( );
17     cout << endl;

18     SalariedEmployee boss("Mr. Big Shot", "987-65-4321", 10500.50);
19     cout << "Check for " << boss.get_name( ) << endl;
20     boss.print_check( );

21     return 0;
22 }

```

The functions `set_name`, `set_ssn`, `set_rate`, `set_hours`, and `get_name` are inherited unchanged from the class `Employee`. The function `print_check` is redefined. The function `get_hours` was added to the derived class `HourlyEmployee`.

Sample Dialogue

Check for Mighty Joe for 40 hours.

 Pay to the order of Mighty Joe
 The sum of 820 Dollars

 Check Stub: NOT NEGOTIABLE
 Employee Number: 123-45-6789
 Hourly Employee.
 Hours worked: 40 Rate: 20.5 Pay: 820

 Check for Mr. Big Shot

 Pay to the order of Mr. Big Shot
 The sum of 10500.5 Dollars

 Check Stub NOT NEGOTIABLE
 Employee Number: 987-65-4321
 Salaried Employee. Regular Pay: 10500.5

Redefining Versus Overloading

Do not confuse *redefining* a function definition in a derived class with *overloading* a function name. When you redefine a function definition, the new function definition given in the derived class has the same number and

types of parameters. On the other hand, if the function in the derived class were to have a different number of parameters or a parameter of a different type from the function in the base class, then the derived class would have both functions. That would be overloading. For example, suppose we added a function with the following function declaration to the definition of the class `HourlyEmployee`:

```
void set_name(string first_name, string last_name);
```

The class `HourlyEmployee` would have this two-argument function `set_name`, and it would also inherit the following one-argument function `set_name`:

```
void set_name(string new_name);
```

The class `HourlyEmployee` would have two functions named `set_name`. This would be *overloading* the function name `set_name`.

On the other hand, both the class `Employee` and the class `HourlyEmployee` define a function with the following function declaration:

```
void print_check( );
```

In this case, the class `HourlyEmployee` has only one function named `print_check`, but the definition of the function `print_check` for the class `HourlyEmployee` is different from its definition for the class `Employee`. In this case, the function `print_check` has been *redefined*.

If you get redefining and overloading confused, you do have one consolation. They are both legal. So, it is more important to learn how to use them than it is to learn to distinguish between them. Nonetheless, you should learn the difference.

Signature

A function's **signature** is the function's name with the sequence of types in the parameter list, not including the `const` keyword and not including the ampersand (&). When you overload a function name, the two definitions of the function name must have different signatures using this definition of signature.²

If a function has the same name in a derived class as in the base class but has a different signature, that is overloading, not redefinition.

² Some compilers may allow overloading on the basis of `const` versus no `const`, but you cannot count on this and so should not do it. For this reason, some definitions of *signature* include the `const` modifier, but this is a cloudy issue that is best avoided until you become an expert.



VideoNote
Inheritance Example

Access to a Redefined Base Function

Suppose you redefine a function so that it has a different definition in the derived class from what it had in the base class. The definition that was given in the base class is not completely lost to the derived class objects. However, if you want to invoke the version of the function given in the base class with an object in the derived class, you need some way to say “use the definition of this function as given in the base class (even though I am an object of the derived class).” The way you say this is to use the scope resolution operator with the name of the base class. An example should clarify the details.

Consider the base class `Employee` (Display 15.2) and the derived class `HourlyEmployee` (Display 15.4). The function `print_check()` is defined in both classes. Now suppose you have an object of each class, as in

```
Employee jane_e;
HourlyEmployee sally_h;
```

Then

```
jane_e.print_check( );
```

uses the definition of `print_check` given in the class `Employee`, and

```
sally_h.print_check( );
```

uses the definition of `print_check` given in the class `HourlyEmployee`.

But, suppose you want to invoke the version of `print_check` given in the definition of the base class `Employee` with the derived class object `sally_h` as the calling object for `print_check`. You do that as follows:

```
sally_h.Employee::print_check( );
```

Of course, you are unlikely to want to use the version of `print_check` given in the particular class `Employee`, but with other classes and other functions, you may occasionally want to use a function definition from a base class with a derived class object. An example is given in Self-Test Exercise 6.

SELF-TEST EXERCISES

- The class `SalariedEmployee` inherits both of the functions `get_name` and `print_check` (among other things) from the base class `Employee`, yet only the function declaration for the function `print_check` is given in the definition of the class `SalariedEmployee`. Why isn't the function declaration for the function `get_name` given in the definition of `SalariedEmployee`?
- Give a definition for a class `TitledEmployee` that is a derived class of the base class `SalariedEmployee` given in Display 15.5. The class

`TitledEmployee` has one additional member variable of type `string` called `title`. It also has two additional member functions: `get_title`, which takes no arguments and returns a `string`; and `set_title`, which is a `void` function that takes one argument of type `string`. It also redefines the member function `set_name`. You do not need to give any implementations, just the class definition. However, do give all needed `#include` directives and all `using namespace` directives. Place the class `TitledEmployee` in the namespace `employeessavitch`.

6. Give the definitions of the constructors for the class `TitledEmployee` that you gave as the answer to Self-Test Exercise 5. Also, give the redefinition of the member function `set_name`. The function `set_name` should insert the title into the name. Do not bother with `#include` directives or namespace details.

15.2 INHERITANCE DETAILS

The devil is in the details.

COMMON SAYING

This section presents some of the more subtle details about inheritance. Most of the topics are relevant only to classes that use dynamic arrays or pointers and other dynamic data.

Functions That Are Not Inherited

As a general rule if `Derived` is a derived class with base class `Base`, then all “normal” functions in the class `Base` are inherited members of the class `Derived`. However, there are some special functions that are, for all practical purposes, not inherited. We have already seen that, as a practical matter, constructors are not inherited and that private member functions are not inherited. Destructors are also effectively not inherited.

In the case of the copy constructor, it is not inherited, but if you do not define a copy constructor in a derived class (or any class for that matter), C++ will automatically generate a copy constructor for you. However, this default copy constructor simply copies the contents of member variables and does not work correctly for classes with pointers or dynamic data in their member variables. Thus, if your class member variables involve pointers, dynamic arrays, or other dynamic data, then you should define a copy constructor for the class. This applies whether or not the class is a derived class.

The assignment operator `=` is also not inherited. If the base class `Base` defines the assignment operator, but the derived class `Derived` does not define the assignment operator, then the class `Derived` will have an assignment operator, but it will be the default assignment operator that C++ creates

(when you do not define =); it will not have anything to do with the base class assignment operator defined in Base.

It is natural that constructors, destructors, and the assignment operator are not inherited. To correctly perform their tasks, they need information that the base class does not possess. To correctly perform their functions, they need to know about the new member variables introduced in the derived class.

Assignment Operators and Copy Constructors in Derived Classes

Overloaded assignment operators and constructors are not inherited. However, they can be, and in almost all cases must be, used in the definitions of overloaded assignment operators and copy constructors in derived classes.

When overloading the assignment operator in a derived class, you normally use the overloaded assignment operator from the base class. We will present an outline of how the code for doing this is written. To help understand the code outline, remember that an overloaded assignment operator must be defined as a member function of the class.

If `Derived` is a class derived from `Base`, then the definition of the overloaded assignment operator for the class `Derived` would typically begin with something like the following:

```
Derived& Derived::operator =(const Derived& right_side)
{
    Base::operator =(right_side);
}
```

The first line of code in the body of the definition is a call to the overloaded assignment operator of the `Base` class. This takes care of the inherited member variables and their data. The definition of the overloaded assignment operator would then go on to set the new member variables that were introduced in the definition of the class `Derived`.

A similar situation holds for defining the copy constructor in a derived class. If `Derived` is a class derived from `Base`, then the definition of the copy constructor for the class `Derived` would typically use the copy constructor for the class `Base` to set up the inherited member variables and their data. The code would typically begin with something like the following:

```
Derived::Derived(const Derived& object)
    : Base(object), <probably more initializations>
{
}
```

The invocation of the base class copy constructor `Base(object)` sets up the inherited member variables of the `Derived` class object being created. Note that since `object` is of type `Derived`, it is also of type `Base`; therefore, `object` is a legal argument to the copy constructor for the class `Base`.

Of course, these techniques do not work unless you have a correctly functioning assignment operator and a correctly functioning copy constructor

for the base class. This means that the base class definition must include a copy constructor and that either the default automatically created assignment operator must work correctly for the base class or the base class must have a suitable overloaded definition of the assignment operator.

Destructors in Derived Classes

If a base class has a correctly functioning destructor, then it is relatively easy to define a correctly functioning destructor in a class derived from the base class. When the destructor for the derived class is invoked, it automatically invokes the destructor of the base class, so there is no need for the explicit writing of a call to the base class destructor; it always happens automatically. The derived class destructor therefore need only worry about using *delete* on the member variables (and any data they point to) that are added in the derived class. It is the job of the base class destructor to invoke *delete* on the inherited member variables.

If class B is derived from class A and class C is derived from class B, then when an object of the class C goes out of scope, first the destructor for the class C is called, then the destructor for class B is called, and finally the destructor for class A is called. Note that the order in which destructors are called is the reverse of the order in which constructors are called.

SELF-TEST EXERCISES

7. You know that an overloaded assignment operator and a copy constructor are not inherited. Does this mean that if you do not define an overloaded assignment operator or a copy constructor for a derived class, then that derived class will have no assignment operator and no copy constructor?
8. Suppose `Child` is a class derived from the class `Parent`, and the class `Grandchild` is a class derived from the class `Child`. This question is concerned with the constructors and destructors for the three classes `Parent`, `Child`, and `Grandchild`. When a constructor for the class `Grandchild` is invoked, what constructors are invoked and in what order? When the destructor for the class `Grandchild` is invoked, what destructors are invoked and in what order?
9. Give the definitions for the member function `add_value`, the copy constructor, the overloaded assignment operator, and the destructor for the following class. This class is intended to be a class for a partially filled array. The member variable `number_used` contains the number of array positions currently filled. The other constructor definition is given to help you get started.

```
#include <iostream>
#include <cstdlib>
```

```

using namespace std;

class PartFilledArray
{
public:
    PartFilledArray(int array_size);
    PartFilledArray(const PartFilledArray& object);
    ~PartFilledArray();
    void operator =(const PartFilledArray& right_side);
    void add_value(double new_entry);
    //There would probably be more member functions
    //but they are irrelevant to this exercise.
protected:
    double *a;
    int max_number;
    int number_used;
};
PartFilledArray::PartFilledArray(int array_size)
    : max_number(array_size), number_used(0)
{
    a = new double[max_number];
}

```

(Many authorities would say that the member variables should be private rather than protected. We tend to agree. However, using *protected* makes for a better practice assignment, and you should have some experience with protected variables because some programmers do use them.)

10. Define a class called `PartFilledArrayWMax` that is a derived class of the class `PartFilledArray`. The class `PartFilledArrayWMax` has one additional member variable named `max_value` that holds the maximum value stored in the array. Define a member accessor function named `get_max` that returns the maximum value stored in the array. Redefine the member function `add_value` and define two constructors, one of which has an `int` argument for the maximum number of entries in the array. Also define a copy constructor, an overloaded assignment operator, and a destructor. (A real class would have more member functions, but these will do for an exercise.)

15.3 POLYMORPHISM

All experience is an arch, to build upon.

HENRY ADAMS, *The Education of Henry Adams*

Polymorphism refers to the ability to associate multiple meanings to one function name. As it has come to be used today, *polymorphism* refers to a very particular way of associating multiple meanings to a single function

name. That is, **polymorphism** refers to the ability to associate multiple meanings to one function name by means of a special mechanism known as *late binding*. Polymorphism is one of the key components of a programming philosophy known as *object-oriented programming*. Late binding, and therefore polymorphism, is the topic of this section.

Late Binding

A *virtual function* is one that, in some sense, may be used before it is defined. For example, a graphics program may have several kinds of figures, such as rectangles, circles, ovals, and so forth. Each figure might be an object of a different class. For example, the `Rectangle` class might have member variables for a height, width, and center point, while the `Circle` class might have member variables for a center point and a radius. In a well-designed programming project, all of them would probably be descendants of a single parent class called, for example, `Figure`. Now, suppose you want a function to draw a figure on the screen. To draw a circle, you need different instructions from those you need to draw a rectangle. So, each class needs to have a different function to draw its kind of figure. However, because the functions belong to the classes, they can all be called `draw`. If `r` is a `Rectangle` object and `c` is a `Circle` object, then `r.draw ()` and `c.draw ()` can be functions implemented with different code. All this is not news, but now we move on to something new: *virtual functions* defined in the parent class `Figure`.

Now, the parent class `Figure` may have functions that apply to all figures. For example, it might have a function called `center` that moves a figure to the center of the screen by erasing it and then redrawing it in the center of the screen. `Figure::center` might use the function `draw` to redraw the figure in the center of the screen. When you think of using the inherited function `center` with figures of the classes `Rectangle` and `Circle`, you begin to see that there are complications here.

To make the point clear and more dramatic, let's suppose the class `Figure` is already written and in use and at some later time we add a class for a brand-new kind of figure, say, the class `Triangle`. Now, `Triangle` can be a derived class of the class `Figure`, and so the function `center` will be inherited from the class `Figure`; thus, the function `center` should apply to (and perform correctly for!) all `Triangles`. But there is a complication. The function `center` uses `draw`, and the function `draw` is different for each type of figure. The inherited function `center` (if nothing special is done) will use the definition of the function `draw` given in the class `Figure`, and that function `draw` does not work correctly for `Triangles`. We want the inherited function `center` to use the function `Triangle::draw` rather than the function `Figure::draw`. But the class `Triangle`, and therefore the function `Triangle::draw`, was not even written when the function `center` (defined in the class `Figure`) was written and compiled! How can the function `center` possibly work correctly for `Triangles`? The compiler did not know anything about `Triangle::draw` at

the time that `center` was compiled. The answer is that it can apply provided `draw` is a *virtual function*.

When you make a function **virtual**, you are telling the compiler, “I do not know how this function is implemented. Wait until it is used in a program, and then get the implementation from the object instance.” The technique of waiting until run-time to determine the implementation of a procedure is called **late binding** or **dynamic binding**. Virtual functions are the way C++ provides late binding. But enough introduction. We need an example to make this come alive (and to teach you how to use virtual functions in your programs). In order to explain the details of virtual functions in C++, we will use a simplified example from an application area other than drawing figures.

Virtual Functions in C++

Suppose you are designing a record-keeping program for an automobile parts store. You want to make the program versatile, but you are not sure you can account for all possible situations. For example, you want to keep track of sales, but you cannot anticipate all types of sales. At first, there will be only regular sales to retail customers who go to the store to buy one particular part. However, later you may want to add sales with discounts, or mail-order sales with a shipping charge. All these sales will be for an item with a basic price and ultimately will produce some bill. For a simple sale, the bill is just the basic price, but if you later add discounts, then some kinds of bills will also depend on the size of the discount. Your program will need to compute daily gross sales, which intuitively should just be the sum of all the individual sales bills. You may also want to calculate the largest and smallest sales of the day or the average sale for the day. All these can be calculated from the individual bills, but the functions for computing the bills will not be added until later, when you decide what types of sales you will be dealing with. To accommodate this, we make the function for computing the bill a virtual function. (For simplicity in this first example, we assume that each sale is for just one item, although with derived classes and virtual functions we could, but will not here, account for sales of multiple items.)

Displays 15.9 and 15.10 contain the interface and implementation for the class `Sale`. All types of sales will be derived classes of the class `Sale`. The class `Sale` corresponds to simple sales of a single item with no added discounts or charges. Notice the reserved word *virtual* in the function declaration for the function `bill` (Display 15.9). Notice (Display 15.10) that the member function `savings` and the overloaded operator `<` both use the function `bill`. Since `bill` is declared to be a virtual function, we can later define derived classes of the class `Sale` and define their versions of the function `bill`, and the definitions of the member function `savings` and the overloaded operator `<`, which we gave with the class `Sale`, will use the version of the function `bill` that corresponds to the object of the derived class.

DISPLAY 15.9 Interface for the Base Class Sale

```

1 //This is the header file sale.h.
2 //This is the interface for the class Sale.
3 //Sale is a class for simple sales.
4 #ifndef SALE_H
5 #define SALE_H
6
7 #include <iostream>
8 using namespace std;
9
10 namespace salesavitch
11 {
12
13     class Sale
14     {
15     public:
16         Sale();
17         Sale(double the_price);
18         virtual double bill() const;
19         double savings(const Sale& other) const;
20         //Returns the savings if you buy other instead of the calling object.
21     protected:
22         double price;
23     };
24
25     bool operator <(const Sale& first, const Sale& second);
26     //Compares two sales to see which is larger.
27 }//salesavitch
28
29 #endif // SALE_H

```

DISPLAY 15.10 Implementation of the Base Class Sale (part 1 of 2)

```

1 //This is the implementation file: sale.cpp
2 //This is the implementation for the class Sale.
3 //The interface for the class Sale is in
4 //the header file sale.h.
5 #include "sale.h"
6
7 namespace salesavitch
8 {
9     Sale::Sale() : price(0)
10    {}
11
12    Sale::Sale(double the_price) : price(the_price)
13    {}
14

```

(continued)

DISPLAY 15.10 Implementation of the Base Class Sale (part 2 of 2)

```

15     double Sale::bill() const
16     {
17         return price;
18     }
19
20     double Sale::savings(const Sale& other) const
21     {
22         return ( bill() - other.bill() );
23     }
24
25     bool operator <(const Sale& first, const Sale& second)
26     {
27         return (first.bill() < second.bill());
28     }
29 }//salesavitch

```

For example, Display 15.11 shows the derived class `DiscountSale`. Notice that the class `DiscountSale` requires a different definition for its version of the function `bill`. Nonetheless, when the member function `savings` and the overloaded operator `<` are used with an object of the class `DiscountSale`, they will use the version of the function definition for `bill` that was given

DISPLAY 15.11 The Derived Class DiscountSale (part 1 of 2)

```

1 //This is the interface for the class DiscountSale.
2 #ifndef DISCOUNTSALE_H
3 #define DISCOUNTSALE_H
4 #include "sale.h"
5
6 namespace salesavitch
7 {
8     class DiscountSale : public Sale
9     {
10    public:
11        DiscountSale();
12        DiscountSale(double the_price, double the_discount);
13        //Discount is expressed as a percent of the price.
14        virtual double bill() const;
15    protected:
16        double discount;
17    };
18 }//salesavitch
19 #endif //DISCOUNTSALE_H

```

This is the file discountsale.h.

*The keyword **virtual** is not required here, but it is good style to include it.*

(continued)

DISPLAY 15.11 The Derived Class DiscountSale (part 2 of 2)

```

1 //This is the implementation for the class DiscountSale.
2 #include "discountsale.h"
3
4 namespace salesavitch
5 {
6     DiscountSale::DiscountSale() : Sale(), discount(0)
7     {}
8     DiscountSale::DiscountSale(double the_price, double the_discount)
9         : Sale (the_price), discount(the_discount)
10    {}
11    double DiscountSale::bill ( ) const
12    {
13        double fraction = discount/100;
14        return (1 - fraction)*price;
15    }
16 }//salesavitch

```

with the class `DiscountSale`. This is indeed a pretty fancy trick for C++ to pull off. Consider the function call `d1.savings(d2)` for objects `d1` and `d2` of the class `DiscountSale`. The definition of the function `savings` (even for an object of the class `DiscountSale`) is given in the implementation file for the base class `Sale`, which was compiled before we ever even thought of the class `DiscountSale`. Yet, in the function call `d1.savings(d2)`, the line that calls the function `bill` knows enough to use the definition of the function `bill` given for the class `DiscountSale`.

How does this work? In order to write C++ programs, you can just assume it happens by magic, but the real explanation was given in the introduction to this section. When you label a function *virtual*, you are telling the C++ environment, "Wait until this function is used in a program, and then get the implementation corresponding to the calling object."

Display 15.12 gives a sample program that illustrates how the virtual function `bill` and the functions that use `bill` work in a complete program.

DISPLAY 15.12 Use of a Virtual Function (part 1 of 2)

```

1 //Demonstrates the performance of the virtual function bill.
2 #include <iostream>
3 #include "sale.h" //Not really needed, but safe due to ifndef.
4 #include "discountsale.h"
5 using namespace std;
6 using namespace salesavitch;
7

```

(continued)

DISPLAY 15.12 Use of a Virtual Function (part 2 of 2)

```
8  int main()
9  {
10     Sale simple(10.00); //One item at $10.00.
11     DiscountSale discount(11.00, 10); //One item at $11.00 at 10% discount.
12
13     cout.setf(ios::fixed);
14     cout.setf(ios::showpoint);
15     cout.precision(2);
16
17     if (discount < simple)
18     {
19         cout << "Discounted item is cheaper.\n";
20         cout << "Savings is $" << simple.savings(discount) << endl;
21     }
22     else
23         cout << "Discounted item is not cheaper.\n";
24
25     return 0;
26 }
```

Sample Dialogue

```
Discounted item is cheaper.
Savings is $0.10
```

There are a number of technical details you need to know in order to use virtual functions in C++. We list them here:

- If a function will have a different definition in a derived class than in the base class and you want it to be a virtual function, you add the keyword *virtual* to the function declaration in the base class. You do not need to add the reserved word *virtual* to the function declaration in the derived class. If a function is virtual in the base class, then it is automatically virtual in the derived class. (However, it is a good idea to label the function declaration in the derived class *virtual*, even though it is not required.)
- The reserved word *virtual* is added to the function declaration and not to the function definition.
- You do not get a virtual function and the benefits of virtual functions unless you use the keyword *virtual*.

Since virtual functions are so great, why not make all member functions virtual? Almost the only reason for not always using virtual functions is

efficiency. The compiler and the run-time environment need to do much more work for virtual functions, and so if you label more member functions *virtual* than you need to, your programs will be less efficient.

Overriding

When a virtual function definition is changed in a derived class, programmers often say the function definition is **overridden**. In the C++ literature, a distinction is sometimes made between the terms *redefined* and *overridden*. Both terms refer to changing the definition of the function in a derived class. If the function is a virtual function, it's called *overriding*. If the function is not a virtual function, it's called *redefining*. This may seem like a silly distinction to you, the programmer, since you do the same thing in both cases, but the two cases are treated differently by the compiler.

Polymorphism

The term **polymorphism** refers to the ability to associate multiple meanings to one function name by means of late binding. Thus, polymorphism, late binding, and virtual functions are really all the same topic.

SELF-TEST EXERCISE

11. Suppose you modify the definitions of the class `Sale` (Display 15.9) by deleting the reserved word *virtual*. How would that change the output of the program in Display 15.12?

Virtual Functions and Extended Type Compatibility

We will discuss some of the further consequences of declaring a class member function to be *virtual* and do one example that uses some of these features.

C++ is a fairly strongly typed language. This means that the types of items are always checked and an error message is issued if there is a type mismatch,

such as a type mismatch between an argument and a formal parameter when there is no conversion that can be automatically invoked. This also means that normally the value assigned to a variable must match the type of the variable, although in a few well-defined cases C++ will perform an automatic type cast (called a *coercion*) so that it appears that you can assign a value of one type to a variable of another type. For example, C++ allows you to assign a value of type *char* or *int* to a variable of type *double*. However, C++ does not allow you to assign a value of type *double* or *float* to a variable of any integer type (*char*, *short*, *int*, *long*).

However, as important as strong typing is, this strong type checking interferes with the very idea of inheritance in object-oriented programming. Suppose you have defined class A and class B and have defined objects of type class A and class B. You cannot always assign between objects of these types. For example, suppose a program or unit contains the following type declarations:

```
class Pet
{
public:
    virtual void print();
    string name;
};

class Dog : public Pet
{
public:
    virtual void print(); //keyword virtual not needed, but is
                          //put here for clarity. (It is also good style!)
    string breed;
};

Dog vdog;
Pet vpet;
```

Now concentrate on the data members, name and breed. (To keep this example simple, we have made the member variables *public*. In a real application, they should be *private* and have functions to manipulate them.)

Anything that is a Dog is also a Pet. It would seem to make sense to allow programs to consider values of type Dog to also be values of type Pet, and hence the following should be allowed:

```
vdog.name = "Tiny";
vdog.breed = "Great Dane";
vpel = vdog;
```

C++ does allow this sort of assignment. You may assign a value, such as the value of *vdog*, to a variable of a parent type, such as *vpel*, but you are not allowed to perform the reverse assignment. Although the assignment above is allowed, the value that is assigned to the variable *vpel* loses its breed

field. This is called the **slicing problem**. The following attempted access will produce an error message:

```
cout << vpet.breed; //Illegal: class Pet has no member named breed
```

You can argue that this makes sense, since once a `Dog` is moved to a variable of type `Pet` it should be treated like any other `Pet` and not have properties peculiar to `Dogs`. This makes for a lively philosophical debate, but it usually just makes for a nuisance when programming. The dog named `Tiny` is still a `Great Dane` and we would like to refer to its breed, even if we treated it as a `Pet` someplace along the line.

Fortunately, C++ does offer us a way to treat a `Dog` as a `Pet` without throwing away the name of the breed. To do this, we use pointers to dynamic object instances. Suppose we add the following declarations:

```
Pet *ppet;
Dog *pdog;
```

If we use pointers and dynamic variables, we can treat `Tiny` as a `Pet` without losing his breed. The following is allowed:

```
pdog = new Dog;
pdog->name = "Tiny";
pdog->breed = "Great Dane";
ppet = pdog;
```

Moreover, we can still access the `breed` field of the node pointed to by `ppet`. Suppose that

```
Dog::print();
```

has been defined as follows:

```
//uses iostream
void Dog::print()
{
    cout << "name: " << name << endl;
    cout << "breed: " << breed << endl;
}
```

The statement

```
ppet->print();
```

will cause the following to be printed on the screen:

```
name: Tiny
breed: Great Dane
```

This is by virtue of the fact that `print()` is a *virtual* member function. (No pun intended.) We have included test code in `Display 15.13`.

DISPLAY 15.13 More Inheritance with Virtual Functions (part 1 of 2)

```
1 //Program to illustrate use of a virtual function
2 //to defeat the slicing problem.

3 #include <string>
4 #include <iostream>
5 using namespace std;
6
7 class Pet
8 {
9 public:
10     virtual void print();
11     string name;
12 };
13
14 class Dog : public Pet
15 {
16 public:
17     virtual void print(); //Keyword virtual not needed, but put
18                             //here for clarity. (It is also good style!)
19     string breed;
20 };
21
22 int main()
23 {
24     Dog vdog;
25     Pet vpet;
26
27     vdog.name = "Tiny";
28     vdog.breed = "Great Dane";
29     vpet = vdog;
30
31     //vp.pet.breed; is illegal since class Pet has no member named breed
32
33     Dog *pdog;
34     pdog = new Dog;
35     pdog->name = "Tiny";
36     pdog->breed = "Great Dane";
37
38     Pet *ppet;
39     ppet = pdog;
40     ppet->print(); // These two print the same output:
41     pdog->print(); // name: Tiny breed: Great Dane
42
43     //The following, which accesses member variables directly
44     //rather than via virtual functions, would produce an error:
45     //cout << "name: " << ppet->name << " breed: "
```

(continued)

DISPLAY 15.13 More Inheritance with Virtual Functions (part 2 of 2)

```

46     //     << ppet->breed << endl;
47     //generates an error message: 'class Pet' has no member
48     //named 'breed' .
49     //See Pitfall section "Not Using Virtual Member Functions"
50     //for more discussion on this.
51
52     return 0;
53 }
54
55 void Dog::print()
56 {
57     cout << "name: " << name << endl;
58     cout << "breed: " << breed << endl;
59 }
60
61 void Pet::print()
62 {
63     cout << "name: " << endl; //Note no breed mentioned
64 }

```

Sample Dialogue

```

name: Tiny
breed: Great Dane
name: Tiny
breed: Great Dane

```

PITFALL The Slicing Problem

Although it is legal to assign a derived class object to a base class variable, assigning a derived class object to a base class object slices off data. Any data members in the derived class object that are not also in the base class will be lost in the assignment, and any member functions that are not defined in the base class are similarly unavailable to the resulting base class object.

If we make the following declarations and assignments:

```

Dog vdog;
Pet vpet;
vdog.name = "Tiny";
vdog.breed = "Great Dane";
vpel = vdog;

```

then vpet cannot be a calling object for a member function introduced in Dog, and the data member, Dog::breed, is lost. ■

PITFALL **Not Using Virtual Member Functions**

In order to get the benefit of the extended type compatibility we discussed earlier, you must use *virtual* member functions. For example, suppose we had not used member functions in the example in Display 15.13. Suppose that in place of

```
ppet->print();
```

we had used the following:

```
cout << "name: " << ppet->name
      << " breed: " << ppet->breed << endl;
```

This code would have precipitated an error message. The reason for this is that the expression

```
*ppet
```

has its type determined by the pointer type of `ppet`. It is a pointer type for the type `Pet`, and the type `Pet` has no field named `breed`.

But `print()` was declared *virtual* by the base class, `Pet`. So, when the compiler sees the call

```
ppet->print();
```

it checks the *virtual* table for classes `Pet` and `Dog` and sees that `ppet` points to an object of type `Dog`. It therefore uses the code generated for

```
Dog::print(),
```

rather than the code for

```
Pet::print().
```

Object-oriented programming with dynamic variables is a very different way of viewing programming. This can all be bewildering at first. It will help if you keep two simple rules in mind:

1. If the domain type of the pointer `p_ancestor` is a base class for the domain type of the pointer `p_descendant`, then the following assignment of pointers is allowed:

```
p_ancestor = p_descendant;
```

Moreover, none of the data members or member functions of the dynamic variable being pointed to by `p_descendant` will be lost.

2. Although all the extra fields of the dynamic variable are there, you will need *virtual* member functions to access them. ■

PITFALL Attempting to Compile Class Definitions Without Definitions for Every Virtual Member Function

It is wise to develop incrementally. This means code a little, then test a little, then code a little more, and test a little more, and so forth. However, if you try to compile classes with *virtual* member functions but do not implement each member, you may run into some very hard to understand error messages, even if you do not call the undefined member functions!

If any virtual member functions are not implemented before compiling, then the compilation fails with error messages similar to this: “undefined reference to *Class_Name* virtual table.” Even if there is *no derived class* and there is *only one virtual* member, this kind of message still occurs if that function does not have a definition.

What makes the error messages very hard to decipher is that without definitions for the functions declared *virtual*, there may be further error messages complaining about an undefined reference to default constructors, even if these constructors really are already defined. ■

■ **PROGRAMMING TIP** Make Destructors Virtual

It is a good policy to always make destructors virtual, but before we explain why this is a good policy, we need to say a word or two about how destructors and pointers interact and about what it means for a destructor to be virtual.

Consider the following code, where *SomeClass* is a class with a destructor that is not virtual:

```
SomeClass *p = new SomeClass;
. . .
delete p;
```

When *delete* is invoked with *p*, the destructor of the class *SomeClass* is automatically invoked. Now, let’s see what happens when a destructor is marked as *virtual*.

The easiest way to describe how destructors interact with the virtual function mechanism is that destructors are treated as if all destructors had the same name (even though they do not really have the same name). For example, suppose *Derived* is a derived class of the class *Base* and suppose the destructor in the class *Base* is marked *virtual*. Now consider the following code:

```
Base *pBase = new Derived;
. . .
delete pBase;
```

When *delete* is invoked with *pBase*, a destructor is called. Since the destructor in the class *Base* was marked *virtual* and the object pointed to is of type

Derived, the destructor for the class `Derived` is called (and it in turn calls the destructor for the class `Base`). If the destructor in the class `Base` had not been declared as *virtual*, then only the destructor in the class `Base` would be called.

Another point to keep in mind is that when a destructor is marked as *virtual*, then all destructors of derived classes are automatically virtual (whether or not they are marked *virtual*). Again, this behavior is as if all destructors had the same name (even though they do not).

Now we are ready to explain why all destructors should be virtual. Suppose the class `Base` has a member variable `pB` of a pointer type, the constructor for the class `Base` creates a dynamic variable pointed to by `pB`, and the destructor for the class `Base` deletes the dynamic variable pointed to by `pB`. And suppose the destructor for the class `Base` is *not* marked *virtual*. Also suppose that the class `Derived` (which is derived from `Base`) has a member variable `pD` of a pointer type, the constructor for the class `Derived` creates a dynamic variable pointed to by `pD`, and the destructor for the class `Derived` deletes the dynamic variable pointed to by `pD`. Consider the following code:

```
Base *pBase = new Derived;
    . . .
delete pBase;
```

Since the destructor in the base class is not marked *virtual*, only the destructor for the class `Base` will be invoked. This will return to the freestore the memory for the dynamic variable pointed to by `pB`, but the memory for the dynamic variable pointed to by `pD` will never be returned to the freestore (until the program ends).

On the other hand, if the destructor for the base class `Base` were marked *virtual*, then when *delete* is applied to `pBase`, the destructor for the class `Derived` would be invoked (since the object pointed to is of type `Derived`). The destructor for the class `Derived` would delete the dynamic variable pointed to by `pD` and then automatically invoke the destructor for the base class `Base`, and that would delete the dynamic variable pointed to by `pB`. So, with the base class destructor marked as *virtual*, all the memory is returned to the freestore. To prepare for eventualities such as these, it is best to always mark destructors as virtual. ■

SELF-TEST EXERCISES

12. Why can't we assign a base class object to a derived class variable?
13. What is the problem with the (legal) assignment of a derived class object to a base class variable?
14. Suppose the base class and the derived class each have a member function with the same signature. When you have a pointer to a base class object

and call a function member through the pointer, discuss what determines which function is actually called—the base class member function or the derived-class function.

CHAPTER SUMMARY

- Inheritance provides a tool for code reuse by deriving one class from another and by adding features to the derived class.
- Derived class objects inherit all the members of the base class and may add members.
- Late binding means that the decision of which version of a member function is appropriate is decided at run-time. Virtual functions are what C++ uses to achieve late binding. Polymorphism, late binding, and virtual functions are really all the same topic.
- A *protected* member in the base class is directly available to a publicly derived class's member functions.

Answers to Self-Test Exercises

1. Yes. You can plug in an object of a derived class for a parameter of the base class type. An `HourlyEmployee` is an `Employee`. A `SalariedEmployee` is an `Employee`.
2.

```
class SmartBut : public Smart
{
public:
    SmartBut( );
    SmartBut(int new_a, int new_b, bool new_crazy);
    bool is_crazy( ) const;
private:
    bool crazy;
};
```
3. It is legal because `a` and `b` are marked *protected* in the base class `Smart` and so they can be accessed by name in a derived class. If `a` and `b` had instead been marked *private*, then this would be illegal.
4. The declaration for the function `get_name` is not given in the definition of `SalariedEmployee` because it is not redefined in the class `SalariedEmployee`. It is inherited unchanged from the base class `Employee`.
5.

```
#include <iostream>
#include "salariedemployee.h"
using namespace std;
namespace employeessavitch
```

```

{
    class TitledEmployee : public SalariedEmployee
    {
    public:
        TitledEmployee( );
        TitledEmployee(string the_name, string the_title
                        string the_ssn, double the_salary);
        string get_title( ) const;
        void set_title(string the_title);
        void set_name(string the_name);
    private:
        string title;
    };
} //employeessavitch

```

6. *namespace* employeessavitch

```

{
    TitledEmployee::TitledEmployee( )
        : SalariedEmployee( ), title("No title yet")
    {
        //deliberately empty
    }

    TitledEmployee::TitledEmployee(string the_name,
                                    string the_title,
                                    string the_ssn, double the_salary)
        : SalariedEmployee(the_name, the_ssn, the_salary),
          title(the_title)
    {
        //deliberately empty
    }

    void TitledEmployee::set_name(string the_name)
    {
        Employee::set_name(title + the_name);
    }
} //employeessavitch

```

7. No. If you do not define an overloaded assignment operator or a copy constructor for a derived class, then a default assignment operator and a default copy constructor will be defined for the derived class. However, if the class involves pointers, dynamic arrays, or other dynamic data, then it is almost certain that neither the default assignment operator nor the default copy constructor will behave as you want them to.
8. The constructors are called in the following order: first Parent, then Child, and finally Grandchild. The destructors are called in the reverse order: first Grandchild, then Child, and finally Parent.
9. //Uses *iostream* and *cstdlib*:
void PartFilledArray::add_value(*double* new_entry)

```

{
    if (number_used == max_number)
    {
        cout << "Adding to a full array.\n";
        exit(1);
    }
    else
    {
        a[number_used] = new_entry;
        number_used++;
    }
}
PartFilledArray::PartFilledArray
    (const PartFilledArray& object)
    : max_number(object.max_number),
      number_used(object.number_used)
{
    a = new double[max_number];
    for (int i = 0; i < number_used; i++)
        a[i] = object.a[i];
}
void PartFilledArray::operator =
    (const PartFilledArray& right_side)
{
    if (right_side.max_number > max_number)
    {
        delete [] a;
        max_number = right_side.max_number;
        a = new double[max_number];
    }
    number_used = right_side.number_used;
    for (int i = 0; i < number_used; i++)
        a[i] = right_side.a[i];
}
PartFilledArray::~PartFilledArray()
{
    delete [] a;
}
10. class PartFilledArrayWMax : public PartFilledArray
{
    public:
        PartFilledArrayWMax(int array_size);
        PartFilledArrayWMax(const PartFilledArrayWMax& object);
        ~PartFilledArrayWMax();
        void operator= (const PartFilledArrayWMax& right_side);
        void add_value(double new_entry);
        double get_max();
}

```

```

private:
    double max_value;
};

PartFilledArrayWMax::PartFilledArrayWMax(int array_size)
    : PartFilledArray(array_size)
{
    //Body intentionally empty.
    //Max_value uninitialized, since there
    //is no suitable default value.
}

/*
Note that the following does not work, because it calls the
default constructor for PartFilledArray, but PartFilledArray
has no default constructor:
PartFilledArrayWMax::PartFilledArrayWMax(int array_size)
    : max_number(array_size), number_used(0)

{
    a = new double[max_number];
}
*/

PartFilledArrayWMax::PartFilledArrayWMax
    (const PartFilledArrayWMax& object)
    : PartFilledArray(object)
{
    if (object.number_used > 0)
    {
        max_value = a[0];
        for (int i = 1; i < number_used; i++)
            if (a[i] > max_value)
                max_value = a[i];
    } //else leave max_value uninitialized
}

//This is equivalent to the default destructor supplied
//by C++, and so this definition can be omitted.
//But, if you omit it, you must also omit the destructor
//declaration from the class definition.
PartFilledArrayWMax::~PartFilledArrayWMax()
{
    //Intentionally empty.
}

void PartFilledArrayWMax::operator =
    (const PartFilledArrayWMax& right_side)
{
    PartFilledArray::operator =(right_side);
    max_value = right_side.max_value;
}

```

```

//Uses iostream and cstdlib:
void PartFilledArrayWMax::add_value(double new_entry)
{
    if (number_used == max_number)
    {
        cout << "Adding to a full array.\n";
        exit(1);
    }
    if ((number_used == 0) || (new_entry > max_value))
        max_value = new_entry;
    a[number_used] = new_entry;
    number_used++;
}

double PartFilledArrayWMax::get_max()
{
    return max_value;
}

```

11. The output would change to
Discounted item is not cheaper.
12. There would be no member to assign to the derived class's added members.
13. Although it is legal to assign a derived class object to a base class variable, this discards the parts of the derived class object that are not members of the base class. This situation is known as the *slicing problem*.
14. If the base class function carries the *virtual* modifier, then the type of the object to which the pointer was initialized determines whose member function is called. If the base class member function does not have the *virtual* modifier, then the type of the pointer determines whose member function is called.

PRACTICE PROGRAMS

Practice Programs can generally be solved with a short program that directly applies the programming principles presented in this chapter.

1. Write a program that uses the class `SalariedEmployee` in Display 15.5. Your program is to define a class called `Administrator`, which is to be derived from the class `SalariedEmployee`. You are allowed to change *private* in the base class to *protected*. You are to supply the following additional data and function members:

A member variable of type `string` that contains the administrator's title (such as `Director` or `Vice President`).

A member variable of type `string` that contains the company area of responsibility (such as Production, Accounting, or Personnel).

A member variable of type `string` that contains the name of this administrator's immediate supervisor.

A *protected*: member variable of type `double` that holds the administrator's annual salary. It is possible for you to use the existing salary member if you did the change recommended earlier.

A member function called `set_supervisor`, which changes the supervisor name.

A member function for reading in an administrator's data from the keyboard.

A member function called `print`, which outputs the object's data to the screen.

An overloading of the member function `print_check()` with appropriate notations on the check.

2. Add temporary, administrative, permanent, and other classifications of employee to the hierarchy from Displays 15.2, 15.4, and 15.5. Implement and test this hierarchy. Test all member functions. A user interface with a menu would be a nice touch for your test program.
3. Listed below are definitions of two classes that use inheritance, code for their implementation, and a `main` function. Put the code into appropriate files with the necessary include statements and preprocessor statements so that the program compiles and runs. It should output "Circle has radius 2 and area 12.5664".

```
class Shape
{
public:
    Shape();
    Shape(string name);
    string getName();
    void setName(string newName);
    virtual double getArea() = 0;
private:
    string name;
};
Shape::Shape()
{
    name="";
}
Shape::Shape(string name)
{
    this->name = name;
```



```
}
string Shape::getName()
{
    return this->name;
}
void Shape::setName(string newName)
{
    this->name = newName;
}
class Circle : public Shape
{
public:
    Circle();
    Circle(int theRadius);
    void setRadius(int newRadius);
    double getRadius();
    virtual double getArea();
private:
    int radius;
};
Circle::Circle() : Shape("Circle"), radius(0)
{ }
Circle::Circle(int theRadius) : Shape("Circle"),
    radius(theRadius)
{ }
void Circle::setRadius(int newRadius)
{
    this->radius = newRadius;
}
double Circle::getRadius()
{
    return radius;
}
double Circle::getArea()
{
    return 3.14159 * radius * radius;
}
int main()
{
    Circle c(2);
    cout << c.getName() << " has radius " <<
        c.getRadius() << " and area " <<
        c.getArea() << endl;
    return 0;
}
```

Add another class, `Rectangle`, that is also derived from the `Shape` class. Modify the `Rectangle` class appropriately so it has private width and height variables, a constructor that allows the user to set the width and height, functions to

retrieve the width and height, and an appropriately defined `getArea` function that calculates the area of the rectangle.

The following code added to `main` should output “Rectangle has width 3 has height 4 and area 12.0”.

```
Rectangle r(3,4);
cout << r.getName() << " has width " <<
    r.getWidth() << " has height " <<
    r.getHeight() << " and area " <<
    r.getArea() << endl;
```

PROGRAMMING PROJECTS

Programming Projects require more problem-solving than Practice Programs and can usually be solved many different ways. Visit www.myprogramminglab.com to complete many of these Programming Projects online and get instant feedback.

1. Give the definition of a class named `Doctor` whose objects are records for a clinic’s doctors. This class will be a derived class of the class `SalariedEmployee` given in Display 15.5. A `Doctor` record has the doctor’s specialty (such as “Pediatrician,” “Obstetrician,” “General Practitioner,” etc., so use type `string`) and office visit fee (use type `double`). Be sure your class has a reasonable complement of constructors, accessor, and mutator member functions, an overloaded assignment operator, and a copy constructor. Write a driver program to test all your functions.
2. Create a base class called `Vehicle` that has the manufacturer’s name (type `string`), number of cylinders in the engine (type `int`), and owner (type `Person`, given below). Then create a class called `Truck` that is derived from `Vehicle` and has additional properties: the load capacity in tons (type `double` since it may contain a fractional part) and towing capacity in pounds (type `int`). Be sure your classes have a reasonable complement of constructors, accessor, and mutator member functions, an overloaded assignment operator, and a copy constructor. Write a driver program that tests all your member functions.

The definition of the class `Person` follows. The implementation of the class is part of this Programming Project.

```
class Person
{
public:
    Person();
    Person(string the_name);
    Person(const Person& the_object);
    string get_name() const;
    Person& operator = (const Person& rt_side);
    friend ostream& operator >>(ostream& in_stream,
        Person& person_object);
```



VideoNote
Solution to Programming
Project 15.1

```

    friend ostream& operator <<(ostream& out_stream,
                               const Person& person_object);
private:
    string name;
};

```

3. Define a `Car` class that is derived from the `Vehicle` class given in Programming Project 2. Define a class called `SportsCar` that is derived from `Car` class. Be creative in choosing member variables and functions. Write a driver program to test the `Car` and `SportsCar` classes. (No pun intended.)
4. Give the definition of two classes, `Patient` and `Billing`, whose objects are records for a clinic. `Patient` will be derived from the class `Person` given in Programming Project 2. A `Patient` record has the patient's name (inherited from the class `Person`) and primary physician, of type `Doctor` defined in Programming Project 2. A `Billing` object will contain a `Patient` object, a `Doctor` object, and an amount due of type `double`. Be sure your classes have a reasonable complement of constructors, accessor, and mutator member functions, an overloaded assignment operator, and a copy constructor. First write a driver program to test all your member functions, and then write a test program that creates at least two patients, at least two doctors, and at least two `Billing` records, then prints out the total income from the `Billing` records.
5. Consider a graphics system that has classes for various figures—rectangles, squares, triangles, circles, and so on. For example, a rectangle might have data members for height, width, and center point, while a square and circle might have only a center point and an edge length or radius, respectively. In a well-designed system, these would be derived from a common class, `Figure`. You are to implement such a system.

The class `Figure` is the base class. You should add only `Rectangle` and `Triangle` classes derived from `Figure`. Each class has stubs for member functions `erase` and `draw`. Each of these member functions outputs a message telling what function has been called and what the class of the calling object is. Since these are just stubs, they do nothing more than output this message. The member function `center` calls the `erase` and `draw` functions to erase and redraw the figure at the center. Since you have only stubs for `erase` and `draw`, `center` will not do any “centering” but will call the member functions `erase` and `draw`. Also add an output message in the member function `center` that announces that `center` is being called. The member functions should take no arguments.

There are three parts to this project:

- a. Write the class definitions using no virtual functions. Compile and test.
- b. Make the base class member functions virtual. Compile and test.
- c. Explain the difference in results.

For a real example, you would have to replace the definition of each of these member functions with code to do the actual drawing. You will be asked to do this in Programming Project 6.

Use the following main function for all testing:

```
//This program tests Programming Project 5.
#include <iostream>
#include "figure.h"
#include "rectangle.h"
#include "triangle.h"
using std::cout;

int main( )
{
    Triangle tri;
    tri.draw( );
    cout <<
        "\nDerived class Triangle object calling center( ).\n";
    tri.center( ); //Calls draw and center
    Rectangle rect;
    rect.draw( );
    cout <<
        "\nDerived class Rectangle object calling center().\n";
    rect.center( ); //Calls draw and center
    return 0;
}
```

6. Flesh out Programming Project 5. Give new definitions for the various constructors and the member functions `Figure::center`, `Figure::draw`, `Figure::erase`, `Triangle::draw`, `Triangle::erase`, `Rectangle::draw`, and `Rectangle::erase` so that the draw functions actually draw figures on the screen by placing the character ‘*’ at suitable locations. For the erase functions, you can simply clear the screen (by outputting blank lines or by doing something more sophisticated). There are a lot of details in this problem, and you will have to make decisions about some of them on your own.
7. Banks have many different types of accounts, often with different rules for fees associated with transactions such as withdrawals. Customers are allowed to transfer funds between accounts incurring the appropriate fees associated with withdrawal of funds from one account.

Write a program with a base class for a bank account and two derived classes (as described below) representing accounts with different rules for withdrawing funds. Also write a function that transfers funds from one account (of any type) to another. A transfer is a withdrawal from one account and a deposit into the other. Since the transfer can be done at any time with any type of account, the withdraw function in the classes must

be virtual. Write a main program that creates three accounts (one from each class) and tests the transfer function.

For the classes, create a base class called `BankAccount` that has the name of the owner of the account (a string) and the balance in the account (*double*) as data members. Include member functions `deposit` and `withdraw` (each with a *double* for the amount as an argument) and accessor functions `getName` and `getBalance`. `deposit` will add the amount to the balance (assuming the amount is nonnegative) and `withdraw` will subtract the amount from the balance (assuming the amount is nonnegative and less than or equal to the balance). Also create a class called `MoneyMarketAccount` that is derived from `BankAccount`. In a `MoneyMarketAccount` the user gets two free withdrawals in a given period of time (don't worry about the time for this problem). After the free withdrawals have been used, a withdrawal fee of \$1.50 is deducted from the balance per withdrawal. Hence, the class must have a data member to keep track of the number of withdrawals. It also must override the `withdraw` definition. Finally, create a `CDAccount` class (to model a Certificate of Deposit) derived from `BankAccount` that in addition to having the name and balance also has an interest rate. CDs incur penalties for early withdrawal of funds. Assume that a withdrawal of funds (any amount) incurs a penalty of 25% of the annual interest earned on the account. Assume the amount withdrawn plus the penalty are deducted from the account balance. Again, the `withdraw` function must override the one in the base class. For all three classes, the `withdraw` function should return an integer indicating the status (either ok or insufficient funds for the withdrawal to take place). For the purposes of this exercise, do not worry about other functions and properties of these accounts (such as when and how interest is paid).

8. Radio Frequency Identification (RFID) chips are small tags that can be placed on a product. They behave like wireless barcodes and can wirelessly broadcast an identification number to a receiver. One application of RFID chips is to use them to aid in the logistics of shipping freight. Consider a shipping container full of items. Without RFID chips, a human has to manually inventory all of the items in the container to verify the contents. With an RFID chip attached to the shipping container, the RFID chip can electronically broadcast to a human the exact contents of the shipping container without human intervention.

To model this application, write a base class called `ShippingContainer` that has a container ID number as an integer. Include member functions to set and access the ID number. Add a virtual function called `getManifest` that returns an empty string. The purpose of this function is to return the contents of the shipping container.

Create a derived class called `ManualShippingContainer` that represents the manual method of inventorying the container. In this method, a human simply attaches a textual description of all contents of the container. For example, the description might be “4 crates of apples. 10 crates of pears.” Add a new class variable of type `string` to store the manifest. Add a function called `setManifest` that sets this string. Override the `getManifest` function so that it returns this string.

Create a second derived class called `RFIDShippingContainer` that represents the RFID method of inventorying the container. To simulate what the RFID chips would compute, create an `add` function to simulate adding an item to the container. The class should store a list of all added items (as a `string`) and their quantity using the data structures of your choice. For example, if the `add` function were invoked three times as follows:

```
rfidContainer.add("crate of pears"); // Add one crate of pears
rfidContainer.add("crate of apples"); // Add one crate of apples
rfidContainer.add("crate of pears"); // Add one crate of pears
```

At this point, the data structure should be storing a list of two items: crate of apples and crate of pears. The quantity of apples is 1 and the quantity of pears is 2. Override the `getManifest` function so that it returns a string of all items that is built by traversing the list of items. In the example above, the return string would be “2 crate of pears. 1 crate of apples.”

Finally, write a main program that creates an array of pointers to six `ShippingContainer` objects. Instantiate the array with three `ManualShippingContainer` objects and three `RFIDShippingContainer` objects. For the `ManualShippingContainer` objects, you will have to invoke `setManifest` to set the contents. For the `RFIDShippingContainer` objects, you will have to invoke `add` to set the contents (although, if this were real, the contents of the container would “add” themselves via the RFID chips instead of requiring a human to type them in). Finally, write a loop that iterates through all `ShippingContainer` pointers and outputs each object’s manifest along with the shipping container ID. This is the output that the receiver of the shipping containers would like to see.

You may need to convert an integer into a string. A simple way to do this in C++11 is: `string s = to_string(intVariable);`

9. The goal for this Programming Project is to create a simple two-dimensional predator-prey simulation. In this simulation the prey are ants and the predators are doodlebugs. These critters live in a world composed of a 20×20 grid of cells. Only one critter may occupy a cell at a time. The grid is enclosed, so a critter is not allowed to move off the edges of the world. Time is simulated in time steps. Each critter performs some action every time step.

The ants behave according to the following model:

- **Move.** Every time step, randomly try to move up, down, left, or right. If the neighboring cell in the selected direction is occupied or would move the ant off the grid, then the ant stays in the current cell.
- **Breed.** If an ant survives for three time steps, then at the end of the time step (that is; after moving) the ant will breed. This is simulated by creating a new ant in an adjacent (up, down, left, or right) cell that is empty. If there is no empty cell available, then no breeding occurs. Once an offspring is produced, an ant cannot produce an offspring until three more time steps have elapsed.

The doodlebugs behave according to the following model:

- **Move.** Every time step, if there is an adjacent ant (up, down, left, or right), then the doodlebug will move to that cell and eat the ant. Otherwise, the doodlebug moves according to the same rules as the ant. Note that a doodlebug cannot eat other doodlebugs.
- **Breed.** If a doodlebug survives for eight time steps, then at the end of the time step it will spawn off a new doodlebug in the same manner as the ant.
- **Starve.** If a doodlebug has not eaten an ant within the last three time steps, then at the end of the third time step it will starve and die. The doodlebug should then be removed from the grid of cells.

During one turn, all the doodlebugs should move before the ants do.

Write a program to implement this simulation and draw the world using ASCII characters of "o" for an ant and "X" for a doodlebug. Create a class named `Organism` that encapsulates basic data common to both ants and doodlebugs. This class should have a virtual function named `move` that is defined in the derived classes of `Ant` and `Doodlebug`. You may need additional data structures to keep track of which critters have moved.

Initialize the world with 5 doodlebugs and 100 ants. After each time step, prompt the user to press Enter to move to the next time step. You should see a cyclical pattern between the population of predators and prey, although random perturbations may lead to the elimination of one or both species.

10. Listed below is code to play a guessing game. In the game two players attempt to guess a number. Your task is to extend the program with objects that represent either a human player or a computer player. The `rand()` function requires you include `cstdlib` (see Appendix 4):

```
bool checkForWin(int guess, int answer)
{
    cout << "You guessed" << guess << ".";
```



```

    if (answer == guess)
    {
        cout<< "You're right! You win!" <<endl;
        return true;
    }
    else if (answer < guess)
        cout<< "Your guess is too high." <<endl;
    else
        cout<< "Your guess is too low." <<endl;
    return false;
}
void play(Player &player1, Player &player2)
{
    int answer = 0, guess = 0;
    answer = rand() % 100;
    bool win = false;
    while (!win)
    {
        cout<< "Player 1's turn to guess." <<endl;
        guess = player1.getGuess();
        win = checkForWin(guess, answer);
        if (win) return;
        cout<< "Player 2's turn to guess." <<endl;
        guess = player2.getGuess();
        win = checkForWin(guess, answer);
    }
}

```

The `play` function takes as input two `Player` objects. Define the `Player` class with a virtual function named `getGuess()`. The implementation of `Player::getGuess()` can simply return 0. Next, define a class named `HumanPlayer` derived from `Player`. The implementation of `HumanPlayer::getGuess()` should prompt the user to enter a number and return the value entered from the keyboard. Next, define a class named `ComputerPlayer` derived from `Player`. The implementation of `ComputerPlayer::getGuess()` should randomly select a number between 0 and 99 (see Appendix 4 for information on random number generation). Finally, construct a main function that invokes `play(Player &player1, Player &player2)` with two instances of a `HumanPlayer` (human versus human), an instance of a `HumanPlayer` and `ComputerPlayer` (human versus computer), and two instances of `ComputerPlayer` (computer versus computer).

11. The computer player in Programming Project 10 does not play very well in the number guessing game, since it only makes random guesses. Modify the program so that the computer plays a more informed game. The specific strategy is up to you, but you must add function(s) to the `Player` and `ComputerPlayer` classes so that the `play(Player& player1, Player`

&p1ayer2) function can send the results of a guess back to the computer player. In other words, the computer must be told if its last guess was too high or too low, and it also must be told if its opponent's last guess was too high or too low. The computer then can use this information to revise its next guess. Also, add any necessary functions to allow the computer player to play multiple consecutive games.

12. Start with the definition of the Queue class given in Section 13.2 and modify it to store integers instead of characters. A special type of queue is a *priority queue*. A priority queue behaves like a regular queue except the remove function always extracts the item with the smallest value (this is the item with the highest priority). Create a PriorityQueue class that is derived from the Queue class with appropriate constructors. Redefine the remove function in the PriorityQueue class to extract the item with the smallest value. Test the PriorityQueue class by adding several numbers to a PriorityQueue object, then remove each one, printing the removed numbers as they are removed from the queue.
13. The following is an attempt to create a class to represent information about pets:

```
class Pet
{
public:
    Pet();
    void printDescription();

    string name;
    int type;
    bool neuterSpayed;
    bool talks;
};

Pet::Pet() : type(0), neuterSpayed(false),
            talks(false)
{ }

void Pet::printDescription()
{
    switch (type)
    {
    case 0:
        cout << "Dog named " << name << endl;
        cout << "Neuter/Spayed: " <<
            neuterSpayed;
        break;
    case 1:
        cout << "Cat named " << name << endl;
        cout << "Neuter/Spayed: " <<
            neuterSpayed;
    }
```

```
        break;
    case 2:
        cout << "Bird named " << name << endl;
        cout << "Talks: " << talks << endl;
        break;
    }
    cout << endl;
}
```

Rewrite this code using inheritance. You should have a `Pet` class with subclasses for `Dog`, `Cat`, and `Bird`. Variables should be associated with the appropriate classes, defined as `private` when appropriate, and have appropriate functions to access the variables. Rewrite the `printDescription` function as a virtual function. There should no longer be the need for a `switch` statement or a `type` variable.

Write a `main` function that creates a vector or array of pets that includes at least one bird, one dog, and one cat, and then loops through and outputs a description of each one.

Exception Handling 16

16.1 EXCEPTION-HANDLING BASICS 895

A Toy Example of Exception Handling 895

Defining Your Own Exception Classes 904

Multiple Throws and Catches 904

Pitfall: Catch the More Specific Exception First 908

Programming Tip: Exception Classes Can Be Trivial 909

Throwing an Exception in a Function 909

Exception Specification 911

Pitfall: Exception Specification in Derived Classes 913

16.2 PROGRAMMING TECHNIQUES FOR EXCEPTION HANDLING 914

When to Throw an Exception 914

Pitfall: Uncaught Exceptions 916

Pitfall: Nested *try-catch* Blocks 916

Pitfall: Overuse of Exceptions 916

Exception Class Hierarchies 917

Testing for Available Memory 917

Rethrowing an Exception 918



It's the exception that proves the rule.

COMMON MAXIM (possibly a corruption of something like: *It's the exception that tests the rule.*)

INTRODUCTION

One way to write a program is to first assume that nothing unusual or incorrect will happen. For example, if the program takes an entry off a list, you might assume that the list is not empty. Once you have the program working for the core situation where things always go as planned, you can then add code to take care of the exceptional cases. In C++, there is a way to reflect this approach in your code. Basically, you write your code as if nothing very unusual happens. After that, you use the C++ exception-handling facilities to add code for those unusual cases. Exception handling is commonly used to handle error situations, but perhaps a better way to view exceptions is as a way to handle “exceptional situations.” After all, if your code correctly handles an “error,” then it no longer is an error.

Perhaps the most important use of exceptions is to deal with functions that have some special case that is handled differently depending on how the function is used. Perhaps the function will be used in many programs, some of which will handle the special case in one way and some of which will handle it in some other way. For example, if there is a division by zero in the function, then it may turn out that for some invocations of the function, the program should end, but for other invocations of the function something else should happen. You will see that such a function can be defined to throw an exception if the special case occurs, and that exception will allow the special case to be handled outside of the function. That way, the special case can be handled differently for different invocations of the function.

In C++, exception handling proceeds as follows: Either some library software or your code provides a mechanism that signals when something unusual happens. This is called *throwing an exception*. At another place in your program, you place the code that deals with the exceptional case. This is called *handling the exception*. This method of programming makes for cleaner code. Of course, we still need to explain the details of how you do this in C++.

PREREQUISITES

With the exception of one subsection that can be skipped, Section 16.1 uses material only from Chapters 2 to 6 and 10 to 11. The Pitfall subsection of Section 16.1 entitled “Exception Specification in Derived Classes” uses material from Chapter 15. This Pitfall subsection can be skipped without loss of continuity.

With the exception of one subsection that can be skipped, Section 16.2 uses material only from Chapters 2 to 8 and 10 to 12 and Section 15.1 of Chapter 15 in addition to Section 16.1. The subsection of Section 16.2 entitled “Testing for Available Memory” uses material from Chapter 15. This subsection can be skipped without loss of continuity.

16.1 EXCEPTION-HANDLING BASICS

Well, the program works for most cases. I didn't know it had to work for that case.

COMPUTER SCIENCE STUDENT, APPEALING A GRADE

Exception handling is meant to be used sparingly and in situations that are more involved than what is reasonable to include in a simple introductory example. So, we will teach you the exception-handling details of C++ by means of simple examples that would not normally use exception handling. This makes a lot of sense for learning about exception handling, but do not forget that these first examples are toy examples, and in practice, you would not use exception handling for anything that simple.

A Toy Example of Exception Handling

For this example, suppose that milk is such an important food in our culture that people almost never run out of it, but still we would like our programs to accommodate the very unlikely situation of running out of milk. The basic code, which assumes we do not run out of milk, might be as follows:

```
cout << "Enter number of donuts:\n";
cin >> donuts;
cout << "Enter number of glasses of milk:\n";
cin >> milk;
dpg = donuts/static_cast<double>(milk);
cout << donuts << " donuts.\n"
    << milk << " glasses of milk.\n"
    << "You have " << dpg
    << " donuts for each glass of milk.\n";
```

If there is no milk, then this code will include a division by zero, which is an error. To take care of the special situation in which we run out of milk, we can add a test for this unusual situation. The complete program with this added test for the special situation is shown in Display 16.1. The program in Display 16.1 does not use exception handling. Now, let's see how this program can be rewritten using the C++ exception-handling facilities.

DISPLAY 16.1 Handling a Special Case Without Exception Handling

```
1  include <iostream>
2  using namespace std;
3  int main()
4  {
5      int donuts, milk;
6      double dpg;
7      cout << "Enter number of donuts:\n";
8      cin >> donuts;
9      cout << "Enter number of glasses of milk:\n";
10     cin >> milk;
11
12     if (milk <= 0)
13     {
14         cout << donuts << " donuts, and No Milk!\n"
15             << "Go buy some milk.\n";
16     }
17     Else
18     {
19         dpg = donuts/static_cast<double>(milk);
20         cout << donuts << " donuts.\n"
21             << milk << " glasses of milk.\n"
22             << "You have " << dpg
23             << " donuts for each glass of milk.\n";
24     }
25     cout << "End of program.\n";
26     return 0;
27 }
```

Sample Dialogue

```
Enter number of donuts:
12
Enter number of glasses of milk:
0
12 donuts, and No Milk!
Go buy some milk.
End of program.
```

In Display 16.2, we have rewritten the program from Display 16.1 using an exception. This is only a toy example, and you would probably not use an exception in this case. However, it does give us a simple example. Although the program as a whole is not simpler, at least the part between the words *try* and *catch* is cleaner, and this hints at the advantage of using exceptions. Look

DISPLAY 16.2 Same Thing Using Exception Handling (*part 1 of 2*)

```
1  #include <iostream>
2  using namespace std;
3
4  int main()
5  {
6      int donuts, milk;
7      double dpg;
8
9      try
10     {
11         cout << "Enter number of donuts:\n";
12         cin >> donuts;
13         cout << "Enter number of glasses of milk:\n";
14         cin >> milk;
15
16         if (milk <= 0)
17             throw donuts;
18
19         dpg = donuts/static_cast<double>(milk);
20         cout << donuts << " donuts.\n"
21              << milk << " glasses of milk.\n"
22              << "You have " << dpg
23              << " donuts for each glass of milk.\n";
24     }
25     catch(int e)
26     {
27         cout << e << " donuts, and No Milk!\n"
28              << "Go buy some milk.\n";
29     }
30
31     cout << "End of program.\n";
32     return 0;
33 }
```

Sample Dialogue 1

```
Enter number of donuts:
12
Enter number of glasses of milk:
6
12 donuts.
6 glasses of milk.
You have 2 donuts for each glass of milk.
```

(continued)

DISPLAY 16.2 Same Thing Using Exception Handling (*part 2 of 2*)**Sample Dialogue 2**

```
Enter number of donuts:  
12  
Enter number of glasses of milk:  
0  
12 donuts, and No Milk!  
Go buy some milk.  
End of program.
```

at the code between the words *try* and *catch*. That code is basically the same as the code in Display 16.1, but rather than the big *if-else* statement (shown in color in Display 16.1) this new program has the following smaller *if* statement (plus some simple nonbranching statements):

```
if (milk <= 0)  
    throw donuts;
```

This *if* statement says that if there is no milk, then do something exceptional. That something exceptional is given after the word *catch*. The idea is that the normal situation is handled by the code following the word *try*, and that the code following the word *catch* is used only in exceptional circumstances. We have thus separated the normal case from the exceptional case. In this toy example, this separation does not really buy us too much, but in other situations it will prove to be very helpful. Let's look at the details.

The basic way of handling exceptions in C++ consists of the *try-throw-catch* threesome. A **try block** has the syntax

```
try  
{  
    Some_Code  
}
```

This *try* block contains the code for the basic algorithm that tells the computer what to do when everything goes smoothly. It is called a *try* block because you are not 100 percent sure that all will go smoothly, but you want to "give it a try."

Now if something *does* go wrong, you want to throw an exception, which is a way of indicating that something went wrong. The basic outline, when we add a *throw*, is as follows:

```
try  
{
```

```

    Code_To_Try
    Possibly_Throw_An_Exception
    More_Code
}

```

The following is an example of a *try* block with a *throw* statement included (copied from Display 16.2):

```

try
{
    cout << "Enter number of donuts:\n";
    cin >> donuts;
    cout << "Enter number of glasses of milk:\n";
    cin >> milk;
    if (milk <= 0)
        throw donuts;
    dpg = donuts/static_cast<double>(milk);
    cout << donuts << " donuts.\n"
        << milk << " glasses of milk.\n"
        << "You have " << dpg
        << " donuts for each glass of milk.\n";
}

```

The following statement **throws** the *int* value donuts:

```
throw donuts;
```

The value thrown, in this case donuts, is sometimes called an **exception**, and the execution of a *throw* statement is called **throwing an exception**. You can throw a value of any type. In this case, an *int* value is thrown.

throw Statement

SYNTAX

```
throw Expression_for_Value_to_Be_Thrown;
```

When the *throw* statement is executed, the execution of the enclosing *try* block is stopped. If the *try* block is followed by a suitable *catch* block, then flow of control is transferred to the *catch* block. A *throw* statement is almost always embedded in a branching statement, such as an *if* statement. The value thrown can be of any type.

EXAMPLE

```
if (milk <= 0)
    throw donuts;
```

As the name suggests, when something is “thrown,” something goes from one place to another place. In C++, what goes from one place to another is the flow of control (as well as the value thrown). When an exception is thrown, the code in the surrounding *try* block stops executing and another portion of code, known as a **catch block**, begins execution. This executing of the *catch* block is called catching the exception or handling the exception. When an exception is thrown, it should ultimately be handled by (caught by) some *catch* block. In Display 16.2, the appropriate *catch* block immediately follows the *try* block. We repeat the *catch* block here:

```
catch(int e)
{
    cout << e << " donuts, and No Milk!\n"
        << "Go buy some milk.\n";
}
```

This *catch* block looks very much like a function definition that has a parameter of a type *int*. It is not a function definition, but in some ways, a *catch* block is like a function. It is a separate piece of code that is executed when your program encounters (and executes) the following (within the preceding *try* block):

```
throw Some_int;
```

So, this *throw* statement is similar to a function call, but instead of calling a function, it calls the *catch* block and says to execute the code in the *catch* block. A *catch* block is often referred to as an **exception handler**, which is a term that suggests that a *catch* block has a function-like nature.

What is that identifier *e* in the following line from a *catch* block?

```
catch(int e)
```

That identifier *e* looks like a parameter and acts very much like a parameter. So, we will call this *e* the **catch-block parameter**. (But remember, this does not mean that the *catch* block is a function.) The *catch*-block parameter does two things:

1. The *catch*-block parameter is preceded by a type name that specifies what kind of thrown value the *catch* block can catch.
2. The *catch*-block parameter gives you a name for the thrown value that is caught, so you can write code in the *catch* block that does things with the thrown value that is caught.

We will discuss these two functions of the *catch*-block parameter in reverse order. In this subsection, we will discuss using the *catch*-block parameter as a name for the value that was thrown and is caught. In the subsection entitled “Multiple Throws and Catches,” later in this chapter, we will discuss which *catch* block (which exception handler) will process a value that is thrown. Our

current example has only one *catch* block. A common name for a *catch*-block parameter is *e*, but you can use any legal identifier in place of *e*.

Let's see how the *catch* block in Display 16.2 works. When a value is thrown, execution of the code in the *try* block ends and control passes to the *catch* block (or blocks) that are placed right after the *try* block. The *catch* block from Display 16.2 is reproduced here:

```
catch(int e)
{
    cout << e << " donuts, and No Milk!\n"
        << "Go buy some milk.\n";
}
```

When a value is thrown, the thrown value must be of type *int* in order for this particular *catch* block to apply. In Display 16.2, the value thrown is given by the variable *donuts*, and since *donuts* is of type *int*, this *catch* block can catch the value thrown.

Suppose the value of *donuts* is 12 and the value of *milk* is 0, as in the second sample dialogue in Display 16.2. Since the value of *milk* is not positive, the *throw* statement within the *if* statement is executed. In that case, the value of the variable *donuts* is thrown. When the *catch* block in Display 16.2 catches the value of *donuts*, the value of *donuts* is plugged in for the *catch*-block parameter *e* and the code in the *catch* block is executed, producing the following output:

```
12 donuts, and No Milk!
Go buy some milk.
```

If the value of *donuts* is positive, the *throw* statement is not executed. In this case, the entire *try* block is executed. After the last statement in the *try* block is executed, the statement after the *catch* block is executed. Note that if no exception is thrown, then the *catch* block is ignored.

This makes it sound like a *try-throw-catch* setup is equivalent to an *if-else* statement. It almost is equivalent, except for the value thrown. A *try-throw-catch* setup is similar to an *if-else* statement *with the added ability to send a message to one of the branches*. This does not sound much different from an *if-else* statement, but it turns out to be a big difference in practice.

To summarize in a more formal tone, a *try* block contains some code that we are assuming includes a *throw* statement. The *throw* statement is normally executed only in exceptional circumstances, but when it is executed, it throws a value of some type. When an exception (a value like *donuts* in Display 16.2) is thrown, that is the end of the *try* block. All the rest of the code in the *try* block is ignored and control passes to a suitable *catch* block. A *catch* block applies only to an immediately preceding *try* block. If the exception is thrown, then that exception object is plugged in for the *catch*-block parameter, and the statements in the *catch* block are executed. For example, if you look at the dialogues in Display 16.2, you will see that as soon as the user

catch-Block Parameter

The *catch*-block parameter is an identifier in the heading of a *catch* block that serves as a placeholder for an exception (a value) that might be thrown. When a (suitable) value is thrown in the preceding *try* block, that value is plugged in for the *catch*-block parameter. You can use any legal (nonreserved word) identifier for a *catch*-block parameter.

EXAMPLE

```
catch(int e)
{
    cout << e << " donuts, and No Milk!\n"
        << "Go buy some milk.\n";
}
```

e is the *catch*-block parameter.

enters a nonpositive number, the *try* block stops and the *catch* block is executed. For now, we will assume that every *try* block is followed by an appropriate *catch* block. We will later discuss what happens when there is no appropriate *catch* block.

Next, we summarize what happens when no exception is thrown in a *try* block. If no exception (no value) is thrown in the *try* block, then after the *try* block is completed, program execution continues with the code after the *catch* block. In other words, if no exception is thrown, then the *catch* block is ignored. Most of the time when the program is executed, the *throw* statement will not be executed, and so in most cases, the code in the *try* block will run to completion and the code in the *catch* block will be ignored completely.

try-throw-catch

This is the basic mechanism for throwing and catching exceptions. The *throw* **statement** throws the exception (a value). The *catch* **block** catches the exception (the value). When an exception is thrown, the *try* block ends and then the code in the *catch* block is executed. After the *catch* block is completed, the code after the *catch* block(s) is executed (provided the *catch* block has not ended the program or performed some other special action).

If no exception is thrown in the *try* block, then after the *try* block is completed, program execution continues with the code after the *catch* block(s). (In other words, if no exception is thrown, then the *catch* block(s) are ignored.)

SYNTAX

```

try
{
    Some_Statements
    < Either some code with a throw statement or a
        function invocation that might throw an
        exception>
    Some_More_Statements
}
catch(Type_Name e)
{
    < Code to be performed if a value of the
        catch-block parameter type is thrown in the
        try block>
}

```

EXAMPLE

See Display 16.2.

SELF-TEST EXERCISES

1. What output is produced by the following code?

```

int wait_time = 46;
try
{
    cout << "Try block entered.\n";
    if (wait_time > 30)
        throw wait_time;
    cout << "Leaving try block.\n";
}
catch(int thrown_value)
{
    cout << "Exception thrown with\n"
        << "wait_time equal to " << thrown_value << endl;
}
cout << "After catch block." << endl;

```

2. What would be the output produced by the code in Self-Test Exercise 1 if we make the following change? Change the line

```

int wait_time = 46;

to

int wait_time = 12;

```

3. In the code given in Self-Test Exercise 1, what is the *throw* statement?
4. What happens when a *throw* statement is executed? This is a general question. Tell what happens in general, not simply what happens in the code in Self-Test Question 1 or some other sample code.
5. In the code given in Self-Test Exercise 1, what is the *try* block?
6. In the code given in Self-Test Exercise 1, what is the *catch* block?
7. In the code given in Self-Test Exercise 1, what is the *catch*-block parameter?

Defining Your Own Exception Classes

A *throw* statement can throw a value of any type. A common thing to do is to define a class whose objects can carry the precise kind of information you want thrown to the *catch* block. An even more important reason for defining a specialized exception class is so that you can have a different type to identify each possible kind of exceptional situation.

An exception class is just a class. What makes it an exception class is how it's used. Still, it pays to take some care in choosing an exception class's name and other details. Display 16.3 contains an example of a program with a programmer-defined exception class. This is just a toy program to illustrate some C++ details about exception handling. It uses much too much machinery for such a simple task, but it is an otherwise uncluttered example of some C++ details.

Notice the *throw* statement, reproduced in what follows:

```
throw NoMilk(donuts);
```

The part `NoMilk(donuts)` is an invocation of a constructor for the class `NoMilk`. The constructor takes one *int* argument (in this case `donuts`) and creates an object of the class `NoMilk`. That object is then “thrown.”

Multiple Throws and Catches

A *try* block can potentially throw any number of exception values, and they can be of differing types. In any one execution of the *try* block, only one exception will be thrown (since a thrown exception ends the execution of the *try* block), but different types of exception values can be thrown on different occasions when the *try* block is executed. Each *catch* block can only catch values of one type, but you can catch exception values of differing types by placing more than one *catch* block after a *try* block. For example, the program in Display 16.4 has two *catch* blocks after its *try* block.

Note that there is no parameter in the *catch* block for `DivideByZero`. If you do not need a parameter, you can simply list the type with no parameter.

DISPLAY 16.3 Defining Your Own Exception Class

```

1  #include <iostream>
2  using namespace std;

3  class NoMilk
4  {
5  public:
6      NoMilk();
7      NoMilk(int how_many);
8      int get_donuts();
9  private:
10     int count;
11 };

12 int main()
13 {
14     int donuts, milk;
15     double dpq;
16     try
17     {
18         cout << "Enter number of donuts:\n";
19         cin >> donuts;
20         cout << "Enter number of glasses of milk:\n";
21         cin >> milk;
22         if (milk <= 0)
23             throw NoMilk(donuts);
24         dpq = donuts/static_cast<double>(milk);
25         cout << donuts << " donuts.\n"
26              << milk << " glasses of milk.\n"
27              << "You have " << dpq
28              << " donuts for each glass of milk.\n";
29     }
30     catch(NoMilk e)
31     {
32         cout << e.get_donuts() << " donuts, and No Milk!\n"
33              << "Go buy some milk.\n";
34     }
35     cout << "End of program.";
36     return 0;
37 }

38
39 NoMilk::NoMilk()
40 {}
41 NoMilk::NoMilk(int how_many) : count(how_many)
42 {}

43
44 int NoMilk::get_donuts()
45 {
46     return count;
47 }

```

This is just a toy example to learn C++ syntax. Do not take it as an example of good typical use of exception handling.

The sample dialogues are the same as in Display 16.2.

DISPLAY 16.4 Catching Multiple Exceptions (part 1 of 2)

```

1  #include <iostream>
2  #include <string>
3  using namespace std;
4
5  class NegativeNumber
6  {
7  public:
8      NegativeNumber();
9      NegativeNumber(string take_me_to_your_catch_block);
10     string get_message();
11 private:
12     string message;
13 };
14
15 class DivideByZero
16 {};
17
18 int main()
19 {
20     int jem_hadar, klingons;
21     double portion;
22
23     try
24     {
25         cout << "Enter number of JemHadar warriors:\n";
26         cin >> jem_hadar;
27         if (jem_hadar < 0)
28             throw NegativeNumber("JemHadar");
29
30         cout << "How many Klingon warriors do you have?\n";
31         cin >> klingons;
32         if (klingons < 0)
33             throw NegativeNumber("Klingons");
34         if (klingons != 0)
35             portion = jem_hadar/static_cast<double>(klingons);
36         else
37             throw DivideByZero();
38         cout << "Each Klingon must fight "
39              << portion << " JemHadar.\n";
40     }
41     catch(NegativeNumber e)
42     {
43         cout << "Cannot have a negative number of "
44              << e.get_message() << endl;
45     }

```

Although not done here, exception classes can have their own interface and implementation files and can be put in a namespace. This is another toy example.

(continued)

DISPLAY 16.4 Catching Multiple Exceptions *(part 2 of 2)*

```
46     catch (DivideByZero)
47     {
48         cout << "Send for help.\n";
49     }
50
51     cout << "End of program.\n";
52     return 0;
53 }
54
55
56 NegativeNumber::NegativeNumber()
57 {}
58
59 NegativeNumber::NegativeNumber(string take_me_to_your_catch_block)
60     : message(take_me_to_your_catch_block)
61 {}
62
63 string NegativeNumber::get_message()
64 {
65     return message;
66 }
```

Sample Dialogue 1

```
Enter number of JemHadar warriors:
1000
How many Klingon warriors do you have?
500
Each Klingon must fight 2.0 JemHadar.
End of program
```

Sample Dialogue 2

```
Enter number of JemHadar warriors:
-10
Cannot have a negative number of JemHadar
End of program.
```

Sample Dialogue 3

```
Enter number of JemHadar warriors:
1000
How many Klingon warriors do you have?
0
Send for help.
End of program.
```

This case is discussed a bit more in the Programming Tip section entitled “Exception Classes Can Be Trivial.”

PITFALL Catch the More Specific Exception First

When catching multiple exceptions, the order of the *catch* blocks can be important. When an exception value is thrown in a *try* block, the following *catch* blocks are tried in order, and the first one that matches the type of the exception thrown is the one that is executed.

For example, the following is a special kind of *catch* block that will catch a thrown value of any type:

```
catch(...)  
{  
    <Place whatever you want in here>  
}
```

The three dots do not stand for something omitted. You actually type in those three dots in your program. This makes a good default *catch* block to place after all other *catch* blocks. For example, we could add it to the *catch* blocks in Display 16.4 as follows:

```
catch(NegativeNumber e)  
{  
    cout << "Cannot have a negative number of "  
        << e.get_message() <<endl;  
}  
catch(DivideByZero)  
{  
    cout<< "Send for help.\n";  
}  
catch(...)  
{  
    cout << "Unexplained exception.\n";  
}
```

However, it only makes sense to place this default *catch* block at the end of a list of *catch* blocks. For example, suppose we instead used:

```
catch(NegativeNumber e)  
{  
    cout << "Cannot have a negative number of "  
        << e.get_message() <<endl;  
}  
catch(...)  
{  
    cout << "Unexplained exception.\n";  
}  
catch(DivideByZero)
```

```

{
    cout << "Send for help.\n";
}

```

With this second ordering, an exception (a thrown value) of type `NegativeNumber` will be caught by the `NegativeNumber` *catch* block, as it should be. However, if a value of type `DivideByZero` were thrown, it would be caught by the block that starts *catch*(...). So, the `DivideByZero` *catch* block could never be reached. Fortunately, most compilers tell you if you make this sort of mistake. ■

■ PROGRAMMING TIP Exception Classes Can Be Trivial

Here we reproduce the definition of the exception class `DivideByZero` from Display 16.4:

```

class DivideByZero
{
};

```

This exception class has no member variables and no member functions (other than the default constructor). It has nothing but its name, but that is useful enough. Throwing an object of the class `DivideByZero` can activate the appropriate *catch* block, as it does in Display 16.4.

When using a trivial exception class, you normally do not have anything you can do with the exception (the thrown value) once it gets to the *catch* block. The exception is just being used to get you to the *catch* block. Thus, you can omit the *catch*-block parameter. (You can omit the *catch*-block parameter anytime you do not need it, whether the exception type is trivial or not.) ■

Throwing an Exception in a Function

Sometimes it makes sense to delay handling an exception. For example, you might have a function with code that throws an exception if there is an attempt to divide by zero, but you may not want to catch the exception in that function. Perhaps some programs that use that function should simply end if the exception is thrown, and other programs that use the function should do something else. So you would not know what to do with the exception if you caught it inside the function. In these cases, it makes sense to not catch the exception in the function definition, but instead to have any program (or other code) that uses the function place the function invocation in a *try* block and catch the exception in a *catch* block that follows that *try* block.

Look at the program in Display 16.5. It has a *try* block, but there is no *throw* statement visible in the *try* block. The statement that does the throwing in that program is

```

if (bottom == 0)
    throw DivideByZero();

```

DISPLAY 16.5 Throwing an Exception Inside a Function (part 1 of 2)

```
1  #include <iostream>
2  #include <cstdlib>
3  using namespace std;
4
5  class DivideByZero
6  {};
7
8  double safe_divide(int top, int bottom) throw (DivideByZero);
9
10 int main()
11 {
12     int numerator;
13     int denominator;
14     double quotient;
15     cout << "Enter numerator:\n";
16     cin >> numerator;
17     cout << "Enter denominator:\n";
18     cin >> denominator;
19
20     try
21     {
22         quotient = safe_divide(numerator, denominator);
23     }
24     catch(DivideByZero)
25     {
26         cout << "Error: Division by zero!\n"
27              << "Program aborting.\n";
28         exit(0);
29     }
30
31     cout << numerator << "/" << denominator
32          << " = " << quotient << endl;
33
34     cout << "End of program.\n";
35     return 0;
36 }
37
38
39 double safe_divide(int top, int bottom) throw (DivideByZero)
40 {
41     if (bottom == 0)
42         throw DivideByZero();
43
44     return top/static_cast<double>(bottom);
45 }
```

(continued)

DISPLAY 16.5 Throwing an Exception Inside a Function (*part 2 of 2*)

Sample Dialogue 1

```
Enter numerator:
5
Enter denominator:
10
5/10 = 0.5
End of Program.
```

Sample Dialogue 2

```
Enter numerator:
5
Enter denominator:
0
Error: Division by zero!
Program aborting.
```

This statement is not visible in the `try` block. However, it is in the `try` block in terms of program execution, because it is in the definition of the function `safe_divide` and there is an invocation of `safe_divide` in the `try` block.

Exception Specification

If a function does not catch an exception, it should at least warn programmers that any invocation of the function might possibly throw an exception. If there are exceptions that might be thrown, but not caught, in the function definition, then those exception types should be listed in an **exception specification**, which is illustrated by the following function declaration from Display 16.5:

```
double safe_divide(int top, int bottom) throw (DivideByZero);
```

As illustrated in Display 16.5, the exception specification should appear in both the function declaration and the function definition. If a function has more than one function declaration, then all the function declarations must have identical exception specifications. The exception specification for a function is also sometimes called the **throw list**.

If there is more than one possible exception that can be thrown in the function definition, then the exception types are separated by commas, as illustrated here:

```
void some_function( ) throw (DivideByZero, OtherException);
```

All exception types listed in the exception specification are treated normally. When we say the exception is treated normally, we mean it is treated as we have described before this subsection. In particular, you can place the function invocation in a *try* block followed by a *catch* block to catch that type of exception, and if the function throws the exception (and does not catch it inside the function), then the *catch* block following the *try* block will catch the exception. If there is no exception specification (no throw list) at all (not even an empty one), then it is the same as if all possible exception types were listed in the exception specification; that is, any exception that is thrown is treated normally.

What happens when an exception is thrown in a function but is not listed in the exception specification (and not caught inside the function)? In that case, the program ends. In particular, notice that if an exception is thrown in a function but is not listed in the exception specification (and not caught inside the function), then it will not be caught by any *catch* block, but instead your program will end. Remember, if there is no specification list at all, not even an empty one, then it is the same as if all exceptions were listed in the specification list, and so throwing an exception will not end the program in the way described in this paragraph.

Keep in mind that the exception specification is for exceptions that “get outside” the function. If they do not get outside the function, they do not belong in the exception specification. If they get outside the function, they belong in the exception specification no matter where they originate. If an exception is thrown in a *try* block that is inside a function definition and is caught in a *catch* block inside the function definition, then its type need not be listed in the exception specification. If a function definition includes an invocation of another function and that other function can throw an exception that is not caught, then the type of the exception should be placed in the exception specification.

To say that a function should not throw any exceptions that are not caught inside the function, you use an empty exception specification like so:

```
void some_function( ) throw ( );
```

By way of summary:

```
void some_function( ) throw (DivideByZero, OtherException);
//Exceptions of type DivideByZero or OtherException are
//treated normally. All other exceptions end the program
//if not caught in the function body.
```

```
void some_function( ) throw ( );
//Empty exception list; all exceptions end the
//program if thrown but not caught in the function body.
```

```
void some_function( );
//All exceptions of all types treated normally.
```

Keep in mind that an object of a derived class¹ is also an object of its base class. So, if D is a derived class of class B and B is in the exception specification, then a thrown object of class D will be treated normally, since it is an object of class B and B is in the exception specification. However, no automatic type conversions are done. If *double* is in the exception specification, that does not account for throwing an *int* value. You would need to include both *int* and *double* in the exception specification.

One final warning: Not all compilers treat the exception specification as they are supposed to. Some compilers essentially treat the exception specification as a comment, and so with those compilers, the exception specification has no effect on your code. This is another reason to place all exceptions that might be thrown by your functions in the exception specification. This way all compilers will treat your exceptions the same way. Of course, you could get the same compiler consistency by not having any exception specification at all, but then your program would not be as well documented and you would not get the extra error checking provided by compilers that do use the exception specification. With a compiler that does process the exception specification, your program will terminate as soon as it throws an exception that you did not anticipate. (Note that this is a run-time behavior, but which run-time behavior you get depends on your compiler.)

Warning!

PITFALL Exception Specification in Derived Classes

When you redefine or override a function definition in a derived class, it should have the same exception specification as it had in the base class, or it should have an exception specification whose exceptions are a subset of those in the base class exception specification. Put another way, when you redefine or override a function definition, you cannot add any exceptions to the exception specification (but you can delete some exceptions if you want). This makes sense, since an object of the derived class can be used anywhere an object of the base class can be used, and so a redefined or overwritten function must fit any code written for an object of the base class. ■

SELF-TEST EXERCISES

8. What is the output produced by the following program?

```
#include <iostream>
using namespace std;
void sample_function(double test) throw (int);
```

¹ If you have not yet learned about derived classes, you can safely ignore the remarks about them.

```

int main()
{
    try
    {
        cout << "Trying.\n";
        sample_function(98.6);
        cout << "Trying after call.\n";
    }
    catch(int)
    {
        cout << "Catching.\n";
    }
    cout << "End of program.\n";
    return 0;
}

void sample_function(double test) throw (int)
{
    cout << "Starting sample_function.\n";
    if (test < 100)
        throw 42;
}

```

9. What is the output produced by the program in Self-Test Exercise 8 if the following change were made to the program? Change

```
sample_function(98.6);
```

in the *try* block to

```
sample_function(212);
```

16.2 PROGRAMMING TECHNIQUES FOR EXCEPTION HANDLING

Only use this in exceptional circumstances.

WARREN PEACE, *The Lieutenant's Tools*

So far, we have shown you lots of code that explains how exception handling works in C++, but we have not yet shown even one example of a program that makes good and realistic use of exception handling. However, now that you know the mechanics of exception handling, this section can go on to explain exception-handling techniques.

When to Throw an Exception

We have given some very simple code in order to illustrate the basic concepts of exception handling. However, our examples were unrealistically simple. A more complicated but better guideline is to separate throwing an exception

and catching the exception into separate functions. In most cases, you should include any *throw* statement within a function definition, list the exception in the exception specification for that function, and place the *catch* clause in a different function. Thus, the preferred use of the *try-throw-catch* triad is as illustrated here:

```
void functionA() throw (MyException)
{
    .
    .
    .
    throw MyException(<Maybe an argument>);
    .
    .
    .
}
```

Then, in *some other function* (perhaps even some other function in some other file), you have

```
void functionB()
{
    .
    .
    .
    try
    {
        .
        .
        .
        functionA();
        .
        .
        .
    }
    catch(MyException e)
    {
        <Handle exception.>
    }
    .
    .
    .
}
```

Moreover, even this kind of use of a *throw* statement should be reserved for cases in which it is unavoidable. If you can easily handle a problem in some other way, do not throw an exception. Reserve *throw* statements for situations in which the way the exceptional condition is handled depends on how and where the function is used. If the way that the exceptional condition is handled depends on how and where the function is invoked, then the

When to Throw an Exception

For the most part, *throw* statements should be used within functions and listed in an exception specification for the function. Moreover, they should be reserved for situations in which the way the exceptional condition is handled depends on how and where the function is used. If the way that the exceptional condition is handled depends on how and where the function is invoked, then the best thing to do is to let the programmer who invokes the function handle the exception. In all other situations, it is almost always preferable to avoid throwing an exception.

best thing to do is to let the programmer who invokes the function handle the exception. In all other situations, it is almost always preferable to avoid throwing exceptions.

PITFALL Uncaught Exceptions

Every exception that is thrown by your code should be caught someplace in your code. If an exception is thrown but not caught anywhere, your program will end. ■

PITFALL Nested *try-catch* Blocks

You can place a *try* block and following *catch* blocks inside a larger *try* block or inside a larger *catch* block. In rare cases, this may be useful, but if you are tempted to do this, you should suspect that there is a nicer way to organize your program. It is almost always better to place the inner *try-catch* blocks inside a function definition and place an invocation of the function in the outer *try* or *catch* block (or maybe just eliminate one or more *try* blocks completely).

If you place a *try* block and following *catch* blocks inside a larger *try* block, and an exception is thrown in the inner *try* block but not caught in the inner *try-catch* blocks, then the exception is thrown to the outer *try* block for processing and might be caught there. ■

PITFALL Overuse of Exceptions

Exceptions allow you to write programs whose flow of control is so involved that it is almost impossible to understand the program. Moreover, this is not hard to do. Throwing an exception allows you to transfer flow of control

from anyplace in your program to almost anyplace else in your program. In the early days of programming, this sort of unrestricted flow of control was allowed via a construct known as a *goto*. Programming experts now agree that such unrestricted flow of control is very poor programming style. Exceptions allow you to revert to these bad old days of unrestricted flow of control. Exceptions should be used sparingly and only in certain ways. A good rule is the following: If you are tempted to include a *throw* statement, then think about how you might write your program or class definition without this *throw* statement. If you think of an alternative that produces reasonable code, then you probably do not want to include the *throw* statement. ■

Exception Class Hierarchies

It can be very useful to define a hierarchy of exception classes. For example, you might have an `ArithmeticError` exception class and then define an exception class `DivideByZeroError` that is a derived class of `ArithmeticError`. Since a `DivideByZeroError` is an `ArithmeticError`, every *catch* block for an `ArithmeticError` will catch a `DivideByZeroError`. If you list `ArithmeticError` in an exception specification, then you have, in effect, also added `DivideByZeroError` to the exception specification, whether or not you list `DivideByZeroError` by name in the exception specification.



VideoNote
The STL Exception Class

Testing for Available Memory

In Chapter 13, we created new dynamic variables with code such as the following:

```
struct Node
{
    int data;
    Node *link;
};
typedef Node* NodePtr;
. . .
NodePtr pointer = new Node;
```

This works fine as long as there is sufficient memory available to create the new node. But, what happens if there is not sufficient memory? If there is not sufficient memory to create the node, then a `bad_alloc` exception is thrown. The type `bad_alloc` is part of the C++ language. You do not need to define it.

Since `new` will throw a `bad_alloc` exception when there is not enough memory to create the node, you can check for running out of memory as follows:

```
try
{
    NodePtr pointer = new Node;
}
```

```
    catch (bad_alloc)
    {
        cout << "Ran out of memory!";
    }
```

Of course, you can do other things besides simply giving a warning message, but the details of what you do will depend on your particular programming task.

Rethrowing an Exception

It is legal to throw an exception within a *catch* block. In rare cases, you may want to catch an exception and then, depending on the details, decide to throw the same or a different exception for handling farther up the chain of exception-handling blocks.

SELF-TEST EXERCISES

10. What happens when an exception is never caught?
11. Can you nest a *try* block inside another *try* block?

CHAPTER SUMMARY

- Exception handling allows you to design and code the normal case for your program separately from the code that handles exceptional situations.
- An exception can be thrown in a *try* block. Alternatively, an exception can be thrown in a function definition that does not include a *try* block (or does not include a *catch* block to catch that type of exception). In this case, an invocation of the function can be placed in a *try* block.
- An exception is caught in a *catch* block.
- A *try* block may be followed by more than one *catch* block. In this case, always list the *catch* block for a more specific exception class before the *catch* block for a more general exception class.
- Do not overuse exceptions.

Answers to Self-Test Exercises

1. Try block entered.
Exception thrown with
wait_time equal to 46
After catch block.

2. Try block entered.
Leaving try block.
After catch block.

3. `throw wait_time;`

Note that the following is an *if* statement, not a *throw* statement, even though it contains a *throw* statement:

```
if (wait_time > 30)
    throw wait_time;
```

4. When a *throw* statement is executed, that is the end of the enclosing *try* block. No other statements in the *try* block are executed, and control passes to the following *catch* block(s). When we say control passes to the following *catch* block, we mean that the value thrown is plugged in for the *catch*-block parameter (if any), and the code in the *catch* block is executed.

5.

```
try
{
    cout << "Try block entered.";
    if (wait_time > 30)
        throw (wait_time);
    cout << "Leaving try block.";
}
```

6.

```
catch(int thrown_value)
{
    cout << "Exception thrown with\n"
        << "wait_time equal to" << thrown_value << endl;
}
```

7. `thrown_value` is the *catch*-block parameter.

8. Trying.
Starting `sample_function`.
Catching.
End of program.

9. Trying.
Starting `sample_function`.
Trying after call.
End of program.

10. If an exception is not caught anywhere, then your program ends.

11. Yes, you can have a *try* block and corresponding *catch* blocks inside another larger *try* block. However, it would probably be better to place the inner *try* and *catch* blocks in a function definition and place an invocation of the function in the larger *try* block.

PRACTICE PROGRAMS

Practice Programs can generally be solved with a short program that directly applies the programming principles presented in this chapter.



VideoNote
Solution to Practice
Program 16.1

1. A function that returns a special error code is often better implemented by throwing an exception instead. This way, the error code cannot be ignored or mistaken for valid data. The following class maintains an account balance.

```
class Account
{
private:
    double balance;
public:
    Account()
    {
        balance = 0;
    }
    Account(double initialDeposit)
    {
        balance = initialDeposit;
    }
    double getBalance()
    {
        return balance;
    }
    // returns new balance or -1 if error
    double deposit(double amount)
    {
        if (amount > 0)
            balance += amount;
        else
            return -1; // Code indicating error
        return balance;
    }
    // returns new balance or -1 if invalid amount
    double withdraw(double amount)
    {
        if ((amount > balance) || (amount < 0))
            return -1;
        else
            balance -= amount;
        return balance;
    }
};
```

Rewrite the class so that it throws appropriate exceptions instead of returning `-1` as an error code. Write test code that attempts to withdraw and deposit invalid amounts and catches the exceptions that are thrown.

2. The Standard Template Library includes a class named `exception` that is the parent class for any exception thrown by an STL function. Therefore, any exception can be caught by this class. The following code sets up a `try-catch` block for STL exceptions:

```
#include <iostream>
#include <string>
#include <exception>
using namespace std;

int main()
{
    string s = "hello";
    try
    {
        cout << "No exception thrown." << endl;
    }
    catch (exception& e)
    {
        cout << "Exception caught: " <<
            e.what() << endl;
    }
    return 0;
}
```

Modify the code so that an exception is thrown in the `try` block. You could try accessing an invalid index in a string using the `at` member function.

PROGRAMMING PROJECTS

Programming Projects require more problem-solving than Practice Programs and can usually be solved many different ways. Visit www.myprogramminglab.com to complete many of these Programming Projects online and get instant feedback.

1. Write a program that converts 24-hour time to 12-hour time. The following is a sample dialogue:

```
Enter time in 24-hour notation:
13:07
That is the same as
1:07 PM
Again?(y/n)
y
Enter time in 24-hour notation:
10:15
That is the same as
10:15 AM
Again?(y/n)
y
```



```

Enter time in 24-hour notation:
10:65
There is no such time as 10:65
Try again:
Enter time in 24-hour notation:
16:05
That is the same as
4:05 PM
Again?(y/n)
n
End of program

```

You will define an exception class called `TimeFormatMistake`. If the user enters an illegal time, like `10:65` or even gibberish like `8&*68`, then your program will throw and catch a `TimeFormatMistake`.

2. Write a program that converts dates from numerical month/day format to alphabetic month/day (for example, `1/31` or `01/31` corresponds to January 31). The dialogue should be similar to that in Programming Project 1. You will define two exception classes, one called `MonthError` and another called `DayError`. If the user enters anything other than a legal month number (integers from 1 to 12), then your program will throw and catch a `MonthError`. Similarly, if the user enters anything other than a valid day number (integers from 1 to either 29, 30, or 31, depending on the month), then your program will throw and catch a `DayError`. To keep things simple, always allow 29 days for February.
3. Write a program that inputs numeric values from 1 through 10 and outputs a textual histogram of the values using `*`'s to count the number of occurrences of each value. The program should first ask the user how many numbers to enter. If the user enters a value that does not consist of all digits or a number outside the range 1 to 10, then an exception should be caught. (*Hint*: Input each number as a string, and then scan through the string to see if it contains all digits. If not, throw an exception. To convert a string `str` to an integer, use the following code:

```
atoi(str.c_str());
```

The `atoi` function is described in Chapter 8.) Here is a sample dialogue:

```

How many numbers to enter?
5
Enter number 1:
one
Please enter your number using digits only. Try again.
Enter number 1:
9
Enter number 2:

```



VideoNote
Solution to Programming
Project 16.3

```

3
Enter number 3:
3
Enter number 4:
33
The number must be between 1-10. Try again.
Enter number 4:
3
Enter number 5:
7

```

Here is the histogram of values:

```

1 :
2 :
3 : ***
4 :
5 :
6 :
7 : *
8 :
9 : *
10:

```

4. Define a class named `CheckedArray`. The objects of this class are like regular arrays but have range checking. If `a` is an object of the class `CheckedArray` and `i` is an illegal index, then use of `a[i]` will cause your program to throw an exception (an object) of the class `ArrayOutOfRangeException`. Defining the class `ArrayOutOfRangeException` is part of this project. Note that, among other things, your `CheckedArray` class must have a suitable overloading of the `[]` operators, as discussed in Appendix 6.
5. Stacks were introduced in Chapters 13 and 14. Define a stack class for storing a stack of elements of type `char`. A stack object should be of fixed size; the size is a parameter to the constructor that creates the stack object. When used in a program, an object of the stack class will throw exceptions in the following situations:
 - Throw a `StackOverflowException` if the application program tries to push data onto a stack that is already full
 - Throw a `StackEmptyException` if the application program tries to pop data off an empty stack

Defining the classes `StackOverflowException` and `StackEmptyException` is part of this project. Write a suitable test program.

6. (Based on a problem in Stroustrup, *The C++ Programming Language*, 3rd edition) Write a program consisting of functions calling one another to a calling depth of 10. Give each function an argument that specifies the level

at which it is to throw an exception. The `main` function prompts for and receives input that specifies the calling depth (level) at which an exception will be thrown. The `main` function then calls the first function. The `main` function catches the exception and displays the level at which the exception was thrown. Don't forget the case where the depth is 0, where `main` must both throw and catch the exception.

(Hints: You could use 10 different functions or 10 copies of the same function that call one another, but don't. Rather, for compact code, use a `main` function that calls another function that calls itself recursively. Suppose you do this; is the restriction on the calling depth necessary? This can be done without giving the function any additional arguments, but if you cannot do it that way, try adding an additional argument to the function.)

7. Programming Project 7 in Chapter 9 described a technique to emulate a two-dimensional array with wrapper functions around a one-dimensional array. If the indices of a desired entry in the two-dimensional array were invalid (for example, out of range), you were asked to print an error message and exit the program. Modify this program (or do it for the first time) to instead throw an `ArrayOutOfRangeException` exception if either the row or column indices are invalid. Your program should define the `ArrayOutOfRangeException` exception class.



Templates 17

17.1 TEMPLATES FOR ALGORITHM ABSTRACTION 926

Templates for Functions 927

Pitfall: Compiler Complications 931

Programming Example: A Generic Sorting
Function 933

Programming Tip: How to Define Templates 937

Pitfall: Using a Template with an Inappropriate
Type 938

17.2 TEMPLATES FOR DATA ABSTRACTION 939

Syntax for Class Templates 939

Programming Example: An Array Class 942

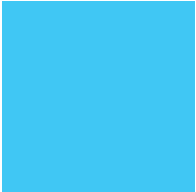

*All men are mortal.
Aristotle is a man.
Therefore, Aristotle is mortal.
All X's are Y.
Z is an X.
Therefore, Z is Y.
All cats are mischievous.
Garfield is a cat.
Therefore, Garfield is mischievous.*

A SHORT LESSON ON SYLLOGISMS

INTRODUCTION

This chapter discusses C++ templates. Templates allow you to define functions and classes that have parameters for type names. This will allow you to design functions that can be used with arguments of different types and to define classes that are much more general than those you have seen before this chapter.

PREREQUISITES

Section 17.1 uses material from Chapters 2 through 5 and Sections 7.1, 7.2, and 7.3 of Chapter 7. It does not use any material on classes. Section 17.2 uses material from Chapters 2 through 7 and 10 through 12.

17.1 TEMPLATES FOR ALGORITHM ABSTRACTION

Many of our previous C++ function definitions have an underlying algorithm that is much more general than the algorithm we gave in the function definition. For example, consider the function `swap_values`, which we first discussed in Chapter 5. For reference, we now repeat the function definition:

```
void swap_values(int& variable1, int& variable2)
{
    int temp;

    temp = variable1;
    variable1 = variable2;
    variable2 = temp;
}
```

Notice that the function `swap_values` applies only to variables of type `int`. Yet the algorithm given in the function body could just as well be used to swap the values in two variables of type `char`. If we want to also use the function

swap_values with variables of type *char*, we can overload the function name by adding the following definition:

```
void swap_values(char& variable1, char& variable2)
{
    char temp;

    temp = variable1;
    variable1 = variable2;
    variable2 = temp;
}
```

But there is something inefficient and unsatisfying about these two definitions of the swap_values function: They are almost identical. The only difference is that one definition uses the type *int* in three places and the other uses the type *char* in the same three places. Proceeding in this way, if we wanted to have the function swap_values apply to pairs of variables of type *double*, we would have to write a third almost identical function definition. If we wanted to apply swap_values to still more types, the number of almost identical function definitions would be even larger. This would require a good deal of typing and would clutter up our code with lots of definitions that look identical. We should be able to say that the following function definition applies to variables of any type:

```
void swap_values(Type_Of_The_Variables& variable1,
                Type_Of_The_Variables& variable2)
{
    Type_Of_The_Variables temp;

    temp = variable1;
    variable1 = variable2;
    variable2 = temp;
}
```

As we will see, something like this is possible. We can define one function that applies to all types of variables, although the syntax is a bit different from what we have shown above. That syntax is described in the next subsection.

Templates for Functions

Display 17.1 shows a C++ template for the function swap_values. This function template allows you to swap the values of any two variables, of any type, as long as the two variables have the same type. The definition and the function declaration begin with the line

```
template<class T>
```

This is often called the **template prefix**, and it tells the compiler that the definition or function declaration that follows is a **template** and that T is a

type parameter. In this context, the word *class* actually means *type*.¹ As we will see, the type parameter *T* can be replaced by any type, whether the type is a class or not. Within the body of the function definition, the type parameter *T* is used just like any other type.

The function template definition is, in effect, a large collection of function definitions. For the function template for `swap_values` shown in Display 17.1, there is, in effect, one function definition for each possible type name. Each of these definitions is obtained by replacing the type parameter *T* with a type name. For example, the function definition that follows is obtained by replacing *T* with the type name *double*:

```
void swap_values(double& variable1, double& variable2)
{
    double temp;

    temp = variable1;
    variable1 = variable2;
    variable2 = temp;
}
```

A template
overloads the
function name

Another definition for `swap_values` is obtained by replacing the type parameter *T* in the function template with the type name *int*. Yet another definition is obtained by replacing the type parameter *T* with *char*. The one function template shown in Display 17.1 overloads the function name `swap_values` so that there is a slightly different function definition for every possible type.

The compiler will not literally produce definitions for every possible type for the function name `swap_values`, but it will behave exactly as if it had produced all those function definitions. A separate definition will be produced for each different type for which you use the template, but not for any types you do not use. Only one definition is generated for a single type regardless of the number of times you use the template for that type. Notice that the function `swap_values` is called twice in Display 17.1: One time the arguments are of type *int* and the other time the arguments are of type *char*.

Consider the following function call from Display 17.1:

```
swap_values(integer1, integer2);
```

When the C++ compiler gets to this function call, it notices the types of the arguments—in this case *int*—and then it uses the template to produce a function definition with the type parameter *T* replaced with the type name *int*. Similarly, when the compiler sees the function call

```
swap_values(symbol1, symbol2);
```

¹ In fact, the ANSI standard provides that you may use the keyword *typename* instead of *class* in the template prefix. Although we agree that using *typename* makes more sense than using *class*, the use of *class* is a firmly established tradition, and so we use *class* for the sake of consistency with most other programmers and authors.

DISPLAY 17.1 A Function Template

```

1  //Program to demonstrate a function template.
2  #include <iostream>
3  using namespace std;

4  //Interchanges the values of variable1 and variable2.
5  template<class T>
6  void swap_values(T& variable1, T& variable2)
7  {
8      T temp;
9
10     temp = variable1;
11     variable1 = variable2;
12     variable2 = temp;
13 }

14 int main( )
15 {
16     int integer1 = 1, integer2 = 2;
17     cout << "Original integer values are "
18         << integer1 << " " << integer2 <<endl;
19     swap_values(integer1, integer2);
20     cout << "Swapped integer values are "
21         << integer1 << " " << integer2 <<endl;

22     char symbol1 = 'A', symbol2 = 'B';
23     cout << "Original character values are "
24         << symbol1 << " " << symbol2 <<endl;
25     swap_values(symbol1, symbol2);
26     cout << "Swapped character values are "
27         << symbol1 << " " << symbol2 <<endl;

28     return 0;
29 }

```

Output

```

Original integer values are 1 2
Swapped integer values are 2 1
Original character values are A B
Swapped character values are B A

```

it notices the types of the arguments—in this case *char*—and then it uses the template to produce a function definition with the type parameter *T* replaced with the type name *char*.

Notice that you need not do anything special when you call a function that is defined with a function template; you call it just as you would any

Calling a
function
template

other function. The compiler does all the work of producing the function definition from the function template.

Notice that in Display 17.1 we placed the function template definition before the `main` part of the program, and we used no template function declaration. A function template may have a function declaration, just like an ordinary function. You may (or may not) be able to place the function declaration and definition for a function template in the same locations that you place function declarations and definitions for ordinary functions. However, many compilers do not support template function declarations and do not support separate compilation of template functions. When these are supported, the details can be messy and can vary from one compiler to another. Your safest strategy is to not use template function declarations and to be sure the function template definition appears in the same file in which it is used and appears before the function template is used.

We said that a function template definition should appear in the same file as the file that uses the template function (that is, the same file as the file that has an invocation of the template function). However, the function template definition can appear via a `#include` directive. You can give the function template definition in one file and then `#include` that file in a file that uses the template function. That is the cleanest and safest general strategy. However, even that may not work on some compilers. If it does not work, consult a local expert.

Although we will not be using template function declarations in our code, we will describe them and give examples of them for the benefit of readers whose compilers support the use of these function declarations.

In the function template in Display 17.1, we used the letter `T` as the parameter for the type. This is traditional but is not required by the C++ language. The type parameter can be any identifier (other than a keyword). `T` is a good name for the type parameter, but sometimes other names may work better. For example, the function template for `swap_values` given in Display 17.1 is equivalent to the following:

```
template<class VariableType>
void swap_values(VariableType& variable1,
                VariableType& variable2)
{
    VariableType temp;
    temp = variable1;
    variable1 = variable2;
    variable2 = temp;
}
```

More than one
type parameter

It is possible to have function templates that have more than one type parameter. For example, a function template with two type parameters named `T1` and `T2` would begin as follows:

```
template<class T1, class T2>
```

However, most function templates require only one type parameter. You cannot have unused template parameters; that is, each template parameter must be used in your template function.

PITFALL Compiler Complications

Many compilers do not allow separate compilation of templates, so you may need to include your template definition with your code that uses it. As usual, at least the function declaration must precede any use of the template function.

Your safest strategy is not to use template function declarations and to be sure the function template definition appears in the same file in which it is used and appears before the function template is called. However, the function template definition can appear via a `#include` directive. You can give the function template definition in one file and then `#include` that file in a file that uses the template function.

Another common technique is to put your definition and implementation, all in the header file. If you use this technique, then you would only have a header (.h) file and no implementation (.cpp) file. Finally, an alternate approach is to include the implementation (.cpp) file for your template class instead of the header file (.h).

Some C++ compilers have additional special requirements for using templates. If you have trouble compiling your templates, check your manuals or check with a local expert. You may need to set special options or rearrange the way you order the template definitions and the other items in your files. ■



VideoNote
Issues Compiling Programs
with Templates

Function Template

The function definition and the function declaration for a function template are each prefaced with the following:

```
template<class Type_Parameter>
```

The function declaration (if used) and definition are the same as any ordinary function declaration and definition, except that the *Type_Parameter* can be used in place of a type.

For example, the following is a function declaration for a function template:

```
template<class T>  
void show_stuff(int stuff1, T stuff2, T stuff3);
```

The definition for this function template might be as follows:

```
template<class T>  
void show_stuff(int stuff1, T stuff2, T stuff3)
```

(continued)

```
{
    cout << stuff1 << endl
         << stuff2 << endl
         << stuff3 << endl;
}
```

The function template given in this example is equivalent to having one function declaration and one function definition for each possible type name. The type name is substituted for the type parameter (which is *T* in the example above). For instance, consider the following function call:

```
show_stuff(2, 3.3, 4.4);
```

When this function call is executed, the compiler uses the function definition obtained by replacing *T* with the type name *double*. A separate definition will be produced for each different type for which you use the template but not for any types you do not use. Only one definition is generated for a specific type regardless of the number of times you use the template.

SELF-TEST EXERCISES

1. Write a function template named `maximum`. The function takes two values of the same type as its arguments and returns the larger of the two arguments (or either value if they are equal). Give both the function declaration and the function definition for the template. You will use the operator `<` in your definition. Therefore, this function template will apply only to types for which `<` is defined. Write a comment for the function declaration that explains this restriction.
2. We have used three kinds of absolute value function: `abs`, `labs`, and `fabs`. These functions differ only in the type of their argument. It might be better to have a function template for the absolute value function. Give a function template for an absolute value function called `absolute`. The template will apply only to types for which `<` is defined, for which the unary negation operator is defined, and for which the constant `0` can be used in a comparison with a value of that type. Thus, the function `absolute` can be called with any of the number types, such as `int`, `long`, and `double`. Give both the function declaration and the function definition for the template.
3. Define or characterize the template facility for C++.
4. In the template prefix
`template<class T>`
what kind of variable is the parameter `T`?

- a. T must be a class.
- b. T must not be a class.
- c. T can be only types built into the C++ language.
- d. T can be any type, whether built into C++ or defined by the programmer.

Algorithm Abstraction

As we saw in our discussion of the `swap_values` function, there is a very general algorithm for interchanging the value of two variables, and this more general algorithm applies to variables of any type. Using a function template, we were able to express this more general algorithm in C++. This is a very simple example of *algorithm abstraction*. When we say we are using **algorithm abstraction**, we mean that we are expressing our algorithms in a very general way so that we can ignore incidental detail and concentrate on the substantive part of the algorithm. Function templates are one feature of C++ that supports algorithm abstraction.

PROGRAMMING EXAMPLE

A Generic Sorting Function

In Chapter 7 we gave a simple sorting algorithm to sort an array of values of type *int*. The algorithm was realized in C++ code as the function `sort`, which we gave in Display 7.12. Here we repeat the definition of this function `sort`:

```
void sort(int a[], int number_used)
{
    int index_of_next_smallest;
    for (int index = 0; index < number_used - 1; index++)
    { //Place the correct value in a[index]:
        index_of_next_smallest =
            index_of_smallest(a, index, number_used);
        swap_values(a[index], a[index_of_next_smallest]);
        //a[0] <= a[1] <= ... <= a[index] are the smallest of
        //the original array elements. The rest of the
        //elements are in the remaining positions.
    }
}
```

If you study this definition of the function `sort`, you will see that the base type of the array is never used in any significant way. If we replace the base type of the array in the function header with the type *double*, then we would obtain a sorting function that applies to arrays of values of type *double*. Of

Helping functions course, we also must adjust the helping functions so they apply to arrays of elements of type *double*. So let's consider the helping functions that are called inside the body of the function `sort`. The two helping functions are `swap_values` and `index_of_smallest`.

We already saw that `swap_values` can apply to variables of any type, provided we define it as a function template (as in Display 17.1). Let's see if `index_of_smallest` depends in any significant way on the base type of the array being sorted. The definition of `index_of_smallest` is repeated next so you can study its details.

```

    int index_of_smallest(const int a[], int start_index,
                       int number_used)
    {
        int min = a[start_index];
        int index_of_min = start_index;
        for (int index = start_index + 1;
            index < number_used; index++)
        {
            if (a[index] < min)
            {
                min = a[index];
                index_of_min = index;
                //min is the smallest of a[start_index] through
                //a[index]
            }
        }
        return index_of_min;
    }

```

The function `index_of_smallest` also does not depend in any significant way on the base type of the array. If we replaced the two highlighted instances of the type *int* with the type *double*, then we will have changed the function `index_of_smallest` so that it applies to arrays whose base type is *double*.

To change the function `sort` so that it can be used to sort arrays with the base type *double*, we only needed to replace a few instances of the type name *int* with the type name *double*. Moreover, there is nothing special about the type *double*. We can do a similar replacement for many other types. The only thing we need to know about the type is that the operator `<` is defined for that type. This is the perfect situation for function templates. If we replace a few instances of the type name *int* (in the functions `sort` and `index_of_smallest`) with a type parameter, then the function `sort` can sort an array of values of any type provided that the values of that type can be compared using the `<` operator. In Display 17.2 we have written just such a function template.

Notice that the function template `sort` shown in Display 17.2 can be used with arrays of values that are not numbers. In the demonstration program in Display 17.3, the function template `sort` is called to sort an array of characters. Characters can be compared using the `<` operator. Although the exact meaning of the `<` operator applied to character values may vary somewhat from one

DISPLAY 17.2 A Generic Sorting Function

```

1 //This is file sortfunc.cpp

2 template<class T>
3 void swap_values(T& variable1, T& variable2)
4     <The rest of the definition of swap_values is given in Display 17.1.>

5 template<class BaseType>
6 int index_of_smallest(const BaseType a[], int start_index, int number_used)
7 {
8     BaseType min = a[start_index];
9     int index_of_min = start_index;
10
11     for (int index = start_index + 1; index < number_used; index++)
12         if (a[index] < min)
13         {
14             min = a[index];
15             Index_of_min = index;
16             //min is the smallest of a[start_index] through a[index]
17         }
18
19     return index_of_min;
20 }

21
22 template<class BaseType>
23 void sort(BaseType a[], int number_used)
24 {
25     int index_of_next_smallest;
26     for (int index = 0; index < number_used - 1; index++)
27         {//Place the correct value in a[index]:
28             index_of_next_smallest =
29                 index_of_smallest(a, index, number_used);
30             swap_values(a[index], a[index_of_next_smallest]);
31             //a[0] <= a[1] <= ... <= a[index] are the smallest of the original array
32             //elements. The rest of the elements are in the remaining positions.
33         }
34 }

```

implementation to another, some things are always true about how `<` orders the letters of the alphabet. When applied to two uppercase letters, the operator `<` tests to see if the first comes before the second in alphabetic order. Also, when applied to two lowercase letters, the operator `<` tests to see if the first comes before the second in alphabetic order. When you mix uppercase and lowercase letters, the situation is not so well behaved, but the program shown in Display 17.3 deals only with uppercase letters. In that program, an array of

DISPLAY 17.3 Using a Generic Sorting Function (part 1 of 2)

```

1 //Demonstrates a generic sorting function.
2 #include <iostream>
3 using namespace std;
4
5 //The file sortfunc.cpp defines the following function:
6 //template<class BaseType>
7 //void sort(BaseType a[], int number_used);
8 //Precondition: number_used <= declared size of the array a.
9 //The array elements a[0] through a[number_used - 1] have values.
10 //Postcondition: The values of a[0] through a[number_used - 1] have
11 //been rearranged so that a[0] <= a[1] <= ... <= a[number_used - 1].
12
13 #include "sortfunc.cpp"
14
15 int main( )
16 {
17     int i;
18     int a[10] = {9, 8, 7, 6, 5, 1, 2, 3, 0, 4};
19     cout << "Unsorted integers:\n";
20     for (i = 0; i < 10; i++)
21         cout << a[i] << " ";
22     cout << endl;
23     sort(a, 10);
24     cout << "In sorted order the integers are:\n";
25     for (i = 0; i < 10; i++)
26         cout << a[i] << " ";
27     cout << endl;
28
29     double b[5] = {5.5, 4.4, 1.1, 3.3, 2.2};
30     cout << "Unsorted doubles:\n";
31     for (i = 0; i < 5; i++)
32         cout << b[i] << " ";
33     cout << endl;
34     sort(b, 5);
35     cout << "In sorted order the doubles are:\n";
36     for (i = 0; i < 5; i++)
37         cout << b[i] << " ";
38     cout << endl;
39
40     char c[7] = {'G', 'E', 'N', 'E', 'R', 'I', 'C'};
41     cout << "Unsorted characters:\n";
42     for (i = 0; i < 7; i++)
43         cout << c[i] << " ";
44     cout << endl;

```

Many compilers will allow this function declaration to appear as a function declaration and not merely as a comment. However, including the function declaration is not needed, since the definition of the function is in the file `sortfunc.cpp`, and so the definition effectively appears before `main`.

(continued)

DISPLAY 17.3 Using a Generic Sorting Function (*part 2 of 2*)

```
43     sort(c, 7);
44     cout << "In sorted order the characters are:\n";
45     for (i = 0; i < 7; i++)
46         cout << c[i] << " ";
47     cout << endl;
48     return 0;
49 }
```

Output

```
Unsorted integers:
9 8 7 6 5 1 2 3 0 4
In sorted order the integers are:
0 1 2 3 4 5 6 7 8 9
Unsorted doubles:
5.5 4.4 1.1 3.3 2.2
In sorted order the doubles are:
1.1 2.2 3.3 4.4 5.5
Unsorted characters:
G E N E R I C
In sorted order the characters are:
C E E G I N R
```

uppercase letters is sorted into alphabetical order with a call to the function template `sort`. (The function template `sort` will even sort an array of objects of a class that you define, provided you overload the `<` operator to apply to objects of that class.)

PROGRAMMING TIP How to Define Templates

When we defined the function template in Display 17.2, we started with a function that sorts an array of elements of type `int`. We then created a template by replacing the base type of the array with the type parameter `T`. This is a good general strategy for writing templates. If you want to write a function template, first write a version that is not a template at all but is just an ordinary function. Completely debug the ordinary function and then convert the ordinary

function to a template by replacing some type names with a type parameter. There are two advantages to this method. First, when you are defining the ordinary function you are dealing with a much more concrete case, which makes the problem easier to visualize. Second, you have fewer details to check at each stage; when worrying about the algorithm itself, you need not concern yourself with template syntax rules. ■

PITFALL Using a Template with an Inappropriate Type²

You can use a template function with any type for which the code in the function definition makes sense. However, all the code in the template function must make sense and must behave in an appropriate way. For example, you cannot use the `swap_values` template (Display 17.1) with the type parameter replaced by a type for which the assignment operator does not work at all or does not work “correctly.”

As a more concrete example, suppose that your program defines the template function `swap_values` as in Display 17.1. You cannot add the following to your program:

```
int a[10], b[10];  
<some code to fill arrays>  
swap_values(a, b);
```

This code will not work, because assignment does not work with array types. ■

SELF-TEST EXERCISES

5. Display 7.10 shows a function called `search`, which searches an array for a specified integer. Give a function template version of `search` that can be used to search an array of elements of any type. Give both the function declaration and the function definition for the template. (*Hint:* It is almost identical to the function given in Display 7.10.)
6. In Practice Program 8 of Chapter 4 you were asked to overload the `abs` function so that the name `abs` would work with several of the built-in types that had been studied at the time. Compare and contrast function overloading of the `abs` function with the use of templates for this purpose in Self-Test Exercise 2.

² The example in this Pitfall section uses arrays. If you have not yet covered arrays (Chapter 7), you should skip this Pitfall section and return after covering arrays.

17.2 TEMPLATES FOR DATA ABSTRACTION

Equal wealth and equal opportunities of culture . . . have simply made us all members of one class.

EDWARD BELLAMY, *Looking Backward: 2000–1887*

As you saw in the previous section, function definitions can be made more general by using templates. In this section, you will see that templates can also make class definitions more general.

Syntax for Class Templates

The syntax for class templates is basically the same as that for function templates. The following is placed before the template definition:

```
template<class T>
```

The type parameter `T` is used in the class definition just like any other type. As with function templates, the type parameter `T` represents a type that can be any type at all; the type parameter does not have to be replaced with a class type. As with function templates, you may use any (nonkeyword) identifier instead of `T`.

Type parameter

For example, the following is a class template. An object of this class contains a pair of values of type `T`; if `T` is `int`, the object values are pairs of integers, if `T` is `char`, the object values are pairs of characters, and so on.

```
//Class for a pair of values of type T:
template<class T>
class Pair
{
public:
    Pair();

    Pair(T first_value, T second_value);

    void set_element(int position, T value);
    //Precondition: position is 1 or 2.
    //Postcondition:
    //The position indicated has been set to value.

    T get_element(int position) const;
    //Precondition: position is 1 or 2.
    //Returns the value in the position indicated.
private:
    T first;
    T second;
};
```

Once the class template is defined, you can declare objects of this class. The declaration must specify what type is to be filled in for `T`. For example, the

Declaring objects

following code declares the object `score` so it can record a pair of integers and declares the object `seats` so it can record a pair of characters:

```
Pair<int> score;
Pair<char> seats;
```

The objects are then used just like any other objects. For example, the following sets the score to be 3 for the first team and 0 for the second team:

```
score.set_element(1, 3);
score.set_element(2, 0);
```

Defining member functions

The member functions for a class template are defined the same way as member functions for ordinary classes. The only difference is that the member function definitions are themselves templates. For example, the following are appropriate definitions for the member function `set_element` and for the constructor with two arguments:

```
//Uses iostream and cstdlib:
template<class T>
void Pair<T>::set_element(int position, T value)
{
    if (position == 1)
        first = value;
    else if (position == 2)
        second = value;
    else
    {
        cout << "Error: Illegal pair position.\n";
        exit(1);
    }
}

template<class T>
Pair<T>::Pair(T first_value, T second_value)
    : first(first_value), second(second_value)
{
    //Body intentionally empty.
}
```

Notice that the class name before the scope resolution operator is `Pair<T>`, not simply `Pair`.

The name of a class template may be used as the type for a function parameter. For example, the following is a possible declaration for a function with a parameter for a pair of integers:

```
int add_up(const Pair<int>& the_pair);
//Returns the sum of the two integers in the_pair.
```

Class Template Syntax

The class definition and the definitions of the member functions are prefaced with the following:

```
template<class Type_Parameter>
```

The class and member function definitions are then the same as for any ordinary class, except that the *Type_Parameter* can be used in place of a type.

For example, the following is the beginning of a class template definition:

```
template<class T>
class Pair
{
public:
    Pair();
    Pair(T first_value, T second_value);
    void set_element(int position, T value);
    . . .
```

Member functions and overloaded operators are then defined as function templates. For example, the definition of a function definition for the sample class template above could begin as follows:

```
template<class T>
void Pair<T>::set_element(int position, T value)
{
    . . .
```

Note that we specified the type, in this case *int*, that is to be filled in for the type parameter *T*.

You can even use a class template within a function template. For example, rather than defining the specialized function *add_up* given above, you could instead define a function template as follows so that the function applies to all kinds of numbers:

```
template<class T>
T add_up(const Pair<T>& the_pair);
//Precondition: The operator + is defined for values of type T.
//Returns the sum of the two values in the_pair.
```

Type Definitions

You can specialize a class template by giving a type argument to the class name, as in the following example:

```
Pair<int>
```

The specialized class name, like `Pair<int>`, can then be used just like any class name. It can be used to declare objects or to specify the type of a formal parameter.

You can define a new class type name that has the same meaning as a specialized class template name, such as `Pair<int>`. The syntax for such a defined class type name is as follows:

```
typedef Class_Name<Type_Argument> New_Type_Name;
```

For example:

```
typedef Pair<int> PairOfInt;
```

The type name `PairOfInt` can then be used to declare objects of type `Pair<int>`, as in the following example:

```
PairOfInt pair1, pair2;
```

The type name `PairOfInt` can also be used to specify the type of a formal parameter.

PROGRAMMING EXAMPLE An Array Class

Display 17.4 contains the interface for a class template whose objects are lists. Since this class definition is a class template, the lists can be lists of items of any type whatsoever. You can have objects that are lists of values of type `int`, or lists of values of type `double`, or lists of objects of type `string`, or lists of items of any other type.

Display 17.5 contains a demonstration program that uses this class template. Although this program does not really do anything much, it does illustrate how the class template is used. Once you understand the syntax details, you can use the class template in any program that needs a list of values. Display 17.6 gives the implementation of the class template.

Notice that we have overloaded the insertion operator `<<` so it can be used to output an object of the class template `GenericList`. To do this, we made the operator `<<` a friend of the class. In order to have a parameter that is of the same type as the class, we used the expression `GenericList<ItemType>` for the parameter type. When the type parameter is replaced by, for example, the type `int`, this list parameter will be of type `GenericList<int>`.

A friend

Also note that the implementation of the overloaded insertion operator `<<` has been placed in the header file rather than the implementation file. This may seem unusual, but it is quite common when using friend functions or operators within a template. Although we are defining `<<` like it is a member of `GenericList`, recall that friend functions really exist outside the class and are part of the namespace. The compiler will have an easy time finding the implementation of `<<` this way when the class is included from other files.

DISPLAY 17.4 Interface for the Class Template `GenericList` (part 1 of 2)

```

1 //This is the header file genericlist.h. This is the interface for the
2 //class GenericList. Objects of type GenericList can be a list of items
3 //of any type for which the operators << and = are defined.
4 //All the items on any one list must be of the same type. A list that
5 //can hold up to max items all of type Type_Name is declared as follows:
6 //GenericList<Type_Name> the_object(max);
7 #ifndef GENERICLIST_H
8 #define GENERICLIST_H
9 #include <iostream>
10 using namespace std;
11
12 namespace listsavitch
13 {
14     template<class ItemType>
15     class GenericList
16     {
17     public:
18         GenericList(int max);
19         //Initializes the object to an empty list that can hold up to
20         //max items of type ItemType.
21         ~GenericList( );
22         //Returns all the dynamic memory used by the object to the freestore.
23
24         int length( ) const;
25         //Returns the number of items on the list.
26
27         void add(ItemType new_item);
28         //Precondition: The list is not full.
29         //Postcondition: The new_item has been added to the list.

```

(continued)

DISPLAY 17.4 Interface for the Class Template `GenericList` (part 2 of 2)

```

30
31     bool full( ) const;
32     //Returns true if the list is full.
33
34     void erase( );
35     //Removes all items from the list so that the list is empty.
36
37     friend ostream& operator <<(ostream& outs,
38                               const GenericList<ItemType>& the_list)
39     {
40         for (int i = 0; i < the_list.current_length; i++)
41             outs << the_list.item[i] << endl;
42         return outs;
43     }
44     //Overloads the << operator so it can be used to output the
45     //contents of the list. The items are output one per line.
46     //Precondition: If outs is a file output stream, then outs has
47     //already been connected to a file.
48     //
49     //Note the implementation of the overloaded << in the header
50     //file! This is commonly done with overloaded friend templates.
51     //Since << is a friend it is NOT a member of the class but
52     //rather in the namespace, this is the simplest implementation
53     //and may make more sense than putting it in genericlist.cpp.
54     private:
55         ItemType *item; //pointer to the dynamic array that holds the list.
56         int max_length; //max number of items allowed on the list.
57         int current_length; //number of items currently on the list.
58     };
59 } //listsavitch
60 #endif //GENERICLIST_H

```

DISPLAY 17.5 Program Using the `GenericList` Class Template (part 1 of 2)

```

1  //Program to demonstrate use of the class template GenericList.
2  #include <iostream>
3  #include "genericlist.h"
4  #include "genericlist.cpp"
5  using namespace std;
6  using namespace listsavitch;
7
8  int main( )
9  {
10     GenericList<int> first_list(2);
11     first_list.add(1);
12     first_list.add(2);

```

Since `genericlist.cpp` is included, you need compile only this one file (the one with the main).

(continued)

DISPLAY 17.5 Program Using the GenericList Class Template (part 2 of 2)

```

12     cout << "first_list = \n"
13         << first_list;
14     GenericList<char> second_list(10);
15     second_list.add('A');
16     second_list.add('B');
17     second_list.add('C');
18     cout << "second_list = \n"
19         << second_list;

20     return 0;
21 }

```

Output

```

first_list =
1
2
second_list =
A
B
C

```

DISPLAY 17.6 Implementation of GenericList (part 1 of 2)

```

1 //This is the implementation file: genericlist.cpp
2 //This is the implementation of the class template named GenericList.
3 //The interface for the class template GenericList is in the
4 //header file genericlist.h.
5 #ifndef GENERICLIST_CPP
6 #define GENERICLIST_CPP
7 #include <iostream>
8 #include <cstdlib>
9 #include "genericlist.h" //This is not needed when used as we are using this file,
10 //but the #ifndef in genericlist.h makes it safe.
11 using namespace std;
12
13 namespace listsavitch
14 {
15     //Uses cstdlib:
16     template<class ItemType>
17     GenericList<ItemType>::GenericList(int max) : max_length(max),
18                                                 current_length(0)

```

(continued)

DISPLAY 17.6 Implementation of GenericList (part 2 of 2)

```
19     {
20         item = new ItemType[max];
21     }
22
23     template<class ItemType>
24     GenericList<ItemType>::~GenericList( )
25     {
26         delete [] item;
27     }
28
29     template<class ItemType>
30     int GenericList<ItemType>::length( ) const
31     {
32         return (current_length);
33     }
34
35     //Uses iostream and cstdlib:
36     template<class ItemType>
37     void GenericList<ItemType>::add(ItemType new_item)
38     {
39         if ( full( ) )
40         {
41             cout << "Error: adding to a full list.\n";
42             exit(1);
43         }
44         else
45         {
46             item[current_length] = new_item;
47             current_length = current_length + 1;
48         }
49     }
50
51     template<class ItemType>
52     bool GenericList<ItemType>::full( ) const
53     {
54         return (current_length == max_length);
55     }
56
57     template<class ItemType>
58     void GenericList<ItemType>::erase( )
59     {
60         current_length = 0;
61     }
62 } //listsavitch
63 #endif // GENERICLIST_CPP Notice that we have enclosed all the template
64 // definitions in #ifndef. . . #endif.
```

A note is in order about compiling the code from Displays 17.4, 17.5, and 17.6. A safe solution to the compilation of this code is to `#include` the template class definition and the template function definitions before use, as we did. In that case, only the file in Display 17.5 needs to be compiled. Be sure that you use the `#ifndef #define #endif` mechanism to prevent multiple file inclusion of all the files you are going to `#include`.

Also note that that the implementation of the overloaded insertion operator `<<` has been placed in the header file rather than the implementation file. This may seem unusual, but it is quite common when using friend functions or operators within a template. Although we are defining `<<` like it is a member of `GenericList`, recall that friend functions really exist outside the class and are part of the namespace. The compiler will have an easy time finding the implementation of `<<` this way when the class is included from other files.

If you want to separate the implementation of the overloaded friend insertion operator `<<` from the header, then it requires a little bit of extra work. We must make a forward declaration of the `<<` operator which in turn requires a forward declaration of the `GenericList` class. Display 17.7 illustrates the required changes to `genericlist.h` while Display 17.8 illustrates the changes to `genericlist.cpp`, which simply has the additional implementation.

DISPLAY 17.7 Interface for the Class Template `GenericList` Without Implementation (part 1 of 2)

```

1 //This version moves the implementation of the overloaded <<
2 //to the .cpp file, but requires adding some forward declarations.
3 #ifndef GENERICLIST_H
4 #define GENERICLIST_H
5 #include <iostream>
6 using namespace std;
7
8 namespace listsavitch
9 {
10     template<class ItemType>
11     class GenericList;
12     //We need a forward declaration of the GenericList template
13     //class for the friend header declaration that comes right after it.
14
15     template<class ItemType>
16     ostream& operator <<(ostream& outs, const GenericList<ItemType>& the_list);
17     //Forward declaration of the friend << for the definition inside the
18     //GenericList class below. These must be defined here since << is not
19     //a member of the class.
20
21     template<class ItemType>

```

(continued)

DISPLAY 17.7 Interface for the Class Template `GenericList` Without Implementation (*part 2 of 2*)

```

22     class GenericList
23     {
24         The rest of this class is identical to Display 17.4 except the overloaded
25         operator below has no implementation code and an additional <>.
26
27         friend ostream& operator << <>(ostream& outs,
28                                     const GenericList<ItemType>& the_list);
29         //Overloads the << operator so it can be used to output the
30         //contents of the list.
31         //Note the <> needed after the operator (or function) name!
32         //The implementation is in genericlist.cpp (Display 17.8).
33     };
34 } //listsavitch
35 #endif //GENERICLIST_H

```

DISPLAY 17.8 Implementation of `GenericList` with Overloaded Operator

```

1 //This is the implementation file: genericlist.cpp
2 //This is the implementation of the class template named GenericList.
3 //The interface for the class template GenericList is in the
4 //header file genericlist.h.
5 #ifndef GENERICLIST_CPP
6 #define GENERICLIST_CPP
7 #include <iostream>
8 #include <cstdlib>
9 #include "genericlist.h" //Not needed when used as we are using this file,
10                        //but the #ifndef in genericlist.h makes it safe.
11 using namespace std;
12
13 namespace listsavitch
14 {
15     The rest of this file is identical to Display 17.6 except for the
16     Implementation of <<.
17     template<class ItemType>
18     ostream& operator <<(ostream& outs, const GenericList<ItemType>& the_list)
19     {
20         for (int i = 0; i < the_list.current_length; i++)
21             outs << the_list.item[i] << endl;
22         return outs;
23     }
24 } //listsavitch
25 #endif // GENERICLIST_CPP Notice that we have enclosed all the template
26 // definitions in #ifndef . . . #endif.

```

SELF-TEST EXERCISES

7. Give the definition for the member function `get_element` for the class template `Pair` discussed in the section “Syntax for Class Templates.”
8. Give the definition for the constructor with zero arguments for the class template `Pair` discussed in the section “Syntax for Class Templates.”
9. Give the definition of a template class called `HeterogeneousPair` that is like the class template `Pair` discussed in the section “Syntax for Class Templates,” except that with `HeterogeneousPair` the first and second positions may store values of different types. Use two type parameters `T1` and `T2`; all items in the first position will be of type `T1`, and all items in the second position will be of type `T2`. The single mutator function `set_element` in the template class `Pair` should be replaced by two mutator functions called `set_first` and `set_second` in the template class `HeterogeneousPair`. Similarly, the single accessor function `get_element` in the template class `Pair` should be replaced by two accessor functions called `get_first` and `get_second` in the template class `HeterogeneousPair`.
10. Is the following true or false?

Friends are used exactly the same for template and nontemplate classes.

CHAPTER SUMMARY

- Using function templates, you can define functions that have a parameter for a type.
- Using class templates, you can define a class with a type parameter for subparts of the class.

Answers to Self-Test Exercises

1. Function Declaration:

```
template<class T>
T maximum(T first, T second);
//Precondition: The operator < is defined for the type T.
//Returns the maximum of first and second.
```

Definition:

```
template<class T>
T maximum(T first, T second)
{
    if (first < second)
```

```

        return second;
    else
        return first;
}

```

2. Function Declaration:

```

template<class T>
T absolute(T value);
//Precondition: The expressions  $x < 0$  and  $-x$  are defined
//whenever  $x$  is of type T.
//Returns the absolute value of its argument.

```

Definition:

```

template<class T>
T absolute(T value)
{
    if (value < 0)
        return -value;
    else
        return value;
}

```

3. Templates provide a facility to allow the definition of functions and classes that have parameters for type names.
4. d. Any type, whether a primitive type (provided by C++) or a type defined by the user (a *class* or *struct* type, an *enum* type, or a defined array type, or *int*, *float*, *double*, etc.).
5. The function declaration and function definition are given here. They are basically identical to those for the versions given in Display 7.10 except that two instances of *int* are changed to *BaseType* in the parameter list.

Function Declaration:

```

template<class BaseType>
int search(const BaseType a[],
          int number_used, BaseType target);
//Precondition: number_used is  $\leq$  the declared size of a.
//Also, a[0] through a[number_used-1] have values.
//Returns the first index such that a[index] == target,
//provided there is such an index; otherwise, returns -1.

```

Definition:

```

template<class BaseType>
int search(const BaseType a[], int number_used,
          BaseType target)

```

```

{
    int index = 0, found = false;
    while ((!found) && (index < number_used))
        if (target == a[index])
            found = true;
        else
            index++;

    if (found)
        return index;
    else
        return -1;
}

```

6. Function overloading only works for types for which an overloading is provided. Overloading may work for types that automatically convert to some type for which an overloading is provided but may not do what you expect. The template solution will work for any type that is defined at the time of invocation, provided that the requirements for a definition of < are satisfied.

7. *//Uses iostream and cstdlib:*
- ```

template<class T>
T Pair<T>::get_element(int position) const
{
 if (position == 1)
 return first;
 else if (position == 2)
 return second;
 else
 {
 cout << "Error: Illegal pair position.\n";
 exit(1);
 }
}

```

8. There are no natural candidates for the default initialization values, so this constructor does nothing, but it does allow you to declare (uninitialized) objects without giving any constructor arguments.

```

template<class T>
Pair<T>::Pair()
{
 //Do nothing.
}

```

9. *//Class for a pair of values, the first of type T1  
//and the second of type T2:*
- ```

template<class T1, class T2>

```

```

class HeterogeneousPair
{
public:
    HeterogeneousPair();
    HeterogeneousPair(T1 first_value, T2 second_value);
    void set_first(T1 value);
    void set_second(T2 value);
    T1 get_first() const;
    T2 get_second() const;
private:
    T1 first;
    T2 second;
};

```

The member function definitions are as follows:

```

template<class T1, class T2>
HeterogeneousPair<T1, T2>::HeterogeneousPair( )
{
    //Do nothing.
}

template<class T1, class T2>
HeterogeneousPair<T1, T2>::HeterogeneousPair
    (T1 first_value, T2 second_value)
    : first(first_value), second(second_value)
{
    //Body intentionally empty.
}

template<class T1, class T2>
T1 HeterogeneousPair<T1, T2>::get_first() const
{
    return first;
}

template<class T1, class T2>
T2 HeterogeneousPair<T1, T2>::get_second() const
{
    return second;
}

template<class T1, class T2>
void HeterogeneousPair<T1, T2>::set_first(T1 value)
{
    first = value;
}

```

```
template<class T1, class T2>
void HeterogeneousPair<T1, T2>::set_second(T2 value)
{
    second = value;
}
```

10. True.

PRACTICE PROGRAMS

Practice Programs can generally be solved with a short program that directly applies the programming principles presented in this chapter.

1. Write a function template for a function that has parameters for a partially filled array and for a value of the base type of the array. If the value is in the partially filled array, then the function returns the index of the first indexed variable that contains the value. If the value is not in the array, the function returns -1 . The base type of the array is a type parameter. Notice that you need two parameters to give the partially filled array: one for the array and one for the number of indexed variables used. Also, write a suitable test program to test this function template.
2. Write a template version of the iterative binary search from Display 14.8. Specify and discuss the requirements on the template parameter type.
3. Write a template version of the recursive binary search from Display 14.6. Specify and discuss the requirements on the template parameter type.

PROGRAMMING PROJECTS

Programming Projects require more problem-solving than Practice Programs and can usually be solved many different ways. Visit www.myprogramminglab.com to complete many of these Programming Projects online and get instant feedback.

1. Rewrite the definition of the class template `GenericList` given in Display 17.4 and Display 17.6 so that it is more general. This more general version has the added feature that you can step through the items on the list in order. One item is always the current item. You can ask for the current item, change the current item to the next item, change the current item to the previous item, start at the beginning of the list by making the first item on the list the current item, and ask for the n th item on the list. To do this, you will add the following members: an additional member variable that records the position on the list of the current item, a member function that returns the current item as a value, a member function that makes the next item the current item, a member function that makes the previous item the current item, a member function that makes the first item on the

list the current item, and a member function that returns the n th item on the list given n as an argument. (Number items as in arrays, so that the first item is the 0th item, the next is item number 1, and so forth.)

Note that there are situations in which some of these function actions are not possible. For example, an empty list has no first item, and there is no item after the last item in any list. Be sure to test for the empty list and handle it appropriately. Be sure to test for the beginning and end of the list and handle these cases appropriately. Write a suitable test program to test this class template.

2. Write a template for a function that has parameters for a list of items and for a possible item on the list. If the item is on the list, then the function returns the position of the first occurrence of that item. If the item is not on the list, the function returns -1 . The first position on the list is position 0, the next is position 1, and so forth. The type of the items on the list is a type parameter. Use the class template `GenericList` that you defined in Project 1. Write a suitable program to test this function template.
3. Redo Programming Project 3 in Chapter 7, but this time make the function `delete_repeats` a template function with a type parameter for the base type of the array. It would help if you first did the nontemplate version; in other words, it would help if you first did Programming Project 3 in Chapter 7, if you have not already done it.
4. Display 17.3 gives a template function for sorting an array using the selection sort algorithm. Write a similar template function for sorting an array, but this time use the insertion sort algorithm as described in Programming Project 6 of Chapter 7. If you have not already done it, it would be a good idea to first do the nontemplate version; in other words, it would be a good idea to first do Programming Project 6 from Chapter 7.
5. (This project requires that you know what a stack is and how to use dynamic arrays. Stacks are covered in Chapter 14; dynamic arrays are covered in Chapter 9. This is an appropriate project only if you have covered Chapters 9 and 14.)

Write a template version of a stack class. Use a type parameter for the type of data that is stored in the stack. Use dynamic arrays to allow the stack to grow to hold any number of items.

6. Write a template version of a class that implements a priority queue. Queues are discussed in Chapter 13 and priority queues are discussed in Chapter 18. To summarize, a priority queue is essentially a list of items

that is always ordered by priority. Each item that is added to the list requires an associated priority value. For this problem, make the priority an integer where 0 is the highest priority and larger values are lower in priority. Removing an item from the queue removes the item with the highest priority.

The add function of the priority queue should take a generic type and then an integer priority. In the following example, the generic type is a char and we have added three items to the queue:

```
q.add('X', 10);
q.add('Y', 1);
q.add('Z', 3);
```

The remove function should return and remove from the priority queue the item that has the highest priority. Given the example above, we would expect the following:

```
cout << q.remove();           // Outputs Y (priority 1)
cout << q.remove();           // Returns Z (priority 3)
cout << q.remove();           // Returns X (priority 10)
```

Test your queue on data with priorities in various orders (for example, ascending, descending, mixed). You can implement the priority queue by storing the items using a list(s) of your choice (for example, vector, array, linked list, or `GenericList` described in this chapter) and then performing a linear search for the item with the lowest integer value in the remove function. In future courses you may study a data structure called a heap that affords a more efficient way to implement a priority queue.

7. Write a template-based class that implements a set of items. A set is a collection of items in which no item occurs more than once. Internally, you may represent the set using the data structure of your choice (for example, list, vector, arrays, etc.). However, the class should externally support the following functions:
 - a. Add a new item to the set. If the item is already in the set then nothing happens.
 - b. Remove an item from the set.
 - c. Return the number of items in the set.
 - d. Determine if an item is a member of the set.
 - e. Return a pointer to a dynamically created array containing each item in the set. The caller of this function is responsible for deallocating the memory.

Test your class by creating different sets of different data types (for example, strings, integers, or other classes). If you add objects to your set, then you may need to overload the `==` and `!=` operators for the object's class so your template-based set class can properly determine membership.



VideoNote
Solution to Programming
Project 17.7

8. This project requires that you complete Programming Project 7 from this chapter and Programming Project 8 from Chapter 14. Programming Project 8 asked you to write a program to find all permutations of a set. Modify the program so that it generates permutations given an instance of the template-based set class defined in Programming Project 7. You may wish to also use your template-based set class to help simplify the implementation of the permutation algorithm itself.

The algorithm requires that you store a set of lists. C++ allows you to create a set of lists with your template-based set class. For example, `myset<vector<T> >` will define a set containing a vector of type `T`. Be careful to place a space between the last two `>`'s, or the compiler may get confused. The code `myset<vector<T>>` without a space will likely produce a compiler error unless you are using C++11 or higher.

Your program should print all permutations of sets of several different sizes and comprised of several different types of data (for example, a set of three integers, a set of four strings, or a set of five doubles).

9. In this chapter we used only a single template class type parameter. C++ allows you to specify multiple type parameters. For example, the following code specifies that the class accepts two type parameters:

```
template<class T, class V>
class Example
{
    ...
}
```

When creating an instance of the class, we must now specify two data types, such as:

```
Example<int, char> demo;
```

Create a Map class that maps keys to values. The data type for the keys and values should be specified separately using type parameters. The map forms the basis for a simple database. For example, to map from employee ID numbers to employee names, we might use integers for the data type of the keys and strings for the data type of the names. The class should have functions to:

1. Add a new key/value pair to the map
2. Set an existing key/value pair to a new value given the key
3. Delete a key/value pair from the map given the key
4. Check if a key/value pair exists in the map given the key
5. Retrieve the value for a key/value pair given the key

Use any data type you wish to implement the map. Write a main function that tests the class by exercising all of the functions with sample data.

Standard Template Library 18

18.1 ITERATORS 959

using Declarations 959

Iterator Basics 960

Programming Tip: Use `auto` to Simplify Variable Declarations 964

Pitfall: Compiler Problems 964

Kinds of Iterators 966

Constant and Mutable Iterators 970

Reverse Iterators 971

Other Kinds of Iterators 972

18.2 CONTAINERS 973

Sequential Containers 974

Pitfall: Iterators and Removing Elements 978

Programming Tip: Type Definitions in Containers 979

Container Adapters `stack` and `queue` 979

Associative Containers `set` and `map` 983

Programming Tip: Use Initialization, Ranged `for`, and `auto` with Containers 990

Efficiency 990

18.3 GENERIC ALGORITHMS 991

Running Times and Big-O Notation 992

Container Access Running Times 995

Nonmodifying Sequence Algorithms 997

Container Modifying Algorithms 1001

Set Algorithms 1003

Sorting Algorithms 1004



Libraries are not made; they grow.

AUGUSTINE BIRRELL

INTRODUCTION

There is a large collection of standard data structures for holding data. Since they are so standard it makes sense to have standard portable implementations for them. The Standard Template Library (STL) includes libraries for such data structures. Included in the STL are implementations of the stack, queue, and many other standard data structures. When discussed in the context of the STL, these data structures are usually called *container classes* because they are used to hold collections of data. In Chapter 8 we presented a preview of the STL by describing the vector template class, which is one of the container classes in the STL. In this chapter we will present an overview of some of the basic classes included in the STL. We do not have room to give a comprehensive treatment of the STL here, but we will present enough to get you started using some basic STL container classes.

The STL was developed by Alexander Stepanov and Meng Lee at Hewlett-Packard and was based on research by Stepanov, Lee, and David Musser. It is a collection of libraries written in the C++ language. Although the STL is not part of the core C++ language, it is part of the C++ standard and so any implementation of C++ that conforms to the standard would include the STL. As a practical matter, you can consider the STL to be part of the C++ language.

As its name suggest, the classes in the STL are template classes. A typical container class in the STL has a type parameter for the type of data to be stored in the container class. The STL container classes make extensive use of iterators, which are objects that facilitate cycling through the data in a container. An introduction to the concept of an iterator was given in Section 13.1, where we discussed pointers used as iterators. You will find it helpful to read that section before reading this chapter. If you have not already done so, you should also read Section 8.3, which covers the vector template class of the STL.

The STL also includes implementations of many important generic algorithms, such as searching and sorting algorithms. The algorithms are implemented as template functions. After discussing the container classes, we will describe some of these algorithm implementations.

The STL differs from other C++ libraries, such as `<iostream>` for example, in that the classes and algorithms are **generic**, which is another way of saying they are template classes and template functions.

PREREQUISITES

This chapter uses the material from Chapters 2 through 13, 15, and Chapter 17.

18.1 ITERATORS

The White Rabbit put on his spectacles. "Where shall I begin, please your Majesty?" he asked.

"Begin at the beginning," the King said, very gravely, "And go on till you come to the end: then stop."

LEWIS CARROLL, *Alice in Wonderland*

Vectors, introduced in Chapter 8, are one of the container template classes in the STL. Iterators are a generalization of pointers. (Chapter 13 includes an introduction to pointers used as iterators.) This section shows you how to use iterators with vectors. Other container template classes, which we introduce in Section 18.2, use iterators in the same way. So, all you learn about iterators in this section will apply across a wide range of containers and does not apply solely to vectors. This reflects one of the basic tenets of the STL philosophy: The semantics, naming, and syntax for iterator usage should be (and are) uniform across different container types. We begin with a review and discussion of the *using* declarations, which we will use extensively when discussing iterators and the STL.

using Declarations

It may help to review the subsection entitled "Qualifying Names" in Chapter 12 before you continue with this subsection and this chapter.

Suppose `my_function` is a function defined in the namespace `my_space`. The following *using* declaration allows you to use the identifier `my_function` and have it mean the versions of `my_function` defined in the namespace `my_space`:

```
using my_space::my_function;
```

Within the scope of this *using* declaration an expression such as `my_function(1,2)` means the same thing as `my_space::my_function(1,2)`; that is, within the scope of this *using* declaration the identifier `my_function` always indicates the version of `my_function` defined in `my_space`, as opposed to any definition of `my_function` defined in any other namespace.

When discussing iterators we will often apply the `::` operator to another level. You will often see expressions such as the following:

```
using std::vector<int>::iterator;
```

In this case, the identifier `iterator` names a type. So within the scope of this `using` directive, the following would be allowed:

```
iterator p;
```

This declares `p` to be of the type `iterator`. What is the type `iterator`? It is defined in the definition of the class `vector<int>`. Which class `vector<int>`? The one defined in the namespace `std`. (We will fully explain the type `iterator` later. At this point we are concerned only with explaining `using` directives.)

You may object that this is all a big to-do about nothing. There is no class `vector<int>` defined in any namespace other than the namespace `std`. That may or may not be true, but there could be a class named `vector<int>` defined in some other namespace either now or in the future. You may object further that you never heard of defining a type within a class. We have not covered such definitions, but they are possible and they are common in the STL. So, you must know how to use such types, even if you do not define such types.

In summary, consider the `using` directive

```
using std::vector<int>::iterator;
```

Within the scope of this `using` directive the identifier `iterator` means the type named `iterator` that is defined in the class `vector<int>`, which in turn is defined in the `std` namespace.

Iterator Basics

An **iterator** is a generalization of a pointer, and in fact is typically even implemented using a pointer, but the abstraction of an iterator is designed to spare you the details of the implementation and give you a uniform interface to iterators that is the same across different container classes. Each container class has its own iterator types, just like each data type has its own pointer type. But just as all pointer types behave essentially the same for dynamic variables of their particular data type, so too does each iterator type behave the same, but each iterator is used only with its own container class.

An iterator is not a pointer, but you will not go far wrong if you think of it and use it as if it were a pointer. Like a pointer variable, an iterator variable is located at (“points to”) one data entry in the container. You manipulate iterators using the following overloaded operators that apply to iterator objects:

- Prefix and postfix increment operators, `++`, for advancing the iterator to the next data item
- Prefix and postfix decrement operators, `--`, for moving the iterator to the previous data item.
- Equal and unequal operators, `==` and `!=`, to test whether two iterators point to the same data location.

- A dereferencing operator, `*`, so that if `p` is an iterator variable, then `*p` gives access to the data located at (“pointed to by”) `p`. This access may be read-only, write-only, or allow both reading and changing of the data, depending on the particular container class.

Not all iterators have all of these operators. However, the vector template class is an example of a container whose iterators have all these operators and more.

A container class has member functions that get the iterator process started. After all, a new iterator variable is not located at (“pointing to”) any data in the container. Many container classes, including the vector template class, have the following member functions that return iterator objects (iterator values) that point to special data elements in the data structure:

- `c.begin()` returns an iterator for the container `c` that points to the “first” data item in the container `c`.
- `c.end()` returns something that can be used to test when an iterator has passed beyond the last data item in a container `c`. The iterator `c.end()` is completely analogous to `NULL` used to test when a pointer has passed the last node in a linked list of the kind discussed in Chapter 13. The iterator `c.end()` is thus an iterator that is located at no data item, but that is a kind of end marker or sentinel.

For many container classes, these tools allow you to write *for* loops that cycle through all the elements in a container object `c`, as follows:

```
//p is an iterator variable of the type for the container object c.
for (p = c.begin(); p != c.end(); p++)
    process *p //*p is the current data item.
```

That’s the big picture. Now let’s look at the details in the concrete setting of the vector template container class.

Display 18.1 illustrates the use of iterators with the vector template class. Keep in mind that each container type in the STL has its own iterator types, although they are all used in the same basic ways. The iterators we want for a vector of *ints* are of type

```
std::vector<int>::iterator
```

Another container class is the `list` template class. Iterators for lists of *ints* are of type

```
std::list<int>::iterator
```

In the program in Display 18.1, we specialize the type name `iterator` so that it applies to iterators for vectors of *ints*. The type name `iterator` that we want in Display 18.1 is defined in the template class `vector` and so if we specialize the template class `vector` to *ints* and want the iterator type for `vector<int>`, we want the type

```
std::vector<int>::iterator;
```

DISPLAY 18.1 Iterators Used with a Vector

```

1  //Program to demonstrate STL iterators.
2  #include <iostream>
3  #include <vector>
4  using std::cout;
5  using std::endl;
6  using std::vector;
7  int main()
8  {
9      vector<int> container;
10     for (int i = 1; i <= 4; i++)
11         container.push_back(i);
12     cout << "Here is what is in the container:\n";
13     vector<int>::iterator p;
14     for (p = container.begin(); p != container.end(); p++)
15         cout << *p << " ";
16     cout << endl;
17     cout << "Setting entries to 0:\n";
18     for (p = container.begin(); p != container.end(); p++)
19         *p = 0;
20
21     cout << "Container now contains:\n";
22     for (p = container.begin(); p != container.end(); p++)
23         cout << *p << " ";
24     cout << endl;
25     return 0;
26 }
```

Sample Dialogue

```

Here is what is in the container:
1 2 3 4
Setting entries to 0:
Container now contains:
0 0 0 0
```

Since the vector definition places the name `vector` in the `std` namespace, the entire `using` declaration is

```
using std::vector<int>::iterator;
```

The basic use of iterators with the vector (or any container class) is illustrated by the following lines from Display 18.1:

```
vector<int>::iterator p;
for (p = container.begin(); p != container.end(); p++)
    cout << *p << " ";
```

Recall that `container` is of type `vector<int>`.

A vector `v` can be thought of as a linear arrangement of its data elements. There is a first data element `v[0]`, a second data element `v[1]`, and so forth. An **iterator** `p` is an object that can be **located at** one of these elements. (Think of `p` as pointing to one of these elements.) An iterator can move its location from one element to another element. If `p` is located at, say, `v[7]`, then `p++` moves `p` so it is located at `v[8]`. This allows an iterator to move through the vector from the first element to the last element, but it needs to find the first element and needs to know when it has seen the last element.

You can tell if an iterator is at the same location as another iterator using the operator `==`. Thus, if you have an iterator pointing to the first, last, or other element, you could test another iterator to see if it is located at the first, last, or other element.

If `p1` and `p2` are two iterators, then the comparison

```
p1 == p2
```

is true when and only when `p1` and `p2` are located at the same element. (This is analogous to pointers. If `p1` and `p2` were pointers, this would be true if they pointed to the same thing.) As usual, `!=` is just the negation of `==` and so

```
p1 != p2
```

is true when `p1` and `p2` are not located at the same element.

The member function `begin()` is used to position an iterator at the first element in a container. For vectors, and many other container classes, the member function `begin()` returns an iterator located at the first element. (For a vector `v` the first element is `v[0]`.) Thus,

```
vector<int>::iterator p = v.begin();
```

initializes the iterator variable `p` to an iterator located at the first element. So, the basic `for` loop for visiting all elements of the vector `v` is

```
vector<int>::iterator p;
for (p = v.begin(); Boolean_Expression; p++)
    Action_At_Location p;
```

The desired *Boolean_Expression* for a stopping condition is

```
p == v.end()
```

The member function `end()` returns a sentinel value that can be checked to see if an iterator has passed the last element. If `p` is located at the last element, then after `p++`, the test `p = v.end()` changes from *false* to *true*. So the `for` loop with the correct *Boolean_Expression* is

```
vector<int>::iterator p;
for (p = v.begin(); p != v.end(); p++)
    Action_At_Location p;
```

Note that `p != v.end()` does not change from *true* to *false* until after `p`'s location has advanced past the last element. So, `v.end()` is not located at any

element. The value `v.end()` is a special value that serves as a sentinel value. It is not an ordinary iterator, but you can compare `v.end()` to an iterator using `==` and `!=`. The value `v.end()` is analogous to the value `NULL` used to mark the end of a linked list of the kind discussed in Chapter 13.

The following *for* loop from Display 18.1 uses this exact technique with the vector named `container`:

```
vector<int>::iterator p;
for (p = container.begin(); p != container.end(); p++)
    cout << *p << " ";
```

The action taken at the location of the iterator `p` is

```
cout << *p << " ";
```

The dereferencing operator `*` is overloaded for STL container iterators so that `*p` produces the element at location `p`. In particular, for a vector container, `*p` produces the element located at the iterator `p`. So, the `cout` statement above outputs the element located at the iterator `p` and the entire *for* loop outputs all the elements in the vector container.

The **dereferencing operator** `*p` always produces the element located at the iterator `p`. In some situations, `*p` produces read-only access, which does not allow you to change the element. In other situations, it gives you access to the element and will let you change the element. For vectors, `*p` will allow you to change the element located at `p`, as illustrated by the following *for* loop from Display 18.1:

```
for (p = container.begin(); p != container.end(); p++)
    *p = 0;
```

This *for* loop cycles through all the elements in the vector container and changes all the elements to 0.

■ PROGRAMMING TIP Use `auto` to Simplify Variable Declarations

The `auto` keyword can make your code much more readable when it comes to templates and iterators. Declaring an iterator can be really verbose:

```
vector<int>::iterator p = v.begin();
```

We can do the same thing much more compactly with `auto`:

```
auto p = v.begin();
```

PITFALL Compiler Problems

Some compilers have problems with iterator declarations. You can declare an iterator in different ways. For example, we have been using the following:

```
using std::vector;
. . .
vector<char>::iterator p;
```

Iterator

An iterator is an object that can be used with a container to gain access to elements in the container. An iterator is a generalization of the notion of a pointer, and the operators `==`, `!=`, `++`, and `--` behave the same for iterators as they do for pointers. The basic outline of how an iterator can cycle through all the elements in a container is

```
STL_Container<type>::iterator p;
for (p = container.begin(); p != container.end(); p++)
    Process_Element_At_Location p;
```

`STL_Container` is the name of the container class (for example, `vector`) and `type` is the data type of the item to be stored. The member function `begin()` returns an iterator located at the first element. The member function `end()` returns a value that serves as a sentinel value one location past the last element in the container.

Alternatively, if your code only uses a single type of iterator, you could use the following:

```
using std::vector<char>::iterator;
. . .
iterator p;
```

You also could use the following, which is not quite as nice, because it introduces all names from the `std` namespace to the current declarative region, increasing the likelihood of a name conflict.

```
using namespace std;
. . .
vector<char>::iterator p;
```

There are other, similar variations. Your compiler should accept any of these alternatives. However, we have found that some compilers will accept only certain of them. If one form does not work with your compiler, try another. ■

Dereferencing

The dereferencing operator `*p` when applied to an iterator `p` produces the element located at the iterator `p`. For some STL container classes, `*p` produces read-only access, which does not allow you to change the element. For other STL container classes, it gives you access to the element and will let you change the element.

SELF-TEST EXERCISES

1. If `v` is a vector, what does `v.begin()` return? What does `v.end()` return?
2. If `p` is an iterator for a vector object `v`, what is `*p`?
3. Suppose `v` is a vector of `ints`. Write a `for` loop that outputs all the elements of `v`, except for the first element.

Kinds of Iterators

Different containers have different kinds of iterators. Iterators are classified according to the kinds of operations that work on them. Vector iterators are of the most general form; that is, all the operations work with vector iterators. So, we will again use the vector container to illustrate iterators. In this case we use a vector to illustrate the iterator operators of *decrement* and *random access*. Display 18.2 shows another program using a vector object named `container` and an iterator `p`.

DISPLAY 18.2 Bidirectional and Random Access Iterator Use (part 1 of 2)

```

1 //Program to demonstrate bidirectional and random access iterators.
2 #include <iostream>
3 #include <vector>
4 using std::cout;
5 using std::endl;
6 using std::vector;
7
8 int main()
9 {
10     vector<char> container;
11     container.push_back('A');
12     container.push_back('B');
13     container.push_back('C');
14     container.push_back('D');
15
16     for (int i = 0; i < 4; i++)
17         cout << "container[" << i << "] == "
18             << container[i] << endl;
19     vector<char>::iterator p = container.begin();
20     cout << "The third entry is " << container[2] << endl;
21     cout << "The third entry is " << p[2] << endl;
22     cout << "The third entry is " << *(p + 2) << endl;
23
24     cout << "Back to container[0].\n";
25     p = container.begin();
26     cout << "which has value " << *p << endl;

```

Three different notations for the same thing.

This notation is specialized to vectors and arrays.

These two work for any random access iterator.

(continued)

DISPLAY 18.2 Bidirectional and Random Access Iterator Use (part 2 of 2)

```

25     cout << "Two steps forward and one step back:\n";
26     p++;
27     cout << *p << endl;
28     p++;
29     cout << *p << endl;
30     p--;
31     cout << *p << endl;
32     return 0;
33 }

```

This is the decrement operator. It works for any bidirectional iterator.

Sample Dialogue

```

container[0] == A
container[1] == B
container[2] == C
container[3] == D
The third entry is C
The third entry is C
The third entry is C
Back to container[0].
which has value A
Two steps forward and one step back:
B
C
B

```

The **decrement operator** is used in Display 18.2, where the line containing it is shown in highlight. As you would expect, `p--` moves the iterator `p` to the previous location. The decrement operator `--` is the same as the increment operator `++`, but it moves the iterator in the opposite direction.

The increment and decrement operators can be used in either prefix (`++p`) or postfix (`p++`) notation. In addition to changing `p`, they also return a value. The details of the value returned are completely analogous to what happens with the increment and decrement operators on `int` variables. In prefix notation, first the variable is changed and the changed value is returned. In postfix notation, the value is returned before the variable is changed. We prefer not to use the increment and decrement operators as expressions that return a value and use them only to change the variable value.

The following lines from Display 18.2 illustrate that with vector iterators you have *random access* to the elements of a vector, such as container:

```
vector<char>::iterator p = container.begin();
cout << "The third entry is " << container[2] << endl;
cout << "The third entry is " << p[2] << endl;
cout << "The third entry is " << *(p + 2) << endl;
```

Random access means you can go in one step directly to any particular element. We have already used `container[2]` as a form of random access to a vector. It is simply the square bracket operator that is standard with arrays and vectors. What is new is that you can use this same square bracket notation with an iterator. The expression `p[2]` is a way to obtain access to the element indexed by 2.

The expressions `p[2]` and `*(p + 2)` are completely equivalent. By analogy to pointer arithmetic (see Chapter 9), `(p + 2)` names the location two places beyond `p`. Since `p` is at the first (index 0) location in the above code, `(p + 2)` is at the third (index 2) location. The expression `(p + 2)` returns an iterator. The expression `*(p + 2)` dereferences that iterator. Of course, you can replace 2 with a different nonnegative integer to obtain a pointer pointing to a different element.

Be sure to note that neither `p[2]` nor `(p + 2)` changes the value of the iterator in the iterator variable `p`. The expression `(p + 2)` returns another iterator at another location, but it leaves `p` where it was. The same thing happens with `p[2]`. Also note that the meaning of `p[2]` and `(p + 2)` depends on the location of the iterator in `p`. For example, `(p + 2)` means two locations beyond the location of `p`, wherever that may be.

For example, suppose the previously discussed code from Display 18.2 were replaced with the following (note the added `p++`):

```
vector<char>::iterator p = container.begin();
p++;
cout << "The third entry is " << container[2] << endl;
cout << "The third entry is " << p[2] << endl;
cout << "The third entry is " << *(p + 2) << endl;
```

The output of these three couts would no longer be

```
The third entry is C
The third entry is C
The third entry is C
```

but would instead be

```
The third entry is C
The third entry is D
The third entry is D
```

The `p++` moves `p` from location 0 to location 1 and so `(p + 2)` is now an iterator at location 3, not location 2. So, `*(p + 2)` and `p[2]` are equivalent to `container[3]`, not `container[2]`.

Kinds of Iterators

Different containers have different kinds of iterators. The following are the main kinds of iterators:

Forward iterators: ++ works on the iterator.

Bidirectional iterators: both ++ and -- work on the iterator.

Random access iterators: ++, --, and random access all work with the iterator.

We now know enough about iterators to make sense of how iterators are classified. The main kinds of iterators are

Forward iterators: ++ works on the iterator.

Bidirectional iterators: both ++ and -- work on the iterator.

Random access iterators: ++, --, and random access all work with the iterator.

Note that these are increasingly strong categories: Every random access iterator is also a bidirectional iterator, and every bidirectional iterator is also a forward iterator. As we will see, different template container classes have different kinds of iterators. The iterators for the vector template class are random access iterators.

Note that the names *forward iterator*, *bidirectional iterator*, and *random access iterator* refer to kinds of iterators, not type names. The actual type names will be something like `std::vector<int>::iterator`, which in this case happens to be a random access iterator.

SELF-TEST EXERCISE

4. Suppose the vector `v` contains the letters 'A', 'B', 'C', and 'D' in that order. What is the output of the following code?

```
vector<char>::iterator i = v.begin();
i++;
cout << *(i + 2) << " ";
i--;
cout << i[2] << " ";
cout << *(i + 2) << " ";
```

Constant and Mutable Iterators

The categories forward iterator, bidirectional iterator, and random access iterator each subdivide into two categories: *constant* and *mutable*, depending on how the dereferencing operator behaves with the iterator. With a **constant iterator** the dereferencing operator produces a read-only version of the element. With a constant iterator *p*, you can use **p*, for example, to assign it to a variable or output it to the screen, but you cannot change the element in the container by, for example, assigning it to **p*. With a **mutable iterator** *p*, **p* can be assigned a value and that will change the corresponding element in the container. The vector iterators are mutable, as shown by the following lines from Display 18.1:

```
cout << "Setting entries to 0:\n";
for (p = container.begin(); p != container.end(); p++)
    *p = 0;
```

If a container has only constant iterators, you cannot obtain a mutable iterator for the container. However, if a container has mutable iterators and you want a constant iterator for the container, you can have it. You might want a constant iterator as a kind of error checking if you intend that your code not change the elements in the container. For example, the following will produce a constant iterator for a vector container named *container*:

```
std::vector<char>::const_iterator p = container.begin();
```

or equivalently

```
using std::vector<char>::const_iterator;
const_iterator p = container.begin();
```

With *p* declared in this way, the following would produce an error message:

```
*p = 'Z';
```

For example, Display 18.2 would behave exactly the same if you change

```
vector<int>::iterator p;
```

to

```
vector<int>::const_iterator p;
```

However, a similar change would not work in Display 18.1 because of the following line from the program in Display 18.1:

```
*p = 0;
```

Note that *const_iterator* is a type name, while *constant iterator* is the name of a kind of iterator. However, every iterator of a type named *const_iterator* will be a constant iterator.

Constant Iterator

A constant iterator is an iterator that does not allow you to change the element at its location.

Reverse Iterators

Sometimes you want to cycle through the elements in a container in reverse order. If you have a container with bidirectional iterators, you might be tempted to try

```
vector<int>::iterator p;
for (p = container.end(); p != container.begin(); p--)
    cout << *p << " ";
```

This code will compile, and you may be able to get something like this to work on some systems, but there is something fundamentally wrong with this: `container.end()` is not a regular iterator, but only a sentinel, and `container.begin()` is not a sentinel.

Fortunately, there is an easy way to do what you want. For a container with bidirectional iterators, there is a way to reverse everything using a kind of iterator known as a **reverse iterator**. The following will work fine:

```
vector<int>::reverse_iterator rp;
for (rp = container.rbegin(); rp != container.rend(); rp++)
    cout << *rp << " ";
```

The member function `rbegin()` returns an iterator located at the last element. The member function `rend()` returns a sentinel that marks the “end” of the elements in the reverse order. Note that for an iterator of type `reverse_iterator`, the increment operator `++` moves backward through the elements. In other words, the meanings of `--` and `++` are interchanged. The program in Display 18.3 demonstrates a reverse iterator.

Reverse Iterators

A reverse iterator can be used to cycle through all elements of a container, provided that the container has bidirectional iterators. The general scheme is as follows:

```
STL_Container<type>::reverse_iterator rp;
for (rp = c.rbegin(); rp != c.rend(); rp++)
    Process_At_Location rp;
```

The object `c` is a container class with bidirectional iterators.

DISPLAY 18.3 Reverse Iterator

```
1 //Program to demonstrate a reverse iterator.
2 #include <iostream>
3 #include <vector>
4 using std::cout;
5 using std::endl;
6 using std::vector;
7
8 int main()
9 {
10     vector<char> container;
11     container.push_back('A');
12     container.push_back('B');
13     container.push_back('C');
14     cout << "Forward:\n";
15     vector<char>::iterator p;
16     for (p = container.begin(); p != container.end(); p++)
17         cout << *p << " ";
18     cout << endl;
19     cout << "Reverse:\n";
20     vector<char>::reverse_iterator rp;
21     for (rp = container.rbegin(); rp != container.rend(); rp++)
22         cout << *rp << " ";
23     cout << endl;
24     return 0;
25 }
```

Sample Dialogue

```
Forward:
A B C
Reverse:
C B A
```

The `reverse_iterator` type also has a constant version, which is named `const_reverse_iterator`.

Other Kinds of Iterators

There are other kinds of iterators that we will not cover in this book. Briefly, two kinds of iterators you may encounter are an **input iterator**, which is essentially a forward iterator that can be used with input streams, and an

output iterator, which is essentially a forward iterator that can be used with output streams. For more details, you will need to consult a more advanced reference.

SELF-TEST EXERCISES

5. Suppose the vector `v` contains the letters 'A', 'B', 'C', and 'D' in that order. What is the output of the following code?

```
vector<char>::reverse_iterator i = v.rbegin();
i++;
i++;
cout << *i << " ";
i--;
cout << *i << " ";
```

6. Suppose you want to run the following code, where `v` is a vector of `ints`:

```
for (p = v.begin(); p != v.end(); p++)
    cout << *p << " ";
```

Which of the following are possible ways to declare `p`?

```
std::vector<int>::iterator p;
std::vector<int>::const_iterator p;
```

18.2 CONTAINERS

*Put all your eggs in one basket and
—WATCH THAT BASKET.*

MARK TWAIN, *Pudd'n head Wilson*

The **container classes** of the STL are different kinds of data structures for holding data, such as lists, queues, and stacks. Each is a template class with a parameter for the particular type of data to be stored. So, for example, you can specify a list to be a list of `ints`, or `doubles`, or `strings`, or any class or struct type you wish. Each container template class may have its own specialized accessor and mutator functions for adding data and removing data from the container. Different container classes may have different kinds of iterators. For example, one container class may have bidirectional iterators while another container class may have only forward iterators. However, whenever they are defined the iterator operators and the member functions `begin()` and `end()` have the same meaning for all STL container classes.

DISPLAY 18.4 Two Kinds of Lists

`slist`: a singly linked list.
 ++ defined -- not defined

`list`: a doubly linked list.
 Both ++ and -- defined

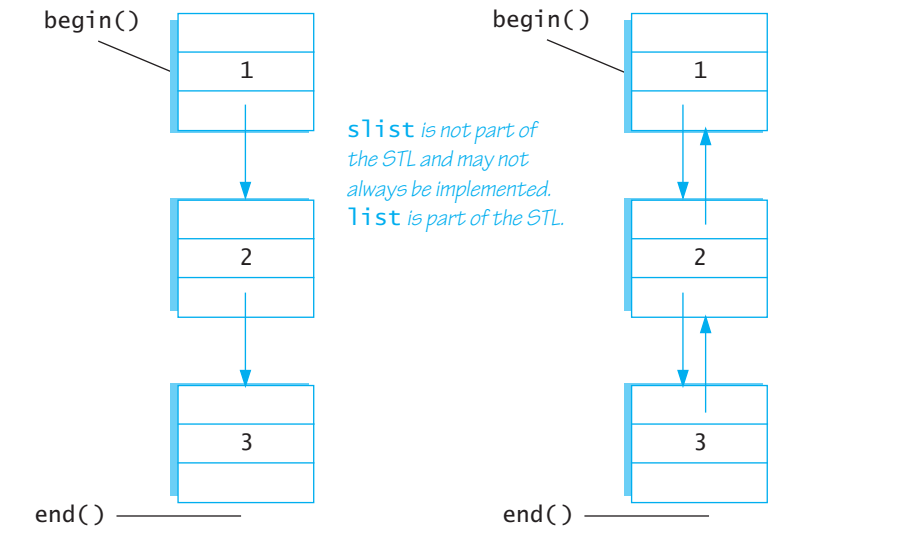

Sequential Containers

A sequential container arranges its data items into a list so that there is a first element, a next element, and so forth up to a last element. The linked lists we discussed in Chapter 13 are examples of a kind of list. The lists we discussed in Chapter 13 are sometimes called **singly linked lists** because there is only one link from one location to another. The STL has no container corresponding to such singly linked lists, although some implementations do offer an implementation of them, typically under the name `slist`. The simplest list that is part of the STL is the **doubly linked list**, which is the template class named `list`. The difference between these two kinds of lists is illustrated in Display 18.4.

The lists in Display 18.4 contain the three integer values 1, 2, and 3 in that order. The types for the two lists are `slist<int>` and `list<int>`. That display also indicates the location of the iterators `begin()` and `end()`. We have not yet told you how you can enter the integers into the lists.

In Display 18.4 we have drawn our singly and doubly linked lists as nodes and pointers of the form discussed in Chapter 14. The STL class `list` and the nonstandard class `slist` might (or might not) be implemented in this way.

However, when using the STL template classes, you are shielded from these implementation details. So, you simply think in terms of locations for the data (which may or may not be nodes) and iterators (not pointers). You can think of the arrows in Display 18.4 as indicating the directions for ++ (which is down) and -- (which is up in Display 18.4).

We wanted to present the template class `slist` to help give a context for the sequential containers. It corresponds to what we discussed most in Chapter 13, and it is the first thing that comes to the mind of most programmers when you mention *linked lists*. However, since the template class `slist` is not standard, we will discuss it no more. If your implementation offers the template class `slist` and you want to use it, the details are similar to those we will describe for `list`, except that the decrement operators -- (prefix and postfix) are not defined for `slist`.

A simple program using the STL template class `list` is given in Display 18.5. The function `push_back` adds an element to the end of the list. Notice that for the `list` template class, the dereferencing operator gives you access to the data for reading and for changing the data. Also notice that with the `list` template class and all the template classes and iterators of the STL, all definitions are placed in the `std` namespace.

DISPLAY 18.5 Using the `list` Template Class (part 1 of 2)

```
1 //Program to demonstrate the STL template class list.
2 #include <iostream>
3 #include <list>
4 using std::cout;
5 using std::endl;
6 using std::list;
7
8 int main()
9 {
10     list<int> list_object;
11
12     for (int i = 1; i <= 3; i++)
13         list_object.push_back(i);
14
15     cout << "List contains:\n";
16     list<int>::iterator iter;
17     for (iter = list_object.begin(); iter != list_object.end(); iter++)
18         cout << *iter << " ";
19     cout << endl;
20
21     cout << "Setting all entries to 0:\n";
```

(continued)

DISPLAY 18.5 Using the list Template Class (part 2 of 2)

```
22     for (iter = list_object.begin(); iter != list_object.end(); iter++)
23         *iter = 0;
24
25     cout << "List now contains:\n";
26     for (iter = list_object.begin(); iter != list_object.end(); iter++)
27         cout << *iter << " ";
28     cout << endl;
29
30     return 0;
31 }
```

Sample Dialogue

```
List contains:
1 2 3
Setting all entries to 0:
List now contains:
0 0 0
```

Note that Display 18.5 would compile and run exactly the same if we replace `list` and `list<int>` with `vector` and `vector<int>`, respectively. This uniformity of usage is a key part of the STL syntax.

There are, however, differences between a vector and a list container. One of the main differences is that a vector container has random access iterators while a list has only bidirectional iterators. For example, if you start with Display 18.2, which uses random access, and replace all occurrences of `vector` and `vector<char>` with `list` and `list<char>`, respectively, and then compile the program, you will get a compiler error. (You will get an error message even if you delete the statements containing `container[i]` or `container[2]`.)

The basic sequential container template classes of the STL are given in Display 18.6. A sample of some member functions is given in Display 18.7. Other containers, such as stacks and queues, can be obtained from these using techniques discussed in the subsection entitled “Container Adapters `stack` and `queue`.” All these sequence template classes have a destructor that returns storage for recycling.

Deque, pronounced “d-queue” or “deck,” stands for “doubly ended queue.” A deque is a kind of super queue. With a queue you add data at one end of the data sequence and remove data from the other end. With a deque

DISPLAY 18.6 STL Basic Sequential Containers

Template Class Name	Iterator Type Names	Kind of Iterators	Library Header File
slist	slist<T>::iterator	mutable forward	<slist>
Warning: slist is not part of the STL.	slist<T>::const_iterator	constant forward	Depends on implementation and may not be available.
list	list<T>::iterator list<T>::const_iterator list<T>::reverse_iterator list<T>::const_reverse_iterator	mutable bidirectional constant bidirectional mutable bidirectional constant bidirectional	<list>
vector	vector<T>::iterator vector<T>::const_iterator vector<T>::reverse_iterator vector<T>::const_reverse_iterator	mutable random access constant random access mutable random access constant random access	<vector>
deque	deque<T>::iterator deque<T>::const_iterator deque<T>::reverse_iterator deque<T>::const_reverse_iterator	mutable random access constant random access mutable random access constant random access	<deque>

DISPLAY 18.7 Some Sequential Container Member Functions (part 1 of 2)

Member Function (c is a Container Object)	Meaning
c.size()	Returns the number of elements in the container.
c.begin()	Returns an iterator located at the first element in the container.
c.end()	Returns an iterator located one beyond the last element in the container.
c.rbegin()	Returns an iterator located at the last element in the container. Used with reverse_iterator. Not a member of slist.
c.rend()	Returns an iterator located one beyond the first element in the container. Used with reverse_iterator. Not a member of slist.
c.push_back(<i>Element</i>)	Insert the <i>Element</i> at the end of the sequence. Not a member of slist.

(continued)

DISPLAY 18.7 Some Sequential Container Member Functions (*part 2 of 2*)

<code>c.push_front(<i>Element</i>)</code>	Insert the <i>Element</i> at the front of the sequence. Not a member of vector.
<code>c.insert(<i>Iterator</i>, <i>Element</i>)</code>	Insert a copy of <i>Element</i> before the location of <i>Iterator</i> .
<code>c.erase(<i>Iterator</i>)</code>	Removes the element at location <i>Iterator</i> . Returns an iterator at the location immediately following. Returns <code>c.end()</code> if the last element is removed.
<code>c.clear()</code>	A void function that removes all the elements in the container.
<code>c.front()</code>	Returns a reference to the element in the front of the sequence. Equivalent to <code>*(c.begin())</code> .
<code>c1 == c2</code>	True if <code>c1.size() == c2.size()</code> and each element of <code>c1</code> is equal to the corresponding element of <code>c2</code> .
<code>c1 != c2</code>	<code>!(c1 == c2)</code>

<All the sequential containers discussed in this section also have a default constructor, a copy constructor, and various other constructors for initializing the container to default or specified elements. Each also has a destructor that returns all storage for recycling and a well-behaved assignment operator.>

you can add data at either end and remove data from either end. The template class `deque` is a template class for a deque with a parameter for the type of data stored.

Sequential Containers

A sequential container arranges its data items into a list so that there is a first element, a next element, and so forth up to a last element. The sequential container template classes that we have discussed are `slist`, `list`, `vector`, and `deque`.

PITFALL Iterators and Removing Elements

When you add or remove an element to or from a container, that can affect other iterators. In general, there is no guarantee that the iterators will be located at the same element after an addition or deletion. Some containers do, however, guarantee that the iterators will not be moved by additions or deletions, except of course if the iterator is located at an element that is removed.

Of the template classes we have seen so far, `list` and `slist` guarantee that their iterators will not be moved by additions or deletions, except of course if the iterator is located at an element that is removed. The template classes `vector` and `deque` make no such guarantee. ■

■ PROGRAMMING TIP Type Definitions in Containers

The STL container classes contain type definitions that can be handy when programming with these classes. We have already seen that STL container classes may contain the type names `iterator`, `const_iterator`, `reverse_iterator`, and `const_reverse_iterator` (and hence must contain their type definitions behind the scenes). There are typically other type definitions as well.

All the template classes we have discussed so far have the defined types `value_type` and `size_type`. The type `value_type` is the type of the elements stored in the container. For example, `list<int>::value_type` is another name for `int`. Another defined type is `size_type`, which is an unsigned integer type that is the return type for the member function `size`. As we noted in Chapter 8, the `size_type` for the `vector` template class is *unsigned int*, although most compilers will be happy if you think of the type as just plain `int`. ■

SELF-TEST EXERCISES

7. What is a major difference between a `vector` and a `list`?
8. Which of the template classes `slist`, `list`, `vector`, and `deque` have the member function `push_back`?
9. Which of the template classes `slist`, `list`, `vector`, and `deque` have random access iterators?
10. Which of the template classes `slist`, `list`, `vector`, and `deque` can have mutable iterators?

Container Adapters `stack` and `queue`

Container adapters are template classes that are implemented on top of other classes. For example, the `stack` template class is by default implemented on top of the `deque` template class, which means that buried in the implementation of the `stack` is a `deque`, which is where all the data resides. However, you are shielded from this implementation detail and see a `stack` as a simple last-in/first-out data structure.

Other container adapter classes are the `queue` and `priority_queue` template classes. Stacks and queues were discussed in Chapter 13. A **priority queue** is like a queue with the additional property that each entry is given a priority when it is added to the queue. If all entries have the same priority, then entries are removed from a priority queue in the same manner as they are removed from a queue. If items have different priorities, the higher-priority items are removed before lower-priority items. We will not be discussing priority queues in any detail, but mention it for those who may be familiar with the concept.

Although an adapter template class has a default container class on top of which it is built, you may choose to specify a different underlying container, for efficiency or other reasons depending on your application. For example, any sequential container may serve as the underlying container for a stack and any sequential container other than `vector` may serve as the underlying container for a queue. The default underlying data structure is the deque for both the stack and the queue. For a `priority_queue`, the default underlying container is a `vector`. If you are happy with the default underlying container type, then a container adapter looks like any other template container class to you. For example, the type name for the stack template class using the default underlying container is `stack<int>` for a stack of `ints`. If you wish to specify that the underlying container is instead the `vector` template class, you would use `stack<int, vector<int>>` as the type name. We will always use the default underlying container.

Warning

If you do specify an underlying container, be warned that C++ compilers prior to C++11 cannot compile code with two `>` symbols in the type expression without a space in between them. Use `stack<int, vector<int> >`, with a space between the last two `>`'s. Do not use `stack<int, vector<int>>`. C++11 compilers do not need a space between the two `>` symbols.

The member functions and other details about the stack template class are given in Display 18.8. For the queue template class these details are given in Display 18.9. A simple example of using the stack template class is given in Display 18.10.

DISPLAY 18.8 Stack Template Class (part 1 of 2)

Stack Adapter Template Class Details

Type name `stack<T>` or `stack<T, Underlying_Container>` for a stack of elements of type `T`.

Library header: `<stack>`, which places the definition in the `std` namespace.

Defined types: `value_type`, `size_type`.

There are no iterators.

(continued)

DISPLAY 18.8 Stack Template Class (part 2 of 2)*Sample Member Functions*

Member Function (s is a Stack Object)	Meaning
s.size()	Returns the number of elements in the stack.
s.empty()	Returns <i>true</i> if the stack is empty; otherwise returns <i>false</i> .
s.top()	Returns a mutable reference to the top member of the stack.
s.push(<i>Element</i>)	Inserts a copy of <i>Element</i> at the top of the stack.
s.pop()	Removes the top element of the stack. Note that pop is a void function. It does not return the element removed.
s1 == s2	True if s1.size() == s2.size() and each element of s1 is equal to the corresponding element of s2; otherwise returns <i>false</i> .

The stack template class also has a default constructor, a copy constructor, as well as a constructor that takes an object of any sequential container class and initializes the stack to the elements in the sequence. It also has a destructor that returns all storage for recycling and a well-behaved assignment operator.

DISPLAY 18.9 Queue Template Class (part 1 of 2)**Queue Adapter Template Class Details**

Type name `queue<T>` or `queue<T, Underlying_Container>` for a queue of elements of type `T`.

For efficiency reasons, the `Underlying_Container` cannot be a vector type.

Library header: `<queue>` which places the definition in the `std` namespace.

Defined types: `value_type`, `size_type`.

There are no iterators.

Sample Member Functions

Member Function (q is a Queue Object)	Meaning
q.size()	Returns the number of elements in the queue.
q.empty()	Returns <i>true</i> if the queue is empty; otherwise returns <i>false</i> .

(continued)

DISPLAY 18.9 Queue Template Class (*part 2 of 2*)

<code>q.front()</code>	Returns a mutable reference to the front member of the queue.
<code>q.back()</code>	Returns a mutable reference to the last member of the queue.
<code>q.push(<i>Element</i>)</code>	Adds <i>Element</i> to the back of the queue.
<code>q.pop()</code>	Removes the front element of the queue. Note that <code>pop</code> is a void function. It does not return the element removed.
<code>q1 == q2</code>	True if <code>q1.size() == q2.size()</code> and each element of <code>q1</code> is equal to the corresponding element of <code>q2</code> ; otherwise returns <i>false</i> .

The queue template class also has a default constructor, a copy constructor, as well as a constructor that takes an object of any sequential container class and initializes the stack to the elements in the sequence. It also has a destructor that returns all storage for recycling and a well-behaved assignment operator.

DISPLAY 18.10 Program Using the Stack Template Class (*part 1 of 2*)

```

1  //Program to demonstrate the use of the stack template class from the STL.
2  #include <iostream>
3  #include <stack>
4  using std::cin;
5  using std::cout;
6  using std::endl;
7  using std::stack;
8
9  int main()
10 {
11     stack<char> s;
12
13     cout << "Enter a line of text:\n";
14     char next;
15     cin.get(next);
16     while (next != '\n')
17     {
18         s.push(next);
19         cin.get(next);
20     }
21
22     cout << "Written backward that is:\n";
23     while ( !s.empty() )
24     {

```

(continued)

DISPLAY 18.10 Program Using the Stack Template Class (part 2 of 2)

```

25         cout << s.top();
26         s.pop();
27     }
28     cout << endl;
29
30     return 0;
31 }

```

The member function `pop` removes one element, but does not return that element. `pop` is a void function. So, we needed to use `top` to read the element we remove.

Sample Dialogue

Enter a line of text:

straw

Written backward that is:

warts

SELF-TEST EXERCISES

11. What kind of iterators (forward, bidirectional, or random access) does the stack template adapter class have?
12. What kind of iterators (forward, bidirectional, or random access) does the queue template adapter class have?
13. If `s` is a `stack<char>`, what is the type of the returned value of `s.pop()`?

Associative Containers set and map

Associative containers are basically very simple databases. They store data, such as structs or any other type of data. Each data item has an associated value known as its **key**. For example, if the data is a struct with an employee's record, the key might be the employee's Social Security number. Items are retrieved on the basis of the key. The key type and the type for data to be stored need not have any relationship to one another, although they often are related. A very simple case is when the each data item is its own key. For example, in a set every element is its own key.

The set template class is, in some sense, the simplest container you can imagine. It stores elements without repetition. The first insertion places an element in the set. Additional insertions after the first have no effect, so no element appears more than once. Each element is its own key; basically, you

just add or delete elements and ask if an element is in the set or not. Like all STL classes, the set template class was written with efficiency as a goal. In order to work efficiently, a set object stores its values in sorted order. You can specify the order used for storing elements as follows:

```
set<T, Ordering> s;
```

Ordering should be a well-behaved ordering relation that takes two arguments of type T and returns a *bool* value.¹ T is the type of elements stored. If no ordering is specified, then the ordering is assumed to be the < relational operator. Some basic details about the set template class are given in Display 18.11. A simple example that shows how to use some of the member functions of the template class set is given in Display 18.12.

A **map** is essentially a function given as a set of ordered pairs. For each value *first* that appears in a pair, there is at most one value *second* such that the pair (*first*, *second*) is in the map. The template class map implements map objects in the STL. For example, if you want to assign a unique number to each string name, you could declare a map object as follows:

```
map<string, int> number_map;
```

For string values known as *keys*, the *number_map* object can associate a unique *int* value.

An alternate way to think of a map is as an **associative array**. A traditional array maps from a numerical index to a value. For example, `a[10] = 5` would store the number 5 at index 10. An associative array allows you to define your own indices using the data type of your choice. For example, `numberMap["c++"] = 5` would associate the integer 5 with the string "c++". For convenience, the [] square bracket operator is defined to allow you to use an array-like notation to access a map, although you also can use the `insert` or `find` methods if you want.

Like a set object, a map object stores its elements in sorted order by its key values. You can specify the ordering on keys as a third entry in the angular brackets <>. If you do not specify an ordering, a default ordering is used. The restrictions on orderings you can use is the same as those on the orderings allowed for the set template class. Note that the ordering is on key values only. The second type can be any type and need not have anything to do with any ordering. As with the set object, the sorting of the stored entries in a map object is done for reasons of efficiency.

¹ The ordering must be a *strict weak ordering*. Most typical orderings used to implement the < operator is strict weak ordering. For those who want the details: A **strict weak ordering** must be: (irreflexive) `Ordering(x, x)` is always false; (antisymmetric) `Ordering(x, y)` implies `!Ordering(y, x)`; (transitive) `Ordering(x, y)` and `Ordering(y, z)` imply `Ordering(x, z)`; and (transitivity of equivalence) if *x* is equivalent to *y* and *y* is equivalent to *z*, then *x* is equivalent to *z*. Two elements *x* and *y* are equivalent if `Ordering(x, y)` and `Ordering(y, x)` are both false.

DISPLAY 18.11 set Template Class

set Template Class Details

Type name `set<T>` or `set<T, Ordering>` for a set of elements of type `T`. The `Ordering` is used to sort elements for storage. If no `Ordering` is given, the ordering used is the binary operator `<`.

Library header: `<set>`, which places the definition in the `std` namespace.

Defined types include: `value_type`, `size_type`.

Iterators: `iterator`, `const_iterator`, `reverse_iterator`, and `const_reverse_iterator`. All iterators are bidirectional and those not including `const_` are mutable. `begin()`, `end()`, `rbegin()`, and `rend()` have the expected behavior. Adding or deleting elements does not affect iterators, except for an iterator located at the element removed.

Sample Member Functions

Member Function (<i>s</i> is a Set Object)	Meaning
<code>s.insert(<i>Element</i>)</code>	Inserts a copy of <i>Element</i> in the set. If <i>Element</i> is already in the set, this has no effect.
<code>s.erase(<i>Element</i>)</code>	Removes <i>Element</i> from the set. If <i>Element</i> is not in the set, this has no effect.
<code>s.find(<i>Element</i>)</code>	Returns a mutable iterator located at the copy of <i>Element</i> in the set. If <i>Element</i> is not in the set, <code>s.end()</code> is returned.
<code>s.erase(<i>Iterator</i>)</code>	Erases the element at the location of the <i>Iterator</i> .
<code>s.size()</code>	Returns the number of elements in the set.
<code>s.empty()</code>	Returns <i>true</i> if the set is empty; otherwise returns <i>false</i> .
<code>s1 == s2</code>	Returns <i>true</i> if the sets contains the same elements; otherwise returns <i>false</i> .

The set template class also has a default constructor, a copy constructor, as well as other specialized constructors not mentioned here. It also has a destructor that returns all storage for recycling and a well-behaved assignment operator.

DISPLAY 18.12 Program Using the set Template Class

```

1  //Program to demonstrate use of the set template class.
2  #include <iostream>
3  #include <set>
4  using std::cout;
5  using std::endl;
6  using std::set;
7
8  int main()
9  {
10     set<char> s;
11
12     s.insert('A');
13     s.insert('D');
14     s.insert('D');
15     s.insert('C');
16     s.insert('C');
17     s.insert('B');
18
19     cout << "The set contains:\n";
20     set<char>::const_iterator p;
21     for (p = s.begin(); p != s.end(); p++)
22         cout << *p << " ";
23     cout << endl;
24
25     cout << "Removing C.\n";
26     s.erase('C');
27     for (p = s.begin(); p != s.end(); p++)
28         cout << *p << " ";
29     cout << endl;
30
31     return 0;
32 }

```

No matter how many times you add an element to a set, the set contains only one copy of that element.

Sample Dialogue

```

The set contains:
A B C D
Removing C.
A B D

```

The easiest way to add and retrieve data from a map is to use the [] operator. Given a map object *m*, the expression *m*[*key*] will return a reference to the data element associated with *key*. If no entry exists in the map for *key*, then a new entry will be created with the default value for the data element.

For numeric data types, the default value is 0. For objects of type `string`, the default value is an empty string.

The `[]` operator can be used to add a new item to the map or to replace an existing entry. For example, the statement `m[key] = newData;` will create a new association between `key` and `newData`. Note that care must be taken to ensure that map entries are not created by mistake. For example, if you execute the statement `val = m[key];` with the intention of retrieving the value associated with `key` but mistakenly enter a value for `key` that is not already in the map, then a new entry will be made for `key` with the default value and assigned into `val`.

Some basic details about the map template class are given in Display 18.13. In order to understand these details, you first need to know something about the `pair` template class.

The STL template class `pair<T1,T2>` has objects that are pairs of values such that the first element is of type `T1` and the second is of type `T2`. If `aPair` is an object of type `pair<T1,T2>`, then `aPair.first` is the first element, which is of type `T1`, and `aPair.second` is the second element, which is of type `T2`. The member variables `first` and `second` are public member variables, so no accessor or mutator functions are needed.

The header file for the `pair` template is `<utility>`. So, to use the `pair` template class, you need the following, or something like it, in your file:

```
#include <utility>
using std::pair;
```

The map template class uses the `pair` template class to store the association between the key and a data item. For example, given the definition

```
map<string, int> numberMap;
```

we can add a mapping from "c++" to the number 10 by using a `pair` object:

```
pair<string, int> toInsert("c++", 10);
numberMap.insert(toInsert);
```

or by using the `[]` operator:

```
numberMap["c++"] = 10;
```

In either case, when we access this `pair` using an iterator, `iterator->first` will refer to the key "c++" while `iterator->second` will refer to the data value 10. A simple example that shows how to use some of the member functions of the template class `map` is given in Display 18.14.

We will mention two other associative containers, although we will not give any details about them. The template classes `multiset` and `multimap` are essentially the same as `set` and `map`, respectively, except that a `multiset` allows repetition of elements and a `multimap` allows multiple values to be associated with each key value.

DISPLAY 18.13 map Template Class

map Template Class Details

Type name `map<KeyType, T>` or `map<KeyType, T, Ordering>` for a map that associates (“maps”) elements of type `KeyType` to elements of type `T`.

The `Ordering` is used to sort elements by key value for efficient storage.

If no `Ordering` is given, the ordering used is the binary operator `<`.

Library header: `<map>` places the definition in the `std` namespace.

Defined types include: `key_type` for the type of the key values, `mapped_type` for the type of the values mapped to, and `size_type`. (So, the defined type `key_type` is simply what we called `KeyType` earlier.)

Iterators: `iterator`, `const_iterator`, `reverse_iterator`, and `const_reverse_iterator`.

All iterators are bidirectional. Those iterators not including `const_` are neither constant nor mutable, but something in between. For example, if `p` is of type

`iterator`, then you change the key value but not the value of type `T`. Perhaps it is best, at least at first, to treat all iterators as if they were constant.

`begin()`, `end()`, `rbegin()`, and `rend()` have the expected behavior. Adding or deleting elements does not affect iterators, except for an iterator located at the element removed.

Sample Member Functions

Member Function (m is a Map Object)	Meaning
<code>m.insert(Element)</code>	Inserts <i>Element</i> in the map. <i>Element</i> is of type <code>pair<KeyType, T></code> . Returns a value of type <code>pair<iterator, bool></code> . If the insertion is successful, the second part of the returned pair is true and the iterator is located at the inserted element.
<code>m.erase(Target_Key)</code>	Removes the element with the key <i>Target_Key</i> .
<code>m.find(Target_Key)</code>	Returns an iterator located at the element with key value <i>Target_Key</i> . Returns <code>m.end()</code> if there is no such element.
<code>m[Target_Key]</code>	Returns a reference to the object associated with the key <i>Target_Key</i> . If the map does not already contain such an object, then a default object of type <code>T</code> is inserted and returned.
<code>m.size()</code>	Returns the number of pairs in the map.
<code>m.empty()</code>	Returns <i>true</i> if the map is empty; otherwise returns <i>false</i> .
<code>m1 == m2</code>	Returns <i>true</i> if the maps contains the same pairs; otherwise returns <i>false</i> .

The map template class also has a default constructor, a copy constructor, as well as other specialized constructors not mentioned here. It also has a destructor that returns all storage for recycling and a well-behaved assignment operator.

DISPLAY 18.14 Program Using the map Template Class (part 1 of 2)

```

1  //Program to demonstrate use of the map template class.
2  #include <iostream>
3  #include <map>
4  #include <string>
5  using std::cout;
6  using std::endl;
7  using std::map;
8  using std::string;
9
9  int main()
10 {
11     map<string, string> planets;
12
12     planets["Mercury"] = "Hot planet";
13     planets["Venus"] = "Atmosphere of sulfuric acid";
14     planets["Earth"] = "Home";
15     planets["Mars"] = "The Red Planet";
16     planets["Jupiter"] = "Largest planet in our solar system";
17     planets["Saturn"] = "Has rings";
18     planets["Uranus"] = "Tilts on its side";
19     planets["Neptune"] = "1500 mile-per-hour winds";
20     planets["Pluto"] = "Dwarf planet";
21     cout << "Entry for Mercury - " << planets["Mercury"]
22         << endl << endl;
23     if (planets.find("Mercury") != planets.end())
24         cout << "Mercury is in the map." << endl;
25     if (planets.find("Ceres") == planets.end())
26         cout << "Ceres is not in the map." << endl << endl;
27     cout << "Iterating through all planets: " << endl;
28     map<string, string>::const_iterator iter;
29     for (iter = planets.begin(); iter != planets.end(); iter++)
30     {
31         cout << iter->first << " - " << iter->second << endl;
32     }
33     return 0;
34 }

```

Sample Dialogue

Entry for Mercury - Hot planet

Mercury is in the map.

Ceres is not in the map.

Iterating through all planets:

Earth - Home

The iterator will output the map in order sorted by the key. In this case the output will be listed alphabetically by planet.

(continued)

DISPLAY 18.14 Program Using the map Template Class (part 2 of 2)

```
Jupiter - Largest planet in our solar system
Mars - The Red Planet
Mercury - Hot planet
Neptune - 1500 mile-per-hour winds
Pluto - Dwarf planet
Saturn - Has rings
Uranus - Tilts on its side
Venus - Atmosphere of sulfuric acid
```



VideoNote
C++11 and Containers

PROGRAMMING TIP Use Initialization, Ranged for, and auto with Containers

Several features introduced in C++11 make it easier to work with collections. In particular, you can initialize your container objects using the uniform initializer list format, which consists of initial data in curly braces. You can also use `auto` and the ranged for loop to easily iterate through a container. Consider the following two initialized collection objects:

```
map<int, string> personIDs = {
                                {1, "Walt"},
                                {2, "Kenrick"}
                            };
set<string> colors = {"red", "green", "blue"};
```

We can iterate through each container conveniently using a ranged for loop and `auto`:

```
for (auto p : personIDs)
    cout << p.first << " " << p.second << endl;
for (auto p : colors)
    cout << p << " ";
```

The output of this snippet is:

```
1 Walt
2 Kenrick
blue green red
```

Efficiency

The STL was designed with efficiency as an important consideration. In fact, the STL implementations strive to be optimally efficient. For example, the `set` and `map` elements are stored in sorted order so that algorithms that search for the elements can be more efficient.

Each of the member functions for each of the template classes has a guaranteed maximum running time. These maximum running times are expressed using what is called big-O notation, which we discuss in Section 18.3.

(Section 18.3 also gives some guaranteed running times for some of the container member functions we have already discussed. These are in the subsection entitled “Container Access Running Times.”) When using more advanced references or even later in this chapter, you will be told the guaranteed maximum running times for certain functions.

SELF-TEST EXERCISES

14. How many elements will be in the map `mymap` after the following code is executed?

```
map<int, string> mymap;
mymap[5] = "c++";
cout << mymap[4] << endl;
```
15. Can a set have elements of a class type?
16. Suppose `s` is of the type `set<char>`. What value is returned by `s.find('A')` if 'A' is in `s`? What value is returned if 'A' is not in `s`?

18.3 GENERIC ALGORITHMS

“Cures consumption, anemia, sexual dysfunction, and all other diseases.”

TYPICAL CLAIM BY A TRAVELING SALESMAN OF “SNAKE OIL”

This section covers some basic function templates in the STL. We cannot give you a comprehensive description of them all here, but will present a large enough sample to give you a good feel for what is contained in the STL and to give you sufficient detail to start using these template functions.

These template functions are sometimes called **generic algorithms**. The term *algorithm* is used for a reason. Recall that an algorithm is just a set of instructions for performing a task. An algorithm can be presented in any language, including a programming language like C++. But when using the word *algorithm*, programmers typically have in mind a less formal presentation given in English or pseudocode. As such, it is often thought of as an abstraction of the code defining a function. It gives the important details but not the fine details of the coding. The STL specifies certain details about the algorithms underlying the STL template functions and that is why they are sometimes called generic *algorithms*.

These STL function templates do more than just deliver a value in any way that the implementers wish. The function templates in the STL come with minimum requirements that must be satisfied by their implementations if they are to satisfy the standard. In most cases, they must be implemented with a guaranteed running time. This adds an entirely new dimension to the idea of a function interface. In the STL, the interface not only tells a programmer what the function does and how to use the functions; the interface also tells how rapidly the task will be done. In some cases, the standard even specifies the

particular algorithm that is used, although not the exact detail of the coding. Moreover, when it does specify the particular algorithm, it does so because of the known efficiency of the algorithm. The key new point is a specification of an efficiency guarantee for the code. In this chapter we will use the terms *generic algorithm*, *generic function*, and *STL function template* to all mean the same thing.

In order to have some terminology to discuss the efficiency of these template functions or generic algorithms, we first present some background on how the efficiency of algorithms is usually measured.

Running Times and Big-O Notation

If you ask a programmer how fast his or her program is, you might expect an answer like “two seconds.” However, the speed of a program cannot be given by a single number. A program will typically take a longer amount of time on larger inputs than it will on smaller inputs. You would expect that a program to sort numbers would take less time to sort ten numbers than it would to sort one thousand numbers. Perhaps it takes two seconds to sort ten numbers, but ten seconds to sort one thousand numbers. How, then, should the programmer answer the question, “How fast is your program?”

The programmer would have to give a table of values showing how long the program took for different sizes of input. For example, the table might be as shown in Display 18.15. This table does not give a single time, but instead gives different times for a variety of different input sizes. The table is a description of what is called a **function** in mathematics. Just as a (non-void) C++ function takes an argument and returns a value, so too does this function take an argument, which is an input size, and returns a number, which is the time the program takes on an input of that size. If we call this function T , then $T(10)$ is 2 seconds, $T(100)$ is 2.1 seconds, $T(1000)$ is 10 seconds, and $T(10,000)$ is 2.5 minutes. The table is just a sample of some of the values of this function T . The program will take some amount of time on inputs of every size. So although they are not shown in the table, there are also values for $T(1)$, $T(2)$, . . . , $T(101)$, $T(102)$, and so forth. For any positive integer N , $T(N)$ is the amount of time it takes for the program to sort N numbers. The function T is called the **running time** of the program.

DISPLAY 18.15 Some Values of a Running-Time Function

Input Size	Running Time
10 numbers	2 seconds
100 numbers	2.1 seconds
1000 numbers	10 seconds
10,000 numbers	2.5 minutes

So far we have been assuming that this sorting program will take the same amount of time on any list of N numbers. That need not be true. Perhaps it takes much less time if the list is already sorted or almost sorted. In that case, $T(N)$ is defined to be the time taken by the “hardest” list, that is, the time taken on that list of N numbers which makes the program run the longest. This is called the **worst-case running time**. In this chapter *we will always mean worst-case running time* when we give a running time for an algorithm or for some code.

The time taken by a program or algorithm is often given by a formula, such as $4N + 3$, $5N + 4$, or N^2 . If the running time $T(N)$ is $5N + 5$, then on inputs of size N the program will run for $5N + 5$ time units.

Following is some code for searching an array a with N elements to determine whether a particular value $target$ is in the array:

```
int i = 0;
bool found = false;
while (( i < N) && !(found))
    if (a[i] == target)
        found = true;
    else
        i++;
```

We want to compute some estimate of how long it will take a computer to execute this code. We would like an estimate that does not depend on which computer we use, either because we do not know which computer we will use or because we might use several different computers to run the program at different times. One possibility is to count the number of “steps,” but it is not easy to decide what a step is. In this situation the normal thing to do is to count the number of **operations**. The term *operations* is almost as vague as the term *step*, but there is at least some agreement in practice about what qualifies as an operation. Let us say that, for this C++ code, each application of any of the following will count as an operation: $=$, $<$, $\&\&$, $!$, $[\]$, $==$, and $++$. The computer must do other things besides carry out these operations, but these seem to be the main things that it is doing and we will assume that they account for the bulk of the time needed to run this code. In fact, our analysis of time will assume that everything else takes no time at all and that the total time for our program to run is equal to the time needed to perform these operations. Although this is an idealization that clearly is not completely true, it turns out that this simplifying assumption works well in practice and so is often made when analyzing a program or algorithm.

Even with our simplifying assumption, we still must consider two cases: Either the value $target$ is in the array or it is not. Let us first consider the case when $target$ is not in the array. The number of operations performed will depend on the number of array elements searched. The operation $=$ is performed two times before the loop is executed. Since we are assuming that $target$ is not in the array, the loop will be executed N times, one for each element of the array. Each time the loop is executed, the following operations are performed: $<$, $\&\&$, $!$, $[\]$, $==$, and $++$. This adds six operators for each of N loop iterations. Finally, after N iterations, the Boolean expression is again checked and found to be false. This adds a final

three operations (<, &&, !).² If we tally all these operations, we get a total of $6N + 5$ operations when the target is not in the array. We will leave it as an exercise for you to confirm that if the target is in the array, then the number of operations will be $6N + 5$ or less. Thus, the worst-case running time is $T(N) = 6N + 5$ operations for any array of N elements and any value of target.

We just determined that the worst-case running time for our search code is $6N + 5$ operations. But operations is not a traditional unit of time, like nanoseconds, seconds, or minutes. If we want to know how long the algorithm will take on some particular computer, we must know how long it takes that computer to perform one operation. If an operation can be performed in 1 nanosecond, then the time will be $6N + 5$ nanoseconds. If an operation can be performed in 1 second, the time will be $6N + 5$ seconds. If we use a slow computer that takes 10 seconds to perform an operation, the time will be $60N + 50$ seconds. In general, if it takes the computer c nanoseconds to perform one operation, then the actual running time will be approximately $c(6N + 5)$ nanoseconds. (We say *approximately*, since we are making some simplifying assumptions and so the result may not be the absolutely exact running time.) This means that our running time of $6N + 5$ is a very crude estimate. To get the running time expressed in nanoseconds, you must multiply by some constant that depends on the particular computer you are using. Our estimate of $6N + 5$ is only accurate to “within a constant multiple.” There is a standard notation for these sorts of estimates and we discuss this notation next.

Estimates on running time, such as the one we just went through, are normally expressed in something called **big-O notation**. (The O is the letter “Oh,” not the digit zero.) Suppose we estimate the running time to be, say, $6N + 5$ operations and suppose we know that no matter what the exact running time of each different operation may turn out to be, there will always be some constant factor c such that the real running time is less than or equal to $c(6N + 5)$.

Under these circumstances, we say the code (or program or algorithm) runs in time $O(6N + 5)$. This is usually read as “big-O of $6N + 5$.” We need not know what the constant c will be. In fact, it will undoubtedly be different for different computers, but we must know that there is one such c for any reasonable computer system. If the computer is very fast, then the c might be less than 1—say, 0.001. If the computer is very slow, the c might be very large—say, 1000. Moreover, since changing the units, say from nanosecond to second, only involves a constant multiple, there is no need to give any units of time.

Be sure to notice that a big-O estimate is an upper-bound estimate. We always approximate by taking numbers on the high side, rather than the low side, of the true count. Also notice that when performing a big-O estimate, we need not determine a very exact count of the number of operations performed. We only need an estimate that is correct “up to a constant multiple.” If our estimate is twice as large as the true number, that is good enough.

² Because of short circuit evaluation, ! (found) is not evaluated, so we actually get two, not three operations. However, the important thing is to obtain a good upper bound. If we add in one extra operation that is not significant.

An order of magnitude estimate, such as the previous $6N + 5$, contains a parameter for the size of the task solved by the algorithm (or program or piece of code). In our sample case, this parameter N was the number of array elements to be searched. Not surprisingly, it takes longer to search a larger number of array elements than it does to search a smaller number of array elements. Big- O running time estimates are always expressed as a function of the size of the problem. In this chapter all our algorithms will involve a range of values in some container. In all cases N will be the number of elements in that range.

The following is an alternative, pragmatic way to think about big- O estimates:

Look only at the term with the highest exponent and do not pay attention to constant multiples.

For example, all of the following are $O(N^2)$:

$$N^2 + 2N + 1, 3N^2 + 7, 100N^2 + N$$

All of the following are $O(N^3)$:

$$N^3 + 5N^2 + N + 1, 8N^3 + 7, 100N^3 + 4N + 1$$

Big- O running-time estimates are admittedly crude, but they do contain some information. They will not distinguish between a running time of $5N + 5$ and a running time of $100N$, but they do let us distinguish between some running times and so determine that some algorithms are faster than others. Look at the graphs in Display 18.16; notice that all the graphs for functions that are $O(N)$ eventually fall below the graph for the function $0.5N^2$. The result is inevitable: An $O(N)$ algorithm will always run faster than any $O(N^2)$ algorithm, provided we use large enough values of N . Although an $O(N^2)$ algorithm could be faster than an $O(N)$ algorithm for the problem size you are handling, programmers have found that in practice $O(N)$ algorithms perform better than $O(N^2)$ algorithms for most practical applications that are intuitively “large.” Similar remarks apply to any other two different big- O running times.

Some terminology will help with our descriptions of generic algorithm running times. **Linear running time** means a running time of $T(N) = aN + b$. A linear running time is always an $O(N)$ running time. **Quadratic running time** means a running time with highest term N^2 . A quadratic running time is always an $O(N^2)$ running time. We will also occasionally have logarithms in running-time formulas. Those normally are given without any base, since changing the base is just a constant multiple. If you see $\log N$, think log base 2 of N , but it would not be wrong to think log base 10 of N . Logarithms are very slow-growing functions. So, a $O(\log N)$ running time is very fast. Sometimes $\log_2 N$ is written as $\lg N$.

Container Access Running Times

Now that we know about big- O notation, we can express the efficiency of some of the accessing functions for container classes that we discussed in Section 18.2 “Containers.” Insertions at the back of a vector (`push_back`),

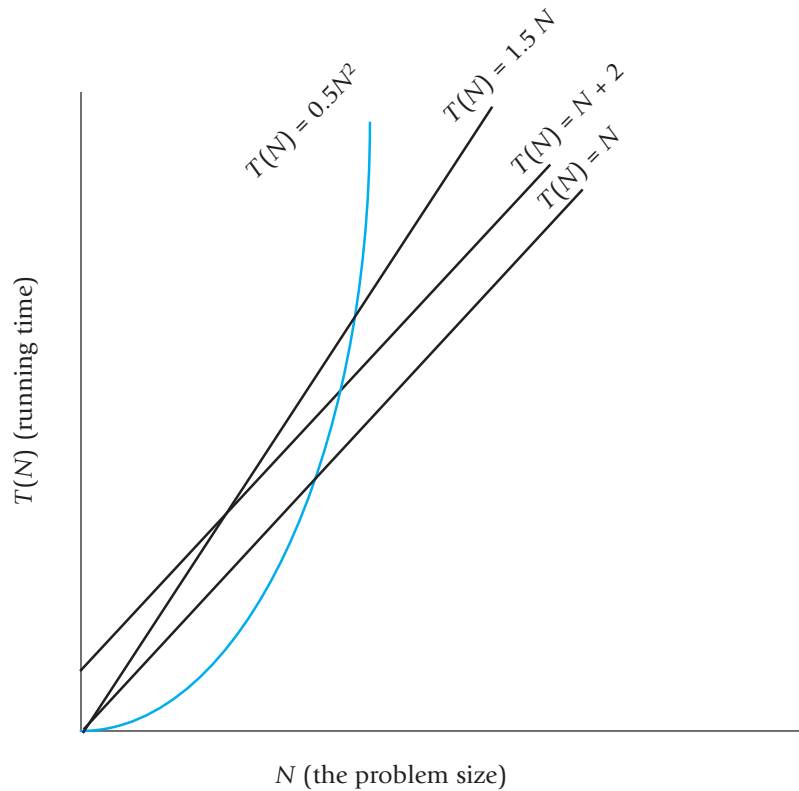
DISPLAY 18.16 Comparison of Running Times

the front or back of a deque (`push_back` and `push_front`), and anywhere in a list (`insert`) are all $O(1)$ (that is, a constant upper bound on the running time that is independent of the size of the container.) Insertion or deletion of an arbitrary element for a vector or deque is $O(N)$, where N is the number of elements in the container. For a set or map, finding (`find`) is $O(\log N)$, where N is the number of elements in the container.

SELF-TEST EXERCISES

17. Show that a running time $T(N) = aN + b$ is an $O(N)$ running time. (*Hint:* The only issue is the $+ b$. Assume N is always at least 1.)
18. Show that for any two bases a and b for logarithms, if a and b are both greater than 1, then there is a constant c such that $\log_a N \leq c(\log_b N)$. Thus, there is no need to specify a base in $O(\log N)$. That is, $O(\log_a N)$ and $O(\log_b N)$ mean the same thing.

Nonmodifying Sequence Algorithms

This section describes template functions that operate on containers but do not modify the contents of the container in any way. A good simple and typical example is the generic `find` function.

The generic `find` function is similar to the `find` member function of the `set` template class but is a different `find` function; in particular, the generic `find` function takes more arguments than the `find` function we discussed when we presented the `set` template class. The generic `find` function searches a container to locate a particular element, but the generic `find` can be used with any of the STL sequential container classes. Display 18.17 shows a sample use of the generic `find` function used with the class `vector<char>`. The function in Display 18.17 would behave exactly the same if we replaced `vector<char>` with `list<char>` throughout, or if we replaced `vector<char>` with any other sequential container class. That is one of the reasons why the functions are called *generic*. One definition of the `find` function works for a wide selection of containers.

If the `find` function does not find the element it is looking for, it returns its second iterator argument, which need not be equal to some `end()` as it is in Display 18.17. Sample Dialogue 2 shows the situation when `find` does not find what it is looking for.

DISPLAY 18.17 The Generic `find` Function (part 1 of 2)

```
1  //Program to demonstrate use of the generic find function.
2  #include <iostream>
3  #include <vector>
4  #include <algorithm>
5  using std::cin;
6  using std::cout;
7  using std::endl;
8  using std::vector;
9  using std::find;
10 int main()
11 {
12     vector<char> line;
13     cout << "Enter a line of text:\n";
14     char next;
15     cin.get(next);
16     while (next != '\n')
17     {
18         line.push_back(next);
19         cin.get(next);
20     }
```

(continued)

DISPLAY 18.17 The Generic find Function (part 2 of 2)

```

21     vector<char>::const_iterator where;
22     where = find(line.begin(), line.end(), 'e');
23     //where is located at the first occurrence of 'e' in line.

24     vector<char>::const_iterator p;
25     cout << "You entered the following before you entered your first e:\n";
26     for (p = line.begin(); p != where; p++)
27         cout << *p;
28     cout << endl;
29     cout << "You entered the following after that:\n";
30     for (p = where; p != line.end(); p++)
31         cout << *p;
32     cout << endl;

33     cout << "End of demonstration.\n";
34     return 0;
35 }

```

If `find` does not find what it is looking for, it returns its second argument.

Sample Dialogue 1

```

Enter a line of text
A line of text.
You entered the following before you entered your first e:
A lin
You entered the following after that:
e of text.
End of demonstration.

```

Sample Dialogue 2

```

Enter a line of text
I will not!
You entered the following before you entered your first e:
I will not!
You entered the following after that:
End of demonstration.

```

If `find` does not find what it is looking for, it returns `line.end()`.

Does `find` work with absolutely any container classes? No, not quite. To start with, it takes iterators as arguments, and some containers, such as `stack`, do not have iterators. To use the `find` function, the container must have iterators, the elements must be stored in a linear sequence so that the

`++` operator moves iterators through the container, and the elements must be comparable using `==`. In other words, the container must have forward iterators (or some stronger kind of iterators, such as bidirectional iterators).

When presenting generic function templates, we will describe the iterator type parameter by using the name of the required kind of iterator as the type parameter name. So `ForwardIterator` should be replaced by a type that is a type for some kind of forward iterator, such as the `iterator` type in a `list`, `vector`, or other container template class. Remember, a bidirectional iterator is also a forward iterator, and a random access iterator is also a bidirectional iterator. So the type name `ForwardIterator` can be used with any iterator type that is a bidirectional or random access iterator type as well as a plain old forward iterator type. In some cases, when we specify `ForwardIterator` you can use an even simpler iterator kind; namely, an input iterator or output iterator, but since we have not discussed input and output iterators, we do not mention them in our function template declarations.

Remember the names *forward iterator*, *bidirectional iterator*, and *random access iterator* refer to kinds of iterators, not type names. The actual type names will be something like `std::vector<int>::iterator`, which in this case happens to be a random access iterator.

Display 18.18 gives a sample of some nonmodifying generic functions in the STL. The display uses a notation that is common when discussing container iterators. The iterator locations encountered in moving from an iterator `first` to, but not equal to, an iterator `last` is called the **range** [`first`, `last`). For example, the following `for` loop outputs all the elements in the range [`first`, `last`):

```
for (iterator p = first; p != last; p++)
    cout << *p << endl;
```

Note that when two ranges are given they need not be in the same container or even in the same type of container. For example, for the search function, the ranges [`first1`, `last1`) and [`first2`, `last2`) may be in the same or different containers.

Range [`first`, `last`)

The movement from some iterator `first`, often `container.begin()`, up to but not including some location `last`, often `container.end()`, is so common it has come to have a special name, **range** [`first`, `last`). For example, the following outputs all elements in the range [`c.begin()`, `c.end()`), where `c` is some container object, such as a vector:

```
for (iterator p = c.begin(); p != c.end(); p++)
    cout << *p << endl;
```

DISPLAY 18.18 Some Nonmodifying Generic Functions

These all work for forward iterators, which means they also work for bidirectional and random access iterators. (In some cases they even work for other kinds of iterators, which we have not covered in any detail.)

```

1  template<class ForwardIterator, class T>
2  ForwardIterator find(ForwardIterator first,
3                      ForwardIterator last, const T& target);
4  //Traverses the range [first, last) and returns an iterator located at
5  //the first occurrence of target. Returns second if target is not found.
6  //Time complexity: linear in the size of the range [first, last).

7  template<class ForwardIterator, class T>
8  int3 count(ForwardIterator first, ForwardIterator last, const T& target);
9  //Traverses the range [first, last) and returns the number
10 //of elements equal to target.
11 //Time complexity: linear in the size of the range [first, last).

12 template<class ForwardIterator1, class ForwardIterator2>
13 bool equal(ForwardIterator1 first1, ForwardIterator1 last1,
14            ForwardIterator2 first2);
15 //Returns true if [first1, last1) contains the same elements in the same order as
16 //the first last1-first1 elements starting at first2. Otherwise, returns false.
17 //Time complexity: linear in the size of the range [first, last).
18
19 template<class ForwardIterator1, class ForwardIterator2>
20 ForwardIterator1 search(ForwardIterator1 first1, ForwardIterator1 last1,
21                        ForwardIterator2 first2, ForwardIterator2 last2);
22 //Checks to see if [first2, last2) is a subrange of [first1, last1).
23 //If so, it returns an iterator located in [first1, last1) at the start of
24 //the first match. Returns last1 if a match is not found.
25 //Time complexity: quadratic in the size of the range [first1, last1).

26 template<class ForwardIterator, class T>
27 bool binary_search(ForwardIterator first, ForwardIterator last,
28                   const T& target);
29 //Precondition: The range [first, last) is sorted into ascending order using <.
30 //Uses the binary search algorithm to determine if target is in the range
31 //[first, last).
32 //Time complexity: For random access iterators  $O(\log N)$ . For non-random-access
33 //iterators
34 //linear is  $N$ , where  $N$  is the size of the range [first, last).

```

³The actual return type is an integer type that we have not discussed, but the returned value should be assignable to a variable of type `int`.

Notice that there are three search functions in Display 18.18—`find`, `search`, and `binary_search`. The function `search` searches for a subsequence, while the `find` and `binary_search` functions search for a single value. How do you decide whether to use `find` or `binary_search` when searching for a single element? One returns an iterator and the other returns just a Boolean value, but that is not the biggest difference. The `binary_search` function requires that the range being searched be sorted (into ascending order using `<`) and run in time $O(\log N)$; the `find` function does not require that the range be sorted but it guarantees only linear time. If you have or can have the elements in sorted order, you can search for them much more quickly by using `binary_search`.

Note that with the `binary_search` function you are guaranteed that the implementation will use the binary search algorithm, which was discussed in Chapter 14. The importance of using the binary search algorithm is that it guarantees a very fast running time, $O(\log N)$. If you have not read Chapter 14 and have not otherwise heard of binary search, just think of it as a very efficient search algorithm that requires that the elements be sorted. Those are the only two points about binary search that are relevant to the material in this chapter.

SELF-TEST EXERCISES

19. Replace all occurrences of the identifier `vector` with the identifier `list` in Display 18.17. Compile and run the program.
20. Suppose `v` is an object of the class `vector<int>`. Use the `search` generic function (Display 18.18) to write some code to determine whether or not `v` contains the number 42 immediately followed by 43. You need not give a complete program, but do give all necessary `include` and `using` directives. (*Hint:* It may help to use a second vector.)

Container Modifying Algorithms

Display 18.19 contains descriptions of some of the generic functions in the STL which change the contents of a container in some way.

Remember that when you add or remove an element to or from a container, that can affect any of the other iterators. There is no guarantee that the iterators will be located at the same element after an addition or deletion unless the container template class makes such a guarantee. Of the template classes we have seen, `list` and `slist` guarantee that their iterators will not be moved by additions or deletions, except of course if the iterator is located at an element that is removed. The template classes `vector` and `deque` make no such guarantee. Some of the function templates in Display 18.19 guarantee the values of some specific iterators and those guarantees you can, of course, count on, no matter what the container is.

DISPLAY 18.19 Some Modifying Generic Functions

```

1  template<class T>
2  void swap(T& variable1, T& variable2);
3  //Interchanges the values of variable1 and variable2

```

*The name of the iterator type parameter tells the kind of iterator for which the function works. Remember that these are minimum iterator requirements. For example, **ForwardIterator** works for forward iterators, bidirectional iterators, and random access iterators.*

```

4  template<class ForwardIterator1, class ForwardIterator2>
5  ForwardIterator2 copy(ForwardIterator1 first1, ForwardIterator1 last1,
6      ForwardIterator2 first2, ForwardIterator2 last2);
7  //Precondition: The ranges [first1, last1) and [first2, last2) are the same size.
8  //Action: Copies the elements at locations [first1, last1) to locations
9  //[[first2, last2).
10 //Returns last2.
11 //Time complexity: linear in the size of the range [first1, last1).

12 template<class ForwardIterator, class T>
13 ForwardIterator remove(ForwardIterator first, ForwardIterator last,
14     const T& target);
15 //Removes those elements equal to target from the range [first, last).
16 //The size of
17 //the container is not changed. The removed values equal to target are
18 //moved to the
19 //end of the range [first, last). There is then an iterator i in this
20 //range such that
21 //all the values not equal to target are in [first, i). This i is returned.
22 //Time complexity: linear in the size of the range [first, last).

23 template<class BidirectionalIterator>
24 void reverse(BidirectionalIterator first, BidirectionalIterator last);
25 //Reverses the order of the elements in the range [first, last).
26 //Time complexity: linear in the size of the range [first, last).

27 template<class RandomAccessIterator>
28 void random_shuffle(RandomAccessIterator first, RandomAccessIterator last);
29 //Uses a pseudorandom number generator to randomly reorder the elements
30 //in the range [first, last).
31 //Time complexity: linear in the size of the range [first, last).

```

SELF-TEST EXERCISES

21. Can you use the `random_shuffle` template function with a `list` container?
22. Can you use the `copy` template function with vector containers, even though `copy` requires forward iterators and `vector` has random access iterators?

Set Algorithms

Display 18.20 shows a sample of the generic set operation functions defined in the STL. Note that these generic algorithms assume the containers store their elements in sorted order. The containers `set`, `map`, `multiset`, and `multimap` do store their elements in sorted order, so all the functions in Display 18.20 apply to these four template class containers. Other containers, such as `vector`, do not store their elements in sorted order and these functions should not be used with such containers. The reason for requiring that the elements be sorted is so that the algorithms can be more efficient.

DISPLAY 18.20 Set Operations (part 1 of 2)

These operations work for sets, maps, multisets, multimaps (and other containers) but do not work for all containers. For example, they do not work for vectors, lists, or deques unless their contents are sorted. For these containers to work, the elements in the container must be stored in sorted order. These operators all work for forward iterators, which means they also work for bidirectional and random access iterators. (In some cases they even work for other kinds of iterators, which we have not covered in any detail.)

```

1  template<class ForwardIterator1, class ForwardIterator2>
2  bool includes(ForwardIterator1 first1, ForwardIterator1 last1,
3              ForwardIterator2 first2, ForwardIterator2 last2);
4  //Returns true if every element in the range [first2, last2) also occurs in the
5  //range [first1, last1). Otherwise, returns false.
6  //Time complexity: linear in the size of [first1, last1) plus [first2, last2).
7
8  template<class ForwardIterator1, class ForwardIterator2,
9          class ForwardIterator3>
10 void set_union(ForwardIterator1 first1, ForwardIterator1 last1,
11              ForwardIterator2 first2, ForwardIterator2 last2,
12              ForwardIterator3 result);
13 //Creates a sorted union of the two ranges [first1, last1) and [first2, last2).
14 //The union is stored starting at result.
15 //Time complexity: linear in the size of [first1, last1) plus [first2, last2).
16
17 template<class ForwardIterator1, class ForwardIterator2,
18          class ForwardIterator3>
19 void set_intersection(ForwardIterator1 first1, ForwardIterator1 last1,
20                      ForwardIterator2 first2, ForwardIterator2 last2,
21                      ForwardIterator3 result);
22 //Creates a sorted intersection of the two ranges [first1, last1) and
23 // [first2, last2).
24 //The intersection is stored starting at result.
25 //Time complexity: linear in the size of [first1, last1) plus [first2, last2).
26
27 template<class ForwardIterator1, class ForwardIterator2,
28          class ForwardIterator3>

```

(continued)

DISPLAY 18.20 Set Operations (*part 2 of 2*)

```

28 void set_difference(ForwardIterator1 first1, ForwardIterator1 last1,
29                   ForwardIterator2 first2, ForwardIterator2 last2,
30                   ForwardIterator3 result);
31 //Creates a sorted set difference of the two ranges [first1, last1) and
32 //[first2, last2).
33 //The difference consists of the elements in the first range that are not in the
34 //second.
35 //The result is stored starting at result.
36 //Time complexity: linear in the size of [first1, last1) plus [first2, last2).

```

SELF-TEST EXERCISE

23. The mathematics course version of a set does not keep its elements in sorted order and it has a union operator. Why does the `set_union` template function require that the containers keep their elements in sorted order?

Sorting Algorithms

Display 18.21 gives the declarations and documentation for two template functions, one to sort a range of elements and one to merge two sorted ranges of elements. Note that the sorting function `sort` guarantees a run time of $O(N \log N)$. Although it is beyond the scope of this book, it can be shown that you cannot write a comparison-based sorting algorithm that is faster than $O(N \log N)$. So this guarantees that the sorting algorithm is as fast as is possible, up to a constant multiple.

DISPLAY 18.21 Some Generic Sorting Algorithms

```

1  template<class RandomAccessIterator>
2  void sort(RandomAccessIterator first, RandomAccessIterator last);
3  //Sorts the elements in the range [first, last) into ascending order.
4  //Time complexity:  $O(N \log N)$ , where  $N$  is the size of the range [first, last).
5
6  template<class ForwardIterator1, class ForwardIterator2,
7          class ForwardIterator3>
8  void merge(ForwardIterator1 first1, ForwardIterator1 last1,
9            ForwardIterator2 first2, ForwardIterator2 last2,
10           ForwardIterator3 result);
11 //Precondition: The ranges [first1, last1) and [first2, last2) are sorted.
12 //Action: Merges the two ranges into a sorted range [result, last3), where
13 //last3 = result + (last1 - first1) + (last2 - first2).
14 //Time complexity: linear in the size of the range [first1, last1)
15 //plus the size of [first2, last2).

```

Sorting uses the < operator, and so the < operator must be defined. There are other versions, not given here, that allow you to provide the ordering relation. Sorted means sorted into ascending order.

CHAPTER SUMMARY

- An iterator is a generalization of a pointer. Iterators are used to move through the elements in some range of a container. The operations `++`, `--`, and dereferencing `*` are usually defined for an iterator.
- Container classes with iterators have member functions `end()` and `begin()` that return iterator values such that you can process all the data in the container as follows:

```
for (p = c.begin(); p != c.end(); p++)  
    process *p /*p is the current data item.
```

- The main kinds of iterators are
 - Forward iterators: `++` works on the iterator.
 - Bidirectional iterators: both `++` and `--` work on the iterator.
 - Random access iterators: `++`, `--`, and random access all work with the iterator.
- With a constant iterator `p`, the dereferencing operator `*p` produces a read-only version of the element. With a mutable iterator `p`, `*p` can be assigned a value.
- A bidirectional container has reverse iterators that allow your code to cycle through the elements in the container in reverse order.
- The main container template classes in the STL are `list`, which has mutable bidirectional iterators, and the template classes `vector` and `deque`, both of which have mutable random access iterators.
- `stack` and `queue` are container adaptor classes, which means they are built on top of other container classes. A `stack` is a last-in/first-out container. A `queue` is a first-in/first-out container.
- The `set`, `map`, `multiset`, and `multimap` container template classes store their elements in sorted order for efficiency of search algorithms. A `set` is a simple collection of elements. A `map` allows storing and retrieving by key values. The `multiset` class allows repetitions of entries. The `multimap` class allows a single key to be associated with multiple data items.
- The STL includes template functions to implement generic algorithms with guarantees on their maximum running time.

Answers to Self-Test Exercises

1. `v.begin()` returns an iterator located at the first element of `v`. `v.end()` returns a value that serves as a sentinel value at the end of all the elements of `v`.
2. `*p` is the dereferencing operator applied to `p`. `*p` is a reference to the element at location `p`.

3. `vector<int>::iterator p;`
`for (p = v.begin(), p++; p != v.end(); p++)`
`cout << *p << " ";`
4. D C C
5. B C
6. Either would work.
7. A major difference is that a vector container has random access iterators whereas a list has only bidirectional iterators.
8. All except `slist`.
9. `vector` and `deque`.
10. They all can have mutable iterators.
11. The `stack` template adapter class has no iterators.
12. The `queue` template adapter class has no iterators.
13. No value is returned; `pop` is a void function.
14. `mymap` will contain two entries. One is a mapping from 5 to "c++" and the other is a mapping from 4 to the default string, which is blank.
15. Yes they can be of any type, although there is only one type for each set object. The type parameter in the template class is the type of elements stored.
16. If 'A' is in `s`, then `s.find('A')` returns an iterator located at the element 'A'. If 'A' is not in `s`, then `s.find('A')` returns `s.end()`.
17. Just note that $aN + b \leq (a + b)N$, as long as $1 \leq N$.
18. This is mathematics, not C++, so `=` will mean *equals* not assignment.

First note that $\log_a N = (\log_a b)(\log_b N)$.

To see this first identity, just note that if you raise a to the power $\log_a N$, you get N , and if you raise a to the power $(\log_a b)(\log_b N)$, you also get N .

If you set $c = (\log_a b)$, you get $\log_a N = c(\log_b N)$.

19. The programs should run exactly the same.
20. `#include <iostream>`
`#include <vector>`
`#include <algorithm>`
`using std::cout;`
`using std::vector;`
`using std::search;`

```

...
vector<int> target;
target.push_back(42);
target.push_back(43);
vector<int>::const_iterator result = search(v.begin(), v.end(),
                                          target.begin(), target.end());
if (result != v.end())
    cout << "Found 42, 43.\n";
else
    cout << "42, 43 not there.\n";

```

21. No, you must have random access iterators, and the `list` template class has only bidirectional iterators.
22. Yes, a random access iterator is also a forward iterator.
23. The `set_union` template function requires that the containers keep their elements in sorted order to allow the function template to be implemented in a more efficient way.

PRACTICE PROGRAMS

Practice Programs can generally be solved with a short program that directly applies the programming principles presented in this chapter.

1. Write a program in which you declare a deque to store values of type *double*, read in ten *double* numbers, and store them in the deque. Then call the generic `sort` function to sort the numbers in the deque and display the results.
2. Write a program that uses the `map` template class to compute a histogram of positive numbers entered by the user. The `map`'s key should be the number that is entered, and the value should be a counter of the number of times the key has been entered so far. Use `-1` as a sentinel value to signal the end of user input. For example, if the user inputs:

```

5
12
3
5
5
3
21
-1

```

then the program should output the following (not necessarily in this order):

```

The number 3 occurs 2 times.
The number 5 occurs 3 times.
The number 12 occurs 1 times.
The number 21 occurs 1 times.

```



VideoNote
Solution to Practice
Program 18.2

3. Given a variable of type `string` set to arbitrary text, write a program that uses the `stack` template class of type `char` to reverse the string.
4. You have a list of student ID's followed by the course number (separated by a space) that the student is enrolled in. The listing is in no particular order. For example, if student 1 is in CS100 and CS200 while student 2 is in CS105 and MATH210 then the list might look like this:

```
1 CS100
2 MATH210
2 CS105
1 CS200
```

Write a program that reads data in this format from the console. If the ID is -1 then stop inputting data. Use the `map` template class to map from an integer (the student ID) to a vector of type `string` that holds each class that the student is enrolled in.

After all data is input, iterate through the map and output the student ID and all classes stored in the vector for that student. The result should be a list of classes organized by student ID.

If you aren't using C++11 or higher then don't forget that you need a space between the `>>` characters when defining the map of vectors.

PROGRAMMING PROJECTS

Programming Projects require more problem-solving than Practice Programs and can usually be solved many different ways. Visit www.myprogramminglab.com to complete many of these Programming Projects online and get instant feedback.

1. Write a program that allows the user to enter any number of student names and their scores. The program should then display the student names and scores according to the ascending order of scores. Use the template class `vector` and the generic `sort` function from the STL. Note that you will need to define a structure or class type for data consisting of one student name and score. You will also need to overload the `<` operator for this structure or class.
2. A **prime** number is an integer greater than 1 and divisible only by itself and 1. An integer x is **divisible** by an integer y if there is another integer z such that $x = y * z$. The Greek mathematician Eratosthenes (pronounced: Er-ah-tos-thin-eeze) gave an algorithm, called the *Sieve of Eratosthenes*, for finding all prime numbers less than some integer N . The algorithm works like this: Begin with a list of integers 2 through N . The number 2 is the first prime. (It is instructive to consider why this is true.) The *multiples* of 2, that is, 4, 6, 8, etc., are *not prime*. We cross these off the list. Then the first number after 2 that was not crossed off is the next prime. This number is 3. The *multiples*

of 3 are not primes. Cross the multiples of 3 off the list. Note that 6 is already gone, cross off 9, 12 is already gone, cross off 15, etc. The first number not crossed off is the next prime. The algorithm continues on in this fashion until we reach N . All the numbers not crossed off the list are primes.

- a. Write a program using this algorithm to find all primes less than a user-supplied number N . Use a vector container for the integers. Use an array of *bool* initially set to all *true* to keep track of crossed-off integers. Change the entry to *false* for integers that are crossed off the list.
- b. Test for $N = 10, 30, 100,$ and 300 .

We can improve our solution in several ways:

- c. The program does not need to go all the way to N . It can stop at $N/2$. Try this and test your program. $N/2$ works and is better but is not the smallest number we could use. Argue that to get all the primes between 1 and N the minimum limit is the square root of N .
 - d. Modify your code from part (a) to use the square root of N as an upper limit.
3. Suppose you have a collection of student records. The records are structures of the following type:

```
struct StudentInfo
{
    string name;
    int grade;
};
```

The records are maintained in a `vector<StudentInfo>`. Write a program that prompts for and fetches data and builds a vector of student records, then sorts the vector by name, calculates the maximum and minimum grades and the class average, then prints this summarizing data along with a class roll with grades. (We aren't interested in who had the maximum and minimum grade, though, just the maximum, minimum, and average statistics.) Test your program.

4. Continuing Programming Project 3, write a function that separates the students in the vector of `StudentInfo` records into two vectors, one containing records of passing students and one containing records of failing students. (Use a grade of 60 or better for passing.)

You are asked to do this in two ways, and to give some run-time estimates.

- a. Consider continuing to use a vector. You could generate a second vector of passing students and a third vector of failing students. This keeps duplicate records for at least some of the time, so don't do it that way. You could create a vector of failing students and a test-for-failing function. Then you `push_back` failing student records, then erase

- (which is a member function) the failing student records from the original vector. Write the program this way.
- b. Consider the efficiency of this solution. You are potentially erasing $O(N)$ members from the middle of a vector. You have to move a lot of members in this case. erasing from the middle of a vector is an $O(N)$ operation. Give a big- O estimate of the running time for this program.
 - c. If you used a `list<StudentInfo>`, what are the run-times for the erase and insert functions? Consider how the time efficiency of erase for a `list` affects the run-time for the program. Rewrite this program using a `list` instead of a vector. Remember that a `list` provides neither indexing nor random access and its iterators are only bidirectional, not random access.
5. Redo (or do for the first time) Programming Project 9 from Chapter 11, except use the STL `set` template class instead of your own `set` class. Use the generic `set_intersection` function to compute the intersection of `Q` and `D`.

Here is an example of `set_intersection` to intersect set `A` with `B` and store the result in `C`, where all sets are sets of strings:

```
#include <iterator>
#include <set>
#include <string>
...

set<string> C;
// Note space between >> in line below
insert_iterator<set<string> > cIterator(C, C.begin());
set_intersection(A.begin(), A.end(),
                 B.begin(), B.end(),
                 cIter);
// set C now contains the intersection of A and B
```

6. In this project you are to create a database of books that are stored using a vector. Keep track of the author, title, and publication date of each book. Your program should have a main menu that allows the user to select from the following: (1) Add a book's author, title, and date; (2) Print an alphabetical list of the books sorted by author; and (3) Quit.

You must use a class to hold the data for each book. This class must hold three string fields: one to hold the author's name, one for the publication date, and another to hold the book's title. Store the entire database of books in a vector in which each vector element is a book class object.

To sort the data, use the generic `sort` function from the `<algorithm>` library. Note that this requires you to define the `<` operator to compare two objects of type `Book` so that the author field from the two books are compared.



A sample of the input/output behavior might look as follows. Your I/O need not look identical, this is just to give you an idea of the functionality.

Select from the following choices:

1. Add new book
2. Print listing sorted by author
3. Quit

1

Enter title:

More Than Human

Enter author:

Sturgeon, Theodore

Enter date:

1953

Select from the following choices:

1. Add new book
2. Print listing sorted by author
3. Quit

1

Enter title:

Problem Solving with C++

Enter author:

Savitch, Walter

Enter date:

2015

Select from the following choices:

1. Add new book
2. Print listing sorted by author
3. Quit

2

The books entered so far, sorted alphabetically by author are:
Savitch, Walter. Problem Solving with C++. 2015.
Sturgeon, Theodore. More Than Human. 1953.

Select from the following choices:

1. Add new book
2. Print listing sorted by author
3. Quit

1

Enter title:

At Home in the Universe

Enter author:

Kauffman

Enter date:

1996

Select from the following choices:

1. Add new book
 2. Print listing sorted by author
 3. Quit
- 2

The books entered so far, sorted alphabetically by artist are:
 Kauffman, At Home in the Universe, 1996
 Savitch, Walter. Problem Solving with C++. 2015.
 Sturgeon, Theodore. More Than Human. 1953.

7. Redo or do for the first time Programming Project 8 from Chapter 14, except use the STL set class for all set operations and the STL linked list class to store and manipulate each individual permutation. When creating a set containing lists, make sure to place a space between the last two >'s if you are using a compiler earlier than C++11. For example, `set<list<int>>` defines a set where elements are linked lists containing elements of type `int`. The code `set<list<int> >` without a space will produce a compiler error. (This issue was eliminated with the release of C++11.)
8. You have collected a file of movie ratings where each movie is rated from 1 (bad) to 5 (excellent). The first line of the file is a number that identifies how many ratings are in the file. Each rating then consists of two lines: the name of the movie followed by the numeric rating from 1 to 5. Here is a sample rating file with four unique movies and seven ratings:

```
7
Harry Potter and the Order of the Phoenix
4
Harry Potter and the Order of the Phoenix
5
The Bourne Ultimatum
3
Harry Potter and the Order of the Phoenix
4
The Bourne Ultimatum
4
Wall-E
4
Glitter
1
```

Write a program that reads a file in this format, calculates the average rating for each movie, and outputs the average along with the number of reviews. Here is the desired output for the sample data:

```
Glitter: 1 review, average of 1 / 5
Harry Potter and the Order of the Phoenix: 3 reviews, average
of 4.3 / 5
```

The Bourne Ultimatum: 2 reviews, average of 3.5 / 5
Wall-E: 1 review, average of 4 / 5

Use a map or multiple maps to calculate the output. Your map(s) should index from a string representing each movie's name to integers that store the number of reviews for the movie and the sum of the ratings for the movie.

9. Consider a text file of names, with one name per line, that has been compiled from several different sources. A sample follows:

```
Brooke Trout  
Dinah Soars  
Jed Dye  
Brooke Trout  
Jed Dye  
Paige Turner
```

There are duplicate names in the file. We would like to generate an invitation list but don't want to send multiple invitations to the same person. Write a program that eliminates the duplicate names by using the set template class. Read each name from the file, add it to the set, and then output all names in the set to generate the invitation list without duplicates.

10. Do Programming Project 16 from Chapter 8 except use a `Racer` class to store information about each race participant. The class should store the racer's name, bib number, finishing position, and all of his or her split times as recorded by the RFID sensors. You can choose appropriate structures to store this information. Include appropriate functions to access or change the racer's information, along with a constructor.

Use a map to store the race data. The map should use the bib number as the key and the value should be the `Racer` object that corresponds to the bib number. With the map you won't need to search for a bib number anymore, you can directly access the splits and final position based on the bib number.

If you aren't using C++11 or higher then don't forget that you need a space between the `>>` characters when defining the map of vectors.

This page intentionally left blank

C++ Keywords

The following keywords should not be used for anything other than their pre-defined purposes in the C++ language. In particular, do not use them for variable names or for programmer-defined functions. In addition to the following keywords listed, identifiers containing a double underscore (`__`) are reserved for use by C++ implementations and standard libraries and should not be used in your programs.

<i>alignas</i>	<i>default</i>	<i>if</i>	<i>reinterpret_cast</i>	<i>try</i>
<i>alignof</i>	<i>delete</i>	<i>inline</i>	<i>return</i>	<i>typedef</i>
<i>asm</i>	<i>do</i>	<i>int</i>	<i>short</i>	<i>typeid</i>
<i>auto</i>	<i>double</i>	<i>log</i>	<i>signed</i>	<i>typename</i>
<i>bool</i>	<i>dynamic_cast</i>	<i>long</i>	<i>sizeof</i>	<i>union</i>
<i>break</i>	<i>else</i>	<i>mutable</i>	<i>static</i>	<i>unsigned</i>
<i>case</i>	<i>enum</i>	<i>namespace</i>	<i>static_assert</i>	<i>using</i>
<i>catch</i>	<i>explicit</i>	<i>new</i>	<i>static_cast</i>	<i>virtual</i>
<i>char</i>	<i>export</i>	<i>noexcept</i>	<i>struct</i>	<i>void</i>
<i>class</i>	<i>extern</i>	<i>nullptr</i>	<i>switch</i>	<i>volatile</i>
<i>const</i>	<i>false</i>	<i>operator</i>	<i>template</i>	<i>wchar_t</i>
<i>const_cast</i>	<i>float</i>	<i>private</i>	<i>this</i>	<i>while</i>
<i>constexpr</i>	<i>for</i>	<i>protected</i>	<i>thread_local</i>	
<i>continue</i>	<i>friend</i>	<i>public</i>	<i>throw</i>	
<i>decltype</i>	<i>goto</i>	<i>register</i>	<i>true</i>	

These alternative representations for operators and punctuation are reserved and also should not be used otherwise.

<i>and</i> <code>&&</code>	<i>and_eq</i> <code>&=</code>	<i>bitand</i> <code>&</code>	<i>bitor</i> <code> </code>	<i>compl</i> <code>~</code>	<i>not</i> <code>!</code>
<i>not_eq</i> <code>!=</code>	<i>or</i> <code> </code>	<i>or_eq</i> <code> =</code>	<i>xor</i> <code>^</code>	<i>xor_eq</i> <code>^=</code>	

Precedence of Operators

All the operators in a given box have the same precedence. Operators in higher boxes have higher precedence than operators in lower boxes. Unary operators and the assignment operator are executed right to left when operators have the same precedence. For example, $x = y = z$ means $x = (y = z)$. Other operators that have the same precedences are executed left to right. For example, $x + y + z$ means $(x + y) + z$.

:: scope resolution operator
. dot operator -> member selection [] array indexing () function call ++ postfix increment operator (placed after the variable) -- postfix decrement operator (placed after the variable)
++ prefix increment operator (placed before the variable) -- prefix decrement operator (placed before the variable) ! not - unary minus + unary plus * dereference & address of new delete delete[] sizeof
* multiplication / division % remainder (modulo)
+ addition - subtraction
<< insertion operator (output) >> extraction operator (input)
< less than <= less than or equal > greater than >= greater than or equal
== equal != not equal
&& and
or
= assignment += add and assign -= subtract and assign *= multiply and assign /= divide and assign %= modulo and assign

*Highest precedence
(done first)*



*Lowest precedence
(done last)*

The ASCII Character Set

Only the printable characters are shown. Character number 32 is the blank.

32		56	8	80	P	104	h
33	!	57	9	81	Q	105	i
34	"	58	:	82	R	106	j
35	#	59	;	83	S	107	k
36	\$	60	<	84	T	108	l
37	%	61	=	85	U	109	m
38	&	62	>	86	V	110	n
39	'	63	?	87	W	111	o
40	(64	@	88	X	112	p
41)	65	A	89	Y	113	q
42	*	66	B	90	Z	114	r
43	+	67	C	91	[115	s
44	,	68	D	92	\	116	t
45	-	69	E	93]	117	u
46	.	70	F	94	^	118	v
47	/	71	G	95	_	119	w
48	0	72	H	96	'	120	x
49	1	73	I	97	a	121	y
50	2	74	J	98	b	122	z
51	3	75	K	99	c	123	{
52	4	76	L	100	d	124	
53	5	77	M	101	e	125	}
54	6	78	N	102	f	126	~
55	7	79	O	103	g		

Some Library Functions

The following lists are organized according to what the function is used for, rather than what library it is in. The function declaration gives the number and types of arguments as well as the type of the value returned. In most cases, the function declarations give only the type of the parameter and do not give a parameter name. (See the section “Alternate Form for Function Declarations” in Chapter 4 for an explanation of this kind of function declaration.)

Arithmetic Functions

Function Declaration	Description	Header File
<code>int abs(int);</code>	Absolute value	<code>cstdlib</code>
<code>long labs(long);</code>	Absolute value	<code>cstdlib</code>
<code>double fabs(double);</code>	Absolute value	<code>cmath</code>
<code>double sqrt(double);</code>	Square root	<code>cmath</code>
<code>double pow(double, double);</code>	Returns the first argument raised to the power of the second argument.	<code>cmath</code>
<code>double exp(double);</code>	Returns e (base of the natural logarithm) to the power of its argument.	<code>cmath</code>
<code>double log(double);</code>	Natural logarithm (ln)	<code>cmath</code>
<code>double log10(double);</code>	Base 10 logarithm	<code>cmath</code>
<code>double ceil(double);</code>	Returns the smallest integer that is greater than or equal to its argument.	<code>cmath</code>
<code>double floor(double);</code>	Returns the largest integer that is less than or equal to its argument.	<code>cmath</code>

Input and Output Member Functions

Form of a Function Call	Description	Header File
<code>Stream_Var.open (External_File_Name);</code>	Connects the file with the <i>External_File_Name</i> to the stream named by the <i>Stream_Var</i> . The <i>External_File_Name</i> is a string value.	<code>fstream</code>
<code>Stream_Var.fail();</code>	Returns <i>true</i> if the previous operation (such as <code>open</code>) on the stream <i>Stream_Var</i> has failed.	<code>fstream</code> or <code>iostream</code>
<code>Stream_Var.close();</code>	Disconnects the stream <i>Stream_Var</i> from the file it is connected to.	<code>fstream</code>
<code>Stream_Var.bad();</code>	Returns <i>true</i> if the stream <i>Stream_Var</i> is corrupted.	<code>fstream</code> or <code>iostream</code>
<code>Stream_Var.eof();</code>	Returns <i>true</i> if the program has attempted to read beyond the last character in the file connected to the input stream <i>Stream_Var</i> . Otherwise, it returns <i>false</i> .	<code>fstream</code> or <code>iostream</code>
<code>Stream_Var.get (Char_Variable);</code>	Reads one character from the input stream <i>Stream_Var</i> and sets the <i>Char_Variable</i> equal to this character. Does <i>not</i> skip over whitespace.	<code>fstream</code> or <code>iostream</code>
<code>Stream_Var.getline (String_Var, Max_Characters +1);</code>	One line of input from the stream <i>Stream_Var</i> is read, and the resulting string is placed in <i>String_Var</i> . If the line is more than <i>Max_Characters</i> long, only the first <i>Max_Characters</i> are read. The declared size of the <i>String_Var</i> should be <i>Max_Characters</i> +1 or larger.	<code>fstream</code> or <code>iostream</code>
<code>Stream_Var.peek();</code>	Reads one character from the input stream <i>Stream_Var</i> and returns that character. But the character read is <i>not</i> removed from the input stream; the next read will read the same character.	<code>fstream</code> or <code>iostream</code>

Input and Output Member Functions (*continued*)

Form of a Function Call	Description	Header File
<code>Stream_Var.put (Char_Exp);</code>	Writes the value of the <i>Char_Exp</i> to the output stream <i>Stream_Var</i> .	<code>fstream</code> or <code>iostream</code>
<code>Stream_Var.putback (Char_Exp);</code>	Places the value of <i>Char_Exp</i> in the input stream <i>Stream_Var</i> so that that value is the next input value read from the stream. The file connected to the stream is not changed.	<code>fstream</code> or <code>iostream</code>
<code>Stream_Var.precision (Int_Exp);</code>	Specifies the number of digits output after the decimal point for floating-point values sent to the output stream <i>Stream_Var</i> .	<code>fstream</code> or <code>iostream</code>
<code>Stream_Var.width (Int_Exp);</code>	Sets the field width for the next value output to the stream <i>Stream_Var</i> .	<code>fstream</code> or <code>iostream</code>
<code>Stream_Var.setf(Flag);</code>	Sets flags for formatting output to the stream <i>Stream_Var</i> . See Display 6.5 for the list of possible flags.	<code>fstream</code> or <code>iostream</code>
<code>Stream_Var.unsetf(Flag);</code>	Unsets flags for formatting output to the stream <i>Stream_Var</i> . See Display 6.5 for the list of possible flags.	<code>fstream</code> or <code>iostream</code>

Character Functions

For all of these the actual type of the argument is *int*, but for most purposes you can think of the argument type as *char*. If the value returned is a value of type *int*, you must perform an explicit or implicit typecast to obtain a *char*.

Function Declaration	Description	Header File
<i>bool</i> isalnum(<i>char</i>);	Returns <i>true</i> if its argument satisfies either isalpha or isdigit. Otherwise, returns <i>false</i> .	cctype
<i>bool</i> isalpha(<i>char</i>);	Returns <i>true</i> if its argument is an upper- or lowercase letter. It may also return <i>true</i> for other arguments. The details are implementation dependent. Otherwise, returns <i>false</i> .	cctype
<i>bool</i> isdigit(<i>char</i>);	Returns <i>true</i> if its argument is a digit. Otherwise, returns <i>false</i> .	cctype
<i>bool</i> ispunct(<i>char</i>);	Returns <i>true</i> if its argument is a printable character that does not satisfy isalnum and is not whitespace. (These characters are considered punctuation characters.) Otherwise, returns <i>false</i> .	cctype
<i>bool</i> isspace(<i>char</i>);	Returns <i>true</i> if its argument is a whitespace character (such as blank, tab, or new line). Otherwise, returns <i>false</i> .	cctype
<i>bool</i> iscntrl(<i>char</i>);	Returns <i>true</i> if its argument is a control character. Otherwise, returns <i>false</i> .	cctype
<i>bool</i> islower(<i>char</i>);	Returns <i>true</i> if its argument is a lowercase letter. Otherwise, returns <i>false</i> .	cctype
<i>bool</i> isupper(<i>char</i>);	Returns <i>true</i> if its argument is an uppercase letter. Otherwise, returns <i>false</i> .	cctype
<i>int</i> tolower(<i>char</i>);	Returns the lowercase version of its argument. If there is no lowercase version, returns its argument unchanged.	cctype
<i>int</i> toupper(<i>char</i>);	Returns the uppercase version of its argument. If there is no uppercase version, returns its argument unchanged.	cctype

String Functions

Function Declaration	Description	Header File
<code>int atoi(const chara[]);</code>	Converts a string of characters to an integer.	<code>cstdlib</code>
<code>long atol(const chara[]);</code>	Converts a string of characters to a <i>long</i> integer.	<code>cstdlib</code>
<code>double atof(const char a[]);</code>	Converts a string of characters to a <i>double</i> .	<code>cstdlib</code> ¹
<code>strcat(String_Variable, String_Expression);</code>	Appends the value of the <i>String_Expression</i> to the end of the string in the <i>String_Variable</i> .	<code>cstring</code>
<code>strcmp(String_Exp1, String_Exp2)</code>	Returns <i>true</i> if the values of the two string expressions are different; otherwise, returns <i>false</i> . ²	<code>cstring</code>
<code>strcpy(String_Variable, String_Expression);</code>	Changes the value of the <i>String_Variable</i> to the value of the <i>String_Expression</i> .	<code>cstring</code>
<code>strlen(String_Expression)</code>	Returns the length of the <i>String_Expression</i> .	<code>cstring</code>
<code>strncat(String_Variable, String_Expression, Limit);</code>	Same as <code>strcat</code> except that at most <i>Limit</i> characters are appended.	<code>cstring</code>
<code>strncmp(String_Exp1, String_Exp2, Limit)</code>	Same as <code>strcmp</code> except that at most <i>Limit</i> characters are compared.	<code>cstring</code>
<code>strncpy(String_Variable, String_Expression, Limit);</code>	Same as <code>strcpy</code> except that at most <i>Limit</i> characters are copied.	<code>cstring</code>
<code>strstr(String_Expression, Pattern)</code>	Returns a pointer to the first occurrence of the string <i>Pattern</i> in <i>String_Expression</i> . Returns the NULL pointer if the <i>Pattern</i> is not found.	<code>cstring</code>
<code>strchr(String_Expression, Character)</code>	Returns a pointer to the first occurrence of the <i>Character</i> in <i>String_Expression</i> . Returns the NULL pointer if <i>Character</i> is not found.	<code>cstring</code>
<code>strrchr(String_Expression, Character)</code>	Returns a pointer to the last occurrence of the <i>Character</i> in <i>String_Expression</i> . Returns the NULL pointer if <i>Character</i> is not found.	<code>cstring</code>

¹ Some implementations place it in `cmath`.

² Returns an integer that is less than zero, zero, or greater than zero according to whether *String_Exp1* is less than, equal to, or greater than *String_Exp2*, respectively. The ordering is lexicographic ordering.

Random Number Generator

Function Declaration	Description	Header File
<code>int random(int);</code>	The call <code>random(n)</code> returns a pseudorandom integer greater than or equal to 0 and less than or equal to <code>n-1</code> . (Not available in all implementations. If not available, then you must use <code>rand</code> .)	<code>cstdlib</code>
<code>int rand();</code>	The call <code>rand()</code> returns a pseudorandom integer greater than or equal to 0 and less than or equal to <code>RAND_MAX</code> . <code>RAND_MAX</code> is a predefined integer constant that is defined in <code>cstdlib</code> . The value of <code>RAND_MAX</code> is implementation dependent but will be at least 32767.	<code>cstdlib</code>
<code>void srand(unsigned int);</code> <code>void srandom(unsigned int);</code> (The type <code>unsigned int</code> is an integer type that only allows nonnegative values. You can think of the argument type as <code>int</code> with the restriction that it must be nonnegative.)	Reinitializes the random number generator. The argument is the seed. Calling <code>srand</code> multiple times with the same argument will cause <code>rand</code> or <code>random</code> (whichever you use) to produce the same sequence of pseudorandom numbers. If <code>rand</code> or <code>random</code> is called without any previous call to <code>srand</code> , the sequence of numbers produced is the same as if there had been a call to <code>srand</code> with an argument of 1.	<code>cstdlib</code>

Trigonometric Functions

These functions use radians, not degrees.

Function Declaration	Description	Header File
<code>double acos(double);</code>	Arc cosine	cmath
<code>double asin(double);</code>	Arc sine	cmath
<code>double atan(double);</code>	Arc tangent	cmath
<code>double cos(double);</code>	Cosine	cmath
<code>double cosh(double);</code>	Hyperbolic cosine	cmath
<code>double sin(double);</code>	Sine	cmath
<code>double sinh(double);</code>	Hyperbolic sine	cmath
<code>double tan(double);</code>	Tangent	cmath
<code>double tanh(double);</code>	Hyperbolic tangent	cmath

Inline Functions

When a member function definition is short, you can give the function definition within the definition of the class. You simply replace the member function declaration with the member function definition; however, since the definition is within the class definition, you do not include the class name and scope resolution operator. For example, the class `Pair` defined below has inline function definitions for its two constructors and for the member function `get_first`:

```
class Pair
{
public:
    Pair( ) {}
    Pair(char first_value, char second_value)
        : first(first_value), second(second_value) {}
    char get_first()
    {
        return first;
    }
    ...
private:
    char first;
    char second;
};
```

Note that there is no semicolon needed after the closing brace in an inline function definition, though it is not incorrect to have a semicolon there.

Inline function definitions are treated differently by the compiler and so they usually run more efficiently, although they consume more storage. With an inline function, each function call in your program is replaced by a compiled version of the function definition, so calls to inline functions do not have the overhead of a normal function call.

Overloading the Array Index Square Brackets

You can overload the square brackets, [], for a class so that they can be used with objects of the class. If you want to use [] in an expression on the left-hand side of an assignment operator, then the operator must be defined to return a reference, which is indicated by adding & to the returned type. (This has some similarity to what we discussed for overloading the I/O operators << and >>.) When overloading [], the operator [] *must* be a member function; the overloaded [] *cannot* be a friend operator. (In this regard, [] is overloaded in a way similar to the way in which the assignment operator = is overloaded; overloading = is discussed in the section of Chapter 11 entitled “Overloading the Assignment Operator.”)

For example, the following defines a class called `Pair` whose objects behave like arrays of characters with the two indexes 1 and 2 (not 0 and 1):

```
class Pair
{
public:
    Pair();
    Pair(char first_value, char second_value);
    char& operator[](int index);
private:
    char first;
    char second;
};
```

The definition of the member function [] can be as follows:

```
char& Pair::operator[](int index)
{
    if (index == 1)
        return first;
    else if (index == 2)
        return second;
    else
    {
        cout << "Illegal index value.\n";
        exit(1);
    }
}
```

Objects are declared and used as follows:

```
Pair a;  
a[1] = 'A';  
a[2] = 'B';  
cout << a[1] << a[2] << endl;
```

Note that in `a[1]`, `a` is the calling object and `1` is the argument to the member function `[]`.

The `this` Pointer

When defining member functions for a class, you sometimes want to refer to the calling object. The `this` pointer is a predefined pointer that points to the calling object. For example, consider a class like the following:

```
class Sample
{
public:
    ...
    void show_stuff();
    ...
private:
    int stuff;
    ...
};
```

The following two ways of defining the member function `show_stuff` are equivalent:

```
void Sample::show_stuff()
{
    cout << stuff;
}
//Not good style, but this illustrates the this pointer:
void Sample::show_stuff()
{
    cout << (this->stuff);
}
```

Notice that `this` is not the name of the calling object, but is the name of a pointer that points to the calling object. The `this` pointer cannot have its value changed; it always points to the calling object.

As the comment before the previous sample use of `this` indicates, you normally have no need for the pointer `this`. However, in a few situations it is handy.

One place where the `this` pointer is commonly used is in overloading the assignment operator `=`. For example, consider the following class:

Overloading
the assignment
operator

```

class StringClass
{
public:
    ...
    StringClass& operator =(const StringClass& right_side);
    ...
private:
    char *a;//Dynamic array for a string value ended with '\0.'
};

```

The following definition of the overloaded assignment operator can be used in chains of assignments like

```
s1 = s2 = s3;
```

This chain of assignments means

```
s1 = (s2 = s3);
```

The definition of the overloaded assignment operator uses the *this* pointer to return the object on the left side of the = sign (which is the calling object):

```

//This version does not work in all cases. Also see the next version.
StringClass& StringClass::operator =(const StringClass& right_side)
{
    delete [] a;
    a = new char[strlen(right_side.a) + 1];
    strcpy(a, right_side.a);
    return *this;
}

```

The definition above does have a problem in one case: If the same object occurs on both sides of the assignment operator (like *s=s*), then the array member will be deleted. To avoid this problem, you can use the *this* pointer to test this special case as follows:

```

//Final version with bug fixed:
StringClass& StringClass::operator =(
const StringClass& right_side)
{
    if (this == &right_side)
    {
        return *this;
    }
    else
    {
        delete [] a;
        a = new char [strlen(right_side.a) + 1];
        strcpy(a, right_side.a);
        return *this;
    }
}

```

In the section of Chapter 11 entitled “Overloading the Assignment Operator,” we overloaded the assignment operator for a string class called `StringVar`. In that section, we did not need the *this* pointer because we had a member variable called `max_length` that we could use to test whether or not the same object was used on both sides of the assignment operator `=`. With the class `StringClass` discussed above, we have no such alternative because there is only one member variable. In this case, we have essentially no alternative but to use the *this* pointer.

Overloading Operators as Member Operators

8

In this book we have normally overloaded operators by treating them as friends of the class. For example, in Display 11.5 of Chapter 11 we overloaded the + operator as a friend. We did this by labeling the operator a friend inside the class definition, as follows:

```
//Class for amounts of money in U.S. currency.  
class Money  
{  
public:  
    friend Money operator +(const Money& amount1,  
                            const Money& amount2);  
    . . .
```

We then defined the overloaded operator + outside the class definition (as shown in Display 11.5).

It is also possible to overload the operator + (and other operators) as **member operators**. To overload the + operator as a member operator, the class definition would instead begin as follows:

```
//Class for amounts of money in U.S. currency.  
class Money  
{  
public:  
    Money operator +(const Money& amount2);
```

Note that when a binary operator is overloaded as a member operator, there is only one (not two) parameters. The calling object serves as the first parameter. For example, consider the following code:

```
Money cost(1, 50), tax(0, 15), total;  
total = cost + tax;
```

When + is overloaded as a member operator, then in the expression `cost + tax`, the variable `cost` is the calling object and `tax` is the one argument to +.

The definition of the member operator + would be as follows:

```
Money Money::operator +(const Money& amount2)  
{  
    Money temp;
```

```
    temp.all_cents = all_cents + amount2.all_cents;  
    return temp;  
}
```

Notice the following line from this member operator definition:

```
temp.all_cents = all_cents + amount2.all_cents;
```

The first argument to `+` is an unqualified `all_cents`, and so it is the member variable `all_cents` of the calling object.

Overloading an operator as a member variable can seem strange at first, but it is easy to get used to the new details. Many experts advocate always overloading operators as member operators rather than as friends. That is more in the spirit of object-oriented programming. However, there is a big disadvantage to overloading a binary operator as a member operator. When you overload a binary operator as a member operator, the two arguments are no longer symmetric. One is a calling object and only the second “argument” is a true argument. This is unaesthetic, but it also has a very practical shortcoming. Any automatic type conversion will only apply to the second argument. So, for example, the following would be legal:

```
Money base_amount(100, 60), full_amount;  
full_amount = base_amount + 25;
```

This is because `Money` has a constructor with one argument of type `long`, and so the value `25` will be considered a `long` value that is automatically converted to a value of type `Money`.

However, if you overload `+` as a member operator, then you cannot reverse the two arguments to `+`. The following is illegal:

```
full_amount = 25 + base_amount;
```

This is because `25` cannot be a calling object. Conversion of `long` values to type `Money` works for arguments but not for calling objects.

On the other hand, if you overload `+` as a friend, then the following is perfectly legal:

```
full_amount = 25 + base_amount;
```

Index

SYMBOLS

- +, addition operator, 69–72
- \a, alert escape sequence, 53–54
- &, ampersand symbol, 260–261, 263, 268, 270–271, 511, 519–520
- address-of operator, 511
- call-by-reference parameters, 260–261, 263, 268, 270–271, 519–520
- memory locations and, pointers, 511, 519–520
- >, arrow operator, 742, 744
- =, assignment operator, 69, 74, 81–82, 493, 511–512, 514, 569, 757–758, 860–861
- arithmetic operators and, 69, 74
- dynamic data structures and, 757–758
- inheritance and, 860–861
- objects used with, 569
- overloading, 680–682
- pointers and, 511–512, 514, 757–758
- variables and, 69, 511–512
- vectors, 493
- *, asterisk symbol, 22, 509–512, 961, 964–965
- dereferencing operator, 510–511, 961, 964–965
- multiplication operator, 22, 70
- pointer variable declaration, 509–512
- \, backslash, 23
- \, backslash escape sequence, 53
- &&, Boolean and operator, 78–79, 112–116
- !, Boolean not operator, 79, 113, 118
- ||, Boolean or operator, 78, 80, 112–116
- { }, braces, 24–25, 82, 84–86, 121–123, 137–138, 543, 547
- C++ programming layout, 24–25
- conditional statements and, 82
- local variable declaration, 137–138
- loop body execution, 84–86
- nested statements and, 121–123, 137–138
- structure member names, 543, 547
- :, colon symbol, 557–558, 600–601
- derived class separation, 600–601
- inheritance and, 600–601
- scope resolution operator, 557–558
- ,, comma for separation in declarations, 44, 431
- //, comment symbols, 93–94
- ==, comparison equal to operator, 78, 81–82, 456–457, 487
- >, comparison greater than operator, 78
- >=, comparison greater than or equal to operator, 78, 80
- <, comparison less than operator, 78
- <=, comparison less than or equal to operator, 78
- !=, comparison not equal to operator, 78–79
- , decrement operators, 87–91, 143–144, 960–961, 967–969
- <> >>, direction arrows, 21
- #, directive notation, 25
- /, division operator, 70–72
- ., dot (calling) operator, 313, 545, 550
- \", double quote escape sequence, 53
- " ", double quotes for string characters, 64–65
- =, equal sign, 22, 456–457
- >>, extraction operator, 309, 316–318, 464, 650–658
- n!, factorial function, 230–231
- ++, increment operators, 87–91, 141–144, 960–961, 967–969, 971
- <<, insertion operator, 310, 316–318, 329, 464, 650–658
- \n, new line instruction, 23, 338–360, 345–346
- \n, new-line instruction, 53, 58
- \0, null character, 453–454, 456
- (), parentheses, 71, 78–79, 84–86, 130, 184, 191, 197
- arguments, 184

- arithmetic order, 71
 - Boolean expressions, 78–79, 84–86
 - controlling expressions, 130
 - predefined functions and, 184, 191, 197
 - return statements, 197
 - type casting and, 191
 - < >, predefined function header files, 184–186
 - \\, real backslash escape sequence, 53
 - %, remainder operator, 70–71
 - ;, semicolons, 24, 44, 131, 146, 149–150, 547
 - end of declarations, 24, 44, 131
 - for statements, 146, 149–150
 - structure definitions, 547
 - ' ', single quotes for constant characters, 65
 - [], square brackets, 378–379, 392–393, 427, 431, 489, 492
 - arrays using, 378–379, 392–393
 - multidimensional arrays and, 427, 431
 - variable declaration and, 378–379, 489
 - vectors using, 489, 492
 - +, string concatenation, 66–67.
 - , subtraction operator, 70
 - \t, tab escape sequence, 53
 - _, underscore symbol for identifiers, 70, 475–477
 - <cstring> library, 458–459
 - <string> library, 472, 474
- A**
- abs function, 186–187
 - Absolute value functions, 186–187
 - Abstract data types (ADT), 588–597, 705–715
 - application file, 714
 - case study: *DigitalTime*—a Class Compiled Separately, 706–712
 - class types for, 588–597
 - compiling programs using, 705–715
 - implementation files, 592–597, 708–715
 - information hiding, 597
 - interface files, 592–593, 705–707
 - private member function changes, 593, 597, 705–716
 - programming, 588–597
 - reusable components of, 715
 - separate compilation using, 705–715
 - writing, rules for, 591–592
 - Accessor functions, 567–568, 626
 - Adapter container classes, 979–983
 - addition (+), 70
 - Addresses, 4–5, 32, 509–511, 528–529
 - address-of operator (&), 511
 - arithmetic performed on pointers, 528–529
 - memory location and, 4–5, 32
 - pointers, 509–511, 528–529
 - ADT, *see* Abstract data types (ADT)
 - Algorithms, 12–16, 30–32, 212–213, 278, 400–402, 792–793, 811–812, 926–938, 991–1004
 - abstraction, 926–938
 - array programs, 400–402
 - bubble sort, 421–423
 - design, 212–213, 278, 400–402, 792–793
 - development of, 12–14
 - generic, 991–1004
 - implementation phase, 15
 - logic errors, 30–31
 - object-oriented programming (OOP) for, 16–17
 - problem solutions using, 12–15
 - problem-solving phase, 15
 - procedural abstraction and, 212–213, 278
 - program design using, 15–16
 - programming use of, 12–16, 32
 - pseudocode, 213
 - recursion programs, 792–793, 811–812
 - templates for, 926–938, 991–1004
 - Ampersand symbol (&), 260–261, 263, 268, 270–271, 511, 519
 - Ancestor class, 844
 - And operator (&&), 78–79, 112–116
 - Appending to a file, 320–322
 - Application file, ADT, 714
 - Arguments, 183–184, 197–198, 200–201, 265–268, 332, 346–349, 389–398, 459–460, 548–549, 585–586, 747
 - array parameters for, 391–396
 - arrays and, 389–398, 459–460
 - C strings, 459–460
 - call-by-reference parameters, 265–268
 - call-by-value parameters, 197–198
 - character I/O, 346–349
 - const parameter modifier for, 394–397
 - constructors without, 585–586
 - default, 348–349
 - formal parameters and, 197–198, 200–201
 - function calls using, 183–184, 197–198, 265–268
 - function subtasks using, 265–268
 - functions in arrays, 389–398
 - incorrect order of, 200–201

- Arguments (*continued*)
 - indexed variables as, 389–391
 - linked lists as, 747
 - parentheses () and, 184
 - predefined functions, 183–184, 459–460
 - programmer-defined functions, 197–198, 200–201
 - streams as, 332, 346–347
 - structures as, 548–549
 - Arithmetic functions, 1019
 - Arithmetic operators, 69–74, 112–116, 528–529
 - addition (+), 70
 - assignment operator (=) and, 69, 74
 - Boolean operations compared to, 112–115
 - data types and, 69–72
 - division (/), 70–72
 - double* used with, 70
 - expressions and, 69–72
 - int* used with, 70–72
 - multiplication (*), 70
 - negative integers in, 71
 - Op* shorthand notation, 74
 - parentheses () for order of, 71
 - pointer addresses using, 528–529
 - remainder (%), division with, 70–71
 - subtraction (-), 70
 - variables and, 69–72
 - Array parameter, 391–396
 - Array variables, 521–523
 - Arrays, 377–450, 453–472, 521–527, 530–532, 660–682, 1027–1028
 - arguments to functions, 389–398
 - base type, 379
 - C strings, 453–472
 - case study: Production Graph, 398–409
 - class members, 664–667
 - classes and, 660–682, 942–943
 - const* modifier, 376–382, 394–397
 - constructor calls for, 661
 - declaring, 378–384, 426–427, 453–454
 - dynamic, 521–527, 530–532, 667–682
 - errors in, 383–384
 - for* loops used with, 380
 - functions and, 389–398
 - index (subscript), 379, 383–384, 1027–1028
 - indexed variables and, 379–386, 389–391, 426, 431
 - initializing, 386, 454–455
 - int* data types, 378–382
 - memory locations, 382–383, 393–394
 - multidimensional, 425–431, 530–532
 - overloading, 1027–1028
 - parameters, 391–397, 414, 426–427
 - partially filled, 411–413
 - programming with, 411–423
 - referencing, 378–384
 - searching, 414–416
 - size of, 379–382, 394, 411–414, 426–427
 - sorting, 417–423
 - square brackets [] used for, 378–379, 392–393, 427
 - strings as types of, 453–472
 - subtasks for functions of, 399–400
 - two-dimensional, 427, 531–532
 - variables in, 378–386, 389–391, 453–460
 - Arrow (->) operator, 742, 744
 - Ask-before-iterating looping technique, 157, 159
 - Assembly language, 8
 - assert macro, 290–291
 - Assignment operator (=), 69, 74, 81–82, 493, 511–512, 514, 569, 680–682, 757–758, 860–861
 - Assignment statements, 45–49, 511–512
 - pointers and, 511–512
 - variable values and, 45–49
 - Associative containers, 983–990
 - Asterisk symbol (*), 22, 70, 509–512
 - atof function, 467
 - atoi function, 467–468
 - atoll function, 467
 - Augusta, Ada, 12–13
 - auto
 - C++11, 63
 - using with containers, 990
 - variable declaration using, 964
 - Automatic variables, 518
- ## B
- Babbage, Charles, 12–13
 - Backslash \ use, 23
 - Base (stopping) cases, 798
 - Base class, 834, 836–837, 848–850, 858
 - Base type, 379
 - Bidirectional iterators, 966–969
 - Big-O notation, 994–995
 - Binary digits, 4
 - Binary tree, 761–762
 - Bits (binary digits), 4, 32
 - Black box analogy, 204–207.
 - See also* Procedural abstraction
 - Blocks, 135–137, 226–227
 - branching statements as, 137
 - functions and, 226–227
 - local variables and, 135–137, 226–227
 - nested, 137
 - scope, 137, 226–227
 - statement, 137
 - bool* values, 66, 116, 199
 - data type, 66

- int*, converting to, 116–118
- programmer-defined functions returning, 199
- Boolean expressions, 66, 77–79, 84–87, 112–119
- and (&&) operator used in, 78–79, 112–116
- arithmetic operations
 - compared to, 112–115
- branching mechanisms using, 77–79, 112–119
- complete evaluation, 116
- data values, 66
- evaluating, 112–116
- int* value conversion, 116–118
- looping mechanisms using, 84–87, 112–119
- not (!) operator, 79, 113, 118
- or (||) operator, 78, 80, 112–116
- parentheses () for, 78–79, 84–86
- precedence rules, 114–115
- short-circuit evaluation, 115
- subexpressions, 115
- true/false* values, 66, 116
- truth tables, 112–114
- Braces { }, 24–25, 82, 84–86, 121–123, 137–138, 543, 547
- Branching mechanisms, 75–82, 112–139, 203
 - and operator (&&) for, 78–79
 - blocks, 135–137
 - Boolean expressions, 77–79, 112–120
 - braces { } used for, 82, 121–123, 137–138
 - break* statements, 131–133
 - C++ flow of control using, 75–82
 - comparison operators for, 77–82
 - compound statements, 82
 - controlling expression, 130–132
 - flow of control using, 75–82, 112–139
 - if-else* statements, 75–82, 120–128
 - indenting, 120–121, 123–125
 - local variables, 135–137
 - menus, 133–134
 - multiway, 120–139
 - nested statements, 120–123, 137
 - or operator (||) for, 78, 80
 - programmer-defined function calls in, 203
 - string of inequalities from, 80–81
 - switch* statements, 128–135
- break* statements, 131–133, 153–154
- branching mechanisms, 131–133
- flow of control using, 131–133, 153–154
- loop mechanisms, 153–154
- looping mechanisms, 153–154
- nested loops using, 154
- switch* statements, 131–133
- Bubble sort, 421–423
- Bug, 29. *See also* Debugging
- Bytes, 4–5, 32
- C**
- C++ programming, 39–110
 - arithmetic operators, 69–74
 - assignment statements, 45–49
 - asterisk symbol (*), 22
 - backslash (\) use, 23
 - braces { }, 24–25, 82, 84–86
 - branching mechanisms, 75–82
 - cin* (input) statements, 21–23, 56–57
 - comments, 93–95
 - compilers and, 24–25
 - compiling, 26–28
 - compound statements, 82
 - constants, 95–97
 - cout* (output) statements, 21–23, 50–52
 - data types, 44–45, 60–74
 - debugging, 29–31
 - declaration of variables, 21–23, 44–45
 - direction arrows (<> >>) , 21
 - directives #, 25, 52–53
 - expressions, 69–74
 - flow of control, 74–92
 - increment and decrement operators, 87–91
 - indentation, 93
 - input, 21–23, 56–59
 - input/output (I/O), 50–59
 - instructions, 19–23
 - language, 18–19
 - line breaks, 24
 - loop mechanisms, 84–91, 98
 - main()* function, 25
 - names and, 49, 95–97
 - object code, 26–27
 - output, 21–23, 50–56
 - programmer role, 19
 - return* statement, 25–26
 - running, 26–28
 - spacing, 24, 26
 - statements, 21–26, 40–50, 82
 - user role, 19
 - variables, 21–23, 40–50, 60–69
- C++11 programming, 27, 63–64
 - auto, 63
 - constructor delegation in, 587–588
 - conversion between strings and numbers, 488
 - data values, 63–64
 - decltype*, 64
 - member initialization in, 587
 - nullptr* in, 745
 - range-based, 386–387

- C strings, 453–472, 484–488
 - <cstring> library, 458–459
 - arguments, 459–460
 - arrays, 453–472
 - declaration of, 453–454
 - equality operators = and ==
 - used for, 456–457
 - extraction (>>) operator used for, 464
 - functions, 457–460, 467–468
 - getline function, 465–466
 - initializing, 454–455
 - input/output (I/O), 464–466
 - insertion (<<) operator used for, 464
 - null (\0) character and, 453–454, 456
 - number conversions, 466–470
 - parameters, 460
 - predefined functions, 457–460, 467–468
 - robust input, 468, 470–471
 - strcat function, 459–460
 - strcmp function, 457–460
 - strcpy function, 457–460
 - string object conversion, 487–488
 - values, 456–458
 - variables, 453–460
- Call-by-reference parameters, 259–266, 519–520
 - ampersand symbol (&)
 - for, 260–261, 263, 268, 270–271, 519–520
 - arguments, 265–268
 - call-by-value combined with, 268–271
 - function calls, 259–260
 - memory locations and, 260–261
 - pointers, 519–520
- Call-by-value parameters, 197–198, 224–226, 268–271, 674–675
 - arguments for, 197–198
 - call-by-reference combined with, 268–271
- classes and, 674–675
 - dynamic arrays and, 674–675
 - local variables as, 224–226, 270–271
- Calls (invocations), 183–188, 196–198, 208–211, 259–260, 265–268, 583–584
 - absolute value functions, 186–187
 - arguments and, 183–184, 197–198, 265–268
 - call-by-reference parameters, 259–260
 - call-by-value parameters, 197–198
 - constructors, 583–584
 - functions, 183–188, 196–198, 208–211, 259–260, 265–268
 - header files (< >) and, 184–186
 - #include directives, 184–186
 - loop body as, 208
 - nested loops and, 208–211
 - predefined functions, 183–188
 - procedural abstraction and, 208–211
 - programmer-defined functions, 196–198
 - return statements and, 196–197
- capacity() function, 493–494
- catch block, 900–901, 901–902, 908–909
- catch-block parameter, 900–902
- Central processing unit (CPU), 3, 6–7
- char data type, 64–66
- Characters, 64–65, 68, 338–360, 1022
 - blank spaces and, 338–339
 - data values, 64–65
 - default arguments, 348–349
 - editing text files, 355–357
 - eof function for, 353–354
 - functions, 348–349, 1022
 - get function for, 338–341
 - input/output (I/O), 338–349
 - isspace function, 358–359
 - member functions, 338–354
 - new-line (\n), 338–360, 345–346
 - new_line() function for, 343–345, 347–348
 - predefined functions, 356, 358–360
 - put function for, 341–342
 - putback function for, 342–343
 - stream parameters and, 346–347
 - toupper and tolower functions for, 358–360
 - values returned, 358–360
 - whitespace, 68, 358
- Child class, 600, 834, 844
- Chips, computer processors and, 6
- cin (input) statements, 21–23, 56–57
- Classes, 17, 66–68, 312–315, 472–488, 541–617, 619–682, 762–765, 833–892, 904–905, 973–990
 - abstract data types (ADT), 588–597
 - adapter, 979–983
 - ancestor, 844
 - arrays and, 660–682
 - base, 834, 836–837, 848–850, 858
 - C++ programming and, 17
 - call-by-value parameters and, 674–675
 - child, 600, 834, 844
 - constructors for, 576–588, 661, 668–671
 - containers, 973–990
 - copy constructors for, 675–679

- defining, 600–603
- derived, 598–603, 834–836, 837–845, 854–856, 860–861
- destructors for, 671–673
- dot operator (.) for, 557–558
- dynamic arrays and, 667–682
- encapsulation, 556
- exceptions, 904–905
- file I/O and, 312–315
- friend functions, 620–642
- hierarchies, 599–600
- inheritance and, 598–603, 833–892
- linked lists of, 762–765
- member functions of, 312–314, 554–558, 570–574, 576–588
- member variables, 664–667
- object-oriented programming (OOP) and, 17
- objects and, 312–315, 554, 566, 569, 576–588
- overloading operators, 643–660
- parent, 600–601, 834, 844
- private members used in, 559–568
- public members used in, 559–568
- redefining functions, 853–856
- scope resolution operator (::) for, 557–558
- streams and, 312–315
- string, 66–68, 472–488
- stringvar, 668–671
- structures compared to, 542–550, 575
- templates for, 973–990
- close function, 310–311, 318
- Coding, 213–214, 278–280, 400–407, 793–794, 812–816
 - array programs, 400–407
 - procedural abstraction and, 213–214, 278–280
 - recursion programs, 793–794, 812–816
- Colon (:), 557–558, 600–601
- Comma (,) separation in declarations, 44
- Comments, C++ programming and, 93–95
- Compact discs (CDs), 6
- Comparison operators, 77–82, 482, 487
 - and operator (&&) for, 78–79
 - equal to (==), 78, 81–82
 - greater than (>), 78
 - greater than or equal to (>=), 78, 80
 - less than (<), 78
 - less than or equal to (<=), 78
 - not equal to (!=), 78–79
 - or operator (||) for, 78, 80
 - string class and, 482, 487
 - string of inequalities from, 80–81
- Compiler programs, 9–11, 24–32, 704–718
 - abstract data types (ADT) interface for, 705–715
 - C++ programming, 24–28, 32
 - compiling process, 26–28
 - error messages, 30–31
 - #ifndef directive, 25, 26, 716–718
 - #include directive, 25, 26, 716
 - language translation using, 9–11
 - line breaks, 24
 - linking code, 9–11
 - object code, 9–11, 26–27
 - separate compilation, 704–718
 - spacing, 24, 26
 - syntax error, 30
 - testing, 27–29
- Complete evaluation, 116
- Compound statements, 82
- Computer systems, 2–12
 - compilers, 9–11
 - hardware, 2–7
 - input/output devices, 3
 - languages for, 8–11
 - linkers, 9–11
 - mainframe, 2
 - memory, 3–6
 - network, 2
 - operating systems, 7
 - personal (PC), 2
 - processor (CPU), 3, 6–7
 - programs, 2, 7–11
 - software, 2, 7–8
- Concatenation (+), strings, 66–67
- const modifier, 96–97, 376–382, 394–397, 638–642
 - array declaration using, 376–382
 - array parameters, 394–397
 - C++ programming using, 96–97
 - friend functions and, 638–642
 - inconsistent use of, 397
- Constant array parameters, 395
- Constant iterators, 970–971
- Constant parameters, 638–642
- Constants, 60–62, 65, 95–97, 119–120, 221–223, 473, 636
 - data types, 60–62
 - declared, 96
 - enumerated types, 119–120
 - friend functions and, 636
 - functions and, 221–223
 - global named, 221–223
 - naming, 95–97
 - numbers, leading zeros in, 636
 - single quotes (') for characters, 65
 - string class conversion, 473

- Constructors, 473–474, 492, 576–588, 661, 668–671, 675–679, 845–848, 860–861
 - arrays and, 661, 668–671, 675–679
 - calling (invoking), 583–584, 661
 - classes and, 576–588, 668–671, 675–679
 - copy, 675–679, 860–861
 - default, 473–474, 584–585, 661
 - dynamic arrays, 668–671, 675–679
 - inheritance and, 845–848, 860–861
 - initialization of objects using, 576–583
 - member functions as, 576–588
 - no arguments and, 585–586
 - overloaded, 578
 - size of arrays and, 668–671
 - string class and, 473–474
 - vectors and, 492
 - Container modifying algorithms, 1001–1002
 - Containers, 973–990, 995–996
 - access running times, 995–996
 - adapter classes, 979–983
 - associative, 983–990
 - auto, using with, 990
 - deque, 976
 - doubly linked lists, 974
 - efficiency of, 990–991
 - initializing, 990
 - map class, 983–990
 - priority_queue class, 979–983
 - queue class, 979–983
 - ranged for, using with, 990
 - sequential, 974–979
 - set class, 983–990
 - singly linked lists, 974
 - stack class, 979–983
 - templates for, 973–990
 - type definitions in, 979
 - Controlling expression, 130–132
 - Copy constructors, 675–679, 860–861
 - Count–controlled loops, 158
 - cout (output) statements, 21–23, 50–52, 289–290
 - debugging with, 289–290
 - direction arrows (<> >>), 21
 - program output using, 21–23, 50–52
 - streams, as
 - variable declaration and, 21–23
- D**
- Dangling pointers, 517, 522–523
 - Data, computer programs and, 7–8
 - Data abstractions, templates for, 939–948
 - Data types, 44–45, 60–74, 95–97, 119–120, 942
 - arithmetic operators and, 69–74
 - bool*, 66
 - Boolean, 66
 - C++11, 63–64
 - char*, 64–66
 - character, 64–65
 - compatibility of, 68–69
 - constants as, 60–62, 65, 95–97, 119–120
 - double*, 44, 60–64
 - enumerated, 119–120
 - expressions and, 69–74
 - float*, 63
 - floating–point notation, 61–63
 - int*, 44, 60–62, 63, 70–72
 - integer, 60–62
 - long*, 62–63
 - names for declaration, 44–45
 - numeric, 44, 60–64
 - Op* shorthand notation, 74
 - short*, 63
 - string class and, 66–68
 - templates for, 942
 - variables as, 44–45, 60–74
 - Debugging, 29–31, 162–164, 281–287, 287–291
 - assert macro for, 290–291
 - bugs, 29
 - code, 290
 - common errors, 287
 - cout statement for, 289–290
 - error messages, 30–31
 - functions, 281–287, 287–291
 - localizing errors, 288–290
 - logic errors, 30–31
 - loops, 162–164
 - off-by-one error, 162
 - retesting changes, 164
 - run–time errors, 30
 - second opinions and, 287
 - syntax errors, 30
 - testing programs for, 29–31, 281–287
 - tracing variables, 162–163, 288
 - warning messages, 30
 - Decimal (.) notation, 55–56, 61
 - Declaration, 21–23, 44–45, 48–49, 193, 195–196, 199–201, 275–281, 308–309, 378–384, 426–427, 453–454, 489–490
 - arrays, 378–384, 426–427
 - cin* (input) statements for, 21–23
 - comma (,) for separation in, 44, 431
 - const* modifier and, 376–382
 - cout (output) statements for, 21–23
 - C–string variables, 453–454
 - double* variable type, 44

- functions, 193, 195–196, 199–201, 275–281
 - illegal ranges, 383–384
 - indexed variables, 379–384
 - initializing in, 48–49
 - int* variable type, 21, 44, 378–380
 - memory and, 382–383
 - multidimensional arrays, 426–427
 - postconditions, 275–281
 - preconditions, 275–281
 - programmer-defined functions, 193, 195–196, 199–200
 - semicolon (;) for end of, 44
 - square brackets [] used for, 378–379, 489
 - streams, 308–309
 - type names and, 44–45
 - variables, 21–23, 44–45, 48–49, 64, 378–382, 453–454, 489–490
 - vectors, 489–490
 - Declared size, 379
 - `decltype`, 64
 - Decrement operators (--), 87–91, 143–144, 967–969
 - Default arguments, 348–349
 - Default constructors, 473–474, 584–585, 661
 - `delete` operator, 517–518, 524–527, 530–531
 - Deque, 976
 - Dereferencing (*) operator, 510–511, 961, 964–965
 - Derived classes, 598–603, 834–836, 837–845, 854–856, 860–861, 913
 - assignment (=) operators used for, 860–861
 - colon (:) for separation of, 600–601
 - constructors used in, 845–848
 - copy constructors used in, 860–861
 - defining, 600–603
 - destructors used in, 861
 - exception specification in, 913
 - implementation of, 834–836
 - inheritance and, 598–603, 834–836, 837–845, 854–856, 860–861
 - redefining functions, 853–856
 - Descendants, 844
 - Destructors, 671–673, 861, 875–876
 - dynamic arrays, 671–673
 - inheritance and, 860–861
 - polymorphism and, 875–876
 - virtual, 875–876
 - Digital video discs (DVDs), 6
 - `digit_to_int` function implementation, 635–636
 - Direction arrows (<> >>), 21
 - Directives (#), 25, 52–53
 - Diskettes (floppy disks), 6
 - Division operator (/), 70–72
 - do-while* loop statements, 87–91, 139–140, 154
 - break* statement for, 154
 - execution of, 87, 139–140
 - infinite, 87–91
 - syntax of, 87–88, 139–140
 - Dot (.) operator, 313, 545, 550
 - double*, 44, 55–56, 60–64, 70
 - arithmetic operators and, 70
 - decimal (.) notation for, 61
 - exponent (e) notation for, 61
 - floating-point notation of, 61–62
 - numeric data type, 44, 60–64
 - output values from, 55–56
 - scientific notation of, 61–62
 - variable type, 44
 - Double quotes (" ") for string characters, 64–65
 - Double-precision numbers, 60–61
 - Doubly linked lists, 760–761, 974
 - Drivers, function testing using, 282–284
 - Dynamic arrays, 521–527, 530–532, 667–682, 740, 757–758
 - array variables and, 521–523
 - assignment operator (=) and, 757–758
 - call-by-value parameters and, 674–675
 - classes and, 667–682
 - constructors for, 668–671
 - copy constructors for, 675–679
 - creating and using, 522–527
 - `delete` operator, 524–527, 530–531
 - destructors for, 671–673
 - linked lists and, 740, 757–758
 - multidimensional, 530–532
 - new* operator, 524–527
 - pointer arithmetic and, 528–529
 - pointer variables and, 521–523, 527, 740, 757–758
 - size of, 668–671
 - square brackets [] used for, 524–527, 526–527
 - `stringvar` class, 668–671
 - variables, 521–523, 527, 740, 757–758
- ## E
- Echoing input, 58
 - Empty statements, 150
 - Encapsulation, 17
 - `#endif` directive, 716–717
 - `endl` instruction, 54–55
 - `eof` function, 353–354
 - `equal` function, 620–626
 - Equal to comparison operator (==), 78, 81–82, 456–457

- Errors, 29–31, 287–290, 316, 383–384, 431, 638–642, 874–875
- arrays and, 383–384, 431
- bugs, 29
- commas between index variables, 431
- common, 287
- compiler, 30–31, 875
- constant parameters for, 638–639
- debugging, 287–290
- file I/O, 316
- index variables out of range, 383
- localizing, 288–290
- logic, 30–31
- messages, 30–31, 316
- polymorphism and, 874–875
- run-time, 31
- syntax, 30
- testing for, 30–31
- tracing variables, 162–163, 288
- virtual member functions and, 874–875
- warning messages compared to, 30
- Escape sequences, 53–55
- Exceptions, 893–924
- catch*-block parameter, 900–902
 - catch* block used for, 900–901, 901–902, 908–909
 - class hierarchies, 917
 - classes defined for, 904–905
 - derived classes and, 913
 - functions, throwing in, 909–911
 - handler, 900
 - handling, 893–924
 - memory, testing for, 917–918
 - multiple, 904, 906–909
 - nested try-catch blocks, 916
 - overuse of, 916–917
 - programming techniques for, 914–918
 - rethrowing, 918
 - specification, 911–913
 - throw list, 911–913
 - throw* statement used for, 898–900, 909–911
 - throwing exceptions, 909–911, 914–916
 - trivial, 909
 - try* block used for, 898–899, 901
 - try-throw-catch* mechanism in, 898, 901–903
 - uncaught, 916
- Executable statements. *See* Statements
- Executing programs, 8
- exit* function, 315, 318
- Exit-on-flag loop termination, 159
- Exponent (e) notation, 61
- Expressions, 69–74. *See also* Arithmetic operators; Boolean expressions
- External file name, 310
- Extraction operator (>>), 309, 316–318, 464, 650–658
- ## F
- fabs* function, 187
- factorial* (n!) function, 230–231
- fail* function, 314
- Files, 6, 306–323, 332–337, 353–358, 588–597, 705–715
- abstract data types (ADT), 588–597, 705–715
 - appending, 320–322
 - application, 714
 - character I/O and, 353–358
- close* function used for, 310–311, 318
- computer memory and, 6
 - end of, 332–335, 353–354
 - eof* function used for, 353–354
- error messages, 316
- exit* function used for, 315, 318
- external name, 310
- extraction operator (>>) for, 309, 316–318
- fail* function used for, 314
- implementation, 592–597, 708–715
- include* directives used for, 309, 318, 329
- input/output (I/O), 306–323, 332–337
- insertion operator (<<) for, 316–318, 329
- interface, 592–593, 705–707, 713
- member functions, 312–314
- memory storage and, 6
- names and, 308–310, 318
- namespaces and, 335–336
- open* function used for, 309–310, 318
- opening successfully, 309–310, 315
- permanent storage, as, 307–308
- reading, 308
- separate compilation of, 705–715
- streams and, 306–338
- text editing, 355–357
- writing, 308–310
- First-in/first-out (FIFO) data structure, 771
- Fixed-point notation, 326
- Flags, 159, 325–327
- Flash drives, 6
- float data type, 63
- Floating-point notation, 61–63
- Flow of control, 74–92, 111–164
- Boolean expressions for, 77–79, 112–120
 - branching mechanisms, 75–82, 112–139

- C++ programming and, 74–92
- comparison operators for, 77–82
- compound statements, 82
- enumerated types, 119–120
- increment and decrement operators, 87–91, 141–144
- loop mechanisms, 84–91, 98, 112–120, 139–155
- for* statements, 144–150, 154, 380
- arrays using, 380
- empty (null) statements, 150
- multistatement body, 148–149
- numeric calculations using, 143–146
- semicolons (;) and, 146, 149–150
- variables and, 145–146
- Formal parameters. *See* Parameters
- Forward iterators, 969
- Freestore, 516–517
- friend functions, 620–642
 - accessor functions and, 626
 - const parameter modifier, 638–642
 - constant parameters, 638–639
 - `digit_to_int` implementation, 635–636
 - `equal`, 620–626
 - leading zeros in number constants, 636
 - Money class, example for, 628–635
 - nonmember functions, as, 624–628
 - private members, access to, 624
 - syntax, 627
- Function body, 196
- Function declaration, 193, 195–196, 199–201
- Function definition, 193–194, 196–197, 201–203, 791, 798, 937–938
- Function headers, 196, 200
- Functions, 181–250, 251–303, 312–314, 323–338, 338–349, 389–398, 414, 457–460, 467–468, 567–568, 620–642, 791–807, 850, 853–856, 864–876, 909–911, 1019–1026. *See also* Calls (invocations)
 - arguments and, 183–184, 197–198, 265–268, 389–394, 414
 - arithmetic, 1019
 - array size and, 414
 - arrays as arguments, 391–394, 414
 - arrays in, 389–398
 - C++ library, 1019–1025
 - C string, 457–460, 467–468
 - call-by-reference, 259–266
 - call-by-value parameters, 197–198, 268–271
 - calls (invocations), 183–188, 196–198, 208–211, 259–260, 265–268
 - case study: Production Graph, 398–409
 - character, 348–349, 1022
 - `const` parameter modifier, 394–397, 638–642
 - debugging, 281–287, 287–291
 - declaration, 193, 195–196, 199–201, 275–281
 - default arguments, 348–349
 - definition, 193–194, 196–197, 201–203, 791, 798
 - `digit_to_int` implementation, 635–636
 - driver programs for, 282–284
 - `equal`, 620–626
 - factorial ($n!$), 230–231
 - flags and, 325–327
 - formatting output using, 323–338
 - friend, 620–642
 - graph, 407
 - indexed variables as arguments, 389–391
 - inheritance and, 850, 853–856
 - inline, 1026
 - input/output (I/O), 323–349, 338–349, 1020–1021
 - local variables and, 218–229, 270–271
 - manipulators, 329
 - member, 312–314, 338–349
 - member functions accessor, 551–552
 - mutator, 567–568
 - names, 221–224, 232–238
 - nonmember, 624–628
 - not inherited, 850, 859–860
 - overloading names, 232–238
 - overriding, 869
 - parameters, 197–201, 207–208, 224–226, 259–266, 391–397
 - polymorphism and, 864–876
 - predefined, 183–192, 457–460, 467–468
 - procedural abstraction and, 204–217, 273–281
 - programmer-defined, 193–203
 - random number generator, 188–189, 1024
 - recursive, 791–807
 - redefining functions, 853–856
 - return* statements, 196–197, 202, 255–259
 - returning an array, 397–398
 - `scale`, 402–407
 - signature, 857
 - stream I/O, 323–338
 - string, 1023

- Functions (*continued*)
 stub, 284–286
 subtasks, 251–303, 399–400
 tasks, recursion for, 791–803
 testing, 214–217, 281–287
 throwing exceptions in,
 909–911
 top–down design for,
 182–183, 398–409
 trigonometric, 1025
 type casting, 190–192
 value returned, 181–250,
 804–807
 virtual, 864–876
 void, 252–259
- G**
- Generic algorithms, 991–1004
 big-O notation, 994–995
 container access running
 times, 995–996
 container modifying,
 1001–1002
 nonmodifying sequence,
 997–1001
 running times, 991–996
 set, 1003–1004
 sorting, 1004
 templates for, 991–1004
 get function, 338–341
 getline function, 465–466,
 475–476, 478–479
 Global named constants,
 221–224
 Global scope, 226–227
 Global variables, 223–224, 518
 graph function, 407
 Greater than comparison
 operator (>), 78
 Greater than or equal to com-
 parison operator (>=), 78, 80
- H**
- Handling exceptions, 894
 Hard disks, 6
 Hardware
 computer systems and, 2–7, 32
 input/output devices, 3
 main memory, 3–5
 processor (CPU), 3, 6–7
 secondary memory, 6
 Header files (< >), predefined
 functions, 184–186
 Hierarchy of structures, 549
 High-level languages, 8–9
- I**
- Identifiers, variables, 42–44
if-else statements, 75–82,
 120–128
 Boolean expressions for,
 77–79
 braces { } used with, 82,
 121–123
 branching mechanisms,
 75–82, 120–128
 comparison operators for,
 77–82
 compound statements and,
 82
 dangling *else* problem,
 121–123
 indenting, 120–121,
 123–125
 multiway branches, 123–128
 nested, 120–123
#ifndef directive, 716–718
ifstream, 308–309, 318
 Implementation files, ADT,
 592–597, 708–715,
 718–719
 Implementation phase, 15
#include directive, 21, 25–26,
 52–53, 184–186, 309, 318,
 716–718
 C++ programming and, 21,
 25–26
 directive notation (#) for, 25
 file I/O, 309, 318, 329
 header files and, 184–186
 #ifndef directive and,
 716–718
 manipulator functions
 and, 329
 output and, 52–53
 predefined functions and,
 186–187
 preprocessors for, 186
 separate compilation and,
 716–718
 Increment operators (++),
 87–91, 141–144, 960–961,
 967–969, 971
 Indentation, C++ programming
 and, 93
 Indenting branching
 statements, 120–121,
 123–125
 Index (subscript) of arrays, 379,
 383–384
 Indexed variables, 379–386,
 389–391, 426, 431
 arguments to functions, as,
 389–391
 arrays and, 379–386
 commas (,) between, 431
 declaration of, 379–384
 functions and, 389–391
 illegal range of, 383–384
 initializing, 386
 multidimensional arrays,
 426, 431
 square brackets [] used for,
 378–379, 431
 Infinite loop statements, 87–91,
 152
 Infinite recursion, 799
 Information hiding, 205,
 597. *See also* Procedural
 abstraction
 Inheritance, 17, 598–603,
 833–892
 ancestor class, 844
 assignment (=) operators
 used for, 860–861
 base class, 834, 836–837,
 848–850, 858
 child class, 600, 834, 844
 class hierarchy, 599–600
 colon (:) used for, 600–601
 constructors used in, 845–848

- copy constructors used in, 860–861
- derived classes and, 598–603, 834–836, 837–845, 854–856, 860–861
- descendants, 844
- destructors and, 860–861
- function signature, 857
- functions not inherited, 850, 859–860
- member functions, 845, 850–852, 853–856
- parent class, 600–601, 834, 844
- polymorphism and, 862–876
- private members and, 848–850
- protected qualifier, 850–852
- redefining functions, 853–856
- Initialization, 48–49, 145–146, 386, 454–455, 551, 576–583
 - arrays, 386, 454–455
 - C strings, 454–455
 - constructors for, 576–583
 - declaration and, 48–49
 - objects, 576–583
 - structures, 551
 - variables, 48–49, 145–146, 386, 454–455
- Inline functions, 1026
- Input, 3, 21–23, 50, 56–58, 157–160, 306–312, 343–349
 - character data, 343–349
 - `cin` statements for, 21–23, 56–57
 - computer hardware devices, 3
 - echoing, 58
 - extraction operator (`>>`) for, 309
 - `get` function, 338–341
 - loops, design for ending, 157–160
 - member functions for, 343–348
 - `new_line()`, 343–345, 347–348
 - new-line character (`\n`) and, 345–346
 - `put` function, 341–342
 - `putback` function, 342–343
 - reading files, 308–309
 - streams, 50, 306–312
- Input iterators, 972
- Input/output (I/O), 50–59, 305–376, 464–466, 475–477, 1020–1021
 - arguments (parameters) and, 332, 348–349
 - C++ programming and, 50–59
 - C strings, 464–466
 - character, 338–360
 - `cin` (input) statements, 56–57
 - `cout` (output) statements, 50–52
 - decimal points for formatting numbers, 55–56
 - designing, 58
 - `double` statements, 55–56
 - end of files (eof), 332–335, 353–354
 - escape sequences, 53–55
 - files, 306–323, 332–337
 - flags, 325–327
 - formatting, 323–338
 - functions, 323–349, 353–354, 1020–1021
 - `getline` function, 475–476
 - `#include` directive, 52–53
 - manipulators, 329
 - namespaces, 52–53, 335–336
 - `new_line` function, 343–344, 346–348
 - new-line instruction (`\n`), 54–55, 58, 340–341, 345–346
 - predefined character functions, 356–360
 - streams, 50, 305–376
 - string class for, 475–477
 - `using` directive, 52, 335–336
- Insertion operator (`<<`), 310, 316–318, 329, 464, 650–658
- `in_stream`, 307, 308–309, 312–314, 318
- `int`, 21, 44, 60–61, 63, 70–72, 116–118, 378–382, 489–491
 - arithmetic operators and, 70–72
 - array declaration using, 378–382
 - Boolean expressions and, 116–118
 - enumerated types, 119–120
 - numeric data type, 44, 60–61, 63
 - unsigned type, 490–491
 - value conversion, 116–118
 - variable declaration using, 21, 44, 378–382, 489–491
 - vector declaration using, 489–491
- Integers, 21, 60–62, 190–192
 - data values, 60–62
 - type casting by division, 190–192
 - variables, 21
- Interface files, ADT, 592–593, 705–707, 713, 723, 724
- `ios::fixed` flag, 325–327
- `ios::left` flag, 327
- `ios::right` flag, 327
- `ios::showpoint` flag, 325–327
- `ios::showpos` flag, 327
- `iostream` library, 25
- `isalpha` function, 359
- `isdigit` function, 359
- `islower` function, 359
- `isspace` function, 358–359
- `isupper` function, 359

- Iterators, 84–87, 157, 159, 755, 802–803, 817–818, 959–973
 - auto, variable declaration using, 964
 - bidirectional, 966–969
 - compiler problems, 964–965
 - constant, 970–971
 - decrement operators (`--`) for, 967–969
 - dereferencing (`*`) operator for, 964–965
 - forward, 969
 - increment operators (`++`) for, 960–961, 967–969, 971
 - input, 972
 - loop mechanisms and, 84–87, 157, 159
 - mutable, 970
 - operators for, 960–961
 - output, 973
 - pointers as, 755
 - random access, 966–969
 - recursion compared to, 802–803
 - recursive program version, 817–818
 - reverse, 971–972
 - templates for, 959–973
 - types of, 966–971
 - using directives for, 959–960
 - vectors and, 961–965
- L**
- Languages, 8–11, 18–19
 - assembly, 8
 - C++ programming, 18–19
 - compilers for translation of, 9–11
 - computer programs and, 8–9
 - high-level, 8–9
 - linker programs for, 9–11
 - low-level, 8
 - machine, 8–9
 - program translation of, 8–11
- Last-in/first-out (LIFO) data structure, 766, 801–802
- Late (dynamic) binding, 863–869
- Leaf nodes, 762
- Length function, 480–481
- Less than comparison operator (`<`), 78
- Less than or equal to comparison operator (`<=`), 78
- Lexicographic order, 482
- Line breaks, C++ programming, 24, 26, 202
- Linear running time, 995
- Linked lists, 739–787, 974. *See also* Containers
 - arguments, as, 747
 - assignment (`=`) operators used with, 757–758
 - classes and, 762–765
 - data structures, as, 739–742
 - doubly, 760–761, 974
 - dynamic data structures in, 740, 757–758
 - head of, 746–750
 - inserting nodes in, 747–749, 755–757
 - losing nodes, 750–751
 - middle, 755–757
 - Node class, 762–765
 - nodes and, 740–742, 747–750, 755–757
 - pointers and, 739–787
 - queues and, 771–776
 - removing nodes from, 755–757
 - searching, 751–754
 - singly, 974
 - stacks, 765–766
- Linker programs, 9–11
- List headed-by-size loop termination, 157
- Local variables, 135–137, 218–229, 270–271
 - block scope, 135–137, 226–227
 - call-by-value parameters as, 224–226, 270–271
 - functions and, 218–229, 270–271
 - global constants and, 221–223
 - global scope, 226–227
 - global variables and, 223–224
 - inadvertent, 270–271
 - namespaces and, 227–229
 - scope of, 220–221, 226–227
- Logic errors, 30–31
- long data type, 62–63
- Loop mechanisms, 84–91, 98, 112–120, 139–155, 208–211
 - ask-before-iterating technique for, 157, 159
 - body, 84–86
 - Boolean expressions for, 84–87, 112–120
 - braces `{ }` for execution of, 84–86
 - break* statement for, 153–154
 - count-controlled, 158
 - debugging, 162–164
 - decrement operators (`--`), 87–91, 143–144
 - design choices, 150
 - do-while* statements, 87–91, 139–140, 154
 - ending input loops, 157–160
 - exit-on-flag termination, 159
 - flags, 159
 - flow of control using, 84–91, 98, 139–155
 - for* statements, 144–150, 154
 - increment operators (`++`), 87–91, 141–144
 - infinite, 87–91, 152
 - iteration, 84–87, 157, 159
 - list headed-by-size termination, 157
 - nested, 154, 160–161, 208–211
 - procedural abstraction and, 208–211

- products obtained using, 156–157
 - semicolons (;) and, 149–150
 - sentinel value, 158
 - sums obtained using, 155–156
 - uninitialized variables and, 152
 - while* statements, 84–91, 139–144, 153–154
 - zero times body execution, 87, 141
- Low-level language, 8
- M**
- Machine language, 8–9
- main()* function, 25
- Main memory, 3–5
- Mainframe computer systems, 2
- Manipulator functions, 329
- map* class, 983–990
- Member functions, 312–314, 338–354, 465–466, 480–483, 554–558, 570–574, 576–588, 818–821, 845, 848–856
- at, 480–481
 - accessor functions and, 567–568
- BankAccount class examples of, 570–574
- blank spaces and, 338–339
 - C strings, 465–466
 - character I/O and, 338–354
 - classes and, 312–314, 554–558, 570–574, 576–588
 - constructors, 576–588
 - definition of, 554–558
 - dot (.) operator used for, 313, 557–558
 - eof*, 353–354
 - exit*, 315
 - fail*, 314
 - get*, 338–341
 - getline*, 465–466
 - inheritance and, 845, 850–852
 - length, 480–481
 - mutator functions and, 567–568
 - new_line()*, 343–345, 347–348
 - new-line character (\n) and, 338–360, 345–346
 - objects and, 312–314
 - private*, 559–568, 848–850
 - protected*, 850–852
 - public*, 559–568
 - put*, 341–342
 - putback* function, 342–343
 - recursion and, 818–821
 - redefinition of, 853–856
 - scope resolution (::) operator used for, 557–558
 - stream I/O using, 312–314
 - string* class use of, 480–483
- Member names, structures, 543, 545–546
- Member values, structures, 543, 546
- Member variables, structures, 543, 545–547, 550
- Memory, 3–6, 40–42, 262–264, 382–383, 393–394, 516–518
- addresses, 4–5
 - array declaration and, 382–383
 - array parameters, 393–394
 - bits (binary digits), 4
 - bytes, 4–5
 - call-by-reference parameters and, 262–264
 - computer hardware components, 3–6
 - delete* operator for, 517–518
 - dynamic variables, 516–518
 - files, 6
 - freestore, 516–517
 - locations, 4–5, 41–42, 262–264
 - main, 3–5
 - management, 516–518
 - pointers for, 516–518
 - random access (RAM), 6
 - secondary (auxiliary), 3, 6–7
 - sequential access of, 6
 - storage as, 6
 - variables and, 40–42
- Menus, 133–134
- program choices using, 133–134
 - switch* statements for, 133–134
- Messages, errors, 30–31
- Monitor, computer output device, 3
- Multidimensional arrays, 425–431, 530–532
- commas (,) between indexes, 431
 - declarations for, 426–427
 - delete* [] operator and, 530–531
 - dynamic, 530–532
 - indexed variables and, 426, 431
 - parameters, 426–427
 - size of, 426–427
 - square brackets [] used for, 427, 431
 - two-dimensional example of, 427, 531–532
- Multiplication operator (*), 70
- Mutable iterators, 970
- Mutator functions, 567–568
- N**
- Names, 42–45, 49, 95–97, 207–208, 221–224, 232–238, 308–310, 318, 518–520
- constants, 95–97, 221–224
 - data types, 44–45
 - external file, 310
 - files, 308–310, 318
 - formal parameters, 207–208
 - functions and, 221–224, 232–238

- Names (*continued*)
 - global constants, 221–224
 - identifiers, 42–44
 - overloading functions, 232–238
 - pointer types, 518–520
 - procedural abstractions, 207–208
 - streams, 308–310, 318
 - typedef* function, 518–520
 - variables, 42–45, 49, 308
 - Namespaces, 52–53, 186, 227–229, 335–336, 719–732
 - classes and, 719–732
 - creating, 721–723
 - file I/O and, 335–336
 - global, 732
 - local variables and, 227–229
 - names for, 724–726, 731
 - output and, 52–53
 - qualifying names, 724–726
 - stream I/O and, 335–336
 - unnamed, 726–732
 - using directives for, 52–53, 186, 228–229, 335–336, 719–721, 724–726
 - Nesting, 120–123, 137, 154, 160–161, 208–211, 916
 - blocks, 137, 916
 - braces { } used for, 121–123, 137–138
 - break* statement in, 154
 - dangling *else* problem, 121–122
 - function calls and, 208
 - if-else* statements, 120–123
 - indenting statements, 120–121
 - loops, 154, 160–161, 208–211
 - multiway branches, 120–123, 137
 - procedural abstraction and, 208–211
 - scope of the block for, 137
 - statements, 120–123
 - try-catch* blocks, 916
 - Network computer systems, 2
 - new operator, 513–515, 524–527
 - dynamic arrays and, 524–527
 - pointers using, 513–515
 - new_line()* function, 343–345, 347–348
 - New-line instruction (*\n*), 23, 53, 54–55, 58, 338–360, 345–346
 - C++ programming and, 23
 - endl* used in place of, 54–55
 - input and, 345–346
 - member functions and, 338–360
 - output and, 54–55
 - Node class, 762–765
 - Nodes, 740–742, 747–750, 755–765
 - arrow (*->*) operator used with, 742, 744
 - binary trees and, 761–762
 - doubly linked lists, 760–761
 - head (front) of lists, inserting at, 747–749
 - inserting to lists, 747–749, 755–757
 - leaf, 762
 - linked lists and, 740–742, 747–750, 755–757
 - lost, 750–751
 - middle of lists, inserting and removing, 755–757
 - NULL constant used in, 742–744
 - pointer variables and, 741–742
 - removing from lists, 755–757
 - root, 762
 - searching linked lists using, 751–754
 - structures, 740–742
 - trees and, 761–762
 - Nonmember functions, 624–628
 - Nonmodifying sequence algorithms, 997–1001
 - Not equal to comparison operator (*!=*), 78–79
 - Not operator (*!*), 79, 113, 118
 - Null (*/0*) character, 453–454, 456
 - NULL constant, 742–744
 - Null statements, 150
 - nullptr*, in C++ 11 programming, 745
 - Number formatting, decimal points for, 55–56
 - Number-to-C string conversions, 466–470
 - Numeric calculations, 143–146, 155–157. *See also* Arithmetic operators
 - for* loop statements for, 143–146
 - loop design for, 155–157
 - products, 156–157
 - sums, 155–156
 - Numeric data values, 44, 60–64
- ## O
- Object code, 9–11, 26–27
 - Object-oriented programming (OOP), 16–17
 - classes, 17
 - encapsulation, 17
 - inheritance, 17
 - polymorphism, 17
 - program design using, 16–17
 - Objects, 312–315, 554, 566, 569, 576–588
 - assignment operator (*=*) used with, 569
 - classes and, 312–315, 554, 566
 - constructors for, 576–588
 - file I/O and, 312–315
 - initialization of, 576–583
 - member functions, 312, 576–588
 - public* and *private* specification, 566
 - streams and, 312–315

- Off-by-one error, 162
 - ofstream, 308–309, 318
 - Op operator, 74
 - open function, 309–310, 318
 - Operating systems, computer software for, 7
 - Operators, 69–74, 77–82, 87–91, 112–120, 309, 316–318, 464, 643–658, 1016–1017, 1032–1033
 - arithmetic, 69–74, 112–116
 - Boolean expressions, 77–79, 112–120
 - comparison, 77–82
 - decrement (--), 87–91
 - extraction (>>), 309, 316–318, 464, 650–658
 - increment (++), 87–91
 - insertion (<<), 310, 316–318, 329, 464, 650–658
 - overloading, 643–658, 1032–1033
 - precedence, 114–115, 1016–1017
 - unary, 87, 649–650
 - Or operator (||), 78, 80, 112–116
 - Output, 3, 21–23, 50–56, 58, 306–312, 323–338
 - computer hardware devices, 3
 - cout statements, 21–23, 50–52
 - decimal points for formatting numbers, 55–56
 - double statements, 55–56
 - escape sequences, 53–55
 - flags, 325–327
 - formatting functions, 323–338
 - insertion operator (<<) for, 310
 - manipulators, 329
 - new-line instruction (\n) for, 54–55, 58
 - streams, 50, 306–312, 323–338
 - writing files, 308–310
 - Output iterators, 973
 - out_stream, 307, 308–310, 312–314, 318, 325–326
 - Overloading, 232–238, 578, 643–658, 821, 1027–1028, 1032–1033
 - array index, 1027–1028
 - constructors, 578
 - extraction operator (>>), 650–658
 - function names, 232–238
 - insertion operator (<<), 650–658
 - operators, 643–658, 1032–1033
 - recursion compared to, 821
 - type conversion and, 238, 647–649
 - unary operators, 649–650
 - Overriding functions, 869
- P**
- Parameters, 197–201, 207–208, 224–226, 259–266, 346–349, 391–397, 414, 426–427, 460, 519–520, 638–642
 - arguments and, 197–198, 200–201, 265–268, 348–349, 460
 - array, 391–396
 - arrays and, 391–397, 414, 426–427, 460
 - C string, 460
 - call-by-reference, 259–266, 519–520
 - call-by-value, 197–198, 224–226
 - character I/O, 346–349
 - const modifier, 394–397, 638–642
 - constant, 638–639
 - constant array, 395
 - formal, 197–201, 207–208, 224–226, 414
 - friend functions and, 638–642
 - function arguments and, 414
 - function calls using, 197–198, 259–260
 - function declarations using, 199–201
 - function subtasks using, 259–266
 - local variables and, 224–226, 270–271
 - memory locations, 262–264, 393–394
 - mixed lists, 268–271
 - multidimensional arrays, 426–427
 - names, 207–208, 262
 - pointers, 519–520
 - procedural abstraction and, 207–208
 - programmer-defined functions, 197–201
 - size of arrays and, 394, 414
 - stream versatility, 346–347
- Parent class, 600–601, 834, 844
 - Parentheses (), 71, 78–79, 84–86, 130
 - Partially filled arrays, 411–413
 - Personal computer (PC), 2
 - Pointer variables, 521–523, 527
 - Pointers, 507–540, 674–675, 739–787, 1029–1031
 - addresses, 509–511
 - ampersand (&) symbol and, 511
 - arithmetic performed on, 528–529
 - arrow (->) operator used with, 742, 744
 - assignment operator (=) and, 511–512, 514, 757–758
 - asterisk (*) used for, 509–512
 - automatic variables, 518
 - call-by-reference parameters for, 519–520
 - call-by-value parameters, 674–675
 - dangling, 522–523

- Pointers (*continued*)
 - declaration of, 509–510
 - delete* operator, 517–518, 524–527, 530–531
 - dereferencing (*) operator for, 510–511
 - destructors and, 674–675
 - dynamic arrays and, 521–527, 530–532, 674–675
 - dynamic variables and, 513, 516–518, 740, 757–758
 - freestore, 516–517
 - iterators, used as, 755
 - linked lists and, 739–787
 - memory management for, 516–518
 - names, 518–520
 - new* operator, 513–515
 - nodes, 740–742, 747–750, 755–757
 - NULL constant assigned to, 742–744
 - queues and, 771–776
 - stacks and, 765–766
 - static variables, 518
 - structures containing, 741–742
 - this*, 1029–1031
 - trees and, 761–762
 - typedef* function, 518–520, 530
 - variables and, 508–520, 521–523, 527, 741–742
- Polymorphism, 17, 862–876
 - destructors made virtual for, 875–876
 - errors, 874–875
 - late (dynamic) binding, 863–869
 - overriding functions, 869
 - virtual functions and, 864–876
- pop function, 770
- Postconditions, 275–281
- pow function, 187–188
- Precedence rules, 114–115
- Preconditions, 275–281
- Predefined functions, 183–192, 356, 358–360, 457–460, 467–468
 - abs, 186–187
 - absolute values, 186–187
 - arguments, 183–184, 459–460
 - C string, 457–460, 467–468
 - calls (invocations), 183–188
 - character I/O data, 356, 358–360
 - fabs, 187
 - header files (< >) and, 184–186
 - #include directives, 184–186
 - isspace, 358–359
 - parentheses () and, 184, 191
 - pow, 187–188
 - random number generation using, 188–189
 - sqrt, 183–185, 187
 - srand, 187, 189
 - strcmp, 457–460
 - string-to-number conversions, 467–468
 - strncpy, 457–460
 - toupper and tolower, 358–360
 - type casting using, 190–193
 - using directive, 186
 - value returned, 183, 358–360
- priority_queue class, 979–983
- private members, 559–568, 593, 597, 624, 848–850
 - abstract data types (ADT) and, 593
 - accessor functions and, 567–568
 - classes using, 559–568
 - friend function access to, 624
 - inheritance and, 848–850
 - mutator functions and, 567–568
- public members and, 559–568
- Problem-solving phase, 15, 211–212, 277–278, 398–399
- Procedural abstraction, 204–217, 273–281
 - algorithm design for, 212–213, 278
 - black box analogy, 204–207
 - case study: Buying Pizza, 211–217
 - case study: Supermarket Pricing, 276–281
 - coding, 213–214, 278–280
 - functions calling functions, 273–275
 - functions returning values, 204–217
 - information hiding, 205–206
 - nested loops and, 208–211
 - parameter names and, 207–208
 - postconditions, 275–281
 - preconditions, 275–281
 - problem analysis, 211–212, 277–278
 - program testing, 214–217, 281
 - pseudocode for, 213, 217
 - subfunctions using, 273–281
- Processor (CPU), computer component, 3
- Programmer role, 19
- Programmer-defined functions, 193–203
 - arguments and, 197–198, 200–201
 - body, 196
 - bool* values, returning, 199
 - branching statements and, 203
 - call-by-value parameters, 197–198
 - calls, 196–198, 203
 - declaration, 193, 195–196, 199–201

- definitions, 193–194, 196–197, 201–203
 - headers, 196, 200
 - parameters, 197–201
 - return* statements, 196–197, 202
 - spacing and line breaks in, 202
 - syntax of, 201–202
 - value returned, 196, 199
 - Programming, 12–17, 588–597. *See also* C++ programming; C++11 programming
 - abstract data types (ADT), 588–597
 - algorithms, 12–16
 - implementation phase, 15
 - object-oriented (OOP), 16–17
 - problem-solving phase, 15
 - program design for, 15–17
 - software life cycle, 17
 - Programs, 2, 7–11, 13–16, 27–31
 - algorithms for, 13–16
 - compiler, 9–11, 27–30
 - computer software as, 2, 7–8
 - debugging, 29–31
 - design of, for programming, 15–17
 - executing, 8
 - high-level languages for, 8–9
 - implementation design phase, 15
 - language translation and, 8–11
 - linker, 9–11
 - logic errors, 30–31
 - object code
 - problem-solving design phase, 15
 - run-time errors, 30
 - running, 8–11
 - source code, 9
 - syntax error, 30
 - testing, 27–31
 - protected* members, 850–852
 - Pseudocode, 213, 217
 - public members, 559–568
 - accessor functions and, 567–568
 - classes using, 559–568
 - mutator functions and, 567–568
 - put function, 341–342
 - putback function, 342–343
- Q**
- Quadratic running time, 995
 - queue class, 979–983
 - Queues, 771–776
- R**
- Random access iterators, 966–969
 - Random access memory (RAM), 6
 - Random number generation, 188–189, 1024
 - Ranged for, using with containers, 990
 - Reading files, 308–309
 - Recursion, 789–831
 - base (stopping) cases, 798
 - case study: Binary Search, 810–818
 - case study: Vertical Numbers, 791–797
 - checking program for, 816–817
 - design techniques, 809–810
 - efficiency of, 817
 - ending, 797–798
 - function definition, 791
 - functions, 791–807
 - infinite, 799
 - iteration compared to, 802–803
 - iterative version of, 817–818
 - last-in/first-out (LIFO) data structure, 801–802
 - member functions as, 818–821
 - overloading compared to, 821
 - returning values, 804–807
 - stacks for, 800–802
 - tasks, functions for, 791–803
 - tracing recursive calls, 794–797
 - values, functions for, 804–807
 - void* functions and, 810
 - Remainder operator (%), 70–71
 - reserve function, 494
 - resize function, 494
 - Rethrowing exceptions, 918
 - return* statements, 21, 196–197, 202, 255–259
 - C++ programming and, 21
 - functions and, 196–197
 - parentheses () for, 197
 - programmer-defined functions, 196–197
 - void* functions using, 255–259
 - Returning values, *see* Value returned
 - Reverse iterators, 971–972
 - Robust input, C strings, 468, 470–471
 - Root node, 762
 - Running programs, 8–11, 26–28
 - Running times, 991–996
 - Run-time errors, 30
- S**
- scale function, 402–407
 - Scientific notation, 61–62
 - Scope, 137, 220–221, 226–227
 - block, 137, 226–227
 - global, 226–227
 - local, 220–221, 226–227
 - variables, 220–221, 226–227
 - Scope resolution operator (::), 557–558
 - Searching arrays, 414–416
 - Searching linked lists, 751–754
 - Secondary (auxiliary) memory, 3, 6–7
 - Selection sort, 417–418
 - Semicolons (;), 24, 146, 149–150, 547

- Sentinel value, loop design and, 158
- Sequential access, memory and, 6
- Sequential containers, 974–979
- set algorithms, 1003
- set class, 983–990
- setf function, 325–327
- setprecision manipulator, 329
- setw manipulator, 329
- short* data type, 63
- Short-circuit evaluation, 115
- Single quotes (') for constant characters, 65
- Single-precision numbers, 61
- Size (number of elements), 379–382, 394, 411–414, 426–427, 493–494, 668–671
 - array parameters, 394
 - arrays, 379–382, 394, 411–414, 426–427
 - capacity compared to, 492
 - const* modifier for, 376–382
 - constructors and, 668–671
 - declared, 379
 - dynamic arrays, 668–671
 - function arguments and, 414
 - multidimensional arrays, 426–427
 - partially filled arrays, 411–413
 - resize* function, 494
 - vectors, 493–494
- Software, 2, 7–8, 17, 715
 - abstract data types (ADT), 715
 - computer operating systems, 7–8
 - life cycle, 17
 - programs, 2
 - reusable components, 715
- Sorting algorithms, 1004
- Sorting arrays, 417–423
- Source code, 9
- Spacing, 24, 26, 202, 338–339
 - C++ programming, 24
 - character I/O and, 338–339
 - function definition and, 202
- sqrt* function, 183–185, 187
- Square brackets [], 378–379, 392–393, 427, 431, 492
- srand* function, 187, 189
- Stack class, 766–770, 979–983
- Stacks, 765–766, 800–802, 801–802
 - empty, 770
 - implementation of, 768–770
 - last-in/first-out (LIFO) data structure, 766
 - linked lists as, 765–766
 - overflow, 802
 - pointers and, 765–766
 - pop* function, 770
 - recursion and, 800–802
- Standard Template Library (STL), 963–1013. *See also* Templates
- Statements, 21–26, 33
 - C++ programming instructions, 21–26, 33
 - cin* (input), 21–23
 - cout* (output), 21–23
 - direction arrows (<< >>), 21
 - directives #, 25
 - executable, 21–26
 - #include* directive, 21, 25, 26
 - new line (\n), 23
 - return*, 25–26
 - semicolon (;), 24
- Static variables, 518
- static_cast*<double>, 190–192
- std* namespace, 335–336
- Stepwise refinement, 182–183
- Storage, memory as, 6
- strcat* function, 459–460
- strcmp* function, 457–460
- strcpy* function, 457–461
- Streams, 50, 305–376
 - appending to a file, 320–322
 - arguments to functions, as, 332
 - character I/O and, 338–360
 - cin* as, 307
 - classes and, 312–315
 - cout* as, 307
 - declaring, 308–310
 - default arguments, 348–349
 - fail* function, 314
 - file names and, 308–310, 318
 - files and, 306–338
 - flags and, 325–327
 - formatting functions, 323–328
 - ifstream*, 308–309, 318
 - input/output (I/O), 50
 - in_stream*, 307, 308–309, 312–314, 318
 - manipulator functions for, 329
 - member functions and, 312–314, 338–349
 - namespaces and, 335–336
 - objects and, 312–315
 - ofstream*, 308–309, 318
 - output, formatting using, 323–338
 - out_stream*, 307, 308–310, 312–314, 318, 325–326
 - parameters, 346–349
 - using directives and, 335–336
 - variables as, 308
- string* class, 66–68, 472–488
 - <*string*> library, 472, 474
 - characters, 66–68
 - comparison operators and, 482, 487
 - concatenation (+), 66–67, 472
 - constants converted to, 473
 - data types and, 66–68
 - default constructor for, 473–474
 - double quotes (" ") for characters, 64–65
 - getline* function, 475–476, 478–479
 - input/output (I/O) using, 475–477

- lexicographic ordering of, 482
 - member functions, 480–483
 - object-to-C string conversion, 487–488
 - palindrome testing program
 - example, 484–487
 - variable declaration, 66–68
 - whitespace characters and, 68
 - String functions, 1023
 - String values, 456–458, 668–671
 - C strings, 456–458
 - dynamic arrays, 668–671
 - implementation, 671–673
 - size of, 668
 - String variables, 322–323
 - `stringvar` class, 668–671
 - `strlen` function, 459
 - `strncat` function, 459
 - `strncmp` function, 459
 - `strncpy` function, 457, 459
 - Structures, 542–550, 575, 740–742
 - braces { } for, 543, 547
 - classes compared to, 542–550, 575
 - diverse data of, 542–547
 - dot operator (.) for, 545, 550
 - functional arguments, as, 548–549
 - hierarchy of, 549
 - initializing, 551
 - linked lists and, 740–742
 - member names, 543, 545–546
 - member values, 543, 546
 - member variables, 543, 545–547, 550
 - nodes as, 740–742
 - pointer variables for, 741–742
 - semicolons (;) for, 547
 - value, 543
 - Stubs, function testing using, 284–286
 - Subexpressions, 115
 - Subtasks, 251–303
 - `assert` macro, 290–291
 - call-by-reference parameters, 259–266
 - debugging functions, 282–287
 - functions for, 251–303
 - procedural abstraction, 273–281
 - testing functions, 282–287
 - `void` functions, 252–259
 - Subtraction operator (-), 70
 - switch statements, 128–135
 - `break` statements, 131–133
 - menus, 133–134
 - multiway branching, 128–135
 - Syntax, 30, 45, 939–941
 - class templates for, 939–941
 - errors, 30
 - variable declaration and, 45
- ## T
- Tasks, recursive functions for, 791–803
 - Templates, 925–956, 963–1013
 - algorithm abstraction, 926–938
 - class syntax, 939–941
 - containers, 973–990
 - data abstractions, 939–948
 - function definition, 937–938
 - generic algorithms, 991–1004
 - iterators, 959–973
 - Standard Template Library (STL), 963–1013
 - type definitions, 942
 - Terminal, computer output device, 3
 - Testing programs, 27–31, 214–217, 281–287, 407
 - boundary values, 281
 - compiling and running programs, 27–29
 - debugging and, 29–31
 - drivers, 282–284
 - error messages, 30–31
 - functions, 214–217, 281
 - input, 281
 - logic errors, 30–31
 - procedural abstraction and, 214–217, 281
 - program testing, 214–217, 281
 - run-time errors, 30
 - `scale` function, 407
 - stubs, 284–286
 - syntax errors, 30
 - warning messages, 30
 - Text files, editing, 355–357
 - `this` pointer, 1029–1031
 - Throw list, 911–913
 - `throw` statement, 898–900, 909–911
 - Throwing exceptions, 894, 909–911, 914–916
 - Top-down design, 182–183, 398–409
 - `toupper` and `tolower` functions, 358–360
 - Tracing recursive calls, 794–797
 - Tracing variables, 162–163, 288
 - Trees, data structures as, 761–762
 - Trigonometric functions, 1025
 - Trivial exceptions, 909
 - `true/false` values, 66, 116. *See also* Boolean expressions
 - Truth tables, 112–114
 - `try-catch` blocks, 916
 - `try-throw-catch` mechanism, 898, 901–903
 - Two-dimensional arrays, 427, 531–532
 - Type casting, 190–192
 - Type name, variables, 44–45
 - `typedef` function, 518–520, 530
- ## U
- Unary operators, 87, 649–650
 - Uninitialized variables, 47–49, 152
 - `unsigned int` type, 490–491
 - User role, 19
 - `using` directive, 52, 186, 228–229, 335–336, 719–721, 724–726, 959–960

- V**
- Value returned, 183, 196–197, 199, 202, 358–360, 804–807, 809–810
 - bool* statements, 199
 - character data, 358–360
 - predefined functions, 183
 - programmer-defined functions, 196–197
 - recursion, 804–807
 - return* statements, 196–197, 202
 - toupper and tolower, functions for, 358–360
 - Values, recursive functions for, 804–807
 - Variables, 21–23, 40–50, 60–74, 135–137, 143–144, 147–149, 152, 162–163, 218–229, 288, 308, 378–386, 389–391, 426, 431, 453–460, 489–492, 508–520, 521–523, 527, 664–667, 668–671
 - arithmetic operators for, 69–72
 - arrays and, 378–386, 389–391, 453–460, 521–523, 527, 664–667, 668–671
 - assignment statements, 45–49, 69, 511–512
 - asterisk (*) used for, 509–512
 - automatic, 518
 - blocks and, 135–137
 - C strings, 453–460
 - cin* (input) statements, 21–23
 - class members, 664–667
 - cout* (output) statements, 21–23
 - data types, 44–45, 60–74
 - declaration of, 21–23, 44–45, 48–49, 64, 66–68, 147, 378–382, 453–454
 - dereferencing (*) operator for, 510–511
 - dynamic, 513, 516–518
 - dynamic arrays and, 521–523, 527, 668–671
 - equal sign (=) for, 22
 - for* statements for, 147–149
 - function and, 218–229
 - global, 223–224, 226–227, 518
 - identifiers, 42–44
 - increment/decrement operators for, 143–144
 - indexed, 379–386, 389–391, 426, 431, 489
 - initializing, 48–49, 145–146, 386, 454–455
 - integers as, 21, 44–45
 - local, 135–137, 218–229
 - loop mechanisms and, 135–137, 143–144, 147–149, 152, 162–163
 - memory locations, 41–42, 382–383
 - naming, 42–45, 49
 - new* operator for, 513–515
 - null (/0) character and, 453–454, 456
 - pointers, 508–520, 521–523, 527
 - scope, 220–221, 226–227
 - square brackets [] used for, 378–380, 492
 - static, 518
 - streams as, 308
 - string*, 66–68, 668–671
 - syntax for, 45
 - tracing, 162–163, 288
 - type name, 44–45
 - uninitialized, 47–49, 152
 - values, 22, 45–48, 162–163, 489–492
 - vectors, 489–492
 - Vectors, 489–494, 961–965
 - assignment operator (=) for, 493
 - capacity*() function, 493–494
 - capacity of, 493–494
 - constructor, 492
 - declaring variables, 489–490
 - efficiency of, 493–494
 - indexed variables, 489
 - iterators for, 961–965
 - reserve function, 494
 - size of, 493
 - square brackets [] used for, 492
 - unsigned int* type, 490–491
 - variable values, 489–492
 - Virtual functions, polymorphism and, 864–876
 - void* functions, 252–259, 810
 - C++ definition, 252–254
 - calls, 253–254
 - recursion and, 810
 - return* statements in, 255–259
 - syntax, 253
- W**
- Warning messages, 30
 - while* loop statements, 84–91, 139–144, 153–154
 - braces { } for execution of, 84–86
 - break* statement for, 153–154
 - increment and decrement operators, 87–91, 141–144
 - infinite, 87–91
 - nested, 154
 - syntax of, 86, 140
 - zero times body execution, 87, 141
 - Whitespace characters, 68, 358
 - width* function, 328
 - Workstation, 2
 - Writing abstract data types (ADT), 591–592
 - Writing files, 308–310
- Z**
- Zero times loop body execution, 87, 141
 - Zeros leading in number constants, 636

Credits

Cover, © 145 / Corbis

Figure 1.1a, © Alamy

Figure 1.2b, © Alamy

Figure 1.3c, © Alamy

Chapter 1, pg. 2 "The whole of the development and operation of analysis are now capable of being executed by machinery. . . . As soon as an Analytical Engine exists, it will necessarily guide the future course of science." Charles Babbage(1792–1871)

Chapter 1, pg. 12 "The Analytical Engine has no pretensions whatever to originate anything. It can do whatever we know how to order it to perform. It can follow analysis; but it has no power of anticipating any analytical relations or truths. Its province is to assist us in making available what we are already acquainted with." Ada Augusta, Countess of Lovelace (1815–1852)

Chapter 1, pg. 18 "Language is the only instrument of science . . ." Samuel Johnson (1709–1784)

Chapter 1, pg. 29 "And if you take one from three hundred and sixty-five, what remains?" "Three hundred and sixty-four, of course." Humpty Dumpty looked doubtful. "I'd rather see that done on paper," he said." © Lewis Carroll, Through the Looking-Glass

Chapter 2, pg. 40 "Don't imagine you know what a computer terminal is. A computer terminal is not some clunky old television with a typewriter in front of it. It is an interface where the mind and the body can connect with the universe and move bits of it about." © Douglas Adams, Mostly Harmless (the fifth volume in The Hitchhiker's Trilogy)

Chapter 2, pg. 40 "Once a person has understood the way variables are used in programming, he has understood the quintessence of programming." © E. W. Dijkstra, Notes on Structured Programming

Chapter 2, pg. 50 "Garbage in means garbage out." Programmers' Saying

Chapter 2, pg. 60 "They'll never be happy together. He's not her type." Overheard at a cocktail party

Chapter 2, pg. 74 "If you think we're wax-works," he said, "you ought to pay, you know. Wax-works weren't made to be looked at for nothing. Nohow! "Contrariwise," added the one marked "DEE," "if you think we're alive, you ought to speak." © Lewis Carroll, Through the Looking-Glass

Chapter 2, pg. 93 "In matters of grave importance, style, not sincerity, is the vital thing." © Oscar Wilde, The Importance of Being Ernest

Chapter 3, pg. 112 "When you come to a fork in the road, take it." Attributed to Yogi Berra

Chapter 3, pg. 112 "Contrariwise," continued Tweedledee. "If it was so, it might be; and if it were so, it would be; but as it isn't, it ain't. That's logic." © Lewis Carroll, Through the Looking-Glass

Chapter 3, pg. 120 "Would you tell me, please, which way I ought to go from here?" "That depends a good deal on where you want to get to," said the Cat." © Lewis Carroll, *Alice in Wonderland*

Chapter 3, pg. 139 "It is not true that life is one damn thing after another— It's one damn thing over and over." © Edna St. Vincent Millay, Letter to Arthur Darison Ficke, October 24, 1930

Chapter 3, pg. 155 "Round and round she goes, and where she stops nobody knows." Traditional Carnival Barker's Call

Chapter 4, pg. 182 "There was a most ingenious Architect who had contrived a new method for building Houses, by beginning at the Roof, and working downward to the Foundation." Jonathan Swift, *Gulliver's Travels*

Chapter 4, pg. 193 "A custom-tailored suit always fits better than one off the rack." My Uncle, The Tailor

Chapter 4, pg. 204 "The cause is hidden, but the result is well known." Ovid, *Metamorphoses IV*

Chapter 4, pg. 218 "He was a local boy, not known outside his home town." Common saying

Chapter 4, pg. 232 "...— and that shows that there are three hundred and sixty-four days when you might get un-birthday presents —" "Certainly," said Alice. "And only one for birthday presents, you know. There's glory for you!" "I don't know what you mean by 'glory,'" Alice said. Humpty Dumpty smiled contemptuously, "Of course you don't — till I tell you. I mean 'there's a nice knock-down argument for you!'" "But 'glory' doesn't mean 'a nice knock-down argument,'" Alice objected. "When I use a word," Humpty Dumpty said, in rather a scornful tone, "it means just what I choose it to mean — neither more nor less." "The question is," said Alice, "whether you can make words mean so many different things." "The question is," said Humpty Dumpty, "which is to be master — that's all." © Lewis Carroll, *Through the Looking-Glass*.

Chapter 5, pg. 252 "Everything is possible." Common Maxim

Chapter 5, pg. 273 "My memory is so bad, that many times I forget my own name!" © Miguel de Cervantes Saavedra, *Don Quixote*

Chapter 5, pg. 281 "I beheld the wretch—the miserable monster whom I had created." Mary Wollstonecraft Shelley, *Frankenstein*

Chapter 6, pg. 306 "Fish say, they have their stream and pond; But is there anything beyond? © Rupert Brooke, "Heaven" (1913) "As a leaf is carried by a stream, whether the stream ends in a lake or in the sea, so too is the output of your program carried by a stream not knowing if the stream goes to the screen or to a file." © Washroom wall of a computer science department (1995)

Chapter 6, pg. 306 "Good Heavens! For more than forty years I have been speaking prose without knowing it." © Molière, *Le Bourgeois Gentilhomme*

Chapter 6, pg. 323 "You shall see them on a beautiful quarto page, where a neat rivulet of text shall meander through a meadow of margin." Richard Brinsley Sheridan, *The School for Scandal*

Chapter 6, pg. 332 "That's all there is, there isn't any more." © Ethel Barrymore (1879–1959)

Chapter 6, pg. 338 "Polonius: What do you read, my lord? Hamlet: Words, words, words." William Shakespeare, *Hamlet*

Chapter 7, pg. 378 "It is a capital mistake to theorize before one has data." Sir Arthur Conan Doyle, *Scandal in Bohemia* (Sherlock Holmes)

- Chapter 7**, pg. 411 "Never trust to general impressions, my boy, but concentrate yourself upon details." Sir Arthur Conan Doyle, *A Case of Identity* (Sherlock Holmes)
- Chapter 7**, pg. 424 "Two indexes are better than one." Found on the wall of a Computer Science department restroom
- Chapter 8**, pg. 452 "Polonius: What do you read my lord? Hamlet: Words, words, words." William Shakespeare, *Hamlet*
- Chapter 8**, pg. 453 "In everything one must consider the end." Jean de la Fontaine, *Fables*, Book III (1668)
- Chapter 8**, pg. 472 "I try to catch every sentence, every word you and I say, and quickly lock all these sentences and words away in my literary storehouse because they might come in handy." Anton Chekhov, *The Seagull*
- Chapter 8**, pg. 489 "Well, I'll eat it," said Alice, "and if it makes me grow larger, I can reach the key; and if it makes me grow smaller, I can creep under the door; so either way I'll get into the garden...." © Lewis Carroll, *Alice's Adventures in Wonderland*
- Chapter 9**, pg. 508 "Memory is necessary for all the operations of reason." © Blaise Pascal, *Pensées*.
- Chapter 9**, pg. 508 "Do not mistake the pointing finger for the moon." Zen saying
- Chapter 10**, pg. 542 "The time has come," the Walrus said, "To talk of many things: Of shoes—and ships—and sealing wax—Of cabbages—and kings—" © Lewis Carroll, *Through the Looking-Glass*
- Chapter 10**, pg. 554 "I don't care to belong to any club that will accept me as a member." Groucho Marx, *The Groucho Letters*
- Chapter 10**, pg. 588 "We all know — the Times knows — but we pretend we don't." Virginia Woolf, *Monday or Tuesday*
- Chapter 11**, pg. 620 "Give us the tools, and we'll finish the job." © Winston Churchill, *Radio Broadcast*, February 9, 1941
- Chapter 11**, pg. 643 "He's a smooth operator." Line from a song by Sade (written by Sade Adu and Ray St. John)
- Chapter 11**, pg. 667 "With all appliances and means to boot." William Shakespeare, *King Henry IV, Part III*
- Chapter 12**, pg. 704 "From mine own library with volumes that I prize above my dukedom." William Shakespeare, *The Tempest*
- Chapter 12**, pg. 704 "Your "if " is the only peacemaker; much virtue in "if." William Shakespeare, *As You Like It*
- Chapter 12**, pg. 719 "What's in a name? That which we call a rose By any other name would smell as sweet." William Shakespeare, *Romeo and Juliet*
- Chapter 13**, pg. 740 "If somebody there chanced to be Who loved me in a manner true My heart would point him out to me And I would point him out to you." Gilbert and Sullivan, *Ruddigore*
- Chapter 13**, pg. 765 "But many who are first now will be last, and many who are last now will be first." Matthew 19:30
- Chapter 14**, pg. 790 "After a lecture on cosmology and the structure of the solar system, William James was accosted by a little old lady. "Your theory that the sun is the center of the solar system, and the earth is a ball which rotates around it has a very convincing ring to it, Mr. James, but it's wrong. I've got a better theory," said the little old lady. "And what is that, madam?" inquired James politely. "That we live on a crust of earth which is on the back of a giant turtle." Not wishing to demolish this absurd little theory by bringing to bear the masses of scientific evidence he had at his command, James decided to gently dissuade his opponent by making her see some of

the inadequacies of her position. "If your theory is correct, madam," he asked, "what does this turtle stand on?" "You're a very clever man, Mr. James, and that's a very good question," replied the little old lady, "but I have an answer to it. And it is this: the first turtle stands on the back of a second, far larger, turtle, who stands directly under him." "But what does this second turtle stand on?" persisted James patiently. To this the little old lady crowed triumphantly. "It's no use, Mr. James—it's turtles all the way down." © J. R. Ross, *Constraints on Variables in Syntax*

Chapter 14, pg. 791 "I remembered too that night which is at the middle of the Thousand and One Nights when Scheherazade (through a magical oversight of the copyist) begins to relate word for word the story of the Thousand and One Nights, establishing the risk of coming once again to the night when she must repeat it, and thus to infinity." © Jorge Luis Borges, *The Garden of Forking Paths*

Chapter 14, pg. 804 "To iterate is human, to recurse divine." Anonymous

Chapter 14, pg. 809 "There are two kinds of people in the world: those who divide the world into two kinds of people and those who do not." Anonymous

Chapter 15, pg. 834 "With all appliances and means to boot." William Shakespeare, *King Henry IV, Part III*

Chapter 15, pg. 834 "If there is anything that we wish to change in the child, we should first examine it and see whether it is not something that could better be changed in ourselves." © Carl Gustav Jung, *The Integration of the Personality*

Chapter 15, pg. 859 "The devil is in the details." Common saying

Chapter 15, pg. 862 "All experience is an arch, to build upon." Henry Adams, *The Education of Henry Adams*

Chapter 16, pg. 894 "It's the exception that proves the rule." Common maxim (possibly a corruption of something like: It's the exception that tests the rule.)

Chapter 16, pg. 895 "Well, the program works for most cases. I didn't know it had to work for that case." Computer Science Student, *Appealing a Grade*

Chapter 16, pg. 914 "Only use this in exceptional circumstances." © Warren Peace, *The Lieutenant's Tools*

Chapter 17, pg. 926 "All men are mortal. Aristotle is a man. Therefore, Aristotle is mortal. All X's are Y. Z is an X. Therefore, Z is Y. All cats are mischievous. Garfield is a cat. Therefore, Garfield is mischievous." *A Short Lesson on Syllogisms*

Chapter 17, pg. 939 "Equal wealth and equal opportunities of culture . . . have simply made us all members of one class." © Edward Bellamy, *Looking Backward: 2000–1887*

Chapter 18, pg. 958 "Libraries are not made; they grow." © Augustine Birrell

Chapter 18, pg. 959 "The White Rabbit put on his spectacles. "Where shall I begin, please your Majesty?" he asked. "Begin at the beginning," the King said, very gravely, "And go on till you come to the end: then stop." © Lewis Carroll, *Alice in Wonderland*.

Chapter 18, pg. 973 "Put all your eggs in one basket and" —watch that basket
Mark Twain, *Pudd'n head Wilson*

Chapter 18, pg. 991 "Cures consumption, anemia, sexual dysfunction, and all other diseases." Typical claim by a traveling salesman of "snake oil"



LOCATION OF VIDEONOTES IN THE TEXT

Chapter 1	Compiling and Running a C++ Program, p. 26 Solution to Practice Program 1.6, p. 36 Solution to Programming Project 1.3, p. 37
Chapter 2	C++11 Fixed Width Integer Types, p. 64 Precedence and Arithmetic Operators, p. 71 Common Bugs with = and ==, p. 81 Solution to Practice Program 2.3, p. 104 Solution to Programming Project 2.12, p. 108
Chapter 3	<i>switch</i> Statement Example, p. 130 Nested Loop Example, p. 160 Solution to Programming Project 3.9, p. 177 Solution to Programming Project 3.11, p. 178
Chapter 4	Random Number Generation, p. 188 Programmer-Defined Function Example, p. 201 Walkthrough of Functions and Local Variables, p. 223 Solution to Practice Program 4.7, p. 246 Solution to Programming Project 4.8, p. 250
Chapter 5	Call by Reference and Call by Value, p. 269 Debugging, p. 287 Solution to Practice Program 5.9, p. 297 Solution to Programming Project 5.6, p. 300
Chapter 6	Objects and File I/O Streams, p. 314 Default Arguments, p. 348 Solution to Programming Project 6.11, p. 374
Chapter 7	Array Walkthrough, p. 383 Range-Based For Loop, p. 386 Passing Arrays to Functions, p. 391 Selection Sort Walkthrough, p. 417 Bubble Sort Walkthrough, p. 421 Solution to Programming Project 7.3, p. 440
Chapter 8	Dangers of <code>strcpy</code> , p. 461 Example using <code>cin</code> and <code>getline</code> with the <code>string</code> class, p. 479 Solution to Programming Project 8.1, p. 498 Solution to Programming Project 8.14, p. 504
Chapter 9	Dynamic Arrays and Pointer Arithmetic, p. 529 Solution to Programming Project 9.6, p. 536

(Continued on Inside Back Cover)



LOCATION OF VIDEONOTES IN THE TEXT

Chapter 10	Class Scope, Public and Private Members, p. 565 Default Initialization of Member Variables, p. 587 Separate Interface and Implementation, p. 592 Solution to Practice Program 10.1, p. 611
Chapter 11	<i>const</i> Confusion, p. 639 Arrays of Classes using Dynamic Arrays, p. 671 Overloading = and == for a Class, p. 680 Solution to Programming Project 11.12, p. 701
Chapter 12	Avoiding Multiple Definitions, p. 715 Solution to Practice Program 12.3, p. 736
Chapter 13	Walkthrough of Linked Lists of Classes, p. 762 Solution to Programming Project 13.6, p. 783 Solution to Programming Project 13.9, p. 785
Chapter 14	Recursion and the Stack, p. 801 Solution to Practice Program 14.4, p. 827 Solution to Practice Program 14.4 , p. 828
Chapter 15	Inheritance Example, p. 858 Solution to Practice Program 15.3, p. 882 Solution to Programming Project 15.1, p. 884 Solution to Programming Project 15.10, p. 889
Chapter 16	The STL Exception Class, p. 917 Solution to Practice Program 16.1, p. 920 Solution to Programming Project 16.3, p. 922
Chapter 17	Issues Compiling Programs with Templates, p. 931 Solution to Programming Project 17.7, p. 955
Chapter 18	C++11 and Containers, p. 990 Solution to Practice Program 18.2, p. 1007 Solution to Programming Project 18.6, p. 1010

(Continued from Inside Front Cover)

