

THE COMPLETE  
**GIL HIBBEN**  
K N I F E  
**T** H R O W I N G  
G U I D E

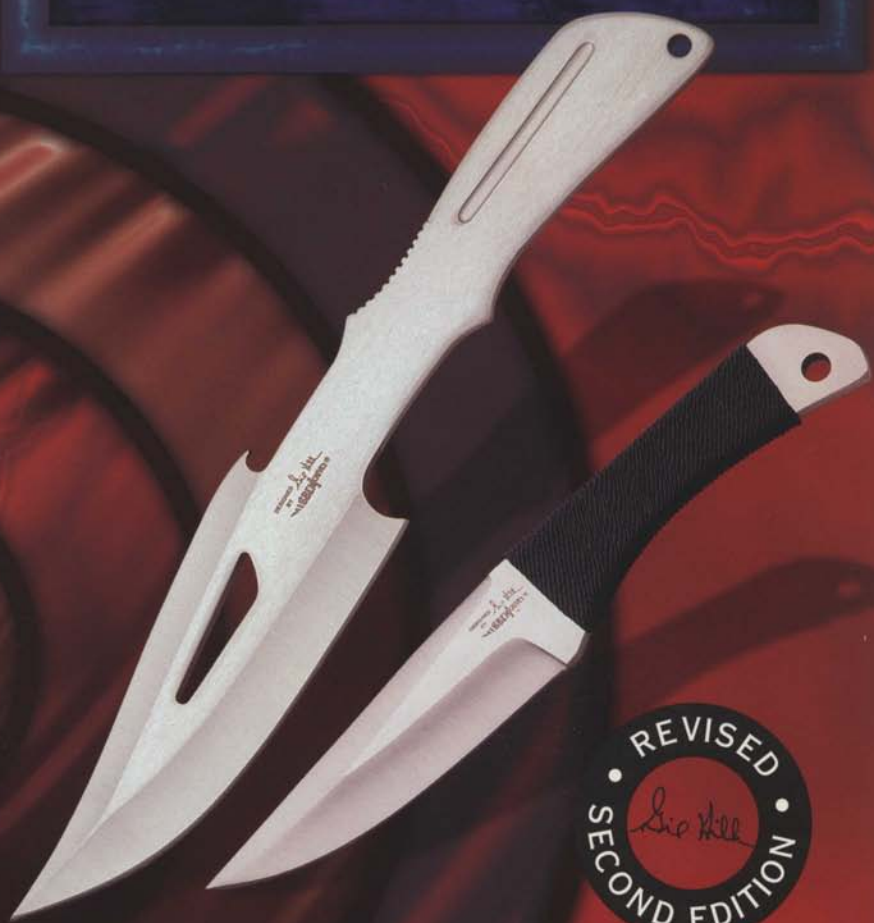

• REVISED •  
*Gil Hibben*  
• SECOND EDITION •

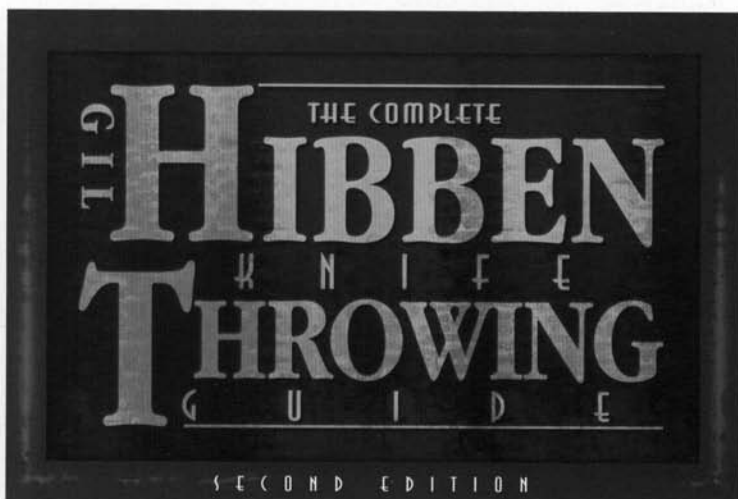

- by -

Gil Hibben

Edited by C. Houston Price

Second edition copyright 1998 by United Cutlery Corp.,  
1425 United Blvd., Sevierville, TN 37876

First edition copyright 1994 by United Cutlery Corp.

All Rights Reserved.

No part of this book may be reproduced in any form without written  
permission from the publisher.

Printed in the United States of America

Photography by John Stewart, Jim Miller, Allen Horrar and Jim Weyer

Cover Art By Carole Boyer

Illustrations By Kit Rae

# TABLE OF CONTENTS

INTRODUCTION	IV
TIPS BEFORE GETTING STARTED	1
SELECTING YOUR THROWING KNIFE	2
CHOOSING YOUR TARGET	11
HOW TO THROW - THE BASIC SKILLS	25
DEVELOPING YOUR OWN STYLE	31
THROWING FROM ANY DISTANCE	38
THE THROWING AXE	40
ABOUT THE AUTHOR	47

## FOREWORD

It is very likely that this book is not your first introduction to knife throwing. Most youngsters do not pass through adolescence and into adulthood without having been involved to some extent in throwing knives.

Throwing knives for sport or relaxation followed many of us into adulthood as we found ourselves competing with comrades or whiling away the time throwing “Ka-Bars,” bayonets or MK III military issue pieces during otherwise boring times spent with the military in the field. Others have thrown knives, either in friendly competition or just for the fun of it, during hunting outings. Those who have been a part of the “buckskinning” hobby have surely witnessed or joined in the sport of knife throwing at muzzleloading events.

If knife throwing is not new to you, your earlier experiences have likely been an influence in your referring to this book. You already recognize that knife throwing is a sport worth pursuing and perhaps you have developed your own style and system. Still, we believe that you’ll find the book will offer many helpful tips for sharpening your aim and throw.

If you haven’t thrown knives before, welcome to the sport. You will soon recognize, along with those who have participated to whatever degree and at whatever period in their lives, that knife throwing can be an interesting as well as challenging sport.

Whether you are an experienced or a beginning thrower, always remember that safety is paramount to the fulfillment to be received from participating in it. Never throw your knife without first considering the safety of persons nearby and, of course, your own.

This book is intended to give a well-rounded view of knife throwing and a look into axe throwing as well. In doing so, it will offer a foundation that can be used right away and continually built upon through practice. Enjoy!



## INTRODUCTION

My love of baseball as a boy is probably one of the reasons that I wanted to throw things – especially knives – and my first love in knives was the bowie. I recall “The Iron Mistress.” It was a very popular movie released about 1952, featuring Virginia Mayo and Alan Ladd, and based on Paul Wellman’s book. Ladd played the hero Jim Bowie and I watched closely whenever he and his opponents threw their knives. It was only natural that I thought the Bowie knife was intended for throwing.

My first real throwing experiences were with my Western brand hunting knife and a tomahawk-like axe with a fork on the back. Issued by the U.S. Forestry Department and called a “Hoe Dag,” it was a pretty neat tool. When I was 18 years old and just out of high school, I spent a summer in the St. Joe National Forest by St. Marries, Idaho. I recall that many hours of boredom turned into more pleasant times when they were spent throwing these weapons and tools.

It was 1957 when I made my first bowie knife and, although I was no longer a teenager, I was anxious to try it out. My brother, Fred and I hurried out to the backyard shed to try out the newly crafted piece. Typical of a bowie, this knife was heavy. After a few throws, nicks and dings appeared on the blade and we had also managed to bend the guard. It was obvious that I wouldn’t have much of a knife left after a few more throws. So I learned the hard way about throwing bowies. Heavy handles put a lot of strain on the blade and tang when the free spinning blade is suddenly stopped and the heavy handle wants to keep on going!

Knife throwing continued to be a favorite pastime but my interest in the sport really picked up in 1968. That was when a Chicago policeman named Charles Gruzanski, who started the True Flight Knife Throwers Club Of America, made me an honorary member and member of the Board of Consultants along with the late Harry McEvoy. With that title and in the company of these fine knife throwers, it became apparent that I should become a little more serious about my hobby.

Some war games were held that summer in our small community of Manti, Utah and Special Forces troops parachuted into the area to practice their battle strategies. I was involved with the Sanpete County Search & Rescue Sheriff Patrol and we were invited to watch and participate – I really think they wanted our jeeps. In the evening the soldiers would come to my Kenpo Karate classes and watch. The Colonel who commanded the operation really liked to throw knives and was quite proficient at the sport. He could throw any type knife and so I introduced my new “Ed Parker” fighter with an all-metal handle. They all loved it! That vote of confidence, added to the fact that my good friend Harry McEvoy liked it, convinced me to include the knife as one of my regular models. The same style is still being offered today. During the Vietnam War, I sent many knives to servicemen and received several letters stating that one of my knives had saved a soldier's life. That was indeed gratifying.

From 1977 through 1979, I was the master knifemaking craftsman at an 1880's theme park near Branson, Missouri called Silver Dollar City. This is the time and place where my “knife throwing act” came together. To make it even more special, it is also where I met and was lucky enough to marry my wife, Linda. I would demonstrate knife and tomahawk throwing to the visitors each hour. The scenario called for my faking an argument with the leather shop craftsman next door, one that would be settled by competitive throwing – his tomahawk against my knife. My brother, Daryl would join in and we would throw for a soft drink. It was a routine that would be settled fairly soon, using a playing card for the target.

One day, while a sizable crowd watched, one of my knives came back at me almost as hard as I had thrown it. I thought it had only slapped me a little, but it had actually penetrated about 1 1/2" into my back while I was trying to get out of its way. Penetrating slightly above the kidney, the knife missed any vital organs but my pride suffered a little injury. Although I felt no pain, I realized what had happened and side-stepped back into my log cabin knife shop (so that the audience wouldn't know) and then drove to the hospital in Branson to get sewn up. Needless to say, the management at Silver Dollar City decided to end the knife throwing demonstrations. Knife throwing can be fun but, even after 10,000 throws, it can also be dangerous. So enjoy the sport but never forget to be careful!



## GETTING STARTED

Generation after generation of young men (and women) have enjoyed the challenge of accurately and effectively throwing knives. It is a sport that had its roots in our country's early pioneer days when it provided competitive recreation as two or more throwers participated. Those same opportunities still exist today as we recognize other benefits, such as mental relaxation and muscle stimulation for better coordination or body control. It can be enjoyed as a solo activity or can be expanded to include other throwing events for keen competition. It's always more fun to throw with a friend, like sharing a fine dinner or glass of wine.

Learning the sport requires a degree of mental discipline and dedication to practice for perfection. But, since knife throwing is a fun pastime, learning and practice of the sport can be fun as well. Making and keeping it a fun sport means that we should also keep it a safe sport, safe to those who throw knives as well as those who choose to watch. Before we get into the subjects of knives, targets and techniques, a few general guidelines need to be considered and remembered for as long as we participate in the sport.

First, this book is not intended to teach showmanship knife throwing. We're not teaching trick throws with knives bursting balloons held by a scantily clad pretty lady. Nor are we trying to teach knife throwing as a means of offense or defense – those aspects of knife throwing are left to the professionals. Its intent is to offer guidelines for learning or improving upon what is already known about the sport.

Because a relatively small – but safe – area is all that is needed, knife throwing can be, and most often is, a back-yard recreational activity. The area selected should offer good visibility from all sides and a shielded background. There should be a clear view of anyone or any thing (such as a dog or cat) approaching the target or throwing range from the rear or sides and the area should be roped off or otherwise protected from those who may wander onto it. And, to keep the sport more fun and less work, it is a good idea to rake away leaves or other debris that may hide knives that have gone astray.



If it strikes the target improperly, the thrown knife can ricochet or bounce off in most any direction. Because of this, you should be ever alert that spectators remain behind the thrower and never off to either side of the target. These dangerous throws don't happen often but they do happen, even to the expert thrower. So always play it safe.

You can make throwing a family recreational activity. I encourage you to do so. In doing so, I encourage you to not only practice safety but to teach it as well to youngsters and others who may join in the sport. Just as with guns, archery equipment, etc. safety must be stressed. Be certain that your young knife thrower is properly supervised, understands the rules and knows why they should be followed.

## SELECTING YOUR THROWING KNIFE

If you're wondering what knife you can throw, the answer is that you can throw any knife. The real question is how effectively can it be thrown and at what cost in terms of damage to the knife or other property. Some knives made especially for throwing have little or no value for other uses and there are knives, made with other specific uses in mind, that have very few of the characteristics needed for throwing. The best techniques known, used by the best coordinated thrower, will give only fair results unless the knife thrown has characteristics that suit it to the task. In this section, we'll consider the characteristics of the theoretical "perfect" throwing knife; but, we'll not forget the importance of practicality in making your choices.

### WHAT TO LOOK FOR

Among the characteristics to consider in selecting a knife or knives that are best for throwing are length, weight, balance and shape or design. The ideal throwing knife should be correct in length as well as weight. Length gives not only a feel of control but it offers actual control as well. Weight, when combined with proper delivery, provides the force needed for deep penetration into the target. Although the length of the ideal throwing knife will vary for the individual thrower by a couple of inches either way, one that is near ten to twelve inches in overall length will best suit most throwers on most occasions.



Knives that are small and light in weight have a place, particularly with young throwers. For adult or adolescent knife throwers, however, the smaller knives tend to lack the length and weight needed for control and depth of penetration and I believe that the serious thrower would soon recognize the advantages of a larger, heavier knife.

A key ingredient for understanding your knife and recognizing properties that make it a good or a poor choice for throwing is balance. The balance of a knife not only determines how well it can be thrown, it also dictates the manner in which it can be most efficiently thrown. It's an easy matter to determine the balance point of your knife by laying it across your finger and moving it until it balances there. Most knives designed for throwing have their balance point close to mid-length or slightly toward the handle end. A good reason for this is that the majority of knife throwers prefer the handle throw. Those who desire can effectively throw a knife with this balance by the blade as well.

While balance is often discussed as the key in determining whether a knife will be good as a throwing knife, it seems that many people get the priorities misplaced. Simply stated, balance is the indication of a knife's weight distribution. All knives, of course, have balance and usually that balance is in keeping with the knife's primary purpose. An ordinary folding pocketknife has a balance that is in keeping with its intended use; but, of all knife types, it is least suited for throwing. While knives designed specifically for throwing will be balanced at or quite near the center, those that are designed primarily as hunting, camping, survival or fighting knives most often have their balance point near or slightly behind the guard. Still they are often used for throwing and most of them serve quite well for this purpose, usually when thrown by the blade. So, the real reason for learning where on the knife is its balance point is to determine the throwing method that will work best for that knife and your own throwing style.

I've said a lot about balance, determining balance point, and its effect upon the thrown knife. If it seems a little complicated at this point, don't worry. You will be amazed at how proficient you will become in a short period of time. Getting to know a knife will be almost second nature. Rather than needing to do the finger balance test or any other, you'll soon be able to pick up a knife and have a near-immediate feel for how it should be thrown.



Shape and design have been mentioned as characteristics that have much to do with selecting the ideal throwing knife. The ideal throwing knife will not be double-edged, beveled or sharpened on both sides. As we'll see later, the most dependable presentation of the knife for throwing is with the blade vertical. Knives with a single edge and flat, thicker back are suited for the vertical blade throw. Rather than a sharply curved blade the ideal throwing knife will have one that is near straight or slightly up-swept. When viewed in profile, the blade's point will be in the middle third of that profile.

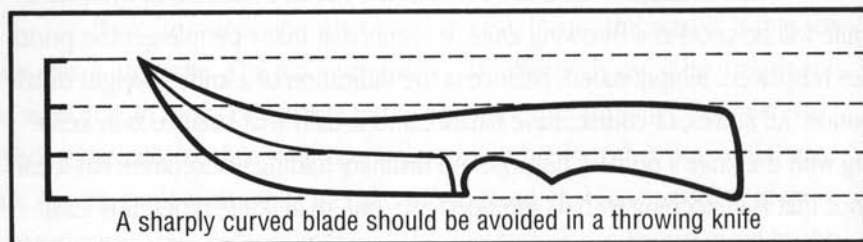
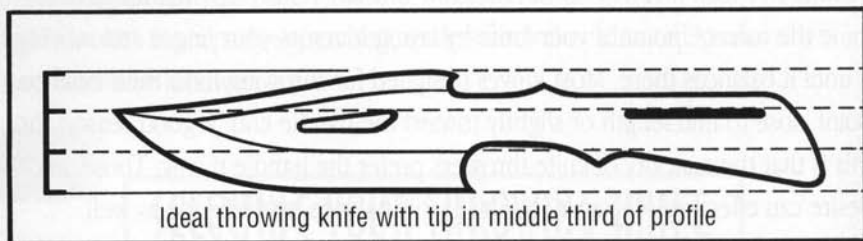

Because we should be practical in the selection process, other considerations are toughness or durability and cost or value. The ideal throwing knife must be constructed to take a great deal of punishment. Design features to consider include the steel from which it is made, the tempering and hardening process and the handle type.

The hardness of the blade steel is important, not in its effectiveness as a throwing knife but in its durability. In any case, the knife should have a good sharp point and this part of the blade is not only the weakest but also the area most subject to punishment in the throw. A blade that is hardened to a relatively high hardness on the Rockwell "C" scale (e.g. HRC 58-60) is too brittle and will be more likely to break in a less than perfect throw. One that is not so hard (in the lower half of the 50's on the Rockwell scale) is much more forgiving to the rigors of throwing.

The pommel design should be such that it will not hinder a smooth handle throw nor so pronounced as to make it easy to break in a poor throw. Most knives made specifically for throwing are made without handle scales. If the knife that is to be thrown has handle scales, they should be made of a tough or break resistant material, usually one of the new man-made materials.

### THE MANY CHOICES

Now that we've deliberated on the attributes of the ideal throwing knife, let's consider a number of other knife categories from which to choose. Depending upon your situation and the priorities for use of your knife, there may be some trade-offs in finding a knife that is sensible for other purposes and one that has good throwing qualities.

One example of an excellent all around knife that works well for cutting, for survival, for hunting and camping use and for throwing as well, is the government issued Mark II combat/utility knife.

Examples of good throwing military knives



With the continually rising value of older and original military issue knives, I would hesitate to risk throwing one of them. There are currently made re-issues of this knife usually generically called the "Ka-Bar" and there are other knives of similar design. Companies such as Ka-Bar, Queen, Camillus and others offer a variety of good choices. About 12" in overall length, the Mark II weighs about 12 ounces, a good length-to-weight ratio. The handle is made of compressed leather washers, with guard and butt-cap of steel. This knife has its balance point about a half-inch behind the guard so that it can be thrown by the handle or the blade. It is long enough to enhance the feel and fact of control and it is heavy enough to permit good target penetration. Other features in its favor are relatively low cost, considering its wide variety of uses, and its durability.

Fixed blade "hunting knives" – often called sheath knives – or sporting type knives serve exceptionally well for hunting, fishing, camping or hiking knives. There are many manufacturers and brands available for consideration. Names such as Case, Queen, Western, Camillus, Schrade, Buck and Remington have been known for several generations. Others such as Rigid, SOG, Cold Steel, Colt, Frost and United are newer names added to those producing good quality sheath knives of the rather standard designs. In addition to service in a variety of other ways, many of them also serve well as a throwing knife.

Examples of hunting knives that can be used for throwing



Some things to consider in evaluating these knives for throwing are those mentioned previously – length, weight, balance and design. Other features to consider concern durability and safety. Most knives of this type are of hidden-tang design, with a handle affixed to the tang. The handle can be made of various materials and, for throwing, the best are those using leather washers or some of the relatively new man-made materials such as Kraton or hard rubber. Wood handles or some of those made of plastic type materials are usually subject to chipping or cracking when they hit a target and should usually be avoided. If, however, you choose a wood handled knife, you may wish to protect the handle by covering it with cloth tape. Other natural materials, such as stag or bone, are at high risk from damage if used for throwing.

Blade design, if it varies away from the rather standard clip or dropped point styles, should be considered. Keep in mind the earlier discussion regarding curved blades or those with unique shapes. Most knives of this type have shorter blades than the one found on most military knives – usually four to six inches compared to seven inches typical of the MK II. With a shorter blade, it is likely that the balance point would be far back of the guard and you may wish to use the blade throw.

The pommel would be of concern if it is very pronounced in form, such as a bird's beak or eagle head type. These could interfere with a smooth and effective handle throw and a broken pommel could shorten the life of a good knife.



Pronounced pommel shapes should be avoided

Among those knives usually considered defense knives – boot knives, daggers, bowies, fighters, etc. – one can usually find some good throwers. Since boot knives are usually small and lightweight while bowies usually are large and heavy, it's likely that you'll not be satisfied with them for throwing on a regular basis. If, however, you find the knife feels right for throwing you can give it a few trial throws.



By doing so, you may have found the throwing knife suited just for you. Fighting knives often have blades with a significant upsweep near the point and a sharpened top edge, making it a safety risk to throw by the blade. The handles of some fighters have a hook-type pommel that would definitely interfere with throwing by the handle. Most boot knives and daggers are double-edged. Because of the danger of cutting the hand when throwing by the blade, a double edged knife is best thrown by the handle. If the knife you choose to throw is double edged and if you really don't want to use the handle throw, be sure to use the horizontal rather than vertical presentation. The precautions mentioned above regarding handle materials apply to these knife types as well, regardless of whether the design is hidden tang or full tang with handle scales.

Pocketknives are usually the best choice for an always-ready cutting tool, however, they are poor choices for throwing. Don't throw them!

### MY OWN CHOICES

I have thrown several of the knife types mentioned above, some with very good and some with not so good results. My longtime involvement with knives has been an advantage for me in that I have designed the knives I throw. I made the first ones, tested and revised them and made more until I was satisfied with the results. These throwers are now made elsewhere to my specifications and are available through many knife retailers at considerably less cost than a handmade knife.

In selecting and designing my throwing knives, I have always been influenced by many years of making hunting, fighting and bowie type knives. Knives were made to cut and to be a useful tool. My throwing knives, although designed primarily for throwing, are made to be used for other purposes as needed. The throwing knife is a tool that can also be used for pleasure when I have some leisure time on my hands or as a sporting instrument when competing among friends. The Hibben Throwers are made in small, medium and large sizes, and are available in the original stainless steel and also in a cord wrapped version. The Thrower I (UC454, UC946) is the smallest with a 3-1/8" blade, 6-1/8" overall length and weight of slightly over two ounces. The medium size Thrower II (UC455, UC947) is 8-1/2" overall length with a 4-1/2" blade. Its weight is six ounces. The Thrower III (UC456, UC948), with its 4-5/8" blade and 10" overall length, weighs ten ounces.



Chinese fist  
with thumb  
on top of fist.

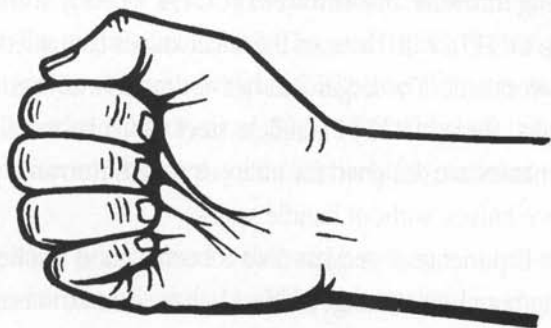

UC454  
Hibben Thrower I

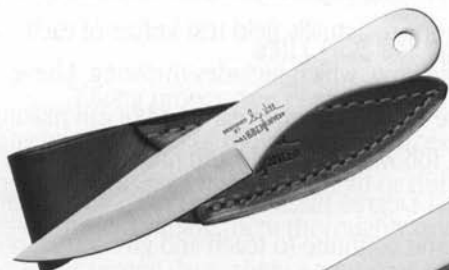

UC455  
Hibben Thrower II

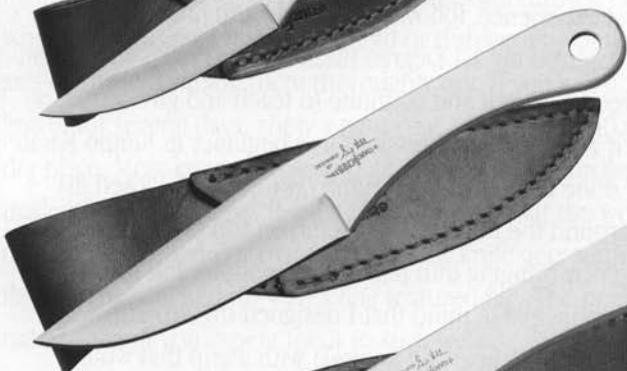

UC456  
Hibben Thrower III



For young throwers, the Thrower I (UC454, UC946) or the Thrower Triple Set (UC458, UC949), with three of the small knives contained in a single sheath, should work well. The larger and heavier models will better suit adolescents and adults. Made of 420 J-2 stainless steel with a Rockwell hardness of HRC 50-52, the blades are designed for utility as well as throwing purposes. They are one-piece knives, without handle scales.

Experience is and has always been a good teacher, not only in knife throwing but in most things in life. I believe that various experiences in using a knife have helped me tremendously in designing knives. As an assistant hunting guide in Alaska, I had an opportunity to actually field test knives of each design that I made. Regarding knife fighting, which includes throwing, I have been involved in the martial arts since 1957, the same year that I began making knives. Judo was my first experience, followed by Aikido and finally, Ed Parker's Kenpo Karate, where I received my 1st Degree Black Belt in 1968. I am currently ranked as a 3rd Degree Black Belt and continue to teach and give seminars.

One of my early and lasting impressions as a beginner in Kenpo Karate was the "Chinese Fist," done by placing the thumb on top of the closed fist instead of wrapping it around the fingers. The thumb on top of the fist makes your wrist much stronger by bringing into play all the tendons and forearm muscles. It was with this principle in mind that I designed the Pro-Throwers (UC866, UC879, UC880, & UC881 [axe and knives]) with a grip that would incorporate this natural strength. This "trigger grip" makes it natural to place the thumb on top of the handle and squeeze the trigger on the bottom. The design not only adds power to your throw, it helps in consistency by automatically guiding your hand into practically the same position each time.

UC880  
Hibben Pro  
Thrower I

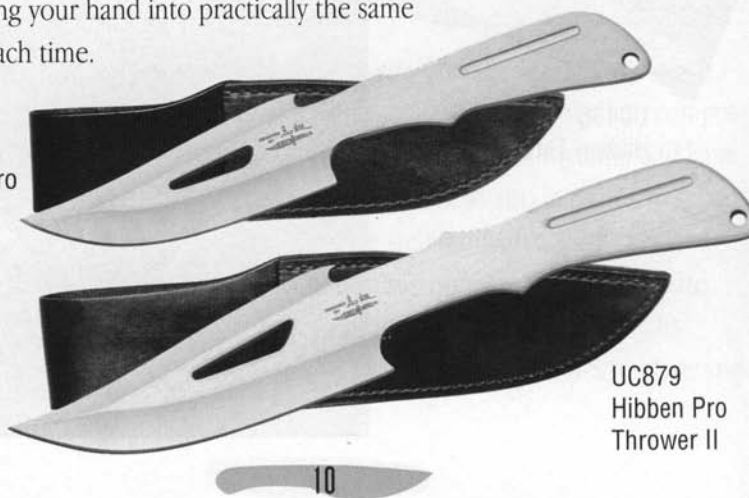

UC879  
Hibben Pro  
Thrower II



The Pro-Thrower I (UC880) is 12" in overall length, with a 5-7/8" blade and weighs ten ounces. The slightly smaller Pro-Thrower II (UC879) weighs eight ounces and is 10" in overall length, with a 4-7/8" blade. Both are made of 420 stainless steel with a Rockwell hardness of 50-52 HRC. Although they have a more futuristic design, they can be used quite effectively for purposes other than throwing.

Whatever type knife you choose for throwing, so long as it has reasonably good characteristics for that use, you should be able to develop your own style for this pleasurable sport.

### KNIFE CARE AND MAINTENANCE

Taking proper care of your throwing knife or knives will insure you many hundreds, if not thousands, of successful throws. Clean them as you would tools, using a mild household or dishwashing detergent to remove dirt and debris and wiping them thoroughly dry. If you will not be using your knives for several days, apply a light coat of oil or WD-40 and store them in a dry place. Most knives today, and all of the Hibben throwers on the market, are made of stainless steels. Remember, however, that the word is "stain less"; it does not mean stain or rust proof. If your knife gets some slight nicks or dings, they can be touched up with a fine textured file. The points should be kept rather sharp if you expect them to stick well.

### CHOOSING YOUR TARGET

Our purpose in this chapter will be to discuss the several options available in targets so that you may determine the type best suited to your purposes and home environment. First, however, let's consider the non-options, the several objects that should not be a target. Some things, such as people and animals, come immediately to mind and we'll discuss those briefly but there are other objects that are poor choices for targets.

Do not throw your knife at anything that you would not want to harm. Do not throw your knife at any living thing! This includes not only people, but animals and trees as well.



While it may seem rudimentary that we would caution against using any of these as targets, it's a rule to always keep in mind whenever you throw your knife. Knife throwing is a sport; it is not an offensive nor a defensive action, nor is it a sportsman-like way of taking game.

Despite what some movies have depicted, there should practically never be an occasion to throw your knife as a weapon. In addition to its many other attributes, a knife certainly can be a weapon. But, once you stop to think about it, the rule that your knife should not be thrown in offense nor in defense is just common sense. If the knife is the only defensive weapon you have, a less than totally accurate throw will mean that you have expended your last means of defense. There have been instances that a thrown knife has been effectively used in offensive combat. These are very few, however, and they have been done by persons highly skilled and trained.

Likewise, few people have had any measure of success in using the thrown knife to take game. The skill required would be extra-ordinary and, in most cases, the knife used would need to possess very special qualities of weight, size, and balance. Knives have very little knock-down power, especially when compared to that of sporting firearms. Lacking this, the knife would have to be accurately and powerfully thrown into a vital area. Otherwise, an injured animal will run off to suffer and perhaps die, taking the knife with it.

Do not throw your knife at trees. These living objects have long been targets for the novice knife thrower, but they are poorly chosen targets. Most of us who have thrown knives can speak from experience since we have used trees for targets – primarily because they were readily available and appeared to offer an ideal material for penetration of the blade's tip. A little thought, however, would have told us the disadvantages of choosing them. First, repeated throws of a knife at a tree can result in severe injury to or loss of the tree. But there are other reasons – self-serving ones – for not choosing a tree as your target.

The tree, since it is basically round in shape, offers only a relatively small and critical target area. If the knife is thrown so that it misses that area, usually limited to a few inches in width, it is likely to be deflected off the tree. The results can vary. It is not unusual that the knife is lost in the brushes or leaves in such a wide area that finding it will be difficult.

Those of us who have used trees as targets have learned the hard way that throwing at trees can be frustrating when we've spent near as much time in looking for knives as in pleasurable and skillful throwing. Further, it is not unusual that the stress from such an impact will damage or break the knife and there's even greater risk when one considers that a ricochet could injure innocent persons in a nearby area.

The target is very important to the overall fun and safety of knife throwing. Some good preparations will yield big dividends. Do be mindful of these considerations whenever you select a target for your thrown knife but don't be discouraged, constructing a target is neither a difficult nor an expensive undertaking. In the following discussion, I'll describe my own target and explain how to construct one like it. Although I believe that it is a target that will serve most knife throwers very well, I've included also some thoughts and information about several sensible targets and approaches to building them. Read on to determine which is best suited for your goals in throwing and the materials or space readily at hand.

### TARGET CONSTRUCTION - HIDDEN STYLE

My own target is one that is not permanently attached to a frame but is built in two component parts so as to be free standing when these parts are assembled. Although it is somewhat heavy, it can be disassembled and transported. If the location is relatively close, it can be carried by two persons and, for transporting greater distances, it can easily be loaded into the bed of a pickup truck.

Building the target was not very difficult and the materials were readily available at our local building supply. The tools needed are a caulking gun, a hammer, two (preferably three) long pipe clamps, and access to a skill saw or band saw. A couple of nylon tie-down straps are helpful but not necessary. Hammers and caulking guns are typically found in most households; clamps often are not. They may, however, be rented from a tool rental business at a very low cost and the benefit of having glued instead of nailed target boards is obvious.



The materials used were:

28 pressure treated 2" X 4" X 8'

1 pressure treated 2" X 12" X 10'

2 tubes of "liquid nail" wood glue

1/4 lb. 20d nails or long wood screws

I spent about \$100.00 for treated lumber. My friend, David Cashion, and I built the target in about 4 hours. The target's width is thirty-eight inches and its height is slightly over eight feet. The thickness of 3-1/2" is sufficient for throwing knives as well as my throwing axe. Frankly, its height is greater than that needed and the extra height could be a disadvantage by making the target heavier to transport. The 2" X 4" boards that I used were standard sizes available at the building supply store and, if I were rebuilding the target, I would saw off a couple of feet from the target boards and construct the target so that it would be slightly over six feet in height when set up. If you do this and if you choose to saw the boards at this time, remember to shorten only the twenty-four boards and leave the remaining four boards at full length. The alternative, of course, is to use the 2" X 4" X 8' boards as described below and saw the target to an appropriate length after they have been firmly glued.

Construction is relatively simple. Prepare to lay twenty-four of the 2" X 4" boards together on their 2" (actually 1-1/2") side by first laying two or three 2" X 4" X 8' boards at a right angle to the direction in which the target boards will be laid. These foundation boards not only allow for some access space beneath the target boards if needed for strapping, etc. but they offer an even working surface. Using the caulking gun, apply the liquid nail glue to the 4" (actually 3-1/2") side of the target boards and lay them together as described above. Once the glue has been applied and all twenty-four boards have been laid side-by-side, check and make necessary adjustments to assure that they are even on the ends.

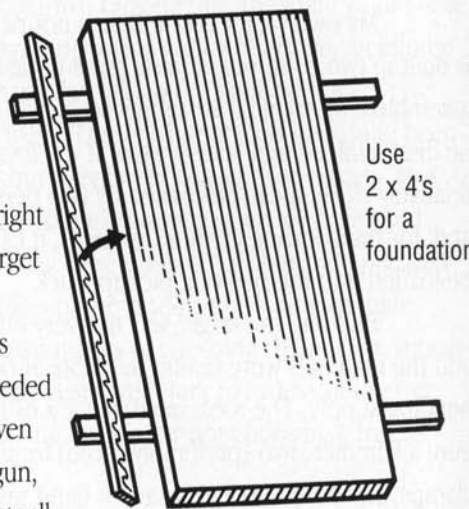

Apply glue to each of the 24 boards, one at a time, and lay together as shown

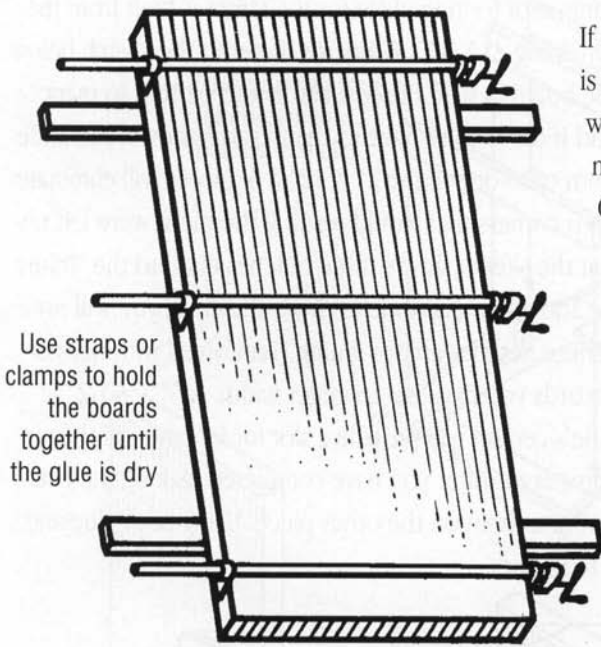

Use straps or clamps to hold the boards together until the glue is dry

If straps are available, this is the time to use them while adjustments are made prior to clamping. Once you are satisfied that the target boards are even, use the clamps to firmly hold the boards together for the length of time required for the glue to dry and cure (check glue manufacturer's recommendations).

The remaining 2" X 4" X 8' boards will be used as top and bottom reinforcement pieces and in building the framework into which the target will be mounted. If you intend to reduce the height of the target and did not shorten the boards prior to gluing them, this should be done after the glue has dried. With the frame boards at the length you desire, measure the width of your target and cut four pieces of that measurement from two of the remaining 2" X 4" X 8' boards. Two of these are then nailed or screwed onto the ends of the target boards at both the top and the bottom; the other two will be used to brace the support frame as described below.

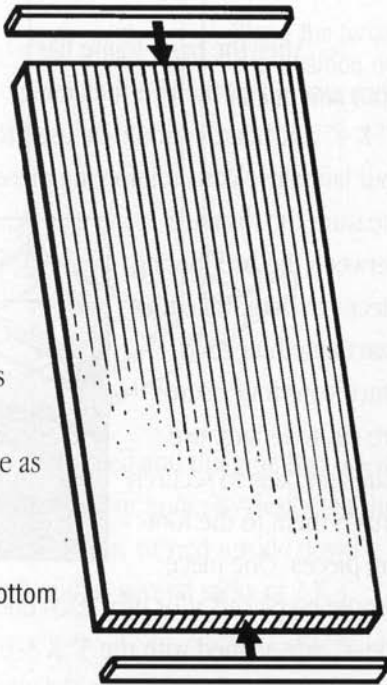

Add top and bottom

The supporting frame or footing piece for the target is built from the 2" X 12" X 10' and the remaining 2" X 4" X 8' boards. Refer to the sketch below and then saw the 12" wide board in half. I used a cardboard pattern to mark the shape of the board and it did help to have my band saw handy in the knife shop. Cutting to the pattern onto one of the 2" X 12" X 5' pieces will eliminate the exposed high and sharp corners that would result if the piece were left uncut. You will note also that the sketch shows three notches cut into the "frame foot." On the bottom side and about eight inches from the ends, you will note a 1-1/2" X 3-1/2" notch. These notches are for gluing (reinforced with nails or screws) the two 2" X 4" boards you have cut to target width. A 5" X 3-1/2" notch, cut into the top side's center, will provide a slot for insertion of the target into its supporting framework. After you have completed making the cuts on this footing piece, duplicate them on the other piece. Using both glue and nails, assemble the parts together.

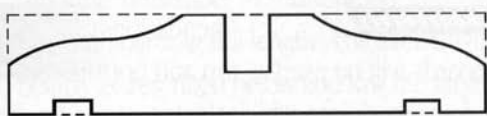

Glue and nail

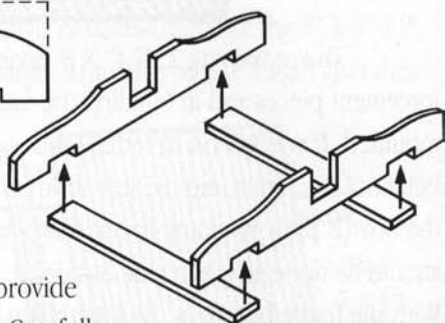

After the basic frame has been assembled the two remaining 2" X 4" X 8' boards should be used to provide four laterally placed reinforcing pieces. Carefully

measure the distance between the two footing pieces to determine the exact length needed.

Once your four boards are cut to length, use glue and nails to securely attach them to the footing pieces. One piece

should be placed at or near each end and the other two should be placed with the 4" side aligned with the 5" X 3-1/2" notch so that they reinforce the area where the target will be inserted into the framework.

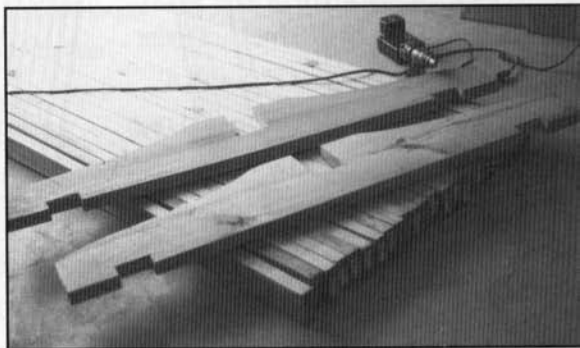

Glue and nail four reinforcement boards in place

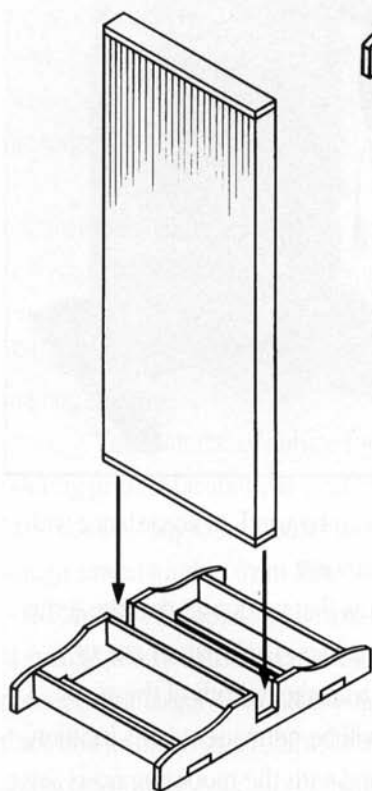
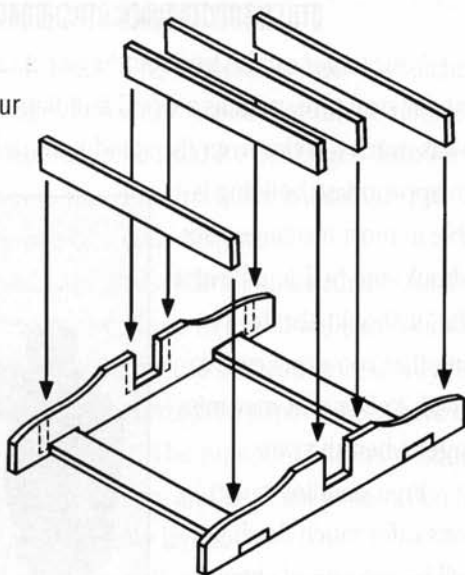

Stand the target into position on supporting frame

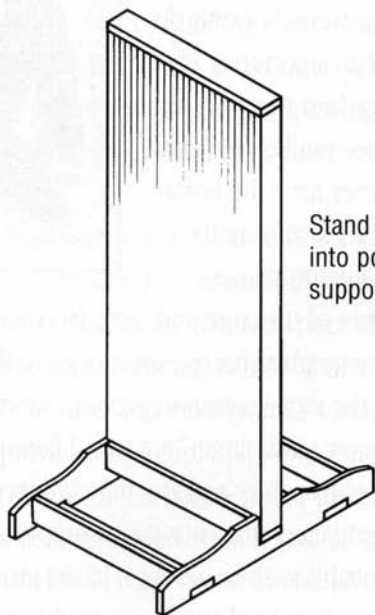

Once the supporting frame is fully assembled and the glue had dried, stand the target into position and enjoy throwing your knife. By designing the target so that it can be lifted out of the base, it can be turned upside down once the wood is worn out. A good base will outlast several racks of 2 X 4 studs.

## OTHER TARGET TYPES - THE MANY ALTERNATIVES

Your target can be free standing or it can be affixed to an appropriate permanent structure, such as a wood building's wall. The permanent structure setup has much to offer from the standpoint of knife throwing, but it is unusual that an appropriate building is available in most instances. Not only should the building be at a safe site, it should also be a building that you don't care to harm with knives that may miss the target when thrown.

Free standing target supports offer much flexibility and will be the one of choice for most throwers. Not only do they offer the opportunity of choosing the best throwing site at home, they can be constructed so that they have the portability needed for moving to knife throwing tournament

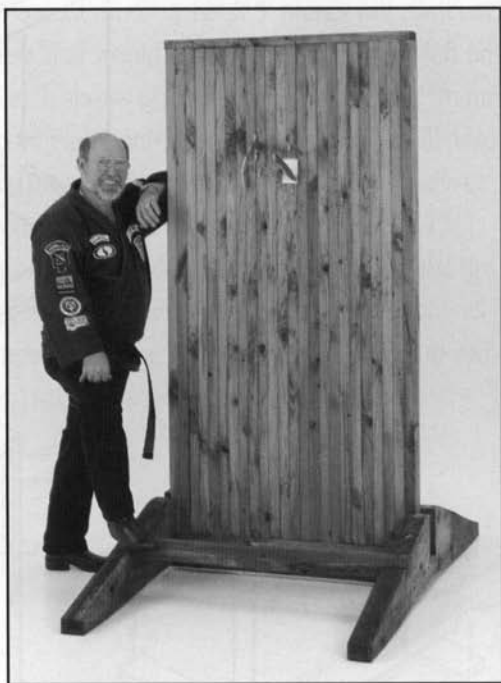

sites. A variety of structure and material types can be used, in accordance with your long range plans for the sport of knife throwing.

In the target selection process, we must first recognize that the terms "target support" and "target" are two different things. Their names are, of course, self-explanatory and you have choices to make in both of these.

If you elect that your target support will be permanent in its location, you will probably wish to mount it in the ground with the mounting posts set into concrete. If you believe that it would be advantageous to have the target transportable, it must be built to mount on a ground-based stand. Although the method of mounting differs, materials and procedures for building the target support are similar. Still, you will need to make the decision before completing your materials list.



## GETTING THE POINT - TARGET MATERIALS

Whether you wish for your target to be suspended from or attached to the support frame is another consideration and it is one that can be decided only after you have selected the material to be used for the target "face" or impact area. This area – at which you intend to throw the knife so that it makes point-first contact – can be one of several materials.

Flattened cardboard boxes make an excellent impact surface for a knife throwing target. They are inexpensive, if not free, and are easy to find and to dispose of when they have been worn out by use or weather. A sturdy backing is needed but, if enough layers of these corrugated paper pieces have been used, a piece of plywood should be sufficient. The number of layers needed is dependent upon the weight of the knife thrown and its usual penetration into the target and will vary from a dozen to twenty layers.

An alternate surface that will serve well on a plywood backing is the relatively inexpensive sheathing materials used by building contractors for covering the wood framework beneath the final brick, wood or vinyl siding. Two 4' x 8' pieces can be cut to make four 4' x 4' layers of long lasting target facing. Either of these two target materials would work best when attached to the target frame.

The material of choice for most seasoned knife throwers and the one offering greater flexibility is a relatively soft wood. Because of their density, Oak, Locust, long-dead Cedars and some Maples are relatively poor choices. Rough sawed lumber from Pine, Birch, Willow, Poplar, Redwood or Cypress are good choices. Except as a backing for a softer and more porous surface material such as the two discussed in the previous paragraph, plywood is not recommended as a target. If wood is your choice, target boards about three inches thick and as much as a foot wide are recommended. A local sawmill should be able to customize your target materials from rough sawed lumber. Not only will your target be solidly built, the materials will cost less than if purchased at a building supply store.

If such a sawmill is not a viable alternative your next best source for lumber is a local building supply dealer. Your choices there, however, may be restricted to standard cut sizes. Because of this, keep in mind that your target can be “two-ply” – boards such as 2" X 12" or 2" X 10" boards running back-to-back, vertically on one side and horizontally on the other. If a two-ply target is used, give consideration to making the actual target surface square rather than rectangular. Using this configuration, you can rotate the target ninety degrees (a quarter turn) whenever you turn the target

around to reverse the impact

faces. Remember that

the knife penetrates best

whenever its

vertical plane

matches that

of the grain

of the wood

target. This rota-

tion allows you to keep

the wood grain of the target

running in the same plane as the

knife blade. Assuming you use a vertical blade throw, you will want the grain of the wood to be vertical. Throwers who use a horizontal blade throw will be able to rotate the target to best serve their throwing methods.

Especially as proficiency improves, the target's center portion gets the greatest amount of punishment from your knife's point. Consequently, it will show wear much quicker than those areas on either side, above, and below the “bullseye” portion. Even if the knife thrown is a relatively light one, the proficient knife thrower will wear out the target's center in less time than one would expect. For this reason, avoid thin boards that will need to be replaced often. Keeping practicality in mind, select the thickest board available. Not only will your target's center last longer but it will also allow the flexibility of turning it over to the unscarred side before replacement is required. Targets made from wood boards can be attached to or suspended from the target frame.

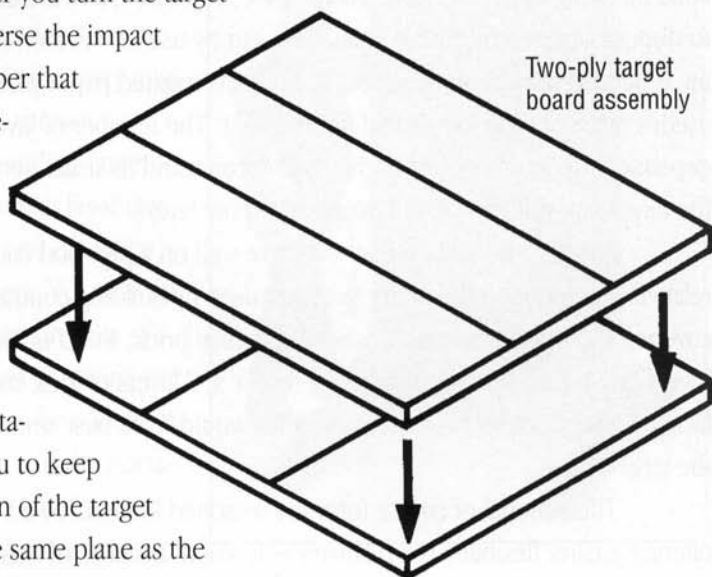

## BACK TO THE TREE - THIS TIME A GOOD CHOICE

An excellent target for either practice, relaxation or competition throwing is a cross-section cut from a large tree or tree stump. Throwing a knife into the end of the wood's grain instead of against it is easy on both the knife and the thrower. If you are fortunate enough to have access to a fallen tree or if you are cutting trees for firewood or other purposes, don't fail to pick out a small section of one for use as a target. And, don't overlook the possibility that a local sawmill can be the source for purchasing an ideal target at a relatively low price or you may even persuade the local utility company's tree crew to cut one for you from a downed tree. An excellent and practical tree cross-section target will be about two feet to thirty inches in diameter and from a minimum of three inches to a maximum of six inches thick. If you think that bigger is better, stop to consider that bigger is also heavier and harder to handle. It is also harder to find and not necessary since, with a little practice, you'll seldom miss the target completely. These targets are long lived, usually inexpensive and they are "recyclable" – all it takes to put a new face on the target surface is to cut off a thin sliver with a chain saw.

This near round piece of wood can be attached to the target frame but you will likely find that suspending it from the frame is much preferred. This allows you to position its height according to your size and throwing style. It also gives you a clearer view of your target because, rather than blending with a nearby background, it stands out in the foreground. The log section can be hung from its frame by using chain attached to metal eye bolts (through the horizontal pipe), eye lag screws (in the log target) and "S" hooks.



Tree cross section target

## MORE ABOUT TARGET SUPPORTS

As described earlier my target stands on a special made support, one that is relatively easy to transport; but as already mentioned, there are other choices. One that seems to me to be the best suited when cross-cut tree sections are used as targets is the fixed support, with the target suspended from it. If a large clear (safe) area is available and if the target is to be permanently located in that area, the easiest to construct and most durable support is a framework made of metal (galvanized or black iron) pipes. You may also find this type of support well suited for other types of targets, especially one made in the two-ply fashion described above.

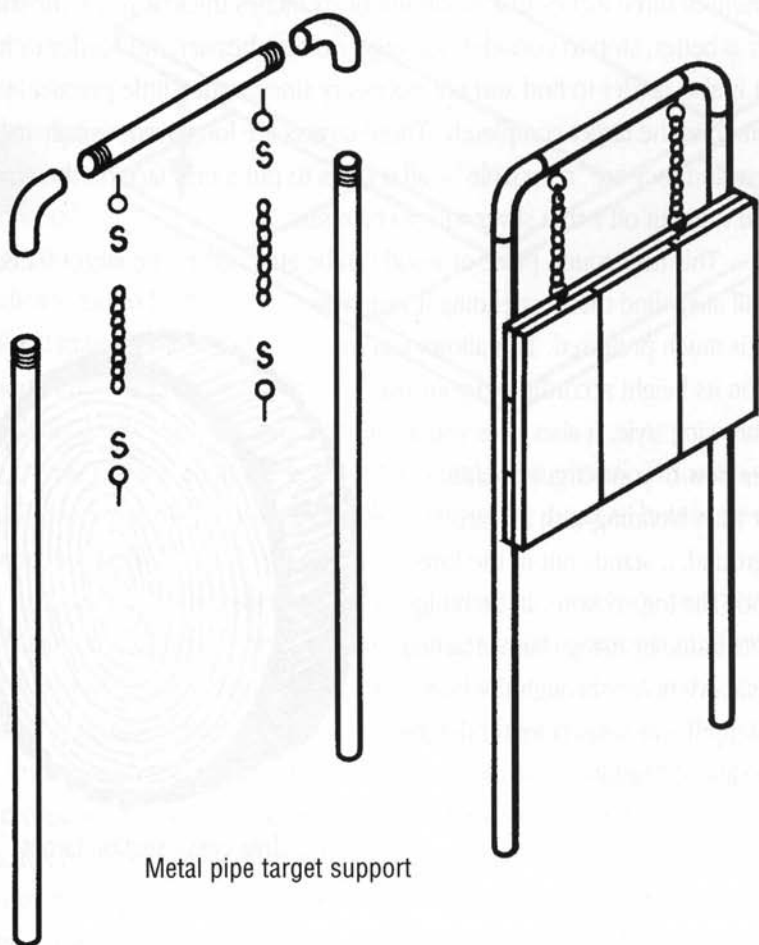

Metal pipe target support

The frame is usually set into in-ground concrete, although it could be a transportable (but heavy) fixture when set into concrete filled concrete building blocks. Assuming the framework is to be permanently installed, the upright pipes should be about eight feet in length to allow for the depth to be set into in-ground concrete. These pipes should be 2" diameter pipes, threaded on one end. A two-foot or three-foot long pipe, of the same diameter and threaded at both ends is used to connect the two upright pipes, using ninety-degree elbows. The top pipe should be drilled so as to accept one or two heavy eye bolts. The materials required for this permanent support are:

- Two sections of 2" pipe, about eight feet in length and threaded on one end
- one section of 2" pipe, two to three feet in length and threaded on both ends
- two ninety-degree elbows of the same diameter as the pipe
- two short lengths (12" to 18") of stout chain
- four heavy (3/8" to 1/2") eye bolts
- four heavy "S" hooks
- two bags of concrete mix

Another type of permanent target support is similar to the one just described except it is made of wood. The wood support is suitable for either a suspended target or one that is attached to the support. The materials required for this support are:

- Two sections of 4" X 4" X 8' treated lumber or landscape timbers
- one section of 4" X 4" X 4' treated lumber or landscape timbers
- two bags of concrete mix
- 60d or larger nails

If you plan to suspend your target from this support you will need the chain and "S" hooks described above as well as four heavy (3/8" to 1/2") eye lag screws. Most throwers, however, prefer to attach the target onto the wood support, using nails or lag screws. In this case, add lag screws or nails of sufficient size to your materials list; you will not need the chain, hooks and eye lag screws.

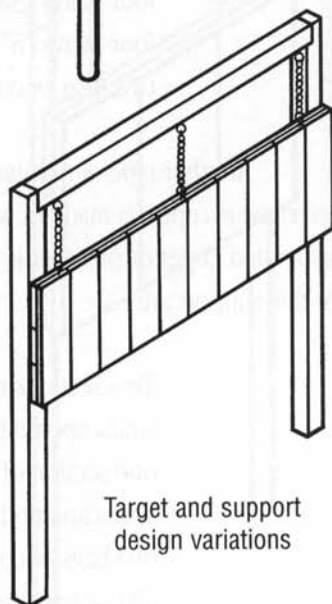
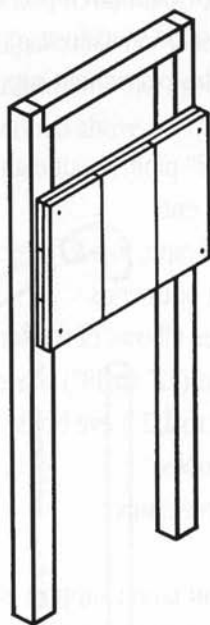
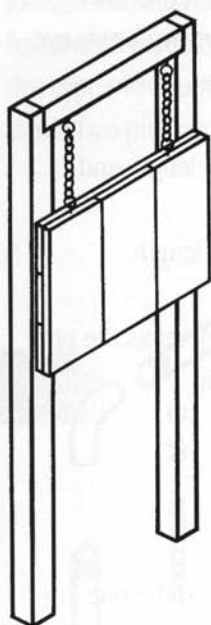

Target and support design variations

I suggest that you saw a notch into the top ends of your upright supports and both ends of the cross piece so that they fit together in a supporting manner. An alternative to notching is to use two metal framing connectors, easily found at building supply stores.

Either of the support frames described above should be set into the ground about 18", with concrete added for the desired stability.

Regardless of the type of target support you choose, your target should be mounted onto the support so that its center is about shoulder level.

## THROWING INDOORS

The best and most natural place to throw knives is outside; but an alternative or supplemental indoor knife throwing range is not out of the question. With proper facilities, materials and "throwing range" preparation, knives can safely and effectively be thrown in a basement or garage. If you chose to throw knives in such an indoor setting, remember that walls, floors and ceilings offer surfaces that can not only damage your knives but offer knife bounce/ricochet hazards as well. It is, therefore, essential that you cover wall and floor areas near your target. The use of carpet or other similar materials will help prevent damage to your knives, yourself or other persons in the area. You may also consider a smaller, lighter model knife for inside throwing.

### HOW TO THROW - THE BASIC SKILLS

Before getting started in throwing your knife, consider a few suggestions concerning getting prepared to throw. First, throwing is much easier when you are young. So, unless you're young and have very good muscle tone, warm up! Even though I try to think young, the old muscles tell me different. If you have played baseball, you have an advantage. I recommend playing a little catch with a friend to loosen up. Otherwise, a brief stretching and bending routine will help. Just be careful not to over do it in the beginning.

Just as you condition your body for the challenge and the pleasures of knife throwing, getting into the proper frame of mind is important. Decide that you will learn from each throw, whether it is your first or one-thousandth. I believe that good knife throwing requires mental discipline and it helps to develop a mind-set that allows you to visualize your knife hitting and sticking into the target's bullseye spot. And finally, do not drink alcohol while throwing knives! Just as alcohol and guns do not mix, neither do alcohol and knives.

Throwing the knife consists of a number of distinct steps: the grip, the stance, the presentation, the delivery (wind-up or back-swing and swing), the release and the follow-through. We'll first consider throwing techniques for the handle throw, the method that I use and recommend. Except for grip and presentation, those techniques will not change as we look later at other methods.

## GRIP

The way you hold the knife - the grip - is very important to successful knife throwing and the manner in which you grip the knife should be as consistent as possible. The flat side of the knife's handle should be firmly seated in the palm of the hand, with its heel "locked into" the back of the palm. The fingers should wrap around the handle and grip the opposite flat side. The thumb's position is very important, not only because it firms up the grip but also because it can serve as a "pointer." It can be placed on the flat side, helping the fingers to hold the knife or on the top.

The position you choose for the thumb may vary depending upon the knife you use, but in whichever manner you choose, it should point forward.

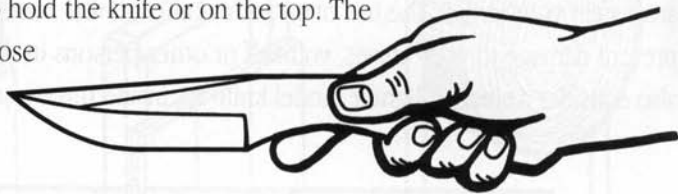

Handle throwing grip



## STANCE

I begin by stepping on my marker - which is about 16-1/2 feet from the target - with my right foot. My left foot is about 1-1/2 feet behind the right foot and about 1 foot to its left. My knees are bent very slightly to offer steadiness and comfort. It is from this position that I present the knife.

As I go into the wind-up, bringing my right arm back and extending my left arm toward the target, I am stepping forward with my left foot. When it touches the ground and is firmly placed, the forward swing begins. The momentum of the swing brings my right leg into motion and, at the point of release, my right heel is off the ground bringing my body into the throw. During the follow-through, I have the option of walking through or settling back down into position. Believing that it adds strength to the throw, I usually walk on through.



Recommending a specific way to stand or, for that matter, which foot to have forward when the knife is thrown is very difficult. I feel comfortable and consistent in my own stance and that is important. It is also important to you, and I should point out that your stance should be the one in which you feel the most comfortable. Whether the right or left foot is forward when the knife leaves the hand matters not as much as whether the thrower feels natural and firmly placed. You may wish to try throwing using a stance similar to mine and then change to throw from the other foot. Remember that your balance and comfort, combined with the consistency are the best determining factors in choosing your stance.

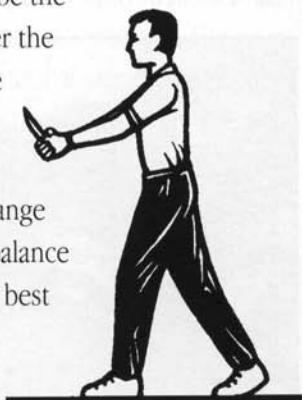

Proper stance examples



## PRESENTATION

After getting a proper grip on the knife's handle, I like to present it to the target, in much the same way as a bowler presents the ball to the pins. This is an excellent opportunity to use your mind to visualize the knife rotating into

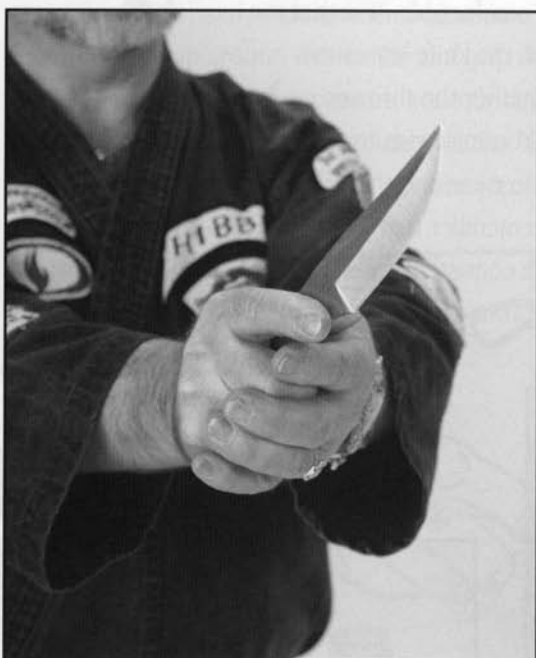

an exact spot on the target. Experience will tell you whether it works for you, but I like to use my left hand (I throw right handed) to help in concentrating on the presentation. I believe it serves to bring the whole body into harmony with the mind, allowing you to extend the mind to a spot on the target.



## DELIVERY

As I begin the wind-up or back-swing by bringing the right arm back past my head and over my shoulder, I am extending the left shoulder and moving that arm into position so that the left hand points at the target. This

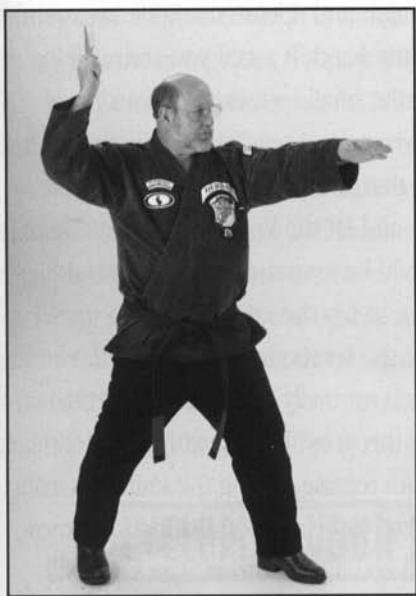

allows for better balance in the wind-up and offers further opportunity to coordinate mind and body in the overall action of throwing. The wind-up or back-swing should be done smoothly



with the plane of the blade remaining vertical.

While my right hand is drawn back, I keep the other hand pointed at the target. Once the throwing arm is in position behind the shoulder, the

delivery swing begins. It also should be done smoothly and in an arc similar to that of the back-swing. As the swing begins, I start to drop the extended left

arm and allow it to swing down and

back, continuing

to be a balancing and power factor. The

swing continues until the knife is released at about eye level and then on

beyond that in the follow-through.

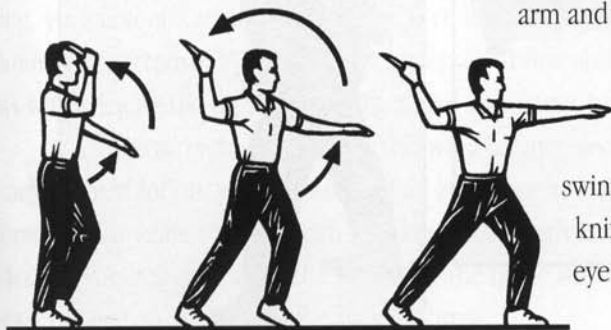

Wind up and delivery

## RELEASE

Whenever your swing has reached the exact point that the knife should begin its flight to the target, release your grip. I throw with considerable strength and release the knife by extending the hand. It's as if you are reaching for that small spot that you've already set your mind on. Releasing your grip is just that and no more; just release the grip and let the knife do the rest. There should be no wrist action that would serve to flip the knife. Doing so would alter the rotational pattern that the knife would normally take in a proper throw.



Swing and release

Furthermore, even if you have a successful throw by flipping with wrist action, you would not be able to repeat it. A smooth release, letting the knife slip from your hand is paramount to an accurate throw. You will soon instinctively know the moment of release and practice will tell you if it is correct. The knife will stick the way you release it. If it sticks diagonally, that's the way you released it. You want it to be straight up and down. Just as with the other steps in throwing, your release should be consistent with each throw.

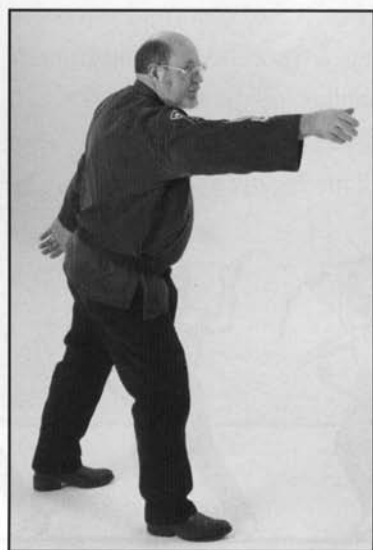

## FOLLOW-THROUGH

Just as it is important in golf, baseball, horseshoes or shooting at a moving target, follow-through is a physical and mental exercise needed for precision. Simply stated, follow-through is an extension or continuation of the swing to insure that the swing does not stop abruptly at the instant the knife is released. It's similar to what a bowler would call "body english." Concentrate on the target and visualize the knife hitting it just where you had planned in the presentation.

Since most of the steps above are inter-related and some are done in conjunction with others, it is difficult to describe them as though they were totally independent of one another. You will develop your own style so that each step will mesh with the others. According to my golfing coach, it is impossible to swing the club exactly the same way each time – only close. That is also true in knife throwing; so, come as close as you can and you'll find that time and continued practice will bring consistency.

## DEVELOPING YOUR OWN THROWING STYLE

I've said a lot earlier about balance but let's tie it in to throwing techniques by recognizing the practical importance of balance. A knife's balance, coupled with the method in which it is thrown, dictates what happens when it is in flight from your hand to the target. Not only does it affect the diameter of the circle it will make in a complete rotation, it determines the distance at which the knife will make full, half, one-and-a-half or two turns. So the bottom line of understanding knife balance, as it relates to throwing, is to know at what distance from the target it should leave your hand in order to make forceful and penetrating contact with the target. Now that you're ready to begin throwing, your first task in applying what you've learned is getting to know your knife's characteristics. Don't be so concerned at first about hitting the bullseye as with sticking the knife in the target on a consistent basis.

To determine your knife's throwing balance and at what distance it makes a revolution, you must use a trial and error method and observe very carefully the knife's impact with the target. Although at some point you will decide whether you prefer the handle or the blade throw, for this learning experience you should use the handle throw.

The purpose of these trial and error throws is to learn the distance at which the knife makes one complete rotation so that you can position yourself there for a perfect stick each time. Fortunately, with the handle throw and the blade in a vertical plane, you will be able to stick your knife into the target even though the point may not hit at a precise right angle. This greater margin of error allows you to better observe the effect of the throwing distance and make very slight adjustments accordingly. Remember, if the knife sticks with the handle angled upward, move closer to the target; if it sticks handle down, move back a little. And, don't forget that when you vary the distance, you must keep your wind-up, release, throwing force and follow-through consistent.

### One Turn Rotation - Handle Throw

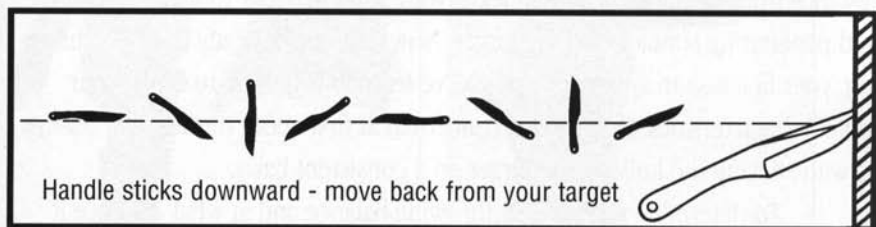
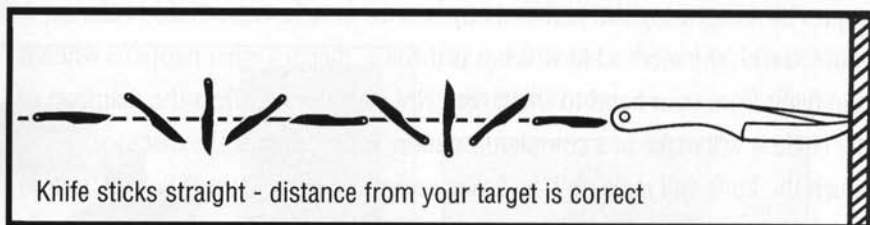
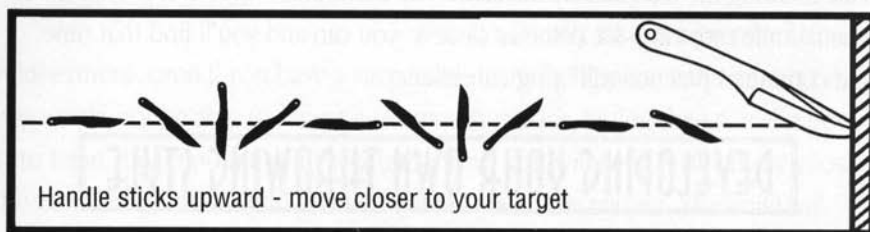

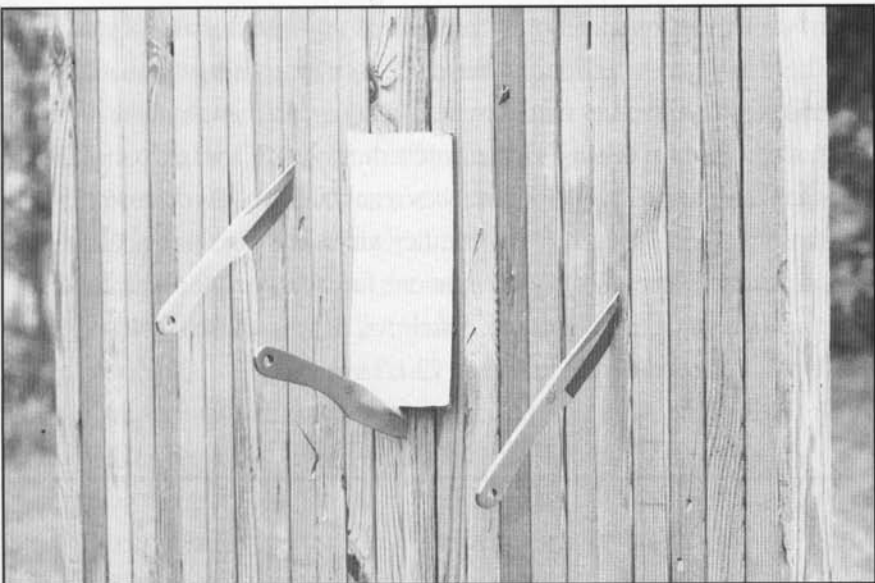

Examples of improper throws

Step off the distance so that you can position yourself at a point where the knife will leave your hand approximately 15 feet from the target. Keeping your throwing techniques the same, watch the knife's contact with the target. If it strikes the target point first with handle not tilted in either direction, you've made a successful throw and found the proper distance from you to the target. On the unlikely occasion that the butt hits first, your position is near half or twice the correct distance for that specific throwing technique. You already know what to do if the knife sticks several times with the handle canted up or down. If it hits flat and fails to stick, try to determine whether it hit the target with handle up or down and adjust your distance accordingly.

Once you've determined the exact distance required for the knife rotation so that it strikes solidly point first, pace off the distance and get a mental image of it as well. This is the position for at least another dozen practice throws to affirm that this truly is the distance for your knife and your techniques and not just luck.

After, and only after, you have learned the characteristics of your knife and the distance required for it to make one rotation consistently should you experiment with the other rotations. Assuming that you have become proficient at the one-turn distance of the handle throw, you'll change to the blade throw method to determine the distances required for a half-rotation or one-and-a-half rotations. It's very likely that they will not be exactly one half or one-and-a-half times the distance needed for one full rotation. If the knife makes exactly one rotation at 15 feet, it very likely will not make a half rotation at 7-1/2 feet nor one-and-a-half rotations at 22-1/2 feet.

#### Blade Throw - Horizontal

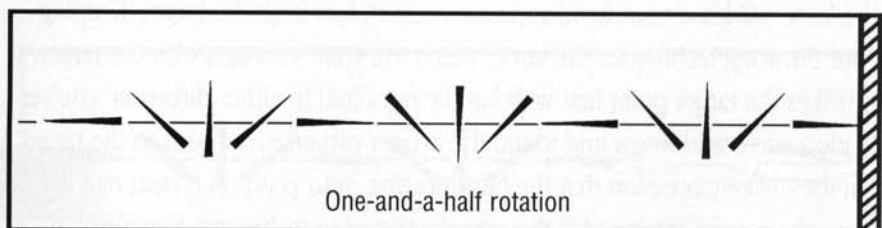
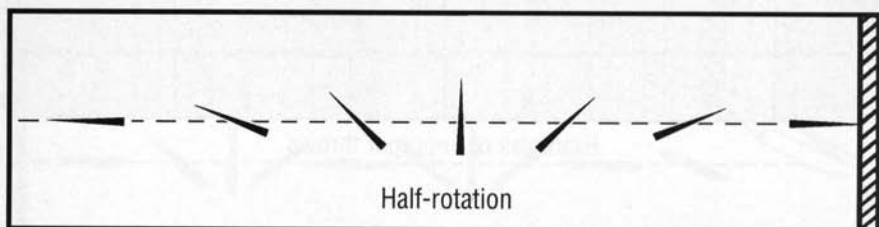

So far, your knife throwing time has been dedicated to learning the rotational characteristics of the knife. With practice, distancing yourself from the target will become almost second nature and, with practice, you'll find that you'll be more able to concentrate on sticking the knife in the bullseye. Up to this point, we have not been so concerned with hitting the bullseye as with sticking the knife into the target at a near right angle. If you have been in the military and had rifle marksmanship training, you will recall that a prerequisite to high-score shooting is being able to "call your shots" – predicting where the bullets hit the target. Only then could you make elevation and windage adjustments to your sights and concentrate on shooting holes in the bullseye.



Improving knife marksmanship is much like that. Get the techniques down pat and then you can confidently move the knife into the target's center spot.

Although you want to get power into your throw, it should be done as smoothly as possible. Therefore, throwing each time at full force is not suggested; full force will vary too much as you tire out. Limit the force you expend so that it will be near the same on each throw.

Practice is important and the more you practice and learn from it, the better you will be able to throw your knife. You should recognize, however, that practicing too long, until your body and mind are exhausted, can be counter-productive. One way to save energy and have more productive time in throwing is to use more than one knife, meaning fewer trips to target and maintaining the exact position for repetitive throws. Whether you throw one or three knives, be sure that you end your practice session on a happy note, with a successful throw.

### THROWING BY THE BLADE

A reason that I throw by the handle, other than the fact that I'm partial to the handle throw, is that my knife's blade is quite sharp. That's because it is made with utility in mind and, for utility purposes, a knife must cut. When thrown by the blade in the vertical plane, it can cut your hand. There are some knives, made only for throwing, that do not have sharpened edges and these can be thrown with a blade grip and with the blade held vertically in much the same manner as the handle grip. If the knife you choose to throw has a sharpened edge, for safety reasons, it should only be thrown by the horizontal blade throw grip. You surely would not want to wrap your fingers around the sharpened edge and then let it slide through the hand at the release point!

So, if we assume that the vertical blade grip is out of the question because of a sharpened blade edge, let's consider the blade grip. Keep in mind that the horizontal blade throw will usually be harder on the knife's blade. That's because of the shock to the blade's tip when the knife firmly sticks (horizontally) in the target and the rest of the blade wants to continue its rotation. You will also recognize that the horizontal blade throw offers less margin of error in sticking than does the vertical throw you have tried earlier.

The bottom line is that your throw, to be successful, must be much more accurate as the sketches below will show. On the plus side, the horizontal blade throw method offers a better feel at the release point and a smoother release.

### Handle Throw - Vertical Rotation

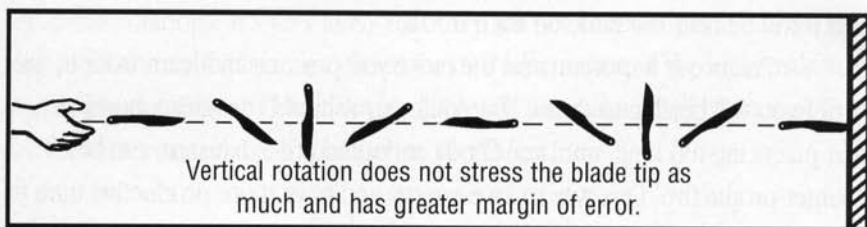

### Blade throw-horizontal rotation

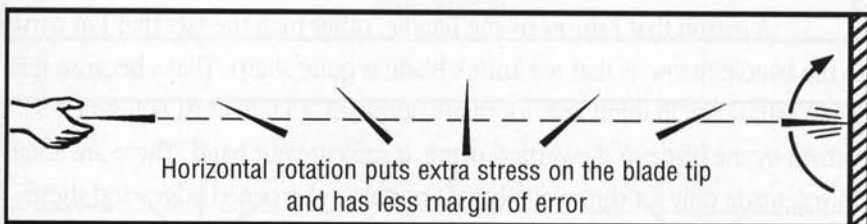

In the blade throw, the knife is gripped with the blade back against the palm of your hand and its edge not in contact with any part of the hand. The blade's bottom surface rests on the fingers and palm of the hand. It is held there by the thumb, which lies across the top surface of the blade and is pointed toward the target.

Because of the necessity of lining up the thumb with the direction of throw the blade back will lie diagonally across the palm. Although all fingers are or can be used, with this positioning the forefinger plays the major role and the little finger is of practically no use. The thumb and forefinger knuckle should be positioned near the guard or, on a guardless knife, at the point where the blade ends and the handle begins. The blade should be gripped firmly, but it is not necessary to grip it really hard. Doing so would alter your throwing techniques and with a moderately firm grip, you won't be letting the knife go until you want to at the release point.

The movements are the same as with the handle throw, but with the distance extended to allow for the one-and-one-half spin or reduced for the one-half spin.

### Blade Throwing Grip - Horizontal

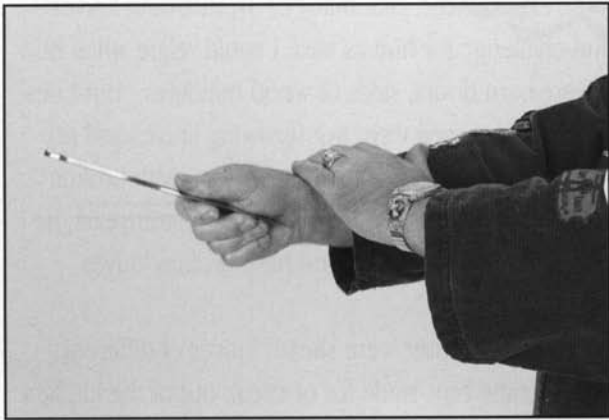

SIDE VIEW

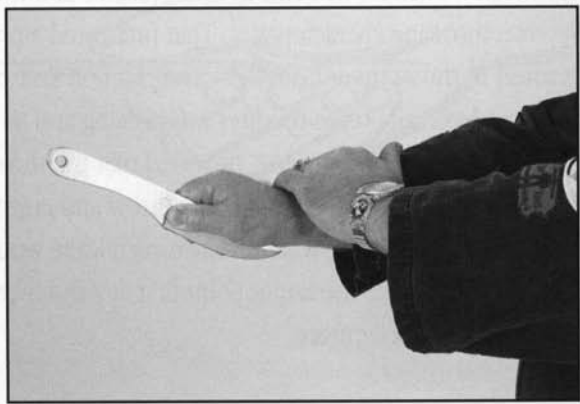

TOP VIEW

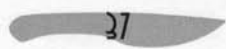

## THROWING FROM ANY DISTANCE

Most often in sport throwing, whether for competition or for personal pleasure, the distance from the thrower to the target remains near the same. Once the knife's rotational patterns are understood and the method (handle or blade) of throwing is determined, the point of throw is marked and used time after time. That's the type of throwing that I have done over the years in competition or in demonstration throwing. Chances are very good that it's the type of throwing that you will be doing most of the time. Still, I want to share some insight into how you can throw your knife at distances that vary from these standards.

One of my good friends is Houston Price and, although one of the several interests we've shared for a number of years is knives, I only recently learned of his knife throwing experiences. Like many of us, throwing knives was a boyhood pastime and challenge for him as well. I could relate when he explained that his targets were barn doors, sides of wood buildings, "out-houses" and - yes - trees. The knives he owned were not throwing knives and no two were the same. And, as he recalls, most of them wound up with broken tips or fractured handles. He must have been pleased when, in later years, he could afford to throw the Marine Corps "Ka-Bar" and have broken knives replaced by the supply sergeant.

The knives he used as a youngster were sheath knives of different styles and sizes – whatever he could buy, trade for or sneak out of the kitchen. Although he usually had two to four available at any one time, each knife had its own throwing characteristics. That presented a problem, especially since he wanted to throw them from the same position and at the same target.

Necessity often requires improvising and so he did. He learned that a knife's rotation is predictable, provided that the throwing technique remains constant. Using the horizontal blade throw and gripping the blade at the guard, he would determine at what distance each knife would make a half turn. Some knives would strike the target point first at a distance of four paces, others might require six or more.

He learned that gripping the blade at other positions would alter the distance required for the half turn. For instance, if a knife thrown with the blade held at the guard makes a half-turn in five paces, it will make that half turn at approximately half that distance when held at a point half way from blade tip to guard. He learned to quickly estimate the distance to the target, to extrapolate that in terms of grip position on the blade and then to use his standard delivery and release.

Throwing from any distance  
using different gripping positions

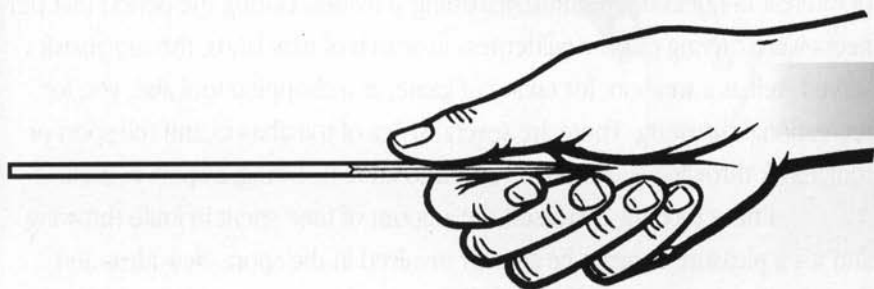
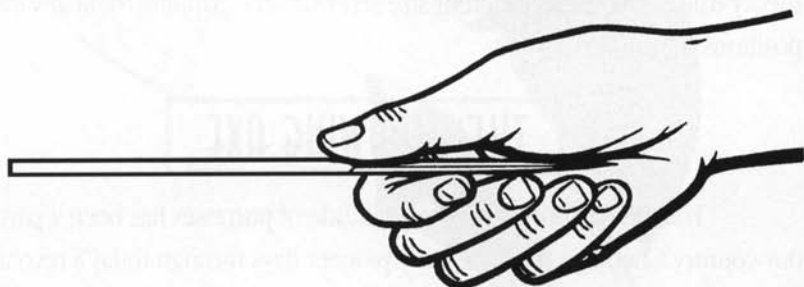
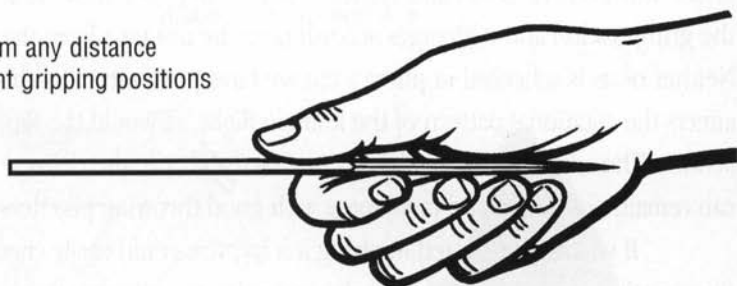

For Houston, the system worked because he compensated for the variety of rotational characteristics while keeping the distance the same. So, in throwing knives of the same or very similar rotational characteristics, one could use the system whenever distance is varied.. It is not unlike changing from handle to blade throw when going from fifteen or twenty feet to a the shorter fixed distance of one-half spin.

I have stated earlier that flipping the knife by wrist action, which I often refer to as the shotgun method, is not advisable. In discussing his experiences, however, Houston and I agree that the effect is similar. What changes is the grip position and it changes according to the distance from the target. Neither of us is schooled in physics but we have presumed that this system affects the rotational pattern of the knife in flight, as would the flip (using wrist action). The advantage is that, unlike with wrist action, the delivery and release can remain consistent and in keeping with good throwing practices.

If you are interested in giving it a try, you could easily check out the theory using a couple of different size screwdrivers, gripping them at various positions on the driver shaft.

## THE THROWING AXE

Tomahawk throwing for a multitude of purposes has been a part of our country's heritage from the early pioneer days through today's revolution of interest in buckskinning/muzzleloading activities. During the period that pioneers were carving out the wilderness in search of new lands, the tomahawk served well as a weapon, for taking of game, as a chopping tool and, yes, for recreational throwing. There are several styles of tomahawks and the sport of tomahawk throwing is, although related to knife throwing, a sport in itself.

I have recently increased the amount of time spent in knife throwing and it's a pleasure to again be actively involved in the sport. New ideas and thoughts for designs have been an offshoot of this renewed involvement. Having thrown tomahawks and unique axes since my young days, I became intrigued in designing and making a truly effective throwing axe. After much thought and the making of several prototype test models, I am quite pleased with the end product. I wish I had thought of it sooner!

The Pro-Thrower Axe (UC866) is 12" in overall length and weighs a full pound. The head is designed to facilitate sticking into the target and the handle's "trigger grip" design guides the hand into the ideal grip for throwing. Although it was designed as a throwing axe, utility was not overlooked. The head will chop and cut as an axe should and the handle profile allows a comfortable and natural position for the chopping grip.

Hibben Pro-Thrower Axe

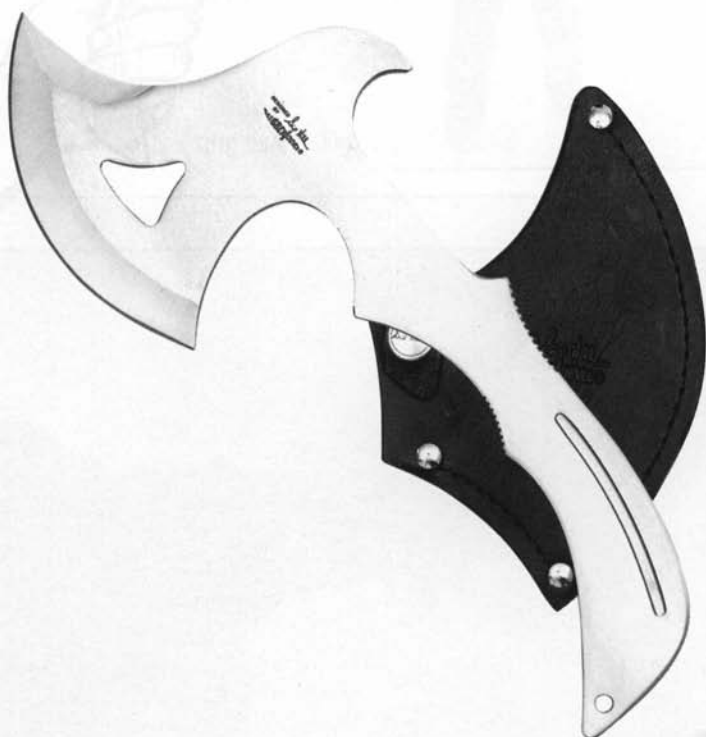

Throwing the axe and sticking it into the target is very easy because of the handle and head design. Using the handle grip, for which it was designed, the thumb rests on the top of the handle (like the Chinese Fist). The palm and fingers are wrapped around the handles so that the forefinger fits into a grip that is not only natural but strong as well. The thumb-on-top grip allows the forearm muscles to be used to stabilize and strengthen the throw.



Axe grip

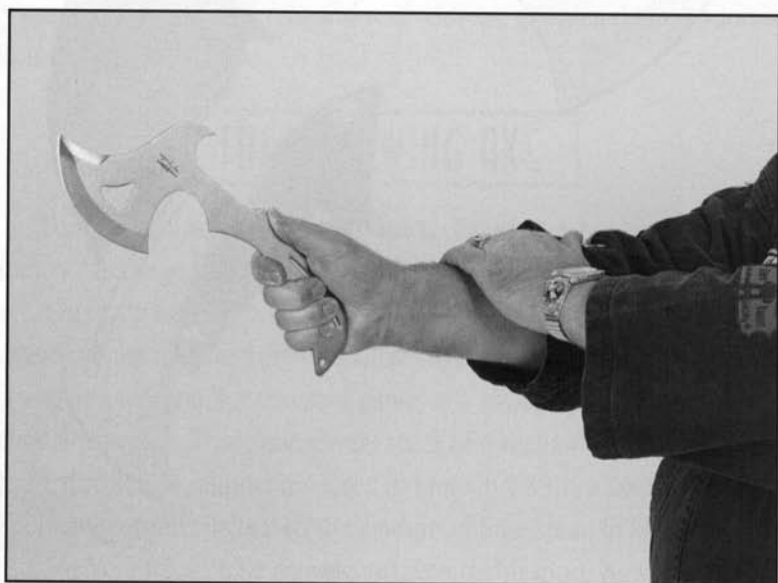



My stance for the throw (Fig. 1) is the same as for knife throwing and I position myself about 16-1/2 feet from the target. Similar to knife throwing, I present the axe to the target and get a mental picture of the axe flying through the air into the target. In the presentation, I use my left hand on the right forearm to bring the whole of my body into the action.



Fig. 1



Axe presentation

I use a short backswing  
**(Fig. 2, 3 & 4)** that  
brings the arm straight  
back beside my head and  
behind my shoulder. The  
delivery is an overhand  
throw.

Wind up and delivery

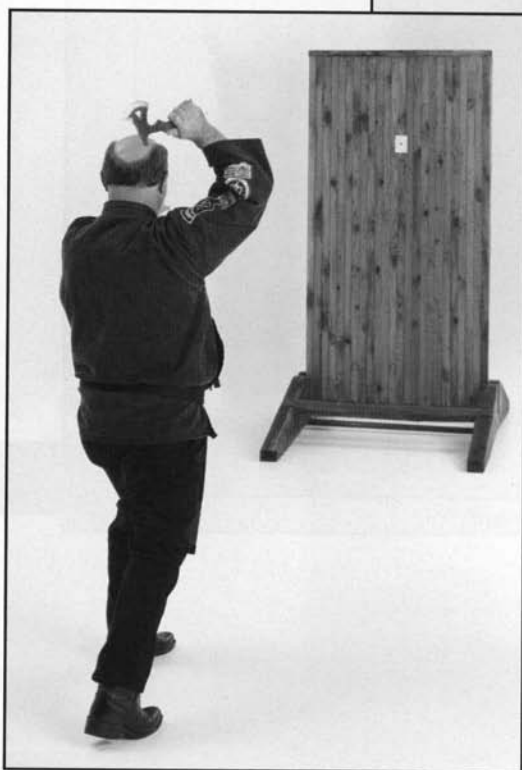
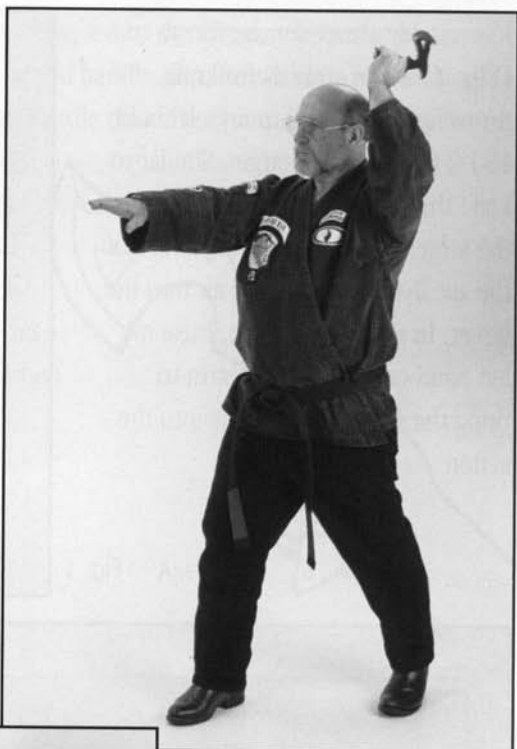

The release (**Fig. 5**) is made by extending the hand to the target and allowing the swing to continue in the follow-through toward the target. I use the whole body in the throw but, with the weight and balance of this axe, it takes very little effort to have a successful throw. Use the trial and error method I described in the Developing Your Own Throwing Style” section to determine the axe’s throwing balance and at what distance it makes a complete rotation. Remember, if the axe sticks with the handle angled upward, move closer to the target; if it sticks handle down, move back a little. Be sure to keep the wind-up, release, throwing force and follow-through consistent each time.



Release

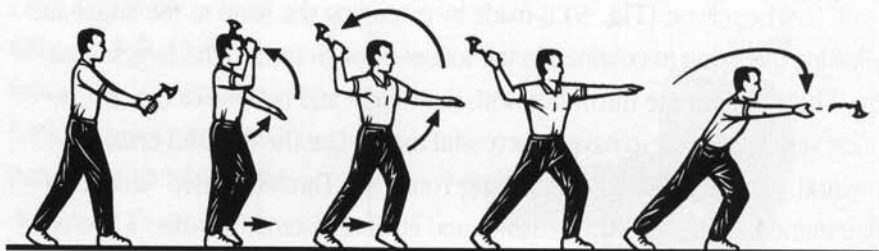

Fig. 1

Fig. 2

Fig. 3

Fig. 4

Fig. 5

STANCE

WIND UP

SWING & RELEASE

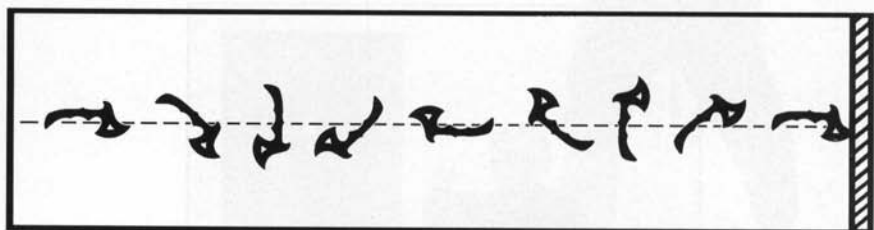

Axe Throw - One Rotation

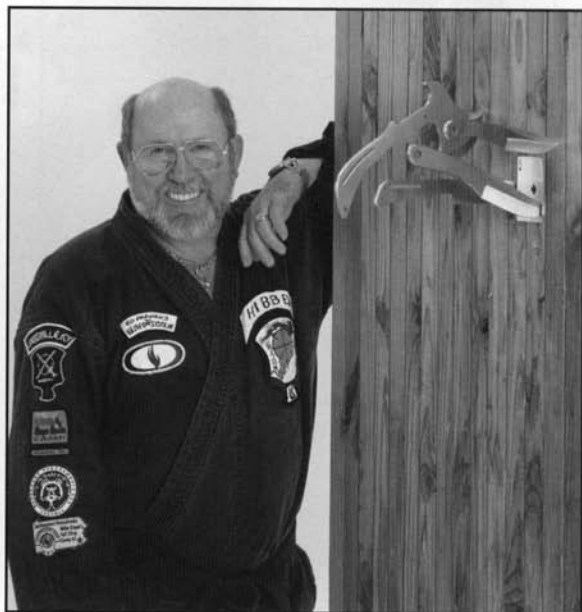

Practice until perfect and have fun!

# GIL HIBBEN - THE MAN AND HIS KNIVES

by C. Houston Price

Gilbert W. Hibben of La Grange, Kentucky is an unusual man, one who has been able to build his life around an object and a profession he truly loves – knives. In his own quiet and unassuming way, Hibben has made his mark in the world of handmade knives. He has pioneered; he has taught; he has influenced; and, for along time, he has had the recognition and respect of custom knife fanciers. As creator of the Rambo III knife and a host of others, Gil Hibben is now recognized throughout this country and most other countries as well.

When one first meets Gil, his soft spoken and friendly manner would quickly reveal that he is a true gentleman, a family man – father and grandfather. Visiting with him reveals seemingly endless talents and experiences – some unrelated to knives and knifemaking. A smooth and pleasing tone sets the stage for learning that Hibben's tenor voice has been heard singing with the Mormon Tabernacle Choir as well as the award winning Thoroughbred Barbershop Chorus. It's a voice that can also be heard as N4LRF on the Amateur Radio bands as well. With musical talents not limited to singing, Gil plays guitar and is extremely talented at the near-lost art of playing "rhythm bones" - learned in childhood from his father. Whether he makes do with teaspoons or uses his own handcrafted "bones," Hibben can complement almost any musical act.

There are other sides to this versatile man such as his expertise in the Martial Arts. He holds a black belt in judo as well as a third degree black belt in Kenpo karate, which he has taught. Hibben enjoys hunting and served as a hunting guide during his residency in Alaska. And, whenever such a busy man seeks time to relax, he does so by riding his Harley-Davidson motorcycle.

Gil has spent the greatest part of his life making knives, beginning it as a hobby after his 1956 discharge from the Navy. His first knife was made in 1950, but he doesn't count it as the beginning of his knifemaking career. That's when he wanted a big knife like the one carried by Jim Bowie and was unable to afford to buy one. Looking back at the experience, Hibben figures that he labored at least sixty hours with a stone grinder, file and drill in making that first knife.

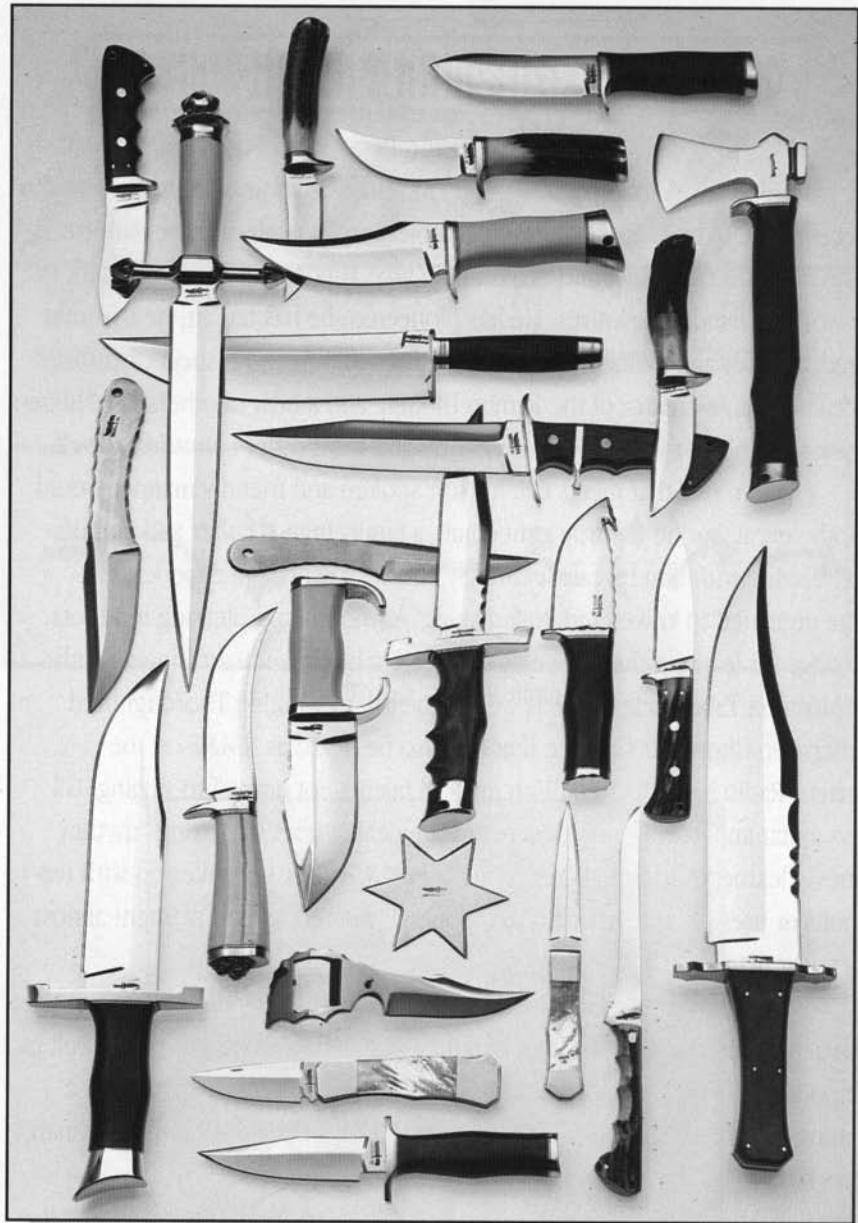

Examples of Gil's many custom made sport, hunting and utility knives

His early knives were given away with his father, his brother and a number of friends as the recipients. "I was having a great time making them. My love of making knives meant more than owning them," he recalls, admitting that as one of his early downfalls. "I enjoyed it so much that I was going broke. I couldn't afford to buy material and then give the knives away - but, I did it." Then someone wanted to buy a knife and he sold his first bowie for \$45. "That's the kicker," he points out, "when you get some money for your work. I was hooked. I had graduated from the pure pleasure of making knives to thinking, hey, people will actually buy these things."

During the next several years as a part-time knifemaker, Hibben was selling knives to local hunters and sportsmen. Knifemaking began to occupy more and more of his time and thoughts so that, in 1964, he became a full-time maker working in Salt Lake City, Utah. In 1965, when one of his knives was pictured on the cover of Guns and Ammo magazine, Hibben was transformed from a maker of knives for local hunters and sportsmen into one that was nationally known. To reduce overhead and because of the area's good fishing and hunting, he moved that year to Manti, about 125 miles south and in the center of the state.



## CUS+⊕M DAGGER

The next five years spent in Manti were significant ones in Hibben's knifemaking career. He had the pleasure of working and learning with, teaching and influencing a number of makers whose names were relatively unknown at the time but could now be



featured in a "Who's Who" of the knifemaking world. The Small Business Association had helped set up a knifemakers' apprentice course, with Hibben as the instructor at the Utah School of Knifemaking



and he is the only knifemaker to have been officially recognized by the government as a teacher of the craft.

Another highlight of his Utah years was his designing, in 1968, all of Browning's original line of knives.

While living in Seattle after his Navy discharge, Hibben worked as a machinist for Boeing Aircraft and learned of some excellent metals. He began making knives using an industrial-use steel known as 01. It was 1964 when he learned of a new "super steel" called 440C. Because it was available only in round, square or hexagon stock, using it was no easy task. Hibben recalls, "We had to hand forge everything into knife blanks. I used gas fired ovens, a fifty pound trip hammer, a big anvil and wore wrist supports while pounding my way through all those knives." He feels confident that he was the first custom knifemaker to use 440C and, to the best of his knowledge, Hibben was the



first maker to mirror polish custom blades. In claiming these innovations, Hibben is quick to add, "Nothing I did was all that special; it's just that I was there." One thing that he's very proud of, however, is having been able to help beginning knifemakers. It is with no small degree of satisfaction that Hibben smiles as he calls himself the Johnny Appleseed of knifemakers – "It seems that wherever I go, there are knifemakers springing up around me."



Hibben was and is a prolific knifemaker. He made about 300 knives for use by our servicemen during the Vietnam conflict and feels that his first hand knowledge of the martial arts has helped him in making knives that are functional. Just as his martial arts experience has benefited his knifemaking abilities, Hibben feels that his five years experience serving in Alaska as a guide to big game hunters helped him to understand just what is required in knives used in the wilderness.

When asked about the Rambo® III movie knife, Hibben explains, "It was luck." Since meeting a few years ago, Sylvester Stallone has purchased over twenty Hibben knives for his own collection. Still, there was real excitement around the Hibben household when Stallone called him one evening and asked if he'd like to make a knife for the new movie. They began discussing designs and agreed that a large bowie made by Hibben many years ago should be a good basic design. The success of the movie is now history, but the knife featured in it continues to establish new records; the Rambo® III knife could well be the best selling knife of this decade. Hibben's association with United Cutlery has resulted in many thousands of knives, factory made to his design and his specifications, selling throughout the world.

Hibben's handmade knives cover a wide variety, from small skinners to large and heavy swords - some with blades a yard in length. Production time can range from a week to six or more months, depending on the design. Prices of his handmade pieces range from about \$300 to over \$10,000, depending upon the knife.

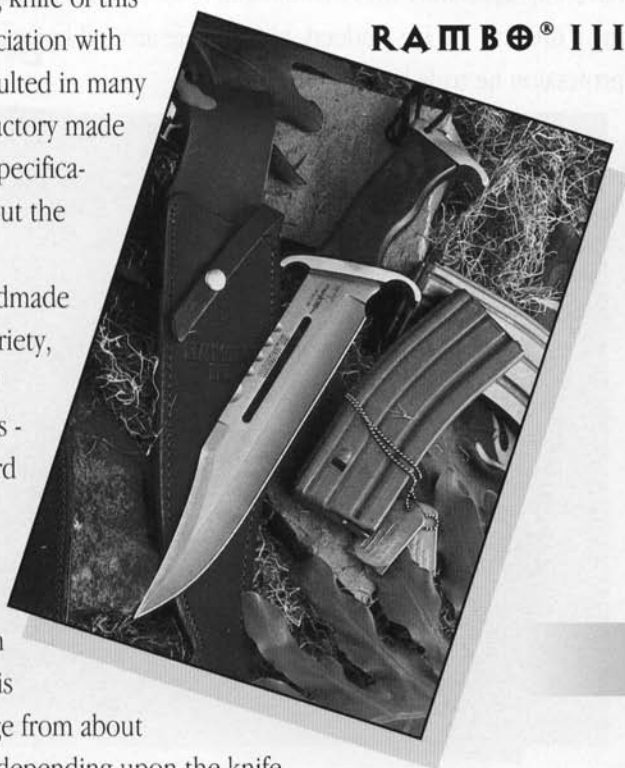

More recently, he has preferred to make art knives and is earning attention for some of his elaborate work. "I liked doing the movie knife," he says, "but I'd like to be remembered even more for being an artist. I never dreamed of being an artist."

As a teenager slaving away to make a knife like Bowie's, Gil never dreamed of a hero like Rambo nor that he would someday be making a special movie knife. Nor did he dream that he'd have the opportunity of making knives for personalities such as John Wayne, Elvis Presley, Steve McQueen, Sylvester Stallone and Steven Segal or world leaders such as Israel's Defense Minister Moshe Dayan and Vice-President Dan Quayle.

As a knifemaker and knife designer, Hibben has earned a dedicated following of knife users and collectors from all parts of the world. Call it luck, if you want, but recognize that the luck has been a long time in coming. Call it the good fortune of being in the right place at the right time, but this knifemaker has been in his share of places during several decades. Gil says, "We all have inner guidance and I would like to give credit to that. It's been like following a dream." He has, indeed, built his life around knives – an object and a profession he truly loves.



**2001  
FIGHTER**

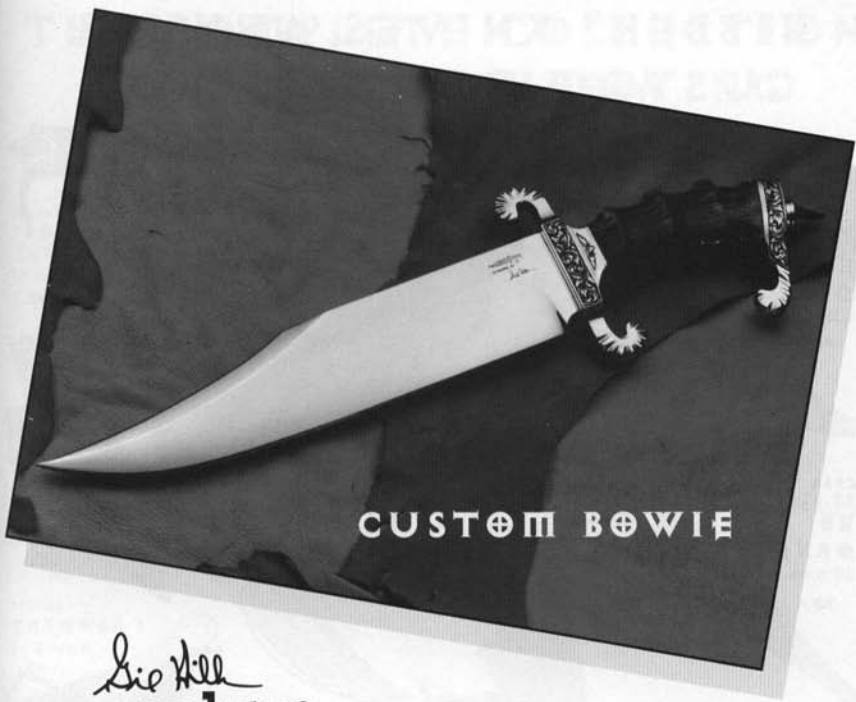

CUSTOM BOWIE

*Sie Hill*  
**HIBBENKNIVES®**

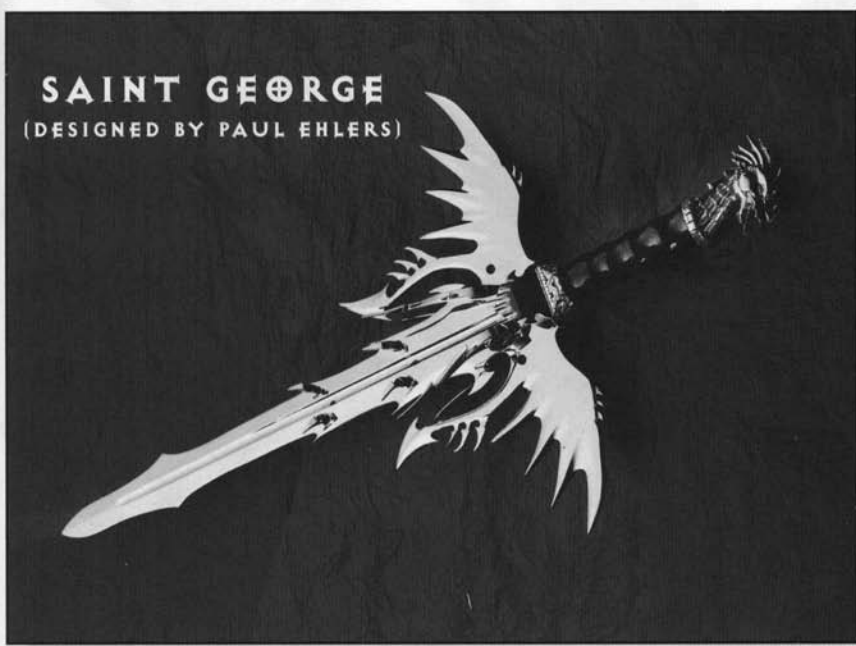

**SAINT GEORGE**

(DESIGNED BY PAUL EHLERS)

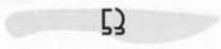

52

# HIBBEN® KNIVES ANNUAL CUSTOM DESIGN SERIES

UC1115  
1998 EDITION  
**THE  
ODYSSEY**  
14-1/16" overall



UC750  
1994 EDITION  
**RAPTOR™**  
13-7/8" overall



UC985  
1997 EDITION  
**THE  
HORNET**  
15-5/8" overall

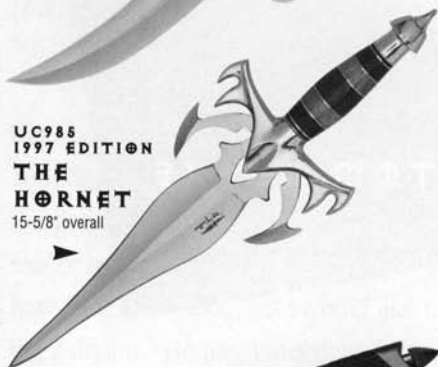

UC751  
1993 EDITION  
**RAVEN™**  
12-3/8" overall



UC898  
1996 EDITION  
**DRAGON  
LORD™**  
14" overall



UC627  
1992 EDITION  
**HIGHLANDER™  
BOWIE**  
13-7/8" overall



UC850  
1996 EDITION  
**WARBIRD™  
DAGGER**  
15" overall



UC453  
1991 EDITION  
**DOUBLE  
SHADOW™  
DAGGER**  
11-1/4" overall



UC851  
1995 EDITION  
**WARBIRD™  
BOWIE**  
15" overall



UC441  
1990 EDITION  
**SILVER  
SHADOW™  
DAGGER**  
12-1/2" overall



# THE COMPLETE COLLECTION OF HIBBEN® THROWING KNIVES

UC880  
**PRO  
THROWER I**  
10" overall



UC879  
**PRO  
THROWER II**  
12" overall

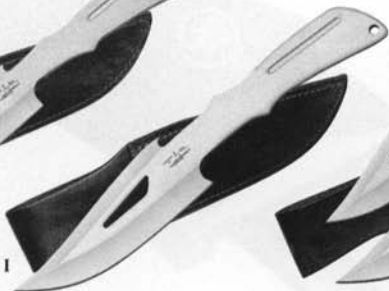

UC879 ▲  
**PRO THROWER  
COMBO**

Includes one each UC879 & UC880

UC454  
**THROWER I**  
6-1/8" overall



UC455  
**THROWER II**  
8-1/2" overall



UC456  
**THROWER III**  
10" overall



UC457  
**THROWER  
COMBO**  
Includes one each  
UC454 & UC455



UC458  
**THROWER  
TRIPLE SET**  
Includes three UC454s

UC866  
**PRO THROWER AXE**  
12" overall



UC946  
**CORD GRIP  
THROWER I**  
6-1/4" overall



UC947  
**CORD GRIP  
THROWER II**  
8-5/8" overall



UC948  
**CORD GRIP THROWER  
COMBO**

Includes one each UC946 & UC957

UC949  
**CORD GRIP THROWER  
TRIPLE SET**  
Includes three UC946s

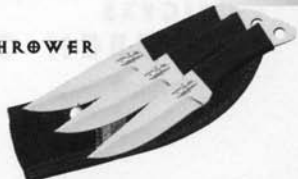

UC950

**KENPO  
KARATE KNIFE**

12-3/4" overall ▶

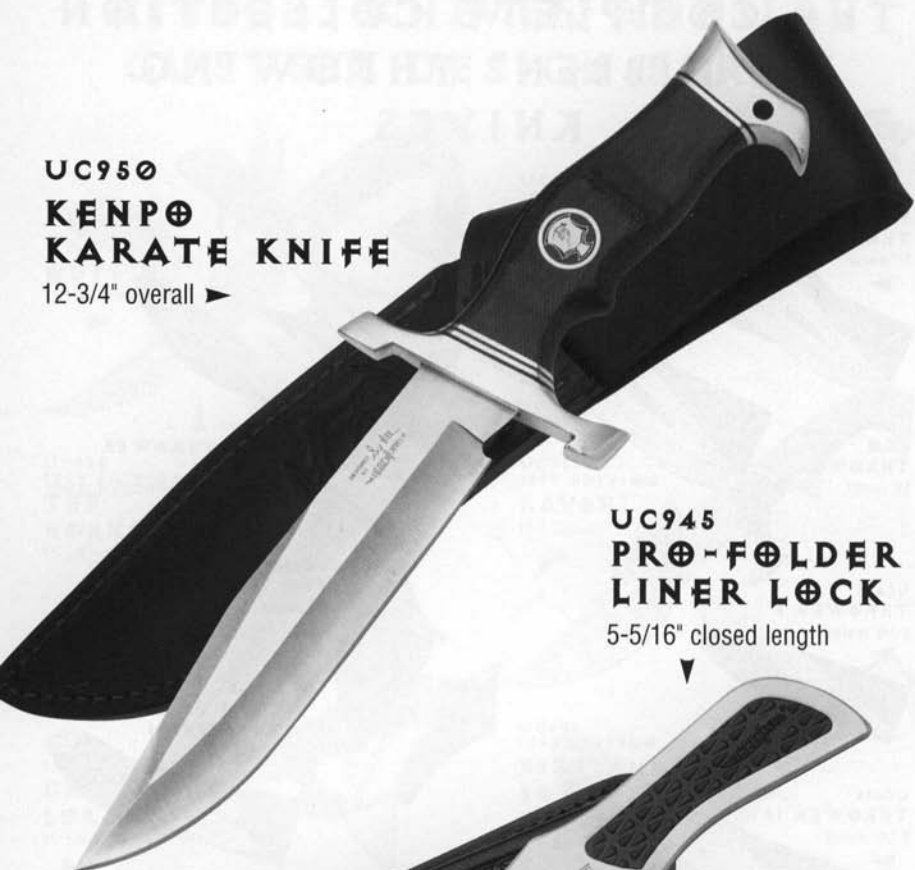

UC945

**PRO-FOLDER  
LINER LOCK**

5-5/16" closed length



UC935

**HIBBEN CLAW ▲**

5" overall





*Gil Hibben needs no introduction to anyone familiar with custom made knives, for he has dedicated his life to the art of knifemaking and design. Gil is a member of the Knifemakers Guild, was inducted into the Blade Magazine Cutlery Hall of Fame, and is well recognized the world over for his fantasy and functional knife designs.*

