

Owner's Manual

PAP M92 PV SEMI-AUTO PISTOL

Cal. 7.62x39MM

PAP M85 PV SEMI-AUTO PISTOL

Cal. 5.56x45MM (.223)



Congratulations on your purchase of the PAP M92 PV / PAP M85 PV Semi-Auto Pistol. With proper care and handling, it will give you long, reliable service. The PAP M92 PV is chambered for the 7.62x39mm cartridge & the PAP M85 PV is chambered for the 5.56x45mm (.223) cartridge.

We specifically disclaim any responsibility for damage or injury whatsoever, occurring as a result of the use of faulty, non-standard or remanufactured ammunition, any modifications or changes made to the firearm; improper use or unsafe handling of the firearm.

Always keep this manual with your firearm. Make sure you understand all the warnings, operation instructions and safety procedures. When you lend, give or sell the firearm, be sure this manual goes with it. You can get a copy of this manual from Century Arms, Inc. on request.

**FIREARMS SAFETY IS THE SOLE RESPONSIBILITY OF THE SHOOTER.
ALWAYS TREAT ALL FIREARMS AS IF THEY WERE LOADED AT ALL TIMES!**



IMPORTANT!

**READ ALL INSTRUCTIONS AND WARNINGS IN
THIS BOOKLET BEFORE USING THIS FIREARM.**



IMPORTANT SAFETY MESSAGE

Children are attracted to and can operate firearms which can cause severe injuries or death. Prevent child access by always keeping guns locked away and unloaded when not in use. If you keep a loaded firearm where a child obtains and improperly uses it, you may be fined or sent to prison.

Firearm Safety Depends on You

A gun is only as safe as the person operating it. You can never be overly careful when handling a firearm. Carelessness is often the cause of shooting accidents, such as failing to keep the muzzle pointed in a safe direction, not being sure of your target and what is behind it, failing to properly engage the safety, leaving ammunition in the chamber or using improper loads. Since a bullet can never be called back once fired, such errors in gun handling can result in the loss of life, severe injury or property damage thus, it is crucial for your safety and the safety of those around you that you learn the principles of safe gun handling and storage before you begin to use your new firearm. Be a safe shooter - please read this instruction book thoroughly even if this is not your first firearm purchase as not all firearms are the same. The first step in being a safe shooter is to learn the rules for the safe operation and handling of firearms. **There is nothing more important in gun handling than safety.**

THE TEN COMMANDMENTS OF FIREARM SAFETY

The Ten Commandments of Firearm Safety must be etched into your memory before you begin to handle firearms. These rules are intended to be followed by all persons handling firearms in the field, on the range or at home. Please read, review and understand these rules before you begin to use or even take your new firearm out of its box. Remember, firearms safety depends on you! Memorizing these safety rules will help prevent gun accidents. Please study these safety rules before handling your firearm.

Commandment #1



Always Keep the Muzzle Pointed in a Safe Direction

This is the most basic and most important safety rule. A safe direction is one in which an accidental discharge will not cause injury to yourself, to others or property damage. This is particularly important when loading or unloading your firearm. Never point your gun at anything you do not intend to shoot. Treat every gun as if it were loaded at all times.

Commandment #2



Firearms Should Be Unloaded When Not Actually in Use

Firearms should only be loaded when you are in the field or on the target range or shooting area, ready to shoot. When not in use, firearms and ammunition should be secured in a safe place, separate from each other. Remember to unload your firearm completely so that there is no ammunition in the chamber or magazine. Before handling this or any firearm, or handing it to someone else, visually check the chamber and magazine to ensure they do not contain ammunition. Always keep the gun's action open when not in use. Never assume a gun is unloaded - even if you were the last person to use it. Never cross a fence, climb a tree, wade through a stream or perform any awkward movement with a loaded gun. When in doubt, unload your gun! Never pull or push a loaded firearm

toward yourself or another person. Never carry a loaded gun in a scabbard, a holster not being worn or a gun case - common sense prevails in gun safety!

Commandment #3



Don't Completely Rely on Your Gun's Safety

Treat every gun as though it could fire at any time, even if you are not applying pressure to the trigger. The "safety" on a firearm is a mechanical device which, like any such device, can become inoperable at the worst possible time and fail to function. By mistake, you may think the safety is "ON" when it actually is not. Or you may think your gun is unloaded when there is actually a round of ammunition in it. The safety serves as a supplement to proper gun handling but cannot serve as a substitute for common sense. Never handle a gun carelessly and assume that the gun won't fire just because "the safety is on." Never touch the firearm's trigger until you are ready to shoot. Keep your fingers away from the trigger when loading or unloading. Never pull the trigger when the safety is engaged or when the safety is positioned between the "SAFE" and "FIRE" positions. Never place your finger on the trigger unless you intend to fire.

Alcohol, Drugs and Guns Don't Mix. Make No Mistake About It!

Never handle firearms after consuming alcohol or taking drugs that can affect your judgment. Shoot sober! Alcohol, certain kinds of drugs and firearms don't mix. Safe firearms handling requires alertness and concentration on one's actions. You cannot handle a firearm safely after consuming alcohol. Never consume anything that can impair your judgment or physical coordination when handling a firearm.

Commandment #4



Be Sure of Your Target - And What Is Beyond It!

Once fired, a bullet (or shot charge) can never be called back; so before you shoot, know where the bullet is going and what it will strike. Be

certain your shot will not injure someone or strike something beyond the target. Never fire in the direction of noise, a movement or at any object you cannot positively identify. Be aware that a .22 Short bullet can travel over 1 ¼ miles. A centerfire cartridge, such as the .30-06, can send its bullet over 3 miles. Shotgun pellets can travel 500 yards and a shotgun slug has a range of over a half mile. Make sure your shot has a safe backstop such as a hillside. Keep in mind how far the bullet will travel if it misses your intended target. Once fired, a bullet can never be called back. You are responsible for your actions and judgment.

Commandment #5



Use the Correct Ammunition

Every firearm is designed to use a certain caliber or gauge of ammunition. It is important that you use the correct ammunition for your firearm. Information on the correct ammunition to use with your firearm appears in the firearm's instruction manual and the manufacturer's markings on the firearm itself. Use of the wrong ammunition, improperly reloaded ammunition or corroded ammunition can result in the destruction of the firearm, serious personal injury and/or death. Form the habit of examining every round of ammunition before you put it into your gun to ensure it is of the proper gauge or caliber and that it is in good condition.



Commandment #6

If Your Gun Fails to Fire When the Trigger Is Pulled, Handle With Care
If a cartridge or shell does not fire when the trigger is pulled, follow **Commandment #1** and keep the firearm's muzzle pointed in a safe direction. Keep the muzzle down range with the action closed and wait at least 30 seconds (to ensure that the ammunition is not delayed in firing) before carefully opening the action, unloading the firearm and safely disposing of the ammunition.



Commandment #7

Always Wear Eye and Ear Protection When Shooting
Exposure to shooting noise can permanently damage hearing. Flying debris, such as powder residue and ejected cartridge cases, can injure your eyes. Thus, it is only common sense to wear both eye protection (such as shooting glasses) and ear protection (such as a sound-muffling headset) whenever shooting. Also, wear eye protection when cleaning or disassembling your gun to ensure that cleaning solvent and tensioned parts (such as springs) do not come into contact with your eyes.



Commandment #8

Be Sure the Barrel Is Clear of Obstructions Before Shooting
Discharging a firearm with an obstruction in the barrel can result in personal injury, property damage and/or death. Before you load your firearm, check the chamber and magazine to ascertain that no ammunition is inside. Also, check the inside of the barrel (called the "bore") to ensure it is free of obstructions. Even a small amount of mud, snow or excess lubricating oil or grease in the bore can cause excessive pressures resulting in a bulged or burst barrel which can injure or kill the shooter and bystanders. It is a good idea to make a habit of cleaning the bore and checking for obstructions with a cleaning rod just before each shooting session. If the noise or recoil experienced upon firing seems low or weak, or something doesn't feel "right," cease firing immediately and check to make sure that there is no obstruction in the barrel. Placing an undersized shell or cartridge into a gun (such as a 20 gauge shell in a shotgun chambered for 12 gauge ammunition) can result in the smaller round of ammunition falling into the barrel and acting as an obstruction. When a round is subsequently fired, the barrel may burst, causing injury to the shooter and bystanders. For reference, re-read Commandment #5.



Commandment #9

Do Not Alter or Modify Your Gun and Have It Serviced Regularly
Firearms are complex mechanisms that are designed to function properly in their original condition. Any alterations or changes made to a firearm after its manufacture can make the gun unsafe and will void its warranty. Do not jeopardize your safety or the safety of others by altering the trigger, mechanical safety or other mechanisms of your firearm. You should have your firearm periodically checked for proper functioning and serviced by a qualified gunsmith.



Commandment #10

Learn the Mechanical and Handling Characteristics of Your Firearm
Not all firearms operate the same way. The method of carrying, handling and operating firearms varies with the mechanical characteristics of each gun. Thus, you

should never handle any firearm until you become familiar with the safe handling, loading, unloading and carrying procedures for that particular firearm, as well as the rules for safe gun handling in general.



LEAD WARNING!

Discharging firearms in poorly ventilated areas, cleaning firearms or handling ammunition may result in exposure to lead and other substances known to cause birth defects, reproductive harm and other serious injuries. Have adequate ventilation at all times when shooting. Wash hands thoroughly after exposure.

Basics of Safe Gun Handling

1. Always keep the muzzle pointed in a safe direction.
2. Firearms should be unloaded when not actually in use.
3. Don't totally rely on your gun's safety.
4. Be sure of your target and what is beyond it.
5. Use the correct ammunition for your firearm.
6. If your gun fails to fire when the trigger is pulled, handle with care.
7. Always wear eye and ear protection when shooting and cleaning.
8. Be sure the barrel is clear of obstructions before shooting.
9. Don't alter or modify your firearm and have your firearm(s) serviced regularly.
10. Learn the mechanics and handling characteristics of the firearm you are using.

Safe gun handling depends on you! A safe shooter is a knowledgeable shooter.



WARNING! STOP SHOOTING IMMEDIATELY AND UNLOAD YOUR FIREARM if your firearm develops a mechanical malfunction; binding or stoppage, spitting powder/gas, a cartridge primer is punctured, a cartridge case is bulged or ruptured, or the sound on firing does not sound quite right. Do NOT try one more shot, but unload your firearm and take it and the ammunition to a qualified gunsmith or send it back to Century Arms for examination. Do not assume that the firearm is empty merely because you checked the chamber. You must also check the bore for any fired shot or wad jammed inside the barrel.



WARNING! Always ensure that the ammunition you are using is clean, undamaged and of the proper caliber before loading your pistol. The manufacturer and distributor of this pistol disclaim any liability for the use of remanufactured, reloaded or hand-loaded ammunition. Protect your investment in this fine firearm by using only factory fresh, quality ammunition. The use of improper caliber or low quality ammunition could result in injury, death and/or property damage upon firing. Remember, firearms safety depends on you!

Specifications:

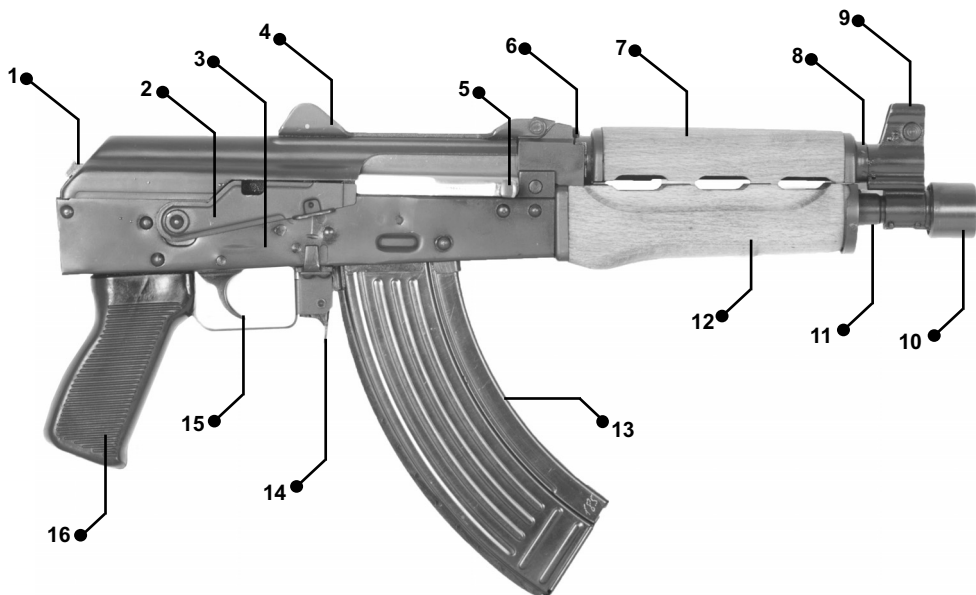
PAP M92 PV - Caliber: 7.62x39mm. Type of Firearm: semi-automatic pistol.
Magazine Capacity: 30 rds. Overall Length: 19.3." Barrel Length: 10." Weight: 6.6 lbs.

PAP M85 PV - Caliber: 5.56x45mm (.223). Type of Firearm: semi-automatic pistol.
Magazine Capacity: 30 rds. Overall Length: 19.7." Barrel Length: 10." Weight: 6.4 lbs.

Illustration #1

Diagram showing major operational parts of the PAP M92 PV & PAP M85 PV Semi-Auto Pistols

Study of this picture will aid you in understanding the instructions in this booklet.



- | | | | |
|----------------------|--------------------------|---------------------|----------------------------|
| 1. Recoil spring cam | 5. Bolt cocking handle | 9. Front sight | 13. Magazine |
| 2. Safety lever | 6. Gas tube securing pin | 10. Muzzle cap | 14. Magazine release lever |
| 3. Receiver | 7. Upper handguard | 11. Barrel | 15. Trigger |
| 4. Rear sight | 8. Gas tube | 12. Lower handguard | 16. Pistol Grip |

External Control Parts - Bolt Block Safety: Located on the receiver above the trigger, pivot slide style. When moved to the full up position it blocks bolt movement, covers bolt and blocks trigger movement. When in the lower position, the bolt is fully exposed and free to move and the firearm will fire if trigger is pulled! Do not disengage the safety unless you are ready to fire the firearm. (Safety engaged- the bolt is covered, blocked and the trigger is blocked from full travel; Safety disengaged- the bolt is fully exposed and the trigger has full travel. **MAKE SURE YOU UNDERSTAND HOW THE SAFETY WORKS BEFORE YOU LOAD OR USE THE FIREARM**). (See Illustrations #2 - #3.)

Bolt Cocking Handle: Located on right hand side of the firearm protrudes from bolt used for pulling bolt rearward. (See Illustration #4.)

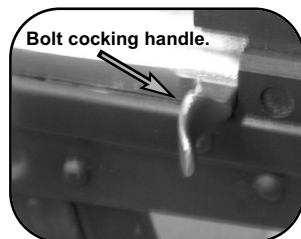
Illustration #2



Illustration #3



Illustration #4



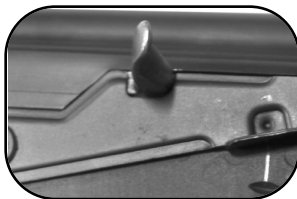
Bolt Catch: To use the bolt catch, move the safety lever to the "FIRE" position and pull the bolt to the rear and then push the safety lever up to the "SAFE" position so that it engages the bolt and holds it in the rear position. Release the bolt and it should be held in place by the safety lever. (See Illustrations #5 - #6.)

Illustration #5



"FIRE" position.

Illustration #6



"SAFE" position.

To Load the Pistol



WARNING! Before loading, make sure the inside of the barrel is free of dirt or other obstructions.

WARNING! Always check each cartridge to ensure it is of the correct caliber before loading the firearm.

WARNING! Never load a firearm indoors. An accidental discharge will cause property damage, serious injury and/or death! Never use live ammunition to function test your pistol indoors.

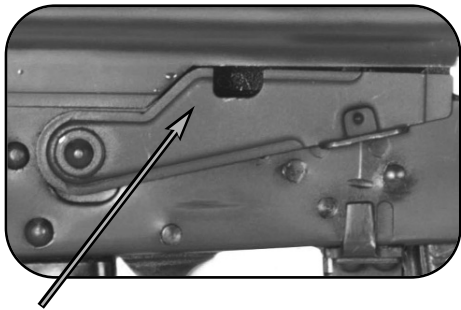
WARNING! Keep fingers away from the trigger while loading.

WARNING! Keep muzzle pointed in a safe direction.

WARNING! The safety lever should not extend below the safety lever stop on the bottom of the receiver or rise past the receiver cover. If it does, put the lever in the safe position by rotating it either up or down into the safe position. If this occurs, have the pistol inspected by a competent gunsmith before further use.

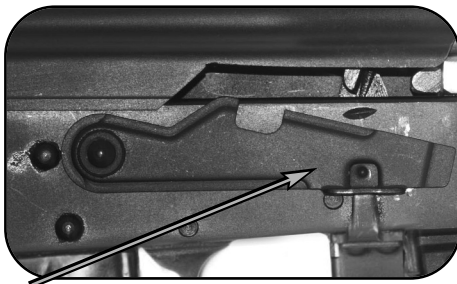
- Place the safety lever in the "SAFE" position. The safety lever is in the "SAFE" position when it is moved to its uppermost (top) position on the receiver. You should hear an audible "click" when it is correctly in place. (See Illustration #7.) **NOTE: When the safety lever is in its lower position on the receiver, the safety lever is in the "FIRE" position. (See Illustration #8.)**

Illustration #7



Safety lever in upper "SAFE" position.

Illustration #8



Safety lever in lower or "FIRE" position. Pulling the trigger when the safety lever is in the lower position will result in the pistol firing if there is a round in the chamber! Exercise extreme caution when handling pistol in this condition.



WARNING! Pulling the trigger when the safety lever is in this lower position will result in the pistol firing a round. To avoid serious injury, death or causing property damage, make sure you know the "SAFE" and "FIRE" positions of the safety lever before attempting to load your pistol!

2. Load the magazine with the correct ammunition by pressing the cartridges one at a time into the spring-loaded magazine's feed lips - rear of the cartridge entering the magazine first. (See Illustration #9.)
3. Install the loaded magazine by tilting it rearward then inserting the front catch surface into the receiver so that it latches on the magazine catch surface on the front wall of the magazine well. Next, rotate the bottom of the magazine rearward until the magazine release lever locks onto the rear locking surface of the magazine. Pull on the magazine lightly to ensure it is securely locked into position. (See Illustration #10.)

Illustration #9

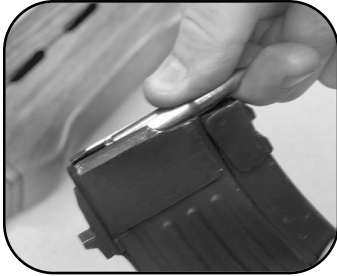
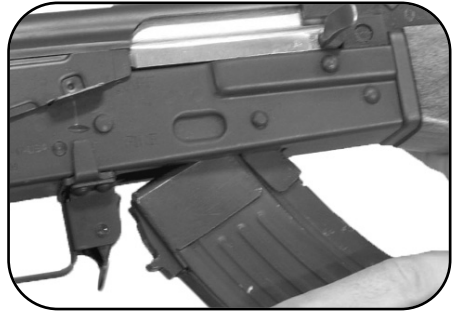


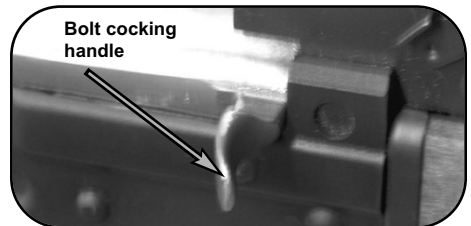
Illustration #10



4. Keeping the muzzle pointed in a safe direction, move the safety lever downward to the "FIRE" position.
5. Pull back the bolt cocking handle to its fully-rearward position and release. As it moves rapidly forward under spring pressure, the bolt will strip a round from the magazine and insert it into the chamber of the barrel, readying the pistol for firing. (See Illustration #11.)

Illustration #11

The bolt cocking handle is drawn to the rear to check the pistol's loaded/unloaded status.



WARNING! The pistol is now loaded and will fire if the safety lever is moved downward to the "FIRE" position and the trigger is pulled! Handle with extreme caution and keep the muzzle (the end of the barrel) pointed in a safe direction!

To Fire the Pistol

1. Keeping the **10 Commandments of Shooting Safety** in mind, aim the pistol downrange at the target. When firing this pistol you may need to experiment with different shooting styles until you find the method which best suits your sporting activity. Remember to always fire the pistol in such a manner that you can maintain a safe muzzle direction at all times.
2. Disengage the safety lever by moving it to the "FIRE" position.

3. Place your trigger finger inside the triggerguard and on the trigger.
4. After aligning the sights, slowly pull the trigger to fire the first round.
5. Being a semi-automatic pistol, the pistol's action (its moving parts) will cycle after the first round is fired. As the bolt moves rearward, the extractor will pull the empty cartridge case from the chamber and eject it from the pistol. (Make sure there are no bystanders in close proximity on either side of the pistol who could be injured by the ejected cartridge case or gasses expelled from the pistol.)



Note: *If the trigger is pressed again, the pistol will fire! Keep the pistol pointed in a safe direction.*

6. Firing may be continued in this manner until the magazine is empty.
7. When firing is finished, place the safety lever in the "SAFE" position.
8. Remove the magazine from the pistol. See section on unloading the pistol below.
9. Check the pistol's chamber to ensure it does not contain a round by placing the safety lever in the "FIRE" position, pulling the bolt cocking handle back and then looking into the chamber through the ejection port while keeping the pistol pointed in a safe direction. When you are finished checking the chamber, release the bolt cocking handle and return the safety lever to the "SAFE" position.



WARNING! Always unload your pistol immediately after use and prior to cleaning and storage to minimize the risk of an accidental discharge. If your pistol ever fails to fire keep it pointed at the target for at least 30 seconds in the event of a hangfire (slow ignition). If the round still does not fire, remove the magazine, eject and discard the bad round. Reload the pistol to resume firing.

Unloading the Pistol



WARNING! Keep muzzle pointed in a safe direction.

1. Move the safety lever to the "SAFE" position. (See Illustration #7.)
2. Remove the magazine. To remove the magazine from the pistol while holding the pistol in the firing position, simply slide your left hand from the lower handguard to the magazine. Grasp the magazine and press the magazine release lever with your thumb. (See Illustration #12.) You will now be able to rotate the bottom of the magazine toward the muzzle end of the pistol and remove it from the magazine well in the receiver. (See Illustration #13.)

Illustration #12

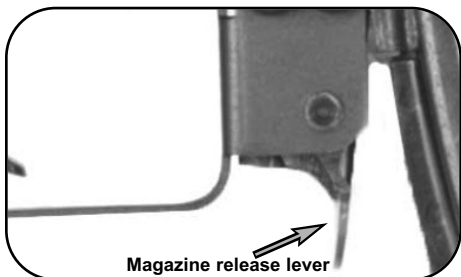
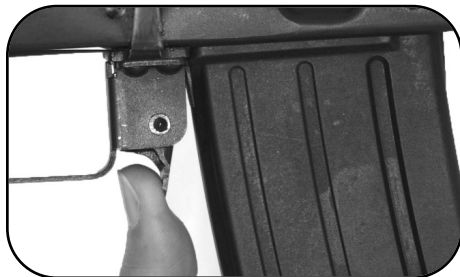


Illustration #13



Press the magazine release lever forward to remove the magazine from the pistol.

3. Move the safety lever to the "FIRE" position and check the pistol's chamber to ensure it does not contain a round. (See Illustration #8.)

- In the event that a cartridge remains in the chamber after pulling the trigger and the extractor fails to remove it (whether or not it has fired), you should remove the magazine, then work the bolt cocking handle several times to try to eject the cartridge. If this does not eject the cartridge, ride the bolt cocking handle home (slowly allow it to return to its forward position without allowing it to impact the back of the cartridge casing). Follow the instructions found on this page to field strip your pistol before attempting to remove the cartridge. If after field stripping your pistol you are still unable to remove the cartridge casing, do not reassemble the pistol. Take the pistol to a competent gunsmith to remove the round and ensure proper functioning.



WARNING! The pistol will fire if the magazine is removed and if the trigger is pulled when a cartridge is in the chamber.

WARNING! If dropped, any firearm could fire when there is a cartridge in the chamber and the safety lever is in the "FIRE" position.

Field Stripping



WARNING! Before beginning the disassembly process, check to ensure the pistol is not loaded. To do so, follow the procedures detailed in the **Unloading the Pistol** section on page 9.



WARNING! Wear eye protection, such as shooting glasses or goggles, when disassembling your firearm to protect your eyes from tensioned parts, such as springs that could be dislodged during disassembly.

- Remove the magazine from the pistol. (See Illustrations #12 - #13.)
- Move the safety lever to the "FIRE" position by rotating the safety lever downward.
- Check the pistol's chamber to ensure it does not contain a round by pulling back on the bolt cocking handle (See Illustration #11) and locking it in place with the bolt catch on the safety lever. Inspect the chamber to ensure it is empty. Once you determine the chamber is empty and no magazine is in the pistol, push down on the safety lever and let the bolt go forward.
- While maintaining a safe muzzle direction, raise the receiver cover by holding the pistol in a secure position (across your lap, resting on a table, etc.) and grasping the rear part of the receiver with your right hand, depress the spring loaded release button on the rear of the receiver. While holding the button, press the recoil spring cam forward. Then raise the receiver cover from the back end first with your left hand. (See Illustration #14.)
- Remove the recoil spring assembly from the pistol by holding the forward portion of the receiver with your left hand and pressing on the back of the recoil spring cam with your right hand until its rear face leaves the groove in the rear of the receiver. Lift the recoil spring cam and remove the recoil spring assembly from the bolt carrier channel. (See Illustration #15.) **NOTE: The recoil spring assembly is under spring pressure. Hold on to the assembly when removing it or injury could result.**

Illustration #14



Spring loaded release button.

Illustration #15

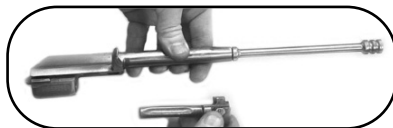


- Remove the bolt carrier and bolt from the pistol by holding the receiver with your left hand and the cocking handle with your right hand. Pull the bolt carrier and bolt to the rear as far as possible. Once the back of the bolt carrier contacts the back plate of the receiver, release pressure on the bolt cocking handle, this will allow the bolt carrier to move up and off the receiver rails. Lift the rear portion of the bolt carrier and remove it and the bolt from the receiver. (See Illustration #16.)
- Remove the bolt from the bolt carrier by turning the bolt carrier over and holding it in your left hand. (See Illustration #17.) Rotate what is now the top of the bolt to the right and move it rearward with your right hand so that the guide lug on the bolt leaves the channel in the bolt carrier. You can now remove the bolt from the bolt carrier by moving it forward and out of its guide hole.

Illustration #16

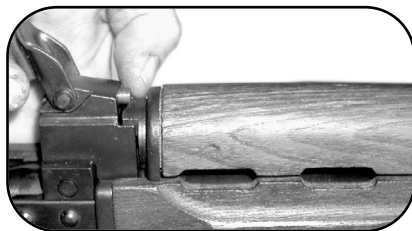


Illustration #17



- Remove the gas tube assembly and upper handguard from the pistol by holding the forward portion of the receiver with your left hand and pressing in the gas tube securing pin. (See Illustration #18.) Then, lift the gas tube end vertically out of its groove in the rear sight base and remove the front end of the gas tube from the gas block.

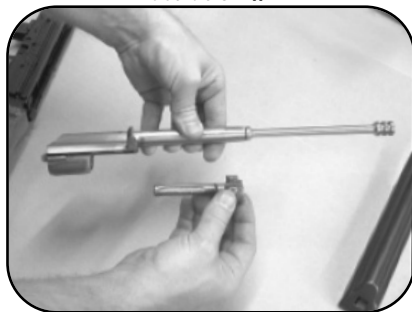
Illustration #18



Reassembly

- Attach the gas tube assembly and upper handguard by holding the pistol by the forward portion of the receiver with your left hand, and with your right hand install the front end of the gas tube on the gas block. Align the gas tube end with its groove in the rear sight base and rotate it downward until it is fully seated in the rear sight base. When the gas tube assembly is fully seated in the rear sight base, the gas tube securing pin will move out and over the gas tube to lock it in place.
- Install the bolt back in the bolt carrier by first holding the bolt carrier upside down in your left hand with the gas piston facing away from you. Then take the bolt in your right hand with the bolt face facing away from you and the guide lug facing upward. Insert the bolt shaft into the guide hole on the bolt carrier and bring the bolt fully rearward. Align the bolt guide lug with the channel in the bolt carrier and rotate the bolt to the left. Once the guide lug has entered the channel in the bolt carrier continue to rotate until the bolt has moved forward as far as possible. (See Illustration #19.)

Illustration #19



3. Make sure that the hammer is cocked (locked underneath the sear) before attempting to install the bolt carrier.
4. Install the bolt carrier and bolt back onto the receiver by holding the forward portion of the receiver with your left hand and with your right hand take the bolt and bolt carrier as shown in Illustration #19 ensuring that your thumb is placed on the back of the bolt to hold it fully forward. Insert the gas piston into the gas tube end and align the back face of the bolt carrier with the inside face of the back plate of the receiver. Using the heel of your right hand, depress the bolt carrier against the pressure from the hammer spring so that the guide grooves on the sides of the bolt carrier are aligned with the rails on the receiver and move the bolt carrier to its fully forward position. (See Illustrations #20 - #22.)

Illustration #20



Illustration #21



Illustration #22



5. Install the recoil spring assembly on the pistol by holding the forward portion of the receiver with your left hand, and with your right hand, insert the recoil spring retainer into the bolt carrier channel. Move the recoil spring cam forward, placing its guide lugs in front of the grooves in the receiver rear plate. Depress the recoil spring cam until its guide lugs are aligned with the channel on the top of the receiver rear plate. Release pressure on the recoil spring cam which will allow it to move rearward and lock into the receiver.
6. To install the receiver cover on the pistol, begin by rotating the rear sight upward so that it is out of the way. Hold the pistol by the forward portion of the receiver with your left hand and with your right hand insert the front edge of the receiver cover into the groove in the back of the rear sight base. Press the back end of the receiver cover forward and downward with the heel of your right hand until the recoil spring cam slides back into place and locks the receiver cover down.
7. Release the hammer by pulling the trigger and move the safety lever to the "SAFE" position.

Cleaning the Pistol



WARNING! Before beginning the cleaning process, check to ensure the pistol is unloaded. (See the **Unloading the Pistol** section on page 9.)

WARNING! You should wear eye protection, such as shooting glasses or goggles, when cleaning your firearm to protect your eyes from tensioned parts, such as springs, that may become dislodged during disassembly.

1. Obtain a quality pistol cleaning kit and thoroughly review the manufacturer's instructions.
Note: *To properly clean an AK style pistol a bore snake should be used to clean the pistol from the chamber end. Cleaning your pistol from the muzzle end can damage the crown and adversely affect accuracy.*
2. Follow the pistol disassembly procedures. (See page 10.)
3. To clean the barrel, select the correct caliber cleaning brush and attach it to a cleaning rod.
Note: *Always clean the barrel from the chamber end to the muzzle.*
4. Dampen the brush with gun cleaning solvent and then push the brush through the barrel several times.
5. Remove the brush and attach a correctly sized cloth cleaning patch to the cleaning rod and push it through the barrel several times to remove loosened fouling.
6. Repeat this process with the brush and cleaning patches until a final patch comes out clean after swabbing the bore. Lightly oil the bore.
7. Remove shooting residue from the pistol's action parts and outer surfaces by wiping them with a soft cloth dabbed in gun cleaning solvent. Then be sure to remove all excess solvent and dry them.
8. Finally, wipe down all outer surfaces with a soft cloth dipped in a good quality gun oil.



WARNING! There may be sharp edges on parts of the firearm. Keep your fingers protected by wearing a pair of protective gloves when cleaning.



WARNING! You should wear eye protection, such as shooting glasses or goggles, when cleaning this pistol to protect your eyes from tensioned parts, such as springs, that could become dislodged during the cleaning procedures.

WARNING! Excessive use of cleaning solvents or lubricants can adversely affect your pistol's functioning. Wipe the inside of the barrel dry before firing and ensure that it is free of obstructions.

WARNING! Some cleaning solvents produce hazardous vapors. Read and follow the solvent manufacturer's cautions found on the product's package.

WARNING! Handling ammunition and cleaning firearms results in exposure to lead and other substances that can pose health risks. Wash your hands and face after firing your pistol or after cleaning it.

WARNING! This firearm should be checked periodically for worn or damaged parts by a competent gunsmith. This will help ensure its safe functioning and a long service life.

Cleaning Intervals

Always clean your pistol as soon as possible after firing to prevent buildup of shooting residue and to prevent corrosion from starting. To properly clean an AK style pistol, a bore snake should be used to clean the pistol from the chamber end. To maintain your pistol in good working order, it should be cleaned regularly even if it has not been fired. If you live in a low-humidity area, this may mean doing a full clean once or twice a year; but if you live in a high-humidity area, it may be necessary to clean your pistol as often as once a week.

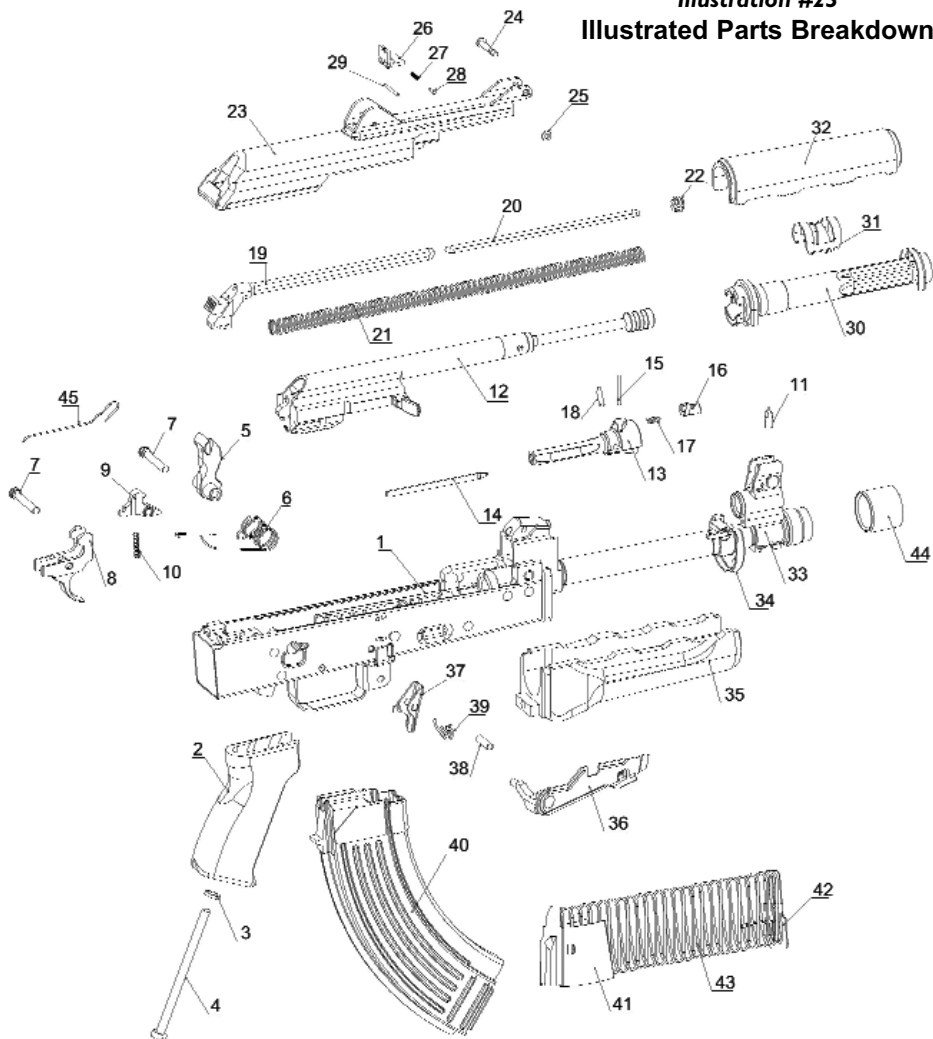
Note: *In freezing weather (below 32° F. or 0° C.), the use of a dry lubricant (instead of oil) for lubrication may work better.*

Storage

Your pistol should be thoroughly cleaned and lightly lubricated before being put away for storage. A light coating of good quality gun oil should be applied to all exposed surfaces. Remove all excess lubrication and use a cleaning rod and cleaning patch to make sure that the bore (the inside of the barrel) is dry and free of obstructions when you remove your pistol from storage and before firing it. **CHECK TO ENSURE THAT YOUR PISTOL IS NOT LOADED BEFORE STORING IT. ALWAYS STORE FIREARMS AND AMMUNITION SEPARATE FROM EACH OTHER AND OUT OF REACH OF CHILDREN. REFERENCE YOUR HOME STATE'S FIREARMS REGULATIONS FOR SAFE STORAGE OF FIREARMS AND AMMUNITION.**

Note: *The use of reloaded, remanufactured, hand-loaded or other non-standard ammunition may result in damage to the pistol and injury or death to the shooter and/or bystanders. The manufacturer does not accept responsibility for malfunctions resulting from the such use.*

Illustration #23
Illustrated Parts Breakdown



#	Part name
1.	Barrel - Receiver
2.	Pistol grip
3.	Washer
4.	Pistol grip screw
5.	Hammer
6.	Hammer spring
7.	Trigger and hammer pin
8.	Trigger
9.	Disconnecter
10.	Disconnecter spring
11.	Front sight
12.	Bolt carrier
13.	Bolt body
14.	Firing pin securing pin
15.	Firing pin retainer
16.	Extractor
17.	Extractor spring
18.	Extractor pin
19.	Recoil spring cam
20.	Recoil spring guide, front
21.	Recoil spring
22.	Securing plate, recoil spring
23.	Cover

#	Part name
24.	Cover axle
25.	Washer
26.	Rear sight
27.	Rear sight securing pin spring
28.	Rear sight securing pin
29.	Rear sight axle
30.	Gas tube
31.	Upper handguard spring
32.	Upper handguard
33.	Gas block
34.	Lower handguard retainer
35.	Lower handguard
36.	Safety lever
37.	Magazine catch
38.	Magazine catch pin
39.	Magazine catch spring
40.	Magazine body
41.	Follower
42.	Magazine bottom plate
43.	Magazine spring
44.	Muzzle cap
45.	Retaining spring



Lubrication Warning

Firing a firearm with oil, grease or any other material even partially obstructing the bore may result in damage to the firearm and injury to the shooter and those nearby. Do not spray or apply lubricants directly on ammunition. If the powder charge of a cartridge is affected by the lubricant, it may not be ignited, but the energy from the primer may be sufficient to push the bullet into the bore where it may become lodged. Firing a subsequent bullet into the obstructed bore will damage the firearm and may cause injury to the shooter and those nearby. Use lubricants properly. You are responsible for the proper care and maintenance of your firearm and ammunition.



WARNING! Altering or modifying parts and/or internal safeties is dangerous and will void the warranty. This firearm was manufactured to perform properly with the original parts as designed. It is your duty to make sure any parts you buy are made for this firearm and are installed correctly and that neither the replacements nor originals are altered or changed. Your gun is a complex precision tool with many parts that must relate correctly to other parts in order for proper and safe operation. Putting a gun together wrong or with incorrect or modified parts can result in a damaged gun, danger, and injury or death to you and others through malfunction. Always have a qualified gunsmith work on your gun or at least check any work not performed by a gunsmith.

Limited Parts Replacement Warranty

The PAP M92 PV & the PAP M85 PV are warranted to be free of manufacturing defects for a period of one year from the original date of purchase of the PAP M92 PV or the PAP M85 PV from a federally licensed firearms retailer. The warranty only applies to the first retail purchaser and is not transferrable or assignable. Proof of purchase must be presented at the time any warranty claim is made. This is a one year warranty limited to replacement of improperly manufactured parts. Any alternations, modifications, abuse, misuse or discharge of poor quality, corrosive or defective ammunition voids the warranty.

Return Authorization

To obtain warranty service, contact us at 1.800.527.1252 to get a return authorization. Please note that a return authorization must be obtained prior to returning the firearm.

Century International Arms, Inc.
236 Bryce Boulevard
Fairfax, Vermont 05454
USA
www.centuryarms.com



PAP M92 PV Semi-Auto Pistol, Cal. 7.62x39mm
PAP M85 PV Semi-Auto Pistol, Cal. 5.56x45mm (.223)

Distributed by:

Century International Arms, Inc.
236 Bryce Boulevard, Fairfax, VT 05454
www.centuryarms.com
Sales Tel: 1.800.527.1252 - 1.561.265.4530
Sales Fax: 1.561.265.4520

Manufactured by:
Zastava