

WINCHESTER[®]

Model 59

Your WINCHESTER Model 59 is a new departure in self-loading shotguns built of the finest materials and to the strictest precision manufacturing specifications. As with all top quality products, proper care will guarantee its long life and continuously smooth, efficient and safe operation.

The bore of your Model 59 should be wiped free of any dampness with an oily patch and all exposed surfaces covered with a thin film of oil. After exposure to rain, snow or salt spray, you may wish to remove the chamber and trigger guard group for cleaning. Be sparing in your use of oil, however, for a little goes a long way and excessive oiling will cause an accumulation of dust and burnt powder that may cause malfunctions.

Once or twice during the shooting season wipe the chamber recess in the barrel and the outer surface of the independent chamber with an oily rag. A drop of oil every once in a while on the inertia rod, the slide cams of the bolt and the coils of the carrier spring will also help to keep the action in smoothest operating condition. Remove the trigger guard group and stand the gun up when performing this latter operation.

When storing for long periods, apply gun grease to the metal parts, and keep in a dry place. Do not plug the muzzle with any obstruction. Before firing, be certain all grease is wiped off . . . especially from the inside of the bore, chamber and action parts.

Should your firearm ever need repairs, return it to the WINCHESTER factory, where it will receive the same careful attention used in its manufacture.

Instructions for your

WINCHESTER[®]

model

59



WINCHESTER-WESTERN DIVISION

NEW HAVEN 4, CONNECTICUT

OLIN MATHIESON CHEMICAL CORPORATION

NHP2330-362

PRINTED
IN
U.S.A.

To Assemble

CAUTION:
Do not retract bolt until gun is fully assembled.

To Load Chamber

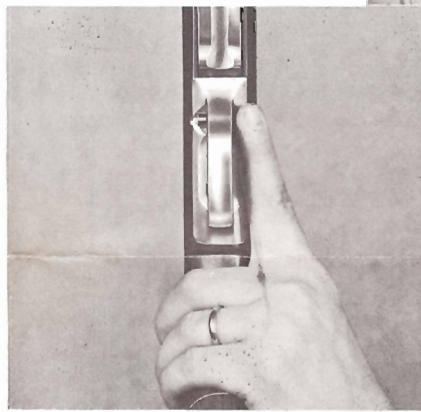
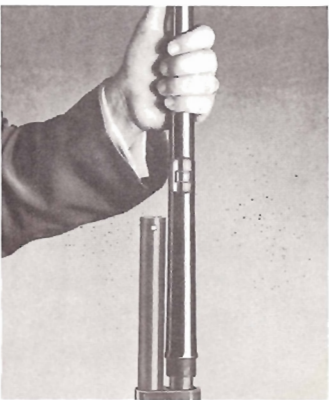

1 Slide the forearm off of magazine tube.

2 Align grooves on barrel shank with non-grooved areas in receiver.



2
Put on safety by pushing button from left to right until red band disappears.

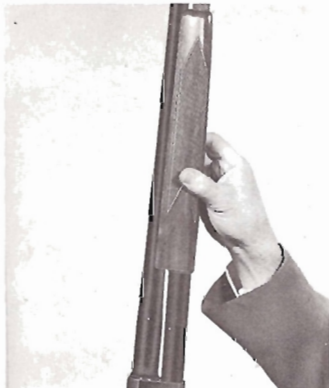

3
Drop a shot shell into loading port.

3 Apply firm downward pressure and twist barrel one quarter turn until threaded holes in magazine tube and barrel lug line up.

4 Replace forearm on magazine tube and seat against receiver. Take-down screw will enter hole in barrel lug.

To Disassemble

To Load Magazine

4
Depress carrier lock button. This releases bolt and loads shell into chamber.

When loading or unloading be sure safety is "ON."

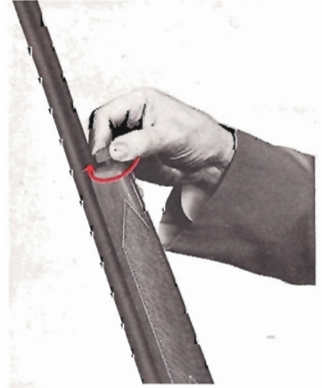

5 Tighten take-down screw in clockwise direction.

1 Loosen take-down screw by turning it in counter-clockwise direction.

1
Depress carrier lock button, press shell down on carrier and insert into magazine. Be sure head of shell passes end of carrier lock. (KEEP BUTTON DEPRESSED). The shell will then remain in the magazine while the next shell is being loaded.



2
To load next shell keep carrier lock button depressed and repeat step 1.

2 Slip the forearm off of magazine tube.

3 Keeping downward pressure, unlock barrel by turning it one quarter turn. Remove barrel.

3
To fire, take off safety by pushing button from right to left so that red band appears.



To Unload Magazine and Chamber



1
To unload magazine, push in carrier lock button. Depress carrier, allowing magazine spring to eject shell. Release carrier lock button and repeat procedure to unload next shell.



2
In one quick motion pull cocking piece all the way back. Shell in chamber will eject through the ejection port.

CAUTION:
Do not fully retract bolt without the chamber assembled. If this should occur reassemble the chamber and close the bolt. If chamber is not available compress carrier lock button holding onto the right slide handle, carefully allow the bolt to return to forward position. Do not compress button with chamber disassembled allowing bolt to slam forward, as it will definitely result in the bolt becoming jammed in the receiver.

To Remove Chamber

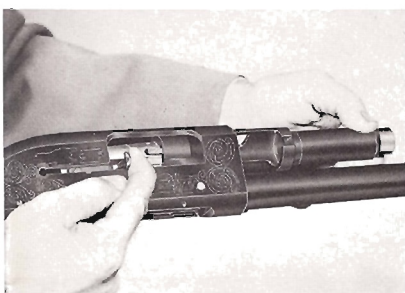

1
Grasp chamber. Using cocking piece, pull bolt back approximately two thirds the length of the ejection port. This unlocks bolt from chamber.



2
Remove chamber, still holding bolt back. Carefully allow bolt to return to forward position.

To Replace Chamber

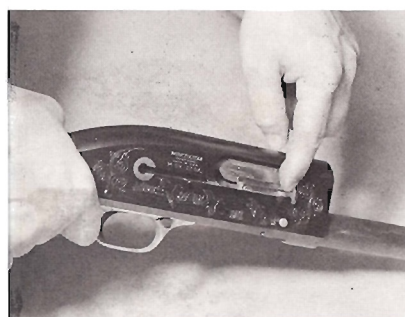

1
With bolt forward, tip front end of bolt down with forefinger.

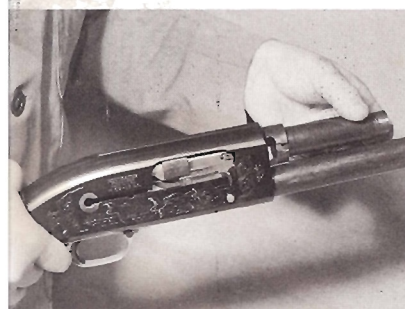

2
Insert chamber into receiver until it stops against breeching shoulder in receiver.

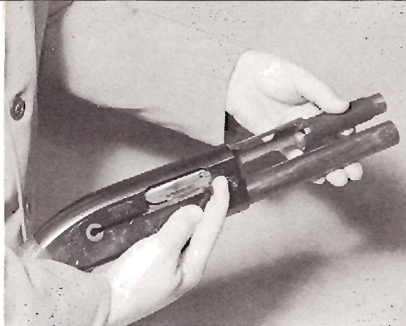

3
Keep rearward pressure on chamber. Pull back cocking piece approximately two thirds length of ejection port. Rear portion of chamber should be out of sight in receiver.



4
Continuing pressure on front end of chamber, allow bolt to slowly move forward to closed position. The breeching shoulder will lock chamber in place.

To Remove Trigger Guard Group

1
Pull bolt back to rear of ejection port, which cocks hammer. Release to closed position and place safety "ON." With any pointed object, push take down pin out a short way from right side of receiver. Remove take down pin.

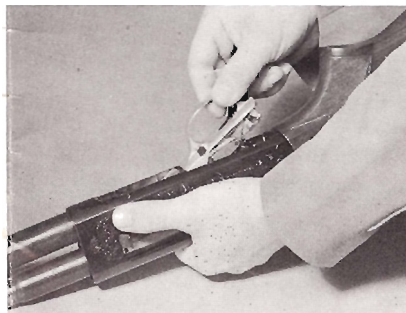
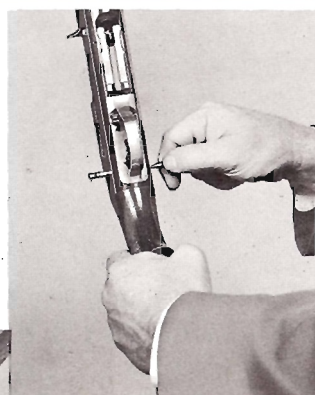

2
Keeping carrier lock button on right side of receiver depressed, lift out trigger guard group, raising rear end first.

To Replace Trigger Guard Group

1
Caution: Keep carrier lock button constantly pressed during this entire operation. Insert trigger guard group into receiver, forward portion first. Snap rear part of group down into place. Then release carrier lock button.

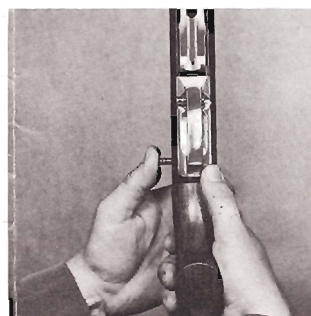
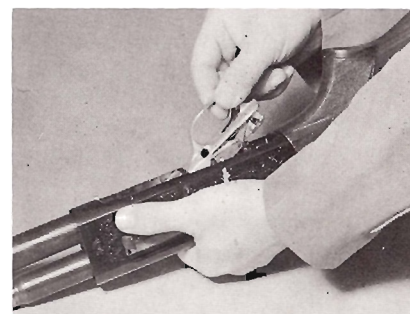

2
Replace take-down pin.

(Steps 3 and 4 at top of next fold.)

WINCHESTER

THE WORLD'S ONLY AUTOMATIC* SHOTGUN WITH NON-RECOILING WIN-LITE BARREL

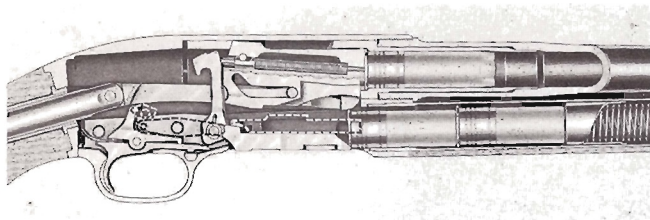

Fired Position

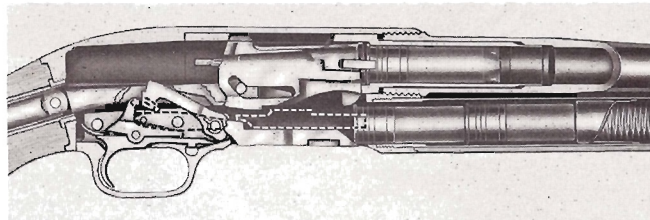

Initial Unlocking Action

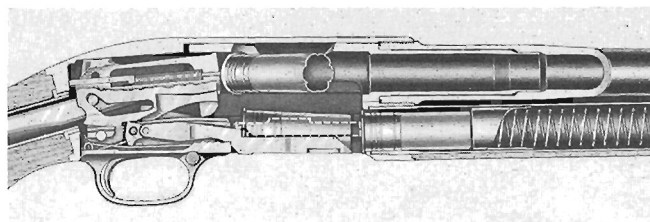

Shell Ejection Position

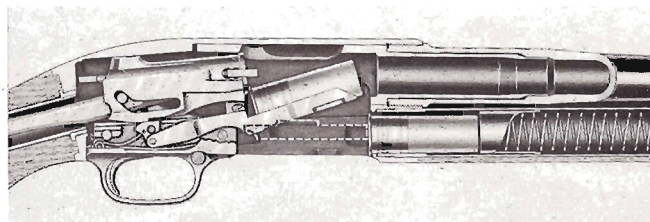

Shell Reloading Position



Streamlined Silhouette

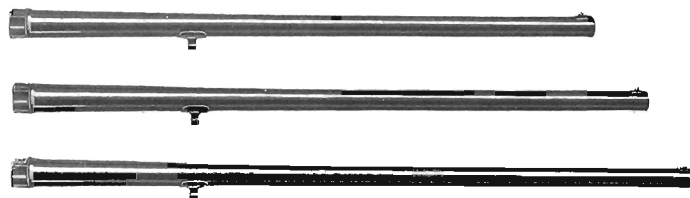

Barrels Interchanged Without Special Fitting

The Model 59 is a typical WINCHESTER streamlined beauty . . . bringing new performance and handling ease to delight the shooting public.

Model 59 is made of the finest materials known to science and . . . the world's first automatic to feature the strong, safe and super-light WIN-LITE BARREL. The receiver is fabricated of finest aluminum alloy for lightness, strength and durability. Other critical parts, including the independent, floating chamber, are of heat treated chrome vanadium steel. The graceful checkered pistol grip stock and forearm are of American walnut worked to a satiny finish. The trigger guard of the Model 59 is gold-anodized to add new beauty and distinctiveness to this fine firearm.

Loading of the first shell is through the convenient port in the receiver, with the second and third shells easily inserted into the magazine. Conforming to Federal Migratory Bird Regulations, Model 59's tubular magazine holds two shells making it a three shot gun. Ejection is fast and sure; the positive WINCHESTER cross-bolt safety in the front portion of the trigger guard is easy to locate by touch or sight.

When the Model 59 is fired, the chamber, bolt and inertia rod move together as a unit about one-tenth of an inch. This starts the inertia rod and the bolt on the way through the full cycle of unlocking the bolt, extracting and ejecting the empty shell, reloading, and locking the bolt. The barrel does not move. There is very little apparent recoil and your Model 59 will function smoothly every time from any firing position.

Built to handle all available 2 $\frac{3}{4}$ " loads without adjustment, Model 59's construction is extremely simple. Field stripping, cleaning and reassembly are quick and easy. A minimum of care will give you maximum servicability and use. Interchangeable barrels, of different lengths and chokes are available from your dealer and can be changed by yourself without factory fitting.

Product of painstaking research and field testing by many of the nation's top experts . . . shot under every possible condition in the field and at skeet and trap clubs across the country . . . Model 59 lives up to the WINCHESTER tradition of shooting superiority. It is a fine shotgun to satisfy the most demanding shooters.

* Model 59's self-loading action will shoot as fast as you pull the trigger, yet the trigger's design prevents the gun from ever going fully automatic.

- 1 Barrel
- 2 Bolt
- 3 Buffer Plug
- 4 Buffer Plug Lock
- 5 Inertia Rod
- 6 Butt Plate
- 7 Butt Stock
- 8 Carrier
- 9 Carrier Lock
- 10 Chamber
- 11 Closing Spring Tube
- 12 Closing Spring
- 13 Ejector
- 14 Firing Pin
- 15 Firing Pin Stop
- 16 Firing Pin Spring
- 17 Forearm
- 18 Front Sight
- 19 Trigger Guard
- 20 Trigger Guard Pin
- 21 Hammer

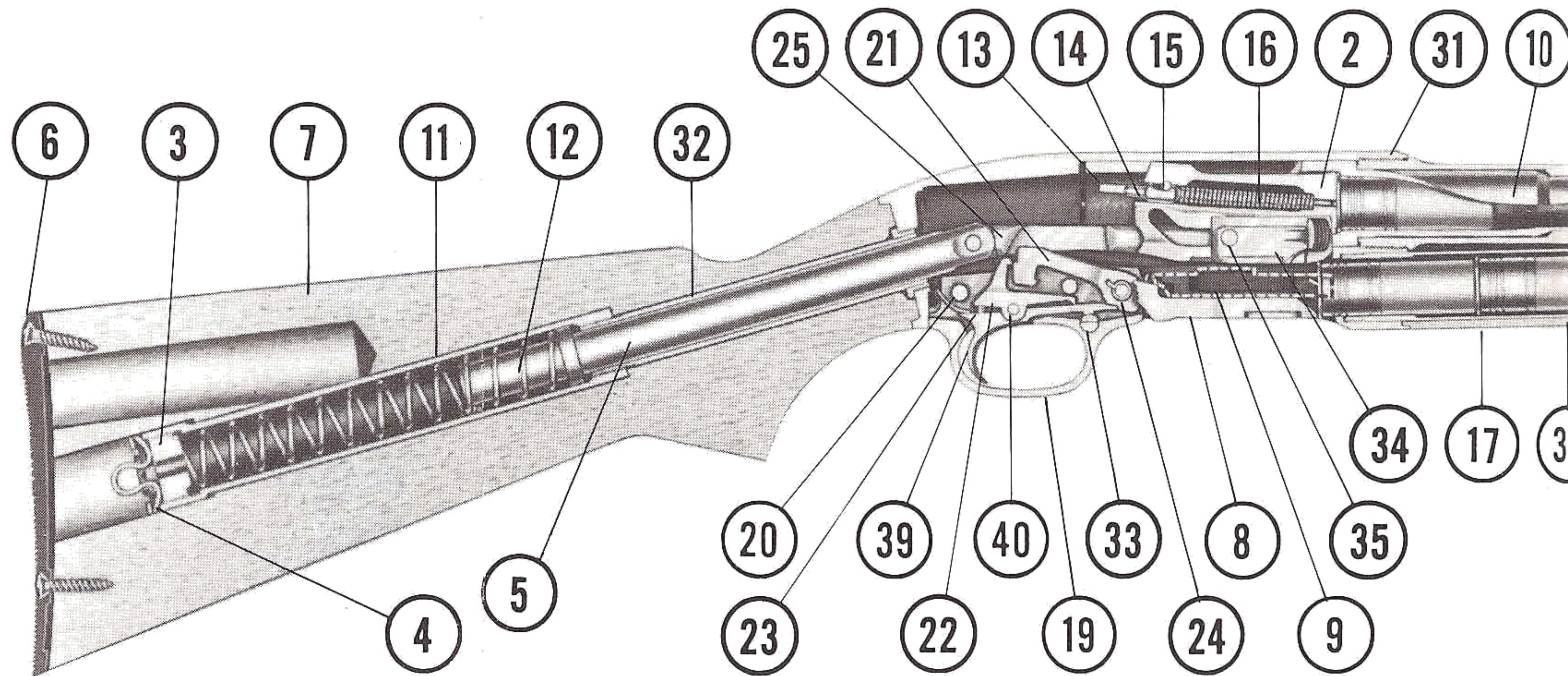

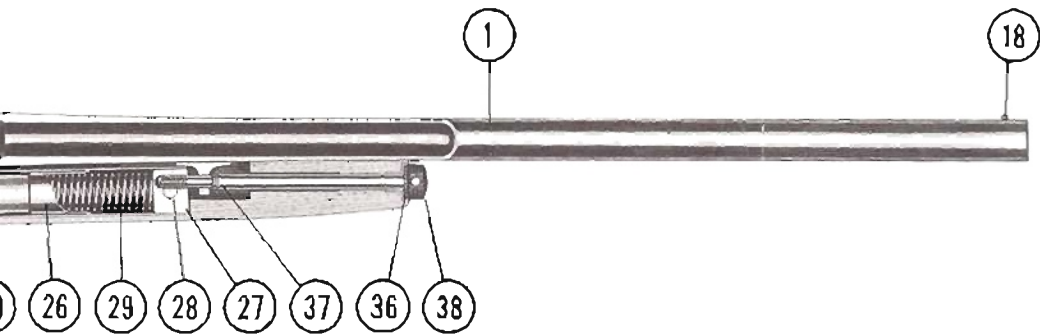

- 22 Hammer Catch
- 23 Hammer Catch Spring
- 24 Hammer Pin and Spring
- 25 Link and Link Pin
- 26 Magazine Follower
- 27 Magazine Plug
- 28 Magazine Plug Pin
- 29 Magazine Spring
- 30 Magazine Tube
- 31 Receiver
- 32 Receiver Extension Tube
- 33 Safety
- 34 Slide Right
- 35 Slide Pin
- 36 Take-Down Bushing and
Take-Down Lock Washer
- 37 Take-Down Screw
Retaining Ring
- 38 Take-Down Screw
- 39 Trigger
- 40 Trigger Pin

NOTE:

Removal of the butt stock is not recommended as adjustment of the operating cycle may be affected. If the butt stock is removed, the buffer plug must be readjusted after the stock is replaced. Tighten buffer plug until the closing spring begins to move the inertia rod. Pull bolt open with cocking handle and with bolt held open back off $2\frac{1}{2}$ turns on the

buffer plug. There should be some backlash to the bolt in its rearward position not over $\frac{1}{8}$ " or less than $\frac{1}{8}$ ". Insufficient backlash requires further backing off of the plug, over $\frac{1}{2}$ " backlash tightening of the plug. When proper adjustment has been reached, it should be secured by the buffer lock.