WINCHESTER[®]
R I F L E S A N D S H O T G U N S

**IMPORTANT INSTRUCTIONS
FOR
MODEL 1885
SINGLE SHOT,
HIGH AND LOW WALL
CENTERFIRE RIFLES**

As one of the Classic Traditions models you can expect the same quality and satisfaction as with the original, historic Model 1885 introduced by Winchester in 1885. And, as with the original, you'll appreciate its elegant design, strong action and smooth functioning.

275 Winchester Avenue
Morgan, UT, USA 84050-9333

Winchester trademarks licensed from Olin Corporation

WINCHESTER

Important instructions for

Winchester Model 1885

SINGLE SHOT, HIGH AND LOW WALL CENTERFIRE RIFLES

Customer Service Department
275 Winchester Avenue
Morgan, Utah 84050-9333
Phone: 1-800-945-5237

If you have any questions or comments regarding your new firearm, please feel free to write or call us. Use the space below to record information about your new firearm.

Model _____

Caliber _____

Serial Number _____

Purchased From _____

Date of Purchase _____

Winchester trademarks licensed from Olin Corporation

PRINTED IN USA • NEU06031/03101

WINCHESTER[®]

Contents	Page
Gun Safety Warnings	2
General Description	4
Terminology and Descriptions	5
Serial Number	5
Ammunition	8
Initial Cleaning	10
Operation of the Hammer	11
General Operating Procedures	14
Shell Deflector	15
Trigger	16
In the Case of a Misfire	17
Firing Procedures	18
Sight Adjustments	19
Hammer Extension	23
Cleaning and Maintenance Suggestions	24
Parts, Service, Repair & Questions	27
Website Information	28

WINCHESTER

GUN SAFETY WARNINGS

IT IS ESSENTIAL THAT THESE OPERATING INSTRUCTIONS BE THOROUGHLY STUDIED BEFORE USING THIS FIREARM TO ASSURE PROPER AND SAFE GUN HANDLING. FAILURE TO FOLLOW THESE INSTRUCTIONS OR FAILURE TO OBEY ANY SAFETY WARNING MAY RESULT IN INJURY TO YOURSELF OR OTHERS, OR CAUSE DAMAGE TO YOUR GUN.

As a gun owner, you accept a set of demanding responsibilities. How seriously you take these responsibilities can be the difference between life and death. There is no excuse for careless or abusive handling of any firearm. At all times handle your rifle and any other firearm with intense respect for its power and potential danger.

PLEASE READ AND UNDERSTAND ALL OF THE CAUTIONS, PROPER HANDLING PROCEDURES AND INSTRUCTIONS OUTLINED IN THIS BOOKLET BEFORE USING YOUR NEW FIREARM.

1. Do not carry a loaded gun with a live round in the chamber while walking, running, climbing a tree, crossing a fence or anywhere you might slip or fall, drop the gun or otherwise bump or jar the gun. A gun that is dropped, bumped, or jarred with a chambered round might accidentally discharge even with the safety on, causing serious injury to you or someone else. When a round is chambered keep the safety on until you are ready to shoot.

2. Do not rely on the safety (half cock position) to prevent accidental discharge. Many safeties merely block the trigger and prevent firing by pulling the trigger. The safety may not prevent an accidental discharge due to dropping, jarring, or bumping a gun.

3. Use only ammunition for which the gun is chambered as indicated on the barrel, to prevent excessive

WINCHESTER®

pressure and possible serious personal injury.

4. Incorrectly reloaded ammunition can cause serious personal injury and damage to the firearm due to excessive pressure. Reload only after proper instruction and in strict compliance with instruction and data contained in current reloading manuals.

5. Never point a gun at anything you do not intend to shoot. Always keep it pointed in a safe direction in case of accidental discharge.

6. Always check to ensure that the barrel is free of obstructions before loading and using the gun. If you experience light recoil or an off sound, open the action, completely unload the rifle and check the barrel for obstruction.

7. Before firing, clean any grease or oil out of the barrel with a cleaning rod and patch. Grease or heavy accumulation of oil can cause excessive pressure and result in serious personal injury.

8. Keep barrel, chamber and action free of rust. Rust in the barrel and chamber can cause excessive pressures resulting in serious injury. A rusted, pitted or eroded barrel should be replaced.

9. Use hearing protection to prevent ear damage from repeated exposure to gunfire.

10. Always use proper shooting glasses to prevent eye injury from flying particles.

11. Never carry a loaded gun in a motor vehicle or carry one into a dwelling. Always carefully unload the gun before entering a motor vehicle, a dwelling or an area such as a camp. Always point a gun in a safe direction while loading or unloading to prevent serious injury in case of an accidental discharge. Never load in the house or in your vehicle.

12. Never shoot at a hard, flat surface or at the surface of water to avoid a ricochet and possible serious personal injury to yourself or a bystander.

13. Store guns in a clean, dry place out of reach of children and separated from stored ammunition.

WINCHESTER®

14. Never alter any parts of your gun. Any alterations or adjustments that may become necessary to the operating mechanism should be performed by a qualified gunsmith.

15. Hunting from elevated surfaces such as tree stands is dangerous. Doing so may increase the risk of handling any firearm. Always make certain that the stand being used is safe, sturdy and stable. Always make certain your firearm is unloaded when it is being taken up and down from the stand. Always make certain that your firearm is not dropped from the stand or dropped while it is being taken up or down from the stand.

16. Discharging firearms in poorly ventilated areas, cleaning firearms, or handling ammunition may result in exposure to lead and other substances known to cause birth defects, reproductive harm and other serious physical injury. Have adequate ventilation at all times. Wash hands thoroughly after exposure.

GENERAL DESCRIPTION

With the introduction of the 1885, the world of single shots was given a welcome addition.

In 1885 competitive target shooting in America had the stature professional golf has today. Huge matches were held at places like Creedmore, New York. Spectators would number in the thousands. The 1885 was uniquely suited to the long range accuracy shooting of the day.

It didn't take long for hunters to embrace the 1885 because of the challenge of hunting with a single shot and the wide variety of hunting chamberings available.

Although other single shots had proceeded it, a new standard was set. Over the years it has certainly appeared that the original Winchester Single Shot 1885 could not be improved upon. It was very close to perfection when it was first made and remains so today.

Figure 1 covers the general features and benefits of

WINCHESTER®

the Model 1885 design. After reading the warnings in the front of this manual, Figure 1 is a good place to start to become familiar with your rifle.

Cycling the lever downward opens the breech and drops the hammer out of the way. This leaves easy access to the chamber area for inserting a round. When the lever is returned upward the breech closes and the hammer moves upward again — but now the hammer is in the cocked position.

After firing, the lever can be returned downward which again lowers the breech block and the hammer, and at the same time extracts the cartridge.

Black powder models of the Model 1885 are also available. Specific instructions and specifications for the black powder models will be included with those particular rifles.

This manual covers the features of all new models of the centerfire Model 1885 after 2002. If you should have an older model of the centerfire Model 1885, please call our Customer Service Dept. at 1-800-945-5237.

TERMINOLOGY AND DESCRIPTIONS

Descriptions in this manual generally refer to the gun in the horizontal position. That is, in the normal firing position. For example, the muzzle is forward or front; the buttstock is rearward or rear; the trigger is downward or underneath; the sights are upward or on top. For general parts terminology refer to Figures 2A, 2B and 2C. Throughout this manual the “action” refers to the mechanism which secures the cartridge in the chamber.

SERIAL NUMBER

The serial number can be found on the lower right side of the receiver toward the rear corner (Figure 3). Record it in the space provided at the front of this manual for future reference.

WINCHESTER®

FIGURE 1

MODEL 1885, FEATURES

After more than 70 years, the Winchester Model 1885 is back. It is a careful reproduction of one of the original configurations. A superb rifle with the fit and finish that you expect in a Winchester.

The massive breech block design is one reason the Model 1885 has proven so accurate

Cartridge ejector system and shell deflector

Traditional three-position hammer: dropped, half cock and full cock

*Drilled and tapped for scope mounts
(Available separately)*

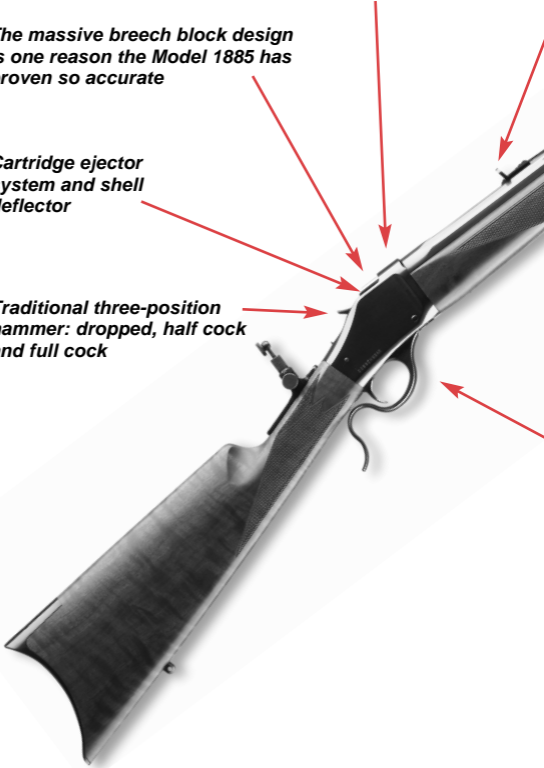

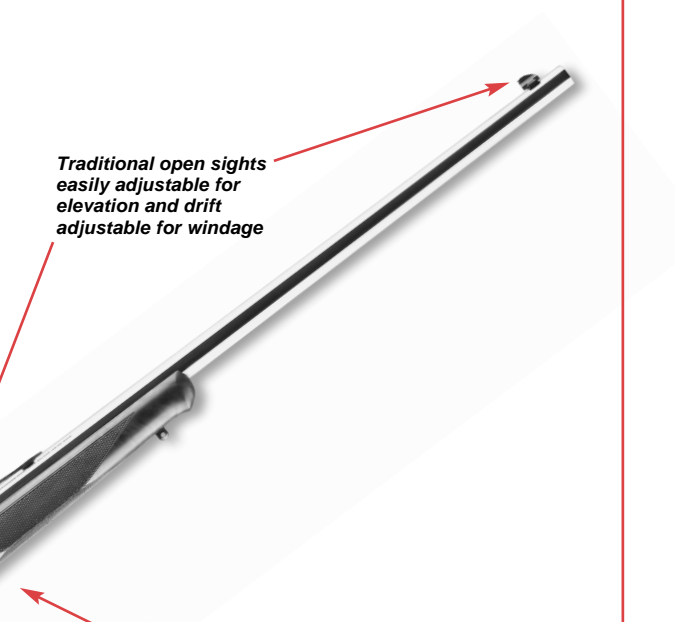

**Traditional open sights
easily adjustable for
elevation and drift
adjustable for windage**

**A special internal hanger system
allows the forearm to be free floating
so it will not affect accuracy**

**The hammer actually drops down,
out of the way, when the lever is
cycled forward. This makes loading
and unloading very convenient**

WINCHESTER®

FIGURE 2A

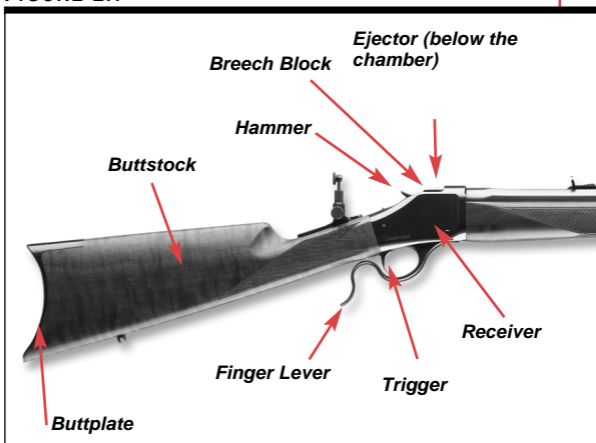

AMMUNITION

Your Winchester Model 1885 is designed to shoot modern factory cartridges only. The caliber of your new Model 1885 is inscribed on the top of the barrel in front of the receiver. Use only ammunition for which your Model 1885 is chambered — as indicated on the barrel — to prevent excessive pressure and possible serious injury. Winchester ammunition is always an excellent choice for your new rifle, delivering unmatched performance and the dependability you want.

MAKE SURE YOU USE ONLY THE EXACT AMMUNITION/CALIBER AS LISTED ON THE BARREL.

Incorrectly reloaded ammunition can cause serious personal injury and damage to the firearm due to excessive pressure. Reload only after proper instruction and in strict compliance with instructions and data contained in current reloading manuals.

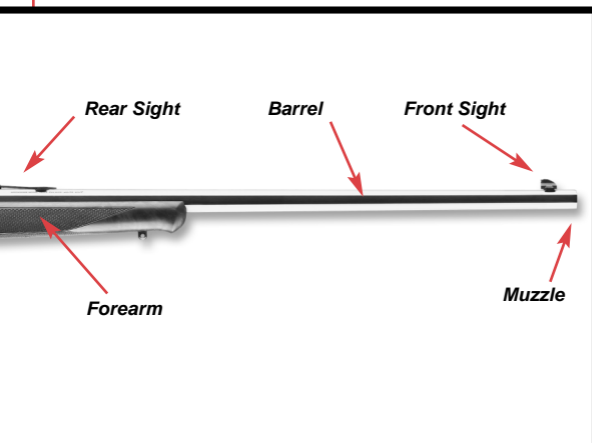
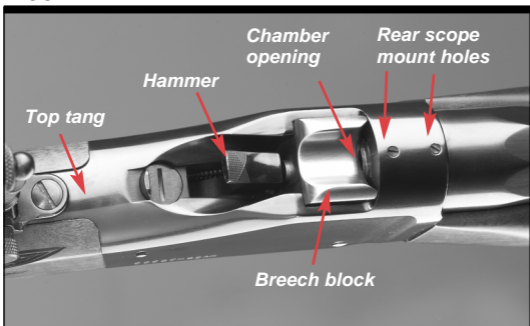
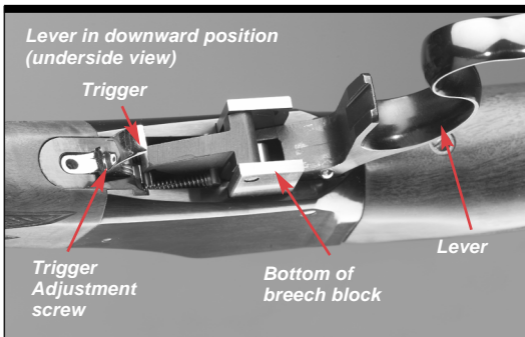

FIGURE 2B



DISCHARGING FIREARMS IN POORLY VENTILATED AREAS, CLEANING FIREARMS OR HANDLING AMMUNITION MAY RESULT IN EXPOSURE TO LEAD AND OTHER SUBSTANCES KNOWN TO CAUSE BIRTH DEFECTS, REPRODUCTIVE HARM AND OTHER SERIOUS PHYSICAL INJURY. HAVE ADEQUATE VENTILATION AT ALL TIMES. WASH HANDS THOROUGHLY AFTER EXPOSURE.

FIGURE 2C



INITIAL CLEANING

Before the first firing, clean the anti-rust compound from the inside of the barrel and receiver with a clean rag and light gun oil. Lightly oil the action along the sides of the breech block and at the pivot points on the lever. Only a small film of oil will ever be necessary. To prevent rust, regularly wipe down all metal surfaces with an oiled rag. See “Cleaning and Maintenance Suggestions” later in the manual.

FIGURE 3



OPERATION OF THE HAMMER

Like most lever action rifles with exposed hammers, the Winchester Model 1885 does not have a separate manual safety. The exposed hammer is an excellent indicator of the status of the rifle. The hammer has three positions: full cock, half cock, and dropped or fired.

FULL COCK POSITION —

The hammer is all the way to the rear (Figure 4). At this point, any pull or tug on the trigger will force the hammer to fall, firing the rifle. The hammer can be placed in this position in either of two ways. First, every time the lever is cycled lever linkage will leave the hammer in the full cock position. The hammer may also be placed at full cock by manually moving it rearward with the thumb until it engages the full cock notch. Be sure to keep your finger off the trigger while cocking the hammer.

HALF COCK POSITION —

The half cock notch on the hammer is a safety feature designed to protect against accidental discharge of the rifle in the event the hammer slips

FIGURE 4



WINCHESTER®

from the thumb while the rifle is being cocked (Figure 5). The half cock hammer position should be used for handling and storage — any time that the rifle is not actually being fired. It is important to note that the Model 1885 has an inertia sear which prevents the hammer from going to the dropped position unless the trigger is pulled with the hammer in the fully cocked position.

DROPPED OR FIRED POSITION —

The dropped-hammer position is the position of the hammer after a round is fired (Figure 6). The dropped position should not be used as a safety position of the hammer. Whenever the hammer has fallen to the dropped position (after firing, for example) it should be immediately moved to the half cock position.

LOWERING THE HAMMER TO HALF COCK —

Always make certain when lowering the hammer from full cock to the half cock position that your thumb is securely and squarely on the hammer and that the rifle is pointed in a safe direction.

A wise practice to follow is to place your thumb extended over the hammer with the point of your thumb just over the “V” between the hammer and

FIGURE 5

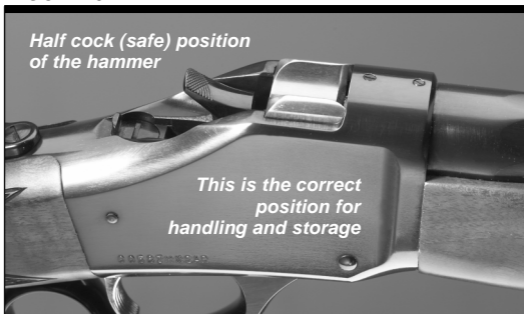

the firing pin so that your thumb can act as a cushion against accidental hammer fall, and at the same time, ease the hammer into the half cock notch. A little practice with an empty rifle will enable a person to become adept at using the thumb in this manner.

To lower the hammer to half cock:

1. Pull the hammer slightly rearward with your thumb still controlling the hammer.
2. Squeeze the trigger and allow the hammer to slowly begin forward travel under the control of your thumb.
3. When the hammer has passed the full cock position, immediately remove your finger from the trigger.
4. Carefully lower the hammer until it catches on the half cock position.

It is possible to move the hammer from the dropped to the half cock position by partially opening the lever.

LEVER OPEN POSITION —

Whenever possible, the lever should be lowered down and fully forward to open the action and lower the breech block. This is the safest status for your rifle.

FIGURE 6



WINCHESTER®

When shooting at ranges, and at many other times, the action should be open unless shooting is imminent.

GENERAL OPERATING PROCEDURES

With a cartridge in the chamber, and the hammer at full cock, the rifle will fire a single round when the trigger is squeezed. The lever is then rotated downward, extracting or ejecting, (depending on model) the fired cartridge. An unfired cartridge may now be placed in the chamber. The hammer remains in the full cock position as the lever is closed, readying the rifle for firing another round.

LOADING —

To load your Model 1885 swing the lever down and fully forward to lower the breech block (Figure 7). Manually insert a cartridge into the chamber (Figure 8). The cartridge should be inserted fully into the chamber to prevent interference with the breech block as it is closed. The top front surface of the breech block is channeled to help load a cartridge protruding slightly from the chamber, but it is best to develop a

FIGURE 7

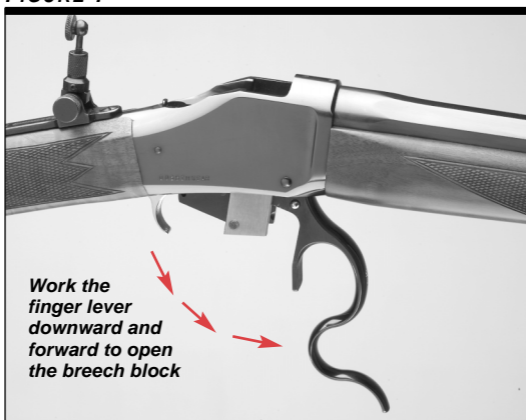
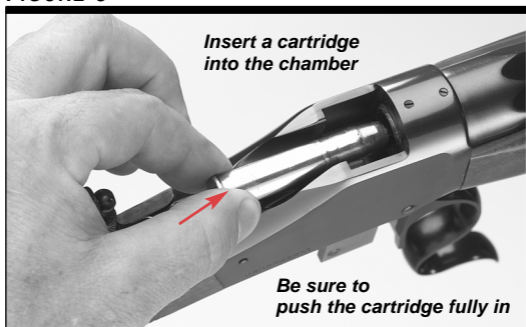

FIGURE 8



habit of pushing the cartridge all the way into the chamber. Now close the lever. This locks the action and leaves the hammer in the full cock, ready-to-fire position.

PLACING THE HAMMER ON HALF COCK —

After loading the rifle, when shooting is not imminent, the correct position of the hammer is at half cock, as pictured in Figure 5 on page 12 (see “Operation of Hammer” section for correct procedure). When the hammer is in the half cock position, you need only thumb the hammer back to the full cock position to prepare the rifle for firing.

UNLOADING —

After firing, or in order to remove a cartridge, swing the lever down. As the lever swings forward the breech block and the hammer move down in the receiver. At the end of the lever cycle, the cartridge is extracted or ejected, depending on the model. Flick away the empty or grasp the loaded cartridge if unloading.

SHELL DEFLECTOR

(ONLY ON MODELS WITH AN EJECTOR SYSTEM)

As a shell is ejected, it will strike the shell deflector. The deflector is found at the back of the receiver behind the hammer (Figures 9 and 10). It is

FIGURE 9

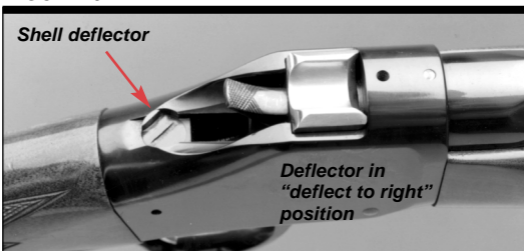
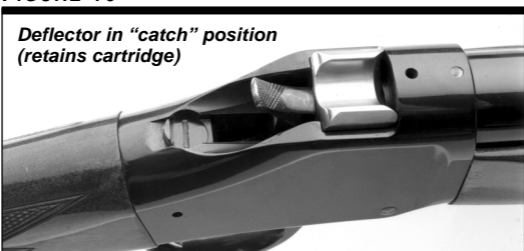

FIGURE 10



adjustable for different deflections depending on your needs. With a screw driver, rotate the deflector to one of the click-stop positions. The deflector may be positioned in a diagonal position to the left or right, deflecting the shell to the left or right respectively, and clearing the stock. To avoid ejecting the shell straight back, always keep the deflector in the right, left or retained position.

TRIGGER

The trigger of the Winchester Model 1885 is adjusted at the factory. The trigger pull can be adjusted in a range of approximately 3½ pounds to over 5 pounds by using a small screwdriver (Figure 11). Clockwise rotation decreases the pull weight to a minimum of approximately 3½ pounds. Counterclockwise rotation increases the trigger pull to a maximum of approximately 5 pounds. If the trigger pull force adjustment is increased too far, the trigger system becomes inop-

WINCHESTER

erative. Should this happen, merely back off the adjustment until the mechanism is again operative.

WARNING: NEVER TAMPER WITH THE TRIGGER PULL ADJUSTMENT MECHANISM IN ORDER TO ALTER THE MINIMUM SETTING OF THIS OR ANY OTHER FIREARM'S TRIGGER PULL.

NEVER ATTEMPT IN ANY WAY TO MODIFY OR ALTER SEAR ENGAGEMENT OR ANY OTHER TRIGGER ASSEMBLY COMPONENT.

IN THE CASE OF A MISFIRE

Only rarely will modern factory ammunition experience a misfire. If this ever happens to you when shooting your Model 1885 please follow these instructions carefully.

CAUTION: IN CASE OF MISFIRE, KEEP THE BARREL POINTED IN A SAFE DIRECTION AND CAREFULLY OPEN THE ACTION WHILE AVOIDING DIRECT EXPOSURE TO THE BREECH BY YOURSELF AND OTHERS.

FIGURE 11

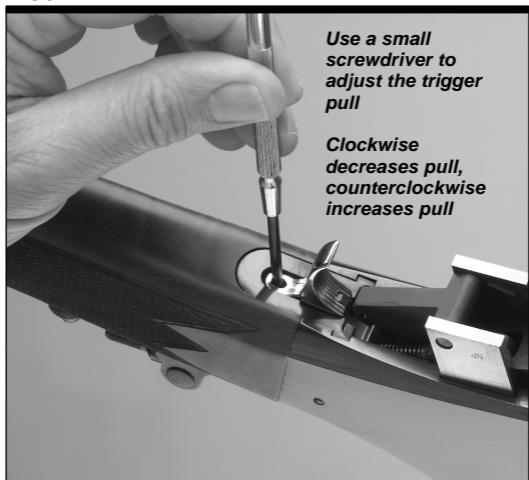

WINCHESTER®

Carefully inspect the extracted cartridge. If the primer is indented, the cartridge should be disposed of in a manner that would prevent accidental injury to you or others.

If there is no indentation, your gun has malfunctioned and should be serviced by a qualified gunsmith. If the gun is under warranty, it must be serviced by a Winchester Firearms Authorized Repair Center (ARC), which you can locate on our website at www.winchesterguns.com.

FIRING PROCEDURES

IMPORTANT: WHEN YOU ARE PREPARING TO SHOOT, IT IS ALWAYS ESSENTIAL THAT YOU BE TOTALLY SURE OF YOUR TARGET. ALWAYS BE AWARE OF ALL OBJECTS BEHIND YOUR TARGET. KNOW THE EXACT LOCATION OF PERSONS WITH YOU AND ANY OTHERS IN YOUR VICINITY. PICK YOUR TARGET WISELY AND CAREFULLY.

Begin with a loaded cartridge in the chamber, the hammer in the half cock position and your finger off the trigger:

FIGURE 12



WINCHESTER®

1. Firmly position your thumb on the hammer and draw the hammer back to the full cock position (Figure 12).

YOUR RIFLE IS NOW READY TO FIRE.

2. Firmly shoulder your gun, take aim and when on target pull the trigger smoothly, without jerking.

TO LOAD ANOTHER ROUND FOR THE NEXT SHOT —

1. Swing the finger lever fully down, extracting or ejecting the fired cartridge case from the chamber on the ejector models. As it is ejected, it will strike the shell deflector. (Figures 9 and 10).

2. Insert another round fully into the chamber.

3. Close the action by returning the lever upward. The closing of the action will leave the hammer in a cocked “ready-to-fire” position.

4. WHEN FIRING IS COMPLETED OR WHEN SHOOTING IS NO LONGER IMMINENT, IMMEDIATELY RETURN THE HAMMER TO THE HALF COCK POSITION.

IMPORTANT: UNDER NO CIRCUMSTANCES SHOULD YOU MOVE ON OR CONTINUE TO HUNT WITH YOUR HAMMER IN THE FULL COCK, FIRE POSITION.

SIGHT ADJUSTMENTS

OPEN SIGHT ADJUSTMENT —

All Model 1885 rifles are fitted with open sights. The style and adjustment system may vary.

The proper procedure is to shoot a group with the sights set as they come from the factory (intermediate position on both elevation and windage), and then make incremental adjustments to move the sight blade and elevator to position the group on your target. The procedures below are for the type of open sights

FIGURE 13

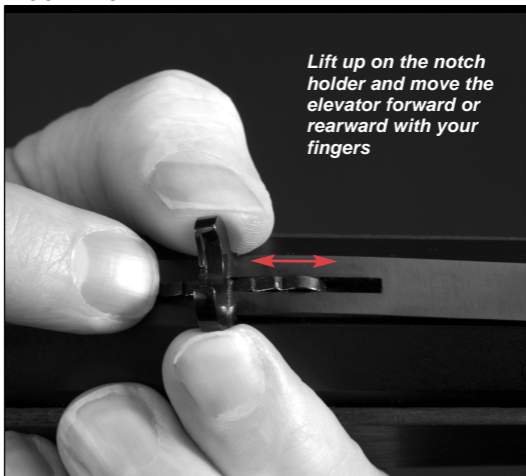

found on current Model 1885 rifles.

BEFORE MAKING ANY SIGHT ADJUSTMENTS, MAKE SURE YOUR RIFLE IS FULLY UNLOADED AND THE ACTION IS OPEN.

UP OR DOWN ELEVATION ADJUSTMENTS —

Adjusting elevation on your Model 1885 requires you to lift up the rear sight blade on your rifle's rear sight with your fingers and move the notched elevator either forward or backward (Figure 13). To raise point of impact, use your fingers to lift up on the blade and slide the elevator rearward. Adjusting the sight to make your gun shoot lower is just the opposite — move the elevator forward. Remember:

- Move the blade up to shoot higher.
- Move the blade down to shoot lower.

RIGHT OR LEFT WINDAGE ADJUSTMENTS —

On most Model 1885 sights, the entire rear sight is

FIGURE 14

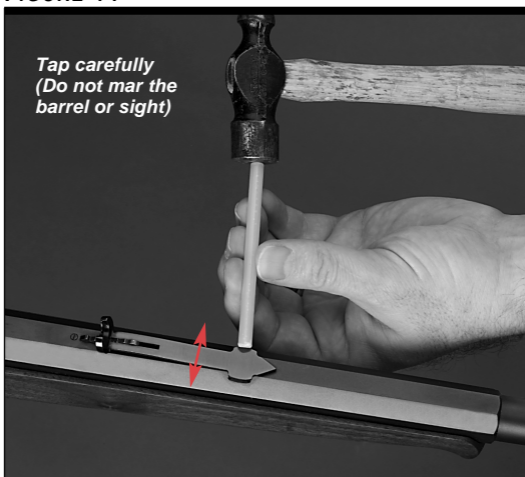

dovetailed in the barrel. To adjust for windage, gently move the rear sight to the right or left by tapping at the dovetail using a wood or fiber dowel or hammer that will not mar the sight (Figure 14).

If you tap to the right your gun will shoot more to the right. Moving the rear sight to the left is just as easily done. Note how much you adjust the sight as you sight-in your Model 1885. Remember:

- Move the rear sight to the right to shoot farther to the right on the target.
- Move the rear sight to the left to shoot farther to the left on the target.

Care should be taken not to mar the finish or bend sight components when adjustments are made.

The front sight bead is also held in a dovetail on the barrel. It is possible to make windage adjustments by tapping it to one side or the other, just like the rear sight. Remember, when adjusting the front sight you get the opposite results: move to the right and you shoot more to the left, move the bead to the left and you'll shoot more to the right.

FIGURE 15

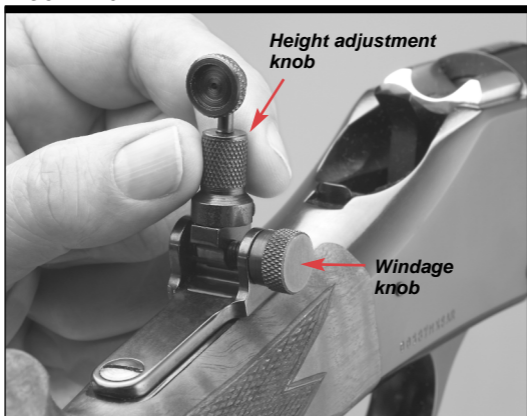

All sight adjustments — of course — are a matter of trial and error. Remember, it is usually necessary to reset your sights when you change type or even brand of ammunition.

Front and rear sight dovetails should be snug.

SIGHT PICTURE —

The correct sight picture for the sights on your Model 1885 is with the front bead resting in the U-shaped notch in the sight blade. The bead itself should rest directly under the point of impact (Figure 16).

For example, if you were shooting a conventional small bore target, the round, black bull's-eye would appear to rest on top of the front bead.

SCOPE MOUNT / SIGHTS —

Some Winchester Model 1885 rifles are drilled and tapped for scope mounts. See your Winchester firearms dealer to purchase the scope mount base and rings appropriate for your Model 1885. The rear tang is drilled and tapped to accept a tang-mounted peep sight (included with some models). A variety of sights are available from major sight manufacturers.

FIGURE 16

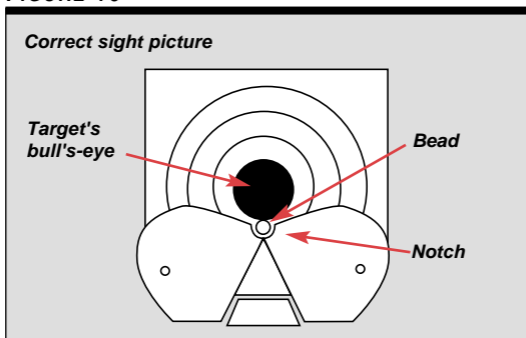

REAR TANG PEEP SIGHT ADJUSTMENT —

Certain models of the 1885 have a rear-tang peep sight. This sight is highly accurate and adjustable for windage and elevation.

Simply raise the sight into position. Turn the knurled knob on the height adjustment clockwise to raise the sight, or shoot higher (Figure 13). Turn counter-clockwise to lower the sight or to shoot lower.

Turn the windage knob located on the right side of the sight (Figure 13), away from you or clockwise to adjust the point of impact to the right. Turn the knob towards you or counterclockwise to adjust the point of impact to the left.

Each click on both height and windage is equal to 1/2 minute of angle.

HAMMER EXTENSION

Hammer extensions are not recommend for use with the Winchester Model 1885 single shot. Using one may cause misfires.

CLEANING AND MAINTENANCE SUGGESTIONS

The Model 1885 will function better and more

WINCHESTER

reliably over a longer period of time if it is properly maintained and kept clean.

BEFORE PERFORMING ANY CLEANING PROCEDURES, ALWAYS MAKE CERTAIN THERE IS NO CARTRIDGE IN THE CHAMBER. ALWAYS OPEN THE ACTION WHEN CLEANING AND MAINTAINING YOUR MODEL 1885.

You should clean your Model 1885 after every day of shooting and more often if it becomes excessively dirty. A minimum cleaning includes wiping down the action and oiling key parts. Most regular maintenance will also include cleaning the barrel. If you encounter a function problem (tight action when working the lever), be sure to give your gun a thorough cleaning to see if it solves the problem before seeking the services of one of our Authorized Repair Centers, our service facility or a competent gunsmith.

To clean your firearm, follow the general outline below:

CLEANING PROCEDURES —

BE CERTAIN YOUR GUN'S CHAMBER IS UNLOADED. ALWAYS WEAR PROTECTIVE SAFETY GLASSES DURING ALL CLEANING PROCEDURES. KEEP AMMUNITION AWAY FROM THE CLEANING AREA. DO NOT TEST THE FUNCTION OF YOUR FIREARM WITH LIVE AMMUNITION.

ALWAYS OPEN THE ACTION FULLY BEFORE BEGINNING ANY CLEANING PROCEDURE.

1. Use a cleaning rod with a tip and patch suitable for the bore diameter of your rifle. Make sure the patch is large enough for a snug fit in the bore.

WINCHESTER®

Insert the rod and patch into the barrel at the breech end and run it back and forth several times. If cleaning is performed from the muzzle end, always use a crown protector. Be careful not to strike the crown of the muzzle with the handle end of the rod. Damage to this area can affect the accuracy of the rifle.

2. Inspect the chamber and bore for brass, copper and powder fouling. A normal amount of powder residue can be expected and is not serious. It can usually be removed by repeating step one, using a patch saturated with solvent. If or when fouling should become heavy, it can be removed with a brass bore brush. Dip or spray the brush with solvent and scrub the chamber and bore until the fouling is removed. To prevent brass bristles from breaking off, the brush should be pushed completely through the bore before being withdrawn. If cast lead bullets are used a lead solvent may be used as well to fully clean the bore. Follow the instructions on all solvents and cleaners.

3. After fouling has been removed the bore should be wiped dry. Then pass a slightly oiled patch through the bore, for preservation. A fine, light gun oil is recommended.

4. Wipe all exposed metal surfaces of the receiver, forearm and barrel with a clean rag. Finger marks should be removed because they provide a place where moisture can accumulate. Any dried oil in the receiver area should also be removed.

5. Then lightly oil your gun at the points described under "Initial Cleaning" on page 10 of this manual. Ordinary good judgment will, of course, indicate that the metal of the gun should receive a light film of oil any time the rifle has been exposed to weather or handling. Remember, the polished, finely fitted surfaces of the receiver and action mechanisms must always have a thin film of oil. Make sure that the surfaces of the breech block, lever components and extractor mechanism parts are especially clean and lightly oiled with a high quality gun oil. Do not use pure silicone or lanolin.

WINCHESTER®

6. INSPECT THE BARREL AND CHAMBER. TO MAKE CERTAIN THAT NO PATCHES HAVE BEEN INADVERTENTLY LEFT IN THEM. REMOVE ANY THAT REMAIN.

7. Wipe all wood surfaces.

8. When transporting only, store your Model 1885 in a quality protective case to prevent scratches and dents. Store in a dry place to prevent corrosion. Store away from children. **MAKE SURE YOUR GUN IS UNLOADED AND ALWAYS STORE AMMUNITION SEPARATELY.**

OTHER CLEANING SUGGESTIONS —

- Never pour large quantities of oil into the receiver or other parts. It can drain down to the wood and soften it — and cause permanent damage and loosening of the stock.
- After extended periods of heavy use, your gun should be taken to one of our Authorized Repair Centers or a qualified gunsmith to have the action disassembled for professional cleaning and lubrication.

NEVER ATTEMPT TO TAKE YOUR MODEL 1885 APART FURTHER THAN EXPLAINED IN THIS MANUAL.

This is a specialized, finely fitted mechanism. You may permanently mar it by attempting to disassemble the inner mechanism assemblies. If further disassembly for service or cleaning is required, take your gun to a Winchester Firearms Authorized Repair Center or a competent gunsmith as explained under “Service or Repair.”

PARTS, SERVICE, REPAIR & QUESTIONS

If your Winchester rifle or shotgun should ever need service or repair, it is often best to utilize one of our Authorized Service Centers. In some cases it is appropriate to use the Winchester Service Center in

WINCHESTER

Arnold, MO. A list of Authorized Service Centers was included with your new firearm. If you need a new listing, call us. We can help you determine the best place to service your firearm.

In order to avoid delays it is important to never send your gun directly to our facility without direct authorization from one of our service specialists. This avoids possible delays in obtaining service. Call us for details on how to receive service first, before sending your gun.

Parts listings, Service Center lists, service procedures and general product information are also found on the web at: www.winchesterguns.com.

GENERAL PRODUCT AND HISTORICAL QUESTIONS —

275 Winchester Avenue
Morgan, UT 84050-9333
1-800-945-5237 (toll free)

PARTS, SERVICE, REPAIR STATUS AND TECHNICAL QUESTIONS —

Winchester Rifles and Shotguns Parts & Service
3005 Arnold Tenbrook Road
Arnold, MO 83010-9406
1-800-322-4626 (toll free)

CAUTION: PARTS ARE MADE FOR WINCHESTER BRAND GUNS MANUFACTURED BY OR FOR U.S. REPEATING ARMS COMPANY, INC., AND SHOULD NOT BE USED IN OTHER GUNS EVEN THOUGH MODELS MAY BE SIMILAR. IMPROPERLY FITTED PARTS MAY BE DANGEROUS.

You Are Responsible For Firearms Safety

As a gun owner, you accept a set of demanding responsibilities. How seriously you take these responsibilities can mean the difference between life and death. Failure to follow any of these instructions can cause extensive damage to your gun and/or possible serious injury or death to yourself and others. There is no excuse for careless or abusive handling of any firearm. At all times handle any firearm with intense respect for its power and potential danger.

PLEASE READ AND UNDERSTAND ALL OF THE CAUTIONS, PROPER HANDLING PROCEDURES AND INSTRUCTIONS OUTLINED IN THE OWNER'S MANUAL BEFORE USING YOUR NEW FIREARM.

1. **ALWAYS KEEP THE MUZZLE OF YOUR RIFLE POINTED IN A SAFE DIRECTION**, even though you are certain that the rifle is unloaded. Never point any firearm at anything you do not intend to shoot. Be extremely alert and aware of all persons and property within the range of your ammunition.
2. **NEVER RELY TOTALLY ON YOUR RIFLE'S MECHANICAL "SAFETY" DEVICE.** The word "safety" describes a gun's trigger block mechanism, sear block mechanism, hammer block mechanism or firing pin block mechanism. These mechanical devices are designed to place your gun in a **SAFER** status. No guarantee can be made that the gun will not fire even if the "safety" is in the "on safe" position. See "**Operations of the Safety**" for instructions on operation of YOUR gun's "safety."
LIKE ANY MECHANICAL DEVICE, A "SAFETY" CAN SOMETIMES FAIL; IT CAN BE JARRED OR INADVERTENTLY MANIPULATED INTO AN UNSAFE CONDITION.
Mechanical "safeties" merely aid safe gun handling and are no excuse for pointing your rifle's muzzle in an unsafe direction.
While it is a good idea to "test" your rifle's mechanical "safeties" periodically for proper function, **NEVER TEST IT WHILE YOUR RIFLE IS LOADED OR POINTED IN AN UNSAFE DIRECTION**
Safe gun handling does not stop with your gun's mechanical "safety devices -- it starts there. Always treat your rifle with the respect due a loaded, ready-to-fire firearm.
3. **WHENEVER YOU HANDLE A FIREARM, OR HAND IT TO SOMEONE, ALWAYS OPEN THE ACTION IMMEDIATELY, VISUALLY CHECK YOUR RIFLE'S CHAMBER, FEED MECHANISM AND MAGAZINE.**
Make certain they do not inadvertently contain any ammunition. Always keep the chamber empty and "safety" in the "on safe" position unless shooting is imminent.
4. **DO NOT TRANSPORT YOUR RIFLE LOADED, WHETHER IN A SCABBARD, GUN CASE, OR OTHER CONTAINER.**
5. **HUNTING FROM ELEVATED SURFACES SUCH AS TREE STANDS IS DANGEROUS**, and may increase the risk of handling a firearm. The following rules should always be observed by you and those you hunt with: **Always** make certain that the stand being used is safe and stable. **Always** make certain that your firearm is unloaded when it is being taken up to and down from the stand. **Always** make certain that your firearm is not dropped from the stand, or dropped while it is being taken up to or down from the stand. **Remember**, a loaded firearm may discharge when dropped, even with the safety in the "on safe" position.

6. **BEWARE OF BARREL OBSTRUCTIONS**, for the safety of both your gun and yourself. Mud, snow, and an infinite variety of other obstructions may inadvertently lodge in a barrel bore. It takes only one small obstruction to cause dangerously increased pressures that can ruin (swell or rupture) the finest rifle barrels.
BEFORE CHECKING FOR A BARREL OBSTRUCTION, BE CERTAIN NO LIVE ROUND IS IN THE CHAMBER AND THAT THE MAGAZINE IS REMOVED AND FEED MECHANISMS ARE COMPLETELY EMPTY. PLACE THE "SAFETY" IN THE "ON SAFE" POSITION.
Look through the barrel to be sure it is clear of any obstruction. If an obstruction is seen, no matter how small it may be, clean the bore with a cleaning rod and patch as described in "**Cleaning and Maintenance Suggestions.**" Before the first firing, clean the bore with a cleaning rod and patch, and wipe away any anti-rust compound in the action/chamber areas.
7. **ALWAYS UNLOAD YOUR RIFLE WHEN NOT IN USE. REFER TO "UNLOADING THE RIFLE" FOR AN EXPLANATION OF HOW TO UNLOAD YOUR RIFLE PROPERLY.**
As a safety precaution, it is preferable to disassemble your gun for storage. Store your gun and ammunition separately -- well beyond the reach of children. Take all safeguards to ensure your rifle does not become available to untrained, inexperienced or unwelcome hands.
8. **USE THE PROPER AMMUNITION.**
The barrel and action of this rifle have been made with substantial safety margins over the pressures developed by established American commercial loads. Nevertheless, Browning assumes no liability for incidents which occur through the use of cartridges of nonstandard dimensions which develop pressures in excess of commercially available ammunition with standards established by the Sporting Arms and Ammunitions Manufacturers' Institute (SAAMI).
BE ALERT TO THE SIGNS OF AMMUNITION MALFUNCTION.
If you detect an off sound or light recoil when a cartridge is fired, **DO NOT LOAD ANOTHER CARTRIDGE INTO THE CHAMBER.** Open the action and remove all cartridges from the magazine, chamber and action areas. With the action open, glance down the barrel to make sure that an obstruction does not remain in the barrel. If there is an obstruction, completely clear the barrel before loading and firing again. Failure to follow these instructions can cause extensive damage to your gun and possible serious injury to yourself and others.
MAKE SURE OF ADEQUATE VENTILATION IN THE AREA THAT YOU DISCHARGE A FIREARM. WASH HANDS THOROUGHLY AFTER EXPOSURE TO AMMUNITION OR CLEANING A FIREARM.
Lead exposure can be obtained from discharging firearms in poorly ventilated areas, cleaning firearms or handling ammunition. Lead is a substance that has been known to cause birth defects, reproductive harm and other serious injury.
9. **DO NOT SNAP THE FIRING PIN ON AN EMPTY CHAMBER -- THE CHAMBER MAY NOT BE EMPTY!**
Treat every gun with the respect due a loaded gun, even though you are certain the gun is unloaded.
10. **KEEP FINGERS AWAY FROM THE TRIGGER WHILE UNLOADING, LOADING, UNTIL YOU ARE READY TO SHOOT.**

11. **BE SURE OF YOUR TARGET AND BACKSTOP.**
Particularly during low light periods. Know the range of your ammunition. Never shoot at water or hard object.
12. **ALWAYS UNLOAD YOUR RIFLE'S CHAMBER BEFORE CROSSING A FENCE, CLIMBING A TREE, JUMPING A DITCH OR NEGOTIATING OTHER OBSTACLES.**
Refer to "**Unloading The Rifle**" for instructions on the unloading of your rifle. Never place your loaded rifle on or against a fence, tree, car or other similar object.
13. **WEAR EYE AND EAR PROTECTION WHEN SHOOTING.**
Unprotected, repeated exposure to gunfire can cause hearing damage. Wear ear protectors (shooting ear plugs or muffs) to guard against such damage. Wear shooting glasses to protect your eyes from flying particles. Allow proper distance (eye relief) between the scope and your eye when firing a scoped rifle or shotgun. Always keep a safe distance between the muzzle of your firearm and any persons nearby, as muzzle blast, debris and ejecting shells could inflict serious injury. Also, wear eye protection when disassembling and cleaning your shotgun to prevent the possibility of springs, spring-tensioned parts, solvent or other agents from contacting your eyes.
14. **DROPPING A LOADED GUN CAN CAUSE AN ACCIDENTAL DISCHARGE** even with the "safety" in the "on safe" position. Be extremely careful while hunting or during any shooting activity, to avoid dropping any firearm.
15. **IF YOUR RIFLE FAILS TO FIRE, KEEP THE MUZZLE POINTED IN A SAFE DIRECTION.**
Hold this position for a minimum of 30 seconds. Carefully open the action and remove the cartridge. If the primer is indented, the cartridge should be disposed of in a way that cannot cause harm. If the primer is not indented, your firearm should be examined by a qualified gunsmith and the cause of the malfunction should be corrected before further use.
16. **BE DEFENSIVE AND ON GUARD AGAINST UNSAFE GUN HANDLING AROUND YOU AND OTHERS.**
Don't be timid when it comes to gun safety. If you observe other shooters violating any of these safety precautions, politely suggest safer handling practices.
17. **BE CERTAIN YOUR RIFLE IS UNLOADED BEFORE CLEANING.** Because so many gun accidents occur when a firearm is being cleaned, special and extreme care should be taken to be sure your gun is unloaded before disassembly, cleaning and reassembly. Keep ammunition away from the cleaning location. Never test the mechanical function of any firearm with live ammunition.
18. **TEACH AND SUPERVISE FIREARMS SAFETY TO ALL MEMBERS OF YOUR FAMILY -- ESPECIALLY TO CHILDREN AND NONSHOOTERS.**
Closely supervise newcomers to the shooting sports. Encourage enrolling in hunting/shooting safety courses.
19. **NEVER DRINK ALCOHOLIC BEVERAGES OR TAKE ANY TYPE OF DRUGS BEFORE OR DURING SHOOTING.**
Your vision and judgment could be dangerously impaired, making your gun handling unsafe to you and to others.

20. **READ AND HEED ALL WARNINGS** in this instruction book, on ammunition boxes and with all accessories that you install on your firearm. It is your responsibility to secure the most up-to-date information on the safe handling procedures of your Browning gun. Browning assumes no liability for incidents which occur when unsafe or improper gun accessories or ammunition combinations are used.
21. **PERIODIC MAINTENANCE -- AVOID UNAUTHORIZED SERVICING.**
Your rifle is a mechanical device which will not last forever, and as such, is subject to wear and requires periodic inspection, adjustment and service. Browning firearms should be serviced by a Browning Recommended Service Center or by Browning's service facility in Arnold, Missouri. Browning cannot assume any responsibility for injuries suffered or caused by unauthorized servicing, alterations or modifications of Browning firearms.
22. **BROWNING RESERVES THE RIGHT TO REFUSE SERVICE ON FIREARMS THAT HAVE BEEN ALTERED, ADDED TO OR SUBSTANTIALLY CHANGED.**
Removal of metal from barrel(s), or modification of the firing mechanism and/or operating parts may lead to Browning's refusal of service on such firearms. Browning will charge the owner parts and labor to return the firearm to original Browning specifications.
DO NOT, UNDER ANY CIRCUMSTANCES, ALTER THE TRIGGER, SAFETY OR PARTS OF THE FIRING MECHANISM OF THIS OR ANY OTHER FIREARM. FAILURE TO OBEY THIS WARNING MAY RESULT IN INJURY OR DEATH TO YOURSELF OR OTHERS.

BE CAREFUL!

WINCHESTERGUNS.COM

U.S. Repeating Arms Company offers an information resource for you on the world wide web.

- List of authorized repair centers.
- Customer service information.
- Answers to many technical and historical questions.
- Links to helpful sites.
- Visit www.winchesterguns.com

NOTES



WINCHESTER
RIFLES AND SHOTGUNS Licensee®

275 Winchester Avenue
Morgan, UT, USA 84050-9333
www.winchesterguns.com

Winchester trademarks licensed from Olin Corporation