

WALTHER

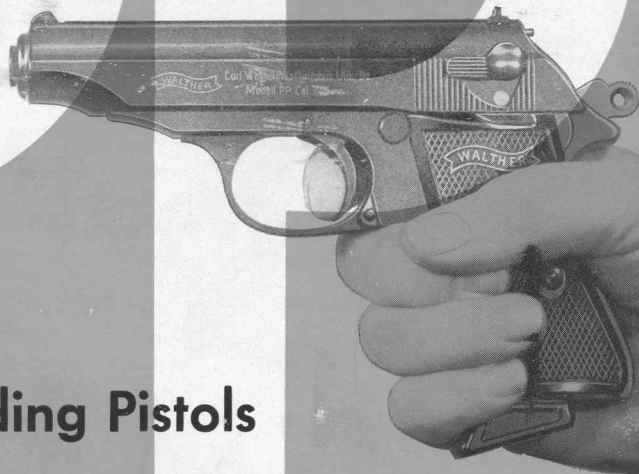

Self-loading Pistols



The **Walther Self-Loading Pistols Model PP and PPK**, renowned all over the **World** and formerly made at Zella-Mehlis in Thuringia, are now once again produced in the new Works of **Carl Walther at Ulm/Donau**.

The unique construction of these WALTHER pistols is a guarantee for their absolute safety, their instant readiness, and their high precision performance.

These arms, designed for self-protection, can be carried without any danger, uncocked though loaded, and nevertheless ready for instant use in an emergency.

Due to their safety, reliability, and instant readiness, they are the best self-loading pistols in the World. For that reason, these pistols have been exclusively adopted as the official weapons by all German Security Authorities and by many similar institutions in other countries.

The mechanism – and therewith the functional performance – of the models PP and PPK are identical. The following pages are intended to furnish detailed information relating to the technical data, handling, dismantling and assembling, and equipment of these pistols.

Index please see page 22

Walther Pistol Model PP

(Jll. 1) in Cal. 7.65 mm, 9 mm short,
and .22 l. r.

with spare magazine, standard
design (without extension).
Available only with steel frame!



Jll. 1

Pistol –
ready to fire



Jll. 2

Pistol – safe

Walther Pistol Model PPK

(Jll. 2) in Cal. 7.65 mm, 9 mm short,
and .22 l. r.

with spare magazine (standard
design without extension).
Steel frame.

In Cal. 7.65 mm and .22 l. r.,
also available with light-alloy frame.

Models PP and PPK in Cal. .22 l. r. are without a signal pin.

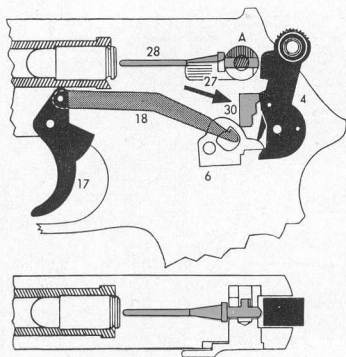

JII. 7

The pistol is loaded and uncocked. The safety lever is 'Off', the weapon thus instantly ready ('Double-Action' shooting). There is an automatic internal safety.

A cartridge is lodged in the chamber. The safety lever (27) is 'Off', the pistol still uncocked. The hammer (4) is blocked by the automatic internal safety (30) (see arrow in JII. 7).

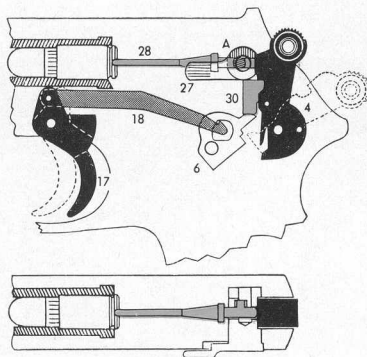

JII. 8

The pistol at the moment of firing. The processes taking place in the mechanism during 'Double-Action' shooting.

The trigger (17) has been pulled back, thus lifting the sear (cocking piece) (6) and at the same time also the locking piece (30) — the automatic internal safety —, thereby allowing the hammer (4) to hit the rear end of the firing pin (28).

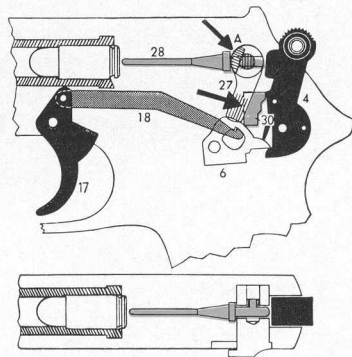

JII. 9

Pistol loaded, thumb safety applied. External safety lever.

As shown already in JII. 7, the hammer (4) is blocked by the locking piece (30), i. e., the automatic internal safety. The firing pin (28), too, can be blocked at will by moving the safety lever (27) to the 'Safe' position, i. e. downwards (see arrow A in JII. 9).

Directions

for using

and handling the

WALTHER PISTOL

Models PP and PPK

It is important to realize that the Models PP and PPK can be dismantled within only a few seconds without the aid of any tool and without fear of inadvertently causing any component parts to become detached and fall out. Care must be taken so as to ensure that the pistols are loaded, unloaded, or dismantled only after the thumb safety has been applied! Moreover, the muzzle should always point to the ground when the pistols are not actually being used.



JII. 10

Loading:

First, apply the thumb safety. This measure must be adopted in any instance of handling either model PP or PPK. Press the magazine catch button with the right thumb. The magazine is pushed out of the pistol by spring pressure. See JII. 10 above. "The pistol shown in JII. 10-20 is the Model PPK. The directions given in the appropriate texts, however, apply naturally also the pistol Model PP."

JII. 11



Filling the Magazine:

Hold the magazine with the left hand and push the cartridges, one by one, – base first – under the magazine lips by carefully depressing the feeder platform with the cartridge rim. (See JII. 11). To empty the magazine, push the cartridges forward and remove them. Any forceful jamming-in or ripping-out will damage the magazine and lead to functional disorders of the pistol.

JII. 12



Introducing the first Cartridge.

The thumb safety is 'On'. Insert a full magazine whilst holding the pistol with the right hand, grip the slide with the left hand at the ribbed end, pull fully back, and let go (See JII. 12). The first cartridge has thus been fed into the chamber.

The hammer is not cocked thereby: so long as the thumb safety on the PP or PPK is 'On', the hammer cannot be cocked as in either 'Single-Action' or 'Double-Action' shooting.

'Single-Action' Shooting

Move the thumb safety lever to the 'Off' position (upward turn.) The **signal pin** – see arrow – which **has been pushed back** already at the moment of loading is now plainly visible, and indicates the presence of a cartridge in the chamber. (See Jll. 13.) Cock the hammer by pulling the latter back to the fullest extent with the right thumb. This manner of preparing for the first shot, especially in practice shooting, considerably reduces the trigger pressure and is therefore all the more commendable.

'Double-Action' Shooting:

In the event of having to use the pistol without delay, push the thumb safety lever upward and pull the trigger through, thus cocking the hammer as in 'Double-Action' shooting with a revolver.

Should the pistol fail to fire a round in consequence of faulty ammunition on exceptional occasions, simply pull the trigger again. A repeated impact of the firing pin on the primer cap will as a rule cause even a faulty round to detonate.





JII. 15

Applying the Thumb Safety while the Hammer is cocked:

If it is not intended to continue the shooting after firing a few rounds, the pistol must be rendered safe by applying the thumb safety. The process is shown in JII. 15. Push the safety lever downward with the thumb.



JII. 16

Manipulating the Pistol after Firing Magazine Content:

When the last round in the magazine has been fired, the slide stays open. If it is intended to continue the shooting, remove the empty magazine (as shown in JII. 10) and introduce the next full magazine. Pull the slide back very slightly, then let it move forward. The first cartridge will thus be fed into the chamber. The hammer, however, will in such case remain cocked. If the firing is not be continued, remove the magazine, push the safety lever downward, pull the slide back, and let go. The hammer will drop forward and come to rest on the safety arbor.

Dismantling

Apply the thumb safety, remove the magazine. Hold the pistol with the right hand and pull the trigger guard downward with the left, while the right index finger – as shown in Jll. 17 – pushes the trigger guard to the left and causes it to rest lightly on the underside of the forward end of the frame.



Jll. 17

Dismantling

Hold the trigger guard in this position with the index finger of the right hand. Now pull the slide fully back, raise it clear off the frame, and let it glide forward and off the barrel. – See Jll. 18.



Jll. 18



III. 19

Cleaning and Oiling

Having thus been partly stripped and separated into its three main units, the pistol may now be readily cleaned. —

See Ill. 19.

It is advisable to remove the recoil spring from the barrel. When re-assembling the pistol, this spring must be placed on the barrel with the smaller coils first, so that the wider end of the recoil spring coincides with the muzzle.

A few drops of a good, acid-free, non-resinous oil should then be applied to the various parts, and the bore of the barrel should be wiped dry again.

Any further dismantling should be carried out only by a skilled gunsmith.

Assembling

To re-assemble the pistol, hold the grip (frame) unit with the right hand, pull the trigger guard downward and push the latter to the left with the right index finger so as to hold it in position against the underside of the forward end of the frame. Now bring the slide obliquely down over the muzzle (as shown in Jll. 20), set it fully down on the frame and retract to the rearmost limit, then let the slide move forward to its normal 'closed' position. **See that the thumb safety is applied** while this operation is being carried out.

Assembling

The slide is now once again in its original place (see Jll. 21). Pull the trigger guard lightly downward with the left hand and allow it to return to its normal position.



Diagrammatical layout of components of Models PP and PPK

JII. 22

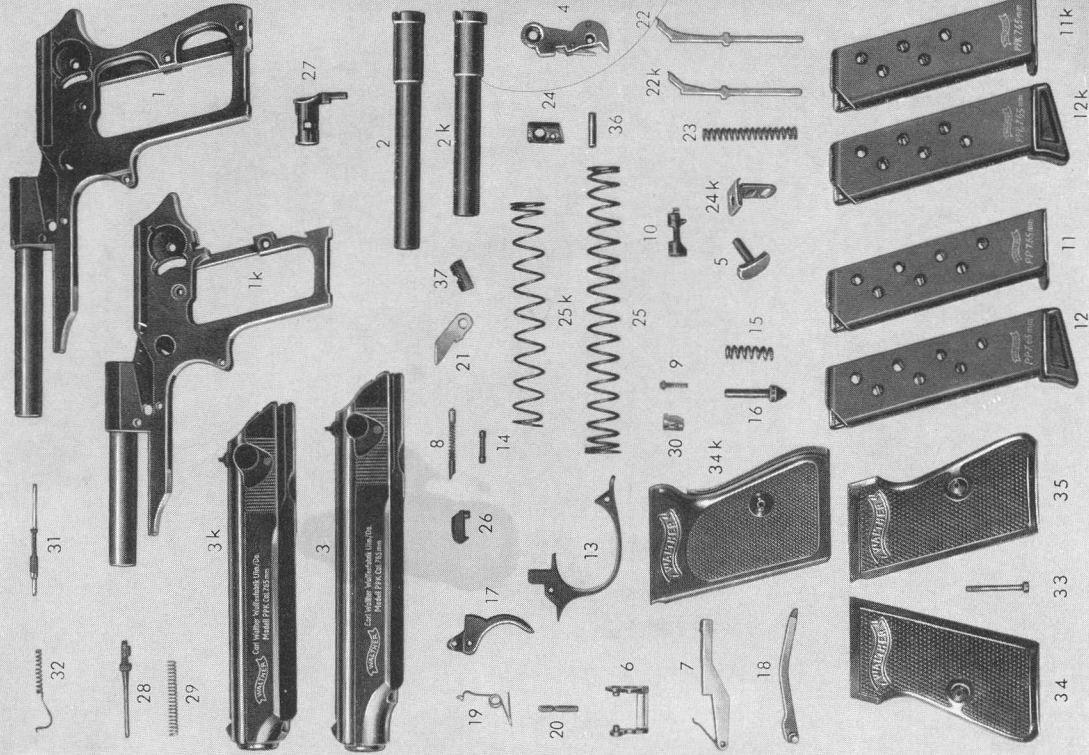

List of component parts of Models PP and PPK

| Denomination | | Model PP | Model PPK |
|---|----|----------|-----------|
| Frame, complete with barrel | 1 | 1 k | |
| Barrel | 2 | 2 k | |
| Slide | 3 | 3 k | |
| Hammer, complete | 4 | 4 | |
| Hammer axle pin | 5 | 5 | |
| Sear (cocking piece) | 6 | 6 | |
| Ejector, with spring | 7 | 7 | |
| Extractor piece and spring | 8 | 8 | |
| Hammer arrester spring, with bush | 9 | 9 | |
| Magazine catch and spring | 10 | 10 | |
| Magazine | 11 | 11 k | |
| Magazine with grip extension | 12 | 12 k | |
| Trigger guard | 13 | 13 | |
| Trigger guard hinge pin | 14 | 14 | |
| Trigger guard spring | 15 | 15 | |
| Guide pin to trigger guard spring | 16 | 16 | |
| Trigger | 17 | 17 | |
| Trigger bar | 18 | 18 | |
| Trigger spring | 19 | 19 | |
| Trigger axle pin | 20 | 20 | |
| Uncocking lever (release lever) | 21 | 21 | |
| Hammer striker shank | 22 | 22 k | |
| Hammer spring | 23 | 23 | |
| Counter bearing to hammer spring | 24 | 24 k | |
| Recoil spring (slide return spring) | 25 | 25 k | |
| Extractor | 26 | 26 | |
| Safety lever, complete with arbor | 27 | 27 | |
| Firing pin | 28 | 28 | |
| Firing pin spring | 29 | 29 | |
| Hammer locking piece | 30 | 30 | |
| Signal pin | 31 | 31 | |
| Signal pin spring | 32 | 32 | |
| Grip plate screw | 33 | 33 | |
| Grip plate, right | 34 | — | |
| Grip plate, left | 35 | 34 k | |
| Hammer spring stop pin | 36 | — | |
| Rear sight | 37 | 37 | |

The signal pin and spring (No. 31 and 32) are not included in the Models PP and PPK Cal. .22 l. r.

The counter bearing to the hammer spring of Model PP (JII. 24) does not include an attachment ring. This component can be added upon request at a small extra charge.

Walther self-loading pistols Model PP and PPK in De Luxe finish

Model PP and PPK can also be supplied either with oak-leaf or else with scroll-work pattern engraving, as well as in burnished, gold-plated, silver-plated, or chromium-plated finish. The Model PP (Jll. 23) is shown to be engraved with an oak-leaf pattern and fitted with white grip plates.



Jll. 23

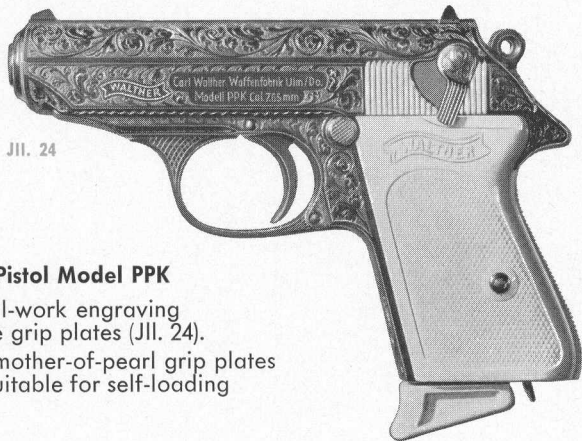

Jll. 24

Walther Pistol Model PPK

with scroll-work engraving and white grip plates (Jll. 24). Ivory or mother-of-pearl grip plates are not suitable for self-loading pistols.

A spare magazine is supplied with every **Walther De Luxe** pistol

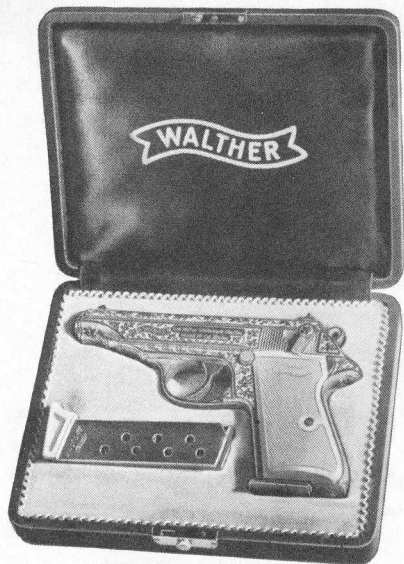

De Luxe fitted case, to suit Models PP and PPK, as shown in JII. 25.

JII. 25

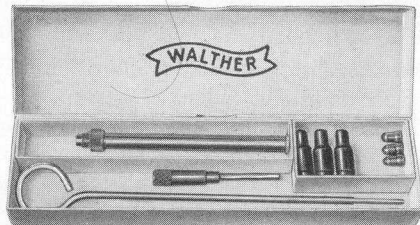

Adaptor barrels for Models PP and PPK Cal. 7.65 mm, for indoor ammunition M 20 Cal. 4 mm, with three steel carriers. Similar adaptor barrels for Models PP and PPK Cal. 7.65 mm for the same M 20 Cal. 4 mm indoor ammunition, but with loading tool, are also available.

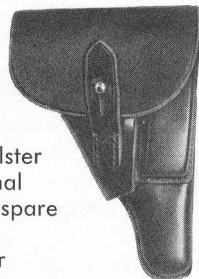

JII. 27

Leather holster with external pocket for spare magazine, suitable for Models PP and PPK.

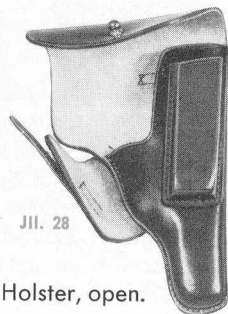

JII. 28

Holster, open.

WALTHER PP-Target-Pistols

Walther Pistols Model **PP Sport** Cal. .22 l. r. are supplied **only** with rounded-off grip plates as shown in Illustrations 29 et seq.

To facilitate adjustment of the lighter trigger let-off, **PP Sport** target pistols of the standard design in 230 mm and 280 mm overall length are developed **only** as 'Single Action' models. Before firing the first shot, the hammer must thus be cocked with the thumb.

Pistols Model **PP Sport** can be supplied as 'Double Action' models only upon special request made at the time of ordering.

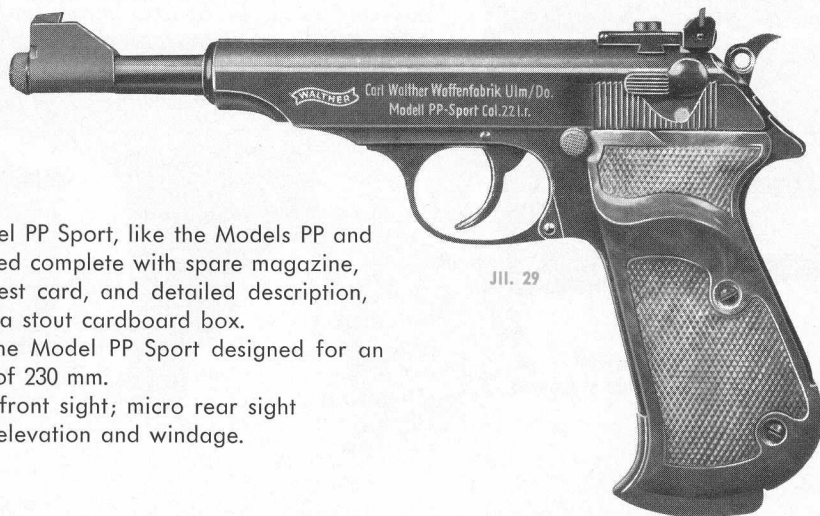

Jll. 29

The pistol Model **PP Sport**, like the Models **PP** and **PPK**, are supplied complete with spare magazine, cleaning rod, test card, and detailed description, and packed in a stout cardboard box.

Jll. 29 shows the Model **PP Sport** designed for an overall length of 230 mm.

Sights: special front sight; micro rear sight adjustable for elevation and windage.

The Walther Pistol Model PP Sport is also available complete with barrel weight.
The barrel weight, fitted with front sight, can be supplied separately.

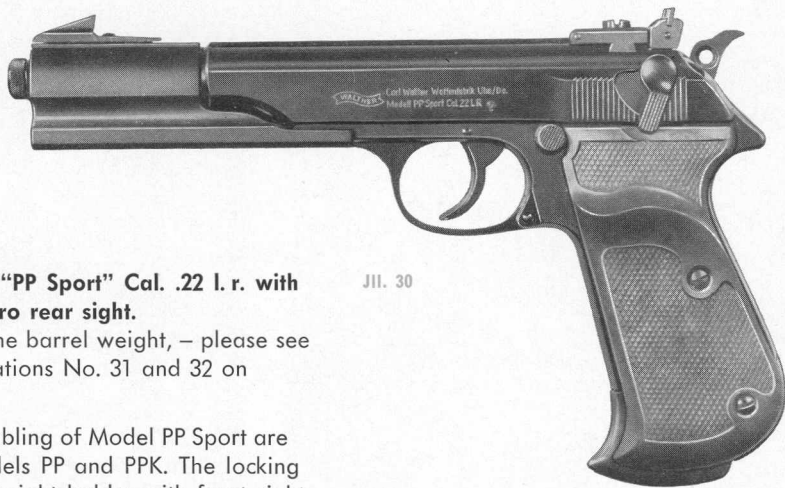

Walther Pistol Model "PP Sport" Cal. .22 I. r. with barrel weight and micro rear sight.

JII. 30

Method of mounting the barrel weight, – please see description and illustrations No. 31 and 32 on page 19.

Dismantling and assembling of Model PP Sport are the same as with Models PP and PPK. The locking nut, locking ring, front-sight holder with front sight and or the barrel weight must be removed before proceeding to dismantle.

To mount the barrel weight

Remove the locking nut from the muzzle.
Withdraw the ring spring and the front-sight
unit from the barrel (see Jll. 31).

Push the barrel weight fully home (see Jll. 32),
then fit the ring spring. Screw the locking nut
down tightly to ensure that the barrel weight
is mounted firmly.

The barrel weight, complete with front sight,
is approx. 160 g.

Jll. 31



Jll. 32



Component parts of Model PP Sport

JII. 33



3 S



4 S 4 SC



37 SII

5

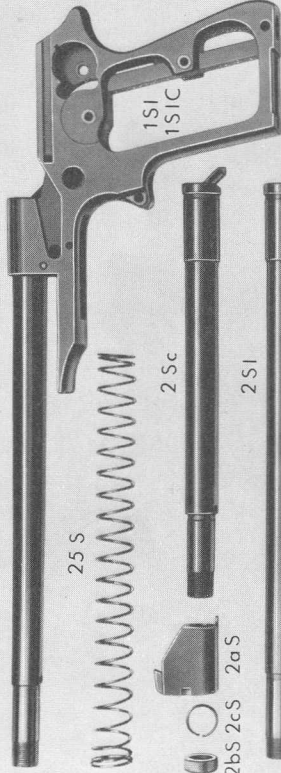

25 S



2 Sc



2bS 2cS 2aS

2 SI



26 S



8 S



27 S

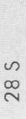

28 S

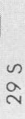

29 S

18



18C

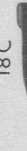

30

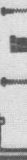

9

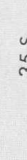

35 S

10



15



16



17S



17SC



19



19C



13

14

21

21C

6

7 S

34 S

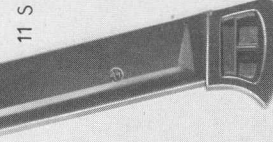
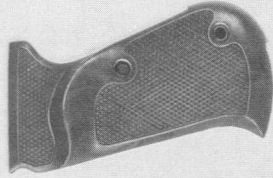
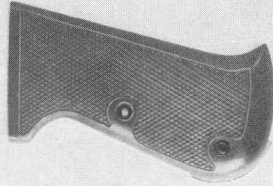

11 S



33 S

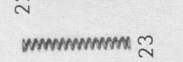

22

23



36



24

List of component parts of Model PP Sport

| Denomination | | Code Number |
|--|--|------------------|
| | | Model PP "SPORT" |
| Frame with barrel of 206 mm length | | 1 SI |
| Frame with barrel of 155 mm length | | 1 SIC |
| Barrel, 206 mm long | | 2 SI |
| Barrel, 155 mm long | | 2 SC |
| Front sight | | 2 a S |
| Nut to front sight | | 5 b S |
| Locking ring to front sight | | 2 c S |
| Slide | | 3 S |
| Hammer, complete | | 4 S |
| Hammer, — 'Single Action' only | | 4 SC |
| Hammer axle pin | | 5 |
| Cocking piece | | 6 |
| Ejector, with spring | | 7 S |
| Extractor piece, with spring | | 8 S |
| Hammer arrester spring, with bush | | 8 S |
| Magazine catch, with spring | | 9 C |
| Magazine with small grip extension | | 10 |
| Trigger guard | | 11 S |
| Trigger guard hinge pin | | 13 |
| Trigger guard spring | | 14 |
| Guide pin to trigger guard spring | | 15 |
| Trigger | | 16 |
| Trigger, — 'Single Action' only | | 17 S |
| Trigger bar | | 17 SC |
| Trigger bar, — 'Single Action' only | | 18 C |
| Trigger spring | | 19 C |
| Trigger spring, — 'Single Action' only | | 19 C |
| Trigger axle pin | | 20 |
| Release lever | | 21 |
| Release lever, — 'Single Action' only | | 21 C |
| Hammer, striker shank thereto | | 22 |
| Hammer spring | | 23 |
| Hammer spring counter-bearing stop | | 24 |
| Recoil spring (slide return spring) | | 25 S |
| Extractor | | 26 S |
| Safety lever with arbor | | 27 S |
| Firing pin | | 28 S |
| Firing pin spring | | 29 S |
| Hammer locking piece | | 30 |
| Screw to grip plates | | 33 S |
| Grip plate, right | | 34 S |
| Grip plate, left | | 35 S |
| Pin to hammer spring stop (No. 24) | | 36 |
| Adjustable rear sight | | 37 S II |

Technical data of the Walther Model PP Sport:

| | |
|---|--------------------|
| Length of barrel | 210 mm and 152 mm |
| Magazine capacity | 8 rounds .22 l. r. |
| Overall length of pistol | 230 mm and 280 mm |
| Height overall | 125 mm |
| Net weight, without barrel weight | 725 g and 765 g |

INDEX

Page

| | |
|---|-------|
| General reference | 1 |
| Descriptive introduction of Models PP and PPK | 2 |
| Technical Data | 3 |
| Sectional view of Model PP (Model PPK similar) | 4 |
| Graphic illustrations with texts | 5 |
| Directions for manipulation, – loading | 6 |
| Filling the magazine | 7 |
| Shooting, – hammer cocked | 8 |
| Applying the safety, – hammer cocked | 9 |
| Dismantling the pistol | 10 |
| Cleaning the parts | 11 |
| Assembling the pistol | 12 |
| Illustrated list of components of Models PP and PPK | 13–14 |
| Pistols in De Luxe Finish | 15 |
| De Luxe case, holsters, and adaptor barrels | 16 |
| Pistols Model PP Sport | 17–18 |
| Mounting the barrel weight for Model PP Sport | 19 |
| Component parts of the Model PP Sport | 20–21 |
| Technical Data of the Model PP Sport | 21 |

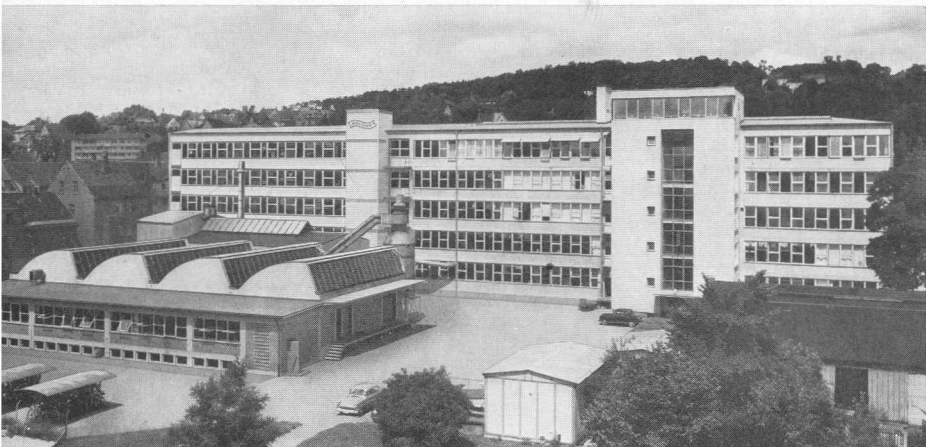

F.A.B IMPORT - DISTRIBUTOR
SACRAMENTO, CALIF.

Carl Walther · Ulm/Donau
Jagd- u. Sportwaffenfabrik

Western Germany