

# TECHNICAL INFORMATION

## SOVIET BLOC SKS CARBINE

---



### **Specifications:**

Weapon nomenclature - Samozariadnyia Karabina Simonova (SKS)

System of operation - Gas, Semi-automatic fire only

Bolt type - one-piece, tipping, rear-cocking

Weight (loaded) - 8.8 lbs.

Length, barrel - 20.34 inches

Length, overall - 40.16 inches

Feed device - 10-round, fixed, staggered double-row box magazine

Sights, front - Hooded post

Sights, rear - Tangent leaf, graduated from 100 to 1000 meters

Cartridge - 7.62 x 39 Soviet M43 (Type PS ball)

Muzzle velocity - 2411 fps

Bullet weight - 122 gr.

Working pressure - 45,000 psi

Bore diameter - .301 inches

Groove diameter - .311 inches

Direction & rate of rifling twist - Right, 1 turn in 9.45 inches

### **Design History:**

The SKS was adopted by the Soviet Union in 1946, and is the basis for the later AK series of weapons. It is a gas-operated, semi-automatic rifle and might be referred to as a miniature version of the 14.5mm PTRS semi-automatic antitank rifle used during World War 2. Both the SKS and the PTRS were designed by the famed Russian arms inventor Sergei Simonov. Because of its light recoil and moderate weight, 35 rounds per minute of aimed fire can be achieved.

Unlike its predecessor, the Tokarev, the SKS features an instantly dismountable gas system. The gas cylinder is an integral part of the handguard and contains

the piston rod. The front end of the combined gas cylinder and handguard fits over a gas port housing pinned to the barrel approximately 7 inches from the muzzle. The rear end butts against the rear sight base which contains the tappet rod and tappet rod return spring. The latch located on the right side of the sight serves to lock the handguard-gas cylinder into place. Its removal for field maintenance takes less than three seconds.

In the 1950's, Soviet technical advisors helped the Chinese government to establish several factories to produce the SKS carbine. The first Chinese SKS carbines were identical to their Soviet counterparts, and were adopted by the Peoples Republic of China as the Type 56 carbine. Subsequently, the Chinese have manufactured several varieties of the original SKS, including selective-fire models, short-barreled "paratrooper" models, and models which use the detachable magazine of the later AK-47 assault rifle.

As the general availability of the AK-47 improved in the early 1960's, the SKS was relegated to the category of a secondary military arm in both the USSR and in the PRC. However, stockpiles of millions of SKS carbines are maintained for the "Peoples Militias" (strategic reserve) and for export to the third world countries as "military aid".

### **Operation:**

When the rifle is fired, gas enters the gas port housing under pressure to thrust the piston rod back against the short tappet rod. In moving back, the tappet rod slides through a hole in the rear sight base and a corresponding one in the top of the receiver to strike the bolt carrier.

The claw-like arrangement of the bolt carrier cams the rear end of the bolt upward, unlocking it completely after 7/16" of rearward travel. The kinetic energy imparted to the bolt carrier upon being struck by the tappet rod is sufficient to cause the bolt and bolt carrier to travel together 3 7/8" rearward to extract and eject the fired case and to compress the recoil spring.

The compressed recoil spring forces the bolt and carrier forward to strip a cartridge from the magazine and chamber it. The camming surfaces within the

bolt carrier force the rear end of the bolt down into the locked position. When locked, the lower rear end of the bolt butts against a hardened steel crosspiece set within the receiver.

**Description:**

SKS carbines have been fitted with two different styles of bayonet. The earlier type is 9" in length and resembles a knife blade. The later type is 12" long, and is needle shaped. Both types are attached to the barrel and fold back under the barrel when not in use. The stock and handguard of the Soviet and Eastern bloc carbines are made of laminated beechwood with a hard, waterproof, clear lacquer finish. Chinese-made SKS carbines are usually found with stocks and handguards made of a porous Asian hardwood resembling teakwood, and brushed with an orange colored shellac-type finish. The Chinese SKS is sometimes fitted with a synthetic plastic resin stock and handguard which is molded in a reddish-brown color.

The buttstock of all versions is hollowed out to receive a cleaning kit contained in a steel capsule. The body of the capsule also serves as a handle for the cleaning rod and its lid fastens over the muzzle to protect the rifle during cleaning. Inside the capsule is a bore brush, a cleaning rod extension, and a tool to clear carbon fowling from the gas port. The capsule lid can also serve as a blank firing device, if properly locked onto the front sight base.

The magazine is unusual and consists of a stamped and welded sheet metal housing, stamped sheet metal floor cap, and a sheet metal follower. Both the follower arm and the floor cap are hinged to the forward end of the magazine body. A coil spring set at the hinge point furnishes sufficient pressure to the follower arm to insure the feeding of cartridges.

The weapon is loaded from above with ten-round stripper clips for which a guide groove has been provided in the forward face of the bolt carrier. It is important to exert thumb pressure against the cartridges as close to the clip as possible, since pressure applied elsewhere makes it difficult to strip the last three rounds. The

stripper clip is a one-piece, spring steel stamping - very sturdy and efficient. The magazine can also be loaded with single rounds.

### **Field Stripping:**

To unload the weapon for field stripping, rapid emptying of the magazine is accomplished by holding one hand under the floor cap to catch the loaded rounds as the other hand pulls back the magazine latch. After clearing the chamber and detaching the sling, swing the latch on the right side of the rear sight upward to the first stop.

The gas cylinder-handguard can be removed by lifting up at the rear and withdrawing it from its forward contact with the gas port housing. By swinging the latch up to its second stop, the plunger and spring can be released easily, but maintain thumb pressure against the tappet rod to prevent it from being expelled by the tappet rod spring.

**NEVER, under any circumstances, attempt to fire this weapon with the handguard-gas cylinder removed, or with a defective handguard latch! The gas port is angled to point directly toward the shooters face and severe injury will result from high pressure gas and flame. The handguard-gas cylinder must be firmly latched in place before firing.**

To dismantle the bolt assembly, lower the bolt on the cleared chamber leaving the hammer cocked, and locate the latch on the right rear of the receiver. Rotate this latch until it is upright and pull it out as far as possible. Remove the receiver cover by lifting it and pulling it to the rear. The recoil spring is removed by drawing it rearward out of the bolt carrier. By pulling the charging handle to the rear and upward, the bolt and bolt carrier will be freed from the receiver.

To remove the trigger group, push the safety lever into the "safe" position. Insert the bullet point of a loaded round in the pocket of the spring catch located directly behind the triggerguard and push forward. The trigger group will become unfastened and jump outward, pushed by a coil spring set into the stock beneath the triggerguard.

Swing the trigger group downward and back to remove. Pull the magazine group down and to the rear to release it. Pull the handle of the bayonet towards the blade to unlatch it. Remove the cleaning rod by flexing it slightly to release it from its slot beneath the front sight. Pivot the bayonet until it locks in the extended position. Grasp the receiver cover latch pin, and use it to lift the receiver up and out of the stock.

By reversing these steps, the weapon can be reassembled. However, the following precautions must be observed. Reseat the fore-end of the stock properly within the barrel band. When replacing the magazine, its forward end must engage the lug extending from the rear sight beneath the barrel.

Hinge the magazine cap upward and hold it in this position while guiding the projecting pins of the trigger group into the receiver lug. Apply pressure to the bottom of the triggerguard; if the trigger group does not lock into place, brace the carbine with one hand and deliver a sharp blow to the triggerguard to insure proper seating. Before installing the trigger group, the hammer must be in the cocked position, and the safety must be engaged.

**Ammunition:**

Surplus military ammunition from Com Bloc nations is currently banned from importation. Some ammunition imported before this ban is still available.

Winchester (USA) and Remington (UMC) supply military ball type ammo in 7.62x39 which is superior to Com Bloc ball. Trajectory data supplied here is generic and presumes a maximum point blank range (bullet remains within 6 inches of line of sight) of 300 yards:

<b>Distance (yards)</b>	25	100	200	300	400	500
<b>Trajectory (inches)</b>	.7	4.7	2.1	-6.1	-26.6	-60

As can be seen from the table, bullet drop makes obtaining hits with the 7.62x39 at ranges beyond 350 yards increasingly difficult. Energy loss also limits effective range.

Identifying Soviet Bloc 7.62 x 39 ammunition:

<b>Designation</b>	<b>Bullet Type</b>	<b>Marking</b>	<b>Round Weight</b>
PS	Ball	none	256.8 gr.
T-45	Tracer	Green	240.7 gr.
Z	Tracer-Incendiary	Red	239.8 gr.
BZ	AP Incendiary	Black & Red	251.5 gr.

---



## Disassembly and Assembly of the SKS Carbine

**D**isassembly of the carbine can be partial or complete. Partial disassembly is conducted for cleaning, lubricating, and inspecting the carbine. Complete disassembly is conducted for cleaning an extremely dirty carbine, after it has been exposed to rain or snow, during transition to a new lubricant, and during repair. Excessive frequent disassembly is harmful to the carbine, since it accelerates wear on the components and mechanisms. Conduct disassembly and assembly on a table or clean mat. Place components and mechanisms on the mat in sequence of disassembly, handling them carefully. Do not use excessive efforts or sharp blows during disassembly and assembly. Training in disassembly and assembly can be conducted with combat carbines only in exceptional circumstances, while observing special caution in handling the components and mechanisms.

### **Sequence of Partial Disassembly of the SKS Carbine:**

Check to ensure that the carbine is unloaded.

1) Pull out the combination tool with accessories (Figure 1). Hold the carbine in the left hand, and push with the finger of the right hand on the cover of the buttstock well, allowing the combination tool to come out under spring pressure. Open the combination tool, and remove the patch holder, bore brush, and drift.



**Figure 1: Removing the combination tool from the buttstock well**

2) Remove the cleaning rod (Figure 2). Rotate the bayonet away from the fore end, draw the head of the cleaning rod away from the barrel and pull it upward. Rotate the bayonet down and snap it back into its folded position.



**Figure 2: Removing the cleaning rod**

3) Remove the receiver cover (Figure 3). Hold the carbine in the left hand behind the small of the stock. Rotate the receiver cover pin upward with the fingers of the right hand and, pressing with the thumb of the left hand on the cover (moving it slightly forward), pull the pin to the right as far as it will go. Remove the cover from the receiver.



**Figure 3: Removing the receiver cover**

4) Remove the recoil mechanism. Grasp it in the right hand and pull it from the channel in the bolt carrier.

5) Remove the bolt assembly (Figure 4). Holding the carbine with the left hand at the fore end, with the right hand draw the bolt assembly back by the handle; rotate the carbine with the right side down and remove the bolt carrier along with the bolt housing.

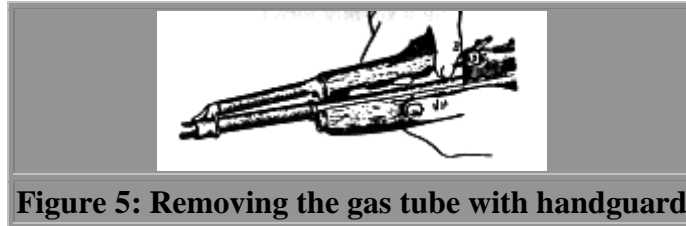

**Figure 4: Removing the bolt assembly from the receiver**

6) Separate the bolt housing from the bolt carrier, holding the bolt carrier.

7) Remove the gas tube with handguard (Figure 5). Holding the carbine in the left hand at the fore end, with the right hand and the aid of the drift rotate the gas tube lock upward about 45 degrees, so that the flat aspect of the pin is vertical; raise the rear portion of the handguard upward and remove it from the gas chamber socket. Then tilt the gas tube downward and the gas piston will slide out.

**Note:** In early models of the carbine, the gas tube lock can be rotated without the aid of the drift.



### **Sequence of Assembly after Partial Disassembly:**

1) Install the gas tube with handguard. Place the gas piston in the gas tube; hold the carbine in the left hand behind the fore end, and with the right hand insert the front end of the gas tube into the gas chamber socket. Press the rear portion of the handguard toward the barrel; rotate the gas tube lock downward to stop.

2) Join the bolt housing to the bolt carrier (Figure 6).

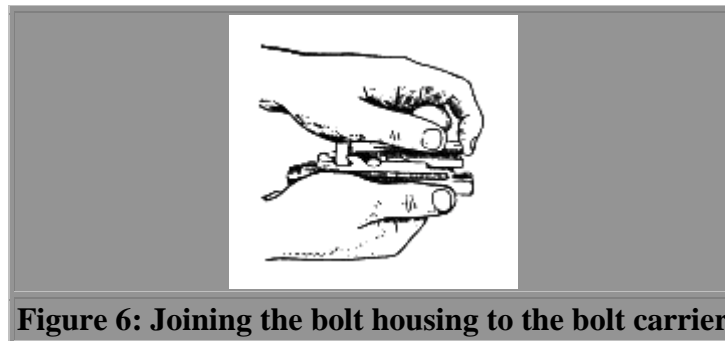

3) Install the bolt in the receiver. Open the magazine cover; holding the carbine in the left hand! behind the fore end of the stock, rotate it with the right side down; with the right hand, install the bolt assembly and move it forward; rotate the carbine with the bolt assembly upward and close the magazine cover.

4) Install the recoil mechanism in the channel of the bolt carrier, collar end first.



5) Install the receiver cover. Rotate the receiver cover pin upward and withdraw it to the right; place the receiver cover on the receiver and slide it forward; holding the cover with the thumb of the left hand, secure it with the pin and rotate the pin downward.

6) Install the cleaning rod. Rotate the bayonet away from the fore end, insert the cleaning rod, and return the bayonet to its stowed position.

7) Replace the combination tool in the buttstock chamber. Place the patch holder, brush, and drift back into the combination tool and close its cover; place the combination tool in the buttstock well with the cover end toward the buttplate.

8) Release the hammer. Take the safety off by rotating the lever downward; squeeze the trigger; place the safety on by rotating the lever upward.

### **Sequence of Complete Disassembly:**

1) Carry out partial disassembly, as detailed above.

2) Pull out the driving rod and spring (Figure 7). Grasp the carbine by the left hand under the rear sight; holding the driving rod with the finger of the left hand, rotate the gas tube lock upward with the right hand; remove the driving rod with spring and remove the spring from the rod; rotate the gas tube lock downward.

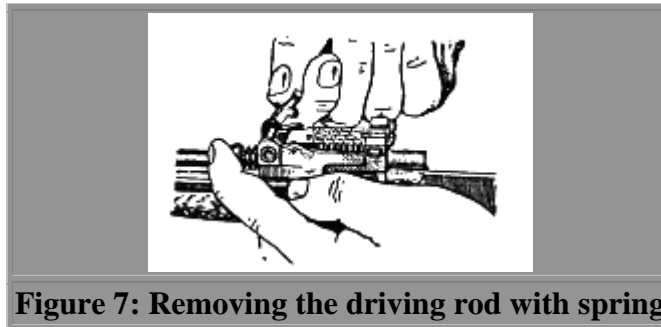

3) Remove the trigger mechanism. Position the carbine in the left hand with the magazine upward; check to ensure that the carbine is on safe (if it is not, put it on safe); with the drift secured in the body of the combination tool, push in on the trigger mechanism latch (Figure 8); grasp the trigger guard and remove the trigger mechanism.



**Figure 8: Depressing the trigger mechanism latch to remove the trigger mechanism**

4) Remove the magazine. Grasp the magazine by the body and remove it. The magazine should not be removed from the carbine or installed if the bolt is in the receiver, because it will damage the lips of the magazine.

5) Separate the barrel and receiver from the stock. Place the bayonet in the combat position [deployed]. Grasp the carbine with the left hand at the small of the stock and the right hand at the rear of the receiver. By hand effort or with a light blow of the hand on the buttstock, remove the barrel (Figure 9). Place the bayonet in the stowed position.



**Figure 9: Separating the barrel with receiver from the stock**

6) Disassembling the trigger mechanism. Release the hammer by taking the safety off, and press on the end of the automatic sear with the index finger of the left hand (Figure 10). Looking through the hole in the trigger body, align the trigger lever with the sear, and then squeeze the trigger.

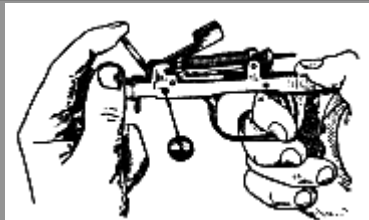

**Figure 10: Releasing the hammer from cock**

Remove the hammer (Figure 11). Grasp the trigger mechanism in the left hand, and with the right hand place the body of the combination tool over the hammer; pressing with the body of the combination tool on the hammer (so that it will not be cocked), compress the hammer spring, remove the hammer pin from the holes of the trigger body. Gradually

weakening the pressure, remove the hammer spring plunger from the circular-shaped collar of the automatic sear and trigger. Remove the hammer spring from the plunger.

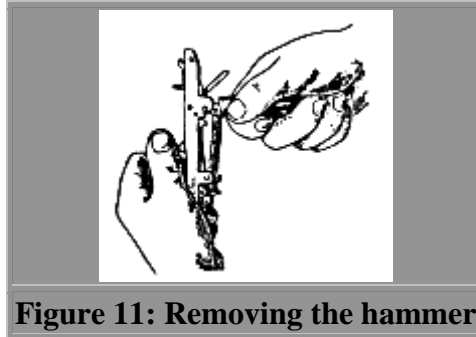

7) Disassemble the recoil mechanism (Figure 12). Place the guide tube over the head of the cleaning rod and rest the cleaning rod on a table or object. Compress the recoil spring and remove the collar. Remove the spring from the guide tube and shaft; take the cleaning rod out of the tube, and then drop the guide rod out of the tube.

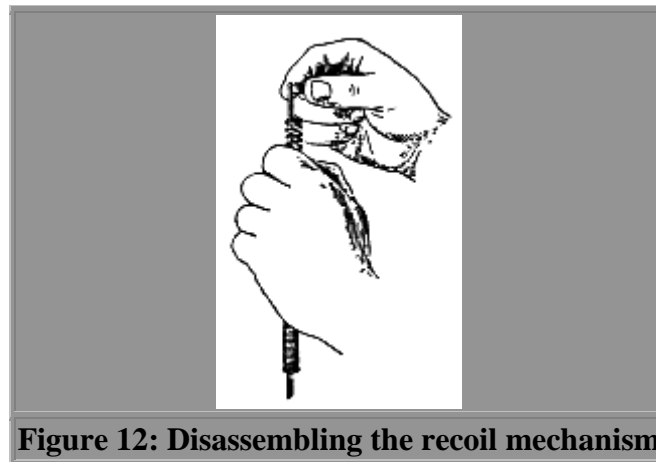

8) Separate the firing pin and extractor from the bolt housing. Drive the dowel out of the bolt housing with the drift and a hammer (Figure 13). Remove the firing pin, push the extractor back and upward with finger pressure, and remove it from the bolt housing (Figure 14). Remove the extractor spring from the extractor slot by rotating it counterclockwise.

**Note:** In early issue bolts, remove the extractor, draw out the extractor spring, drive out the pin, remove the firing pin with spring, then remove the spring from the firing pin.

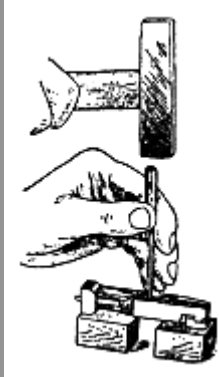

**Figure 13: Driving out the pin to remove the firing pin and extractor.**



**Figure 14: Removing the extractor remove the firing pin and extractor from the bolt housing**

### **Sequence of Assembly of the SKS Carbine After Complete Disassembly:**

1) Install the extractor and firing pin in the bolt housing. Place the extractor spring in the extractor slot. Install the extractor with spring into the extractor well of the bolt housing by pressing forward on the extractor to seat it. Install the firing pin in the channel of the bolt housing so that the notch of the firing pin aligns with the hole for the dowel. Secure the firing pin with the dowel.

Note: For early issue bolts, first place the firing pin spring on the firing pin, install the firing pin, and then install the extractor with spring.

2) Assemble the recoil mechanism. Place the guide rod in the guide tube. Insert the head of the cleaning rod into the guide tube and position it on a table. Install the recoil spring over the rod and tube, compress it, and install the collar. Remove the cleaning rod from the guide tube (in early issue carbines, install the collar with cylindrical projection toward the spring).

3) Assemble the trigger mechanism. Install the hammer by placing the hammer spring on the hammer spring plunger. With the body of the combination tool on the hammer, position the end of the plunger in the circular-shaped collar and, pressing on the hammer with the aid of the combination tool, compress the hammer spring and install the hammer pin in the holes of the trigger housing.

4) Join the barrel with receiver to the stock. Place the bayonet in the combat position. Grasp the stock in the left hand, and the barrel and receiver in the right hand. Guide the fore end ring onto the fore end groove, and the barrel with receiver into the barrel bed of the stock. Place the bayonet in the stowed position.

5) Install the magazine. Grasp the carbine in the left hand with the sights downward. Insert the forward portion of the magazine into the well of the stock until it makes contact with the barrel, then slide it along the barrel until the magazine lug engages the catch on the barrel. Lower the rear portion of the magazine into the receiver.

6) Install the trigger mechanism. Cock the hammer and put the safety on. Grasp the carbine in the left hand with sights downward. Position the ends of the dowel into the notches of the forward pillar of the receiver and push the trigger housing forward and downward. Strike on the trigger guard with the palm of the right hand (Figure 15), so that the latch seats in its opening. After installing the trigger mechanism, take the carbine off safe and check to ensure that the trigger mechanism is firmly held by the latch on the receiver. Place the carbine on safe.

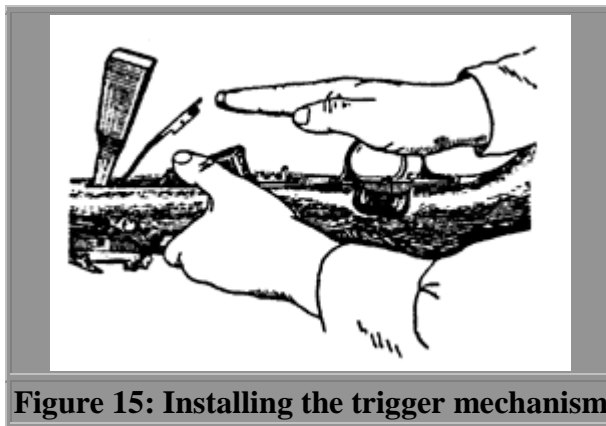

**Figure 15: Installing the trigger mechanism**

You must not install the trigger mechanism with the safety in the lower [off] position, because this will damage the trigger mechanism latch.

7) Install the driving rod with spring. Rotate the gas tube lock upward. Install the spring on the driving rod, and place the rod with spring into the hole at the sight mount. Depress the guide rod with a finger of the left hand, and rotate the gas tube lock downward with the right hand until it reaches the detent at the upper edge of the channel.

8) Conduct subsequent assembly in accordance with the instructions given above.

---

## The SKS Receiver

The SKS receiver serves to join the carbines firing components and mechanism, to ensure the covering of the barrel bore by the bolt and locking of the bolt. It is machined from a solid steel billet in all countries with the single exception of a stamped receiver made in China. It is 9.5 inches long by 1.2 inches wide and 2.4 inches high (including the forward receiver lug to which the magazine attaches).

### Receiver Description

Three types of receivers were manufactured for the SKS Carbine. SKS Carbines manufactured by Russian, Yugoslavian, East German, North Korean and North Vietnamese factories used the Type 1 receiver which was threaded to receive a threaded barrel.

The earliest receivers (Type 1A) are distinguished by observing the right and left sides immediately under the gas piston tunnel housing. The Type 1A receiver will have a raised, squared platform 0.15 inches high by 0.8 inches long. The left side is scalloped into the side of the receiver.

The Type 1B receiver lacks this squared platform. Instead, the gas piston tunnel housing is faired smoothly into the receiver.

Chinese-produced SKS Carbines until 1967 also used the Type 1B threaded receiver and threaded barrel. In 1967, a Type 2 receiver was developed in China which was not threaded. It accepted an unthreaded barrel which was pinned in place. The barrel was held by a pin +/- 0.157 inches in diameter.

A 1.100 long by 0.185 inch high step was cut in the breech face of the Type 2 receiver for the forward stock lug. The 0.157 inch diameter hole for the barrel pin

was 0.497 inches behind the face of the receiver and 0.310 inches above the bottom.

The Type 3 receiver was stamped from sheet metal. It appears to have been manufactured in limited quantities only in China. The stamped receiver was reinforced with blocks of metal at the front and rear of the receiver and was riveted together.

### **Bolt Carrier Guide Lugs**

The receiver interior contains guide lugs (1) on either side of the bolt immediately behind the breech. Behind the bolt carrier guide lugs (halfway to the rear of the receiver) are rails (2) on which the bolt carrier moves, cut 0.11 inches lower. The receiver cover rests on this lower portion and is secured at the rear of the receiver by a captive pin which enters from the right.

The barrel threads into the forward part of the receiver (3), except on the later Chinese models in which the barrels are pinned in place. On the right side, immediately behind the breech, an ejection port (4) was machined 0.55 inches deep and 2.5 inches long to allow empty cartridge cases to be ejected.

### **Recoil Lug**

To the rear of the disconnecter is the recoil lug hole (5). A hardened steel pin, called the recoil lug, 0.275 inches square in cross-section by 1.3 inches long is press-fitted into the recoil lug hole. When in battery the bolt bottoms against the recoil lug. The exact width of the recoil lug helps to determine the headspacing.

### **Ejector**

Behind the face of the breech and on the left side of the receiver is the ejector (6), a 0.15 by 0.4 inches projection of steel machined from the side of the

receiver. Below that, the bolt stop (7) rides in grooves on the inside of either forward receiver leg, 2.75 inches from the face of the breech. Behind the bolt stop is an oval hole 0.30 by 0.45 inches in diameter through which the automatic sear lever protrudes.

### **Driving Rod Channel**

Immediately ahead of the top of the breech, called the bridge, is a channel through which the driving rod passes (8). It is round (0.4 inches in diameter) and is machined from the receiver stock. The rear sight assembly butts against the driving rod channel.

### **Receiver Lugs**

On the bottom of the receiver are machined three lugs. The first two (9) form a pair and are located 3.5 inches behind the front end of the receiver. They contain the bolt stop tracks or rails and the pin (10) which retains the bolt stop. At the base of each forward leg is the notch (11) for the trigger guard pins to hold the trigger guard assembly in place. The third lug (12) at the rear of the receiver holds the rear of the trigger guard assembly in place by a spring catch (13) which is pinned (14) into a slot in the front of this leg.

### **Take Down Latch & Pin Assembly**

The take down latch (15) is stamped from sheet steel. It is 1.3 inches long by 0.35 inches wide at the widest end where it is drilled 1.430 inches in diameter to accept the takedown pin, and 0.25 inches at the end which is bent into a thumb piece 0.15 inches wide by 0.3 inches long. The sheet steel is 0.06 inches thick. The latch is dimpled 0.970 inches from the widest end. The dimple slides into a matching cut on the right side of the receiver to hold the take down latch/pin assembly securely in place under recoil.

The take down pin holds the receiver cover in place on the receiver. It consists of a pin 0.230 inches in diameter by 1.4 inches long and a thumb piece or lever at a right angle to the pin, which is 1.3 inches long. The end of the pin is peened to



secure the thumb piece. The take down pin assembly is held captive in the receiver by a small pin 0.08 inches in diameter and approximately 0.05 inches high which protrudes at right angles from the take down pin, 0.16 inches from the end. On early SKS Carbines, this tiny pin was machined as an integral part of the takedown pin; only later carbines or those in which the takedown pin was replaced, it was press-fitted into the takedown pin shaft.

Soviet SKS takedown levers all have the thumb projection on top of the lever. Early Chinese military production has the thumb projection on the bottom of the lever; later production moved it to the top.

### **Trigger Guard Latch**

The third lug at the rear of the receiver holds a spring catch assembly which secures the rear of the trigger guard assembly in place. The catch itself is a flat spring 1.27 inches long and which is pinned at the top into the leg. The locking cut or ledge at the bottom of the spring to grasp the trigger guard is 0.2 inches wide by 0.4 inches long and 0.1 inches deep.

A cutout or channel on the front inside surface of the leg 0.15 inches deep by 0.3 inches wide is so angled forward that when the trigger guard assembly is pressed into place, the end of the flat spring is pushed forward until it slips into the notch in the trigger guard plate, then snaps back to secure it. The spring tension pushes the trigger guard plate pins forward against the notched in the two forward legs.

Occasionally, the trigger guard latch springs will break. If you cannot find a replacement part, you can shape one with a file from spring steel stock from any gunsmith supply house. Save the broken parts and use them as the pattern to shape the new one.

### **Receiver Markings**

The serial number of the SKS Carbine is stamped on the left outside of the

receiver, opposite the ejection port on Russian and Chinese military SKS Carbines. The serial number is stamped on the left side, below the receiver cover on Chinese civilian production. Various inspection markings are usually stamped ahead of the serial number on the bridge, but may also be found behind the serial number. The right side of the receiver is usually unmarked.

Chinese military production receivers are marked with the producing factory symbol or other identification on the left side behind the serial number. Chinese civilian production SKS Carbine receivers intended for sale in the United States are stamped with the model name, number, caliber, manufacturer and importer's name and address.

Original receivers were given a medium polish and a chemical blue finish that often appears as a shiny black color. Refinished receivers have a dull black appearance.

### **Receiver Cover**

The receiver cover serves to cover the open top of the receiver to protect the bolt and trigger assemblies. It is milled from steel. The receiver cover is 1.2 inches wide by 4.85 inches long by 0.7 inches high, not including the receiver cover lug. The receiver cover lug is located on the bottom rear surface and is 0.5 inches wide by 0.5 inches long by 0.5 inches high. It is drilled with a hole 0.25 inches in diameter, the bottom of which is cut with a key-way 0.1 inch in diameter. The take down pin passes through the hole in the lug, the right angle pin on the take down pin passes through the keyway, then turns at right angles to lock into place.

Chinese receiver covers have two 0.2inch diameter holes drilled vertically through the rails at the rear on either side of the lug.

The serial number of the Carbine's receiver is stamped on the rear of the receiver cover on both Russian and military receiver covers. Late Chinese civilian production receivers are not marked with the Carbine's serial number.

The receiver cover was blued originally. Russian covers were stamped with the symbol of the manufacturer and the date. Chinese receiver covers were not marked on the top.

Inspection stamps in the form of numbers & Cyrillic letters will be found on the inside surfaces on Russian, East German and Yougoslavian-made SKS Carbines

Russian receiver covers that have undergone the refurbishment process are marked with a diamond symbol. The mark was often struck on the bottom of the lug. It may also appear as a "V" if the hand die was not struck squarely.

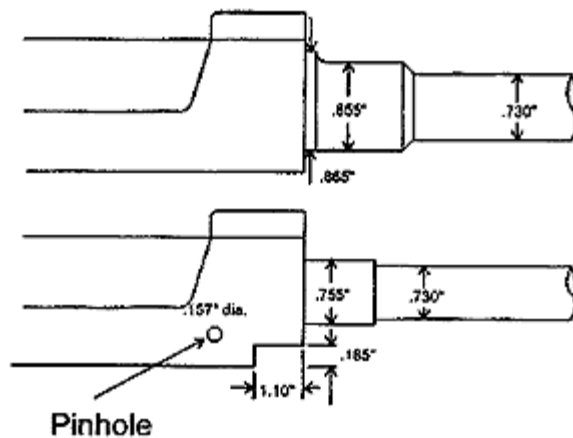
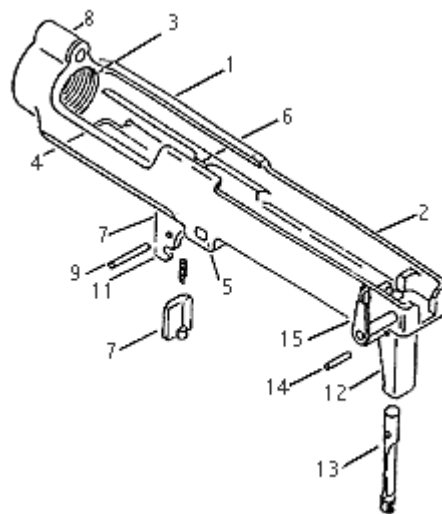

### CAN AN UNLICENSED PERSON MAKE A MACHINE GUN?

**Generally, NO.** But, in the event that documentation can be provided, along with the application to make a machine gun, which establishes that the weapon is being made for distribution to; 1-The United States or any department or agency thereof or 2- A state, or department , agency or political subdivision thereof. Then the individual would be permitted to make a machine gun.

Any machine gun is subject to the NFA and the possession of an unregistered machine gun could subject the possessor to criminal prosecution.



## TABLE OF CONTENTS

<b>HISTORY.....</b>	<b>6</b>
<b>NOMENCLATURE.....</b>	<b>8</b>
<b>CARTRIDGE.....</b>	<b>9</b>
<b>DISASSEMBLY.....</b>	<b>10</b>
<b>TRIGGER GROUP DISSASSMBLY.</b>	<b>14</b>
<b>UNDERSTANDING THE TRIGGER GROUP FUNCTION.....</b>	<b>15</b>
<b>HAMMER.....</b>	<b>19 &amp; 25</b>
<b>BLOCKING THE SEAR DISCONNECTOR.....</b>	<b>20</b>
<b>MINUTE-MAN FAST &amp; EASY WIRE CONVERSION.....</b>	<b>29 &amp; 29</b>

## HISTORY

The SKS gets its name from the following Russian factories: Samozaryadnyi Karabin Simonova.

In World War 2 the Russian army found an immediate need for a medium cartridge. They wanted to counter the very successful German light machine gun. It needed to have an effective range of up to 300 meters.

Russian engineers went to work and developed the 7.62 X 39mm, very similar to the German cartridge. The Russian armory gunsmiths came up with a durable, easy to function, easy to manufacture and reliable rifle. The tilt bolt (a variation of an antitank rifle) is still used in today's SKS model assault rifles. The SKS sights were also copied onto the AK-47.

Many different versions of the SKS were made at various factories around the world. In China it is known as the Type-56, in Yugoslavia it is a Type M-59, etc. Although now it is only used by Honor Guards at the Tomb of the Unknown Soldier, and a few Russian party buildings.

Today most of the SKS's are manufactured by the Chinese. It is designed with a shorter stock, to fit the smaller Asian physique, a longer barrel and a few other small variations, it is still just a copy of the original Russian SKS.

Millions of SKS guns were given by China and Russia to Vietnam and they were found to be very rugged, accurate and reliable guns. In order to stop corrosion in the tropical regions, such as Vietnam, a special fiberglass stock was also manufactured.

A DEEP UNDERGROUND VIETNAMESE MACHINE SHOP. SAFE FROM AMERICAN BOMBERS, THIS SHOP MANUFACTURED SMALL ARMS PARTS

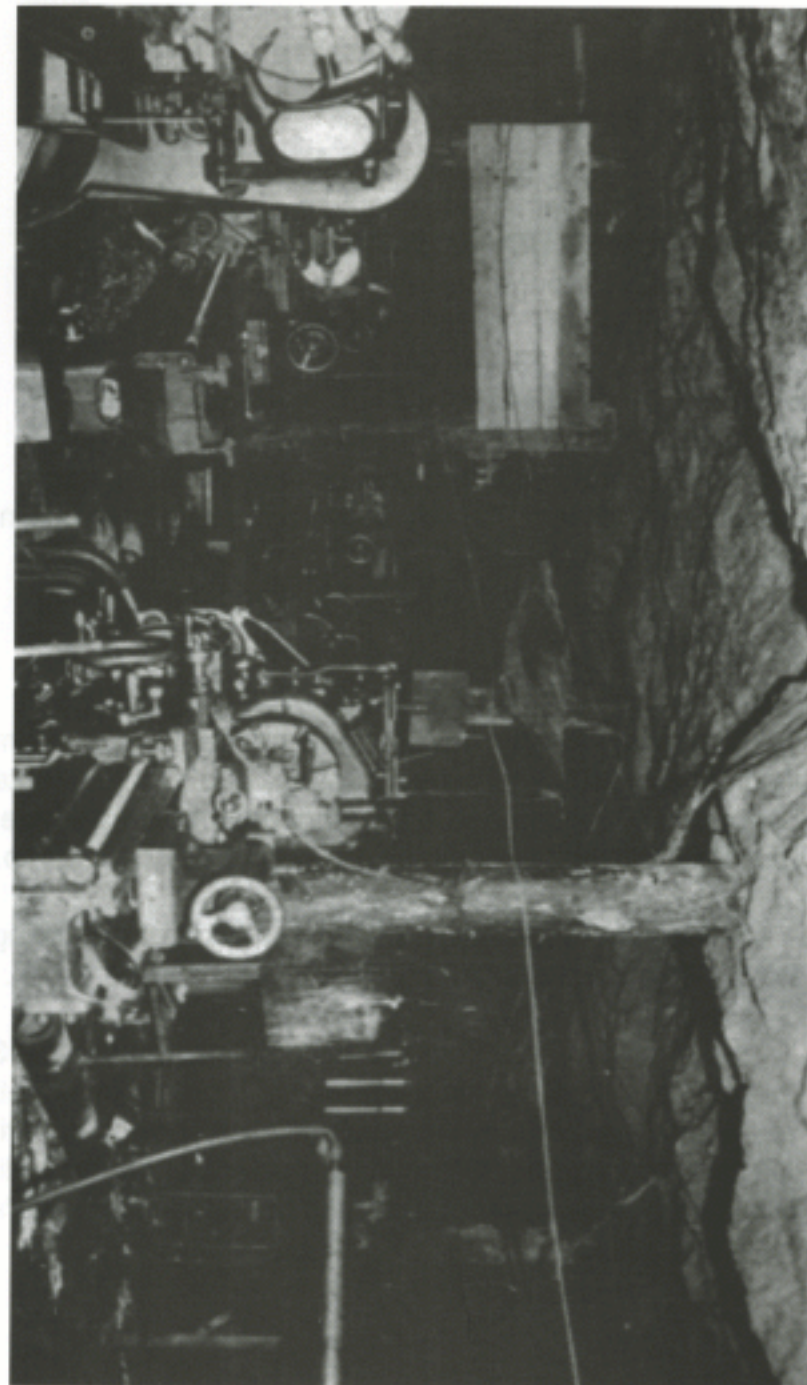

## NOMENCLATURE

**WEIGHT:** 8.8 lbs.

**LENGTH:** 40.2 Inches.

**BARREL:** 20.5" with 4 groves and a right hand twist.

**CHROME LINED BORE:** .311 to .313 grove diameter.

**MAGAZINE:** 10 round box, fixed to receiver.

**MUZZLE VELOCITY:** 2250 Feet Per Second.

**CALIBER:** 7.62 X 39 MM (M43)

**SYSTEM OF OPERATION:** Short stroke gas piston.

**METHOD OF LOCKING:** Positively locked tilting bolt.

**SIGHTS:** (Front) Protected post adjustable for windage and elevation. (Rear) "U" notch tangent adjustable for elevation from 100 to 7 degrees.

**FINISH:** Salt Blued with polished bolt and carrier, and varnished wood.

There are many accessories available to custom modify your SKS into a true hunting rifle. With a Monte Carlo stock, a scope and a five shot fixed box magazine, your SKS will look at home on the wall of any deer camp.

If shooting excitement is what you want, try a folding stock with a detachable 30 round clip and muzzle break.

Most military rifle designs are now incorporating a 3 shot burst to stop the inaccurate spraying of your target. You should note that in Vietnam statistics showed American troops fired 200,000 rounds for each confirmed kill. This clearly shows automatic fire is not needed in today's high-tech military.

## CARTRIDGE

The 7.62x39M cartridge was designed in the Soviet Union in 1943. Designated model 43 or M43, it is now used in most Communist block countries, including Red China. Because of the wide use in SKS, AKS, AK47 assault rifles, and RPD light machine guns it is often called the worlds most popular cartridge.

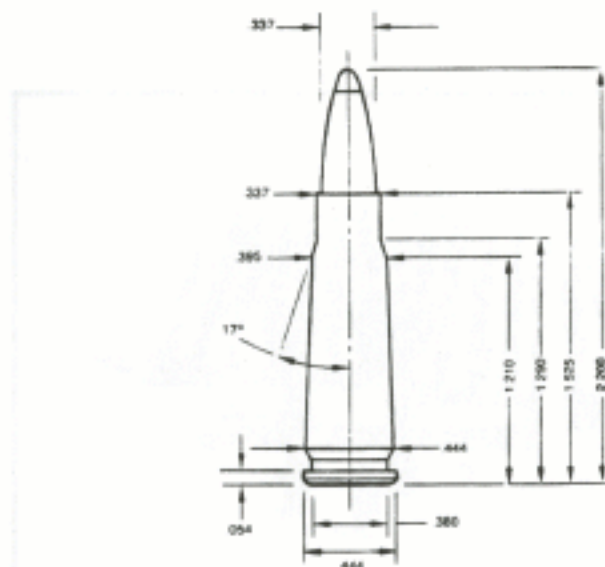

It has a bullet weight of 110 to 150 grains and a bullet diameter of .308 to .312 and it travels at 2250 fps. It is easy to see the wide range of uses this rifle can have.

Generally the heavier bullet weight of 130 grains seems to target closer and work the action better at faster fire rates than the lighter 110 grains.

Over 38 million 7.62x39 rifles have been produced in Russia alone, with all the other countries now selling warehoused rifles. The ammo and parts are cheap and easy to find.

You should note the 7.62x39 ammunition from China and many other Communist block countries will sometimes have copper plated, steel core bullets instead of copper coated lead, and copper plated steel cases instead of brass.

This steel bullet will have extremely powerful penetrating capabilities and will be economical to shoot, although these cases are not reloadable. The "armor piercing" power could be of great benefit.

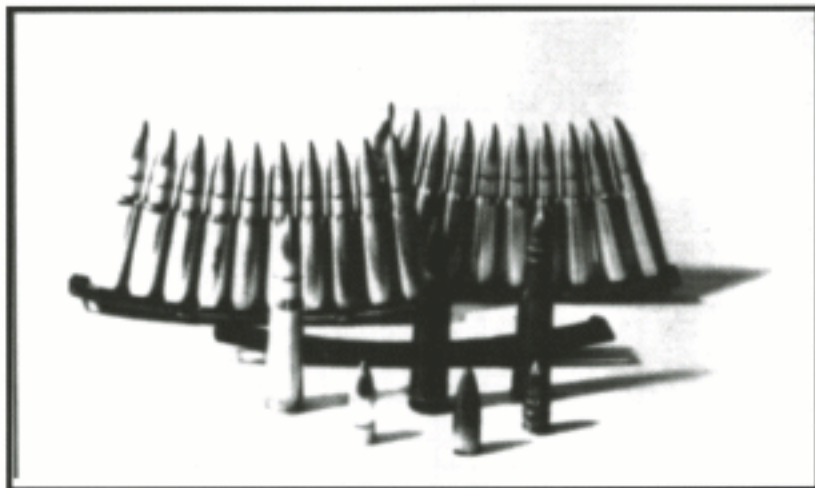

Millions of Americans have enjoyed the SKS and the cheap ammo available for it.

NOTE: you should clean your gun as soon as possible after each use, as cheap ammo is likely to be corrosive.

## DISASSEMBLY

1) To remove the bolt, close bolt carrier and locate lever on right rear receiver. Lift up and draw out lever. You must close bolt to remove spring pressure from receiver cover.

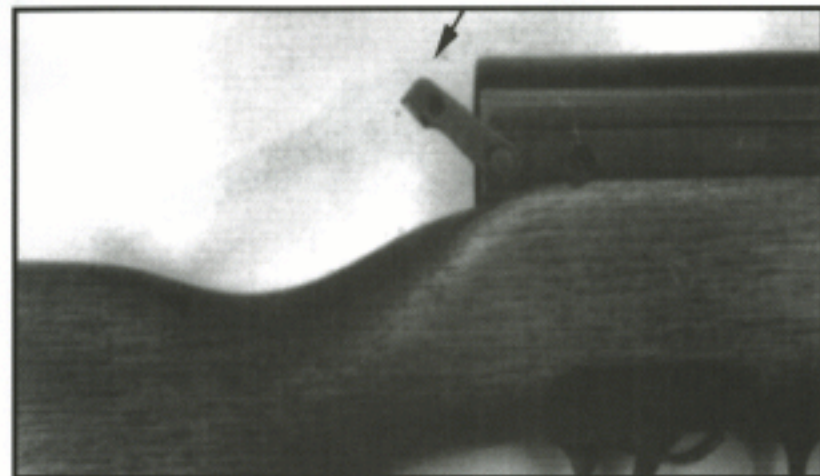

2) Slide receiver cover off, remove spring, slide bolt carrier to the rear and lift out. Draw bolt to the rear and lift out. Clean and inspect.

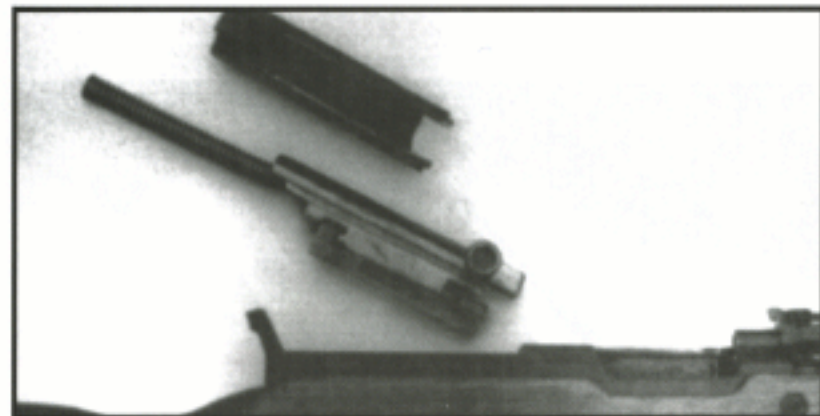

3.) To remove gas piston, locate lever on right rear sight block, lift until cam clears gas piston cylinder, lift out cylinder, clean and inspect.

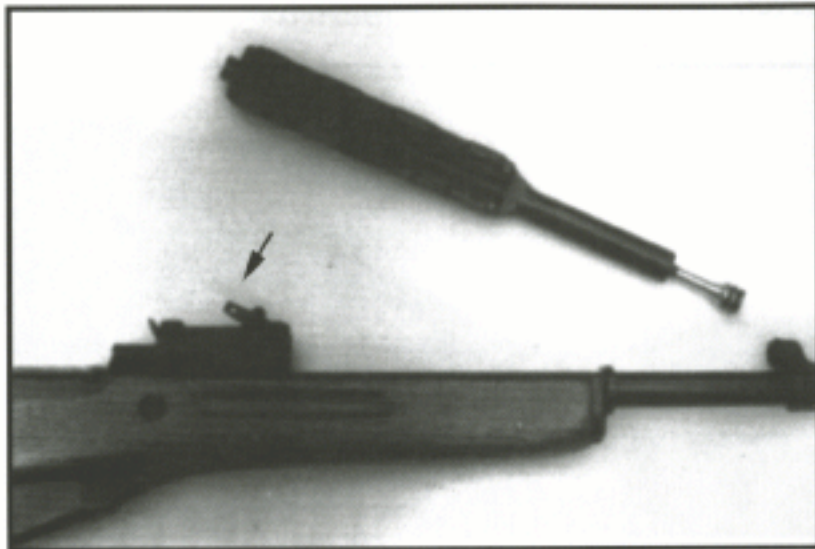

4.) To remove trigger group and magazine, the safety must be up or on safety, and the magazine opened. Locate the pin directly behind finger guard, use a screwdriver, your tool kit or even a bullet to press pin in, lift trigger group out.



5) Lift out magazine. Clean and inspect.

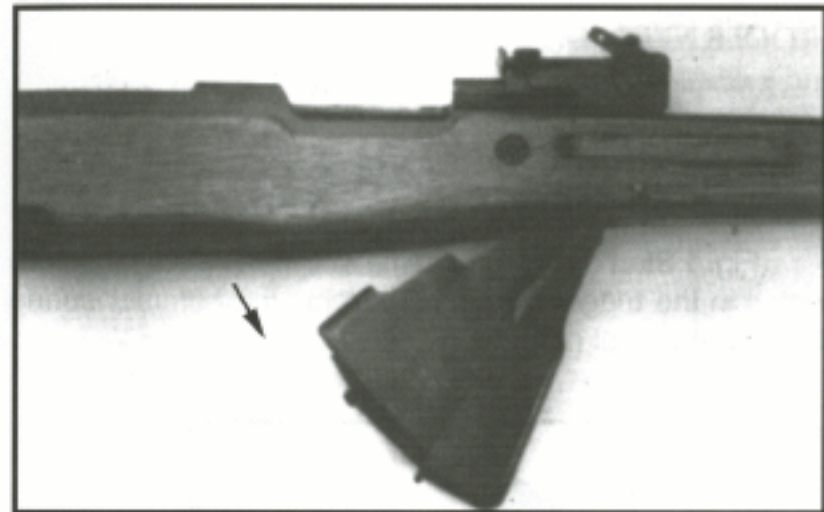

5) lift barrel & receiver from stock. Clean and inspect. Disassembly to this point should take 1/2 hour. Clean and inspect thoroughly.

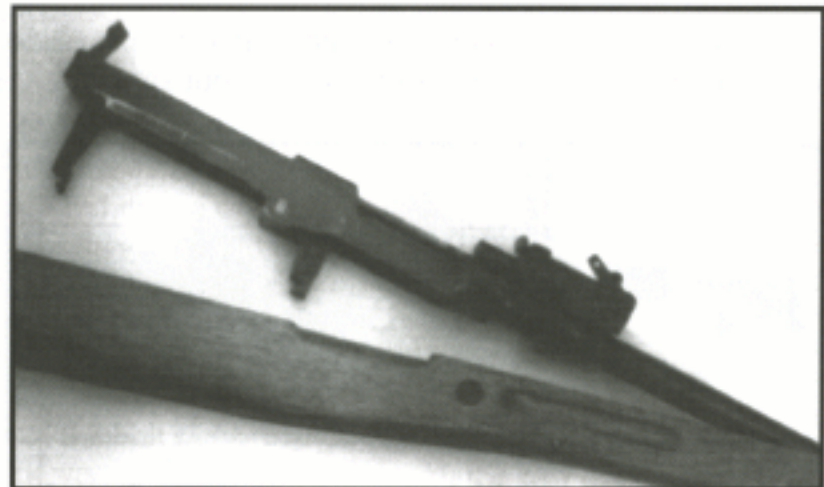



### TRIGGER GROUP DISASSEMBLY

**TOOLS NEEDED:** Safety glasses, hammer, 3/32 pin driver, and a disassembly block (at least 1" thick). Drill a 3/16" hole



Fig. 1 Start by drawing hammer back to clear pins from notch in the trigger frame, be careful, the hammer spring has a great deal of force.

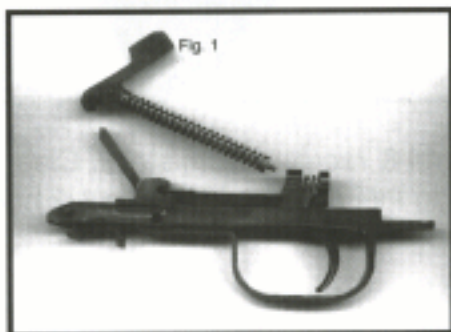

Fig. 2 Drive out magazine catch retaining pin, slide out magazine catch, remove spring, slide out sear.

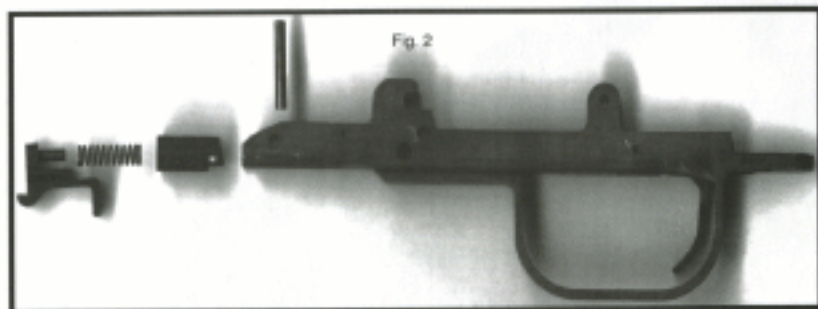
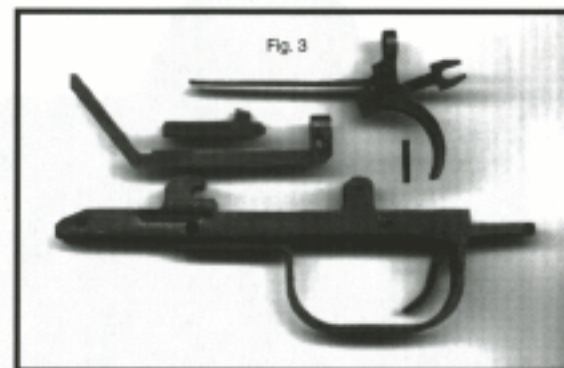

Fig. 3 Drive out bolt follower pin, lift out bolt follower and spring, drive out trigger pin, lift out trigger and sear disconnecter and safety spring. Squeeze disconnecter and lift out. Drive out safety lever pin, remove safety (safety removal is optional).



### UNDERSTANDING TRIGGER GROUP FUNCTION

As you draw the bolt carrier back, the bolt will contact the hammer face, moving the hammer to the rear and compressing the hammer spring. As the hammer moves to the rear it will engage the bolt follower then the sear. Now release the bolt and bolt carrier forward to close. The bolt follower will hit the bolt and drop the sear disconnecter into alignment with the sear and release the hammer catch, the sear now holds the hammer back. When the trigger is squeezed the sear disconnecter will move forward, held in alignment by the bolt follower, it will contact the sear, driving the sear forward, releasing the hammer and firing the rifle.

The bolt follower will not allow the hammer to be released until the bolt closes completely. The bolt will contact the bolt follower, putting it in contact with the sear disconnecter and into alignment with the sear.



## **WARNING**

The Bureau of Alcohol, Tobacco and Firearms has ruled that it is illegal to modify any firearm so that it will fire automatically or to make parts which will make it fully automatic without their prior approval.

**Note;** This booklet is offered for its educational and entertainment purposes only. We are not responsible nor are we liable for the illegal modifications of any firearm

You must stand the trigger group functions to understand this SKS conversion. View the sear disconnecter and sear through a 3/16" hole just below the hammer pin.



Note: The sear disconnecter will move forward to contact the sear only when the bolt follower is in correct position (bolt closed) aligning the sear disconnecter. With the trigger pulled back, note how the sear disconnecter will be forced below the sear when the hammer is drawn all the way back. This is where the conversion studies begin. If the hammer cam is removed, the bolt follower will not force the sear disconnecter down below the sear.

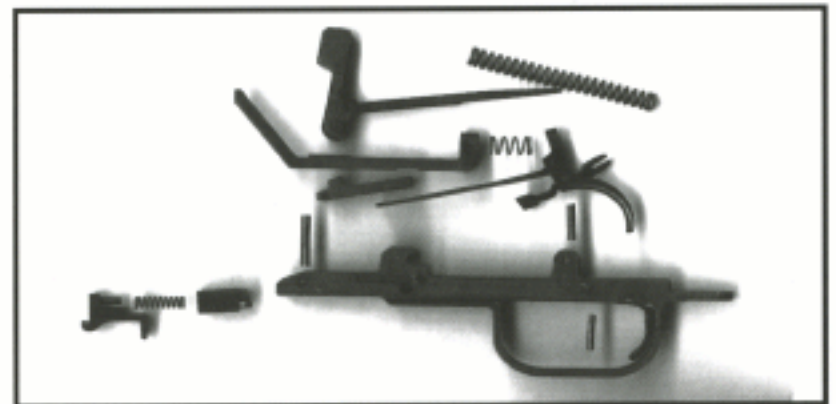

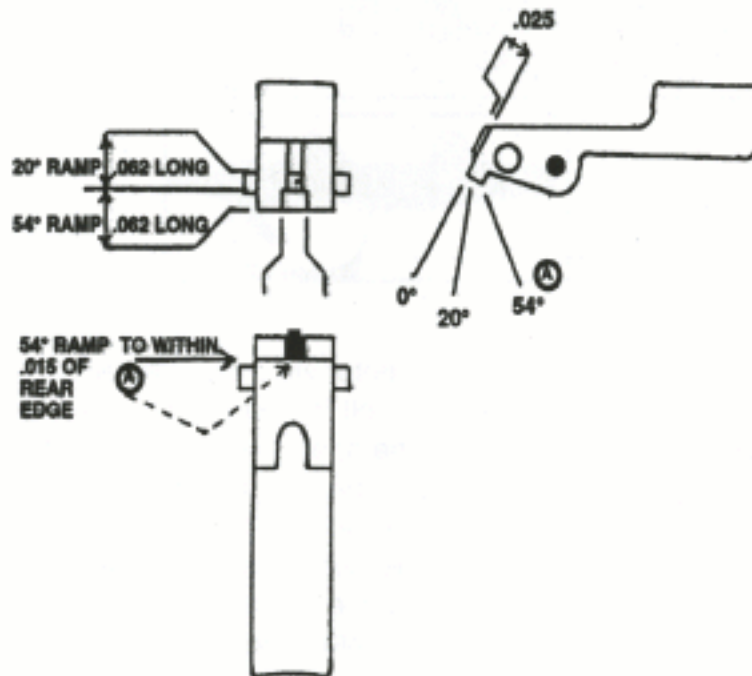

## HAMMER

When the sear disconnecter is not cammed down below the sear, the sear can't move to the rear to make contact with the hammer and hold it. It will make the bolt follower hold the hammer.

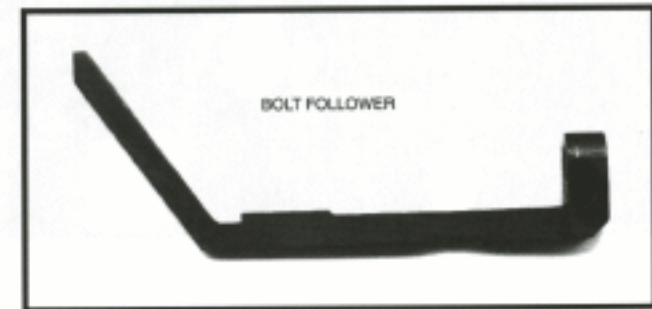

When the bolt closes, the bolt will contact the bolt follower, releasing the hammer and firing the rifle. This cycle will repeat until the trigger is released. When the trigger is released the sear will move to the rear, contacting and holding the hammer, stopping the cycle. When the trigger is squeezed again the cycle will restart. Although this is the first method, it will not be completely reliable

**BLOCKING THE SEAR DISCONNECTOR**

This "KEY" can easily be made at a reasonable cost in any good machine shop. The hole in the "KEY" is just an option and is only there for a key ring

KEY REMOVED

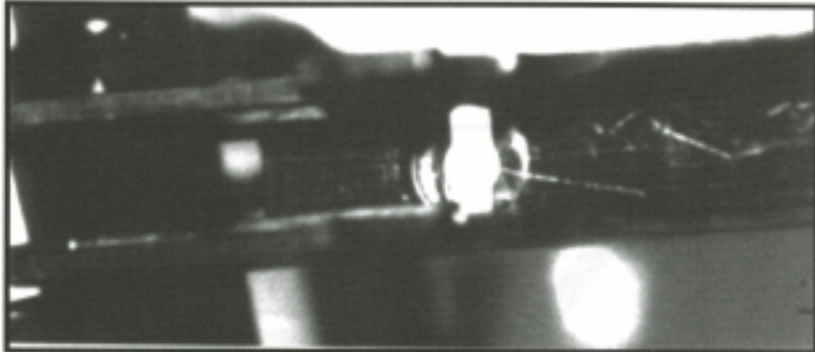

KEY IN PLACE



The "key" will block the sear disconnecter. This positively will not allow the sear disconnecter to drop below the sear. The trigger will be in total control of the sear.

REVISED - Sheet metal stamped trigger housings should open up this dimension to .150 + or - (Custom fitting required)

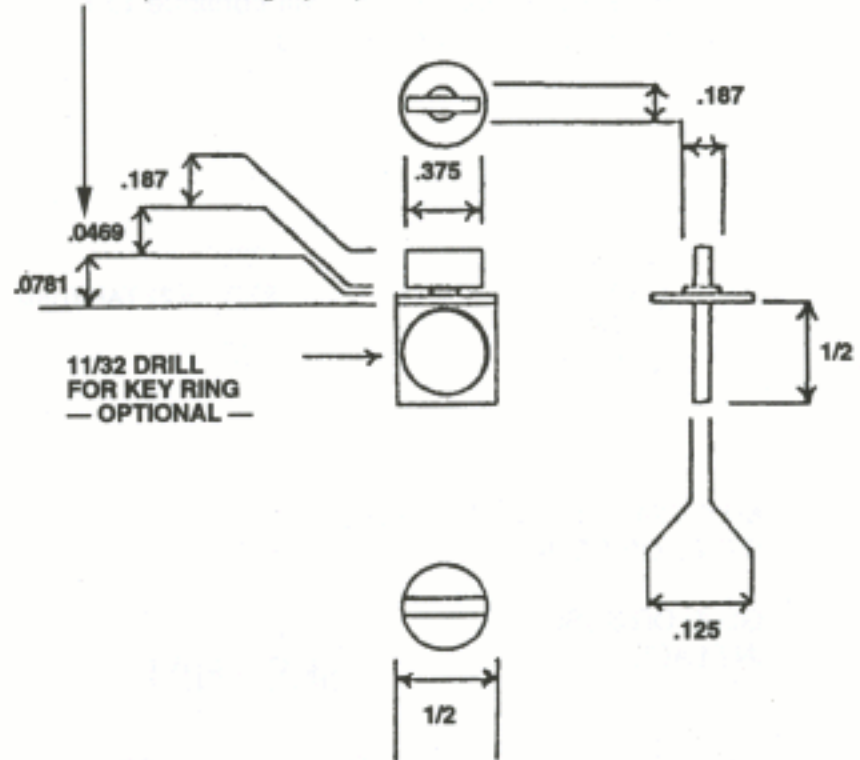

**SKS KEY**

.000 + or - .010  
 FRACTIONS + or - .015  
 NOT TO SCALE

An inexpensive alternative to the key could be to epoxy a thick shim under sear in milled bigger groups.

Although with this shim in place the rifle will fire automatically ONLY. With no semiautomatic option. As long as the trigger is squeezed the rifle will continue to fire. Releasing the trigger will stop the firing.



.375



.187

6-32 TAP THRU

MATERIAL 1018 COLD ROLLED  
STEEL OR EQUAL

GLUE OR SCREW  
IN PLACE

SKS SHIM

.000 + or — .005  
THREAD 2-B  
NOT TO SCALE

With the hammer modification only, the rifle is fully automatic only. The rifle must be returned to semiautomatics. This can be achieved by welding a cam onto the disconnecter as shown in Fig. 4 Below.



### CAUTION

If the "key" were to be installed into a rifle without the hammer modifications, the hammer cam would break the sear disconnecter on the first shot. This would obviously disable the gun.

With the "KEY" or shim inserted, the sear disconnecter will be blocked, and not allowed to drop below the sear. The trigger will be in full command of the sear, thus making the rifle fully automatic. Removal of the "key" or shim will allow the sear disconnecter to drop below the sear, releasing the sear to the rear to catch and hold the hammer, thus producing a semi-auto rifle once again.

A temporary alternative to welding the disconnecter would be to use a good epoxy. Epoxy is very easy to shape and durable enough to do the job. It does have to be custom fit with a file to the proper thickness. With this modification the rifle would be restored to semi-auto fire.

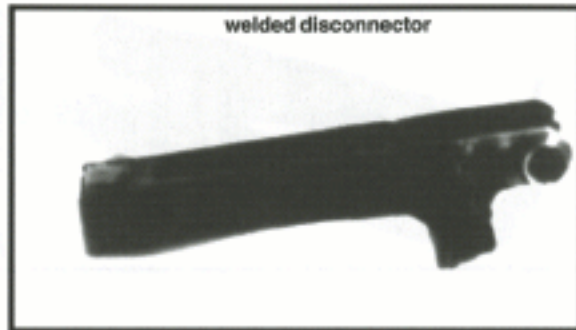

Please note; however, that the manufacturing tolerances on the SKS are quite loose. The disconnecter welds must be custom fit to each rifle, (filed or sandpapered)..



## HAMMER

I would strongly recommend buying a spare hammer or better still an entire milled steel trigger group.

When buying a new trigger group be forewarned, some are made out of stamped sheet metal, they are usually very cheap but not recommended at all. The better choice would be to get the machined steel trigger housing, they are more expensive but definitely worth the extra money.

By only modifying the hammer it should be known that the rifle would fire automatically only with no semi-auto option. As long as the trigger is squeezed the rifle would continue to fire. Releasing the trigger would stop the firing.

The rifle would become a totally reliable select fire system by combining the modification of the hammer, the disconnecter, and by blocking the sear disconnecter with the "key" or shim.

When the key is inserted and turned 90 degrees the rifle would become fully automatic. Removal of the "key" would return the rifle to semi-auto.

NOTE: If a shim is used instead of the "key" the trigger group must be taken apart and the shim removed before the rifle would be semi automatic again.

I have now revealed three separate but interrelated methods.

1). With just the hammer modification fully automatic only, no semi automatic option. (See hammer blueprint on page 16).

2). The more complete and more reliable method requiring just a little more time would be to modify the hammer and the disconnecter. With this method the rifle would be fully automatic only with the shim in place. Remove the shim and the rifle would once again be semi automatic. (See hammer blueprint on page 16, and shim blue print on page 20, and welded disconnecter on page 22).

3). The much more complete and totally reliable system would be to combine all three methods, hammer disconnecter, and the "KEY" to block the sear disconnecter. With this method the rifle would be semi automatic without the "KEY". By inserting the key and turning it 90 degrees the rifle would be fully automatic. (See hammer blue print on pages 16, key blue print on page 19, and welded disconnecter on page 22).

To explain the conversion sequence further, In Step 1) The Hammer modification, you learn how to convert your SKS to cycle fully automatically only. No semi auto fire, Squeeze the trigger and it will fire until you release the trigger or the magazine empties. All that's needed is a file.

In step 2) Disconnecter modification, you'll learn to return your rifle to semi automatic again. So in step 1) you removed the disconnecter cam (which acted on the bolt follower) from the hammer. In step 2 you are putting a raised cam on the Disconnecter *so the disconnecter will now trip the bolt follower* instead of the hammer.

Finally in step 3) you learned that ANYTHING you use to block the sear disconnecter from dropping below the sear will cause full auto cycling. The "KEY" or the SHIM, a pop-cycle stick glued in place, anything that is 3/16" thick.

## MINUTE - MAN FULL-AUTO CONVERSION

I can't take the credit for inventing the innovative design detailed on pages 28 and 29. It was given to me anomalously? This simple wire conversion method is definitely the easiest Full-Auto Conversion I have heard of yet for the SKS because it needs only a piece of 3 / 32" wire (welding rod) plus an hour or so of time for a reliable 'works every time' fitting. The generous "Minute - Man" who invented this slick little low cost wonder deserves some real credit. **THANKS ALEXANDRIA, LOUISIANA!**

As you can see by the hand written and hand drawn graphics (Pages 28-29) I printed the exact pages as I received them, unfortunately this means I have no other information and because the inventor wisely wishes to remain unknown, sorry I can't get any photograph of the original prototype. This design is so basic that it must work plain and simple.

I would recommend you begin construction by using a 3 / 32" welding rod that is easily bent and shaped, at least until you are sure of the exact shape and position of your bends, then copy your test piece using a stainless steel welding rod due to stainless steels very high tensile strength. You'll soon see how difficult it is to bend wire to exact shapes and dimensions without a jig. Get as many extra soft steel "test rods" and stainless steel welding rods as you think your talents will require to become proficient at judging the exact positions, lengths, and radius of your bends.

WITH TRIGGER PULLED AND HELD, HAMMER IS HELD COCKED BY ARM - WITH BOLT LOCK UP ARM IS PUSHED DOWN TRIPPING RELEASE OF HAMMER. MINUTE ADJUSTMENT OF ROD MADE AT 90° BENDS NEW ROD. IT JUST BENDS QUITE RIGHT.

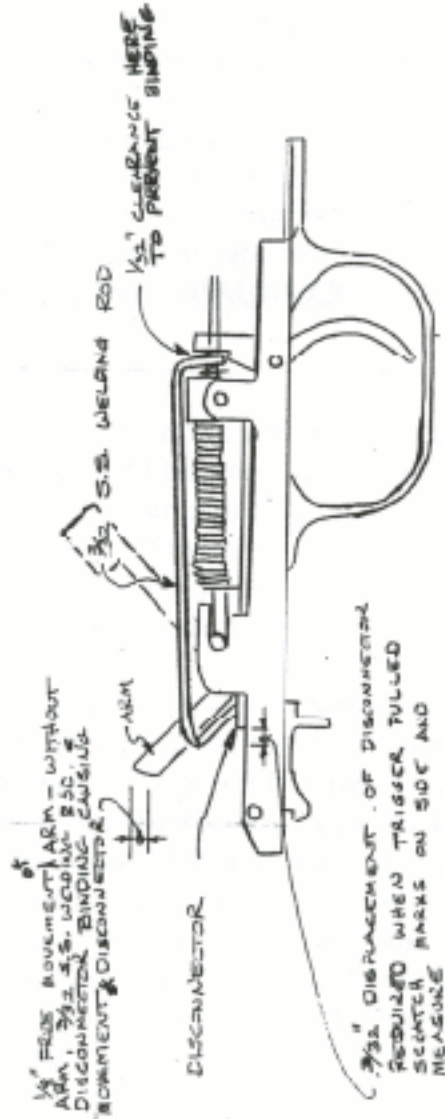

1/8" FREE MOVEMENT ARM - WITHOUT ARM. 3/32" S.S. WELDING DISCONNECTOR BINDING CAUSING MOVEMENT & DISCONNECTOR.

3/32" DISPLACEMENT OF DISCONNECTOR REQUIRED WHEN TRIGGER TULLED SCATCH MARKS ON SIDE AND MEASURE

1/2" CLEARANCE HERE TO PREVENT BINDING

MINUTE-MAN CONVERSION

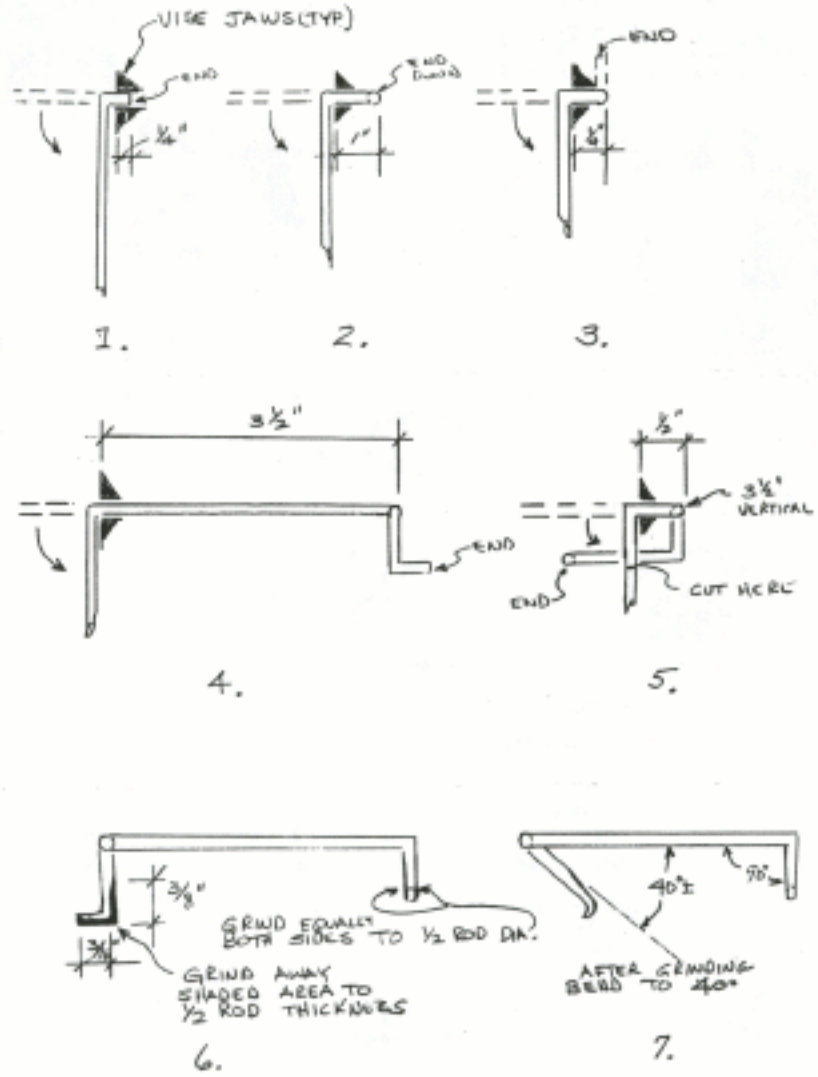

GRIND AWAY SHADED AREA TO 1/2 ROD THICKNESS  
GRIND EQUALY BOTH SIDES TO 1/2 ROD DIA.

AFTER GRINDING BIRD TO 40°