

INSTRUCTION MANUAL FOR

BLUED
STEEL



CALIBER
9mm

RUGER® LC9™

LIGHTWEIGHT COMPACT 9MM PISTOL



**READ THE INSTRUCTIONS AND
WARNINGS IN THIS MANUAL CAREFULLY
BEFORE USING THIS FIREARM**

© 2011 Sturm, Ruger & Co., Inc.

This manual may not be reproduced in whole or in part without the express written permission of Sturm, Ruger & Co., Inc.

**For Product Service on This Model Please Call:
(928) 778-6555 (See p. 29)**

THIS INSTRUCTION MANUAL SHOULD ALWAYS ACCOMPANY THIS FIREARM AND BE TRANSFERRED WITH IT UPON CHANGE OF OWNERSHIP, OR WHEN THE FIREARM IS LOANED OR PRESENTED TO ANOTHER PERSON

State-By-State Warnings

Certain states require by law that their own specified warning notices in larger-than-normal type be conspicuously included by the manufacturer, distributor, or retail dealer with firearms sold in that state. Sturm, Ruger sells its products in compliance with applicable laws and regulations. Because our products may be sold in these states, we include the following:

California:

WARNING

“Children are attracted to and can operate firearms that can cause severe injuries or death. Prevent child access by always keeping guns locked away and unloaded when not in use. If you keep a loaded firearm where a child obtains and improperly uses it, you may be fined or sent to prison.”

ADVERTENCIA

“A los niños los atraen las armas de fuego y las pueden hacer funcionar. Ellos pueden causarse lesiones graves y la muerte. Evite que los niños tengan acceso a las armas de fuego guardándolas siempre con llave y descargadas cuando no las esté utilizando. Si usted tiene un arma de fuego cargada en un lugar en que un niño tiene acceso a ella y la usa indebidamente, le pueden dar una multa o enviarlo a la cárcel.”

Connecticut:

“UNLAWFUL STORAGE OF A LOADED FIREARM MAY RESULT IN IMPRISONMENT OR FINE.”

Florida:

“IT IS UNLAWFUL, AND PUNISHABLE BY IMPRISONMENT AND FINE, FOR ANY ADULT TO STORE OR LEAVE A FIREARM IN ANY PLACE WITHIN THE REACH OR EASY ACCESS OF A MINOR UNDER 18 YEARS OF AGE OR TO KNOWINGLY SELL OR OTHERWISE TRANSFER OWNERSHIP OR POSSESSION OF A FIREARM TO A MINOR OR A PERSON OF UNSOUND MIND.”

Maine:

“ENDANGERING THE WELFARE OF A CHILD IS A CRIME. IF YOU LEAVE A FIREARM AND AMMUNITION WITHIN EASY ACCESS OF A CHILD, YOU MAY BE SUBJECT TO FINE, IMPRISONMENT OR BOTH. KEEP FIREARMS AND AMMUNITION SEPARATE. KEEP FIREARMS AND AMMUNITION LOCKED UP. USE TRIGGER LOCKS.”

Maryland:

“WARNING: Children can operate firearms which may cause death or serious injury. It is a crime to store or leave a loaded firearm in any location where an individual knew or should have known that an unsupervised minor would gain access to the firearm. Store your firearm responsibly!”

Massachusetts:

“WARNING FROM THE MASSACHUSETTS ATTORNEY GENERAL: This handgun is not equipped with a device that fully blocks use by unauthorized users. More than 200,000 firearms like this one are stolen from their owners every year in the United States. In addition, there are more than a thousand suicides each year by younger children and teenagers who get access to firearms. Hundreds more die from accidental discharge. It is likely that many more children sustain serious wounds, or inflict such wounds accidentally on others. In order to limit the chance of such misuse, it is imperative that you keep this weapon locked in a secure place and take other steps necessary to limit the possibility of theft or accident. Failure to take reasonable preventive steps may result in innocent lives being lost, and in some circumstances may result in your liability for these deaths.”

“IT IS UNLAWFUL TO STORE OR KEEP A FIREARM, RIFLE, SHOTGUN OR MACHINE GUN IN ANY PLACE UNLESS THAT WEAPON IS EQUIPPED WITH A TAMPER-RESISTANT SAFETY DEVICE OR IS STORED OR KEPT IN A SECURELY LOCKED CONTAINER.”

New Jersey:

“IT IS A CRIMINAL OFFENSE TO LEAVE A LOADED FIREARM WITHIN EASY ACCESS OF A MINOR.”

New York City:

“THE USE OF A LOCKING DEVICE OR SAFETY LOCK IS ONLY ONE ASPECT OF RESPONSIBLE FIREARM STORAGE. FOR INCREASED SAFETY FIREARMS SHOULD BE STORED UNLOADED AND LOCKED IN A LOCATION THAT IS BOTH SEPARATE FROM THEIR AMMUNITION AND INACCESSIBLE TO CHILDREN AND OTHER UNAUTHORIZED PERSONS.”

North Carolina:

“IT IS UNLAWFUL TO STORE OR LEAVE A FIREARM THAT CAN BE DISCHARGED IN A MANNER THAT A REASONABLE PERSON SHOULD KNOW IS ACCESSIBLE TO A MINOR.”

Texas:

“IT IS UNLAWFUL TO STORE, TRANSPORT, OR ABANDON AN UNSECURED FIREARM IN A PLACE WHERE CHILDREN ARE LIKELY TO BE AND CAN OBTAIN ACCESS TO THE FIREARM.”

Wisconsin:

“IF YOU LEAVE A LOADED FIREARM WITHIN THE REACH OR EASY ACCESS OF A CHILD YOU MAY BE FINED OR IMPRISONED OR BOTH IF THE CHILD IMPROPERLY DISCHARGES, POSSESSES, OR EXHIBITS THE FIREARM.”

* * * * *

Please check with your licensed retailer or state police for additional warnings which may be required by local law or regulation. Such regulations change constantly, and local authorities are in the best position to advise you on such legal matters.

WHY ARE WE INCLUDING A FIRED CARTRIDGE CASE WITH EVERY RUGER PISTOL AND REVOLVER?

Certain states and jurisdictions require that all newly manufactured pistols and revolvers must be accompanied by a cartridge case, which has been test fired from that gun at the factory. The case must be placed in a sealed container bearing certain information concerning this test cartridge.

At the time of retail sale in those jurisdictions, firearms dealers must forward such test cartridge to a designated destination such as their State Police Laboratory. As independent Ruger Distributors have nationwide markets without territorial restrictions, we have decided to include a fired cartridge case with all new Ruger pistols and revolvers, to minimize the possibility of inadvertent non-compliance with these laws.

Retail customers located in other states, where laws or regulations do not require the dealer to so act, may be assured that the fired cartridge case they receive with the firearm at the time of retail purchase is proof that your new Ruger firearm has undergone our normal test firing procedures during manufacture.

LOCKING DEVICE INSTALLATION INSTRUCTIONS



WARNING – USE OF LOCKING DEVICES



- Always keep your firearm pointed in a safe direction, including when you are installing or removing your locking device.
- Always verify that your firearm is completely **unloaded** before installing your locking device.
- Do **not** install locking devices in the trigger guard; always keep your fingers and locking device outside the trigger guard during device installation and removal.
- Store firearms, ammunition and keys separately and securely, away from children and careless adults; do **not** store your firearm with the keys in the locking device.
- Do not attempt to work the action of your firearm with the locking device in place; this may damage your firearm.
- While locking devices are an important aid to security measures, they are not a substitute for safe firearm handling and proper storage. Remember that any mechanical device can be bypassed with enough time, knowledge, determination and equipment.

**LOCKING DEVICES MUST BE USED
SAFELY AND RESPONSIBLY**

Use the Correct Lock: While the basic locking device is substantially similar for all Ruger® firearms, due to the different shapes of the many Ruger® firearms, some firearms utilize different locking devices. The lock with a 5” shackle is used on the **LC9™**. **It is very important to use the correct locking device!**

To Install the Factory-Supplied Locking Device:

1. **Keep the muzzle pointed in a safe direction and your fingers outside the trigger guard at all times!**
2. **Be sure the firearm is completely unloaded and contains no cartridges or cartridge cases!**
3. Remove the magazine from your pistol.
4. Open the action completely. Use the slide stop to keep the action open during installation of the locking device.
5. Apply the locking device by placing the shackle of the lock into your pistol as shown below.
6. Close the lock by pressing the shackle into the body of the lock (the part that receives the key) as tightly together as possible. The lock has bumpers and the shackle is coated with a non-marring material that will not harm the metal finish of your firearm.
7. Once the lock is securely closed, remove the key and pull firmly on the lock to test the connection and be sure it is locked. **Do not leave or store your firearm with the key in the lock!** Store your locked unloaded firearm and the key in secure, separate locations, away from ammunition, children, or unauthorized adults.



*Correct Installation of Lock
on Ruger® LC9™ Pistols*

FIREARMS SAFETY - YOUR RESPONSIBILITY

SAFETY MUST BE THE FIRST AND CONSTANT CONSIDERATION OF EVERY PERSON WHO HANDLES FIREARMS AND AMMUNITION.

This Instruction Manual is designed to assist you in learning how to use and care for your **LC9™** properly. Please contact us if you have any questions.

Only when you are certain you fully understand the Manual and can properly carry out its instructions should you practice loading, unloading, etc. with live ammunition. If you have any doubts about your ability to handle or use a particular type of gun safely, you should seek supervised instruction. Such personalized instruction is often available from gun dealers, gun clubs or police departments. If none of these sources can help you, write to the National Rifle Association, 11250 Waples Mill, Fairfax, VA 22030-7400. They will assist you.

The person possessing a gun has a full-time job. You cannot guess; you cannot forget. You must know how to use your firearm safely. **Do not use any firearm without having a complete understanding of its particular characteristics and safe use.** Remember: There is no such thing as a foolproof gun.

TABLE OF CONTENTS

State-By-State Warnings	3
Locking Device Installation Instructions	6
General Information and Mechanical Characteristics	9
Nomenclature	10
Ammunition	11
Operation of Manual Safety	12
Operation of Internal Lock	14
Operation of Loaded Chamber Indicator	15
Operation of Magazine Disconnect	16
To Load and Fire (with magazine)	16
To Unload	19
To Extract and Eject a Chambered Cartridge	20
To Clear a Malfunction (“Jam”)	21
To Minimize Malfunctions (“Jams”)	22
To Disassemble	22
To Reassemble	26
Magazine Inspection and Care	26
Care and Cleaning	27
Storage	28
Service and Parts Policy	29
Shipping Firearms for Repair	29
Ordering Parts	30
Parts List	31
Exploded View	33
The Basic Rules of Safe Firearms Handling	34
Warranty Information	40

“Ruger” is a registered U.S. trademark.



WARNINGS OF GREAT IMPORTANCE ARE FOUND ON THE FOLLOWING PAGES:

Locking Devices	6	Unloading	19
Alterations	9	Slide Retraction	20
Lead Exposure	12	Malfunctions	21
Ammunition	12	Disassembly	26
Manual Safety	13	Lubrication	28
Loaded Chamber	15	Storage	28
Magazine Disconnect	16	Shipping	29
Firing	18	Parts Purchasers	30
Handling	18		

OTHER CAUTIONS AND WARNINGS APPEAR THROUGHOUT THE MANUAL.

**FIREARMS ARE DANGEROUS WEAPONS -
READ THE INSTRUCTIONS AND WARNINGS
IN THIS MANUAL THOROUGHLY AND
CAREFULLY BEFORE USING.**



WARNING - ALTERATIONS



This product was designed to function properly in its original condition. Alterations can make it unsafe. Do not alter any part or add or substitute parts or accessories not made by Sturm, Ruger & Co. Inc.

DO NOT ALTER ANY GUN

GENERAL INFORMATION AND MECHANICAL CHARACTERISTICS

The **RUGER® LCS™** is a compact, single-strike, double-action only, magazine-fed, recoil-operated pistol chambered for the 9mm cartridge. The **LCS™** incorporates a different “link-less” design in the barrel locking/unlocking system than earlier Ruger P-Series pistols, and features a streamlined slide, and glass reinforced nylon and aluminum subframe grip frame. The following are features with which **LCS™** users should be thoroughly familiar:

NOMENCLATURE

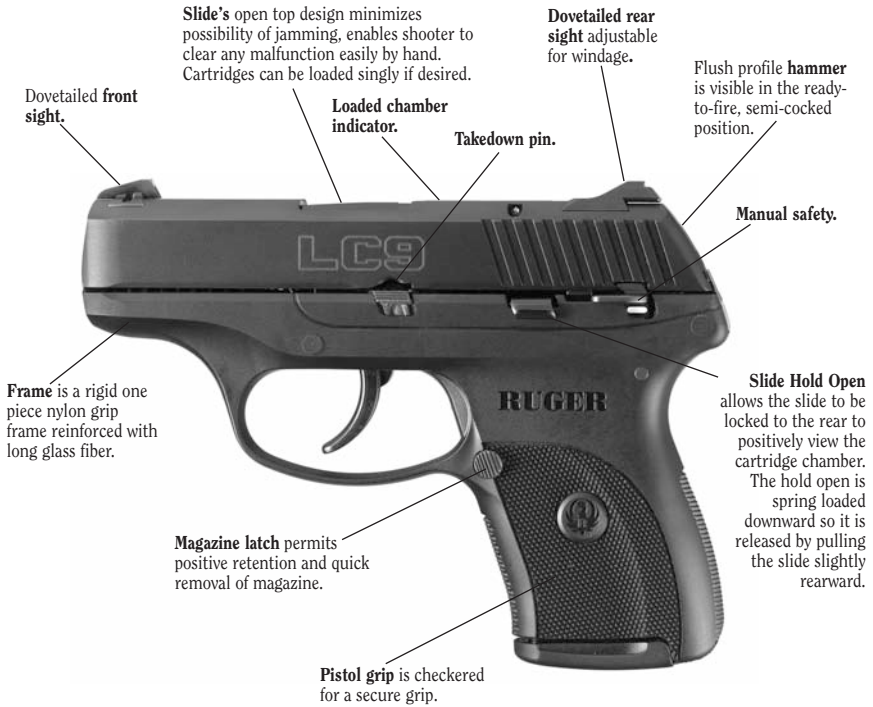

Action: The strong locked breech action of the **RUGER® LCS™** utilizes a tilting barrel design in which the barrel and slide are locked together at the moment of firing. After firing, the barrel and slide recoil to the rear a short distance while securely locked together. After this initial movement, the barrel is cammed downward from its locked position, permitting full recoil of the slide and the extraction and ejection of the spent cartridge case. Upon return of the slide to its forward position by the recoil spring, the barrel is cammed back upward into its locked position in the slide.

The user of this or any autoloading pistol must always remember that when fired, it automatically reloads and recocks itself, so that simply pulling the trigger will fire the pistol again. Therefore, an autoloading pistol user must be particularly conscious to always keep the pistol pointed in a safe direction.

Slide Hold Open: This allows the user to manually lock the slide open. **Note:** when the last shot has been fired and the magazine is empty, the slide hold open automatically holds the slide open. If a loaded magazine is inserted in the pistol when the slide is closed and the slide is then retracted fully, the slide hold open will not automatically hold open the slide. The user can actuate the slide hold open mechanism to hold the slide open at any time by retracting the slide and pushing the slide hold open up.

The slide hold open can be released by drawing back slightly on the slide. When the slide is released, it will move forward under pressure from the recoil spring.

The slide hold open is held in place by a spring. Therefore, when there is a loaded magazine in place and the pistol is jarred, the slide can fly forward and chamber a cartridge. For this reason and as an essential safety practice, the user should always be careful to keep fingers away from the trigger, and always keep the pistol pointed in a safe direction.

Magazines: The Ruger 9mm magazine, included with your **RUGER® LCS™**, has been specifically designed for the **RUGER® LCS™** pistol and is not interchangeable with other Ruger pistol magazines even though it may appear similar and may hold 9mm cartridges. Use of incorrect magazines in any pistol will result in malfunctions.

**DAMAGED, NON-STANDARD, OR IMPROPERLY
ASSEMBLED MAGAZINES SHOULD NOT BE USED.
THEY CAN CAUSE THE PISTOL TO MALFUNCTION.**

AMMUNITION

The **RUGER® LCS™** pistols are chambered for the 9mm cartridge. Do not attempt to load any other cartridges into the magazine or chamber of the pistol. **Do not use “+P+” ammunition.** (See “NOTE on +P Ammunition” on pg. 12.)

The **RUGER® LCS™** pistols are compatible with standard factory ammunition loaded to U.S. Industry Standards, including hollow-point loads loaded in brass or aluminum cases. No 9mm ammunition manufactured in accordance with NATO, U.S., SAAMI, or CIP standards is known to be beyond the design limits or known not to function in these pistols.

Note on +P Ammunition: Although the **RUGER® LCS™** is capable of functioning with 9mm +P ammunition, a steady diet of +P ammunition will shorten the endurance life of the **RUGER® LCS™**. You should never shoot 9mm +P+ ammunition in your **RUGER® LCS™**. There are no SAAMI or CIP pressure limits on 9mm +P+ and use of this ammunition could result in serious injury.

Do not use “+P+” ammunition.

⚠ WARNING - LEAD EXPOSURE	
	Discharging firearms in poorly ventilated areas, cleaning firearms, or handling ammunition may result in exposure to lead and other substances known to the state of California to cause birth defects, reproductive harm, and other serious physical injury. Have adequate ventilation at all times. Wash hands thoroughly after exposure.
SHOOTING OR CLEANING GUNS MAY EXPOSE YOU TO LEAD	

⚠ WARNING - AMMUNITION	
	Death, serious injury, and damage can result from the use of the wrong ammunition, bore obstructions, powder overloads, or incorrect cartridge components. Even the strongest gun can be “blown up” as a result of excess pressure. <u>Always</u> wear shooting glasses and hearing protection.
IMPROPER AMMUNITION DESTROYS GUNS	

AMMUNITION (CARTRIDGES) NOTICE

WE SPECIFICALLY DISCLAIM RESPONSIBILITY FOR ANY DAMAGE OR INJURY WHATSOEVER OCCURRING IN CONNECTION WITH, OR AS A RESULT OF, THE USE IN ANY RUGER FIREARMS OF FAULTY, OR NON-STANDARD, OR “REMANUFACTURED” OR HAND-LOADED (RELOADED) AMMUNITION, OR OF CARTRIDGES OTHER THAN THOSE FOR WHICH THE FIREARM WAS ORIGINALLY CHAMBERED.

OPERATION OF MANUAL SAFETY

The **LCS™** is equipped with a manual safety lever.

To engage the manual safety, point the pistol in a safe direction. Move the safety lever upward fully to the “safe” position. Note that the pistol must be cocked to engage the safety.

When the safety is moved fully upward to the “safe” position, the red oval on the left side of the frame insert will be fully covered by the left safety lever and a white oval will be visible. If any red is showing, the safety is not in the “safe” position. Do not attempt to engage the safety while pulling the trigger.

The safety mechanism provides that the trigger cannot be pulled unless the safety is disengaged. Like the 1911 pistols, the manual safety lever locks the slide shut, ensuring that the pistol will be ready to fire when the safety is disengaged. To disengage the manual safety, point the pistol in a safe direction and push the safety lever fully downward. The red oval signifies that the safety is disengaged and the pistol is ready to fire.

Additionally, the pistol has a separate firing pin block which will not allow the firing pin to move forward and contact the cartridge until the operator pulls the trigger with the safety off (in its “fire” position).

The safety should be in its “safe” position at all times except when the user is deliberately positioned to fire at a selected target. When the safety is in the “fire” position (safety lever down) the red oval is exposed just above the safety lever. See Figures 1 and 2, below, which illustrate the two positions of the safety.

“SAFE” POSITION



FIGURE 1

“FIRE” POSITION

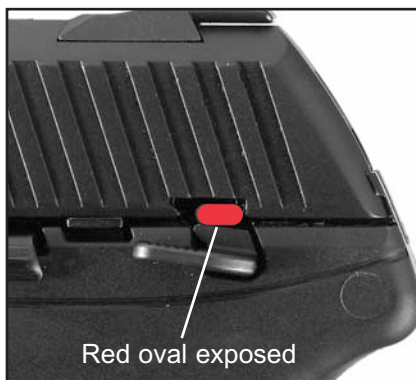

FIGURE 2



WARNING - MANUAL SAFETY



Placing the safety in an intermediate position between “safe” and “fire” can result in the user thinking the pistol is in a safe or fire position when it is not. Pulling the trigger with the safety in an intermediate position may cause the pistol to fire. Therefore, always move the safety fully to its intended position and then check to be sure it is where you want it to be. Unless the red oval is fully covered by the safety lever, the safety is not “ON.” Unless the red oval is fully visible, the pistol is not absolutely ready to fire.

NEVER PUT SAFETY 1/2 ON

OPERATION OF INTERNAL LOCK

Never rely upon any safety mechanism or mechanical device to justify unsafe or careless handling of a firearm. When securing your pistol or to prevent unauthorized access, you should completely unload the pistol and store it in a gun safe or use the key-operated external locking device supplied with your pistol. (See Page 6.) However, for added security, and to comply with certain state and local laws, your **RUGER® LCS™** pistol is also equipped with an internal lock. When actuated, this internal lock will secure the pistol's manual safety in the "on" or "safe" position.

Before activating the internal lock on your pistol, first visually inspect the chamber and magazine to verify that they are empty and do not contain any cartridges.

To activate the internal lock, place the manual safety in the "on" or "safe" position (see Figure 1, p. 13). (Note that the pistol must be cocked to engage the safety.) Next, place the internal lock key (supplied with your pistol) into the internal lock keyway. (See "Nomenclature," p. 10.) Rotate the key clockwise (about 1/4 of a rotation from the fully unlocked position) until it stops. (See Figure 3.) Remove the key and verify that the internal lock is engaged by attempting to move the safety to the "off" or "fire" position. If the internal lock is engaged, the trigger will move freely and will not function.

To deactivate the internal lock, place the internal lock key into the internal lock keyway (see "Nomenclature," p. 10) and rotate the key counter-clockwise (about 1/4 turn from the fully locked position) until it stops. (See Figure 3.)

Be sure to store the internal lock key in a secure location, away from children and careless adults. Do not store your firearm with the key in the internal lock keyway. **Never lock a loaded gun – always unload the gun before locking.**

OPERATION OF INTERNAL LOCK

To engage the internal lock, rotate the key clockwise 1/4 of a rotation.

To deactivate, rotate the key counter-clockwise 1/4 of a rotation.

NOTE: With internal lock engaged, trigger will move freely and will not function.

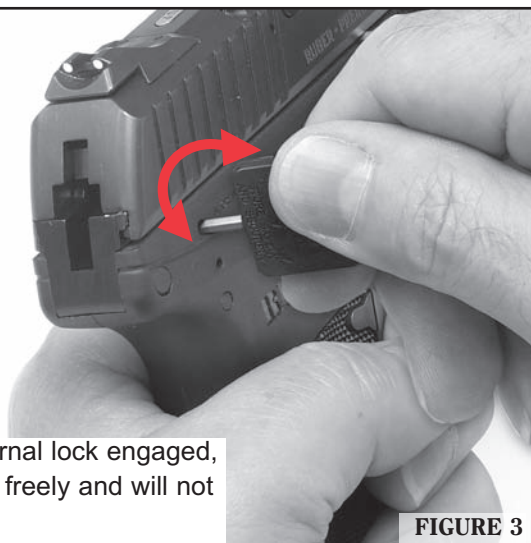

FIGURE 3

OPERATION OF LOADED CHAMBER INDICATOR

You should always treat every gun as though it is loaded and always keep the muzzle pointed in a safe direction. Never rely upon any safety or mechanical device to justify unsafe or careless gun handling. In order to assist you in determining the presence of a cartridge in the chamber of your **RUGER® LCS™** pistol, and to comply with state laws, the **LCS™** is equipped with a loaded chamber indicator. The indicator appears on the top of the slide. (See “Nomenclature,” p. 10.)

When the chamber is empty, the loaded chamber indicator should be flush with the top of the slide. (See Figure 4A, below.)

When the chamber is loaded, the forward portion of the loaded chamber indicator should protrude from the top of the slide. When the chamber contains a cartridge, a red bar should be visible on either side of the loaded chamber indicator. (See Figure 4B, below.)

OPERATION OF LOADED CHAMBER INDICATOR

Indicator
Flush
With Top

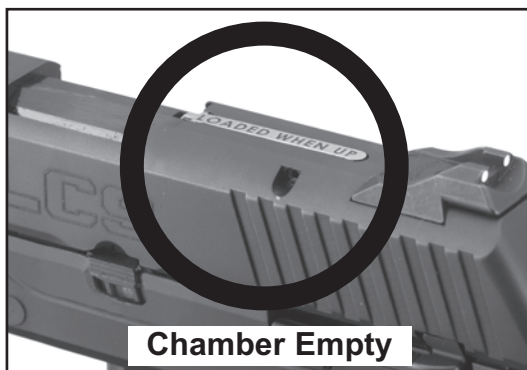

FIGURE 4A

Indicator
Protrudes
From
Top -
Red Bar
Visible



FIGURE 4B



NEVER RELY ON YOUR MEMORY OR ANY LOADED CHAMBER INDICATOR TO KNOW IF A GUN IS LOADED. ANY MECHANICAL DEVICE CAN FAIL. ALWAYS VISUALLY CHECK THE CHAMBER BY RETRACTING THE SLIDE AND EXAMINING THE CHAMBER TO BE SURE WHETHER IT IS EMPTY OR LOADED.

OPERATION OF MAGAZINE DISCONNECT

Your **RUGER® LGS™** pistol is equipped with a magazine disconnect. This device prevents firing if the magazine is removed from the pistol. You will not be able to use your **LGS™** pistol as a single loader (unless you place one cartridge in the magazine and insert it into the pistol) or to fire the pistol with the magazine out of the pistol.



REMEMBER THAT A ROUND MAY STILL BE IN THE CHAMBER AND THAT THE PISTOL MAY STILL BE LOADED EVEN IF THE MAGAZINE IS REMOVED. AS SOON AS AN EMPTY MAGAZINE IS INSERTED, A ROUND IN THE CHAMBER CAN BE FIRED BY PULLING THE TRIGGER.

BE CAREFUL! AS ALWAYS, YOU SHOULD NOT RELY UPON THE MAGAZINE DISCONNECT OR ANY OTHER MECHANICAL DEVICE OR SAFETY TO JUSTIFY CARELESS OR UNSAFE HANDLING OF ANY FIREARM.

Don't rely on your memory or the word of others to know if a gun or magazine is loaded. Visually inspect the magazine and the chamber to be certain.

TO LOAD AND FIRE (WITH MAGAZINE)

Practice this important aspect of safe gun handling with an unloaded pistol until you can perform each of the steps described below with skill and confidence. **But before you do anything with the pistol, first read completely through this manual.**

1. **Be certain the muzzle is pointed in a safe direction.** (See “The Basic Rules of Safe Firearms Handling,” p. 34.)
2. Press the magazine latch and remove the magazine from the frame.

NOTE: The magazine is designed to fall free of the frame when the pistol is held in the normal firing position, but you should always prevent possible damage to the magazine by not letting it drop to the ground unless rapid reloading is absolutely necessary.

3. Place seven (7) or fewer 9mm cartridges into the magazine from the top.
4. Insert the magazine into the frame, taking care that the magazine is locked in place by the magazine latch. Slamming the magazine into the frame forcibly is not necessary.

5. Hold the pistol firmly in the shooting hand but **do not touch the trigger**. **Keep the pistol pointed in a safe direction**. With the thumb and forefinger of the other hand grasp the top of the slide and pull the slide to the rear as far as it will go (see Figure 5A, below). Use care to not place any part of your hand in front of the muzzle (see “Slide Retraction Warning,” p. 20). When released, the slide will fly forward to strip the top cartridge from the magazine and chamber it. The hammer automatically moves to the semi-cocked position as the slide moves forward.

WARNING: The pistol is ready for instant use when the trigger is pulled once the slide moves fully forward. Be careful!



FIGURE 5A

Retracting the slide.

6. Engage the safety by pushing the lever up until it clicks into the cut in the slide.
7. **If the pistol is not to be used immediately, the magazine should be removed and the chamber unloaded.**
8. **The pistol is ready for instant use.** When the pistol is in the “semi-cocked” mode, the first shot can be fired double-action by pulling the trigger all the way to the rear, which fully cocks and releases the hammer and then fires the pistol. Subsequent shots are fired in the same way by releasing and then pulling the trigger until the magazine is empty, the hammer being semi-cocked by the slide as it recoils from each shot. After a shot is fired, the trigger must be allowed to move fully forward. If the trigger is pulled before the trigger mechanism fully resets (two “clicks”) the hammer may or may not fire the cartridge.

! WARNING - FIRING	
	<p>The slide automatically opens and shuts quickly while firing. Keep face and hands away from rear. Hot brass is ejected quickly and can burn you. Always wear shooting glasses, hat with a brim, and hearing protection.</p>
SLIDE OPENS FAST - HOT BRASS EJECTED	

9. Immediately following the firing of a shot, and if a subsequent shot is not to be fired at once, remove the magazine and lock the slide back using the slide hold open. Be sure the chamber is empty. If the slide is shut, the shooter should always assume that there is a cartridge in the chamber! Don't rely on your memory to know if a gun or magazine is loaded. Visually inspect the magazine and chamber.

! WARNING - HANDLING	
	<p>Do not load the pistol until you are ready to use it, and unload it immediately when you have completed shooting. (See "Unloading Warning" on page 19.)</p> <p>If dropped or struck, the pistol may fire. Keep chamber empty unless actually firing!</p> <p>For maximum safety when carrying the pistol with a loaded magazine in place, the chamber should be empty, the slide should be closed and safety engaged. If placed into a holster, check it to be sure that the slide is not retracted far enough to chamber a cartridge from the magazine.</p> <p>The user should never depend on any mechanical device to justify careless handling or permitting the pistol to point in an unsafe direction. The shooter should always be alert to the possibility of accidental discharge. The only absolutely safe pistol is one in which the slide is open, the chamber is empty, and there is no magazine in the gun.</p>
ANY GUN MAY FIRE IF DROPPED	

! WARNING - UNLOADING	
	<p>Removing the magazine does not unload pistol! To unload, first remove magazine, then pull slide to rear, eject chambered cartridge, and visually inspect chamber to be sure it is empty. Always point the pistol in a safe direction when loading or unloading.</p> <p>Removing the magazine should prevent the pistol from firing – but never rely on this or any other mechanical safety device to justify careless handling of any firearm.</p>
REMOVING MAGAZINE DOES NOT UNLOAD CHAMBER	

TO UNLOAD

WARNING: This sequence must be followed exactly as outlined. Failure to do so can result in the chamber being unintentionally loaded with a live cartridge!

1. The muzzle of the pistol must be pointing in a safe direction at all times, and fingers should be outside of the trigger guard.
2. Remove the magazine from the pistol by pushing in on the magazine latch. **REMEMBER** that even though the magazine has been removed, a live round remaining in the chamber can still be fired (see “Unloading Warning,” above).
3. Hold the pistol firmly and grasp the slide. Retract the slide to its rearmost position briskly to extract and eject any chambered cartridge. Always double check visually that the chamber, breech-face, and the interior of the frame are clear of any live rounds. When the slide is fully retracted, push upward on the slide hold open, then allow the slide to move forward until it comes to rest with the rear projection of the slide hold open resting in the notch on the lower left side of the slide.

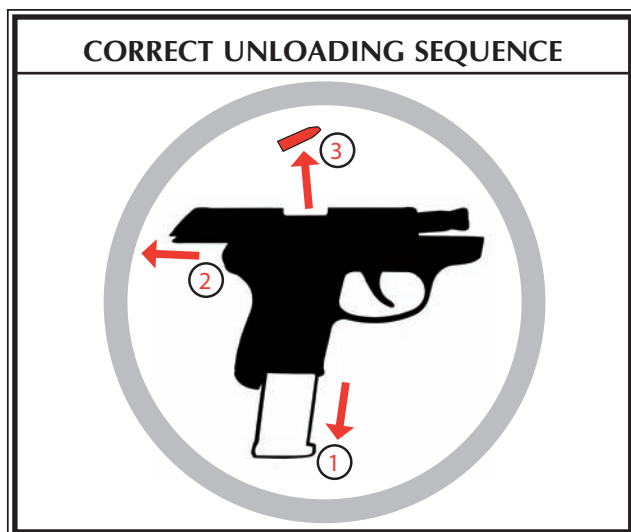



WARNING - SLIDE RETRACTION

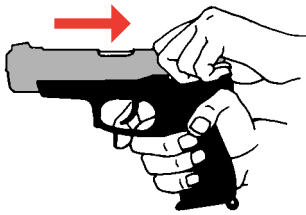

The slide should always be pulled rearward (“retracted”) by pulling the rear portion of the slide. **Always keep fingers away from trigger!**



Never put any part of your hands or body over the muzzle while retracting the slide for loading, unloading, inspection, or clearing a malfunction.

**KEEP HANDS
AWAY FROM MUZZLE AND
FINGER OFF TRIGGER**

4. To close the slide, **again check to be sure the chamber and breech-face are empty.** Pull the slide to its rearmost position and release it. The slide will snap forward. Keep fingers out of ejection port on top of slide!
5. If the magazine contains cartridges, they can be removed by sliding each cartridge forward and out of magazine, one at a time, until the magazine is empty.
6. Push empty (unloaded) magazine into frame until magazine latch locks it in place.

TO EXTRACT AND EJECT A CHAMBERED CARTRIDGE

When the pistol is fired, the same gas pressure that drives the bullet forward also acts through the cartridge case to push the slide to the rear. The action causes extraction and ejection of the fired cartridge case. If a cartridge fails to fire or if the shooter wishes to eject the chambered cartridge manually, follow the procedure “To Unload,” p.19. When the slide is operated by hand, there can be a failure to extract the cartridge from the chamber, or a failure to eject the cartridge clear of the pistol. These failures usually are the result of the slide not being pulled rearward vigorously. The gun user must:



1. **Always visually check the chamber and the breech-face after opening the slide to eject a chambered cartridge.** If the slide is not vigorously retracted when being operated by hand, the extracted cartridge can be “ejected” into the magazine-well of the grip frame or remain held to the breech-face by the extractor.

2. Thoroughly clean the chamber and the extractor as often as necessary.

If an empty magazine is in the pistol when the slide is being hand retracted to extract a cartridge, the cartridge may drop on top of the magazine or remain held to the breech-face by the extractor. Then when the slide goes forward, the cartridge will be chambered again! **Remember — always remove the magazine before clearing the chamber, and visually ensure that no cartridges remain in the gun.**

TO CLEAR A MALFUNCTION (“JAM”)

1. **Be certain the muzzle is continually pointed in a safe direction.**
2. If possible, remove the magazine. It may be necessary to manually remove a jammed cartridge that has only been partially stripped from the magazine. If so, use extreme care. Lock the slide open with the slide hold open before attempting to clear the jam. Drawing the slide fully to the rear may bring the jammed cartridge along. **Keep your face away from the ejection port during this operation.** When attempting to clear a jam, use only wood “tools” so that the cartridge will not be damaged or the primer ignited. A 3/16” wooden dowel with a point on one end is useful.
3. Visually check to make sure that all cartridges have been removed from the pistol. Safely dispose of any cartridges involved in a malfunction incident. Do not use damaged ammunition in any firearm.

 WARNING - MALFUNCTIONS	
	<p>Any autoloading pistol may occasionally malfunction. If a cartridge hangs up, jams, or binds when being chambered, do not attempt to force it into the chamber by pushing or striking the slide. Carefully remove it.</p> <p>Most failures of a cartridge to feed or to chamber properly are caused by a damaged magazine, incorrect gun handling, insufficient lubrication, or improper ammunition.</p> <p>Whatever the cause, the user of the pistol must, above all, recognize that any cartridge jam can result in a potentially very dangerous situation of a cartridge discharging before it is properly chambered. If this happens, the cartridge case may rupture and its fragments fly out of the ejection port of the pistol with sufficient force to cause serious injury. Always wear shooting glasses!</p>
	HITTING PRIMER CAN BURST CARTRIDGE

TO MINIMIZE MALFUNCTIONS (“JAMS”)

1. If it appears that the jam was caused by the type of ammunition being used, try another brand, type, or lot number. Remember — use only factory ammunition of the correct caliber.
2. If changing ammunition does not at once eliminate malfunctions, then the following steps should be taken:
 - a. Thoroughly clean the pistol, paying particular attention to the removal of accumulated grease and dirt. Use a bristle brush and solvent to remove grease and fouling from the breech-face, extractor, chamber, and feed ramp area immediately behind the chamber.
 - b. Check to be sure that the magazine spring firmly returns the magazine follower to the top of the magazine.
 - c. Check the magazine lips to be certain that they are free of nicks and burrs and that they are not deformed or cracked.
 - d. Remove excess oil and solvent from all cleaned components, load the magazine, and try the pistol again. Make sure you are following the correct loading and firing sequence as described in this manual.
 - e. If none of the above steps is effective, try a different magazine of Ruger manufacture. If a new magazine does not function correctly, return the pistol and magazine to the Ruger Product Service Department. (See “Shipping Firearms For Repair” on page 29.)
 - f. **Alterations to the pistol or use of non-Ruger magazines and accessories may cause malfunctions. See “Alteration Warning” on page 9.**

TO DISASSEMBLE

Be sure pistol is unloaded!

1. **Keep pistol pointed in a safe direction.** Press the magazine latch and withdraw the magazine from butt of pistol (see Figure 6).

FIGURE 6



2. Pull slide to the rear and lock in the open position by pushing upward on the slide hold open.
(See Figure 7)



FIGURE 7

3. Inspect the chamber and verify that it is empty (see Figure 8).



FIGURE 8

4. Retract the slide slightly and release it (see Figure 9). This will disengage the slide stop and allow the slide to move fully forward.

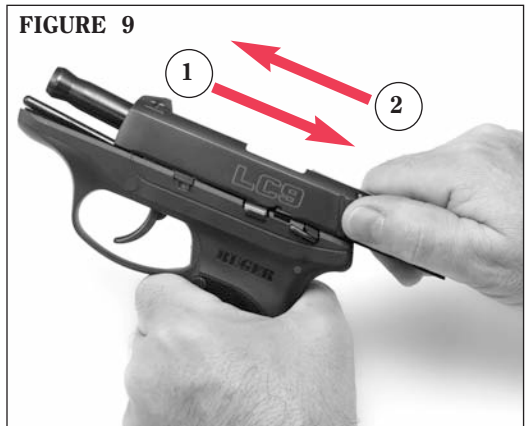

FIGURE 9

- Using a finger or a “soft” tool, push the takedown plate down (see Figure 10A) to expose the takedown pin (see Figure 10B).



FIGURE 10A



FIGURE 10B

- The slide must be pushed back approximately 1/16” before you can insert the Ruger key into the slot on the right side of the frame (see Figure 11A). Now push the takedown pin out the left side of the pistol (see Figure 11B).



FIGURE 11A

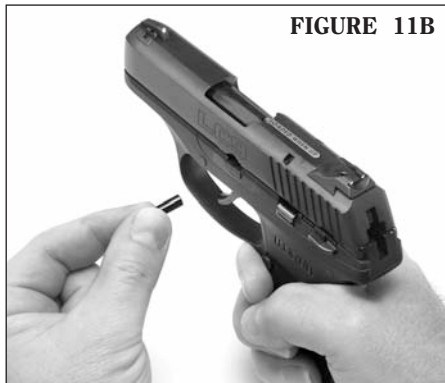

FIGURE 11B

- Move the slide assembly forward and separate it from the grip frame (see Figure 12).



FIGURE 12

8. Compress the recoil spring assembly slightly to disengage it from its seat against the barrel lug, and remove it completely (see Figure 13).



9. Remove the barrel. It will be necessary to move the barrel forward slightly and then down and back to extract it from the slide (see Figure 14).



10. The pistol is now disassembled for cleaning (see Figure 15).



! WARNING – DISASSEMBLY	
	<p style="color: red;">Always unload a firearm before cleaning, lubrication, disassembly or assembly.</p>
UNLOAD BEFORE DISASSEMBLY	

TO REASSEMBLE

1. **Be certain chamber and magazine are empty.**
2. With slide held upside down, replace barrel and push it rearward into its locked position.
3. Replace the recoil spring assembly into position. The rear end of guide rod seats against barrel lug.
4. Replace slide onto frame and place in its “closed” position, as if the pistol were fully assembled.
5. Make sure that the take down plate is fully pressed downward. Pull the slide slightly rearward to allow the pin to clear the slide. Insert the take down pin into the frame insert making sure that it is flush with the frame insert. Move the take down plate upward until it snaps into place.
6. Replace empty magazine in frame through butt of pistol.

MAGAZINE INSPECTION AND CARE

Check the magazine frequently. The magazine follower must move freely and have adequate tension so that each cartridge is quickly raised to the feeding position. The magazine lips should be clean and free of cracks, dents, or nicks, so that cartridges are held in their proper feeding position.

If the magazine becomes dirty, it should be disassembled and thoroughly cleaned. The following disassembly instructions apply:

Snap-On Base - Unload magazine first. Use a punch (your Ruger key will work in a pinch) to press in on the magazine spring seat where it protrudes into the hole in the magazine floorplate. Slide the magazine floorplate toward the front of the magazine, taking care to prevent the forcible ejection of the magazine spring seat and compressed magazine spring. Withdraw the magazine spring seat and magazine spring from the magazine body. Turn magazine upside down to allow the follower to drop out of the magazine; remove the follower. Reassemble in reverse order, being careful to insert the spring in the correct orientation (see Figure 16).

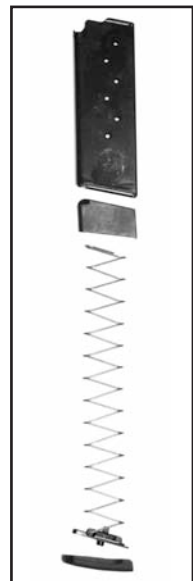

FIGURE 16

When cleaning is necessary, use a solvent that will not rust the metal components or adversely affect the magazine body. After the magazine has been soaked to loosen foreign matter, be certain to shake it vigorously (with the loading opening away from you) to remove solvent or residue from within the magazine. **Penetrating oils and solvents inside a magazine can “kill” or weaken cartridge primers or powder which can result in failures to fire or other possibly dangerous malfunctions, such as leaving a bullet in the bore!**

After cleaning always check to be certain that the magazine follower movement and tension are correct, and that no solvent or debris remain. **Improper reassembly of the magazine spring can cause failure to feed, which is a potentially dangerous malfunction. If cleaning does not restore proper tension, or if you experience a problem with the magazine, don't use it. Get a new one.**

CARE AND CLEANING

Make Sure Gun Is Unloaded!

BEFORE CLEANING, BE CERTAIN THE PISTOL AND ITS MAGAZINE CONTAIN NO CARTRIDGES. (See “Unloading Warning,” p. 19)

At regular intervals, or whenever the pistol has been exposed to sand, dust, extreme humidity, condensation, immersion in water, or other adverse conditions, disassemble, clean, and oil it. Proper periodic maintenance is essential to the reliable functioning of any firearm.

To clean the pistol, proceed as follows:

1. Disassemble (fieldstrip) the pistol to the extent described on pages 22 - 25.
2. Using a cleaning rod, run a solvent-wetted patch through the bore several times. Then attach a solvent-wetted bristle brush to the rod and run it back and forth the full length of the bore as many times as necessary to remove grease and dirt from the bore and chamber. Clean bore with dry patches and examine. Bore fouling can contribute to reduced accuracy, and grease accumulation in the chamber can interfere with proper feeding of cartridges from the magazine.
3. Using powder solvent on a clean patch or bristle brush, remove powder residue from all components of the pistol. After cleaning, run a dry patch through the bore, then follow with a patch that is very lightly oiled. Wipe all surfaces clean with cloth, then wipe all surfaces with a patch or cloth that has been very lightly oiled.
4. **NOTE:** Only a light application of oil is needed to provide adequate lubrication of moving parts and to prevent rust. Excess accumulations of oil tend to attract particles of dust and dirt and may congeal in cold weather, which can interfere with the safe and reliable function of the pistol.
5. Before firing, remove all oil and grease from the bore.

! WARNING - LUBRICATION	
	<p>Firing a pistol with oil, grease, or any other material even partially obstructing the bore may result in damage to the pistol and serious injury to the shooter and those nearby. Do not spray or apply lubricants directly on ammunition. If the powder of a cartridge is affected by the lubricant, it may not be ignited, but the primer firing may push the bullet into the bore where it may be lodged. Firing a subsequent bullet into the obstructed bore may damage the pistol and cause serious injury or death to the shooter and those nearby. Use lubricants properly. You are responsible for the proper care and maintenance of your firearms.</p>
IMPROPER LUBRICATION DESTROYS GUNS	

STORAGE

GUNS SHOULD NOT BE STORED LOADED!

USE THE LOCKING DEVICE SUPPLIED WITH THE PISTOL TO RENDER IT INOPERATIVE FOR SAFE STORAGE.

(SEE PAGE 6)

Do not keep the pistol stored in a leather holster or case. Leather attracts moisture, even though the holster or case may appear to be perfectly dry.

Sturm, Ruger also offers gun safes for sale as a means to secure more than one firearm. Please call the Heritage Safe Co. at 1-800-515-7233 for details and ordering information.

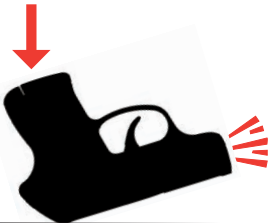
! WARNING - STORAGE	
	<p>Never place or store any firearm in such a manner that it may be dislodged. Firearms should always be stored securely and unloaded, away from children and careless adults. Use the locking device originally supplied with this firearm for storage.</p> <p>The use of a locking device or safety lock is only one aspect of responsible firearms storage. For increased safety, firearms should be stored unloaded and locked in a location that is both separate from their ammunition and inaccessible to children and any other unauthorized person.</p>
STORE SECURELY & UNLOADED	

SERVICE AND PARTS POLICY

If you have any questions with regard to the performance of your **RUGER® LCS™** pistol, please write or call (928-778-6555) our Product Service Department in Prescott, Arizona, fully describing all circumstances and conditions involved. If you should return your pistol to the factory for repair, or order parts for it, please comply with the following suggestions for prompt service:



WARNING—BEFORE SHIPPING ANY FIREARM, BE ABSOLUTELY CERTAIN THAT IT AND ITS MAGAZINE ARE UNLOADED. DO NOT SHIP CARTRIDGES WITH A FIREARM.

SHIPPING FIREARMS FOR REPAIR:

RUGER® LCS™ pistols returned to the factory for services or repair should be sent to: Sturm, Ruger & Company, Inc., Product Service Department, 200 Ruger Road, Prescott, AZ 86301-6181. Telephone (928)778-6555.

Guns should be sent prepaid. We will not accept collect shipments.

The Federal Gun Control Act, as well as the laws of most States and localities, do not prohibit an individual (who is not otherwise barred from purchasing or possessing a firearm) from shipping a firearm directly to the manufacturer for repair. However, before you ship your pistol to us, be certain that your State or locality does not have a law or regulation which will prohibit you from receiving the pistol from us after it has been repaired. If such receiving is prohibited, then please have a Federally Licensed Firearms Dealer ship the gun to us. If your pistol is sent to us by a dealer, it will be returned to that dealer after being repaired. If a handgun (pistol or revolver) is shipped by an individual who does not hold a Federal Firearms License, it must be shipped for overnight delivery via U.P.S., Federal Express or other, similar private overnight service. NOTE: Handguns may not be shipped via U.S. Mail. Persons who do not hold a Federal Firearms License are prohibited by Federal law from shipping a handgun by Mail. Handguns mailed in violation of the law are impounded by the Post Office.

Please do not include holsters, custom grip panels, or accessories with a firearm being shipped to the factory for service. **DO NOT SEND GUN BOXES OR LITERATURE THAT YOU CONSIDER TO BE COLLECTOR'S ITEMS – THESE ARE INVARIABLY DAMAGED OR DESTROYED IN SHIPMENT.** Always insure your shipment.

Enclose a letter which includes your name, address, telephone number, and serial number and model of the firearm. Describe in detail the trouble you have experienced with your firearm, or the work you wish to have done. Merely stating that the firearm “needs repair” is inadequate information. Please enclose copies of any previous correspondence.

All work performed is subject to a minimum labor charge and charges for shipping and handling. Most models can be reblued, but custom gunsmithing service or nonstandard alterations are NOT AVAILABLE from Ruger Product Service Departments. Please contact the Product Service Department for pricing information.

 WARNING - PARTS PURCHASERS	
	It is the purchaser's responsibility to be absolutely certain that any parts ordered from the factory are correctly fitted and installed. Firearms are complicated mechanisms and IMPROPER FITTING OF PARTS MAY RESULT IN A DANGEROUS MALFUNCTION, DAMAGE TO THE FIREARM, AND SERIOUS INJURY TO THE SHOOTER AND OTHER PERSONS. The purchaser and installer of parts must accept full responsibility for the correct adjustment and functioning of the pistol after such installation.
PARTS MUST FIT CORRECTLY	

ORDERING PARTS

Please contact the Prescott, Arizona Product Service Department for parts availability and current prices. All parts orders for the **RUGER® LC9™** pistols should be sent to: Sturm, Ruger & Company, Inc., Parts Department, 200 Ruger Road, Prescott AZ 86301-6181, (928) 778-6555. We cannot comply with open account or C.O.D. requests. Payment in full via credit card (Visa or MasterCard only), money order or certified bank check (no personal checks, please) is required before any service will be performed. Please provide your credit card number, your name as it appears on the credit card, and the expiration date. All parts orders are subject to a minimum charge and charges for shipping and handling. Order parts by Part Name and Part Number and include the entire serial number of the firearm for which the parts are being ordered. There is a minimum labor charge plus a shipping and handling charge if the parts are factory fitted. All factory fitted parts are fit on an exchange basis only. We will not return the replaced parts. Please contact the Product Service Department for pricing information.

Because it is a serial numbered component, the **RUGER® LC9™** frame insert is defined as a "firearm" by Federal law and is not sold as a separate component.

*Parts designated by an asterisk must be factory fitted. These parts are fitted on an exchange basis only. We will not return the replaced parts. We will not return any part that is broken, malfunctioning, badly worn or has been modified. See "Warning - Parts Purchasers," above.



CAUTION: A gun containing modified, broken, malfunctioning, or badly worn parts should not be fired!

RUGER® LC9™

PARTS LIST

Design, prices and specifications subject to change without notice.

SPECIFY MODEL AND CALIBER WHEN ORDERING

(See Exploded View on Page 33)

Key No.	Part Name	Part No.	Model	
†	1	Frame Insert	CP00250	LC9
	2	Trigger Pivot	CP06710	LC9
	3	Trigger	CP03900	LC9
	4	Slide Hold Open	CP03700	LC9
	5	Trigger Bar	CP01700	LC9
	6	Hammer	CP04000	LC9
	7	Hammer Roll Pin	CP05150	LC9
	8	Hammer Spring	CP00400	LC9
	9	Blocker Lever	CP02110	LC9
	10	Hammer Pivot Pin	CP02300	LC9
	11	Magazine Disconnect	CP05000	LC9
	12	Magazine Disconnect Spring	CP05600	LC9
	13	Trigger Pin	CP03950	LC9
	14	Trigger Spring	CP00450	LC9
	15	Ejector Housing	CP00900	LC9
	16	Manual Safety Detent Plunger	CP02380	LC9
	17	Hammer Pivot Detent Spring	CP02360	LC9
	18	Manual Safety Spring Guide	CP01570	LC9
	19	Manual Safety Puck	CP01550	LC9
	20	Manual Safety	CP01500	LC9
	21	Firing Pin Blocker Lifter Spring	CP06420	LC9
	22	Manual Safety Detent Spring	CP01560	LC9
	23	Slide Stop Spring	CP03720	LC9
	24	Take Down Plate	CP03760	LC9
*	25	Slide	CP00100	LC9
	26	Extractor Spring	SC06450	LC9
	27	Extractor Plunger	SC04600	LC9
	28	Firing Pin	CP01100	LC9
	29	Extractor	CP01400	LC9
	30	Loaded Chamber Indicator	CP11000	LC9
	31	Front Sight	CP03200	LC9
	32	Firing Pin Blocker	CP05050	LC9
	33	Loaded Chamber Indicator Spring	CP01150	LC9
	34	Firing Pin Retainer	CP01120	LC9
	35	Loaded Chamber Indicator Pin	CP06350	LC9
	36	Pawl, Hammer Dog & Crane Latch Spring Plunger	KH05100V	LC9

* PARTS SO MARKED MUST BE FACTORY FITTED

† The Frame Insert is a serial-numbered component and is defined as a “firearm” by Federal Law and is not sold as a separate component.

RUGER® LC9™
PARTS LIST

Design, prices and specifications subject to change without notice.
SPECIFY MODEL AND CALIBER WHEN ORDERING
(See Exploded View on Page 33)

Key No.	Part Name	Part No.	Model
37	Firing Pin Blocker Spring	CP05650	LC9
38	Rear Sight	CP03300	LC9
39	8-32 NC -2A X .187 Hex Soc Flat Pt – With Patch	CP08001	LC9
40	Firing Pin Spring	CP01800	LC9
41	Takedown Pin	CP03750	LC9
* 42	Barrel	CP00600	LC9
43	Magazine, Complete, 7-rd.	CP00500	LC9
44	Magazine Floor Plate, Extended	CP01010	LC9
45	Frame Insert Pin, 2 Req'd	CP06305	LC9
46	Hammer Catch Pin	CP02350	LC9
47	Guide Rod	CP02000	LC9
48	Recoil Spring, Outer	CP02810	LC9
49	Recoil Spring, Inner	CP02801	LC9
50	Hammer Catch	CP02200	LC9
51	Hammer Catch Spring	SC00450	LC9
52	Grip Frame	CP00200	LC9
53	Hammer Anchor Pin	CP02410	LC9
54	Hammer Spring Seat	CP02400	LC9
55	Magazine Latch	CP02600	LC9
56	Magazine Latch Spring	CP02700	LC9

* PARTS SO MARKED MUST BE FACTORY FITTED

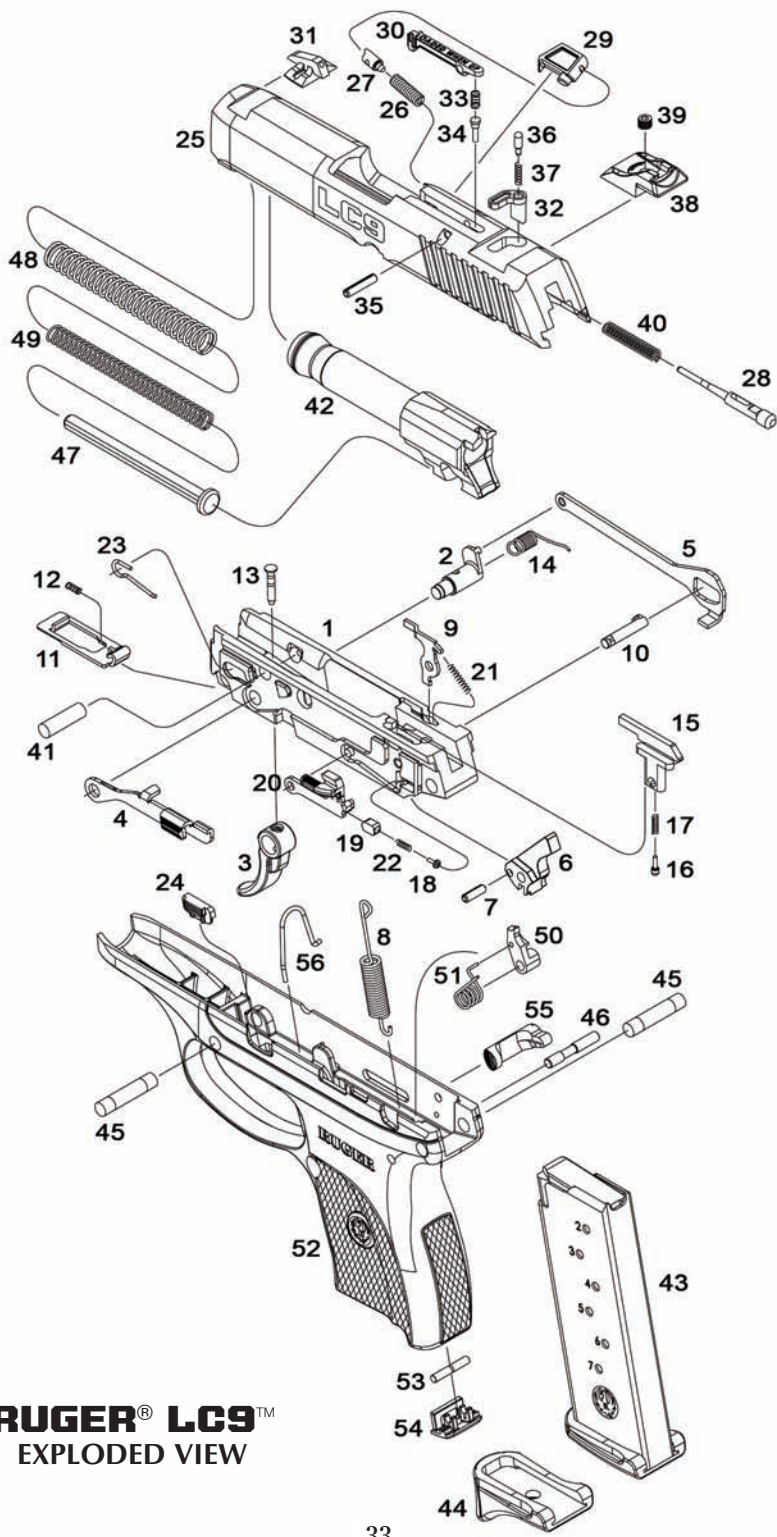

RUGER® LC9™
EXPLODED VIEW

THE BASIC RULES OF SAFE FIREARMS HANDLING

We believe that Americans have a right to purchase and use firearms for lawful purposes. The private ownership of firearms in America is traditional, but that ownership imposes the responsibility on the gun owner to use his firearms in a way which will ensure his own safety and that of others. When firearms are used in a safe and responsible manner, they are a great source of pleasure and satisfaction, and represent a fundamental part of our personal liberty.

Firearms do not cause accidents! Firearms accidents are almost always found to have been the result of carelessness, or ignorance on the part of the shooter of the basic rules of safe gun handling.

The following rules must be observed by gun users at all times. Safe gun handling is not just desirable, it is absolutely essential to your safety, the safety of others, and the continuation of gun ownership and sport shooting as we know it today.

1. LEARN THE MECHANICAL AND HANDLING CHARACTERISTICS OF THE FIREARM YOU ARE USING.



Not all firearms are the same. The method of carrying and handling firearms varies in accordance with the mechanical provisions for avoiding accidental discharge and the various proper procedures for loading and unloading. No person should handle any firearm without first having thoroughly familiarized himself with the particular type of firearms he is using, and with safe gun handling in general.

2. ALWAYS KEEP THE MUZZLE POINTED IN A SAFE DIRECTION.



Be sure of the bullet stop behind your target, even when dry-firing. Never let the muzzle of a firearm point at any part of your body or at another person. This is particularly important when loading or unloading a firearm. In the event of an accidental discharge, no injury can occur as long as the muzzle is pointing in safe direction. A safe direction means a direction which will not permit a discharged bullet to strike a person, or to strike an object from which the bullet may ricochet.

A safe direction must take into account the fact that a bullet may penetrate a wall, ceiling, floor, window, etc., and strike a person or damage property. Make it a habit to know exactly where the muzzle of your gun is pointing whenever you handle it, and be sure that you are always in control of the direction in which the muzzle is pointing, even if you fall or stumble. Keep your finger off the trigger until you are ready to shoot.

3. FIREARMS SHOULD BE UNLOADED WHEN NOT IN USE.

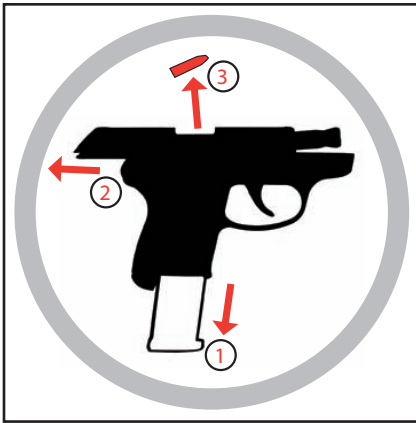

Firearms should be loaded only when you are in the field or on the target range or shooting area, ready to shoot. Firearms and ammunition should be securely locked in safes, racks or cabinets, or by using the locking device supplied with the firearm when not in use. Ammunition should be safely stored separate from firearms. Store your firearms out of sight of visitors and children. It is the gun owner's responsibility to be certain that children and persons unfamiliar with firearms cannot gain access to firearms, ammunition, or components.

4. BE SURE THE BARREL IS CLEAR OF OBSTRUCTIONS BEFORE SHOOTING.

Even a bit of mud, snow or excess lubricating oil or grease in the bore may cause the barrel to bulge, or even burst on firing, and can cause injury to the shooter and bystanders. Be sure that you are using ammunition of the proper caliber and loading for the gun you are using. If the report or recoil on firing seems weak, or doesn't seem quite right, **CEASE FIRING IMMEDIATELY**, unload your firearm, and check to be sure that no obstruction has become lodged in the barrel. Never try to shoot an obstruction out!





5. BE SURE OF YOUR TARGET BEFORE YOU SHOOT.

Don't shoot unless you know exactly where your bullet is going to strike. Be sure of the bullet stop behind your target, even when dry-firing with an unloaded gun. If you are in the field hunting, do not fire at a movement or noise. Take the time to be absolutely certain of your target before you pull the trigger.

6. WEAR SHOOTING GLASSES AND HEARING PROTECTORS WHEN YOU SHOOT.

All shooters should wear protective shooting glasses and adequate hearing protection when shooting. Exposure to shooting noise can damage hearing, and adequate eye protection when shooting is essential.

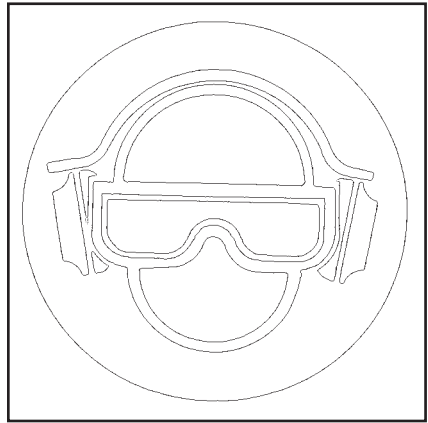

7. NEVER CLIMB A TREE OR FENCE WITH A LOADED FIREARM.

Put the firearm down carefully before climbing a fence, and unload it before climbing or descending a tree or jumping over a ditch or other obstruction. Never pull or push a loaded firearm toward yourself or another person. When in doubt, or whenever you are about to do anything awkward, unload your gun!

8. DON'T SHOOT AT A HARD SURFACE, OR AT WATER.

Bullets can glance off many surfaces like rocks or the surface of water and travel in unpredictable directions with considerable velocity.



9. NEVER TRANSPORT A LOADED FIREARM.

Firearms should always be unloaded before being moved or placed in a vehicle. A suitable carrying case or scabbard should be used to carry an unloaded firearm to and from the shooting area.

10. AVOID ALCOHOLIC BEVERAGES WHEN SHOOTING.

Don't drink until the day's shooting is over. Handling firearms while under the influence of alcohol in any form, or medications that could affect your judgement or co-ordination, constitutes a criminal disregard for the safety of others.



A BRIEF ACCOUNT OF AN EXTRAORDINARY ACHIEVEMENT: RUGER FIREARMS

Sturm, Ruger & Company, Inc., had its beginning in a small machine shop occupying a rented frame building in Southport, Connecticut. In January, 1949, with an initial investment of only \$50,000 and an idea, William B. Ruger and Alexander M. Sturm started production of a .22 caliber autoloading pistol—a design which was so successful that it became the cornerstone upon which one of the most comprehensive lines of sporting firearms ever made in America was established. After Alex Sturm's death in 1951, William B. Ruger continued to direct the Company until his death in 2002. William B. Ruger, Jr. continued to provide guidance, which helped make this Company a sound and successful enterprise, until his retirement in 2006. The Company has continued to prosper, under new management and guidance from our Board, with new products and fresh perspectives.

Ruger, in this relatively short time, has established itself as a leading small arms design organization, developing a unique and broad line of fine quality sporting, military and police firearms to become one of the world's most famous producers of revolvers, pistols, rifles and shotguns. Since 1949 Ruger craftsmen have built many millions of firearms.

During its five decades of growth and progress under the leadership of William B. Ruger, the Company developed a business philosophy and implemented policies which represent a constructive influence in the life of modern America. From the beginning, Ruger played a positive role in conservation efforts and has supported the interests of shooters through such groups as the National Rifle Association, National Shooting Sports Foundation, and many regional sportsmen's organizations.

The Company has always endeavored to market its firearms for constructive and recreational purposes, to emphasize the traditional and responsible aspects of shooting, to render meaningful public services, and to encourage shooters in constructive, responsible, and safe participation in the shooting sports. Its motto, "Arms Makers For Responsible Citizens," exemplifies this Company philosophy.

Today, Ruger is particularly mindful of those elements which have contributed to the creation of its success, and extends heartfelt thanks to its many loyal employees and customers.

The firearms catalog, and instruction manuals for all Ruger firearms, can be downloaded from our website at:

www.ruger.com.

NOTES

WHY NO WARRANTY CARD HAS BEEN PACKED WITH THIS NEW RUGER FIREARM

The Magnuson-Moss Act (Public Law 93-637) does not require any seller or manufacturer of a consumer product to give a written warranty. It does provide that if a written warranty is given, it must be designated as "limited" or as "full" and sets minimum standards for a "full" warranty. Sturm, Ruger & Company, Inc. has elected not to provide any written warranty, either "limited" or "full", rather than to attempt to comply with the provisions of the Magnuson-Moss Act and the regulations issued thereunder. There are certain implied warranties under state law with respect to sales of consumer goods. As the extent and interpretation of these implied warranties varies from state to state, you should refer to your state statutes. Sturm, Ruger & Company wishes to assure its customers of its continued interest in providing service to owners of Ruger firearms.



STURM, RUGER & Company, Inc.
200 Ruger Road
Prescott, Arizona 86301 U.S.A.
www.ruger.com

Arms Makers For Responsible Citizens®

**A COPY OF THE INSTRUCTION MANUAL FOR ANY RUGER
FIREARM IS AVAILABLE FROM THE FACTORY FREE ON REQUEST, OR IT MAY
BE DOWNLOADED FROM OUR WEBSITE AT WWW.RUGER.COM.
THESE INSTRUCTION MANUALS CONTAIN IMPORTANT
WARNINGS WHICH MUST BE UNDERSTOOD
BEFORE USING THESE FIREARMS.**

The Following are Sturm, Ruger & Co., Inc. Trademarks: "22/45," "22 Charger," "Gold Label," "LC9," "Model 96," "P85," "P90," "P91," "P93," "P94," "P95," "P97," "P345D," "Mark III," "P345PR," "Ruger 77/50," "Security-Six," "Service-Six," "Speed-Six," "SR1911," and "SR-556E."

The Following are Registered U.S. Trademarks Belonging to Sturm, Ruger & Co., Inc.: "RUGER," THE STURM, RUGER LOGO, "AC-556," "Arms Makers For Responsible Citizens," "10/22," "All-Weather," "Bearcat," "Blackhawk," Eagle R, Eagle SR, "GP100," the Hard-R Logo, "LCP," "LCR," "M77," "Mini Thirty," "Mini-14," "Old Army," "P345," "Redhawk," "Ruger Titanium," "Ruger 77/17," "Ruger 77/22," "Ruger 77/44," "Ruger SP101," "Ruger Vaquero," "Single-Six," "SR9," the "SR" Design, "SR-22," "SR-556," "Super Redhawk Alaskan" and "Target Grey."

"DEERFIELD" is a registered trademark of Blount, Inc.