

INSTRUCTION MANUAL FOR

BLUED

CALIBER
.308 Win.

RUGER® BOLT-ACTION SCOUT RIFLE



**READ THE INSTRUCTIONS AND
WARNINGS IN THIS MANUAL CAREFULLY
BEFORE USING THIS FIREARM**

© 2010 Sturm, Ruger & Co., Inc.

This manual may not be reproduced in whole or in part without the express written permission of Sturm, Ruger & Co., Inc.

**For Product Service on This Model Please Call:
(603) 865-2442 (See p. 32)**

THIS INSTRUCTION MANUAL SHOULD ALWAYS ACCOMPANY THIS FIREARM AND BE TRANSFERRED WITH IT UPON CHANGE OF OWNERSHIP, OR WHEN THE FIREARM IS LOANED OR PRESENTED TO ANOTHER PERSON.

State-By-State Warnings

Certain states require by law that their own specified warning notices in larger-than-normal type be conspicuously included by the manufacturer, distributor, or retail dealer with firearms sold in that state. Sturm, Ruger sells its products in compliance with applicable laws and regulations. Because our products may be sold in these states, we include the following:

California:

WARNING

“Children are attracted to and can operate firearms that can cause severe injuries or death. Prevent child access by always keeping guns locked away and unloaded when not in use. If you keep a loaded firearm where a child obtains and improperly uses it, you may be fined or sent to prison.”

ADVERTENCIA

“A los niños los atraen las armas de fuego y las pueden hacer funcionar. Ellos pueden causarse lesiones graves y la muerte. Evite que los niños tengan acceso a las armas de fuego guardándolas siempre con llave y descargadas cuando no las esté utilizando. Si usted tiene un arma de fuego cargada en un lugar en que un niño tiene acceso a ella y la usa indebidamente, le pueden dar una multa o enviarlo a la cárcel.”

Connecticut:

“UNLAWFUL STORAGE OF A LOADED FIREARM MAY RESULT IN IMPRISONMENT OR FINE.”

Florida:

“IT IS UNLAWFUL, AND PUNISHABLE BY IMPRISONMENT AND FINE, FOR ANY ADULT TO STORE OR LEAVE A FIREARM IN ANY PLACE WITHIN THE REACH OR EASY ACCESS OF A MINOR UNDER 18 YEARS OF AGE OR TO KNOWINGLY SELL OR OTHERWISE TRANSFER OWNERSHIP OR POSSESSION OF A FIREARM TO A MINOR OR A PERSON OF UNSOUND MIND.”

Maine:

“ENDANGERING THE WELFARE OF A CHILD IS A CRIME. IF YOU LEAVE A FIREARM AND AMMUNITION WITHIN EASY ACCESS OF A CHILD, YOU MAY BE SUBJECT TO FINE, IMPRISONMENT OR BOTH. KEEP FIREARMS AND AMMUNITION SEPARATE. KEEP FIREARMS AND AMMUNITION LOCKED UP. USE TRIGGER LOCKS.”

Maryland:

“WARNING: Children can operate firearms which may cause death or serious injury. It is a crime to store or leave a loaded firearm in any location where an individual knew or should have known that an unsupervised minor would gain access to the firearm. Store your firearm responsibly!”

Massachusetts:

“WARNING FROM THE MASSACHUSETTS ATTORNEY GENERAL: This handgun is not equipped with a device that fully blocks use by unauthorized users. More than 200,000 firearms like this one are stolen from their owners every year in the United States. In addition, there are more than a thousand suicides each year by younger children and teenagers who get access to firearms. Hundreds more die from accidental discharge. It is likely that many more children sustain serious wounds, or inflict such wounds accidentally on others. In order to limit the chance of such misuse, it is imperative that you keep this weapon locked in a secure place and take other steps necessary to limit the possibility of theft or accident. Failure to take reasonable preventive steps may result in innocent lives being lost, and in some circumstances may result in your liability for these deaths.”

“IT IS UNLAWFUL TO STORE OR KEEP A FIREARM, RIFLE, SHOTGUN OR MACHINE GUN IN ANY PLACE UNLESS THAT WEAPON IS EQUIPPED WITH A TAMPER-RESISTANT SAFETY DEVICE OR IS STORED OR KEPT IN A SECURELY LOCKED CONTAINER.”

New Jersey:

“IT IS A CRIMINAL OFFENSE TO LEAVE A LOADED FIREARM WITHIN EASY ACCESS OF A MINOR.”

New York City:

“THE USE OF A LOCKING DEVICE OR SAFETY LOCK IS ONLY ONE ASPECT OF RESPONSIBLE FIREARMS STORAGE. FOR INCREASED SAFETY, FIREARMS SHOULD BE STORED UNLOADED AND LOCKED IN A LOCATION THAT IS BOTH SEPARATE FROM THEIR AMMUNITION AND INACCESSIBLE TO CHILDREN AND OTHER UNAUTHORIZED PERSONS.”

North Carolina:

“IT IS UNLAWFUL TO STORE OR LEAVE A FIREARM THAT CAN BE DISCHARGED IN A MANNER THAT A REASONABLE PERSON SHOULD KNOW IS ACCESSIBLE TO A MINOR.”

Texas:

“IT IS UNLAWFUL TO STORE, TRANSPORT, OR ABANDON AN UNSECURED FIREARM IN A PLACE WHERE CHILDREN ARE LIKELY TO BE AND CAN OBTAIN ACCESS TO THE FIREARM.”

Wisconsin:

“IF YOU LEAVE A LOADED FIREARM WITHIN THE REACH OR EASY ACCESS OF A CHILD YOU MAY BE FINED OR IMPRISONED OR BOTH IF THE CHILD IMPROPERLY DISCHARGES, POSSESSES, OR EXHIBITS THE FIREARM.”

* * * * *

Please check with your licensed retailer or state police for additional warnings which may be required by local law or regulation. Such regulations change constantly, and local authorities are in the best position to advise you on such legal matters.

LOCKING DEVICE INSTALLATION INSTRUCTIONS



WARNING – USE OF LOCKING DEVICES



**Do not store keys
in lock.**

- Always keep your firearm pointed in a safe direction, including when you are installing or removing your locking device.
- Always verify that your firearm is completely unloaded before installing your locking device.
- Do not install locking devices in the trigger guard; always keep your fingers and locking device outside the trigger guard during device installation and removal.
- Store firearms, ammunition and keys separately and securely, away from children and careless adults; do not store your firearm with the keys in the locking device.
- Do not attempt to work the action of your firearm with the locking device in place; this may damage your firearm.
- While locking devices are an important aid to security measures, they are not a substitute for safe firearm handling and proper storage. Remember that any mechanical device can be bypassed with enough time, knowledge, determination and equipment.

**LOCKING DEVICES MUST BE USED
SAFELY AND RESPONSIBLY**

Use the Correct Lock: While the basic locking device is substantially similar for all Ruger® firearms, due to the different shapes of the many Ruger® firearms, some firearms utilize different locking devices. The 3 1/2" lock is for use with **RUGER® SCOUT RIFLE**. **It is very important to use the correct locking device!**

To Install the Factory-Supplied Locking Device:

1. **Keep the muzzle pointed in a safe direction and your fingers outside the trigger guard at all times!**
2. **Be sure the firearm is completely unloaded and contains no cartridges or cartridge cases! Remove the magazine from your firearm.**

3. Open the action completely by drawing the bolt fully to the rear.
4. Apply the lock by placing the shackle of the lock into your **RUGER® SCOUT RIFLE** as shown in Figure 1, below.
5. Close the lock by pressing the shackle into the body of the lock (the part that receives the key) as tightly together as possible. The lock has bumpers and the shackle is coated with a non-marring material that will not harm the metal finish of your firearm; be careful not to dent or scratch wooden stocks.
6. Once the lock is securely closed, remove the key and pull firmly on the lock to test the connection and be sure it is locked. **Do not leave or store your firearm with the key in the lock!** Store your locked unloaded firearm and the key in secure, separate locations, away from ammunition, children, or unauthorized adults.



Figure 1.

**Correct Installation of Lock
For Ruger® Scout Rifles *Only***

FIREARMS SAFETY-YOUR RESPONSIBILITY
**SAFETY MUST BE THE FIRST AND CONSTANT
CONSIDERATION OF EVERY PERSON WHO HANDLES
FIREARMS AND AMMUNITION.**

This Instruction Manual is designed to assist you in learning how to use and care for your **RUGER® SCOUT RIFLE** properly.

Only when you are certain you fully understand the Manual and can properly carry out its instructions should you practice loading, etc. with live ammunition. If you have any doubts about your ability to handle or use a particular type of gun safely, then you should seek supervised instruction. Such personalized instruction is often available from gun dealers, gun clubs or police departments. If none of these sources can help you, write to the National Rifle Association, 11250 Waples Mill Road, Fairfax, VA 22030-7400. They will assist you.

The person with a gun in their possession has a full-time job. You cannot guess; you cannot forget. You must know how to use your firearm safely. **Do not use any firearm without having a complete understanding of its particular characteristics and safe use.** Remember: There is no such thing as a foolproof gun.

TABLE OF CONTENTS

	Page
State-By-State Warnings2
Locking Device Installation Instructions5
General Information and Mechanical Characteristics	8
Nomenclature9
Operation of Safety	10
Ammunition	11
Loading the Magazine	12
Inserting the Magazine	13
Removing the Magazine	13
To Load and Fire (With Magazine)	13
To Load and Fire (Without Magazine)	16
To Unload	16
To Clear a Malfunction (“Jam”)	17
To Minimize Malfunctions (“Jams”)	19
Disassembly	20
Reassembly	23
Magazine Inspection and Care	25
Care and Cleaning	26
Storage	27
Maintenance of Stainless Steel Rifles	28
Attaching Ruger Scope Rings	28
Length of Pull Adjustment	29
Sight Picture	29
Service and Parts Policy	32
Shipping Firearms for Repair	32
Ordering Parts	33
Parts List	34
Parts Drawing	36
The Basic Rules of Safe Firearms Handling	37
Warranty Information	44

“**RUGER**” is a registered U.S. trademark.



WARNINGS OF GREAT IMPORTANCE ARE FOUND ON THE FOLLOWING PAGES:

Locking Devices	5	Unloading	16
Alterations	8	Malfunctions	18
Manual Safety	11	Disassembly	20
Lead Exposure	11	Lubrication	27
Ammunition	12	Storage	27
Loading	14	Shipping	32
Firing	15	Parts Purchasers	33
Handling	15		

OTHER CAUTIONS AND WARNINGS APPEAR THROUGHOUT THE MANUAL.

**FIREARMS ARE DANGEROUS WEAPONS—
READ THE INSTRUCTIONS AND WARNINGS
IN THIS MANUAL THOROUGHLY AND
CAREFULLY BEFORE USING.**



WARNING—ALTERATIONS



This product was designed to function properly in its original condition. Alterations can make it unsafe. Do not alter any part or add or substitute parts or accessories not made by Sturm, Ruger & Co. Inc.

DO NOT ALTER ANY GUN

GENERAL INFORMATION AND MECHANICAL CHARACTERISTICS

The **RUGER® SCOUT RIFLE** is a bolt action, magazine fed, repeating rifle. The receiver incorporates integral scope mount bases (see the illustration on p. 9). A set of two steel one-inch scope rings is included.

Other notable features of the **RUGER® SCOUT RIFLE** include: an LC6™ trigger, three-position safety, a fast lock-time steel trigger mechanism, a patented bedding system, a contoured cut-checked black laminate stock with a black rubber recoil pad, and studs to which sling swivels can be attached. The rifle also features a detachable box magazine, forward mounted Picatinny rail, protected iron sights, and an adjustable length of pull stock.

NOMENCLATURE

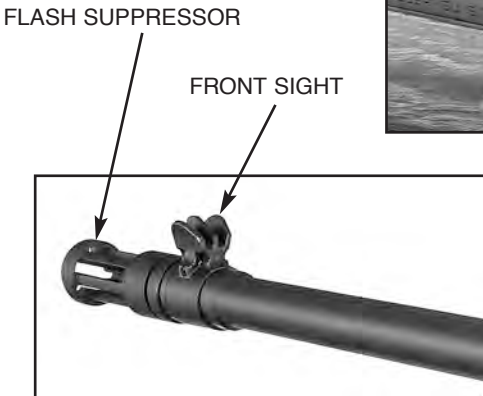
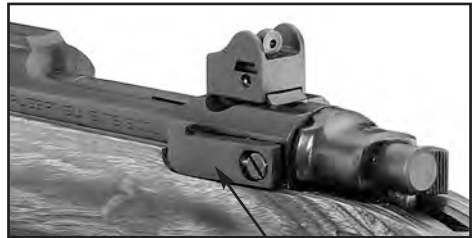
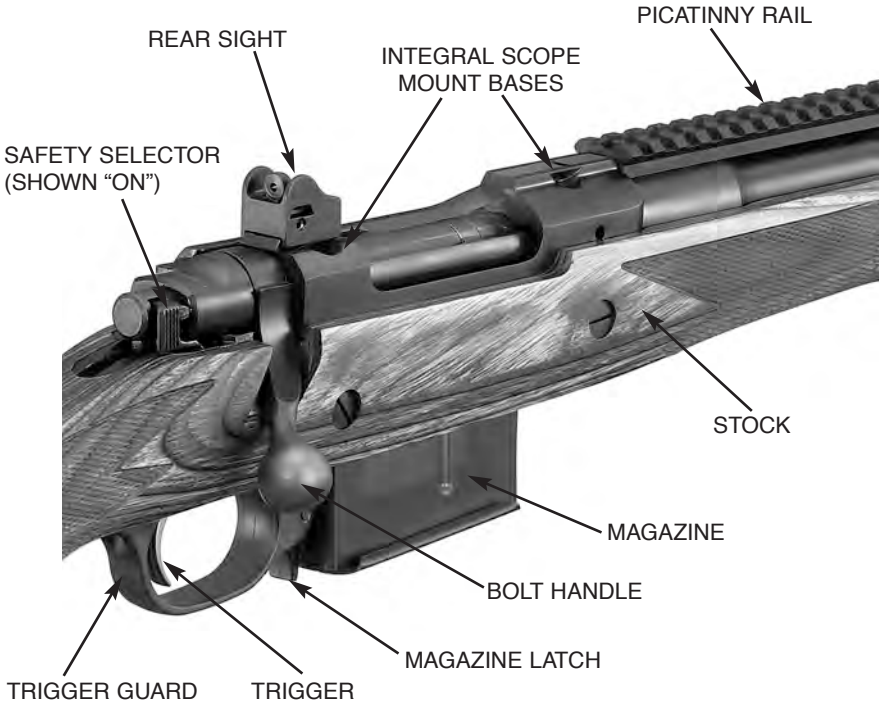

Figure 2. In these illustrations the frequently used operating components are identified. Note that the bolt stop (on the left side of the receiver) permits the bolt to be withdrawn simply by pulling it out to the left. **The safety selector should be in the "Load-Unload" position when the bolt is being removed or installed.**

OPERATION OF SAFETY

The **RUGER® SCOUT RIFLE** has a three-position safety. The safety selector is located at the right of the bolt sleeve (on the left of the bolt sleeve on left-handed versions). The safety selector can be moved from the “Fire” position to its two other positions (“Load-Unload” and “Safe”) only when the firing pin is cocked. Fully raising the bolt handle cocks the firing pin.

The bolt handle can be raised and lowered only when the safety selector is in either the “Fire” or the “Load-Unload” position. When the safety selector is in the “Safe” position, the bolt handle is locked in the closed (full down) position in order to prevent inadvertent lifting of the bolt handle and to ensure that the rifle will be ready to fire when the safety is moved to the “fire” position.

Practice (with an unloaded rifle) moving the safety selector to the three positions until you know the position of the safety selector for the three modes– “Fire,” “Load-Unload,” and “Safe.” **WARNING: When manipulating the safety selector, DO NOT HAVE ANY FINGER INSIDE THE TRIGGER GUARD! When the safety selector is in the “Fire” position and the trigger is pulled, the rifle will fire. The safety selector should always be in the “Safe” position except when the gun user is actually firing or unloading the rifle. The safety selector should unfailingly be moved to the “Safe” position when the gun user ceases firing.**

SAFETY POSITIONS

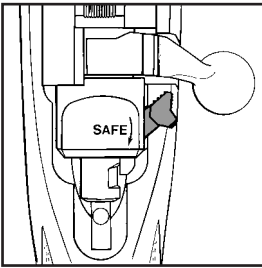

Figure 3. Safety selector in “FIRE” (full forward) position. The safety selector should be moved to this position only when the gun user is actually firing the rifle. When the safety selector is in the fire position, it is referred to as being “off.” (When the safety is in the “SAFE” position, it is referred to as being “on.”)

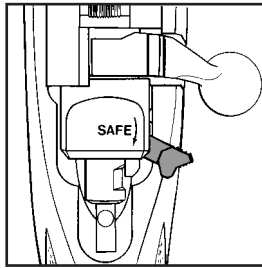

Figure 4. Safety selector in “LOAD-UNLOAD” (middle) position. The safety selector should be in this position when the bolt is being cycled to load a cartridge, or to unload a live round. As soon as a cartridge is chambered, the safety selector should be moved to the “SAFE” position unless the rifle is to be fired immediately.

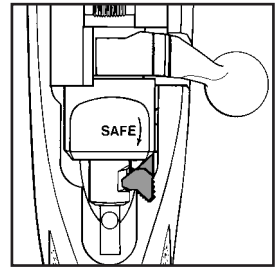
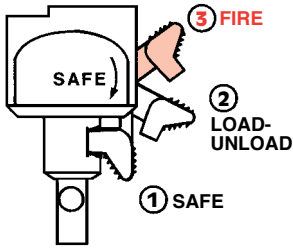

Figure 5. Safety selector in “SAFE” (full rearward) position. The safety selector is fully nested in the groove in the cocking piece. When the safety selector is in this position, the bolt handle cannot be raised. The curved arrow on the bolt sleeve indicates the direction and motion of the safety selector to bring it to the “SAFE” position. **Keep the safety selector in this position except when actually loading, unloading, or firing.**

The safety selector is held in each of its three positions by a plunger that is under spring tension. Therefore, the gun user should frequently check the position of the safety selector to be certain it has not been inadvertently moved. If the safety does not function properly, or if the selector seems to move too easily, or if the safety selector does not seem firmly positioned in any of its three positions, the rifle should be discontinued from use and returned to the Newport Product Service Department for repair (see p. 32).



WARNING – MANUAL SAFETY



Keep the safety on unless actually firing. Always move the safety fully to its intended position and check it. The safety has three positions –“SAFE,” “LOAD-UNLOAD,” and “FIRE.” Never depend on a safety mechanism or any other mechanical device to justify careless handling or permitting the rifle to point in an unsafe direction. The only “safe” rifle is one in which the bolt is open and the chamber and magazine are empty.

KNOW HOW TO USE THE SAFETY



WARNING – LEAD EXPOSURE



Discharging firearms in poorly ventilated areas, cleaning firearms, or handling ammunition may result in exposure to lead and other substances known to the state of California to cause birth defects, reproductive harm, and other serious physical injury. Have adequate ventilation at all times. Wash hands thoroughly after exposure.

**SHOOTING OR CLEANING GUNS
MAY EXPOSE YOU TO LEAD**



AMMUNITION

The **RUGER® SCOUT RIFLE** is chambered for the .308 Win. cartridge manufactured in accordance with U.S. industry practice. The caliber is rollmarked on the barrel. Use cartridges only of the designated caliber that is marked on the barrel. Please see “Warning - Ammunition,” p. 12 and “Warning - Loading” on p. 14.

AMMUNITION (CARTRIDGES) NOTICE

WE SPECIFICALLY DISCLAIM RESPONSIBILITY FOR ANY DAMAGE OR INJURY WHATSOEVER OCCURRING IN CONNECTION WITH, OR AS A RESULT OF, THE USE IN ANY RUGER FIREARMS OF FAULTY, OR NON-STANDARD, OR “REMANUFACTURED” OR HAND-LOADED (RELOADED) AMMUNITION, OR OF CARTRIDGES OTHER THAN THOSE FOR WHICH THE FIREARM WAS ORIGINALLY CHAMBERED.

USE ONLY FACTORY AMMUNITION LOADED TO U.S. INDUSTRY STANDARDS

 WARNING – AMMUNITION	
	Death, serious injury, and damage can result from the use of wrong ammunition, bore obstructions, powder overloads, or incorrect cartridge components. Even the strongest gun can be “blown up” as a result of excess pressure. <u>Always</u> wear shooting glasses and hearing protectors.
	IMPROPER AMMUNITION DESTROYS GUNS

LOADING THE MAGAZINE

Use only clean ammunition of the proper caliber manufactured to U. S. Industry specifications, in good condition. (See Notice and Warnings in other sections of this manual pertaining to Ammunition.)

To load the magazine, align each cartridge with the bullet forward, depress the magazine follower, or the last cartridge loaded, as you insert a cartridge from the front and slide it back to the rear of the magazine. See Figure 6. Do not attempt to load more than the designated number of cartridges for which the magazine has been designed. The **RUGER® SCOUT RIFLE** is available with 5-round and 10-round magazines.

The **RUGER® SCOUT RIFLE** magazines are not interchangeable with the Ruger Mini-14 Ranch or Mini Thirty magazines. Do not use non-Ruger magazines – they may cause malfunctions.

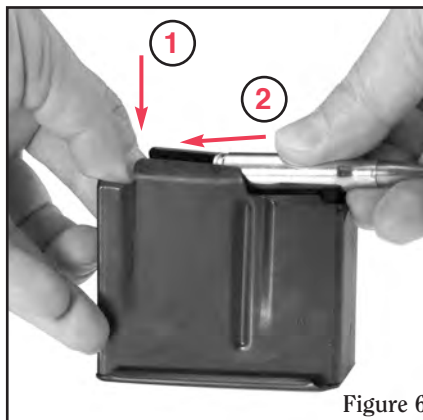

DAMAGED, NON-STANDARD, OR IMPROPERLY ASSEMBLED MAGAZINES SHOULD NOT BE USED. THEY CAN CAUSE THE RIFLE TO MALFUNCTION.

INSERTING THE MAGAZINE

See Figure 7. The magazine may be inserted with the bolt either in the closed or open position.

1. Hold the magazine at an angle as shown and insert all the way up into the magazine well.
2. Pull the bottom of the magazine toward the trigger guard until the magazine latch at the rear of the magazine well engages. Check to be sure that the magazine is securely latched into place by pulling down on the magazine.

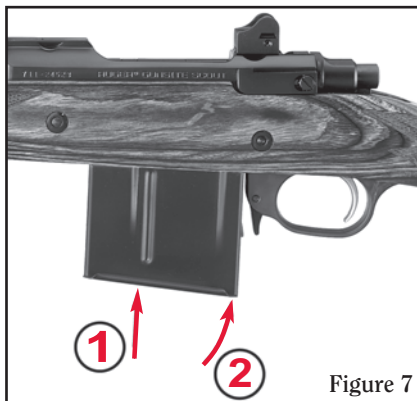

Figure 7

REMOVING THE MAGAZINE

To remove the magazine, push and hold the magazine latch forward as you pull the magazine out of the magazine well. To minimize the possibility of damage and malfunctions, do not let the magazine drop to the ground.

TO LOAD AND FIRE (WITH MAGAZINE)

Practice this important aspect of gun handling (with an unloaded rifle) until you can perform each of the steps - described below - with skill and confidence. But before you do anything with the rifle, please first read completely through this manual. This procedure begins with an empty rifle with its magazine out.

1. **Be certain the muzzle is pointing in a safe direction. (See Rule 2, p. 37.)**
2. Position the safety selector in the “Load-Unload” position (see Figure 4, p. 10).
3. Insert the bolt in the receiver in accordance with “To replace bolt” instructions on Page 24.
4. Draw the bolt fully to the rear.



5. Load a magazine with the desired number of cartridges.
6. Insert the loaded magazine into the magazine well.
7. Push the bolt handle forward. This will strip a cartridge from the magazine and push the cartridge ahead of the bolt into the chamber. Close the bolt handle fully downward and **put the safety fully rearward to the “Safe” position.**

WARNING: If cartridges do not feed smoothly from the magazine into the chamber then do not use the rifle until the problem is corrected. (See “Warning - Malfunctions,” p. 18.)

8. The rifle is now cocked and a loaded cartridge is chambered. Visually check to be certain the safety selector is in the “Safe” position.
9. When you are ready to fire the rifle, move the safety selector to the “Fire” position.

WARNING: DO NOT TOUCH THE TRIGGER UNTIL YOU ARE ACTUALLY READY TO FIRE. KEEP THE SAFETY SELECTOR IN THE “SAFE” POSITION UNLESS ACTUALLY FIRING.

10. Pulling (squeezing) the trigger will discharge the cartridge. **Always be certain that you know where the bullet will strike when you fire the rifle.** Never allow the thumb to touch the cocking piece when firing as it can be pinched when the cocking piece moves forward to fire the rifle.
11. **Immediately following the firing of a shot, and if a subsequent shot is not to be fired at once, put the safety selector in the “Safe” position while the rifle is still pointing in a safe direction down range.** The safety selector should be moved to the “Safe” position as soon as firing is completed, and it should be on “Safe” at all times except when the rifle is on target and being fired.

 <h2 style="margin: 0;">WARNING – LOADING</h2>	
	<p>Know the caliber of your rifle you are loading and load cartridges of only that caliber into it!</p> <p>Before loading, be certain the primer of each cartridge is seated flush with, or below, the surface of the cartridge case base. A cartridge discharged by the closing of the bolt can result in possible serious injury to the shooter and those nearby.</p> <p>If a cartridge does not chamber readily, do not force it. Check the bore and chamber to be certain that each cartridge is the proper caliber and of correct dimensions. If you cannot determine why the cartridge will not fit, clear the rifle of all cartridges and write or call the factory.</p> <p>The wrong ammunition can destroy your gun and result in serious injury.</p>
	<h3 style="margin: 0;">BE SURE WHAT YOU LOAD IS CORRECT</h3>



WARNING: DO NOT TOUCH THE TRIGGER UNTIL YOU ARE ACTUALLY READY TO FIRE THE RIFLE.



WARNING – FIRING



When firing the Ruger Scout rifle, be sure that bystanders are well clear of the shooter and standing a safe distance to the rear. Empty cartridge cases are hot and are normally ejected from the rifle to the right. They could cause injury to any person who is standing too closely alongside the shooter. Shooters who fire right-handed rifles from their left shoulder should be particularly cautious concerning ejected cartridge cases and the back of the bolt as it is drawn rearward.

EJECTED BRASS IS HOT



WARNING – HANDLING

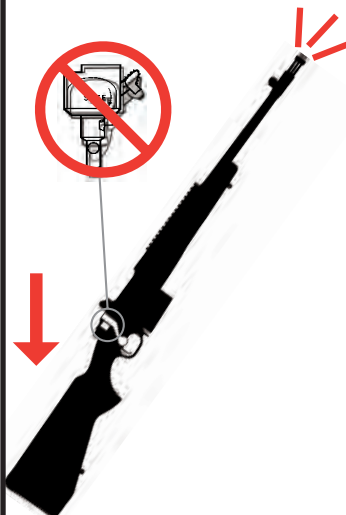

Never carry the rifle loaded with the safety selector in the “FIRE” position. If dropped or struck with the safety off, the rifle may fire. Such a discharge can occur with or without the trigger being directly struck or touched. **Never rest a loaded rifle against any object (wall, fence, vehicle, tree, etc.)** because there is always the possibility that the rifle will be jarred or slide from its position and fall with sufficient force to discharge. **Keep safety on unless actually firing.**



Never lower (uncock) the firing pin with a loaded cartridge in the chamber. Under such circumstances the firing pin will be in direct contact with the primer of the loaded cartridge and a light accidental blow to the firing pin can readily cause the gun to discharge.

ANY GUN MAY FIRE IF DROPPED

TO LOAD AND FIRE (WITHOUT MAGAZINE)

The rifle can be used as a single shot rifle in the absence of a magazine or for safety or training purposes. To do so:

1. **Be certain the muzzle is pointing in a safe direction. (See Rule 2, p. 37.)**
2. Position the safety selector in the “Load-Unload” position (see Figure 4, p. 10).
3. Draw the bolt fully to the rear.
4. Place a cartridge directly into the chamber. Close the bolt handle fully downward and **put the safety fully rearward to the “Safe” position.**
5. Follow steps 8 - 11 on p. 14.

 WARNING – UNLOADING	
	Removing cartridges from the magazine does not prevent the rifle from being fired! When there is a cartridge in the chamber and the safety selector is in the “Fire” position, the cartridge will discharge if the trigger is pulled. It is absolutely essential for the user to know how to completely unload it. “Completely” means removing the magazine and removing a chambered cartridge. The safety selector should always be in the “Load-Unload” position when the rifle is being unloaded. See the “Operation of Safety” section of this manual.
GUN WILL FIRE WITH MAGAZINE OUT	

TO UNLOAD

UNLOAD THE RIFLE IMMEDIATELY WHEN YOU ARE FINISHED SHOOTING

WARNING: This sequence must be followed exactly as spelled out. Failure to do so can result in the rifle’s chamber becoming unintentionally loaded with a cartridge!

1. Keep the muzzle pointed in a safe direction at all times and keep the fingers outside the trigger guard. **Move the safety selector to the “Load-Unload” position if the firing pin is cocked.**
2. Lift the bolt handle fully and then pull it completely to the rear to eject chambered cartridge.
3. **Always visually double check the chamber to be certain it is empty.**

4. Remove the magazine. **REMEMBER** that even though the magazine has been removed, a cartridge remaining in the chamber can still be fired!
5. Close the bolt fully.
6. Move the safety selector in the “Fire” position and **with the rifle pointed in a safe direction, pull the trigger.**

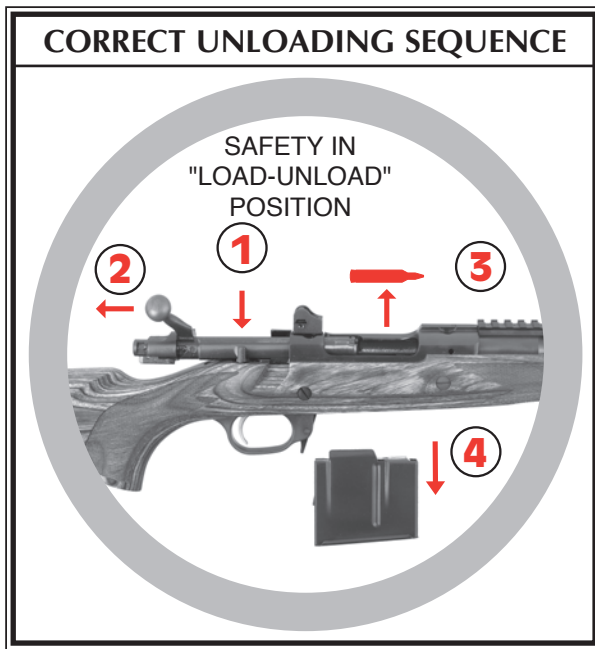



TO CLEAR A MALFUNCTION (“JAM”)

If a jam occurs, immediately put the safety selector in the “Load-Unload” position and be certain the muzzle of the rifle is at all times pointing in a safe direction.

Then study the situation to determine the nature of the jam and how best to clear it.

- If a cartridge or fired case is caught between the bolt and the barrel, or against a cartridge that is in the chamber, remove the magazine from the rifle. Then retract the bolt fully and remove the jammed cartridge or case.
- When attempting to extract a cartridge that is “stuck” in the chamber do not use any type of tool that is likely to act as a “firing pin” and discharge the cartridge should the tool impact on the primer.
- After clearing a jam, inspect the gun mechanism to determine if dirt might be the cause of the problem. Excess lubricant or grease can cause cartridges to feed sluggishly or fail to extract. An accumulation of grease or dirt on the face of the bolt, under the extractor, in the chamber, or in the magazine can contribute to cartridge feeding problems. (See section on “Care and Cleaning” page 26.)

- After clearing a jam, inspect all cartridges that have been removed from the gun. Safely dispose of any cartridges which are in any way damaged.
- If it appears that the rifle and magazine are not at fault and that the jam was caused by the type of cartridge being used, then try another type.
- Examine your fired cartridge cases. If they have split, blown or bulged heads, stop using that ammunition and promptly return the rifle to the factory for examination.
- If the above procedures do not result in a smooth and reliable feeding firearm, don't use the rifle. The **RUGER® SCOUT RIFLE** can be returned directly to our Newport Product Service Department for inspection and repair, if required. See the "Service and Parts Policy" section of the manual for packing and shipping information.

 <h2 style="margin: 0;">WARNING – MALFUNCTIONS</h2>	
	<p>If a cartridge hangs up, jams, or binds when being chambered or when being fed from the magazine into the chamber, do not attempt to force it into the chamber by pushing or striking the bolt handle.</p> <p>Most failures of a cartridge to feed or to chamber are caused by improper loading of the magazine or ammunition that is incorrect or defective.</p> <p>Whatever the cause, the gun user must, above all, recognize that jams can result in the very potentially dangerous situation of a cartridge discharging before it is chambered. If this occurs, the cartridge case will rupture and its fragments will fly out of the gun with sufficient force to cause injury. Always wear shooting glasses and hearing protectors!</p>
	<h3 style="margin: 0;">STRIKING PRIMER CAN BURST CARTRIDGE</h3>

TO MINIMIZE MALFUNCTIONS (“JAMS”)

Firearms of all makes and types are susceptible to occasional malfunctioning due to a cartridge not feeding from the magazine to the chamber, or due to a cartridge or fired case not being extracted and ejected.

To minimize the possibility of such occurrences the gun user should:

- Use ammunition of the correct caliber and type which is loaded to U.S. Industry Specifications. Do not use cartridges that are deformed or cartridges that have been reloaded.
- Clean and lubricate the gun in accordance with the instructions in this manual.
- Learn to correctly operate the bolt and how to properly load and empty the chamber and magazine.
- If the mechanism shows signs of not functioning correctly, or if a part is damaged or broken – don't use the rifle. Have it inspected and repaired.
- Use only genuine **RUGER® SCOUT RIFLE** magazines and carefully load the magazine. Do not exceed the stated magazine capacity. (See “Loading the Magazine,” p. 12.)
- Do not attempt to force a cartridge into the chamber by pushing or striking the bolt handle. Rather, retract the bolt, eject the cartridge, and determine the cause of the problem.
- To minimize the probability of an unfired cartridge being jammed should it ‘fall back’ onto the magazine, remove the magazine *before* retracting the bolt. When extracting an unfired cartridge, tip the right side of the rifle towards the ground so that gravity will assist the cartridge to fall clear of the magazine well. Always retract the slide briskly whenever extracting a live cartridge. Take care to see that a cartridge is not forcibly ejected against a surface where the primer might be set off.

For most repairs we recommend that Ruger guns be returned to the factory. However, if a gun has a cartridge in it which cannot be removed, then it is a violation of Federal Regulations to ship that loaded gun whether it be by U.S. Mail or by common carrier. Contact our Newport Product Service Department at (603) 865-2442.

Alterations to the rifle or use of non-Ruger magazines and accessories may cause malfunctions. See “Warning - Alterations,” on page 9. If the above procedures do not result in a smooth and reliable feeding firearm, don't use the gun. The rifle can be returned directly to our Newport, New Hampshire Product Service Department for repair. See the “Service and Parts Policy” section, page 32, of this manual for packing and shipping information.



WARNING – DISASSEMBLY



Always unload a firearm before cleaning, lubrication, disassembly or assembly.

**UNLOAD BEFORE
CLEANING**

DISASSEMBLY

Be Sure Rifle Is Unloaded!

It is preferable to carry out these procedures on a workbench or table which has a covered top. A piece of shallow nap rug or an old, coarse blanket is an ideal covering. Such a covering not only reduces the chances of the rifle slipping and being scratched, but it serves also to trap pins, plungers and springs that may otherwise get lost. It is advisable to have a container – such as a shoebox – in which each part can be placed as it is removed from the gun.

Before attempting to disassemble the rifle for the first time, study the parts drawing and parts list so as to be familiar with the relative position, appearance and name of each part. Carry out the disassembly slowly and carefully note the position of the part in the gun before starting to remove it. If a part is under spring tension (such as, the Safety Selector, Bolt Stop, Trigger) remove it cautiously and anticipate the direction the spring and plunger are most likely to “jump.”

WARNING: If a spring or plunger become lost do not use a substitute. Springs of correct tension are vital to the safe and reliable performance of firearms. Before starting disassembly, remove the sling, scope and scope rings.

1. **Keep the rifle pointed in a safe direction!** See Figure 8. Put the safety in the “Load-Unload” position.
2. Lift the bolt handle fully and then pull it completely to the rear to eject chambered cartridge.
3. **CHECK TO BE CERTAIN THAT THE CHAMBER IS EMPTY.**
4. Remove the magazine. **REMEMBER** that even though the magazine has been removed, a cartridge remaining in the chamber can still be fired!

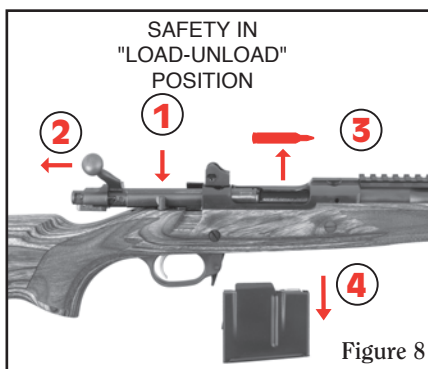
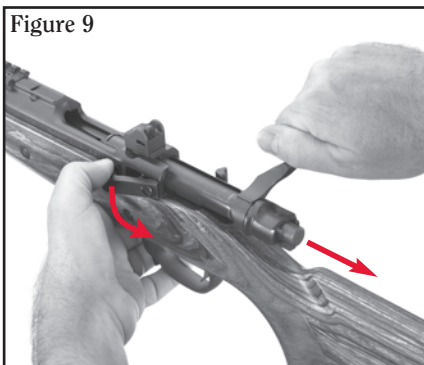

Figure 8

5. To remove the bolt: Open bolt and pull to the rear while at the same time pivoting open the bolt stop which is located on the left side of the receiver on the right-handed version and the right side of the receiver on the left-handed version. This is as far as you need to dismantle the rifle for a routine cleaning. It is rarely necessary to proceed further. See Figure 9.



6. To remove firing pin assembly from bolt: With bolt out of the rifle and firing pin cocked, insert a pin or nail into the “disassembly hole” in the cocking piece.

NOTE: The pin or nail should be as close as possible in size to the hole diameter, and at least 2 inches long so that it can be used to ‘lever’ the firing pin to the rear when reassembling the firing pin assembly into the bolt. Unscrew firing pin assembly and remove from bolt. (Caution: Do not remove the restraining pin until firing pin assembly is reassembled into bolt).



CAUTION: The firing pin assembly is intended to be a permanent assembly and should not be disassembled. The parts are under great spring pressure and if disassembled could fly apart with sufficient force to cause serious injury. Also, special tools are required to correctly reassemble this part.

7. To remove stock:
- Loosen and remove the screw that holds the Front Mounting Lug. See Figures 10a & 10b.

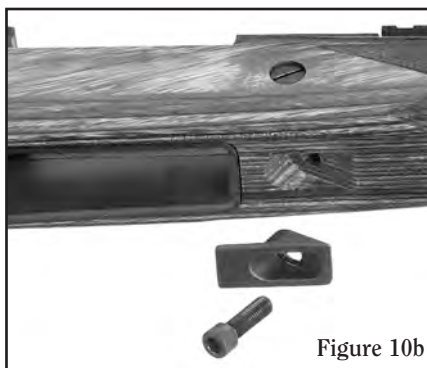
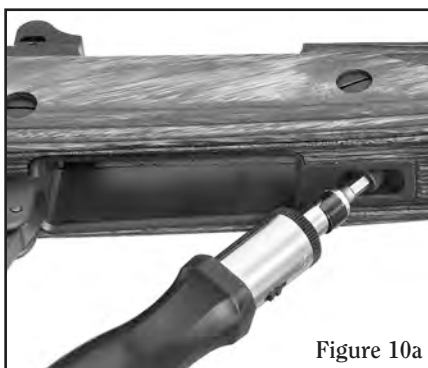

b. Loosen and remove the screw that holds the Trigger Guard/Magazine well. See Figures 11a & 11b.

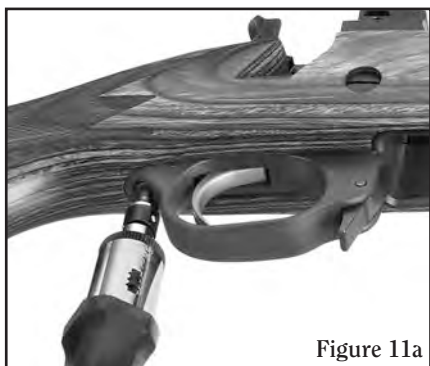

Figure 11a

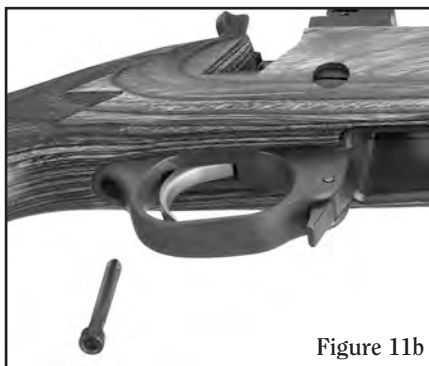

Figure 11b

c. Loosen and remove the Cross Bolt that runs through the stock at the rear of the magazine well. See Figure 12.

d. Remove the Trigger Guard/Magazine well. See Figure 13.



Figure 12



Figure 13

b. Lift the barrel from the stock very carefully. Lift the receiver at the same time as the barrel is lifted so that the barrel-receiver comes out of the stock level and not at an angle. See Figure 14.



Figure 14

8. **To remove the trigger:** (Safety Selector should be in the “Fire” position.)
While holding the trigger in place, press out the trigger pivot pin.
(Caution: Trigger is spring loaded.)
9. **To remove the sear:**
 - a. Press out the sear pivot pin.
 - b. Turn receiver upside down and slide sear forward. Sear will drop out of the top slot in the receiver.
10. **To remove safety assembly:**
 - a. Rotate the safety selector so that the upper section is positioned fully over the center of the receiver tang.
 - b. While holding the safety selector in place with thumb and forefinger, slide the retainer up out of receiver. (Caution: Safety Selector is under spring tension from a spring and plunger acting against the lower section of the safety selector. The spring and plunger will jump out if not contained.)
 - c. Lift out the safety selector.
 - d. Remove the safety selector detent and safety selector detent spring.

REASSEMBLY

(Again, Be Sure Rifle Is Unloaded)

1. **To replace the safety assembly:**
 - a. Place the safety selector detent and safety selector detent spring into the hole in the receiver.
 - b. Set the safety selector in place with its upper section positioned over the center of the receiver tang.
 - c. While holding the safety selector in place with thumb and forefinger while applying downward pressure, slide the safety selector retainer into dovetail from the top. Align the notch in the safety selector retainer with the sear pivot pin hole.
2. **To replace the sear:**
 - a. Place the rear end (the end with the hole in it) of the sear into the slot from the top of the receiver. Swing the rear end of the sear up and slide the sear into position until the hole in the sear is aligned with the mating holes in the receiver.
 - b. Insert the sear pivot pin.
3. **To replace the trigger:**
 - a. Place the trigger/sear spring over the dimple in the trigger.
 - b. Assemble the trigger while aligning the spring with the dimple on the sear.
 - c. While holding the trigger in position, replace the trigger pivot pin.
4. **To replace the stock:**
 - a. Place the barrel-action assembly into stock.
 - b. Replace the Trigger Guard/Magazine well into stock.
 - c. Install and tighten Cross Bolt through the stock at the rear of the magazine well.

- d. Install screw at rear of Trigger Guard loosely.
- e. Install Front Mounting Lug and firmly tighten screw. (This screw is angled and draws the barrel-action assembly into the bedding surface of the stock.) This screw should be tightened to a torque of 90 in-lbs.
- f. Tighten screw at rear of trigger guard to a torque of 20 in-lbs.

5. To reassemble firing pin assembly into bolt:

Screw the assembly fully into the bolt. The assembly is properly positioned in the bolt when the flat on the bottom right side of the bolt sleeve (front of bolt facing you) is aligned with the flat on the bottom end of the bolt handle. Note: There is a shallow notch on the rear end of the bolt body – at the end of the cam cut – into which the nose of the cocking piece ‘fits.’ When the firing pin assembly is being turned into the bolt body, it may be necessary to use the restraining pin as a lever to slightly retract the cocking piece nose so it can be moved into the notch. When the firing pin assembly is correctly positioned in the bolt body, the restraining pin can be removed, but not before!

6. To replace bolt:

- a. With bolt handle in an upward position and bolt head away from you, align the extractor with the right hand locking lug in the right-handed version or the left locking lug in the left-handed version. Align the locking lugs with the channels in each side of the rear of the receiver and partially insert the bolt.
- b. Push the bolt fully forward.

REGARDING ACCURACY: The accuracy of any rifle can vary depending upon the make and type of cartridges used in it. Such being the case, if your **RUGER® SCOUT RIFLE** does not perform to expectations, it is advisable to try several brands and types of cartridges to determine which one delivers the best accuracy, before proceeding further. If your rifle is not as “accurate” as you believe it should be, before concluding that some serious fault exists, run the following checks:

- 1. Be certain the Cross Bolt, Front Mounting Screw, and Rear Mounting Screw are snugly tightened as described in Step 4, p. 23, of the “Reassembly” section of this manual.
- 2. Be certain the bore is clean and free from accumulated metal fouling (deposited by metal jacketed and lead bullets). See the “Care and Cleaning” section of this manual.
- 3. Check the sights for tightness, setting and alignment.

If everything is tight, the bore is clean, the sights are properly aligned and secure but the accuracy problem persists, DO NOT alter the stock bedding in any way. Do not scrape away wood and do not bed with “glass,” plastic, epoxy, etc. Once a rifle stock has been altered, it cannot be reworked by our Product Service Department.

If you still have an accuracy problem, write a brief letter to our Product Service Department in Newport, New Hampshire 03773 and describe the nature of the problem based on the use of factory-loaded cartridges – not reloads. You will receive a prompt response from us and if indicated, detailed instructions with regard to the return of the rifle.

MAGAZINE INSPECTION AND CARE

Check the magazine periodically. The follower must move freely and have adequate spring tension so that each cartridge is quickly raised to the feeding position.

To test the spring tension, load one cartridge into the magazine and then firmly press against the cartridge case. Remove your finger quickly. The cartridge should instantly and fully move in to the feeding position. If it does not, the magazine should be cleaned. If cleaning does not restore proper spring tension, do not use the magazine. (NOTE: After testing, remove the test cartridge.)

When cleaning is necessary, use a solvent that will not rust the metal components or adversely affect the plastic magazine components. The magazine may be disassembled by sliding the bottom cover toward the front of the magazine. CAUTION! The magazine spring is compressed underneath the bottom cover. It will be necessary to use a plastic mallet to tap the bottom cover forward enough to move past its detent bump located near the front of the magazine. With the bottom cover removed, the magazine spring and follower may be removed from the magazine, completing its disassembly. It is not necessary to remove the magazine spring from the follower. Soak the magazine shell in solvent to loosen foreign matter, then shake it vigorously (with the magazine top opening away from you) to remove solvent or residue from the magazine. Carefully wipe the magazine and follower with a cotton cloth to remove excess solvent and loose residue.

Reassembly of the magazine can be accomplished by inserting the magazine follower and spring assembly into the bottom of the magazine shell oriented properly. Carefully compress the spring and slide the magazine bottom onto the bottom of the magazine shell starting at the front and pushing it rearward. It may be necessary to use a plastic mallet to tap the bottom cover past its detent bump and seat it fully rearward on the bottom of the magazine shell.

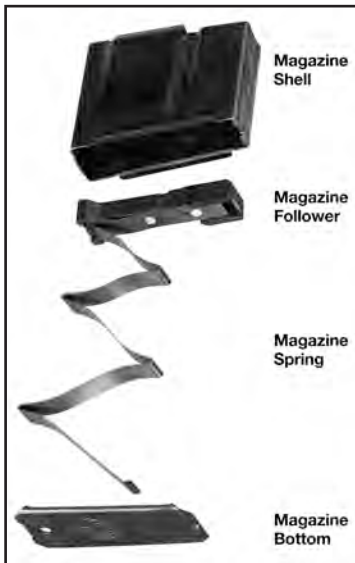

Figure 15. Exploded view of the **RUGER® SCOUT RIFLE** magazine components. This illustration is included to show the relationship and names of the magazine components.

CARE AND CLEANING



WARNING: BEFORE CLEANING, BE CERTAIN THE RIFLE AND ITS MAGAZINE CONTAIN NO CARTRIDGES.

A firearm must be free of rust, dirt, grease and firing residues to function safely and reliably. Periodic maintenance, which includes inspection of components to determine if they are in proper working order, is absolutely essential. Firing deposits particles of bullet lubricant and powder in the bore, chamber, bolt, receiver, magazine and other parts of the rifle. There is no fixed rule as to how frequently the cleaning should be carried out, but the alert gun owner soon learns that any firearm functions most reliably and accurately when it is free of accumulations of grease and other firing residues.

Basic cleaning equipment includes: A correct size cleaning rod equipped with bore brushes (fiber and brass) and a tip in which a cloth patch can be inserted, patches, powder solvent, lubricant, small lint-free cloths and a toothbrush. Use correct size patches and brushes. Larger sizes will bind in the bore and can be very difficult to remove! Insert rod from the chamber end of the barrel and push firmly so the patch or brush emerges from the muzzle. Don't reverse the rod when a brush or patch is being used – it may bind. Don't use patches or brushes dripping with solvent or oil. Use rod and brushes with care so as not to damage gun.

1. For routine cleaning it is necessary only to remove the bolt and magazine.
2. Push-pull a solvent-wetted patch through the bore several times. Next, using a solvent-wetted brush, run it the full length of the bore as many times as is necessary to completely remove all foreign matter from the bore and chamber. Dry the bore with clean patches and examine it. If bore remains fouled, repeat the brushing. Complete the cleaning by dry-patch wiping of bore and chamber.
3. Use a clean, solvent-wetted patch to remove firing residue and dirt from all "reachable" surfaces inside the receiver. Use the solvent-wetted toothbrush to dislodge caked dirt from all parts of the bolt assembly and from surfaces inside the receiver that can't be reached with a patch. Use cleaning patches or the cloth to remove the solvent.
4. Wipe all surfaces – internal and external – with a very light coat of oil. Oil and similar preparations "collect" dirt particles which can interfere with reliable functioning of the rifle. Therefore, use these preparations very sparingly. A drop of oil applied to the bolt assembly components, the pivot points of the trigger mechanism, the safety, the bolt stop, and the magazine latch, will work into all the parts that need lubrication.
5. Reassemble the rifle and carefully wipe all solvent, lubricating and preservative preparations from the stock.
6. If the rifle is to be stored for an extended period, clean the rifle thoroughly. Disassemble to the extent described elsewhere in this manual, taking care to put pins and similar easily mislaid and "rolling" components in a tray. Rewipe all surfaces with preservative oil. Reassemble and store properly.



WARNING – LUBRICATION



Firing a rifle with oil, grease, or any other material even partially obstructing the bore may result in damage to the rifle and serious injury to the shooter and those nearby. Do not spray or apply lubricants directly on ammunition. If the powder charge of a cartridge is affected by the lubricant, it may not be ignited, but the energy from the primer may be sufficient to push the bullet into the bore where it may become lodged. Firing a subsequent bullet onto the obstructed bore may damage the rifle and cause serious injury or death to the shooter and those nearby. Use lubricants properly. You are responsible for the proper care and maintenance of your firearm.

**IMPROPER LUBRICATION
DESTROYS GUNS**

STORAGE

GUNS SHOULD NOT BE STORED LOADED!

**USE THE LOCKING DEVICE SUPPLIED
WITH THE RIFLE TO RENDER IT
INOPERATIVE FOR SAFE STORAGE.**

(SEE PAGE 5)

Sturm, Ruger also offers gun safes for sale as a means to secure more than one firearm. Please call the Heritage Safe Company at 1-800-515-7233 for details and ordering information.

Do not store the rifle in a leather case or scabbard. Leather attracts moisture, even though it may appear to be dry.



WARNING – STORAGE



Never place or store any firearm in such a manner that it may be dislodged. Firearms should always be stored securely and unloaded, away from children and careless adults. Use the locking device originally supplied with this firearm for storage.

The use of a locking device or safety lock is only one aspect of responsible firearms storage. For increased safety, firearms should be stored unloaded and locked in a location that is both separate from their ammunition and inaccessible to children and any other unauthorized person.

STORE SECURELY & UNLOADED

MAINTENANCE OF STAINLESS STEEL RIFLES

Firearms and components made of stainless steel are relatively more resistant to corrosion than those of blued steel. However, in the interest of proper operation and long life of a stainless steel firearm, inspect it frequently and clean, lubricate and apply an appropriate rust preventative.

Sometimes discoloration occurs from perspiration or from contact with some types of gun cases. Rusting may occur as a result of the firearm being exposed to moisture, salt air or chemicals.

Minor discoloration can usually be removed by rubbing the stainless area with an abrasive ink eraser, crocus cloth, or a "metal polishing" compound. When using any of these abrasives, proceed with care and use light pressure to achieve a blending of "color" with those areas that are not discolored.

External surfaces most subject to rusting from handling, or from exposure to the elements should be cleaned and wiped dry after use or after exposure to adverse conditions. If the rifle is to be stored, coat it with a light film of oil or preservative. Where the rifle is in continuing use, and the presence of oil or grease would be objectionable, then the external surfaces can be coated (after cleaning and drying) with a paste wax formulated for use on metals. Apply the wax sparingly, allow time for it to dry hard, then buff lightly with a soft cloth. When applying the wax, take care that it does not get into the mechanism or on the functioning parts or in the bore.

ATTACHING RUGER SCOPE RINGS

The rear sight must be removed before attaching the scope rings. Each Ruger scope ring is a mated assembly of a top and a base. Do not mix the parts of the two ring assemblies as they are not interchangeable. On the underside of each mounting ring assembly there is an integral lug, located off center with respect to the front and back sides of the mount. The lug is nearer to the front surface. By reference to the lug, the mounting ring can be correctly assembled with the front of the ring toward the muzzle of the rifle.

1. Disassemble one ring and reassemble over the scope body between the turret and the eyepiece. Remember - the lug on the base should be on the front side of the scope.
2. Install the four top screws. Do not tighten.
3. Disassemble the other ring and install it on the forward section of the scope tube with the lug forwardly also. Install the four top screws. Again, do not tighten.
4. Assemble the rings to the receiver with the lugs engaging the recesses in the top surface of the receiver. Tighten the clamp nuts so that the rings are locked to the semicircular cuts on the sides of the receiver.
5. Rotate the scope until cross-hairs are aligned properly and slide scope to desired eye relief. Then tighten the eight top screws each a bit at a time to grip the scope body.
6. Sight in according to the directions with your scope.

LENGTH OF PULL ADJUSTMENT

Each **RUGER® SCOUT RIFLE** comes from the factory with three 1/2" spacers (one installed on the rifle and two packaged separately) that allow you to adjust the length of pull from 12-3/4" to 14-1/4" in one-half-inch increments. As shipped from the factory with a single spacer installed, the length of pull is set at 13-1/4".

To adjust the length of pull, simply add or remove spacers, as desired. To add or remove spacers, use the allen wrench supplied with the rifle to remove the recoil pad screws affixing the recoil pad to the stock. (See Figure 16).

Add (by stacking) or remove spacers to achieve the desired length of pull. Now reattach the recoil pad by installing the recoil pad screws using the allen wrench. Be careful not to overtighten the screws, which should just be snugged in place by turning the screws an additional 1/2 turn after the screw makes contact with the recoil pad.

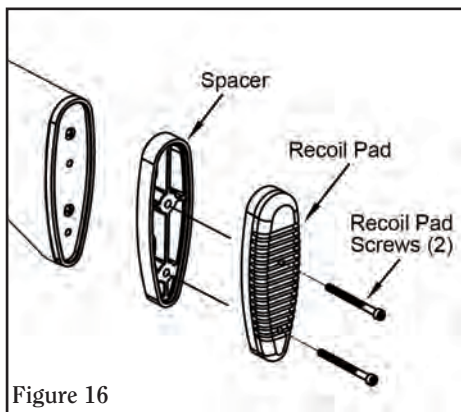

SIGHT ADJUSTMENT

Shooting to determine the setting of the elevation slide (aperture) should be done from a bench rest and over a measured distance.

SUGGESTED SIGHT PICTURE

The front sight is aligned in the center of the rear sight aperture ("peep") and the target (bull's-eye) is positioned to appear as if it is sitting on top of the front sight.

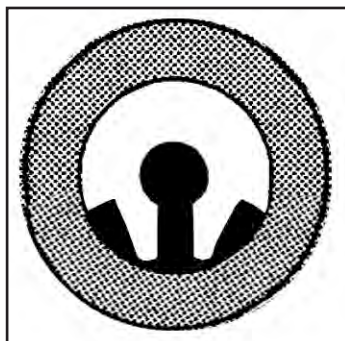

WINDAGE ADJUSTMENT:

1. Loosen the Combination Windage Adjustment and Locking Set Screw (turn it counter-clockwise using a 5/64 hex wrench) on the side that matches the direction of intended aperture travel (right side first to move aperture right, left side first to move aperture left). (See Figures 17a and 17b.) Full turns are not required and any portion of a turn is acceptable. One complete rotation of the hex screw will move the point of impact approximately 5 inches at 100 yards.
2. Tighten the opposite Windage Adjustment and Locking Set Screw. (See Figures 17a and 17b.) The aperture will be pushed and locked up against the screw that was adjusted in Step 1.

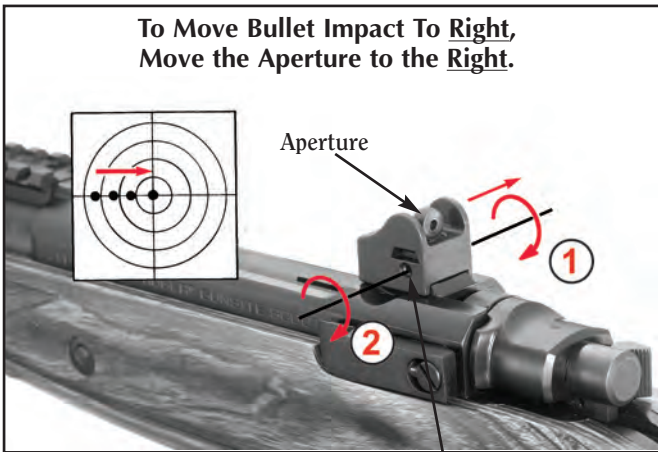

Figure 17a

Windage Adjustment
and Locking Set Screw
(one on each side)

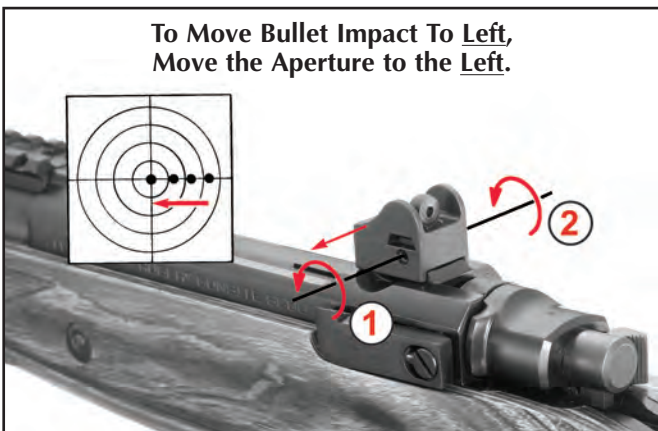

Figure 17b

ELEVATION ADJUSTMENT:

1. Loosen one of the Combination Windage Adjustment and Locking Screws one full turn (either one is fine, however, loosen only one so that the original windage adjustment is maintained).
2. Adjust the aperture by rotating it in half turn increments. Rotating the aperture clockwise will move the aperture down (and therefore the point of impact down as well). Rotating the aperture counter-clockwise will move the aperture up (and therefore the point of impact up). (See Figures 18a and 18b.) Rotating the aperture a single half turn (180 degrees) will move the point of impact approximately 1.25 inches at 100 yards.
3. Tighten the Combination Windage Adjustment and Locking Screw that was loosened in Step One (See Figures 18a and 18b). The Aperture will move against the other screw and will be aligned to the half turn position.

WARNING: DO NOT TIGHTEN THE COMBINATION WINDAGE AND LOCKING SCREW WITH THE APERTURE NOT IN THE HALF TURN POSITION AS THIS WILL DAMAGE THREADS OF THE APERTURE.

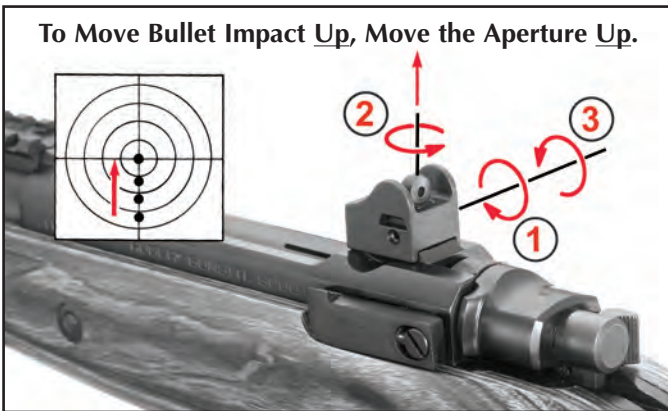

Figure 18a

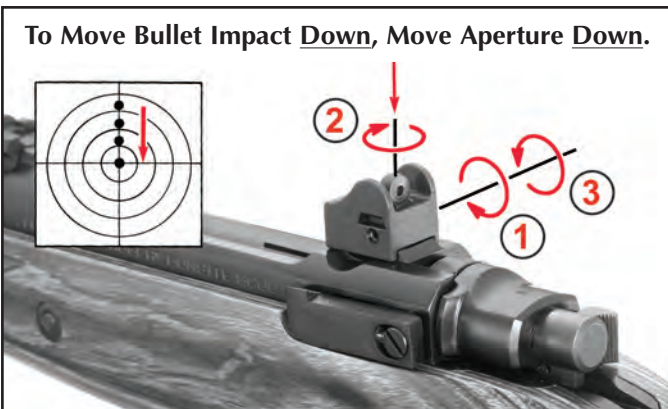

Figure 18b

SERVICE AND PARTS POLICY

If you have any question with regard to the performance of your **RUGER® SCOUT RIFLE** please write or call (603-865-2442) our Product Service Department in Newport, New Hampshire 03773, fully describing all circumstances and conditions involved. If you should return your rifle to the factory for repair, or order parts for it, please comply with the following suggestions for prompt service:



WARNING: BEFORE SHIPPING ANY FIREARM, BE ABSOLUTELY CERTAIN THAT IT AND ITS MAGAZINE ARE UNLOADED. DO NOT SHIP CARTRIDGES WITH A FIREARM.

SHIPPING FIREARMS FOR REPAIR

RUGER® SCOUT RIFLES returned to the factory for repair should be sent to: Ruger, Product Service Department, 411 Sunapee St., Newport, New Hampshire 03773. Telephone (603) 865-2442.

Guns should be sent prepaid. We will not accept collect shipments.

The Federal Gun Control Act, as well as the laws of most States and localities, do not prohibit an individual (who is not otherwise barred from purchasing or possessing a firearm) from shipping a firearm directly to the manufacturer for repair. However, before you ship your rifle to us, be certain that your State or locality does not have a law or regulation which will prohibit you from receiving the rifle from us after it has been repaired. If such receiving is prohibited, then please have a Federally Licensed firearms dealer ship the gun to us. If your rifle is sent to us by a dealer, it will be returned to that dealer after being repaired. If a handgun (pistol or revolver) is shipped by an individual who does not hold a Federal Firearms License, it must be shipped for overnight delivery via U.P.S., Federal Express or other, similar private overnight service. NOTE: Firearms may not be shipped via U.S. Mail. Persons who do not hold a Federal Firearms License are prohibited by Federal law from shipping a handgun by Mail. Handguns mailed in violation of the law are impounded by the Post Office.

DO NOT SEND GUN BOXES OR LITERATURE THAT YOU CONSIDER TO BE COLLECTOR'S ITEMS – THESE ARE INVARIABLY DAMAGED OR DESTROYED IN SHIPMENT. Please do not include rifle case, sling, telescopic sights or custom accessories with a firearm being shipped to the factory for service. Rifles and shotguns may be shipped via Parcel Post. Always insure your shipment.

Enclose a letter which includes your name, address, telephone number, serial number and model of the firearm. Describe in detail the trouble you have experienced with your firearm, or the work you wish to have done. Merely stating that the firearm “needs repair” is inadequate information.

All work performed is subject to a minimum labor charge and charges for shipping and handling. Most models can be reblued, but custom gunsmithing service or nonstandard alterations are **NOT AVAILABLE** from Ruger Product Service Departments. Please contact the Product Service Department for pricing information.



WARNING – PARTS PURCHASERS



It is the purchaser's responsibility to be absolutely certain that any parts ordered from the factory are correctly fitted and installed. Firearms are complicated mechanisms and **IMPROPER FITTING OF PARTS MAY RESULT IN A DANGEROUS MALFUNCTION, DAMAGE TO THE FIREARM, AND SERIOUS INJURY TO THE SHOOTER AND OTHER PERSONS.** The purchaser and installer of parts must accept full responsibility for the correct adjustment and functioning of the rifle after such installation.

PARTS MUST FIT CORRECTLY

ORDERING PARTS

Please contact the New Hampshire Product Service Department for parts availability and current prices. All parts orders for the **RUGER® SCOUT RIFLE** should be sent to: Ruger, Product Service Department, 411 Sunapee Street, Newport, New Hampshire 03773, 603-865-2442. We cannot comply with open account or C.O.D. requests. Payment in full via credit card (Visa or MasterCard only), money order or certified bank check (no personal checks, please) is required before any service will be performed. Please provide your credit card number, your name as it appears on the credit card, and the expiration date. All parts orders are subject to a minimum charge and charges for shipping and handling. Order parts by Part Name and Part Number and include the entire serial number of the firearm for which the parts are being ordered. There is a minimum labor charge plus a shipping and handling charge if the parts are factory fitted. All factory fitted parts are fit on an exchange basis only. We will not return the replaced parts. Please contact the Product Service Department for pricing information.

Barrels, and a number of other component parts must be fitted at the factory. Company policy is to proof-test and/or function fire all barrels after fitting to the receivers in which they are to be used. This procedure ensures maximum protection to our customers. The special proof-test ammunition used in this testing is sold only to bonafide firearms manufacturers and is not available to gun shops, gunsmiths, or individuals.

Because the receiver of the **RUGER® SCOUT RIFLE** is a serial numbered component, it is defined as a "firearm" by Federal law and is not sold as a separate component.

*Parts designated by an asterisk must be factory fitted. These parts are fitted on an exchange basis only. We will not return the replaced parts. We will not return any part that is broken, malfunctioning, badly worn or has been modified. See "Warning – Parts Purchasers," above.



CAUTION: A gun containing modified, broken, malfunctioning, or badly worn parts should not be fired.

RUGER® SCOUT RIFLE

PARTS LIST

Design, prices and specifications subject to change without notice.

SPECIFY MODEL & SERIAL NUMBER WHEN ORDERING

(See Exploded View on Page 36)

Key No.	Part Name	Part No.
* 1	Barrel, .308	0D8140
2	Receiver	DH00160
3	Front Sight Cross Pin	MA07201
4	Front Sight	MS04425
5	Butt Pad Holder	MS06301
6	Butt Plate Screw, 2 Req'd	B09101
7	Stock Cross Bolt Nut	D-90
8	Rear Sling Swivel Stud	S-87
9	Sling Swivel Front Screw	S-86B
10	Recoil Pad Screws, 2 Req'd	MS08300
11	Butt Pad Spacer	MS06300
12	Recoil Pad, Black	D06319
13	Stock, Black Laminate	DH00410
14	Bolt	KD01002HM
15	Bolt Stop	D-53HM
16	Extractor	KD01434HM
* 17	Safety Selector	J03800HM
* 18	Safety Selector Retainer	J02100
19	Magazine Latch	MS03100
20	Flash Suppressor	MA13404
21	Ejector Pivot Pin	KD09000
* 22	Sear	KD02309
23	Extractor Band	KD-15HM
24	Safety Selector Detent Spring	D-32
25	Safety Selector Detent	J04300
26	Rear Sight Base	D06009
27	Sear Pivot Pin	D04200
28	Ejector	D00807
29	Front Mounting Lug	D00702HM
30	Stock Cross Bolt	D-95
31	Bolt Stop Plunger Spring Retaining	D-59
32	Bolt Stop Plunger	D-56
33	Bolt Stop Stud Bushing	D-55
34	Bolt Stop Screw Stud	D-54HM
35	Flash Suppressor Washer	NS00090
36	Dovetail Slide (Rear Sight)	MS05911

Key No.	Part Name	Part No.
37	Rear Sight Windage Screw, 2 Req'd	MS05901
38	Rear Sight Aperture	MS05206
* 39	Trigger	KD02027
40	Ejector Spring	KD00900
41	Trigger/Sear Spring	J02400
42	Magazine, 10-rd or 5-rd	VARIOUS
43	Rear Sight Screw	D06212
44	Picatinny Rail Screw, 4 Req'd	D06210
45	Picatinny Rail	D06104
46	Rear Mounting Screw	D04803
47	Front Mounting Screw	D04606
48	Magazine Latch Pin	D04000
49	Magazine Latch Spring	D03202
50	Trigger Pivot Pin	D02100
51	Firing Pin Spring	D01202
* 52	Firing Pin	D01100
53	TriggerGuard/Magazine Well	D00215
54	Bolt Stop Plunger Spring	D-57
55	Scope Ring, High	D07112HMA
56	Scope Ring, Medium	D07111HMA

* PARTS SO MARKED MUST BE FACTORY FITTED

RUGER® SCOUT RIFLE

EXPLODED VIEW

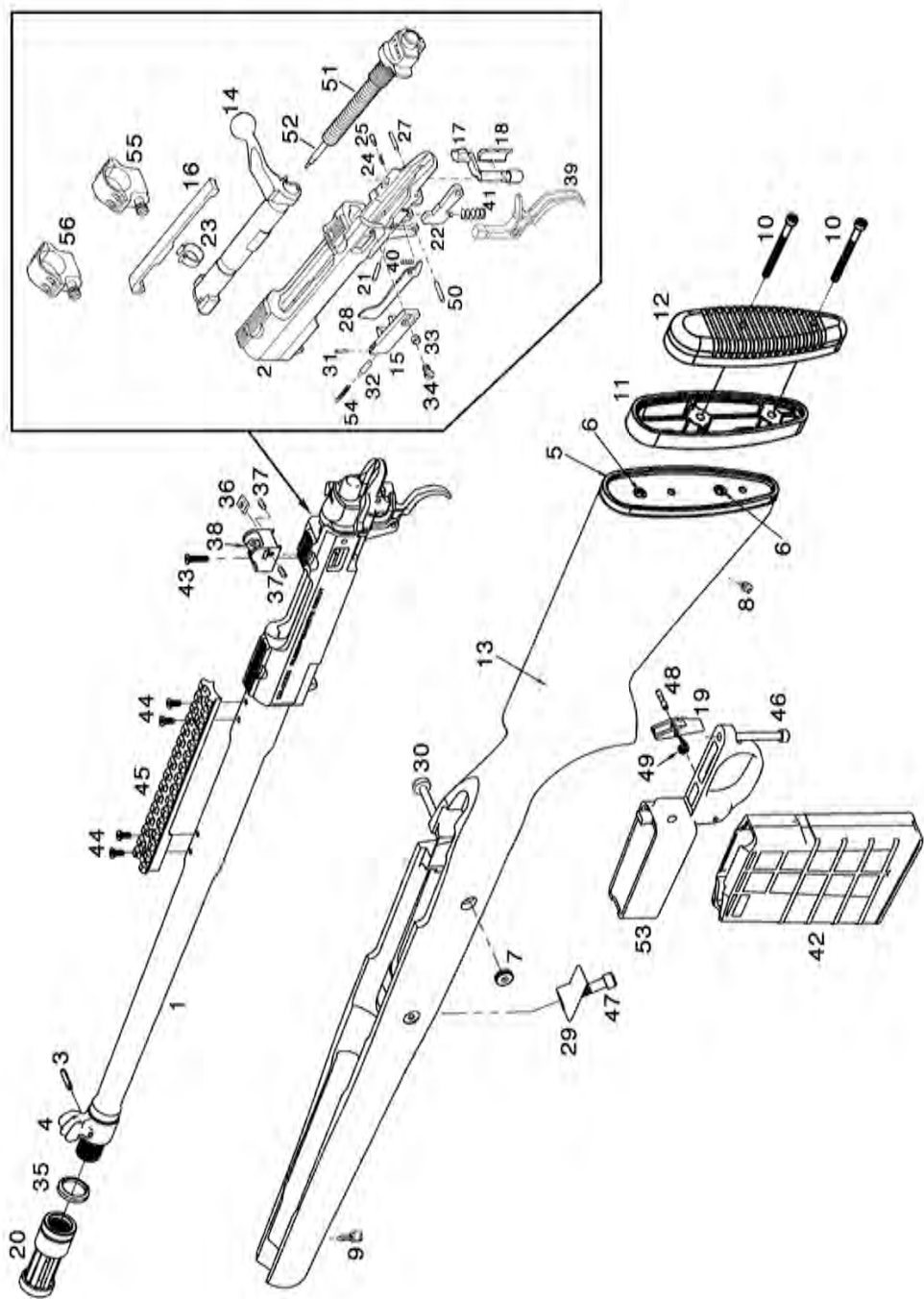

THE BASIC RULES OF SAFE FIREARMS HANDLING

We believe that Americans have a right to purchase and use firearms for lawful purposes. The private ownership of firearms in America is traditional, but that ownership imposes the responsibility on the gun owner to use his firearms in a way which will ensure his own safety and that of others. When firearms are used in a safe and responsible manner, they are a great source of pleasure and satisfaction, and represent a fundamental part of our personal liberty.

Firearms do not cause accidents! Firearms accidents are almost always found to have been the result of carelessness, or ignorance on the part of the shooter of the basic rules of safe gun handling.

The following rules must be observed by gun users at all times. Safe gun handling is not just desirable, it is absolutely essential to your safety, the safety of others, and the continuation of gun ownership and sport shooting as we know it today.

1. LEARN THE MECHANICAL AND HANDLING CHARACTERISTICS OF THE FIREARM YOU ARE USING.



Not all firearms are the same. The method of carrying and handling firearms varies in accordance with the mechanical provisions for avoiding accidental discharge and the various proper procedures for loading and unloading. No person should handle any firearm without first having thoroughly familiarized himself with the particular type of firearm he is using, and with safe gun handling in general.

2. ALWAYS KEEP THE MUZZLE POINTED IN A SAFE DIRECTION.



Be sure of the bullet stop behind your target, even when dry-firing. Never let the muzzle of a firearm point at any part of your body or at another person. This is particularly important when loading or unloading a firearm. In the event of an accidental discharge, no injury can occur as long as the muzzle is pointing in a safe direction. A safe direction means a direction which will not permit a discharged bullet to strike a person, or to strike an object from which the bullet may ricochet.

A safe direction must take into account the fact that a bullet may penetrate a wall, ceiling, floor, window, etc., and strike a person or damage property. Make it a habit to know exactly where the muzzle of your gun is pointing whenever you handle it, and be sure that you are always in control of the direction in which the muzzle is pointing, even if you fall or stumble. Keep your finger off the trigger until you are ready to shoot.

3. FIREARMS SHOULD BE UNLOADED WHEN NOT IN USE.



Firearms should be loaded only when you are in the field or on the target range or shooting area, ready to shoot. Firearms and ammunition should be securely locked in safes, racks or cabinets, or by using the locking device supplied with the firearm, when not in use. Ammunition should safely be stored separate from firearms. Store your firearms out of sight of visitors and children. It is the gun owner's responsibility to be certain that children and

persons unfamiliar with firearms cannot gain access to firearms, ammunition, or components.

4. BE SURE THE BARREL IS CLEAR OF OBSTRUCTIONS BEFORE SHOOTING.

Even a bit of mud, snow or excess lubricating oil or grease in the bore may cause the barrel to bulge, or even burst on firing, and can cause serious injury to the shooter and bystanders. Be sure that you are using ammunition of the proper caliber and loading for the gun you are using. If the report or recoil on firing seems weak, or doesn't seem quite right, **CEASE FIRING IMMEDIATELY**, unload your firearm, and check to be sure that no obstruction has become lodged in the barrel. Never try to shoot out an obstruction!

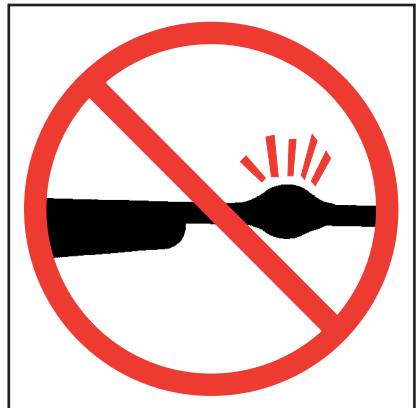



5. BE SURE OF YOUR TARGET BEFORE YOU SHOOT.

Don't shoot unless you know exactly where your bullet is going to strike. Be sure of the bullet stop behind your target, even when dry-firing with an unloaded gun. If you are in the field hunting, do not fire at a movement or noise. Take the time to be absolutely certain of your target before you pull the trigger.

6. WEAR SHOOTING GLASSES AND HEARING PROTECTORS WHEN YOU SHOOT.

All shooters should wear protective shooting glasses and adequate hearing protectors when shooting. Exposure to shooting noise can damage hearing, and adequate eye protection when shooting is essential.



7. NEVER CLIMB A TREE OR FENCE WITH A LOADED FIREARM.

Put the firearm down carefully before climbing a fence, and unload it before climbing or descending a tree or jumping over a ditch or other obstruction. Never pull or push a loaded firearm toward yourself or another person. When in doubt, or whenever you are about to do anything awkward, unload your gun!

8. DON'T SHOOT AT A HARD SURFACE, OR AT WATER.

Bullets can glance off many surfaces like rocks or the surface of water and travel in unpredictable directions with considerable velocity.

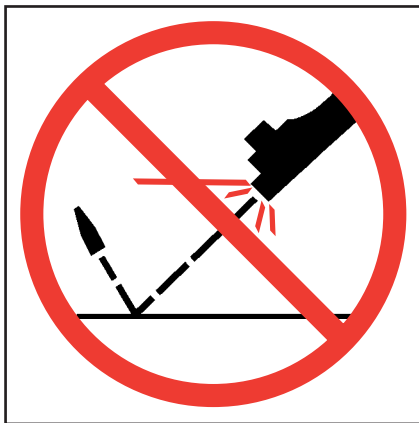

9. NEVER TRANSPORT A LOADED FIREARM.

Firearms should always be unloaded before being placed in a vehicle. A suitable carrying case or scabbard should be used to carry an unloaded firearm to and from the shooting area.

10. AVOID ALCOHOLIC BEVERAGES WHEN SHOOTING.

Don't drink until the day's shooting is over. Handling firearms while under the influence of alcohol in any form, or medications that could affect your judgement or coordination, constitutes a criminal disregard for the safety of others.



A BRIEF ACCOUNT OF AN EXTRAORDINARY ACHIEVEMENT: RUGER FIREARMS

Sturm, Ruger & Company, Inc., had its beginning in a small machine shop occupying a rented frame building in Southport, Connecticut. In January, 1949, with an initial investment of only \$50,000 and an idea, William B. Ruger and Alexander M. Sturm started production of a .22 caliber autoloading pistol—a design which was so successful that it became the cornerstone upon which one of the most comprehensive lines of sporting firearms ever made in America was established. After Alex Sturm's death in 1951, William B. Ruger continued to direct the Company until his death in 2002. William B. Ruger, Jr. continued to provide guidance, which helped make this Company a sound and successful enterprise, until his retirement in 2006. The Company has continued to prosper, under new management and guidance from our Board, with new products and fresh perspectives.

Ruger, in this relatively short time, has established itself as a leading small arms design organization, developing a unique and broad line of fine quality sporting, military and police firearms to become one of the world's most famous producers of revolvers, pistols, rifles and shotguns. Since 1949 Ruger craftsmen have built many millions of firearms.

During its six decades of growth and progress under the leadership of William B. Ruger, the Company developed a business philosophy and implemented policies which represent a constructive influence in the life of modern America. From the beginning, Ruger played a positive role in conservation efforts and has supported the interests of shooters through such groups as the National Rifle Association, National Shooting Sports Foundation, and many regional sportsmen's organizations.

The Company has always endeavored to market its firearms for constructive and recreational purposes, to emphasize the traditional and responsible aspects of shooting, to render meaningful public services, and to encourage shooters in constructive, responsible, and safe participation in the shooting sports. Its motto, "Arms Makers For Responsible Citizens," exemplifies this Company philosophy.

Today, Ruger is particularly mindful of those elements which have contributed to the creation of its success, and extends heartfelt thanks to its many loyal employees and customers.

The firearms catalog, and instruction manuals for all Ruger firearms, can be downloaded from our website at:

www.ruger.com

NOTES

NOTES

WHY NO WARRANTY CARD HAS BEEN PACKED WITH THIS NEW RUGER FIREARM

The Magnuson-Moss Act (Public Law 93-637) does not require any seller or manufacturer of a consumer product to give a written warranty. It does provide that if a written warranty is given, it must be designated as "limited" or as "full" and sets minimum standards for a "full" warranty. Sturm, Ruger & Company, Inc. has elected not to provide any written warranty, either "limited" or "full", rather than to attempt to comply with the provisions of the Magnuson-Moss Act and the regulations issued thereunder. There are certain implied warranties under state law with respect to sales of consumer goods. As the extent and interpretation of these implied warranties varies from state to state, you should refer to your state statutes. Sturm, Ruger & Company wishes to assure its customers of its continued interest in providing service to owners of Ruger firearms.



STURM, RUGER & Company, Inc.
411 Sunapee Street
Newport, New Hampshire 03773 U.S.A.
www.ruger.com

Arms Makers For Responsible Citizens®

**A COPY OF THE INSTRUCTION MANUAL FOR ANY RUGER
FIREARM IS AVAILABLE FROM THE FACTORY FREE ON REQUEST, OR IT MAY
BE DOWNLOADED FROM OUR WEBSITE AT WWW.RUGER.COM.**

**THESE INSTRUCTION MANUALS CONTAIN IMPORTANT
WARNINGS WHICH MUST BE UNDERSTOOD
BEFORE USING THESE FIREARMS.**

"22/45," "22 Charger," "LCP," "LCR," "Model 96," "P90," "P91," "P93," "P94," "P95," "P97," "P345D," "Mark III," "P345PR," "SR-22," and "SR-556" are RUGER TRADEMARKS. "**RUGER**," THE STURM, RUGER LOGO, "AC-556," "Arms Makers For Responsible Citizens," "10/22," "All-Weather," "Bearcat," "Blackhawk," "Gold Label," "GP100," the Hard-R Logo, "Hawkeye," "M77," "Mini Thirty," "Mini-14," "Old Army," "P345," "P85," "Redhawk," "Ruger Titanium," "Ruger 77/17," "Ruger 77/22," "Ruger 77/44," "Ruger 77/50," "Ruger SP101," "Ruger Vaquero," "Security-Six," "Service-Six," "Single-Six," "Speed-Six," "SR9," the "SR" Design, "Super Redhawk Alaskan" and "Target Grey" are REGISTERED U.S. TRADEMARKS.

"DEERFIELD" is a registered trademark of Blount, Inc.