

# Owner's Manual

Instruction Book for:  
MODELS SP-10 MAGNUM  
AUTOLOADING SHOTGUNS

## **IMPORTANT!**

READ ALL INSTRUCTIONS  
AND WARNINGS IN THIS  
BOOK BEFORE USING THE FIREARM.



- PAGE 2.....THE TEN COMMANDMENTS OF  
FIREARM SAFETY
- PAGE 7.....IMPORTANT PARTS OF THE FIREARM
- PAGE 10.....HOW TO LOAD AND UNLOAD
- PAGE 12.....LUBRICATION AND MAINTENANCE
- PAGE 16.....HOW TO OBTAIN PARTS AND SERVICE

*Remington*®



# A Tradition of Performance and Safety.

In 1816 Eliphalet Remington was confident he could make a flintlock that was as good or better than any he could buy. His confidence was well founded. The barrel he handcrafted set a new standard for firearm accuracy and spawned generations of products that have made Remington® Arms America's leading gunmaker. While performance and style are certainly hallmarks of Remington firearms, one factor ultimately drives their performance. Safety. Eliphalet Remington never lost sight of the fact that his rifles were potentially lethal and could kill someone if handled improperly. And after more than 180 years the same holds true for any firearm, including your new Remington. Eliphalet Remington's first flintlock launched a proud tradition of accuracy and responsibility.



*Eliphalet Remington's first flintlock launched a proud tradition of accuracy & responsibility.*

## Safety is Critical to Performance.

A superbly crafted gun is only as good as the hands that hold it. You can never be too careful. Shooting accidents are often caused by careless oversights such as failing to control the direction of the muzzle, failing to fully engage the safety, leaving ammunition in the chamber or using improper loads. These oversights can result in the destruction of life, limb or property. There's no calling back a bullet once it's been fired, so it's critical that you know the principles of safe gun handling and storage before you ever take your new Remington firearm out of the box.

The proper use and performance of your firearm depends on correct assembly and maintenance, so it's critical that you familiarize yourself with the information in this instruction book. Even if you're a veteran shooter with a collection of Remington firearms, take the time to read this literature. Not all firearms are the same. That means the first step in safe handling is to learn the features and requirements of your new Remington.

### THE TEN COMMANDMENTS OF FIREARM SAFETY

The Ten Commandments of Firearm Safety should be etched in your memory forever. Let them govern your action wherever and whenever you're involved with firearms. In the field. On the range. Or in your home. Please take the time to review and understand these rules.

#### 1st COMMANDMENT

### Always Keep the Muzzle Pointed in a Safe Direction.

*This is the most important gun safety rule.* A safe direction is one in which an accidental discharge will not cause injury to yourself or others. Never allow your gun to point at anything you don't intend to shoot. Be especially careful when you're loading or unloading. Treat every gun as if it were loaded. And make it a habit to know where the muzzle is pointed at all times, even when your firearm is unloaded. No one will be injured by an accidental discharge if you keep your firearm pointed in a safe direction. It's as simple as that.



#### 2nd COMMANDMENT

### Firearms Should be Unloaded When Not Actually in Use.

*Load your firearm only* when you're in the field or on the target range and ready to fire. Never let a loaded gun out of your sight or out of your hands. Unload it as soon as you're finished shooting – before you bring it into your car, camp or home. Remember, unloading your firearm means unloading it completely, so there is no ammunition in the chamber or in the magazine. Before handling a firearm or passing it to someone else, visually check the chamber, receiver and magazine to be certain they do not contain ammunition. Always keep the gun's action open when not in use. Never assume a gun is unloaded even if you were the last person to use it. Always check for yourself.

*Let common sense rule* when you carry a loaded gun. If you're in a situation that could risk accidental discharge – such as crossing a fence, wading through a stream or climbing a tree – always unload your gun. Never pull or push a loaded firearm toward yourself or another person. And never carry a loaded gun in a scabbard, detached holster or gun case.



*Firearms should be stored in a secure place where children cannot access them. A gun safe is an ideal way to secure your firearm.*

*Certain firearms* (including some Remington® rifles and shotguns) are equipped with internal security devices to prevent unauthorized use. In addition, some firearms owners use external devices, such as cable locks and trigger blocks, for the same purpose. Even if you use such a device, you should still keep your firearm unloaded when stored or not in use. And using internal or external devices cannot substitute, however, for securing your firearms and ammunition in a separate, locked location.

*Safe storage of firearms* is just as critical as safe handling. Never store guns loaded. Be sure to keep your firearms in a secure place where unauthorized persons cannot get their hands on them without your knowledge.

*Take special care* if there are children around. Children are fascinated by guns. It's a natural curiosity that can have tragic consequences when not properly supervised. Store your firearms in a locked gun safe or some other location that physically bars a child from gaining access.

*Ammunition should be stored and locked* in a location separate from your firearm. Never leave an unsecured firearm or ammunition in a closet, dresser drawer or under the bed. Remember, it is your responsibility to make sure that children and others unfamiliar with firearms cannot get access to your firearm and ammunition.

### 3rd COMMANDMENT

#### **Don't Rely on Your Gun's Safety.**

*Treat every gun* as if it can fire at any time, whether or not there's pressure on the trigger. Your firearm has been carefully designed to maximize performance and safety. However, because a gun's safety is a mechanical device, it could fail.

*Human error is a more likely reason* for a gun safety to fail. By mistake, you may think the safety is on when it really isn't. Or the safety may have been disengaged without your knowledge. Or you could think your gun is unloaded when there's actually a cartridge or shell in it. A mechanical safety is not a substitute for common sense. It's merely a supplement to your proper handling of a firearm.

*Never touch the trigger* on a firearm until you are ready to shoot. Keep your fingers away from the trigger when you're loading or unloading. And don't pull the trigger when the safety is engaged or positioned between safe and fire.

*Before using your gun*, read this instruction book to understand the exact location and operation of your firearm's safety. Even when the safety is on, maintain control of your loaded firearm and control the direction of the muzzle. In other words, don't rely on your safety to justify careless handling. If your firearm's internal mechanisms are broken or have been altered, your firearm may fire even when the safety is on. Remember, you and your safe gun handling practices are your gun's best safety.

### 4th COMMANDMENT

#### **Be Sure of Your Target and What's Beyond It.**



*You can't stop a shot in mid-air*, so never fire unless you know exactly where your shot is going and what it will strike. Never fire at a sound, a movement or a patch of color. A hunter in camouflage can easily be mistaken for a target by an impulsive shooter. Before you pull the trigger be absolutely sure of your target and what's behind it. Make sure the shot has a backstop such as a hillside or dense material like sand. Remember, bullets can travel great distances with tremendous velocity. Know how far your shot will go if you miss your target or the bullet ricochets.

## **Use Proper Ammunition.**

*Every firearm is designed* to use a certain caliber or gauge of ammunition. Using the wrong ammunition, mixing ammunition or using improperly reloaded ammunition can cause serious personal injury or death. And it only takes one cartridge or shotshell of the incorrect caliber or gauge, or which has been improperly reloaded, to destroy your firearm. It's your responsibility to make sure the ammunition you use exactly matches the caliber or gauge of your gun. Refer to this instruction book to find out the specific requirements of your firearm. Always read and heed the instructions on ammunition boxes.

*Confusing shells* or cartridges can cause serious personal injury or death and destroy your firearm. Examine your shells or cartridges closely and use only the precise caliber or gauge for your specific firearm. For example, suppose you accidentally loaded a 20 ga. shell into a 12 ga. shotgun. Because the 20 ga. shell is too small for the chamber, the 20 ga. shell could travel down the barrel and get lodged in the bore. If you then loaded a standard 12 ga. shell behind it and fired, the 12 ga. shot will slam into the lodged 20 ga. shell and may cause the barrel to explode right in your hand. This is commonly called a 12/20 burst, and it can kill you.

*Check all ammunition* before you load it to make sure it matches your gun's requirements. Every Remington® cartridge and shell is head-stamped with its caliber or gauge for easy identification. Likewise, you'll find the caliber or gauge of your new Remington firearm imprinted on the barrel.

## **Reloading Requires Extra Diligence.**

*If you're an ammunition reloader*, you are responsible for personally assuring that the loads and components of your reloaded ammunition meet your gun's factory-tested standards. Never use ammunition which has been reloaded by someone else!

*Many shooters handload* as a hobby or to save money on commercial, factory-made ammunition. However, it requires a thorough knowledge of reloading procedures and a deep respect for the explosive potential of gunpowder.

*Firearms are designed*, manufactured and proof-tested to standards based on factory-loaded ammunition. Handloaded or reloaded ammunition that deviates, either intentionally or accidentally, from load or component recommendations can be very dangerous.

*Reloaders must observe* all possible safety precautions and practices related to the proper handling of explosives. Whether you're a seasoned reloader or just starting out, you should study the subject, watch reloading demonstrations and talk to experienced reloaders.

*The first rule of reloading* is to always follow the manufacturer's instructions for the components you're using. They'll tell you to follow certain guidelines. Namely:

1. Don't mix or substitute powders or primers.
2. Don't use unknown or substandard components.
3. Use only suitable components that have been factory-tested by reputable ammunition, powder and bullet manufacturers.
4. Always be sure to use the manufacturer's recommended recipe when reloading.

*Not following these guidelines* could result in severe injury to yourself or severe damage to your firearm. Dangerously high pressure and explosions can result from an overcharge of powder or other deviations from established reloading guidelines. Be very careful. The process of reloading exposes you to environmentally hazardous material. Lead, which is known to cause cancer and birth defects, is the most common substance in bullets and shot. It is important to handle lead bullets and shot with extreme care. Work only in a well-ventilated area and always wash your hands after exposure and before eating. Never smoke while reloading.

*Primers and powders* are also highly toxic and flammable. So after reloading be sure to clean up all materials from your work area. Don't leave primer or powder spills anywhere on the floor or bench top. Dispose of all waste material in accordance with the manufacturer's recommendations.

*Finally, when reloading* or handloading concentrate on what you're doing at all times. Do not be distracted by talking to others, listening to the radio or watching TV while reloading. Never reload after consuming alcoholic beverages or drugs of any kind. You are working with extremely hazardous materials and you can't risk even a few seconds of distraction. Remember, if you reload, you are the ammunition manufacturer and you are responsible for the performance and safety of your reloaded ammunition.

## 6th COMMANDMENT

### **If Your Gun Fails to Fire When the Trigger is Pulled, Handle With Care.**

*If for some reason the ammunition doesn't fire when you pull the trigger, stop and remember the 1st Commandment of Firearm Safety – always keep the muzzle pointed in a safe direction. Keep your face away from the breech, then put the safety on, carefully open the action, unload the firearm and dispose of the cartridge safely. Remember that anytime there's a shell in the chamber, your gun is loaded and ready to use. Even if you tried to shoot and your gun didn't fire, treat your firearm as if it could still discharge.*

## 7th COMMANDMENT

### **Always Wear Eye and Ear Protection When Shooting.**

*Your sight and hearing risk injury from shooting and should be protected at all times. Wear protective shooting glasses to guard against falling shot, clay target chips, powder residue, ruptured cartridge cases and even twigs and branches in the field. Also be sure to wear eye protection when you're disassembling or cleaning a gun so that tensioned parts (like springs) and cleaning solvents don't come in contact with your eyes. Continued exposure to shooting noise can permanently damage your hearing. On the range, where shooting volume is the loudest, be sure to use the maximum protection of a headset. And learn to use ear protection in the field, especially in confined locations like duck blinds.*



## 8th COMMANDMENT

### **Be Sure the Barrel is Clear of Obstructions Before Shooting.**

*Before loading your gun, open the action and make sure there's no ammunition in the chamber or magazine. Check the barrel for any obstructions or debris. Even a small amount of snow, mud, excess lubricant or grease in the bore can dangerously increase pressure and cause the barrel to bulge or burst when firing. Use a cleaning rod and patch to wipe away anti-rust compounds or any other residues or obstructions in the barrel. Never try to shoot out an obstruction by loading another shell and firing!*

*When firing, rely on your instincts. If the noise or recoil of your firearm seems weak, stop everything, unload your firearm and be sure nothing is lodged in the barrel. Remember the 12/20 burst? That's what can happen when the barrel is obstructed. So always be sure you're using the correct ammunition in your firearm and that it's free of obstructions.*

## 9th COMMANDMENT

### **Don't Alter or Modify Your Gun and Have it Serviced Regularly.**

*Your firearm has been designed to operate according to certain factory specifications. You'll jeopardize your safety and that of others around you by attempting to alter its trigger, mechanical safety or other mechanisms. So never alter or modify your firearm in any way.*



*Like any mechanical device, a firearm is subject to wear. It must be maintained and periodically serviced to assure optimum safety and performance. Only a qualified service facility should service, repair or modify your Remington® firearm. Consult your instruction book for instructions on how to send your firearm to the factory or for the location of the nearest Remington Authorized Service Center.*

*Proper cleaning and lubrication are also important to firearm maintenance and are necessary to assure accuracy, safety and reliability. Before cleaning, always make sure that your gun is completely unloaded. And always clean the barrel from the chamber end to the muzzle when possible.*

*Make it a practice* to clean your bore every time you're going to shoot. Be sure to clean your entire gun before and after long-term storage and no less than once a year. It's also important to clean your gun whenever it's been exposed to adverse conditions such as rain, dirt, mud, snow, sleet or saltwater.

*For safe and dependable* operation of your firearm, all parts of your gun must be properly cleaned and lubricated. Periodically inspect the internal workings of your firearm to be sure they're clean and free of rust, unwanted dirt and debris.

*Use recommended lubricants* on your gun and do not over-lubricate. Excessive use of a non-recommended lubricant could adversely affect the function and safe operation of your firearm. Remember, you are responsible for the proper care and maintenance of your firearm. Failure to properly maintain your firearm can not only damage or ruin your firearm, it can expose you and others to unnecessary risks of personal injury or death.

*Remington® has a wide range* of firearm care products and resources for best results when cleaning your gun. Everything from solvents and lubricants to rods and patches. They're all available from your Remington dealer.

## 10th COMMANDMENT

### **Learn the Mechanics and Handling Characteristics of Your Firearm.**

*Not all guns are alike.* They have different mechanical characteristics that dictate how you should carry and handle them. Anyone who plans to use a firearm should first become totally familiar with the type of firearm it is and the safe handling procedures for loading, unloading, carrying, shooting and storing it.

*Before you even unpack* your new Remington firearm, read this instruction book from cover to cover and familiarize yourself with the different component parts of the gun. Then read, understand and follow the Ten Commandments of Firearm Safety in this book.



**WARNING!** Discharging firearms in poorly ventilated areas, cleaning firearms or handling ammunition may result in exposure to lead, a substance known to cause birth defects, reproductive harm, cancer and other serious physical injury. Have adequate ventilation at all times. Wash hands thoroughly after exposure.

### **SHOOT SOBER!!**

*There's one other rule* that must be followed when handling firearms. In fact, respect for this rule is necessary in order to effectively practice the Ten Commandments of Firearm Safety. The rule is: SHOOT SOBER! Guns and alcohol or drugs make a deadly combination. Never consume anything that would mildly impair your judgment or physical coordination when you're using a firearm. A staggering percentage of the shooting accidents that occur every year involve alcohol or drugs. Be smart. Always shoot sober and stay alive.

**WARNING!** Failure to follow any of these safety rules may cause personal injury or death to the shooter or bystander and damage to property. Do not use a firearm until you fully understand and practice the Ten Commandments of Firearm Safety. If you have any questions about the safe use of a Remington firearm, write to us at Remington Arms Company, Inc., Consumer Service, P.O. Box 700, Madison, NC 27025-0700, or call us at 1-800-243-9700.

### **DON'T KEEP THIS TO YOURSELF.**

*Now that you're a gun owner* you have the obligation to help ensure that shooting sports are safe for everyone – participants and bystanders alike. You can do that by practicing these principles of firearm safety and passing them on to others – especially new shooters. Set an example for beginners. Be a guide to their safe entry into the exciting world of shooting sports. Invest your time and patience for the love of the sport and for its future. After all, it's your love of the sport that led you to buy a new Remington.

*Firearm ownership* is a right and privilege. It's a right guaranteed in this nation's Constitution. It's a privilege which carries with it a personal responsibility to use your firearm in a way which will ensure your safety and the safety of others. The preservation of this right and privilege depends on the personal commitment of you and your fellow shooters to the safe and responsible use of firearms. Let the Ten Commandments of Firearm Safety outlined in the book guide you at all times. Teach and promote these rules whenever you can. Remember, firearm safety depends on you! That's the only way to really enjoy your new Remington firearm and to preserve sport shooting as we know it today.

# Remington® Model SP-10™ Magnum Autoloading Shotgun

Congratulations on your choice of a Remington.® With proper care, it should give you many years of dependable use and enjoyment. For best results, we recommend that you use Remington Ammunition – the ammunition used in factory testing your firearm against our exacting function and performance standards.

**PICTURE 1** This picture shows the main parts of the REMINGTON SP-10™ MAGNUM SHOTGUN. The picture will aid in understanding the instructions in this book. See page 10 for instructions on changing choke tubes.

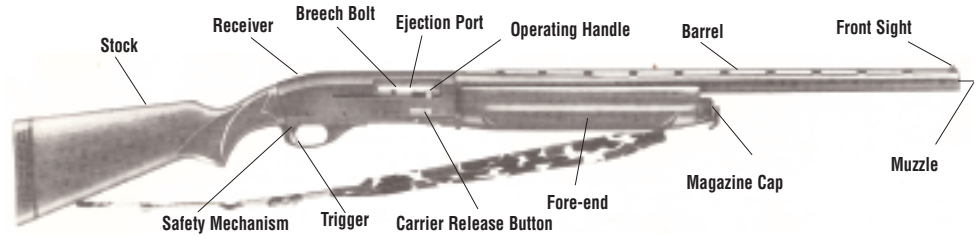

**PICTURE 2** This picture shows the parts of the ammunition.

## SHOTGUN SHELL

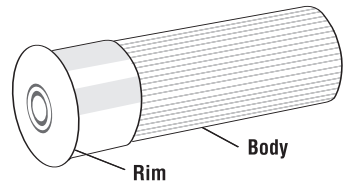

## Important Parts of the Firearm

### The Safety Mechanism

The safety mechanism on the Model SP-10 Magnum Shotgun is a button located behind the trigger. See Pictures 3 and 4.

The safety mechanism provides protection against accidental or unintentional discharge under normal usage when properly engaged and in good working order.

To engage the safety mechanism, push the button so that the **RED BAND MARKING CANNOT BE SEEN**.

Always engage the safety mechanism when the firearm is loaded and you do not intend to shoot.

Never pull the trigger when the safety mechanism is engaged.

When you are ready to fire the firearm, press the safety mechanism so that the **RED BAND MARKING IS SHOWING**. Do not touch the trigger while moving the safety mechanism. Your fingers and all other objects should be kept outside the trigger guard and away from the trigger until you are actually ready to fire by pulling the trigger.

**WARNING:** The firearm will fire when the trigger is pulled and the **RED BAND IS SHOWING**.

Even when the safety mechanism is engaged, careless handling can cause the firearm to fire. See the *Ten Commandments of Firearm Safety* on page 2.

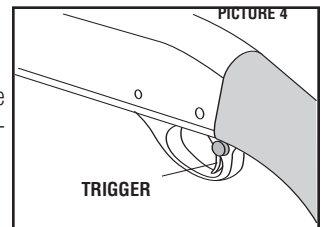
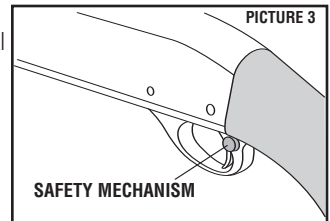



# The Security System

An external lock has been supplied with your firearm. The gun lock is a security device to help you prevent unauthorized use of your firearm. The instructions for the safe and proper use of the gun lock are provided in the packaging for your lock. **READ AND FOLLOW THE INSTRUCTIONS** for the gun lock. You may also obtain the instructions and warnings for the gun lock on the Remington website at [WWW.REMINGTON.COM](http://WWW.REMINGTON.COM). or by calling Remington's toll-free number at 1-800-243-9700.

**THE USE OF THE LOCKING DEVICE IS NOT A SUBSTITUTE FOR SAFE GUN HANDLING AND STORAGE, INCLUDING KEEPING THIS AND EVERY GUN UNLOADED AND LOCKED IN A SECURE PLACE WHEN NOT IN USE. READ AND FOLLOW THESE AND OTHER SAFETY RULES IN THIS INSTRUCTION BOOK. FAILURE TO READ, UNDERSTAND AND OBEY THESE RULES CAN RESULT IN SERIOUS PERSONAL INJURY OR DEATH TO YOU OR OTHERS. SEE THE TEN COMMANDMENTS OF FIREARM SAFETY ON PAGE 2.**

# The Operating Handle

The operating handle is used to pull the bolt rearward to a locked - open position. See Picture 5.

**WARNING:** When the operating handle is forward as shown in Picture 6, the bolt is closed and the firearm can be fired.

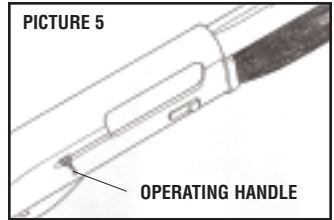

# The Carrier Release Button

1. Point the firearm in a safe direction.
2. Engage the safety mechanism. **RED BAND WILL NOT SHOW.**
3. **CAUTION:** Keep your fingers away from the ejection port and operating handle.
4. Push the carrier release button IN to close the bolt. See Picture 6.

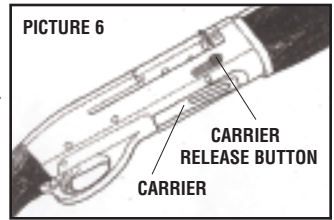

# The Trigger

*Pulling the trigger* fires the firearm.

*The weight* of the trigger pull is preset at the factory.

*All adjustments* to the trigger and trigger plate assembly must be made by the factory or a REMINGTON® AUTHORIZED SERVICE CENTER.

**WARNING: NEVER** put your finger on the trigger unless you are going to fire the firearm.

# The Barrel

The inside of the barrel must be clean and free of obstructions.

## I. TO CHECK THE INSIDE OF THE BARREL:

**WARNING:** MAKE SURE THE FIREARM IS UNLOADED. LOOK INTO THE EJECTION PORT. CHECK THE CHAMBER AND MAGAZINE TO MAKE SURE THERE ARE NO SHELLS IN THE FIREARM.

1. Point the firearm in a safe direction.
2. Engage the safety mechanism. Make sure the **RED BAND IS NOT SHOWING.**
3. Pull the operating handle fully rearward until the bolt is locked open.
4. Insert a cleaning rod into the muzzle. Push the rod completely through the barrel until rod can be seen in the ejection port.

## II. TO REMOVE OBJECT FROM INSIDE THE BARREL:

**WARNING: NEVER** try to remove an object from the barrel by loading another shell and firing. This may cause the barrel to burst or a cartridge case to rupture and cause serious personal injury.

1. Remove the barrel following instructions shown on pages 12 and 13.
2. Use the correct cleaning rod.
3. Insert cleaning rod into the muzzle and lightly tap rod to free object(s).



4. If an object cannot be easily pushed out of the barrel with a cleaning rod, return the firearm to the factory or a REMINGTON AUTHORIZED SERVICE CENTER.

### III. TO CLEAN THE BARREL AND CHOKE TUBE FOLLOW THE INSTRUCTIONS SHOWN ON PAGES 12 AND 13.

#### BEFORE LOADING THE FIREARM

1. Make sure the inside of the barrel is free of dirt or other objects.
2. Check the condition of the gas system parts. See Picture 7. The gas cylinder must slide freely on the gas piston. If not, see page 13 for cleaning instructions.

## To Change the Choke Tube

**WARNING:** UNLOAD the firearm before changing choke tubes. Leave the action **OPEN** and the chamber and magazine **EMPTY**.

1. Point the firearm in a safe direction.
2. Engage the safety mechanism. Make sure the **RED BAND IS NOT SHOWING**.
3. Place the choke tube wrench into the choke tube.
4. Turn the wrench counterclockwise and remove the choke tube.
5. Select the desired choke tube and insert the tube into the barrel.
6. Tighten the choke tube snugly but **DO NOT OVER-TIGHTEN**.
7. With the bolt open and the chamber and magazine empty, check the choke tube occasionally to make sure it has not loosened.

**NOTE:** NEVER fire the firearm without the choke tube installed.

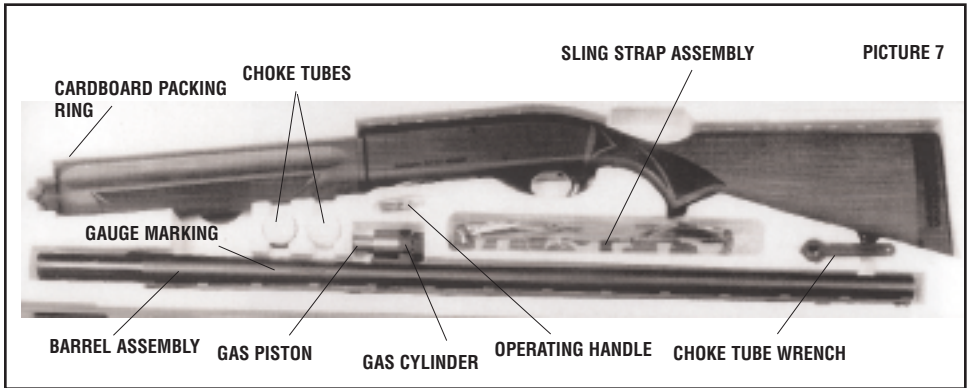

PICTURE 7

## To Assemble

The SP-10™ MAGNUM is shipped with the barrel and operating handle removed. See Picture 7 for location of parts.

**NOTE:** The barrel and chamber should be cleaned before assembling the firearm. Clean the barrel following the instructions on page 16.

1. Point the firearm in a safe direction.
2. Engage the safety mechanism. **RED BAND WILL NOT SHOW**.
3. With the receiver assembly position as shown in picture 8, raise the bolt and insert the operating handle fully into the slot in the slide.
4. Pull the operating handle fully rearward to open the action.
5. Unscrew and remove the fore-end cap.
6. Slide the fore-end forward and remove it from the slide extension assembly.
7. Remove the cardboard packing ring from the end of the magazine tube extension.
8. Make sure that the slide extension assembly prongs are inside the holes in the front of the receiver.

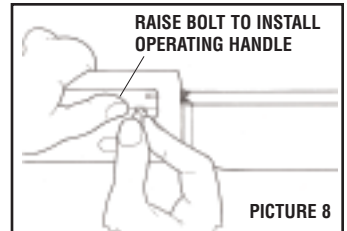

PICTURE 8

9. Hold the barrel in front of the gas piston. See Picture 9.
10. Slide the gas piston over the end of the magazine tube extension and, at the same time, guide the barrel into the receiver..
11. Align the barrel slot with the barrel locator and seat the barrel firmly into the receiver.
12. Slide the fore-end over the barrel lug and the slide extension assembly.
13. Locate the rear of the fore-end into the receiver collar.
14. Replace and tighten the fore-end cap.

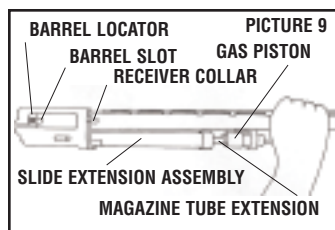

FULLY ASSEMBLED SP-10 MAGNUM

## To Load and Unload

**WARNING:** Before loading, always make sure the ammunition you intend to use is the correct gauge and length.

### I. TO LOAD ONE SHELL ONLY:

1. Point the firearm in a safe direction.
2. Engage the safety mechanism. **RED BAND WILL NOT SHOW.**
3. Pull the operating handle fully rearward until the bolt is locked open.
4. Put one 10 gauge 3 1/2" Magnum shell through the ejection port. See Picture 10.
5. **CAUTION:** Keep your fingers away from the ejection port and operating handle.
6. Push in on the carrier release button to close the bolt. See Picture 6 on page 8.

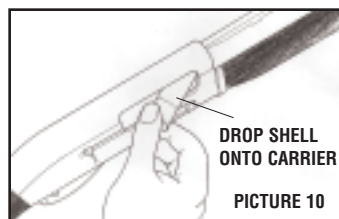

**THE FIREARM IS NOW LOADED.**

7. To fire the firearm, point in the direction of the intended target and then disengage the safety mechanism. **RED BAND WILL SHOW.**

**THE FIREARM IS NOW READY TO FIRE BY PULLING THE TRIGGER.**

8. Pull the trigger to fire the firearm. The bolt will remain open after the firearm is fired.
9. Engage the safety mechanism when you are finished firing.

### II. TO LOAD THE CHAMBER AND MAGAZINE:

**WARNING:** Before loading, always make sure the ammunition you intend to use is the correct gauge and length.

1. Point the firearm in a safe direction.
2. Engage the safety mechanism. **RED BAND WILL NOT SHOW.**
3. Pull the operating handle fully rearward until the bolt is locked open.
4. Put one 10 gauge 3 1/2" Magnum shell through the ejection port. See Picture 10.
5. **CAUTION:** Keep your fingers away from the ejection port and operating handle.
6. Push in on the carrier release button to close the bolt. See Picture 6 on page 8.

**THE FIREARM IS NOW LOADED.**

7. Push in on the carrier release button and press another shell against the carrier until the carrier starts to move. See Picture 11.

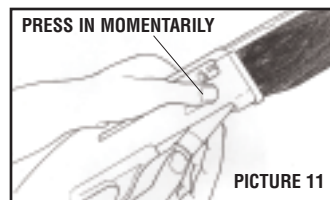

8. Release the pressure on the carrier release button and continue pushing the shell fully forward into the magazine tube.
9. Repeat steps 7 and 8 and push one more shell of the correct gauge fully forward into the magazine tube.
10. Make sure that after loading the last shell, the carrier returns to its latched position.

**WARNING:** Be sure the rim of each shell snaps past the end of the shell stop to prevent the shell from sliding back over the carrier.

**If the shell slides back over the carrier:**

- Keep the firearm pointed in a safe direction.
- Forcefully **OPEN** the action, or
- **REMOVE** the trigger plate assembly following the instructions on pages 14 and 15 and remove the shell, or
- When the chamber is loaded, firing the gun will **CLEAR** the jammed shell.

**THE CHAMBER AND MAGAZINE ARE NOW FULLY LOADED.**

11. To fire the firearm, point in the direction of the intended target and then disengage the safety mechanism. **RED BAND WILL SHOW.**

**THE FIREARM IS NOW READY TO FIRE BY PULLING THE TRIGGER.**

12. Pull the trigger to fire the firearm. The firearm will fire each time the trigger is pulled until the magazine and chamber are empty. The bolt will remain **OPEN** when the last shell is fired.
13. Engage the safety mechanism when you are finished firing.
12. Look into the ejection port to make sure there are no shells inside the receiver, chamber or magazine.

## To Unload the Firearm

1. Point the firearm in a safe direction.
2. Engage the safety mechanism. **RED BAND WILL NOT SHOW.**
3. Pull the operating handle fully rearward to remove the shell from the chamber.
4. Close and open the bolt until all shells are removed.

**WARNING:** Check the chamber and the magazine to make sure there are no shells remaining in the firearm.

## To Disassemble

**WARNING:** Unload the firearm. Check the chamber and the magazine to make sure there are no shells in the firearm.

1. Point the firearm in a safe direction.
2. Engage the safety mechanism. **RED BAND WILL NOT SHOW.**
3. Pull the operating handle fully rearward until the bolt is locked open.
4. Unscrew and remove the fore-end cap.
5. Slide the fore-end forward and remove it from the firearm.
6. Hold the barrel in front of the gas piston and pull the barrel assembly from the receiver.
7. Slide the slide extension assembly forward and remove it from the magazine tube.
8. Allow the bolt to move forward **GENTLY** by holding the operating handle while pressing the carrier release button.
9. Lift the bolt up and pull the operating handle out of the slide.
10. Tap out the front and rear trigger plate pins.
11. Press in and hold the carrier release button and at the same time lift rear of the trigger plate assembly and slide it rearward out of the receiver. See Picture 12.

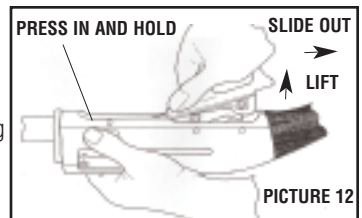

**WARNING: DO NOT** allow the hammer to snap forward when the trigger plate assembly is removed. This can best be assured by keeping the safety mechanism engaged at all times. **RED BAND WILL NOT SHOW.**

- Use a phillips head screwdriver to loosen the top recoil pad screw, then unscrew the lower recoil pad screw and rotate the recoil pad to expose the stock bolt.
- Use a 1/2" hex, socket to unscrew the stock bolt and remove the stock from the action spring tube.
- Place a rod through the hole in the action spring tube and unscrew and remove the action spring tube and action spring from the receiver. See Picture 13.

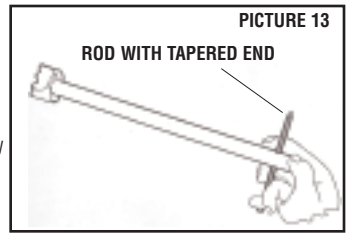

**CAUTION:** The action spring tube is under spring tension.

- Grasp the action spring plunger and pull the slide assembly and bolt to the rear of the receiver.
- Reach into the receiver and hold the front of the slide and while pushing forward on the link, pivot the slide up and out of engagement with the bolt cam pin. See Picture 14.
- Remove the slide assembly from the receiver, by pulling it forward through the action spring tube hole.
- Push the bolt forward out of the receiver.
- Place a small screwdriver at an angle against the corner of the shell stop pivot pin and tap lightly with a hammer to loosen. See Picture 15. Be careful not to damage the receiver.
- Reach inside the receiver and push the shell stop IN against spring pressure and remove the pivot pin. Then remove the shell stop and spring.

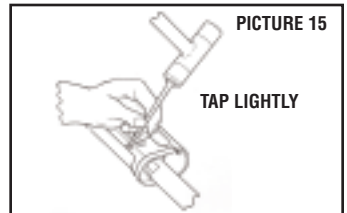
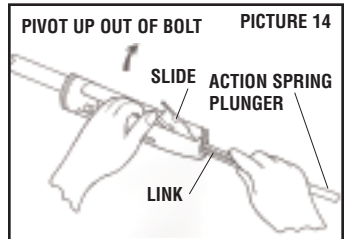

**NOTE:** There is normally no need to remove the magazine follower assembly when cleaning the firearm. However, if this is desired, the brass magazine follower plunger must be depressed and the assembly rotated so that the plunger is held depressed by the magazine tube wall. The magazine follower assembly and the magazine spring can then be pushed rearward out of the magazine tube.

**NOTE:** The magazine tube is permanently bonded to the receiver and no attempt should be made to remove it.

## Lubrication and Maintenance

**WARNING:** Never attempt to clean or perform maintenance on a loaded firearm. Before cleaning, always look into the ejection port and check the chamber and the magazine to make sure the shotgun is completely unloaded.

### CLEANING

The amount of shooting between cleaning will vary greatly depending on climate, weather conditions, ammunition used and the amount of lubrication. The gas system parts and the front face of the bolt should be cleaned more frequently than the rest of the firearm.

#### TO CLEAN THE BARREL:

- Use the instructions and equipment provided in a good cleaning kit. For recommendations, see your Remington® Authorized Service Center.
- Select the correct gauge cleaning brush and attach the brush to the cleaning rod.
- Put the cleaning brush into gun-cleaning solvent.
- Push the cleaning rod through the barrel several times.
- Remove the brush from the rod, attach tip with cleaning patch and push through the bore.
- Repeat several times, using a new, clean patch each time until the patch is not dirty.
- Remove all of the shooting residue from the locking notch in the barrel. See Picture 16.

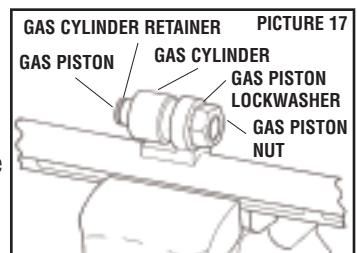
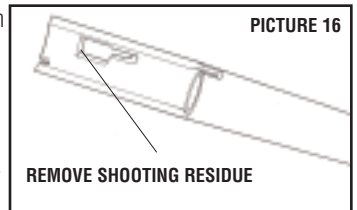

- Clamp the barrel lug in a suitable holding device or, with the barrel upside down carefully clamp the vent rib in a smooth jawed vice. See Picture 17.
- Using a 15/16" open end wrench, unscrew and remove the gas piston nut and lockwasher. Pull the gas system assembly out of the barrel lug.
- Check the gas hole in the barrel. Use a 3/32" diameter wire to clean the gas hole. See Picture 18.

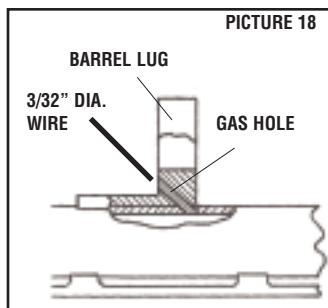

**WARNING:** After cleaning, make sure the barrel is free of obstructions.

### THE GAS PISTON AND GAS CYLINDER

- Pry off the gas cylinder retainer and remove the gas cylinder from the gas piston. See Picture 17.
- Scrub both parts using steel wool and cleaning solvent until all powder residue has been removed. Wipe clean and dry.

### TO CLEAN THE CHOKE TUBE:

- Remove the choke tube from the barrel.
- Clean the choke tube, including the threads, with gun-cleaning solvent and wipe dry.
- Apply Rem™ Oil on threads and reassemble choke tube to the barrel following instructions on page 9.

**WARNING:** After cleaning but before using or storing, make sure the barrel is free of obstructions.

### THE BOLT ASSEMBLY:

Brush the bolt assembly with cleaning solvent and wipe clean and dry. Pay particular attention to the front face of the bolt which must be kept clean and smooth at all times in order to prevent feeding malfunctions. This surface should be cleaned frequently, which can also be accomplished without disassembling the firearm. While holding the bolt handle rearward, reach through the ejection port and wipe the bolt face clean.

### THE SLIDE ASSEMBLY:

Brush the slide, link and action spring plunger with cleaning solvent and wipe clean and dry. Apply a small amount of gun grease to the bolt cam pin track in the slide.

### THE SHELL STOP:

Brush the shell with solvent and wipe clean and dry.

### THE SLIDE EXTENSION ASSEMBLY:

Brush the slide extension assembly with solvent and wipe clean and dry.

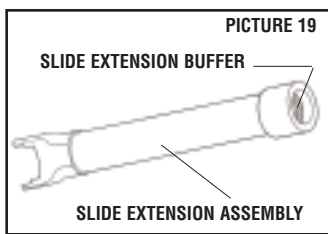

NOTE: Check the condition of the slide extension buffer and replace if worn or damaged. See Picture 19

### THE TRIGGER PLATE ASSEMBLY:

NOTE: Clean as a unit with Rem™ Oil as shown. See note on page 15.

Spray the trigger plate assembly with Rem™ Oil as shown. See Picture 20. Let stand for 15 minutes. Spray again to wash off components. Shake off excess lubricant.

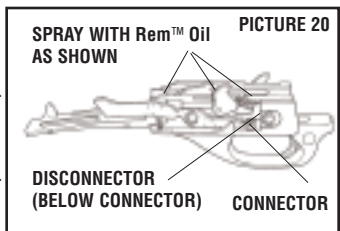

**WARNING:** Excessive use of a non-recommended lubricant could cause serious function problems possibly leading to accidental firing.

## THE RECEIVER ASSEMBLY:

1. Brush the inside of the receiver with cleaning solvent and wipe dry.
2. Clean the outside surface of the magazine tube with cleaning solvent, then wipe dry with a clean cloth.

## How To Reassemble

1. With the receiver positioned on its side, hold the shell stop horizontally and install the shell stop spring in the hole in the shell stop. See Picture 21.
2. Being careful not to dislodge the spring, install the shell stop inside the receiver with the carrier release button area protruding through the receiver slot.
3. Line up the shell stop slot with the shell stop pivot hole in the receiver and install the shell stop pivot pin so that the angled surface blends with the receiver radius. Tap the end of the pin lightly to seat it.
4. Install the bolt assembly through the front of the receiver and slide it to the rear of the receiver.
5. Install the slide assembly by passing the action spring plunger and link through the action spring tube hole in the receiver. Then while holding the link, rotate the cam track of the slide over the bolt cam pin and seat the slide inside the receiver.
6. Push the slide assembly and the bolt to the front of the receiver. Spray a small amount of Rem™ Oil into the receiver.
7. Spray a small amount of Rem™ Oil into the action spring tube and install the action spring into the tube.
8. Place a rod through the hole in the action spring tube as shown in picture 13 on page 11, then position the action spring plunger inside the action spring and screw the action spring tube into the receiver. Tighten snugly and remove the rod.
9. Replace the stock over the action spring tube, then install stock bolt washer, lockwasher and stock bolt and tighten securely.
10. Rotate the recoil pad to center it on the stock and tighten the two recoil pad screws.
11. Check the trigger plate assembly to make sure that the end of the disconnecter is below the connector. See Picture 20 on page 13.
12. Push IN and hold the carrier release button, and at the same time carefully insert the trigger plate assembly at an angle (carrier first) into the receiver. Then rotate it until the rear of the disconnecter stops against the receiver. See Picture 22.
13. While still holding the carrier release button IN, push the end of the disconnecter IN and complete rotation of trigger plate assembly until its bushing holes align with the holes in the receiver.
14. Tap in the front and rear trigger plate pins.
15. Lift upward on the bolt and install the operating handle fully into the slot in the slide.
16. Pull the operating handle fully rearward to lock the bolt open.
17. Install the slide extension assembly over the magazine tube and position its two prongs in the mating holes in the front of the receiver.
18. Install the gas cylinder parts on the barrel. See Picture 17 on page 12.  
NOTE: Do not over-tighten nut and compress the lock washer flat.
19. Hold the barrel in front of the gas piston as shown in picture 9 on page 9, and slide the gas piston over the end of the magazine tube extension, and at the same time guide the barrel into the receiver.
20. Align the barrel slot with the barrel locator and seat the barrel firmly into the receiver.
21. Slide the fore-end over the barrel lug and slide extension, and locate its rear end in the receiver collar.
22. Replace and tighten the fore-end cap.

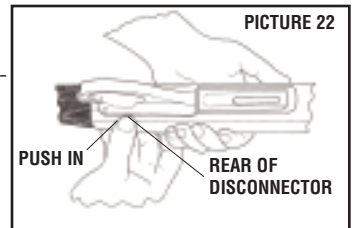
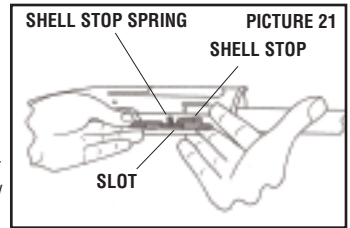

**WARNING:** This firearm should be checked periodically by the Remington Arms Company, Inc. or a REMINGTON AUTHORIZED SERVICE CENTER. This will insure proper inspection and any necessary replacement of worn or damaged parts.

## Lubrication:



Over-lubrication should be avoided at all times. A thin coat of Rem™ Oil is all that is needed to prevent the possibility of rusting. See NOTE below.

When the firearm is to be stored, it should be carefully cleaned and thoroughly oiled. Outside surfaces should be wiped with a light coat of Rem™ Oil occasionally. See NOTE below.

When firearm is to be reused, all excess lubrication must be removed. The chamber and bore must be thoroughly wiped dry.

**NOTE:** Remington Rem™ Oil is available from your local dealer. If your dealer is out of stock, ask him to order Rem™ Oil from his Remington distributor.



# How to Obtain Parts and Service From Remington® Arms Co.

## TO ORDER PARTS:

Many Remington Dealers and Authorized Service Centers carry a full line of parts. Please check with them first before ordering parts.

To expedite your PARTS order or request REPAIR SERVICE visit our web site at [www.remington.com](http://www.remington.com). Detailed instructions are provided along with parts and/or service order forms. You may also reach Remington by calling our toll free customer service number, 1-800-243-9700, Mon.-Fri., 9:00 AM-5:00 PM Eastern time.

1. Fax completed order form (from the web site) to 1-336-548-7801.
2. To order by phone without the order form call 1-800-243-9700.

## Please have the following information ready before you call.

- Firearm model and serial number.
- Part description and quantity. Part descriptions can be found on the parts listing page in this manual.
- Your complete mailing address (P.O. Box and Street Address) including zip code, telephone number and e-mail address.
- Method of payment: Mastercard, Visa, Amex or Discover card number and expiration date. Prepayment may be made by check or money order. A quote may be made to you over the phone. (Sorry, no C.O.D.s.)

## **WARNING!** USE ONLY REMINGTON PARTS IN REMINGTON FIREARMS.

**NOTE:** SOME PARTS MAY BE RESTRICTED. See parts list for details. Owner's manuals/instruction books may be requested via our web site at: [www.remington.com](http://www.remington.com) or by calling 1-800-243-9700.

## REPAIR SERVICES

1. To locate the Remington Authorized Service Center nearest you visit our web site at [www.remington.com](http://www.remington.com) and use our Repair Service Locator. If you need additional on-line assistance, e-mail us at [info@remington.com](mailto:info@remington.com) to obtain a listing of Remington Authorized Service Centers. Contact the Remington Authorized Service Center of your choice for evaluation of your firearm and/or additional shipping instructions.
2. If your Remington Authorized Service Center cannot provide the service or repair you require and you need further assistance, please call our toll free number 1-800-243-9700, Mon.-Fri., 9:00 AM-5:00 PM Eastern time and select the option for repairs. Then, if shipment of your firearm is required, please:
  - Record the serial number of your firearm before sending it to us.
  - Pack your firearm for safety and to prevent further damage in shipping and handling. Preferably, ship in a firearm box.
  - Remove all accessories from the firearm to prevent loss or damage.
  - Enclose a letter with the firearm detailing the model name or number of your firearm and serial number along with a full description of the problem. Be sure to include your full name and address (P.O. Box and Street Address), including zip code, daytime telephone number and e-mail address.
  - Ship your firearm by either United Parcel Service (UPS) or Parcel Post (US Post Office). Remington is not responsible for damage or loss during shipment, so you may elect to purchase insurance from your carrier.

## Ship to:

Remington Arms Company, Inc.  
Attn: Arms Service Division/Repairs  
14 Hoefler Ave.  
Ilion, NY 13357

**WARNING!** DO NOT SEND LIVE OR SPENT SHELLS IN YOUR FIREARM OR IN THE SAME BOX WITH THE FIREARM. THIS IS A VIOLATION OF FEDERAL LAW. IF YOU FEEL YOU MUST SEND SPENT SHELLS, PLEASE SEND THEM IN A SEPARATE PACKAGE AND INCLUDE NAME, ADDRESS (WITH ZIP CODE), TELEPHONE NUMBER, MODEL AND SERIAL NUMBER OF YOUR FIREARM.

# MODEL SP-10™ MAGNUM

## Autoloading Shotgun

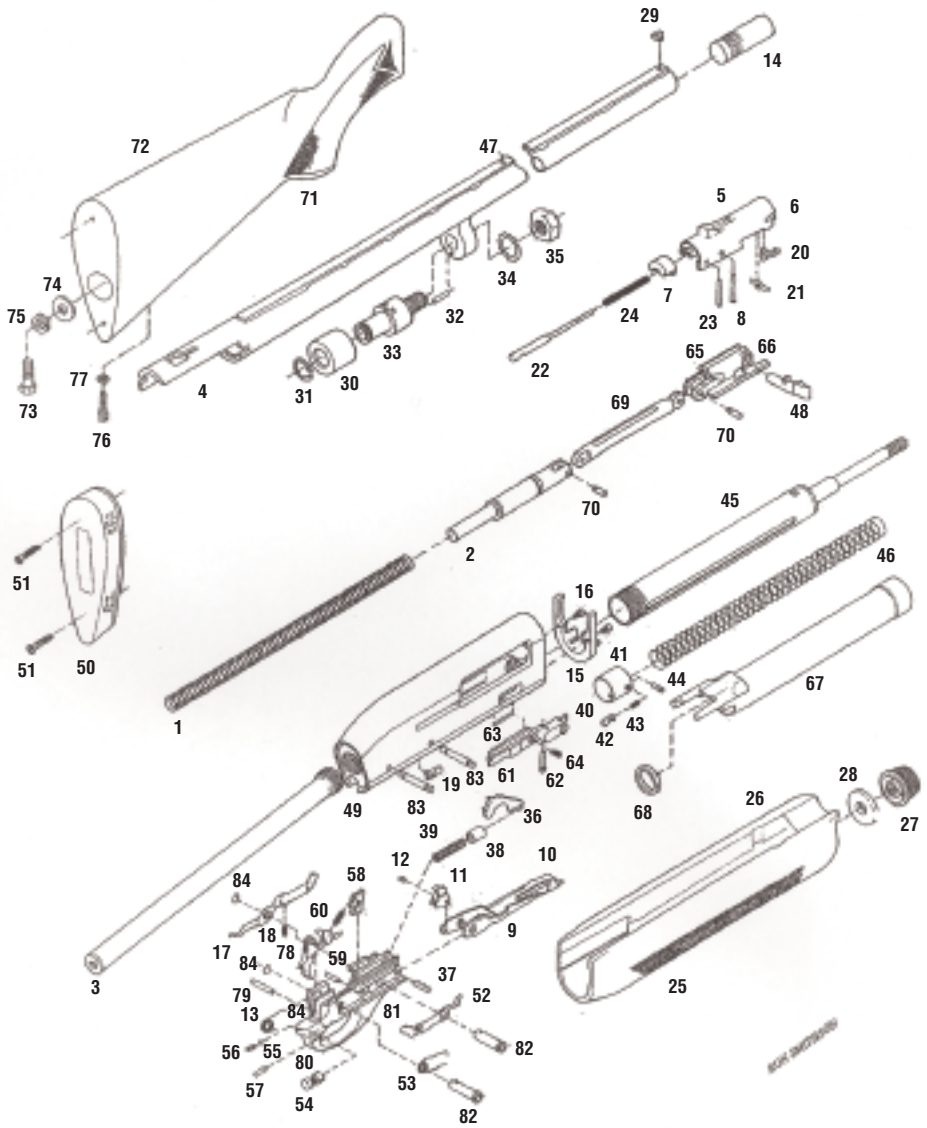

# MODEL SP-10™ Magnum

## Autoloading Shotgun PARTS LIST

VIEW #	PART NAME	VIEW #	PART NAME
<b>NOTE:</b> Parts subject to change without notice FOB Ilion, New York.			
1	Action Spring	48	Operating Handle
2	Action Spring Plunger	49	Receiver Sub-Assembly (Restricted) (Includes # 19 & # 63)
3	Action Spring Tube Assembly	50	Recoil Pad
4	Barrel Assembly	51	Recoil Pad Screw (2)
5	Bolt	52	Release Lever
6	Bolt Assembly	53	Release Lever Spring
7	Bolt Buffer	54	Safety Mechanism
8	Bolt Cam Pin	55	Safety Mechanism Detent Ball
9	Carrier	56	Safety Mechanism Spring
10	Carrier Assembly	57	Safety Mechanism Spring Retaining Pin
11	Carrier Dog	58	Sear
12	Carrier Dog Pin	59	Sear Pivot Pin
13	Carrier Dog Spring	60	Sear Spring
14	Choke Tube	61	Shell Stop
15	Collar	62	Shell Stop Pivot
16	Collar Screw (2)	63	Shell Stop Pivot Retainer
17	Disconnecter	64	Shell Stop Spring
18	Disconnecter Spring	65	Slide
19	Ejector	66	Slide Assembly
20	Extractor	67	Slide Extension Assembly
21	Extractor Plunger	68	Slide Extension Buffer
42	Extractor Spring	69	Slide Link
22	Firing Pin	70	Slide Link Pivot (2)
23	Firing Pin Retaining Pin	71	Stock
24	Firing Pin Spring	72	Stock Assembly
25	Fore-End	73	Stock Bolt
26	Fore-End Assembly	74	Stock Bolt Lockwasher
27	Fore-End Cap Assembly	75	Stock Bolt Washer
28	Fore-End Washer	76	Stock Swivel Screw
29	Front Sight	77	Stock Swivel Screw Washer
30	Gas Cylinder	78	Trigger Assembly (Restricted)
31	Gas Cylinder Retainer	79	Trigger Pivot Pin
32	Gas Lug Pin	80	Trigger Plate Sub Assembly (Restricted)
33	Gas Piston	81	Trigger Plate Assembly
34	Gas Piston Lockwasher	82	Trigger Plate Pin Bushing (2)
35	Gas Piston Nut	83	Trigger Plate Pin (2)
36	Hammer	84	Trigger Plate Detent Spring (2)
37	Hammer Pivot Pin		
38	Hammer Plunger		
39	Hammer Spring		
40	Magazine Follower		
41	Magazine Follower Assembly		
42	Magazine Follower Plunger		
43	Magazine Follower Plunger Spring		
44	Magazine Follower Plunger Retaining Pin		
45	Magazine Tube Sub-Assembly		
46	Magazine Spring		
47	Middle Sight		

# Firearm Owner's Record

---

Model \_\_\_\_\_ Serial # \_\_\_\_\_ Date Purchased \_\_\_\_\_

Purchased From \_\_\_\_\_ Price Paid \_\_\_\_\_

Remember to complete and return the Firearm Warranty Registration Card in order to obtain full benefit of your Limited Two Year Firearm Warranty.

## A WORD ON THE MAINTENANCE AND CARE OF YOUR REMINGTON FIREARM

### Don't Alter or Modify Your Gun and Have it Serviced Regularly.

*Your firearm has* been designed to operate according to certain factory specifications. You'll jeopardize your safety and that of others around you by attempting to alter its trigger, mechanical safety or other mechanisms. So never alter or modify your firearm in any way.

*Like any mechanical device,* a firearm is subject to wear. It must be maintained and periodically serviced to assure optimum safety and performance. Only a qualified service facility should service, repair or modify your Remington® firearm. Consult your instruction book for instructions on how to send your firearm to the factory or for the location of the nearest Remington Authorized Service Center. Remington recommends that you have your firearm professionally serviced annually. You should also have your firearm professionally serviced after prolonged storage, or if there is ever any question pertaining to the proper functioning characteristics of your firearm.

*Proper cleaning and lubrication* are also important to firearm maintenance and are necessary to assure accuracy, safety and reliability. Before cleaning, always make sure that your gun is completely unloaded. And always clean the barrel from the chamber end to the muzzle when possible.

## Firearm Maintenance Record

---

DATE	SERVICE PERFORMED	PERFORMED BY

*Remington*®

REMINGTON IS A TRADEMARK REGISTERED IN THE UNITED STATES PATENT  
AND TRADEMARK OFFICE BY REMINGTON ARMS COMPANY, INC.