

# Owner's Manual

Owner's Manual for:  
Remington R-15 VTR  
Modular Repeating Rifle

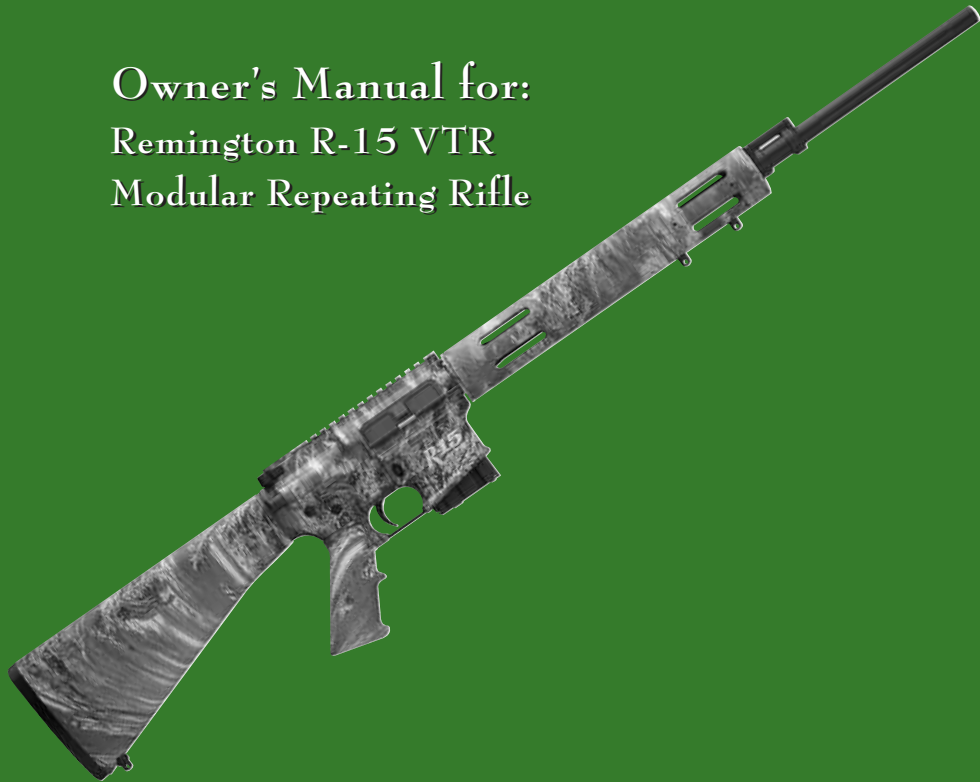

*Remington*®

**IMPORTANT!**

READ ALL WARNINGS AND  
INSTRUCTIONS IN THIS  
MANUAL BEFORE USING THIS RIFLE



## TABLE OF CONTENTS...

---

<b>Warnings / Cautions / Safe Handling</b>	2, 4-8
<b>Dangerous Procedures</b>	8
<b>About Your Remington Rifle</b>	8
<b>Rifle Controls - Identification / Location</b>	9
<b>Clearing Your Rifle</b>	9
<b>Preventative Maintenance Checks</b>	10
<b>Safety Function Check</b>	10
<b>Loading a Magazine</b>	11
<b>Loading Your Rifle</b>	11
<b>Operation / Inserting a Magazine</b>	11-12
<b>Firing Your Rifle</b>	13
<b>Unloading Your Rifle</b>	14
<b>Remedial Actions</b>	14-15
<b>Bullet Stuck in the Bore</b>	16
<b>Disassembling Your Rifle</b>	17-19
<b>Inspection / Cleaning / Lubrication</b>	20
<b>Detailed Cleaning Techniques</b>	20
<b>Cleaning the Upper Receiver</b>	21
<b>Cleaning the Bolt &amp; Carrier</b>	21-23
<b>Cleaning the Ejector</b>	23
<b>Cleaning the Lower Receiver</b>	24
<b>Lubrication / Upper &amp; Lower Receivers</b>	25
<b>Lubrication / Bolt Carrier Group</b>	25-26
<b>Reassembling Your Rifle</b>	27-30
<b>Magazine Disassembly / Reassembly</b>	31
<b>Parts Schematics</b>	32-33
<b>Warranty</b>	34

### PRACTICE SAFE FIREARMS HANDLING

**WARNING: IF THIS FIREARM IS CARELESSLY OR IMPROPERLY HANDLED, UNINTENTIONAL DISCHARGE COULD RESULT AND COULD CAUSE INJURY, DEATH, OR DAMAGE TO PROPERTY. READ THIS INSTRUCTION MANUAL PRIOR TO LOADING AND FIRING THIS FIREARM. FOLLOW ALL INSTRUCTIONS ON THE PROPER HANDLING AND SAFE USE OF THIS FIREARM  
– LIVES MAY DEPEND ON IT!**

## A Tradition of Performance and Safety.

In 1816 Eliphalet Remington was confident he could make a flintlock that was as good or better than any he could buy. His confidence was well founded. The barrel he handcrafted set a new standard for firearm accuracy and spawned generations of products that have made Remington® Arms America's leading gunmaker. While performance and style are certainly hallmarks of Remington firearms, one factor ultimately drives their performance. Safety. Eliphalet Remington never lost sight of the fact that his rifles were potentially lethal and could kill someone if handled improperly. And after more than 180 years the same holds true for any firearm, including your new Remington. Eliphalet Remington's first flintlock launched a proud tradition of accuracy and responsibility.

## Safety is Critical to Performance.

A superbly crafted gun is only as good as the hands that hold it. You can never be too careful. Shooting accidents are often caused by careless oversights such as failing to control the direction of the muzzle, failing to fully engage the safety, leaving ammunition in the chamber or using improper loads. These oversights can result in the destruction of life, limb or property. There's no calling back a bullet once it's been fired, so it's critical that you know the principles of safe gun handling and storage before you ever take your new Remington firearm out of the box.

The proper use and performance of your firearm depends on correct assembly and maintenance, so it's critical that you familiarize yourself with the information in this instruction book. Even if you're a veteran shooter with a collection of Remington firearms, take the time to read this literature. Not all firearms are the same. That means the first step in safe handling is to learn the features and requirements of your new Remington.

### THE TEN COMMANDMENTS OF FIREARM SAFETY

With the privilege of owning a firearm comes the responsibility to use it safely. You must understand and follow the Ten Commandments of Firearms Safety at all times. These time-honored safety rules apply to your ownership and handling of any firearm. They must govern your actions whenever and wherever you are involved with firearms . . . in the field, on the range, or in your home. Commit these Ten Commandments to your memory.

#### 1st COMMANDMENT

### Always Keep the Muzzle Pointed in a Safe Direction.

*This is the most important gun safety rule.* A safe direction is one in which an accidental discharge will not cause injury to yourself or others. Never allow your gun to point at anything you don't intend to shoot. Be especially careful when you're loading or unloading. Treat every gun as if it were loaded. And make it a habit to know where the muzzle is pointed at all times, even when your firearm is unloaded. No one will be injured by an accidental discharge if you keep your firearm pointed in a safe direction. It's as simple as that.

#### 2nd COMMANDMENT

### Firearms Should be Unloaded When Not in Use and Secured from Unauthorized Use.

*Load your firearm only* when you are in the field or on the range and ready to shoot. Unload your firearm as soon as you are finished shooting. Never bring a loaded firearm into your camp, home or vehicle. Unloading means unloading **both** the chamber and the magazine. Before handling a firearm or passing it on to someone else, visually check the chamber, receiver, and magazine to make sure there is no ammunition anywhere in the firearm. Never assume a firearm is unloaded, and never take someone's word for it - look for yourself. When you are finished shooting and have completely unloaded the firearm, leave its action open.

#### 2nd COMMANDMENT (cont'd)

### Firearms Should be Unloaded When Not in Use and Secured from Unauthorized Use.

*Whenever you are carrying a loaded firearm in the field*, you must unload it before crossing a fence, climbing into a tree stand or blind or in any other situation where you may not be able to fully control the firearm. Never pull or push a loaded firearm toward yourself or another person.

*Store your firearms unloaded* in a secure place where unauthorized persons cannot gain access to them. Store firearms and ammunition separately. If you use an external security device such as a cable lock or trigger lock, you must still keep the firearm unloaded when locked. Whether you utilize a locked gun safe or external locking device, it is your responsibility to make sure that children and other unauthorized persons cannot gain access to your firearm and ammunition.

#### 3rd COMMANDMENT

### Never Rely on Your Firearm's Safety Mechanism to Justify Careless Handling.

*If your firearm is equipped with a manual safety mechanism*, do not rely on the safety as an excuse for improper or careless handling of the firearm. The safety mechanism is merely a supplement to your proper handling of the firearm. The safety mechanism may be broken or altered. Even if you think you have previously engaged the safety in the "safe" position, it may have been inadvertently disengaged without your knowledge while being carried. Never assume that the safety mechanism is engaged in the "safe" position. Your assumption may be wrong or mistaken. Treat your firearms safety mechanism like you would treat any other mechanical device - as something that could break or fail.

*Not all safety mechanisms operate in the same manner.* Before using any firearm, know and understand precisely how the safety mechanism on that particular firearm operates. Never pull the trigger when the safety mechanism is in the "safe" position, and keep your fingers away from the trigger while loading, unloading, and engaging or disengaging the safety mechanism.

#### 4th COMMANDMENT

### Know Your Target and What's Beyond It.

*Never fire a shot unless you know exactly where the shot is going and what it will strike.* Bullets and shot can travel great distances with deadly velocity. When hunting game, never fire at a sound, a movement or a patch of color - an impulsive shot can have tragic consequences. A fellow hunter in camouflage may be mistaken for game by an impulsive shooter.

*In addition to being sure of your target*, you must know what lies beyond the target. In other words, make sure of your backstop. Also, beware of ricochets - never shoot at water or a hard surface.

#### 5th COMMANDMENT

### Use Proper Ammunition.

*Every firearm is designed to use only a specified caliber*, gauge or length of ammunition. Use of the wrong ammunition can cause serious personal injury or death. It is your responsibility to make sure the ammunition exactly matches the specifications for your firearm.

*Use of improperly reloaded ammunition can also be dangerous.* Firearms are designed, manufactured, and proof-tested to specified industry standards. Hand-loaded or reloaded ammunition that deviates, either intentionally or accidentally, from specified loadings can be extremely hazardous. It is strongly recommended, therefore, that you use only factory ammunition from a reputable ammunition manufacturer. If you do reload, you have assumed the risks and responsibilities of an ammunition manufacturer.

## 6th COMMANDMENT

### If Your Firearm Fails to Fire When You Pull the Trigger, Handle With Care.

If a chambered round of ammunition does not fire when you pull the trigger, stop and keep the muzzle pointed in a safe direction. Treat your firearm as if it could still discharge. Keep your face away from the breech. Slowly and carefully open the action, return the safety mechanism to the “safe” position, and unload the cartridge from the chamber. Dispose of the cartridge safely. If your firearm repeatedly fails to fire when you pull the trigger, take your firearm and ammunition to a competent gunsmith or return the firearm to the manufacturer for inspection.

## 7th COMMANDMENT

### Always Wear Eye and Ear Protection.

Wear protective shooting glasses and hearing protection when shooting. Be sure to wear eye protection when disassembling or cleaning a firearm to protect your eyes from springs and other tensioned parts. Continued exposure to shooting noise can permanently damage your hearing.

## 8th COMMANDMENT

### Be Sure the Barrel is Clear of Obstructions Before Shooting.

With your firearm completely unloaded, open the action and make sure there are no obstructions or debris in the barrel. Even a small obstruction such as snow or mud in the barrel can cause the barrel or receiver to burst when the next round is fired. Use a cleaning rod to remove obstructions and residues from the barrel. If the firing noise or recoil seems weak, stop and completely unload your firearm to check for obstructions before firing another shot. NEVER try to shoot out an obstruction by loading and firing another round of ammunition.

## 9th COMMANDMENT

### Never Alter or Modify Your Firearm and Have it Cleaned and Serviced Regularly.

Your firearm has been carefully designed and manufactured to operate according to certain factory specifications. NEVER alter or modify your firearm, especially its trigger or safety mechanism, in any way. Such alterations or modifications can adversely affect the safe operation of your firearm, endangering you and those around you.

As with any mechanical device, the parts of a firearm are subject to wear or breakage. To assure optimum safety and performance, your firearm must be maintained and serviced on a regular basis. Only a competent gunsmith or a Remington Authorized Service Center should service or repair your firearm.

Proper cleaning and lubrication are also important to maintain the safe and proper functioning of your firearm. Follow the cleaning and lubrication instructions set forth in the owner's manual for your firearm. NEVER attempt to clean or lubricate a loaded firearm.

## 10th COMMANDMENT

### Learn How Your Firearm Operates.

Not all firearms are alike. Before you use any firearm for the first time, you must become totally familiar with how that firearm operates. When you receive a new firearm, read and understand the owner's manual before assembling the firearm for the first time. If you acquire a used firearm, request an owner's manual and have the rifle inspected by a competent gunsmith to determine whether it is in good working order. If you do not have an owner's manual, contact the manufacturer to obtain one. If you are selling or trading your firearm to someone else, be sure to transfer the owner's manual to the new owner.

## LEAD EXPOSURE WARNING

Discharging firearms in poorly ventilated areas, cleaning firearms or handling ammunition may result in exposure to lead, a substance known to cause birth defects, reproductive harm, cancer and other serious physical injury. Have adequate ventilation at all times. Wash hands thoroughly after exposure.

## SHOOT SOBER!

Guns and alcohol or drugs don't mix. Never consume anything that would even mildly impair your judgement or physical coordination while handling a firearm.

## WARNING

Failure to follow any of these safety rules may cause personal injury or death to the shooter or bystander and damage to property. Do not use a firearm until you fully understand and practice the Ten Commandments of Firearm Safety. If you have any questions about the safe use of any Remington firearm, write to us at Remington Arms Company, Inc., Consumer Service, P.O. Box 700, Madison, NC 27025-0700, or call us at 1-800-243-9700.

## DON'T KEEP THIS TO YOURSELF

Now that you're a gun owner you have the obligation to help ensure that shooting sports are safe for everyone—participants and bystanders alike. You can do that by practicing these principles of firearm safety and passing them on to others—especially new shooters. Set an example for beginners. Be a guide to their safe entry into the exciting world of shooting sports. Invest your time and patience for the love of the sport and for its future. After all, it's your love of the sport that led you to buy a new Remington. Firearm ownership is a right and privilege. It's a right guaranteed in this nation's Constitution. It's a privilege which carries with it a personal responsibility to use your firearm in a way which will ensure your safety and the safety of others. The preservation of this right and privilege depends on the personal commitment of you and your fellow shooters to the safe and responsible use of firearms. Let the Ten Commandments of Firearm Safety outlined in the book guide you at all times. Teach and promote these rules whenever you can. Remember, firearm safety depends on you! That's the only way to really enjoy your new Remington firearm and to preserve sport shooting as we know it today.

## Important Parts of the Firearm

Congratulations on your choice of a Remington® R-15 VTR Modular Repeating Rifle. With proper care and if used in accordance with the Ten Commandments of Firearm's Safety and this Owner's Manual, your rifle should give you many years of dependable use and enjoyment. The following picture depicts the main parts of your rifle and will aid in understanding the instructions in this Owner's Manual.

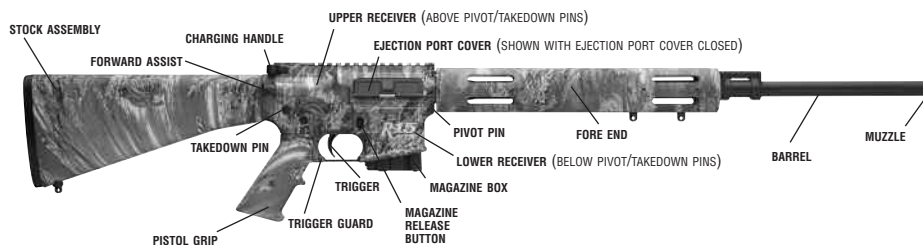

This picture shows the main parts of a Remington R-15 VTR Modular Repeating Rifle. The picture will aid in understanding the instructions in his manual.

**⚠ WARNING: THIS FIREARM COULD CHAMBER A ROUND ⚠** if it is dropped or jarred with a loaded magazine in place - either with the Bolt Carrier Assembly locked to the rear, or in its forward position.

**⚠ WARNING: BEWARE OF DANGEROUS PROCEDURES ⚠**

Be sure Cam Pin is installed in the Bolt Group. If it isn't, your rifle can still fire and **MAY EXPLODE**.

- If your rifle stops firing with a live round in the chamber of a hot barrel (a misfire), **REMOVE THE CHAMBERED ROUND IMMEDIATELY!** However, if you are unable to remove the round within 10 seconds, remove the magazine and wait 15 minutes **with the Rifle Pointing in a SAFE DIRECTION!** This way no one will be hurt by a possible round “cooking-off” (i.e. the round detonating just from the heat of the barrel). In any event, keep your face away from the ejection port while clearing a hot chamber.
- Whenever you are handling the rifle or clearing a chambered round, control the direction of the muzzle and **keep yourself clear of the Muzzle!**
- If there is water in the barrel, do not fire the rifle. **IT COULD EXPLODE!**
- If you hear a noticeable difference in sound or recoil is experienced, **STOP FIRING!** Either condition could indicate an incomplete powder burn and/or a bullet stuck in the bore.

This Owner's Manual covers only **Remington R-15 VTR Modular Repeating rifles**. These firearms are lightweight, gas operated, air-cooled, magazine-fed rifles that are **Semi-Automatic** in operating mode (i.e., a single round will fire each time the trigger is pulled).

- On all models, the Upper And Lower Receivers are easily opened for cleaning and inspection. R-15 Models have forged aluminum Upper and Lower Receivers.
- Barrels are either Chrome Moly Vanadium Steel or 416 Stainless Steel. The Bolt Group locks into the Barrel Extension with 7 locking lugs.
- R-15 VTR rifles can be configured with either 6 position Telescoping Buttstocks or Fixed Buttstocks. Forends are free-float tubes machined from aluminum alloy. Magazine capacity is 5 rounds standard, but all AR-15/M-16 Type magazines of capacities from 5 to 40 rounds will fit the R-15 VTR and function in it.

## Rifle Features & Controls – Identification/Location

### Remington R-15 VTR Rifle (VTR Predator Depicted)

#### Right Side of the R-15 VTR

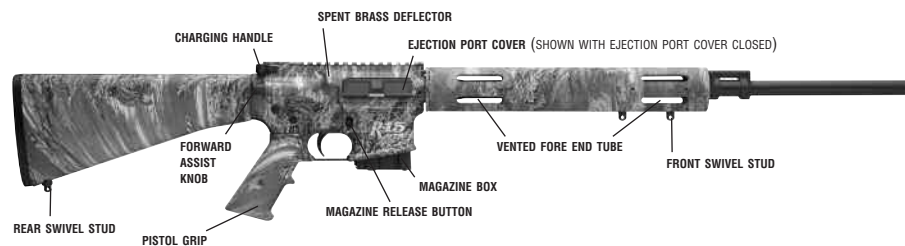

#### Left Side of the R-15 VTR

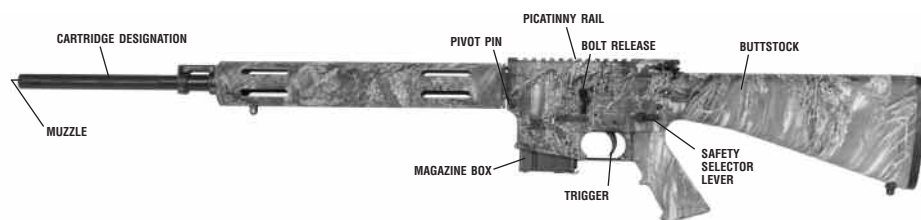

## Clearing Your Rifle

**ALWAYS FOLLOW THE RULES OF SAFE GUN HANDLING.** Assume the rifle is loaded, and then proceed – according to the following steps – to **CLEAR YOUR RIFLE:**

1. Point Rifle in a **SAFE DIRECTION!**
2. Place Safety Selector Lever on SAFE. **NOTE: If the rifle is not cocked, the Safety Selector Lever cannot be placed on SAFE.**
3. Press Magazine Release Button and remove Magazine. (picture 1)
4. To Lock Bolt Open, Pull Charging Handle to rear (picture 2). Press lower portion of Bolt Release and allow Bolt to move forward until it engages Bolt Catch. Return Charging Handle to forward. Make sure the safety selector lever is on **SAFE**.



Picture 1

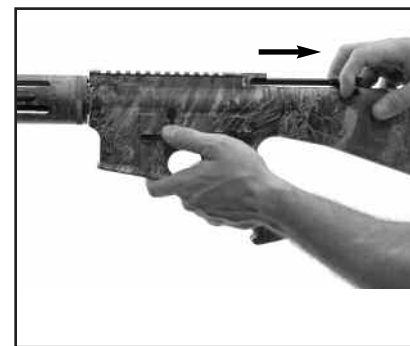

Picture 2



## Preventative Maintenance Checks & Services

---

### CHECK BEFORE YOU FIRE:

1. With your rifle completely **UNLOADED** and the bolt locked open, check to see that there is **NO EXCESSIVE OIL** in the Bore. If there is, swab it out with a patch and the cleaning rod. **ALWAYS CLEAN A NEW RIFLE BEFORE FIRING THE FIRST TIME.**  
**WARNING!** If the rifle is fired with oil, water, or other obstructions in the barrel, excessive pressure may be created causing the rifle to explode.
2. Retract the Bolt to ensure free movement between Bolt Carrier and Gas Tube. (picture 3)
3. Perform Safety Function Check (below) to ensure that Safety Selector Lever works properly.



Picture 3

## Safety Function Check

---

1. Remove Magazine. Pull Charging Handle completely to rear. Visually check to make sure the Chamber is clear and empty. Close the Bolt and Bolt Carrier close.
2. Place Selector Lever in **SAFE** position, point rifle in a safe direction, and pull Trigger. **THE HAMMER SHOULD NOT FALL.**
3. Place Safety Selector Lever in **FIRE** position. Pull the Trigger. **THE HAMMER SHOULD FALL.**
4. Hold Trigger to the rear, pull Charging Handle to the rear and release Charging Handle. Then release pressure on the Trigger with a slow, smooth motion, without hesitations or stops, until the Trigger is fully forward. **NOTE:** For purposes of this check, "SLOW" is defined as one fourth to one half the normal rate of trigger release. **AN AUDIBLE CLICK SHOULD BE HEARD - THE HAMMER SHOULD NOT FALL.**
5. Repeat this Safety function test **FIVE TIMES**. The Rifle must not malfunction during any of these five tests. If the Rifle malfunctions during any of these tests, stop using the rifle and have it serviced by a Remington Authorized Repair Center.

## Loading A Magazine

---

1. Use only quality commercially manufactured ammunition and the caliber specified for use in your rifle. Always examine your ammunition to confirm that the ammunition you are using matches the specified ammunition markings on the barrel of your rifle. Examine each Cartridge - particularly around the primer. Look for dents, scratches, and other signs of damage. **DO NOT USE DAMAGED OR RELOADED AMMUNITION!**
2. With the Magazine facing forward as shown in the illustration, place a Round between the Feed Lips of the Magazine with the Bullet Tip forward. Push the Round down until it is held by the Magazine Feed Lips. (picture 4)

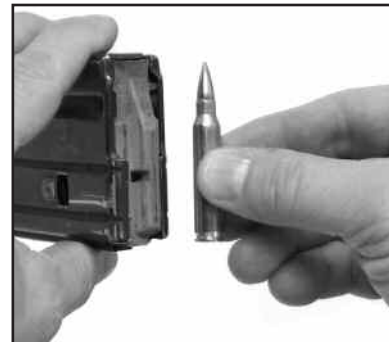

Picture 4

3. If necessary, give the Round a slight push backward to seat it against the inside back edge of the Magazine Feed Lips. Place next Round on top of the previous Round and repeat steps until desired number of Rounds are loaded into Magazine. **CAUTION:** Safe Firearms Handling dictates that you **ONLY LOAD LIVE AMMUNITION INTO YOUR RIFLE WHEN YOU ARE ABOUT TO SHOOT.**

## Loading Your Rifle

---

**WARNING: ALWAYS KEEP THE MUZZLE POINTED IN A SAFE DIRECTION THROUGHOUT THE LOADING PROCESS!**

1. Place Safety Selector Lever on **SAFE**.
2. Pull charging handle completely to the rear end of shell, and check the Firing Chamber. Make sure it is **CLEAR!** (picture 3)
3. Return Charging Handle to forward, locked position. Push loaded Magazine up into Magazine Well until Magazine Catch engages and holds the Magazine. (picture 5)
4. Slap upwards on Magazine bottom to make sure it is seated correctly. (picture 6)

## Loading Your Rifle...cont'd

**NOTE:** The Magazine may be inserted into the Rifle with the Bolt Assembly Open or Closed.

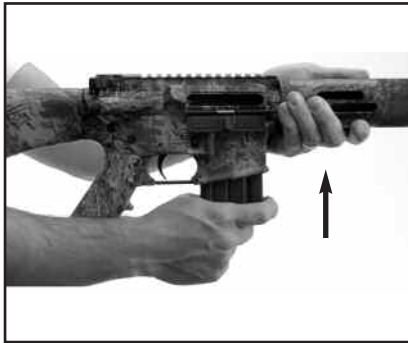

Picture 5

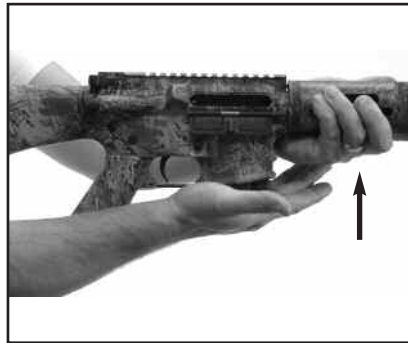

Picture 6

5. Depress upper portion of Bolt Release. Bolt should spring forward. This will chamber a round from the Magazine into the firing chamber. (picture 7) If the Bolt Assembly is open, depress upper portion of Bolt Release. Bolt should spring forward. This will chamber a round from the Magazine into the Chamber. (picture 7) If the Bolt Assembly in closed, pull the Charging Handle fully to the rear, then release the Charging Handle allowing the bolt to spring forward. This will chamber the first round. (picture 9) Never "ride" or "push" the Charging Handle forward. (picture 10) Let it move forward on its own.
6. TAP the Forward Assist with the heel of your hand to ensure that the Bolt is fully forward and locked. **RIFLE IS NOW READY TO BE AIMED AND FIRED!** (picture 8)

**CONDITION:** Rifle is now Loaded, a Round is Chambered, and Safety Selector should be on **SAFE**.



Picture 7



Picture 8

**NOTE:** If Rifle is not going to be fired immediately, make sure the Selector Lever is still on **SAFE**, and close the Ejection Port Cover to keep dirt out of the Chamber and Upper Receiver.

**⚠ WARNING: THE RIFLE CAN FIRE A CHAMBERED ROUND EVEN IF THE MAGAZINE HAS BEEN REMOVED.**

## Loading Your Rifle...cont'd



Picture 9



Picture 10

**WARNING: KEEP THE MUZZLE POINTED IN A SAFE DIRECTION!**

## Firing Your Rifle

1. Once a round is chambered and you are ready to commence firing, move the Safety Selector from **SAFE** to **FIRE**.
2. Aim at the target.
3. Pull or squeeze the trigger.
4. As the rifle fires, release the trigger.
5. The Rifle will automatically eject the spent Cartridge and chamber another in preparation for the next shot. The cycle of pulling the Trigger to shoot, and the Rifle automatically reloading, can be continued until the Magazine and chamber are empty. If you stop firing before the chamber is empty, immediately place the Safety Selector in the **SAFE** position.

**NOTE:** After the last Round is fired, the Bolt Carrier will lock in the rear position. You can then push the Magazine Release Button to drop out the empty magazine, insert a fresh Magazine, release the Bolt Catch, and a new Round will be automatically chambered in preparation for the next firing sequence.

**⚠ WARNING ⚠ IF A NOTICEABLE DIFFERENCE IN SOUND OR RECOIL IS EXPERIENCED, STOP FIRING IMMEDIATELY.**

Either condition could indicate an incomplete powder burn and/or a bullet stuck in the bore. Remove the Magazine and retract the bolt to empty the chamber. Check for unburned powder grains in the Receiver or Bore, and for a Bullet stuck in the Bore (see Page 16). Clean out any unburned powder before resuming firing. If a Bullet is stuck in the Bore, do not attempt to remove it. Take the Rifle to a Remington Authorized Repair Center for removal.

**WARNING... DO NOT LOAD WITH A HOT CHAMBER – A ROUND MAY “COOK OFF”.**

“Cooking Off” means that a Round may Detonate (Fire) unexpectedly just from being exposed to the heat of the Rifle's Firing Chamber.

## Unloading Your Rifle

**⚠ WARNING ⚠ ALWAYS KEEP THE MUZZLE POINTED IN A SAFE DIRECTION THROUGHOUT THE LOADING PROCESS!**

1. Place Safety Selector on **SAFE**.
2. Press Magazine Release Button and remove Magazine.
3. Pull Charging Handle to rear. Press lower portion of Bolt Release. Bolt should lock open. If a round was in the chamber, it should have been ejected. If last round was fired, bolt should already have been locked to the rear.
4. Visually check chamber through ejection port to make sure chamber is empty.
5. With the Magazine removed and the chamber empty, you may now close the bolt by depressing the top portion of the Bolt Release which will allow the bolt to return forward on the empty chamber.
6. Empty the Magazine by sliding the remaining cartridges forward and out of the Magazine.

**CONDITION:** The rifle and magazine are now completely unloaded.  
Securely store ammunition and rifle separately.

## Remedial Actions

**IF YOUR RIFLE STOPS FIRING, Perform the following IMMEDIATE ACTIONS**

1. SLAP upward on Magazine to make sure it is properly seated. (picture 6)
2. PULL Charging Handle all the way back (picture 3). Observe the ejection of the Case or Cartridge. Check Firing Chamber for any obstruction.



Picture 6



Picture 3

3. If Cartridge or Case is ejected, or Chamber is clear, RELEASE Charging Handle to feed a new Round into the chamber. (picture 9) Don't "ride" the Charging Handle forward.
4. Tap Forward Assist to ensure Bolt is locked. (picture 8)
5. Now **FIRE**. (picture 11)

## Remedial Actions...cont'd

**NOTE:** If pulling the charging handle fully to the rear does not extract and eject the chambered cartridge or casing (step 2), then the cartridge or casing may be stuck in the chamber. If this occurs do the following:

- a. Remove the magazine.
- b. Lock the bolt open.
- c. Open the receiver (pictures 14-16).
- d. Remove the Bolt Carrier and Bolt (pictures 17-18).
- e. Try to tap out cartridge or casing with a cleaning rod (picture 12).



Picture 9



Picture 8



Picture 11



Picture 3

**IF THE CARTRIDGE OR CASE CANNOT BE TAPPED OUT WITH THE CLEANING ROD, TAKE THE RIFLE TO A REMINGTON AUTHORIZED REPAIR CENTER**



## Bullet Stuck In The Bore

**WARNING: IF AN AUDIBLE “POP” OR REDUCED RECOIL IS EXPERIENCED DURING FIRING, IMMEDIATELY CEASE FIRING AND THEN PERFORM THE FOLLOWING STEPS:**

1. Place the Selector Lever on **SAFE**.
2. Remove the Magazine (**picture 1**)
2. Lock the Bolt to the rear. (**picture 3**)
3. Use a cleaning rod to check for a Bullet in the Bore. (**picture 12**)



Picture 1



Picture 3



Picture 12



**WARNING**

**IF A BULLET IS STUCK IN THE BARREL, FOR REMOVAL, DO NOT TRY TO REMOVE IT. TAKE THE RIFLE TO A REMINGTON AUTHORIZED REPAIR CENTER.**

## Disassembly

1. **CLEAR YOUR RIFLE!** (follow these steps as described on Page 9). If attached, disconnect the Sling for convenience.
2. Push in Takedown Pin (a metal punch may help) as far as it will go. (**picture 14**) Pivot Upper Receiver from Lower Receiver. (**picture 15**)
3. Push in Pivot Pin (a metal punch may help). (**picture 15**)
4. Pivot Lower Receiver down and away from Upper Receiver. (**picture 16**)



Picture 14



Picture 15

5. Push in Pivot Pin (a metal punch may help).
6. Remove Bolt Carrier and Bolt. (**picture 17-18**)



Picture 16



Picture 17

7. Remove Charging Handle by pulling back and up until “Ears” clear cutouts in Receiver. (**picture 19**)
8. Remove Firing Pin Retaining Pin. A metal punch or pliers may help to remove it from the Bolt Carrier. (**picture 20**)

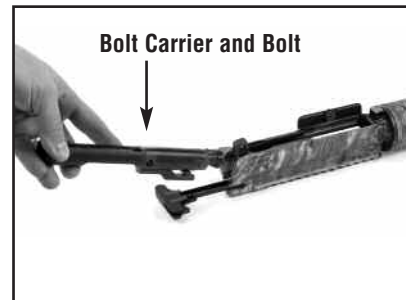

Picture 18

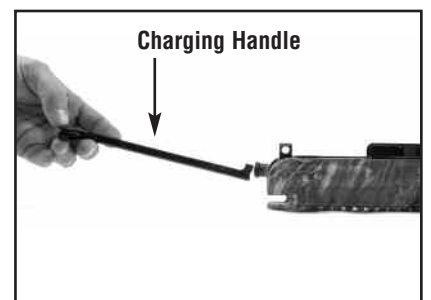

Picture 19

**NOTE:** Wear protective eyewear during disassembly to protect your eyes from spring loaded components.

9. Drop Firing Pin out of rear of Bolt Carrier. (picture 21)
10. Push Bolt in to locked position. (picture 22)



Picture 20



Picture 21



Picture 22

11. Remove Cam Pin by rotating 1/4 turn and lifting out. (picture 23)
12. Remove Bolt Assembly from Bolt Carrier by pulling straight out. (picture 24)

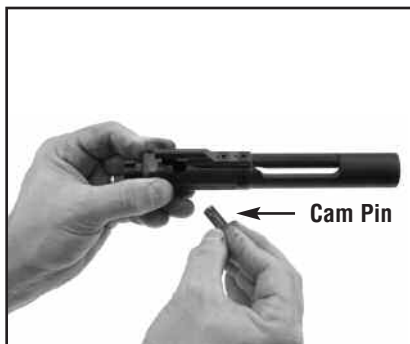

Picture 23

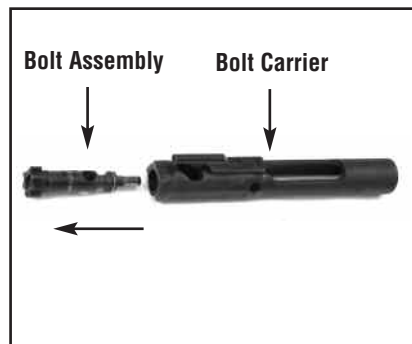

Picture 24

**DISASSEMBLE USING STEPS 13 THRU 16 ONLY WHEN DIRTY.**

**NOTE:** Before removing extractor pin, be prepared to stop movement of extractor spring.

13. Remove Extractor Pin by pushing out with a metal punch. (picture 25)

**PUSH EXTRACTOR PIN OUT...** Don't lose it!

**NOTE:** Press rear of Extractor to check Spring function.



Picture 25

14. Remove Extractor with Spring. (picture 26)

**CAUTION:** Extractor Spring may pop out and get lost!

15. With Hammer cocked, depress Buffer Retainer with metal punch to release Buffer and Spring.

**CAUTION:** Maintain pressure on buffer as it is under tension from Action Spring. (picture 27)

**NOTE:** Hammer must be cocked to allow Buffer and Spring to clear Receiver.



Picture 26



Picture 27

16. Pull out Buffer and Action Spring for cleaning. (picture 28)



Picture 28

**REMINGTON DOES NOT RECOMMEND ANY FURTHER DISASSEMBLY OF YOUR RIFLE.**

## Inspection – Cleaning – Lubrication

**AFTER FIRING YOUR RIFLE**, clean it as soon as possible to make the job easier and to avoid allowing the development of any corrosion.

**When your firearm has not been fired**, you should clean it once or twice a year if you live in a temperate climate, or as often as once a week in a tropical climate.

**If you get your firearm wet**, clean it as soon as possible to avoid the onset of corrosion or rust. Use a high quality Remington rifle cleaning kit that includes a cleaning rod; swab holder; cotton flannel bore patches; a small nylon brush; brass wire bristle bore and chamber brushes and a high quality action cleaner such as Rem Action Cleaner, a high quality gun oil such as Rem Oil and Remington Brite Bore or 40-X Bore Cleaner.

**After you have disassembled the rifle, thoroughly clean, inspect and lubricate all parts according to the techniques described below.**

### Detailed Cleaning Techniques



**WARNING**

**NEVER CLEAN A LOADED FIREARM. BEFORE CLEANING, COMPLETELY UNLOAD THE RIFLE AND DISASSEMBLE AS NECESSARY.**

**CLEANING THE BORE:** The bore of your Remington R-15 rifle has Lands and Grooves called rifling. Rifling makes the bullet spin very fast as it moves down the Bore and down range. It is difficult to **push** a new, stiff Bore Brush through the Bore. You will find it much easier, and more effective, to **pull your Bore Brush through the Bore**. Also, because the brush will clean better if the bristles follow the grooves (this is called tracking), you want the Bore Brush to be allowed to turn as you pull it through. A high quality cleaning rod with a ball bearing handle which allows the brush to turn as it passes through the bore will assist in cleaning your rifle.

**ALWAYS CLEAN FROM FROM CHAMBER TOWARD THE MUZZLE.** Follow these steps:

1. Assemble your cleaning rod if required. Attach the Patch Holder to cleaning rod.
2. Point Muzzle down. Hold the Upper Receiver in one hand while inserting the end of the Rod with Patch Holder attached into the Chamber. Guide the Rod carefully through the Bore. **CAUTION:** Do not let the Rod or its threaded end scratch the Bore or Firing Chamber. About 2 - 3 inches of the Rod should protrude out of the Muzzle.
3. Attach the Handle Section of the Cleaning Rod to the end of the Rod sticking out of the Muzzle (if required), and swab out the Bore with a patch moistened with a high quality bore cleaner such as Remington Brite Bore or 40-X Bore Cleaner.
4. Remove Patch Holder and attach Bore Brush.
5. Pull the Brush through the Bore and out the Muzzle. You should be able to see the Rod twisting as you pull it - this is the Brush "tracking" in the rifling.  
**NEVER** reverse the direction of the Bore Brush while it is in the Bore.
6. After one pull, take off the handle section and repeat the process. After three or four pulls, the three rod sections and the Bore Brush may become screwed tightly together. Loosen them up and repeat the process.
7. Run a patch through the Bore occasionally to help clean out the debris that the brush has loosened. Just replace the Bore Brush with the Rod Tip (Patch Holder) and a wet patch. Pull it through. Always have the Bore **wet with cleaner** before trying to pull a brush through.

## Cleaning The Upper Receiver

**NOTE:** Check to ensure that there is no looseness between the Barrel and the Upper Receiver - if you detect any movement by twisting with your hands, the Barrel Nut must be retorqued. Take the Rifle to a qualified gunsmith or Remington Authorized Repair Center for such maintenance.

1. Using a high quality cleaner such as Rem Action Cleaner, clean all areas (inside and out) of Powder Fouling, Corrosion and Dirt. **NEVER** use a wire brush or any type of abrasive to clean the Aluminum Upper Receiver - you may scratch and damage the finish. A toothbrush or stiff bristle nylon brush is good for loosening any dirt buildup, and won't scratch the Receiver.
2. Clean the Firing Chamber. Dip a Chamber Brush in bore cleaner and use at least 5 plunge strokes and 3 - 360° clockwise rotations. Then swab out the Bore as described previously to remove contaminated solution or loosened debris. (picture 29)
3. Use the Bore Brush - wet with bore cleaner - to clean carbon and powder residue from around the Gas Tube. Run a Pipe Cleaner into the Gas Tube, clean the Bolt Locking Lugs, Bolt Rings, Firing Pin, Bolt Cam Pin, lip of the Extractor, and inside the Bolt Carrier from both front and rear.
4. Wipe all components clean and dry, and inspect for excessive wear, corrosion or mechanical damage. If you notice any excessive wear or damaged components, **DO NOT FIRE THE RIFLE**. Have the rifle inspected by a Remington Authorized Repair Center.



Picture 29

### Cleaning The Bolt, Bolt Carrier & Components

1. Clean out the Gas Key on top of the Bolt Carrier with a cotton swab or a Pipe Cleaner. Also clean out any carbon/powder residue from vent holes in the Bolt Carrier. (picture 30)
2. Clean and inspect Bolt, Cam Pin, Firing Pin and Firing Pin Retaining Pin thoroughly.  
**CHECK THE BOLT:** Look for cracks or fractures, especially in the Cam Pin hole area. (picture 31) Inspect Bolt Face - Bolts with any pitting extending into the firing pin hole should be replaced. (picture 32)  
**CHECK THE CAM PIN:** If it is cracked, or chipped, it should be replaced. **NOTE:** Cam Pin can only be installed in Bolt from one side - so Ejector will be positioned correctly. (picture 31A)  
**CHECK THE FIRING PIN:** If it is bent, cracked, too blunted or too sharp, it should be replaced. (picture 31B)  
**CHECK THE FIRING PIN RETAINING PIN:** If it is bent, or badly worn, it should be replaced. Never use a "Cotter Pin" as a substitute for a real Firing Pin Retaining Pin. Cotter pins are not made of heat treated spring steel and their round head shape will cause damage. (picture 31C)  
(Pictures 30, 31, 31A, 31B, 31C are on page 22)

**WARNING: IF THE CAM PIN IS MISSING, DO NOT FIRE THE RIFLE - IT MAY EXPLODE!**

## CLEAN OUT GAS KEY AND CARRIER VENT HOLES



Picture 30

## BOLT CAM PIN FIRING PIN FIRING PIN RETAINING PIN



Picture 31



Picture 31B



Picture 31A



Picture 31C

## INSPECT BOLT FACE



Picture 32

**3. CHECK THE EXTRACTOR AND EXTRACTOR SPRING:** If the Extractor is chipped, or has broken edges in the area of the lip that engages the cartridge rim, it should be replaced. Check that the rubber insert is inside the Extractor Spring. Clean off any Carbon buildup or powder residue. (picture 33)

## EXTRACTOR



Picture 33

## Cleaning /Lubricating the Ejector

**NOTE:** The design of the Ejector makes its disassembly for cleaning somewhat impractical (i.e. we don't recommend it). Make sure your rifle ejects empty cases efficiently by following these steps on a monthly basis (more frequently if firing blanks).

1. With the Bolt removed from the Bolt Carrier and the Extractor installed, hold it as shown, and dribble a few drops of Rem Oil around the Ejector to form a puddle. (picture 34)
2. Take a fired or dummy case and place it under the lip of the Extractor. With a rocking motion, press the case down against the Ejector. Since the Ejector is spring loaded, some resistance will be felt. Press on the case until it stops against the bolt face. Ease off with your thumb slightly and press down again. Repeat several times. Replace the Rem Oil frequently. Once the spring action of the Ejector is smooth and strong, dry off any excess lubricant. (picture 35)

## EJECTOR



Picture 34

## ROCK EMPTY CASE AGAINST EJECTOR TO LUBRICATE



Picture 35

## Cleaning The Lower Receiver

1. Clean all areas of Powder Fouling, Corrosion, Dirt and Rust. Again, never use a wire brush or any type of abrasive to clean the Aluminum Lower Receiver.
2. Wipe any dirt from the Trigger Mechanism. Carefully clean the Magazine Release Button and the cavity for the Magazine Catch on the left side of the Receiver. Also inspect and clean the Bolt Catch Mechanism and Receiver's Takedown and Pivot Pins. Clean the Buffer, Action Spring, and inside the Lower Receiver Extension (the Buffer Tube). A rag attached to the Cleaning Rod and Patch Holder can be used to wipe inside the Buffer Tube. (picture 28)

### CLEAN INSIDE OF BUFFER TUBE



Picture 28

3. If rifle has been used in very dirty/muddy conditions, the Vent Screw in the fixed Buttstock (shown) or the Vent Hole in the Telestock Receiver Extension may need to be cleaned out. Use a Pipe Cleaner or piece of wire to ensure that Vent Hole is clear. (picture 36)
4. Telescoping Buttstocks may require cleaning as necessary. Telescoping Stock Latch can be pulled down to remove Stock. Clean the 6 Position Lock Holes, and lightly lube the Receiver Extension and Latch Mechanism to ensure proper telescoping action. Solid Buttstocks may require cleaning / lubrication of Storage Compartment Door Latch (if present) and Hinge, and interior of Storage Compartment.

### CLEAN OUT DRAIN HOLE IN THE BUTTPLATE SCREW



Picture 36

## Lubrication – Upper & Lower Receivers

### Upper Receiver

**Lightly Lubricate** the inside of Upper Receiver, the Bore and Chamber (using the cleaning rod and a patch), the outer surfaces of the Barrel, and surfaces under the Handguards. Be sure you lubricate in and around all the Locking Lugs. The Forward Assist should also be lightly lubed inside the Receiver and checked for function.

### Lower Receiver

**Lower Receiver Extension:** Lightly lubricate inside the Lower Receiver Extension (Buffer Tube), the Buffer and the Action Spring. Also lightly lubricate the Telescoping stock Latch (collapsible stock models only) and exterior of the Receiver Extension. Lower Receiver: Generously lubricate **ALL MOVING PARTS INSIDE THE LOWER RECEIVER** with Rem Oil including the Trigger, Hammer, Safety, Bolt Catch, Magazine Release, etc), and their various Pins and Detents. Don't forget the Takedown and Pivot Pins and their Detents. Use an oiled rag to wipe off any fingerprints on the exterior surfaces (they can start the corrosion process). A black cloth is best as it won't leave visible lint.

## Lubrication – Bolt Carrier Group

**Firing Pin:** Lightly lubricate the Firing Pin with Rem Oil – also the Firing Pin recess in the Bolt. (picture 31-31B)

**Bolt:** Generously lubricate the Bolt, its Cam Pin area, the Bolt Gas Rings. A lighter application is good on the Extractor and it's Pin. (picture 31 A and C)



Picture 31



Picture 31B



Picture 31A



Picture 31C



## Lubrication – Bolt Carrier Group...cont'd

**Charging Handle:** Lightly lubricate the Charging Handle and its Latch and Spring.

**Bolt Carrier:** Lightly lubricate the inner and outer surfaces of the Bolt Carrier. Generously lubricate the Cam Pin area and the "Slide" Rail areas of the Bolt Carrier where they contact the inside of the Receiver. **(picture 38)**

**Carrier Key:** The inside of the Carrier Key on the Bolt Carrier should be dried with a cotton swab or Pipe Cleaner - then place one drop of Rem Oil inside. **(picture 39)**

CARRIER KEY SLIDE RAIL AREAS (each side)



Picture 38



Picture 39

## Reassembly

To reassemble the rifle, follow these steps:

1. Insert Action Spring and Buffer (the Spring will lock onto the Buffer if you slide it on - then push and twist counterclockwise). Depress Buffer Detent and push Buffer in past the Detent, then release. **(picture 27)**



Picture 28

RUBBER INSERT



Picture 40

INSERT EXTRACTOR INTO BOLT



Picture 41

2. Insert Extractor and Spring. **NOTE:** Extractor Assembly has a Rubber Insert within the Spring. Be sure not to lose it. If the Spring comes loose, put the large end of the Spring in the extractor and seat it (a metal punch works well). **(picture 40)**
3. Then push down on Extractor to depress Spring, and reinsert Extractor Pin. **(picture 41)**
4. At the back end of the Bolt, stagger the Gas Ring Gaps to reduce gas pressure loss. Position the three ring gaps 120° apart around the bolt (3rd gap not seen at back side of bolt). The rings will slide around in their groove by pushing them into position with a small sharp object. **(picture 42)**

GAPS IN GAS RINGS BOLT BODY

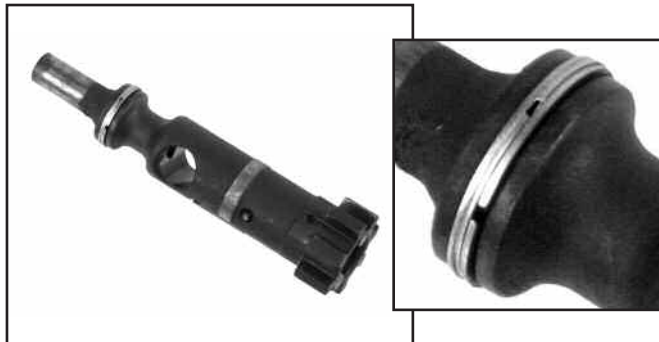

Picture 42

5. Insert Bolt into Bolt Carrier. Twist into position so Cam Pin can be inserted (remember Cam Pin can only be installed in Bolt from one side, so if it doesn't fit right away, twist the Bolt 180° and try again). (picture 43)
6. Once Cam Pin is inserted, twist it 90° (this will allow insertion of the Firing Pin).



Picture 43

**WARNING: THE CAM PIN MUST BE INSTALLED IN THE BOLT GROUP. IF IT ISN'T, YOUR RIFLE CAN STILL FIRE AND MAY EXPLODE!**

7. Drop in and seat Firing Pin. (picture 44) Pull Bolt out (picture 45), then reinsert Firing Pin Retaining Pin. (picture 46) **NOTE:** After inserting Firing Pin Retaining Pin, Firing Pin should not fall out when Bolt Carrier Group is turned upside down.

INSERT FIRING PIN

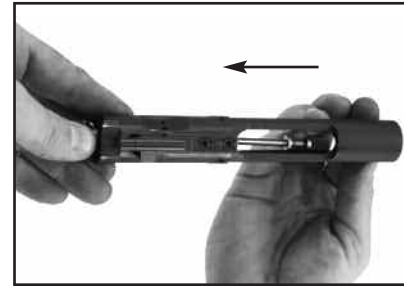

Picture 44

PULL BOLT OUT

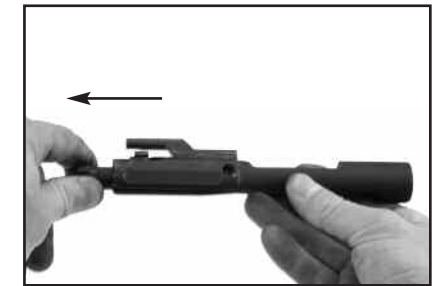

Picture 45

INSERT FIRING PIN RETAINING PIN



Picture 46

**CAUTION: NEVER INTERCHANGE BOLTS BETWEEN DIFFERENT RIFLES. DOING SO COULD RESULT IN DAMAGE, PERSONAL INJURY OR DEATH.**

8. Insert Charging Handle into Upper Receiver and lower the "ears" at front end of Handle into cutouts in Receiver. Then slide Charging Handle partially into Receiver. (picture 19)



Picture 19

## Reassembling Your Rifle...cont'd

- Lower complete Bolt Carrier Assembly into Upper Receiver. **(picture 18)** Gas Key will fit into groove in the Charging Handle. **REMEMBER**, Bolt must be pulled to "out" position in the Carrier so Cam Pin will fit into the channel in the Upper Receiver.
- Then slide the Bolt Carrier Assembly and Charging Handle all the way into the Upper Receiver until Charging Handle Latch locks onto the Receiver. **(picture 17)**  
**NOTE:** If Ejection Port Cover is closed, you will feel some resistance as you push Carrier and Handle in until you pop the Cover open. If Cover is already open, Handle and Carrier should slide in easily.



Picture 18



Picture 17

- To join Upper and Lower Receivers, position Pivot Pin Lug of Upper Receiver into slot at front of Lower Receiver and push Pivot Pin into place. **(picture 47)**  
**CAUTION: ALWAYS** place the Safety Selector Lever on **SAFE** before pivoting the Upper Receiver to a closed position on the Lower Receiver.
- After Receivers are closed, push in Takedown Pin.  
**NOTE:** Pivot Pin and Takedown Pin are "captivated" in the Lower Receiver - meaning that they are held in by their Detents and Springs so they cannot fall out and get lost



Picture 47

## Magazine Disassembly/Reassembly

Most Mil. Spec. design M-16 / AR-15 type Magazines can be disassembled for cleaning. The Magazine Spring, Magazine Follower and Magazine Baseplate can be replaced if broken or excessively worn.

- To disassemble Magazine, pry up on bottom of Baseplate using a punch, and push indentations in Baseplate past Magazine Body. **(picture 48)**
- Slide Baseplate out of Magazine Body. **(picture 49)**



Picture 48



Picture 49

- Remove Magazine Spring and Follower out of magazine box body. **(picture 50)**  
**TO CLEAN and LUBRICATE:** Wipe all dirt from the Magazine Body, Spring, Baseplate and Follower. Then lightly lubricate the Spring.  
**REASSEMBLY** is the REVERSE of these steps. Make sure to slide the base under all four tabs until it snaps back under the catch.  
**NOTE:** Do not remove Follower from Spring.

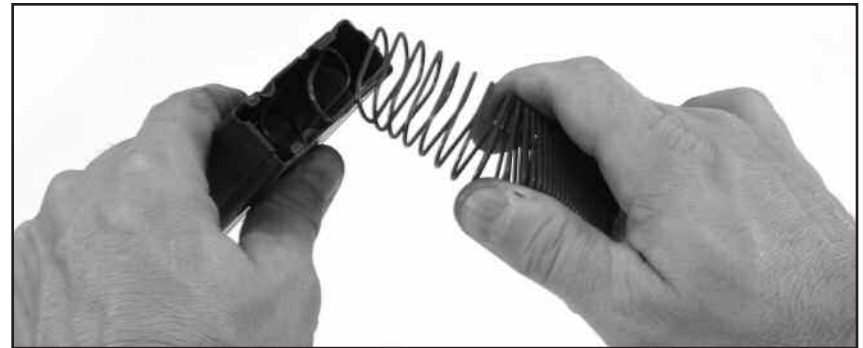

Picture 50

# PARTS LIST

## Remington R-15 VTR Modular Repeating Rifle Exploded View

### List of R-15 VTR Components

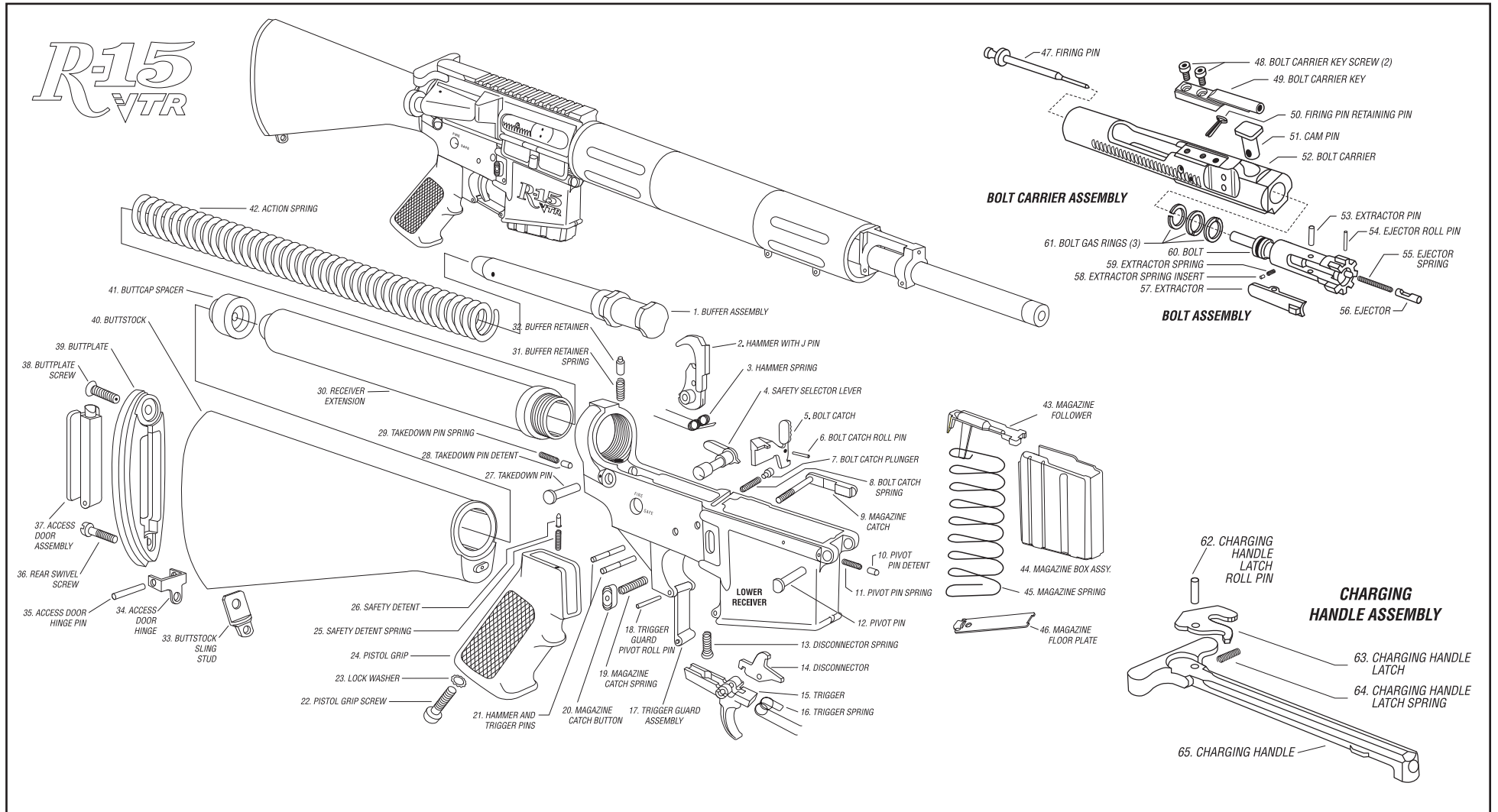

- |                          |                                  |                             |                            |                           |                                |                                    |
|--------------------------|----------------------------------|-----------------------------|----------------------------|---------------------------|--------------------------------|------------------------------------|
| 1. buffer assembly       | 10. pivot pin detent             | 19. magazine catch spring   | 28. takedown pin detent    | 37. access door assembly  | 47. firing pin                 | 57. extractor                      |
| 2. hammer with j pin     | 11. pivot spring                 | 20. magazine catch button   | 29. takedown pin spring    | 38. buttplate screw       | 48. bolt carrier key screw (2) | 58. extractor spring insert        |
| 3. hammer spring         | 12. pivot pin                    | 21. hammer and trigger pins | 30. receiver extension     | 39. buttplate             | 49. bolt carrier key           | 59. extractor spring               |
| 4. safety selector lever | 13. disconnecter spring          | 22. pistol grip screw       | 31. buffer retainer spring | 40. buttstock             | 50. firing pin retaining pin   | 60. bolt                           |
| 5. bolt catch            | 14. disconnecter                 | 23. lock washer             | 32. buffer retainer        | 41. buttcap spacer        | 51. cam pin                    | 61. bolt gas rings                 |
| 6. bolt catch roll pin   | 15. trigger                      | 24. pistol grip             | 33. buttstock sling stud   | 42. action spring         | 52. bolt carrier               | 62. charging handle latch roll pin |
| 7. bolt catch plunger    | 16. trigger spring               | 25. safety detent spring    | 34. access door hinge      | 43. magazine follower     | 53. extractor pin              | 63. charging handle latch          |
| 8. bolt catch spring     | 17. trigger guard assembly       | 26. safety detent           | 35. access door hinge pin  | 44. magazine box assembly | 54. ejector roll pin           | 64. charging handle latch spring   |
| 9. magazine catch        | 18. trigger guard pivot roll pin | 27. takedown pin            | 36. rear swivel screw      | 45. magazine spring       | 55. ejector spring             | 65. charging handle                |
|                          |                                  |                             |                            | 46. magazine floor plate  | 56. ejector                    |                                    |

### Firearm Warranty Information

Remington warrants to you, the original retail purchaser of a new Remington firearm, that from one year from the date of retail purchase, your Remington firearm will be free from defects in material and workmanship. Some limitations apply; select a model from the list on the right for specific warranty details.

#### What is not covered by this warranty?

##### We will not cover damage of your firearm caused by:

- Failure to provide proper care and maintenance.
- Accidents, abuse or misuse.
- Barrel obstruction.
- Hand loaded, reloaded or improper ammunition.
- Unauthorized adjustments, repairs or modifications.
- Normal wear and tear.

#### What will Remington do if you discover a defect?

If you make a claim within the warranty period following the instructions given in the specific model's owner's manual, we will, at our option, repair the defect(s), or replace the firearm at no cost to you. If we send you a new firearm, we will keep the defective one.

#### What is excluded from this warranty?

Remington excludes and will not pay incidental or consequential damages under this warranty. By this we mean any loss, expense or damages other than to repair the defects in the firearm or replace the firearm. No implied warranties extend beyond the term of this written warranty. PLEASE NOTE: Some jurisdictions do not allow exclusion of incidental or consequential damages, or limitation on how long an implied warranty lasts, so the above exclusion and limitations may not apply to you. This warranty gives you specific legal rights and you may also have other rights.

### Repair Services

**If you need assistance, please call our toll free number 1-800-243-9700, Mon.-Fri., 9:00 AM-5:00 PM Eastern time and select the option for repairs. Then, if shipment of your firearm is required, please:**

- Record the serial number of your firearm before sending it to us.
- Pack your firearm for safety and to prevent further damage in shipping and handling. Preferably, ship in a firearm box.
- Remove all accessories from the firearm to prevent loss or damage.
- Enclose a letter with the firearm detailing the model name or number of your firearm and serial number along with a full description of the problem. Be sure to include your full name and address (P.O. Box and Street Address), including zip code, daytime telephone number and e-mail address.
- Ship your firearm by either United Parcel Service (UPS) or Parcel Post (US Post Office). Remington is not responsible for damage or loss during shipment, so you may elect to purchase insurance from your carrier.

#### Ship to:

Remington Arms Company, Inc.  
Attn: Arms Service Division/Repairs  
14 Hoefler Ave.  
Ilion, NY 13357

**WARNING! DO NOT SEND LIVE OR SPENT SHELLS IN YOUR FIREARM OR IN THE SAME BOX WITH THE FIREARM. THIS IS A VIOLATION OF FEDERAL LAW. IF YOU FEEL YOU MUST SEND SPENT SHELLS, PLEASE SEND THEM IN A SEPARATE PACKAGE AND INCLUDE NAME, ADDRESS (WITH ZIP CODE), TELEPHONE NUMBER, MODEL AND SERIAL NUMBER OF YOUR FIREARM.**



## WARNING

Children are attracted to and can operate firearms that can cause severe injuries or death. Prevent child access by always keeping guns locked away and unloaded when not in use. If you keep a loaded firearm where a child obtains and improperly uses it, you may be fined or sent to prison.



## ADVERTENCIA

A los niños les atraen las armas de fuego y los pueden hacer funcionar. Ellos pueden causarse lesiones graves y la muerte. Evite que los niños tengan acceso a las armas de fuego guardándolas siempre con llave y descargadas cuando no las esté utilizando. Si usted tiene un arma de fuego cargada en un lugar en que un niño tiene acceso a ella y la usa indebidamente. Le pueden dar una multa o enviarlo a la cárcel.

# Remington®

Remington is a trademark registered in the United States Patent and Trademark Office by Remington Arms Company, Inc.