



OWNER'S MANUAL

FOR THE SSI-ONE™
SINGLE SHOT
BREAK ACTION
INTERCHANGEABLE
RIFLE/SHOTGUN

IMPORTANT "SAFETY WARNINGS" — NOTE THE SYMBOL



These safety warnings are for your protection as well as the safety of others. Disregarding information in this manual may result in serious injury or death.



Be certain this owners manual is available for reference and is kept with this firearm if transferred to another party. If manual is lost or misplaced, write directly to Mossberg Service Center for a free replacement copy.



After performing any work on your firearm such as cleaning, adjustments, disassembly or installation of any accessory, the gun should be re-checked for proper functioning before firing live ammunition.



Firearms are complex mechanisms. Any modification, alteration, or improper fitting of parts may result in a dangerous malfunction, damage to the firearm and injury to the shooter and/or other persons. The gun owner must accept full responsibility for the correct reassembly and functioning of the firearm after any disassembly or replacement of parts.



If you do not understand any of the material in this manual or have any questions, contact a qualified gunsmith or write the Mossberg Service Center.



Do not attempt to load or use any firearm until you read and understand the information contained in its owner's manual. Before handling your firearm, you should learn how it operates and how to maintain it. This includes knowing its basic parts, how the manual safety and other safety features operate, how to safely open and close the action and how to safely load and unload ammunition from the gun. Improper use and handling is dangerous and could cause severe injury or death to you or those around you. All users of the firearm must become thoroughly familiar with the instructions in this manual.

O.F. MOSSBERG & SONS, INC

P.O. BOX 497 • 7 GRASSO AVENUE, NORTH HAVEN, CONNECTICUT 06473
PHONE (203) 230-5300 FAX (203) 230-5420
www.mossberg.com

Safety and safe firearms handling is everyone's responsibility.



As the owner of a firearm, you must undertake the full-time responsibility of safe firearms handling for your own safety and the safety of those around you:

- Keep all firearms and ammunition out of the reach of children.
- Store your firearms and ammunition separately.
- Never store a loaded firearm.
- Never leave a loaded firearm unattended.
- Never transport a loaded firearm in a vehicle.



Always point the muzzle of your firearm in a safe direction, regardless of whether the firearm is loaded or unloaded. You should become thoroughly familiar with the function and operation of this firearm and the instructions supplied with it.



Always treat every firearm as if it were loaded. Give your firearm to someone with the action open, and the safety button fully rearward to the "ON" (SAFE) position, after you verify the firearm is unloaded. Insist on the same procedure when receiving a firearm from someone else. Learn the location of all the safety features of your firearm and how they operate.



Wear eye and ear protection when shooting. Shooting without proper ear protection can cause hearing damage. The use of eye protection during any type of shooting is important to protect your vision.



When using a firearm with mounted optics, maintain an adequate distance between the rear of the scope and your face at all times. Be certain the scope installation does not interfere with access to, or the proper functioning of the safety.



We specifically disclaim any responsibility for damage or injury whatsoever occurring in connection with, or as a result of, the use of faulty, or non-SAAMI standard, or "remanufactured" or hand-loaded (reloaded) ammunition. Additionally, we disclaim any responsibility for damage or injury which results from any modifications or changes that are not a part of the firearm as delivered from the factory.



Learn to clean your firearm thoroughly and make certain no oil, grease or other materials are blocking the barrel. Obstructions of any kind can cause damage to the firearm resulting in personal injury.



Practice proper firearm maintenance and safety. Make sure all exposed metal surfaces are coated with a thin film of oil, especially after being exposed to damp weather. (See proper section of this manual for cleaning instructions). Do not plug barrel or store in a fabric-lined case, which will absorb lubricants from the firearm. Before using after storage, follow complete instructions stated in this manual for refamiliarization with the firearm. A thorough inspection should be performed before going into the field. Have your gun periodically checked by a qualified gunsmith.

GENERAL INFORMATION AND MECHANICAL CHARACTERISTICS

The Mossberg SSi-ONE is a lever opening break action single shot firearm, featuring a unique interchangeable barrel/caliber/gauge system.

Operational features include an integral hammer block and an Automatic Safety button, which is activated upon opening the action.

The SSi-ONE also employs a mechanical block that prevents closing the action unless cocked, protecting the integrity of the internal mechanism.

The SSi-ONE receiver is comprised of a two-(2) part assembly. The forged receiver supports and positions the barrel. The receiver also supports the lever and houses the locking mechanism.

The second member, the fire control housing, houses the hammer, trigger, sear, safety and cocking indicator while serving as the anchor for the stock assembly.

OPERATING INSTRUCTIONS



Read and understand this entire manual and its safety warnings before firing this gun.

MECHANICAL SAFETY

The safety button is located at the top rear portion of the receiver (Fig. 1) and is automatically moved fully rearward to the "ON" (SAFE) position when the action is opened.

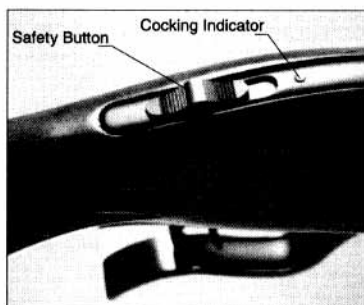

Fig.1

The safety button must be manually moved fully forward to the "OFF" (FIRE) position (Fig. 2) by the shooter. The safety can be returned manually to the "ON" (SAFE) position by moving the button fully rearward.

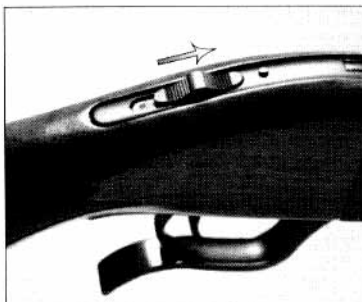

Fig. 2

To engage the safety button to the "ON" (SAFE) position, the safety button must be moved fully rearward. The safety button will now cover the red dot. The red dot is a training aid used only to show the direction of the "ON" (SAFE) position and should not be used as an indicator that the safety button is "on" or "off". Moving the safety button forward toward the muzzle of the gun will place the safety button in the "OFF" (FIRE) position (red dot visible).



Remember that a firearm's manual safety is a mechanical device, which can never replace safe gun handling practices.

ASSEMBLY

The SSi-ONE break action single shot is shipped from the factory with the barrel and forearm disassembled from the receiver/stock assembly.

After carefully removing both components from the box, inspect the inside of the barrel to ensure it is free of any excess oil, grease or obstructions.

Using the 5/32" hex wrench provided, disassemble the forearm from the barrel by removing the forearm screw. Turn the forearm screw counter-clockwise until it is free from the assembly. Using your free hand, pull the forearm from the barrel (Fig. 3). Put the barrel, forearm and forearm screw aside for later use.

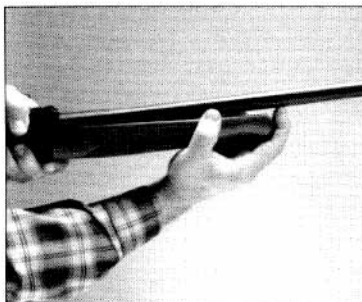

Fig. 3

Next, take the stock/receiver assembly and move the safety button fully rearward to the "ON" (SAFE) position.

To assemble the barrel to the receiver, the action must first be cocked. To cock the action, rotate the cocking lever fully forward (Fig. 4) and return the lever to its resting position. Cocking is confirmed by witnessing the position of the cocking indicator. The cocking indicator is located on the receiver's top surface, forward of the safety button (Fig. 1). The cocking indicator will protrude above the receiver surface (approximately 1/16") when the action is cocked (Fig. 2).

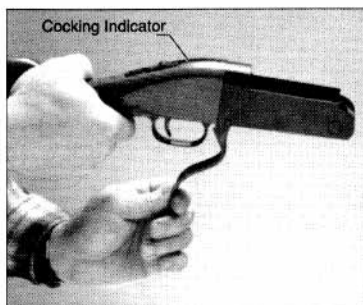

Fig.4

The receiver is now ready to accept the barrel. To assemble the barrel to the stock/receiver assembly, locate the half hole in the barrel lug face (Fig. 5.) and hang the barrel lug on the receiver's hinge pin.



Fig. 5

Swing the barrel up to a fully closed position (Fig. 6). The barreled action is now ready to receive the forearm.



Fig. 6

To install the forearm to the barreled action, locate the rear of the forearm to the receiver and swing the forearm up firmly against the underside of the barrel (Fig. 7).



Fig. 7

Note: Some resistance is expected when seating the forearm. As long as the rear of the forearm and receiver face are in contact, proceed to seat forearm to barrel underside (Fig. 8).



Fig. 8

Using the 5/32" hex wrench, install the forearm screw by turning it clockwise until the forearm and the forearm screw are snug. **Do not overtighten.**

The gun is now fully assembled. With the gun pointed in a safe direction, open the action by rotating the cocking lever fully forward, and assist the barrel swing with your off hand by pulling down on the forearm (Fig. 9).



Fig. 9

Inspect the bore and chamber for excess oil, grease or other obstructions. You can now close the gun, checking for binding or other abnormalities. You may want to repeat opening and closing the action several times to become familiar with its function.

To dry fire your SSi-ONE, the barrel must be in place, unloaded, and fully closed. Failure to follow this procedure may result in internal damage to the mechanism. If you follow this procedure, dry firing will not damage your gun. Make sure your gun is unloaded and pointed in a safe direction when doing so.

Note: After the trigger is pulled, the cocking indicator will drop to the receiver surface (not protruding) indicating a “not cocked” condition (Fig. 1).

TO LOAD THE SSi-ONE

With the SSi-ONE pointed in a safe direction, move the safety button fully rearward to the “ON (SAFE)” position. Open the action as previously described, inspect the bore and chamber for any foreign matter. Insert a cartridge of the correct caliber/gauge **only** when you are ready to shoot.



Check the caliber/gauge stamped on the barrel you are loading, and load cartridges of that caliber/gauge only.



Inspect the ammunition before loading, check the cartridge primer and be sure it is flush or below the cartridge base. A cartridge discharged by closing the breech can result in possible serious injury to the shooter and/or other persons.

Depending on the position of the ejector, the cartridge may or may not engage the ejector when chambering a round (Fig. 10 & Fig. 10A). The ejector is spring loaded and will snap over the cartridge rim/base upon closing. Making sure the muzzle is pointed in a safe direction, close the action. The firearm is now loaded and cocked. You should verify that the safety button is fully rearward in the “ON” (SAFE) position.



If the SSi-ONE with a cartridge on the ejector, (Fig. 10) does not close readily, do not force it. Check the caliber/gauge of the ammunition against the barrel markings to be sure they are identical. Next, check the chamber and bore to be sure they are free from obstructions, dirt, and debris.

Check to see that the round will fully chamber. Gently pull the ejector fully rearward and slip the cartridge by hand, bypassing the ejector, into the chamber. The cartridge should chamber with little or no resistance. If you continue to experience problems, first try another shell. If the problem persists call the Mossberg Service Center.



Do not touch trigger until you are ready to fire.

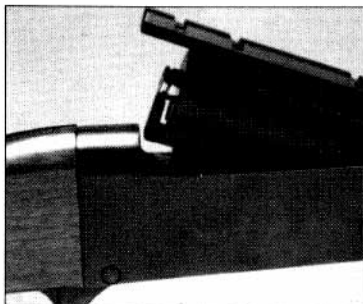

Fig. 10

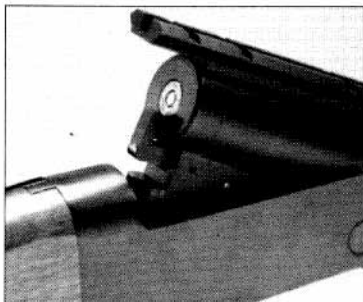

Fig. 10A

TO FIRE THE SSI-ONE

While pointing the gun at your intended target, and making sure there is adequate distance between your face and the scope, push the safety button fully forward to the "OFF" (FIRE) position. Place index finger on the trigger and squeeze the trigger fully rearward. This will discharge the cartridge.



Discharging firearms in poorly ventilated areas, cleaning firearms, or handling ammunition may result in exposure to lead and/or substances known to cause birth defects, reproductive harm, and other serious physical injury. Have adequate ventilation at all times. Wash hands thoroughly after exposure.



Should the round fail to fire, keep the gun pointed in a safe direction. Move the safety button fully rearward to the "ON" (SAFE) position. Remove the misfired round and segregate from other ammunition. Do not attempt to re-fire a misfired round.



If at any time during firing, the report of any given round is noticeably louder or softer than previous rounds fired, STOP! Do not load or fire additional rounds until you have put the safety button fully rearward to the "ON" (SAFE) position. Safely unload your firearm and inspect it for possible damage or an obstruction in the chamber or bore.

TO UNLOAD THE SSI-ONE

Move the safety button fully rearward to the "ON" (SAFE) position. Open the action. Cup your hand over the chamber (Fig. 11) to catch the ejected cartridge.

CAUTION: Cartridge is ejected with spring loaded force.



Fig. 11

Re-check the chamber to be certain the gun is unloaded.

CLEANING AND LUBRICATION

With proper care, your Mossberg SSI-ONE will provide you with years of dependable service. Your firearm should be inspected and cleaned periodically to insure that it remains in good condition. Clean your firearm as soon as possible after use. This is especially important if your firearm has been exposed to moisture.

Use the instructions and equipment provided in a quality gun cleaning kit.

All metal parts should be cleaned with an appropriate gun cleaning solvent and lightly lubricated with gun oil. Over lubrication should be avoided. Use only lubricants specifically designed for firearms. Avoid the use of abrasives, which may damage the metal finish.

Scrub the bore and chamber with solvent and follow with cleaning patches until the barrel is clean. A final pass with a lightly oiled patch will provide a protective coating. Clean and remove any deposits in the barrel.

Normal use requires only that the mechanisms be free of excessive shooting residue. Very little lubrication other than a light oiling of external surfaces is needed to prevent rust.

If the gun is to be stored for a long period of time it should be thoroughly cleaned and oiled. Do not plug the barrel or store the firearm in a case that will absorb lubricant from the gun.

The barrel and forearm can be removed from the stock/receiver assembly and the stock can be removed from the receiver assembly, but further disassembly should be performed by a certified gunsmith only.



Make sure the barrel is free of obstructions and excessive lubricant after cleaning.

Camo guns: Caution should be exercised to avoid exposure of camouflage pattern to strong solvents.

FUNCTION TESTING



After performing any work on your firearm such as cleaning or disassembly and assembly, make sure no cleaning patches or other materials are obstructing the barrel. Check your firearm for proper functioning before loading or firing live ammunition.



Be sure the firearm is completely unloaded and pointed in a safe direction at all times.

Move the button fully rearward to the "ON" (SAFE) position.

Open and close the action several times to check for free movement of the action assembly. Close the action and leave the safety button fully rearward to the "ON" (SAFE) position. Pull the trigger fully rearward. The firing pin should not release.

Remove your finger from the trigger. Move the safety button fully forward to the "OFF" (FIRE) position. The firing pin should not release.

Leave the safety button fully forward in the "OFF" (FIRE) position. Pull the trigger fully rearward. The firing pin should release.

Open the action by moving the operating lever forward, the safety button should automatically move fully rearward to the "ON" (SAFE) position.



If your firearm does not perform as described in any of the previous steps, contact the Mossberg Service Center immediately. Do not attempt to use the firearm.



Firearms are complex mechanisms. Any modification, alteration, or improper fitting of parts may result in a dangerous malfunction, damage to the firearm and injury to the shooter and/or other persons. The gun owner must accept full responsibility for the correct re-assembly and functioning of the firearm after any disassembly or replacement of parts.



If you do not understand any of the material in this manual or have any questions, contact a qualified gunsmith or the Mossberg Service Center.

SSI-ONE SCOPE MOUNTING

Your SSI-ONE has been supplied with a mounted, Weaver-style scope base. Refer to your scope/ring instructions for scope mounting.

Be sure the scope you choose does not interfere with the access of the safety button.

SERVICE INSTRUCTIONS

Should your firearm, or any component of your firearm require service, kindly ship your entire firearm (please do not send components only), via your chosen carrier, postage paid (we do not accept C.O.D. shipments), following these instructions:



- **Make absolutely certain your firearm is unloaded.**
- **Do not send ammunition with your firearm.**
- Remove all accessories from your firearm such as scopes, slings, mounts, etc.
- Ship your firearm in a suitable container, packaging it securely to prevent parts from shifting and/or harm during shipping.
- Include a note with a clear description of the service you wish us to perform, your complete return shipping address (no P.O. boxes please), your daytime telephone number and your e-mail address (if available). It is advisable to place your correspondence inside your shipping container when shipping.

SHIPPING ADDRESS

Mossberg Service Center
101 Powdered Metal Drive
North Haven, CT 06473
Attention: Repair

If you have any questions, please call us at (203) 230-5300

TO ORDER PARTS FROM US

To order parts from our factory, you can fax, phone, mail, or e-mail your order to us at one of the below numbers/addresses.

Fax Number: (203) 230-5479

Phone Number: (203) 230-5300

E-mail Address: service@mossberg.com

Mailing Address: Mossberg Service Center
101 Powdered Metal Drive
North Haven, CT 06473
Attention: Order Department

Please provide your name, address, city, state, zip, your daytime phone number and e-mail address. We'll need Model #, Serial #, Gauge/Caliber, Finish, Part # and Part Name. We have a \$7.50 (U.S.) minimum parts order charge. We accept most major credit cards, personal checks, money orders, and bank drafts.

Service outside of the U.S.A.

For Mossberg firearm parts and service requirements outside of the United States, customers are requested to contact the closest Mossberg stocking dealer/distributor.

PARTS LIST

ITEM	DESCRIPTION	ITEM	DESCRIPTION
1	Sporter Barrel Assembly	30	Hammer Pin / Trigger Pin
2	Bull Barrel Assembly	31	"E" Clip (2)
3	Shotgun Barrel Assembly	** 32	Sear
4	Forearm Assembly – Sporter Barrel	33	Sear Spring
5	Forearm Assembly – Bull / Shotgun Barrel	** 34	Hammer
6	Forearm Shoe	35	Hammer Spring
7	Forearm Shoe Screws (2)	** 36	Lock Plate Assembly
8	Forearm Escutcheon	37	Lock Plate Spring
9	Takedown Screw	38	Lever
10	Wood Screw Eye	39	Lock Plate Catch
11	Scope Base	40	Lock Lever Spring
12	Scope Base Screw (4)	* 41	Top Tang
** 13	Ejector	42	Upper Tang Pin
14	Ejector Spring	43	Cocking Indicator Spring
15	Ejector Spring Pin / Ejector Retain Pin	44	Cocking Indicator
16	Ejector Sear Pin	45	Cocking Indicator Return Spring
17	Ejector Sear	* 46	Safety Button
18	Ejector Trip Pin / Upper Tang Pin	* 47	Safety Detent Plate
19	Ejector Sear Spring	* 48	Safety Screw
20	Ejector Plunger	* 49	Safety Block
** 21	Receiver	* 50	Safety Actuator
** 22	Breech Block	51	Tang Bridge
23	Firing Pin	52	Buttstock Assembly
24	Firing Pin Spring	53	Stock Pin (2)
25	Breech Block Screw	54	Stock Bolt
26	Lower Fire Control Pin	55	Stock Bolt Lock Washer
** 27	Fire Control Housing	56	Stock Bolt Washer
* 28	Trigger	57	Recoil Pad
29	Trigger Spring	58	Buttstock Screws (2)

* Items marked with an asterisk on parts list are reserved for qualified gunsmiths only.

** Items marked with two asterisks on parts list are reserved for factory installation only.

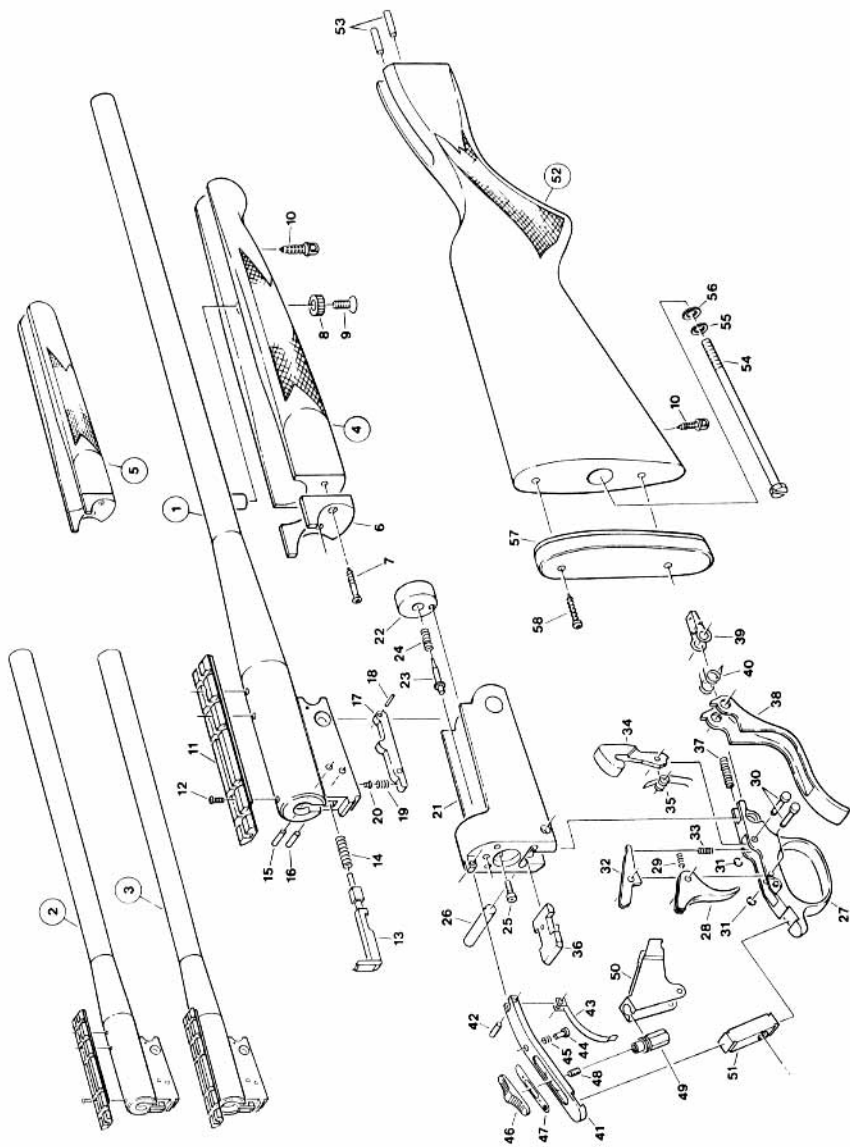

FIREARMS SAFETY DEPENDS ON YOU. MAKE NO MISTAKE ABOUT IT!

From the time an individual picks up a firearm, that individual shooter becomes a part of a system over which he has complete control. He is the only part of the system that can make a gun safe – or unsafe. Hunting and target shooting are among the safest of all sports. This booklet is intended to make them even safer – by re-emphasizing and reaffirming the basics of safe gun handling and storage and by reminding each individual shooter that he or she is the key to firearms safety. You can help meet this responsibility by enrolling in hunter safety or shooting safety courses. You must constantly stress safety when handling firearms, especially to children and non-shooters. Newcomers in particular must be closely supervised when handling firearms with which they may not be acquainted. Don't be timid when it comes to gun safety. If you observe anyone violating any safety precautions, you have an obligation to suggest safer handling practices, such as those in this booklet. Please read these rules carefully and follow the safety procedures outlined. Firearms safety is up to you. Make no mistake about it.

- 1. ALWAYS KEEP THE MUZZLE POINTED IN A SAFE DIRECTION**
- 2. FIREARMS SHOULD BE UNLOADED WHEN NOT ACTUALLY IN USE**
- 3. DON'T RELY ON YOUR GUN'S SAFETY**
- 4. BE SURE OF YOUR TARGET AND WHAT'S BEYOND IT**
- 5. USE CORRECT AMMUNITION**
- 6. IF YOUR GUN FAILS TO FIRE WHEN THE TRIGGER IS PULLED, HANDLE WITH CARE**
- 7. ALWAYS WEAR EYE AND EAR PROTECTION WHEN SHOOTING**
- 8. BE SURE THE BARREL IS CLEAR OF OBSTRUCTIONS BEFORE SHOOTING**
- 9. DON'T ALTER OR MODIFY YOUR GUN, AND HAVE GUNS SERVICED REGULARLY**
- 10. LEARN THE MECHANICAL & HANDLING CHARACTERISTICS OF THE FIREARM YOU ARE USING**

Courtesy of Sporting Arms and Ammunition Manufacturers' Institute, Inc.

MOSSBERG WARRANTY PERFORMANCE Ten Year Limited Warranty

For the time period of the warranty, any Mossberg SSi-ONE firearm defective in material or manufacture and returned postage paid, to the MOSSBERG SERVICE CENTER, will be repaired or replaced at our discretion, free of charge and returned, postage prepaid. This non-transferable warranty is established by return of the Marketing Research Questionnaire and Registration card, which should be mailed by the original owner within thirty (30) days of purchase.

VALID IN THE UNITED STATES AND CANADA ONLY, THIS WARRANTY DOES NOT COVER COSMETIC APPEARANCE OR ANY DAMAGE CAUSED BY ABUSE, MISUSE, NEGLIGENCE, OR ALTERATION OF THE FIREARM.

This warranty gives you specific legal rights, and you may have other rights which vary from State to State.

Address all correspondence to: MOSSBERG SERVICE CENTER
101 Powdered Metal Drive, North Haven, Connecticut 06473