

**WITH 5-YEAR  
WARRANTY**

# **Owner's Manual**

***Marlin<sup>®</sup>***

# **MODEL 1894S LEVER ACTION RIFLE 44 REM. MAG. IMPORTANT**

*This manual contains operating, care and maintenance instructions. To assure safe operation, any user of this firearm must read this manual carefully. Failure to follow the instructions and warnings in this manual can cause accidents resulting in injury or death. This manual should always accompany this firearm, and be transferred with it upon change of ownership.*

*The warranty card attached to the cover must be filled out and mailed within 10 days of purchase.*

**WARNING: KEEP THIS FIREARM OUT OF THE REACH OF CHILDREN.**

## LIMITED WARRANTY

### The Marlin Firearms Company FIVE YEAR LIMITED WARRANTY AGAINST DEFECTS IN MATERIAL & WORKMANSHIP

This firearm warranty is good only to the ORIGINAL OWNER who has registered his ownership with The Marlin Firearms Company at 100 Kenna Drive, North Haven, Connecticut.

WARRANTY and CERTIFICATE OF OWNERSHIP card **must** be completed and mailed to The Marlin Firearms Company at the above address WITHIN TEN (10) DAYS of purchase to insure the protection of the warranty. NOTICE of defect in materials and/or workmanship **must** be received by the company WITHIN FIVE (5) YEARS from the date of purchase.

Normal wear, or damage resulting from neglect, abuse, alteration, or repairs not made or authorized by The Marlin Firearms Company or use of non-Marlin parts are not covered by the warranty.

THIS WARRANTY GIVES YOU SPECIFIC LEGAL RIGHTS, AND YOU MAY ALSO HAVE OTHER RIGHTS WHICH VARY FROM STATE TO STATE.

### MARLIN'S PERFORMANCE UNDER THE ABOVE WARRANTY

1. After notice of defect in material and/or workmanship is received by The Marlin Firearms Company, Marlin shall send instructions for shipment of the firearm; and repairs will be made and the firearm returned within a reasonable time after the firearm is received. Cost of shipping, insurance charges, etc. involved in returning the firearm to the company shall be prepaid by the original owner.
2. Cost of parts and labor performed shall be provided without charge by The Marlin Firearms Company.
3. If The Marlin Firearms Company, after receipt of the firearm, determines that the defects in material and/or workmanship were the result of abuse and/or neglect, or otherwise not covered by the warranty set forth above, Marlin shall notify such owner to that effect and give an estimate for repair. In such cases, repair, return shipping and insurance charges, etc. shall be paid by such owner.
4. In the event that The Marlin Firearms Company is unable to make warranty repairs to the firearm, it shall, within a reasonable time after its receipt, notify the owner to that effect and give him the option either to receive a replacement of the same model, if then available in its inventory, or to receive a refund, either of which, if feasible, will be made through the store of purchase.

**The Marlin Firearms Company**  
100 Kenna Drive, North Haven, CT 06473-0905

## Marlin Model 1894S

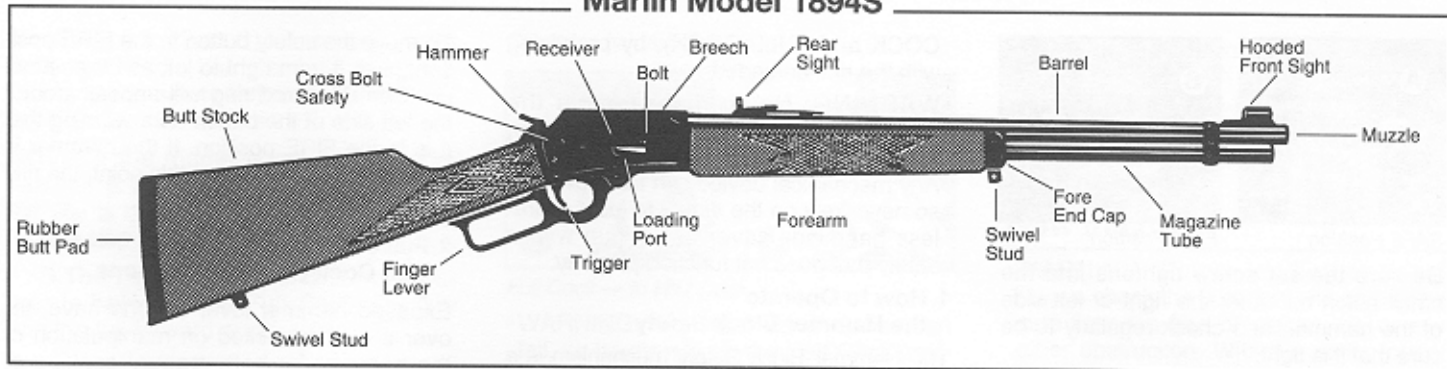

### Before You Use This Firearm

It is very important that you read and understand this manual before using your firearm. Warnings should be read and heeded carefully. Also follow "Marlin's Guide to Gun Safety," printed in this manual.

•**WARNING:** We specifically disclaim responsibility for any damage or injury occurring with a Marlin Firearm in which faulty, non-standard, "remanufactured," or handloaded (reloaded) ammunition is used.

**Ammunition Note:** The 1894S is designed to handle 44 Rem. Magnum factory-loaded ammunition (except wad cutters and shot shells). It will also function with 44 Special cartridges.

Minimum overall cartridge length — 1.535"

Maximum overall cartridge length — 1.610"

•**WARNING:** Do not use Blazer brand ammunition in this rifle. The design is not compatible with the Marlin feeding system, and may result in live rounds inadvertently remaining in the magazine.

### Use of the Hammer Spur

•**WARNING:** Only use the hammer spur on the gun with which it was packed. It will not fasten securely on narrower ( $\frac{1}{4}$ " Marlin or Glenfield hammers, or other hammers, and could cause a dangerous situation.

Because of its solid top, side ejecting receiver, your rifle is ideally suited for use with a scope. The receiver is drilled and

tapped for scope mounting. However, once mounted, most scope and mount combinations do not allow sufficient clearance for your thumb between the eyepiece and hammer for safe operation. In order to operate the hammer safely, we recommend that you use the offset hammer spur packed with your gun, when using a scope. A  $\frac{1}{16}$ " hexagonal wrench for attaching the spur is also included.

For right hand use, position the spur so that it protrudes from the right side of the hammer, slide the spur as far forward on the hammer as it will go, and tighten the set screw. For left hand use, mount the spur so that it protrudes from the left side of the hammer, and tighten the set screw.

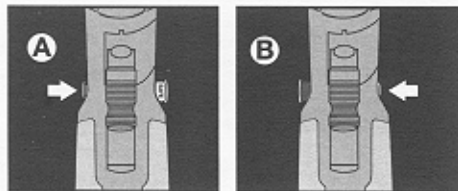

SAFE Position

FIRE Position

Be sure the set screw tightens into the small notch on either the right or left side of the hammer, and check regularly to be sure that it is tight.

- WARNING:** Do not use the gun with a scope unless the hammer spur is securely attached in the proper position. Make periodic checks to be sure the set screw joining the spur to the hammer is tight.

## Safety Features

Your rifle has a two-piece firing pin and a trigger block, both of which prevent firing until the lever is completely closed. It is also equipped with two manual safety devices, a hammer block safety and a half cock safety notch, which, when used properly, provide an added degree of safety.

- WARNING:** Before loading your rifle, become familiar with the operation of the hammer block safety and the hammer positions (FULL FORWARD, HALF

COCK and FULL COCK), by practicing with the rifle unloaded.

- WARNING:** Never disassemble the safety. It has been correctly designed, fitted and tested and is not reversible. Any mechanical device can fail, however, so never rely on the safety to justify careless handling. Never use a gun with a safety that does not function properly.

### 1. How to Operate the Hammer Block Safety

The Hammer Block Safety mechanism is a round button located at the rear of the receiver. To put your rifle on SAFE, first move the hammer to the Half Cock position (See D).

**Note:** You can only move the safety button if the hammer is in the Half Cock or Full Cock position. It will not move if the hammer is in the Full Forward position, or if the hammer is resting on the safety in the SAFE position (slightly forward of Half Cock).

Push the safety button from left to right as far as it will go (See A). The safety is now on SAFE and the word SAFE will appear around the right side of the button. The hammer should now be in the Half Cock position and the safety on SAFE. This is the safest way to carry your rifle when it is loaded. At all other times the action should be open.

To move the safety button to the FIRE position, push it from right to left as far as it will go (See B). A red ring will appear around the left side of the button as a warning that it is in the FIRE position. If the hammer is pulled all the way back at this point, the rifle will be cocked and ready to fire.

### 2. Full Cock and Half Cock Hammer Positions

Exposed hammer lever actions have, for over a century, relied on manipulation of the hammer for both manual cocking of the rifle as well as the traditional Half Cock safety position. Your rifle has these traditional hammer positions as well as the added benefit of a hammer block safety button. Use the following hammer positions in conjunction with the hammer block safety for the safest possible operation.

**A.** The Full Cock position of the hammer is when it is at its furthest point from

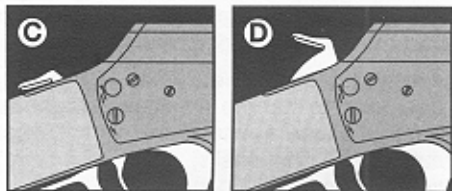

Full Cock

Half Cock

the firing pin (See C). If the trigger is pulled when the hammer is in this position, and the safety button is in the FIRE position, the gun will fire.

**NOTE:** If the trigger is pulled when the hammer is in the Full Cock position, and the rifle is on SAFE, the hammer will fall, but will stop before it strikes the firing pin.

**B.**The Half Cock position of the hammer is between the Full Cock position and the full forward position (See D).

### 3. To Move the Hammer to the Half Cock Position

First put the hammer block safety on SAFE. The hammer may be moved from Full Cock to the Half Cock position by firmly holding the hammer in the Full Cock position with your thumb. Keep your thumb on the hammer as you pull the trigger. As soon as you feel the hammer exerting forward pressure against your thumb, remove your finger from the trigger and ease the hammer slowly forward to the Half Cock position (See E & F). The hammer is now in the traditional Half Cock "Safe" position.

To resume the Full Cock position, simply pull the hammer all the way to the rear (See C).

### Changing hammer position—

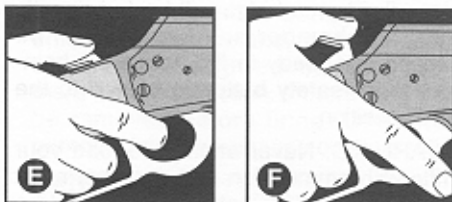

Full Cock — to Half Cock

- WARNING:** Any mechanical device can fail, so never rely on the Half Cock position or the hammer block safety to justify careless handling.
- WARNING:** Never allow the hammer to rest on the firing pin (hammer in full forward position). If the rifle is loaded and the hammer is inadvertently struck in the full forward position, the rifle will fire.
- WARNING:** Should the hammer inadvertently be placed in the Full Forward position, open the bolt, put the hammer block safety on SAFE, and close the bolt. The hammer is now in the Full Cock position. Follow instructions in #3 above to move the hammer to the Half Cock position.
- WARNING:** Become thoroughly familiar with the hammer positions before loading the rifle with ammunition. Failure to

follow the instructions in #3 above, may result in "false half cock", a condition that may allow the hammer to fall and fire the rifle if the hammer block safety button is in the FIRE position, and the trigger is pulled.

## How to Load

- WARNING:** Before loading or firing, always check the bore and chamber to be sure they are free of grease, oil, or any other obstruction. With the action open, and the hammer block safety button on SAFE, look through the barrel to see if there is an obstruction. If there is, it must be removed before firing. Otherwise, personal injury or damage could result.

**1. Loading the magazine.** Be sure the bolt is closed (lever to the rear), the hammer block safety button is on SAFE (See A), the hammer is in the Half Cock position (See D), and the gun is pointed in a safe direction. Insert the cartridges, bullet end first, into the loading port. As the cartridge enters the loading port, push it forward into the magazine tube (See G). Be sure that the last cartridge is completely inside the loading port before preparing to fire, or a jammed action may result.

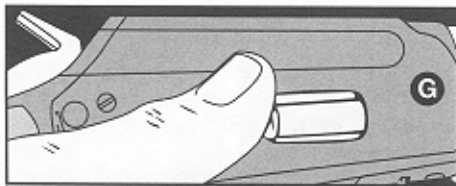

Loading the magazine

**2. Preparing to fire.** With the rifle pointed in a safe direction, completely open and close the lever one time. When the hammer block safety button is moved to the FIRE position, your rifle is loaded, cocked, and ready to fire.

•WARNING: If you do not want to fire at this point, return the hammer block safety button to the SAFE position, and the hammer to the Half Cock position (See E & F).

**3. Loading a Single Cartridge.** With the hammer block safety button on SAFE, the rifle empty, and the lever forward (bolt open), place a single cartridge with the bullet forward, in the ejection port, onto the carrier (See H).

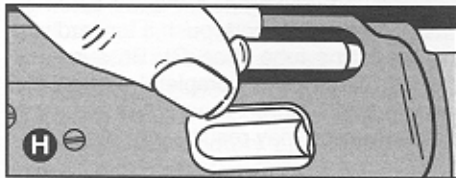

Loading a single cartridge

Return the lever to the rear position (bolt closed). The cartridge will be fed directly into the chamber and the rifle will be cocked and ready to fire, when the hammer block safety button is moved to the FIRE position.

- WARNING: Never attempt to load your rifle with ammunition that does not meet the cartridge designation stamped on the barrel. Use only ammunition suitable for a tubular magazine rifle. We recommend clean, dry, factory-loaded ammunition which conforms to industry standards.
- WARNING: Regarding Ammunition: Some pointed and full metal jacket round nose bullets are on the market which can chainfire other cartridges in a tubular magazine during recoil causing severe injury and damage. If you are uncertain about the safety of using a particular bullet in your Marlin, contact the ammunition or bullet manufacturer.
- WARNING: Aluminum cased ammunition may cause malfunctions.

## How to Fire

With the hammer in the Full Cock position, push the hammer block safety button to the FIRE position and, with the gun pointed at the target, squeeze the trigger. The

gun will fire. Work the lever fully forward and back for each repeat shot. If you do not fire all the cartridges in the magazine, be sure to put the hammer in the Half Cock position and the hammer block safety button on SAFE until you are ready to shoot again.

- WARNING: Remember, until a visual check has been made, you should assume that a live round remains in the chamber. Whenever the action is closed, assume a live round is in the chamber.

## How to Unload

Put the hammer in the Half Cock position and the hammer block safety button on SAFE.

Keeping your fingers away from the trigger, and with the gun pointed in a safe direction, manually eject all cartridges by operating the lever back and forth, until you are sure the chamber and magazine are empty (See I).

The lever must be completely closed and then fully opened to insure proper feeding and ejection of all cartridges. Then, with the lever in the forward position (bolt to the rear), inspect the chamber, carrier and magazine carefully to be sure there are no cartridges left in the gun.

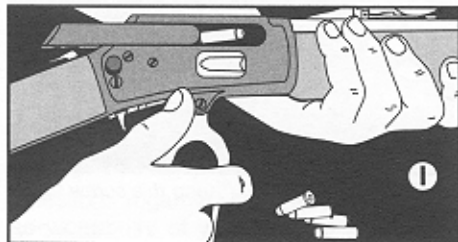

*Unloading*

•**WARNING:** During the unloading process, be sure the hammer block safety button is on SAFE, because each time the lever is completely closed (all the way to the rear), your rifle is cocked and ready to fire. Keep your fingers away from the trigger and be sure the gun is pointed in a safe direction during unloading.

### **What to do if rifle fails to fire**

**1. Misfire.** If you have squeezed the trigger and nothing happens, remain in shooting position, pointing the gun in a safe direction. Count to 10, then open the action.

**2. Underpowered shot.** A "squib", or underpowered shot can normally be detected by the unusually low report it makes.

•**WARNING:** Because the bullet may actually still be in the barrel, you must unload completely and, with the action open, look through the barrel to see if there is an obstruction. If there is, it must be removed before firing. Otherwise, personal injury or damage could result.

### **Sighting**

Your rifle has been sighted-in and test-fired at the factory. However, due to individual shooting characteristics, sighting should be range verified.

**1. Vertical Correction.** To raise the point of impact, raise the rear sight by moving the elevator to the rear. To lower the point of impact, lower the rear sight by moving the elevator forward.

**2. Horizontal Correction.** To move the point of impact to the left, tap the rear sight base to the left. To move the point of impact to the right, tap the rear sight base to the right.

### **Scope Mounting**

Your rifle is drilled and tapped for scope mounts. They are made by Tasco (Part #821L) and Weaver (Part #48763), and others, and are available through your local gun dealer. You may also order directly from Marlin Gun Service. Call 1-800-544-8892 for more information.

•**WARNING:** Improper mounting or use of a scope may result in facial injury. Always allow sufficient space between the scope and eye to avoid contact from recoil. Be sure to follow the scope manufacturer's instructions for correct mounting and use.

### **How to Clean Your Rifle**

•**WARNING:** Never attempt to wipe down or clean a loaded gun.

**1.** Put the hammer block safety button on SAFE and remove all cartridges from the action, chamber and magazine before you begin cleaning or inspecting your rifle.

**2.** To clean the bore from the breech end (recommended), open the lever half way, remove the lever screw (See J) and then the lever. Then remove the breech bolt from the receiver (See K). (This will cause the ejector to be loose inside the receiver

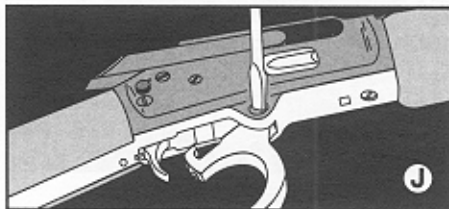

*Removing lever screw*

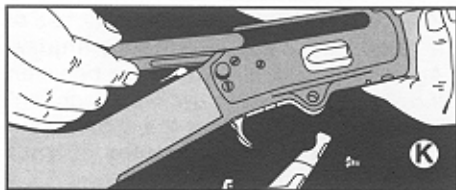

Removing breech bolt

— be careful not to lose it.) Next, remove the ejector from the slot in the left side of the receiver (See L).

•**WARNING:** If you move the hammer block safety to the FIRE position after the bolt has been removed, do not pull the trigger, letting the hammer snap forward, because the hammer blow will damage the safety mechanism.

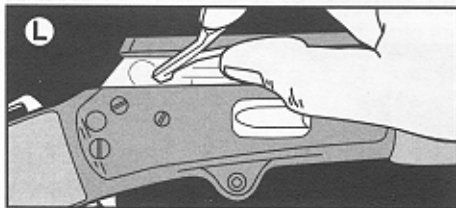

Removing ejector

The bore can now be cleaned, using the proper caliber cleaning rod, cleaning patches and powder solvent. Clean and oil the breech bolt before replacing. The barrel and bore should also be lightly oiled.

**Caution:** Before using any solvent or other gun cleaning product, read the label carefully to be sure it will not damage either the finish, or any part of this firearm.

3. The action may be cleaned and oiled while the gun is in the state of disassembly described above.

4. To reassemble; simple reverse the above steps. Make sure the ejector is positioned properly prior to alignment and insertion of the breech bolt. See M for the relationship of the bolt and ejector for correct alignment. Push the breech bolt into the receiver until within approximately 1" of the fully closed position (See N). The lever may now be inserted as shown in O.

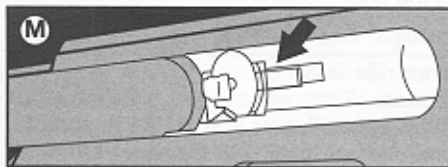

Correct bolt and ejector alignment



Replacing breech bolt (\*Keep this screw tight)

Use a thin coat of light oil during below freezing conditions. Condensation droplets will form soon after the rifle is brought into a warm room, or the rifle may become wet during inclement weather. In any case, all moisture should be removed. Exterior metal finishes may be wiped down with a slightly oiled cloth. For long term storage, lightly oil the bore, barrel and action with gun oil. Your rifle should be completely unloaded and stored in a dry, ventilated area. Do not store it in a carrying case.



Replacing lever



## Repair Instructions

---

Your firearm has been designed, engineered and manufactured in accordance with Marlin's rigid quality control standards. However, any mechanical device may occasionally require adjustment or repair.

Questions regarding the performance and serviceability of your firearm should be addressed to Marlin Gun Service. You should include the Serial Number, Model Number and a full description of the conditions and problems involved.

## Warranty Repairs

---

Our Warranty policy covers all our firearms against defects in workmanship or material for a period of five years from the date of purchase to the original owner. See the inside front cover of this manual for warranty details.

Guns requiring warranty repairs should be returned to the factory. Be sure to follow the "Shipping and Handling" instructions on this page.

## Non-Warranty Repairs

---

Your local gunsmith may be able to repair your gun. If not, ship it to the factory, following the "Shipping and Handling" instructions on this page.

After receiving your firearm, we will send you an estimate of the repair cost. Repairs will begin upon receipt of your check or money order. If repairs are not possible, your gun will be returned.

## Shipping and Handling

---

When sending your firearm to the factory please follow these instructions:

1. Prior to mailing, be absolutely certain that the firearm is completely unloaded (See "How to Unload" on page 5).
2. Pack your gun carefully. Use ample cushioning material and a sturdy outer cardboard box. Do not ship in a special container which you want returned.
3. Accessories such as scopes, scope mounts, gun case, quick detach type swivels, sling straps, etc. should be removed prior to returning the firearm.
4. Inside the box, include the following information: model number, serial number, description of damage or problem, and under what conditions problem occurs.

5. *Keep a record of your serial number when returning a firearm.*

6. Clearly mark your return address on the outside of the box and on your instruction sheet.

7. Do not ship live ammunition under any circumstances.

8. Ship your firearm via insured Parcel Post or U.P.S. Shipment must be prepaid and addressed to:

**MFC INC.  
ATTN: SERVICE DEPT.  
100 KENNA DRIVE  
NORTH HAVEN, CONN. 06473**

## IMPORTANT

If you have any questions or problems relating to your new Marlin, would like additional information on safe operation, or wish to order parts or accessories, just call our Customer Service Center. A Service Representative can be reached at the number listed below, between 8 A.M. and 4:30 P.M. (Eastern Time), Monday through Friday.

**1-800-544-8892**  
**(Toll Free)**

# MODEL 1894S PARTS LIST

For parts prices, call 1-800-544-8892 (8 A.M. to 4:30 P.M., Eastern Time, Weekdays)  
Be sure to mention gun serial number when ordering parts

Ill. No.	Part Name	Part No.	Ill. No.	Part Name	Part No.
**1	Barrel.....	114630	34	Hammer Spring (Main Spring) .....	420294
**2	Breech Bolt.....	114486	35	Hammer Spring Plate.....	320175
	Breech Bolt Assembly (Not Shown) (Consisting of parts 2, 9, 10, and 16 through 19).....	514486	36	Hammer Spur Complete (Includes Parts 37 and 38).....	520377
***3	Bullseye.....	320101	37	Hammer Spur Screw.....	420193
***4	Buttstock Complete.....	514013	38	Hammer Spur Wrench.....	420204
*5	Carrier Assembly.....	514461	39	Loading Spring.....	114594
6	Carrier Screw.....	301190	40	Loading Spring Screw.....	301591
7	Ejector With Spring.....	514268	*41	Locking Bolt.....	114181
8	Ejector Spring.....	401294	42	Magazine Tube.....	201022
***9	Extractor With Spring.....	514569	43	Magazine Tube Follower.....	401424
10	Extractor Retaining Pin.....	420598	44	Magazine Tube Follower Spring.....	401395
*11	Finger Lever Assembly.....	514170	45	Magazine Tube Plug.....	301225
**12	Finger Lever Plunger.....	214071	46	Magazine Tube Plug Screw.....	301990
13	Finger Lever Plunger Pin.....	301197	47	Peep Sight Dummy Screw (2).....	320690
14	Finger Lever Plunger Spring.....	401196	48	Rear Sight Complete.....	501342
15	Finger Lever Screw.....	301192	49	Rear Sight Base.....	520241
16	Firing Pin, Front.....	414299	50	Rear Sight Elevator.....	320242
17	Firing Pin, Rear.....	401199	51	Rear Sight Folding Leaf.....	201342
18	Firing Pin Retaining Pin, (2).....	420299	**52	Receiver.....	114460
19	Firing Pin Spring.....	401295	**53	Recoil Pad.....	417002
20	Forearm.....	114727	54	Recoil Pad Screw (2).....	420590
21	Forearm Tip w/Stud.....	501328	**55	Safety Button Assembly.....	599383
22	Forearm Tip Tenon.....	220429	56	Scope Mount Dummy Screw (4).....	320493
23	Forearm Tip Tenon Screw (2).....	320191	*57	Sear.....	201051
24	Front Band.....	301233	58	Swivel Stud, Rear.....	420793
25	Front Band Screw.....	301291	59	Tang Screw.....	320391
26	Front Sight Base.....	221239	*60	Trigger.....	201243
27	Front Sight Base Screw (2).....	301290	**61	Trigger and Sear Pin.....	401097
28	Front Sight Hood.....	320245	**62	Trigger Guard Plate.....	514158
29	Front Sight Insert.....	330644	63	Trigger Guard Plate Screw.....	301390
	Front Sight Complete (Consisting of above 4 parts) (Not Shown) ..	720339	64	Trigger Guard Plate Support Screw.....	301490
**30	Hammer.....	101273	*65	Trigger Safety Block.....	301859
31	Hammer Strut.....	320174	66	Trigger Safety Block Pin.....	420397
32	Hammer Strut Pin.....	401397	67	Trigger Safety Block Spring.....	401596
33	Hammer Screw.....	301090	68	Trigger Guard Plate Latch Pin.....	401099

Specifications subject to change without notice.

## MODEL 1894S

- \* Restricted availability—Part sent to qualified gunsmith only.
- \*\* Restricted availability—Parts installed at factory only.
- \*\*\* Non-restricted availability—Part may require some final fitting, sanding or filing.

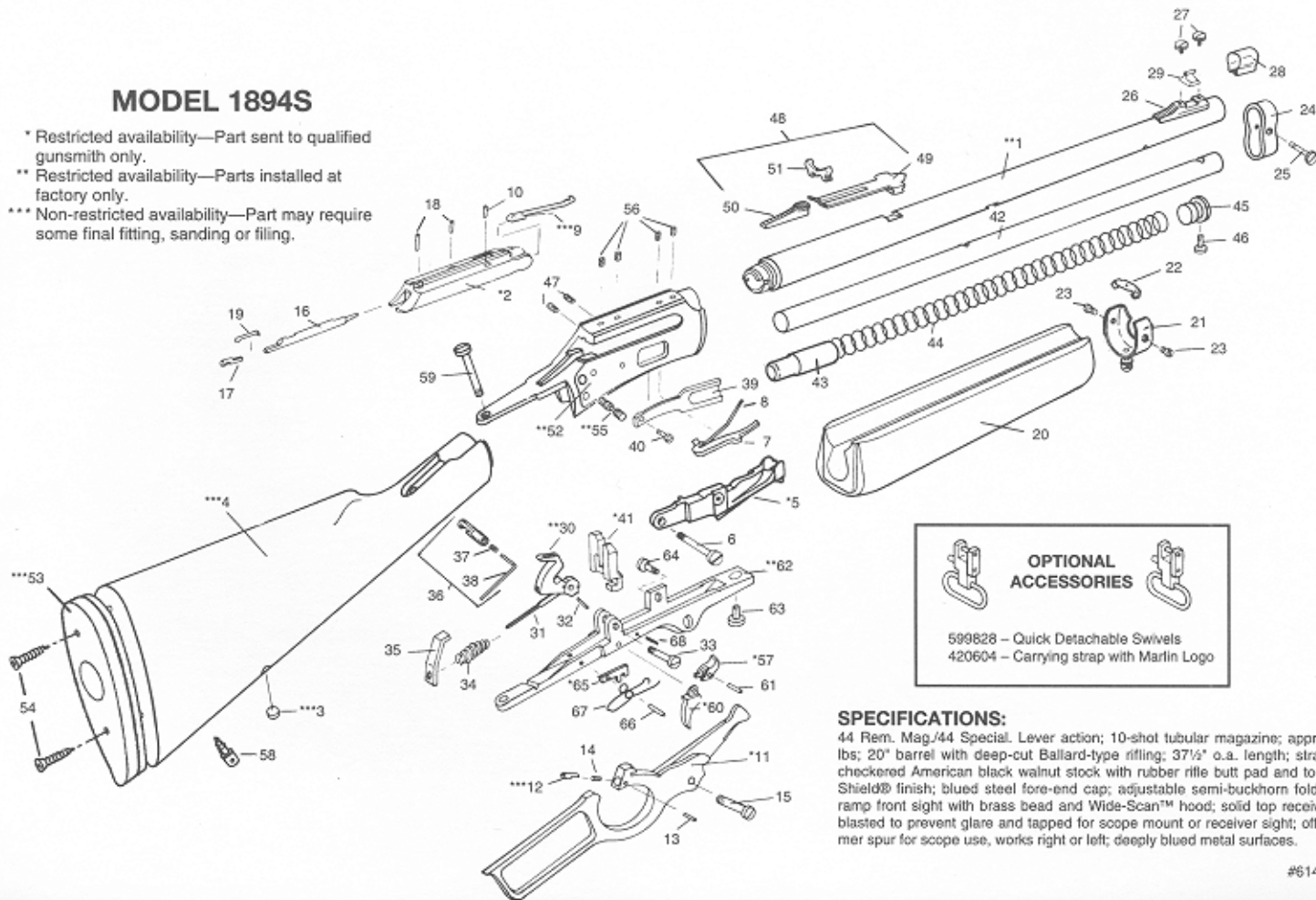

**OPTIONAL ACCESSORIES**

599828 - Quick Detachable Swivels  
420604 - Carrying strap with Marlin Logo

### SPECIFICATIONS:

44 Rem. Mag./44 Special. Lever action; 10-shot tubular magazine; approx. wt. 6 lbs; 20" barrel with deep-cut Ballard-type rifling; 37½" o.a. length; straight-grip checkered American black walnut stock with rubber rifle butt pad and tough Mar-Shield® finish; blued steel fore-end cap; adjustable semi-buckhorn folding rear, ramp front sight with brass bead and Wide-Scan™ hood; solid top receiver sand-blasted to prevent glare and tapped for scope mount or receiver sight; offset hammer spur for scope use, works right or left; deeply blued metal surfaces.

## Marlin's Guide to Gun Safety

1. Handle every gun as you would a cocked and loaded gun.
2. Keep the safety on SAFE until you are ready to shoot.
3. Be sure of your target before you shoot.
4. Before target shooting, be sure you have an adequate backstop. Remember, all rifle ammunition is dangerous at ranges up to, and in excess of a mile.
5. Control the muzzle, and never point a gun at anything you don't want to shoot.
6. Always wear protective glasses when shooting, disassembling or cleaning firearms.
7. Wear hearing protectors when target shooting.
8. Do not use modified, damaged or dirty ammunition.
9. Use only ammunition of the correct caliber, size and bullet shape.
10. Cartridges that have been improperly handloaded can damage the gun and cause personal injury.
11. Avoid ricochets by never shooting at water, or any hard, flat surface.
12. Be sure no one is in path of ejecting shells.
13. Never climb or jump over a fence or other obstacle with a loaded gun.
14. Never climb into or out of a tree, or tree stand with a loaded firearm.
15. Never pull a gun toward you by the muzzle.
16. Avoid alcoholic beverages before and during shooting.
17. Never use a gun that fails to function properly. Do not try to force a jammed action.
18. Be sure to keep the barrel and mechanism free of obstructions.
19. Before cleaning, be sure the chamber, action and magazine are completely unloaded.
20. Always unload a gun before storing, transporting, or leaving unattended.
21. Never enter a motor vehicle with a loaded gun.
22. Store guns and ammunition separately, locked and beyond the reach of children.
23. Always carry your firearm empty with the action open, except when you intend to shoot.
24. Avoid bumping, dropping or jarring any firearm. Bumping, dropping or jarring has resulted in certain firearms discharging accidentally under some circumstances.
25. Consult owner's manual before using any firearm.
26. Never interchange parts between firearms, except where indicated as a safe practice.

***Failure to follow these rules, or other instructions in this manual, can result in personal injury.***

**Health Warning:** Discharging of firearms in poorly ventilated areas and handling ammunition may cause exposure to lead and/or lead compounds. Exposure may cause cancer, birth defects or damage to the kidney, nervous, blood forming and reproductive systems. Have adequate ventilation at all times, especially in confined areas. Wash hands thoroughly after shooting, handling ammunition, or cleaning a firearm. Do not eat or smoke during these activities.

**Safety Warning:** Marlin strongly recommends that you take a hunter safety course, taught by a certified instructor, before you use this firearm. Your State Fish & Game Dept. or a local gun shop can suggest courses in your area.