

OPERATOR'S MANUAL



OCT
1970



M60

MACHINE GUN

SAFETY INFO.



* WARNING *

- KEEP YOUR M60 AIMED AT ONLY WHAT YOU WANT SHOT -- DOWN RANGE.
- CLEAR THE GUN WHENEVER YOU DO NOT INTEND TO FIRE.
- ALWAYS EYEBALL THE CHAMBER AFTER CLEARING THE GUN.
- CHANGE HOT BARRELS ONLY WITH YOUR ASBESTOS MITTEN.

**MUST
HAVE**

WITH EACH GUN & TRIPOD!



LUBRICATING OIL -
LSA - 9150-889-3522

HANDLE ASSY. -
1005-793-6761



(5) ROD SECTIONS - 1005-726-6109

(4) BORE BRUSH - 1005-556-4174

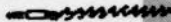

SWAB HOLDER SECTION -
1005-726-6110

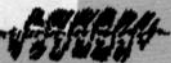
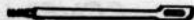

RECEIVER BRUSH -
1005-350-4100

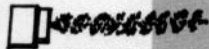

CHAMBER BRUSH -
1005-690-3115



SCREWDRIVER &
REAMER WRENCH -
5120-461-1075



EMS

TM 9-1005-224-10

OPERATING YOUR M60



MORE on HOW TO PUT IT TOGETHER

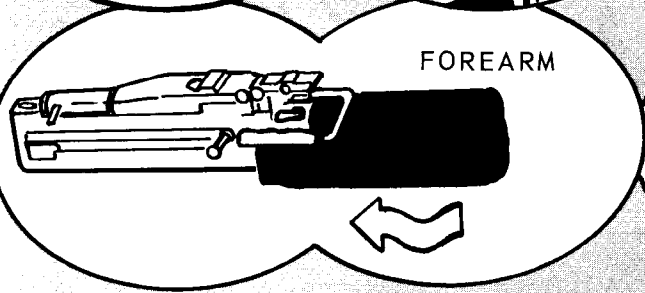
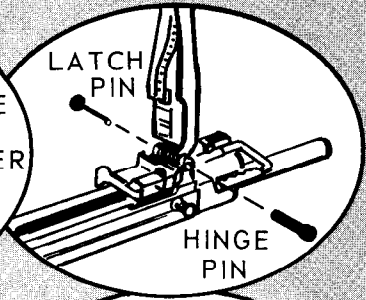
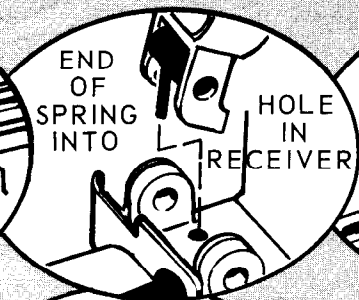
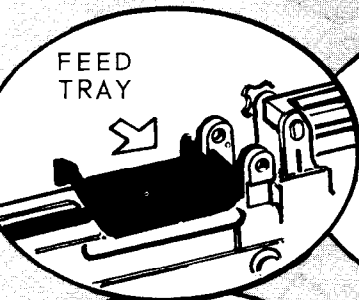

STILL MORE

FINAL WORD on PUTTING IT BACK TOGETHER

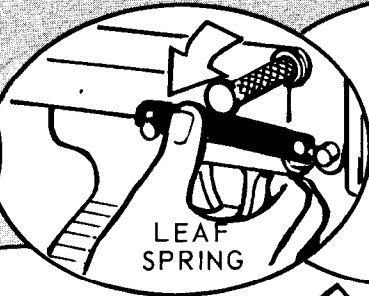
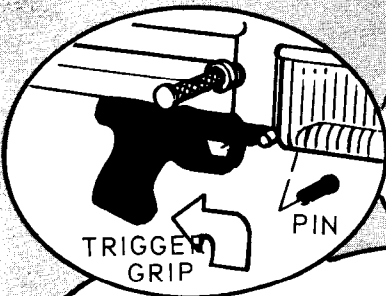

then -
COCK it
and
SAFE it

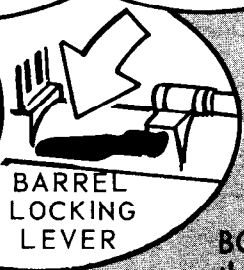
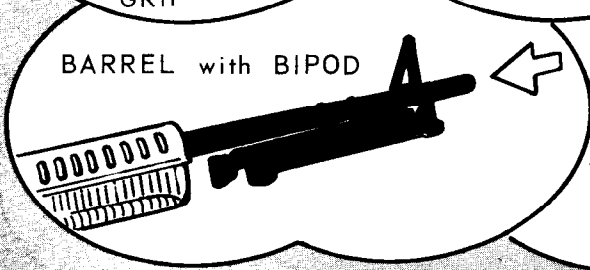

Put on
"FIRE"
and EASE
BOLT FORWARD
then, SAFE IT.

PARTS LEFT OVER ? ..OH OH..DOUBLE CHECK and TRY IT AGAIN !!

"WHERE TO FIND IT"

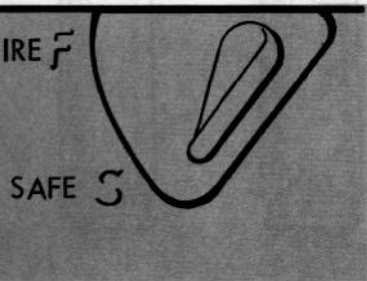
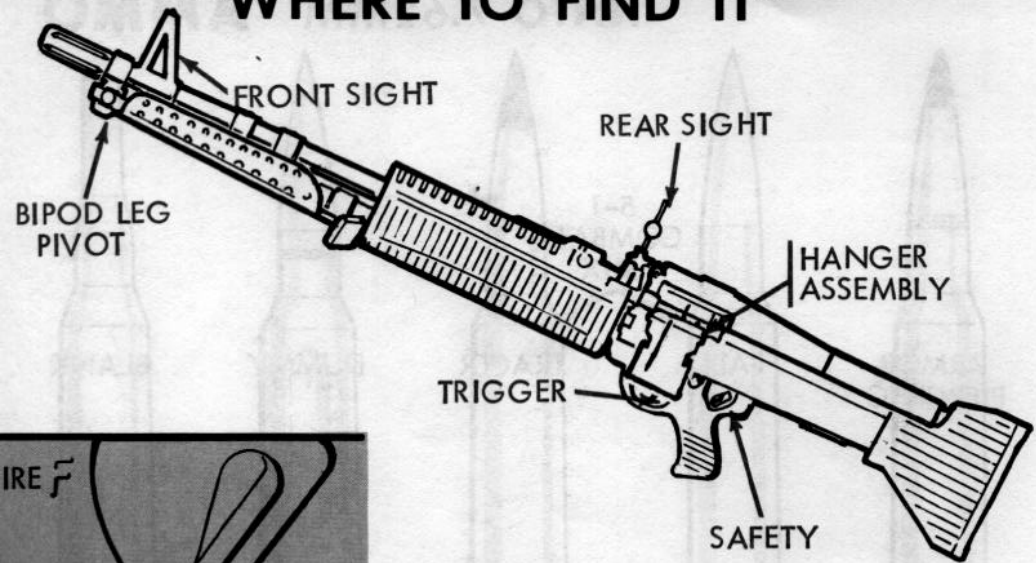

NATO 7.62MM AMMO

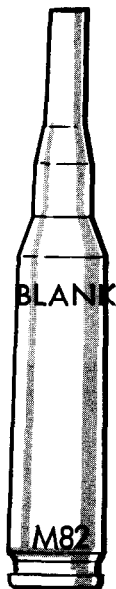
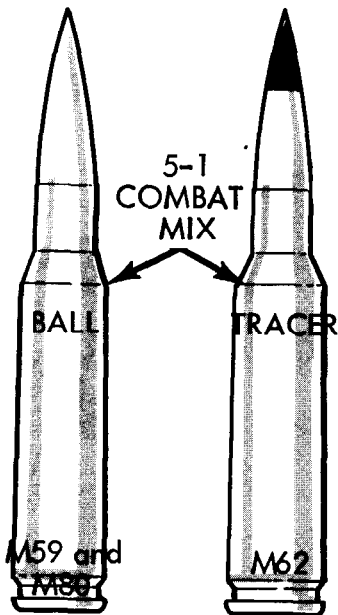

LOADING

- PULL BOLT to rear
- SAFE the gun
- OPEN the cover
- EYEBALL the chamber
- LOAD ammo on feed tray

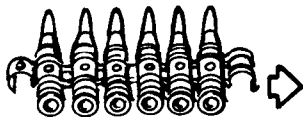
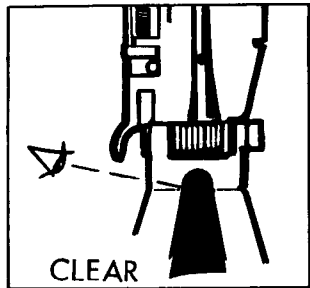

OPEN SIDE of
Links DOWN

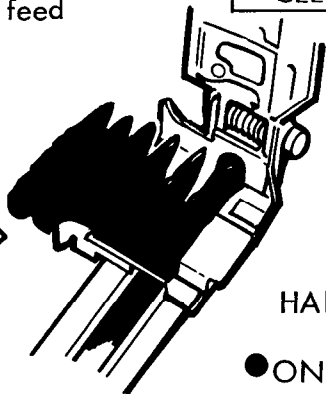

- CLOSE COVER
- RETURN COCKING HANDLE FORWARD
- ON "FIRE" and GO!

UNLOADING & CLEARING

✓ PULL BOLT

✓ SAFE

✓ OPEN THE COVER

✓ REMOVE THE AMMO

✓ EYEBALL THE CHAMBER

✓ EMPTY A-OK

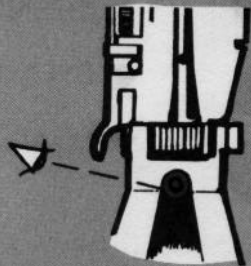

OH OH!

* **ROUND IN CHAMBER**

● CLOSE COVER, AIM, FIRE -

IF IT FIRED AND EXTRACTED, YOU'RE CLEAR.

LOADING

- PULL BOLT to rear
- SAFE the gun
- OPEN the cover
- EYEBALL the chamber
- LOAD ammo on feed tray

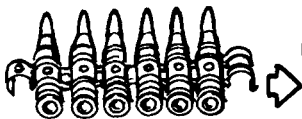

OPEN SIDE of
Links DOWN

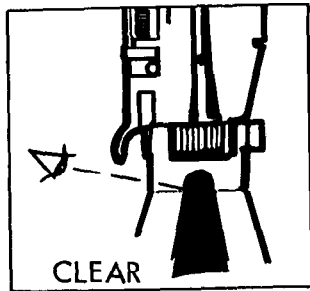
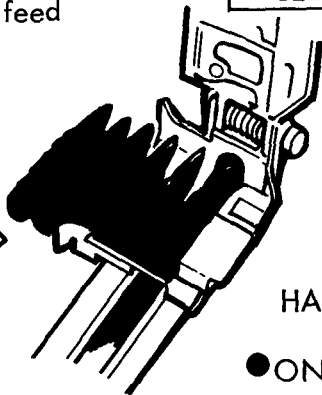

- CLOSE COVER
- RETURN COCKING HANDLE FORWARD
- ON "FIRE" and GO!

IF it didn't extract You got a STUCK CARTRIDGE and TROUBLE

- TAKE THE BARREL OUT
- INSERT CLEANING ROD (BARE END) AND GENTLY TAP OUT CARTRIDGE OR CASE.

★ RUPTURED CARTRIDGE

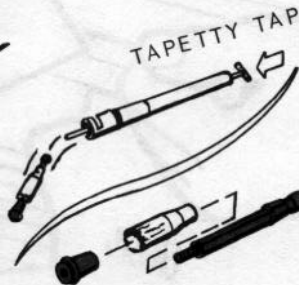
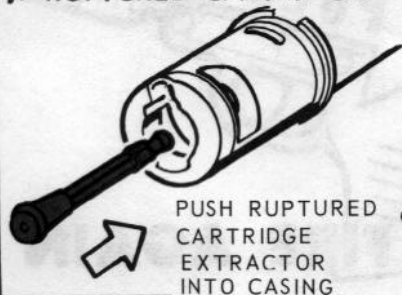

- PUT BARREL BACK
- CLOSE COVER
- HOLD COCKING HANDLE, PULL TRIGGER— AND EASE BOLT FORWARD

★ CLEARED

IF THE GUN DOESN'T FIRE

... TAKE

IMMEDIATE
ACTION

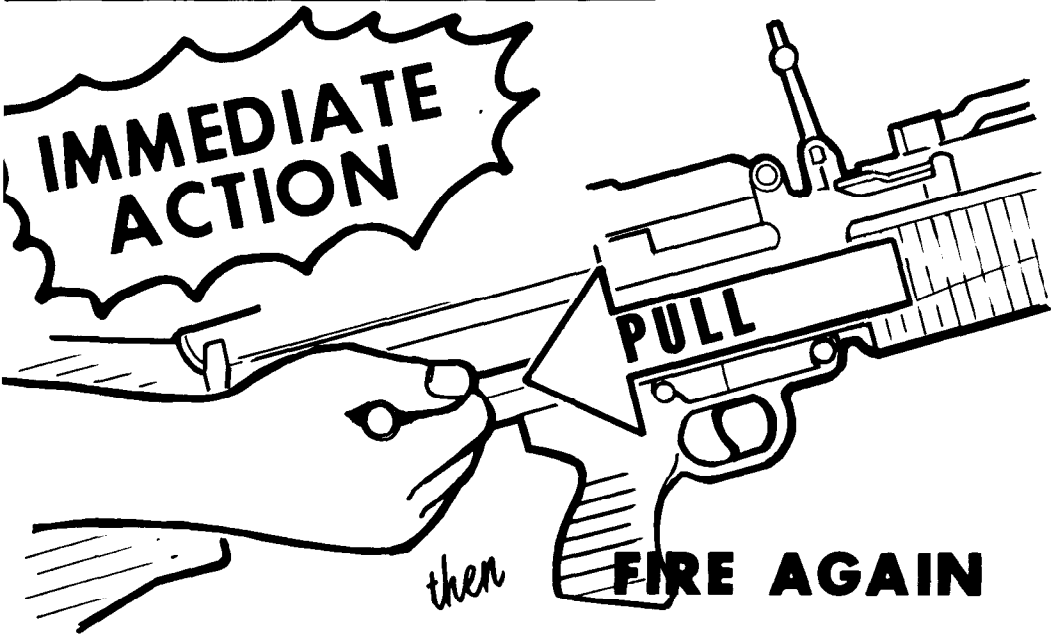

FIRE AGAIN

**IF IMMEDIATE ACTION DOESN'T CURE
YOUR PROBLEM** *CHECK*



lube?

LSA it!

dirty?

clean it!

put together wrong? **fix it!**

barrel trouble?

change it!

"BABY IT" BUDDY

Go over your M60 carefully,
LÔÔK for... **RUST, DENTS,**
DAMAGE, DIRT and **CRAP**

Make sure it's in **TOPNOTCH**
shape **NOW**

Your **LIFE DEPENDS ON IT!**

FIELD STRIP • BARREL with BIPOD

CHARGE
it!
SAFE
it!

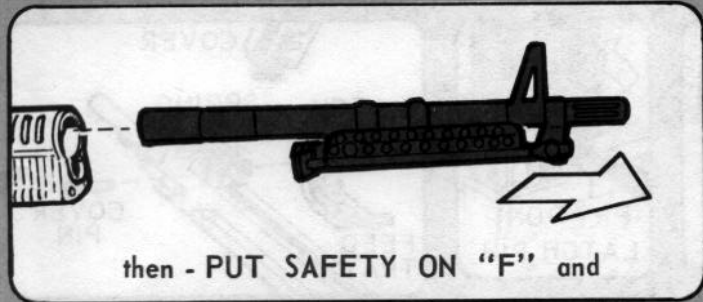
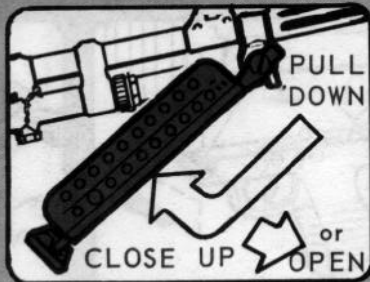

MORE FIELD STRIP

TRIGGER GROUP*GUNSTOCK*FOREARM*
COVER and FEED TRAY

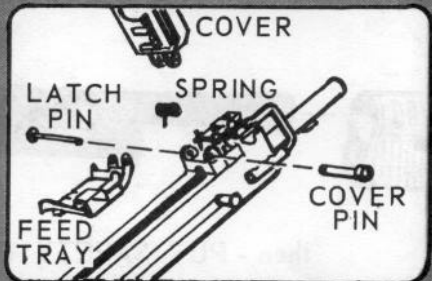
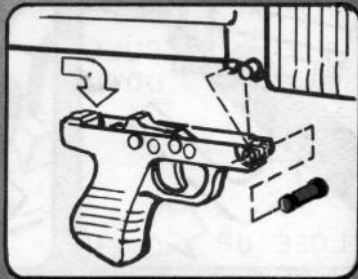

BUFFER * YOKE * DRIVING SPRING & GUIDE * BOLT * OPERATING ROD

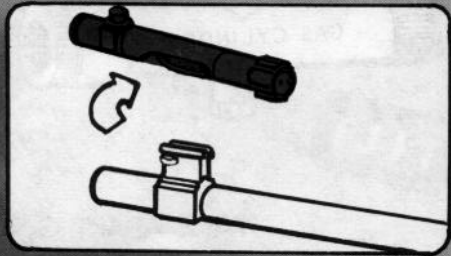
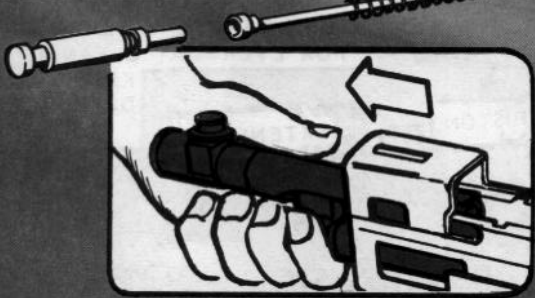
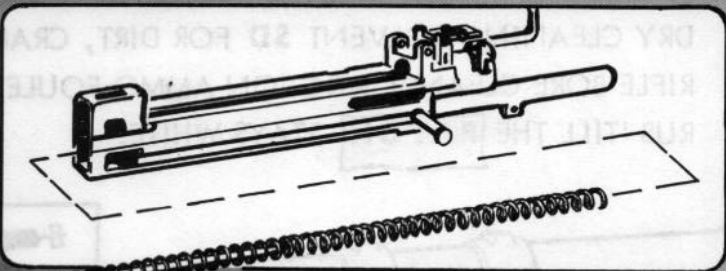
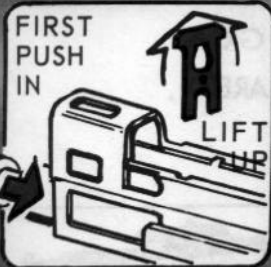

BINGO!

WHITE GLOVE your M60 & M122

DRY CLEANING SOLVENT **SD** FOR DIRT, CRAP, GRIT.
RIFLE BORE CLEANER **RBC** ON AMMO FOULED AREAS.
RUB 'TILL THE **PATCH** STAYS WHITE.

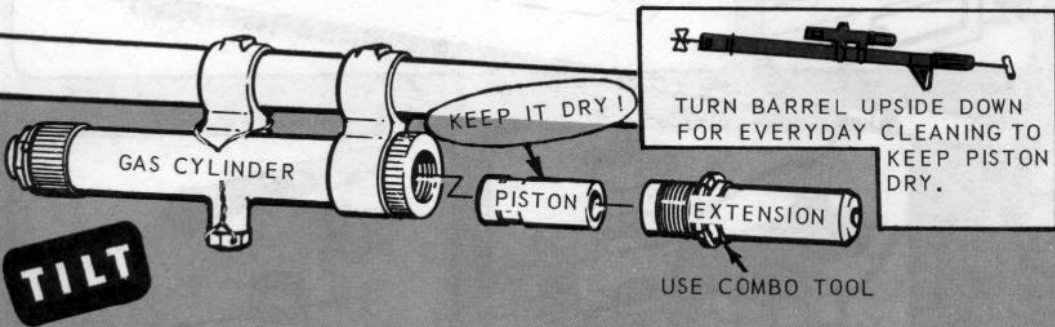

TAKE APART ONLY WHEN THE PISTON WON'T CLICK
WHEN BARRELS TILTED END FOR END.

CLEANING TRIGGER GRIP & BOLT

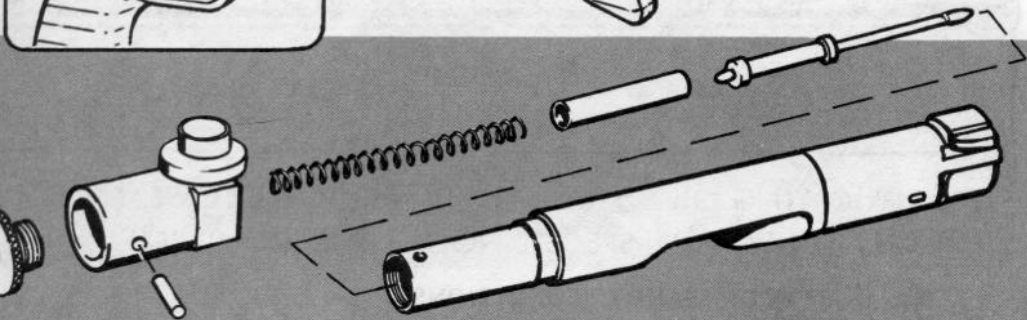
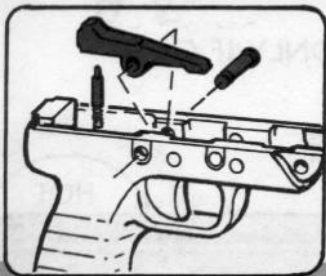

LUBE GUIDE

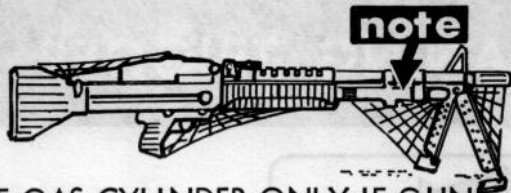

LUBE GAS CYLINDER ONLY IF GUN
IS TO BE INACTIVE !

type of CLIMATE

COLD

0° F

HOT

LAW

* **PL** SPECIAL

LUBRICATING OIL **S**EMI - FLUID, **A**UTOMATIC WEAPONS
ALL THE WAY (IN SPECIAL NOOKS AND CRANNIES).

* DUSTY OR SANDY CONDITIONS?
THEN, A LITTLE DAB'LL DO IT!

SPECIAL NOOKS AND CRANNIES

for

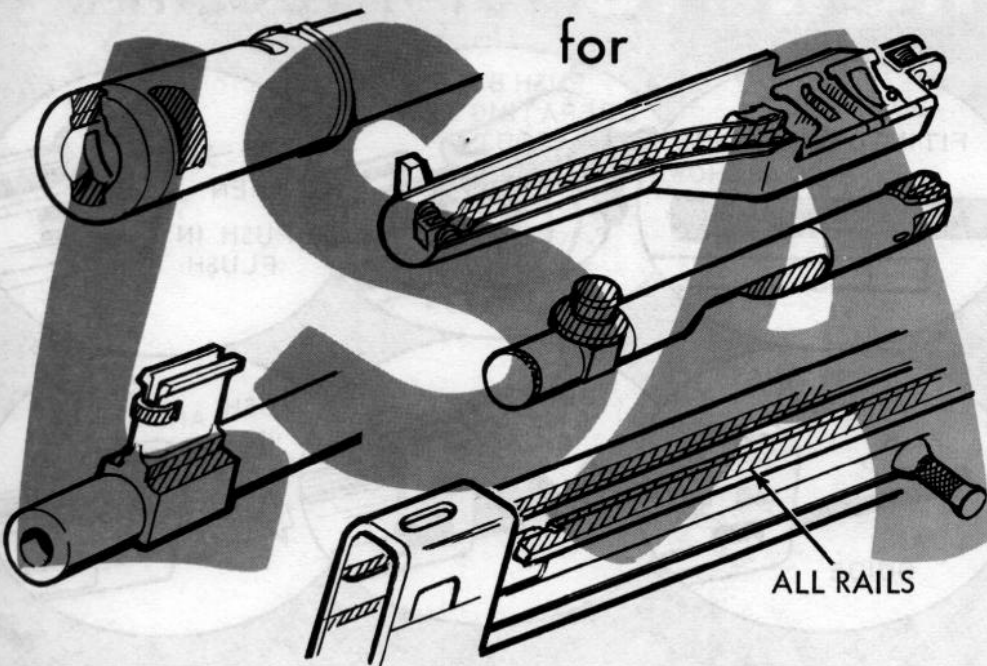

ALL RAILS

HOW TO PUT IT TOGETHER

BOLT MUST
FIT INTO OPERATING
ROD AS SHOWN

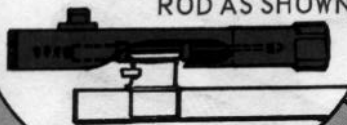

PUSH BOLT &
OPERATING ROD
ABOUT



HALFWAY IN

THEN
PUSH IN
FLUSH



OPERATING
SPRING



AND
GUIDE

BUFFER

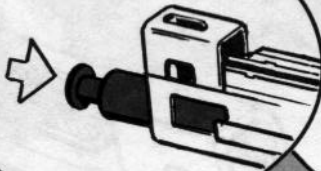

SEAT
AND YOKE
PUSH IN

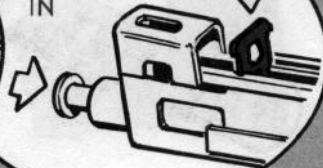

GUARANTEE

IF YOU GO BY ALL THE INSTRUCTIONS IN THIS BOOK, WE GUARANTEE YOUR MACHINE GUN TO SHOOT, AND SHOOT AND SHOOT.

IF YOU'VE DONE YOUR PART AND IT STOPS SHOOTING, TAKE YOUR MACHINE GUN TO YOUR SERGEANT AND HE'LL GET THE ORGANIZATIONAL MAINTENANCE MAN TO RESTORE THE MERCHANDISE TO FULL FIREPOWER FOR YOU.

***It's YOUR machine gun, Soldier,
keep it shootin'!***

This new Department of the Army manual supersedes old TM 9-1005-224-10, with changes, dated 20 Nov. '67.

WHAT IS THE M60?



LOOKIE HERE ! A MACHINE GUN, M60, 7.62-mm.
MAN, THIS BABY'S EVEN GOT FIXED HEADSPACE -SO-
YOU CAN CHANGE THOSE BARRELS IN A BIG HURRY.

WEIGHT 23 pounds

RATE OF FIRE

CYCLIC 550 rounds per minute

SUSTAINED* 100

RAPID* 200

BANDOLEER CAPACITY 100 rounds

* YOU GET THESE RATES THROUGH PRACTICE
AND A TRICKY TRIGGER FINGER !

SIGHTING IN



MAXIMUM EFFECTIVE RANGE IS AS FAR AS YOU CAN SEE TO ADJUST FIRE ACCURATELY ON TARGET.

SO .. CHECK YOUR SIGHT TO SEE THAT IT WORKS -- NO DAMAGE ALLOWED

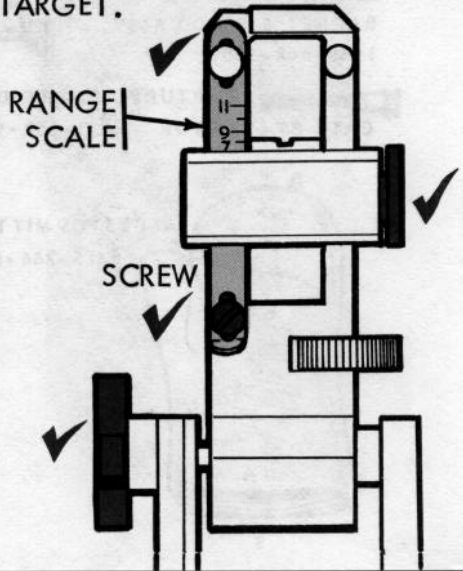



HERE'S WHAT YOU

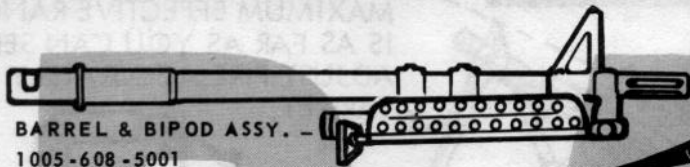

BARREL & BIPOD ASSY. -

1005-608-5001



RUPTURED CARTRIDGE

CASE EXTRACTOR - 4933-652-9950

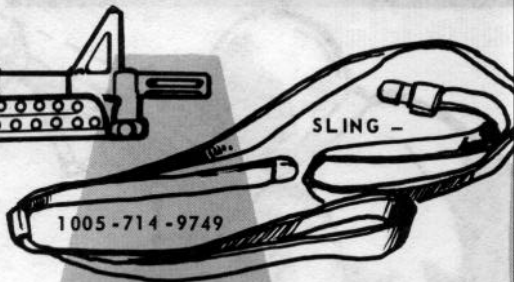

SLING -

1005-714-9749

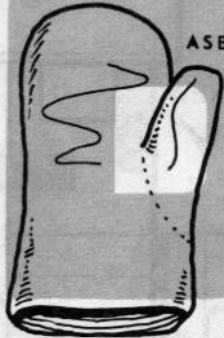

ASBESTOS MITTEN -

8415-266-8843

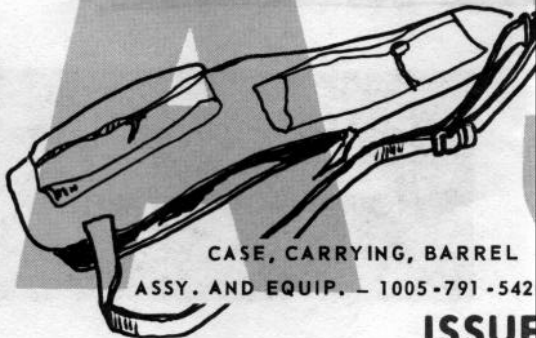

CASE, CARRYING, BARREL
ASSY. AND EQUIP. - 1005-791-542

ISSUE

BLANK FIRING ATTACHMENT

LIVE AMMO IS A **NO NO!**



CLAMPED AROUND
FRONT LEG
OF SIGHT

* TIGHT *

BLANKS
ONLY!

MAKE SURE
IT'S IN
ALL THE WAY!



Operating your M122 Tripod

Where to find it

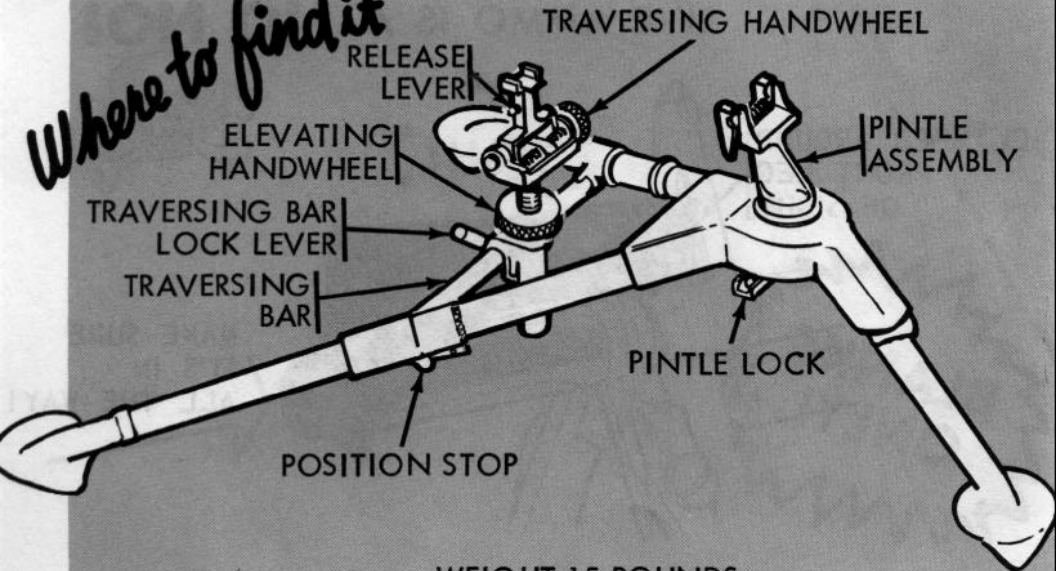

WEIGHT 15 POUNDS

How to put the M60 on the Tripod

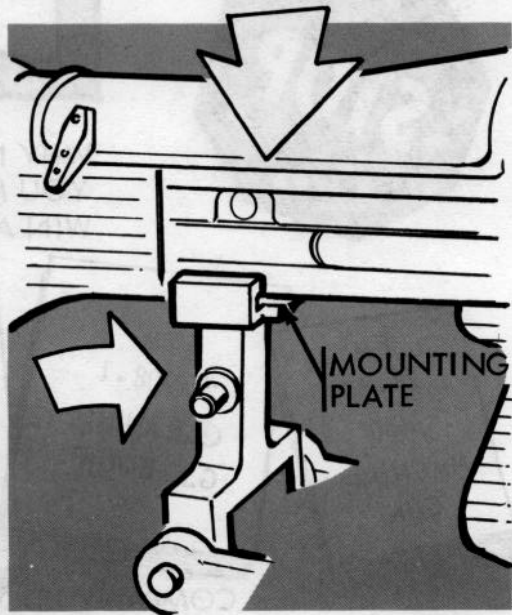
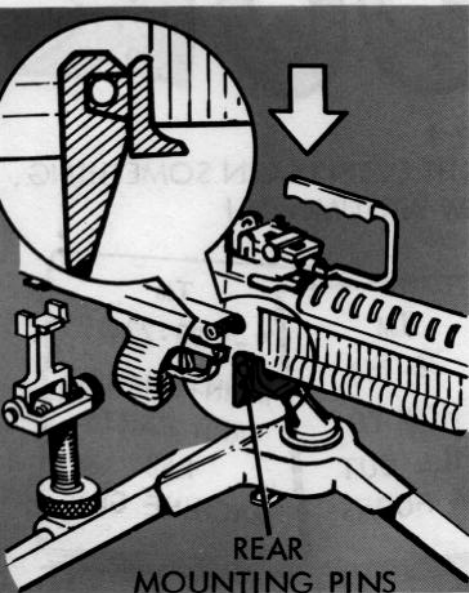



LOOK

WHY NOT !
YOU MIGHT EVEN LEARN SOMETHING .
WIN A FEW ARGUMENTS !

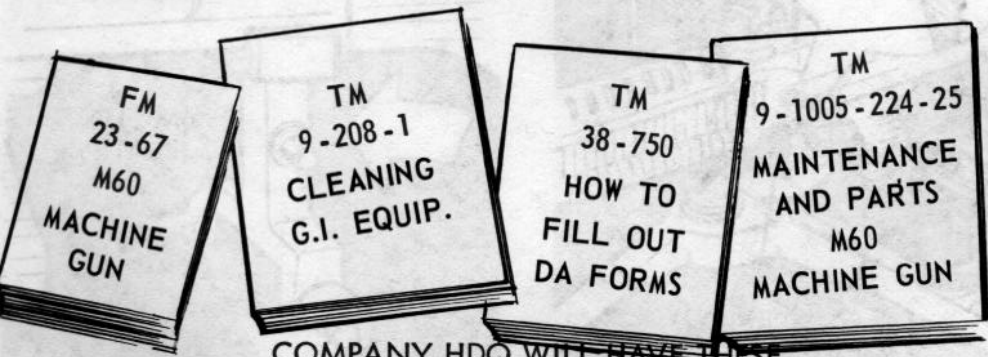

COMPANY HDQ WILL HAVE THESE.