

# ***KHAN SHOTGUNS***



**ARTHEMIS SUPREME OVER & UNDER OWNER'S MANUAL**

# ***KHAN SHOTGUNS***

## **Thank you for choosing KHAN SHOTGUNS**

Your over & under shotgun represents a piece of rich history  
of quality firearms design and manufacture.

During the manufacturing process, we have endeavored to incorporate the  
very finest in material, craftsmanship  
and, with a reasonable amount of care, your gun will provide many years of  
pleasure and dependable service.

Thank You  
Khan Shotguns

# ***KHAN SHOTGUNS***

## Safety Warnings

Regardless of your familiarity or experience with firearms, don't assume that you have no need to study this manual.

The safe handling of firearms requires specialized training, discipline and caution. Firearms, by their nature and intended function, are deadly instruments. Accidental death or serious injury can result if they are handled improperly or carelessly.

A person with a gun in his possession has a full-time responsibility. He must **KNOW** how to keep and use his firearm safely, and then must always **TAKE** the necessary precautions. He cannot guess; he cannot forget. This responsibility is his alone. It cannot be passed off to someone else.

Remember: No gun can be made accident-proof. A gun is just a machine, with no judgement of its own. It responds to your actions, whether wise or foolish. The only truly effective safety device is the mind of a cautious shooter who never forgets that a moment's carelessness can produce permanent tragedy.

## ***KHAN SHOTGUNS***

### Commandments of Firearm Safety

A good hunter is a safe hunter. He knows there is no place for horseplay in hunting, he learns and obeys the commandments of firearms safety and insists that his companions know and follow them too. Every hunter-whether novice or experienced outdoorsman should review these commandments before each hunting season to be sure that his gun handling, both at home and in the field, sets a good example for others.

1. Don't rely on your gun's safety. Treat every gun as if it were loaded and ready to fire. Install gunlock when not in use.
2. Don't shoot unless absolutely sure of your target and what is beyond it.
3. Always be sure the barrel is clear of obstructions.
4. Never point your gun at anything you do not want to shoot. Watch your muzzle so the other person doesn't have to.
5. Never leave your gun unattended unless you unload it first.
6. Avoid alcoholic beverages both before and during shooting.
7. Never carry a loaded gun when you climb a tree, cross a fence, jump a ditch or go through areas where you are apt to slip or trip.
8. Never shoot at a hard, flat surface or the surface of water. Make sure you have a safe backstop
9. Carry only empty guns, taken down or with the action open, into your camp, car or home.

## ***KHAN SHOTGUNS***

10. Store locked guns and ammunition separately, beyond the reach of children.
11. Never insert a shell of the incorrect gauge in any shotgun and use shell of correct length

**IMPORTANT** - Our shotguns are designed, manufactured and proof-tested for use with fresh factory loaded ammunition. Improperly loaded shells are dangerous.

Khanshotguns does not assume responsibility for damages or injury caused by reloaded or improperly loaded ammunition. This shotgun should not be used with broken, missing or altered parts.

### **WARRANTY**

"This product is under manufacturer's warranty which covers defects in materials and / or workmanship for one full year after date of original new gun retail purchase."

All warranty repairs will be completed by Century International Arms, Inc. 236 Bryce Blvd, Georgia, VT 05454. The company is not responsible for any misuse of the product. A request for a Return Authorization number is required by calling 1 -800-527-1252.

## **KHAN SHOTGUNS**

### **GENERAL SPECIFICATIONS OF ARTHEMIS SUPREME OVER & UNDER SHOTGUN**

MODEL	12 / 20 / 28 / 410 GA ARTHEMIS SUPREME MODEL
GAUGE	12/20/28/410
BARREL LENGTH	71cm-28"
RECEIVER	STEEL
CHAMBER	3" FOR 12 / 20 / 410 GA - 2 3/4" FOR 28 GA
CHOKE	CHOKE TUBES FOR 12 / 20 / 28 FIXED CHOKE FOR 410 GA
STOCK	TURKISH WALNUT
FOREND	TURKISH WALNUT
TOP RIB	FOR 12: 10 mm .393"/FOR 20/28: 8mm .314"/FOR 410: 7mm .275"
ENGRAVING	STANDARD
TRIGGER TYPE	SINGLE TRIGGER

1. Over Barrel
2. Under Barrel
3. Top Rib
4. Receiver
5. Fore-End
6. Latch
7. Top Lever
8. Barrel Selector
9. Safety Button
10. Butt Pad
11. Stock
12. Trigger

#### NOMENCLATURE

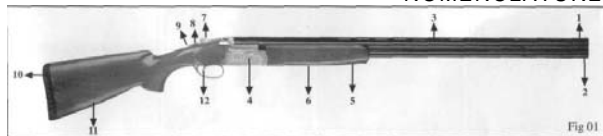

the parts nomenclature are shown in Fig 01

## ***KHAN SHOTGUNS***

### **Operating of the safety**

Both barrels are put on safe by drawing the selector rearward. In this position "S" sign will Appear directly in front of the selector.

Shotguns with single triggers are equipped with a barrel selector located on the upper portion of the trigger assembly. The barrel selector can be indexed to right or left with the firing finger. The position of the barrel selector controls the firing order of the two barrels. When the selector is positioned to the right the bottom barrel fires first and the top barrel will be subsequently discharged when the trigger is pulled a second time. The top barrel is fired first when the selector is positioned on the left side of the selector. Ensure that that safety is in the "Safe" or "S" position, and be careful to avoid contact with the trigger mechanism when the barrel selector is being moved.

# ***KHAN SHOTGUNS***

## **ASSEMBLY**

Before starting to the assembly take the forend section of your shotgun out of the barrel by pulling the latch downward. (See Fig 02 and Fig 03)

Be sure that you moved the top lever to the extreme right position; and release it. The fitting portions have to be free from dirt or burrs. You can apply a coat of preventative lubricant to ail metal surfaces. Take the barrel in your left hand and hold the receiver with your right hand; with the appropriate angle slide the barrel into the receiver. (See Fig 04)

Be sure that the pins on the extractor fit into the grooves. Close the action completely. Place the forend back into its right position by applying pressure and be sure that the latch is completely locked. (See Fig 05)

Your shotgun is now assembled...





## ***KHAN SHOTGUNS***

### **LOADING / FIRING / EXTRACTING OR EJECTING THE EMPTY SHELL**

When you load your shotgun, the muzzle should be pointed in a safe direction. Take the barrel with your left hand and with the thumb of the right hand move the top lever to the extreme right position. Move the barrel downward with the left hand until it cannot be moved. When the chamber is opened take the safety button to the safe position. Check the barrels that they are not obstructed. Put the shells in to the chambers until the extractor or the ejector catches the rims.

With your right hand hold the stock and grasp the barrel with your left hand. Swing the barrel upward and close the gun. Aim at the target push the safety button to the front and pull the trigger. With the barrel selector on the safety button you can choose the barrel that you desire to fire first. Bottom barrel fires first when the selector is positioned to the upright, the top barrel fires first when the selector is positioned on the upleft side of the selector. For extracting the empty shell, move the top lever to the right, swing the barrel to the loading position. The empty shells will be ejected by the extactor, you can take the empty shells out with your fingers. For the ejector models, the empty shells will be ejected automatically from the chamber.

# ***KHAN SHOTGUNS***

## **DISASSEMBLY**

Before starting to disassemble be sure that your gun is unloaded, the safety button is on safe position and the muzzle is pointed in a safe direction. Move the latch downward to take the forend out of the barrel. Take the top lever to the extreme right and swing the barrel down. The extractor has to be fully forward. When pulling the barrel upward with your left hand press the stock downward with your right hand; until you release the barrel from the receiver continue to pull and press with your hands simultaneously. But pay attention not to damage your shotgun, which was produced with very tight tolerances, when you disassemble or assemble it.

## **HOW TO CARE FOR YOUR SHOTGUN**

Your shotgun is a mechanical device and requires periodic maintenance and inspection after usage or storage to make its service life longer. Protect your shotgun with good gun care products, to assure trouble free performance, periodically open the action and push a patch, moistened with a good solvent through the barrel. Push a brass brush soaked in solvent through the entire length of the bore using long even strokes. Push clean patches through the bore in the same manner until the last patch comes out unsoiled. Then push a lightly oiled patch through the entire length of the bore. Brush or blow any residue from action area. Also with a brush and solvent, clean the breech face and extractor. Wipe dry all metal parts and oil lightly. Between hunting seasons apply a coat of oil to the bore and metal parts and store it in a dry place away from dust. Your shotgun should be checked periodically by a competent gunsmith to insure proper operation and replacement of any worn or damaged parts.





## KHAN SHOTGUNS

PLEASE DO NOT FORGET THAT YOU ARE RESPONSIBLE FOR SHOTGUN SAFETY. CARELESS HANDLING OF ANY FIREARM MEANS POTENTIAL DANGER....

IT IS YOUR RESPONSIBILITY TO TAKE PROPER CARE OF YOUR SHOTGUN. WE CAN NOT BE RESPONSIBLE FOR ANY DAMAGE TO THE FINISH OR MECHANISM DUE TO LACK OF CARE AND MAINTENANCE.

PLEASE READ AND UNDERSTAND ALL OF THE CAUTIONS, PROPER HANDLING PROCEDURES AND INSTRUCTIONS OUTLINED IN THIS BOOKLET BEFORE USING YOUR NEW FIREARM.

### CHOKES

PATTERN W/LEAD SHOT		PATTERN W/STEEL SHOT	MARK	USED AREA
★	FULL	NOT RECOMMENDED		WATER FOWLING
★★	IMP MOD	FULL		WATER FOWLING
★★★	MOD	IMP MOD		UPLAND HUNTING - SPORTING CLAYS
★ ★★★	IMP CYL	MOD		UPLAND HUNTING - SPORTING CLAYS
★★ ★★★	CYL	IMP CYL		UPLAND HUNTING - SPORTING SKEET

Standard Inter Choke Tubes for 12,20,28 Gauge, can be used for both steel and lead shots

**Important Note: Technical specifications of this shotgun may change without notice.**

# KHAN SHOTGUNS

## GENERAL ASSEMBLY

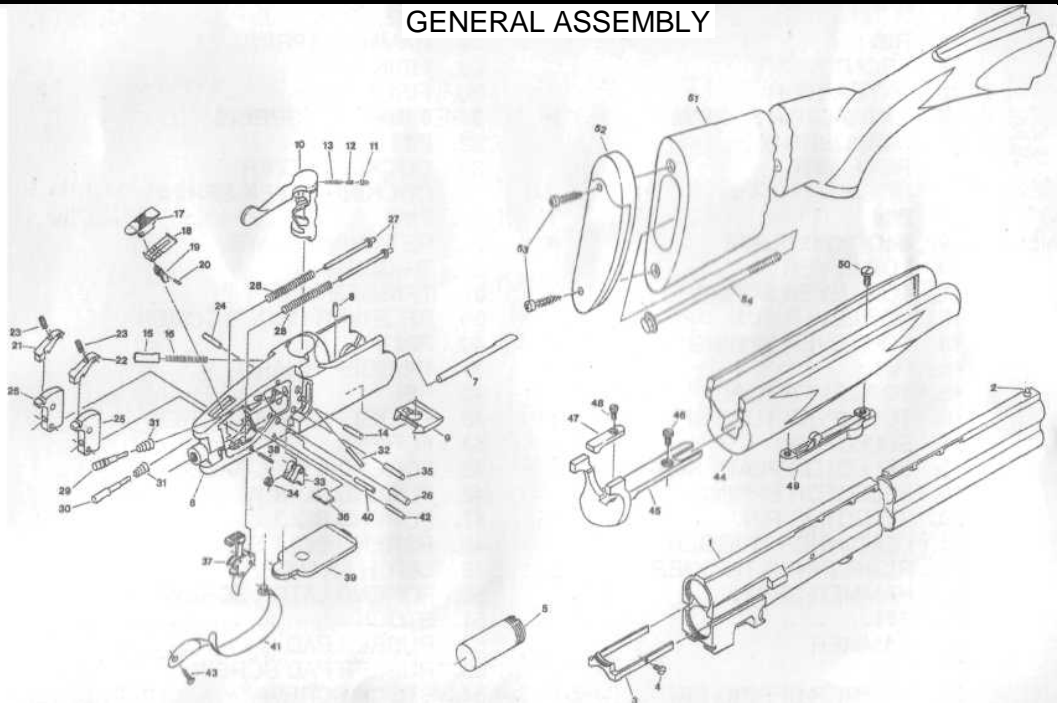

# ***KHAN SHOTGUNS***

## GENERAL PART LISTING

RIB	HAMMER SPRING
FRONT SIGHT	FIRING PIN
EXTRACTOR	FIRING PIN
EXTRACTOR SCREW	FIRING PIN SPRING
MOBILE CHOKE	PIN
RECEIVER	COCKING LEVER
COCK	COCKING LEVER SPRING
PIN	PIN
BLOCKER PLATE	RETAINING PLATE
TOP LEVER	TRIGGER
TOP LEVER SCREW	TRIGGER PIN
TOP LEVER PIN	RECEIVER UNDER COVER
TOP LEVER SPRING	PIN
PIN	TRIGGER GUARD
TOP LEVER TUBE	PIN
TOP LEVER TUBE SPRING	TRIGGER GUARD SCREW
SELECTOR	FOREND
SELECTOR PLATE SPRING	FOREND STEEL BASE
SELECTOR SPRING	FOREND SCREW
SELECTOR PIN	FOREND BOLT
LEFT INNER TRIGGER	FOREND BOLT SCREW
RIGHT INNER TRIGGER	LATCH FRAME
HAMMER SPRING	FOREND LATCH SCREW
PIN	STOCK
HAMMER	RUBBER PAD
PIN	RUBBER PAD SCREW
HAMMER SPRING PIN	STOCK SCREW

## **KHAN SHOTGUNS**

Distributed by Century International Arms, Inc.

236 Bryce Blvd.

Georgia, VT 05454

[www.centuryarms.com](http://www.centuryarms.com)

Sales (800) 527 - 1252 - (561) 998 - 1997