

Owner's Manual



New England
Firearms

Excell Auto™
Shotguns

IMPORTANT

This manual contains operating, care and maintenance instructions. To assure safe operation, any user of this firearm must read this manual carefully. Failure to follow the instructions and warnings in this manual can cause accidents resulting in injury or death. This manual should always accompany this firearm, and be transferred with it upon change of ownership.

WARNING: KEEP THIS FIREARM OUT OF THE REACH OF CHILDREN, UNAUTHORIZED INDIVIDUALS, AND OTHERS UNFAMILIAR WITH THE SAFE HANDLING OF FIREARMS.

Before You Use This Firearm

It is very important that you read and understand this manual before using this firearm. Warnings should be read and heeded carefully.

- **WARNING:** It is a violation of federal law to alter or deface the serial number of any firearm.

How Your Shotgun is Made

Your new shotgun has been made to H&R 1871, LLC's strictest standards of safety and reliability. It has been tested using proof and service ammunition that meets Sporting Arms & Ammunition Manufacturers Institute (SAAMI) & American National Standards Institute (ANSI) performance standards.

Your New Shotgun

Your gun is a 12-gauge semi-automatic shotgun designed to handle 2 $\frac{3}{4}$ " and 3" shells interchangeably. It will function with factory-loaded ammunition of any shot size, as well as rifled slugs.

The barrel has an internal choke tube system, and is provided with four tubes (IC, M, IM, and F, or IC, M, F, and XF Turkey for the Turkey model). Tubes can be removed and installed with the choke key provided, or with a quarter.

- **WARNING:** Except for installation of the barrel, your gun was shipped fully assembled. It should not be used or disassembled without reading and understanding the instructions in this manual.

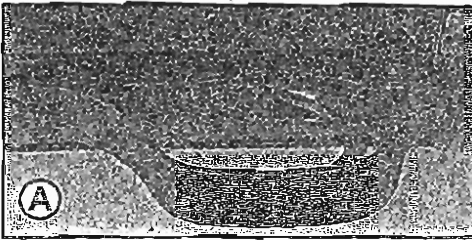

SAFE Position

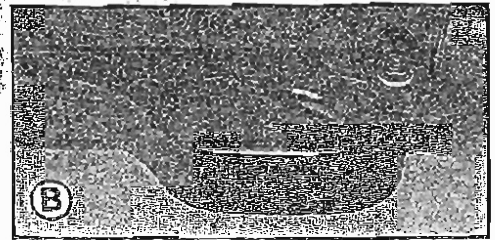

FIRE Position

How to Operate the Safety

- **WARNING:** Before installing the barrel, become thoroughly familiar with the operation of the safety.

The safety mechanism is a round button located behind the trigger. To put your shotgun on **SAFE**, hold it in the normal shooting position, pointed in a safe direction, and push the safety button from left to right as far as it will go. The safety is now on **SAFE** (See A). To move your safety to the **FIRE** position, push the safety button from right to left as far as it will go. A red ring will appear on the left side of the safety button when it is in the **FIRE** position (See B). If the trigger is pulled with the safety in this position, the gun will fire.

- **WARNING:** The safety has been correctly designed and tested. Any mechanical device can fail, however, so never rely on the safety to justify careless handling.

Operating the Action

- **WARNING:** To safely hold the breech bolt to the rear in the "action open" position for operating, cleaning, disassembly/reassembly of the gun, it is necessary to first depress the carrier latch button, located at the back of the carrier (See C1 and C2). Failure to do so may result in **PERSONAL INJURY**. Close the action by pressing the action release button on the side of the receiver (see C1).

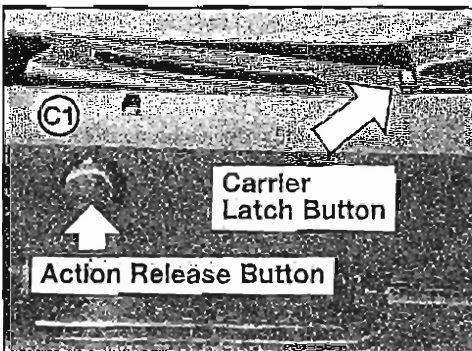

Action locked back properly

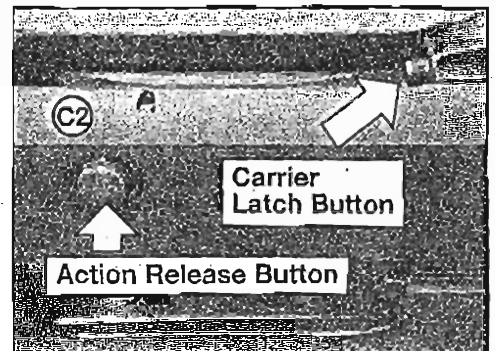

Incorrect – Action may close.
The carrier latch button is fully extended indicating it has not been properly depressed to lock the action open.

How to Install the Barrel

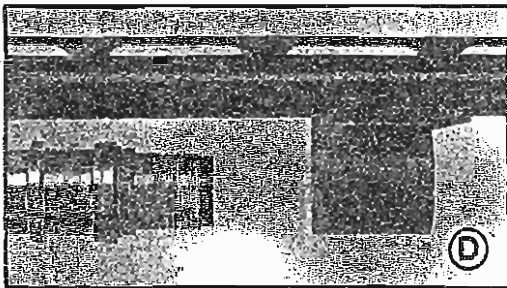

Installing barrel

Replace and tighten the magazine cap while pushing rearward on the barrel. (See D).

With the safety on SAFE, pull the operating lever fully to the rear until the bolt locks open. Remove the magazine tube cap and forearm from the gun.

Look through the barrel to be sure it is free of grease, oil, or any other obstruction.

Install the barrel and be sure it is firmly seated in the receiver.

Loading

Note: Your shotgun was shipped with a 2-shot plug, which must be installed when hunting migratory waterfowl. See the section of this manual entitled "How to Install the Magazine Plug".

• **WARNING:** When loading, keep the safety on at all times and keep the muzzle pointed in a safe direction. Open and close the action to be sure a shell is not chambered.

To load the magazine tube, first open and close the action. Then turn the shotgun upside down and insert a shotgun shell of the correct gauge through the bottom receiver opening, pushing it into the magazine tube until it is held in place by the cartridge latch. As you insert each shell you will hear a "click" that tells you the latch has closed behind it and you can now load the next shell (See E).

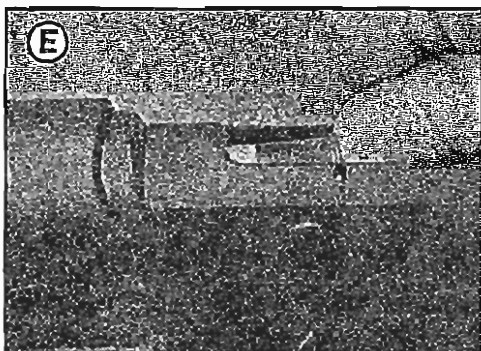

Loading the magazine

Loading a Shell into the Chamber from the Magazine Tube

• **WARNING:** Before loading a shell into the chamber, make sure the safety is in the ON position and keep the muzzle pointed in a safe direction.

Depress the carrier latch button at the back of the carrier (See C1). This will allow a shell from the magazine tube to slide onto the carrier. Now pull the breech bolt fully rearward by the charging handle and release. The shotgun is now chambered and ready to fire.

How to Fire

To fire, point the gun at the target, move the safety button to the FIRE position (red band will appear), and pull the trigger. When the gun fires, it will automatically eject the spent shell and insert a new live shell into the chamber. It will fire every time you pull the trigger until all shells have been fired. If you don't fire all of the shells, be sure to put the safety on SAFE until you are ready to shoot again.

Unloading

- **WARNING:** Before loading a shell into the chamber, make sure the safety is in the **SAFE** position and keep the muzzle pointed in a safe direction.

First, open the action and eject any shotgun shell that is in the chamber. Put the action back to the closed position. Then turn the shotgun upside down. Push the carrier into the receiver with your thumb, and with the other hand, push the action release button. A shotgun shell will be ejected from the magazine tube and rest against your thumb. Removing pressure from the action release button will keep the remaining shells in the magazine tube as you remove the shell that has been ejected out of the tube. Repeat this sequence for the remaining rounds in the magazine tube (See F).

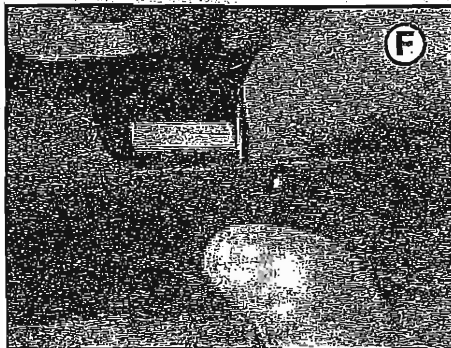

Visually check to make sure that no cartridges may be remaining in the magazine tube. Open the action and lock the bolt into the rear position.

- **WARNING:** To safely hold the breech bolt to the rear in the "action open" position, it is necessary to first depress the carrier latch button, located at the back of the carrier (See D1 and D2). Failure to do so may result in **PERSONAL INJURY**.

What to do if Your Shotgun Fails to Fire

1. Underpowered Shot. A "squib" or underpowered shot should not occur if the ammunition is clean, dry and factory-loaded. You can tell if a shot is underpowered by the unusually low report it makes.

- **WARNING:** Because wads, shot protector or lead may still be in the barrel, you must unload completely and, with the action open, and the safety on **SAFE**, remove the barrel and look through it to see if there is any obstruction. If there is, it must be removed before shooting the gun again.

2. Misfire. If you squeeze the trigger and the shell does not fire, remain in shooting position and count to 10. Then operate the action to eject the misfired shell.

How to Disassemble Your Shotgun

Disassembly of your Excell autoloading shotgun should only be necessary for thorough cleaning of the gun. The following instructions should be followed closely, and it is recommended that you keep the parts in order as they come off the gun to make reassembly easier. Further disassembly beyond what is recommended in these instructions is **NOT** recommended, and may result in voiding your warranty. Do not attempt to repair or alter the components of your shotgun.

Before beginning disassembly, check the chamber and magazine to make sure the gun is entirely unloaded. Engage the safety switch by pushing the button to the right.

Step 1: Unscrew the magazine cap.

Step 2: Grasp the fore-end and slide it forward off the magazine tube.

Step 3: Remove the barrel and the neoprene "O" ring.

Step 4: Slide the piston seal assembly off the magazine tube (See G).

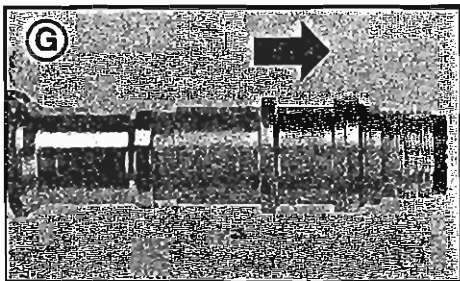

Slide the piston seal assembly off

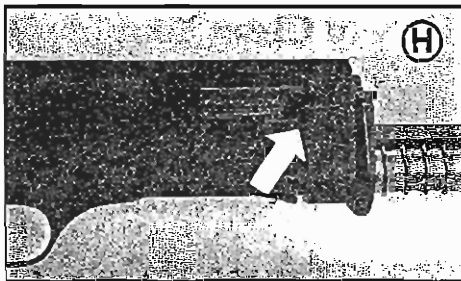

Pull the operating lever out of the bolt assembly

NOTE: Be sure to carefully note the orientation of this assembly on the tube. It is possible to reinstall it upside down (see Use of Magnum Loads). For standard loads, the end with the split ring and collar must be toward the muzzle-end of the gun.

Step 5: Manually and slowly guide the bolt handle rearward until it aligns correctly (about midway) into the key hole slot. This proper alignment will then allow for handle removal. (See H).

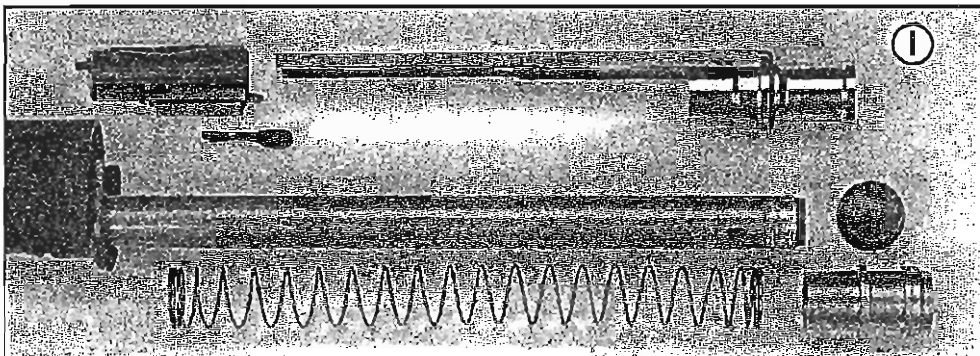

Slide the action bar assembly and bolt assembly forward, toward the muzzle-end

Step 6: Move the Action Bar Assembly, including the Breech Bolt Assembly, forward along the magazine tube and out of the receiver, then remove the Bolt Return Spring from the magazine tube. (See I).

Step 6: Firmly grasp and slide the bolt assembly forward out of the receiver (See I).

NOTE: The Breech Bolt Assembly has two main components. Be sure to note how they fit together, and how the Breech Bolt Assembly fits to the Action Bar Assembly when the assembly is removed.

Step 7: Using a properly sized punch, gently tap out the front and rear trigger assembly pins (See J). The trigger assembly may then be lifted out of the receiver.

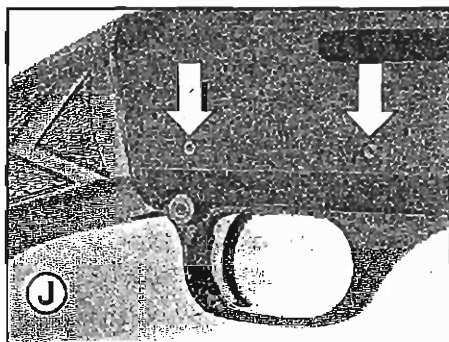

Gently tap out the front and rear trigger assembly pins with a punch

How to Clean Your Shotgun

- **Warning:** Regular, proper cleaning of your shotgun will help to extend its useful life and keep it operating smoothly and reliably. Cleaning is especially important if the gun gets wet or if foreign material gets into the receiver or barrel. Before cleaning your shotgun, be certain it is completely unloaded.

Never attempt to wipe down or clean a loaded firearm. Follow instructions under "Unloading" before cleaning.

To clean the chamber and bore, you will need a standard commercial shotgun cleaning rod, a bronze bore brush of the proper diameter, a commercial powder solvent, and cleaning patches. Never use a steel bore brush as it may damage the bore. It is usually also wise to use a solvent that removes the traces of plastic that are sometimes left in the bore during the passage of the wads

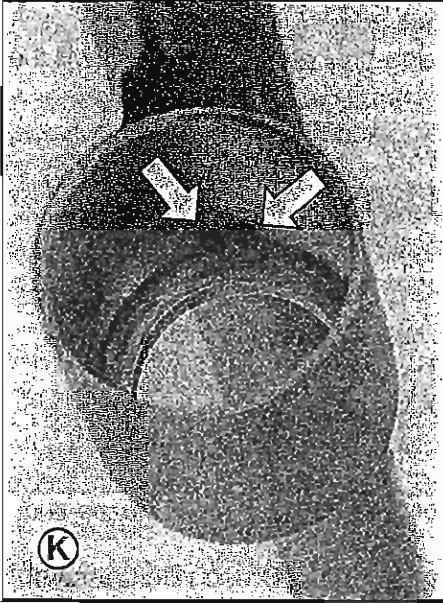

Gas ports, attached to barrel

First, run a patch saturated with solvent through the bore and let it stand for a few minutes. Then dip the bronze brush in solvent and run it through the bore, followed by clean, dry patches. Use additional dry patches until they come out clean. If necessary, repeat the entire procedure. Finally, run a patch through the bore that has been saturated with light gun oil to protect it from rust.

Brush the piston seal assembly, action bar assembly, breech bolt assembly and inside of the receiver with solvent and wipe clean and dry. If the piston seal assembly is badly fouled, fine steel wool may be used to remove the fouling. Apply a light coat of oil to the surface of all components.

Your shotgun is gas operated, and it is especially important to clean the ports through which powder gases are bled from the barrel to operate the piston assembly, which functions the action. These gases contain combustion residue, which can foul the parts and piston seal assembly. To clean the two ports, which may only be done while the barrel is removed from the gun, use a 1/16th" diameter wire. The ports are located in the gas cylinder, which is permanently attached to the barrel at approximately its midpoint (See K).

Lightly oil the trigger assembly and other contact points where friction may occur inside the gun before reassembling. **DO NOT OVER-OIL.**

To clean the choke tube, unscrew and remove it from the barrel. Clean the choke, including the threads, with solvent and wipe dry. At this time, it is also a good idea to clean the threads on the inside of the barrel with solvent and a small brush, such as an old toothbrush. Lightly oil the choke and threads, and replace the choke. Tighten firmly, but do not over-tighten.

Dry and clean the outer surfaces of the gun with a soft cloth, removing all moisture and fingerprints. You may find an old toothbrush useful for cleaning hard-to-reach crevices. Finally, apply a light coat of gun oil to the receiver and all external metal surfaces.

During freezing conditions, oil may congeal and cause sluggish operation of your gun. It is recommended that only a very thin coat of light oil be used in these conditions.

Condensation droplets of water will form soon after a cold firearm is brought into a warm room. The gun may also become wet during inclement weather. In these cases, all moisture should be removed immediately to avoid the formation of rust. Exterior metal finish may be wiped down with a lightly oiled cloth.

For long term storage, lightly oil the bore, barrel and receiver with gun oil. Your firearm should be completely unloaded and stored in a dry area. Never store your firearm in a carrying case.

Reassembly of Your Shotgun

Reassembly is basically the process of reversing the disassembly procedures. If you were careful to keep the parts in order and note their relationship to each other as you removed them, reassembly is easy.

Step 1: Replace the trigger assembly, aligning the two trigger assembly pin holes in the assembly with the matching holes in the receiver. Insert the pins and lightly tap them into place. It is recommended that a plastic hammer be used to avoid marring the surface of the receiver.

Step 2: Slide the Bolt Return Spring on to the magazine tube.

Step 3: Slide the Action Bar Assembly on to the magazine tube, until stopped by the Bolt Return Spring.

Step 4: Fit the metal tab on the bottom of the (assembled) Breech Bolt Assembly into the slot at the rear of the Action Bar Assembly.

Step 5: Carefully slide the fitted Action Bar/Bolt Assembly into the receiver (while compressing the Bolt Return Spring) until the bolt is visible in the Receiver Ejection Port. **DO NOT RELEASE YOUR PRESSURE ON THE ACTION BAR ASSEMBLY AND SPRING.**

Step 6: Insert the Operating Handle (bolt pull handle) into the visible slot in the Breech Bolt Assembly. Note: The Breech Bolt can be moved forward and rearward, while maintaining pressure on the Action Bar Assembly and Bolt Return Spring, to allow you to locate the key slot that corresponds to the shape of the operating handle shaft.

Step 7: Depress the Carrier Latch Button and slide the bolt to the rear until it is locked open.

Step 8: Slide the Piston Seal on to the magazine tube, making sure it is positioned for the type of shells you next intend to use, as noted by the arrows etched on Piston Seal, and slide the neoprene "o" ring on to the magazine tube.

Step 9: Replace the barrel, slipping the gas cylinder over the end of the magazine tube and sealing the barrel unit firmly into the receiver.

Step 10: Replace the forend, and screw on the magazine cap.

Use of Steel Shot

• Warning: Steel shot is substantially harder than lead shot. It is enclosed in a plastic wad in most reputable shotshells to help protect the barrel from scoring by the hard steel shot. However, when the steel shot charge passes through the choke construction in the barrel, the barrel or screw-in choke may be damaged if a tightly-constricted choke is in place. For that reason, we strongly recommend that a choke of no greater constriction than Modified be used when firing steel in your shotgun. Use of an Improved Modified or Full Choke when firing steel shot will void your warranty.

Use of Magnum Loads

It is possible by turning the piston upside down (letter M on the top facing muzzle) to reduce the recoil when using magnum loads. Remember to replace the piston to its original position (letter M on the bottom facing trigger) when reverting to standard loads.

Excell Choke System

Your shotgun was provided with four choke tubes to meet varying shooting and hunting situations.

A unique notching system allows choke tubes to be easily identified in minimal light conditions, as shown in the following chart.

NO. OF SLOTS ON CHOKE TUBE	CHOKE DESIGNATION
I	Full
II	Improved Modified
III	Modified
IIII	Improved Cylinder
IIIII	Cylinder

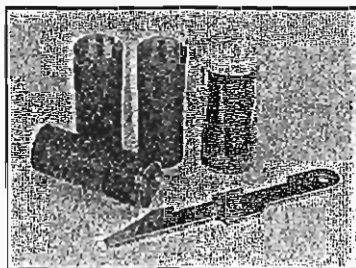

If you would like to purchase additional choke tubes, please call the H&R Service Department at (978) 630-8220, and have the serial number of the shotgun available.

- Warning: Always unload your shotgun and open the action before changing chokes. NEVER fire your shotgun without a choke installed. Doing so may damage the threads and/or barrel. Always make sure the choke is firmly screwed into the barrel, but do not over-tighten. Never use a choke that is bent or out-of-round.

Magazine Plug

- Warning: According to the Federal Migratory Bird Treaty Act, and some state laws, a magazine plug must be installed prior to hunting which limits the magazine capacity to two shells. It is the responsibility of the gun owner to make sure a plug is installed when required.

How to Install the Magazine Plug

CAUTION: Wear safety glasses while installing or removing the magazine plug. The magazine spring retainer is under tension from the magazine spring and may cause injury unless care is taken in releasing it.

With the safety on SAFE, be sure there are no shells in the chamber or magazine. Remove the magazine cap, barrel, forearm and piston seal assembly. With your hand over the end of the magazine tube, turn the retainer to the left with a large screwdriver. (You may need to depress the retainer protrusion in the slot on the side of the magazine.) (See L).

Place the plug inside the magazine spring, push it into the magazine tube, and tighten the retainer (See M). Reassemble piston seal assembly, forearm, barrel, and magazine cap.

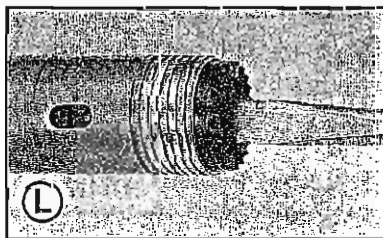

Remove retainer with a screwdriver

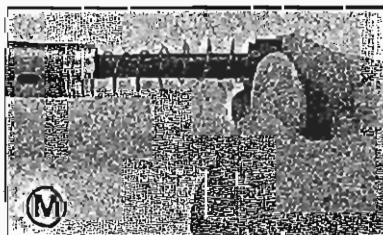

Place plug inside magazine spring

Guide to Firearm Safety

1. Read and understand the owner's manual before using a firearm.
2. If you are unfamiliar with firearms, attend a firearms safety class taught by a certified instructor.
3. Handle every firearm as if it were loaded and ready to fire.
4. Control the muzzle, and never point a firearm at anything you don't want to shoot.
5. Keep the safety on SAFE until you are ready to shoot.
6. Unless you are hunting, carry your firearm empty, with the action open.
7. Before shooting, be sure you have an adequate backstop. All ammunition is dangerous beyond your line of sight.
8. Avoid ricochets by never shooting at water or any hard, flat surface.
9. Do not run, climb, or jump over an obstacle with a loaded firearm.
10. Do not climb into or out of a tree or tree stand with a loaded firearm. Do not allow others to pass loaded firearms to you while in a tree stand.
11. Do not enter or ride in a motor vehicle with loaded firearms.
12. Do not lean a loaded firearm against anything.
13. Do not bump, drop or jar a loaded firearm.
14. Do not pull a firearm toward you by the muzzle.
15. Wear hearing protectors when shooting.
16. Wear impact-protective glasses when shooting, disassembling or cleaning firearms.
17. Avoid alcoholic beverages and drugs before and during shooting.
18. Use only ammunition of the correct gauge, caliber, size and bullet shape for your firearm.
19. Do not use damaged, dirty, modified, or improperly handloaded ammunition.
20. Keep the barrel and mechanism of the firearm free of obstructions.
21. Do not use a firearm that fails to function properly. Do not try to force a jammed action.
22. Be sure no one is in the path of ejecting shells or cartridges.
23. Do not interchange parts between firearms, and be sure disassembly and reassembly are correct and complete.
24. Before cleaning, be sure the chamber, action and magazine are completely unloaded.
25. Unload firearms before storing, transporting, or leaving unattended.
26. Store firearms and ammunition separately, locked and out of the reach of children.

Failure to follow these rules, or other instructions in this manual, can result in personal injury or death.

Health Warning:

Discharging of firearms in poorly ventilated areas and handling ammunition may cause exposure to lead and/or lead compounds. Exposure may cause cancer; birth defects or damage to the kidney, nervous, blood forming and reproductive systems. Have adequate ventilation at all times, especially in confined areas. Wash hands thoroughly after shooting, handling ammunition, or cleaning a firearm. Do not eat or smoke during these activities.

Safety Warning:

We strongly recommend that you take a hunter safety course, taught by a certified instructor, before you use this firearm. Your State Fish & Game Department or a local gun shop can suggest courses in your area.

Safety Warning:

Keep this firearm out of the reach of children, unauthorized individuals, and others unfamiliar with the safe handling of firearms.



WARNING

Children are attracted to and can operate firearms that can cause severe injuries or death.

Prevent child access by always keeping guns locked away and unloaded when not in use. If you keep a loaded firearm where a child obtains and improperly uses it, you may be fined or sent to prison.



ADVERTENCIA

A los niños los atraen las armas de fuego y las pueden hacer funcionar. Ellos pueden causarse lesiones graves y la muerte.

Evite que los niños tengan acceso a las armas de fuego guardándolas siempre con llave y descargadas cuando no las esté utilizando. Si usted tiene un arma de fuego cargada en un lugar en que un niño tiene acceso a ella y la usa indebidamente, le pueden dar una multa o enviarlo a la cárcel.

Service Policy

H&R 1871, LLC will repair or replace any firearm of its manufacture if it is found to be defective due to materials or workmanship within one (1) year of the original date of purchase. If your firearm should require service, return it to the factory as follows:

1. Describe completely in a note the type of service to be performed and the problem with your firearm, if any, and include your name, shipping address, daytime telephone number, model number and serial number of the firearm.
2. Make sure the firearm is unloaded and package it carefully to avoid damage in transit, including the note and a copy of your sales receipt inside the package.
3. Do not ship live ammunition in the package with the firearm as this is a violation of Federal law.
4. Do not include the Trigger Locking Device or accessories with the firearm.
5. Insure and ship the firearm insured to:

H&R 1871 • P.O. Box 1871 • Madison, NC 27025
Phone 866-776-9292 • www.hr1871.com

Please record the firearm serial number with two letter prefix, date of purchase and where purchased below.

Serial #: _____

Date of Purchase: _____

Purchased From: _____

In case of loss or theft, supply this information to the proper authorities.



Excell Auto™ Shotgun

Autoloading • 12 Gauge • 3" Chamber

- * Restricted availability-Part sent to qualified gunsmith only.
- ** Restricted availability-Parts Installed at factory only.
- *** Non-restricted availability-Part may require some final fitting sanding or filing.

Harrington & Richardson

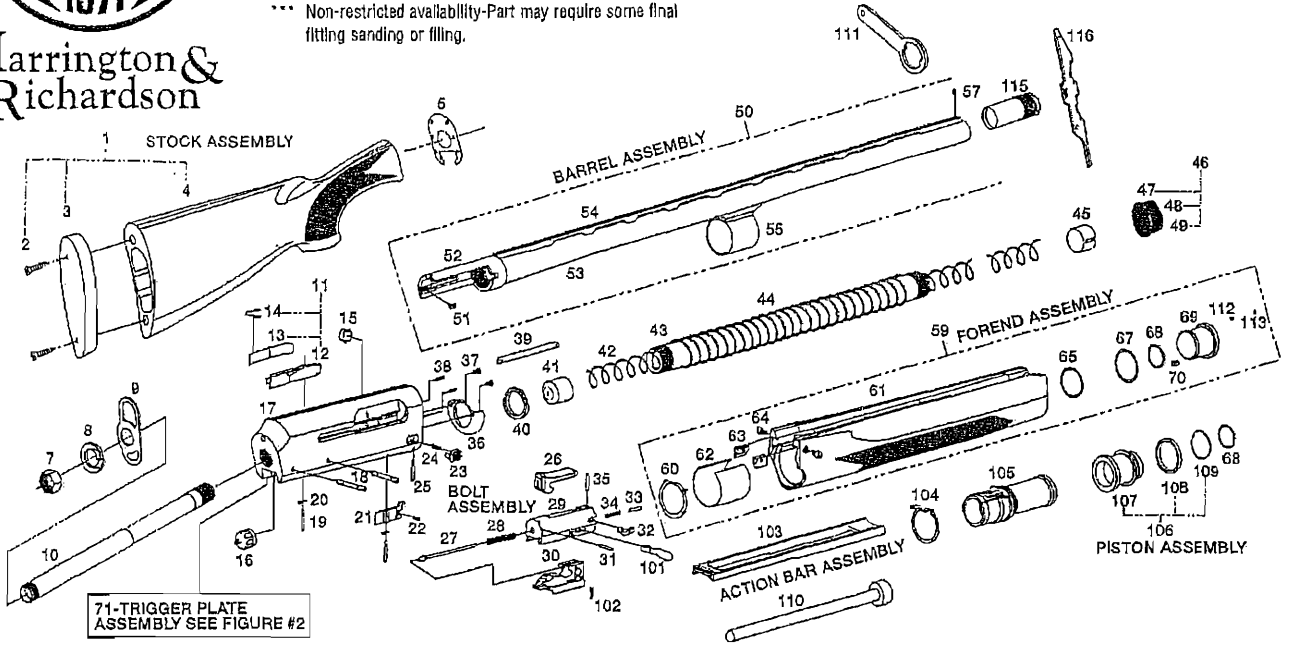

71-TRIGGER PLATE ASSEMBLY SEE FIGURE #2

ILL. NO.	PART NAME	ILL. NO.	PART NAME	ILL. NO.	PART NAME
1	STOCK ASSEMBLY	42	MAGAZINE SPRING	**83	HAMMER (FIG. #2)
2	BUTT PLATE SCREW	43	MAGAZINE TUBE	84	HAMMER SPRING FOLLOWER (FIG. #2)
3	RECOIL PAD	44	ACTION SPRING	85	HAMMER SPRING (FIG. #2)
4	STOCK	45	MAGAZINE SPRING RETAINER	86	HAMMER PIN (FIG. #2)
5	STOCK BUFFER	46	CYLINDER RUBBER GUIDE	**87	CARRIER (FIG. #2)
6	STOCK SWIVEL (SYNTHETIC ONLY-NOT SHOWN)	47	MAGAZINE CAP	88	BREECH BLACK LATCH (FIG. #2)
7	STOCK PLUG	48	HANGER SCREW	89	BREECH BLACK LATCH PIN (FIG. #2)
8	STOCK ELASTIC WASHER	49	HANGER RING	90	BREECH BLACK LATCH INTERNAL PIN (FIG. #2)
9	STOCK INTERNAL BUFFER	**50	BARREL ASSEMBLY	91	BREECH BLACK LATCH SPRING FOLLOWER (FIG. #2)
10	STOCK FASTENING TUBE	**51	EJECTOR	**92	CARRIER MAIN SPRING (FIG. #2)
**11	CARRIER LATCH ASSEMBLY	**52	BARREL EXTENSION	**93	CARRIER AUXILIARY SPRING (FIG. #2)
**12	CARRIER LATCH	**53	BARREL	94	TRIGGER GUARD PIN BUSHING (FIG. #2)
13	AUXILIARY MAGAZINE LATCH	**54	TOP BAND	95	TRIGGER GUARD PIN BUSHING SPRING (FIG. #2)
**14	CARRIER LATCH SPRING	**55	BARREL GAS CYLINDER	**96	HAND SAFETY SPRING (FIG. #2)
**15	CARRIER LATCH BUTTON	56	N/A	**97	HAND SAFETY SPRING FOLLOWER (FIG. #2)
16	RECEIVER SHOCK ABSORBER	**57	FRONT SIGHT	**98	HAND SAFETY SPRING RETAINING PIN (FIG. #2)
17	RECEIVER	58	N/A	**99	AUTOMATIC SAFETY LEVER (FIG. #2)
18	TRIGGER PLATE PIN	**59	FOREND ASSEMBLY	**100	AUTOMATIC SAFETY SPRING (FIG. #2)
19	LATCH PIN	**60	FOREND INTERNAL BUFFER	101	OPERATING HANDLE
20	LATCH PIN RETAINING SPRING	**61	FOREND	102	OPERATING HANDLE SPRING
21	MAGAZINE SHELL LATCH	**62	FOREND PLASTIC BED	103	ACTION BAR
22	MAGAZINE SHELL LATCH SPRING	**63	FOREND CENTERING BED	104	ACTION BAR RETAINING SPRING
23	MAGAZINE CUT OFF BUTTON	**64	FOREND CENTERING SCREW	105	ACTION BAR SUPPORT
24	MAGAZINE CUT OFF SPRING	**65	FOREND FRONT SUPPORT RETAINING SCREW	106	PISTON ASSEMBLY
25	MAGAZINE CUT OFF BUTTON PIN	66	N/A	107	PISTON
**26	LOCKING BLOCK	**67	BEARING WASHER	108	PISTON COMPRESSION SPRING
**27	FIRING PIN	**68	RUBBER RING	109	COMPRESSION RING RETAINING SPRING
28	FIRING PIN SPRING	**69	FOREND FRONT SUPPORT	110	PLUG
29	BOLT ASSEMBLY	**70	KEY	111	N/A
30	BOLT SLIDE	71	TRIGGER PLATE ASSEMBLY (FIG. #2)	**112	FRONT SUPPORT SPRING
31	FIRING PIN SPRING STOP	**72	TRIGGER PLATE (FIG. #2)	**113	FRONT SUPPORT BALL
**32	EXTRACTOR	73	HAND SAFETY (FIG. #2)	114	N/A
33	EXTRACTOR PLUNGER	74	TRIGGER ASSEMBLY (FIG. #2)	115	HIDDEN CHOKE
*34	EXTRACTOR SPRING	75	TRIGGER (FIG. #2)	116	CHOKE TUBE KEY
35	EXTRACTOR PIN	76	TRIGGER ARM (FIG. #2)		
36	FOREND REAR SUPPORT	77	TRIGGER ARM PIN (FIG. #2)		
37	FOREND SUPPORT SCREW	78	TRIGGER PIN (FIG. #2)		
38	FOREND DOWEL	79	SEAR SPRING (FIG. #2)		
39	LOCKING BLACK SCREW	**80	SEAR (FIG. #2)		
40	SUPPORT SHOCK ABSORBER	81	SEAR SPRING PIN (FIG. #2)		
41	MAGAZINE FOLLOWER	82	SEAR PIN (FIG. #2)		

ILL. NO.	PART NAME	SYNTHETIC SA1-128 12 GAUGE	WALNUT SA1-129 20 GAUGE	WATERFOWL SA1-130 12 GAUGE	TURKEY SA1-131 12 GAUGE	COMBO SA1-132 12 GAUGE
1	STOCK ASSEMBLY	S03580	S03580	S03580	S03580	S03580
2	BUTT PLATE SCREW	S03957	S03957	S03957	S03957	S03957
3	RECOIL PAD	S03980	S03980	S03980	S03980	S03980
4	STOCK	S03981	S03981	S03981	S03981	S03981
5	STOCK BUFFER	S03495	S03495	S03495	S03495	S03495
6	STOCK SWIVEL (SYNTHETIC ONLY)	S03496	S03496	S03496	S03496	S03496
7	STOCK PLUG	S03497	S03497	S03497	S03497	S03497
8	STOCK ELASTIC WASHER	S03498	S03498	S03498	S03498	S03498
9	STOCK INTERNAL BUFFER	S03499	S03499	S03499	S03499	S03499
10	STOCK FASTENING TUBE	S03500	S03500	S03500	S03500	S03500
**11	CARRIER LATCH ASSEMBLY	S03982	S03982	S03982	S03982	S03982
**12	CARRIER LATCH	S03501	S03501	S03501	S03501	S03501
13	AUXILIARY MAGAZINE LATCH	S03502	S03502	S03502	S03502	S03502
**14	CARRIER LATCH SPRING	S03503	S03503	S03503	S03503	S03503
**15	CARRIER LATCH BUTTON	S03504	S03504	S03504	S03504	S03504
16	RECEIVER SHOCK ABSORBER	S03505	S03505	S03505	S03505	S03505
17	RECEIVER	S03983	S03983	S03983	S03983	S03983
18	TRIGGER PLATE PIN	S03506	S03506	S03506	S03506	S03506
19	LATCH PIN	S03507	S03507	S03507	S03507	S03507
20	LATCH PIN RETAINING SPRING	S03508	S03508	S03508	S03508	S03508
21	MAGAZINE SHELL LATCH	S03509	S03509	S03509	S03509	S03509
22	MAGAZINE SHELL LATCH SPRING	S03510	S03510	S03510	S03510	S03510
23	MAGAZINE CUT OFF BUTTON	S03511	S03511	S03511	S03511	S03511
24	MAGAZINE CUT OFF SPRING	S03512	S03512	S03512	S03512	S03512
25	MAGAZINE CUT OFF BUTTON PIN	S03513	S03513	S03513	S03513	S03513
**26	LOCKING BLOCK	S03514	S03514	S03514	S03514	S03514
**27	FIRING PIN	S03515	S03515	S03515	S03515	S03515
28	FIRING PIN SPRING	S03516	S03516	S03516	S03516	S03516
29	BOLT ASSEMBLY	S03517	S03517	S03517	S03517	S03517
30	BOLT SLIDE	S03518	S03518	S03518	S03518	S03518
31	FIRING PIN SPRING STOP	S03519	S03519	S03519	S03519	S03519
**32	EXTRACTOR	S03520	S03520	S03520	S03520	S03520
33	EXTRACTOR PLUNGER	S03521	S03521	S03521	S03521	S03521
*34	EXTRACTOR SPRING	S03522	S03522	S03522	S03522	S03522
35	EXTRACTOR PIN	S03523	S03523	S03523	S03523	S03523
36	FOREND REAR SUPPORT	S03984	S03984	S03984	S03984	S03984
37	FOREND SUPPORT SCREW	S03524	S03524	S03524	S03524	S03524
38	FOREND DOWEL	S03985	S03985	S03985	S03985	S03985
39	LOCKING BLACK SHOE	S03986	S03986	S03986	S03986	S03986
40	SUPPORT SHOCK ABSORBER	S03525	S03525	S03525	S03525	S03525
41	MAGAZINE FOLLOWER	S03526	S03526	S03526	S03526	S03526
42	MAGAZINE SPRING	S03527	S03527	S03527	S03527	S03527
43	MAGAZINE TUBE	S03528	S03528	S03528	S03528	S03528
44	ACTION SPRING	S03529	S03529	S03529	S03529	S03529
45	MAGAZINE SPRING RETAINER	S03530	S03530	S03530	S03530	S03530
46	CYLINDER RUBBER GUIDE	S03987	S03987	S03987	S03987	S03987
47	MAGAZINE CAP	S03531	S03531	S03531	S03531	S03531
48	HANGER SCREW	S03988	S03988	S03988	S03988	S03988
49	HANGER RING	S40004	S40004	S40004	S40004	S40004
**50	BARREL ASSEMBLY-RIB W/CHOKES	S03581	S03581	S03581	S03581	S03581
**50	BARREL ASSEMBLY-RIFLED SLUG	S03582	S03582	S03582	S03582	S03582
**51	EJECTOR	S03532	S03532	S03532	S03532	S03532
**52	BARREL EXTENSION	S03989	S03989	S03989	S03989	S03989
**53	BARREL	S03353	S03354	S03355	S03356	S03357
**54	TOP BAND	S03990	S03990	S03990	S03990	S03990
**55	BARREL GAS CYLINDER	S03991	S03991	S03991	S03991	S03991
56	N/A	N/A	N/A	N/A	N/A	N/A
**57	FRONT SIGHT	S03533	S03533	S03533	S03533	S03533
58	N/A	N/A	N/A	N/A	N/A	N/A

ILL. NO.	PART NAME	SYNTHETIC SA1-128 12 GAUGE	WALNUT SA1-129 20 GAUGE	WATERFOWL SA1-130 12 GAUGE	TURKEY SA1-131 12 GAUGE	COMBO SA1-132 12 GAUGE
**59	FOREND ASSEMBLY	S03583	S03583	S03583	S03583	S03583
**60	FOREND INTERNAL BUFFER	S03534	S03534	S03534	S03534	S03534
**61	FOREND	S03992	S03992	S03992	S03992	S03992
**62	FOREND PLASTIC BED	S03993	S03993	S03993	S03993	S03993
**63	FOREND CENTERING BED	S03994	S03994	S03994	S03994	S03994
**64	FOREND CENTERING SCREW	S03535	S03535	S03535	S03535	S03535
**65	FOREND FRONT SUPPORT RETAINING RING	S03536	S03536	S03536	S03536	S03536
66	N/A	N/A	N/A	N/A	N/A	N/A
**67	BEARING WASHER	S03538	S03538	S03538	S03538	S03538
**68	RUBBER RING	S03539	S03539	S03539	S03539	S03539
**69	FOREND FRONT SUPPORT	S03540	S03540	S03540	S03540	S03540
**70	KEY	S03995	S03995	S03995	S03995	S03995
71	TRIGGER PLATE ASSEMBLY	S03996	S03996	S03996	S03996	S03996
**72	TRIGGER PLATE	S03541	S03541	S03541	S03541	S03541
**73	HAND SAFETY	S03542	S03542	S03542	S03542	S03542
74	TRIGGER ASSEMBLY	S03543	S03543	S03543	S03543	S03543
75	TRIGGER	S03547	S03547	S03547	S03547	S03547
76	TRIGGER ARM	S03997	S03997	S03997	S03997	S03997
77	TRIGGER ARM PIN	S03998	S03998	S03998	S03998	S03998
78	TRIGGER PIN	S03548	S03548	S03548	S03548	S03548
79	SEAR SPRING	S03549	S03549	S03549	S03549	S03549
**80	SEAR	S03550	S03550	S03550	S03550	S03550
81	SEAR SPRING PIN	S03551	S03551	S03551	S03551	S03551
82	SEAR PIN	S03552	S03552	S03552	S03552	S03552
**83	HAMMER	S03553	S03553	S03553	S03553	S03553
84	HAMMER SPRING FOLLOWER	S03554	S03554	S03554	S03554	S03554
85	HAMMER SPRING	S03555	S03555	S03555	S03555	S03555
86	HAMMER PIN	S03556	S03556	S03556	S03556	S03556
**87	CARRIER	S03557	S03557	S03557	S03557	S03557
88	BREECH BLACK LATCH	S03558	S03558	S03558	S03558	S03558
89	BREECH BLACK LATCH PIN	S03559	S03559	S03559	S03559	S03559
90	BREECH BLACK LATCH INTERNAL PIN	S03560	S03560	S03560	S03560	S03560
91	BREECH BLACK LATCH SPRING FOLLOWER	S03561	S03561	S03561	S03561	S03561
**92	CARRIER MAIN SPRING	S03562	S03562	S03562	S03562	S03562
**93	CARRIER AUXILIARY SPRING	S03563	S03563	S03563	S03563	S03563
94	TRIGGER GUARD PIN BUSHING	S03564	S03564	S03564	S03564	S03564
95	TRIGGER GUARD PIN BUSHING SPRING	S03565	S03565	S03565	S03565	S03565
**96	HAND SAFETY SPRING	S03566	S03566	S03566	S03566	S03566
**97	HAND SAFETY SPRING FOLLOWER	S03567	S03567	S03567	S03567	S03567
**98	HAND SAFETY SPRING RETAINING PIN	S03568	S03568	S03568	S03568	S03568
**99	AUTOMATIC SAFETY LEVER	S03569	S03569	S03569	S03569	S03569
**100	AUTOMATIC SAFETY SPRING	S03570	S03570	S03570	S03570	S03570
101	OPERATING HANDLE	S03571	S03571	S03571	S03571	S03571
102	OPERATING HANDLE SPRING	S03572	S03572	S03572	S03572	S03572
103	ACTION BAR	S03573	S03573	S03573	S03573	S03573
104	ACTION BAR RETAINING SPRING	S03574	S03574	S03574	S03574	S03574
105	ACTION BAR SUPPORT	S03575	S03575	S03575	S03575	S03575
106	PISTON ASSEMBLY	S03576	S03576	S03576	S03576	S03576
107	PISTON	S03999	S03999	S03999	S03999	S03999
108	PISTON COMPRESSION SPRING	S04000	S04000	S04000	S04000	S04000
109	COMPRESSION RING RETAINING SPRING	S04001	S04001	S04001	S04001	S04001
110	PLUG	S03577	S03577	S03577	S03577	S03577
111	N/A	N/A	N/A	N/A	N/A	N/A
**112	FRONT SUPPORT SPRING	S04002	S04002	S04002	S04002	S04002
**113	FRONT SUPPORT BALL	S04003	S04003	S04003	S04003	S04003
114	N/A	N/A	N/A	N/A	N/A	N/A
115	HIDDEN CHOKE	S03578	S03578	S03578	S03578	S03578
116	CHOKE TUBE KEY	S03579	S03579	S03579	S03579	S03579



Harrington &
Richardson

Excell Auto™ Shotgun

Autoloading • 12 Gauge
3" Chamber

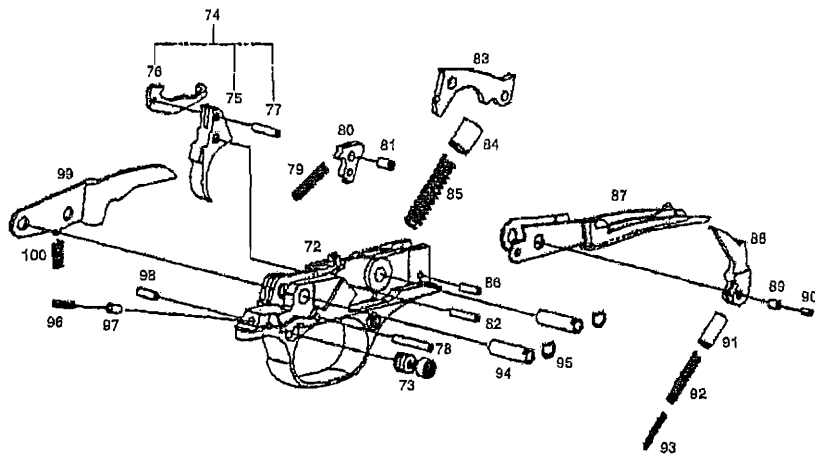

Figure 2:
Trigger Plate Parts Assembly



Harrington &
Richardson

H&R 1871 • P.O. Box 1871 • Madison, NC 27025
Phone 866-776-9292 • www.hr1871.com