



Fisher Labs



Metal Detector

# Users Manual



The F75 is a multipurpose metal detector. Its most popular uses are coinshooting and relic hunting, and it is also well-suited to gold prospecting.

## PRODUCT FEATURES

---

- Light weight and well-balanced: best ergonomically engineered detector in the industry.
- Intuitive menu-driven user interface
- Large LCD screen
- Visual indicators of important values such as:
  - Target Identification
  - Target Confidence
  - Target Depth (both running-depth and pinpoint-depth)
  - Ground Mineralization
- Multiple Search Modes:
  - Discrimination
  - Static All-Metal
  - Motion All-Metal
- Trigger-actuated FASTGRAB™ ground balancing with manual override
- Waterproof 11-inch open-frame BiAxial™ searchcoil
  - Housing constructed of a carbon fiber-polycarbonate blend
- Trigger-actuated target pinpointing with variable audio pitch
- Fully Adjustable Arm Rest
- Display backlight for night and low-light conditions
- Notch and discrimination controls
- Covers provided for both the control housing and battery box.
- Made in the USA

If you have any questions, or need assistance with your metal detector, Call **1-915-225-0333**, and ask for Fisher Hobby Technical Service

*Copyright Fisher Research Labs, Inc., April 22, 2009*

# Table Of Contents

<b>Specifications</b> .....	4
<b>Quick-Start</b> .....	5
<b>Mechanicals</b>	
Assembly Instructions .....	6-7
Mechanicals .....	8
Arm Rest adjustment .....	8
Using Headphones (not included) .....	9
<b>Introduction to the F75</b>	
General information .....	10
Controls .....	11-12
Menu System .....	13
Ground Balancing .....	14-16
Motion All Metal Mode .....	17
Static All Metal Mode .....	18
Discrimination Mode .....	19-22
PinPoint Feature .....	23
LCD Visual Display .....	24-26
Numeric Target Identification .....	24
Probable Target Identification .....	24
Target Indicators .....	25
Depth Indicators .....	25
Confidence Indicator .....	25
Fe <sub>3</sub> O <sub>4</sub> Graph .....	25
Battery Indicator .....	26
G.B. ....	26
Settings .....	26
Messages .....	26
Frequency Shifting .....	27
Capabilities & Limitations .....	28-30
<b>Tips &amp; Techniques</b>	
Search Techniques	
How to sweep the searchcoil .....	31
Pinpointing targets .....	31
Estimating target size and depth .....	32
False signals and chatter .....	33
Adjusting Sensitivity .....	35
Tips on ground balancing .....	36
Detecting Activities	
Coinshooting .....	37
Relic Hunting .....	38-39
Gold Prospecting .....	39-40
Cache Hunting .....	41
Shallow Water Hunting .....	41-42
Salt-Water Hunting .....	42
How metal detectors work .....	43
<b>Warranty</b> .....	Back Page

## Specifications

---

<b>Mechanical:</b>	S-rod with electronics housing mounted on handgrip, 3-piece breakdown, batteries under elbow, 2-way armrest adjustment — forward/backward & around forearm.
<b>Searchcoil:</b>	11" (28 cm) open-frame elliptical double-D, waterproof.
<b>Batteries:</b>	4 AA, alkaline (included).
<b>Weight:</b>	3.5 pounds (1.6 kg) with alkaline batteries installed.
<b>Static Balance:</b>	force in vertical plane normal to elbow 0.47 pounds (0.22 kg). Varies with adjustment and user's stance and arm/hand physiology.
<b>Dynamic Balance:</b>	axial moment, 0.29 foot-pounds (0.39 newton-meters). Varies with adjustment and user's stance and arm/hand physiology.
<b>Sweep Effort:</b>	lateral moment 5.2 foot-pounds (7.1 newton-meters).
<b>Operating Principle:</b>	VLF induction balance
<b>Operating Frequency:</b>	nominal 13 kHz, quartz crystal timing reference
<b>Basic Sensitivity:</b>	$6 \times 10^9$ root Hertz (detectivity)
<b>Lag Coefficient:</b>	78 milliseconds
<b>Reactive Overload:</b>	approximately 10,000 micro-cgs units (volume susceptibility) 40,000 micro-cgs units with sensitivity < 30.
<b>Resistive Overload:</b>	approximately 1,200 micro-cgs units (volume susceptibility) 4,800 micro-cgs units with sensitivity < 30.
<b>Ground Balancing Range:</b>	From ferrite to salt, inclusive
<b>Discrimination</b>	
<b>Ground Suppression:</b>	combination of second and third order methods
<b>ID Ground Suppression:</b>	third order
<b>Battery Life:</b>	Typically 40 hours with high quality alkaline batteries Estimated 80 hours with nickel oxyhydroxide batteries Estimated 65 hours with lithium iron disulfide batteries
<b>Operating Temp Range:</b>	4 to +122 degrees F (-20 to +50 degrees C)
<b>Operating Humidity Range:</b>	0-90% non-condensing

## Quick Start

---

### Use your F75 right out of the box

1. Assemble the detector (see instructions beginning page 4).
2. Install four AA **alkaline** batteries. **All positive (button-end) terminals point up.**  
Batteries are included with the detector.
3. Turn the knob, located under the armrest, fully clockwise.  
This turns the machine on and sets audio volume to maximum.
4. When first turned on, the **F75** starts out in the Discrimination mode, with:  
Sensitivity preset to 60  
Discrimination Level preset to 10  
Number of Tones preset to 3  
Process# preset to dE  
Sweep the searchcoil from side to side, parallel to the ground. Keep the searchcoil moving over the ground. If you stop moving the searchcoil, the sound will also stop.  
Probable target type will be indicated at the top of the LCD screen.
5. If the searchcoil is not in motion and not close to metal, the detector should be silent.
6. If you experience false signals from electrical interference, from the soil itself, or from lots of trash metal, press the MENU button.  
**Sensitivity** will be highlighted.  
Rotate the **Settings** knob to the left (counterclockwise),  
Reduce the sensitivity setting until the false signals go away.  
After 7 seconds, the machine will exit the menu and return to normal operation.
7. Find a patch of ground free of metal, toss a coin on the ground and sweep back and forth over it a few times to get a feel for how the machine responds.
8. You are now ready to search.
9. Pull and hold the trigger switch with your index finger to pinpoint the exact location of targets, making them easier to unearth.

When the trigger is pulled, PinPoint is engaged ....

The searchcoil need not be in motion to detect an object.

The 2-digit numeric display indicates approximate target depth, in inches.

## Assembly

1. Remove all components from box.
2. Attach **searchcoil** to **lower rod** by lining up the holes.  
Push **coil knob** through hole and tighten knob gently.  
*You will tighten up the coil knob later.*
3. Insert **smallest rod** into **S-rod** (S-rod holds detector body).  
Turn **top locking collar** counter-clockwise to open up.  
Push in pin on small rod.  
Slide small rod into upper rod.  
Click pin into hole and tighten locking collar firmly clockwise.
4. Push **lower rod** into **small rod** as follows:  
Turn locking collar counterclockwise to open up.  
If plastic insert tab interferes, push it down, or turn tube upside down.  
Push in pin to allow rod to slide in.  
Slide lower rod in.  
Click pin into any hole.
5. Remove **velcro strip** from lower rod.
6. Wrap **cable** around stem as follows:  
Leave some slack in cable at base of lower rod.  
Secure cable at base of rod with velcro strip.  
Wrap cable loosely around entire stem up to bent part of upper rod.  
*You will re-wrap the cable later after sizing the rods to your height.*

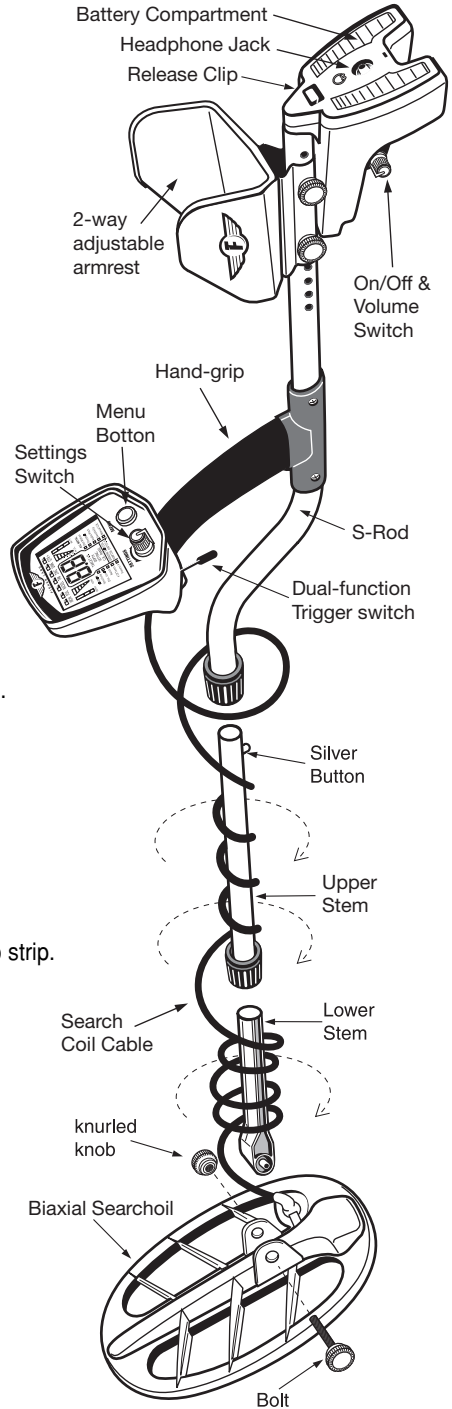

## *Assembly (continued)*

---

7. Push cable into connector on back of housing.  
**Do not twist the cable or plug.**
8. Tighten **knurled cap nut** by hand to secure cable connection to housing.  
**Use minimal finger pressure to start thread. Do not force threads.**  
**Nut may not completely cover all threads when fully engaged.**
9. Adjust to your height:  
Hold detector, standing up, with your arm in the **armrest**.  
Place searchcoil flat on the ground with back edge of coil 6" in front of your toes.  
Click pin on lower rod into nearest hole.  
Firmly tighten **bottom locking collar** to secure lower stem.
10. Attach cable to top of rod with **upper Velcro strip**
11. Tighten up coil knob to keep searchcoil from flopping.
12. Insert batteries.  
4 batteries are all installed the same way -- **positive terminals pointed upward.**

After establishing a comfortable length, **firmly tighten the locking collars** on the rods to prevent the tubes from rattling. Rotate the collars a full 270° to engage and lock in place. If you are unable to rotate a full 270°, use gloves for a better grip.

If the searchcoil appears crooked with respect to the pole, loosen both locking collars and re-adjust. Hold each of the lower poles in the counterclockwise position as you tighten the locking collars.

## *Mechanicals*

---

### **BATTERIES**

The **F75** requires four AA batteries.

These **non-rechargeable** chemistries may be used: Alkaline, Nickel Oxy-Hydroxide (Panasonic Oxyride or Duracel PowerPix), and lithium iron disulfide (Energizer L91). Nickel metal hydride and nickel-cadmium **rechargeable** chemistries may also be used.

Zinc-carbon and so-called "heavy duty" batteries may not work, especially in cold weather. Do not use these batteries.

Expect 40 hours of service in the field with one set of alkaline batteries.

Rechargeable batteries will usually deliver over 25 hours of service without recharging, but when they start running low, they die suddenly with little warning.

Always install batteries which are of the same type and the same state of charge. Otherwise battery life will be determined by the weakest battery, because the good batteries cannot deliver their power with a dead battery blocking the current.

All 4 batteries are installed with the **positive terminals facing upward**.

The LCD screen shows battery condition on the right.



## Mechanicals (continued)

### ARM REST

The arm rest WIDTH and POSITION are both adjustable.

**Arm Rest Width:** The sides of the arm rest can be bent inward and outward. To best stabilize the detector to your arm and body movement, squeeze the sides of the arm rest around your forearm. For a very secure fit, some users prefer to bend the arm rest in tightly against the forearm such that you pry the sides loose each time you place your arm into the arm rest.

**Arm Rest Position on Pole:** Remove the two bolts to position the arm rest farther forward or back, to adapt to your arm's length.

- To reinsert the bolts, spin and twist them into place. Be careful not to damage the power cable that runs through the aluminum tube.
- Insert both bolts completely through both sides of the bracket before attaching the nut to the opposite side.
- After reinserting the bolts, tighten them very securely. You may need to use gloves for a firm grip. As you swing the detector from side-to-side, you want the bolts tight enough so that you do not feel any movement between the pole and arm rest mounting bracket.

**If you notice unwanted movement while swinging detector, check the tightness of the locking collars.** The locking collars must be rotated a full 270° to reach the locking position.

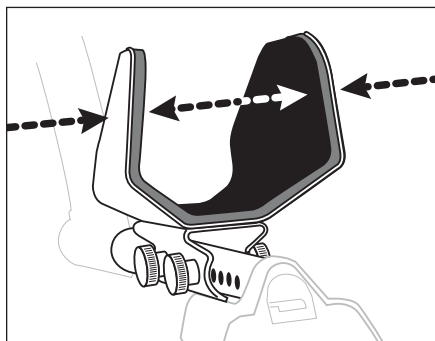

Adjust the arm rest in or out accordingly

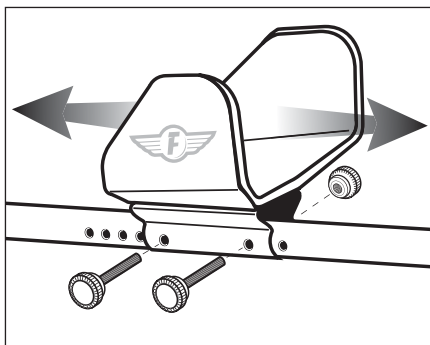

Adjust the arm rest forward or back, to adapt to your arm's length.

### HEADPHONES (not included)

The F75 is equipped with a standard 1/4-inch stereo headphone jack at the rear of the unit, located under the elbow as you hold the detector for use. Any headphone with a stereo plug should work; headphones with a mono plug will not work. This device is to be used with interconnecting cables/headphones shorter than three meters.

Using headphones (not supplied) improves battery life, and prevents the sounds from annoying bystanders. It also allows you to hear subtle changes in the sound more clearly, particularly if searching in a noisy location. For safety reasons, do not use headphones near traffic or where other dangers, like rattlesnakes, are present.

This device is to be used with interconnecting cables/headphone cables shorter than three meters.

## *Introduction to the Fisher F75*

---

**HIGH PERFORMANCE** The **F75** is a multi-purpose high-performance computerized metal detector. It has the high sensitivity and ground balancing control needed for professional gold prospecting, the discrimination responsiveness needed for serious relic hunting under difficult conditions, and visual target ID considered essential in searching for coins. The **F75** operates at 13 kHz for good sensitivity to gold nuggets and jewelry as well as to coins. The **F75** comes with an 11-inch elliptical Bi-Axial searchcoil for maximum detection depth in mineralized soils.

**USER COMFORT** The **F75** is among the lightest and best balanced of all high-performance metal detectors, so you can hold and swing it almost effortlessly. The arm rest position is adjustable to fit your arm. The grip is durable high-friction foam elastomer, comfortable in any kind of weather. The controls are conveniently located and easy to learn how to use. Locking collars on the tubes eliminate rattling.

**EASY-TO-USE & INFORMATIVE INTERFACE** The entire menu is always visible on the LCD display. The LCD display indicates the electrical signature (target I.D.) of the detected metal object. The display provides continuous information on battery condition and on ground mineralization, which affects detection depth. Help messages are automatically displayed on the bottom of the display when necessary.

**LOW OPERATING COST** The **F75** is powered by four AA alkaline batteries, which will typically last for more than 40 hours of use before needing replacement.

### **DESIGNED BY MANY OF THE INDUSTRY'S MOST TALENTED ENGINEERS**

The lead engineers on the **F75** design team were John Gardiner and David Johnson. David Johnson's previous Fisher design credits include the CZ-platform, the Gold Bug-series, most of the 1200-series, Impulse Underwater Detector, CZ-20 Underwater Detector, FX3 magnetometer, the Gemini 2-box locator, the XLT-16 Acoustical Leak Detector, and the XLG-80 Ultrasonic Leak Detector. John and David were supported by fellow electrical engineers Jorge Corral, and Mark Krieger. The mechanical design was a collaboration among David Johnson, Brad Fulghum, John Griffin, and Tom Walsh.

### **MECHANICAL ENGINEERING**

While the **F75** is robustly engineered for outdoor use, it is not indestructible and it is not waterproof.

### **RESET function**

The **F75's** microprocessor saves all settings which you input, even after the power is turned off.

If you wish to reset the settings to the factory preset, follow this process:

1. Turn detector off.
2. Press-and-hold the red MENU button and push-forward-and-hold the TOGGLE SWITCH.
3. Turn the detector on, while you are still holding the controls.
4. Release the MENU button and TOGGLE SWITCH.
5. See the F symbol. When the F disappears, the detector is reset.

## Controls

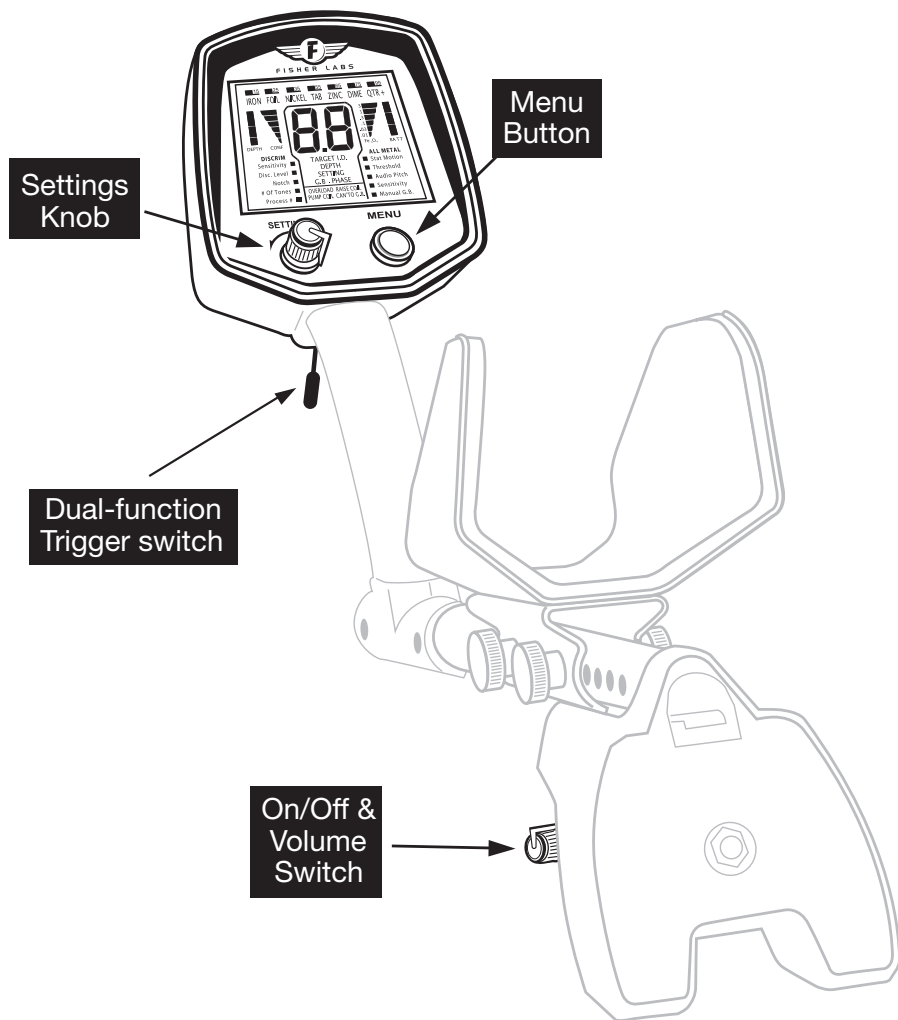

### **ON-OFF & VOLUME Knob** (Under the elbow)

This knob turns the machine on or off, and controls speaker volume and headphone volume. Knob position has no effect on detector's sensitivity or susceptibility to noise from electrical interference

## *Controls (continued)*

---

The **F75** has two controls on the front panel, MENU and SETTINGS.

### **MENU Pushbutton** (Red button on right of the front panel)

Push the MENU button to:

1. Step through the menu selections on the display.

With each push of the button, the next menu selection will be highlighted.

The SETTINGS knob then allows you to change values for the highlighted selection.

2. Recall the last setting which you adjusted.

After you have adjusted a setting, an indicator will remain highlighted next to this menu selection. One push of the button will recall that selection and display the stored value.

This recall function is useful for a value you want to adjust frequently, such as the ground balance setting. In order to adjust a stored value with the SETTINGS knob, you must first press the MENU button to reactive the user interface.

### **SETTINGS Knob** (On the left of the front panel)

Rotate the SETTINGS knob to:

1. Change the setting (or value) of the highlighted menu selection you have chosen.

2. Select the operating MODE when the top line of the menu is highlighted.

When used to switch back and forth between the DISCRIMINATION mode and ALL METAL modes, the detector changes modes as soon as the corresponding selection is highlighted.

The All Metal modes are used to detect all metal objects, including small or deep objects.

Use the Discrimination mode to ignore trash metal such as nails, foil, or pull-tabs.

**NOTE:** When the menu selection **highlight disappears**, the **SETTINGS knob is deactivated**. If settings values do not change when the SETTINGS knob is rotated, press the MENU button to reactivate the user interface.

### **TRIGGER SWITCH** (Under the display in front of your hand)

While the trigger is **pulled** back, metal objects are temporarily detected without the need for searchcoil motion. This aids in pinpointing the exact location of objects which were found while searching in the Discrimination or motion All Metal modes.

When in static all metals mode, pulling the trigger zeroes the audio threshold to the signal level currently preset. If the searchcoil is up in the air away from metal, this maneuver corrects for threshold drift due to temperature changes.

When the trigger is **pushed** forward, FASTGRAB automatic ground balancing is activated. The internal computer measures the magnetic properties of the soil in order to cancel interference from naturally-occurring minerals in the ground. After the detector measures the soil in this manner, the detector then uses this information to control operation in both the All Metal and Discrimination search modes. FASTGRAB can be used at any time during operation.

## The Menu System

The entire menu is printed on the LCD display. The display highlights the mode and settings which are in use.

There are three search modes, Static All Metals, Motion All Metals, and Discrimination. To change between an All Metals mode and Discrimination mode, the top line of the menu system must be highlighted. Press the MENU button until the top line of the menu is highlighted. When either **All Metal** or **Discrimination** is highlighted, rotate the SETTINGS knob to move between the two categories.

Each search mode has several adjustable function settings:

**ALL METAL:** Threshold (not adjustable in stat mode), Audio Pitch, Sensitivity, and Manual Ground Balance

**DISCRIMINATION:** Sensitivity, Discrimination Level, Notch, Number of Tones, and Process Number.

To select a function, push the MENU button and continue pushing in order to move to the function you want. The word **SETTING** will pop up in the middle of the display, and the present setting of that function will be displayed as a number.

To change a setting, rotate the knob.

To increase a value, rotate to the right (clockwise)

To decrease a value, rotate to the left (counterclockwise)

If you select a function and do not make a change to that function after 7 seconds, the detector will exit the menu system automatically, deactivate the SETTINGS knob, and resume normal operation.

If you press the MENU button while the machine is in normal operation, the user interface will return to the last menu feature setting. This feature allows you to have quick access to a function that you want to adjust frequently.

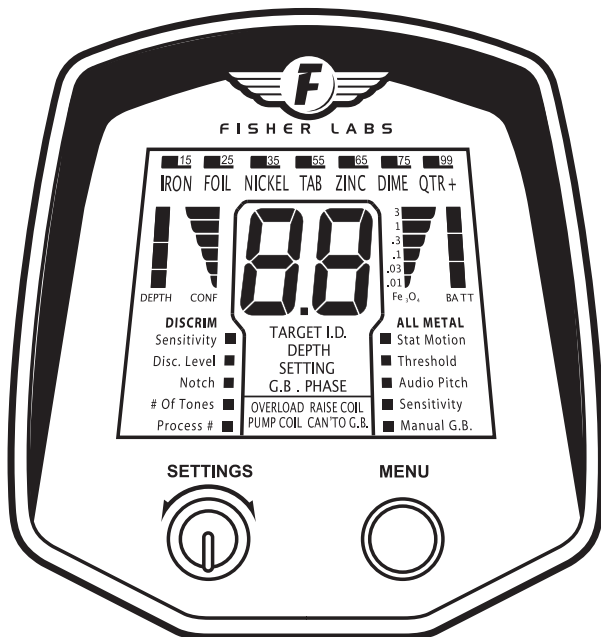

## Ground Balancing

### What is Ground Balancing?

All soils contain minerals. Signals from ground minerals are often tens or hundreds of times as strong as the signal from a buried metal object. The magnetism of iron minerals, found in nearly all soils, causes one type of interfering signal. Dissolved mineral salts, found in some soils, are electrically conductive, causing another type of interfering signal.

Ground Balancing is the process by which the metal detector cancels the unwanted ground signals while leaving signals from buried metal objects intact. This is accomplished by establishing the detector's internal Ground Balance setting; this setting is calibrated to the soil and eliminates the signal produced by ground minerals.

Calibration to the actual soil condition will result in deeper target detection, quieter operation, and more accurate target identification. This calibration, or Ground Balancing, can be accomplished automatically with the detector's internal computer, by pushing the Trigger Switch forward, or manually in the All Metal menu.

The ground balance setting carries through into all operating modes. In Discrimination mode, the ground signal is generally inaudible unless the discrimination setting is 0.

### **AUTOMATIC GROUND BALANCING PROCEDURE (FASTGRAB™)**

1. Find a spot of ground where there is no metal present.
2. Hold the detector with the searchcoil about one foot above the ground.
3. Push the TRIGGER SWITCH forward with your index finger.
4. Physically *pump* the searchcoil and detector up and down over the ground.

Lift it about 6 inches above the ground and lower it to within 1 inch of the ground, about once or twice a second.

5. A 2-digit value will appear on the display. This is the Ground Balance setting.

*If the detector's internal computer is unable to ground balance, an error message will appear:*

- If the message **OVERLOAD RAISE COIL – CAN'T GB** appears, you will also hear a siren sound. You are probably over metal.
- If the message **CAN'T GB** appears, you may not be pumping the coil, or you may be over a small piece of metal.

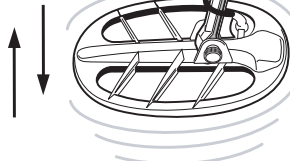

**Note:** FASTGRAB will not automatically balance over highly conductive soils, such as a wet salt water beach.

## Ground Balancing (continued)

### MANUAL GROUND BALANCING

In most situations, it is preferable to push the trigger switch to activate FASTGRAB automatic ground balancing. Generally, it is best to first let the computer automatically cancel interference from ground minerals. However, for gold prospecting, searching on a wet saltwater beach, or searching in an area with so much metal trash that there is no *clean* ground for the computer to sample, we recommended that you manually ground balance. Manual ground balancing requires a bit of skill, acquired with some practice.

The range of ground balance settings indicated on the display range from 0 to 99; however, each displayed number spans 5 detent steps on the settings knob. The actual internal ground balance settings change with each step; there are a total of 500 different settings. Under some ground conditions you may be able to hear the individual steps in the setting.

The  $\text{Fe}_3\text{O}_4$  bar graph on the LCD display indicates the *amount* of magnetic mineralization. The searchcoil must be in motion to measure  $\text{Fe}_3\text{O}_4$ . The most accurate measurement is obtained by *pumping* the searchcoil, as in the Ground Balancing procedure.

The two-digit G.B. Setting number displayed on the LCD indicates the *type* of ground mineralization.

Some typical ground mineralization types are:

0 – 10	Wet salt and alkali
5 – 25	Metallic iron. Very few soils in this range. You are probably over metal.
26–39	Very few soils in this range -- occasionally some saltwater beaches
40–75	Red, yellow, and brown iron-bearing clay minerals
75–95	Magnetite and other black iron minerals

When manually ground balancing, try to “feel out” a spot on the ground to make sure there is no metal present. In order to avoid locking onto metal, the computer will not balance to ground where the GB setting is less than 40. Where the ground reads less than 40, manual ground balancing is required.

To perform the Manual Ground Balancing operation, do the following:

1. Select the **MANUAL G.B.** function  
The legend **G.B. SETTING** appears.  
The present ground balance setting is displayed (**0-99**).  
The message **PUMP COIL TO G.B.** will appear.
2. Physically *pump* the searchcoil and detector up and down over the ground.  
Lift it about 6 inches above the ground and lower it to within 1 inch of the ground, about once or twice a second.

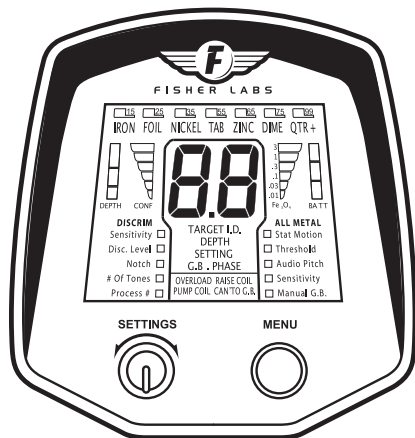

## *Ground Balancing (continued)*

---

3. Turn the SETTINGS KNOB to adjust the setting.

The goal is to eliminate the sound as the coil is being pumped over the ground. In some soils, the sound is not completely eliminated.

If the ground balance adjustment is incorrect, there will be a difference in the sound as the searchcoil is either moving toward or away from the ground. It sounds like you are either ***pulling the sound out of the ground***, or ***pushing the sound into the ground***.

- If the sound is louder as you raise the searchcoil, increase the ground balance setting.
- If the sound is louder as you lower the searchcoil, reduce the ground balance setting.

NOTE: Experienced users often prefer to adjust the ground balance to get a weak but audible response when lowering the searchcoil. This is called *adjusting for positive response*.

### ***Positive and Negative Response***

The purpose of ground balancing is to adjust the metal detector to ignore ground minerals. If the setting is incorrect, ground minerals will give either a *positive* or a *negative* response, depending on which direction the adjustment is off.

#### *POSITIVE RESPONSE*

If the G.B. setting is too high a number, the response of minerals will be *positive*. This means that when the searchcoil is lowered to the ground in PinPoint, Stat, or Motion All Metals mode, the sound will get louder as the searchcoil approaches the ground. The sound will grow quieter as the searchcoil is raised. What, if anything, you will hear in discrimination mode depends on the discrimination setting.

When searching in an All Metals mode, if ground balance is properly set to cancel the ground, and you sweep over a *positive hot rock*, the rock will give a “zip” sound similar to that of a metal object.

#### *NEGATIVE RESPONSE*

If the G.B. setting is too low a number, the response of minerals will be *negative*. When the searchcoil is lowered to the ground in PinPoint, Stat, or Motion All Metals mode, the machine will be silent. The machine will sound off as the searchcoil is lifted away from the ground. What, if anything, you hear in discrimination mode depends on the discrimination setting.

When searching in Motion All Metals mode, a *negative hot rock* will produce a “boing” sound after passing over it, making it difficult to know where it is located. It will not have the sound and “feel” of a metal object.



## *Motion All Metal Mode*

---

The Motion All Metal mode is more sensitive and offers better *feel* than the Discrimination mode, and is used to find all metal objects present in the ground. The searchcoil must be in motion for objects to be detected. This is a single filter search mode similar to the “fast autotune”, “SAT”, or “P4” modes found in other detectors you might already be familiar with.

**THRESHOLD:** Adjustable from -9 to +9. For maximum ability to hear the weakest signals, adjust this background noise level high enough so that it is barely audible while the detector is in use in the field. To eliminate the weakest signals, adjust into the negative region, which will allow the machine to run silently if the Sensitivity is not set too high.

The threshold level changes slightly with each detent step on the SETTINGS knob. Each number on the numeric readout corresponds to five steps.

**AUDIO PITCH** This control allows you to change the range of frequencies that you hear. Values range from -9 to 9; 0 is default. Negative numbers lower the frequency of the tone you hear; positive numbers raise the frequency. This feature is intended to make the tone more pleasant to your ear; choose your personal preference. Users who have suffered some hearing loss, (including the natural loss of ability to detect high and low frequencies with age) may find this control helpful.

**SENSITIVITY** This controls the *signal gain*, and is adjustable from 1 to 99. In the presence of electrical interference, high ground mineralization, or variable ground mineralization, operation will usually be too noisy (wobbly and erratic sound) if the sensitivity is set too high. **At settings above 90, the internal circuit noise of the machine will probably be audible.** The sensitivity level setting is largely a matter of personal preference. However, if you cannot hear at least some noise, the smallest or deepest objects will not be detected.

The sensitivity system has two stages, 1-29 (low gain), and 30-99 (high gain). As you decrease sensitivity and cross the transition from 30 to 29, you may notice that the background noise *increases*. Despite this increase as you decrease sensitivity to the lower setting, 29, the sensitivity is in fact lower under 30, and the machine is less susceptible to overload from large targets, ground minerals, and salt water. You may need to adjust to a setting of 29 or less to silence electrical interference, or to prevent overload on highly mineralized ground or in salt water. You may also notice a shift in the ground balance setting over difficult ground conditions as you cross this transition.

### **MANUAL GROUND BALANCE**

Manual Ground Balance can only be performed while in an All Metal mode, but the resultant setting will carry over if you change into Discrimination mode. See the previous section on Ground Balancing for instructions on how to use this feature.

We suggest that you manually ground balance using only the MOTION All Metal Mode. The result will be more accurate than when using STAT All Metal Mode.

## *Static All Metal Mode*

---

This mode is useful for finding large, deep objects, i.e. larger than a coin and deeper than 12 inches (30cm). STATIC functions similar to PinPoint but occupies a different position on the user interface. The audio signal gets stronger as the searchcoil approaches the ground. Unlike the other modes, the detection sound will not disappear if you stop moving the searchcoil.

The four adjustments are performed the same as with MOTION All Metal Mode, as described on the preceding page.

### **THRESHOLD**

The audio threshold in the STATIC mode is internally fixed and cannot be adjusted by the user.

*Retuning:* The audio threshold will slowly drift when searching in this mode. If you move quickly between temperature environments, such as from shade to sun, audio threshold may drift more rapidly until the searchcoil temperature stabilizes. *When the audio threshold drifts in this fashion, pull the trigger back momentarily to retune the detector.* You will need to retune periodically when searching in this mode.

### **AUDIO PITCH**

Works the same as in MOTION mode; see previous page.

### **SENSITIVITY**

Set the sensitivity high enough to hear some random background noise and/or a slight amount of ground response. If you do not hear these noises, you will sacrifice detection depth. If the background chatter is too annoying, or the ground noise is so high that it impedes operation, reduce sensitivity. Such a downward adjustment in sensitivity improves depth detection as you can now hear weak signals better.

The sensitivity system has two stages, 1-29 (low gain), and 30-99 (high gain). As you lower sensitivity and cross the transition from 30 to 29 in STATIC mode, it may be necessary to retune by pulling the trigger switch momentarily. You may need to adjust to a setting of 29 or less to silence electrical interference, or to prevent overload on highly mineralized ground or in salt water. You may also notice a shift in the ground balance setting over difficult ground conditions as you cross this transition.

### **GROUND BALANCE**

Always perform the ground balance procedure before searching in STAT mode, using the trigger or with the manual adjustment.

If you do not ground balance before searching in STAT mode, most ground will produce an audible tone as you lower the searchcoil; the ground will "sound off." Some soils will not sound off, but will remain quiet with a loss of sensitivity.

### **DEPTH DISPLAY**

To see a target's depth, in inches, pull the toggle switch.

### **TARGET ID**

Move coil back-and-forth over target to see visual target ID.

## Discrimination Mode

The Discrimination Mode is used to eliminate trash metal objects from detection, e.g. nails, aluminum foil, or pull-tabs. The searchcoil must be in motion for metal objects to be detected. Discrimination incurs some loss of sensitivity to small or deep objects.

The **F75** discrimination system is much improved over conventional discrimination systems, and may function quite differently than other discriminators you may be accustomed to. In older systems, the apparent sensitivity decreases as discrimination level increases. The **F75's** sensitivity may increase as discrimination increases, depending on the process number and notches being used. Therefore, *do not use the discriminator to control sensitivity*. First set the discrimination level and notches to establish objects to detect or eliminate; then adjust sensitivity downward to eliminate interference, or upward to “work into the noise,” if preferred.

### SENSITIVITY

This controls the *signal gain*, and is adjustable from 1 to 99. Unlike the All Metal modes, the Discrimination mode is designed to operate silently. If you hear noise when there is no metal present or when the searchcoil is not in motion, reduce the Sensitivity setting until the machine goes quiet. NOTE: there is no interaction between the sensitivity settings of the All Metal and Discrimination Modes.

The sensitivity system has two stages, 1-29 (low gain), and 30-99 (high gain). As you lower sensitivity and cross the transition from 30 to 29, you may notice the background noise *increase*. You may need to adjust to a setting of 29 or less to silence electrical interference, or to prevent overload on highly mineralized ground or in salt water. You may also notice a shift in the ground balance setting over difficult ground conditions as you cross this transition.

### DISCRIMINATION LEVEL

This is adjustable from 0 to 65, and controls the range of objects to be eliminated from detection (discriminated out or rejected). Objects with numeric values below the selected discrimination level will not be detected. NOTE: the numerical range that pertains to each class of object is printed at the top of the visual display. To eliminate iron, a setting of 15 is usually about right. A setting of 65 will eliminate aluminum trash and zinc pennies, but nickels will also be lost, unless you notch-in nickels with the NOTCH feature.

#### *To use DISC LEVEL*

1. Highlight DISC LEVEL using the MENU button.
2. Rotate the SETTINGS knob.
  - As you rotate the knob, a number between 0 and 65 appears.
3. Press MENU when you reach the desired target discrimination value.
  - If you do not press MENU, and let the display time-out, the last displayed value will be stored as the discrimination value.
  - All targets, up to and including the value selected, will be eliminated from detection, unless notched-in.
5. A slash will appear over the target words being eliminated. Notice that two slashes can appear over each word. The left slash represents the bottom half of the range; the right slash represents the top half of the range. When you select a value within any range, the slash will appear, *even though all values within that range might not be eliminated from detection*. To recall the discrimination setting, press the MENU button until you enter the DISC LEVEL feature.

## Discrimination Mode (continued)

### NOTCH

Unlike Discrimination Level, which eliminates all targets from the left of the scale to the right, NOTCH can eliminate and re-include targets within the scale displayed at the top of the display. Inclusion or exclusion of target ranges is indicated with a half-crossed or crossed icon.

To demonstrate how to set a notch, follow this instruction **at first use**.

1. Reset all detector values to default:
  - a. turn detector off
  - b. press-and-hold red MENU button and push-forward-and-hold Toggle Switch
  - c. turn detector on while continuing to hold MENU and Toggle
  - d. release Menu and Toggle.
2. Press MENU button 4 times to move down to the NOTCH feature
  - then rotate the SETTINGS knob to the right until the number **40** appears.
  - then press MENU again to accept this notch value.
3. Notice that a thin line appears across the word "TAB" printed on the top of the display.
4. Press MENU again to exit the NOTCH feature.
5. Targets in the first 1/2 of the TAB range (TAB range is from 36 to 55) will be eliminated from detection.
6. A half-slash will be permanently displayed across the top-left of the word "TAB."

NOTCH allows you to select target ranges equal to **1/2 of each category** for inclusion or exclusion from detection. As you rotate the knob, the target indicator will appear above the range currently selected. If you set the notch value anywhere within the range, the notch value will not necessarily stop at this number, notch ranges are fixed as follows:

- |                 |                 |
|-----------------|-----------------|
| 1. 1-7 iron     | 6. 31-35 nickel |
| 2. 8-15 iron    | 7. 36-45 tab    |
| 3. 16-20 foil   | 8. 46-55 tab    |
| 4. 21-25 foil   | 9. 56-60 zinc   |
| 5. 26-30 nickel | 10. 61-65 zinc  |

The following are characteristics of NOTCH programming:

- As you rotate the knob to enter a notch range, the target indicator block at the top edge of the screen illuminates to show you the range you are in.
- After you have selected a notch, a slash is illuminated over that range, indicating that all targets within that range (see chart above) are eliminated from detection.
- When you enter the program to make a change to the notch settings, you are **changing the status of the notch**. If no slash is illuminated and you press MENU to set a notch range, you will be notching-out this range. If a slash was previously illuminated and you press MENU to set this notch range, you will be notching-in this range.
- **Programming a notch range always reverses the status of the notch.**

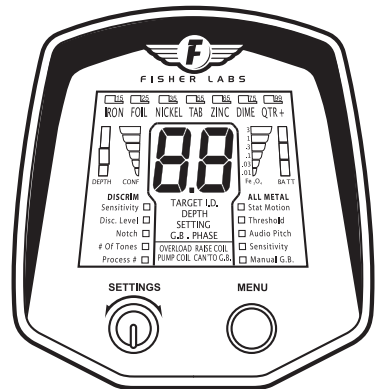

## *Discrimination Mode (continued)*

---

Using DISC LEVEL in conjunction with NOTCH gives you a great deal of flexibility in deciding which values to include or exclude from detection. Beware that this combination can be confusing.

### **Here are some examples of NOTCH used in conjunction with DISC LEVEL**

If Discrimination Level is set at 60, and you set the top-of-foil (21-25) notch between 21 and 25, then: top-of-foil range (21-25) is NOTCHED-IN (i.e. detected)

If Discrimination Level is set at 23, and you set the top-of-foil (21-25) notch between 21 and 25, then: 21, 22, & 23 are NOTCHED-IN. 24 & 25 are NOTCHED-OUT

If Discrimination Level is set at 15, and you set the top-of-foil (21-25) notch between 21 and 25, then: 21-25 are NOTCHED-OUT

### **NUMBER OF TONES (# OF TONES)**

This menu selection allows you to select the number of audio tones emitted by the detector. Different search conditions, search objectives, or personal preference will determine how many tones you want to hear. With the below settings, you can decide to hear the same tone, regardless of the target category, or have different categories of targets induce different tones.

#### **The “# OF TONES” selections are:**

- 1:** SINGLE MEDIUM PITCH TONE.  
All types of metal induce the same tone.
- 1F:** MEDIUM-TO-HIGH PITCH TONE varying in proportion to target signal strength.  
Large shallow objects will produce a squeal. The variable audio pitch provides you more information about the detected object, but some people find the sound on strong signals too annoying.
- 2F:** TWO TONES.  
Similar to **1F**, except that iron produces a low-pitched tone regardless signal strength. Useful if you want to hear all targets and want to identify iron. Most relic hunters prefer this selection.
- 3H:** same as **3**, except that nickels produce a high tone.
- 3:** THREE DIFFERENT AUDIO TONES. Iron produces a low pitch tone. Aluminum trash, zinc pennies, and nickels produce a medium tone. High conductivity coins produce a high tone. The 3-tone selection is often preferred for coinshooting. Most users will set the discrimination level below nickels, at about 25, and dig only objects that produce a consistent and repeatable high tone. NOTE: with this setting, steel bottle caps may produce consistent high tones, similar to coins. See Capabilities & Limitations section for advice on identifying steel bottle caps.
- 4H:** same as **4**, except that nickels produce a high tone.  
Useful when coinshooting in a trashy area.

## *Discrimination Mode (continued)*

---

- 4:** FOUR DIFFERENT AUDIO TONES This selection is similar to **3**, but with a fourth medium-high tone for targets in the numeric range of 53 to 65. This four-tone system is useful for searching in areas where there may be very old coins which register in this range.
- dP:** DELTA PITCH This setting produces a tone whose pitch varies in relation to the visual ID number -- the higher the ID, the higher the pitch. Good for relic hunting. This setting is also useful in areas with a high concentration of steel bottle caps. Coins will produce a fairly constant pitch as you sweep back and forth. Bottle caps produce inconsistent tones, often with a *squawk* at the beginning of the sound.

### **Process Number (Process #)**

This menu selection offers the user a choice among several different methods of audio discrimination to accommodate a variety of search conditions and personal preferences. These methods differ in the way the signals are processed for analysis.

### **The Process Number selections are:**

- dE:** DEFAULT PROCESS  
This is the best process to use for most conditions, and is thus the default.
- JE:** JEWELRY PROCESS  
Detector will be more sensitive to small and low-conductivity metals like jewelry, but will run noisier in trashy areas.
- bc:** BOTTLE CAP MODE  
Response is modified so that steel bottle caps will usually produce inconsistent, or non-repeatable, tones and broken sounds. There may be a slight reduction in the ability to separate adjacent targets. Use this process in areas with a high concentration of steel bottle caps. Also refer to the Capabilities & Limitations section for sweep techniques to aid in the identification of steel bottle caps
- PF:** for use in plowed fields.  
Some users may prefer this process for hunting in irregular ground, especially plowed fields.

### **WHAT YOU SEE VS. WHAT YOU HEAR**

The visual target ID displayed on the LCD is based entirely on sampled processing; the number displayed represents a *snapshot* of the target's identification as the searchcoil passes over the object. When using these different processes, or methods, the detector's audible response may differ from the visual. When using the different processes, there is not a 100% correspondence between what you see and what you hear, especially on buried targets where ground minerals influence target ID and audible response. By making the audio and visual systems independent, the **F75** allows each system to do what it does best. The audio is optimized for quick response and target feel, whereas the visual system provides the best numeric resolution of target ID.

## *PinPoint Feature*

---

After a buried target has been located using the All Metal or Discrimination modes, you want to pinpoint the exact location of the target in order to facilitate its recovery. Accurate target pinpointing will minimize digging.

Activate the PinPoint feature by pulling the trigger switch located under the housing. Unlike the motion All Metal and Discrimination modes, PinPoint does not require motion to detect metal. PinPoint will detect objects while the coil is in motion and will continue to detect metal if searchcoil motion stops over the target.

### **Ground Pick-Up**

If you have not performed the ground balancing procedure, the PinPoint feature usually causes the ground to sound off. This means that while pulling the pinpoint trigger, the audio tone will get louder as you lower the searchcoil to the ground; this is called *ground pick-up*. Since you want to hear the target, rather than the ground, we recommend first ground balancing in order to eliminate ground pick-up. Alternatively, if you experience ground pick-up, you may place the coil very close to the ground, off to the side of the target; then pull the trigger, and raise the searchcoil slightly while passing it over the target.

### **How to Pinpoint**

Position the searchcoil an inch or two (2.5-5cm) above the ground, and to the side of the target. Then pull the trigger. Now move the searchcoil slowly across the target, and the sound will indicate the target's location. As you sweep from side to side, and hear no sound at the ends of the sweep, the target is located in the middle of that zone, where the sound is loudest and the audio pitch is highest. If the sound is loud over a wide area, the buried object is large. Use the PinPoint feature to trace an outline of such large objects.

### **Narrow It Down**

To further narrow the field of detection, position the searchcoil near the center of the response pattern (but not at the exact center), release the trigger, and then pull it again. Now you will only hear a response when the searchcoil is right over the top of the target. Repeat this procedure to narrow the zone even further. Each time you repeat the procedure, the field of detection will narrow further.

### **Buy a Pinpointer**

When you kneel down to unearth the desired object, you may find it frustrating as the object may appear exactly like the surrounding soil. You may hold the object in your hand, and find it necessary to pass a handful of dirt over the searchcoil to see if it contains metal. An easier way is to use a handheld pinpointer. It is a probe-like device which is poked into the ground, making close up pinpointing a snap, reducing digging time, and minimizing the size of the holes you will dig. Fisher Research Labs offers the **FPoint™** pinpointer, a robust and inexpensive device designed for this purpose.

## LCD Visual Display

In normal operation, when the searchcoil passes over a metal object, the electrical signature (2-digit I.D.) of the metal object is displayed on the numeric display for 4 seconds, unless superceded by another detected object. On a given buried object, the number will bounce around if the signal is weak or if the amount of ground mineralization is high.

At the top of the display, a block illuminates to indicate the classification of the object. Target ID is provided in all three modes, and requires motion in all modes, including STAT.

### NUMERIC TARGET I.D. (2-digits)

The **following table** shows the numbers typically associated with certain commonly encountered nonferrous metal objects. Older silver U.S. coins usually read about the same as their modern clad equivalents. Modern quarter-sized dollar coins like the Susan B. Anthony and the Sacagawea read about the same as a quarter. Many Canadian coins are minted from a magnetic nickel alloy which gives very inconsistent readings and may register as iron. Most one-ounce silver bullion coins will fall into the same range as the modern U.S. \$1 Eagle.

#### OBJECT

Most iron objects  
foil from gum wrapper  
U.S. nickel (5¢ coin)  
aluminum pull-tab  
aluminum screwcap  
zinc penny (dated after 1982)  
aluminum soda pop can

copper penny, clad dime  
U.S. quarter (25¢ coin), clad  
50¢ coin, modern clad  
old silver dollar coin  
US silver Eagle \$1 coin

#### TARGET I.D.

4-12  
16-25  
typically 30  
33-55  
60 - 70  
typically 60  
most often 63-69,  
but can vary widely  
typically 70  
typically 80  
typically 86  
typically 90  
typically 91

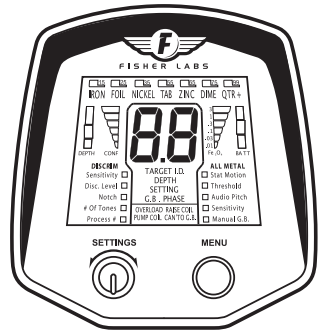

### PROBABLE TARGET I.D.

The probable target ID zones at the top of the LCD display represent the signal ranges produced by various coins and types of metal objects. When a metal target is detected, the microcomputer analyzes the signal and categorizes it based on what kinds of metal objects usually produce that kind of signal. The microprocessor then displays a rectangle-like icon along the top of the LCD screen above the corresponding category.

For instance, if the detected signal fits within the parameters usually exhibited by zinc pennies, the microcomputer will categorize the signal as "zinc penny". The LCD screen will then illuminate the block above "ZINC"

Copper pennies (pre-1982) will usually register in the DIME zone.

Most gold jewelry is small, and will tend to read in the 16-55 range. Silver jewelry usually has more metal in it and therefore tends to produce higher readings.



## *LCD Visual Display (continued)*

Since different metal objects can produce similar signals, and since minerals in the soil can distort the signals, the probable target ID's are just that -- probable. There is no way of knowing for sure what's buried other than to dig it up. Experienced metal detector users have a rule of thumb -- "when in doubt, dig".

### **DEPTH**

When the trigger is pulled to facilitate pinpointing an object, the 2-digit numerical display indicates the approximate depth of the object, in inches, based on the assumption that the object is a typical U.S. coin. Small objects will read deeper than they actually are, and large objects will usually read shallower than they actually are.

The **DEPTH** bar graph on the left of the display divides target depth into shallow, medium, and deep. This depth range appears while searching, and is less accurate than the value derived using the pinpoint toggle switch.

Bar graph ranges for a coin-sized object are Shallow (0-4inches), Medium (4-8inches), and Deep (8inches +).

### **CONF (Target Confidence Indicator)**

This 6-segment graphic indicates how confident the detector is of the 2-digit target identification it has assigned. If all 6 segments are displayed, you can be confident that the target ID is accurate. If 3 or fewer segments are displayed, the confidence is very low. Junk targets tend to produce lower confidence indications than coin targets of similar electrical conductivity. Sloppy sweep technique also reduces the confidence indication. You can use this indicator to train yourself to sweep more skillfully.

### **Fe<sub>3</sub>O<sub>4</sub> BAR GRAPH (magnetite)**

This bar graph displays the magnetic mineralization factor, or magnetic susceptibility, of the soil. Magnetic susceptibility is expressed in terms of the percent volume of the iron mineral magnetite, which most black sand is made of. The depth to which objects can be accurately identified is strongly influenced by the magnetic susceptibility of the soil. High Fe<sub>3</sub>O<sub>4</sub> values have a greater effect on detection depth in the Discrimination mode than in the All Metal mode. For the most accurate Fe<sub>3</sub>O<sub>4</sub> reading, pump the searchcoil as though you were ground balancing.

<b>Fe<sub>3</sub>O<sub>4</sub> Range</b>	<b>approx. micro-cgs</b>	<b>Description</b>
3	7,500	uncommon but not rare, heavy mineralization
1	2,500	heavy mineralization, not uncommon in goldfields
0.3	750	heavy mineralization, but not uncommon in some regions
0.1	250	medium mineralization, typical
0.03	75	light mineralization, but common
0.01	25	light mineralization, your G. B setting may also be low
blank	<14	quartz & coral white beach sands

## *LCD Visual Display (continued)*

---

### **BATTERY CONDITION INDICATOR**

Fresh alkaline batteries will illuminate all three bars. When no bars are displayed and the batteries are about to go dead, the **BATT** legend will start flashing. The detector should operate for an additional 30 minutes from the time the **BATT** legend starts flashing. If using NiMH rechargeable batteries, the display will remain stuck on the second or third bar for most of the battery life; when it drops to the first bar, the batteries will go dead within several minutes.

### **G.B.**

This is the ground balance setting, 0-99. It is displayed when in the Manual G.B. menu setting, or when the trigger is pushed for FASTGRAB computer-assisted ground balancing.

### **SETTING**

This is illuminated when you are in the menu. When the word "SETTING" is indicated, the number being displayed is a setting, and not, for instance, a Target ID indication.

### **MESSAGES**

The small rectangular box at the bottom-center of the LCD displays advisory messages.

If a metal object or highly magnetic soil is so close to the searchcoil that the signal is overloading the circuit, the message **OVERLOAD - RAISE COIL** will appear. Such overloads will not harm the detector, but the detector will not detect metals properly under these conditions. Raise the coil until the message disappears; the siren sound will also stop. Resume normal detection.

The message **RAISE COIL** only appears when using the **bc** process, accessed through the PROCESS # menu selection. This message indicates the presence of a target which may be too close to the searchcoil to be accurately identified. For better target identification, sweep the searchcoil farther away from the surface of the ground.

The message **PUMP COIL TO GB** will appear when you push the trigger forward to ground balance. See the Ground Balance section of this manual for instructions.

The message **CAN'T GB** can only appear when the trigger is pushed forward, invoking FASTGRAB automatic ground balancing. This message appears when the detector is unable to measure the soil in a manner suitable for ground balancing. This message is usually the result of the presence of metal. Try another spot to find an area free of metal.

### **BACK LIGHT**

The LCD is back-lighted for use in low light and dark conditions.

The backlight is always illuminated, but the illumination is usually not evident in daylight. You cannot turn the backlight off. The single high-efficiency light emitting diode providing the illumination is a low current device, and has a negligible impact on battery life.

## Frequency Shifting

One disadvantage of a highly sensitive metal detector is its susceptibility to electrical interference from other electronic devices. If the detector chatters while the searchcoil is not in motion, the cause is either electrical interference or internal circuit noise due to a high sensitivity setting. If the detector chatters or emits intermittent false signals in the field, you are also probably experiencing electrical interference. If you suspect electrical interference, you may change the **F75's** operating frequency. This is a trial and error method to try to find a frequency different from the suspected source.

To shift frequencies:

1. Hold the MENU button down. Do not release the button.
2. Push the trigger forward  
OR pull the trigger back to change the frequency.

Each frequency change requires a push of the MENU button.

Each actuation will shift the frequency by one value.

The LCD will display the frequency, from F1 to F4. F1 is the lowest frequency. And the default frequency. The **F75** does not retain changes in the frequency setting, when powered off.

See the Search Techniques section of this manual for more information on electrical interference.

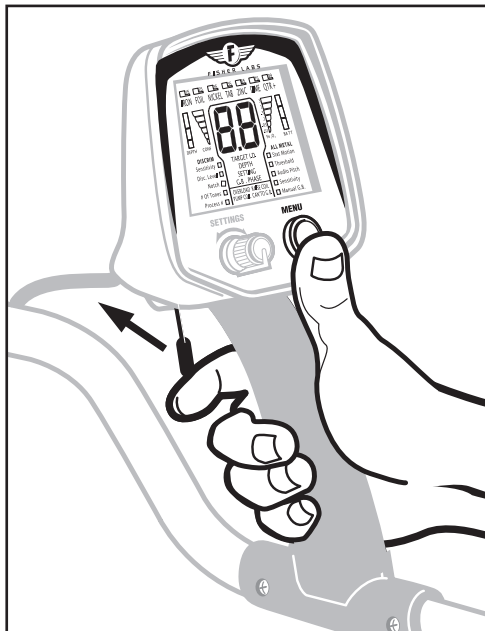

## *Capabilities And Limitations*

---

### **DEPTH**

The F75 can detect U.S. coins to a depth of up to 15-16 inches (37-40cm) under good conditions. Large objects (55 gallon drums, manhole covers, etc.) can be detected to a depth of up to several feet (1-2 meters).

Electrical interference from power lines and from electrical appliances and electronic equipment can reduce detection depth, or cause audible interference, making it necessary for the user to reduce the sensitivity setting. Soils with large amounts of iron or salt minerals may also reduce detection depth or necessitate a reduction in the sensitivity setting.

### **TARGET IDENTIFICATION**

The F75 identifies the probable type of metal object by measuring its effective electrical conductivity, which is displayed as a number from 0 to 99 on the LCD screen. The *effective electrical conductivity* of an object depends on its metallic composition, size, shape, and orientation relative to the searchcoil. Since coins are minted to tightly controlled specifications, they can be accurately identified. Identification of pull-tabs and foil is less consistent because these kinds of targets come in wide variety. In general, smaller objects, and objects made from lower conductivity alloys such as iron, bronze, brass, lead, pewter, and zinc will read lower on the effective conductivity scale. Larger objects and objects made from higher conductivity alloys such as silver, copper, and aluminum, will tend to read higher. The notable exceptions are gold, which usually reads low because it is rarely found in large pieces, and zinc pennies, which read moderately high because of their size and shape. Although nails and other iron and steel objects will usually give low readings, ring-shaped pieces of iron (for instance steel washers and harness rings) will usually produce medium to high readings. Flat pieces of iron or steel, such as can lids, will occasionally do the same.

Most targets can be identified accurately in air to a distance of about 10 inches. The minerals in many soils will cause identification to be less accurate. In most soils, effective target identification can be had to a depth of at least 8 inches.

### **REQUIREMENT FOR MOTION: PINPOINT FEATURE**

As with other modern metal detectors, the F75's searchcoil must be kept in motion in order to both detect and identify targets. The All Metal modes are more forgiving of sweep speed variation than is the Discrimination mode.

The trigger-activated PinPoint feature continues to detect metal if searchcoil motion stops over the target. The PinPoint feature is used primarily to pinpoint the exact location of a target so that it can be retrieved with a minimum of digging, and does not provide target identification.

## *Capabilities And Limitations (continued)*

---

### **GROUND BALANCING**

To achieve maximum depth in any detection mode, as well as when using the PinPoint feature, the **F75** offers the ability to cancel out ground minerals either by manual adjustment, or automatically using the FASTGRAB feature.

If you do not perform the ground balancing operation, the Discrimination mode will usually still work fairly well, but the ALL METAL modes will not. The Pinpoint feature can be used for pinpointing objects at moderate depth in most soils without prior ground-balancing.

The internal computer will not cancel salt water, so when detecting on wet ocean beaches, ground balancing must be done manually.

### **DISCRIMINATION**

Discrimination refers to a metal detector's ability to ignore metal objects in selected categories, especially iron and aluminum. This makes searching much more pleasant in an area with a lot of metal trash. The **F75** offers a wide variety of discrimination features which you can select according to the search conditions and your personal preference.

### **DEPTH READING**

The estimated Depth Reading displayed when pulling the PinPoint toggle is based on the strength of the signal. It is calibrated to coin-sized objects. Smaller objects will read deeper than they actually are, and large objects will read shallower than they actually are.

### **AIR TESTING**

There may be times when you want to test or demonstrate the metal detector without sweeping it over the ground, for instance, if not fully assembled, or if you are indoors. To air test, place the searchcoil in a spot where the detector is stable and more than two feet away from any large masses of metal, including the reinforcing steel usually present in concrete. If you are wearing a wristwatch or jewelry on your hand or arm, remove it. Then, test or demonstrate by waving metal objects over the searchcoil; wave objects briskly, several inches over the top of, and parallel to, the searchcoil.

Ground balancing cannot be tested or demonstrated in air unless you happen to have appropriate specimens of iron minerals available.

### **SWEEP SPEED**

The **F75** is noted for its quick response. This gives it unsurpassed ability to locate and identify good targets surrounded by trash. It also permits the user to sweep the searchcoil quickly in order to cover more ground with very little risk of losing targets. In general, if you are searching an area where the desirable targets are more than 8 to 10 inches deep, a faster sweep speed will detect to a greater depth and yield more accurate target IDs.

### **CHECKING A TARGET**

In order to most accurately verify a detected target with most other metal detectors, users will narrow their sweep and loiter over the top of the target. The **F75** is different. The **F75**'s quick response and advanced signal sampling system produces the most accurate target IDs with deliberate (shoulder width) sweeps all the way across the target, even if there are other targets nearby. If you check targets using sweep techniques learned on some other detectors, you run the risk of getting less accurate target IDs. You can use the confidence level indicator to improve your technique.

## Capabilities And Limitations (continued)

### STEEL BOTTLE CAPS & FLAT IRON TRASH

Modern motion-type target ID metal detectors usually have difficulty consistently identifying steel bottle caps and other flat iron trash objects. Double-D searchcoils also have a reputation for having difficulty distinguishing steel bottle caps from coins, and for being unable to eliminate steel bottle caps from detection. If you are searching in an area where there are many steel bottle caps or other flat iron trash targets, minimize the amount of unnecessary digging with the following methods:

1. **SEARCH WITH THE **bc** (BOTTLE CAP) PROCESS** using the PROCESS # feature. This method calculates visual ID differently in order to cause steel bottle caps to read lower on the scale, and to register less consistently. A desirable object such as a coin will usually produce numeric values that are fairly consistent in both directions of sweep. See PROCESS # under the DISCRIMINATION Mode section of this manual.
2. **SEARCH WITH THE **dP** PROCESS.** This method calculates visual ID differently in order to cause steel bottle caps to ID lower on the scale and to register less consistently. It also produces more audio clues to the character of the target.
3. **LIFT THE SEARCHCOIL.** Within 2 inches of a Bi-Axial searchcoil, the crossed magnetic fields of the Double-D construction can produce anomalous responses. If the object feels shallow (strong signal, narrow response, or multiple responses in a single sweep) and is giving consistent high readings like a coin, raise the searchcoil 2 to 3 inches and try again. A coin will almost always continue to give consistent readings unless it is right next to an iron object. **A steel bottle cap that is at least 3 inches away from the searchcoil will usually produce readings that bounce around from medium to low numbers.**
4. **SWEEP THE REAR OF THE SEARCHCOIL OVER THE CENTER OF THE TARGET, OR SWEEP RAPIDLY.**
  - a. If the ID# is repeatable in the range of 68 to 72, when passing the center of the searchcoil over the target at a normal speed, then the target is probably a dime or copper penny.
  - b. If the ID# is not in the range of 68 to 72 then:
    - i. Sweep the back end of the searchcoil over the target. If tones change from high to low, the target is probably a bottle cap.
    - ii. Sweep the center of the searchcoil rapidly across the target.
      1. If tone and ID# drop, it is probably a bottle cap.
      2. If a bottle cap, then the faster you sweep, the lower the tone.
5. **USE THE CONFIDENCE INDICATOR**  
Coins will usually produce a high confidence level, whereas steel bottle caps and other trash will usually indicate a low or erratic confidence, even if the ID numbers are consistently in the range of a coin. Confidence level is useful even if not using the dP or 3b processes.

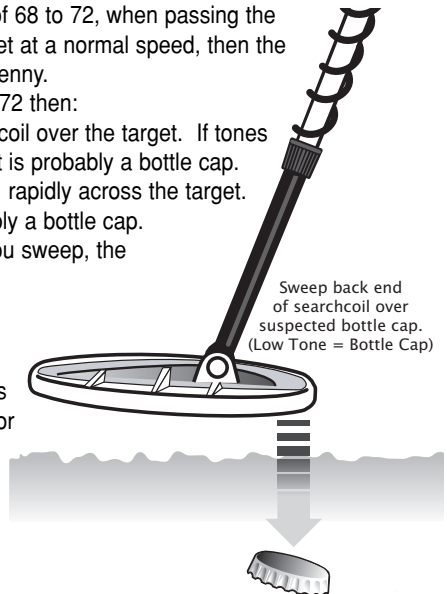

## Search Techniques

**Sweeping Searchcoil** (this does not apply to Pinpointing with the trigger switch) Keep the searchcoil in motion to detect targets. Sweep the searchcoil parallel to the ground; do not lift the searchcoil at the end of the sweep.

When you have located a target and continue sweeping back and forth for verification, use broad, deliberate sweeps across the target for the most accurate target ID. Do not use short sweeps as you might with other metal detectors.

### Shallow Targets

Shallow targets tend to give multiple responses, with the last response being the one that remains illuminated on the visual display. This last response is usually sampled at the edge of the searchcoil and will tend to be inaccurate. If you suspect a shallow target (within 2 to 3 inches of the searchcoil), lift the searchcoil slightly, and slow down your sweep speed until you notice a single response consistently in the same place.

Large shallow targets can cause signal overload, indicated by the siren sound. In these instances, raise the searchcoil until the overload warning disappears, and sweep at this increased height.

### Large Targets

If an overload warning is not confined to a small spot, you are probably overloading on a large object, for example, a large iron pipe, reinforcing steel in concrete, or buried sheet metal. It is usually not possible to locate objects, such as coins, in close proximity to large masses of metal.

### Pinpointing With the Trigger Switch

When you turn the F75 on, the ground balance setting is preset to give a positive response on nearly all soils. This means that if you are pulling the pinpoint trigger, the audio tone will get louder as you lower the searchcoil to the ground. But you do not want to hear the ground; you just want to hear the target. So always Ground Balance first.

After you have discovered a buried metal target using the ALL METAL or DISCRIMINATION Modes, use the trigger switch to pinpoint its exact location.

Position the searchcoil an inch or two (2.5-5cm) above the ground, and to the side of the target. Then pull the trigger. Now move the searchcoil slowly across the target, and the sound will indicate the target's location. As you sweep from side to side, and hear no sound at the ends of the sweep, the target is located in the middle of that zone, where the sound is loudest and the audio pitch is highest. If the sound is loud over a wide area, the buried object is large. Use the PinPoint feature to trace an outline of such large objects.

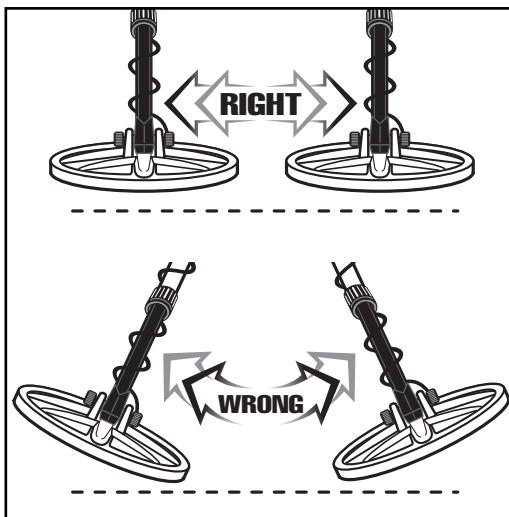

## *Search Techniques (continued)*

---

### **Estimating Target SIZE, DEPTH, and SHAPE**

When the trigger is pulled to activate Pinpoint, the LCD displays estimated depth. The estimate is based on the presumption that it is a coin-sized target.

But what if it is not a coin-sized target? The most common example is that of an aluminum can. Flattened aluminum cans are usually identified as quarters. Their large size will produce a strong signal, tricking the microcomputer into thinking that it is a shallow coin.

The following explains techniques for differentiating buried aluminum cans from coins. Sweep back and forth to get a feel for the target, keeping the searchcoil close to the ground. Now, continue to sweep back and forth as you slowly raise the searchcoil higher and higher. If the response diminishes quickly and never gets very broad, the target is probably a coin. If the response diminishes slowly as you lift the searchcoil, and you get a broad response, the target is probably an aluminum can. If you practice this by laying a coin and a flattened aluminum can on the ground, you will quickly understand how to differentiate the two and you will probably never have to dig another aluminum can. And, you will know whether it was deep or shallow. This technique works well in the All Metal modes, and to a lesser extent in Discrimination mode.

Objects which are ring-shaped, or flat and round like coins, tend to give a narrower, crisper response than objects of similar size with irregular shapes. The easiest way to demonstrate this is with an aluminum screwcap from a soda bottle. In its normal shape, it occupies a volume, and gives a somewhat broader response than that of a coin. But if you flatten it, the response will be crisper and more like that of a coin. Again, these differences are most readily noticed in the All Metal modes.

Long skinny iron or steel objects such as nails usually produce a double response when scanned lengthwise, and a weaker single response when scanned crossways. This is most noticeable in the Motion All Metal mode. However, a coin lying on its edge can produce a similar response, so rely on both the target ID as well as *target feel* to distinguish between different kinds of objects. Objects within 2 to 3 inches of the searchcoil will often produce multiple responses as you sweep across them, because the response field close to the searchcoil is irregular.



## *Search Techniques (continued)*

---

### **Estimating Target I.D.**

With a single sweep over a target, you will usually see a 2-digit target ID displayed on the LCD. Repeated sweeps back and forth over the target may cause the 2-digit target ID values to change with each sweep of the coil; this may seem inconsistent with your discrimination setting. These variations and inconsistencies provide important clues regarding the identity of the buried object.

Most metal detectors have difficulty properly identifying steel bottle caps, and the **F75** is no exception. Steel bottle caps will often read in the coin range, at the high end of the scale. The ID number you receive from a buried coin will usually be consistent regardless of sweep speed or angle. The readings from a steel bottle cap will tend to bounce around a lot more, especially with variations in sweep speed or angle. By paying attention and taking this into account, you can minimize the number of bottle caps you dig.

The information provided by the Visual Target ID may be different than the detector's Audio Feedback because the visual and audio systems are independent of one another. The internal signals and algorithms controlling the Visual and Audio output are different. Therefore what you hear, or do not hear, provides additional information regarding target ID. For instance, if discrimination is set at 12, and most sweeps result in no visual target ID, the target is most likely iron even though the majority of the ID numbers will be greater than 12.

The **F75** has a tendency to *up-average* nonferrous targets in the proximity of iron, indicating ID numbers higher than would be obtained in an air test. This tendency is connected with the **F75's** enhanced *see-through* ability – that is, the ability to find valuable targets in an area where there is a lot of iron trash.

### **False Signals and Chatter**

At times the detector may beep when there is nothing there, or it may seem like there is nothing there. There are five major causes for this: electrical interference, nuisance buried objects, ground minerals, hot rocks, and sensitivity set so high that internal circuit noise is audible. The problem can usually be corrected by reducing the sensitivity setting, but sometimes other measures can also be taken.

### **ELECTRICAL INTERFERENCE**

Electrical Interference can be caused by power lines, appliances, computer equipment, cell phones, fluorescent and vapor type lamps, household light dimmers, other nearby metal detectors, electric fences, radio transmitters, and electrical storms. If you get abnormal noise while holding the searchcoil motionless in the air, the cause is either electrical interference or internal circuit noise. If it is electrical interference, by walking around with the metal detector, you can often follow the signal and track it back to the offending device; simply turn the device off, or come back at another time when it may be off. If the interference is from power lines, you might try another time of day. Interference on power lines is usually caused by something connected to them which may be idle in the evenings or on weekends. If the interference is from a communications or broadcast transmitting antenna, reducing the sensitivity is usually your only recourse.

The **F75** allows you to shift operating frequencies to avoid electrical interference. See the Frequency Shifting section for information about this technique.

## *Search Techniques (continued)*

---

### **NUISANCE BURIED OBJECTS**

In some areas there is a lot of metallic trash which produces weak signals. These could include deeply buried objects, little bits and pieces of rusty iron and corroded foil. These items can be detected, but are difficult to pinpoint due to their depth and small size. When you dig and find nothing, it may seem like the machine is beeping at nothing even though there is actually something there. The best solution is usually to reduce sensitivity.

If searching a very trashy area and unwanted signals are a problem, search with the searchcoil 2 inches away from the ground. Trash objects very close to the searchcoil will sometimes not be completely eliminated, even when the discrimination setting should have eliminated the target.

Metal detectors are designed to see one metal object at a time. Where there are two iron objects near each other, the detector can be fooled into thinking that the gap between them is nonferrous metal. This is a common condition where a wooden building has burned or been torn down, and the site is littered with nails. A signal from a nonferrous metal object such as a coin will usually be repeatable, whereas a *false positive* signal resulting from multiple or oddly shaped iron objects will seem to wander around and even to vanish. Experienced detectorists call these *non-repeating* signals and usually do not bother digging them since nonrepeating signals are almost always trash.

### **GROUND MINERALS**

Conductive mineral salts usually produce broad signals which will not be mistaken for a metallic object. Common causes are concentrations of mineral fertilizer, spots where evaporation has concentrated naturally occurring mineral salts, residue from de-icing salts, and urine from livestock. Unless dry, "cow pies" can sound off like they are metal. Ocean beaches have salt water—that subject is discussed toward the end of the manual.

In spots where there has been intense fire, such as a campfire site or where a stump was burned during land clearing, the soil minerals may be altered by oxidation so that their ground balance setting is lower than that of the surrounding soil. In such cases, search slowly and change the G.B. setting as frequently as necessary.

In some areas, electrically conductive industrial minerals such as fuel coke, slag, clinkers (left over from burning mineral fuels), or charcoal have been dumped or used as landfill. Individual lumps of these materials can usually be quieted by reducing sensitivity and searching with a discrimination level of at least 25. However, where the ground consists primarily of such materials, you may not be able to search quietly. In that case, do not dig unless a signal is crisp and repeatable.

Electrically conductive natural minerals such as graphite, graphitic slate, or sulfide ore minerals are rarely encountered except when gold prospecting. When gold prospecting, you need to be able to hear everything, and you can expect to dig conductive minerals that turn out not to be gold. In a given locality you may learn to recognize what type of rocks these minerals are found in, and to ignore them if people in the area say that gold is not found in rocks of that type.

## *Search Techniques (continued)*

---

### **HOT ROCKS**

A *hot rock* is a rock which causes the metal detector to sound off because the rock contains iron minerals. They come in two basic types.

*Negative hot rocks* (also called cold rocks) are usually magnetite or contain magnetite, and give a negative response because their ground balance value is a higher number than the soil they are found in. They tend to be dark in color, usually black, and usually heavy. In some cases they will have rust stains. They are usually attracted to a magnet, and for this reason gold prospectors always carry a magnet—the ultimate ferrous/nonferrous discriminator. In Motion All Metal mode, negative hot rocks produce a *boing* sound rather than the *zip* sound of a metallic target; recognize the difference and you will learn to ignore them.

*Positive hot rocks* are iron-bearing rocks which have been oxidized by natural weathering processes so that their Ground Balance number is a number lower than the soil they are found in. They are often small, right on the surface, sound just like a gold nugget, and are common in many gold prospecting areas. They are usually, but not always, drawn to a magnet. They are most often reddish in color but are often black, brown, or yellow. On relic hunting sites, red clay bricks and rocks which have lined a fireplace or a campfire will often be *hot rocks*. The discriminator will usually eliminate them without difficulty if widely scattered, but if there is a large concentration of them, the discriminator may not quiet them all. In that case, you can revert to the rule of thumb -- “don’t dig non-repeatable signals”.

### **Using the sensitivity control**

When the **F75** is first turned on, the Sensitivity is at a medium setting appropriate for most coinshooting. For relic hunting or gold prospecting, higher Sensitivity settings are usually preferred.

In the event of detection of electrical interference from electrical power lines, electrical or electronic appliances, or another metal detector, it is usually necessary to reduce the Sensitivity setting to achieve quiet operation. Alternatively, use the Frequency Shift feature described earlier in this manual.

If, while searching, you are constantly getting signals from which you cannot recover metal targets, you may be detecting small or deep targets which are not recoverable using the methods at hand. So, you may do better if you reduce the Sensitivity setting.

## *Search Techniques (continued)*

---

### **Tips on ground balancing**

When the **F75** first turns on, the ground balance setting is preset to 90. This will give a *positive* response on nearly all soils. If you search in the Discrimination mode, you will probably not have to balance to the ground. If you switch to All Metal mode, ground balancing will probably be necessary.

You must find a spot of ground which is free of metal to accurately balance to the ground. Before you attempt to Ground Balance, sweep back and forth to see if any metal target is present. Locate what seems to be a clear area and then Ground Balance. Ground Balancing may be done automatically by pushing the trigger, or manually if you are in All Metal mode. After you have ground balanced, sweep back and forth to see if there is little or no audible response to the soil. This is best done either in All Metal mode, or in Discrimination mode with discrimination set to zero. Alternatively, use the PinPoint trigger to check the spot. If there is little or no response, ground balancing was successful. If there is still substantial response, there may have been metal present where you attempted to ground balance, so find another promising spot and try again. If you cannot find a spot to successfully ground balance, it is time to give up. Reset the ground setting to 90 and then use the machine without ground balancing.

In most areas, once you have ground balanced, the ground balance setting will remain satisfactory for a long time. However, if the soil has been disturbed by digging or the addition of fill dirt, or if you are in a geologically complex setting such as is commonly encountered in gold prospecting areas, you may have to frequently perform the ground balancing procedure to accommodate changing soil conditions.

When you ground balance, the numerical Ground Setting will momentarily appear on the LCD screen. In general, sandy or gravelly soils will tend to read in the 75-95 range, light colored loams and clays will tend to read in the 50-80 range, and red clays will tend to read in the 35-55 range. To express it in other terms, the more highly weathered, oxidized, or finely grained the soil is, the lower the numeric reading will be.

The  $\text{Fe}_3\text{O}_4$  bar graph indicates how much iron mineralization is present. For it to work, the searchcoil must remain in motion. The most accurate readings will be achieved by *pumping* the coil as you do when ground balancing. The higher the mineralization, the greater the necessity to ground balance the detector for the best depth performance.

If you are searching for relics, you can make a map of the soil of the site. Make a grid of the site. Then collect data. Ground Balance to document mineral *type*; view mineral *amount* on the  $\text{Fe}_3\text{O}_4$  bar graph. Then plot the data on the site map and draw isolines. In this way you may be able to locate areas which have been dug, backfilled, or subjected to fire. This information in turn helps to reveal the history of the site.

## *Detecting Activities*

### *Coinshooting*

Coinshooting is searching for coins, usually in places like parks, schoolyards, church lawns, and people's yards. In most places where coins are likely to be found, there is also a lot of aluminum trash like pull-tabs and bottle caps, as well as steel bottle caps and often nails. Sometimes there is jewelry present. You will usually search using discrimination to get rid of the iron and the aluminum trash, even though this mode will cause you to miss some of the jewelry.

Much coinshooting is done in lawn areas, where digging holes would cause damage to the grass. We recommend use of an accessory hand-held pinpointer in such cases. Recovering targets is usually done by first accurately pinpointing the target, then carefully cutting a slit in the turf with a knife, and tamping it firmly when you are finished. In these situations, you cannot recover deep targets for fear of damaging the turf, so you can cut down on nuisance signals by reducing the sensitivity.

When searching on private property, first get the permission of the property owner. Most of the public places where one is likely to do coinshooting are city, county, or school district property. There is usually no ordinance prohibiting use of a metal detector as long as you are not causing damage. Sometimes such ordinances do exist. Administrators and security personnel often have the legal authority to prohibit any activity they do not like even if there is no ordinance against it. If there is a metal detecting club in your area, someone will usually know what areas can and cannot be searched. If you are ever in doubt about hunting an area, then ask before hunting.

**Be prepared to always put your best foot forward when using a metal detector in a public place.** Pick up any trash you recover; put it in a pouch or pocketed apron. This way you can explain that you are performing a public service by helping keep the place free of trash, especially pieces of metal or glass that could endanger a child at play. Be proficient at recovering targets without causing damage to the lawn. Explain that whenever you find jewelry which has personal identification marks, such as a class ring, you make an attempt to determine the owner and to return it. When someone who questions what you are doing understands that you are causing no damage and are actually performing a public service, you will usually be welcome.

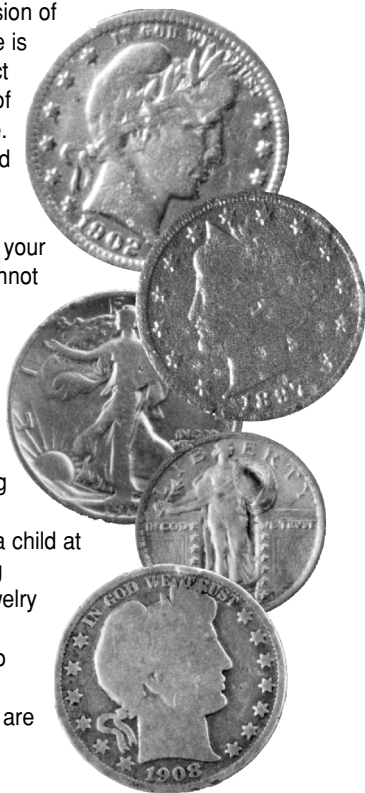
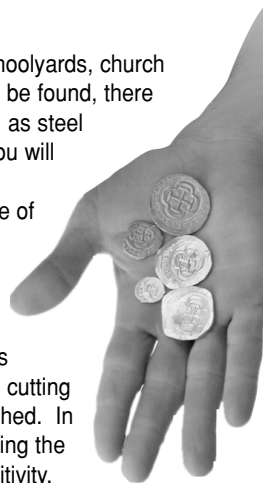

## *Detecting Activities (continued)*

### *Relic Hunting*

*Relic hunting* is searching for historical artifacts. The most common desired objects are battlefield debris, coins, jewelry, harness hardware, metal buttons, trade tokens, metal toys, household items, and tools used by workmen and trades people. The most common unwanted metal is iron (nails, fence wire, rusted cans, etc.), but some iron and steel objects such as weapons may be valuable. If you are at a site where you may encounter unexploded ordinance, use caution.

Most relic hunting locations are in fields, forested areas and vacant lots where digging holes will not damage turf grass, so having a detector with good depth sensitivity is important. Some places are so littered with iron that it is necessary to discriminate out iron in order to be able to search, even though you may miss some potentially valuable artifacts.

Before you go relic hunting, obtain permission from the property owner. If you intend to hunt on public land, check first with the administrator to make sure it's not illegal. Certain kinds of sites, on both public and private land, are protected by law from relic hunting. If there is a metal detecting club in your area, some of the members will probably know what the laws are in that area and which sites are, and are not, off limits.

Relic hunting is most rewarding if you have an avid interest in history. In many cases, the value of a relic is not the object itself, but the story it's a part of -- what historians call *context* and archeologists call *provenance*. A few pieces of rusty metal can tell the story of life in a specific place, or that of a specific family or person from hundreds of years ago. They can capture our imagination and help to give context to our lives today.

The value and context of a find can be readily lost without proper documentation and storage. Add finds to your collection with care. Take the trouble to understand the site you are searching and keep track of where you find things. Describe exactly how and where items were found. Consider including a sketch of the site with your finds. Organization techniques might include storing together all finds from the same site. Alternatively, if you have an interest in specific items, like buttons, make a button collection, and within that collection, document the circumstances surrounding each button found. If your finds are mixed together, without categorization

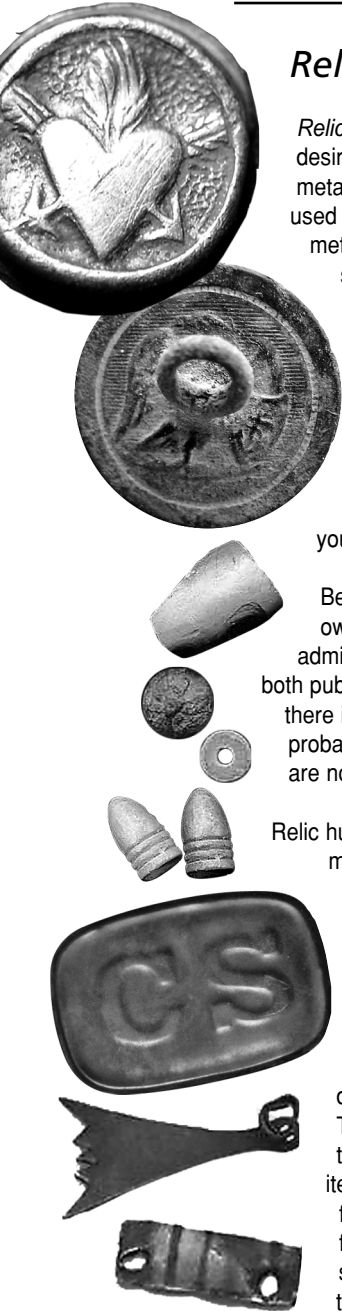

## *Detecting Activities (continued)*

---

### *Relic Hunting (continued)*

or documentation, their context will be lost.

The ground balancing and  $\text{Fe}_3\text{O}_4$  bar graph features of the **F75** can be used to map the soils of a site. In this way you might determine which areas have been dug, backfilled, or subjected to fire. This information in turn helps to reveal the history of the site.

To find promising sites to hunt, conduct research at your local library, look for clues in old newspapers, and seek information on the internet. Where did buildings used to be? Which have since been torn down? Where did people gather for public events like dances and county fairs? Where did train and stage lines run? Where were the swimming holes? In almost every town there is a historical society and museum of local history. Most museums are grateful for anything they can put on display, and when you dig something you cannot identify, the curator can often identify it for you. If you work closely with the local historical society or museum, landowners will be more willing to grant you permission to search their property.

Some of the most promising sites for relic hunting are places being cleared for development. After the site is built on, whatever is in the ground will become inaccessible. The property owner can often be persuaded that the site should be searched immediately while it is still searchable.

### *Gold Prospecting*

In the United States, gold is found in many places in the western states, Alaska, and in a few localities in the Appalachians. The old saying "Gold is where you find it", means that to find gold, you should look in areas where the yellow metal is known to be present.

Hillsides are the best areas for gold prospecting using a metal detector, because hillsides cannot be cleaned out by panning and dredging the way streams can. Also, gold on hillsides, not far from its source vein, tends to be larger, and hence more readily detected, than alluvial (placer) gold which tends to get pounded to pieces and worn away as it rolls along the streambed with gravel during floods. Gold is valuable because it is a scarce commodity. Even in a good gold producing area, you will often spend an entire day without finding any gold. Meanwhile you will dig bits and pieces of other metal-- birdshot, shells and bullets from hunting and target practice, bits of rusted barbed wire, chips off shovels and other mining tools, rusted tin cans, etc. Hot rocks -- rocks containing concentrations of iron oxides that sound like metal when you pass over them -- are also a nuisance in many gold areas. Discrimination is usually ineffective because the loss of sensitivity resulting from discrimination is enough to cause those little nuggets to vanish. If you have gone many hours without finding gold and are wondering if there is something wrong with your metal detector or how you are using it, the most important clue is this: if you are digging *tiny* pieces of trash metal, then if gold were present you would have found small gold pieces too!

Because most gold nuggets are tiny, and are usually found in soil which is high in iron oxide

## *Detecting Activities (continued)*

### *Gold Prospecting (continued)*

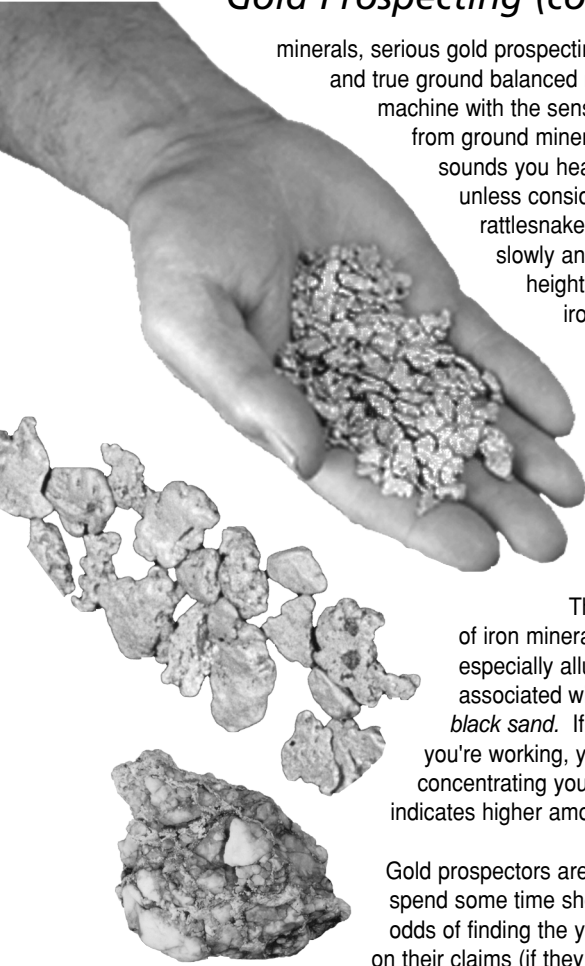

minerals, serious gold prospecting requires a detector with high sensitivity and true ground balanced motion all metal operation. Run the machine with the sensitivity high enough to hear some noise from ground minerals, and *learn the language* of the sounds you hear. Headphones are recommended unless consideration for safety (for instance rattlesnakes) rules them out. Move the searchcoil slowly and deliberately, carefully controlling its height above the ground to minimize noise from iron minerals in the soil. If you hear ground noise, your Ground Setting could be a bit off, so perform the ground balancing procedure again. As you walk even a very short distance, ground conditions can change. The ground geology typically associated with gold will tend to change over very short distances.

The  $\text{Fe}_3\text{O}_4$  bar graph indicates the amount of iron mineralization in the soil. In most gold fields, especially alluvial (placer) deposits, gold tends to be associated with iron minerals, especially magnetite *black sand*. If you know this to be the case in the area you're working, you can maximize your gold recovery by concentrating your effort on areas where the bar graph indicates higher amounts of iron mineralization.

Gold prospectors are mostly a friendly bunch, and willing to spend some time showing a beginner how to increase his odds of finding the yellow stuff. Many will invite you to search on their claims (if they have any) once they get to know you.

In some gold areas, a lot of the terrain is under claim, so you need to learn how to recognize posted claims and stay off of them unless you have the claim owner's permission. Prospecting clubs such as the GPAA often own claims which are open to their members, and sponsor group outings to good gold areas.

It's a thrilling experience to dig into the ground and pull out a precious piece of yellow metal that you are the first person on earth to see. If you love being outdoors, have patience, and can stay motivated by the prospect of finding that next nugget, then *beeping for gold* may be the hobby for you. While only a few get rich prospecting, if you are not among them, think of it as outdoor recreation where your finds defray the expense of having fun!



## *Detecting Activities (continued)*

### *Cache Hunting*

A *cache* (pronounced "cash") is an accumulation of money, jewelry, gold, or other valuables, which someone has hidden. When people bury a cache, they usually put it in a strongbox or in a jar. To search for a cache, you first need a reason to believe the cache may exist. This means doing research. Some caches have been the subject of many stories you can read about in print, but you need to be able to sort fact from fiction. If you can get copies of old newspaper stories about the circumstances surrounding the hiding of the cache, you may find discrepancies which help you to judge the reliability of the information available. Often the best information on an old cache is to be learned from old timers who live in the area where the cache is thought to be. In the case of newer caches, often the only information is what can be obtained from family and acquaintances of the person who is believed to have hidden the cache.

The ownership of a cache is not always clear. Sometimes it belongs to the person or heirs of the person who hid it, sometimes it belongs to the owner of the property on which it is located, and sometimes it belongs to the person who finds it -- or some combination of the above. If the contents of the cache were stolen, this fact can also complicate the question of ownership. Find out what laws apply to the cache in question, and always make sure that the issue of ownership is resolved prior to recovering a cache.

Compared to a coin, a cache is usually large and deep. Searching in Motion All Metal mode is recommended. However, for a really deep cache, it may be advantageous to search in STAT mode, frequently pulling the trigger momentarily to maximize sensitivity.

### *Shallow Water Hunting*

All **Fisher Research Labs** searchcoils are waterproof, allowing you to search in shallow water about two feet deep. If searching around water, be careful not to get the electronics housing wet. Avoid salt spray, as it will work its way into the control housing and damage the electronics -- such damage is not covered by the warranty.



## *Detecting Activities (continued)*

---

### *Shallow Water Hunting (continued)*

Both fresh and salt water beaches are popular places for metal detecting. Vacationers lose money and jewelry playing in the sand and in the water. It is usually easy to dig in a beach environment, and metal detecting is permitted on most beaches. Occasionally you may be able to help someone recover a piece of jewelry they have lost minutes before; this is a gratifying experience.

When searching on a beach, it is best to either search in Motion All Metal mode, or to search with the discrimination level set just high enough to eliminate iron, because the value of beach finds is largely in the jewelry rather than in the coins. You will dig a lot of aluminum trash, but the digging is easy, and you can tell people that you are helping to clean up the beach and make it safer for people's feet. We recommend the use of a special *sand scoop* for recovering valuables from the sand quickly -- most metal detector dealers sell these.

The electrical conductivity of the water itself can pose some challenges. You may get false signals when going into and coming out of the water, making it necessary to pay careful attention to keep the coil either in or out of the water, but not to touch the surface. This effect may be observed in either fresh or salt water.

### *Salt Water Hunting*

Salt water is highly conductive, and produces a strong signal which is like that of metal. The **F75** is not specifically designed for high performance in salt water, but can be used in this environment.

If you desire to search in or over salt water, the following measures will usually be sufficient to silence the salt water response while retaining acceptable sensitivity:

1. Set the **sensitivity** in both modes to **less than 30**.
2. Ground balance the machine manually in Motion All Metal mode.
3. Search in the Discrimination mode with a discrimination setting higher than 25.

## *How Metal Detectors Work*

---

Most hobby metal detectors use *VLF Induction Balance* technology. Here's how they work.

The search coil (also called search head or loop) contains two electrical induction coils which are like antennas. One coil transmits a rapidly alternating magnetic field, *illuminating* the region surrounding the search coil. If metal is present, its electrical conductivity distorts the magnetic field. If iron metal is present, its magnetism also distorts the magnetic field, but in a different way, allowing the metal detector to distinguish between ferrous and nonferrous metals.

The other coil is a receiving antenna which detects changes in the magnetic field caused by the presence of metal. Electronic circuits amplify this weak signal, analyze it to determine the changes which occur as the search coil sweeps over the target, and then convey the information to the user in the form of a visual display or audio tones. Most modern metal detectors perform many of these tasks in software running on an internal microcomputer.

The iron minerals which are present in most soils also distort the magnetic field, obscuring the weak signals of small or deep objects. This can cause the object to go undetected, or to be misidentified when it is detected. Much of the technology that goes into modern metal detectors is devoted to the task of eliminating the unwanted signals from iron minerals in the soil, while not losing the signals from metal objects.

## *Treasure Hunter's Code of Ethics:*

---

- Always check Federal, State, County and local laws before searching.
- Respect private property and do not enter private property without the owner's permission.
- Take care to refill all holes and try not to leave any damage.
- Remove and dispose of any and all trash and litter found.
- Appreciate and protect our inheritance of natural resources, wildlife and private property.
- Act as an ambassador for the hobby, use thoughtfulness, consideration and courtesy at all times.
- Never destroy historical or archaeological treasures.
- All treasure hunters may be judged by the example you set; always conduct yourself with courtesy and consideration of others

## *5-Year Limited Warranty*

The **F75** metal detector is warranted against defects in materials and workmanship under normal use for five years from the date of purchase to the original owner.

Damage due to neglect, accidental damage or misuse of this product is not covered under this warranty. Decisions regarding abuse or misuse of the detector are made solely at the discretion of the manufacturer.

**Proof of Purchase is required to make a claim under this warranty.**

Liability under this Warranty is limited to replacing or repairing, at our option, the metal detector returned, shipping cost prepaid, to Fisher Labs. Shipping cost to Fisher Labs is the responsibility of the consumer.

To return your detector for service, please first contact Fisher Labs for a Return Authorization (RA) Number. Reference the RA number on your package and return the detector within 15 days of calling to:

**Fisher Research Labs, Inc.  
1465-H Henry Brennan Dr.  
El Paso, TX 79936  
Phone: 915-225-0333 ext.118**

Warranty coverage does not include the cost of transporting the detector back to an owner who is located outside of the United States of America.

**NOTE TO FOREIGN COUNTRY CUSTOMERS**

This warranty may vary in other countries, check with your distributor for details. Factory warranty follows the channel of distribution. Warranty does not cover shipping costs.



**Fisher Labs**

Copyright© 2009 by Fisher Research Labs, Inc.

All rights reserved, including the right to reproduce this book, or parts thereof, in any form.

Published by Fisher Research Labs, Inc.

Fisher® is a registered trademark of Fisher Research Labs, Inc.

**[www.fisherlab.com](http://www.fisherlab.com)**

1465-H Henry Brennan Dr., El Paso, TX 79936 • (915) 225-0333