



Fisher Labs

CZ-3D

Deep Search, 4-Tone, Target I.D. Metal Detector

*Maximized for finding older era coins
at older sites!*

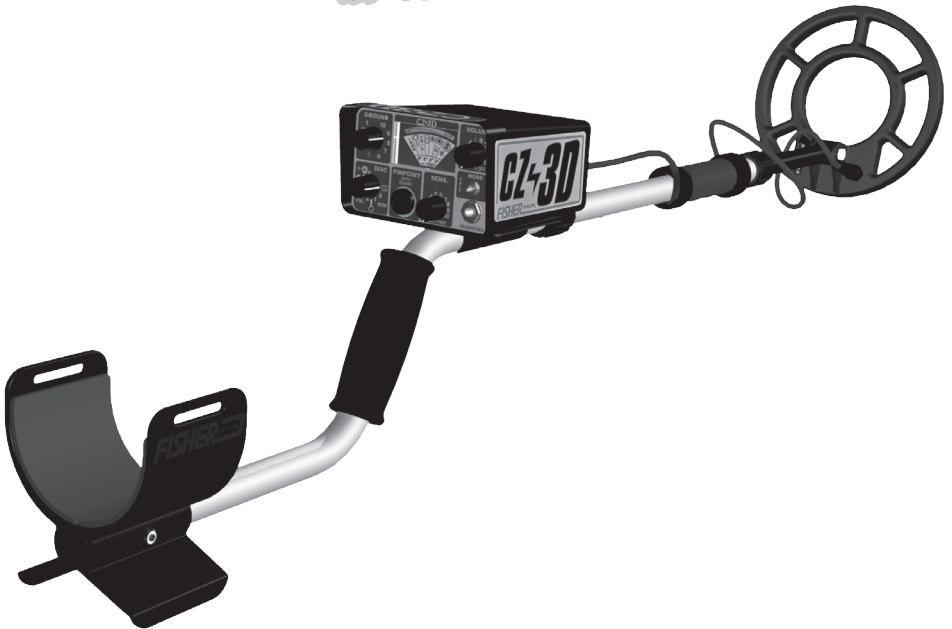

OPERATING MANUAL

FISHER RESEARCH LABORATORY

CONTENTS

About Your Detector	pg. 3
Condensed Operating Instructions	pg. 4
Factory Preset “Turn-On-And-Go” Marks	pg. 4
Setting Up	pg. 5
Hipmounting.....	pg. 7
Control Panel	pg. 7
Turn-On Procedure	pg. 9
Ground Balancing	pg. 9
Pushbutton Method	pg. 10
“Bobbing” The Search Coil Method	pg. 10
Search Modes.....	pg. 12
Search Modes: Auto Tune	pg. 13
Search Modes: Target ID	pg. 13
Searching	pg. 18
Pinpointing: Pushbutton Pinpoint Mode.....	pg. 20
Pinpointing: Target ID and Autotune Modes.....	pg. 21
Depth Reading.....	pg. 24
Target Recovery	pg. 25
Recovery Tools.....	pg. 26
False Signals.....	pg. 26
Maintenance	pg. 27
Treasure Hunters’ Code Of Ethics.....	pg. 28
Battery Replacement.....	pg. 29
Specifications	pg. 30

ABOUT YOUR DETECTOR

Your CZ-3D is an extremely advanced and sophisticated instrument. It is maximized for a very specific function - finding & properly identifying older era coins at older sites. Simply select the "enhance mode" with the utilization of the "salt/enhance" switch to find more rare coins!

The CZ-3D was designed to find more *good metals* such as brass, bronze, copper, silver, and certain gold: reporting it as a high tone. In addition, a fourth tone has been added to distinguish between the midtone heard on round & square "pull tabs" and foil - this enhances your ability to recover gold jewelry.

With this detector, performance and ID can be further enhanced by a slower coil sweep speed, more so than previous CZ models, especially in trashy areas.

Read this instruction manual thoroughly, practice often and you will be ready for some exciting treasure hunting. Drop us a line if you have any questions, comments or good finds to tell us about. In the meantime...

Happy Hunting!
Fisher Research Laboratory

CONDENSED OPERATING INSTRUCTIONS

FACTORY PRE-SET “TURN-ON-AND-GO” MARKS

Your CZ-3D is fairly simple to operate, especially when compared to other target ID machines. Even so, we strongly recommend that you read this entire manual. You'll be able to tune your CZ-3D to your specific needs and conditions. A good understanding what to do and why will lead you to more finds.

If you can't wait any longer, and you're an experienced detector user, here's some quick instructions to get you going:

1. Set all the controls to the red numbered “Turn-On-And-Go” marks:

GROUND = 5

DISC = 4

SENSITIVITY = 3

MODE = ENHANCE

VOLUME = 5

This puts you in a “coins-only” mode and you're ready to start searching. Keep in mind that the GROUND setting of 5 is probably not the optimum setting for the ground you're searching and that's why the sensitivity level is set low—to reduce false signals caused by ground mineralization.

2. If you're using headphones, adjust the volume controls for a comfortable volume when the coil is passed over a large shallow object.
3. Walk slowly, overlap your sweeps and keep the search coil moving. Remember you are in a “motion” search mode and the coil must be moving at least slightly to detect a target.
4. When you get a good, repeatable signal, pinpoint the target by placing the coil on the ground away from the target, pushing and holding the pinpoint button and then bringing the coil back over the target.
5. Once you've pinpointed the target, note the approximate depth reading on the meter, then identify it by releasing the pinpoint button and moving the coil side to side in short strokes over the target. The meter needle will lock onto the appropriate target classification.
6. Happy Hunting!

SETTING UP

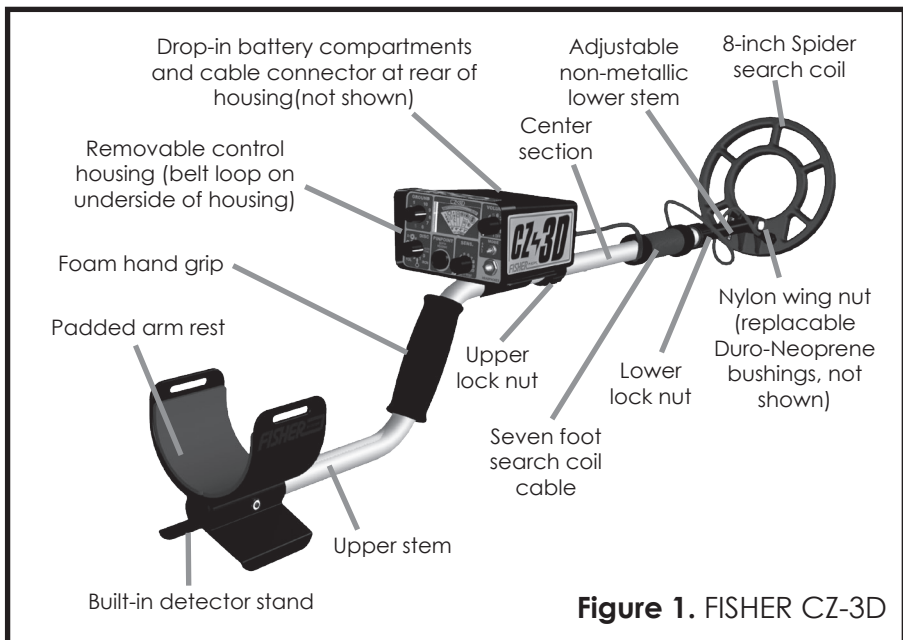

The CZ-3D comes to you just about ready to use. Take a look at the diagram above and familiarize yourself with the parts of the CZ-3D before proceeding.

1. Unpack your new CZ-3D carefully. Save the carton and inserts for future storage or shipment.
2. Take a look inside the locknut on the upper stem. Note the clear plastic locking pad on the left hand side and loosen the lock nut by rotating it fully counterclockwise.
3. Slip the lower stem into the center section.
4. Adjust the stem length (using the guide pin & stem lock nut) and the coil angle (using the nylon wing nut) so the search coil rests flat on the ground about 6 inches in front of, and slightly to the right of your right foot, (to the left of your left foot for left handers). Your arm should be straight and relaxed, with the grip held loosely.

REMEMBER: The longer the shaft, the more you will have to bend your elbow and the sooner your arm will get tired. The CZ-3D is balanced for comfortable searching in a tight semicircle around the front of the operator.

SETTING UP

5. With the stem length properly adjusted, wrap the loop cable tightly around the center section stem and secure it with the two Velcro straps. Connect the cable connector to the control housing.

CAUTION: Make sure that the cable is not pulled tight at the control housing and that you have enough slack at the search coil to adjust it to any angle.

6. With the shaft length and coil angle properly adjusted, you should be able to move into your “search” position (as shown in illustration below) by leaning forward very slightly and raising your arm (still straight) until the search coil is about 2 inches above the ground and 12 inches in front of your foot. The search coil should be parallel to the ground and may have to be slightly readjusted at this point.

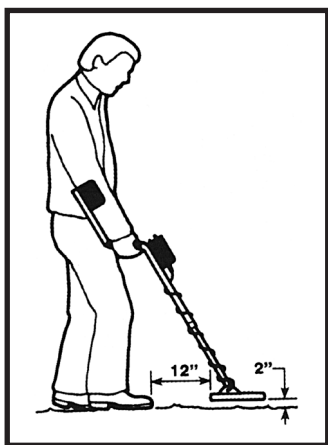

Figure 2. SEARCH POSITION.

Adjust the stem length and coil angle so the coil rests flat on the ground about 6 to 12 inches in front of your foot. Move into your “search” position by leaning forward slightly and raising the coil about 2 inches off the ground. This should put the search coil out about 12 to 18 inches in front of your foot.

HIPMOUNTING

1. Disconnect the cable from the control housing and unwind all but the last twelve inches from the stem. Secure the lower end of the cable with a Velcro strap at least twelve inches up from the coil.
2. Slide the control housing off the handle by holding the handgrip with one hand and pulling the housing towards you with the other hand.
3. Reconnect the cable to the control housing. *It is especially important that the cable connector be installed tightly to prevent false signals during hipmount use. Tight, but never tightened with anything but your hands.*
4. Put your belt through the slots on the underside of the housing.
5. Left handers should wear the housing on their right hip and right handers on their left hip.

NOTE: If you're working in shallow water you may want to hang the control housing around your neck or chest-mount with Fisher's Chest Harness. Just make sure you put it in a heavy plastic bag sealed tightly around the cable. Remember, the only thing waterproof about the CZ-3D is the search coil.

CONTROL PANEL

1. **GROUND:** Used to electronically cancel the effects of ground mineralization. Proper use of this control will minimize false ground signals and insure that the CZ-3D is operating at its maximum potential in just about any ground condition including wet ocean sand.
2. **DISC:** In the 0 through 6 position the CZ-3D is in the target ID mode, which is a silent, no-threshold, motion-discrimination mode of operation with the ability to identify and then ignore ("reject") or accept many kinds of small metal targets. In the AUTOTUNE position, the CZ-3D is in an all-metal mode. In this mode, the CZ-3D has a wider and deeper search pattern, however, it lacks the ability to discriminate

CONTROL PANEL

or identify targets.

- 3. PINPOINT/DEPTH READING:** A three purpose, spring loaded push-button. When pushed and held, the CZ-3D goes into a no-motion, all-metal mode for precise pinpointing and approximate depth reading of coin-sized targets. This button is also used in conjunction with the GROUND control during the ground balancing procedure.
- 4. SENSITIVITY/BATT TEST:** In the extreme counter-clockwise position, the battery condition is checked as indicated by a strong or weak tone and a meter reading. When rotated clockwise, sensitivity to targets (as well as ground mineralization and electrical interference) is increased. When in the AUTOTUNE mode, this control also acts as a “threshold tone” control.
- 5. HEADPHONES:** This connector accepts most stereo headphones.
- 6. MODE:** ENHANCE position for dry land or shallow fresh water hunting. SALT position for wet-sand ocean beaches or hunting in shallow surf.
- 7. VOLUME/OFF:** Power on-off and volume control. Volume is gradually increased from 1 to 5 settings. From 5 to 10, loud target depth response is held constant while faint targets continue to get louder (audio boost).

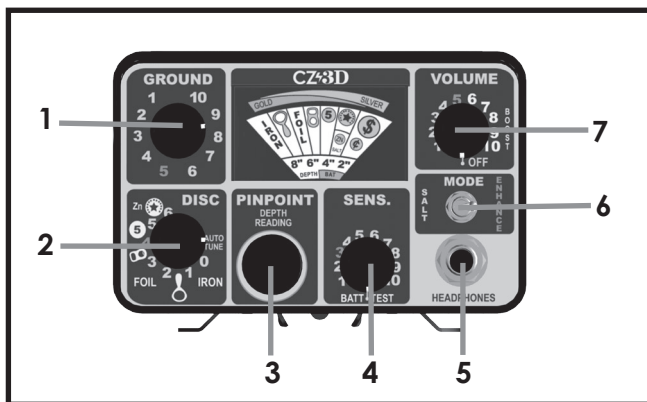

Figure 3, CONTROL PANEL

TURN ON PROCEDURE

1. Set your controls as follows:
 - GROUND = 10**
 - DISC = 0** for normal use in target ID mode. (Set DISC to “Auto tune” for deep search, all-metal Auto tune mode.)
 - SENSITIVITY = 10**
 - MODE = ENHANCE**
 - VOLUME = OFF**
2. Hold the search coil waist high, away from any nearby metal.
3. Turn the VOLUME control to 10. A brief bell tone is normal when you turn the VOLUME control on. If you're in the Auto tune Mode, you'll hear an audio “threshold” hum. Lower the SENSITIVITY control until you can just barely hear it.
4. If you're wearing headphones, reduce the headphone volume controls to a comfortable level when the search coil is passed over a large, shallow target.

GROUND BALANCING

When your CZ-3D is properly “ground balanced,” it will have only a minimum response to ground mineralization. Precise adjustment of the ground control is critical. The higher the degree of ground mineralization or sensitivity setting, the more critical it is. Once you adjust it in either the Autotune mode or Target ID mode, you can switch back and forth between the two modes without resetting it, *unless you increase the sensitivity level or go from dry sand to wet sand or vice versa*. You should also recheck your setting occasionally as you search since ground conditions often change rapidly.

If you have difficulty ground balancing, try reducing your sensitivity level or moving to another spot just in case you are over a buried piece of metal. In some areas of high ground mineralization you may not be able to use the “pushbutton” method.

“PUSHBUTTON” GROUND BALANCE METHOD

This will probably be your method of choice in all but the most difficult of ground conditions. It's fast, easy and accurate. You can use this method in either the Autotune or Target ID mode.

1. With your controls set as in the “Turn-On” procedure, (GROUND control at 10), hold the search coil parallel to and 6 to 12 inches off the ground. Press the PINPOINT button and hold it until you've completed step 2. Make sure you're at least three feet away from any metal objects.
2. Still pressing the PINPOINT button, lower the coil to the ground. Starting at 10, rotate the GROUND control clockwise until you hear an audio tone. Then back it off to the exact point where the tone disappears. Release the PINPOINT button and you're ready to search.

NOTES:

1. If you get an audio response as you first lower the coil with the GROUND control at 10, you're probably over a piece of metal. Move and try again.
2. If you get a sudden belltone not preceded by an increasing audio response as you lower the coil, you're probably in some very highly mineralized soil or sand. In this case, it's best to use the “Bobbing” method.
3. If you don't get any audio response, or just a very faint one as you rotate the GROUND control from 10 all the way to 0, you're probably in an area where there's very little ground mineralization. Just leave the GROUND control at 10 and begin searching.
4. Recheck your ground balance occasionally and make sure you haven't accidentally moved the MODE switch.

“BOBBING” THE SEARCH COIL METHOD

This method takes a little more practice, but you may find it slightly more accurate with fewer false signals from ground minerals.

"BOBBING" THE SEARCH COIL METHOD

1. Set as in the "Turn-On" procedure, making sure the DISC control is at AUTOTUNE and the SENSITIVITY control is set so you can just barely hear a threshold hum. Hold the search coil parallel to and 6 to 12 inches over the ground and at least three feet away from any metal objects. *Do not use the PINPOINT button during any part of this procedure.*
2. Lower the coil to an inch or two above the ground and then quickly raise it. Note that as you lower the coil, the tone disappears, then gets louder as you raise it and finally returns to normal when you stop it 6 to 12 inches above the ground. *Conversely, if you set the GROUND control to 1, the threshold hum will get louder as you lower the coil and disappear when you raise it.*
3. Your objective now is to adjust the GROUND control so that there is no change, or only a minimum change in the threshold hum, as you move the coil up and down. Start by lowering the GROUND control to 9. Lower the coil and raise it again. One of three things will happen to your threshold hum:
 - A It will fade again as you lower the coil and increase as you raise it. Continue to lower the ground balance setting in small increments until the threshold hum remains the same (or changes very little) as the coil is lowered and raised.
 - B It will get louder as you lower the coil and go silent as you raise it. Increase the ground balance level (rotating the control counterclockwise) in small increments until there is little or no change in the threshold level.
 - C The hum will remain the same, or if it changes slightly, the change is the same whether you lower or raise the coil. Your CZ-3D is properly ground balanced, and you are ready to begin your search. You have gone past the correct ground balance setting.
4. With a little practice, you should be able to ground balance quickly by "bobbing" the coil up and down in a continuous movement as you adjust the GROUND control with your thumb.

“BOBBING” THE SEARCH COIL METHOD

NOTES:

1. If you get an audio response as you first lower the coil with the GROUND CONTROL at 10, you’re probably over a piece of metal. Move and try again.
2. If you get a sudden bell tone, not preceded by an increasing audio response, you’re probably in some very highly mineralized soil or sand. Instead of lowering the coil to an inch or two above the ground as in step 2 above, stop just before you hear the bell tone and ground balance as instructed. It will then be necessary to maintain that coil height as you search.
3. If you don’t get an audio response, or if the hum stays the same no matter where you set the GROUND controls as you bob the coil up and down, you’re probably in an area where there’s very little ground mineralization. Just leave the GROUND control at 10 and begin searching.

SEARCH MODES

Your CZ-3D has two search modes: 1) Target ID or 2) Autotune. Both search modes are “motion” modes, meaning the search coil must be in motion to detect a target.

AUTOTUNE SEARCH MODE

Set the DISC control to Autotune for a very sensitive, wide-scan, all-metal, motion search mode. Since this mode responds to all metal targets and does not have the ability to identify or reject targets, this will probably not be your normal search mode.

The Autotune mode does have some advantages however which make it useful to use in at least two situations:

- 1. Non-Trashy Areas.** Since the Autotune mode has a wider scan than the ID mode, you're less likely to miss a good target when using it. Search in the Autotune mode until you find a target. Pinpoint the target using the PINPOINT button and then switch the DISC control to "0" to identify it. The DISC control is positioned so that you can switch back and forth between Autotune and "0".
- 2. Highly Mineralized Soil or Sand.** The Autotune Mode is recommended for black or gray sand beaches or highly mineralized soil. Under these conditions it may be necessary to lower the sensitivity level and sweep several inches off the ground. Gold nuggets are generally found in highly mineralized soil so this will be the search mode of choice for prospectors.

TARGET ID SEARCH MODE

When the DISC control is set in the 0 through 6 position, the CZ-3D has the ability to identify many types of small targets and, depending on the discrimination level, reject or ignore most of them. To better understand just how your CZ-3D responds to different targets, try the following:

- 1.** Scatter some sample targets such as coins, rings, pull tabs, nails and foil on the ground at least 18 inches apart. Include some large targets as well; jar lids, soda cans, etc.
- 2.** Set the DISC control at "0", SENSITIVITY at "5", MODE at 'ENHANCE', VOLUME at "10". If you're wearing headphones, reduce the volume to a comfortable level when you are over a large target.
- 3.** Ground balance the CZ-3D as in the "Ground Balance" procedure.
- 4.** Hold the search coil about two inches above and parallel to the ground and move it slowly back and forth across each sample. Remember, the coil must be in motion to

- get a response. Keep in mind that for accurate target ID, the coil center must pass directly over the target.
5. Note the response you get over small targets. For small iron or steel targets, the meter needle will usually lock in the "IRON" category. Most pull tabs, foil, nickels and the newer zinc pennies will also be correctly classified. Silver coins, copper coins, and the newer clad coins will ID in the highest category.
 6. Note that an elongated ferrous object such as a nail will give you a double "beep" as you cross it from end to end and a single "beep" if you cross its center.
 7. Most silver rings will ID at the highest end of the scale. If you have enough gold rings you will note that some fall in the round tab category, some in the "FOIL" category, some in the square tab category, a few in the nickel category, and very few in the remaining coin categories. This is due to the fact that the combination of size, shape and conductivity of a particular ring will almost always add up to a target that is electronically identical to either a piece of foil, pull tab or nickel. Most metal detectors have a difficult time separating gold rings, nickels, tabs, and foil, but, the patented circuitry of your CZ-3D can easily tell the difference between nickels and most trash. Better yet, it will allow you to find many types of gold rings while completely ignoring at least some types of pull tabs and small pieces of foil.
 8. Note also the different audio responses:
 - a) an iron target will give you a low tone
 - b) foil a mid low tone
 - c) tabs a medium tone
 - d) coins a high tone.
 9. When you go over a large, shallow target the CZ-3D will respond with a distinctive belltone. This is due to the fact that metal detectors can only identify small targets. What usually happens is that the detector circuits will overload and identify a large target as "good" (silver, coin, etc.). Your CZ-3D, however, will alert you to the fact that the target is big and shallow and can not be accurately identified. Big deep targets, however, will usually be classified as a coin. Also, be aware that large coins on

the surface may set off the bell tone. The optional, smaller 5 inch coil is more likely to overload than the standard 8 inch coil.

10. You may also note that some square tabs ID as round tabs and vice versa. Because of the wide variety of sizes, shapes and conductivity of the many pull tabs manufactured over the years, there is overlap as far as identification goes. Small pieces of tabs or aluminum are often misidentified. The tail of a round tab for example, may ID as a nickel. However, most tabs and most of the items on the CZ-3D meter face will be identified correctly.
11. Now increase the DISC control to "1". You will find that the CZ-3D rejects the small iron targets and no longer responds either with an audio tone or needle deflection.
12. Continue to increase your DISC control, noting that with each successive step up you reject more and more targets. At DISC = 4 for example, you are in a "coins-only" mode, ignoring iron, tabs and foil while accepting and identifying most nickels, zinc pennies and silver, clad and copper coins.
13. At the maximum DISC level of 6 the CZ-3D will ignore most all-small targets except silver, clad, zinc and copper coins.
14. Now switch the DISC control to the AUTOTUNE position and note the completely different kind of response. No tone or meter identification, just a solid, smooth, response over every target.
15. The chart on page 14 shows some of the responses you may expect over different targets and at different levels of discrimination. As you progressively increase the discrimination level, you eliminate more and more targets.

NOTE: Due to the virtually infinite variety of sizes, shapes and alloys of many "good" targets (relics, jewelry, foreign coins, etc.), they may be misidentified. For example, a Civil War mini ball may be identified as foil, or a new Canadian coin as a rectangular pull tab.

SEARCH MODES

FIGURE 4. TYPICAL CZ-3D AUDIO AND METER REPOSSES.

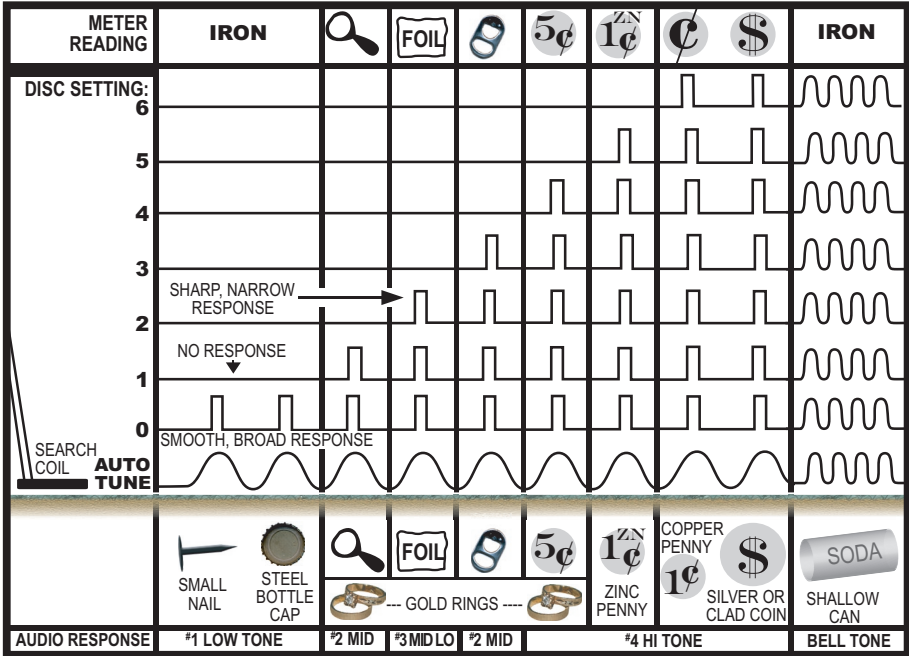

SEARCH MODES

SUPPLEMENT A. TOM DANKOWSKI'S "ENHANCED" ID CHART

- "REAL WORLD - OTHER" = Probable reading of what all other detectors will ID the specified target as in real dirt.
- "REAL WORLD - CZ-3D" = Most probable reading on the CZ-3D in 'enhance' mode.

• TARGET/REAL WORLD

"REAL WORLD OTHER"

"REAL WORLD CZ-3D"

• Dirt exposed Indian Head Cent

Trash /mid-tone

High-Tone

• 1857-1864 White (nickel) Cent

Square-Tab/mid-tone

Square-Tab

• U.S. 3-Cent Silver

Trash/mid-tone

High-Tone

• U.S. Half-Dime; real dirt scenario

Trash/mid-tone

High-Tone

• Silver Dime or Quarter; partial masking

Trash/mid-tone

High-Tone

• Shield Nickel & 'V' Nickel; no/slight corrosion

Trash/mid-tone

High-Tone

• Buffalo Nickel; mild corrosion

Trash/mid-tone

High-Tone

• \$2.50 Gold Quarter-Eagle

Round-Tab/mid-tone

Square-Tab

• \$5.00 Gold Half-Eagle

Trash/mid-tone

High-Tone

• \$10.00 Gold Eagle

High-Tone

High-Tone

• \$20.00 Gold Double-Eagle

High-Tone

High-Tone

• Many Non-U.S. Coins

Trash/mid-tone

High-Tone

Noteworthy: The older nickels that would previously read as a 'mid-tone/foil ID' should now read as a 'high-tone/nickel ID'. All other items in this list will now read 'high-tone' audio with either a 'zinc cent' or 'high coins' meter ID. This is due in part to infinite variables such as ground mineralization, multiple targets in close proximity, tilted coins, coins on edge or a combination thereof. Happy "Enhanced" Hunting, Thomas J. Dankowski

SEARCHING

Good search techniques are as important to your success as having a good detector.

1. Make sure your CZ-3D is properly ground balanced and the MODE switch is in the proper position: SALT for wet ocean beaches, ENHANCE for just about every other situation.
2. Decide which search mode you're going to use, Target ID or Autotune. *Recommended starting point: Target ID mode with the DISC control set at "4".*
3. Set your SENSITIVITY control. Only experience will tell you how to set it in every situation but you'll probably want to run it as high as you can. *Recommended starting point: SENSITIVITY 5 . If you're in the Autotune mode, set it so that you can just barely hear a slight audio hum.*
4. Adjust your VOLUME control. Remember that a setting above 5 will amplify the response of faint targets so they sound like a shallow or large target. Some searchers prefer not to use it above 5 so the audio response will give them some idea as to the depth and/or size of the target. *Recommended starting point: VOLUME = 10. If you're using headphones, adjust the headphone volume controls for a comfortable, not-too-loud response over loud targets.*
5. Once you've got your controls properly set, begin your search by walking slowly and sweeping the search coil in a tight semicircle.
6. Keep the coil parallel to the ground and as close to the ground as practical. This is extremely important for maximum coverage and depth. If you're searching on a lawn, you may set the coil right on the grass and slightly "scrub" it.
7. Overlap your sweeps by at least 50%. Remember that your coil's search pattern is conical and if you don't overlap each sweep you'll miss the deeper targets.
8. Search in a methodical manner. Pay close attention to where you're going and where you've been.
9. Keep the search coil moving at a comfortable rate. Remember that the CZ-3D is a motion detector and responds only when the coil (or the target) is moving (except in the Pinpoint mode).
10. Take your time. If you walk too fast you can't overlap your sweeps and you'll miss a lot of ground. If you swing your coil too fast you lose some sensitivity to deep and/or small targets.
11. Figure 7 on the next page shows the CZ-3D search coil pattern and how it is affected by sweep speed, ground mineralization and search mode.

SEARCHING

Figure 5. SEARCH PATTERN.

When the stem length is properly adjusted, the CZ-3D is balanced for sweeping in a tight semicircle. Wide to the right for right handers. Wide to the left for left handers. Be sure to overlap your sweeps.

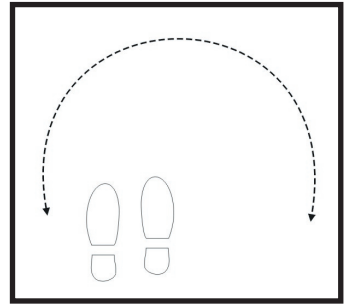
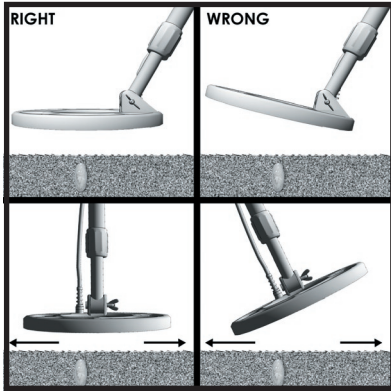
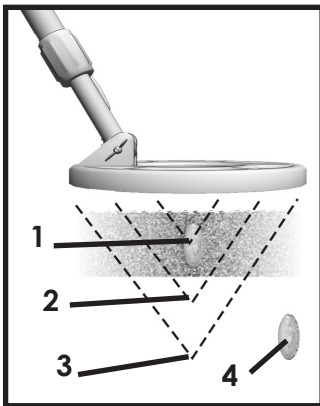

Figure 6. COIL ORIENTATION

Keep the search coil parallel and close to the ground at all times.

Figure 7. SEARCH COIL DETECTION PATTERN



1. Minimum Depth
 - a. Very slow or fast sweep speed.
 - b. Discrimination set at "6."
2. Good Depth
 - a. Moderate sweep speed.
 - b. Discrimination set at "4."
3. Maximum Depth
 - a. Moderate sweep speed.
 - b. Discrimination set at "0."
4. Missed Target
Many targets within range will not be detected unless you closely overlap your sweeps.

NOTE: Unlike other metal detectors, the discrimination level has little if any effect on the depth capability of the CZ-3D. Note however, that the all-metal, Autotune mode has a wider search pattern and may detect a little deeper. Depth is also determined by the size, shape and conductivity of the target as well as the sensitivity setting of the CZ-3D.

PINPOINTING

PUSHBUTTON PINPOINT MODE

Target location is quick and easy using the push-button Pinpoint mode. You do not have to keep the coil moving to get a response in this mode.

1. Once the presence of a target is indicated by the “beep-beep” of your CZ-3D, simply move the coil away from the target area, and with the coil lightly on the ground or very close to it, press and hold the PINPOINT button. It doesn't matter which mode you're searching in, Autotune or Target ID.
2. As you bring the coil back into the target area, still pressing the PINPOINT button, the audio volume and pitch will increase and the meter needle will swing to the right.
3. When the needle, pitch and volume are at their highest points, stop the coil and move it forward and backward a couple of times, again stopping over the strongest response.
4. Repeat one more time, side to side and then front to back, keeping the PINPOINT button pushed in and stopping over the spot where you get the maximum volume, pitch and meter reading. Your target should be directly below the center of your search coil. With a little practice, you'll find that you don't even need to look at the meter unless you want a depth reading.

NOTE: For quick and accurate pinpointing of strong signals from large or shallow targets, push and hold the pinpoint button with the coil very close to the approximate target area. This will “tune-out” most of your target so you will receive a response directly over it. You may also try reducing the sensitivity level and/or raising the coil so you can barely hear the signal.

For very weak signals, make sure you press the PINPOINT button with the coil completely out of the target area. You may also try moving the coil closer to the ground or increasing the sensitivity and volume levels.

TARGET ID AND AUTOTUNE MODES

Pinpointing in either of the search modes is difficult and requires practice. but with practice you should be able to get the hang of it. Many CZ-3D operators don't even bother with the Pinpoint mode unless they want a depth reading.

In Target ID or Autotune, simply use the same basic procedure for the Pinpoint mode, moving the coil side to side and front to back over the target area, stopping over the strongest audio response. The only difference is that you should use as short a stroke as possible (4 to 6 inches is plenty). When you stop the coil, you will lose the audio signal. You **MUST** keep the coil moving at least slightly, to determine the location of the strongest signal.

TARGET IDENTIFICATION

Target ID with the CZ-3D is quick and simple. Just keep in mind these four rules:

- A.** You must be in the Target ID mode. If you're searching in Auto tune, switch over to "0" on your DISC control.
- B.** For accurate identification, the center of the search coil must pass directly over the target.
- C.** There are many good targets, which are not classified by the CZ-3D. As mentioned earlier, gold rings for example may fall in just about any category except iron. Gold nuggets, depending on their size and shape, may fall into just about any category, the smaller nuggets falling on the lower half of the scale. So if you're not just looking for U.S. coins, you should test some sample targets to determine what level of discrimination you want to work at and what targets you want to dig.
- D.** Your CZ-3D will correctly identify most small targets most of the time, but it can be fooled. Large targets, uneven ground mineralization, a good target lying next to a bad target, and deep targets, are sources of error.

Remember, the CZ-3D is designed to ID small, coin size targets only, and even some of these may be deep, bent, damaged, or corroded enough to give a false signal.

TARGET IDENTIFICATION

1. Once you've located a target, pinpoint its exact location as in the "Pinpointing" procedure. *Since accurate ID is dependent on accurate pinpointing, it is recommended that you always press the PINPOINT button rather than try to pinpoint your target in either the Autotune or Target ID mode.*
2. Once you've pinpointed your target, release the PINPOINT button. If you're searching in the Autotune mode, switch over to DISC = 0. If you are already in the Target ID mode, just leave the DISC control where it is.
3. Move the coil just enough, left-right-left, across the target to get a good signal. The meter needle should lock onto a target classification, which in turn will agree with the audio response (one of 4 tones)
4. If you no longer get a meter reading or audio response once you've pinpointed the target, then you're over something that falls below the DISC setting you've chosen and the CZ-3D is rejecting it.
5. Here's a quick and easy way to tell the difference between a small shallow piece of foil and a gold ring (or other possibly good target) without digging: if you get a good solid, "FOIL" ID, set the search coil down close to the target and then whip it *rapidly* across the target just once with what can best be described as a flick of the wrist. If the target disappears, it's probably a small shallow piece of foil. If not, dig it up—it could be that gold ring you're looking for. Practice this over some foil until you get the hang of it.
6. Don't be afraid to turn your sensitivity down. True, the higher the sensitivity, the deeper your CZ-3D will go and the more you'll find. But that's only under optimum conditions. If you're getting a lot of false signals caused by electrical interference, ground mineralization or dense trash, lower your sensitivity. If you have to back it down to 4, 3 or even 2 to eliminate the falsing, do it. That's what your SENSITIVITY control is for. You'll be surprised at how much you might find in an area that would otherwise be unsearchable at high sensitivity levels.

TARGET IDENTIFICATION

7. Set your discrimination at an appropriate level. If there's very little trash in the area, set it low, say at iron discrimination and dig every good signal. If there is a lot of trash present and you're mainly interested in coins, set the discrimination level high—you may even want to sacrifice nickels and zinc pennies in extremely trashy areas. If you're looking for gold rings, relics, artifacts, or small ancient coins, you'll have to set your discrimination level low. The best way to find out how low is to bury some sample targets or just dig everything for awhile until you get a feel for which target classifications will be the most productive.
8. Look for repeatable signals and don't waste time on disappearing or one-way signals. If you hear a good beep but can't repeat it when you go back over the target area, or if it beeps in only one sweep direction, it's probably a piece of trash—something below your discrimination setting.
9. If you're in a relatively non-trashy area, try searching in the Autotune mode and then identify your targets by switching to DISC = 0. You'll find more and deeper targets this way.
10. If you're having any difficulty pinpointing or identifying a target in the ID mode, don't waste any more time. Push the pinpoint button for quick pinpointing then release it for accurate ID.
11. If your target disappears when you go into the Pinpoint mode, you've probably tuned it out by pressing the button too close to the target or over another piece of metal. Try again, this time pushing the PINPOINT button over another piece of ground.
12. Don't waste a lot of time digging holes for targets you can't find if your hole keeps getting deeper and wider, cover it up and go on. You may be over a buried pipe or some other large deep target.

DEPTH READING

Your CZ-3D will give you a quick and approximate depth reading of coin-size targets, usually within an inch.

1. Place the search coil lightly on the ground at least twelve inches away from your target area.
2. Press and hold the PINPOINT button.
3. Still pressing the PINPOINT button, bring the coil back over the target and pinpoint its location by stopping the coil over the point where you get maximum pitch, volume and needle response.
4. Place the search coil lightly on the ground directly over the target, and still pressing the PINPOINT button, note the position of the needle over the depth reading scale. For example, if the needle is midway between the four inch and six inch marks, your target is approximately five inches deep.

You will quickly realize that the depth reading procedure is just like pinpointing, however there is one very important difference: When pinpointing, where or when you press the pinpoint button is not real critical. It is often desirable to “detune” your target by pressing the button when the search coil is very close to your target and either on the ground or slightly above it. When taking a depth reading, however, it is important that the coil be placed lightly on the ground at least twelve inches away from the target (or any other metal) before pressing the PINPOINT button. Also, remember that while you can pinpoint just about any size target, depth reading is only accurate for coin size targets.

TARGET RECOVERY

Once you have identified and pinpointed a target, your objective is to recover it quickly and neatly, leaving virtually no trace of your excavation. There are almost as many ways to do this, as there are treasure hunters. Whatever works for you is good enough as long as you don't break any laws, damage vegetation, or leave uncovered holes. Generally speaking, beachcombers do little if any damage to the environment while recovering targets. However, if you plan to use your CZ-3D on lawns or in parks, your target recovery method can be very important. Two of the most successful methods are illustrated in a separate booklet "Origin of the M-Scope/Target Recovery" enclosed with your detector .

1. Use headphones. You'll hear fewer distracting sounds and more target sounds. And you'll find more.
2. It's always a good idea to walk slowly and overlap your sweeps. But if you're searching large expanses of new territory you may want to walk a little faster and not overlap your sweeps as much until you start making a few good finds. Then, slow down, overlap your sweeps and cover every inch of ground.
3. In trashy areas, to reduce the "masking" effects of trash on nearby good targets, use a shorter and slower sweep pattern. Also, the optional smaller 5-inch search coil will zero in on good targets closer to trash.
4. When in doubt, dig. If your CZ-3D can't quite decide whether a target is good or bad, dig it up.
5. Good things often come in twos. Or even threes. Once you've recovered a good target, always recheck the hole for a second signal and carefully search the immediate area by walking slowly around the hole two or three times, overlapping your sweeps in an ever widening circle. *Always dig every suspicious sound in the vicinity of a good find.*
6. Recheck your hole even if your find was trash. Good targets are often found beneath the bad ones.
7. Practice. Practice over known targets. Practice ground balancing. Practice pinpointing. Reread the appropriate part of this manual if you're having problems.

NOTE: *Whichever method you choose, remember that responsible treasure hunters take pride in their ability to leave soil and vegetation intact and undamaged.*

RECOVERY TOOLS

A heavy duty blunt screwdriver, sturdy hunting knife, or garden trowel are commonly used. Made especially for the Hobby of Metal Detecting are several well designed sand scoops, trowels, and digging tools . See your local dealer for more information.

FALSE SIGNALS

A "False Signal" occurs when something sounds like a good target, but is not. Your CZ-3D does a great job of discriminating, but bad "targets" with similar electrical characteristics can fool it. Large pieces of trash or items very close to the search coil will occasionally sound "good". Experience is the best teacher. As you accumulate more hours with your CZ-3D, you will soon learn how to distinguish "false signals". Initially when you pass over a target, and get a good response, you will find that crossing over the target once or twice more, the signal will break up or completely disappear.

The following are some sources of false signals and the solution:

- 1. Electrical Interference:** Caused by radio and TV towers, power lines, or other metal detectors.
SOLUTION: Move farther away from the source, slow down the sweep speed, or lower the sensitivity.
- 2. Highly Mineralized Soil:** Soils with a high iron or salt content.
SOLUTION: Reduce the sensitivity, raise the discrimination level or readjust the ground adjust setting..
- 3. Extremely Trashy Areas:** May result in a lot of "chatter".
SOLUTION: adjust the discrimination level or reduce the sensitivity. In some areas, a smaller coil will be beneficial to better achieve target separation.
- 4. Metal Interference:** The CZ-3D will pick up metal ABOVE and on the SIDE of the coil, as well as under. WATCH FOR: Large metal structures, your digging tool, metal in shoes and your coil cable hanging loose above the coil.

Figure 8. TARGETS THAT AREN'T THERE.

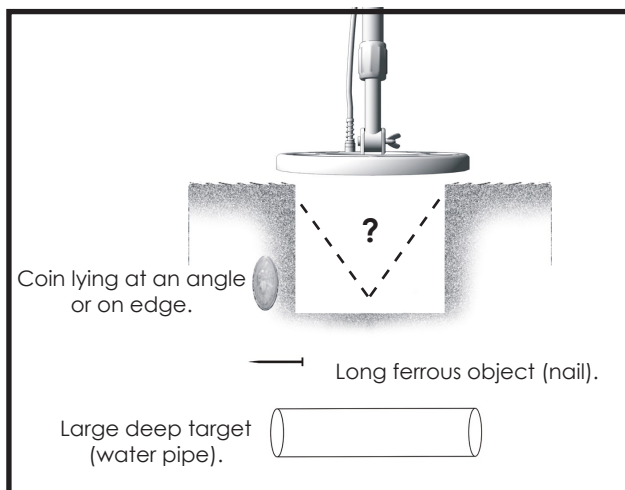

MAINTENANCE

Your CZ-3D doesn't require a lot of care. It's built with high quality materials but there are a few things you should do to keep it in peak operating condition.

1. If you're not going to be using it for a while, take the batteries out. Acid damage caused by leaking batteries can be severe.
2. Avoid extreme temperatures. Don't leave it inside a closed car sitting in the sun, or even worse, the trunk of a car.
3. If you "scrub" the search coil on the ground, you'll eventually wear through the bottom of the coil. Replacement coils are expensive. Instead, invest in a coil cover. They're cheap.
4. Keep your CZ-3D dry and clean. If you've been working in or around salt water or dust, wipe it down with a damp cloth and dry it with a hair dryer (low or no heat) or dry cloth. Remove and clean the lower stem. Keep the lock nut free of sand and dirt.

TREASURE HUNTERS' CODE OF ETHICS

LET'S PRESERVE OUR TREASURED SPORT!

Laws governing the use of metal detectors are becoming more and more common. In many countries, the use of metal detectors is illegal or severely restricted. Don't let this happen in your area.

ALWAYS get permission to hunt on private property.

ALWAYS leave a site cleaner than you found it. Take at least some trash with you or, if you can, take it all.

ALWAYS fill in your holes neatly whether you're in a city park or remote wilderness. Leave the land as it was before you disturbed it.

ALWAYS obey all laws relating to treasure hunting.

ALWAYS return valuable property if you can locate the original owner.

ALWAYS do whatever you can to give the hobby of treasure hunting the good image it needs and deserves.

BATTERY REPLACEMENT

Check your batteries frequently by clicking the SENSITIVITY control counter clockwise into the BATT test position. The condition of the batteries will be indicated in two ways:

- 1) An Audio Tone. The stronger the better. A loud, high-pitched tone indicates good batteries. A weak, low-pitched tone indicates weak batteries.
- 2) A Meter Reading. Replace the batteries when the needle falls below gray BATT area. Two nine volt transistor batteries are located in a compartment at the rear of the housing. Always replace both batteries at the same time. You may also use rechargeable Nicads but expect about 1/2 the battery life of an alkaline battery.
 1. Remove the battery door by loosening the two captive screws.
 2. Tilt the housing slightly and the batteries will slide out.
 3. Install the new batteries. Make sure the contact end goes in first and that you match the polarity markings on the battery door.

If either or both of the batteries are installed incorrectly, the CZ-3D will not turn on. The instrument will not be damaged.

4. Finger tighten the screws down snugly. Do not use a screwdriver or other hand tool.

Figure 9. BATTERY REPLACEMENT



SPECIFICATIONS¹

LENGTH²Extended.....51"
Collapsed³ 41"

WEIGHT²Complete..... 3.7 lbs
Control Housing..... 1.5 lbs
Handle and Coil..... 2.2 lbs

FREQUENCY
1. Multiple Frequency Transmit &
Dual, VLF Receive⁴5 KHz and 15 KHz
2. Target Response:
Iron ID.....200 Hz (LO)
Foil 350 Hz (MID LOW)
Tabs.....450 Hz (MID)
Coin ID..... 1 KHz (HI)
Auto tone 500 Hz -1 KHz (VCO)⁵
Pinpoint/Depth..... 500 Hz -1 KHz (VCO) ⁵

OPERATING MODES.....
Auto Tone - VLF-Motion⁶, all metal with threshold tone
Target ID - VLF Slow Motion⁶, silent search discrimination Meter.. Lock on 7
categories

PINPOINT/DEPTH VLF, all metal, no motion

BATTERIES
Drop-in, no wires..... Yes
Type Two, 9-Volt Alkaline⁷
Life..... 10-20 hours²

SPECIAL FEATURES.....
Manual Ground Adjust Yes
Manual Threshold Tuning..... Auto tune mode only
Wet Sand Operation..... Yes⁸
Handle Mount/ Hip Mount... Yes
Audio Output Jack Stereo Headphones(Optional)
Faint Target Audio Boost Yes⁹
Speaker Yes
Tone 4 tones plus bell tone for large shallow targets
Universal Arm Rest/Detector Stand

SPECIFICATIONS

SEARCH COIL.....
Type Concentric, Co-planar Spider Coil
Diameter 8"
Shielding 100% ESI⁰
Interchangeable Yes
Submersible..... Yes

WARRANTY2-Year Limited Warranty*

*Warranty may vary outside of the United States, see your dealer for details

OPTIONAL ITEMS.....
Coil covers, hard carrying case, 10 1/2" Spider coil, 5" search coil, carry bag, holster, Fisher phones, stereo phones

NOTES:

1. Subject to improvement or modification without notice.
2. Approximate.
3. The CZ-3D disassembles to fit into an optional carrying case measuring approximately 6" x 21" x 15".
4. The CZ-3D Fourier Domain Signal Analysis transmits multiple frequencies simultaneously and processes two received frequencies for deeper target ID in mineralized soil.
5. VCO: Voltage Controlled Oscillator. Volume and frequency increase as target is approached for pinpoint accuracy.
6. The CZ-3D is a motion detector in the AUTOTUNE and Target ID modes. The search coil must be moving at least slightly to detect a target.
7. For maximum performance and battery life, always use Alkaline Batteries.
8. Compensates for salt water and sand minerals simultaneously.
9. Volume control limits loud-target response, amplifies faint targets when level is set above 5.
10. ESI: Electro-Static Insulated to eliminate certain types of false signals.



Fisher Labs

• QUALITY •

Fisher detectors are renowned for their quality construction. In the Fisher tradition, each and every detector is hand crafted with pride.

• PERFORMANCE •

Since 1931, treasure hunters worldwide have relied on Fisher. Proven in the field durable, dependable, deeper.

• REPUTATION •

Dr. Fisher invented the first patented metal detector over 70 years ago. Today, Fisher continues to set the standard by which all detectors are judged.

• 2-YEAR LIMITED WARRANTY •

Fisher believes in the products we produce and backs this belief with a 2-Year Limited Warranty. Warranty may vary outside of the United States. See your dealer for details

• SERVICE •

Fisher is committed to providing you, our valued customer, with superior service. Each and every instrument is rigidly tested and carefully inspected during assembly and before shipment.

Should you have any questions or problems, contact:

FISHER RESEARCH LABORATORY

1465-H Henry Brennan,

El Paso, Texas 79936

Tel 915.225.0333 Fax 915.225.0336

www.fisherlab.com email:info@fisherlab.com