



Zastava
a f m s

EZ SERIES PISTOLS

9 mm, 40 sw, 45 acp

DESCRIPTION, HANDLING AND MAINTENANCE

Respected customer,

*The name **ZASTAVA** arms on the weapon that you now own means quality, reliability and gunsmith tradition since 1853. Your weapon was made in accordance with very strict requirements, of the highest quality materials used for this type of products and tested by our quality control.*

To be able to handle this weapon safely, you are obliged to read carefully and completely the Instruction manual. In case of any misunderstanding, please apply to your dealer or manufacturer for detailed explanations within shortest time.

If your weapon needs servicing, apply to one of the service shops authorized by your dealer. Do not send your weapon directly to the manufacturer, since this will unnecessarily prolong the time of servicing, while any service can be made very fast and with good quality in every service shop.

Thank you for choosing our product.

ZASTAVA ARMS



WARNING: BEFORE USING THIS FIREARM, READ AND FOLLOW THESE INSTRUCTIONS!

CAUTION: ALWAYS KEEP AND CARRY YOUR WEAPON EMPTY TO AVOID UNINTENTIONAL DISCHARGE.

WARNING: USE ONLY ORIGINAL HIGH QUALITY COMMERCIALY MANUFACTURED AMMUNITION IN GOOD CONDITION, WHICH IS APPROPRIATE TO THE CALIBER OF YOUR PISTOL.

READ CAREFULLY THE FOLLOWING PRECAUTIONS BEFORE TAKING THIS FIREARM OUT OF ITS PACKAGE.

This product is classified as a firearm or dangerous weapon; it is, therefore, potentially lethal!

WARNING: IF THIS FIREARM IS CARELESSLY OR IMPROPERLY HANDLED, UNINTENTIONAL DISCHARGE COULD CAUSE INJURY, DEATH, OR DAMAGE TO PROPERTY.

CAUTION: Your safety and safety of others depends on your compliance with these recommendations and proper handling with this weapon. Training and all additional information can be obtained in your local shooting clubs and similar organizations.

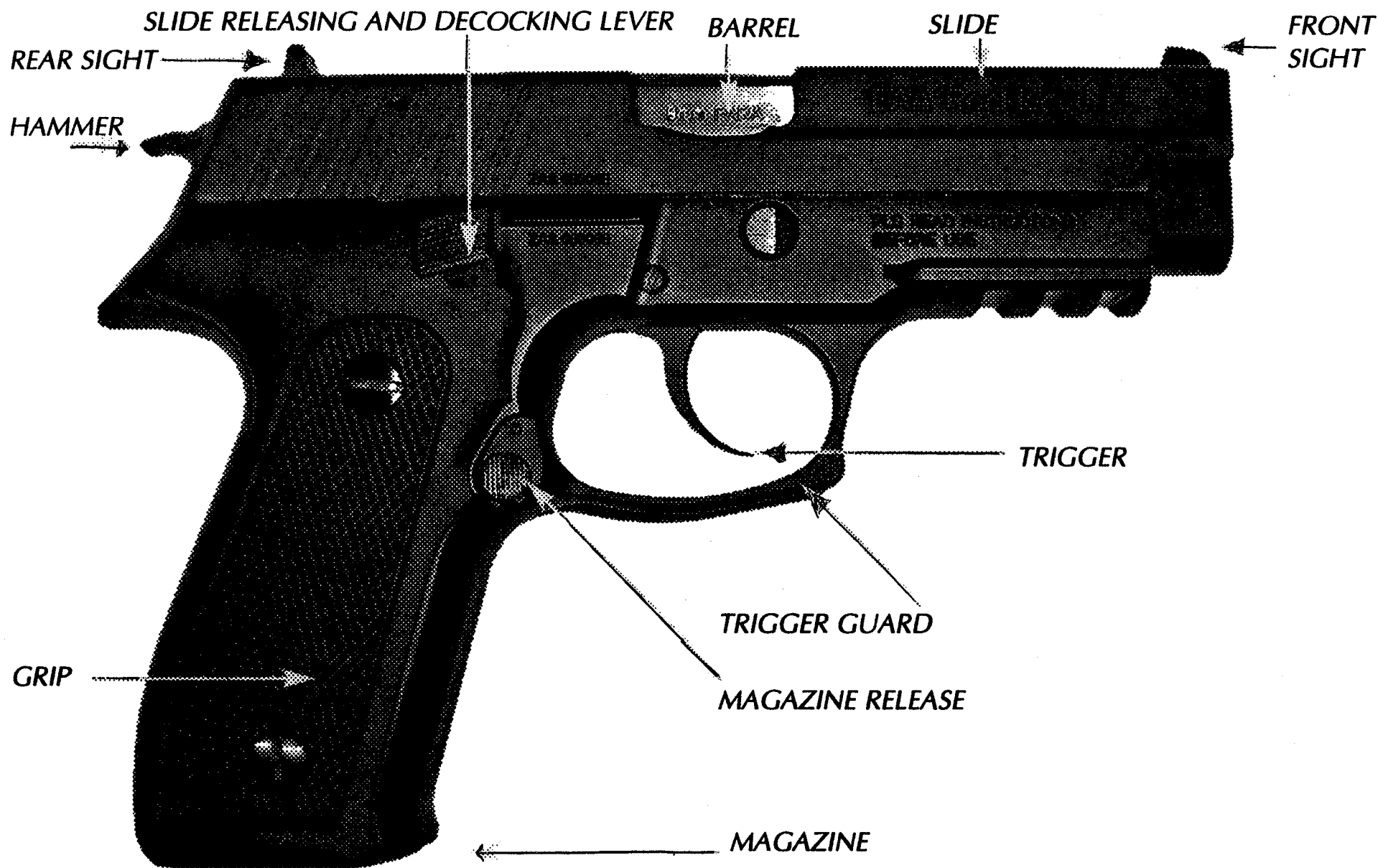

Fig. 1 EZ SERIES PISTOL - RIGHT SIDE

SECTION 1

SAFETY INSTRUCTIONS

We want you to enjoy safe shooting with your ZASTAVA weapon. You may be an experienced shooter, already familiar with the procedures in this Instruction manual, but we urge you to read this entire Instruction manual carefully. You must follow the safety instructions for your safety and the safety of others.

WARNING: ALWAYS CARRY YOUR WEAPON EMPTY IN ORDER TO AVOID RISK OF ACCIDENTAL DISCHARGE.

SAFETY MEASURES

1. ALWAYS HANDLE YOUR WEAPON AS IF IT WERE LOADED so that you never fire it accidentally when you think it is unloaded.

2. NEVER POINT YOUR WEAPON AT ANYTHING YOU DO NOT INTEND TO SHOOT so that if it fires accidentally, injury, death or damage to property will be prevented.

3. NEVER TAKE ANYONE'S WORD THAT A WEAPON IS UNLOADED, check it for yourself with fingers off the trigger and weapon pointed in a safe direction.

4. ALWAYS KEEP AND CARRY YOUR WEAPON EMPTY, WITH THE HAMMER FORWARD EXCEPT WHEN YOU INTEND TO SHOOT, SO THAT IT CANNOT BE FIRED WHEN YOU DO NOT MEAN IT.

5. NEVER DRINK ALCOHOLIC BEVERAGES OR TAKE DRUGS BEFORE OR DURING SHOOTING, as your vision and judgment could be seriously impaired making your weapon handling unsafe.

6. ALWAYS SEEK DOCTOR'S ADVICE IF YOU ARE TAKING ANY MEDICATION, to be sure you are fit to shoot and handle your weapon safely.

7. ALWAYS USE ONLY CLEAN, DRY, ORIGINAL HIGH QUALITY COMMERCIALLY MANUFACTURED AMMUNITION IN GOOD CONDITION, WHICH IS APPROPRIATE TO THE CALIBER OF YOUR WEAPON.

8. ALWAYS BE SURE THAT BARREL INTERIOR IS CLEAN AND THAT THE BORE AND THE MUZZLE ARE CLEAR OF OBSTRUCTIONS. Clean a fouled weapon immediately, so that it will function correctly and safely.

9. ALWAYS WEAR AND ENCOURAGE OTHERS TO WEAR EAR PROTECTION WHEN SHOOTING, especially on a range. Without ear protection the noise from your weapon and other weapon close to you, could leave ringing in the ears for some time after firing, while the cumulative long term effect could be permanent hearing loss.

10. ALWAYS WEAR AND ENCOURAGE OTHERS TO WEAR PROTECTIVE-SHOOTING GLASSES.

11. ALWAYS PUT A KNOWLEDGEABLE AND RESPONSIBLE PERSON IN CHARGE TO MAINTAIN SAFETY CONTROL WHEN A GROUP IS FIRING ON A RANGE. Obey his commands so that discipline is maintained to reduce the likelihood of accidents.

12. ALWAYS BE SURE YOUR BACKSTOP IS ADEQUATE TO STOP AND CONTAIN BULLETS BEFORE BEGINNING TARGET PRACTICE, SO THAT YOU DO NOT HIT ANYTHING OUTSIDE THE RANGE SHOOTING AREA.

13. ALWAYS BE ABSOLUTELY SURE OF YOUR TARGET AND THE AREA BEHIND IT BEFORE YOU SQUEEZE THE TRIGGER. A bullet could travel through or past your target. It has enough energy to cause unwanted consequences at large distances. If in doubt, do not shoot.

14. NEVER SHOOT AT A HARD SURFACE OR AT WATER. A bullet may ricochet and travel in any direction to strike you, or an object you cannot see, causing injury, death or damage to property.

15. NEVER FIRE YOUR WEAPON NEAR AN ANIMAL UNLESS IT IS TRAINED TO ACCEPT THE NOISE; an animal's startled reaction could injure it or cause an accident.

16. NEVER USE YOUR WEAPON IF IT FAILS TO FUNCTION PROPERLY, AND NEVER FORCE A JAMMED ACTION, AS A ROUND MAY EXPLODE CAUSING SEVERE DAMAGE TO YOUR WEAPON, SERIOUS INJURY OR POSSIBLE DEATH.

17. DURING SHOOTING ALWAYS KEEP YOUR HANDS AWAY FROM THE BARREL AND EXTERNAL MOVING PARTS OF THE WEAPON (CYLINDER, BOLT, BOLT CARRIER LEVER, SLIDE) SINCE THEY CAN BE HURT.

18. NEVER SQUEEZE THE TRIGGER OR PUT YOUR FINGER IN THE TRIGGER GUARD UNTIL YOU ARE AIMING AT A TARGET AND READY TO SHOOT. This will prevent you from firing the pistol when it is pointing in an unsafe direction.

19. IN CASE OF MISFIRE:

When the weapon fails to fire, keep holding it pointed toward the target or a safe open area and wait 60 seconds. If a hang fire (slow ignition) has occurred, round could fire within 60 seconds. If round does not fire, remove magazine, eject round, and examine primer. If firing pin indent on primer is light, off center, or non-existent, have the pistol examined by a competent gunsmith. If firing pin indent on primer appears normal (in comparison with similar previously fired rounds) assume faulty ammunition. Segregate misfired round from other live ammunition and empty cases, reload and carry on firing.

20. NEVER LEAVE YOUR WEAPON READY TO FIRE, SINCE THIS POSITION IS EXTREMELY DANGEROUS BECAUSE OF RISK OF ACCIDENTAL DISCHARGE CAUSING SERIOUS INJURY, DEATH OR DAMAGE TO PROPERTY.

21. KEEP THE WEAPON POINTING TOWARDS THE BACKSTOP WHEN LOADING, FIRING AND UNLOADING, TO ELIMINATE THE RISK OF INJURY, DEATH OR DAMAGE TO PROPERTY.

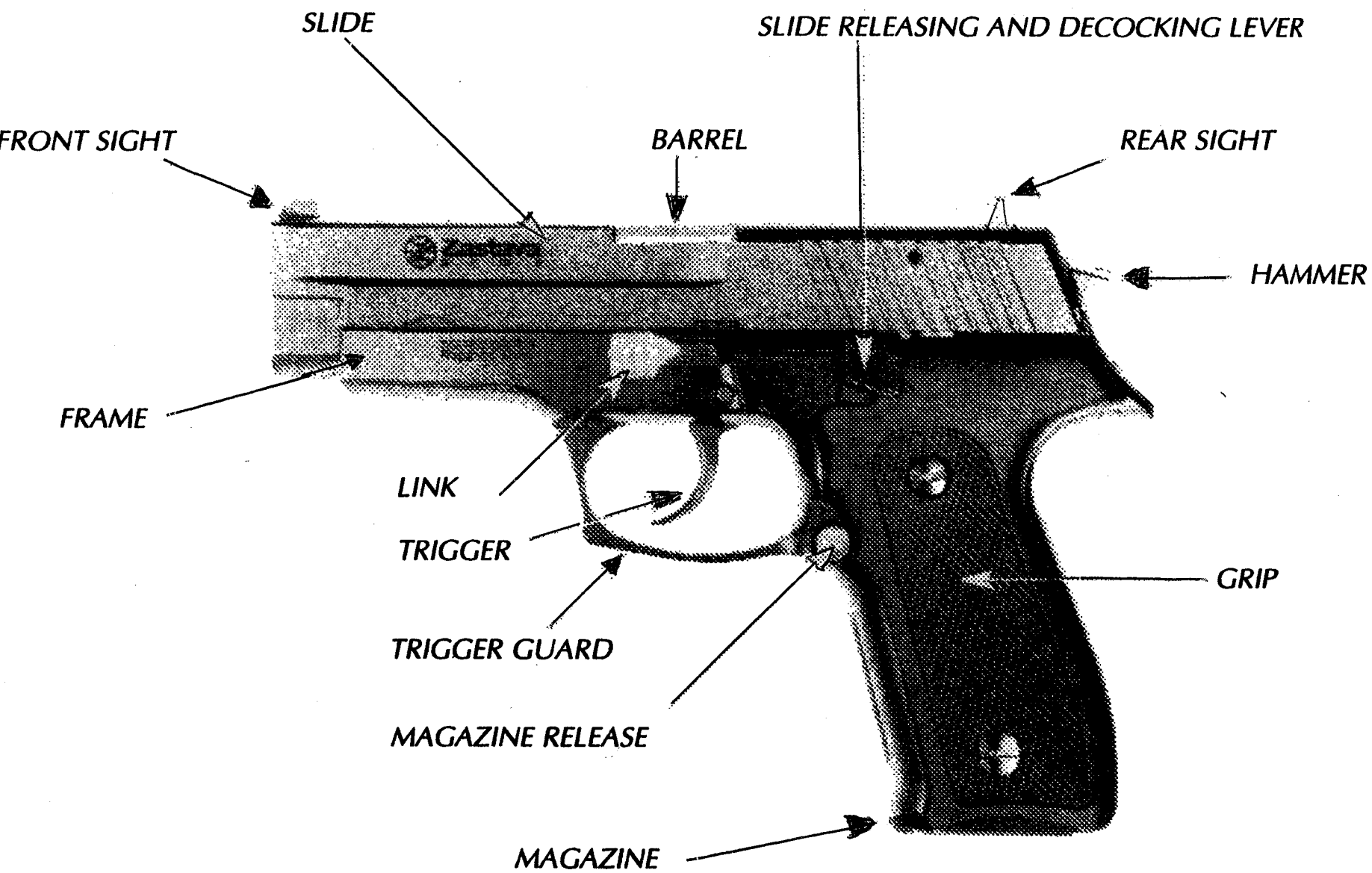

Fig. 2 EZ SERIES PISTOL - LEFT SIDE

22. NEVER LEAVE A LOADED WEAPON UNATTENDED. There is always a chance that someone will use it and cause injury, death or damage to property.

23. NEVER INDULGE IN HORSEPLAY WHILE HOLDING YOUR WEAPON AS IT MAY BE ACCIDENTALLY DISCHARGED.

24. ALWAYS INSTRUCT CHILDREN TO RESPECT FIREARMS. Keep your weapon out of reach of children. The training of all, including children (age determined by law), should be performed by authorized people in institutions equipped and authorized for that kind of activity.

25. NEVER WALK, CLIMB OR FOLLOW A COMPANION WITH YOUR WEAPON COCKED READY TO FIRE, OUT OF ITS HOLSTER, OR WITH HAMMER IN ANY POSITION OTHER THAN FORWARD ON AN EMPTY CHAMBER, TO ELIMINATE RISK OF ACCIDENTAL DISCHARGE.. Always hold your weapon so that you can control the direction of the muzzle.

26. ALWAYS MAKE SURE YOUR WEAPON IS NOT LOADED BEFORE CLEANING, STORING OR TRAVELLING, MAGAZINE REMOVED FROM IT, BEFORE YOU STORE IT OR TRANSFER IT TO SOMEBODY ELSE, SO THAT IT CANNOT FIRE ACCIDENTALLY.

27. ALWAYS KEEP AND STORE YOUR WEAPON AND AMMUNITION IN SEPARATE LOCKED RECEPTACLES, OUT OF REACH AND SIGHT OF CHILDREN AND UNTRAINED PEOPLE.

DISCLAIMER OF LIABILITY

The manufacturer shall not be responsible for injury, death, or damage to property resulting from either intentional or accidental discharge of this firearm, or from its function when used for purposes or subjected to treatment for which it was not designed. The manufacturer also will not honor claims involving this firearm which result from careless or improper handling, unauthorized adjustment or parts replacement, corrosion, neglect, or the use of wrong caliber ammunition, or the use of ammunition other than original high quality commercially manufactured ammunition in good condition, or any combination thereof.

IMPORTANT

Before it left the factory, this firearm was tested, carefully inspected and packaged. The manufacturer cannot control product handling after it leaves the factory, therefore, please examine this firearm carefully at the time of purchase to insure that it is unloaded and undamaged. This Instruction manual should always accompany this firearm and be transferred with it upon change of ownership.

SECTION 2 TECHNICAL CHARACTERISTICS

TECHNICAL DATA

EZ SERIES Pistol is a semiautomatic handgun, which operates on the barrel short recoil principle. Locking is achieved by vertical oscillation of the barrel, which enters a hole in the slide. Magazine is double row type with capacity of 15 and 10 rounds. Operating controls of the pistol enable its handling with either right or left hand - they are ambidextrous. Designer solutions make possible that the same operating controls have several functions. Sights are square with white spots, optionally with tritium powered inserts, for aiming at low visibility.

The pistol has some specific characteristics: mode selector, which is used for choosing the pistol or revolver type of operation, loaded chamber indicator and indicator for the last three rounds in the magazine.

EZ SERIES Pistol has not mode selector and indicator for the last three rounds in the magazine.

Caliber	9 mm Para / .40 S&W	
Barrel length	chrome plated	108 mm
Length	198 mm	
Height	140 mm	
Thickness over covers	34 mm	
Thickness over levers	42 mm	
Weight without magazine	831 g	
Magazine capacity	15 /10 rds	
Weight of empty mag.	94 g	
Weight with empty mag.	925 g	
Weight with loaded mag.	1100 g	
Trigger pull:	DA	4,5 daN
	SA	2 daN
Finish	optional (on customer's request)	

SAFETY FEATURES

EZ SERIES Pistols incorporate several positive safety devices, which, if properly employed, can minimize the danger of accidental firing.

Trigger Guard

Trigger guard is a semicircular part of the frame, which encircles the trigger and in that way decreases the possibility of its accidental squeezing during use.

Safety Stop on Hammer

The safety stop is a flat shelf-like surface on the hammer. It excludes a mistake during cocking of the hammer, preventing the hammer from falling fully forward unintentionally and disabling it to cause unwanted firing. It also prevents the hammer from striking the firing pin should your hand slip from the slide or hammer while cocking the pistol properly.

Decocking Lever

Correct use of decocking lever minimizes the risk of accidental discharge through mishandling by allowing the hammer to be decocked without touching the trigger. The decocking lever is

ambidextrous and it also has a function of retaining and releasing the slide from the rear position after the last round has been fired and during stripping of the pistol.

CAUTION: ALWAYS POINT PISTOL IN SAFE DIRECTION AND KEEP FINGERS CLEAR OF THE TRIGGER WHEN OPERATING DECOCKING LEVER TO LOWER THE HAMMER.
This will avoid accidental injury in the unlikely event of discharge.

Disconnect Function of the Trigger Lever

This safety device prevents a round being fired before the pistol is fully locked. When the slide is not fully forward, the disconnect, controlled by the recess on the slide, disconnects triggering system. When the pistol is fully locked, disconnect engages the triggering system.

CAUTION: NEVER ATTEMPT TO CHECK OR DEMONSTRATE THE DISCONNECTOR FUNCTION WITH A LOADED PISTOL. Putting the muzzle on your hand or on any other portion of the body is extremely dangerous and could result in accidental discharge causing injury, death, or damage to property.

Firing pin

The firing pin is placed in the slide and is held to the rear of its chamber by a spring. It cannot protrude through the face of slide unless a hammer blow overcomes the spring force and the inertia of the pin.

Firing Pin Lock

The firing pin lock engages the firing pin to prevent its movement until the trigger is squeezed. Housed in the slide, the firing pin lock is spring loaded down into engagement with the firing pin to prevent its movement. Squeezing the trigger moves the trigger lever forward. This safety device minimizes the risk of accidental discharge through mishandling, such as when a loaded pistol is dropped or receives a blow to the muzzle.

SPECIFIC CHARACTERISTICS

Fig 5 Loaded chamber indicator is located on the slide, for visual or tactile check. When there is a round or a case in the chamber, the indicator pin is protruding on the upper surface of the slide.

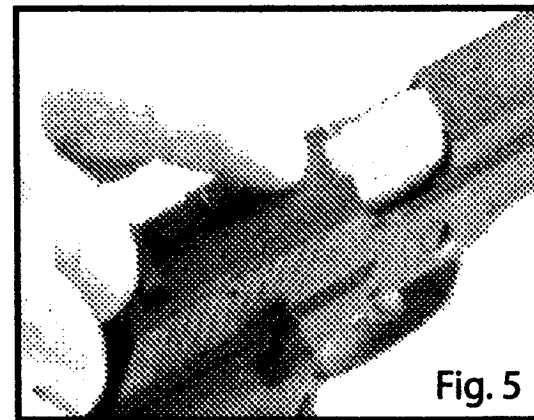

Fig. 5

SECTION 3 FUNCTIONING OF THE PISTOL

EZ SERIES Pistols are ready to fire when a loaded magazine is inserted into the pistol, the slide pulled back and released to go forward. By that movement it feeds a round from the magazine into the chamber. Final forward slide movement locks the weapon. When the pistol is functioning in double action, the trigger is, by lever system, engaging the hammer in the first half of its travel. The trigger, by the lever system, activates the mechanism which unblocks the firing pin. Final movement of the trigger releases the hammer. The hammer pivots forward under force of the main-spring to strike the firing pin, which activates the primer in the base of the cartridge. The energy imparted to the primer ignites the primer compound, which in turn ignites the main powder charge. In burning, it rapidly generates extremely high gas pressure to drive the bullet down the barrel. Rifling grooves in the barrel impart stabilizing spin to the bullet so that it will follow an accurate path to the target. Force starts the slide and barrel on their rearward travel. However, the slide unlocks from the barrel only after gas pressure is reduced to a safe level. The extractor on the slide takes the empty case, which in the contact with the

ejector is propelled through the ejection port on the slide. If the last round in the magazine has been fired, the magazine follower will activate the lever mechanism, which will hold the slide to the rear. If a round remains in the magazine, the slide will move forward to feed the next round in the chamber.

The trigger must be released and squeezed again to fire the next round. At the end of every firing cycle, the slide cocks the hammer. To drop the hammer forward without squeezing the trigger, decocking lever is used. After that, the pistol is ready to fire in double action.

NOTE: If, after triggering, there is a misfire (the round is not functioning), there will be no energy to return the slide to the rear, so the pistol will function in double action.

If the hammer is in the forward position (not cocked), the pistol will function in double action by firmly squeezing the trigger. It can also function in single action, by cocking the hammer by hand into the final rear position. When doing this, your fingers should be removed from the trigger.

LOADING

To Load A Magazine:

1. **CAUTION: READ SECTION 1 - SAFETY INSTRUCTIONS**

2. Use only ammunition recommended in this Instruction manual. Examine the ammunition, particularly the primer. Look for dents, scratches, and other signs of damage. Do not load damaged ammunition.

3. Grasp magazine in one hand, with the follower uppermost. Place a round on magazine follower with base just forward of retaining lips (Fig. 4). Press round down and back until base of round touches rear flat edge of magazine. Place the next round on top of previous round and press down and back. Repeat until magazine is loaded.

CAUTION: TO MINIMIZE RISK OF UNINTENTIONAL DISCHARGE, LOAD LIVE AMMUNITION INTO PISTOL ONLY WHEN YOU ARE ABOUT TO SHOOT.

To Load The Pistol:

1. **CAUTION: READ SECTION 1 - SAFETY INSTRUCTIONS - KEEP THE PISTOL POINTING IN SAFE DIRECTION AND DO NOT TOUCH THE TRIGGER.**

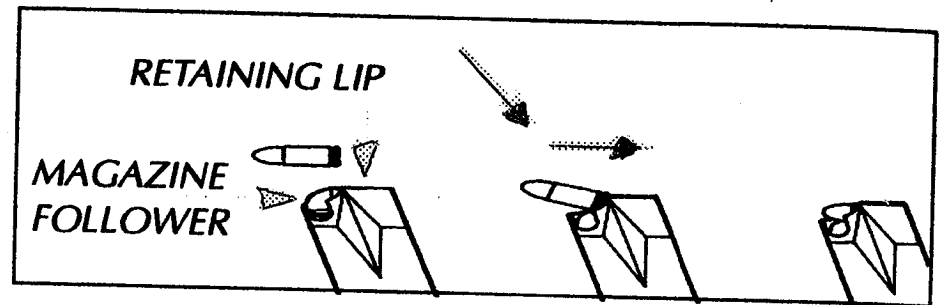

Fig. 6 MAGAZINE LOADING

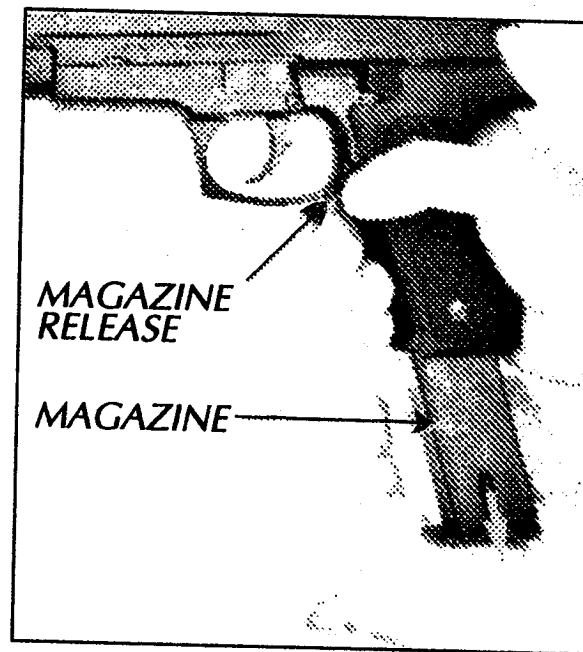

Fig. 7 REMOV. MAGAZINE

2. Remove empty magazine from pistol. Procedure: Place your hand under the magazine to prevent it from falling and press magazine release (located on both sides of pistol behind trigger guard). In that way, you released and ejected the magazine from magazine well (Fig. 7).

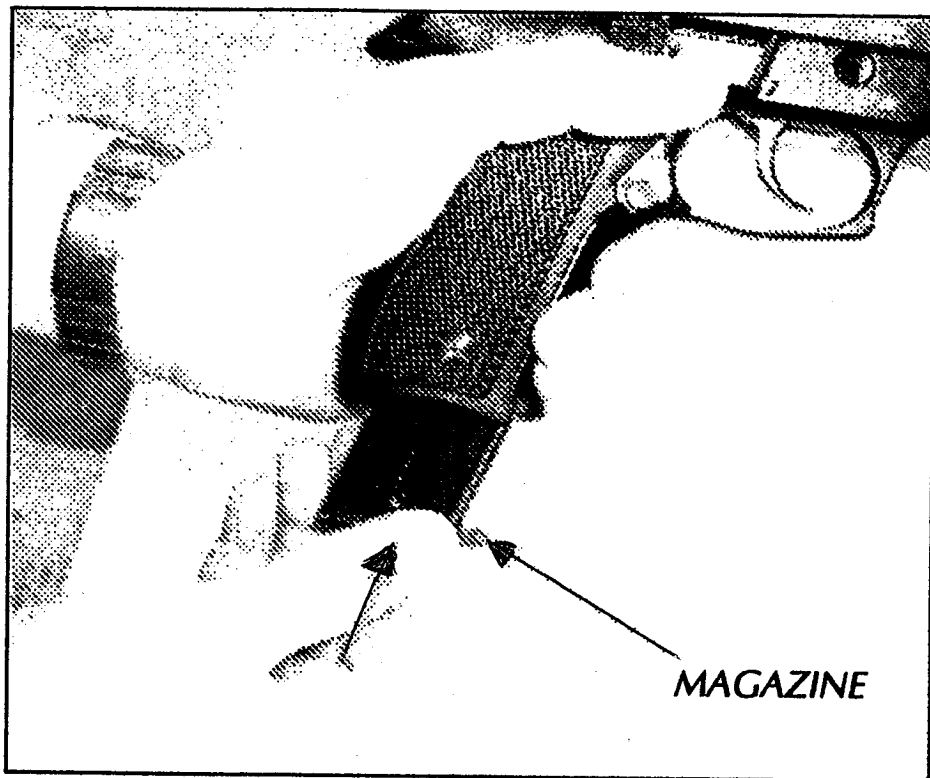

Fig. 8 INSERTING MAGAZINE

3. Hold the pistol by handgrip with one hand and, keeping other hand clear of ejection port, grasp serrated finger grips on both sides of slide. Pull slide back slightly and **LOOK IN CHAMBER TO ENSURE IT IS EMPTY**, allow slide to return forward.

(For safety, decock the hammer by pushing down the decocking lever, keeping fingers clear of trigger.)

4. Insert loaded magazine into magazine well with bullets pointing forward (Fig 8). Push magazine fully home until magazine catch is heard to "click", locking it in place.

IMPORTANT: Do not strike base of magazine to drive it home, just push it firmly into the pistol. Otherwise, you could damage magazine and injure your hand.

5. When you are ready to shoot, keeping the pistol for handgrip with one hand, take the slide for serrated finger grips and pull it firmly rearward. Release the slide to feed a round from the magazine into the chamber.

THE PISTOL IS NOW LOADED AND READY TO FIRE.

The hammer is cocked and your pistol will shoot in single action (SA). The pistol will fire by squeezing the trigger lightly.

6. If you do not want to fire immediately, for safety, press down decocking lever to drop the hammer forward and your pistol is ready to fire in double action. **THE PISTOL IS NOW LOADED, DECOCKED AND READY TO FIRE IN DOUBLE ACTION BY SQUEEZING THE TRIGGER FIRMLY.**

CAUTION: NEVER LEAVE PISTOL READY TO FIRE (as in Step 5), as this is extremely dangerous.

CARRYING MODES (If you are legally allowed)

This pistol may be carried in any one of the following modes, depending on your needs:

MODE 1 MAGAZINE EMPTY, CHAMBER EMPTY
Pistol cannot be discharged
Use mode 1 for storage, transporting, cleaning, repair, demonstrating and dry practice.

MODE 2 MAGAZINE LOADED, CHAMBER EMPTY, HAMMER DOWN
Pistol cannot be fired until the slide is cycled and the trigger is squeezed
Use Mode 2 when CARRYING THE PISTOL READY FOR USE.

WARNING: WHEN YOU SQUEEZE THE TRIGGER, YOU MUST EXPECT THE GUN TO FIRE, AND YOU MUST TAKE FULL RESPONSIBILITY FOR FIRING IT. YOUR CARE CAN AVOID ACCI-

DENTAL DISCHARGE, AND YOU WILL THEREBY AVOID ACCIDENTAL INJURY OR DEATH. NEVER CARRY YOUR PISTOL WHEN THE MAGAZINE OR CHAMBER ARE FULL AND HAMMER IS COCKED.

UNLOADING

CAUTION: ALWAYS UNLOAD YOUR PISTOL IMMEDIATELY AFTER USE AND BEFORE CLEANING AND STORAGE TO MINIMIZE THE RISK OF ACCIDENTAL DISCHARGE.

To Unload:

1. Be sure you are familiar with Safety Instructions in Section 1. Keep the pistol pointing in safe direction, do not touch trigger and always keep your hands away from muzzle and ejection port.

2. Place your hand under magazine to prevent it from falling and press magazine release to release and eject magazine.

Note: If slide is fully rearward, Step 3 does not apply.

3. Using serrated finger grips, pull slide sharply rearward to extract and eject a round from the chamber. (Keep your hands clear of the ejection

port to allow round to eject without obstruction). Examine previously chambered round for dents or other damage and dispose of it as explained in Section 1.

4. CAUTION: LOOK IN THE CHAMBER TO ENSURE IT IS EMPTY AND SEE THAT MAGAZINE HAS BEEN REMOVED.

5. Keep the pistol pointing in safe direction, allow slide to return forward on empty chamber. Push decocking lever to lower the hammer. (If slide is held to the rear by the slide stop, pull slide back slightly, then release it.). Squeezing the trigger instead of using the decocking lever in this step makes doubly sure that the chamber is empty. Caution: see point 4.

6. Remove remaining live rounds by sliding them forward out of the magazine.

7. Collect undamaged live ammunition for safe storage and future use. Collect spent cartridge cases for disposal. Segregate misfired and damaged live ammunition for disposal according to ammunition manufacturer's instructions.

FIRING

Before firing your pistol, practice your stance, aim and rhythm of breathing for steady aim, with your pistol UNLOADED.

Practice firing on a range before using your pistol for any other type of shooting.

To Fire:

1. Be sure you are familiar with Safety Instructions in Section 1.

KEEP THE PISTOL POINTING IN SAFE DIRECTION.

2. Load pistol as previously described.

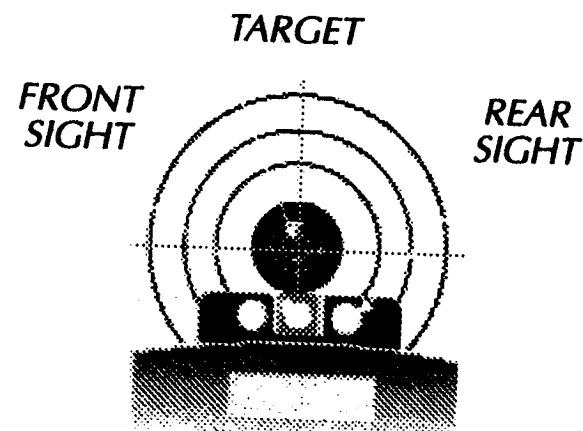

Fig. 9 AIMING

3. Grasp the pistol by handgrip and, with index finger resting along the outside of trigger guard, take aim. Aim by matching target with front and rear sights (Fig. 9).

4. Note: Squeezing the trigger in single action needs much lighter force than in double action.

5. Keeping steady aim, place your index finger on trigger and squeeze gently until hammer falls. Do not jerk the trigger as you will disturb your aim and spoil your accuracy. To fire the second and subsequent rounds, all that is necessary is to release the trigger and squeeze it again lightly after every shot until you have completed firing.

6. This is a semi-automatic pistol and is immediately loaded.

7. Release the trigger, remove your index finger from it. Push down decocking lever and release it. This will decock the hammer without squeezing the trigger. However, if you have fired the last round from the magazine, the slide will stay to the rear, ready for magazines to be changed. The procedure of replacement is identical to the described procedures of extracting the empty and inserting full magazine in paragraph To Load the Pistol. As the slide is already in rear position, its releasing is done by pushing the lever. Now you can proceed with shooting or stop, according to already described procedures.

CAUTION: IF PISTOL FAILS TO FIRE, HOLD IT, KEEPING IT POINTED TOWARDS THE TARGET OR SAFE OPEN AREA AND WAIT 60 SECONDS.

If a hang fire (slow ignition) has occurred, round could fire within 60 seconds. If round does not fire, remove magazine, eject round and examine primer. If firing pin indent on primer is light, off center or non-existent, have pistol examined by a competent gunsmith. If firing pin on primer appears normal (in comparison with similar previously fired rounds) assume faulty ammunition, segregate misfired round from other live ammunition and empty cases; reload and carry on firing.

Note: Dispose of misfired rounds in accordance with the ammunition manufacturer's instructions.

8. CAUTION: KEEP THE PISTOL POINTING IN SAFE DIRECTION.

Unload as previously described.

IMPORTANT: If you cocked your pistol but did not fire it, use decocking lever to lower the hammer. If you lose the opportunity to fire, unload your pistol as previously described. Remember, if a round is in the chamber there is a risk of accidental discharge.

CAUTION: NEVER LEAVE THE PISTOL COCKED READY TO FIRE, as it is extremely dangerous, and pistol could easily be accidentally discharged causing injury, death, or damage to property.

Like any other precision mechanism, your pistol will function better, last longer, and remain safer when it is properly maintained. Follow the advice in this Section to keep your pistol in peak competitive conditions.

CAUTIONS: Before stripping and cleaning, make sure that the pistol is not loaded.

WARNING: Do not strip your pistol if you suspect a major defect and when additional expert servicing and repairs are necessary.

WHEN TO CLEAN: You should clean your pistol as soon after firing as possible, so that the job will be easier and there will be less opportunity for corrosion to start. When your pistol has not been fired, clean it periodically, every three months, or once a month if storing conditions are unfavorable.

HOW TO CLEAN: The following cleaning procedure may be used both periodically and after firing.

MATERIALS: Cleaning rod, lubrication brush, cotton flannel patches (cut to fit into the bore), lubrication oil and gun cleaning solution to eliminate powder deposits.

NOTE: If ambient temperature is below 0°C (32°F) avoid use of lubrication oil; instead, apply a dry lubricant sparingly.

CLEANING PROCEDURE:

1. **CAUTION:** Ensure that the pistol is not loaded.
2. Strip for cleaning as described in this Instruction manual.
3. The brush dipped into gun cleaning solution pass through the barrel several times to eliminate powder deposits.
4. With the same brush, clean the grooves on the slide, frame, slide interior and top surface of the insert in frame.
5. Attach cotton flannel patch to end of cleaning rod and pass it through the barrel several times to eliminate dirt and powder deposits. Change the patches until the last patch comes out clean.
6. With cotton flannel patches clean external surfaces of the barrel, slide interior and the frame.
7. After cleaning, lubricate the barrel and other metal parts with oil.

STRIPPING FOR CLEANING

1. To remove magazine, press magazine release with the right or left hand thumb. The magazine will fall out of the pistol (Fig. 5).

2. Pull slide back to retain it in rear position with one hand, while holding the grip with the other. When the slide is brought into rear position, with the thumb of the hand holding the grip lift the slide stop. The slide will now remain in rear position (Fig 11).

WARNING

Lead or lead compounds are known to the State of California to cause cancer, birth defects, reproductive toxicity, and other serious physical injury. Those who clean firearms should take protective measures to avoid contact or exposure to such chemicals.

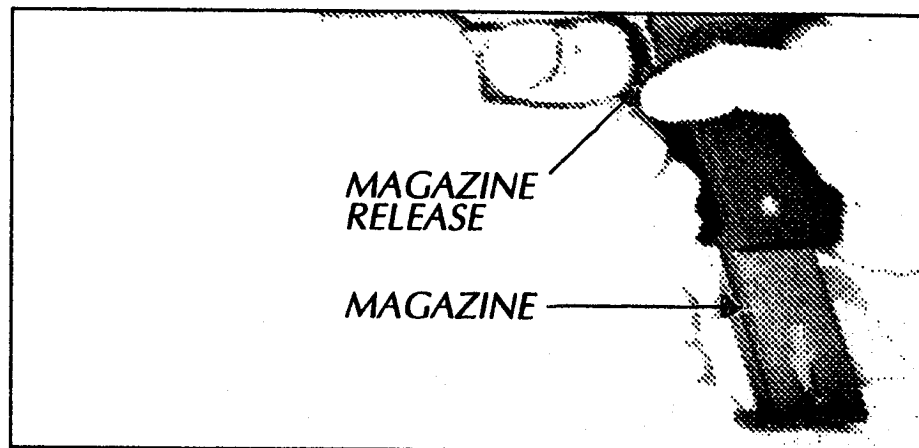

Fig.10 REMOVING MAGAZINE

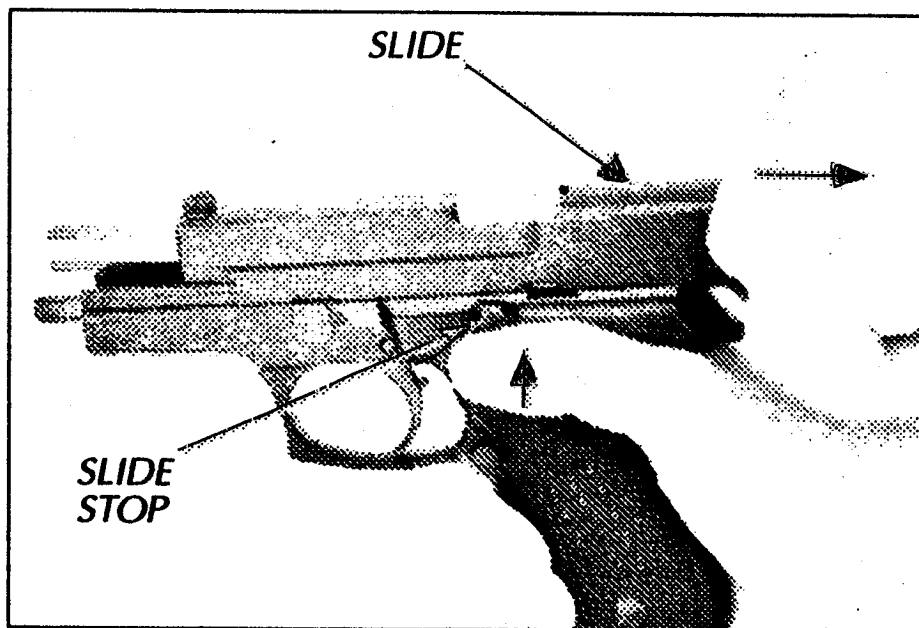

Fig. 11 PULLING SLIDE BACK
IN THE REAR POSITION

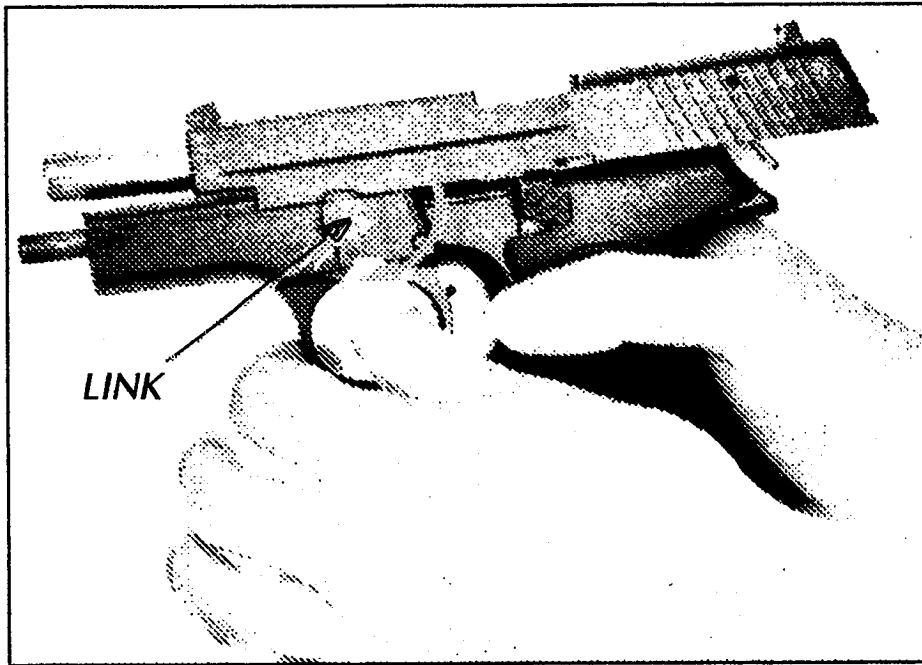

Fig. 12 SWIVELING BARREL LINK

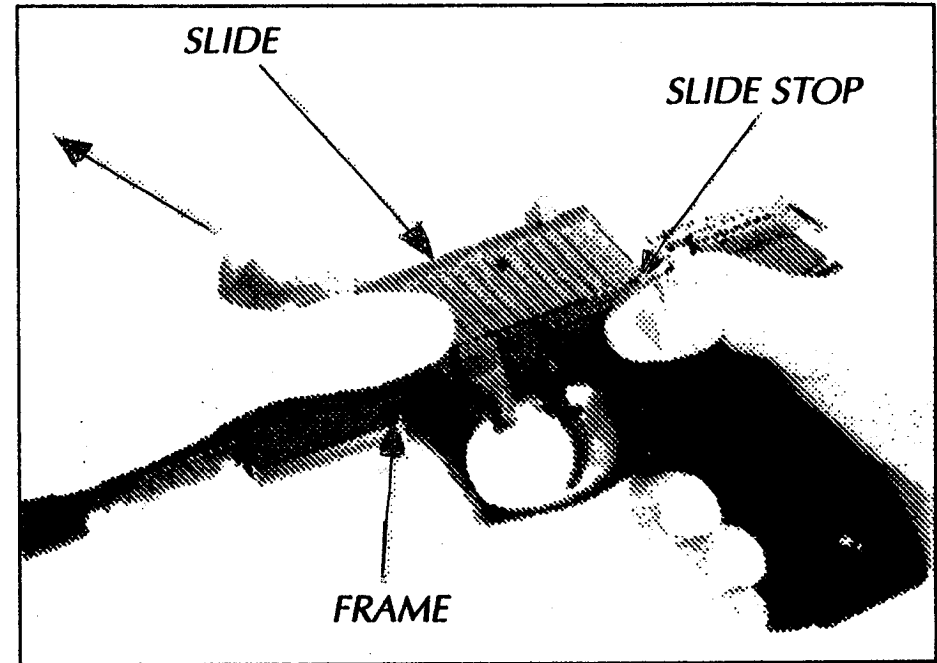

Fig. 13 SEPARATING SLIDE FROM THE FRAME

4. Swivel barrel link by 90° (downwards - Fig. 12) to release the barrel. The slide can be separated from the frame now.

5. To separate slide, barrel and recoil spring from the frame depress the slide stop with the thumb of the hand holding the grip, holding the barrel link swivelled with the thumb of the other hand (Fig.13). Hold the slide and the parts in it and move them forward to separate from the frame.

6. Slide, barrel, guide and recoil spring are stripped by mild pressing the guide and pulling from the rest on the barrel.
In this way, the pistol is stripped for cleaning.

ASSEMBLING

Assembling is to be done by the opposite sequence.

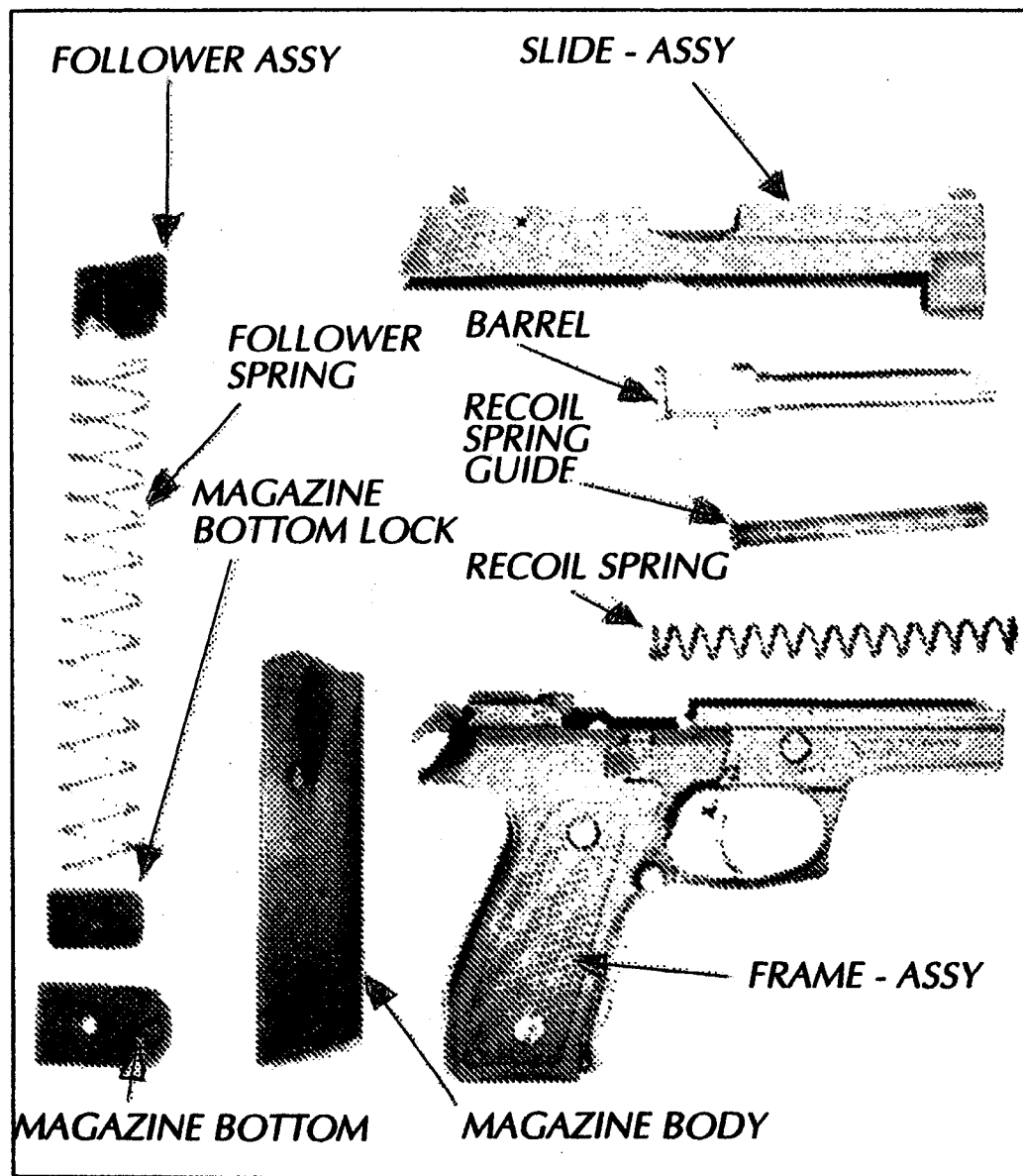

Fig. 14 STRIPPED PISTOL

THIS SET INCLUDES

- | | |
|--------------------------|--------|
| 1. Pistol | |
| 2. Cleaning brush | 149 |
| 3. Warranty | 111975 |
| 4. Protective | |
| polyethylene bag 270x180 | 106373 |
| 5. Protective | |
| polyethylene bag 150x80 | 106374 |
| 6. Package box | 3983 |
| 7. Instruction manual | 120028 |

SECTION 5 PISTOL PARTS EZ SERIES PISTOL

List and illustration will help you identify parts of this weapon properly.

O.N.	PART NAME	Part No.	O.N.	PART NAME	Part No.
1.	Front sight	108445	31.	Magazine release button	110942
2.	Rear sight	108475	32.	Magazine catch spring	106341
3.	Frame, ins.assy	120022	33.	Magazine catch axle	114386
4.	Screw holder	114334	34.	Barrel link	114384
5.	Lever holder	106307	35.	L.H. cover	114351
6.	L.H.Lever	114336	36.	R.H. cover	114352
7.	R.H.Lever	114337	37.	Cover screw	114353
8.	L.H.Lever spring	106311	38.	Slide	120025
9.	R.H.Lever spring	106312	39.	Extractor	106353
10.	Slide stop	106313	40.	Firing pin	106354
11.	Slide stop spring	106314	41.	Firing pin lock	106357
12.	Trigger lever, ins.assy	114338	42.	Lock spring	106358
13.	Lever spring	106318	43.	Barrel	106381
14.	Trigger	111152	44.	Recoil spring guide	114366
15.	Trigger axle	106320	45.	Lock	106355
16.	Locking insert	114340	46.	Firing pin spring	106356
17.	Sear, ins. assy	106341	47.	Recoil spring	114367
18.	Sear spring	106323	48.	Magazine, assy	120027
19.	Sear axle	114342	49.	Magazine body	120030
20.	Spring limiting shaft	106325	50.	Follower spring	106367
21.	Triggering lever	114343	51.	Follower	114370
22.	Hammer, ins.assy	114383	52.	Magazine bottom lock	106369
23.	Hammer axle	106330	53.	Magazine bottom	106371
24.	Hammer spring	114347	54.	Loaded chamber indicator	106344
25.	Spring guide	114348	55.	Lock	106362
26.	Rest	114335	56.	Spring	106345
27.	Rest spring	106336	57.	Axle	106350
28.	Rest axle	106337			
29.	Ejector	114395			
30.	Magazine catch	106339			

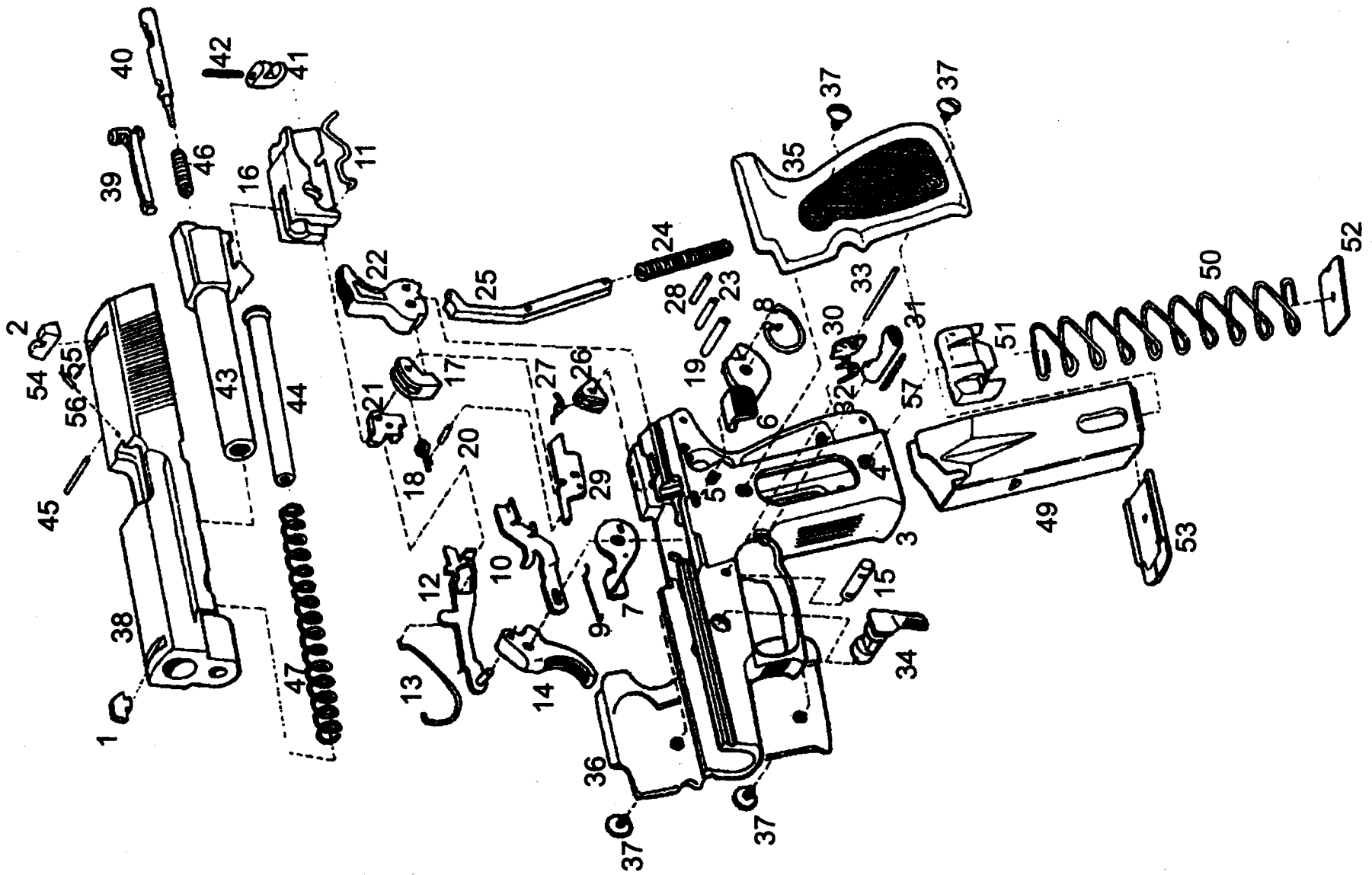

Fig. 15 EZ SERIES PISTOL PISTOL PARTS

DANGER – AMMUNITION WARNING

Firearms may be damaged and serious personal injury or death to the shooter or bystanders may result from any condition which contributes to the generation of excessive pressure or uncontrolled release of gas within the firearm. Such adverse conditions can be caused by bore or chamber obstruction, propellant powder overloads or by defective, incorrect or improperly loaded and assembled cartridge components. Even the strongest firearm can be blown up as a result of excessive pressure. It is extremely dangerous to use a cartridge whose pressure is greater than that developed by cartridges loaded to industry standards.

AMMUNITION (CARTRIDGES) NOTICE

We specifically disclaim responsibility for any damage, personal injury or death occurring in connection with or as the result of the use of European American Armory Corp. pistols with faulty, nonstandard, remanufactured, Super-Vel, +P, hand-loaded or reloaded ammunition, used cartridges or cartridges other than factory cartridges for which

the firearm was originally chambered.

LUBRICATION WARNING

Firing a pistol with oil, grease or any other material even partially obstructing the bore may result in damage to the revolver and personal injury to the shooter and those nearby. Do not spray or apply lubricants directly on ammunition. If the powder charge of a cartridge is affected by the lubricant, it may not fully ignite yet the energy from the primer and/or powder may be sufficient to push the projectile or wad into the bore where it may become lodged. Firing a subsequent cartridge into the obstructed bore will damage the pistol and may cause personal injury to the shooter and those nearby. Use lubricants properly. You are responsible for the proper care and maintenance of your firearm and ammunition.

LIFETIME LIMITED WARRANTY

This European American Armory Corp. firearm is warranted to the original retail customer for life from date of purchase against defects in material and

workmanship. All parts and labor or replacement at our option are covered.

Transportation to and from our repair facilities, government fees, damage caused by failure to perform normal maintenance, sales outside the United States, damage due to use of high velocity, high pressure, reloaded or other nonstandard ammunition, or any unauthorized repair, modification, misuse, abuse, or alteration of the product are not covered by this Lifetime Limited Warranty.

Any implied warranties, including the implied warranties of merchantability and fitness for a particular purpose, are limited to one year from date of original retail purchase. Consequential or incidental damages and/or expenses, or any other expenses are not covered by this warranty.

To obtain warranty performance send your firearm to:

**EAA Corp.
411 Hawk Street
Rockledge, FL 32955**

NOTICE:

It is illegal to ship a firearm with ammunition in the firearm or in the same packaging. Firearms and ammunition must be shipped separately. For information about shipping ammunition, call European American Armory Corp. at (321) 639-4842.

WARNING—ALTERATIONS OR MODIFICATIONS

Altering or modifying parts and/or internal safeties is dangerous and will void the warranty. This pistol was manufactured to perform properly with the original parts as designed. It is your duty to make sure any parts you buy are made for this firearm and are installed correctly and that neither the replacements nor originals are altered or changed. Your gun is a complex precision tool with many parts that must relate correctly to other parts in order for proper and safe operation. Putting a gun together wrong or with incorrect or modified parts can result in a damaged gun, danger, and personal injury or death to you and others through malfunction. Always

have a qualified gunsmith work on your gun or at least check any work not performed by a gunsmith.

YOUR OWNER'S MANUAL

Always keep this manual with your firearm. Make sure you understand all the warnings, operation instructions and safety procedures. When you lend, give or sell the firearm, be sure this manual goes with it. You can get a copy of this manual from European American Armory Corp. upon request.

**ALL PARTS ORDERS ARE SUBJECT TO A \$10.00 CHARGE FOR SHIPPING AND HANDLING. Please state Model, Caliber, Serial Number, and Finish Color when ordering. For parts, information and service contact: European American Armory Corp., ~~4621 Highway 190, Rockledge, FL 32955~~
Phone: (321) 639-4842.**

MANUFACTURER:

IMPORTER:

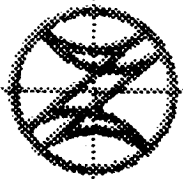

Zastava

a r m s

ZASTAVA ORUŽJE AD

34000 KRAGUJEVAC, Trg topolivaca 4
Serbia

Phone > ++381 34 336077

Fax > ++381 34 323683

e-mail > zastavanp@ptt.yu

web site > zastava-arms.co.yu

EAA Corp.

411 Hawk Street

Rockledge, FL 32955