

Made in the USA.

OPERATIONS MANUAL



Calibers Featured Include:

.204 Ruger, .22LR, 5.56 x 45mm, .223 Rem., 6.8mm Rem. SPC,
7.62 x 39mm, .243 Win., .260 Rem., .308 Win., .300 Rem. SAUM



www.dpmsinc.com

1-800-578-DPMS

SERIAL NUMBER INFORMATION

Record the serial number of your DPMS/Panther Arms firearm!

(When holding the firearm the serial number will be found on the left side of the firearm, stamped on the magazine well):

and a description of it:

Make a copy of this operations manual and proof of purchase/sales record. Maintain these items in a secure safe or fireproof container. These materials will be necessary if the firearm is damaged, stolen or returned to DPMS/Panther Arms for warranty or repair.

Attach original proof of purchase here!

TABLE OF CONTENTS

Warnings & Notice	4
General Handling Cautions	5
Dangerous Procedures	5
Use of Safety Selector	5
Function Check	6
Safety Features	6
5.56 x 45mm/.223 Caliber	7-20, 34-35
Sights	8-9
Loading a Magazine	10
Loading & Unloading the Rifle	10
Firing the Rifle	11
Maintenance	12-13
Cleaning the Rifle	14-15
Lubricating & Inspecting the Rifle	16-17
Assembly	18-19
Extreme Conditions	20
Troubleshooting	34-35
.22LR Caliber	21-27
Sights	22
Loading a Magazine	22
Loading & Unloading the Rifle	23
Firing the Rifle	24
Mounting Optics	24
Maintenance & Cleaning	25
Unusual Conditions	26
Troubleshooting	26-27
.30 Caliber	28-35
Loading the Magazine	29
Loading the Rifle	29
Unloading the Rifle	30
Firing the Rifle	30
Mounting Optics	31
Maintenance	31-32
Cleaning	32-33
Unusual Conditions	33
Trouble Shooting	34-35
Warranty	36
Alterations & Modifications	36
Returns	36

WARNING

If this firearm is carelessly or improperly handled, unintentional discharge could result and could cause personal injury, death or damage to property.

FOR YOUR SAFETY AND THE SAFETY OF OTHERS, this Operations Manual contains important instructions, warnings and safety procedures that must be understood BEFORE using your DPMS/Panther Arms firearm. It is imperative that you read the ENTIRE MANUAL and if you do not understand any part of it or the operation of your DPMS/Panther Arms firearm, you should seek professional firearms instruction.



WARNING

Children are attracted to and can operate firearms that can cause severe injuries or death. Prevent child access by always keeping guns locked away and unloaded when not in use. If you keep a loaded firearm where a child obtains and improperly uses it, you may be fined or sent to prison.



ADVERTENCIA

A los niños los atraen las armas de fuego y las pueden hacer funcionar. Ellos pueden causarse lesiones graves y la muerte. Evite que los niños tengan acceso a las armas de fuego guardándolas siempre con llave y descargadas cuando no las este utilizando. Si usted tiene una arma de fuego cargada en un lugar en que un niño tiene acceso a ella y la usa indebidamente, le pueden dar una multa o enviarle a la cárcel.

NOTICE

DPMS shall not be responsible for personal injury, death or damage to property resulting from either intentional or accidental discharge of this firearm, or from its function when used for purposes or subjected to treatment for which it was not designed. DPMS will not honor claims involving this firearm which result from careless or improper handling, unauthorized adjustment or parts replacement, corrosion, neglect, or the use of wrong caliber ammunition, other than original high quality commercially manufactured ammunition in good condition, or any combination thereof. DPMS will not honor claims involving this firearm for any reason or cause when the second or subsequent owner makes such claims.

Before the rifle left the factory, this firearm was tested, carefully inspected and packaged. DPMS cannot control product handling after it leaves the factory; therefore please examine this firearm carefully at the time of purchase to ensure that it is unloaded and undamaged.

GENERAL HANDLING CAUTIONS

1. Do NOT alter or modify your DPMS/Panther Arms firearm, and have it serviced regularly!
2. Always handle your firearm as if loaded.
3. Never point your firearm at anything you don't intend to shoot.
4. Always make sure your firearm is not loaded and the bolt is latched open and to the rear before laying it down or handing it to someone else.
5. Never leave a loaded firearm unattended.
6. Always be sure bore, muzzle, chamber and action are clear of obstruction.
7. Always check that ammunition is clean and undamaged.
8. Never drink alcoholic beverages or take drugs before or during shooting.
9. Always wear eye and ear protection when shooting.
10. Always keep safety on "SAFE" when firearm is loaded and a round is chambered until ready to shoot.
11. Never attempt to fire if water is in the bore.
12. Never indulge in "horseplay" when holding your firearm.

DANGEROUS PROCEDURES

1. Be sure the cam pin is installed in the bolt group. If it isn't, your rifle can still fire but it could possibly explode, causing you personal injury or harm. **(Applies only to the .308 caliber and 5.56/.223 caliber rifles, not the .22LR rifle.)**
2. DO NOT exchange or switch bolt assemblies from one rifle to another. It could cause personal injury to you and others and damages to your rifle.
3. If your firearm fails to fire, hold it, keep it pointed towards the target and wait 30 seconds. If a hangfire has occurred, the round will fire within 30 seconds. If the round does not fire, remove magazine, eject round and examine the primer. If firing pin indent is light, misaligned or non-existent, have your firearm examined by a competent gunsmith. If firing pin indent on primer appears normal (in comparison to previously fired rounds) assume faulty ammunition; appropriately dispose of misfired round from other live ammunition; reload and resume firing.

USE OF SAFETY SELECTOR

A selector lever, located on the left of lower receiver, has two positions, "FIRE" and "SAFE". When set to "FIRE" the firearm will fire a single shot each time the trigger is squeezed. When set to "SAFE" a cam bears upon the rear of the trigger, blocking movements and preventing the hammer from being released.



“SAFE”

Rifle will not fire. Selector lever cannot be on safe unless rifle is cocked. Always place on SAFE when loading and unloading.



“FIRE”

Rifle will fire one round each time the trigger is pulled.

FUNCTION CHECK

SAFE Note: Remove magazine and make sure your rifle is unloaded and there is no ammunition in the chamber. Point in safe direction. Pull charging handle to rear and release. Place on safe. Pull trigger. Hammer should not fall.

FIRE Note: Remove magazine and make sure your rifle is unloaded and there is no ammunition in the chamber. Point in safe direction. Place selector on fire. Pull trigger and hold to rear. Hammer should fall. Pull charging handle to rear and release. Release trigger and pull again. Hammer should fall.

SAFETY FEATURES

Disconnecter

The disconnecter, a part of the firing mechanism, prevents the firearm from firing full automatic. As the hammer is cocked after each shot the disconnecter holds the hammer until the trigger is released. When the trigger is released, retention of hammer passes from disconnecter to trigger ready for the next shot.

Firing Pin Collar

The bolt carrier assembly, located within the upper receiver, is designed to prevent the firing pin from striking a cartridge until the bolt is locked to the barrel.

The following sections contain caliber specific information. Please open to the section relevant to your particular rifle's caliber. If you are unsure of the caliber of the rifle, the caliber marking can be found on the barrel of the rifle, immediately in front of the gas block on the bottom of the barrel.

Everyone should read page 36 for additional information pertaining to the Three Year Limited Warranty and returns!

.204 Ruger
5.56 x 45mm
6.8mm Rem. SPC
.223 Rem.
7.62 x 39mm

Includes the Following Rifles:

Panther LR-204	Panther Classic Sixteen
Pardus Rifle	Panther Lite 16
Panther 20th Anniversary Rifle	Panther Carbine
Panther Bull Sweet Sixteen	Panther A2 Tactical 16
Panther Bull Twenty	Panther AP4 Carbine w/Miculek Comp
Panther Bull Twenty-Four	Panther AP4 Carbine
Panther Race Gun	Panther 6.8mm AP4 Carbine
Panther Bull 24 Special	Panther 6.8mm 20" Rifle
Panther Super Bull 24	Southpaw Panther
Arctic Panther	Panther Pump Action Rifle
Panther Tuber	Panther Pump Action Pistol
Panther Bull Classic	DPMS Single Shot AR Rifle
Panther Lo-Pro Classic	Panther Kitty-Kat
Panther DCM	Panther 7.62 x 39mm
Panther Classic	



AP4 Panther Carbine

.223 CALIBER

SIGHTS

1. Rear sight can be adjusted for both windage and elevation and has a dual aperture peep sight, one for short range and one for long range.
2. When flipped forward, the aperture is marked 0-2 for zero to 200 meters. When using this setting the elevation knob should be set at 8/3 low or 6/3 for detachable carry handle or flat top rear sights and at its lowest position.
3. When the aperture is flipped back, it is set for using the long range sight. When using this setting you can adjust the elevation knob for range required: 8/3 low for 300 m, 4 for 400 m, 5 for 500 m, 6 for 600 m, 7 for 700 m, and 8/3 high for 800 m. There are click settings in between for fine tuning.
4. The windage knob is located on the right side of the rear sight. To adjust for horizontal movement on target, turn knob clockwise for right and counter-clockwise for left.
5. The front sight is adjustable for elevation zeroing only, it is not used at any other time in firing.

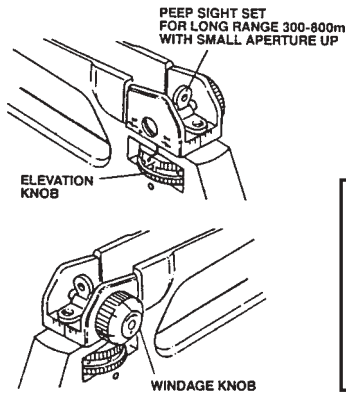

FRONT SIGHT - To adjust elevation, depress detent, rotate post. To raise strike of bullet, rotate post in the direction of arrow marked up. Reverse the direction of rotation to lower strike of bullet. Each graduation (notch) moves the point of impact of bullet as indicated in chart.

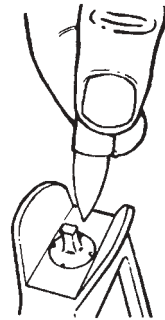
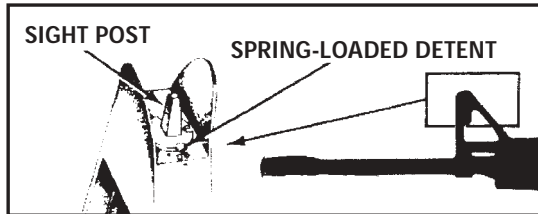

ZEROING SIGHTS

This procedure is for .223 ammunition. For our rifles chambered in 7.62x39mm and 6.8mm SPC the trajectory will differ, please call DPMS with any questions. The procedure described is for zeroing at 25 meters but may be adjusted accordingly for longer ranges. The following table shows change of impact per click at specific range.

Windage:		
25 m		3/8 in.
100m		1 3/8 in.
200m		2 3/8 in.
Elevation:		
25 m		1/8 in.
100 m		1/2 in.
200 m		1 in.
300 m		1 1/2 in.
400 m		2 in.
500 m		2 1/2 in.
600 m		3 in.
700 m		3 1/2 in.
800 m		4 in.

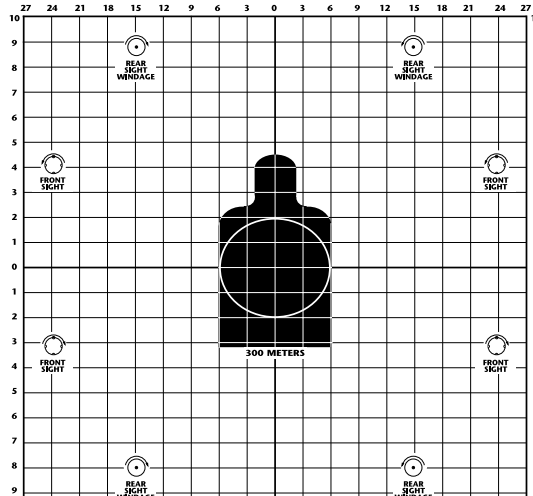

ZEROING SIGHTS

1. Set elevation to 8/3 low or 6/3 for detachable carry handle and flat top rear sights, then raise it one click. No further adjustment should be made during zeroing.
2. Flip aperture to small long range sight.
3. Set aperture to mechanical zero by adjusting windage until sight is aligned with center line on scale under sight.
4. Carefully aim and fire at bull's-eye on target at 25 meters: Fire ten rounds to establish a group.
5. Compare group with bull's-eye, if they match, no further adjustment is necessary.
6. If group does not match bull's-eye, measure vertical and horizontal distance from bull's eye.
7. Calculate clicks of windage required to move impact appropriate distance. Turn windage knob accordingly. (see chart on page 6 for 25m windage clicks)
8. Calculate clicks of front sight required to raise or lower impact appropriate distance. (1 click = 3/8 in. at 25 m)
9. Depress plunger and front sight required number of clicks. Clockwise will lower sight and raise impact, and counter-clockwise will raise sight and lower impact.
10. Repeat steps 4 through 9 until impact matches bull's-eye. Your sight is now zeroed.
11. Set elevation knob back to 8/3 or 6/3 low and flip aperture back to 0-2 for ranges of 0-200 m.

BATTLESIGHT ZERO

TO ZERO THE RIFLE, YOU MUST HAVE THE FRONT SIGHT (ELEVATION) AND THE REAR SIGHT (WINDAGE) ADJUSTED SO THAT IT CAN HIT YOUR POINT OF AIM AT A GIVEN RANGE.

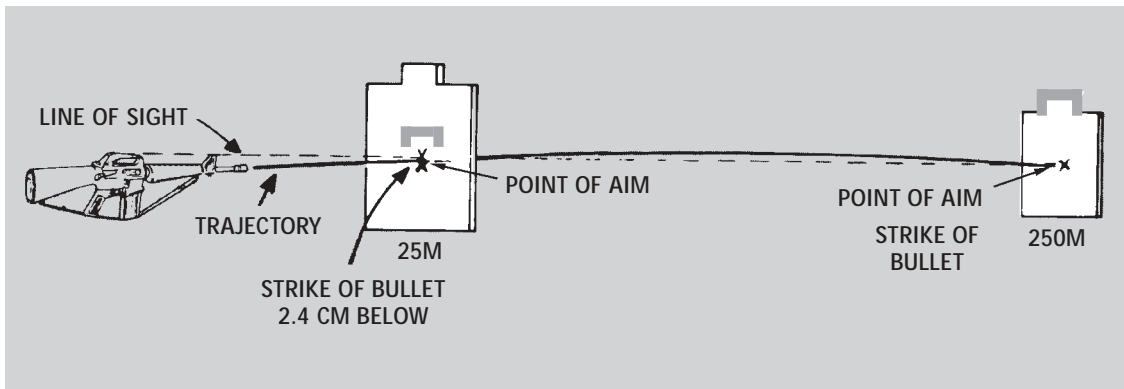

NOTE:

To battlesight zero your rifle, you adjust your sights so you can hit an aiming point at 250 meters. Zeroing can also be accomplished on a 25 meter range by adjusting the sights so that the bullet will strike 2.4 centimeters below the point of aim.

LOADING

CAUTION: Always check that ammunition is clean and undamaged before using the forward assist. Forcing damaged ammunition into the chamber could result in personal injury or death to you and others and damage your rifle and property. The use of reloaded, hand-loaded or high pressure ammunition can be dangerous and will void the warranty.

To load a magazine...

1. Use only ammunition for which your firearm is chambered.
2. With front of magazine forward, place a round between the lips of the magazine with the bullet forward. Press the round down until it is retained by the magazine lips. Place the next round on top of the last and repeat until desired number is loaded.

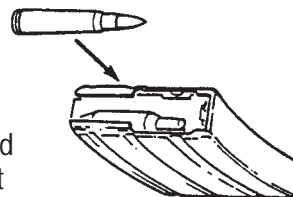

Make sure the rifle is pointed in a safe direction and the safety is engaged at all times while loading the rifle.
NEVER allow your fingers or other objects to contact the trigger while loading or unloading the rifle.
Do **NOT** disengage the safety until you are ready to fire and have the rifle pointed safely downrange.

To load the rifle...

1. Press in on bottom of bolt catch while pulling back on charging handle, to cock the hammer and leave the bolt and carrier to the rear.
2. Return the charging handle to fully forward until it locks and remove finger from bolt catch.
3. Set selector to "SAFE" position.
4. With the bullets pointing forward, insert loaded magazine into magazine well and push it in until it stops and is retained by magazine catch.
5. With the rifle pointed in a safe direction press in on top of bolt catch. This will release the bolt and carrier and move a round into chamber. The rifle is now loaded with a round in the chamber and the hammer cocked.
6. You may now close the ejection port cover if you wish; it is located on the right side of the upper receiver and will open automatically when the first round is fired.

To Unload the Rifle...

1. Set selector to "SAFE" position.
2. Press magazine catch button and remove magazine.
3. Pull charging handle to rear and push in lower portion of bolt catch. If a round had been in the chamber it should have been ejected. If last round in magazine had been fired and if the magazine was in place, bolt and carrier should already be held to the rear.

CLEAR YOUR RIFLE

1. Place selector on SAFE. If weapon is not cocked, lever cannot be pointed toward SAFE.



2. Remove magazine

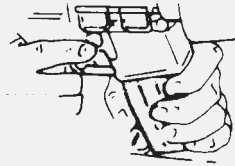

3. To lock bolt open, pull charging handle rearward, press bottom of bolt catch & allow bolt to move forward until it engages bolt catch. Return charging handle to forward. If you haven't before, place on SAFE.

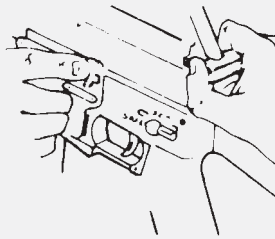

4. Eyeball receiver and chamber to ensure these areas contain no ammo.

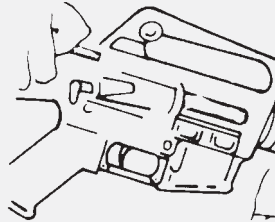

5. With selector lever pointing toward SAFE, allow bolt to go forward by pressing upper portion of bolt catch

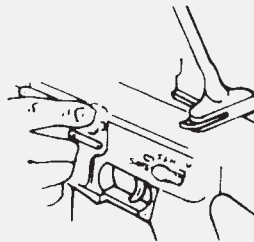

Before firing your rifle, practice your stance, aim, rhythm and breathing for steady aim with your firearm unloaded. Practice firing on a range before going hunting or using your firearm for any other type of shooting.

FIRING

NEVER load a cartridge into the chamber until you are ready to fire the rifle. Do **NOT** disengage the safety until the rifle is pointed in a safe direction and you are ready to fire.

To Fire...

1. Always wear ear and eye protection when firing your weapon.
2. Load firearm as previously described.
3. Set rear sight to range required.
4. Grasp firearm with one hand on hand guard and other hand on pistol grip with trigger finger resting along side of trigger guard. Raise firearm and pull buttstock firmly into shoulder.
5. Aim by aligning target with

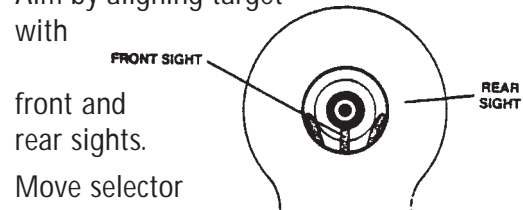

6. Move selector lever to "FIRE".
7. Keeping steady aim, place trigger finger on trigger and squeeze gently until trigger releases hammer. Do not jerk the trigger as you will disturb your aim and ruin your accuracy. To fire the next round and subsequent rounds, all that is necessary is release the trigger and squeeze it again after every shot until you are finished or the magazine is emptied.
8. This is a semi-automatic firearm and is immediately loaded and ready to fire after each shot until magazine is empty.
9. Release trigger, remove finger from trigger, and set selector lever to "SAFE". If you have fired the last round from magazine, the bolt and carrier will be held to the rear so that you can quickly reload by replacing the magazine or the chamber can be checked to ensure it is empty.

.223 CALIBER

MAINTENANCE

Your DPMS rifle is based on military rifle design and is very rugged but proper maintenance is necessary to keep it in good working condition.

Field Stripping/Disassembly

1. Press take down pin in from left of lower receiver (it may be necessary to use a punch as the fit between upper and lower may be very tight). Pull it out the right side until it comes to a positive stop.
2. Pivot lower receiver down and away from upper portion of receiver.
3. Press front pivot pin in from left side of lower receiver and pull out right side until it comes to a positive stop.
4. You can now separate the upper and lower receivers.
5. Pull charging handle to rear and remove bolt and carrier assembly.
6. Remove charging handle by pulling it backwards to key way and down out of receiver.

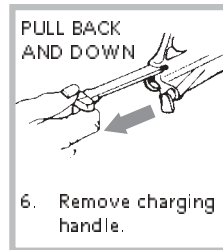
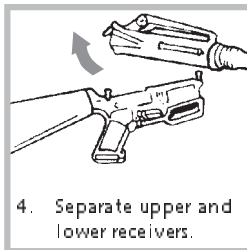
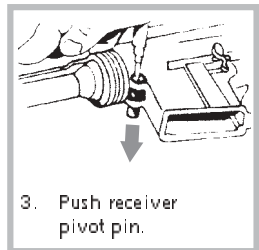
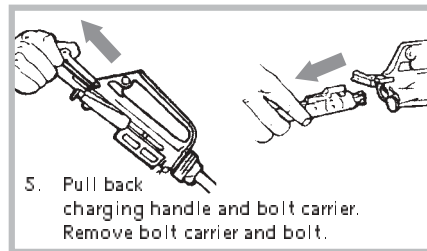
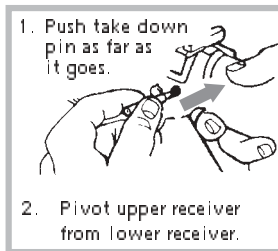
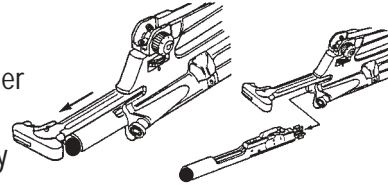

7. Push in firing pin retaining pin right-to-left of bolt carrier and remove it by pulling it out to the left.
8. Tilt bolt face up and remove firing pin. (Page 13, Picture 8)
9. Push bolt in towards the carrier until it rotates and comes to a stop, then turn cam pin 90°. (Page 9)
10. Remove cam pin by lifting it out away from bolt and carrier.

11. Pull bolt forward out of carrier. (Page 13, Picture 11)

12. Depress buffer, maintaining pressure as buffer is under spring tensions, to prevent it from being ejected when buffer retainer is depressed. Depress buffer retainer to permit buffer and spring to move forward. Then depress hammer to allow the buffer and spring to continue to move forward and be removed from receiver extension. (Page 13, Picture 15 a & b).

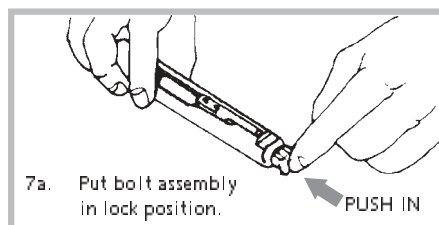
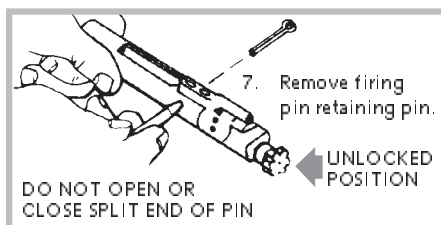
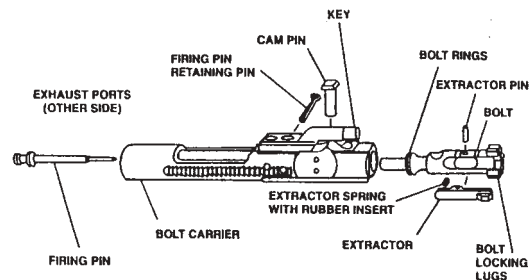

MAINTENANCE

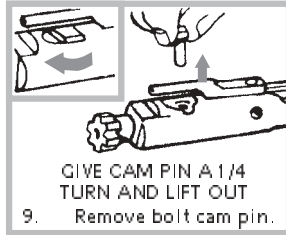
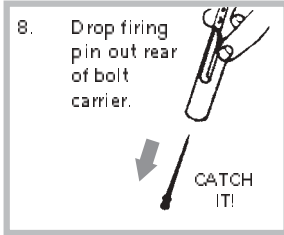

13. With a punch, remove the extractor pin from the bolt assembly.

14. Remove the extractor and spring. DO NOT remove the spring from extractor.

15. Press top of extractor spring rubber tip to test spring function.

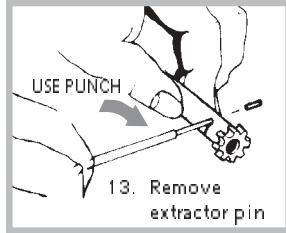
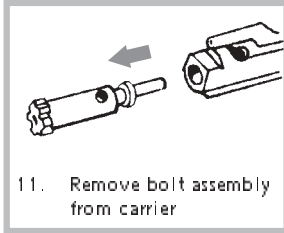

FURTHER DISASSEMBLY SHOULD ONLY BE PERFORMED BY THE FACTORY (DPMS)

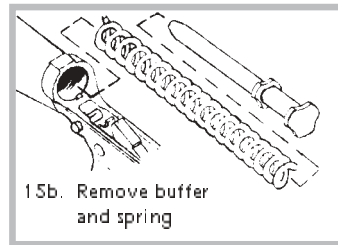
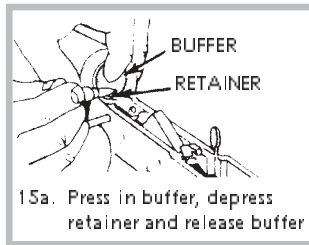

16. To remove handguards, push delta ring towards receiver while pulling up on half of the handguard. Repeat process for other half of handguard.

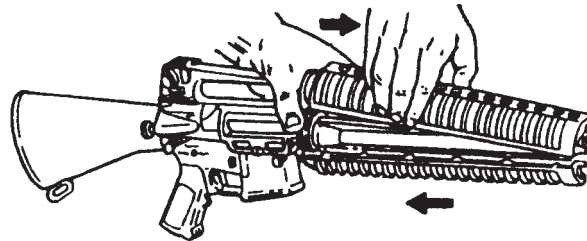

NOTE: Do not strip your firearm further than previously described. If additional maintenance is necessary consult a competent gunsmith.

***Your rifle is now field stripped for cleaning.
To reassemble repeat procedure in reverse order.***

.223 CALIBER

THOROUGH CLEANING

upper receiver

Be sure to include:
CLEAN WITH RBC
 (Rifle Bore Cleaner)

- All areas of powder fouling, corrosion, dirt and rust
- Bore & chamber
- Locking lugs
- Gas tube

Use a worn bore brush to get outside surface of protruding gas tube (get sides and bottom from bottom of receiver)

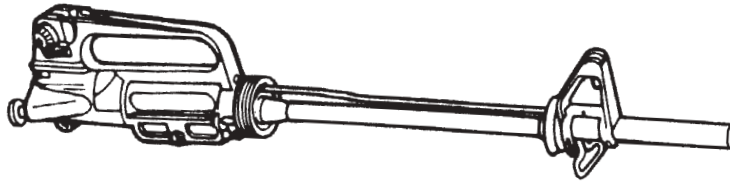

START AT RECEIVER

GO RIGHT THROUGH THE COMPENSATOR OR END OF BARREL.

BORE BRUSH (DON'T REVERSE DIRECTION WHILE IN BORE)

BARREL LOCKING LUGS AND GAS TUBE

.223 CALIBER

bolt carrier group

- Be sure to include:
- Outer & inner surfaces of bolt carrier
 - Carrier key
 - Firing pin recess and firing pin
 - Firing pin hole (Use pipe cleaner there)

WORN BORE BRUSH

GET THAT LAST 1/16" TOO!

CARRIER KEY

Charging Handle Assembly UR-19

Bolt Carrier w/Key & Screws BT-19

BT-17 Cam Pin

BT-02 Bolt

BT-16 Firing Pin Retaining Pin

BT-14 Firing Pin

BT-08 Extractor Spring Assembly

BT-07 Extractor

BT-03 Extractor Pin

- Carbon deposits & dirt from locking lugs
- Areas behind bolt ring and under lip of extractor

THOROUGH CLEANING

lower receiver group

- Clean areas of powder fouling, corrosion and dirt
- Wipe dirt from trigger mechanism
- Clean buffer and inside lower receiver extension

CAUTION

Do not use wire brush or any type of abrasive material to clean aluminum surfaces.

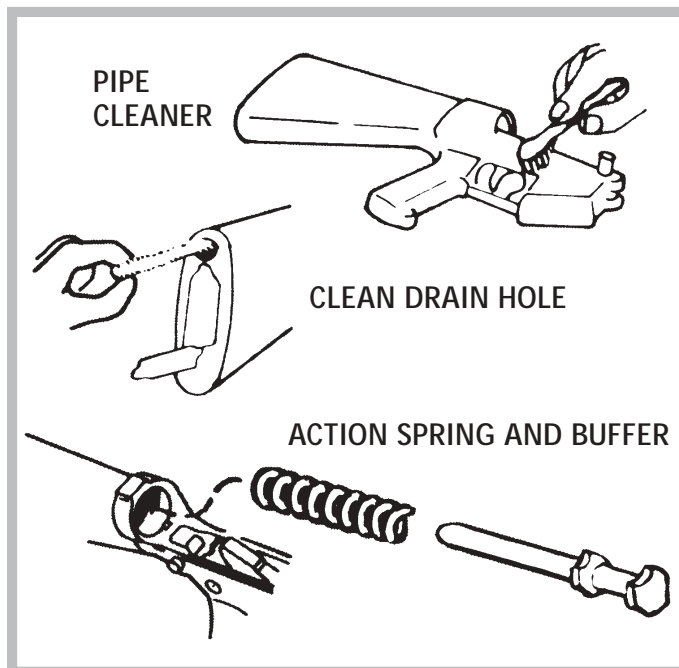

CLEAN...INSPECT...LUBE

With the rifle disassembled, thoroughly clean, inspect and lube so you have a reliable weapon you can always depend on.

After firing, clean your weapon for 3 consecutive days with Rifle Bore Cleaner (RBC). Wipe dry and lube according to lubrication instructions.

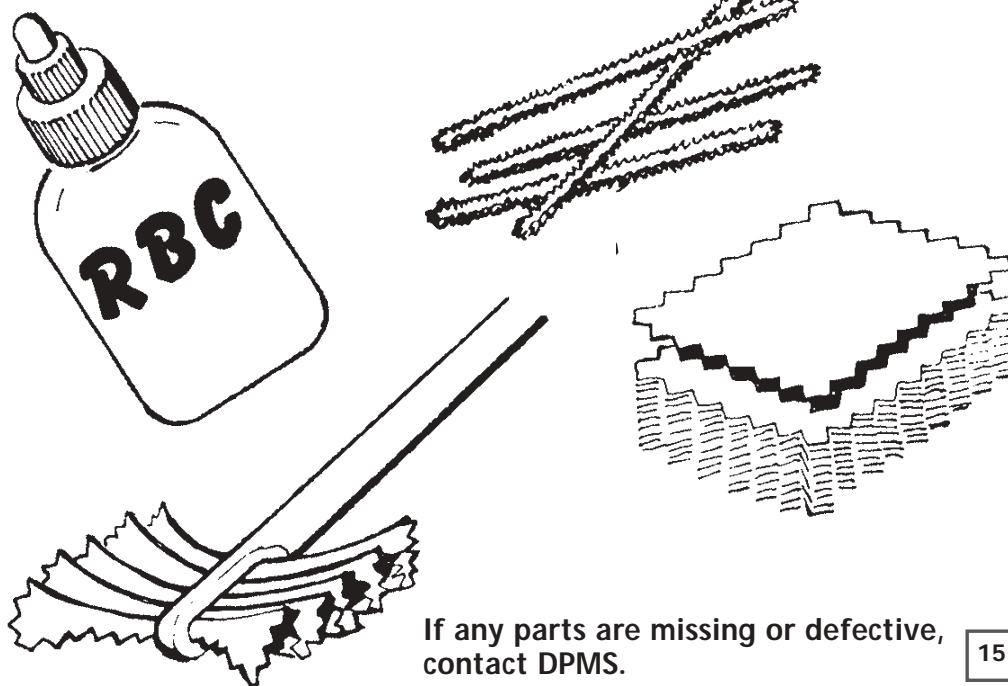

If any parts are missing or defective, contact DPMS.

15

.223 CALIBER

LUBRICATING GUIDE

Lightly Lube - A film of oil barely visible to the eye.

Generously Lube - Heavy enough so that it can be spread with the finger.

Remember to remove excessive oil from the bore before firing.

LUBRICATING

Upper Receiver

LIGHTLY LUBE:

BORE & CHAMBER, OUTER SURFACES OF BARREL AND FRONT SIGHT, SURFACES UNDER HANDGUARD, DEPRESS FRONT SIGHT DETENT SEVERAL TIMES TO WORK LUBE INTO THE SPRING.

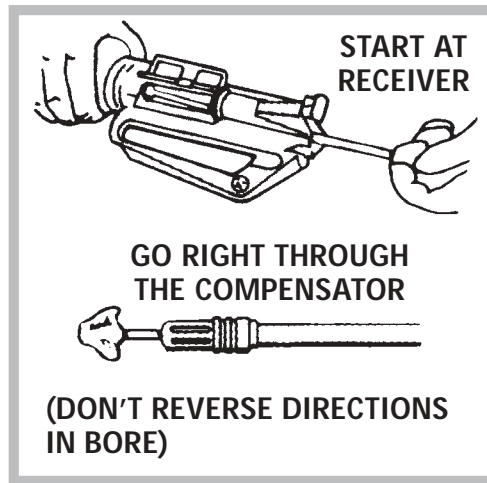
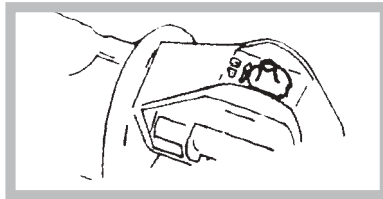
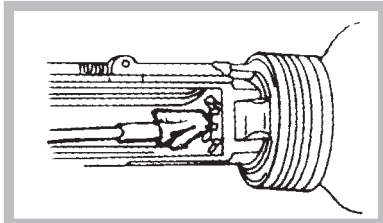
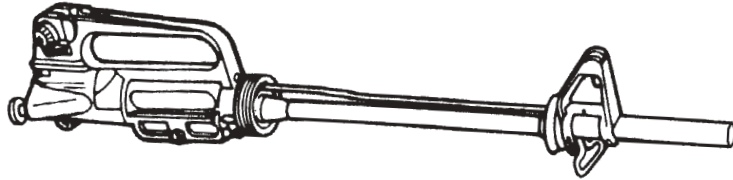

Bolt Carrier Group

GENEROUSLY LUBE OUTSIDE OF THESE PARTS

MAKE CERTAIN TO GET CAM PIN AREA, PISTON RINGS, AND OUTSIDE OF THE BOLT BODY.

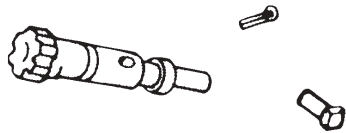

CAUTION

Lightly lube firing pin and firing pin recess in bolt.

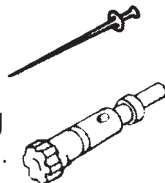

DRY WITH PIPE CLEANER, THEN PLACE ONE DROP OIL

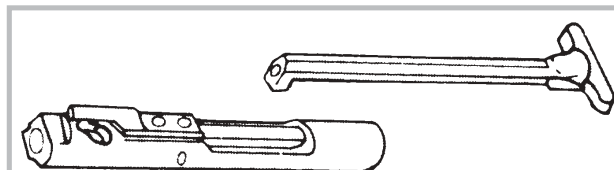
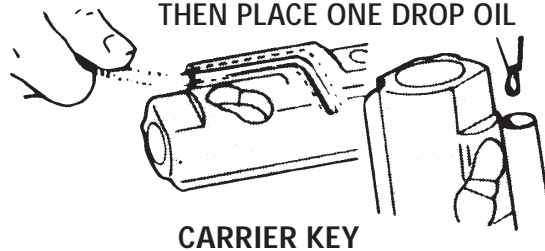

LIGHTLY LUBE CHARGING HANDLE, INNER AND OUTER SURFACES OF BOLT CARRIER. GENEROUSLY LUBE SLIDE AND CAM PIN AREA OF BOLT.

LUBRICATING

Lower Receiver Group

GENEROUSLY LUBE

TAKE DOWN AND PIVOT PINS

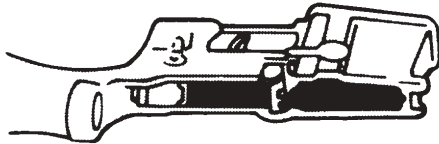

INSIDE PARTS LOWER RECEIVER

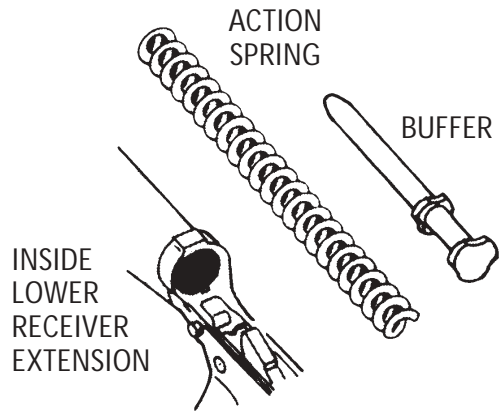

INSPECT - before assembly

WARNING DO NOT interchange bolts between rifles

BT-02A



BOLT - Cracks or fractures, especially in the cam pin hole area. Bolts that contain pits extending into the firing pin hole need replacing.

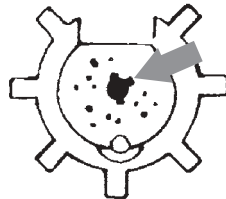

BT-16

FIRING PIN RETAINING PIN - Replace if bent, broken, or badly worn.

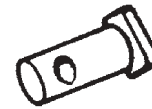

BT-17

CAM PIN - Replace if cracked, chipped or missing.



BT-14

FIRING PIN - Replace if it has a bent, cracked or blunted end.



BT-08

BT-07

IF PARTS ARE MISSING OR DEFECTIVE, CONTACT DPMS.

EXTRACTOR AND EXTRACTOR SPRING - Check extractor for chipped or broken edges in the area of the lip that engages the cartridge rim.

.223 CALIBER

ASSEMBLY

.223 CALIBER

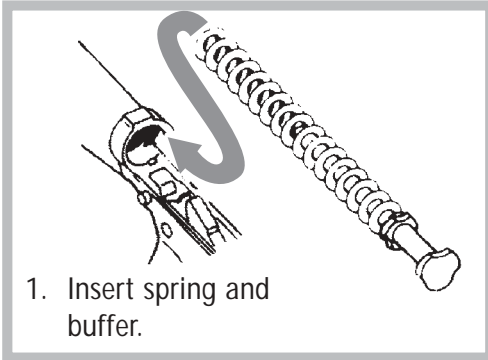

New extractor has a silicone insert w/spring. Be sure not to lose it. If the spring comes loose, put the large end of spring in the extractor and seat.

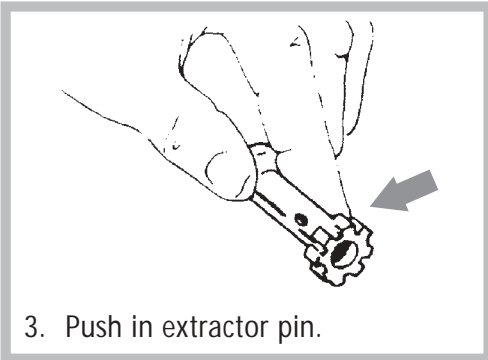
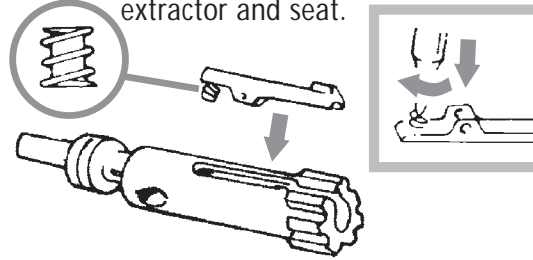

WARNING

Don't switch bolts between rifles.

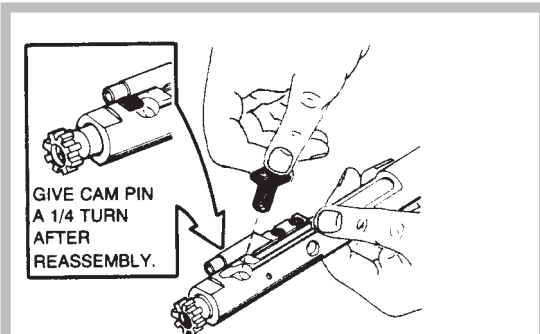
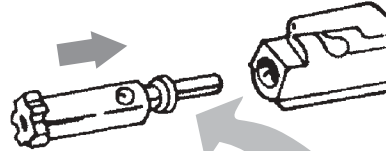

WARNING

Be sure that the cam pin is installed in the bolt group. If it isn't, your rifle can still fire and will explode.

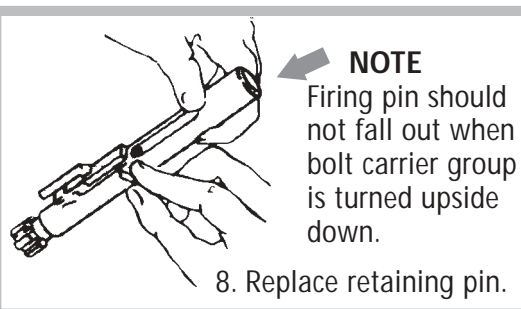
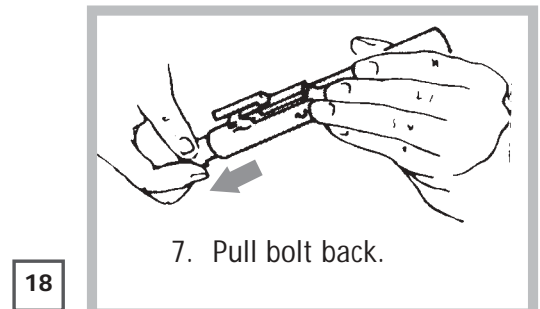
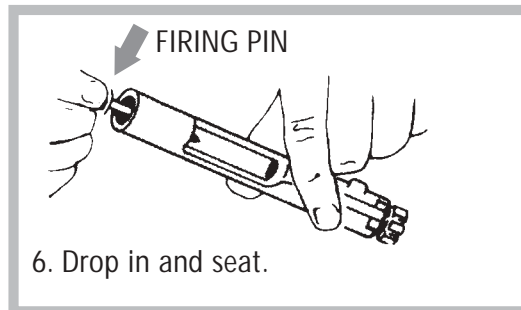
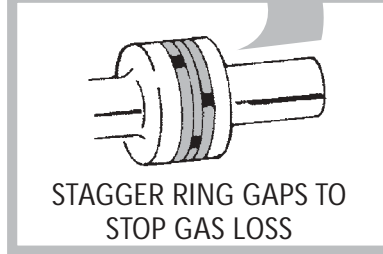

ASSEMBLY

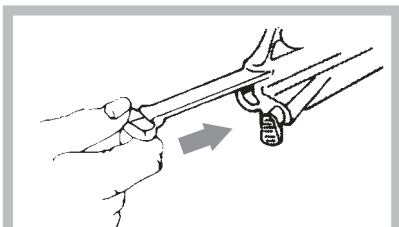

9. Engage, then push charging handle part way.

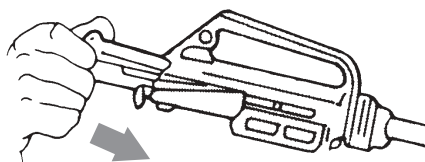

11. Push in charging handle and bolt carrier group together.

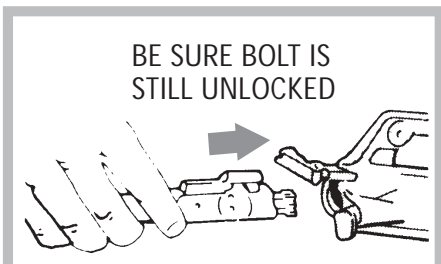

10. Slide in bolt carrier group.

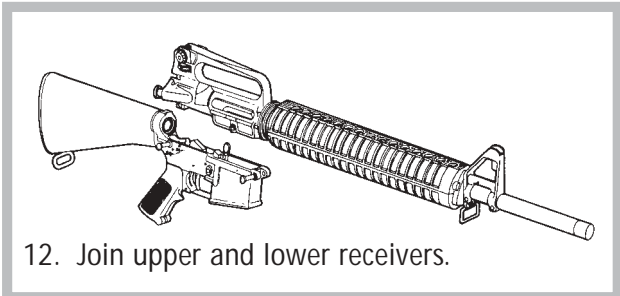

12. Join upper and lower receivers.

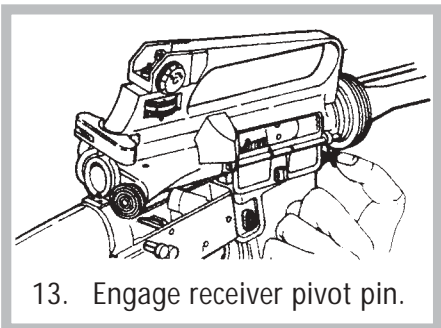

13. Engage receiver pivot pin.

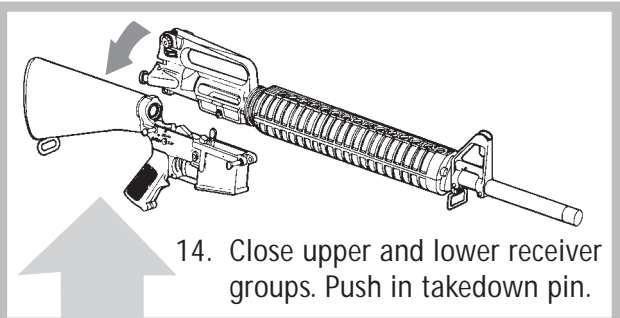

14. Close upper and lower receiver groups. Push in takedown pin.

CHECK THE **selector lever** BY PERFORMING THE **FUNCTIONAL CHECK** SEE PAGE 6.

CAUTION

Selector lever must be on safe before closing upper receiver.

FIRE



SAFE

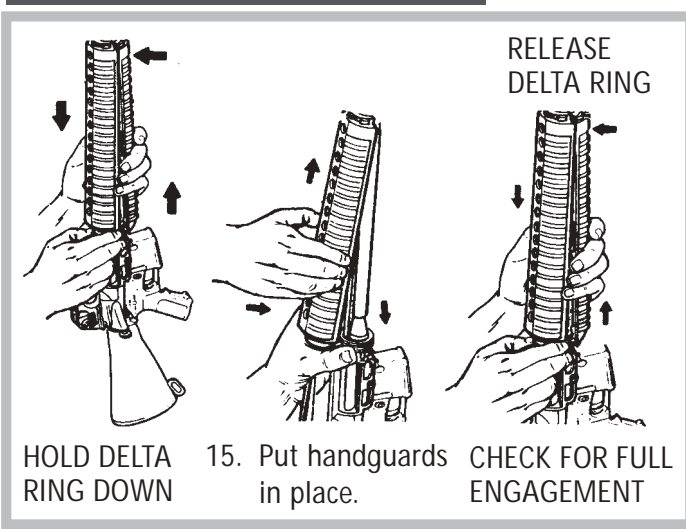

HOLD DELTA RING DOWN

15. Put handguards in place.

CHECK FOR FULL ENGAGEMENT

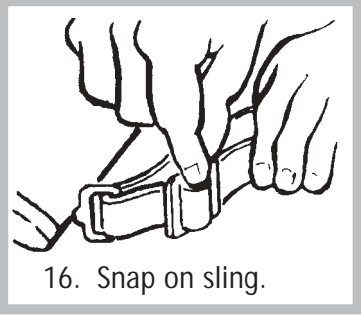

16. Snap on sling.

IS EVERYTHING INSTALLED?

.223 CALIBER

UNUSUAL CONDITIONS

EXTREME COLD -

- Clean and lubricate rifle with gun lubricant. Keep it moisture-free.
- Operate controls through their entire range, at intervals, to keep them from freezing up.
- When your rifle is not being used and kept outside, protect it with a cover.

HOT CLIMATES -

- Inspect rifle and bipod more frequently, especially the hidden surfaces of bolt carrier group, forward assist assembly and lower receiver components. Make certain they are lubricated using gun lubricant.
- When handling, make certain to wipe dry, as moisture could cause corrosion. After drying, lubricate with gun lubricant.

HOT, DRY CLIMATES -

Clean and oil rifle more frequently with gun lubricant.

DUSTY AND SANDY AREAS -

- Clean and lubricate your rifle more frequently.
- Keep sand out of parts when inspecting, lubricating, or assembling rifle. Apply only a very light amount of lubrication on outside of rifle.
- Use magazine bag and muzzle cap for dust and sand protection.

CAUTION: Do not use magazine bag and muzzle cap on stored rifles.

PROJECTILE LODGED IN BORE

WARNING

If an audible "POP" or reduced RECOIL is experienced during firing, immediately **CEASE FIRE**, remove the magazine (1), lock the bolt to the rear (2), and place the selector lever on the "SAFE" position (3). Visually inspect and/or insert a cleaning rod into the bore to ensure there is not a projectile lodged in the bore (4).

DO NOT APPLY IMMEDIATE ACTION.

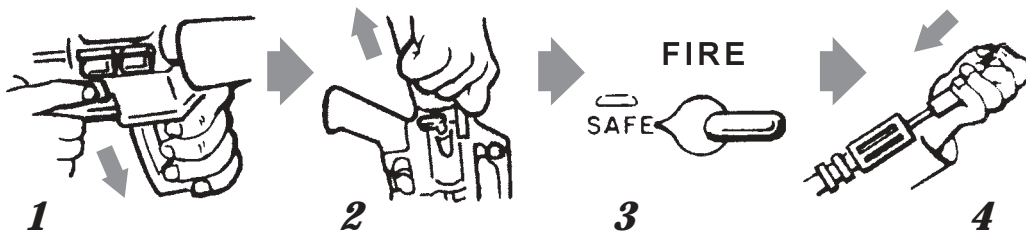

If a projectile is lodged in the barrel of the weapon, **DO NOT** attempt to remove it. Contact DPMS.

***TROUBLESHOOTING SECTION
LOCATED ON PAGES 34-35***

.22LR

Includes the Following Rifles:

Panther .22LR

Panther DCM .22LR

Panther AP4 .22LR Training Rifle

Panther.22LR Pistol



Panther .22LR



Panther DCM .22LR



*Panther AP4 .22LR
Training Rifle*



*Panther AP4 .22LR
Pistol*

.22LR CALIBER

***Before continuing in this section, please
be sure you have read pages 4-6!***

SIGHTS

The .22LR bull barrel and the AP4 training rifle can have a scope, reflex sight or other sighting device mounted directly to the Picatinny Rail on top of the receiver. The AP4 can also utilize a detachable A2 sight or carry handle, and the DCM rifle comes standard with national match A2 sights.

The front sight of both the DCM and the AP4 rifle is adjustable for elevation during zeroing. Once zeroed, the front sight is not adjusted during normal firing.

The rear sight is adjustable for both windage and elevation, and can be easily used during shooting to compensate for range and windage.

Although the elevation knob is the same as the one used on other DPMS rifles, you will not be able to “battle sight zero” and adjust for elevation as you would with the 5.56. This is due to the reduced ballistics offered by the .22LR. In order to adjust the rear sight for elevation or windage, adjust the aperture in the direction you wish to move the impact of the bullet. For example, if you are hitting left of your intended target, move the rear sight to the right. If you are hitting low, adjust the sight higher, etc.

LOADING A MAGAZINE

CAUTION: Always check that ammunition is clean and undamaged before using. Loading damaged ammunition into the chamber could damage your rifle and could result in personal injury, death or damage to property.

1. Only use ammunition for which your firearm is chambered.
2. With front of magazine forward, place a round between the lips of the magazine with the bullets pointed forward. Press the round until the magazine lips retain it. Place the next round on top of the last and repeat until the desired number is loaded.



LOADING THE RIFLE

Make sure the rifle is pointed in a safe direction and the safety is engaged at all times while loading the rifle.

NEVER allow your fingers or other objects to contact the trigger while loading or unloading the rifle.

Do **NOT** disengage the safety until you are ready to fire and have the rifle pointed safely downrange.

1. Ensure that the selector is in the "SAFE" position. (Photo 23-A)
2. With the bullets facing forward, insert loaded magazine into magazine well and push it in until it stops and is retained by the magazine catch. Tap the bottom of the magazine in an upward motion to ensure that the magazine is seated tight. (Photo 23-B) (Photo 23-C)



3. With the rifle pointed in safe direction pull all the way back on the charging handle and return it to the fully forward locked position to cock the hammer and feed a round into the chamber. The rifle is now loaded with a round in the chamber and the hammer cocked. (Photo 23-D) (Photo 23-E)
4. Make sure safety selector is still on safe. (Photo 23-F)



UNLOADING THE RIFLE

1. Set selector to "SAFE" position. (Photo 23-G)
2. Press magazine catch button and remove magazine. (Photo 23-H)
3. Pull charging handle completely to the rear. If a round had been in the chamber it should have been ejected. Make sure to visually check to make sure that the chamber is empty. After visual inspection of the chamber, allow the bolt forward to the closed position. (Photo 23-I)



FIRING THE RIFLE

Firing Preparation

Before firing your rifle, practice your stance, aim, rhythm and breathing for a steady aim with your firearm unloaded. You should practice firing on a range before going hunting or before using your firearm for any other type of shooting.

1. Always wear eye and ear protection when firing your weapon.
2. Load firearm as previously described.
3. Grasp firearm with one hand on handguard and the other hand on the pistol grip with trigger finger resting along side of the trigger guard. Raise firearm and pull buttstock firmly into shoulder.
4. Aim by aligning your scope with the target. (Scope not included)
5. Move selector to "FIRE".
6. Keeping steady aim, place trigger finger on trigger and gently squeeze until trigger releases hammer. Do not jerk trigger as you will disturb your aim and ruin your accuracy. To fire the next round and subsequent rounds, all that is necessary is to release the trigger and gently squeeze the trigger again after every shot until you are finished firing or the magazine is emptied.
7. This is a semi-automatic firearm and is immediately loaded and ready to fire after each shot until the magazine is empty and the last round in the chamber has been fired.
8. Release trigger, remove finger from trigger and set selector lever to "SAFE." If you have fired the last round from magazine, the bolt assembly will not be held to the rear, so you will need to pull back the bolt to ensure the chamber is empty.
9. **Important! This rifle will fire a chambered round with the magazine removed.**

Attention: No bolt hold open device for last round!

MOUNTING OPTICS

The Panther .22LR rifle has either a flattop upper receiver featuring a MIL-STD-1913 Picatinny rail on top, or an A2 upper receiver.

The rail will accept Weaver-based rings and mounts. Standard size rings will be sufficient for scopes with objective diameters less than 40mm. Larger diameter scopes, depending on the size of the objective lens, may need either a riser or high rings.

The A2 upper receiver features a scope hole mount for many of the A2 mounting systems.



A2 Upper Receiver



Flattop Upper Receiver

MAINTENANCE

Your DPMS rifle is based on a military rifle design and is very rugged but proper maintenance is necessary to keep it in good working condition.

Field Stripping Disassembly (Make sure your rifle is unloaded, with no ammunition in the chamber.)

1. Bolt assembly should be closed in the forward position.
2. Press the rear take down pin in from left of lower receiver (it may be necessary to use a punch as the fit between upper and lower receivers may be very tight.) Pull the pin out until it comes to a positive stop. A detent keeps the take down pin from falling out of the rifle.
3. Pivot the upper receiver and barrel assembly down and away from the lower receiver.
4. Press the front pivot pin in from the left side of lower receiver and pull out right side until it comes to a positive stop. A detent keeps the front pivot pin from falling out of the rifle.

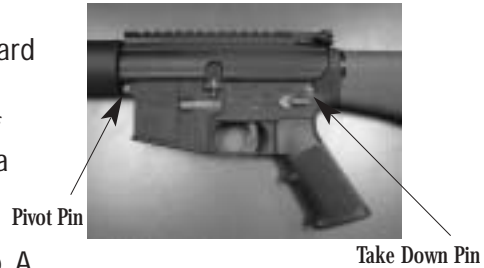

5. You can now separate the upper and lower receivers. (Photo 25-A)
6. Pull charging handle to rear and remove bolt assembly. (Photo 25-B)
7. Remove charging handle by gently pulling it backwards until you feel a slight resistance. Charging handle will fall free from the upper receiver. Do not force the charging handle, damage to the charging handle wings may occur. (Photo 25-C)
8. Gently clean and lubricate the .22LR bolt assembly, but do not disassemble further without first contacting DPMS.



25-A



25-B



25-C

CLEANING

Upper Receiver (CLEAN WITH BORE CLEANER)

- All areas of powder fouling, corrosion, dirt and rust (25-D)
- Bore & chamber (25-E)

BORE BRUSH-(DON'T REVERSE DIRECTION WHILE IN BORE)

Use a worn bore brush to clean the inside surfaces of the upper receiver.

Lower Receiver

- Clean areas of powder fouling, corrosion and dirt.
- Wipe dirt from trigger mechanism.

CAUTION: Do not use wire brush or any type of abrasive material to clean aluminum surfaces.



25-D



25-E

UNUSUAL CONDITIONS

Extreme Cold-

- a. Clean and lubricate rifle using a gun lubricant. (Break Free™, Mil-Tech™, etc.) Keep it moisture free.
- b. Operate controls through their entire range, at intervals, to keep them from freezing up.
- c. When your rifle is not being used and kept outside, protect it with a cover.

Hot Climates-

- a. Inspect rifle more frequently, especially the hidden surfaces of the bolt assembly, and lower receiver components. Make certain they are lubricated with a gun lubricant.
- b. When handling, make certain to wipe dry, as moisture could cause corrosion. After drying, lubricate with gun lubricant.

Hot, Dry Climates-

- a. Clean and oil rifle more frequently with a gun lubricant.

Dusty and Sandy Areas-

- a. Clean and lubricate your rifle more frequently.
- b. Keep sand out of parts when inspecting, lubricating, or assembling rifle. Apply only a very light amount of lubrication on outside of rifle. Using too much lubricant can attract dust and sand.

TROUBLESHOOTING

Problem	Check For	What To Do
Won't Fire	Selector lever on SAFE	Put on FIRE
	Defective ammo Too much carbon on firing pin	Remove & discard Clean
Won't Extract	Broken extractor spring or extractor Dirty or corroded ammo	Contact DPMS Remove. Push the round out by running a cleaning rod down the barrel from the muzzle. Be careful not to scrape or gouge the rifling.
	Carbon in chamber - Fouling or carbon in extractor recess or lip.	Clean chamber
Won't Feed	Dirty or corroded ammo	Clean
	Dirty magazine	Clean
	Defective magazine	Replace

TROUBLESHOOTING

Problem	Check For	What To Do
Won't Feed <i>(Press button on right side. Turn catch clockwise to tighten and counterclockwise to loosen.)</i>	Magazine not fully seated	Adjust magazine catch.
Won't Chamber	Dirty or corroded ammo Damaged ammo Carbon in chamber	Replace ammo Replace Clean
Double Feed	Defective magazine	Replace
Short Recoil	Defective ammo Carbon or dirt in carrier	Replace Clean
Selector Lever Binds	Needs oil	Lubricate with gun lubricant

ATTENTION:

Please Note: .22LR rifles may not function properly with an adjustable trigger installed.

Additional information pertaining to the three year limited warranty, additional warnings and information concerning how to return merchandise to DPMS can be found on page 36.



Panther LR-308

.30 Caliber

Includes the Following Rifles:

Panther LR-243

Panther LR-308T

Panther LR-260

Panther LR-308AP4

Panther LR-260H

Panther LRT-SASS

Panther LR-308

Panther LR-30S

Panther LR-308B

*Before continuing in this section, please
be sure you have read pages 4-6!*

LOADING A MAGAZINE

CAUTION: Always check that ammunition is clean and undamaged before using. Loading damaged ammunition into the chamber could damage your rifle and could result in personal injury, death or damage to property.

1. Use only ammunition for which your firearm is chambered (Photo 29-A).
2. With front of magazine forward, place a round between the lips of the magazine with the bullets pointed forward. Press the round until the magazine lips retain it. Place the next round on top of the last and repeat until desired number is loaded (Photo 29-B)(Photo 29-C).



LOADING THE RIFLE

1. Pull back on the charging handle to cock the hammer, and then press in on the bottom of the bolt catch to lock back the bolt carrier assembly (Photo 29-D).
2. Return the charging handle fully forward until it locks and remove finger from bolt catch (Photo 29-E).
3. Set selector to "SAFE" position (Photo 29-F).



4. With the bullets facing forward, insert loaded magazine into magazine well and push it in until it stops and is retained by the magazine catch. Tap the bottom of the magazine in an upward motion to ensure that the magazine is seated tight. (Photo 29-G)
5. With the rifle pointed in safe direction press in on the top button of bolt catch. This will release the bolt and carrier and move a round into the chamber. The rifle is now loaded with a round in the chamber and the hammer cocked. (Photo 29-H)
6. Make sure safety selector is still on safe. (Photo 29-I)



UNLOADING THE RIFLE

1. Set selector to "SAFE" position. (Photo 30-A)
2. Press magazine catch button and remove magazine. (Photo 30-B)
3. Pull charging handle to rear and push in lower portion of the bolt catch. If a round had been in the chamber it would have been ejected. Make sure to visually check to make sure that the chamber is empty. If last round in magazine had been fired, bolt and carrier should already be held to the rear, if the magazine was in place. (Photo 30-C)



FIRING THE RIFLE

Firing Preparation

Before firing your rifle, practice your stance, aim, rhythm and breathing for a steady aim with your firearm unloaded. You should practice firing on a range before going hunting or before using your firearm for any other type of shooting.

1. Always wear eye and ear protection when firing your weapon.
2. Load firearm as previously described.
3. Grasp firearm with one hand on handguard and other hand on pistol grip with trigger finger resting along side of trigger guard. Raise firearm and pull buttstock firmly into shoulder.
4. Aim by aligning target with your scope. (Scope not included)
5. Move selector to "FIRE".
6. Keeping steady aim, place trigger finger on trigger and gently squeeze until trigger releases hammer. Do not jerk trigger as you will disturb your aim and ruin your accuracy. To fire the next round and subsequent rounds, all that is necessary is to release the trigger and gently squeeze the trigger again after every shot until you are finished firing or the magazine is emptied.
7. This is a semi-automatic firearm and is immediately loaded and ready to fire after each shot until the magazine is empty and the last round in the chamber has been fired.
8. Release trigger, remove finger from trigger and set selector lever to "SAFE." If you have fired the last round from magazine, the bolt and carrier will be held to the rear so that you can quickly reload by replacing the magazine or if not reloading, the chamber should be checked to ensure that it is empty.
9. **WARNING:** This rifle will fire a chambered round with the magazine removed.

MOUNTING OPTICS

Panther .308 rifles feature a Lo-Pro style upper receiver. These rifles have a Mil-Std-1913 Picatinny Rail on the top of the receiver.

This will accept Weaver based rings and mounts. Standard size rings will be sufficient for scopes with objective diameters less than 40mm. Larger diameter scopes, depending on the size of the objective lens, may need either a riser or high rings.



MAINTENANCE

Your DPMS rifle is based on a military rifle design and is very rugged but proper maintenance is necessary to keep it in good working condition.

Field Stripping Disassembly (Make sure your rifle is unloaded, with no ammunition in the chamber.)

1. Bolt carrier assembly should be closed in the forward position.
2. Press the rear take down pin in from left of lower receiver (it may be necessary to use a punch as the fit between upper and lower receivers may be very tight.) Pull the pin out until it comes to a positive stop. A detent keeps the take down pin from falling out of the rifle.
3. Pivot the upper receiver and barrel assembly down and away from the lower receiver.
4. Press the front pivot pin in from the left side of lower receiver and pull out right side until it comes to a positive stop. A detent keeps the front pivot pin from falling out of the rifle.
5. You can now separate the upper and lower receivers.
6. Pull charging handle to rear and remove bolt and carrier assembly. (Photo 31-A)
7. Remove charging handle by gently pulling it backwards until you feel a slight resistance. Charging handle will fall free from the upper receiver. Do not force the charging handle, damage to the charging handle wings will occur.
8. To remove the firing pin, first you must remove the firing pin retainer. Push the firing pin retainer from right to left. Remove it by pulling the retainer pin all the way out of the carrier.

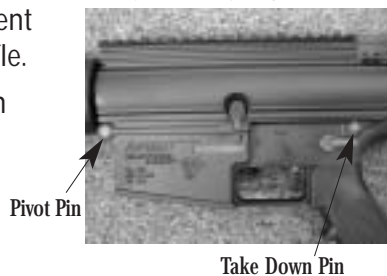

MAINTENANCE

9. Tilt bolt face up and remove firing pin.
10. Push bolt in towards the carrier until it rotates and comes to a stop.
11. Remove cam pin by lifting it out away from bolt and carrier.
12. Pull bolt forward out of carrier. (Photo 32-A)
13. Depress buffer, maintaining pressure as buffer is under spring tension, to prevent it from being ejected when buffer retainer is depressed. Depress buffer retainer to permit buffer and spring to move forward and be removed from receiver extension. (Photo 32-B)
14. With a punch, remove the extractor pin from the bolt assembly. (Photo 32-C)
15. Remove the extractor and spring. DO NOT remove the spring from extractor! (Photo 32-D)
16. Press top of extractor spring for spring function. Do not strip your firearm further than previously described. If additional maintenance is necessary, consult DPMS or a competent gunsmith. Your rifle is now field stripped for cleaning. To reassemble, repeat procedure in reverse order.



Notes on the Panther .308

The .308 does use a different buffer and spring than the standard A-15 rifles even though it takes the same A-15 A2 stock.

CLEANING

Upper Receiver [CLEAN WITH RBC (Rifle Bore Cleaner)]

- All areas of powder fouling, corrosion, dirt and rust (32-E)
- Bore & chamber (32-F)
- Locking lugs (32-F)
- Gas tube (32-G)

BORE BRUSH-

(DON'T REVERSE DIRECTION WHILE IN BORE!)

Use a worn bore brush to get outside surface of protruding gas tube (get sides and bottom from bottom of receiver.)



CLEANING

Lower Receiver

- Clean areas of powder fouling, corrosion and dirt.
- Wipe dirt from trigger mechanism.
- Clean buffer and inside lower receiver extension.

CAUTION: Do not use wire brush or any type of abrasive material to clean aluminum surfaces.

Bolt Carrier Group

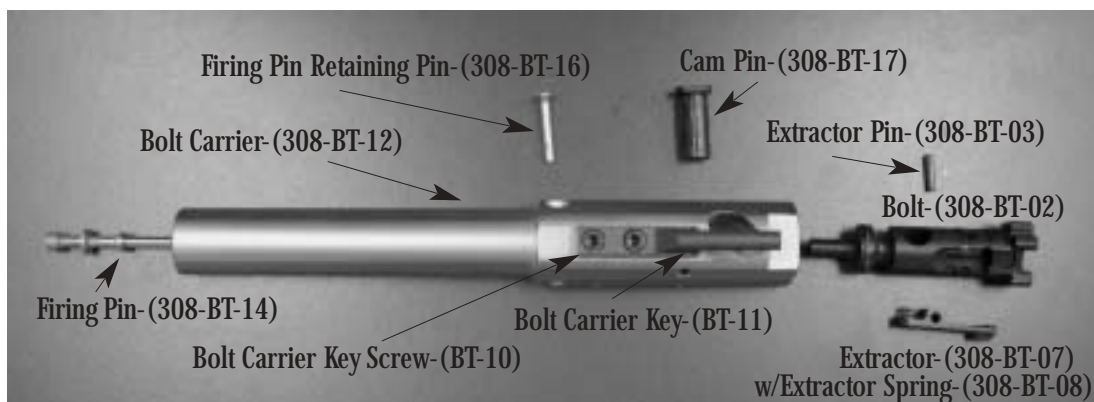

CLEANING

Bolt Carrier Group

- Outer & inner surfaces of bolt carrier. (Photo 33-A)
- Carrier key. (Photo 33-A)
- Firing pin recess and firing pin. (Photo 33-B)
- Firing pin hole (Use pipe cleaner)
- Carbon deposits & dirt from locking lugs. (Photo 33-C)
- Areas behind bolt ring and under lip of extractor. (Photo 33-D)

NOTE: There is no rubber tip inside the extractor spring.

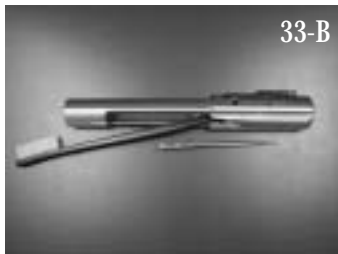

UNUSUAL CONDITIONS

Extreme Cold-

- a. Clean and lubricate rifle using a gun lubricant. (Break Free™, Mil-Tech™, etc.) Keep it moisture free.
- b. Operate controls through their entire range, at intervals, to keep them from freezing up.
- c. When your rifle is not being used and kept outside, protect it with a cover.

Hot Climates-

- a. Inspect rifle more frequently, especially the hidden surfaces of the bolt assembly, and lower receiver components. Make certain they are lubricated with a gun lubricant.
- b. When handling, make certain to wipe dry, as moisture could cause corrosion. After drying, lubricate with gun lubricant.

Hot, Dry Climates-

- a. Clean and oil rifle more frequently with a gun lubricant.

Dusty and Sandy Areas-

- a. Clean and lubricate your rifle more frequently.
- b. Keep sand out of parts when inspecting, lubricating, or assembling rifle. Apply only a very light amount of lubrication on outside of rifle. Using too much lubricant can attract dust and sand.

TROUBLESHOOTING

Problem	Check For	What To Do
Won't Fire	Selector lever on SAFE	Put on FIRE
	Improper assembly of firing pin	Assemble correctly
	Too much oil in firing pin recess	Wipe off
	Defective ammo	Remove & discard
Bolt Won't Unlock	Too much carbon on firing pin	Clean
	Dirty	Clean
Won't Extract	Broken extractor spring	Contact DPMS
	Dirty or corroded ammo	Remove. Push stuck round with cleaning rod. Be careful not to damage rifling. If possible, use a plastic rod.
	Carbon in chamber - Fouling or carbon in extractor recess or lip.	Clean chamber

TROUBLESHOOTING

.30 CALIBER

Problem	Check For	What To Do
Won't Feed	Dirty or corroded ammo	Clean
	Dirty magazine	Clean
	Defective magazine	Replace
	Too many rounds in magazine	Take out excess
	Restricted buffer assembly action	Take out buffer and spring, clean
	Magazine not fully seated	Adjust magazine catch. <i>(Press button on right side. Turn catch clockwise to tighten and counterclockwise to loosen.)</i>
Won't Chamber	Dirty or corroded ammo	Replace ammo
	Damaged ammo	Replace
	Carbon in chamber	Clean
Won't Lock	Dirt, corrosion or carbon buildup in barrel locking lugs	Clean lugs
	Frozen extractor	Remove and clean
	Restricted buffer assembly	Remove and clean
	Restricted movement of bolt	Remove, clean, lube carrier group. <i>(When putting bolt back in, make sure gas tube fits into carrier key and moves freely.)</i>
Double Feed	Defective magazine	Replace
Short Recoil	Gaps in bolt rings (not staggered)	Stagger ring gaps
	Carbon or dirt in carrier key or on outside of gas tube	Clean
Bolt Fails to Lock After Last Round	Dirty or corroded bolt catch	Clean
	Faulty magazine	Replace
Selector Lever Binds	Needs oil	Lubricate with a gun lubricant
Bolt Carrier "Hung Up"	Round jammed between bolt and charging handle	
	1. Remove magazine charging handle	
	2. Hold charging handle back and bang rifle butt on ground. KEEP CLEAR OF MUZZLE! Caution: After round is removed, bolt is under tension.	
	3. While bolt is held to rear, push charging handle forward. Round should fall through magazine well.	

THREE YEAR LIMITED WARRANTY

This DPMS/Panther Arms firearm is warranted to the original retail customer for Three Years from the date of purchase against defects in material and workmanship. All parts and labor or replacement at our option are covered.

Transportation to and from our repair facilities, government fees, damage caused by failure to perform normal maintenance, sales outside the United States, damage due to high velocity, high pressure, reloaded or other nonstandard ammunition, or any unauthorized repair, modification, misuse, abuse, or alteration of the product is not covered by this Limited Warranty.

Any implied warranties, including the implied warranties of merchantability and fitness for a particular purpose, are limited to one year from date of purchase. Consequential or incidental damages and/or expenses, or any other expenses are not covered by this warranty.

To obtain warranty performance send your firearm with proof of retail purchase, freight prepaid to:

DPMS/Panther Arms
3312 12th Street SE
St. Cloud, MN 56304

WARNING - Alterations & Modifications

Altering or modifying parts is dangerous and will void the warranty. This DPMS/Panther Arms rifle was manufactured to perform properly with the original parts as designed. It is your duty to make sure any parts you buy are made for this rifle and are installed correctly and that neither the replacements nor originals are altered or changed. Your DPMS/Panther Arms rifle is a complex precision tool with many parts that must relate correctly to other parts in order for proper and safe operation. Putting a rifle together wrong or with incorrect or modified parts can result in a damaged rifle, serious personal injury or death to you and others through malfunction. Always have a qualified gunsmith work on your rifle or at least check any work not performed by a gunsmith.

PROBLEMS/RETURNS

Although we go to great lengths to make a perfect product and get it to you in perfect condition, sometimes things happen! If there is a problem with our product or if shipping damage has occurred, please call us immediately for instructions at 800-578-3767, visit our website at www.dpmsinc.com or email us at dpms@dpmsinc.com.

NOTE: It is illegal to ship a firearm with ammunition in the firearm or in the same packaging. Firearms and ammunition must be shipped separately. For more information about shipping, call DPMS/Panther Arms at (320) 258-4448.

AMMUNITION WARNING

Due to a number of calls and comments concerning AR-type rifles, we have incurred feeding problems with the following:

- A) 1. Israeli ammunition
- 2. Korean ammunition

We have heard and reviewed several reports of problems with many manufacturers' rifles using this ammunition. The problem appears to be the bullet contour and the overall length of the cartridge, which is contacting the rifling before firing. This is creating a gas port pressure and chamber pressure higher than recommended, therefore causing feeding and extraction problems due to the increased bolt carrier velocity. In addition, there is accelerated fatigue on internal parts. There are also indications that brass may be oversized, which could create an unsafe condition.

- B) 1. PMP
- 2. South African produced surplus

We have used this ammunition in the past for testing purposes and found that the brass is extremely soft and can "flow" into microscopic pores and grooves in the chamber, creating "sticky" extraction. This had been reported in many types of rifles, but is more prevalent in semi-automatic weapons.

- C) Lacquer Coated Ammunition or Steel-cased, lacquer coated ammunition

The problem with this ammunition is the lacquer coating on the case. As the barrel heats up, the lacquer turns to a soft, varnish substance and upon cool down, becomes very solid and difficult to remove. This effectively creates an undersized chamber and creates understandable problems.

DPMS recommends the use of high quality, domestically produced ammunition for best results and highest accuracy. For plinking and practice, we recommend only domestic, commercially manufactured ammunition or high quality surplus NATO specification ammunition. **Please note that the use of re-loaded ammunition voids the factory warranty as well as the use of the above-mentioned types of ammunition.**

Your rifle is an investment and it only makes sense to choose quality ammunition for a quality rifle!

BARREL INFORMATION

To achieve the best results for accuracy you should clean the chamber and bore after every round for the first 25 rounds and then every 10 rounds up to 100 rounds. It usually takes about 200 rounds per barrel for optimum accuracy. Please keep in mind that our barrels are production barrels not custom barrels. Accuracy is dependent upon many factors such as bullet weight, powder load, rifling twist, rifling lands, operator technique, etc. Our production barrels have achieved anywhere from 1/8" to 1 1/2" M.O.A. Obviously, we would hope that every production barrel would shoot 1/8" M.O.A., but with all of the above factors, we cannot guarantee a specific group size.

RIFLES • PARTS • ACCESSORIES

**DPMS offers a complete line of
AR Rifles,
Parts and Accessories**

**Call for a catalog or visit us
online at www.dpmsinc.com and
download the latest version!**

**THANK YOU FOR
CHOOSING DPMS!**





3312 12th Street SE, St. Cloud, MN 56304
Phone 1-320-258-4448 • Fax 1-320-258-4449
www.dpmsinc.com • email: dpms@dpmsinc.com

1-800-578-DPMS

Orders only please (3767)