

# **POWER LINE<sup>®</sup> MODEL 1200**

*.177 Cal. Gas Operated CO<sub>2</sub> B•B Pistol*

## **OPERATION MANUAL**



MODEL 1200

**CAUTION:** NOT A TOY. ADULT SUPERVISION REQUIRED. MIS-USE OR CARELESS USE MAY CAUSE SERIOUS INJURY OR DEATH. MAY BE DANGEROUS UP TO 253 YARDS (232 METERS).

THIS IS A HIGH POWER CO<sub>2</sub> GAS GUN INTENDED FOR USE BY THOSE 16 YEARS OF AGE OR OLDER. READ ALL INSTRUCTIONS BEFORE USING. THE PURCHASER AND USER SHOULD CONFORM TO ALL LAWS GOVERNING USE AND OWNERSHIP OF CO<sub>2</sub> GAS GUNS.

Shoots: B•B Cal. (4.5mm) Steel Air Gun Shot <sup>®</sup>

The Power Line Model 1200 CO<sub>2</sub> B•B pistol is a new and more powerful type gun than a traditional spring air B•B pistol. It shoots with twice the power of the spring air B•B gun and must be treated as any powerful gun.

The Air Pistol Shooting Guide section of this manual is important to the care and safe handling of any gun. **READ THIS SECTION.** Follow the safety rules and make certain that anyone using your pistol follows the safety rules.

For your safety and the safety of others, read complete operating instructions before attempting to shoot the pistol.

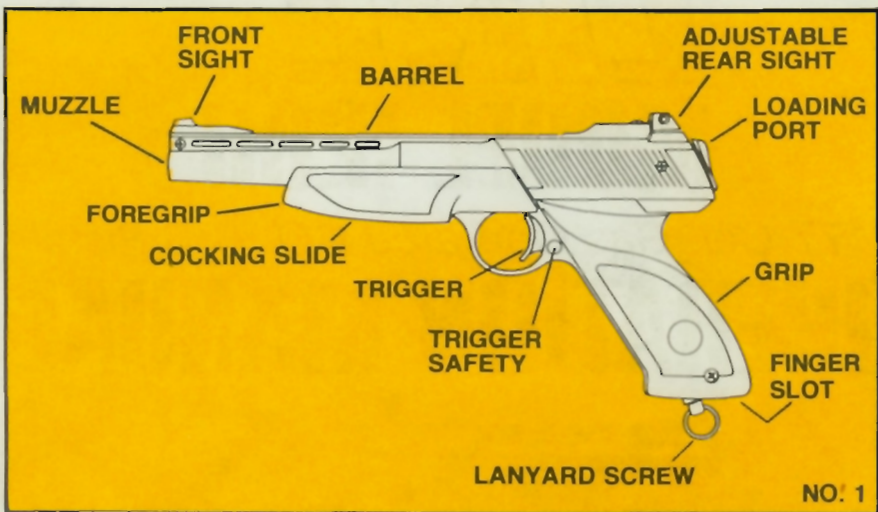

## PRIOR TO OPERATION

**LOAD B•B MAGAZINE:** PUT ON SAFE (See Operation Step 1). Swing loading gate either direction to uncover loading port (Drawing 2). Fill with approximately 60 B•Bs, then swing loading gate closed. **CAUTION:** Use only B•Bs that are labeled as such. Do not use lead pellets, buck shot, ball bearings, or other foreign objects because they could damage or jam the pistol.

## INSERT CO<sub>2</sub> CYLINDER:

1. Remove left grip cover by lifting at the finger slot on the bottom of the grip (Drawing 1).
2. Turn lanyard ring counterclockwise until there is enough room to insert a CO<sub>2</sub> cylinder.
3. Lay the CO<sub>2</sub> cylinder, narrow end up, in the groove below the puncture pin retainer (Drawing 3).
4. Replace the left grip cover.

5. Turn lanyard ring clockwise to puncture the CO<sub>2</sub> cylinder. Continue turning **RAPIDLY** until finger tight. Note: A slight seepage of gas may occur until lanyard ring is tight.

**CAUTION:** Use only CO<sub>2</sub> cylinders. Any attempt to use other types of gas cylinders would be extremely dangerous and could result in serious injury.

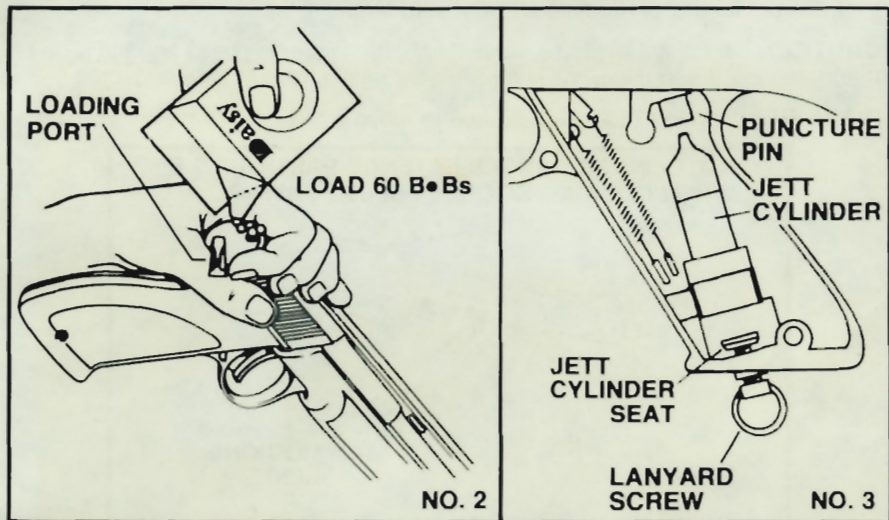

## OPERATION STEPS

1. PUT "ON SAFE"
2. COCK AND LOAD (muzzle down)
3. AIM AT SAFE TARGET
4. TAKE "OFF SAFE"
5. FIRE

### NEVER STORE A LOADED GUN.

REMOVE CO<sub>2</sub> CYLINDER AND UNLOAD YOUR PISTOL AT THE END OF THE SHOOTING SESSION AS A SAFETY PRECAUTION.

### Step 1. PUT "ON SAFE"

Push trigger safety (Drawing 1) from left to right until no red is showing. In this position, the pistol cannot be fired by pulling the trigger. NOTE: The trigger safety is not automatic. It will only do its job when you do yours. REMEMBER, THE BEST SAFETY IS GOOD GUN HANDLING.

## Step 2. COCK AND LOAD (muzzle down)

Point your gun in a safe direction and lower muzzle approximately 30 degrees to the ground. Place your thumb in the slot under the foregrip and push cocking slide forward until it stops (Drawing 4). Release the slide. A B•B IS NOW LOADED.

**IMPORTANT:** The cocking slide must be pushed completely forward to load a B•B. Do not load until ready to fire at a safe target.

**CAUTION:** The pistol will fire if safety is off, the trigger is pulled and the slide is then released. Keep finger away from trigger until aiming at safe target.

**WARNING:** Cocking slide must be free to move rearward when firing.



## Step 3. AIM AT A SAFE TARGET

To be a consistent marksman, use the correct sight picture each time you fire the pistol (Drawing 5). **CAUTION:** Due to the power of the CO<sub>2</sub> 1200, use extra precaution in selecting a safe target. Pick a target that cannot be penetrated, or one that will not cause a ricochet of the B•B because of the target's hard surface.

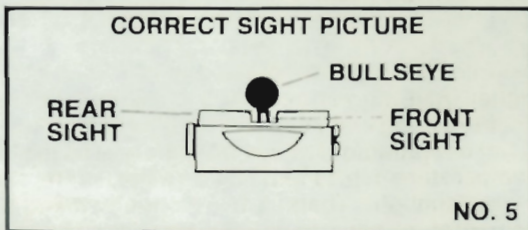

## **Step 4. TAKE "OFF SAFE"**

Place trigger safety "Off Safe" by pushing from right to left so that red is showing. Pulling the trigger will fire the gun.

## **Step 5. FIRE**

After completing the operating steps, your pistol is fired by pulling the trigger. Should your pistol fail to shoot, keep it pointed in a safe direction and make the following checks:

1. See section on CO<sub>2</sub> characteristics.
2. Change CO<sub>2</sub> cylinder. See "How To Remove CO<sub>2</sub> Cylinder" section.

If your pistol does not shoot after you have carefully repeated the operating steps and the above check list, you should assume there is a malfunction in the pistol. Remove CO<sub>2</sub> cylinder and send pistol directly to Daisy Manufacturing Company Service Department. Under no circumstances should you take it apart or attempt to correct the problem by yourself. To do so could further damage your pistol. (See "How to Send Gun for Repairs" Section).

## **HOW TO REMOVE CO<sub>2</sub> CYLINDER:**

1. Place the trigger safety in "On Safe" position.
2. With the left-hand grip cover in place, slowly turn lanyard screw counter-clockwise until any remaining gas is discharged.
3. Remove left-hand grip cover by lifting at the finger slot on the bottom of the grip.
4. Remove CO<sub>2</sub> cylinder.

## **CO<sub>2</sub> CHARACTERISTICS**

There are occasions when a CO<sub>2</sub> pistol may be subjected to abnormal conditions which can produce effects on the pistol's performance. These conditions include operation and/or storage of the pistol at temperatures that are considerably higher or lower than normal outdoor temperatures (60 - 70° F), as well as conditions of rapid fire.

1. High temperatures can produce pressures in the CO<sub>2</sub> cylinder that are considerably higher than normal operating pressures. Such pressures may prevent the pistol from firing and may result in permanent damage to the valve seal. The maximum operating or storage temperature should not exceed 105° F (40°C.). This temperature can be reached on a hot, sunny day by leaving the pistol directly in the sunlight. Therefore, the shooter should not expose his pistol to high temperature conditions and direct sunlight for any extended period of time.

2. At low temperatures, rapid firing of the gun will cause further temperature reductions in the pistol and gas. This will result in lower B•B velocity and may even lower gas pressures enough that the pistol will not fire. This condition can be avoided by allowing more time between shots; this permits the gas to increase in temperature and pressure and produce normal velocity.

## HOW TO UNLOAD

Remove CO<sub>2</sub> cylinder, swing loading gate open, turn pistol muzzle up and shake until all B•Bs are removed. To insure there is not a B•B remaining in the firing chamber, lower the muzzle of the pistol, push cocking slide forward, release and pull the trigger. This will clear the firing chamber by allowing a remaining B•B to roll out of the muzzle.

## REAR SIGHT ADJUSTMENT

**WINDAGE:** To move the point of impact to the right, move the sight to the right by turning screw "A" clockwise (Drawing 6). To move left, turn screw "A" counterclockwise (Drawing 6). **ELEVATION:** To move the point of impact up, move the sight up by turning screw "B" counterclockwise. To move down, turn screw "B" clockwise (Drawing 6).

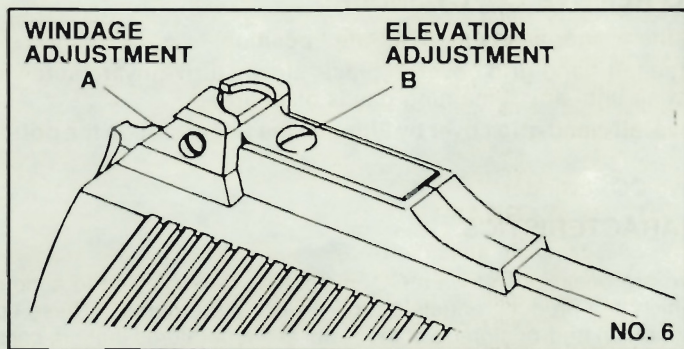

## STORAGE

Store your pistol unloaded. Keep pistol away from children and untrained shooters. Store B•Bs and CO<sub>2</sub> cylinders separately from the pistol.

Protect your pistol from moisture and dirt. When not shooting, remove the CO<sub>2</sub> cylinder, clean gun, wipe it with oil and wrap it in a smooth, dry cloth. Or, store the pistol in the package it came in when new. **CAUTION:** A CO<sub>2</sub> cylinder contains gas under pressure. If exposed to a high temperature, such as inside a closed car in direct sunlight, it could explode. Be sure to store all cylinders in a cool place.

## **MODIFICATION - CAUTION:**

The components of this gun were engineered to deliver optimum performance. Any modification or tampering with a gun may cause a malfunction and may make it unsafe to use. Any change in performance, such as a lowered trigger force and shortened trigger travel, indicates possible wear, and such guns should be inspected, replaced, or properly repaired by qualified personnel. Any gun that has been dropped should be checked by qualified personnel to insure that its function has not been affected.

## **REPAIR OF DAISY GUNS**

**WARNING:** A GUN THAT IS NOT OPERATING PROPERLY MAY BE DANGEROUS. IT SHOULD BE KEPT SAFELY FROM USE BY ANYONE UNTIL REPAIRED OR DESTROYED. DO NOT TRY TO TAKE THE GUN APART. IT IS DIFFICULT TO REASSEMBLE, AND IMPROPER REASSEMBLY CAN CAUSE A HAZARDOUS CONDITION.

## **GUNS IN WARRANTY**

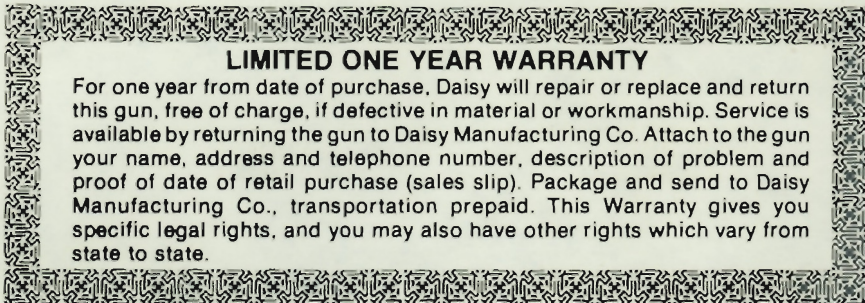

### **LIMITED ONE YEAR WARRANTY**

For one year from date of purchase, Daisy will repair or replace and return this gun, free of charge, if defective in material or workmanship. Service is available by returning the gun to Daisy Manufacturing Co. Attach to the gun your name, address and telephone number, description of problem and proof of date of retail purchase (sales slip). Package and send to Daisy Manufacturing Co., transportation prepaid. This Warranty gives you specific legal rights, and you may also have other rights which vary from state to state.

## **GUNS OUT OF WARRANTY**

If your Daisy needs repair, attach to the gun your name, address, and description of problem. Package and send transportation prepaid to Daisy Manufacturing Co. Service Department. Daisy will repair the gun or replace it with a reconditioned gun of the same model, if available, otherwise with a model of equivalent quality. A charge of \$14.00 will be made for repairing or replacing your gun.

Any gun should be accompanied by check or money order (not cash) in payment of the charge. If payment is not included, you will be invoiced for the charges plus a handling charge of \$4.00, and upon receipt of payment the gun will be shipped to you.

Exploded gun parts drawings and price lists are available from Daisy Service Department. Please make sure you state model number stamped on barrel. Service and parts charges are subject to change without notice.

Daisy Manufacturing Co.  
Service Department  
P.O. Box 220  
Rogers, AR 72756

**IMPORTANT:** The CO<sub>2</sub> 1200 pistol is controlled by Federal Postal Regulations. You may mail an inoperative CO<sub>2</sub> 1200 pistol to Daisy, but it is unlawful for Daisy to mail a working pistol to you. The pistol must be mailed to a Registered Federal Firearms Dealer. So include in the letter the name and address of a local firearms dealer who will accept the return of your pistol and then notify you. The pistol will be returned to your attention in care of the dealer.



## CO<sub>2</sub> 1200 PISTOL SPECIFICATIONS

Style	custom target
Action	repeater
Ammunition	B•B cal. (4.5 mm)
Feed	gravity
Caliber	.177 cal. (4.5 mm)
B•B Capacity	60 B•Bs
Maximum distance	253 yds. (232 m)
Velocity	420 fps (128 mps) - Maintains velocity through 100 plus shots
Barrel Length	8.18 inches (207.7 mm)
Sight radius	9.25 inches (234.1 mm)
Trigger pull force	3.25 lbs. (1.5 kg)
Trigger travel	.102 inches (2.6 mm)
Safety	trigger block, cross bolt
Cocking force	32 oz. (.91 kg)
Size	Adult size
Weight	1.9 lbs. (.86 kg)
Sights	Blade & ramp front, fully adjustable rear for Model 1200, 1205 elevation only
Power source	12 gm. CO <sub>2</sub> cylinder

**CAUTION: CO<sub>2</sub> cylinders may explode at temperatures above 160° F (71° C).**

# AIR PISTOL SHOOTING GUIDE

**An introduction to  
a lifetime sport.**

Although not a firearm, a Daisy is a gun and not a toy. Properly used and maintained, it will provide many hours of safe, trouble free recreational shooting. Misused, it can be dangerous. Therefore, we recommend it be used only by those 16 years of age or older.

Safe gun handling depends upon proper safety training and the right attitude toward gun ownership. This booklet is designed to cover the basic facts everyone should understand before shooting a gun. Take time to study it thoroughly. A proper understanding of these basics will greatly increase your enjoyment of the lifetime sport of recreational air pistol shooting, and at the same time give you the satisfaction of preparing yourself as a skilled shooter.

Read this book in conjunction with the operation manual. It tells you how to handle your new air pistol properly and how to prepare the proper shooting range. And remember, it's your responsibility as an air pistol owner to make certain that anyone using it is instructed in the rules of proper gun handling.

A majority of air gun accidents in this country are caused by - 1) careless and improper handling of the gun, 2) believing the gun to be empty when it isn't, or 3) shooting at improper targets. All three causes can be avoided if the shooter handles the gun properly.

## THE RULES OF PROPER GUN HANDLING

1. Treat every gun as if it were loaded and ready to shoot.
2. **Never** carry a loaded or cocked gun into your home, camp, or public place. (Shooting your Daisy indoors may be enjoyed when proper range facilities and adult supervision are available.)
3. Always be sure the barrel is clean and not plugged.
4. Carry your Daisy so that you can control the direction of the muzzle, even if you stumble.
5. Be sure of your target before you shoot. The only time you put your finger on the trigger is when you are aiming at a safe target.
6. **Never** point a gun at anyone. **Never** point a gun at anything you do not want to shoot. **Never** point your Daisy at any living thing.
7. **Never** climb a fence or a tree, or jump a ditch, with a loaded gun.
8. Avoid ricochet; never shoot at a flat, hard surface, or at the surface of water.
9. Guns not being used should always be unloaded and properly stored.
10. Always respect other people's property.

It is also very important for you to remember that any time you receive a gun from anyone, or take a gun from its storage place, you should make sure it's unloaded and uncocked.

**Never** look into the muzzle of your air gun. You can't tell by looking if your gun is loaded, so always treat it as if it were.

## WHERE TO SHOOT AND AT WHAT

Setting up a safe target arrangement is the first order of business. You can make your own safe target backstop. First, take a corrugated cardboard box 12 inches or more deep with at least 18" x 18" of front surface. Center 3" of tightly bound magazines on the inside back wall of the box opposite where the target will be located and fill it with tightly packed, crumpled newspaper. Paper targets should be taped (not tacked or stapled because of the possibility of ricochet), to the front of the box.

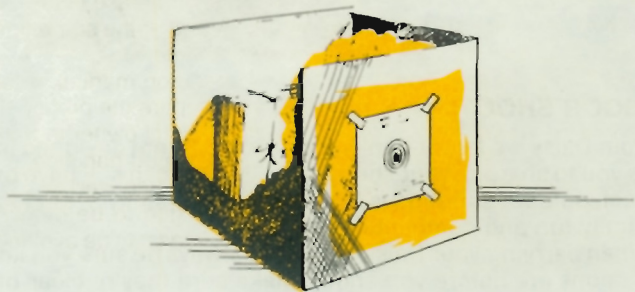

**CAUTION:** It is important to remember that **backstops will wear out** with continued use. It is good practice to check your backstop before every shooting session. Always position your target backstop so if it should fail, the B•B will not injure anyone or damage property. Check your target backstop carefully before and after each use.

A rebound or ricochet is an indication that the backstop is faulty and you should stop using it immediately.

## INDOOR SHOOTING

Yes, your Daisy is **safe** for indoor shooting as long as you observe the proper safety rules.

First, you need about 9 to 12 feet from the firing line to the target.

Second, you must have a safe target placed so there are no entry ways in front of the firing line or behind the targets. If this is not possible, then doorways in the areas should be blocked. Third, you should have a canvas or blanket behind the target which hangs free from the wall and clears the floor. This will prevent ricochet should you miss the target. Finally, your target should be well lighted.

Remember to keep your Daisy unloaded until the target is set up and you are ready to shoot. **Never** point it in any direction except toward the target.



## OUTDOOR SHOOTING

Your Daisy is a target-plinking air pistol; it's not designed for hunting but it allows you to sharpen your shooting skills. You can still have outdoor fun with it; in fact, outdoor shooting is a great way for a family to get together for some real family fun and competition.

When carrying your Daisy outdoors, always be sure you know where your companions are before you shoot. Make sure they're clear of the target.

## HOW TO BECOME AN EXPERT MARKSMAN

If you learn the techniques, and practice regularly, you can become a marksman with your Daisy Air Pistol. Marksmanship will provide you with a lot of enjoyment all your life.

### AIMING (OR SIGHTING)

The trick in aiming is holding the proper sight picture. First, because your eyes can't focus on three things at once, concentrate your focus on the middle object which will be the front sight. This will allow you to see the rear sight and the bullseye fairly well. Next, the front sight should be centered within the rear sights notch and the same height. The bullseye should look like a black ball sitting above the front sight blade.

Try sighting. Then check what you see against the sight pictures.

To be a consistent marksman, use the correct sight picture each time you fire the gun.



TOO HIGH



TOO LOW



JUST RIGHT

### STANCE AND GRIP

To get into the formal one-hand shooting stance, your body should be facing almost a  $\frac{1}{4}$  turn to the left of the target. (Left hand shooters should reverse the procedure.) The arm should be fully extended, but not strained, and the elbow locked. Your feet should be placed about as far apart as your shoulders are wide. The shoulders, right arm and pistol should be in a straight line.

The left arm should be totally relaxed. Let it hang at your side. Put your hand in your pocket, or hook your thumb over your belt, whichever feels more comfortable.

The grip should be firm but relaxed. Don't apply any pressure with the thumb or trigger finger to the side of the pistol. The trigger finger should just lay across the trigger at or near the first joint.

## TRIGGER AND BREATH CONTROL

When you get right down to it, trigger control is simply knowing your gun. Get your sights in line. The moment you have the proper sight picture, squeeze the trigger. Never jerk the trigger or you will ruin your aim. To do this, you must know your gun well enough to exert enough pressure on the trigger to where it's just short of firing the gun. Then at the exact instant you wish, the trigger can be squeezed with as little disturbance to the sight picture as possible.

Trigger control comes only with practice. Keep trying, you'll get it down to an art.

Breathing at the wrong moment can cause your body to move and your aim to go astray. So breathe properly.

Prior to raising the gun to the shooting position, inhale deeply, then exhale partially with arm in shooting position. Hold the remaining breath until shot is fired.

If after about 7 or 8 seconds you haven't got the shot off, cock your arm back 90 degrees (muzzle up), relax and breathe normally for a few seconds, then take your "aiming breath" and try again.

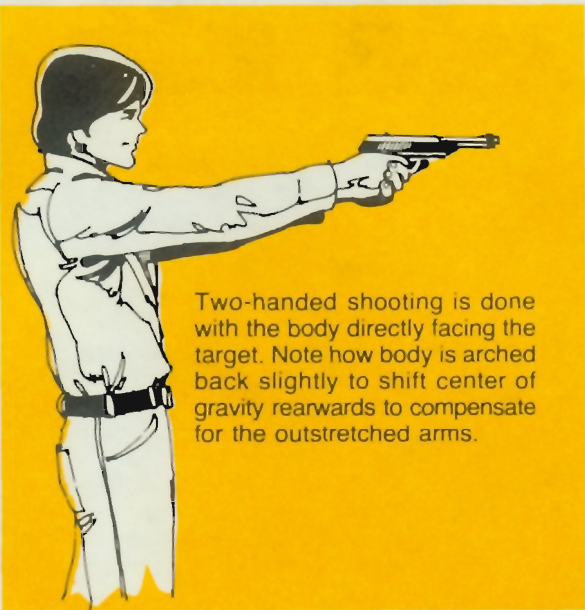

Two-handed shooting is done with the body directly facing the target. Note how body is arched back slightly to shift center of gravity rearwards to compensate for the outstretched arms.

## GETTING THE MOST ACCURACY

Of all the possible ways to hold a handgun, the formal one-hand style talked about earlier is the most difficult. Since the better we are at something, the more we can enjoy it, let's look at other styles of handgun shooting that are more accurate and more fun.

There's no right or wrong way to apply a two-handed grip when shooting an air pistol. Notice that left hand is firmly clasped over the right.

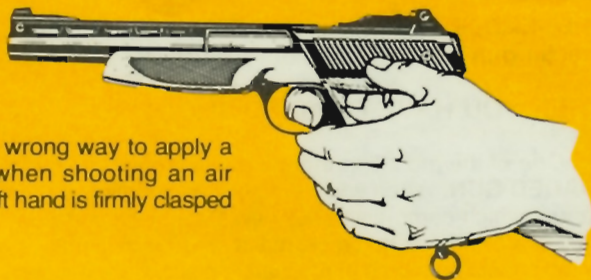

Shown here is the steadiest of all hand gunning positions short of an artificial rest. Back is fully supported, while firmly-planted feet lend support to arms via the knees.

Another field position which takes advantage of the body's steadying influence. Anything's better than *just an outstretched arm* when you want to increase your chances of hitting what you're aiming at!



# POWER LINE 917

*Crafted by Daisy for shooters 16 years of age or older.*



## **THE WORLD'S ONLY 5-SHOT PELLET REPEATER!**

Take a look at the new Power Line 917 5-shot clip repeater. The only air rifle in the world that lets you shoot five .177 caliber pellets without reloading.

Power Line 917 delivers a muzzle velocity of 635 fps, with rifled barrel accuracy. But it makes little noise and you can control its pneumatic power with the number of times you pump it. That means you can shoot whenever you want to. Indoors or out. At a fraction of the cost of shooting powder guns.

Power Line 917. It's like no other gun you own. Also available in .22 caliber.

**DAISY**

Division of Midway Products & Company, Inc.

**KEDDE**

10000 W. 100th Street, Overland Park, KS 66213  
P.O. Box 1000, Overland Park, KS 66213  
©1984, Midway Products & Company, Inc.

*For more information on world famous Power Line air guns, write for our free fact folder.*





Be on target. Use Daisy Golden Bullseye® B•Bs, famed for their uniformity and exclusive golden glow, and Daisy Bullseye® Jetts CO<sub>2</sub> Cylinders.

# WARRANTY VALIDATION CARD

Please complete and return this information card to validate your warranty.

Model No. \_\_\_\_\_ Lot No. on Barrel \_\_\_\_\_

Date of Purchase \_\_\_\_\_ Age of Purchaser \_\_\_\_\_  
Month Day Year

1. \_\_\_\_\_ Mr. 2. \_\_\_\_\_ Mrs. 3. \_\_\_\_\_ Ms. 4. \_\_\_\_\_ Miss Age of User \_\_\_\_\_

Name (first/initial/last) \_\_\_\_\_

Street \_\_\_\_\_

City \_\_\_\_\_

State \_\_\_\_\_

Zip \_\_\_\_\_

## A. How did you receive your Daisy gun?

- Purchase for personal use
- Purchase for family use
- Gift from Husband
- Gift from Wife
- Gift from son/daughter
- Gift from mother/father
- Gift from other relative
- Gift from friend

## B. How many air guns did you have prior to owning this Daisy gun? Number \_\_\_\_\_

## C. Who else was involved in the decision to purchase this Daisy gun?

- Husband
- Wife
- Son/Daughter
- Mother/Father
- Friend
- No one else was involved in my decision
- I received it as a gift

## D. What influenced you to buy this Daisy gun?

- Newspaper ad
- Magazine ad
- Comic book ad
- Store catalog
- Display at store
- Parent
- Friend
- Owned one before

## E. Where was your Daisy gun purchased?

- Department Store
- Hardware Store
- Auto Supply Store
- Sporting Goods Store
- Discount Store
- Mail Order Catalog

## F. What influenced your selection of this Daisy gun?

- Brand name
- Features
- Price
- Warranty
- Dealer recommendation
- Advertising
- Power

If this purchase was a Daisy Power Line product, please check the following:

## G. Which group best describes your family income?

- Under \$10,000
- \$10,000 - 14,000
- \$15,000 - 19,999
- \$20,000 - 24,999
- \$25,000 - 29,999
- \$30,000 - 39,999
- \$40,000 - 49,999
- \$50,000 & over

## H. For your primary residence, do you —

- Own a house
- Rent a house
- Rent an apartment

## I. What is your occupation (check one)

- Professional/Technical
- Upper Mgt./Administrative
- Sales Service/Middle Mgt.
- Clerical/White Collar
- Craftsman/Blue Collar
- Student
- Housewife
- Retired
- Other

PLACE  
STAMP  
HERE

DAISY MANUFACTURING CO.

BOX 220

ROGERS, AR. 72756

**REMEMBER:** Use only proper shot in your CO<sub>2</sub> gun, B•B caliber (4.5 mm) steel air gun shot, and do not reuse shot.

## WHEN YOU HAVE FINISHED SHOOTING

One of the most important rules of proper gun handling is **NEVER STORE A LOADED GUN.** When you have finished shooting, unload your gun. The operation manual which came with your new Daisy tells you how. Before putting your gun away in a cabinet or gun rack, make sure it is clean, dry, oiled, empty and uncocked. Ammo should be stored in a separate place to keep it away from untrained shooters.



**DAISY**  
Subsidiary of Kidde, Inc.  
**KIDDE**

Daisy Manufacturing Company  
Rogers, Ark. 72756 U.S.A.  
In Canada: Kidde Recreation Products  
Cambridge, Ontario N1R6T4