

INSTRUCTION MANUAL

CZ 200



ČESKÁ ZBROJOVKA

PLEASE READ THIS MANUAL BEFORE USING YOUR NEW RIFLE, IT CONTAINS IMPORTANT SAFETY INFORMATION AND INSTRUCTION ON HANDLING, ADJUSTMENT AND MAINTENANCE.

Improper and careless handling of the gun could result in an unintentional discharge and could cause injury, death or damage to property. The same consequences can be caused by unauthorized modifications or adjustments, corrosion or using the damaged ammunition. In these cases the manufacturer shall not be responsible in any manner for the resultant consequences.

Before leaving the factory the air gun was tested, carefully inspected and packed. The manufacturer cannot control manipulation with the air gun after leaving the factory. Therefore examine please the gun carefully at the time of purchase to ensure that it is unloaded and undamaged.

This instruction manual should always accompany the air gun and that even in the case of its loan or sale .

CONTENTS

SAFETY INSTRUCTIONS	18	Disassembly for cleaning	23
AIR RIFLE DESCRIPTION AND TERMINOLOGY	19	Assembling the rifle	24
OPERATING INSTRUCTIONS	20	Cleaning the rifle	24
Ammunition	20	Cleaning the bore and pellet chamber	24
Reservoir filling	20	Cleaning other parts of the rifle	25
Sights adjustments	22	Lubrication	25
Pellet velocity (energy)	22	ILLUSTRATION AND LIST OF PARTS	26
Adjustment of the trigger mechanism	22	TROUBLESHOOTING	28
Cocking and loading the rifle	23	TECHNICAL DATA	29
MAINTENANCE INSTRUCTIONS	23	LIST OF FIGURES	30

SAFETY INSTRUCTIONS

Always follow the safety instructions for your safety and the safety of others.

1. Always treat the gun as if loaded.
 2. Always keep the gun muzzle pointed in a safe direction; never point your gun at anything you do not intend to shoot, even if unloaded.
 3. Never take anyone's word that the gun is unloaded.
 4. Always make sure that your gun is not loaded before laying it down or handing to another person.
 5. The gun not in use should always be unloaded and uncocked.
 6. Never abuse your gun by using it for any purpose other than shooting.
 7. Only load or cock the gun when you are shooting.
 8. Always keep the gun muzzle clean and clear of obstructions.
 9. Always use only clean, original quality manufactured ammunition appropriate to caliber of your gun.
 10. Never drink alcoholic beverages or take drugs before or during shooting.
 11. Never squeeze the trigger or put your finger in the trigger guard until you are aiming at the target and ready to shoot.
 12. Before you squeeze the trigger check your target and the area beyond it. The pellet could travel through or past your target up to several hundred meters.
 13. Avoid ricochet. Never shoot at a flat hard surface or at the surface of water.
 14. Never indulge in "horseplay" while holding your gun.
 15. Always make sure your air gun is not loaded before cleaning, storing or traveling.
 16. Always store your air gun and ammunition separately, beyond reach of children and trespassers.
 17. Never alter parts of your air gun as its safety and proper function can be seriously compromised.
 18. Always be aware that corrosion, use of damaged ammunition, dropping the gun on a hard surface or other rough handling could cause damage, you may not see.
-

AIR RIFLE DESCRIPTION AND TERMINOLOGY

The names of all air rifle parts are given in the chapter *Illustration and List of Parts*.

Series CZ 200 PCP (pre-charged pneumatic) air rifles is a result of the close co-operation between Czech arms factory Ceska Zbrojovka and renown English air guns manufacturer Air Arms.

These guns, involving a compact receiver with a fixed or removable compressed air reservoir, feature accurate, consistent and recoilless behavior that will be appreciated mainly by the wide spectrum of young and beginning shooters.

The basic CZ 200 S versions are made in caliber .177"/4.5mm or .22"/5.5 mm and can be used beside sporting also for pest control purposes (if allowed) as their muzzle energy can be set up to 16 Joule.

Model CZ 200 S PCP air rifle can be designated also as Model AA S 200.

The target style model CZ 200 T, made in caliber .177"/4.5 mm, is designed mainly for the training and basic competition shooting. Design of the air rifle complies with ISSF rules.

Model CZ 200 T PCP air rifle can be designated also as Model AVANTI Valiant.

CZ 200 PCP air rifles are based on a modular concept, containing following sub-assemblies (Fig. 1):

- *Receiver (A)* involves an adjustable trigger mechanism, single-shot cocking/loading mechanism and an adjustable striking device. The receiver body enables installation or change of various components. Manual safety is not available at current products.
- *Compressed air reservoir (B)* can be pressurized either by means of a quick release coupling or through the striking valve input, if instead the filling connector an air pressure meter is fitted. The air pressure is released in course of the shot via a sophisticated pneumatic circuit.
- *Barrel assembly (C)* based on the precision rotary swaged barrels in caliber .177 "or .22" with 12 fine grooves and conical choke, enables to fit various sighting devices or muzzle complements.
- *Two-piece stock (D)* is made of quality beech-wood either in solid or adjustable sporting shape version, inclusive an adjustable butt-pad, cheek-piece and fore-end rail.
- *Sight system* is not an integral part of the rifle; the customer may select from a broad offer of devices, which may include mechanical open, aperture sights, telescope or electronic point sights, if fitting to the 3/8" dovetail.

CAUTION!

The compressed air reservoir was carefully assembled, adjusted and tested as a pressure vessel by the manufacturer. Therefore any dismantling by the customer must be avoided. Do not pressurize the cylinder if there are any surface abrasions or dents. Do not store the rifle in places with, or near sources of high temperature. Contact manufacturer for advice if any trouble relating to the compressed air reservoir will occur or entrust it to a competent air rifle repair shop. The manufacturer cannot carry the responsibility for damage caused by unauthorized manipulation.

The safety rules must be unconditionally respected!

OPERATING INSTRUCTIONS**Ammunition**

For shooting use only quality pellets in caliber .177" or .22", as per. par. 9 of Safety Instructions.

Reservoir filling

USE ONLY CLEAN, FILTERED AND DRY COMPRESSED AIR.

For filling the compressed air reservoir use only compressed-air bottle, compressor or mechanical pump complying with your country's requirements on manipulation with such devices and limited to 230 bar operation. The reservoir is hydraulic tested by the manufacturer at 300 bar, **but do not attempt to exceed the 200 bar air pressure. The reservoir can be damaged irreversibly and thus the gun in whole.** In the interest of safety the compressed-air reservoir has a safety device that operates at approximately 250 bar. Once operated (indicated by deformation of the cylinder end) the reservoir is beyond further use and the cylinder must be replaced.

NOTE: Filling to a higher pressure will not increase power and may actually trouble operation, filling to lower pressures will not reduce power, only the number of shots. If the rifle is continually fired when the pressure in the compressed-air reservoir is below refill pressure (less than 60 bar), the remaining air will eventually escape through the barrel spontaneously. This is not harmful to the rifle but can cause surprise to yourself or bystanders.

NOTE: The rifle must be unloaded when refilling or replacing the reservoir.

Filling the reservoir by the quick release coupling (Fig. 2)

This type of reservoir (only at Models AA S 200) can be filled with the gun after removing the cover.

- Connect the coupling at the hose (A) from the compressed-air bottle (or other pressurizing device) with the coupling connector located at the reservoir.
- Check that the release screw (C) at the adapter (B) is closed.
- **Slowly** open the main bottle valve (D) and feed the air in the reservoir until the pointer of adapter manometer (E) will approach the 190 bar value.
- Close the bottle valve immediately.
- Turn the air release screw to release the excessive air from the interconnecting hose.
- Disengage the quick release coupling.

The compressed air reservoir and the gun are ready to further manipulation and use.

Filling the reservoir with the air pressure gauge (Fig. 3)

This type of reservoir must be first removed (unscrewed) from the gun.

- Screw the reservoir (A) on the adapter (B) attached to the valve of the compressed-air bottle.
- Check that the release screw at the adapter is closed.
- **Slowly** open the main bottle valve and simultaneously check the value shown by pointer of the pressure gauge. As soon as it approaches 170 bar (Model CZ 200 T) event. 190 bar (Model CZ 200 S) value, close the valve.
- Check again the value indicated by the pressure gauge.
- Turn the release screw to release the excessive air from the adapter.
- Unscrew cautiously the reservoir from the adapter.

The reservoir is ready to be screwed in the receiver. The PCP rifle is prepared for further use.

Sights adjustments

The sights to be fitted on the 3/8" dovetail and adjusted according to the instruction of their manufacturer.

Pellet velocity (energy)

Models CZ 200 S can be set for the pellet muzzle energy up to 16 Joule. According to the purpose of use the rifle performance can be optimized for specific pellets controlling the muzzle velocity of the pellet by a chronograph.

Models CZ 200 T are set for the pellet muzzle energy of 7.5 Joule maximum.

Because of seriousness of the pellet muzzle energy readjustment contact please in this matter for advice the trading company's representative.

WARNING!

It is a very serious offence to be in possession of a gun that you are not authorized for.

Adjustment of the trigger mechanism

Striking point adjustment

The trigger mechanism is set by the manufacturer for the two-stage weight, the 1st stage up to 3 N and the 2nd stage over 5 N. The engagement of the trigger lever and the 1st stage trigger weight are not recommended to change from original. The rifle for these adjustments is recommended to commit to a competent workshop.

Trigger play, pull and position adjustment

The trigger play can be controlled by M3x6 screw, which is located in the front side of the trigger base (Fig. 4). After longer time of use it may come to its release (having no influence on the rifle performance). The screw is resting on the pawl washer in the receiver. When screwing it in the play will be reduced.

2nd stage trigger weight can be regulated by the adjustment screw located behind the trigger guard.

Position of the trigger can be changed by shifting it on the trigger base after releasing the clamping screw.

CAUTION! Be careful during the adjustment procedure, it may come to an unwanted rifle discharge.

Cocking and loading the rifle

WHEN LOADING KEEP ALWAYS THE RIFLE MUZZLE POINTED IN A SAFE DIRECTION!

Before shooting check if the reservoir, with air pressure meter, is filled.

Holding the gun securely with your left hand grasp the bolt handle firmly and rotate counterclockwise and pull toward the rear of the gun. The bolt will remain open when it reaches the full rear position, the trigger mechanism will be engaged (Fig. 5).

If the bolt is gripped with the thumb on the other side, the cocking action will be smoother.

The proper caliber pellet can be inserted into the pellet channel (Fig. 6). Beware of its proper orientation.

Push the loading bolt right the way forward and at the end of the stroke turn clockwise until locked. The pellet is loaded in the barrel and striking mechanism is cocked. Check if the cocking arm is returned under action of the cocking arm spring to the initial position. If be there, the gun is ready to shoot.

CAUTION!

The gun has no trigger safety. Therefore do not insert your finger in the trigger guard in course of cocking and loading.

MAINTENANCE INSTRUCTIONS

Disassembly for cleaning

KEEP ALWAYS THE RIFLE MUZZLE POINTED IN A SAFE DIRECTION!

The CZ 200 Series PCP air rifles are based on a modular concept, consisting from sub-assemblies shown at Fig. 1. To dismantle the rifle in the mentioned subassemblies follow this procedure:

- Loosen the fore-end screw by the socket screw key (Fig. 7). After its unscrewing you can strip the fore-end stock forward.
- The compressed-air reservoir can be unscrewed by hand.

- Barrel assembly can be removed after loosening the two M5x6 socket head screws situated in the front part of the receiver (Fig. 8).
- The butt-stock can be taken apart by means of a screwdriver after loosening the right side stock screw and unscrewing the nut situated in the pistol grip (Fig. 9).

The gun is ready for cleaning.

CAUTION!

Do not continue dismantling of a.m. subassemblies, as they were preset by the manufacturer and an unauthorized action can cause change of the adjustment eventually also their damage.

Assembling the rifle

- Insert the barrel assembly in the receiver and fix by means of two screws.
- The compressed-air reservoir screw on by hand.
- Apply the fore-end stock and secure it by the screw.
- Put the butt-stock on the receiver and fasten-down by screw and nut.

Cleaning the rifle

The rifle to be cleaned

- after getting wet
- in the mild weather conditions at least once a year
- in the severe weather conditions at least once per month, depending on frequency of use

Cleaning the bore and pellet chamber

For ultimate accuracy clean and re-lube the barrel frequently.

Correct materials for this purpose are very important, therefore use only products recommended by air rifle specialists in relevant countries. Cleaners and oils intended for firearms needn't be suitable for air guns.

For cleaning we recommend the following procedure:

- Cut a piece of the nylon (or nylon coated) fishing line (10 kg) 3-times the length of your barrel, fold in half and tie ends together.
- Open loading bolt.
- Feed un-knotted end down barrel from the muzzle end until short piece of folded end protrudes.
- Pass a piece of the soft cotton cloth between the protruding loop, spray it with 'Gun Cleaner' or white spirit, turn the rifle upside down and pull the line through the barrel slowly.
- Repeat the previous two steps until the cloth is clean.
- Repeat the previous two steps once more without any cleaner to dry the barrel.
- Repeat the previous two steps once more with the cloth sprayed with 'Gun Oil'.

Cleaning other parts of the rifle

Maintenance of other parts of the rifle can be carried out with a dry soft cloth, on the stock may be applied a suitable polishing product.

Lubrication (Fig. 10)

Lubrication of the internal mechanism should not be required until the annual service.

A small dab of 'Gun Grease' (A) may be applied to the loading bolt and cocking arm. Work them by moving them forward and backwards.

A small drop of the 'Gun Oil' (B) may be applied to the striker.

Keep your gun in a dry and dust-free environment. Regular care and proper handling will keep your gun as new and its functioning will not be compromised.

Before shooting wipe the barrel bore and chamber dry.

ILLUSTRATION AND LIST OF PARTS CZ 200 T

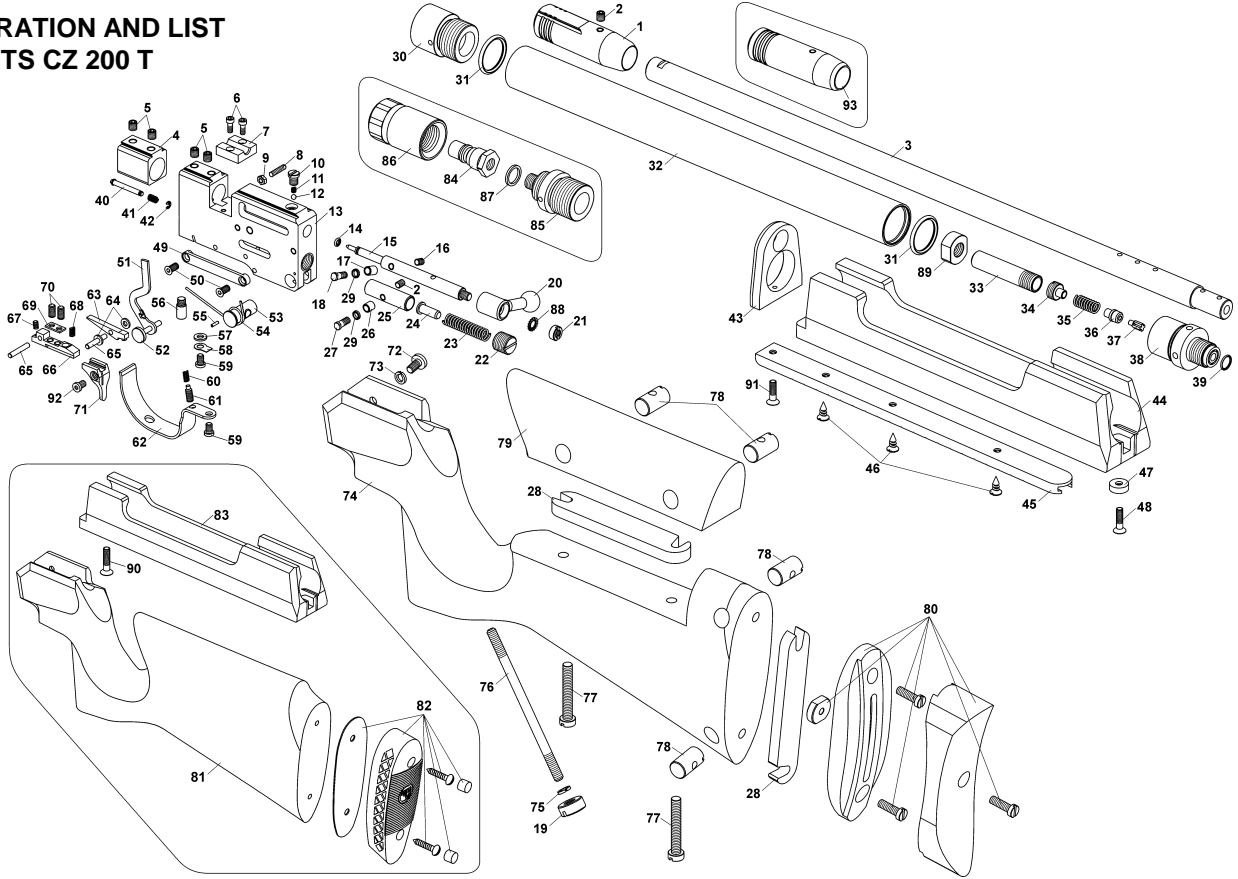

1 Muzzle Extension	29 Roller Bush	54 Cocking Arm Spring	88 Lock Washer
2 M4x5 Screw	30 Pressure Gauge	55 $\text{\AA}1.6 \times 8$ Spring Pin	89 Latching Nut
3 Barrel	31 $\text{\AA}21 \times 2$ O-Ring, Cylinder Tube	56 Fastening Screw	91 M4x10 Screw
4 Sight Base	32 Cylinder Tube	57 $\text{\AA}4 \times 8$ Seal Ring	92 M4x8 Screw
5 M5x6 Screw	33 Pott	58 Latch Washer	
6 Pellet Channel Screw	34 Valve Cap	59 Trigger Screw	<u>CZ 200 S Different Parts</u>
7 Pellet Channel	35 Valve Spring	60 Trigger Lever Spring	81 Solid Butt-Stock
8 M3x12 Screw	36 Firing Valve Seal	61 Adjustment Screw, Rear	82 Ventilated Rubber Butt-Pad
9 M3 Nut	37 Firing Valve Gate	62 Trigger Guard	83 Single Fore-end Stock
10 Ball Catch Screw	38 End Plug, Firing Valve	63 Trigger Lever	90 M4x16 Screw
11 Ball Catch Spring	39 $\text{\AA}6.5 \times 2$ O-Ring, Plug	64 Distance Washer	93 Muzzle Extension
12 $\text{\AA}3$ Steel Ball	40 Striking Pin	65 Pin	
13 Receiver Body	41 Striking Pin Spring	66 Trigger Base	<u>AA S 200 Different Parts</u>
14 $\text{\AA}3 \times 1$ O-Ring, Loading Bolt	42 $\text{\AA}1.9$ Retaining Ring	67 M3x6 Screw	81 Solid Butt-Stock
15 Loading Bolt	43 Supporting Bracket	68 Trigger Base Spring	82 Ventilated Rubber Butt-Pad
16 M4x4 Screw	44 Fore-end Stock	69 Locking Washer	83 Single Fore-end Stock
17 Roller Bush	45 Fore-end Rail	70 Adjustment Screw, Front	84 Filling Connector
18 Screw, Loading Bolt	46 3.9x9.5 Wood Screw	71 Trigger	85 Filling Connector End Plug
19 Nut	47 Washer	72 Stock Side Screw	86 Connector Cover
20 Bolt Handle	48 Fore-end Stock Screw	73 $\text{\AA}5$ Washer	87 Washer
21 M6 Bolt Handle Nut	49 Cocking Arm Guide	74 Butt-Stock	93 Muzzle Extension
22 Adjustment Screw	50 Cocking Arm Guide Screw	75 $\text{\AA}6$ Washer	
23 Main Spring	51 Cocking Arm	76 Connecting Screw	
24 Main Spring Guide	52 Pivot, Cocking Arm	77 M5x45 Screw	
25 Striker	53 Nut Socket	78 Roller	
26 Roller Bush		79 Cheek-piece	
27 Screw, Cocking		80 Adjustable Butt Pad	
28 Washer 4 or 8			

TROUBLESHOOTING

When properly used and maintained there is minimum probability of troubles.

If a trouble will occur observe the following instructions.

CAUTION:

If a function fault will occur during shooting, the probability of an unwanted discharge will raise. Therefore when troubleshooting the fault keep carefully all earlier given safety instructions.

KEEP ALWAYS THE RIFLE MUZZLE POINTED IN A SAFE DIRECTION!

Don't turn the rifle and don't put your hands in front of the barrel muzzle.

Trouble	Probable cause	Troubleshooting
The gun didn't discharge after pulling the trigger.	The bolt insufficiently cocked.	Repeat bolt cocking procedure.
	The pellet is inserted incorrectly.	Disassemble the barrel and carefully remove the jammed pellet.
	Insufficient air pressure in the compressed-air reservoir.	Refill the compressed-air reservoir.
After cocking the bolt to the rear position the striking mechanism is not retained.	Damage or change of adjustment to the trigger mechanism.	Gun to be committed for repair to the competent gunsmith.

TECHNICAL DATA

Model	CZ 200 S	CZ 200 T
Caliber	.177"/4.5 mm or .22"/5.5 mm	.177"/4.5 mm
Overall length [mm]	907	872 - 928
Distance between trigger (in rear position) and stock end [mm]	360	320 - 336 ... short stock 340 - 356 ... medium stock 360 - 376 ... long stock
Rifle height w/o sights [mm]	165	180
Overall width [mm]	53	53
Barrel length [mm]	485	485
Rifling	12 R/H grooves	12 R/H grooves
Rifling pitch [mm/turn]	450	450
Total weight [kg]	2.80 approx.	3.0 max. approx.
Reservoir volume [ml]	122	122
Filling pressure [bar]	190	170
Muzzle energy [Joule]	16 max.	7.5 max.
Trigger pull [N]	2-stage adjustable	2-stage adjustable

LIST OF FIGURES

1. Basic sub-assemblies of the gun
2. Filling the reservoir with quick release coupling
3. Filling the reservoir with air pressure gauge
4. Trigger play and pull adjustment
5. Cocking the striking mechanism
6. Loading the pellet
7. Fore-end stock releasing screw
8. Barrel fixing screws
9. Butt-stock disassembly screw and nut
10. Lubrication points

The Manufacturer, reserves the right to make any changes it thinks necessary to improve its models or to meet any requirements of manufacturing or commercial nature.

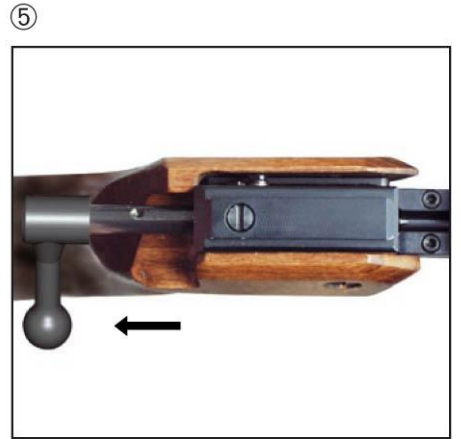
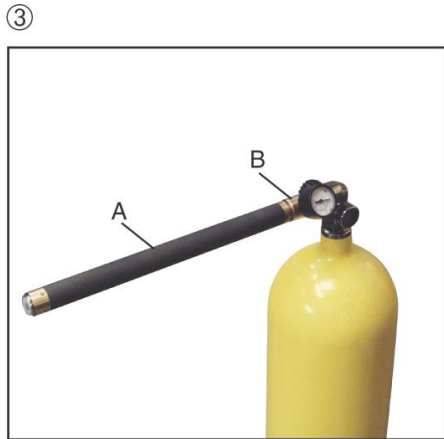
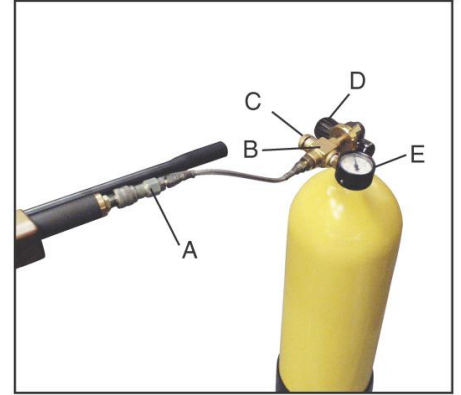
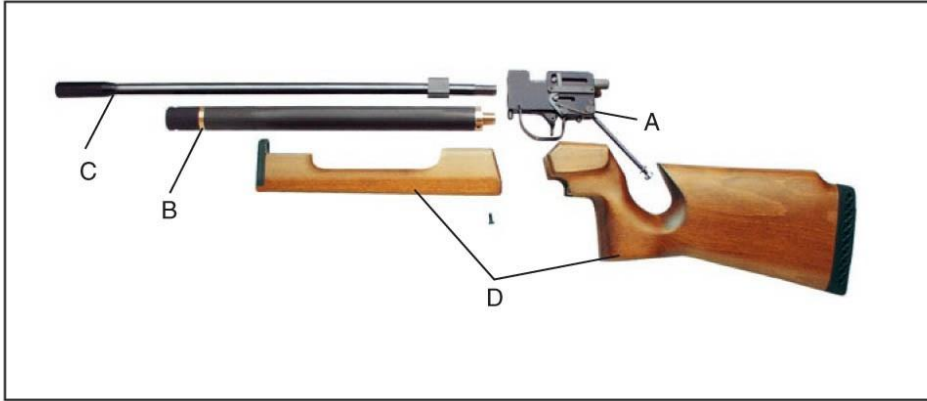

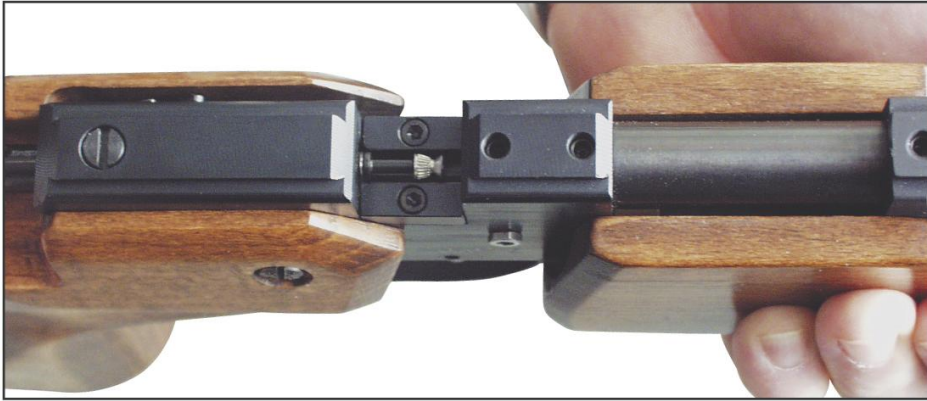

⑥

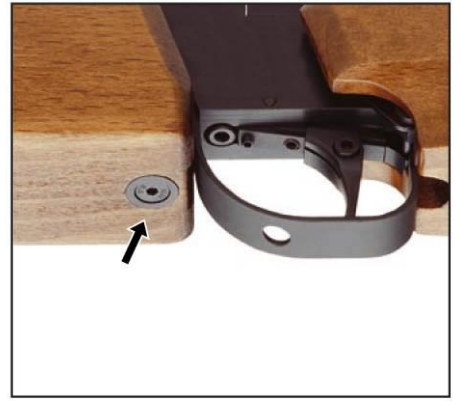

⑦

⑧



⑨

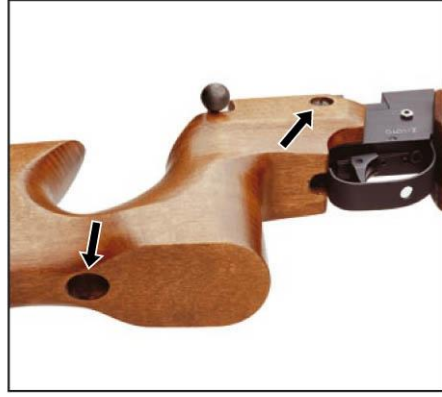

⑩

