

**TABLE OF CONTENTS**  
**CVA OPTIMA ELITE BREAK-ACTION RIFLE**  
**WARRANTY BOOK**

A. Introduction to Break-action Rifles and Shotguns ..... 3

B. Getting Started ..... 3

C. Ten Commandments of Firearm Safety ..... 4

D. Safety Considerations For Both Muzzleloaders and Centerfires ..... 4

E. Specific Cautions for Safe Use of CVA In-Line Muzzleloaders ..... 5

F. Basic Accessories for a Muzzleloader ..... 6

G. Propellants ..... 7

H. Projectiles ..... 7

I. Recommended Loading Data ..... 8

J. Loading and Shooting CVA Muzzleloading Rifles ..... 9

K. Loading and Shooting CVA Muzzleloading Shotguns ..... 10

L. Ignition System ..... 12

M. Safety System ..... 12

N. Break-Action Disassembly/ Assembly for  
 Cleaning and Maintenance ..... 12

O. Pulling a Charge ..... 13

P. Loading and Firing the CVA Optima Elite Centerfire Rifle and  
 Shotgun ..... 14

Q. Sight Adjustments ..... 14

R. Scope Mounting ..... 14

S. Voluntary Recall ..... 15

T. Service & Repair ..... 15

U. Ordering Instructions for Replacement Parts ..... 15

V. Limited Lifetime Warranty ..... 16

# Main Components of the Optima Elite Muzzleloading Rifle

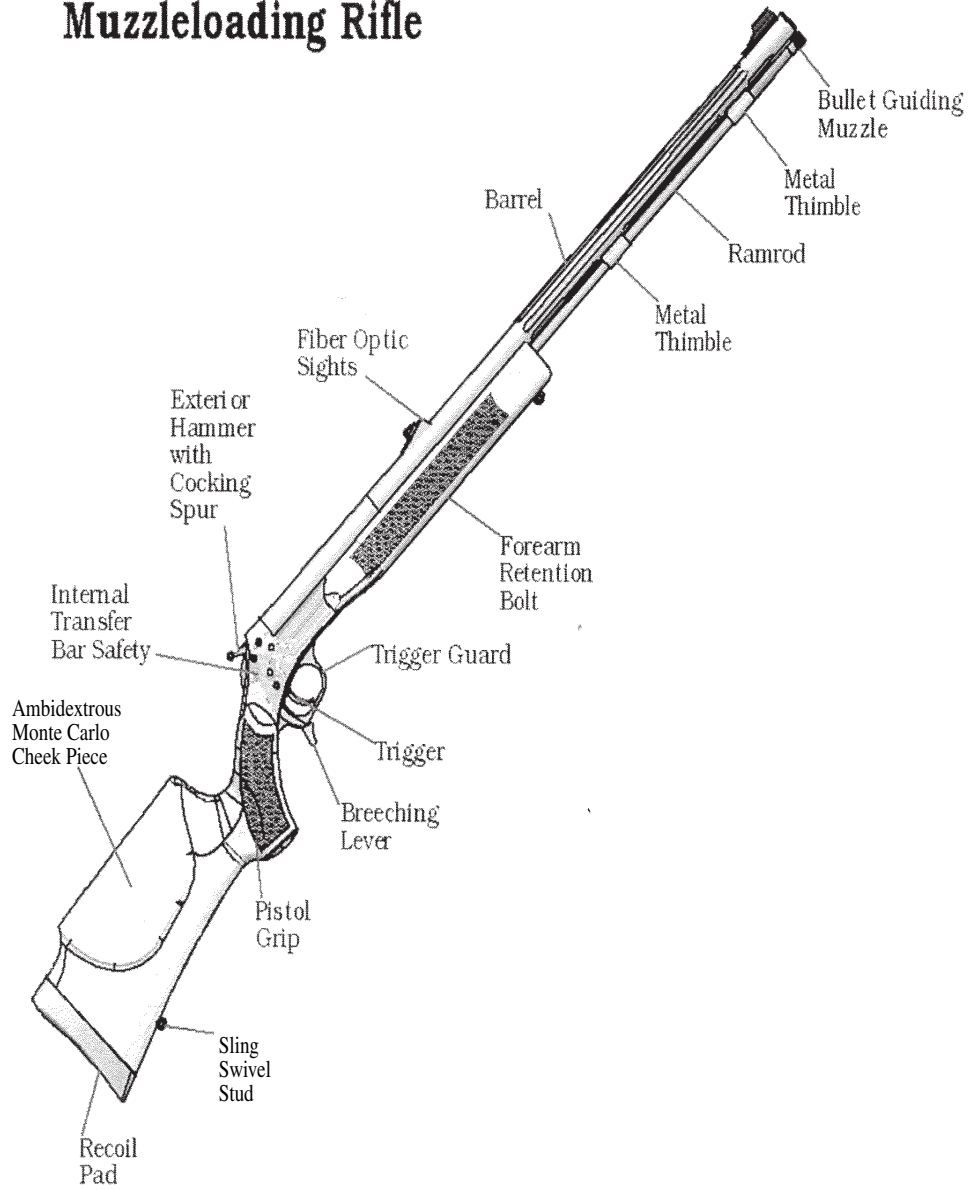



**WARNING: THE INFORMATION CONTAINED IN THIS MANUAL IS CRITICAL FOR THE PROPER USE AND CARE OF YOUR FIREARM.**

The CVA Optima Elite rifle utilizes a unique frame and barrel assembly that allows for quick and easy conversion from a muzzleloading rifle or shotgun to a number of popular centerfire calibers. This makes the Optima Elite one of the most versatile firearms that you can buy.

If, after reading the instructions, cautions and dangers detailed in this manual, you are not willing to accept the responsibilities involved in the safe handling and shooting of a firearm, return the firearm in its entirety to the place of purchase. If you have any questions about the safe use of your CVA firearm, write, call or e-mail our Customer Service Department at 5988 Peachtree Corners East, Norcross, GA 30071; 770-449-4687; info@cva.com.

## A. INTRODUCTION TO BREAK-ACTION RIFLES AND SHOTGUNS

Break-Action design firearms are so described due to the fact that the barrel and receiver are joined by a pivoting hinge. When the breeching lever is depressed, the receiver and barrel open in a breaking motion. Break-action muzzleloaders are considered to be in-line rifles due to the fact that the ignition source, the 209-shotgun style primer, is located directly in line with the powder charge.

The CVA Optima Elite is available as a muzzleloader, a centerfire rifle and as a shotgun. A variety of finishes are available. As time passes, you may want to add one or more extra barrels to your Optima Elite in order to increase its versatility. In this way you can use the same basic gun for most of your hunting needs.

All Optima Elite rifles feature a state-of-the-art Bergara Barrel™ that is produced in one of the world's most highly respected gun-making areas - Northern Spain. These Bergara Barrels™ are made on the most modern and accurate barrel machines in the world. After precision deep-hole drilling, the barrel blank is honed to size in a three-step process using diamond-coated tools. This honing process leaves a finish that is far smoother than traditional reaming and is ideal for the button rifling process. CVA has partnered with Bergara Barrel™ on the Elite models in order to offer you a truly custom-quality barrel at a production barrel price. The Optima Elite also features a fully ambidextrous design, a Crush-Zone recoil pad, fiber-optic sights and factory installed cocking spur.

All CVA break-action muzzleloaders are capable of handling a "magnum" powder charge of 150 grains when using pelletized powder (typically charges of loose powder exceeding 110 grains will not fully burn in the barrel). Such "magnum" loads should never be fired in sidelock guns or in any other CVA in-lines that do not feature the one-piece Monoblock barrel design.

## B. GETTING STARTED

1. After fully reading and understanding this manual, remove the gun and related tools from the box.
2. Safety First! Verify that the gun is unloaded.
3. Check all mechanical functions.





**DO NOT ATTEMPT TO LOAD  
OR FIRE YOUR FIREARM UNTIL YOU READ AND UNDERSTAND THE  
INFORMATION DESCRIBED IN THIS MANUAL.**

CVA strongly  
urges you to carefully read this manual from front to back, paying special attention to the safety  
notices that are printed in red.

**NOTE: If you sell, trade or give this firearm to any other person, this owner's manual  
must accompany the firearm. Replacement books are available from CVA, or online at  
the company's web-site [www.cva.com](http://www.cva.com).**





4. Remove the breechplug using the provided tool. Apply CVA breechplug grease or high temperature anti-seize compound to the breech plug threads. (Muzzleloaders only)
5. Clean the shipping grease from the inside and outside of the barrel.
6. Replace the breech plug. Turn it in only until it is snug, do not over tighten. (Muzzleloaders only)
7. Understand all terminology and procedures prior to loading or firing.
8. Get any and all questions and doubts answered prior to loading or firing.

**FOR YOUR SAFETY AND THE SAFETY OF OTHERS:** CVA encourages you to take a certified hunter’s safety course before using this rifle or any other firearm. Consult your local Game & Fish authorities, The National Muzzleloading Rifle Association or your local sporting goods dealer for information on the courses available. Even if you do not intend to hunt game animals, the information gained from taking a hunter’s safety course can help in preventing dangerous or fatal accidents from occurring.

### C. THE TEN COMMANDMENTS OF FIREARM SAFETY

1. Always keep the gun’s muzzle pointed in a safe direction. Never pull the gun towards you by the muzzle.
2. Be sure of your target and what is beyond it.
3. Never rely on a gun’s mechanical “safety”.
4. The gun should remain unloaded until ready to use.
5. Always wear hearing and eye protection.
6. The barrel should be clear of all obstructions before loading and shooting.
7. Handle every gun as if it were loaded.
8. Store guns and ammo separate and in a locked area.
9. Avoid alcoholic beverages and drugs before and during the use of a firearm.
10. Do not alter or modify your firearm. Have your firearm checked regularly by a competent gunsmith. Make sure all parts work properly prior to each use.

Health Warning: Discharging firearms in a poorly ventilated area and/or handling ammunition may cause exposure to lead or lead compounds. According to the state of California, exposure to lead or lead compounds may cause cancer, birth defects, or other reproductive harm. Make sure that you have proper ventilation at all times. Be sure to wash your hands thoroughly after shooting, handling ammunition, or cleaning your firearm. Do not eat or smoke during these activities.

### D. SAFETY CONSIDERATIONS FOR BOTH MUZZLELOADERS AND CENTERFIRES

If you have questions, doubts, or concerns, please call CVA Customer Service.

1. Never smoke when shooting or handling a firearm or related equipment. Ashes and/or loose sparks may cause powder or caps/primers to ignite, resulting in personal injury or death.
2. Always wear eye protection. Flying debris from the breech area and muzzle are common with any firearm.
3. Never pour powder into the muzzleloader directly from a powder can, flask, horn, or any other large volume, enclosed container. Hot embers or sparks in the barrel can cause a flash that, in turn, may cause the container to explode.



CAREFULLY READ THIS SECTION AS THE SAFETY CONCERNS ARE APPLICABLE TO BOTH MUZZLELOADERS AND CENTERFIRE GUNS.





4. All powder storage containers and primers/caps should be kept well away from the shooting area. Sparks from shooting could cause accidental ignition of these materials. Follow manufacturer's instructions regarding long-term storage of these products.
5. Use only blackpowder or approved blackpowder substitutes in your muzzleloading firearms. If you have any questions regarding approved blackpowder substitutes call, write or e-mail CVA Customer Service.
  
6. Always check to make sure your firearm is in good working order before use. Test the hammer, trigger, and breeching lever carefully prior to loading. Check the barrel for any obstructions, as any obstruction can cause the barrel to burst causing severe injury or death.
7. Use only the recommended loading data for the Optima Elite muzzleloader. Other models may have different powder charge and/or bullet requirements and limitations. Improper loading or overloading of a muzzleloader can result in severe injury or death.
8. Never prime or cap a muzzleloader, or load a centerfire gun until you are ready to fire. The primer/cap/cartridge should always be removed when walking, climbing trees or fences, transferring the gun from one person to another, leaving the gun unattended, etc.
9. Never lean a loaded firearm against a wall, tree, vehicle, or other surface. Any fall of a loaded gun may result in an accidental firing of the gun, which may result in severe injury or death.
10. Never transport a loaded firearm in any type of vehicle. A muzzleloader is considered loaded until powder, bullet, and primer/cap have been removed. A centerfire is considered loaded until the cartridge is removed.
11. Never give, or accept from anyone else, a loaded muzzleloader. Only the party who loaded, or witnessed the loading of, the muzzleloader should fire it. This practice will help prevent dangerous double-loading which, when fired, may result in severe injury or death.
12. Never store a loaded firearm. The cartridge, or the bullet, powder, and primer/cap should be removed and the gun cleaned prior to any storage.
13. Never load a firearm without first making sure the barrel is unloaded and unobstructed.
14. Use extreme caution when hunting from a tree stand. The accidental dropping of a firearm may cause a discharge, which may result in severe injury or death. Be sure the firearm is unloaded before raising or lowering the firearm.
15. Never allow the hammer or bolt to rest directly on the primer or cap. A direct blow to the hammer or bolt may cause a discharge, which may result in severe injury or death.
16. Firearms should always be handled as if ready to fire, regardless of the position or condition of the mechanical safety.
17. Always use proper cleaning procedures. Firing of an improperly maintained or corroded firearm may lead to unsafe pressure conditions and/or cause the barrel to rupture resulting in severe injury or death.
18. Make sure the projectile is fully seated on the powder charge in a muzzleloader. The firing of a "short start," or improperly seated bullet, may cause the barrel to burst resulting in severe injury or death.
19. Always keep the barrel pointed in a safe direction when loading. Never allow the barrel to point at anything that you do not wish to see destroyed.

## **E. SPECIFIC CAUTIONS FOR THE SAFE USE OF CVA IN-LINE MUZZLELOADERS**

All muzzleloading firearms, including in-lines, are faithful to the original basic designs. For this reason, muzzleloading guns cannot be made with many of the refinements and features that are standard on modern cartridge firearms. Shooters must remember that even now, despite the modern appearance of in-line design rifles, there is no way to build a muzzleloader that absolves



**NEVER USE MODERN SMOKELESS POWDER IN ANY MUZZLELOADER.** The use of any amount of smokeless powder in a muzzleloader, by itself or in mixture with blackpowder or approved substitutes, will create dangerously high pressures which may, upon ignition, result in severe injury or death to the shooter or bystanders.



Never rely upon a mechanical safety!







the user from the need to use the special safety precautions and good judgment unique to all muzzleloading firearms. When handled properly, a muzzleloader is a safe and enjoyable firearm for shooting and hunting. But, if abused, harmful consequences can result.

As a gun owner, you must accept a set of demanding responsibilities. At all times you must handle your muzzleloader with intense respect for its potential dangers. Read and understand the functions and terminology explained in this book before attempting to use your CVA muzzleloading rifle.

1. When selecting powder loads, be sure to use the correct loading data for your particular model of rifle.
2. “Magnum” loads for CVA in-lines are safe only when using pelletized powder. “Magnum” loads of loose powders are inefficient and are not recommended. All CVA break action guns are approved for use with “magnum” charges of pelletized powder over 100 grains (NOT to exceed 150 grains).
3. Always follow recommended loading data when selecting bullet type and weight. Improper selection of bullet type or weight may cause dangerous pressures upon firing, resulting in possible severe injury or death.
4. PowerBelt™ Bullets or sabot bullets are recommended when using pelletized powder. Both provide the tight gas seal necessary for efficient and complete burning of the entire pellet charge.
5. For maximum accuracy when shooting sabots or older lubricated solid lead bullets, the barrel should be cleaned of powder fouling, plastic, or lubrication residue after each shot. PowerBelt™ Bullets do not leave this residue and do not require cleaning after each shot.
6. Round ball and patch loads are not recommended for CVA break action rifles. The fast rifling pitch (1 turn in 28 inches) will not properly stabilize round balls and will result in less than satisfactory accuracy.
7. Never use modern smokeless powder in any amount, by itself or in mixture, in any muzzleloading firearm. To do so will very likely result in severe injury or death.
8. Do not use a “Poly-Patch” in any CVA rifle.

## F. BASIC NEEDS FOR SHOOTING A MUZZLELOADER

### 1. LOADING ACCESSORIES

**Propellant-** Blackpowder or an approved substitute. Never use any amount of modern smokeless powder.

**Projectile-** PowerBelt™, sabot, or conical bullet.

**Ignition Source-** Modern #209 shotgun primer or equivalent.

**Powder Flask-** For carrying a supply of loose powder (not required with pelletized powder).

**Powder Measure-** For measuring the correct volume of loose powder and for transferring a single charge to the muzzle of the gun (not required with pelletized powder).

**Bullet Starter-** To start the bullet into the muzzle of the gun.

**Capper-** To carry and dispense extra #209 primers.

**Speed loaders-** To carry extra pre-measured powder charges and bullets for quick reloading.

### 2. CLEANING ACCESSORIES

**Barrel Brush-** To loosen and remove hard deposits and fouling.

**CVA Barrel Blaster™ Foaming Bore Cleaner™-** For easy barrel cleaning.

**CVA Barrel Blaster™ Pre-Soaked Cleaning Patches-** For barrel swabbing.

**CVA Barrel Blaster™ Parts Soaker-** For easy parts cleaning.

**Dry Patches-** For cleaning and drying the inside of the barrel.

**Breech Plug Wrench-** For removing the breech plug. Included with your CVA rifle.



muzzleloading firearm with the full respect due any firearm.

Treat any

**YOU ARE RESPONSIBLE FOR FIREARM SAFETY!**





**CVA Lifetime Range Rod-** Doubles as a range loading rod and a cleaning rod.

**Patch Jag-** To retain the patch on the rifle.

**CVA Barrel Blaster™ Rust Prevent Patches-** For the final protection of the bore. Also good for wiping down the outside of the gun to help prevent rust and corrosion.

## G. PROPELLANTS

The use of any amount of modern smokeless powder in a muzzleloader will create dangerously high pressures upon ignition which will likely lead to severe injury or death to the shooter or bystanders. The use of smokeless powder will immediately void the warranty.

Muzzleloader shooters are limited in their choices of propellants. Only the following propellants should be considered as being safe for use:

1. **BLACKPOWDER-** (IMPORTANT! The term “blackpowder” refers to the formulation of the propellant, not the color. Most of the smokeless propellants manufactured for modern cartridge guns are also black in color but will cause dangerous pressures when fired in guns made for blackpowder use.) Blackpowder is available in several granulations (the average size of each particle of the powder) which are rated as FG, FFG, FFFG, and FFFFFG. The more “F’s” in the name, the finer the powder. Care must be taken to assure that only the proper granulation is used. **ONLY FFG POWDER OR ITS EQUIVALENT GRANULATION OF BLACKPOWDER SUBSTITUTE SHOULD BE USED IN YOUR CVA MUZZLELOADING RIFLE OR SHOTGUN BARREL.** The use of other granulations may result in improper burning or higher than acceptable pressures. The use of genuine blackpowder is less common today than in the past due to tight regulations regarding its transportation and storage.
2. **BLACKPOWDER SUBSTITUTES-** Safer and cleaner-burning substitutes for blackpowder have been developed and are perfectly suitable for use in your CVA muzzleloader. Some of the brands available at the time of this printing are Hodgdon’s Pyrodex™ and Triple Seven™, American Pioneer Powder™, Goex Pinnacle™ and Black Mag3™. Most of these are available in granular or pellet form. An important thing to remember is that individual rifles will perform differently with the same propellant and bullet combinations. Each of these blackpowder substitutes have their own characteristics and CVA recommends that you try several to see which one gives you the performance you are looking for. Please refer to the powder manufacturer’s written instructions for the specific propellant you are using. If you have technical questions concerning the propellant you are using, please contact the customer service or technical department listed on the product label.

## H. PROJECTILES

1. **POWERBELT™ BULLETS-** PowerBelt™ Bullets are conical projectiles with a patented plastic base designed to seal the bore and trap the propellant’s pressure. This provides consistent pressure and un-surpassed accuracy. Unlike sabots, however, the PowerBelt™ bullet is easy to load and leaves no plastic residue to foul the barrel. PowerBelt™ Bullets are also full caliber and deliver the maximum energy possible out of a muzzleloader. They are available in a variety of calibers and bullet weights, in copper coated or pure lead, and in hollow point or AeroTip™ design. All weights of PowerBelt™ bullets can be used in CVA rifles. PowerBelt™ bullets are the #1 selling muzzleloading projectile on the market and the only bullet specifically recommended by CVA for our in-line rifles.





NEVER USE ANY AMOUNT OF MODERN SMOKELESS POWDER IN ANY MUZZLELOADER!





2. **CONICAL BULLETS-** These pure lead, pre-lubricated bullets are an economical choice and provide acceptable accuracy as well as good “knock-down” power. These bullets tend to foul the bore with both lead and residual lubricant. To maintain acceptable accuracy, the bore will have to be cleaned after each shot. **CAUTION:** Do not use conical lead bullets weighing more than 400 grains in your CVA rifle.

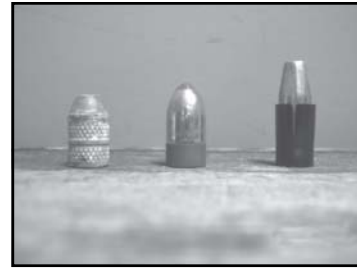

3. **SABOTED BULLETS-** The sabot is a plastic sleeve that is utilized to hold a smaller-than-bore diameter bullet, normally designed for pistols but occasionally one designed specifically for muzzleloaders, tightly in the bore. The rifling in the bore never touches the bullet but instead spins the sabot which in turn spins the bullet inside it. Saboted bullets from various manufacturers have been tested and found to deliver acceptable accuracy in CVA muzzleloaders when used in accordance with the sabot manufacturer’s instructions. Sabots typically leave a heavy plastic fouling in the bore requiring cleaning of the barrel after each shot. **CAUTION:** Do not use saboted bullets weighing more than 300 grains in your CVA rifle.

## I. RECOMMENDED LOADING DATA

The proper charge for any muzzleloading firearm is an efficient load that provides consistent ignition and velocity while keeping breech pressures below the maximum safe levels. It is important to remember that shooting muzzleloaders is not an exact science. Each individual rifle will have its own preference in powder, charge and bullet. The muzzleloader shooter must be willing to experiment to some degree if he is to find the “perfect” load for his rifle.

The shooter should use the chart below as a guide in determining the minimum and maximum charge limitations. It is recommended to begin shooting using a charge in the middle of the recommended range, gradually increasing or decreasing the load to obtain the desired results. Tests have shown that heavier loads increase breech pressures while providing only a small increase in velocity. Heavy loads may also tend to be less accurate than more moderate loads.

CALIBER FIREARM	PROJECTILE TYPE	CHARGE	CHARGES IN GRAINS	
			MINIMUM	MAXIMUM
.50	.50 Conical	Powder FFG	50	100
.45	.45 PowerBelt™/Saboted Bullet	Powder FFG	50	100
.50	.50 PowerBelt™/Saboted Bullet	Powder FFG	50	100
.45	.45 PowerBelt™/Saboted Bullet	Pellet	50	100
.50	.50 PowerBelt™/Saboted Bullet	Pellet	50	100
.45	.45 PowerBelt™/Saboted Bullet	"Magnum Pellet"		
.50	.50 PowerBelt™/Saboted Bullet	"Magnum Pellet"		

This is a “Magnum” charge and can only be safely loaded and used in magnum rated rifles. Magnum capable rifles from CVA include all CVA Break-Action guns, all CVA Pivot-Action rifles, all CVA Bolt-Action rifles (MagBolt, HunterBolt, and FireBolt), and any year 2001 or newer Eclipse and Staghorn conventional in-line rifles. These “Magnum” capable conventional in-lines can be identified by the one-piece barrel construction, a serial number ending in -01 (year of manufacturer) or higher, and the designation “magnum” on the barrel. These “Magnum” loads require the use of a musket cap or #209 primer in order to efficiently



150\*  
150\*

\*WARNING:



ignite the entire charge.

## J. LOADING AND SHOOTING CVA IN-LINE RIFLES

1. Protect your eyesight and hearing by using approved, good quality shooting glasses and hearing protection devices.
2. by removing the breechplug and looking into the bore. Make sure the breech plug is coated with breech plug grease and re-install until snug (do not over tighten!).
  - a. Unscrew the jag on the end of the ramrod and extend it to the cleaning position by continuing to unscrew until the jag turns free. Pull the jag out and continue the unscrewing motion until the second set of threads engage. The ramrod is fully extended when the jag stops turning with normal pressure.
  - b. Place the ramrod into the barrel until it contacts the breech plug. Place a permanent marking on the ramrod flush with the muzzle. From now on, this will be your “unloaded” indicator and you can use this marking to assure you of the loaded or unloaded condition of your barrel.
3. Clean all oil and grease from the interior of the barrel.
4. With the rifle pointed in a safe direction, place a #209 primer in the breech plug.
5. Cock the hammer and fire the primer to insure that the breech and bore are dry of solvent or moisture. Repeat 4 & 5 a minimum of 3 times. **NEVER DRY-FIRE YOUR CVA RIFLE OR SHOTGUN. DOING SO MAY DAMAGE THE FIRING PIN AND/OR TRANSFER BAR. THIS DAMAGE WILL NOT BE COVERED BY YOUR WARRANTY.**
6. **DO NOT LOAD POWDER OR PELLETS INTO YOUR BARREL WITH A LIVE #209 PRIMER IN THE BREECH PLUG!**
7. If using loose powder, pour powder from a flask into a powder measure that is pre-set for the correct powder charge. (See picture 2)
8. With the muzzle pointed up and no part of your body or head over the barrel, pour the powder charge into the muzzle. (See picture 3)



Picture 2



Picture 3

9. If you are using pelletized powder, simply drop the correct number of pellets down the bore.
10. Start the bullet into the bore using your fingers, making sure the bullet is centered and straight.
11. Use a bullet starter to push the bullet into the bore. Use the short end first, then the long end. (see picture 4)
12. Using the ramrod or a range rod, push the bullet down the barrel onto the powder charge. Be careful not to crush the powder or pellets. (see picture 5)



Never fire these “Magnum” loads in any CVA in-line that does not fit this description, or in any side-lock rifle design.

Verify that the rifle is not already loaded







Picture 4



Picture 5

13. \_\_\_\_\_ and the hammer in the forward position, press the breeching lever and open the breech. Place a #209 primer into the breech plug (see picture 6) and close with a firm, snapping motion. **THE GUN IS NOW LOADED.**



Picture 6

14. Take aim at the target and, with your finger off the trigger, cock the hammer. **THE GUN IS NOW READY TO FIRE.**
15. Squeeze the trigger to fire.
16. After firing, wait one minute to reload. This allows all remaining sparks in the barrel to burn out prior to loading another charge of powder into the barrel.
17. If a misfire or failure to fire occurs, wait at least one minute while keeping the gun pointed in a safe direction. Then, try the following procedures:
- Install a new #209 primer and try to fire again.
  - If the gun still does not fire, refer to section "O", pulling a charge.
  - With the charge removed, go back to Step 1 and try again.

## K. LOADING AND SHOOTING CVA IN-LINE MUZZLELOADING SHOTGUNS

The CVA Optima Elite Muzzleloading Shotgun functions just like its rifle cousin and all safety precautions for firearms handling and loading should be observed.

To successfully load and shoot the CVA Optima Elite Muzzleloading Shotgun you will need a few accessories. These should be available where you purchased the gun.

- Powder Flask
- Shotgun volumetric measure
- Plastic shot cups with over powder wads and over shot cards
- Small scissors or wire cutters to cut the wads (not shown)

The shooter can control the patterns produced by the muzzleloading shotgun in several ways:

- Type, brand, or amount of powder.** Genuine blackpowder in FFG granulation, Pyrodex RS™ and Triple 7™ powder in FFG granulation are the only recommended powders for this shotgun. **The use of pelletized powder manufactured for use in muzzleloading rifles is**



WITH THE GUN POINTED IN A SAFE DIRECTION



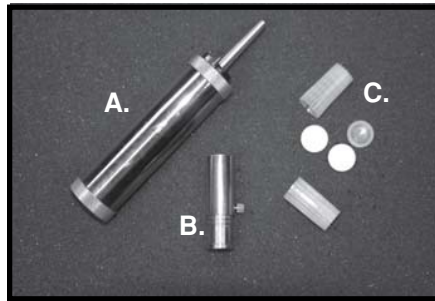

**not acceptable due to the improper diameter of the pellet for the shotgun. Use of these pellets will result in an unsafe condition that may result in severe injury or death.**

2. **Brand, size, or composition of shot.** Experimenting with different shot sizes and types is recommended. Each gun will show a preference that can only be determined by shooting. In our testing, #5 and #6 shot produced the densest and most consistent patterns. While experimenting, always keep in mind the type of game you are preparing to hunt, the average distance you will be shooting, and the applicable game laws.
3. **Shot cup preparation.** The CVA Shot Cups (AC1493) are specifically designed for muzzleloading shotguns and are recommended for use with all loads in your Optima Pro Shotgun. Use small scissors or wire cutters to cut slits into the shot cup. The farther back you cut the cup, the faster the shot will spread. 4 slits will also open faster than 3. Commercially available wads for conventional shot shells are not designed for use with muzzleloaders and are not recommended for use with your Optima Pro.
4. **Screw-in choke tubes (if applicable).** Year 2006 and later Optima Pro Shotguns are furnished with a screw-in choke system. A full choke is included from the factory, but many other constrictions are available from your local gun shop. Optima Pro tubes are interchangeable with Winchester WinChoke™ and Browning Invector™ choke systems.

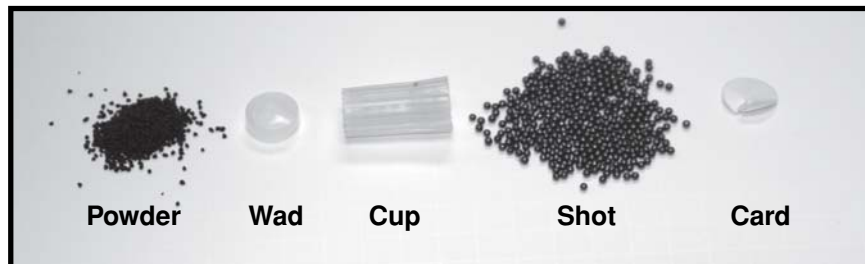

**Loading Procedure:**

1. Start by cutting 3 or 4 equal length longitudinal slits into the shot cup using sharp scissors or wire cutters.
2. Carefully measure your powder into the volumetric measure. You should use the same volume of powder as you use of shot. An ounce and a quarter (by volume) load is considered to be the maximum. Triple 7™ charges should be reduced by approximately 15%. Pour the powder into the barrel.
3. Place the plastic cushion wad into the muzzle and push it down the barrel with the ramrod until it is seated on the powder charge. Starting the wad at an angle or sideways into the barrel is often easier. The wad will straighten out as it is pushed in.
4. Push the prepared shot cup into the muzzle and slightly into the bore. Measure the shot into the volumetric measure and pour it into the cup. **For best results the cup should be slightly overfilled.** With light loads you may have to shorten the cup. Push the cup down the barrel with the ramrod until it is seated on the cushion wad.



5. Push the over shot card down the barrel until it is firmly seated on top of the shot. Starting this card at an angle will aid in getting it down the barrel. Tearing the card about 1/4" inward from the edge will aid in letting air escape from the barrel and will also help to move the card out of the pattern when escaping the barrel.
6. If you are using a choke tube with an extreme restriction (super full or turkey choke) it may be necessary to remove the tube to perform steps 3-5. Never fire the gun without the choke in place or damage to the barrel will occur. Always make sure the choke is firmly tightened.
7. Place a 209 primer in the breech plug. You are now ready to shoot.

**Cleaning the Optima Elite Muzzleloading Shotgun:** Clean your Optima Elite Shotgun in the same manner as described for the CVA Break-Action rifle (section N). For shotguns equipped with screw-in chokes, you will also need to remove the screw-in choke from the muzzle, clean both the choke tube and the barrel threads, re-lubricate the threads with CVA breech plug grease or anti-seize and reinstall. Do not over tighten. Failure to clean these parts after each shooting session may result in a stuck tube.

## L. IGNITION SYSTEM

All CVA Break-Action muzzleloaders come standard with a #209 Shotgun Primer Ignition System that accepts a modern #209 primer or equivalent. This is the most reliable primer for all weather conditions and is suitable for use with loose or pelletized powders. Some primer manufacturers have recently begun development of new #209 type primers formulated specifically to meet the needs of muzzleloader shooters. These new primers promise to reduce the fouling caused by the #209 shotgun primer when used in muzzleloading guns.

## M. SAFETY SYSTEM

CVA Optima Elites are equipped with an automatic internal transfer bar safety system. With this system, a transfer bar rises into place as the trigger is pulled. This transfer bar allows the blow of the hammer to reach the firing pin. When the trigger is released, the transfer bar disengages and lowers into the frame.

## N. BREAK-ACTION DISASSEMBLY/ASSEMBLY FOR CLEANING AND MAINTENANCE







Residues from firing blackpowder and blackpowder substitutes are very corrosive. Therefore prompt and careful cleaning of your muzzleloader is a must. If left uncleaned for any length of time, even for just a few hours, the fouling will absorb water from the atmosphere and cause rust, pits, and degradation of the metal. This damage will not be covered by your warranty.

1. Make sure the gun is unloaded.
2. Remove the ramrod from the gun. (muzzleloader only)
3. Open the action and remove the breech plug using the tool provided. If you have misplaced the breech plug wrench, a 12mm 6-point socket works well. (muzzleloader only)
4. Loosen and remove the screw from the underside of the foregrip.
5. Remove the foregrip from the barrel.
6. Separate the barrel from the action. It is best to do this with the receiver and frame in the open position. Use a soft punch (brass, aluminum, plastic, or hardwood) and small hammer to drive the pivot pin out of the receiver and release the barrel.
7. Use the extended ramrod, a range rod, or a cleaning rod with a bore brush or patches and solvent to clean all residues from the bore.



**NO MECHANICAL SAFETY SHOULD EVER BE RELIED UPON TO  
TAKE THE PLACE OF SAFE GUN HANDLING!**



- 
- 
- 
- 
8. Use a solvent-soaked patch or a breech brush to clean the breech plug threads.  
(muzzleloader only)
  9. Clean the outside of the barrel using a soft cloth and solvent. Pay special attention to the area between the barrel block and the foregrip lug on the bottom of the barrel. Corrosive gases are vented into this area upon firing. (muzzleloader only)  
**IMPORTANT: LUBRICATE THE BREECH PLUG THREADS WITH BREECH PLUG GREASE OR ANTI-SEIZE BEFORE REINSTALLING. DO NOT OVER TIGHTEN.**  
(muzzleloader only)
  10. Do not attempt to disassemble the receiver. To do so will void the warranty. Clean as a one-piece unit. Use a solvent soaked patch, soft cloth, or cotton swab to clean the breech face and locking block. Use a swab around the hammer and trigger opening.
  11. To clean the firing pin and spring you must utilize the two screws on the right side of the receiver. The front screw engages a slot in the firing pin and retains it in the proper position. The rear screw allows the transfer bar to tilt to the rear so that the firing pin can slide out. You must follow these instruction in this sequence:
    - a. Check and make sure that the gun is unloaded
    - b. Cock the hammer. Loosen the rear screw until the transfer bar will tilt to the rear.
    - c. Loosen the front screw until the firing pin is released. Block the firing pin with a fingertip during this operation to insure that the pin is not lost. (Note: If you loosen the firing pin screw before cocking the hammer, it will block the transfer bar and prevent the hammer from cocking. If this happens, pull the hammer back just enough to use a small screwdriver to push the firing pin back into the receiver so that the firing pin screw can be tightened again.)
    - d. Clean the firing pin, spring, and the hole in the receiver and reassemble in reverse order.
    - e. **IMPORTANT TIP-** This operation is much easier if you use a screwdriver with a magnetic tip.
  12. Reassemble the rifle in reverse order. Wipe all parts with a cloth and non-petroleum oil. Check all functions of the guns carefully to assure safe operation.
- 
- 

CVA makes a full line of cleaning and maintenance products sold under the Barrel Blaster™ name. These products include gel cleaners, foaming cleaners, and parts soaking baskets that make cleaning your gun quick and easy. These products are highly recommended for maintaining your CVA firearms.

## O. PULLING A CHARGE

Under normal conditions, a muzzleloading firearm is unloaded simply by firing it into a suitable and safe backstop. There are, however, some conditions under which the firearm cannot be fired and the charge must be removed. The two most common conditions are:

1. The projectile is not, or cannot be, fully seated on the powder charge.
2. If the rifle is loaded in a proper manner yet fails to fire after repeated attempts.



DO NOT ATTEMPT TO USE THIS RIFLE IF ANY OF THE SAFETY FEATURES DO NOT OPERATE PROPERLY. SEND THE GUN TO CVA CUSTOMER SERVICE TO CORRECT ANY PROBLEM THAT YOU MAY FIND. USE OF AN IMPROPERLY WORKING GUN CAN RESULT IN SEVERE INJURY OR DEATH.

ALWAYS STORE YOUR RIFLE UNLOADED IN A COOL, DRY PLACE.

NEVER ATTEMPT TO PULL A CHARGE UNTIL THE POWDER HAS BEEN RENDERED INERT BY THOROUGHLY SOAKING IN WATER.





Removing a projectile is dangerous when there is a powder charge behind the projectile. The two accepted methods for doing this are to: (1) Use a CO<sub>2</sub> discharger, available in most sporting goods stores that sell muzzleloaders, to blow the load out in a safe direction, and (2) With the muzzle pointed in a safe direction, and the primer removed from the breech plug, remove the breech plug from the barrel. Empty the powder into a safe container. Using the ramrod (or a range rod) with a jag and a solvent soaked patch, push the bullet out of the barrel.

After the bullet has been removed from the bore, clean the bore and reassemble the firearm.

If for any reason you are unable to remove the charge in the manner recommended, soak the barrel in hot water for 1/2 hour. Once the powder has been rendered inert, take the barrel to a qualified gunsmith.

## P. LOADING AND FIRING THE OPTIMA ELITE CENTERFIRE RIFLE & SHOTGUN

1. Before proceeding, break open the rifle by depressing the breeching lever. Verify that the gun is unloaded and that the bore is clean and unobstructed.
2. Review the safety warnings and considerations contained in sections A – D of this book.
3. With the muzzle pointed in a safe direction, insert a factory-loaded cartridge or shell of the same caliber and name as marked on the side of the barrel into the breech and close the gun.
4. Aim at a safe target with a suitable backstop and, with your finger off the trigger, cock the hammer. You are now ready to fire.
5. After firing, break the rifle open and remove the empty cartridge or shell. The Optima Elite is equipped with an extractor that will pull the fired brass partially out of the barrel.
6. To unload a loaded rifle or shotgun, break open the barrel and remove the cartridge or shell.
7. Refer to section N for cleaning and maintenance instructions. Ignore the steps that are clearly for muzzleloaders only.

## Q. SIGHT ADJUSTMENTS

Your CVA Optima Elite has fully adjustable sights to help you take advantage of its full accuracy potential. When sighting in your gun it is important to remember that the rear sight should be moved in the same direction as you need the point of impact to move. In other words, if you need the point of impact to move up, move the rear sight up. If you need the point of impact to move right, move the rear sight right, and so on. (Note: Guns shipped as a “combo,” meaning with an extra barrel in the box, are equipped with only one set of sights as it is assumed that at least one barrel will be scoped. Additional sights are available from your retailer or from CVA Customer Service at reasonable prices.)

## R. SCOPE MOUNTING

CVA rifles come drilled and tapped for easy installation of a scope and mounts. Do not drill additional holes in your barrel as this can weaken the barrel and cause it to burst, resulting in severe injury or death.

Without a doubt, the most common cause of unacceptable accuracy is inferior scope mounts and rings. Often the price difference between the cheapest mounts and rings on the shelf and a set of good quality heavy-duty mounts and rings is just a few dollars. Certainly it is less than the pack of bullets and the powder you will shoot before you figure out that those \$10 rings were “false economy.” CVA uses and recommends the DuraSight™ brand of precision scope mounts and rings to compliment your CVA rifle. These quality mounts and rings should be available from the dealer where you bought your rifle. If not, contact CVA Customer Service.





Follow the scope mount manufacturer's recommended instructions when installing the mounts and rings. The use of Loctite™ thread-locking compound is optional but certainly not required. If you decide to use this material, use a low-strength grade and use it sparingly. Take care to assure that the front bell on the scope is not contacting the barrel. Make sure that the rear bell of the scope is an appropriate distance from your eye so that you are not struck by the scope during recoil.

## S. VOLUNTARY RECALL

In August of 1997, CVA implemented a Voluntary Recall of all in-line rifle models with serial numbers ending in -95 or -96.

If you, or someone you know, have a CVA in-line rifle with such a serial number, do not use or allow anyone else to use the gun under any circumstances. Call CVA immediately at 770-449-4687 for complete details and instructions on how to receive a replacement gun.

In May of 1999, Blackpowder Products, Inc. purchased the assets of Connecticut Valley Arms, Inc. and now operates under the trade name of Connecticut Valley Arms and/or CVA. Any claims relating to the above-described Voluntary Recall should be addressed to Connecticut Valley Arms, Inc., not to Blackpowder Products, Inc. Blackpowder Products, Inc. assumes no liability for any products manufactured or sold prior to January 1, 1998.

## T. SERVICE & REPAIR (770) 449-4687 MONDAY – FRIDAY 8:30AM - 4:00PM EASTERN TIME

Should your CVA firearm require repair, we recommend that it be returned to our Warranty Repair Center. This will assure that a competent staff of trained technicians performs all work. Under U.S. law, your Optima Elite can be shipped by you directly to our warranty repair center, and we can return it directly to you. If you use a dealer or gunsmith to ship the rifle, we must return it to the same dealer or gunsmith. NO EXCEPTIONS WILL BE MADE. (Section 178.147 Federal Firearms Regulations)

Any firearm returned to the repair center should be marked to the attention of OPTIMA ELITE REPAIR DEPARTMENT. A detailed letter of instructions should be enclosed to facilitate handling. Please be sure to include your name, shipping address, and a daytime phone number.

Our Repair Center will inspect and evaluate the problem. Should any work not be covered by warranty, you will be advised of the cost. No work will be done without your approval. The address for the CVA Repair Center is:

CVA  
Attn: Optima Elite Repair Department  
5988 Peachtree Corners East  
Norcross, GA 30071

## U. ORDERING REPLACEMENT PARTS

All parts orders and correspondence must be mailed to:

CVA  
Attn: Customer Service Department  
5988 Peachtree Corners East  
Norcross, GA 30071



Example of a recalled serial number: 61-13-xxxxxx-95



All firearms must be unloaded and shipped via United Parcel Service (UPS).





You can also purchase parts by phone with a major credit card by calling (770) 449-4687.

When ordering you must have:

1. The model of the gun.
2. Part number or description
3. Caliber and type of gun (Flintlock, percussion, in-line, .30-06, etc)

If the proper part identification is not possible, send the specific part in question to aid in identification.

Discontinued items are subject to availability. CVA will reserve the right to make compatible substitutions when necessary.

Enclose the total retail price of the items plus postage and handling. Refer to the chart to determine this:

**POSTAGE AND HANDLING CHART**

<b>Orders totaling:</b>	<b>Add</b>
Up to \$20 .....	\$3.50
\$20.01 to \$30 .....	\$5.00
\$30.01 to \$50 .....	\$7.00
\$50.01 to \$80 .....	\$10.00
\$80.01 to \$110 .....	\$15.00
\$110.01 to \$200 .....	\$20.00
\$200.01 to \$500 .....	\$25.00
over \$500 .....	\$30.00

Georgia residents must add 6% sales tax

**V. LIMITED LIFETIME WARRANTY**

CVA warrants all factory-finished firearms to be free of defects in workmanship or materials for the lifetime of the firearm. This Limited Lifetime Warranty only applies to the original consumer owner. This warranty is put into effect by the return of the authorized warranty card within 15 days of purchase and is not transferable. To save time and postage, the warranty information may also be transmitted electronically via our web site at [www.cva.com](http://www.cva.com).

Any covered CVA firearm or part thereof that is returned postage paid to the Repair Center or Customer Service Department will be repaired or replaced to our commercial standard, free of charge, and returned to the consumer postage prepaid.

This warranty does not cover any damage resulting from careless handling, improper loading, rust or corrosion, neglect, or customer alterations. Nor does it cover normal wear of any part, metal or stock finish, cost of inconvenience due to product failure, or transportation to the Repair Center. CVA reserves the right to refuse to repair or replace any firearm or parts thereof damaged by any of the above.

This warranty gives you certain specific legal rights. You may also have other rights, which vary from state to state. This warranty is void if:

- Any propellant other than the correct type of blackpowder or blackpowder substitute is used.
- CVA recommended maximum powder charge has been exceeded.
- Any form of plastic patch has been used (sabots and PowerBelts™ not included).
- Gun is returned in an abused or neglected condition (rusty, corroded, etc.).
- Cartridges other than factory-loaded cartridges are fired in centerfire barrels.

