



WARNING:

BEFORE USING THIS FIREARM, READ AND FOLLOW THESE INSTRUCTIONS

If there is anything you do not understand, get help from someone qualified in the safe handling of firearms.



SAFETY
AND
INSTRUCTION
MANUAL

**COLT® GOVERNMENT MODEL® MKIV™
SERIES 70
MODEL 01970A1™**

Copyright© 2001 Colt's Manufacturing Company, Inc. All Rights Reserved.
This instruction manual should always accompany this pistol.
When you lend, give or sell this firearm, be sure this manual goes with it.

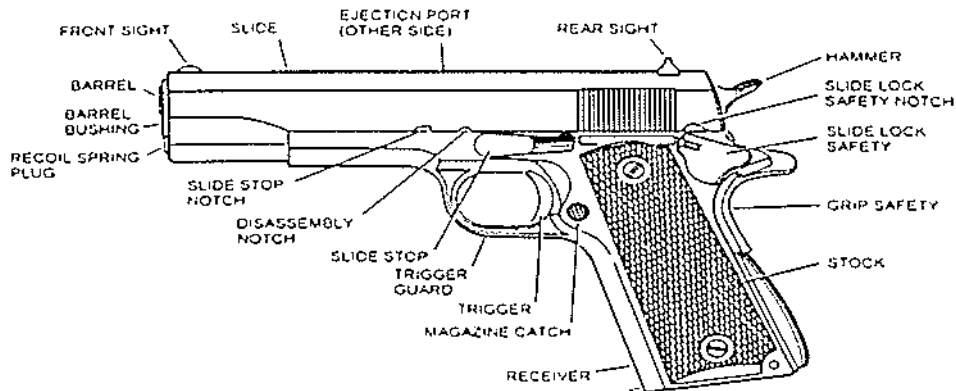

FIGURE 1 – COLT® GOVERNMENT MODEL® MKIV™/Series 70 MODEL O1970A1™

! **CAUTION:** ALWAYS KEEP AND CARRY YOUR PISTOL EMPTY, WITH THE HAMMER FORWARD EXCEPT WHEN YOU INTEND TO SHOOT, so that your pistol cannot be fired when you do not mean to fire it.

! **CAUTION:** USE ONLY CLEAN, DRY ORIGINAL HIGH QUALITY COMMERCIALY MANUFACTURED .45 ACP AMMUNITION IN GOOD CONDITION. Never carry the pistol with a round in the chamber until ready to shoot.

SECTION 1**PRECAUTIONS**

READ AND UNDERSTAND ALL THE FOLLOWING PRECAUTIONS BEFORE REMOVING THIS FIREARM FROM ITS PACKAGE.

This Colt product is classified by the Alcohol, Tobacco and Firearms Division of the Internal Revenue Service, U.S. Treasury Department, as a firearm or dangerous weapon; it is, therefore, potentially lethal!

 **WARNING: IF THIS FIREARM IS CARELESSLY OR IMPROPERLY HANDLED, UNINTENTIONAL DISCHARGE COULD RESULT AND COULD CAUSE INJURY, DEATH, OR DAMAGE TO PROPERTY.**

 **CAUTION: CAREFULLY READ THIS INSTRUCTION MANUAL WHICH GIVES BASIC ADVICE ON THE PROPER HANDLING AND FUNCTIONING OF THIS COLT FIREARM PRIOR TO LOADING AND FIRING. However, your safety and the safety of others (including your family) depends on your mature compliance with that advice, and your adoption, development and constant of safe practices.**

If unfamiliar with firearms, seek further advice through safe handling courses run by your local gun clubs, NRA approved instructor, or similar qualified organizations.

NOTICE

Colt shall not be responsible for injury, death, or damage to property resulting from either intentional or accidental discharge of this firearm, or from its function when used for purposes or subjected to treatment for which it was not designed. Colt will not honor claims involving this firearm which result from careless or improper handling, unauthorized adjustment or parts replacement, corrosion, neglect, or the use of wrong caliber ammunition, or the use of ammunition other than original high quality commercially manufactured ammunition in good condition, or any combination thereof. Colt will not honor claims involving this firearm for any reason or cause when such claims are made by the second or subsequent owner.

IMPORTANT

Before it left the factory this firearm was tested, carefully inspected, and packaged. Colt cannot control product handling after it leaves the factory; therefore, please examine this firearm carefully at the time of purchase to insure that it is unloaded and undamaged. The dealer will be pleased to assist you in making this examination and endeavor to answer your further questions.

This instruction manual should always accompany this firearm. When you lend, give or sell this firearm, be sure this manual goes with it.

LIST OF SECTIONS

SECTION	TITLE	PAGE	SECTION	TITLE	PAGE
1	PRECAUTIONS	1		Unloading	26
2	Main Features	4		To Unload	26
3	Safety Instructions:	5		Firing	28
	Cautions	6		To Fire	28
	Safety Features:	14	5	Maintenance:	31
	Trigger Guard	14		Stripping for Cleaning	32
	Slide Lock Safety	14		Assembling after Cleaning	35
	Grip Safety	15		When to Clean	38
	Half Cock Notch in Hammer	16		How to Clean and Lubricate	38
	Disconnecter	17		Cleaning the Magazine	41
	Inertia Firing Pin	18		Storage	43
4	Function:	19		Servicing and Repair	43
	Ammunition Selection	20	6	Parts Illustration and List	46
	Loading	21	7	The Customized Gun	49
	To Load a Magazine	21			
	To Load the Pistol	23			
	Carrying Modes	25			

SAFETY DEPENDS ON YOU

SECTION 2**MAIN FEATURES**

This COLT® GOVERNMENT MODEL® MKIV™/Series 70 MODEL O1970A1™ retains a quality of endurance acknowledged since 1970. Manual and automatic safety devices can be depended on to serve you reliably and safely provided you handle the pistol properly. This O1970A1™ pistol is a faithful reissue and is **NOT** equipped with a firing pin safety mechanism. If this firearm is carelessly or improperly handled, discharge could result and could cause injury, death or damage to property.

Caliber	Barrel Length	Finish	Magazine Capacity	Sights
.45 ACP	5"	Blue	7 rounds	 Fixed round notch rear, Fixed blade front. Sight radius 6 1/2"

We want you to enjoy shooting your Colt pistol, but we want you to enjoy it safely. You may be an experienced safe shooter already familiar with the procedures in this instruction manual, or you may never have handled a gun before. Either way we urge you to **READ THIS ENTIRE INSTRUCTION MANUAL CAREFULLY. YOU MUST FOLLOW THE SAFETY INSTRUCTIONS FOR YOUR SAFETY AND THE SAFETY OF OTHERS.**

 **WARNING: WHEN A ROUND IS IN THE CHAMBER, THIS PISTOL MAY DISCHARGE ACCIDENTALLY IF IT IS DROPPED OR RECEIVES A BLOW. (THIS CAN OCCUR REGARDLESS OF THE POSITION OF THE HAMMER OR ANY OF THE VARIOUS SAFETY DEVICES.) DO NOT PUT A ROUND IN THE CHAMBER UNTIL THE PISTOL IS IN YOUR HAND AND YOU ARE READY TO SHOOT, AND CLEAR THE PISTOL IMMEDIATELY AFTER SHOOTING.**

 **WARNING: When you squeeze the trigger, you must expect the gun to fire, and you must take full responsibility for firing it. Your care can avoid accidental discharge, and you will thereby avoid accidental injury and death.**



CAUTIONS:

GENERAL HANDLING CAUTIONS:

- 1. ALWAYS HANDLE YOUR PISTOL AS IF IT WERE LOADED** so that you never fire it accidentally when you think it is unloaded.
- 2. NEVER POINT YOUR PISTOL AT ANYTHING YOU DO NOT INTEND TO SHOOT** so that if it fires accidentally, injury, death, or damage to property will be prevented.
- 3 NEVER TAKE ANYONE'S WORD THAT A GUN IS UNLOADED:** check for yourself with fingers off the trigger and gun pointed in a safe direction, so that you never fire the gun accidentally when you think it is unloaded.
- 4. ALWAYS MAKE SURE YOUR PISTOL IS NOT LOADED AND THE SLIDE IS LATCHED OPEN BEFORE LAYING IT DOWN, OR HANDING IT TO ANOTHER PERSON,** so that it cannot be fired when it is unsafe to do so.
- 5. ALWAYS KEEP AND CARRY YOUR PISTOL EMPTY, WITH THE HAMMER FORWARD** except when you intend to shoot, so that your pistol cannot be fired when you do not mean to fire it.

6. ALWAYS BE AWARE OF POSSIBLE RISK FROM DROPPING YOUR PISTOL. Some parts of the mechanism could be damaged. You may not see the damage but if it is severe, the pistol may discharge and cause injury, death, or damage to property. If your pistol has been dropped, have it examined by a competent gunsmith before using it again.

7. NEVER LEAVE PISTOL COCKED READY TO FIRE as this condition is extremely dangerous, and pistol could easily be accidentally discharged, causing injury, death, or damage to property.

8. NEVER PLACE OR ALLOW THE HAMMER TO REMAIN IN THE HALF-COCK NOTCH. THIS IS NOT A SAFE CARRYING POSITION. ANY EFFORT TO ENGAGE THE HAMMER IN THE HALF-COCK NOTCH MAY RESULT IN THE HAMMER PERCHING ON THE LIP OF THE HALF-COCK NOTCH. THIS IS EXTREMELY HAZARDOUS. IF THE HAMMER IS IN THIS CONDITION IT COULD FALL FORWARD AND DISCHARGE THE PISTOL, THEREBY RISKING INJURY, DEATH, OR DAMAGE TO PROPERTY.

9. NEVER LEAVE A LOADED PISTOL UNATTENDED. Someone, especially a child, may fire it and cause injury, death, or damage to property.

10. ALWAYS INSTRUCT CHILDREN TO RESPECT FIREARMS. If you teach your children to shoot, teach them or get them trained by a qualified instructor to treat and use the pistol properly, and always supervise them

closely. Always stress safety so that your children will not fire the pistol when it is unsafe to do so.



RANGE CAUTIONS

11. ALWAYS BE SURE YOUR BACKSTOP IS ADEQUATE to stop and contain bullets before beginning target practice so that you do not hit anything outside the range shooting area. **THINK!** *What will you HIT if you MISS the target?*

12. ALWAYS PUT A KNOWLEDGEABLE AND RESPONSIBLE PERSON IN CHARGE TO MAINTAIN SAFETY CONTROL WHEN A GROUP IS FIRING ON A RANGE. Obey his commands so that discipline is maintained to reduce the likelihood of accidents.

13. ALWAYS CARRY YOUR PISTOL EMPTY WITH SLIDE LATCHED OPEN WHILE ON A RANGE until preparing to fire. Keep it pointing towards the backstop when loading, firing and unloading, to eliminate the risk of injury, death, or damage to property.



LOADING CAUTIONS

14. ALWAYS BE SURE BARREL BORE, CHAMBER AND ACTION ARE CLEAN AND CLEAR OF OBSTRUCTIONS. Clean a fouled pistol immediately so that

It will function correctly and safely.

15. ALWAYS USE ONLY CLEAN, DRY, ORIGINAL HIGH QUALITY COMMERCIALY MANUFACTURED AMMUNITION IN GOOD CONDITION WHICH IS APPROPRIATE TO THE CALIBER OF YOUR PISTOL. Gun and ammunition manufacturers design their products within exacting engineering safety limits. Handloads and remanufactured ammunition are sometimes outside those limits and can be so unsafe as to blow up the chamber, slide and receiver and cause injury, death, or damage to property.



SHOOTING CAUTIONS

16. NEVER DRINK ALCOHOLIC BEVERAGES OR TAKE DRUGS BEFORE OR DURING SHOOTING, as your vision, coordination and judgment could be seriously impaired making your gun handling unsafe.

17. ALWAYS SEEK A DOCTOR'S ADVICE IF YOU ARE TAKING MEDICATION, to be sure you are fit to shoot and handle your pistol safely.

18. ALWAYS WEAR AND ENCOURAGE OTHERS TO WEAR EAR PROTECTION WHEN SHOOTING, especially on a range. Without ear protection, the noise of even one shot from your pistol, and other guns close to you, could

leave a "ringing" in the ears for some time after firing while the cumulative long term effect could be permanent hearing loss.

19. ALWAYS WEAR AND ENCOURAGE OTHERS TO WEAR PROTECTIVE SHOOTING GLASSES. Flying particles could damage eyes and cause blindness; but protective shooting glasses should prevent such injury.

20. ALWAYS KEEP THE SAFETY ON WHEN PISTOL IS LOADED AND COCKED UNTIL YOU ARE READY TO FIRE. This will minimize risk of an accidental discharge.

21. ALWAYS KEEP CLEAR AND KEEP OTHERS CLEAR OF THE EJECTION PORT. Spent cartridges are ejected with enough force to cause injury. The ejection port must also be unobstructed by your hand to insure safe ejection of live rounds. Never place fingers in ejection port; they could be burned by hot metal or injured by the slide moving forward.

22. NEVER SQUEEZE THE TRIGGER OR PUT YOUR FINGER IN THE TRIGGER GUARD UNTIL YOU ARE AIMING AT A TARGET AND READY TO SHOOT. This will prevent you from firing the pistol when it is pointing in an unsafe direction.

23. ALWAYS BE ABSOLUTELY SURE OF YOUR TARGET AND THE AREA BEHIND IT BEFORE YOU SQUEEZE THE TRIGGER. A bullet could travel through

or past your target up to 1st miles . . . If in doubt, don't shoot. **THINK!** *What will you HIT if you MISS the target?*

24. NEVER SHOOT AT A HARD SURFACE SUCH AS ROCK, OR A LIQUID SURFACE SUCH AS WATER. A bullet may ricochet and travel in any direction to strike you, or an object you cannot see, causing injury, death, or damage to property.

25. NEVER DISCHARGE A FIREARM NEAR FLAMMABLE MATERIAL. Flame and sparks erupt from the firearm when discharged. They could start a fire or cause flammable liquids and gasses to explode.

26. NEVER FIRE YOUR FIREARM NEAR AN ANIMAL unless it is trained to accept the noise; an animal's startled reaction could injure it or cause an accident.

27. NEVER INDULGE IN "HORSEPLAY" WHILE HOLDING YOUR PISTOL as it may be accidentally discharged.

28. NEVER WALK, CLIMB OR FOLLOW A COMPANION WITH YOUR PISTOL, COCKED READY TO FIRE, out of its holster, or with the hammer in any position other than forward on an empty chamber, to eliminate risk of accidental discharge. When hunting, hold your pistol so that you can always control the direction of the muzzle.



MALFUNCTION CAUTIONS

29. FAILURE TO FIRE: ALWAYS HOLD THE PISTOL, KEEPING IT POINTED TOWARD THE TARGET OR A SAFE OPEN AREA AND WAIT 30 SECONDS when the pistol fails to fire. If a hangfire (slow ignition) has occurred, round will fire within 30 seconds. If round does not fire, remove magazine, eject round and examine primer; If firing pin indent on primer is light, off center, or non-existent, have the pistol examined by a competent gunsmith before firing again. If firing pin indent on primer appears normal (in comparison with similar previously fired rounds) assume faulty ammunition; segregate misfired round from other live ammunition and empty cases, reload and carry on firing.

NOTE: Dispose of misfired rounds in accordance with ammunition manufacturer's instructions.

30. NEVER USE YOUR PISTOL IF IT FAILS TO FUNCTION PROPERLY. AND NEVER FORCE A JAMMED ACTION, as a round may explode causing serious injury, possible death, or severe damage to your pistol.



CLEANING AND STORAGE CAUTIONS

31. ALWAYS MAKE SURE YOUR PISTOL IS NOT LOADED BEFORE CLEANING, STORING, TRAVELING, LAYING IT DOWN, OR HANDING IT TO ANOTHER PERSON, so that it cannot be fired when it is unsafe to do so.

32. ALWAYS KEEP AND STORE YOUR PISTOL AND AMMUNITION IN SEPARATE LOCKED RECEPTACLES OUT OF REACH AND SIGHT OF CHILDREN AND UNTRAINED PEOPLE, to minimize the risk of pistol and ammunition being easily available for loading and firing.



GUN ABUSE CAUTION

33. NEVER ABUSE YOUR PISTOL by using it for any purpose other than shooting.

34. NEVER DRY FIRE THE PISTOL WHEN THE SLIDE IS REMOVED FROM THE RECEIVER, and do not alter parts as the level of safety could be reduced.

NOTE: Please note that we have chosen to use the word "SQUEEZE" in this instruction manual instead of "PULL" or "PRESS" when trigger movement is described; this is simply to remind you of the need for a gentle squeezing action to achieve accuracy.

SAFETY FEATURES

This Colt® Model O1970A1™ pistol incorporates several positive safety devices which, if properly employed, can minimize the danger of accidental firing. These safety devices are described on the following pages.

Trigger Guard

The Trigger Guard is a metal loop around the trigger to protect it from damage and to help prevent accidental discharge.

Slide Lock Safety

The Slide Lock Safety is located on the left rear of the pistol just below the slide. With the hammer fully cocked and Slide Lock Safety applied, the upper part of the Slide Lock Safety engages the slide lock notch to prevent rearward movement of the slide, while an internal cam surface engages the sear to prevent forward hammer movement when the trigger is squeezed. This safety device can be applied only when the slide is fully forward and hammer is fully cocked.

To apply Slide Lock Safety, point pistol in a safe direction, keep fingers outside the trigger guard, pull slide fully to rear and allow it to return sharply forward, leaving the hammer in the fully cocked position. Press up on the Slide Lock Safety until it fully engages the slide lock notch (See Figure 2).

When the Slide Lock Safety is down, the sear is free to release the hammer to fire the pistol when it is properly gripped and the trigger is squeezed.

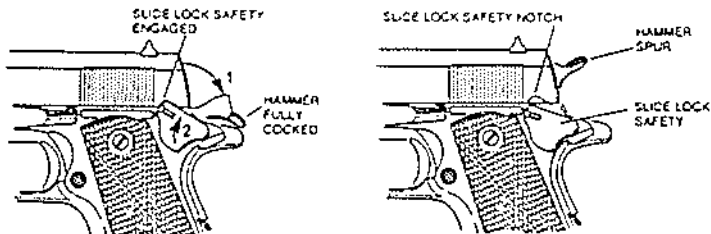

FIGURE 2 - SLIDE LOCK SAFETY

Grip Safety

The Grip Safety is located on the upper rear part of the receiver (See Figure 1). The Grip Safety is automatically applied by spring action to prevent rearward travel of the trigger unless the pistol grip is firmly and properly grasped. The front of the Grip Safety (inside the pistol frame) contacts the rear of the trigger to prevent its rearward movement. When the pistol grip is positively grasped, the Grip Safety is rotated out of contact with the rear of the trigger to allow trigger movement.

Half Cock Notch in Hammer

The Half Cock Notch is an automatically operating fail-safe device which will engage the sear in the unlikely event of primary sear notch failure. This will prevent the hammer from falling fully forward unintentionally and insure against uncontrolled automatic fire. It also prevents the hammer from striking the firing pin should your hand slip from the slide while cocking the pistol, provided the hammer is rotated past the Half Cock Notch. The Half Cock Notch is not meant to be engaged by hand.



CAUTION: NEVER PLACE OR ALLOW THE HAMMER TO REMAIN IN THE HALF COCK NOTCH. THIS IS NOT A SAFE CARRYING POSITION. ANY EFFORT TO ENGAGE THE HAMMER IN THE HALF COCK NOTCH MAY RESULT IN THE HAMMER PERCHING ON THE LIP OF THE HALF COCK NOTCH; THIS IS EXTREMELY HAZARDOUS. IF THE HAMMER IS IN THIS CONDITION IT COULD FALL FORWARD AND DISCHARGE THE PISTOL, THEREBY RISKING INJURY, DEATH, OR DAMAGE TO PROPERTY.



CAUTION: CONTROL HAMMER WITH YOUR THUMB AND ALWAYS POINT PISTOL IN A SAFE DIRECTION WHEN SQUEEZING THE TRIGGER TO LOWER THE HAMMER.

This will avoid accidental injury in the unlikely event of pistol discharge, but lowering the hammer in this way should be done only when the chamber is empty.

Disconnecter

This safety device prevents a round from being fired before it is in the chamber with the slide and barrel locked. When the slide is not fully forward the Disconnecter is depressed; its lower part disengages the sear, so that the hammer cannot be released if the trigger is squeezed. However, when the slide and barrel are locked, a spring pushes the Disconnecter up into a recess in the slide; this links the trigger and sear so that the pistol can be fired by squeezing the trigger.



CAUTION: NEVER ATTEMPT TO CHECK OR DEMONSTRATE THE DISCONNECTOR FUNCTION WITH A LOADED PISTOL. Pushing on the muzzle with your hand or any other portion of the body is extremely dangerous and could result in accidental discharge causing injury, death, or damage to property.

Inertia Firing Pin

The Firing Pin, which is shorter than its housing, is held to the rear by a spring and cannot protrude past the breech face of the slide unless a hammer blow overcomes the spring force of the firing pin spring and the inertia of the firing pin.



CAUTION: DO NOT CARRY YOUR PISTOL WITH THE HAMMER DOWN ON A LIVE CARTRIDGE. To do so means you must lower the hammer. To lower the hammer you must squeeze the trigger. This is not a safe condition. Instead, we urge you to follow the instructions in this manual. When you do, you can enjoy the safe use of your pistol.

IMPORTANT: These safety devices are designed and installed in this pistol to prevent accidental discharge. Of course, this Colt pistol is designed primarily to discharge bullets, and it will do this efficiently when it is loaded and you squeeze the trigger. *Always expect the gun to fire when you squeeze the trigger.*

This Colt® Model O1970A1™ pistol is ready to fire when a loaded magazine is inserted into the pistol, the slide pulled back to cock the hammer, and then released to travel forward and feed a round from the magazine into the chamber. Final forward slide movement locks the barrel and slide together and deactivates the disconnecter.

When the pistol is grasped, the grip safety is released so that the trigger may now be squeezed. When the trigger is squeezed the trigger bar acts to disengage the sear from the hammer. The hammer pivots forward under the force of the mainspring to strike the rear of the firing pin. The firing pin is driven forward to strike the primer in base of cartridge.

The energy imparted to the primer ignites it; the primer in turn ignites the main powder charge which in burning, rapidly generates extremely high gas pressure to drive the bullet down the barrel. Rifling grooves in the barrel impart stabilizing spin to the bullet so that it will follow a more accurate path to the target when it leaves the muzzle.

Force rearward on the slide breech face starts the slide and barrel on their rearward travel; however, the slide unlocks from the barrel only after gas pressure is reduced to a safe level. Rearward slide travel depresses the

disconnecter, carries spent cartridges rearward on the extractor until the base of the cartridge is struck by the ejector to propel it through the ejection port.

Slide movement continues under momentum to fully cock the hammer. If the last round has been fired, the magazine follower will activate the slide stop to hold the slide to rear, but if a round remains in the magazine, the slide will move forward to feed and lock the next round in the chamber. The trigger must be released and squeezed again to fire the next round.

AMMUNITION SELECTION

Colt firearms are designed to function with a variety of brands and types of factory-manufactured ammunition in the appropriate caliber; but not all ammunition produces the same result. Colt recommends that after you read and understand this manual, you go to the range and fire different ammunition which is appropriate to the caliber of your firearm. Once you find the ammunition which functions best, keep using it. **Every time before loading your pistol, examine the ammunition, particularly on and around the primer. Look for dents, scratches and other signs of damage. Do not load damaged ammunition.**

NOTE: Extensive use of +P ammunition will accelerate wear in your pistol.

LOADING

 **CAUTION: TO MINIMIZE RISK OF UNINTENTIONAL DISCHARGE, LOAD LIVE AMMUNITION INTO PISTOL ONLY WHEN YOU INTEND TO SHOOT, AND THEN KEEP AN EMPTY CHAMBER UNDER THE HAMMER.**

 **CAUTION: ALWAYS EXERCISE EXTREME CARE TO KEEP MUZZLE POINTING IN A SAFE DIRECTION, WELL CLEAR OF YOUR BODY particularly when loading and unloading.**

To Load A Magazine:

-  **1. CAUTION: READ SAFETY INSTRUCTIONS (Section 3).**
- 2. Use only .45 ACP ammunition recommended as suitable for your pistol. Examine the ammunition, particularly on and around the primer. Look for dents, scratches, and other signs of damage. Do not load damaged ammunition.**
- 3. With open end uppermost, grasp the magazine in one hand. Place a round on the magazine follower with the base of the round just forward of the retaining lips (see Figure 3). Press the round down and back until the base of the round touches the rear flat edge of the magazine.**

Place the next round on top of the previous round and press down and back. Repeat until the magazine is loaded, but do **NOT** exceed its capacity. For magazine capacity, see Section 2 - Main Features.

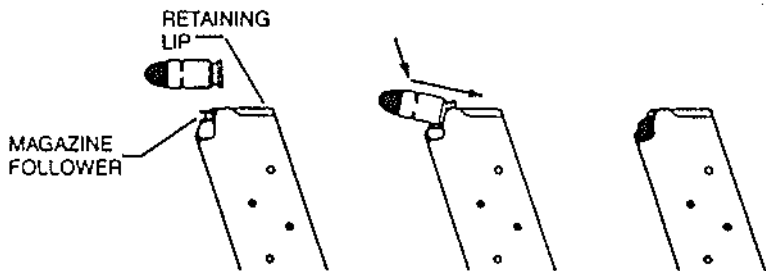

FIGURE 3 - LOADING MAGAZINE



CAUTION: TO MINIMIZE RISK OF UNINTENTIONAL DISCHARGE, LOAD LIVE AMMUNITION INTO PISTOL ONLY WHEN YOU ARE ABOUT TO SHOOT.

22

SAFETY DEPENDS ON YOU



To Load The Pistol:

1. **CAUTION: READ SAFETY INSTRUCTIONS (Section 3)—KEEP PISTOL POINTING IN SAFE DIRECTION AND DO NOT TOUCH THE TRIGGER.**

2. Remove magazine from pistol. Place your hand under magazine to prevent it from falling. Press magazine catch (located on left side of pistol behind trigger guard) to drop the magazine out of the magazine well (See Figure 4).

3. Hold pistol by stock with one hand. Keep other hand clear of ejection port and grasp serrated finger grips on both sides of slide. Pull slide back slightly and **LOOK IN CHAMBER TO ENSURE IT IS EMPTY**; allow slide to return forward. (If slide was fully to rear, release cocked hammer by squeezing trigger after ensuring chamber is empty).

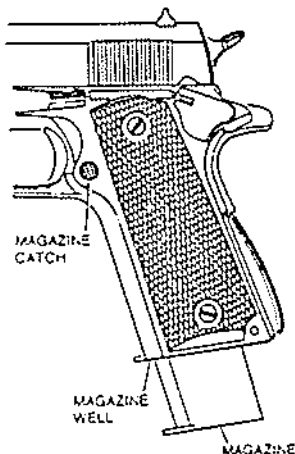

FIGURE 4—MAGAZINE PARTIALLY INSERTED

4. Insert loaded magazine into magazine well with bullets pointing forward. Push magazine fully "home" until magazine catch is heard to "click" locking it in place.

IMPORTANT: Do not strike base of magazine to drive it home — just push it firmly into pistol. Otherwise, you could damage magazine and injure your hand.



WARNING: WHEN A ROUND IS IN THE CHAMBER, THIS PISTOL MAY DISCHARGE ACCIDENTALLY IF IT IS DROPPED OR RECEIVES A BLOW. (THIS CAN OCCUR REGARDLESS OF THE POSITION OF THE HAMMER OR ANY OF THE VARIOUS SAFETY DEVICES.) DO NOT PUT A ROUND IN THE CHAMBER UNTIL THE PISTOL IS IN YOUR HAND AND YOU ARE READY TO SHOOT, AND CLEAR THE PISTOL IMMEDIATELY AFTER SHOOTING.

5. When you are ready to shoot, grip the slide as described in Step 3 and pull it fully rearward to cock the hammer. Release the slide to feed a round from the magazine into the chamber. **THE PISTOL IS NOW LOADED AND READY TO FIRE.**

6. Apply slide lock safety by pushing it up to prevent the hammer from falling forward if trigger is moved.



CAUTION: NEVER LEAVE PISTOL COCKED AND READY TO FIRE (as in Step 5) as this condition is extremely dangerous; pistol could easily be accidentally discharged, causing injury, death or damage to property.

CARRYING MODES

NOTE: This pistol may be carried in any one of the following three modes according to your needs:

Mode 1: — **MAGAZINE EMPTY, CHAMBER EMPTY.**

- Pistol cannot be discharged.
- Use Mode 1 for storage, transporting, cleaning, repair, demonstrating and dry practice.

Mode 2: — **MAGAZINE LOADED, CHAMBER EMPTY HAMMER DOWN.**

- Pistol cannot be fired until slide is cycled and trigger is squeezed.
- Use Mode 2 when **CARRYING THE PISTOL READY FOR USE.**

Mode 3: — **MAGAZINE LOADED, CHAMBER LOADED, HAMMER COCKED, SAFETY ON.**

- Pistol can be fired when slide lock safety is off and trigger is squeezed.
- Use Mode 3 when you **MUST BE PREPARED** to use the pistol **IMMEDIATELY** without warning.



WARNING: When you squeeze the trigger, you must expect the gun to fire, and you must take full responsibility for firing it. Your care can avoid accidental discharge, and you will thereby avoid accidental injury and death.

UNLOADING



CAUTION: ALWAYS UNLOAD YOUR PISTOL IMMEDIATELY AFTER USE AND BEFORE CLEANING AND STORAGE to minimize the risk of accidental discharge.

To Unload:

1. Be sure you are familiar with Safety Instructions in Section 3. Keep pistol pointing in a safe direction, do not touch trigger and always keep hands away from muzzle and ejection port.
2. Place hand under magazine to prevent it from falling and press magazine catch to release and eject magazine.

NOTE: If slide is fully rearward, Step 3 does not apply.

3. Grasp serrated finger grips on both sides of slide and pull slide sharply rearward to extract and eject a round from the chamber. Keep your hands clear of the ejection port to allow round to eject without obstruction. Examine previously chambered round for dents or other damage; if damaged, dispose of it as explained in Paragraph 7.



4. CAUTION: KEEP PISTOL POINTING IN A SAFE DIRECTION WHILE YOU LOOK IN THE CHAMBER TO ENSURE IT IS EMPTY AND SEE THAT MAGAZINE HAS BEEN REMOVED.

5. Keep pistol pointing in a safe direction, allow slide to return forward on empty chamber and squeeze the trigger to allow hammer to fall forward. (If slide is held to rear by the slide stop, pull slide back slightly, then release it).

6. Remove remaining live rounds by sliding them forward out of the magazine.

7. Collect undamaged live ammunition for safe storage and future use. Collect spent cartridge cases for disposal. **Segregate misfired and damaged live ammunition for disposal according to ammunition manufacturer's instructions.**

FIRING

Before firing your Colt pistol, practice your stance, aim, rhythm and breathing for steady aim with your pistol UNLOADED.

Practice firing on a range before going hunting or using your pistol for any other type of shooting.



CAUTIONS

1. ALWAYS WEAR AND ENCOURAGE OTHERS TO WEAR EAR PROTECTION WHEN SHOOTING, especially on a range. Without ear protection, the noise of just one round from your pistol, and other guns close to you, could leave a "ringing" in your ears for some time after firing. The cumulative long term effect could be permanent hearing loss.

2. ALWAYS WEAR AND ENCOURAGE OTHERS TO WEAR PROTECTIVE SHOOTING GLASSES. Flying particles could damage eyes and cause blindness; but protective shooting glasses should prevent such injury.

To Fire



1. **CAUTION:** READ SAFETY INSTRUCTIONS (Section 3)—KEEP PISTOL POINTING IN SAFE DIRECTION AND DO NOT TOUCH THE TRIGGER.

2. Load pistol as previously described.
3. Grasp pistol by stock and, with index finger resting along the outside of trigger guard, take aim. Aim by aligning target with front and rear sights. (See Figure 5). After identifying your target and seeing that it is clear to shoot, focus on the front sight. Be sure you have a safe backstop. **THINK!** *What you will HIT if you MISS the target?*
4. Release Slide Lock Safety by pressing it down out of engagement with slide lock notch.
5. Keeping steady aim, place index finger on trigger and squeeze, until hammer falls. Don't jerk the trigger as you will disturb your aim and spoil your accuracy. To fire the second and subsequent rounds, all that is necessary is to release the trigger and squeeze it again after every shot until you have completed firing.

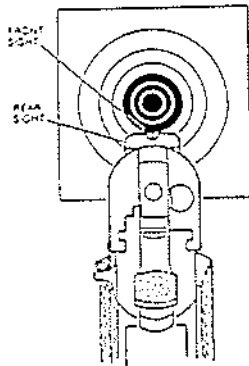

FIGURE 5--AIMING

6. THIS IS A SEMI-AUTOMATIC PISTOL AND IS IMMEDIATELY LOADED AND COCKED READY TO FIRE AGAIN AFTER EACH SHOT UNTIL THE MAGAZINE IS EMPTY.

NOTE: This pistol can be fired without a magazine in place.

7. Release trigger, remove finger from trigger and apply Slide Lock Safety by pushing it up into the slide lock notch. However, if you have fired the last round from the magazine the slide will stay to the rear and you will be unable to apply the Slide Lock Safety.



CAUTION: IF PISTOL FAILS TO FIRE, HOLD IT, KEEPING IT POINTED TOWARD THE TARGET OR SAFE OPEN AREA AND WAIT 30 SECONDS. If a hangfire (slow ignition) has occurred, round will fire within 30 seconds. If round does not fire, remove magazine, eject round and examine primer. If firing pin indent on primer is light, off center or nonexistent, have pistol examined by a competent gunsmith before firing again. If firing pin on primer appears normal (in comparison with similar previously fired rounds) assume faulty ammunition; segregate misfired round from other live ammunition and empty cases; reload and carry on firing.

NOTE: Dispose of misfired rounds in accordance with the ammunition manufacturer's instructions.

-  **8. CAUTION: KEEP PISTOL POINTING IN A SAFE DIRECTION.** Unload as previously described.

IMPORTANT: If you cock your pistol but do not fire it, apply Slide Lock Safety until ready to fire. If you lose the opportunity to fire, unload your pistol as previously described. Remember, if a round is in the chamber there is a risk of accidental discharge.

-  **CAUTION: NEVER LEAVE PISTOL COCKED READY TO FIRE** as the fire condition is extremely dangerous, and pistol could easily be accidentally discharged causing injury, death, or damage to property.

SECTION 5

MAINTENANCE

Like any other precision mechanism, your pistol will function better, last longer, and remain safer when it is properly maintained. Follow the advice in this section to keep your pistol in peak condition. Keep your pistol clean and properly lubricated to prolong its reliable life.

 **CAUTIONS:**

- 1. ENSURE THAT MAGAZINE IS REMOVED AND THE PISTOL IS NOT LOADED BEFORE STRIPPING AND CLEANING,** so that pistol will not fire.

2. **WEAR SAFETY GLASSES** in case you lose control of some spring loaded component such as the recoil spring or guide which could injure your eyes.

3. **NEVER DRY FIRE THE PISTOL WHEN THE SLIDE IS REMOVED FROM THE RECEIVER**, and do not alter parts as the level of safety could be reduced.

NOTE: Force is unnecessary and should never be used to strip or assemble your pistol.

STRIPPING FOR CLEANING

1. Ensure magazine is removed and pistol is **NOT** loaded. Be sure you are familiar with the Safety Instructions in Section 3.

2. Rest pistol on table or bench with muzzle pointing upward.

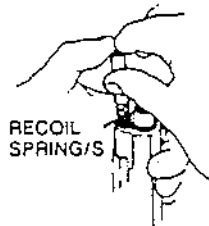
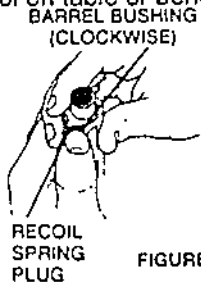

FIGURE 6--RELEASING SPRING TENSION

SAFETY DEPENDS ON YOU

⚠ CAUTION: THE SPRINGS ARE STRONG AND COULD FLY OUT AND INJURE OR EVEN BLIND SOMEBODY if they are not handled with care.

3. Push slide back about 1/4 inch, press down on recoil spring plug (located just below muzzle) and at the same time rotate barrel bushing **clockwise** about 1/4 turn, using barrel bushing wrench if necessary; this will free plug and recoil spring. Keep pressure on plug to prevent it from being ejected by the spring, then allow plug and spring to gradually extend out of slide. (See Figure 6).

Rotate plug counterclockwise and remove from spring.

4. Cock the hammer by pulling back on hammer spur.

5. Pull slide to rear until lug on slide stop is opposite disassembly notch (See Figure 7) and push rounded end of pin of slide stop (on right side of receiver) inward and through receiver to disengage slide stop from slide.

6. Lift out slidestop. (See Figure 7).

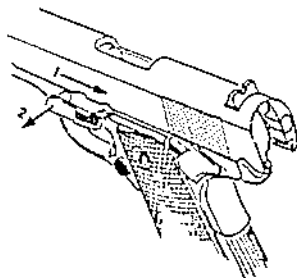

FIGURE 7- REMOVING SLIDE STOP

SAFETY DEPENDS ON YOU

7. Push slide forward off the receiver.
8. Lift recoil springs and guide and pull them rearward out of slide. (See Figure 8).
9. Turn barrel bushing counterclockwise, push barrel and barrel bushing forward until bushing is clear of slide, then remove bushing from barrel.
10. Push link forward and remove barrel from slide.

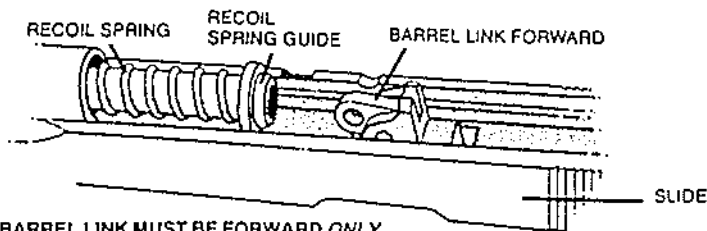

FIGURE 8 - BARREL LINK MUST BE FORWARD *ONLY* FOR BARREL TO BE REMOVED AND ASSEMBLED THROUGH THE SLIDE.

IMPORTANT: Do not strip your pistol further than previously described. Do not remove or alter parts, particularly safety parts. If additional maintenance is required, see "Service and Repair" later in this instruction manual.

ASSEMBLING AFTER CLEANING

1. With slide upside down and barrel link forward, assemble barrel into the slide, as in Figure 8.
2. (See Figure 9). Place barrel bushing over muzzle of barrel and into slide until it is flush with the face of the slide, (STEP 1). Turn bushing clockwise as far as it will go. (STEP 2).
3. Place the recoil guide into the recoil spring so that the closed end of the spring is up against the collar of the guide.

Assemble the recoil spring and guide into the slide by pushing the open end of the spring through the slide from the rear, (STEP 3). Position the arched portion of the recoil spring guide over the outside surface of the barrel, (STEP 4).

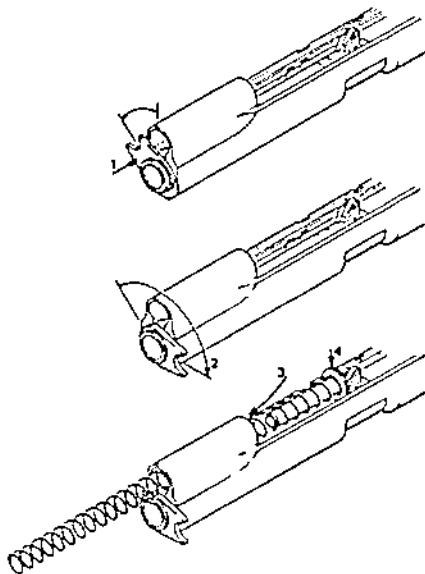

FIGURE 9—INSTALLING BARREL BUSHING AND RECOIL SPRING/S

4. Cock the hammer. Run the slide onto the receiver.

Look through the slide stop hole in the side of the receiver. Move the slide along the receiver until you see the hole in the barrel link line up with the hole in the side of the receiver. Insert the slide stop through the hole until it is almost home; (See Figure 10).

Continue pushing the slide rearward until the disassembly notch lines up with the rear part of the slide stop. Now push the slide stop up and in against the slide stop plunger until the slide stop is fully home.

5. Rest pistol on table or bench with muzzle pointing upward.

6. Push slide back about 1/4 inch, press down on recoil spring plug compressing the recoil spring into the slide until the plug is fully home, then rotate the barrel bushing. Align the arched part of the bushing so that it straddles the recoil spring plug and locks it in place.

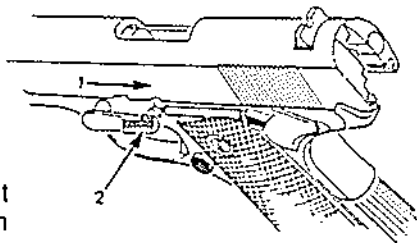

FIGURE 10—INSTALLING SLIDE STOP



CAUTION: YOU COULD DAMAGE YOUR PISTOL WHEN YOU FIRE, OR ATTEMPT TO FIRE IF THE RECOIL SPRING PLUG IS NOT CORRECTLY SEATED AND LOCKED AS DESCRIBED ABOVE.

7. After assembling the pistol, check its function as follows:

Remove Magazine. Pull the slide back fully and let it go. It should fly forward and close over the **empty chamber**. The hammer should stay cocked. Push the safety up and squeeze the trigger. The hammer should stay cocked. Push the safety down and squeeze the trigger. The hammer should fall. Pull the hammer back slightly without touching the trigger. You should hear a click as the sear slips into the half cock notch. Lower the hammer to engage the half cock notch.

Rotate the hammer rearward slightly without touching the trigger. While holding the hammer in this position, slightly squeeze the trigger to get by the front of the half cock notch and then hold the trigger fully rearward while releasing the hammer down onto the firing pin stop. Finally, release the trigger.

Insert an **empty magazine**. Pull the slide back fully and let it go. It should NOT fly forward. Hold slide, push down on the slide stop and ease the slide fully forward. Put your thumb on the hammer, squeeze the trigger and ease the hammer down onto the firing pin stop.

IMPORTANT: Do these checks **only** after you strip and assemble the pistol. Do **not** slam the slide forward at any other time, except when loading. If you exercise the slide, control it with your hand.

WHEN TO CLEAN

You should clean your pistol as soon after firing as possible so that the job will be easier and there will be less opportunity for corrosion to start. When your pistol has not been fired, clean it periodically; we suggest once or twice a year in a temperate climate, or as often as once a month in a tropical climate. If you carry a loaded pistol, **UNLOAD** it and clean it at least once a month. If you get your pistol wet, clean it as soon as possible.

HOW TO CLEAN AND LUBRICATE

The following cleaning procedure may be used both periodically and after firing; however, those items marked "*" are unnecessary for periodic cleaning.

Materials: Cleaning rod, cotton flannel patches (cut to fit snugly into the bore), a small toothbrush, good quality light gun oil, *gun cleaning solution, and *a brass wire bristle bore cleaning brush.

NOTE: In freezing conditions (below 32°F or 0° C) avoid the use of oil for lubrication; instead apply dry lubricant sparingly.



Procedure

1. **CAUTION: ENSURE THAT THE PISTOL IS NOT LOADED.**

2. Strip for cleaning as previously described.

NOTE: Avoid contact between cleaning rod and muzzle as resultant wear will reduce accuracy. To avoid damaging the muzzle always clean from breech end forward.

3. Attach cotton flannel patch to end of cleaning rod, insert it in breech and pass rod and patch down through barrel. Repeat, changing patches until last patch comes out clean.

4. Visually inspect barrel; if it is clean, proceed directly to step 7, but if it remains dirty, continue with step 5.

5. ***(NOTE: This item should be applicable only after firing).** Attach brass wire bristle brush to cleaning rod and dip brush in gun cleaning solution. Thoroughly scrub out barrel, passing the brush all the way through before reversing the movement. If you try to change direction with brush in barrel, the brush will stick.

6. Repeat steps 3 and 4 above.

7. Clean rear face of barrel and face of slide, using a small toothbrush.

8. Lightly moisten a flannel patch with gun oil and pass it once through barrel, leaving a thin film of oil on the inside surface. Leave this film of oil on the inside surface if pistol is to be stored. If it is not to be stored, or if it is being removed from storage for use, pass a dry patch through the barrel to remove as much oil as possible.

9. Check that flannel or brush bristles have not become lodged in any part of the pistol. Wipe all the metal surfaces you can reach with a flannel patch lightly moistened with gun oil. Be sure to wipe the rails inside the slide and the rails on the receiver. Wipe the barrel on the outside surface. Wipe the barrel bushing area. Put one small drop of oil in each of the locking grooves in the slide. Put one small drop of oil on the hammer pivot pin, the barrel link pin and the sear pivot pin. Movement of the slide should distribute sufficient oil to other areas within the pistol. Wipe away any excess oil. (See **NOTE** on cold weather lubrication).

10. Reassemble pistol as previously described.

11. Again wipe external surfaces with oil moistened patch to remove any finger prints. (Finger moisture, if left, could start corrosion process). (See **NOTE** on cold weather lubrication).

12. Remove any gun cleaning solution and oil from the stock.

CLEANING THE MAGAZINE

It is advisable to clean the magazine whenever the pistol is cleaned. **To do so**, remove the magazine follower and spring and clean all components, taking care to remove carbon deposits from the lips of the magazine and the magazine follower. Wipe components with lightly oiled cloth and reassemble.

The magazines are disassembled from the top.

To remove the magazine follower and spring, depress them with a piece of wood (pen or pencil) about two inches into the magazine and insert a thin rod (small screwdriver) through the lower of the front two holes in the magazine body. This will hold spring under tension.

Turn the magazine upside down and lightly tap it so that the follower falls away from the spring; lift out the follower from the magazine body. Push down on the spring to take up the spring tension, remove the thin rod and allow the spring to extend, then remove it completely.

To assemble magazine, place the spring correctly oriented, i.e. with loop uppermost pointing forward into the magazine body, compress the spring and insert a thin rod as for dismantling. Place the follower into the magazine on top

of the compressed spring, remove the thin rod and allow the spring to reassert its influence on the follower.

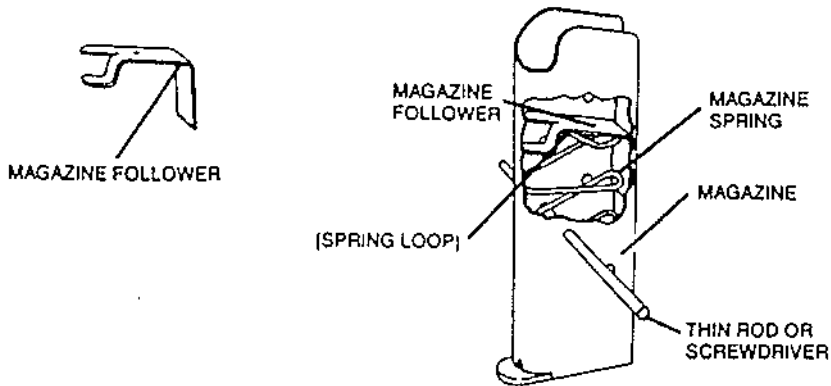

FIGURE - 11 MAGAZINE ASSEMBLY WITHOUT REMOVABLE BASE

STORAGE



CAUTION: ALWAYS UNLOAD YOUR PISTOL FOR STORAGE AND STORE AMMUNITION SEPARATELY. Keep and store your pistol and ammunition securely locked and in separate locations out of reach and sight of children. (Children are naturally curious and do not always believe the real danger of guns).

NOTE: Remove your pistol from its holster at the end of the day. Do not store your pistol in an air-tight container, and do not seal or attempt to seal the barrel to exclude dust, as the internal steel surface is more likely to corrode. Use the Colt packaging case, with a padlock on it to carry and store your **EMPTY** pistol.

SERVICING AND REPAIR

Should your pistol require adjustment, or repair, make sure it is **NOT LOADED** and send it to Colt's. For spare parts, seek advice from the Dealer who should have up-to-date information on how best to obtain genuine Colt parts.

An illustration and list of part names are included in the next section of this instruction manual to help you identify the part you need, but it is important to note that all parts are not available for sale. Those parts which are available should be installed by Colt's or by a competent gunsmith. When ordering parts, please give part name as given on the Parts List. Also give the caliber, model

SAFETY DEPENDS ON YOU

name, serial number and metal finish of your pistol.

IMPORTANT: If you make unauthorized adjustments or use unauthorized parts, Colt will not assume responsibility for the functioning of this pistol.

THIS GUN IS MANUFACTURED TO PERFORM PROPERLY WITH THE ORIGINAL PARTS AS DESIGNED. IT IS YOUR DUTY TO MAKE SURE ANY PARTS YOU BUY ARE INSTALLED CORRECTLY AND THAT NEITHER REPLACEMENTS NOR ORIGINALS ARE ALTERED OR CHANGED. THIS IS WHY WE SAY RETURN IT TO COLT'S. YOUR GUN IS A COMPLEX TOOL WITH MANY PARTS THAT MUST RELATE CORRECTLY TO OTHER PARTS. PUTTING A GUN TOGETHER WRONG OR WITH MODIFIED PARTS CAN RESULT IN A DAMAGED GUN, DANGER, AND INJURY OR DEATH TO YOU AND OTHERS THROUGH MALFUNCTION. ALWAYS LET A QUALIFIED GUNSMITH WORK ON YOUR GUN AND CHECK ANY WORK YOU THINK WAS NOT PERFORMED BY A GUNSMITH. WE AT COLT THINK THIS IS A SMALL PRICE TO PAY FOR FIREARMS SAFETY.

NOTE: Various Federal and State laws and local ordinances govern the transfer and transportation of firearms, so take the advice of the Dealer in your state on how to send your firearm to Colt's. Before shipping your pistol, here are some important points to remember:

 **1. CAUTION: MAKE SURE THAT THE MAGAZINE AND PISTOL ARE NOT LOADED.**

2. Write a letter explaining the problem and your requirements in as much detail as possible. Include the model name and serial number of your pistol together with your return address, then enclose it with the empty pistol in the Colt packaging case or a well padded package.

3. Do not send presentation boxes, accessories or ammunition.

4. Colt's address for receiving packages is: CMCI
Talcott Road
West Hartford, CT 06110

5. Do not indicate the contents, or include "COLT" in the address on the package so that an inquisitive thief is not attracted to it by such information.

6. Insure the package contents against loss or theft.

SECTION 6**PARTS ILLUSTRATION AND LISTS**

This section is provided so that you may identify names of parts for your own interest. However, for adjustment, repair, or spare parts information, see Section 5, "Servicing and Repair."

See page 47 for Illustrations.

See page 48 description of parts.

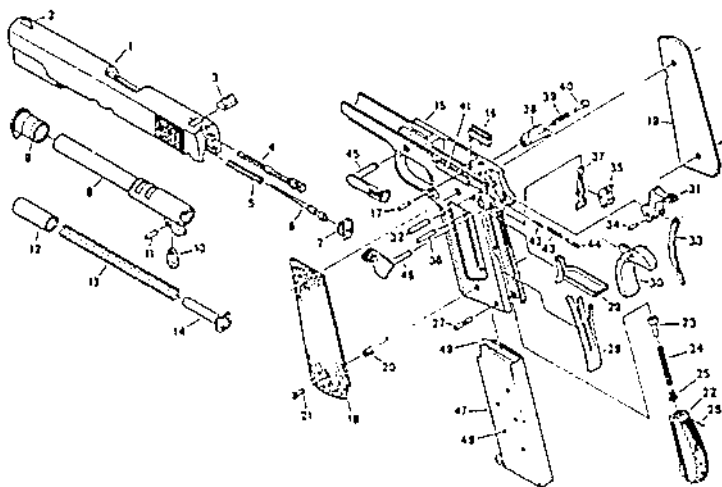

FIGURE 12 – COLT® GOVERNMENT MODEL® MKIV™/Series 70 MODEL O1970A1™
PARTS ILLUSTRATION

DESCRIPTION

- | | | |
|-----------------------------|--------------------------------------|------------------------|
| 1. Slide | 22. Main Spring Housing (arched) | 42. Slide Stop Plunger |
| 2. Front Sight | 23. Main Spring Cap | 43. Plunger Spring |
| 3. Rear Sight | 24. Main Spring | 44. Safety Lock |
| 4. Extractor | 25. Main Spring Housing Pin Retainer | 45. Slide Stop |
| 5. Firing Pin Spring | 26. Main Spring Cap Pin | 46. Safety Lock |
| 6. Firing Pin | 27. Main Spring Housing Pin | 47. Magazine Assembly |
| 7. Firing Pin Stop | 28. Sear Spring | 48. Magazine Spring |
| 8. Barrel | 29. Trigger Assembly | 49. Magazine Follower |
| 9. Barrel Bushing | 30. Grip Safety | |
| 10. Barrel Link | 31. Hammer | |
| 11. Barrel Link Pin | 32. Hammer Pin | |
| 12. Recoil Spring Plug | 33. Hammer Strut | |
| 13. Recoil Spring | 34. Hammer Strut Pin | |
| 14. Recoil Spring Guide | 35. Sear | |
| 15. Receiver | 36. Sear Pin | |
| 16. Ejector | 37. Disconnecter | |
| 17. Ejector Pin | 38. Magazine Catch | |
| 18. Left Hand Stock | 39. Magazine Catch Spring | |
| 19. Right Hand Stock | 40. Magazine Catch Lock | |
| 20. Stock Screw Bushing (4) | 41. Plunger Tube | |
| 21. Stock Screw (4) | | |

Our Colt Custom Shop offers a wide range of special services such as engraving, inlaying and special serializing to the same high standard of quality long synonymous with the name "COLT". Sometimes modifications, which meet our customer's special requirements, necessitate deviations from standard design and manufacturing tolerances which result in functional differences from a standard gun. Consequently, this instruction manual does not apply to a customized gun unless its applicability has been confirmed by the Colt Custom Shop. For further information, write to Colt Custom Shop, P.O. Box 1868, Hartford, Connecticut 06144-1868, USA.

CONVERSION UNITS. . . IMPORTANT. If you purchase a Colt 22, 9mm or other caliber Conversion Unit, NOTE that only a Colt Series 70 Conversion Unit is compatible with this Colt® Model O1970A1™ reissued pistol. Do NOT install an incompatible Series 80 Conversion Unit on this pistol because the combination will render this pistol inoperable. If in doubt, get advice from Colt.

FIREARM RECORD

Colt Model _____

Serial No. _____

Caliber _____

Purchased
from _____Date
Purchased _____Purchase
Price _____

WARRANTY STATEMENT

Based on Magnuson-Moss Warranty Act, Colt offers no express warranty on its product line. However, Colt recognizes its obligations concerning implied warranty. Colt also stands behind its products as it has historically, and will continue to provide service to its product line as it has over the years. Colt products will be serviced for a period of one year from the date of retail purchase, for defects in materials or workmanship, at no charge to the purchaser. Be sure to retain your sales slip as proof of purchase date when making a claim.



HEALTH AND ENVIRONMENTAL WARNING

Discharging firearms in poorly ventilated areas, cleaning firearms, or handling ammunition may result in exposure to lead and other substances known to cause birth defects, reproductive harm, cancer, and other serious physical injury. Have adequate ventilation at all times. Wash hands thoroughly after exposure.

NOTES

If your instruction manual becomes lost or destroyed, obtain a replacement by writing to **Colt's Manufacturing Company, Inc., Box 1868, Hartford, Connecticut 06144-1868 USA** or call **1-800-962-COLT**. Make a note of the address. When requesting a manual, include the information which is on the left side of your firearm together with its serial number or quote the Part No. as shown on the back cover of this manual.



, and all other Colt trademarks are the exclusive property of Colt's Manufacturing Company, Inc. For permission to reprint for noncommercial instructional purposes, prior approval from Colt's is required.

This instruction manual should always accompany this firearm. When you lend, give or sell this firearm, be sure this manual goes with it.

PRINTED IN U.S.A.

SAFETY DEPENDS ON YOU



Avvertimento Italiano

Se c'è qualcosa che non riuscite a capire, rivolgetevi a qualcuno che sia qualificato nel maneggiare in maniera sicura le armi da fuoco

Advertencia en Español

Para cualquier aclaración de esta manual, consulte con alguna Persona perita en el manejo seguro de armas de fuego.

Message Seculaire en Francais

Pour tous renseignements complementaires, veuillez consulter un Armurier qualifie dans le maniement de ces armes.

Deutsche Sicherheitshinweise

Sollten Sie noch weitere Fragen haben, wenden Sie sich bitte an Einen Waffenspezialisten.

FUNDAMENTAL NRA RULES FOR SAFE GUN HANDLING

1. ALWAYS KEEP THE GUN POINTED IN A SAFE DIRECTION.
2. ALWAYS KEEP YOUR FINGER OFF THE TRIGGER UNTIL READY TO SHOOT.
3. ALWAYS KEEP THE GUN UNLOADED UNTIL READY TO USE.