

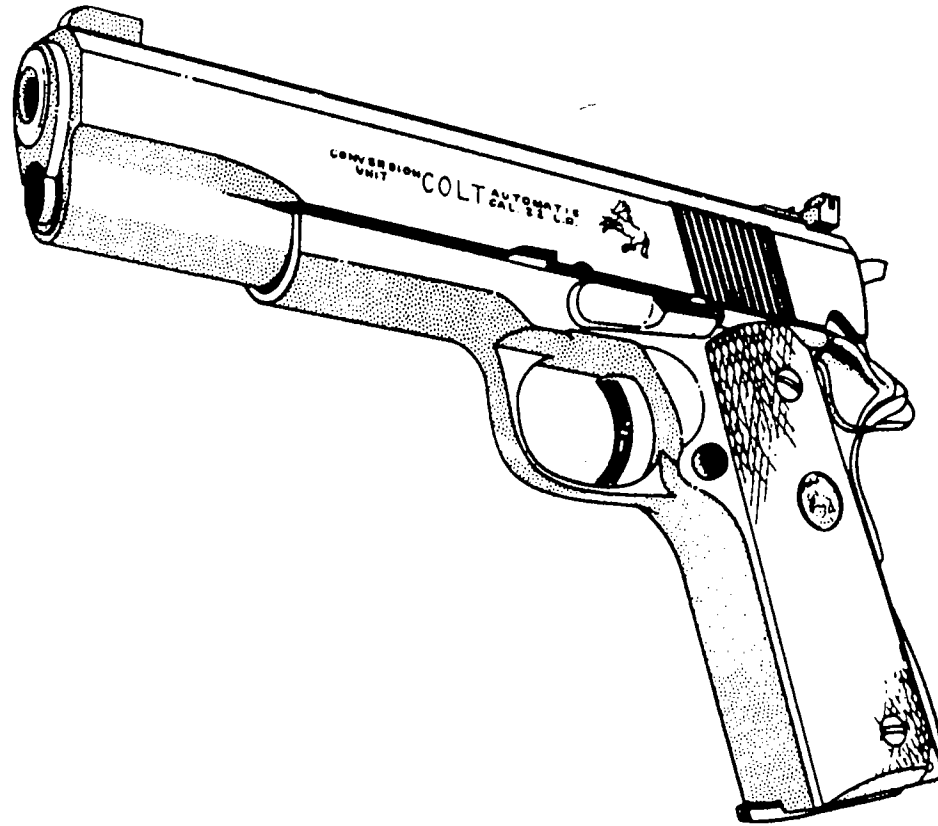

MAINTENANCE AND USE OF THE COLT 22 CAL. CONVERSION UNIT FOR COLT SEMI-AUTOMATIC SERIES 80 PISTOLS

Copyright © 1995 Colt's Manufacturing Company, Inc. All Rights Reserved.
These instructions and the accompanying pistol instruction manual should always accompany this conversion unit . When you lend, give or sell this unit, be sure this manual goes with it.



The Colt 22 cal. Conversion Unit can be installed on the receivers of those Colt Series 80 Government Models and Gold Cup National Match semi-automatic pistols which are chambered for 45 ACP and 38 Super Auto ammunition. It is important that the first conversion be made professionally, but after that you may convert your pistol from 22 cal. to its original caliber and back again whenever you wish by following the instructions in this pamphlet and the accompanying manual

SAFETY DEPENDS ON YOU

FEATURES OF THE UNIT

The unit is designed for lower cost shooting by using 22 Long Rifle (LR) ammunition in your full size pistol. This allows you to experience the same feel, balance and simulated recoil of your master pistol. A floating chamber provides simulation of the heavier recoil while assuring positive semi-automatic action from the lower impulse of 22 LR cartridges.

With the converted pistol you will master the fundamentals of target practice at a lower cost. You will also do this without developing the habits of flinching and fighting the recoil that are habits acquired by beginners trying to learn with larger calibers.

COMPONENTS OF THE UNIT

This 22 cal. Conversion Unit provides a barrel with floating chamber, a barrel bushing, a 10 round magazine, special slide stop (stamped 2), ejector, shorter recoil spring and a Series 80 slide. The slide comes complete with a rimfire firing pin assembly, a firing pin safety plunger, and either a fixed sight or an Accro adjustable rear sight already installed.

It is important, to assure the function of the firing pin safety, that the Series 80 slide be used only on a Series 80 receiver, and not on a Series 70 or earlier receiver.

SAFETY DEPENDS ON YOU

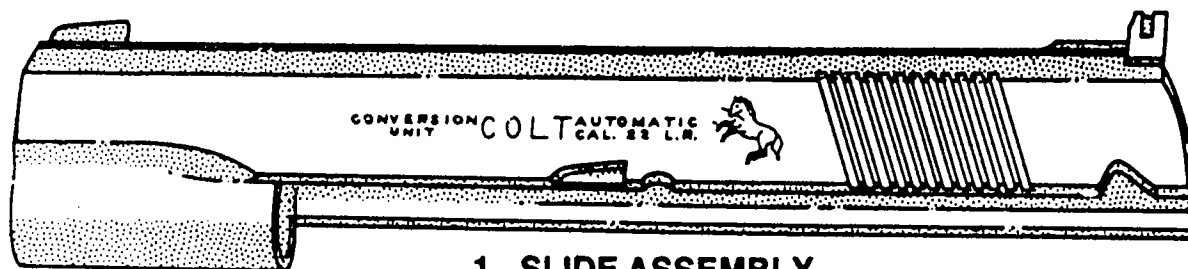

1. SLIDE ASSEMBLY

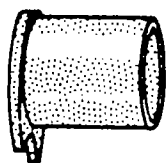

4. BUSHING

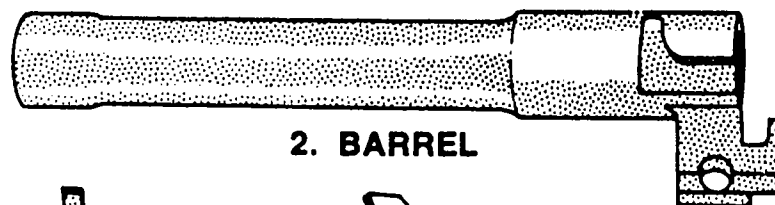

2. BARREL

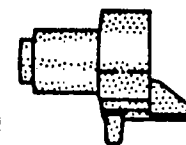

3. FLOATING CHAMBER



5. EJECTOR



6. RECOIL SPRING

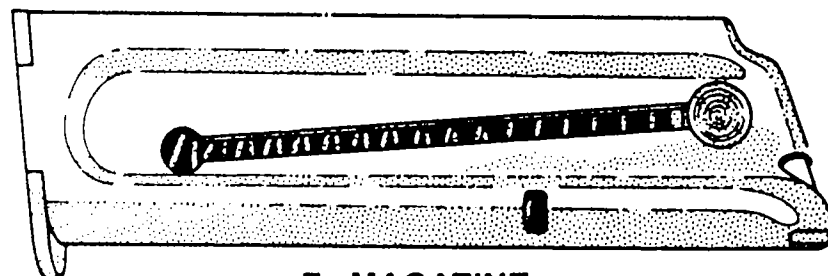

7. MAGAZINE

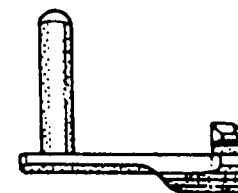

8. SLIDE STOP

SAFETY PRECAUTIONS



ALL SAFETY PRECAUTIONS AND FEATURES DESCRIBED IN THE ACCOMPANYING INSTRUCTION MANUAL ARE RELEVANT AND APPLICABLE TO THE CONVERTED PISTOL; READ AND UNDERSTAND THEM BEFORE HANDLING THE PISTOL.

FIRST CONVERSION

To assure proper function of your Conversion Unit, have it installed the first time at a Colt Authorized Repair Service Station. A list of them is included. In this way you will be sure that the parts fit properly, that the safety features function correctly, and that the pistol functions reliably.

After the first conversion, you should be able to switch back and forth between 22 cal. and the caliber of your master pistol. Maintenance procedures in the manual and in this pamphlet show how to assemble and disassemble the pistol in either configuration.

REAR SIGHT

See manual for information on adjusting the rear sight.

SAFETY DEPENDS ON YOU

LOADING, UNLOADING AND FIRING

Follow the procedures and safety precautions described in the accompanying pistol instruction manual when loading, unloading or firing your pistol, but load only 22 LR ammunition as illustrated here.

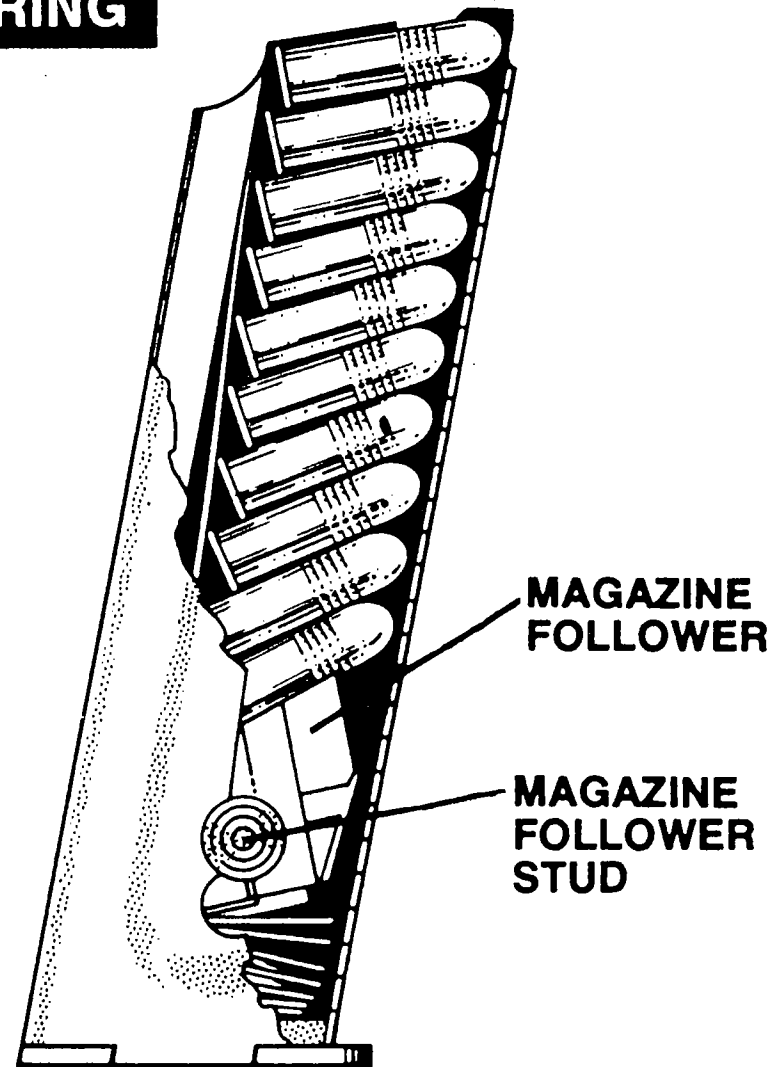

LOADED MAGAZINE

MAINTENANCE

The converted pistol should be maintained in the same way as the master pistol except that the barrel and ejector should be removed and reassembled as follows:



CAUTION: READ THE CAUTIONS IN SECTION 5 OF THE ACCOMPANYING PISTOL INSTRUCTION MANUAL.

1. After the slide has been removed from the receiver and the barrel bushing from the slide, pull barrel forward until ejector is clear of retaining groove and lift out ejector. See illustration.

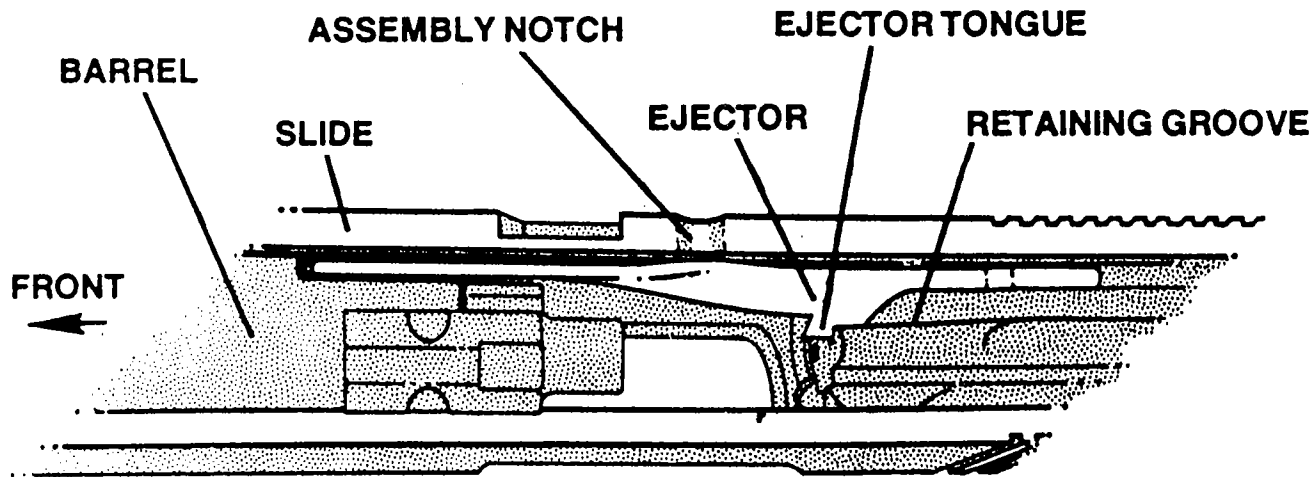

LOOKING AT UNDERSIDE OF SLIDE

SAFETY DEPENDS ON YOU

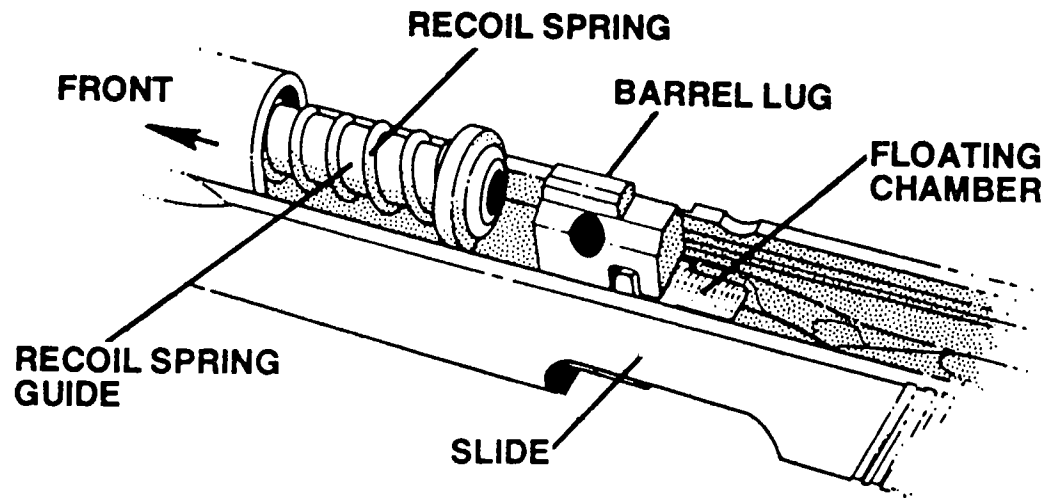

2. Carefully align floating chamber with barrel lug and remove barrel and chamber assembly from front of slide.
3. Rotate floating chamber out of alignment with barrel lug and remove chamber from barrel. Thoroughly clean the floating chamber and barrel using barrel cleaning materials, and occasionally put a little thin oil on the friction points of the pistol.
4. Assemble in reverse order. When installing the ejector, the small ejector tongue must be engaged in the retaining groove of the slide. (See illustration above). After the barrel and barrel bushing* are assembled into the slide, run

the slide onto the receiver until the barrel lug hole is exposed through the slide stop hole. Insert the slide stop* into the receiver and through the barrel lug, taking care not to scratch the pistol. Snap the slide stop into place by pressing up and in against the slide stop detent when the slide clearance notch is properly aligned. Then continue reassembling the pistol.

***Note:** Be sure to install the correct barrel bushing and slide stop. The slide stop in the conversion unit is stamped "2".

After the first conversion has been made professionally, you may assemble the pistol in either the 22 cal. mode or in the caliber of your master pistol. If you wish to retain the 22 cal. mode, use the components of the conversion unit and follow the instructions in this pamphlet. If you prefer to return your pistol to its original caliber, then follow these instructions to remove all the components of the conversion unit and follow the assembly instructions in the accompanying pistol instruction manual to assemble the components of your master pistol.

SERVICE AND REPAIR

Should your converted pistol require service or repair, see Section 5 of the accompanying pistol instruction manual for advice.

WARRANTY STATEMENT

Based on Magnuson-Moss Warranty Act, Colt offers no express warranty on its product line. However, Colt recognizes its obligations concerning implied warranty, Colt also stands behind its product as it has historically and will continue to provide service to its product line as it has over the years. Colt products will be serviced for a period of one year from date of retail purchase, for defects in materials or workmanship, at no charge to the purchaser. Be sure to retain your sales slip as proof of purchase date when making a claim.

These instructions and the accompanying pistol instruction manual should always accompany this conversion unit. When you lend, give or sell this firearm, be sure this manual goes with it.

HEALTH AND ENVIRONMENTAL WARNING



Discharging firearms in poorly ventilated areas, cleaning firearms, or handling ammunition may result in exposure to lead and other chemicals known to cause birth defects, reproductive harm, cancer, and other serious physical injury. Have adequate ventilation at all times. Wash hands thoroughly after exposure.

NOTES

Printed in USA

SAFETY DEPENDS ON YOU

795WG1M

 **Avvertimento Italiano**
Se c'e qualcosa che non riuscite a capire, rivolgetevi a qualcuno che sia qualificato nel maneggiare in maniera sicura le armi da fuoco.

Advertencia en Español
Para cualquier aclaración de esta manual, consulte con alguna persona perita en el manejo seguro de armas de fuego.

Message Secutaire en Francais
Pour tous renseignements complementaires, veuillez consulter un armurier qualifie dans le maniement de cesarmes.

Deutsche Sicherheitschinweise
Sollten Sie noch weitere Fragen haben, wenden Sie sich bitte an einen Waffenspezialisten.

FUNDAMENTAL NRA RULES FOR SAFE GUN HANDLING

- 1. ALWAYS KEEP THE GUN POINTED IN A SAFE DIRECTION.**
- 2. ALWAYS KEEP YOUR FINGERS OFF THE TRIGGER UNTIL READY TO SHOOT.**
- 3. ALWAYS KEEP THE GUN UNLOADED UNTIL READY TO USE.**

If there is anything you do not understand, get help from someone qualified in the safe handling of firearms.

Part No. 94874 REV. B JUL 95