

1

Inside Cover

Swiss Army

No. 53.101 f

Rifle

(Model 11, Model 31, Scoped Model 31/42, 31/43 and 55)

1958

Approved on order of the Federal Military Department
Bern, 5.2.58 Chief of Instruction

Preliminary Remarks

1. The 1958 edition of the regulation of the included rifles introduces the following modifications from the 1952 edition:

- section 17 : new instructions for cases of malfunction
- sections 33-34 : inspection procedures go into more detail
- sections 38-46 : Scoped Rifle Model 55 is new
- sections 43-44 : Changes pertaining to the new style blank rifle cartridge
- sections 52-59 : More detail to and simplifications of instructions
- Figures 23-30 : Are new
- Appendix I : The figures in this appendix are new

2. The regulation 53.101 f is issued to

- a) To personnel of the following titles
 - To Commissioned and Non-Commissioned officers of troops armed with the rifle
 - To Commissioned Officers of Health Service
 - To all gunsmiths while they are in basic training
 - To all members of the Military Police Service
 - To all officers on field duty

It is not allowed to exchange the 1958 version for the previous version.

3

- b) The following will receive service copies for the command archives
- To all Army units , Border Brigades, Fortress Brigades and Redoubt Brigades (2 Copies)
- To Troop Corps and units (elite and landwehr) equipped with the rifle (1 Copy)

The commanders of troops equipped with the Scoped Rifle Model 1955 should order the necessary manuals for their cadres instructed in the use of this weapon, from the Central printing and materiel office, Bern 3.

Table of Contents

	Section
Part I: Weapon Description	1-37
I. Overview	
II. Parts and Accessories	2-3
III. Disassembly and Reassembly	4-10
1. Weapon disassembly	4-5
2. Weapon Reassembly	6-7
3. Magazine Disassembly and Reassembly	8-10
IV. Function	11-16
1. Trigger mechanism and weapon discharge	11
2. Unlocking and opening the bolt	12-13
3. Closing and locking the bolt	14-15
4. Safety	16
V. Malfunctions and repairs	17-21
VI. Weapon Maintenance	22-34
1. Overview	22-25
2. Cleaning	26-32
3. Inspection	33-34
VII. The Scoped Rifles	35-46
A. Scoped Rifles Models 1931/42 and 1931/43	35-37
1. Overview	35
2. Maintenance	36
3. Operation	37
B. Scoped Rifle Model 1955	38-46
1. Overview	38
2. Technical Data	39-40
3. Operation and Maintenance	41-42
4. Adjustment (Sighting In) Procedures	43
5. Weapon Use	44

6. Training	45
7. Safety Measures	46
8. Shooting Program	-
Part 2: Ammunition	
I. Overview	47
II. Ball Cartridges	48-57
1. Common rifle cartridge	48-49
2. Armor piercing cartridge	50
3. Tracer Cartridge	51
III. Blank Cartridges	52-54
IV. Handling Cartridges	55
V. Handling and storage	59-60
Part 3: Rifle Operation	
1. Loading, reloading, and removal of cartridges	61-64
2. Shooter position, weapon support and discharge	65-70
3. Aiming	71-73
4. Bayonet use	74
5. Safety Rules	75
Appendices:	
Appendix I: Training Figures	90-103
Appendix II: Tables	104-107
Appendix III: Orders regarding ammunition	108-109
Appendix IV: Instructions for avoiding small arms damage	110-137

Technical Information

Weapon:	Rifle 11	Rifle 31	
Barrel Length in mm	592	652	
Caliber in mm	7.54	7.51	
Number of riflings	4	4	
Length of riflings in mm	270	270	
Depth of Rifling in mm	0.12	0.14	
Max Chamber pressure in atm.	3200	3200	
Muzzle velocity in m/sec (Vo)	760	780	
Sight radius in mm	490	568	
Elevation Gradient from 100m in 100m	300-1500	100-1500	
Weapon weight unloaded and without bayonet in kg	3.9	4.0	
Ammunition:	Weight	Length	
Ball Ammunition	26.8 g	78mm	
Blank Ammunition	13.7 g	70mm	
Package of 480 Ball cartridges	15.5 kg		
Package of 480 Blank cartridges	9.3 kg		
Scoped Rifles:	31/42	31/43	55
Magnification	1.8	2.8	3.5
Field of View	125 ^{0/00}	80 ^{0/00}	75 ^{0/00}
Objective Diameter	9 mm	12 mm	22 mm
Eyepiece Diameter	5 mm	4.3 mm	6 mm
Elevation:			
Elevation gradient divided in 100 in 100 m	100-1000m	100-700m	0-800m

Part I

Weapon Description

I. Overview

- 1 The rifle (model 11 and model 31) is the soldier's personal arm that he uses as a precision arm for his protection at short distance. The great accuracy of this weapon allows the user to hit very small targets at distances of more than hundreds of meters.
The Scoped Rifle is the weapon of the elite marksman. The scope improves visibility and allows for more precise aiming.
The firing rate is very quick, due to the straight pull bolt that allows for simpler reloading motion. A good marksman can fire 10 to 12 well-aimed shots per minute.
The rifle is used as well for launching anti-tank and smoke grenades. A grenade launcher is provided for this purpose; the anti-tank grenade is launched with the help of a special propulsive cartridge (contained in a special magazine).

II. Parts and Accessories

- 2 The principal parts of the rifle are:
 - The barrel, caliber 7.5 (fig. 2) with the sight mechanism. (figs. 3 to 5)
 - The receiver (fig. 6 and 7) with the bolt stop;
 - The bolt with the bolt cam follower (fig. 8) , the cylinder (fig. 9) , the locking sleeve (fig. 10) and the firing pin mechanism (fig. 11 and 12);
 - The trigger mechanism (fig. 6 and 7) with the trigger, sear and the trigger spring. The trigger spring on the Model 31 activates the ejector as well.
 - The magazine (fig. 13), which holds 6 cartridges.
 - The Stock (fig.1) with the hand guard and fittings. (fig. 14)
- 3 The accessories comprise
 - The muzzle cover to protect the mouth of the barrel and the front sight.
 - The bayonet (fig. 15)
 - The accessories pouch (fig. 16)

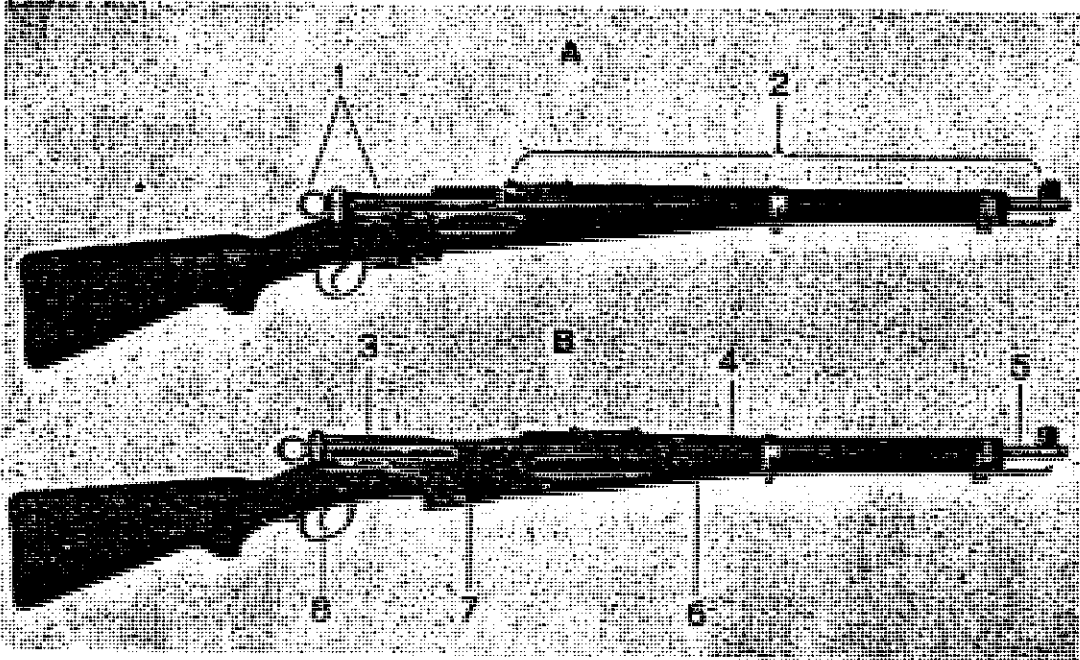

Fig. 1

A. Mq. Mod 31

1. Bolt with firing mechanism
2. Sights

B. Mq. Mod 11

3. Receiver
4. Hand Guard
5. Barrel
6. Stock
7. Magazine
8. Trigger

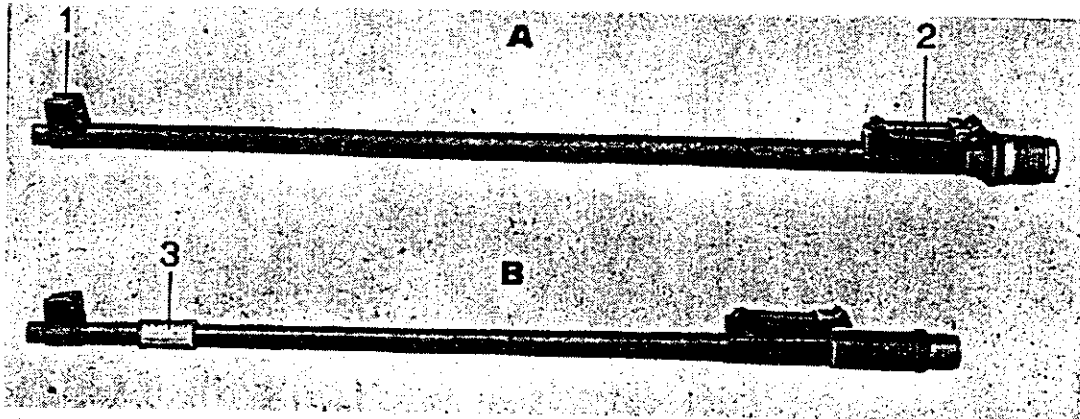

Figure 2

B. Mq. Mod 11

1. Front sight housing
2. Rear Sight

A. Mq Mod 31

3. Mounting Sleeve

The interior of the barrel has 4 lands and 4 grooves (right hand twist)

Barrel Caliber tolerances:

Mq. Mod 31 – 7.50 to 7.57mm

Mq. Mod 11 – 7.54 to 7.60mm

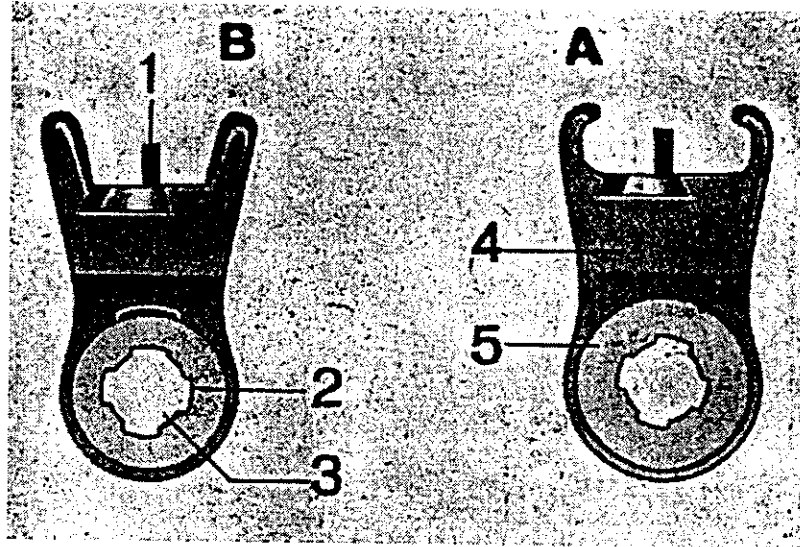

Figure 3

B. Mq. Mod 11

1. Front Sight Blade
2. Groove
3. Land

A. Mq. Mod 31

4. Front Sight Housing
5. Barrel Cross Section

Front Sight

The front sight may be moved from side to side by use of a front sight adjustment tool. 1 mm of front sight movement moves the point of impact a 300 m:

Model 31 = 12 cm
 Model 11 = 14 cm

To adjust the average height of the point of impact, we can change the front sight blade; there are 5 types of front sight blades:

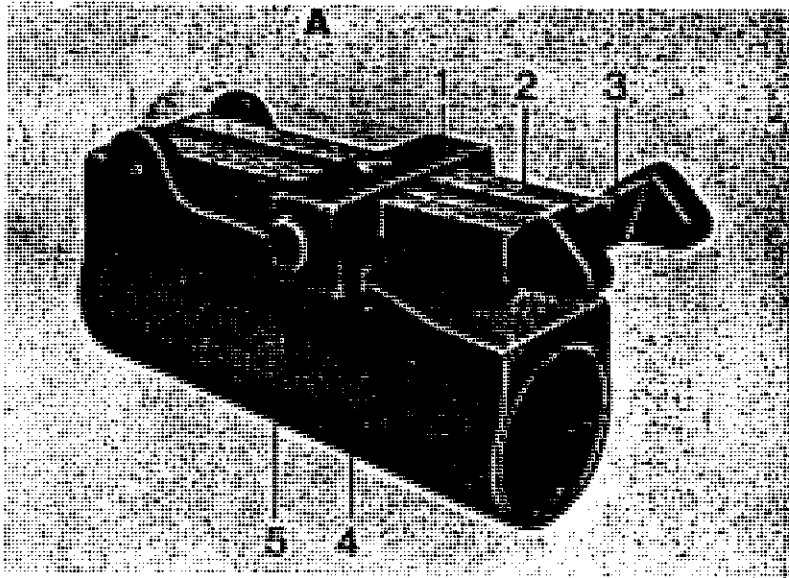

Figure 4
Rear Sight

A. Mq. Mod 31

1. Elevation Adjustment Slide
2. Sight Leaf
3. Rear Sight Slot
4. Sight Housing
5. Slide Stop

Front Sight types	Code	Front Sight height in mm	Change in impact height from one front site to the next
Tallest	.	7.1	Model 31: 16 cm
Tall	+	6.8	
Normal		6.5	
Short	-	6.2	Model 11: 18 cm
Shortest	-	5.9	

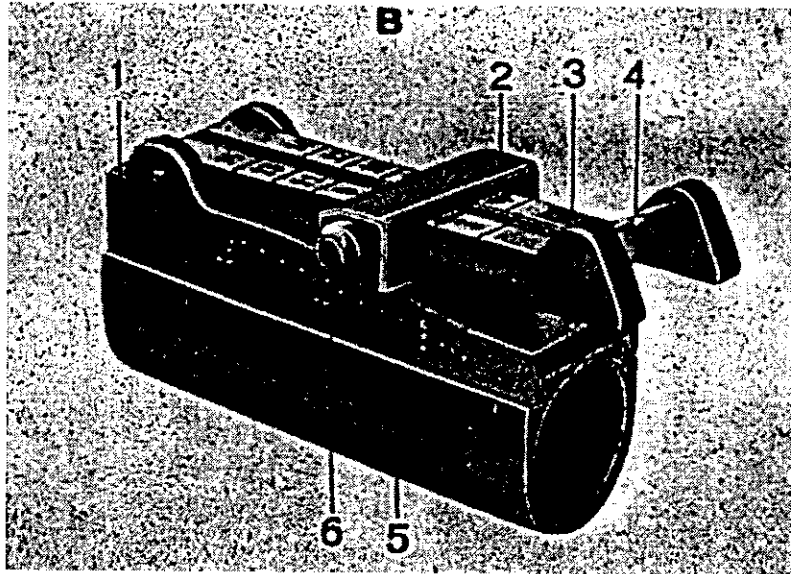

Figure 5
Rear Sight

B. Mq. Mod 11

1. Rear Sight Base
2. Elevation Adjustment Slide
3. Sight Leaf
4. Rear Sight Slot
5. Slide Stop

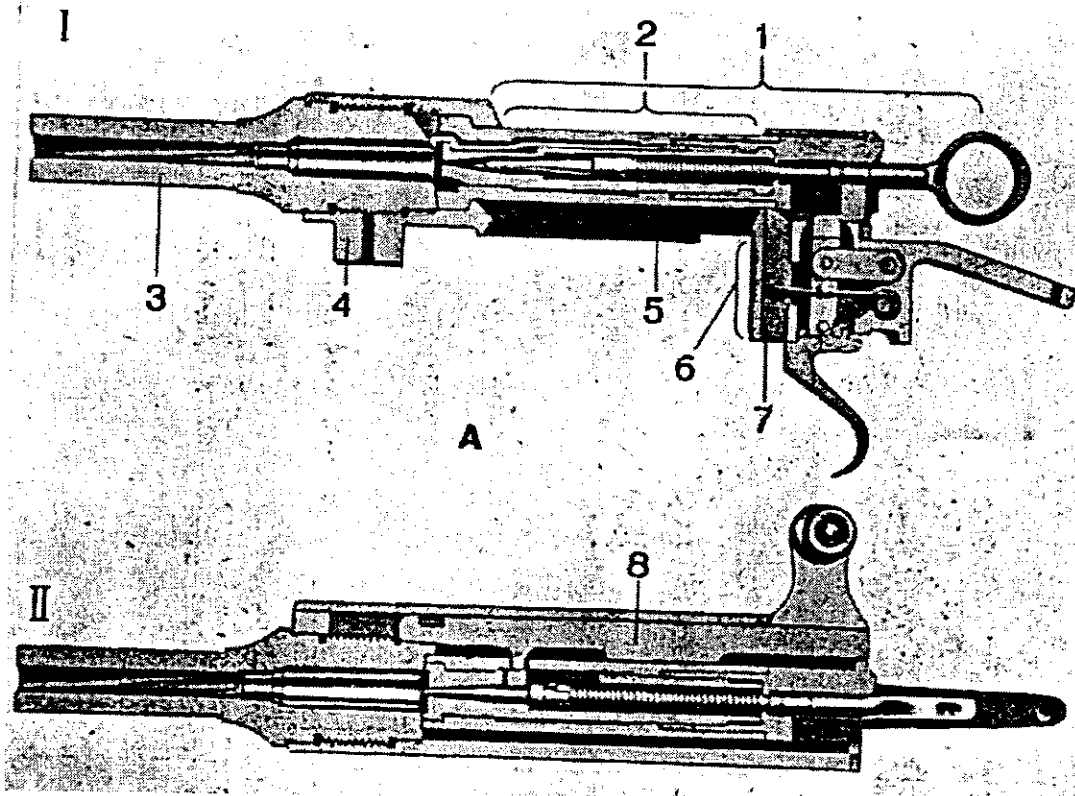

Figure 6

A. Mq. Mod 31

- I. Armed
 - 1. Bolt with firing mechanism
 - 2. Loading Slot
 - 3. Barrel
 - 4. Receiver
 - 5. Magazine Slot
 - 6. Trigger Mechanism
 - 7. Ejector
- II. Disarmed
 - 8. Cam Follower Plate

16 and 17

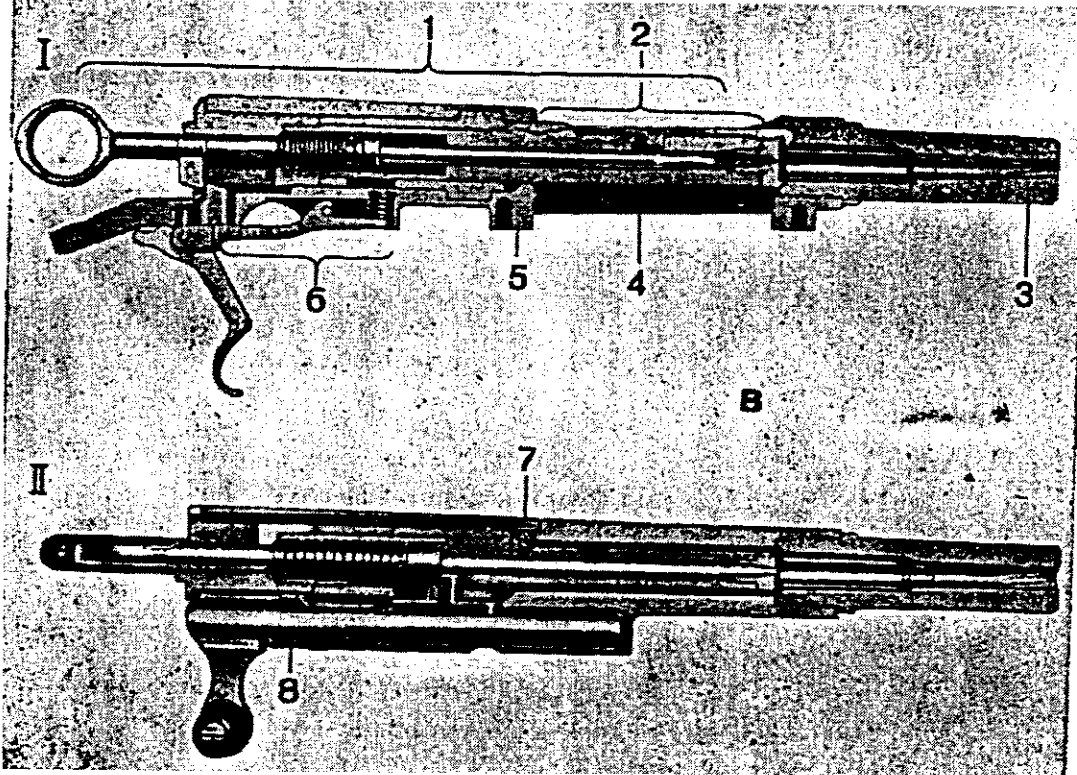

Figure 7

B. Mq. Mod 11

I. Armed

1. Bolt with firing mechanism
2. Loading Slot
3. Barrel
4. Receiver
5. Magazine Slot
6. Trigger Mechanism

III. Disarmed

7. Ejector
8. Cam Follower

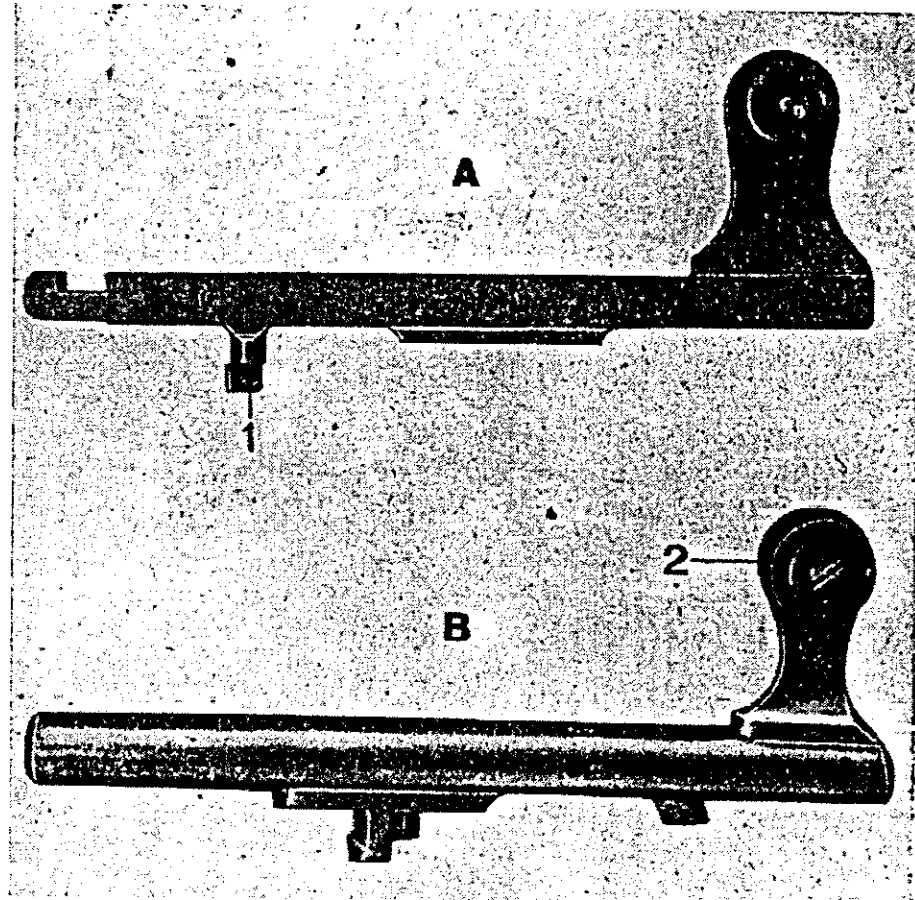

Figure 8
Cam Follower

A. Mq. Mod31

B. Mq Mod 11

1. Cam follower pin

2. Cam follower handle

The inner part of the cam follower pin slides in the helical slot of the locking sleeve and makes it turn when the bolt is opened or closed; when the bolt is opened, the outer part of the cam follower pin arms the firing pin mechanism by pushing against the base of the firing pin.

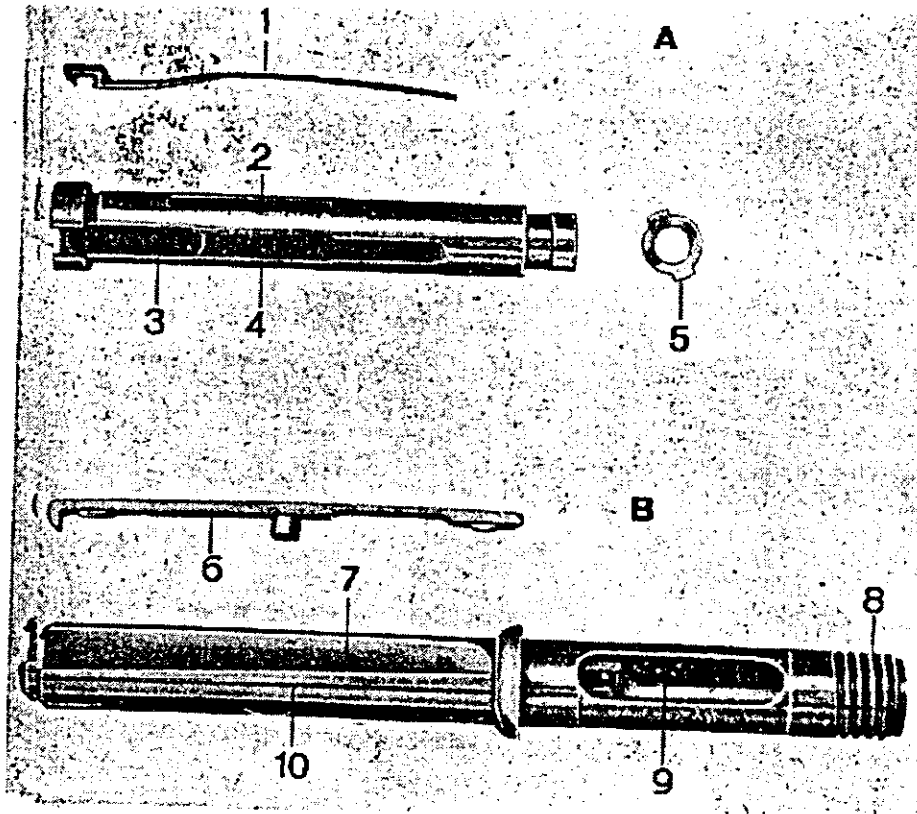

Figure 9

A. Mq. Mod 31

B. Mq. Mod 11

1. Extractor
2. Cam follower pin slot
3. Extractor groove
4. Cylinder
5. Attachment lug
6. Extractor
7. Cylinder
8. Threaded Connector
9. Cam follower pin slot
10. Extractor Housing

When the bolt is reassembled:

- a) for Model 31 : the locking sleeve completely surrounds the cylinder; the cylinder and the bolt plug are held in place by a locking lug arrangement.

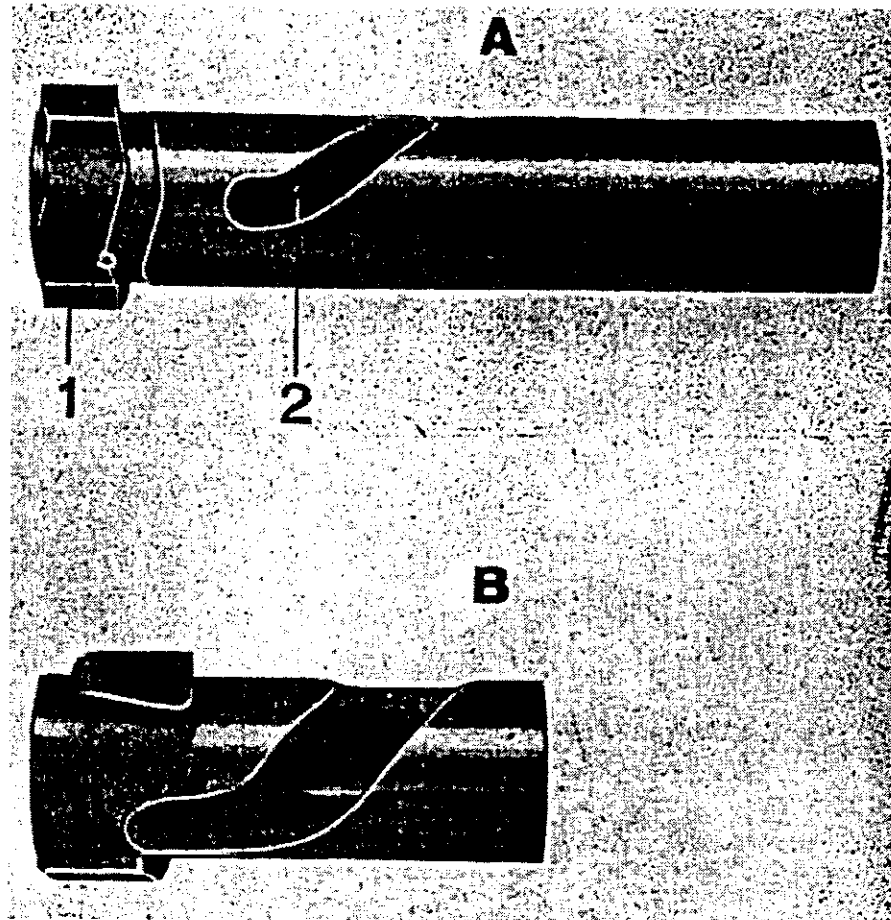

Figure 10
Locking Sleeve

A. Mq. Mod 31

B. Mq Mod 11

1. Locking Lugs
2. Helical Slot

b) for Model 11 : only the rear part of the cylinder is surrounded by the locking sleeve; The bolt plug and the cylinder are attached to each other by a male threaded area on the cylinder and a female threaded area on the bolt plug.

The cam follower pin slides in the helical slot in the locking sleeve and makes the locking sleeve turn when the bolt is opened or closed. It is this rotational movement that locks the lugs in place in the receiver when the bolt is closed. (locked bolt) When the bolt is opened, the lugs move from their locked position in the receiver and the bolt is unlocked.

The locking lug slots are found in the following locations

- a) Model 31: ahead of the loading slot
- b) Model 11: aft of the loading slot

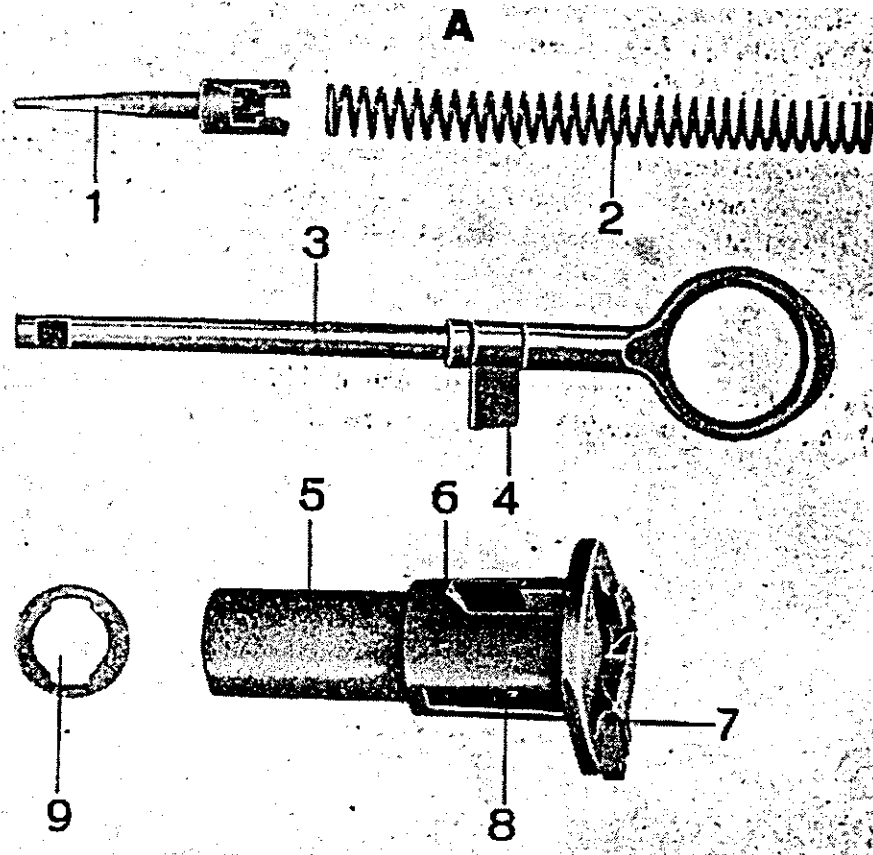

Fig. 11
Firing Mechanism

A. Model 31

- | | |
|-----------------------|-----------------------|
| 1. Firing Pin | 5. Bolt Plug |
| 2. Firing Pin Spring | 6. Safety Slot |
| 3. Cocking Piece | 7. Cam Follower Slot |
| 4. Cocking Piece Sear | 8. Firing Slot |
| | 9. Cylinder Lug slots |

The bolt plug is assembled to the bolt cylinder by means of a lug/slot arrangement.

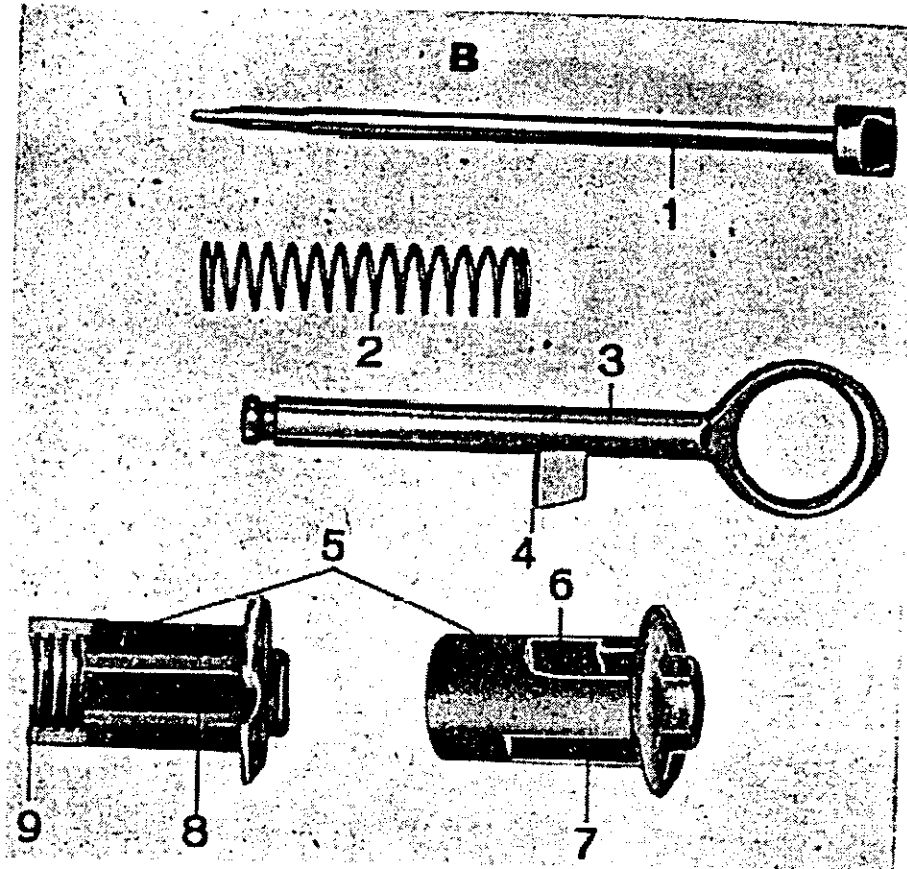

Fig. 12
Firing Mechanism

B. Mq. Model 11

- | | |
|-----------------------|-----------------------|
| 1. Firing Pin | 5. Bolt Plug |
| 2. Firing Pin Spring | 6. Safety Slot |
| 3. Cocking Piece | 7. Cam Follower Slot |
| 4. Cocking Piece Sear | 8. Firing Slot |
| | 9. Threaded connector |

The bolt plug is attached to the cylinder by means of a threaded connection

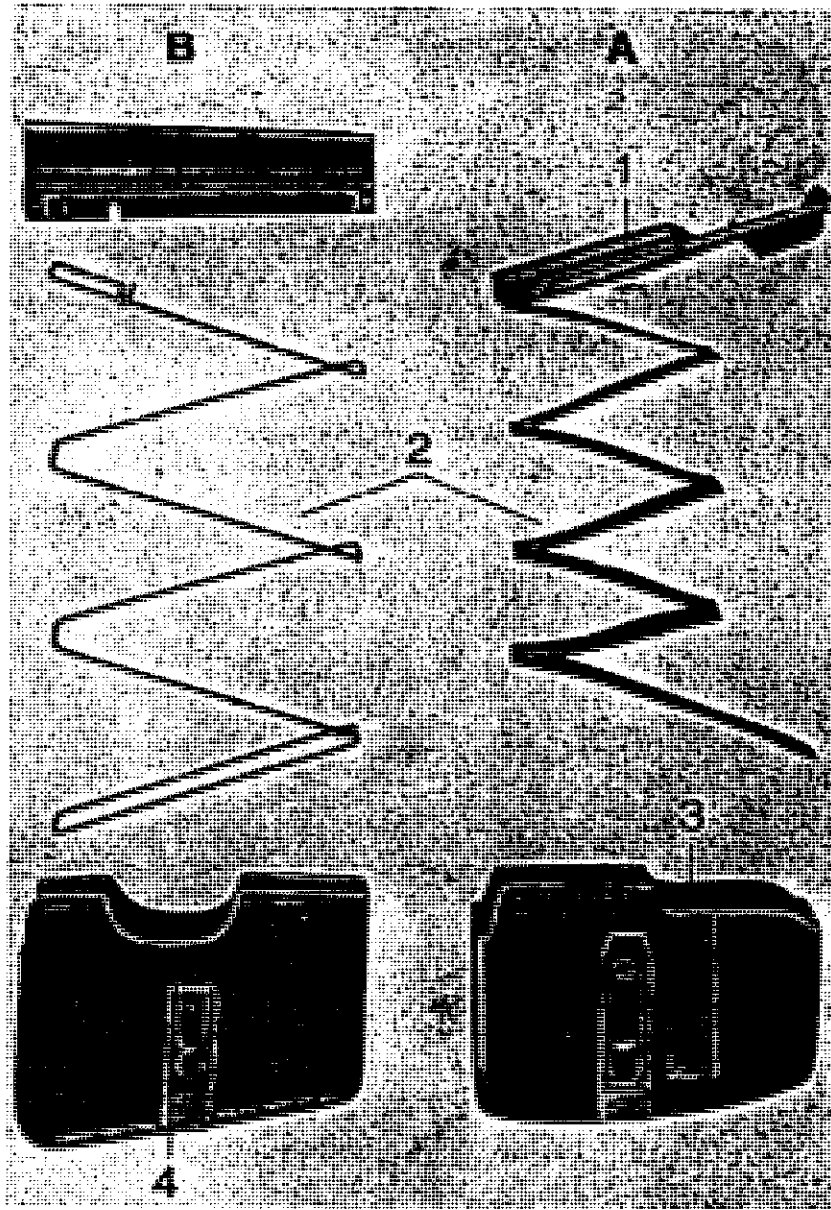

Fig. 15

B. Mq. Model 11

A. Mq. Model 31

- 1. Magazine Plate
- 2. Magazine Spring

- 3. Magazine Case
- 4. Magazine Stop

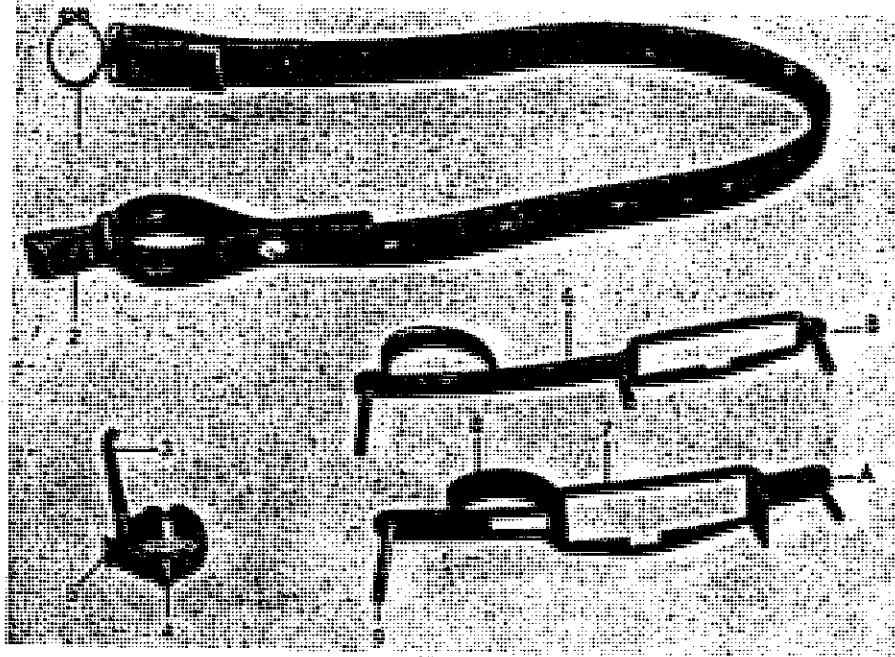

Fig. 14

Hardware

A. Mq. Model 31

1. Sling Loop
2. Sling Hook
3. Stacking Hook
4. Forward Barrel Band
5. Bayonet Lug
7. Magazine Plate
8. Trigger Guard
9. Action Screws (fore and aft)

B. Mq. Model 11

1. Sling Loop
2. Sling Hook
3. Stacking Hook
4. Forward Barrel Band
5. Bayonet Lug
6. Magazine Plate

A sling hook is attached to the lower part of the sling. It permits the lower part of the sling to be removed from the hook attachment bar, and also to put the weapon in a bandolier configuration or to remove the sling when wearing a gas mask.

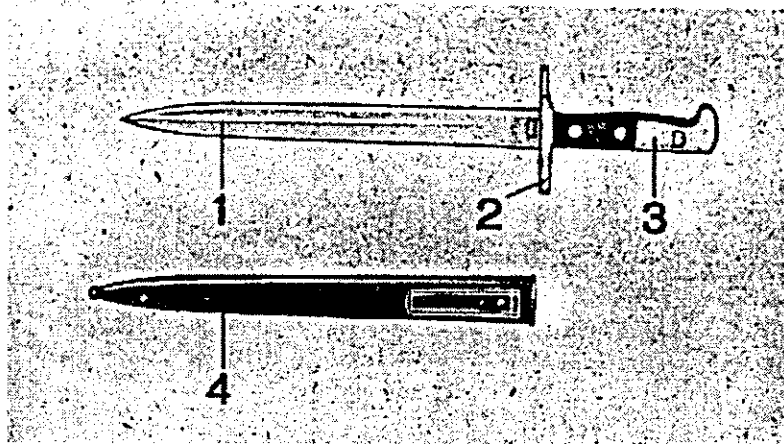

Fig. 15

Model 18 Bayonet with Sheath

1. Blade
2. Hand Guard
3. Hilt
4. Sheath

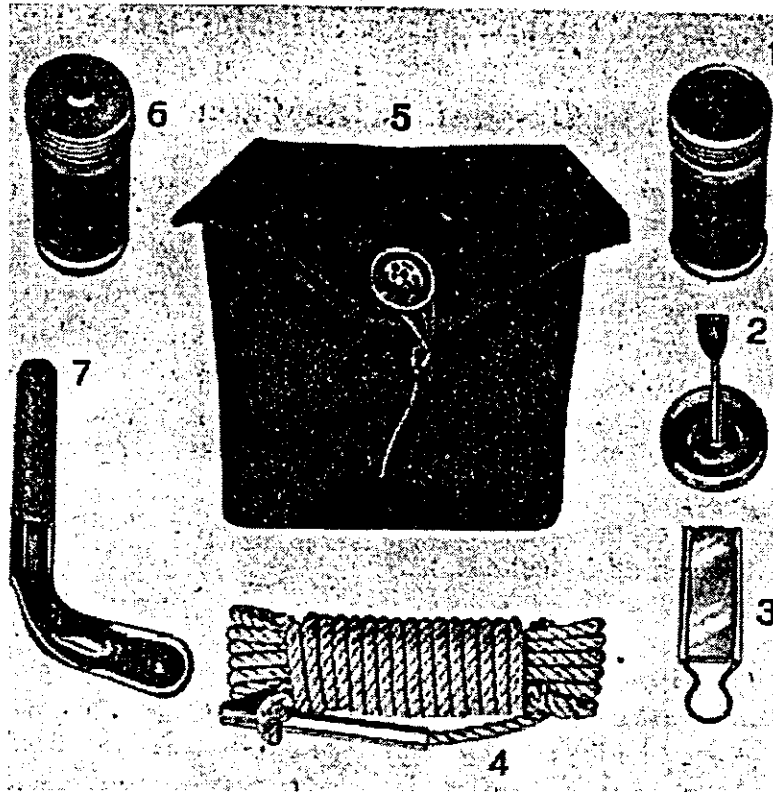

Fig. 16
Accessory Pouch

1. Grease Can
2. Grease Can Lid
3. Chamber Mirror
4. Cleaning Cord
5. Accessory Pouch
6. Grease Can
7. Chamber Cleaning Tool

III. Disassembly and Reassembly

1. Weapon Disassembly

- 4 **Before disassembly it is important to check for and remove all cartridges by inspecting the magazine and chamber.**

The weapon should be disassembled no more than is necessary for proper cleaning. To avoid dirtying the rifle parts all parts should be placed on a clean surface.

- 5 Disassemble the Rifle per the following:
- Remove the Magazine** (disassemble the magazine, if required, per section 9)
 - Remove the bolt**
 - Disassemble the bolt**

Mq.11	Mq. 31
<p>Grasp the bolt in the left hand</p> <p>Place the cocking piece sear between the two slots in the bolt plug</p> <p>With the left hand, turn the locking sleeve to the right; simultaneously push and remove the cam follower piece.</p> <p>Detain the firing pin spring by placing the cocking piece sear in the firing slot in the bolt plug.</p> <p>Remove the firing mechanism by unscrewing the cylinder from the bolt plug.</p> <p>Separate the locking sleeve from the cylinder.</p> <p>With both thumbs, remove the extractor by rotating it to the right; if necessary, support the left part of the claw against as stop and tap lightly on the cylinder to free the extractor.</p>	<p>Grasp the bolt in the left hand; place the cocking piece sear between the two slots on the bolt plug.</p> <p>Remove the cam follower pin from the helical slot in the locking sleeve; then remove the cam follower by pushing forward through the slot in the bolt plug.</p> <p>Grasp the locking lugs with the thumb and the middle finger.</p> <p>Hold the cylinder with the index finger next to the extractor.</p> <p>Turn the bolt plug a quarter turn.</p> <p>Separate the firing mechanism from the locking sleeve and the cylinder.</p> <p>Separate the cylinder from the locking sleeve</p> <p>Remove the 3mm extractor with a screwdriver by pushing it forward. (Avoid removing the extractor if possible as removal may break or weaken the spring)</p> <p>Retain the firing pin spring by placing the cocking piece sear in the firing slot in the bolt plug.</p>

d) Disassembly of the firing mechanism

- Compress the firing pin spring
- Remove the firing pin, the firing pin spring and the bolt plug.

e) Disassembly from the stock

This procedure should be performed very rarely, for example when the weapon has been wet, when it has lain dirty for a long period of time or for weapon inspection.

Completely unscrew and remove the forward barrel band. Unscrew 2-3 turns the screw on the rear barrel band (Sling loop) (never remove completely!), slide the barrel band forward and remove. Remove the hand guard.

Mq. 11

To remove the hand guard; it is necessary to raise the rear sight leaf to a 90 degree angle, then carefully lift the hand guard turning it at the same time to clear the sight leaf. Unscrew the action screw and the magazine plate screw and remove the barrel and the receiver.

<p>Mq. 11 Remove the barrel from the stock by grasping it towards the rear.</p>	<p>Mq. 31 Remove the barrel from the stock by grasping it from the muzzle</p>
---	---

Only a gunsmith is authorized to disassemble the weapon further.

2. Re-assembly

- 6 Re-assembly is accomplish in reverse order of the disassembly. Be careful to not mix parts of different rifles. Only parts with the same serial number should be assembled together.
- 7 **Re-assembly operations**

a) Mounting

Mq. 11	Mq. 31
<p>Place the barrel in the stock front end first so the mounting sleeve fits tightly into the milled slot in the stock.</p> <p>Replace the Magazine Plate</p> <p>Loosely tighten the Magazine plate Screws and the Action Screw.</p> <p>Tighten the center magazine screw securely, then the remaining two screws</p> <p>Lift the rear sight leaf to a 90-degree angle and replace the hand guard. Lower the sight leaf</p> <p>Slide the rear barrel band with the sling loop and tighten it without bottoming out the screw</p> <p>Inspect the Sling loop spring to ensure there is free movement and that the barrel band is tight</p> <p>Replace the front Barrel Band by placing the lower part against the stock then swing the upper part into position and tighten the screw.</p>	<p>Place the barrel in the stock receiver first.</p> <p>Replace the magazine plate</p> <p>Loosely tighten the two magazine plate screws</p> <p>Final tighten the forward screw first and then the aft screw</p> <p>Replace the hand guard by ensuring that the metal tab engages the slot in the rear sight housing.</p>

32 and 33

b) Bolt

Mq. 11	Mq. 31
<p>Replace the Extractor</p> <p>Slide the locking sleeve, lugs forward, over the cylinder</p> <p>Replace the cocking piece and slide it into the firing groove in the bolt plug</p> <p>Replace the firing pin spring over the cocking piece and compress it and hold</p> <p>Replace the firing pin, release the spring</p> <p>Pull and turn the cocking piece so the sear rests between the two slots in the bolt plug</p> <p>Assemble and tighten the firing mechanism assembly to the cylinder/sleeve assembly</p> <p>Grasp the bolt in the left hand</p> <p>Turn the locking sleeve until the end of the helical slot aligns with the cam follower pin slot on the cylinder and that these align with the cam follower shaft slot in the bolt plug.</p> <p>Replace the cam follower shaft by first placing the cam follower pin in the forward part of the helical slot as well as the cam follower pin slot in the cylinder. Place the small pin in the bolt plug slot.</p> <p>Pull the cam follower shaft all the way to the rear causing the locking sleeve to turn left to the point the cam follower pin falls into the aft pocket of the helical slot.</p> <p>Place the Cocking Piece Sear into the safety slot.</p>	<p>Replace the extractor</p> <p>Slide the locking sleeve with the lugs in front over the cylinder</p> <p>Replace the cocking piece and slide it into the firing groove in the bolt plug</p> <p>Replace the firing pin spring over the cocking piece and compress it and hold</p> <p>Replace the firing pin, release the spring</p> <p>Pull and turn the cocking piece so the sear rests between the two slots in the bolt plug</p> <p>With the cylinder/locking sleeve assembly in the left hand, hold the locking lugs with the thumb and middle finger. Align the ejector slots in the locking sleeve and the cylinder and hold them aligned with the tip of the index finger.</p> <p>Slide the sleeve/cylinder assembly into the firing mechanism assembly until it bottoms, with the cam follower plate slot in the bolt plug turned to the left. Turn the sleeve/cylinder assembly a quarter turn until the rear pocket of the helical slot in the locking sleeve aligns with the cam follower plate slot in the bolt plug.</p> <p>Replace the cam follower plate by inserting the rear end of the plate in the cam follower plate slot in the bolt plug; Slide the cam follower plate back until it bottoms and turn the bolt to the left until cam follower pin can slide into the pocket on the aft end of the helical slot in the locking sleeve.</p> <p>Place the Cocking Piece Sear in the safety slot in the bolt plug.</p>

- c) Replace the bolt
- d) Replace the Magazine

3. Disassembly and Assembly of the Magazine

- 8 The magazine should only be rarely disassembled. Perform only if the Magazine is very dirty. Exercise caution when disassembling the Mod. 31 Magazine as it is very easy to break the magazine spring at the point it is attached to the magazine follower plate so it is important not to exert pressure at that point.

9 Magazine Disassembly

Mq. 11	Mq. 31
Remove the magazine plate by rocking it to the right Carefully remove the spring	Take the Magazine in the left hand with the stop turned toward the body With the left index finger, lightly press the left side of the magazine plate in such a way to raise the right side Grasp the protruding side with the right index finger and thumb and remove the lateral bulge from the tabs by rocking the plate lightly along the longitudinal axis. Grasp the plate by the bulge and carefully remove it as well as the magazine spring. (never pull the plate along its longitudinal axis).

10 Magazine Re-assembly

Mq. 11	Mq. 31
Replace the spring in a relaxed position with the small rectangle formed by the steel wire placed front to back Replace the magazine plate in such a way that the end of the spring engages the small notch in the plate Replace the magazine and Inspect and function test	Replace the spring and the magazine plate by inserting the assembly at an angle Replace the magazine vigorously until the magazine stop engages completely Inspect and function test

IV. Function

I. Trigger Mechanism and Rifle Discharge

(Fig. 17)

- 11 When the weapon is ready to fire, the bolt is closed and locked, the trigger mechanism is armed (normal position. See Fig. 17)

The pressure placed on the trigger causes the trigger sear to lower; this trigger movement is paused as the rear trigger boss comes into contact with the receiver. (stop point).

The lip of the trigger sear then holds the Cocking Piece Sear lightly such that a very slight pressure on the trigger is all that is required to lower it completely.

At the moment that the cocking piece sear is freed from the restraint of the trigger sear, the cocking piece, under the pressure of the firing pin spring, is projected forward. The firing pin strikes the cartridge primer and it ignites.

2. Unlocking and opening the bolt

(Fig. 18)

- 12 When the handle of the cam follower is pulled to the rear, the cam follower pin slides in the longitudinal slot in the cylinder and at the same time along the helical slot in the locking sleeve.

The cam follower pin arms the firing mechanism by moving rearward the firing pin and the cocking piece and compresses the firing pin spring. The aft pocket of the helical slot in the locking sleeve ensures that the cam follower pin will not be pushed forward by the firing pin spring. The firing mechanism is armed in this fashion.

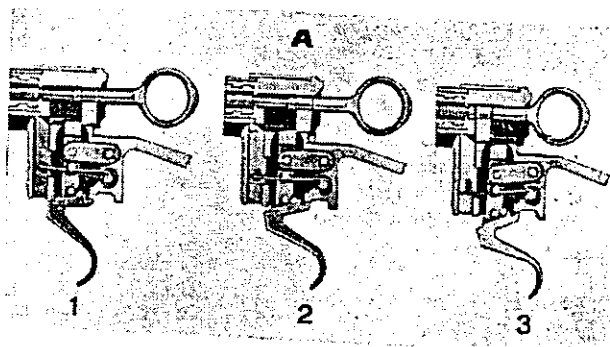

Fig. 17

A. Mq. Mod. 31

The three trigger positions

1. Normal Position
2. Position after trigger first stage (sear ready to release)
3. Post Weapon Discharge

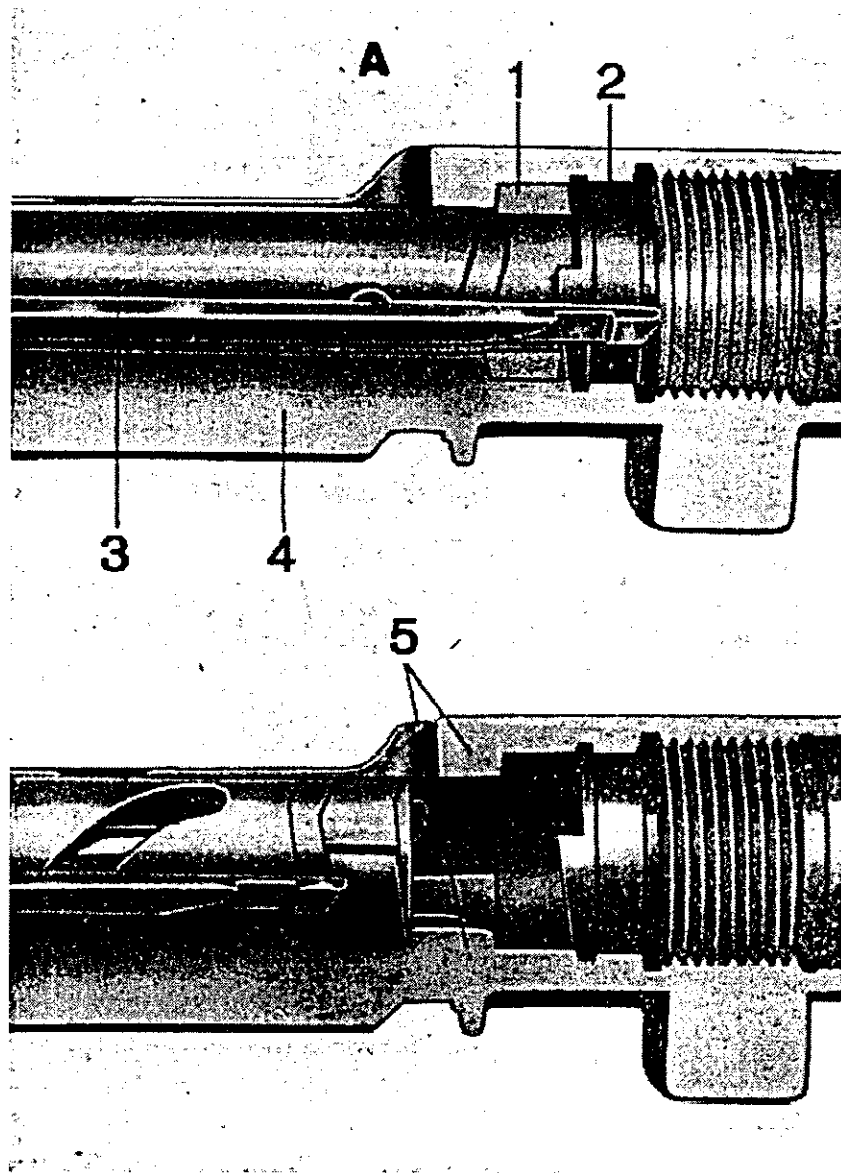

Fig. 18

A. Mq. Mod. 31

1. Locking Lugs
2. Barrel
3. Cam follower plate
4. Receiver
5. Locking Lug slots

- 13 During locking sleeve rotation, the locking lugs exit the locking lug slots in the receiver and stop rotation at the entrance of the locking lug guide grooves that run along the length of the inside of the receiver; the bolt is, in this position, unlocked and may be pulled freely to the rear up to the bolt stop.
At the same time, the extractor pulls out the empty case and the case is ejected at the point where it hits the ejector.
The upper cartridge in the magazine is raised into position by the magazine spring and stops in front of the bolt

3. Closing and locking the bolt

- 14 When the bolt is pushed forward, the locking sleeve turns slightly as guided by the angled surfaces on the locking lugs. The same movement frees the cam follower pin from the aft pocket in the helical slot in the locking sleeve. The lip of the trigger sear then restrains the cocking piece sear. The firing pin spring is remains compressed in this fashion. As the cam follower plate is pushed further forward, the cam follower pin, guided by the helical slot in the locking sleeve, turns the locking sleeve. The locking lugs turn into the locking lug slots in the receiver and the bolt is locked.
A bolt that is not completely locked exposes the shooter to the risk of accident, also the risk of damaging the cam follower pin (see appendix IV of the present regulation "Instructions for damage avoidance to small arms"). During bolt closure the bolt pushes the top cartridge in the magazine forward and into the chamber. The extractor claw then snaps into the lip of the cartridge case.
- 15 When all of the cartridges in the magazine have been fired, it is not possible, then, to close the bolt; the shooter is thus made aware of the need to reload.

4. Safety

- 16 When the cocking ring is pulled rearward and turned to the right, the cocking piece sear can be placed in the safety slot in the bolt plug. This slot is shorter than the firing slot; it is for this reason the firing pin cannot protrude past the face of the bolt cylinder. All contact with the cartridge primer is thus prevented. The cocking piece sear falls into a pocket that keeps the bolt from opening accidentally.

V. Malfunctions and Repairs

- 17 Most of the time, malfunctions are caused by poorly executed bolt operation, by poor maintenance, or from inadequate inspection.
If malfunctions or misfires occur during operation and handling a loaded weapon is required, it is necessary to proceed in the following fashion:
- a) Secure the weapon by turning the cocking piece sear into the safety slot.
Open the bolt and remove the cartridge from the chamber.
 - b) If the bolt can be opened easily:
 - Load and close the bolt,
 - Inspect the cam follower plate to ensure that it is pushed all the way forward.
 - Recock the weapon and continue shooting

or

- c) If the bolt cannot be opened:
 - Remove the magazine.
 - Place the cocking piece sear between the safety slot and the firing slot in the bolt plug.
 - Pull the bolt back by the handle with blows of the palm of the hand if required,
 - Remove the bolt, disassemble and inspect all of the parts (especially the cam follower pin),
 - If no defect or damage is found reassemble and reload per step b,
 - d) If the bolt cannot be opened per step c:
 - Safe the weapon and contact the specialist (gunsmith).
- 18 **Loading malfunctions** are caused the majority of the time by cartridges that are poorly placed in the magazine or and foreign object in the system.
If the malfunction is caused by a case that is lodged in the chamber, extract it by closing and opening the bolt several times; the bolt should be open by small taps to the handle of the cam follower plate. If the case still remains in the chamber, use a cleaning rod to remove it. The cause of this malfunction could be due to a worn or broken extractor claw or because the chamber has become so dirty that the case remains stuck in the chamber.
- 19 **Misfires** can be caused when the bolt is not closed all the way, the firing channel is dirty or full of grease or the point of the firing pin is broken. If these causes have been eliminated and the rifle still does not discharge and the cartridge will not fire in another rifle, then the cartridge must be considered a "misfire".
- 20 Only the gunsmith is authorized to:
 - Repair trigger mechanism malfunctions (for example, insufficient sear engagement)
 - Remove foreign object, such as cleaning rods or parts of cleaning cord that are jammed in the barrel.All needed repairs to be performed while on duty, can only be performed by troop gunsmiths or arsenal gunsmiths; all repairs that may be required while off duty, can only be performed by gunsmiths authorized to repair service (military) weapons.
- 21 If serious damage or malfunctions occur to the weapon or ammunition, apart from those caused by weapon discharge, and if this damage will cause or could cause an accident, carefully gather all of the damaged parts, as well as the cartridges, and set them aside without any modification. Advise Military Technical Services in Bern by telephone at (031/61 76 26) or by telegraph so that the damage may be studied in place and without delay, to determine the cause.

VI. Weapon Maintenance

1. Overview

- 22 Each shooter is responsible for the maintenance of his rifle. The Group and Section Chiefs as well as Unit Commanders of reserve units are responsible for periodic weapon inspection. The group and section chiefs will perform an inspection and comment on all maintenance issues such as the condition of the barrel, cleanliness and so forth.
A gunsmith should be present, if possible, to repair at site all small malfunctions, and to retain all weapons that need repaired or returned to the arsenal.
- 23 Select locations for weapons storage that are dry and not subject to wide temperature variations. The weapon should be unloaded, bolt closed, trigger spring released, if it will not be used for a long period of time. The weapon should be well greased beforehand especially the barrel bore.
- 24 **When a weapon is being shipped** either by train or post, the front and rear sights should be well padded. The bolt should be wrapped in thick paper or well wrapped in packaging material.
- 25 In order to properly handle the weapon, the following is forbidden:
- Carrying more than one rifle on the same shoulder.
 - Loading unpackaged weapons into vehicles.
 - To obstruct the barrel muzzle with grease or a cleaning patch.
 - To modify the weapon in any way.
 - To use rifles as a stretcher.

2. Cleaning

- 26 **The degree of rifle cleaning** will depend on how dirty the weapon is. When the weather is dry it is sufficient to dry then grease the exterior of the weapon and the bolt. After shooting with ball or blank ammunition or with propulsive cartridges, a more thorough cleaning is required, also if the weapon is soiled or wet.
If it is not possible to clean the weapon immediately after firing, the bore of the barrel should at least be greased while it is still warm.
Only material provided in the accessory pouch and the weapon grease delivered to the troop should be used for cleaning. **Cleaning rods should be used only to grease and degrease the barrels.** they should not be used for cleaning.
Cleaning materials should be kept in good condition. The cleaning cord should be equipped with a wire mesh that is not worn out. To wash the cleaning cord use hot water no hotter than 30° C; the wire mesh should be removed beforehand. The wire mesh should only be placed on the cord and the cord rolled only after the cord is dry.
- 27 **Metal parts** of the weapon should be rubbed with a dry cloth. It is necessary to remove old dried on grease and gunpowder residue with a little fresh grease and clean the grooves and hard to reach parts with small pieces of wood. One the cleaning is complete; lightly rub all of the metal parts with a clean greased cloth. Ensure particularly that moving parts are well greased, especially the locking sleeve and the cam follower plate/rod. **The firing pin and the firing pin channel should not be greased.**
Rub rusted spots with a dry cloth, then grease sufficiently, then rub again. Repeat in this fashion until all of the rust is gone and only the dark spots are visible.
- 28 **The wooden parts of the rifle, the stock and hand guard,** should be cleaned with a clean cotton cloth and then lightly greased.

44 (cont), 45 and 46

- 29 Barrel cleaning is performed by means of a cleaning cord, after having removed the bolt and the magazine. For Mq. 31 the locking sleeve should be re-inserted in place to ensure that the ejector does not snag the cleaning cord. The cleaning cord is inserted through the receiver. The wire mesh should be well greased and in good enough condition so that the wire will penetrate the grooves of the rifling; if the wire mesh is too narrow, widen it by inserting a small piece of wood into the cord. Two men should pull the cleaning cord exactly down the barrel axis; on each cleaning pass, the wire mesh should pass all the way through the barrel. After having removed all powder residues in this fashion, wrap a small thin patch around the cord **just ahead of the wire mesh**, and clean the barrel again until the patch emerges clean. The barrel is then inspected. Special attention should be paid to ensure rifling grooves are clean. After inspection, grease the bore by greasing a thin cotton patch and wrapping it around the cord **just ahead of the wire mesh**, then run the cord again through the barrel. The cleaning rod can also be used to grease the barrel.
- 30 **The chamber** is cleaned by means of the chamber-cleaning tool. Grease the wire mesh and loosen powder residue by inserting the tool into the chamber. Wrap a dry patch around the tool and clean the chamber of all remaining residue. Inspect the chamber. Wrap a clean greased patch around the tool and grease the chamber again after the inspection. If the chamber-cleaning tool is not large enough to clean the sides of the chamber, it may be enlarged with a screwdriver.
- 31 **Worn out wire meshes and wire mesh** from the cleaning cord and cleaning tool should be replaced. Place the new wire mesh into the buckle of the cleaning cord by placing the small sides of the mesh against the center of the buckle and form the mesh in an 's' shape through the two pins on the buckle.
- 32 As a general rule, it is not necessary to perform a **major disassembly** except for purpose of inspection by an arms inspector; a major disassembly may also be necessary after a long period of bad weather. Before reassembling the weapon, grease all of the rifle parts that are not visible outside of the stock.

3. Inspections

- 33 **A minor inspection** either by the shooter himself or by the non-commissioned officer after each cleaning, or when the weapon has not been used during a certain period of time. Inspected are:
- a) The cleanliness of the different parts, especially the bore
 - b) The smooth function of the bolt, the trigger, the magazine follower plate and the magazine spring.
 - c) The position of the front barrel band and the sling loop barrel band and if the band screws **are securely tightened**.
 - d) That the bore and the moving parts surfaces are sufficiently greased.
 - e) The shooter will inspect the weapon for cracks in the cam follower pin during each rifle cleaning and inspection. If the shooter is uncertain of the condition of the pin, he should contact a gunsmith (if not on active duty, he should contact the arms inspector or the arsenal).

34 If a **major inspection** is required, contact the responsible officers. A major inspection should take place at least one time during short time active duty and once every two or three weeks during prolonged periods of active duty. This inspection is composed of the following elements:

- a) Remove all cartridges, the bolt and the magazine.
- b) Degrease the barrel bore and the chamber (clean if necessary)
- c) Perform a major disassembly, remove the stock if necessary
- d) Barrel inspection:
 - Place the bore mirror in the loading slot; inspect the rifling and the chamber
- e) Inspect the sights: ensure the front sight housing is fixed in place, that the elevation slide moves freely, check the condition of the slide stop and the condition of the rear sight notch,
- f) Inspect the movement in the trigger mechanism and the bolt stop.
- g) Inspect the stock and the hand guard (for cracks)
- h) Bolt inspection:
 - Disassemble the bolt into 4 parts, the firing mechanism will not be disassembled and the extractor will stay fixed to the cylinder.
 - Cylinder: firing pin channel and extractor slot are intact,
 - Locking sleeve: no visible cracks, inspect free movement of the sleeve over the cylinder.
 - Firing mechanism: point of the firing pin is in good condition, check the wear on the cocking piece sear, verify that there are no cracks in the bolt plug,
 - The cam follower plate: the shooter must inspect the cam follower pin for cracks at the range as well as during rifle cleaning and inspection. If there is a doubt as to whether the cam follower pin is fractured, contact a gunsmith (if not on active duty, contact the arms inspector or the arsenal,
- i) Magazine: check that the spring is in the proper position, check magazine follower plate for free movement.
- j) Reassemble the rifle without the magazine:
 - Inspect the sears, weapon shouldered
 - Inspect the firing mechanism by moving the bolt,
- k) Inspect the bayonet: Fix it to the barrel and to the lug and check for movement (slight play is allowed)
- l) Inspect the screws and the barrel bands (on the Mq. 11 check that the mounting sleeve is well inserted into the stock and the hand guard),
- m) Check that the serial number of the weapon, the bolt, the magazine, and the bayonet are the same,
- n) Check that the weapon inspection information has been recorded in the weapon service log.

VII. Scoped Rifles

A. Scoped rifles 1931/42 and 1931/43

1. Overview

35 There are two Model 31 Scoped rifles:

- Model 31/42, scope power 1.8X
- Model 31/43, scope power 2.8X

The scope is set offset in the model 31 rifle. Because of this the regular iron sights can be used as well as the scope.

The nomenclature of the different parts of the scoped rifle is outlined in fig. 19 and 20. The scope reticle is shown in fig.21.

2. Maintenance

36 Maintenance of the scoped rifle itself is performed per the instructions provided for the regular issue rifle. Perform scope maintenance per the following instructions:

- Handle carefully:** protect the scope from impacts.
- Keep the scope clean and dry:** if the scope gets wet, dry it out of the weather but not next to a heat source.
- Clean the eyepiece lens** with a soft cloth or with a chamois, after removing any sand grains with tweezers.
- Oil only the metal parts lightly; **in no circumstance use grease or gasoline.**
- Scope adjustment** (aimpoint adjustment) cannot be performed by anyone except a gunsmith. The adjustment key is found in the cp. fus. & car. gunsmiths kit.
- No scope repair can be performed by troops in the field. Scoped rifles that need repair must be returned to the issuing arsenal.

3. Handling

37 At all ranges the scope sees a 'full view'. It is necessary therefore to move the crosshairs to the center of the target.

If the distance between the view point and the impact point is more than 1 0/00, that is represented in target A, an impact point outside the visual field, the scope should be adjusted by a gunsmith. For firing, it is necessary to raise the objective and place the elevation range on the sight leaf of the scope.

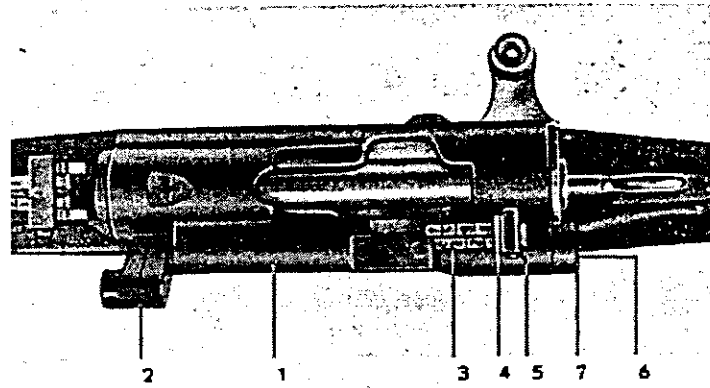

Fig. 19

Scoped Rifle 31/42 and 31/43
With objective in view position

1. Scope housing
2. Mobile objective
3. Sight leaf
4. Elevation slide
5. Elevation Slide Stop
6. Eyepiece
7. Eyepiece protector

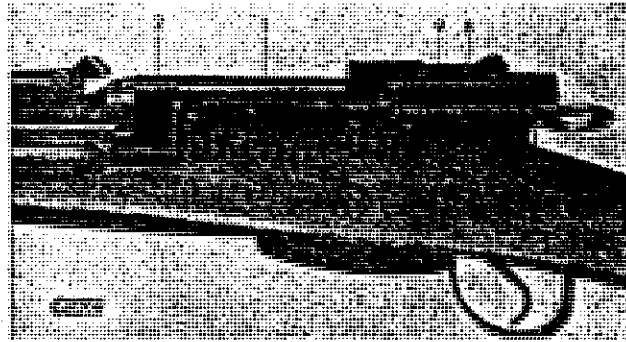

Fig.20

Scoped rifle 31/42 and 31/43
With objective lowered

1. Scope housing
2. Mobile objective
8. Windage adjustment screw
9. Elevation adjustment screw

51, 52 and 53

After shooting, the mobile objective must be lowered into its slot in the stock and lower the elevation slide to 1. If the objective remains raised, it can be easily bumped.

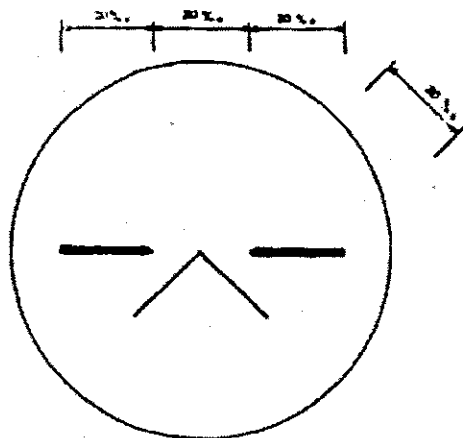

The thickness of the reticle crosshairs is 0.5_{0/00}. The thickness of the auxiliary crosshairs is 2_{0/00}. The visual field of Model 41/42 (magnification 1.8X) measures 125_{0/00}. The visual field of Model 31/43 (magnification 2.8X) measures 80_{0/00}.

Fig. 21

B. Scoped Rifle Model 1955

38 Scoped rifle Model 1955 is a weapon for precision shooters. It is a firearm that resembles the Mq. Mod 31. In the hands of a good marksman, it is capable of destruction, using few cartridges, up to distances of 500 to 600 meters, of targets isolated and not easily visible to the naked eye or in dim lighting conditions. The scope not only facilitates sight, but also permits observation of the target area. Thanks to good optics, an enlarged visual field and the stability of the weapon (bipod, muzzle brake, weight of the weapon) one may observe the arrival of the shot on target.

2. Technical Information

39	Caliber	7.5 mm
	Muzzle Velocity	780 m/s
	Uses the GP 11 cartridge	
	Weapon weight (ready to fire without bayonet)	6100 gr
	Weapon weight (unloaded, without scope)	5530 gr
	Weapon length	121 cm
	Height of the barrel axis from the ground (firing position with bipod)	32 cm
	Scope	
	Scope weight	520 gr
	Scope weight with case	1050 gr
	Magnification	3.5X
	Visual field	75 _{0/00}
	Correction tolerance	?75 _{0/00}
	Distance adjustment	from 0-800 m
	View adjustment tolerance	?2 diopters

Additional information

- 40 The scope can be removed.
A bayonet can be mounted to the barrel.
The rifle can be aimed with the iron sight with the scope mounted to a distance of 800 m.
Compared with the Mq. 31 the Mq. Lu 55 has a smaller target dispersion pattern due to the weight of the weapon and the barrel muzzle brake.
A good marksman, using the bipod, and after sighting in, can achieve 95 points in 10 shots at a 300 m 10 point target.
The weapon is adjusted to a 300-meter zero. Due to this the impact point for all distances will be $1 \frac{0}{100}$ higher than the aimpoint.

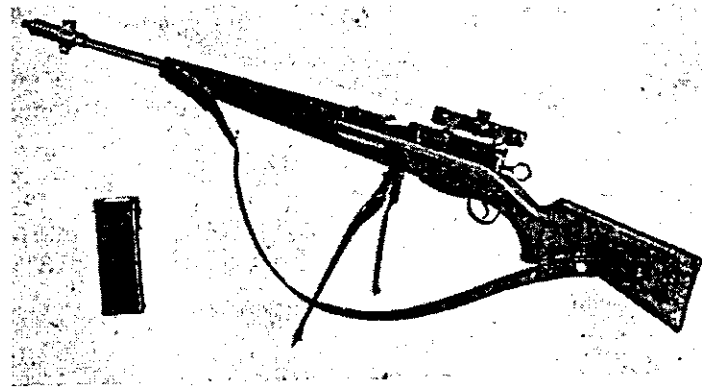

Fig.22

3. Handling and Maintenance

- 41 The methods for carrying the weapon, loading, removing cartridges, and firing are in principle the same as that of the Mq. Mod 31.

To reload, be sure to insert the charger at a slight angle from right to left. After use, the scope is to be placed in its case in order to avoid damaging it. The scope should be mounted only just prior to taking a firing position. During a march and changes in firing position, the scope must be placed in the case.

For weapon maintenance, the same procedures used for the Mq. Mod 31 will be used, especially the instructions concerning disassembly. Instructions concerning the assembly of all the parts differ from those of the Mq. 31 with the exception of the firing pin, the cocking piece and the firing pin spring.

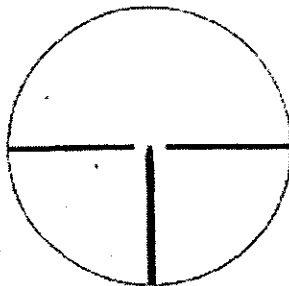

Width of vertical crosshair $2 \frac{0}{100}$

Width of horizontal crosshair $1 \frac{0}{100}$

Gap in the horizontal crosshair $8 \frac{0}{100}$

Fig. 23

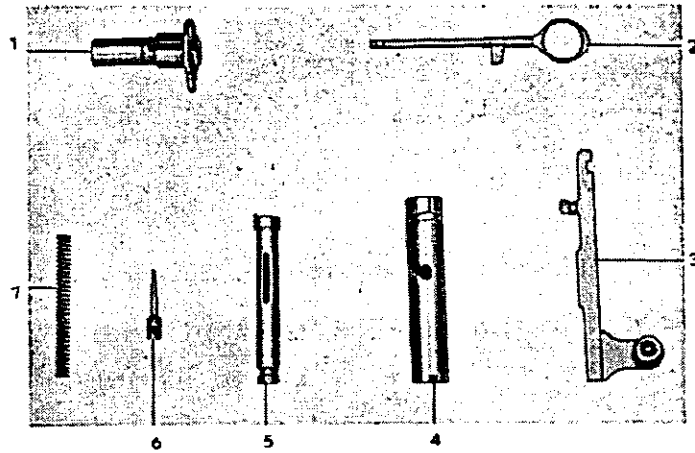
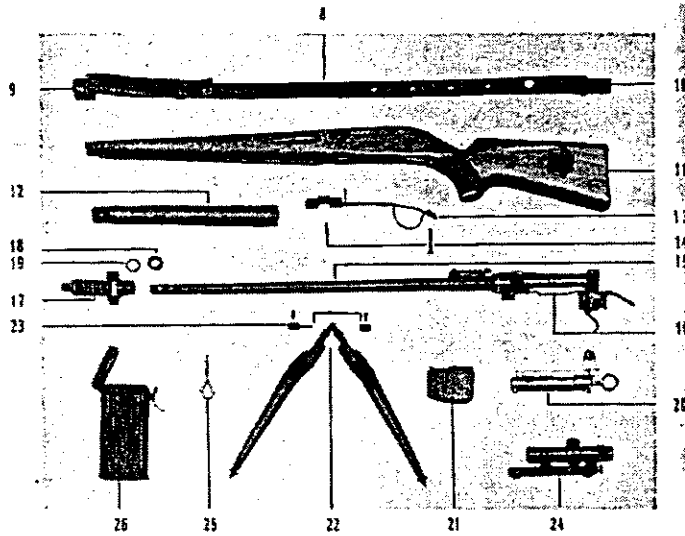

Fig. 24

1. Bolt plug
2. Cocking piece
3. Cam follower plate
4. Locking sleeve
5. Cylinder
6. Firing pin
7. Firing pin spring



- | | |
|---|--|
| <ol style="list-style-type: none"> 8. Sling 9. Sling loop band 10. Sling Hook 11. Stock 12. Handguard 13. Magazine plate 14. Receiver screws (front and rear) 15. Barrel 16. Receiver with trigger mechanism | <ol style="list-style-type: none"> 17. Muzzle brake (disassembled only by a gunsmith) 18. Round Screw 19. Locking ring 20. Bolt 21. Magazine 22. Bipod 23. Bipod mounting 24. Scope 25. Screwdriver for scope 26. Scope Case |
|---|--|

For the scoped rifle, it is important to pay attention to the following points:

Use the weapon with care to avoid impacts, wet and dirty conditions. If the scope gets wet, dry it at room temperature, not next to a heater or not in its case.

The lenses should be cleaned with a clean lens cloth or a chamois. Sand particles should be removed preferably beforehand with tweezers.

Metal scope parts should only be lightly oiled. The lenses should never come in contact with grease or petroleum based oils.

Troops are not authorized to make repairs to the scope.

Damaged scopes should be sent with the rifle to a competent arsenal.

42 Sight adjustment

The weapon should be sighted in without the scope. If this is not the case, it must be adjusted with the help of a gunsmith per the gunsmith's regulations. If the average point of impact while shooting on the bipod, Target A at 300 meters with the elevation set at 3 and windage of 0, in calm and normal conditions, is outside the black region on the target, the scope must be adjusted.

Scope adjustment will be performed by the soldier to which the weapon was issued or the gunsmith.

Procedure as follows:

While adjusting the elevation and windage knobs during sighting in, the average impact point should be in the center of the black, with the aim point at "dead center"

Next, the elevation adjustment knob should be firmly held, the screws loosened around one turn with the provided screwdriver found in the case, The scale on the knob will be set to 3 and the screws retightened.

To adjust the windage, follow the same procedure, but now the scale on the knob should be placed at "0".

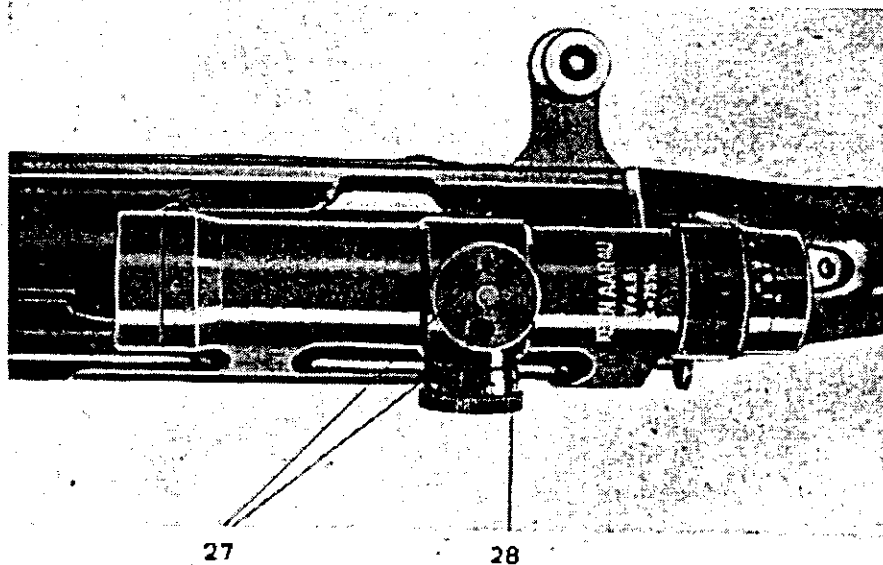

27 Countersunk screws for adjusting elevation

Fig. 26

28 Windage knob

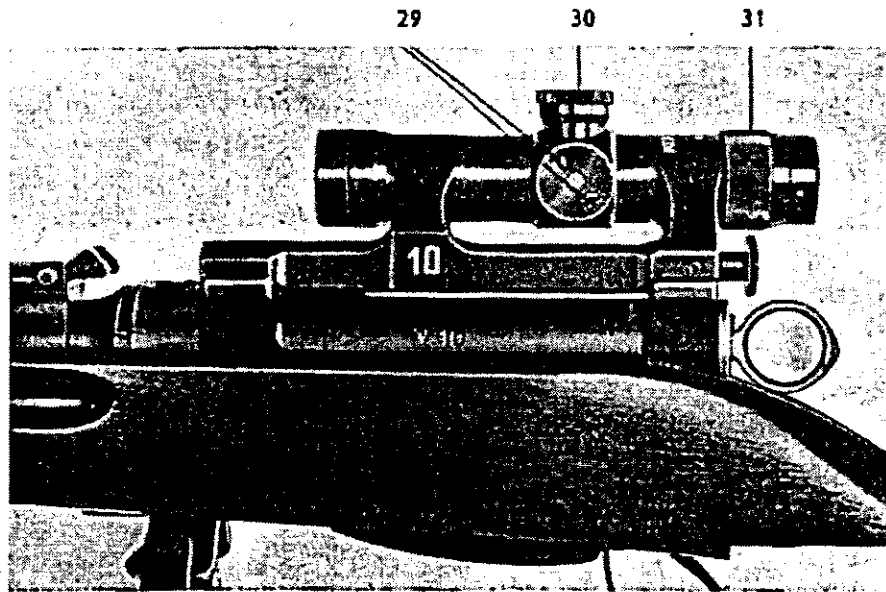

Fig. 27

- 29 Countersunk screws for windage adjustment (loosen 1 turn) 30 Elevation knob
 31 Focus ring

4. Sight adjustment procedure

- 43 As a general rule, the scoped rifle will be fired using the bipod; or per the situation, perhaps supported on sandbags or on a window frame
 Before each shot, the diopter adjustment will be inspected.
 For the Mq. 31, small corrections in windage and elevation are made by changing the sighting point; the procedure is the same for the Mod. 55 Scoped Rifle when not using the scope.
 When using the scope, always aim at the center of the target after having adjusted the elevation and windage to 'dead center'.
 Ensure when sighting that your eye is sighting directly down the axis of the scope, if not, the aim point will vary from the sighting point.
 Adjust the scope aim point per the following instructions:

Windage:

To move the aim point to the left; turn the windage knob counterclockwise.

To move the aim point to the right; turn the windage knob clockwise.

To measure windage correction: 1 knob mark in 6 clicks is equivalent to a correction of 45cm (roughly a mans width) at 300 m or 1/5 0/00.

Elevation:

To adjust the aim point higher; turn the elevation knob to smaller number.

To adjust the aim point lower; turn the elevation knob to a larger number.

Unlike the windage knob, the elevation knob doe not have stop clicks.

To measure elevation correction: an adjustment of 3 to 4 moves the impact point around 35 cm higher at a distance of 300 m.

If not many shots are fired, small adjustments, say one click on the windage knob, will not assure an accurate adjustment due to the fact that at 300 m the impact point can theoretically move 7.5 cm with the overall pattern of the rifle being approximately 20 cm.

For this reason; one should not, as a general rule, adjust the knobs unless the impact point is at least 0.5 $\frac{0}{100}$ off center or is at least 15 cm off center at 300 m.

5. Weapon Use

- 44 The Scoped Rifle Model 55 is a weapon for advanced marksman, with which small, important targets can be engaged at long distances.

The success of an elite marksman equipped with a Scoped Rifle is dependant on the following conditions:

Only marksmen who have proven themselves extremely competent using the Mq. 31 and the assault rifle can be considered as Elite Marksmen.

Elite marksmen should not only be instructed in marksmanship but also in ways to use the terrain, target reconnaissance, distance estimation, and use of binoculars as well as the scope of the rifle.

It will be necessary to give elite marksman the opportunity to inspect the scope adjustment with more than the usual number of shots.

With a 'sighted in' rifle, a target of 0.2m² (target style G) must be hit with the first shot at a distance of 300 m.

Over larger distances, it is required most of the time to adjust while shooting. The visual field for a target placed closer is too small to estimate with confidence the true aimpoint.

In order to enable a marksman to adjust his shot, it is necessary to know the enemies position. The clarity and the lay of the terrain should permit observing the effect of his shot.

A marksman should not be able to see the effects of his shot except at distances of 300m and beyond. In effect, at shorter distances the time from cartridge discharge, to when the bullet strikes the target is so short that it is impossible to see the effect of the shot.

Elite marksmen operate alone or in teams. For this reason, a well defined mission should always allow the snipers to operate independently within the combat structure.

A sniper team is composed of a man equipped with a scoped rifle and a second man equipped with and assault rifle and binooculars.

This second man observes the terrain with the binoculars and looks to locate where the bullets strike the target in the case the shooter cannot do it by himself.

Snipers are deployed in the following situations:

- Against hard to engage targets up to distances of 600m,

- At nightfall up to 300m.

- During the night against clearly seen targets,

- Against an enemy on the march at long range,

- Against especially dangerous targets, that are worth the effort (observation posts, snipers, officers, tank viewports, marksmen hidden in trees, on roofs or in caves).

6. Training

- 45 Training will be performed by an officer. Soldiers selected for sniper training should continue their training in the special disciplines and will adapt their weapons knowledge to the scoped rifle. Since an elite marksman should be able to hit small targets up to distances of 500m that are difficult to engage, he will shoot for the most part on a bipod, and in special cases supported or with the help of the sling. As training progresses, shooting will be done in situations more and more difficult, with perfect camouflage.

a) Supports

The fundamental rule for shooting, sitting and standing, is to put the left side of the body forward and in general support the body against a solid mass (tree, wall etc.).

The sling can be wrapped around the around to give the weapon greater stability.

In order to shoot more accurately, the bipod and other supports that permit the shooter to have a selection of good positions.

b) Choice of Position

When positioning the elite marksman, one must take into consideration the following factors:

- Space for two men (where possible)
- Free visual field, in the area of the rifle barrel, such that sight of the shooter will not be blocked by flying dust or branches.
- Camouflaged and covered position
- No position on the crest of a hill
- No position that can be easily engaged.
- Position changes that can be attained under cover.

c) Approaching and departing the shooting position.

Often, it will take much time to attain or leave a position during the day.

Taking position by day: slowly, under cover

Leaving a position: slowly, under cover.

Accessory Materials: Rope/cord (pioneer tool), camouflage materials

d) Map (target map), distance estimate.

-Mark the target by means of a map (target map)

-Estimate the distance, with or without a measuring device.

The map should be a simple, good representation of the target area.

e) Target reconnaissance.

Training that consists of reconnoitering targets up to distances of 500m is of extreme importance. To perform this training one must use the same field over which will be performed the target acquisition exercises. With more experience visualizing the target at different distances an experienced sniper can estimate different ranges very precisely.

(fig. 28)

Differentiation of hard to engage targets.

-Search and find target with binoculars.

-Shoulder the weapon and search with the scope

It is possible to increase the difficulty of the exercises with small or camouflaged targets.

This training can be done without live fire ammunition and in double action exercise.

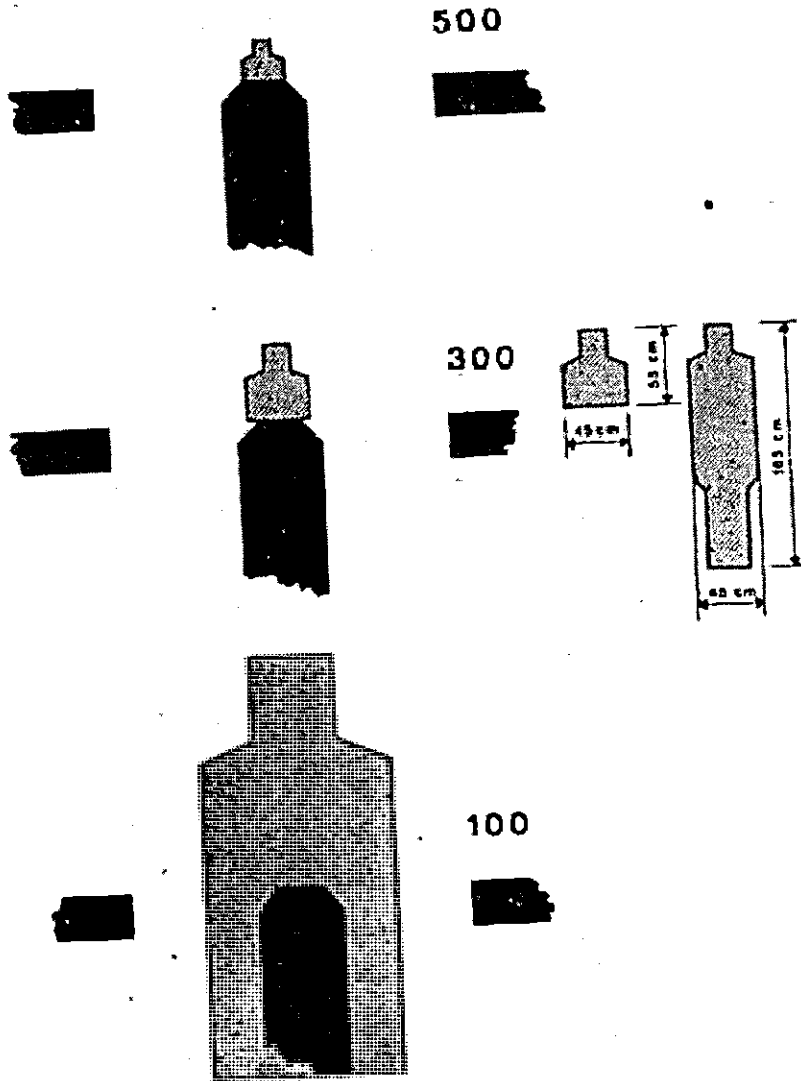

Fig.28
Method for gauging field targets at distances of 100, 300 and 500 m

The shooting program should contain the exercises mentioned the Chapter 8 and can be developed according the circumstances. Where it is not possible to shoot over an open field, camouflaged targets must be used. In this situation, only sight in on the center of the target. In normal situations, the choice of shooting positions should change; shooting in a sitting position should be practiced as well as other positions. When performing a more advanced training stage, the time for the exercise will be limited. Shooting at a 10-point target at 300m, after performing exercise numbers 1 and 2 will be the exception and not the rule. Most of the practice time and ammunition should be spent in sight adjustment training on field targets at unknown distances.

7. Safety

- 46 The same safety rules apply for the Mq. Lu. Model 55 as those for the Model 31 (Section 75 and regulation 51.30 " Safety procedures for combat exercises", sections 75-77)

8. Shooting Program for Scoped Rifles

Exercise	Distance	Target	# of Shots	Exercise Objective	Passing Score
1	300m	10 pt.	18	Allow shooter to become familiar with his weapon, to note the effects of changes in sight elevation and windage. Sight in before performing exercise #2.	-
2	300m	10 pt.	10	Exercise using a 'sighted in' weapon	90 points
3	300m	K	10	Target style K, not visible to the naked eye, placed before a corresponding background; after sighting in using the 10 pt. target	8 hits
4a	300m 500m	G	6 Shots Max	Sight adjustment in the field	-
4b	300m 500m	G	10	Hard to see target over an unknown distance after 'sighting in' per exercise 4a.	6 hits
5	200m	E	12	Moving Target	6 hits
6	100m 150m	E	12	Nightfall	6 hits
7	200m	G	12	At night. Target Style G, lighted, light is extinguished when the target falls.	6 hits

Part 2 Munitions

I. Overview

47 Ammunition for long rifle, musketoon (short rifle), Automatic rifle, and machine gun are delivered to troops ready to fire. They are all the same.

The **cartridge** is composed of the bullet (projectile), the propulsive charge, and the case.

The **bullet** is inserted into the neck of the case. In order to hold the bullet tightly and seal the interior of the case, the case neck is crimped into a circular groove near the base of the bullet. In addition, a grease ring at the neck crimping seals the cartridge.

The **propulsive charge** placed inside the case, is composed of stick powder, which produces very little smoke upon discharge (nitrocellulose).

The **case** is composed of brass. The sides of the case gradually thicken near the base. The **primer** is placed in a special pocket located in the base of the cartridge. When a shot is fired, the point of the firing pin strikes the center of the primer where the percussion material is placed. The percussion material then creates a spark that ignites the propulsive charge.

The manufacturing data for the cartridge is stamped onto the base of the cartridge around the primer. The letters and numbers indicate the following information:

Left Letter: Source of the case material

Right Letter: The initial of the munitions factory

Upper Number: Month of manufacture

Lower Number: Year of Manufacture

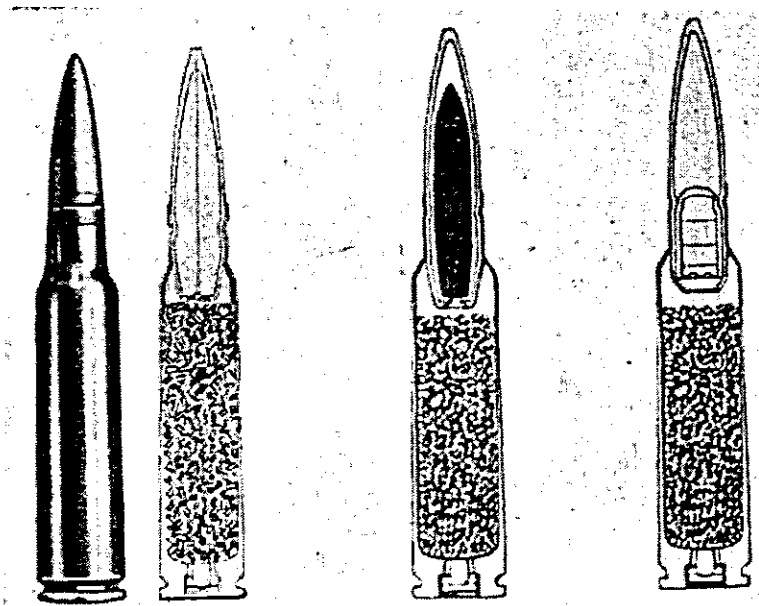

Common Rifle Cartridge 11

Armor Piercing Cartridge

Tracer Cartridge

Fig. 29 Ball Cartridges

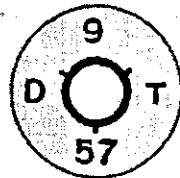
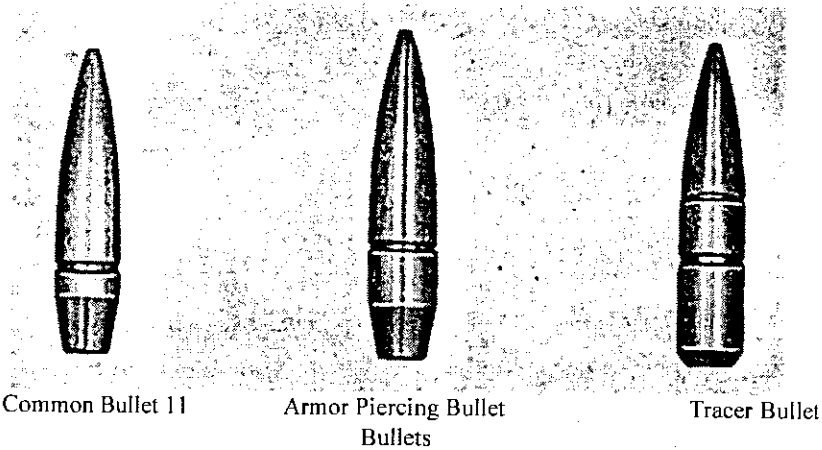

Common Cartridge
(No Color)

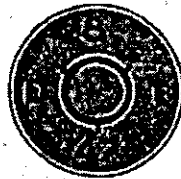

Armor Piercing Cartridge
(Purple)
Cartridge Bases

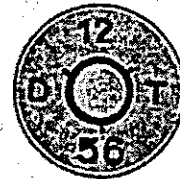

Tracer Cartridge
(Red)

Fig. 30

Cartridges that carry a special bullet have been painted a particular color on the base:
Armor Piercing Cartridge: Purple
Tracer Cartridge: Red

II. Common Ball Cartridge 11

(Fig. 29 and 30)

- 48 There are three types of ball ammunition:
-Common Rifle Cartridge 11, 7.5 mm caliber
-Armor Piercing Cartridge, 7.5 mm caliber
-Tracer Cartridge, 7.5 mm caliber

These are identifiable by the color of their respective bases.

All of these ball munitions can be fired from either the Short Rifle (musketoen), Long Rifle, the Automatic Rifle, and the Machine Gun.

Exception: One part of the ball ammunition (red label) has been designated as blue label ammunition for security reasons. These 'blue' munitions should not be fired by any weapon except a Machine Gun (see section 56, Packaging)

1. Rifle Cartridge 11

(Common)

- 49 The bullet has a tapered form, pointed in front with a truncated cone at the rear. The middle of the bullet is a cylinder that serves to guide the bullet on the inside of the barrel. The larger part of the bullet is composed of lead, that gives it a relatively heavy weight. This leaden center is covered with a steel jacket which makes the bullet more durable.

At 4000m the remaining bullet momentum is still sufficient to cause death.

Bullet Weight:	11.3 g
Powder Charge	3.2 g
Case Weight	<u>12.3 g</u>
Cartridge Weight	26.8 g

Exterior Characteristics: No color code on the base of the cartridge.

2. Armor Piercing Cartridge

- 50 The armor-piercing bullet is similar in shape to the common bullet. The cylindrical part is slightly longer. A specially hardened steel core and wrapped in lead is found inside the bullet. The armor piercing cartridge is used shoot lightly armored targets that it can perforate at short distances. The penetration power diminishes rapidly at longer ranges and if the bullet hits the armor at an angle.
Weight: Identical to the Common rifle cartridge 11
Color Code: Purple

3. Tracer Cartridge

- 51 The jacket covers a lead core and a cavity, located in the aft part of the bullet that contains a luminous chemical.
Upon discharge, the luminous material ignites. It will burn up to a distance of 800m. Due to the fact that the shape of the bullet is slightly different than that of the common bullet and it constantly loses mass due to the consumption of the luminous material during trajectory, the trajectory also is slightly different than that of the common bullet. However, this difference is so minimal that it is not necessary to make adjustments for distances less than 1000 m.
The tracer bullet allows observation of the trajectory while the tracer chemical is ignited. This bullet is used when quickly changing the direction of fire is required; for example, moving targets (aerial or ground). Ordinarily tracer bullets will be mixed with common bullets or armor piercing bullets.
The luminous chemical ignites upon discharge and leaves residue in the barrel; It is necessary, therefore, to clean the barrel with the wire mesh and cleaning cord, as quick as possible after shooting, while the barrel is still warm. If cleaning is not possible in the field, the barrel should at least be greased while warm.
Weight: Identical to the Common rifle cartridge 11
Color Code: Red

III. Blank Rifle Cartridge

(Fig. 31)

- 52 **The blank rifle cartridge** is used to simulate fire during combat exercises. The forward part is composed of a green plastic material that opens upon discharge. The discharged gas that is expelled from the muzzle is under high pressure and at short distances can cause burns. For this reason, a minimum safe distance of 30m is recommended.
Weight: 12.3g
Color Code: Forward part composed of green plastic.

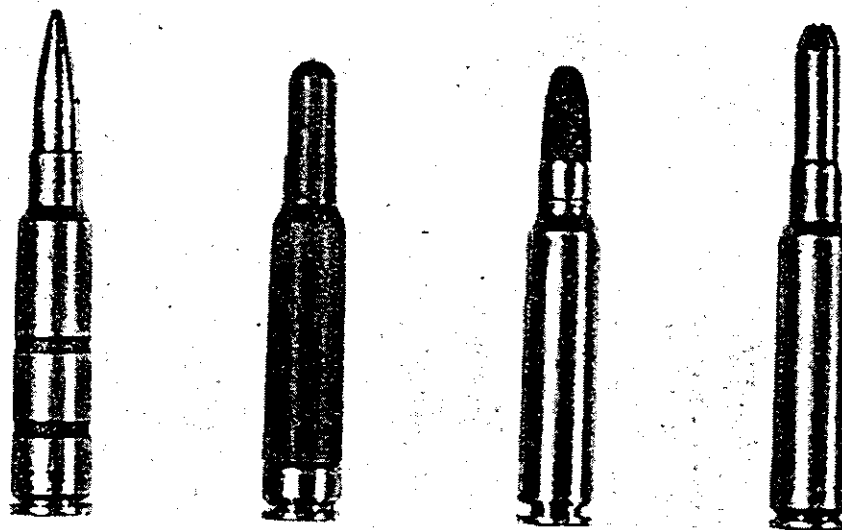

Fig. 31

Handling
Cartridge

Blank Rifle
Cartridge

Blank Automatic
Rifle Cartridge

Blank Machine Gun
Cartridge

- 53** Shooting blank cartridges labeled "Blank Automatic Rifle Cartridge" (with a green wooden bullet) and "Blank Machine Gun Cartridges" in a rifle is prohibited.
- 54** On the exterior the special cartridge for the Pz-WG. 44 and Ex-WG. 44 resembles the Blank Machine Gun cartridge. This cannot be used except with the short rifle for use as the propulsive charge for antitank grenade. To enable these cartridges to be distinguished from other ammunition, this cartridge is stamped (with white color); the rearward part of the case is striped. The magazine that holds these cartridges is stamped as well.

IV. Handling Cartridge

(Fig. 31)

- 55** The handling cartridge resembles in shape, the ball cartridge. It does not have a powder charge or primer. It can be handled without risk. These cartridges are used to practice loading and unloading, as well as to demonstrate bolt operation. To distinguish these cartridges, two black rings are machined into the case. Fabrication, by troops of handling cartridges from blank cartridges (such as machine gun blanks) is prohibited.

V. Packaging

- 56 The charger with 6 cartridges and the package of 10 cartridges are the smallest available Packages. Packaging Details:

Common Ball Cartridges:	Brown Chargers (for sport shooting while off duty: packages of 10 cartridges with a red label)
Armor Piercing Cartridges:	Purple Charger
Tracer Cartridge:	Packages of 10 cartridges without a label (previously labeled with a diagonal yellow stripe)
Blank Rifle Cartridges:	White Chargers with a small piece of wood on the forward section.
Handling Cartridges:	Red Chargers

10 chargers or 6 small packages (60 cartridges) are packaged together in a larger package; 8 of these packages of 60 are packaged together into a carton of 480 cartridges. This is the standard package for issue to troops. Damaged packages that are not per regulation are not issued. For field use, the cartons should be placed in boxes.

- 57 The packages, the cartons and boxes are labeled per the type and quantity of the enclosed munitions, as well as a stamp with the manufacture date. These labels will have a white heading; the colored part carries the number '11' (previously 1911).
 Red: Ball munitions
 Blue: Machine Gun Ammunition only
 Green: Blank munitions
 Details:
- | | |
|----------------------------|---|
| Common rifle cartridge 11: | No particular symbol |
| Armor Piercing munitions: | White triangle on a red (blue) field (previously a brown diagonal) |
| Tracer munitions: | White disc on a red (blue) field (previously a yellow diagonal) |
| Blank munitions: | Black writing (red writing = blank cartridge for machine gun 11 and 51 only). |

- 58 A perfect knowledge of the charger colors corresponding to different munitions and of the label colors, should eliminate confusion between ball and blank cartridges. For the same reason, the white chargers with blank munitions are supplied with a wooden block that only permits the entry of blank cartridges and excludes live ball cartridges into the same charger.
Using different color chargers or packages than that which corresponds to the appropriate ammunition is prohibited.

VI. Handling and Storage

- 59 Ammunition should be stored in regulation packaging, organized by ammunition type and date of manufacture. Unused, issued ammunition that are retired from troops and that will be restocked should be reassembled into chargers (tracer cartridges into cartons) and in cartons. Opened cartons should be kept and used as soon as possible, before using unopened cartons. Ball and blank ammunition should be stored separately. If they cannot be stored in separate storage areas they should be physically separated.

- 60 When choosing a storage location, an uninhabited and isolated place should be chosen, if possible. Good storage locations for munitions will be dry, easy to aerate and provided with a floor. Storing munitions on rock or dirt will damage the packaging. If the packaging becomes wet and impossible to transport in cartons, find a dry floor and ensure that there is sufficient aeration in the storage area.
- Stacking cartons more than 5 cartons high is prohibited. Between different stacks as well as the between the walls of the storage facility and the stacks the spacing should be such to ensure good aeration of the cartons.

Part 3 Rifle Handling

I. Loading, Reloading and Unloading (Fig. 34-37)

- 61 **Handling cartridges** instead of live ball or blank ammunition should be used to practice all different **handling movements**.
The shooter should be able to load and reload rapidly and without malfunctions in all shooting positions, on the march and in the dark.
The soldier need not be concerned about loading details that are not covered in the following sections:
- 62 **Loading:** is should be performed either in the prone or combat position:
- Grasp the weapon in the left hand next to the trigger guard (toward the center of gravity),
 - Right thumb placed on the left side of the cocking ring, the other fingers on the bolt handle on the cam follower,
 - Open the bolt by pushing with the right thumb,
 - Grasp the charger in the right hand and place it in the loading slot (fig. 34),
 - Insert the cartridges in two movements (fig. 35), press the cartridges downward with the base of the thumb, and then press the cartridges firmly down to the bottom, into the magazine with the tip of the thumb,
 - Grasp the charger in the right hand,
 - With the right hand firmly closed, close the bolt with **one, hard movement**.
 - Place the charger in the ammo pouch and close it with the right hand.
 - Rest the rifle alongside the body if not immediately shooting.
- To load standing, place the left foot slightly forward and angle the rifle slightly upward while resting it on the ammo pouch.
The load command is as follows: "Load" (Chargez)
- 63 **Reloading:** After each shot the shooter reloads of his own accord without order:
- With the rifle on the shoulder, grasp the handle on the cam follower in the right hand and pull quickly to the rear.
 - Close the bolt again with **one hard movement** forward.
 - Hold the rifle near the center of gravity; place index finger inside the trigger guard,
 - Lower the rifle if shooting is interrupted.
- If the bolt will not close because the magazine is empty, the shooter will reload using a **fresh charger** as follows:
- Lower the weapon
 - Place the charger into the loading slot,
 - Insert the cartridges per section 62.
 - Discard the empty charger,
 - Close the bolt per section 62,
 - Close the ammo pouch,
 - Per the situation: Shoot, observe, or secure the weapon
- 64 **Remove the cartridges** (the weapon has been secured)
- Rest the weapon at an upward angle, as if loading in a standing position,

81, 82, 83

- Place the left thumb over the loading slot (fig. 36)
- Open the bolt with the right hand, and push the exposed cartridge downward into the magazine with the right thumb.
- Remove the magazine with the right hand and lower the rifle, bolt open, and lean it against the body.
- Take the magazine and the empty charger in the left hand with the points of the cartridges toward the shooter,
- Transfer the cartridges from the magazine to the charger (fig. 37)
- Place the charger into the ammo pouch with the right hand and close the ammo pouch.
- Take the rifle vertically in the right hand, magazine in the left and insert it into the magazine slot, making sure that the magazine clip locks.
- Position the weapon in the "load standing" position; Check to make sure the chamber and the magazine are empty.
- Close the bolt and lower the weapon.

If cartridge removal is ordered, the following command is given: "Remove Cartridges"

The soldier puts the weapon to his shoulder with the bolt open, after inspecting the magazine. Once the inspection is complete, he will grasp the cam follower handle with the right hand, come to the "load standing" position, close the bolt and lower the weapon.

II. Shooter Position, Shouldering the Weapon and Weapon Discharge

(Fig. 38-47)

- 65 In order to make a good shot, the shooter should **take a shooting position** most suited to the terrain. The most used shooting positions are the prone and standing positions; over a slope or berm and in the sitting position. (Fig. 47)
- The kneeling position is used as a combat position with a support.
- If at all possible, the weapon should be supported if the terrain allows for it. (Fig. 42-47).
- In this case, the rifle should not come in contact with a hard object (rock, wood, etc.) The rifle should be supported as close as possible to the center of gravity. If the rifle cannot be supported, shoot free standing.
- Prone Position:** The prone position is slightly angled in relationship to direction of the shot. The soldier will fall to the ground on the left knee and left hand, rifle held in the right hand. In order to perform this movement noiselessly, the soldier may go down on the right hand instead of the left, and hold the rifle in the left hand. Be careful not to render the weapon inoperable by getting dirt in the barrel or damaging the sights.
- Standing Position:** Grasp the rifle in the left hand and put the left foot forward. Hold the rifle horizontally at waist height, in the direction of the shot, place the feet shoulder width apart.
- 66 After assuming shooting position, the shooter prepares the weapon in such a way that he can quickly and easily bring it to his shoulder:
- Put the weapon forward, with the right index finger in the cocking ring,
 - Place the weapon in fire mode,
 - Grasp the stock pistol grip firmly with the index finger placed inside the trigger guard.
- The rear sight is moved forward if necessary.
- Generally the shooter will perform these movements without command. If command should be required, the command is as follows: "Ready!" (Armed to shoot; lit.)
- Usually, the soldiers will safe the weapon without command. If command should be required, the command is as follows: "Safe your weapon!"
- Safe the weapon by turning the cocking ring,
 - Replace the rear sight slide.
 - Rest the weapon against the body.
- If the shooter stays in position, he will only perform the first movement. The weapon will be safed prior any additional movement; however, the weapon will not be safed during a change in shooting position or while firing in combat.
- 67 To shoulder and fire the weapon, the shooter looks at the target, raises the rifle to shoulder height, and points the rifle at the target. The weapon is supported in the left hand.

83 (cont), 84

While bringing the weapon to the shoulder, the shooter will calmly inhale and exhale, set the rear sight in one click, hold his breath, sight and pull the trigger with the index finger until the weapon discharges.

After firing, the shooter will stay for a moment in the same position, assess the shot (during training, the shot execution is announced out loud after firing) and observe, if possible, the effect on the target. He then will reload per section 63.

- 68 In the prone position, the body is at a slight angle in relationship to the direction of the shot, the two elbows are supported (Fig. 38). In the standing position, the left arm supports the weapon close to the center of gravity, the elbow is free or supported against the body; the right arm is nearly horizontal (Fig. 39 & 40)
- 69 Generally, standing shots are taken at fleeing and approaching targets. For a quick shot, precise sighting is barely possible. To shoot closing moving targets, one may also shoot from the hip; the shooter points the weapon towards the target, judges the distance and shoots without bringing the weapon to shoulder (Fig. 41).
- 70 At distances in excess of 300m, it is necessary to aim at the bottom of the target; less than 300m, aim at the center or just at the bottom (See Appendix II, tables 4 and 5).

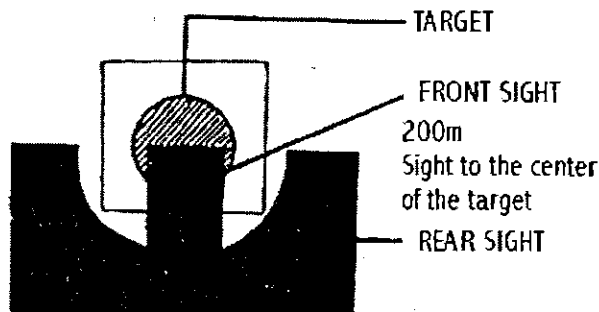
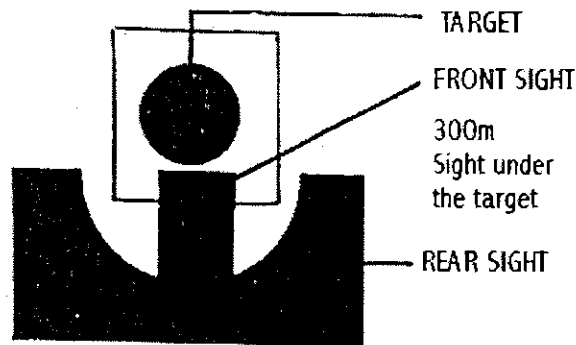

Figs. 32 & 33

85, 86, 87, 88

Every rifle has its own aim point, that can vary depending on the eye of the shooter, the resolution of the target as well as other factors. If the distance off target is small, the shooter will adjust the aim point by himself to adjust for the distance by observing where the shots hit the target. Otherwise, if the shot distance off target is large, then the front sight should be moved or changed.

A poor shooter will commit the error of firing at the instant where their line of sight is the same as the aim point. This is a very tense method of aiming, in general and the shot is "pulled". While sighting a slight displacement of the rifle is unavoidable; therefore if the shooter correctly lets the shot fly more relaxed, in the same moment his line of sight does not exactly align to the aim point, the shot is more likely to arrive on target. The aim point is therefore, a small "aiming zone".

III. Conduct of Fire

71 Most of the time, rifle shooting is a "fire at will" exercise conducted under minimal direction. The Group Commander will, in general, indicate where the target, or the target area is. The shooter will then choose by himself where he will shoot and at what distance.

The shooter will then ready his weapon under cover where possible, so that he can open fire, once in position. He will halt fire once the mission objective has been completed or the engaged enemy retreats. It is not logical to move to different cover after each shot because such movements will attract too much attention from enemy fire. Due to this it is better to stay calmly in one position.

72 If the soldier can see the effect of his shots, he will adjust shot placement by himself by changing the aim point and by changing the sight elevation. If the firing exercise is directed, elevation corrections can be ordered. For example: "Elevation plus Two!"

Corrections in windage are called off in meters. For example: "Left, three meters!"

73 To order a cease fire the command is: "Halt!"

The shooter ceases firing and remains at alert to the orders of the commander. At the order of: "Safe" the shooter pulls the rear sight slide all the way to the rear and safes his weapon.

If the command for cease fire and safe is not given, the shooter safes his weapon before leaving his position.

IV. Use of the Bayonet

74 For combat at very short distances (assault, night, fog and in open terrain), it may be necessary to place the bayonet onto the barrel in order to use the rifle as a shock weapon. Fix the bayonet to the rifle with the left hand and check with your hand that it is locked into place.

Placement into the scabbard is performed as well with the left hand. The respective commands are as follows: "Fix Bayonet!" and "Retire Bayonet!"

V. Safety Rules

75 The following rules should be well known to all shooters in order to avoid accidents:

1. Every weapon should be considered loaded unless the shooter has personally determined that the magazine and chamber are empty.

All cartridges should be removed prior each disassembly and prior to aiming exercises.

2. Pointing a rifle at someone in jest is not permitted. The rifle is not a toy.

3. No person should carry live and blank ammunition at the same time.

4. Before shooting exercises, with ball, blank, or propulsive ammunition, the barrel should be inspected and if necessary, cleaned.

5. During peacetime, a loaded rifle cannot be placed in firing position unless the rifle is pointed toward a target. Before leaving the shooting position, it should be safed again. The shooter must not move with a loaded, cocked weapon.

6. Upon completion of shooting exercises, all cartridges should be removed. Excess ammunition should be gathered and troops made aware of orders concerning munitions.

7. When shooting in a shooting stand, the weapon should not be loaded except while in the stand, and all cartridges should be removed prior to leaving the stand.

8. While shooting ball ammunition in combat, shooting toward or over friendly troops is not permitted except in the following conditions:

88 (cont)

-When shooting toward or over friendly troops, the friendly troops should not be more than 100m from the weapon and in all cases at a shorter distance than that of the target.

-When shooting over friendly troops, the trajectory should pass 5m or more over the troops so the same are not found at a "dead angle".

-When shooting toward friendly troops the line of the shot should pass beyond two fist widths (measured with the shooters arm extended), to the left or to the right of the closest soldiers.

9. Shooting with blank cartridges is prohibited at distances of less than 30m.

Appendix I

Training Figures



Fig. 34

Loading: Inserting the Charger



Fog. 35

Loading: Inserting the Charger



Fig.36
Removing cartridges: Opening the Bolt



Fig. 37
Removing cartridges: Replacing the cartridges in the charger

94.95

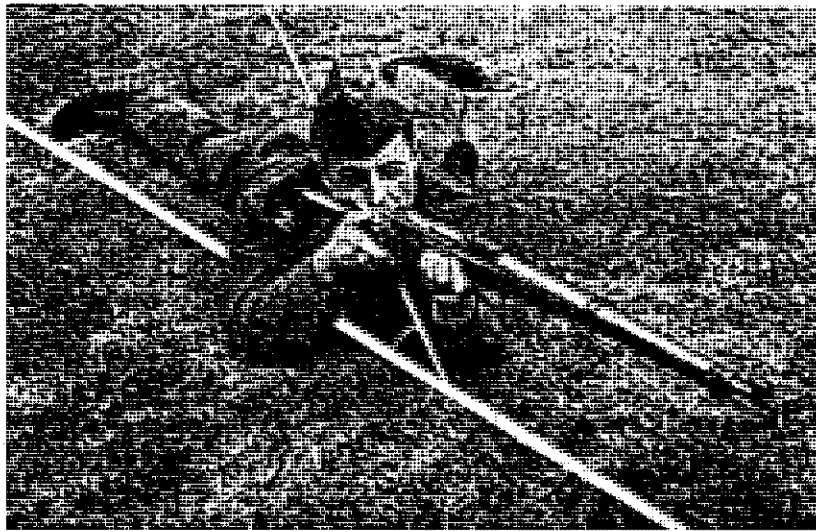

Fig. 34
Prone Position



Fig. 35
Standing Position: Rapid fire



Fig. 40
Standing Position with body support



Fig. 41
Rapid Fire from the hip while marching



Fig. 42
Prone Position with support



Fig. 43
Combat position on a slope with the elbow on a shovel



Fig. 44
Example of a kneeling position



Fig. 45
Standing position behind a tree



Fig. 46
Shooting position in a tree

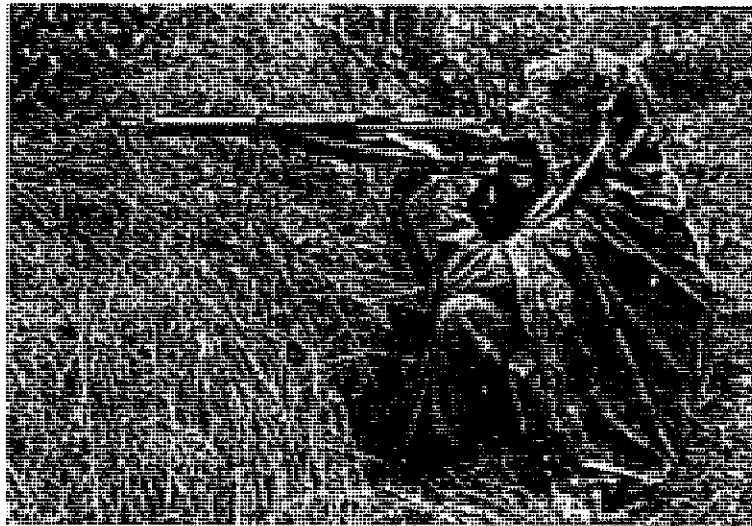

Fig. 47 String Position

Appendix II

Tables

Table 1

Trajectory Danger Zones in meters

(Aim point = Target center)

Elevation	Target Height in m					
	Target head .33m K		Target Knee 1.00m F		Standing Target 1.65m E	
	Danger Zone					
	From to	Is	From to	Is	From to	Is
300	250-340	90	0-400	400	0-440	440
500	480-520	40	415-555	140	345-585	240
1000	993-1007	14	980-1020	40	965-1035	70

Table 2

Weapon Shot Spread

Shot spread for the Mod. 31 in cm

Rifle fixed to sighting apparatus

Distance (meters)	Spread in width DI 50%	Spread in Elevation DH 50%
100	1	2
200	3	4
300	4	6
400	6	9
500	8	12
600	11	16
800	15	27
1000	21	43

Table 4

Sighting Errors

Displacement in meters, from impact point caused by sighting errors; shooting distance 300m Mod. 31

Front sight very thin, barely visible	0.37
Front sight off center touching the exterior edge of the rear sight slot	0.37
Rifle angled transversely at 10 deg (shot displacement downward)	0.31

106, 107

Table 5

Aim Point

Weapon	Shot Distance	Elevation Setting	Aim point lower than the shot
Mod. 11	100m	300	30 cm
	200m	300	40 cm
	300m	300	30 cm
Mod. 31	100m	100	0 cm (full height)
	200m	200	10 cm (full height)
	300m	300	30 cm

Table 6

Sight Margin (windage correction)







Values in meters, sight margin for perpendicularly moved targets in the shot direction

Approximate Distance	100m	200m	500m	1000m
Man walking	0.3	0.7	1.2	3
Man running	0.4	1.0	1.5	4
Horse walking	0.3	0.7	1.2	3
Horse trotting	0.6	1.5	2.5	5.5
Horse at gallop	0.8	2.0	3.0	8
Cyclist	1.1	2.5	4.0	10
Motor vehicles (30 km.h)	-	4.0	6.0	-

Table 7

Penetration: average with Common cartridge 11

Distance	5 m	300m	600m	1200m
Pine Wood	60	50	40	35
Sand	30	40	40	30
Earth	60	70	60	50
Packed snow	120	130	130	110
Sheet Metal	1	0.5	-	-

Distance	Type of target	Perpendicular Movement in the direction of the shot	Sight Margin in cm	Target Image at time of discharge magnified 2X
50m	Man	Walking	0	
50m	Man	Running	0	
100m	Man	Walking	20-30	
100 m	Man	Running	35-40	
200 m	Man	Walking	40-50	
200 m	Man	Running	80-90	

Appendix III
Order of the Federal Military Department
 Concerning
Ammunition
 (10 April 1951)

1. The following are considered munitions
 - Ball and blank cartridges of all types and calibers
 - Live and practice hand grenades
 - Explosives and means of lighting of all types
 - Bombs, projectiles and fuses, as well as propellants and loads of all types and calibers.
 - Cartridges, smoke grenades, firecrackers, and toxic chemicals
 - All pyrotechnic lighting and signaling materials
2.
 - a) At entry to service, after each exercise and at decommissioning, all weapons must be unloaded. The commanders and officer in charge are responsible for inspection of these weapons.
 - b) While on active duty, officers non commissioned officers, and soldiers are not authorized to carry ammunition on their person, unless authorized by their superiors, or unless a general order allows them to do so. Section 2 letter C is the exception.
 - c) Officer and non-commissioned officers than are issued pistols will receive with their weapon 24, 7.65mm pistol cartridges, or 16, 9mm cartridges (pocket ammunition) They will enter service with this ammunition and will return it upon discharge. Officers and non-commissioned officers will carry the pistol unloaded, but will have at hand a charger filled with ball cartridges;
 - d) In all branches of military service (schools and courses) there will be a strict inspection of issued munitions.
Munitions not expended, will be returned after each exercise.
 - e) Soldiers may not carry ball and blank cartridges at the same time.
 - f) Ball and blank cartridges are to be stored separately.
 - g) Except for by special order, carrying or retaining upon discharge, service ammunition, is not allowed.
 - h) Issue pocket munitions for portable firearms will not be used except for a specific purpose or for service purposes.
3.
 - a) Any person is found to possess munitions in violation of this regulation, will be found in violation of service duties per article 72 of the Military Penal Code of the 13th of June 1927 and can be imprisoned by order of a military tribunal.
 - b) Any found using munitions abusively, stealing or abandoning them, or damaging or intentionally misplacing by negligence, or to benefit financially from the sale of stolen munitions, or renders munitions unusable, can be punished to imprisonment or discharge by a military tribunal. Abuse of material (art. 73 MPC), theft (art. 129), abuse of trust (art. 131) or property damage (art. 135).
4. Upon enlistment to service, after each exercise and upon discharge, this order will be communicated to each soldier.
It will be posted in each detachment and canton, at shooting ranges and in ammunition storage facilities.
5. Other instructions concerning explosive munitions lighting methods and flamethrower oil*) are the exceptions to this rule.
6. This order is valid as of 15 April 1951.
It replaced at this date the service order dated 9 October 1956 (FOM 46/190)

Federal Military Department: KOBELT

*) see also regulation 63.4 "Instructions for munitions in schools and courses"

Appendix IV

Instructions for avoiding Small Arms Damage

Avoid Weapon Damage!

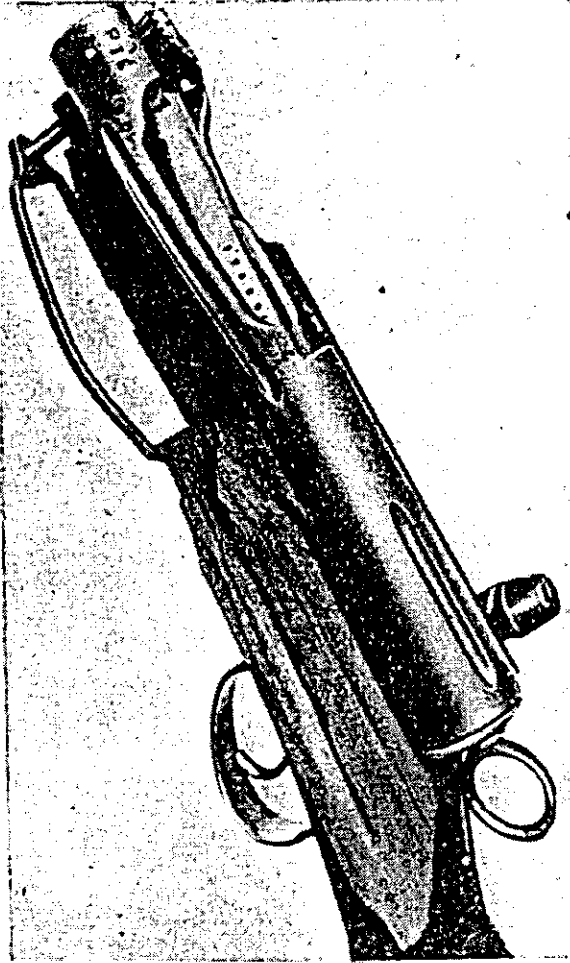

Shooting foreign ammunitions or non-issued ordnance with your weapon can destroy it

112, 113

1. How do you avoid barrel bulging?

- Never plug the barrel of your rifle with cleaning patches or grease.
- Ensure no dirt or snow gets in your barrel, especially while not in combat exercises.
- Never attempt to clear a barrel blockage with another discharge of ball or blank ammunition.
- Before each shot, make sure the barrel of your weapon is clear.

Remember That:

Shooting with a plugged barrel will cause the barrel to bulge.

If a barrel bulge is to occur, the barrel will be changed **at your cost**.

Be careful not to block the barrel of your rifle!



With Dirt

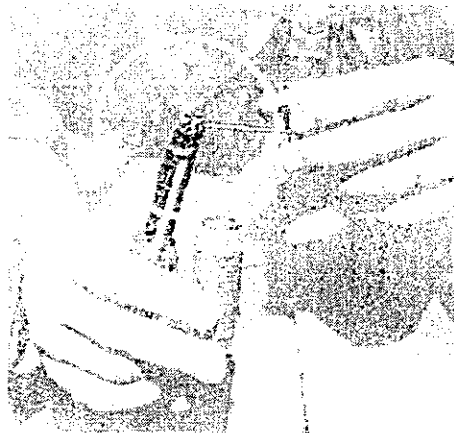

With grease

Shooting with a blocked barrel will cause a barrel bulge

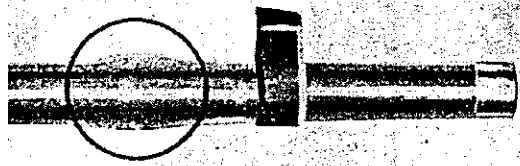

Bulged Barrel

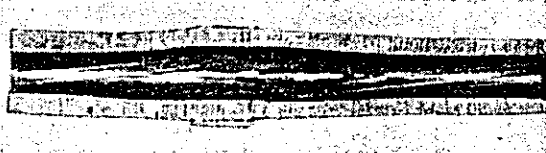

Fractured Bulge



Blocked, exploded barrel

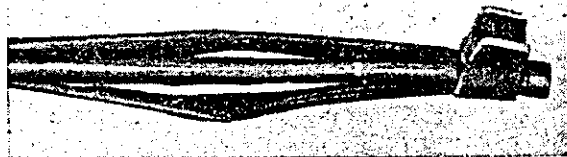

Exploded Barrel

Before each shooting session, check to ensure the weapon is not blocked!



Barrel Inspection

Before each shooting session, especially under combat conditions, make sure that the weapon is not blocked. By performing this inspection, you will avoid a barrel bulge, in other words, unnecessary expense to the State and to yourself.

A barrel bulge is caused by a abnormal increase in pressure inside the barrel, specifically, if the barrel is blocked in near the muzzle by grease, dirt, snow, water, or whatever foreign object. A piece of cleaning rod, or cord in the barrel can cause an explosion while shooting.

The barrel must be replaced if it is bulged

WISS WAPPENFABRIK
 FASSBREMSE FÜR DIE WISS WAPPENFABRIK
 WISSEN IST DIE KRAFT DER ZUKUNFT

Rechnung
 Faktura

Am 22. November 1932

Bestell-Nr. 21021

Bestell-Nr. 21021

Bestell-Nr. 21021

Bezeichnung	Menge	Preis	Summe
Reparatur des Gewehrs Nr. 55493, vom Kaufdatum 1928/29			
Reparatur des Gewehrs	1	16,50	16,50
Reparatur des Gewehrs	1	5,00	5,00
Reparatur des Gewehrs	1	25,75	25,75
Reparatur des Gewehrs	1	22,50	22,50
Reparatur des Gewehrs	1	16,75	16,75
Reparatur des Gewehrs	1	1,70	1,70
Summe			88,20

Bestell-Nr. 21021

Bestell-Nr. 21021

Bestell-Nr. 21021

2. Take care of your weapon!

Manage your weapon to ensure wise treatment and proper handling.

- If you shoot when the handle is not all the way forward, you run the risk of breaking the cam follower pin.
- Incorrectly disassembling the magazine will break the spring.
- The extractor should not be disassembled unless necessary. If this is required, do it correctly.
- Entrust the adjustment of the sear to a gunsmith, who has been trained in this repair.
- Avoid breaking or damaging the butt of your rifle by subjecting it to rough treatment.

Take care of your parts!

Incorrect

Correct

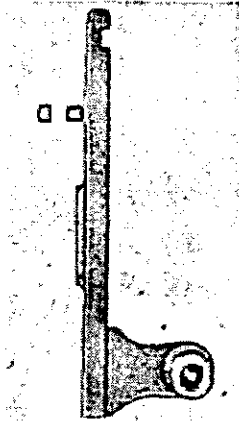

Broken Cam
follower pin

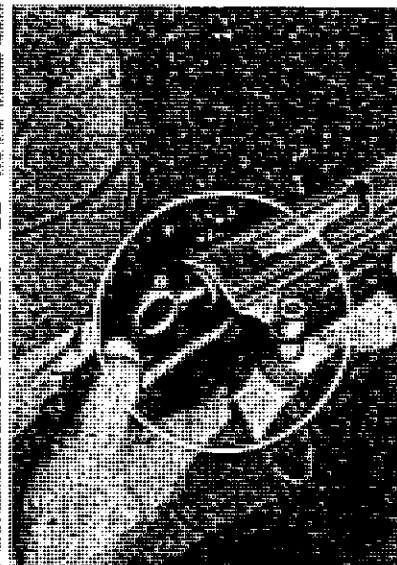
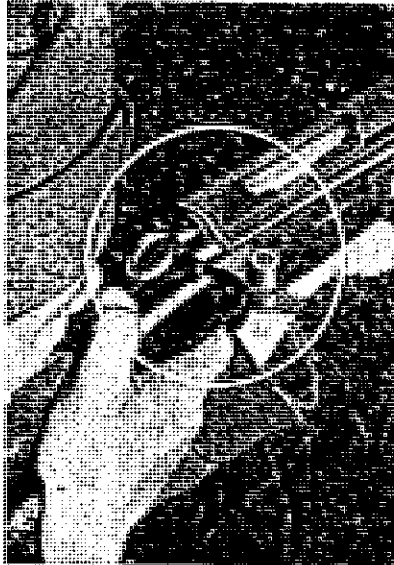

If you shoot when the handle is not all the way forward, you run the risk of breaking the cam follower pin

Magazine Disassembly

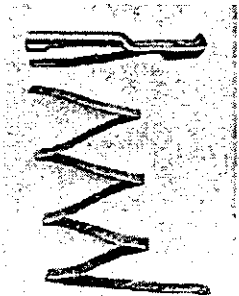

Broken Magazine
Spring

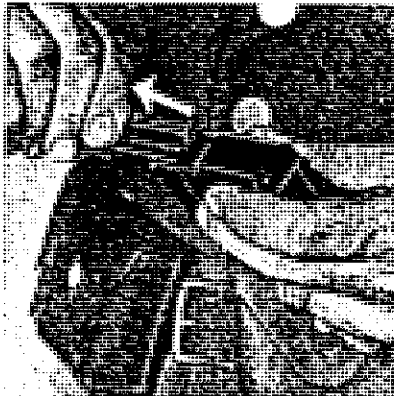

If you pull the magazine plate
out like this it will break the spring

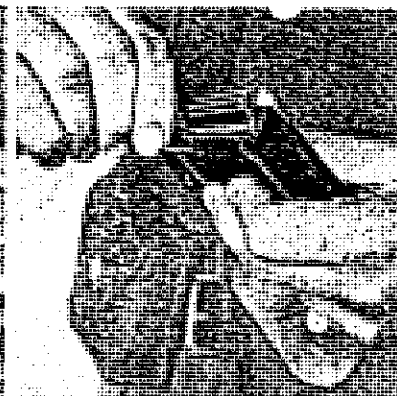

Block the plate and turn it out



Losing a Magazine!

Loss of a magazine due to poor placement in the weapon.



When inserting a magazine into your weapon, check to make sure it is locked into place. This way you will avoid losing it.

Removing the extractor

The extractor should only be removed when necessary

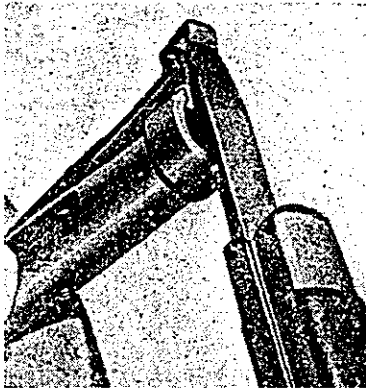

WRONG!

You will deform the extractor removing it in this fashion.

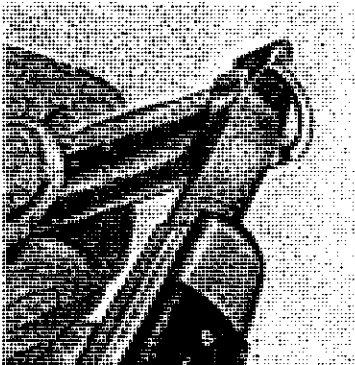

Correct!

Lift lightly to remove.

Sear adjustment

Troops in the field are prohibited from adjusting or tampering with the rifle sear. Only gunsmiths may adjust the sear of a rifle. Forcing or grinding the sears damages your weapon and runs the risk of causing an accident.

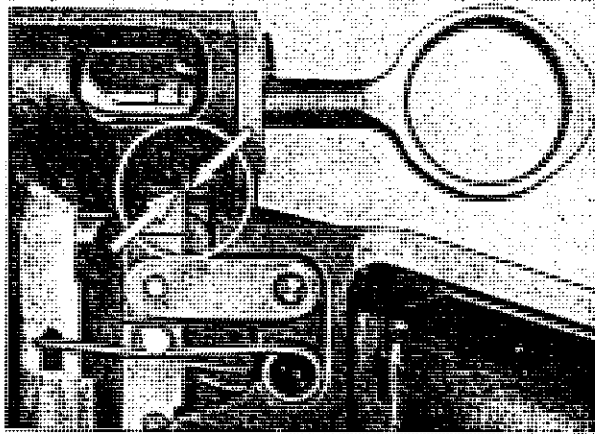

Rounded Sear

You will damage in this fashion, the parts of your weapon, parts that will need to be replaced.

Avoid damaging your rifle stock

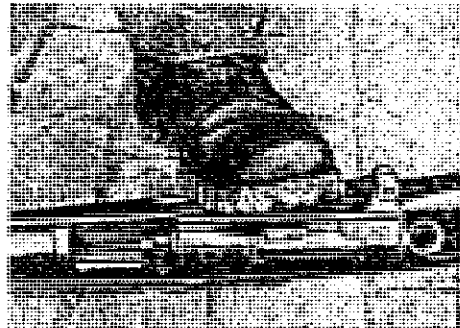

The butt is not a sledgehammer.

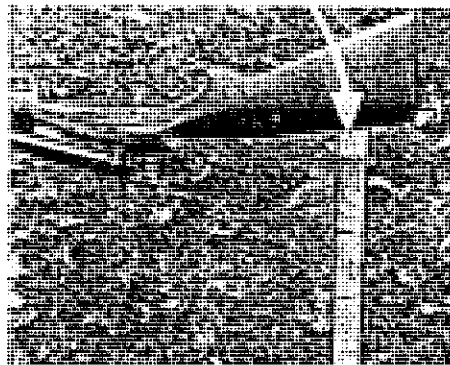

Broken stock butts are caused by using the rifle butt to pound in stakes, to carry or lift heavy objects, to avoid obstacles, or while loading weapons onto a vehicle. Take care of your weapon.

124, 125

**Stock disassembly for the Mod. 11
Removing the hand guard**

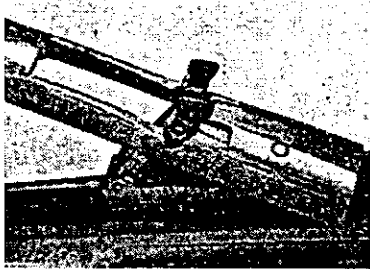

WRONG

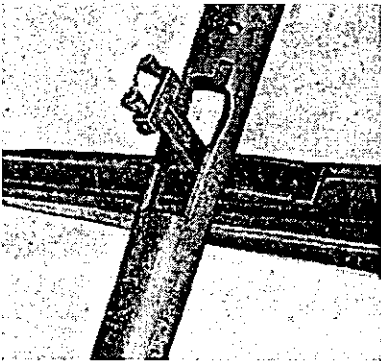

Correct

Do not forget to raise the sight leaf vertically and remove the hand guard by turning it perpendicular to the barrel.

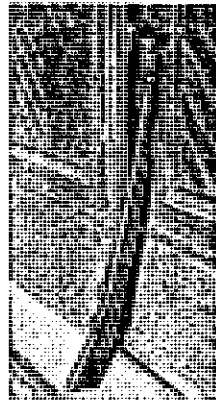
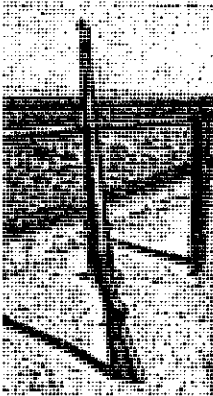

It is not prudent to lean your weapon against a wall, a fence or a door. If it falls it will be damaged.

You will damage your comrade's weapons by carrying them this way.

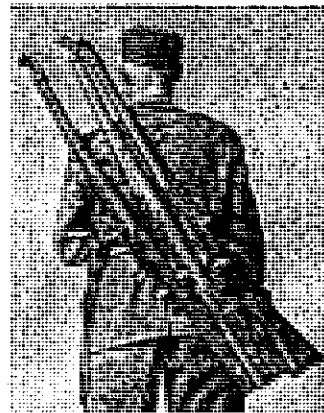

3. Cleaning and greasing the barrel

-Take care of the barrel of your rifle and avoid oxidation by proper cleaning and greasing.

-After each shooting session, immediately grease the barrel with the help of a cleaning rod and brush. (The barrel should still be warm.)

-As soon as you return to base, clean the barrel by means of a cleaning cord. Pay attention to pull the wire mesh through in the correct way. The wire mesh should be well greased. Inspect for cleanliness and regrease the barrel.

-Steel wool, emery cloth, or acids are the worst enemy of the rifle bore.

-Avoid ovalizing the muzzle of your barrel. The cleaning cord should be pulled straight down the barrel axis.

-To clean the barrel, use a good wire mesh that will create a slight resistance to pull inside the barrel. It is only necessary to pass the cord 3 or 4 times through the barrel.



These are a barrel's worst enemies
(emery, steel wool, acid)

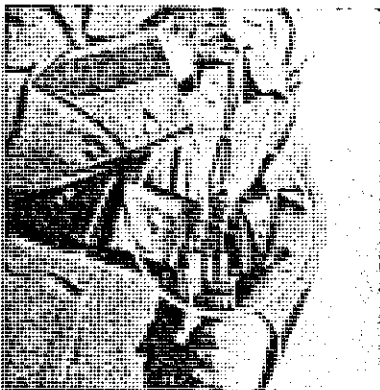

Steel wool will scratch the inside of the barrel.

Take care of your cleaning cord!

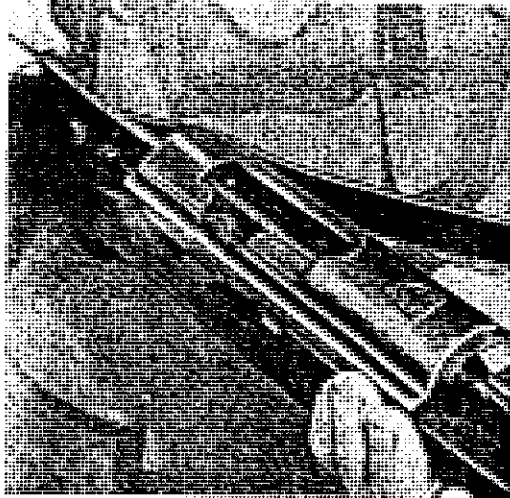

WRONG!

Without the locking sleeve, the cord will snag on the ejector as it passes

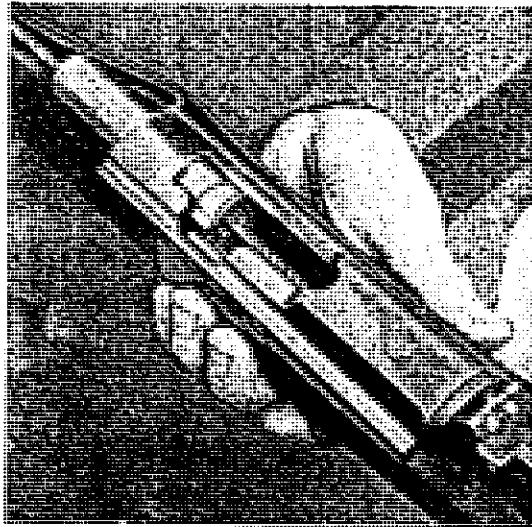

Correct!

Insert the locking sleeve

Ovalization of the muzzle

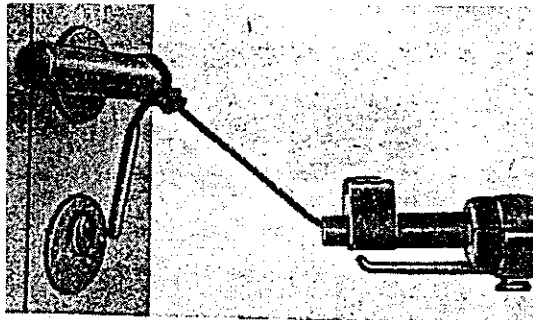

Using this cleaning method will ovalize the muzzle of your barrel. A barrel with an ovalized muzzle, loses its accuracy. Ensure the cleaning cord is always pulled down the axis of the barrel.

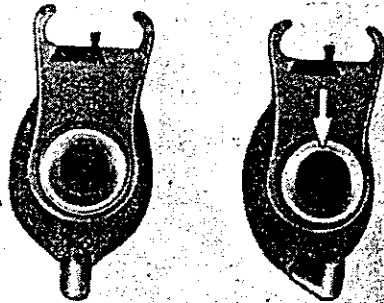

Normal Muzzle

Ovalized Muzzle

Avoid scratching the inside of your barrel!

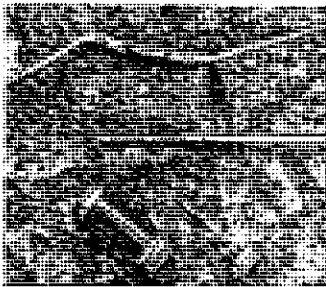

Sand will scratch the interior of the barrel.

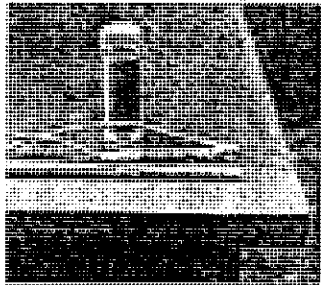

Keep grease and cleaning articles clean

Before inserting the cleaning rod into the barrel, clean the rod with a clean cloth.

4. Shooting with a reducer tube

If you fired the weapon with a reducer tube, Please note the following points:

- Upon completion of shooting, remove the reducer tube from the weapon.
- Thoroughly clean the barrel and the chamber. Remove all powder residue or lead.
- A deep cleaning of the chamber is very important. While shooting with a reducer tube, an amount of residue will be deposited in the chamber. If cleaning is neglected, there is a risk of malfunction (jammed case).

Reducer tube for Mod. 31

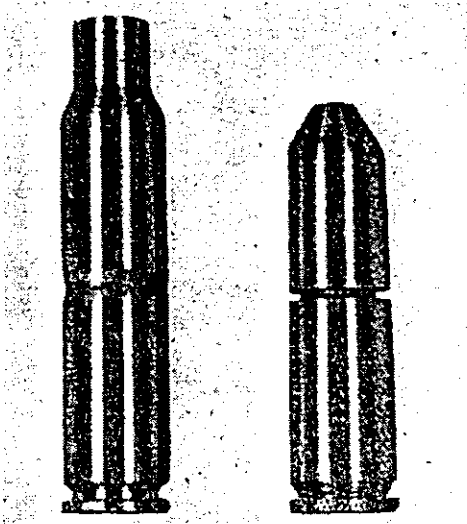
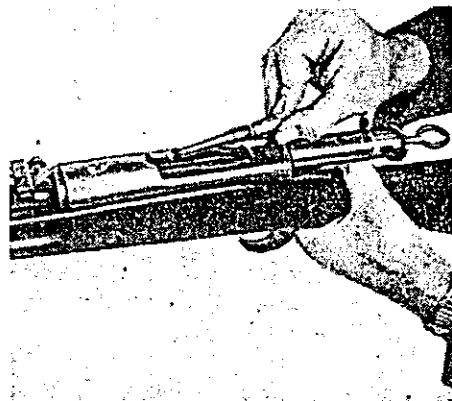

Deformed case.

While shooting with a reducer tube, a hardened ring of powder residue is formed in the chamber, that will cause while shooting normal cartridges, case deformation and jamming.

5. Using the Muzzle Cover

-Protect the rifle barrel with a muzzle cover.

-Aside from issued muzzle covers, other cover are authorized for use, such as celluloid, bakelite or other soft material or metal, providing they fulfill the following conditions:

1. Weight not greater than 1.3g
2. Held to the barrel by slots that provide space so the barrel is not hermitically sealed.
3. Will not cause the barrel to be sealed by grease or a patch. (risk of barrel bulge)

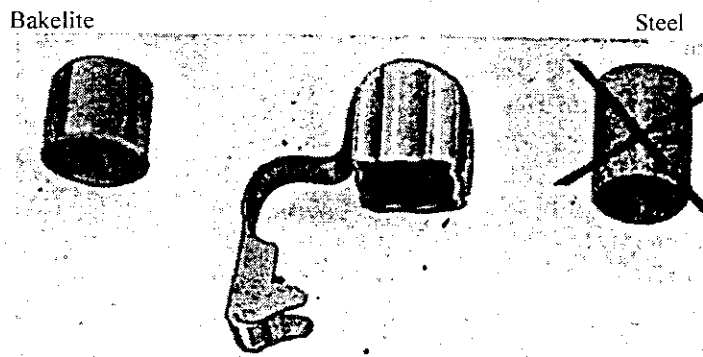

6. Sighting in the weapon

The impact point of your weapon is good, if when aiming at the 6 o'clock position, the shots hit the center of the target.

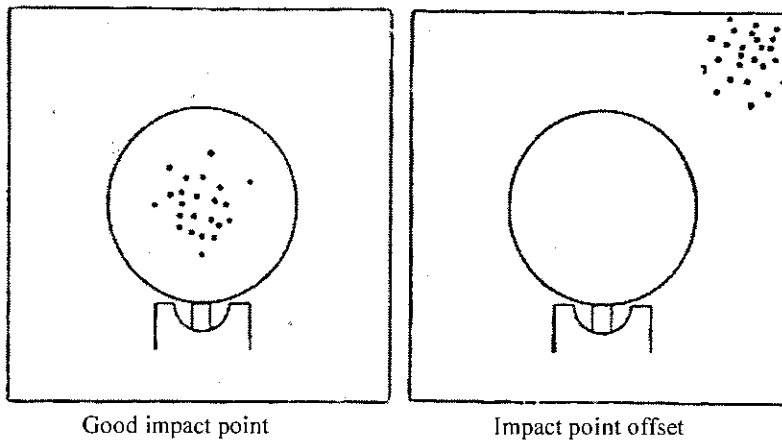

Weapons where the impact point is offset should be sighted in.

Sighting in is a gunsmith's job

The gunsmith has in his equipment, several types of front sights that will allow him to adjust the elevation of the impact point. The windage adjustment is accomplished by moving the front sight.

If moving the front sight will not change the impact point, for example while shooting during off-duty. Refer to the cantonal arsenal that is closest to your domicile.

Proper reassembly and proper screw pressures on your weapon are essential for weapon accuracy.

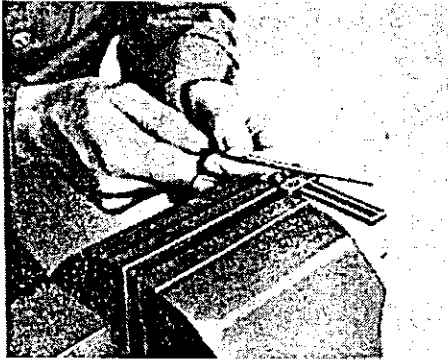

Modifications to the elevation adjustment and front sight are prohibited.

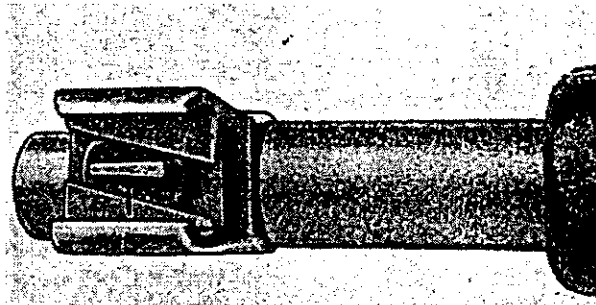

After sight adjustment, the gunsmith will mark the front sight.

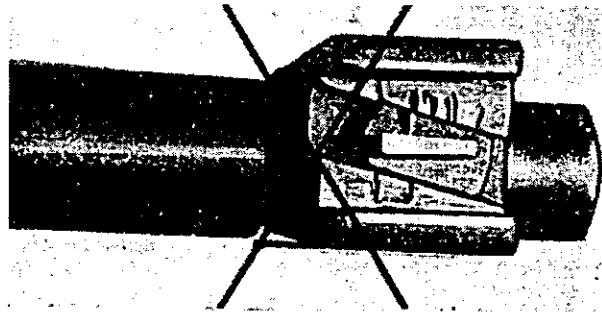

A front sight housing marked in this fashion is unusable and should be changed.

This Manual Was Provided To You By:



**CENTURY
INTERNATIONAL
ARMS INC.**

www.centuryarms.com