

KHANSHOTGUNS



OWNER'S MANUAL FOR 20 GAUGE OVER & UNDER SHOTGUN

KHANSHOTGUNS

1

Thank you for choosing KHANSHOTGUNS 20 Gauge over & under shotgun

Your over & under shotgun represents a piece of rich history
of quality firearms design and manufacture.

During the manufacturing process, we have endeavored to incorporate the
very finest in material, craftsmanship
and, with a reasonable amount of care, your gun will provide many years of
pleasure and dependable service.

Thank You
Khanshotguns

Safety Warnings

Regardless of your familiarity or experience with firearms, don't assume that you have no need to study this manual.

The safe handling of firearms requires specialized training, discipline and caution. Firearms, by their nature and intended function, are deadly instruments. Accidental death or serious injury can result if they are handled improperly or carelessly.

A person with a gun in his possession has a full-time responsibility. He must **KNOW** how to keep and use his firearm safely, and then must always **TAKE** the necessary precautions. He cannot guess; he cannot forget. This responsibility is his alone. It cannot be passed off to someone else.

Remember: no gun can be made accident-proof. A gun is just a machine, with no judgement of its own. It responds to your actions, whether wise or foolish. The only truly effective safety device is the mind of a cautious shooter who never forgets that a moment's carelessness can produce permanent tragedy.

Commandments of Firearm Safety

A good hunter is a safe hunter. He knows there is no place for horseplay in hunting. He learns and obeys the commandments of firearms safety and insists that his companions know and follow them too. Every hunter-whether novice or experienced outdoorsman should review these commandments before each hunting season to be sure that his gun handling, both at home and in the field, sets a good example for others.

1. Don't rely on your gun's safety. Tread every gun as if it were loaded and ready to fire. Install gunlock when not in use.
2. Don't shoot unless absolutely sure of your target and what is beyond it.
3. Always be sure the barrel is clear of obstructions.
4. Never point your gun at anything you do not want to shoot. Watch your muzzle so the other person doesn't have to.
5. Never leave your gun unattended unless you unload it first.
6. Avoid alcoholic beverages both before and during shooting.
7. Never carry a loaded gun when you climb a tree, cross a fence, jump a ditch or go through areas where you are apt to slip or trip.
8. Never shoot at a hard, flat surface or the surface of water. Make sure you have a safe backstop.

KHANSHOTGUNS

4

9. Carry only empty guns, taken down or with the action open, into your camp, car or home.
10. Store locked guns and ammunition separately, beyond the reach of children.
11. Never insert a shell of the incorrect gauge in any shotgun and use shell of correct length

IMPORTANT - Our shotguns are designed, manufactured and proof-tested for use with fresh factory loaded ammunition. Improperly loaded shells are dangerous.

Khanshotguns does not assume responsibility for damages or injury caused by reload or improperly loaded ammunition. This shotgun should not be used with broken, missing or altered parts.

WARRANTY

"This product is under manufacturer's warranty which covers defects in materials and / or workmanship for one full year after date of original new gun retail purchase."

KHANSHOTGUNS

5

GENERAL SPECIFICATIONS OF 20 GAUGE OVER & UNDER SHOTGUN

MODEL	20 GAUGE ARTHEMIS MODEL
GAUGE	20
BARREL LENGTH	71cm-28"
RECEIVER	ALUMINIUM
CHAMBER	3"
CHOKE	CHOKE TUBES
STOCK	TURKISH WALNUT
FORE-END	TURKISH WALNUT
TOP RIB	8mm
ENGRAVING	STANDARD
TRIGGER TYPE	SINGLE TRIGGER

NOMENCLATURE

The parts nomenclature are shown in the Fig 01.

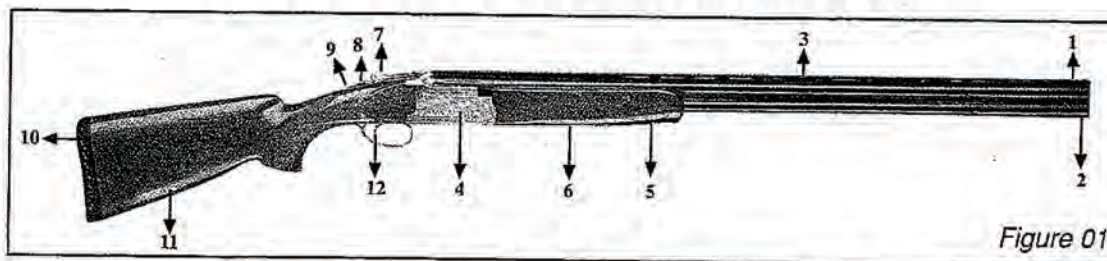

Figure 01

KHANSHOTGUNS

6

- | | | | |
|-----------------|-------------|--------------------|--------------|
| 1. Over Barrel | 4. Receiver | 7. Top Lever | 10. Butt Pad |
| 2. Under Barrel | 5. Fore-End | 8. Barrel Selector | 11. Stock |
| 3. Top Rib | 6. Latch | 9. Safety Button | 12. Trigger |

Operating of the safety

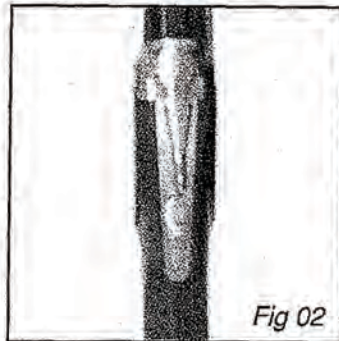

Safety Off

Both barrels fire when the switch is in the middle position

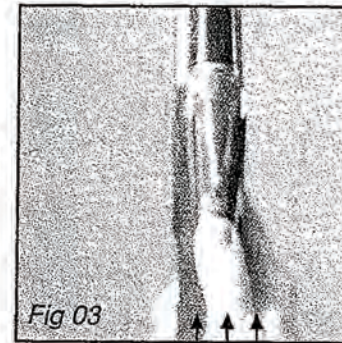

Safety On

Both barrels are put on safe by drawing the selector rearward. In this position "S" sign will appear directly in front of the selector. The above applies whether the selector is set of "O" or "U" to fire first (See figure 02 and 03).

ASSEMBLY

Before starting to the assembly take the forend section of your shotgun out of the barrel by pulling the latch downward. (See Fig 04 and Fig 05)

Be sure that you moved the top lever to the extreme right position; and release it. The fitting portions have to be free from dirt or burrs. You can apply a coat of preventative lubricant to all metal surfaces. Take the barrel in your left hand and hold the receiver with your right hand; with the appropriate angle slide the barrel into the receiver. (See Fig 06)

Be sure that the pins on the extractor fit into the grooves. Close the action completely. Place the forend back into its right position by applying pressure and be sure that the latch is completely locked. (See Fig 07)

Your shotgun is now assembled...

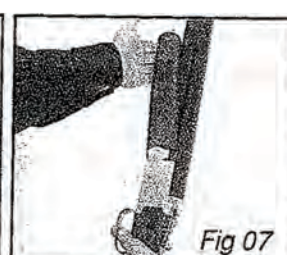
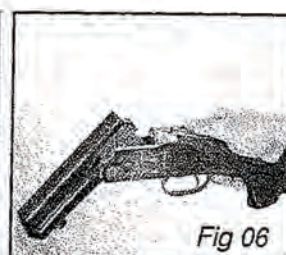
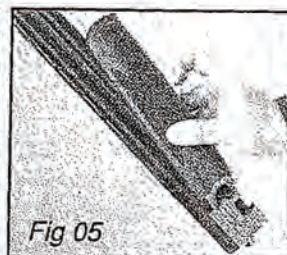

KHANSHOTGUNS

8

LOADING / FIRING / EXTRACTING THE EMPTY SHELL

When you load your shotgun, the muzzle should be pointed in a safe direction. Take the barrel with your left hand and with the thumb of the right hand move the top lever to the extreme right position. Move the barrel downward with the left hand until it cannot be moved. When the chamber is opened take the safety button to the safe position. Check the barrels that they are not obstructed. Put the shells in to the chambers until the extractor catches the rims.

With your right hand hold the stock and grasp the barrel with your left hand. Swing the barrel upward and close the gun. Aim at the target push the safety button to the front and pull the trigger. With the barrel selector on the safety button you can choose the barrel that you desire to fire first. When the selector is set is on "O" (Over Barrel) or "U" (Under Barrel) is fired first. For extracting the empty shell, move the top lever to the right, swing the barrel to the loading position. The empty shells will be ejected by the extactor, you can take the empty shells out with your fingers.

DISASSEMBLY

Before starting to disassemble be sure that your gun is unloaded, the safety button is on safe position and the muzzle is pointed in a safe direction. Move the latch downward to take the forend out of the barrel. Take the top lever to the extreme right and swing the barrel down. The extractor has to be fully forward. When pulling the barrel upward with your left hand press the stock downward with your right hand; until you release the barrel from the receiver continue to pull and press with your hands simultaneously. But pay attention not to damage your shotgun, which was produced with very tight tolerances, when you disassemble or assemble it.

HOW TO CARE FOR YOUR SHOTGUN

Your shotgun is a mechanical device and requires periodic maintenance and inspection after usage or storage to make its service life longer. Protect your shotgun with good gun care product. To assure trouble free performance open periodically the action and push a patch, moistened with a good solvent through the barrel. Push a brass brush soaked in solvent through the entire length of the bore using long even strokes. Push clean patches through the bore in the same manner until the last patch comes out unsoiled. Then push a lightly oiled patch through the entire length of the bore. Brush or blow any residue from action area. Also with a brush and solvent, clean the breech face and extractor. Wipe dry all metal parts and oil lightly. Between hunting seasons apply a coat of oil to the bore and metal parts and store it in a dry place away from dust. Your shotgun should be checked periodically by a competent gunsmith to insure proper operation and replacement of any worn or damaged parts.

KHANSHOTGUNS

10

PLEASE DO NOT FORGET THAT YOU ARE RESPONSIBLE FOR SHOTGUN SAFETY. CARELESS HANDLING OF ANY FIREARM MEANS POTENTIAL DANGER....

IT IS YOUR RESPONSIBILITY TO TAKE PROPER CARE OF YOUR SHOTGUN. WE CAN NOT BE RESPONSIBLE FOR ANY DAMAGE TO THE FINISH OR MECHANISM DUE TO LACK OF CARE AND MAINTENANCE.

PLEASE READ AND UNDERSTAND ALL OF THE CAUTIONS, PROPER HANDLING PROCEDURES AND INSTRUCTIONS OUTLINED IN THIS BOOKLET BEFORE USING YOUR NEW FIREARM.

THIS MANUEL PRIMARILY DISCUSSES THE 20 GAUGE OVER&UNDER SHOTGUN BUT THE ASSEMBLY, DISASSEMBLY AND GENERAL OPERATIONAL INSTRUCTIONS CAN ALSO BE APPLIED TO 12 GAUGE AND 410 GAUGE OVER&UNDER MODELS.

KHANSHOTGUNS

GENERAL ASSEMBLY

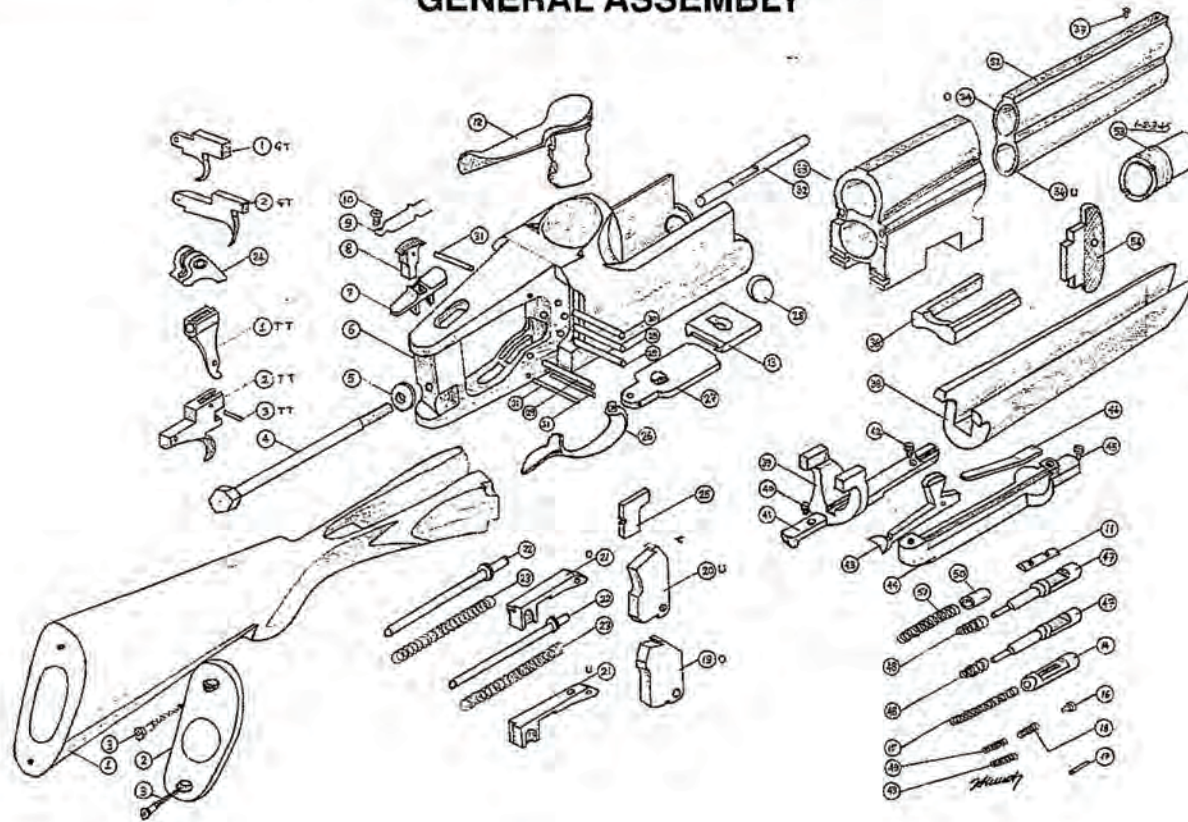

KHANSHOTGUNS

12

GENERAL PART LISTING

- | | | |
|---------------------------------|-------------------------------------|-----------------------------|
| 1. Stock | 28. Receiver Screw | Double Trigger |
| 2. Stock Plate | 29. Pin | |
| 3. Stock Plate Screw | 30. Pin | 1. Right Trigger |
| 4. Stock Screw | 31. Pin | 2. Left Trigger |
| 5. Stock Nut | 32. Cock | |
| 6. Receiver | 33. Monoblock | Single Trigger |
| 7. Safety Button | 34. Over Barrel | |
| 8. Barrel Selector | 35. Under Barrel | 1. Trigger Propulsive Block |
| 9. Safety Spring | 36. Extractor | 2. Single Trigger |
| 10. Safety Spring Screw | 37. Front Sight | 3. Trigger Pin |
| 11. Safety Pin | 38. Walnut Forend | |
| 12. Top Lever | 39. Forend Steel Base | |
| 13. Blocker Plate | 40. Forend Bolt Screw | |
| 14. Top Lever Tube | 41. Forend Bolt | |
| 15. Top Lever Tube Spring | 42. Forend Screw | |
| 16. Top Lever Automatic Pin | 43. Latch | |
| 17. Top Lever Propulsive Pin | 44. Latch Frame | |
| 18. Top Lever Propulsive Spring | 45. Forend Locking Screw | |
| 19. Right Hammer | 46. Forend Lock Spring | |
| 20. Left Hammer | 47. Pin | |
| 21. Left-Right Inner Trigger | 48. Pin Spring | |
| 22. Hammer Spring Pin | 49. Left-Right Inner Trigger Spring | |
| 23. Hammer Spring | 50. Selector Tube | |
| 24. Cocking Lever | 51. Selector Tube Spring | |
| 25. Retaining Plate | 52. Rib | |
| 26. Trigger Guard | 53. Mobile Choke | |
| 27. Receiver Under Cover | 54. Mobile Choke Key | |

This Manual Was Provided To You By:



**CENTURY
INTERNATIONAL
ARMS INC.**

www.centuryarms.com