

 **WARNING: BEFORE USING THIS FIREARM,
READ AND FOLLOW THESE INSTRUCTIONS.**

If there is anything you do not understand,
get help from someone qualified in the safe handling of firearms.



For all
BUSHMASTER
XM15 Models

OPERATING AND SAFETY INSTRUCTION MANUAL

A1 & A2 Sight Systems
All Rifles & Carbines
including V Match

PLEASE PRACTICE SAFE FIREARMS HANDLING!

This instructional manual should always accompany your Bushmaster firearm.

 **WARNING: IF THIS FIREARM IS CARELESSLY OR IMPROPERLY HANDLED, UNINTENTIONAL DISCHARGE COULD RESULT AND COULD CAUSE INJURY, DEATH, OR DAMAGE TO PROPERTY.**

 **CAUTION: CAREFULLY READ THIS INSTRUCTION MANUAL PRIOR TO LOADING AND FIRING THIS FIREARM. FOLLOW ALL INSTRUCTIONS ON THE PROPER HANDLING AND SAFE USE OF THIS FIREARM - LIVES MAY DEPEND ON IT!** If unfamiliar with firearms, seek further advice through safe handling courses run by your local gun clubs, NRA approved instructor, or similar qualified organizations.

 **CAUTION: USE ONLY CLEAN, DRY, HIGH QUALITY COMMERCIALY MANUFACTURED AMMUNITION IN GOOD CONDITION** which is appropriate to the .223 Rem. caliber of your firearm. We do not recommend the use of remanufactured or hand loaded ammunition because it may damage your rifle. Use of improper ammunition will invalidate your warranty.

 **WARNING: THIS WEAPON COULD CHAMBER A ROUND** if it is dropped or jarred with a loaded magazine in place - either with the Bolt Carrier Assembly locked to the rear, or in its forward position.

PLEASE PRACTICE SAFE FIREARMS HANDLING!

FUNDAMENTAL RULES FOR SAFE GUN HANDLING

ALWAYS KEEP THE GUN POINTED IN A SAFE DIRECTION.

NEVER LOAD THE GUN UNTIL READY TO USE.

KEEP YOUR FINGER OFF THE TRIGGER UNTIL READY TO SHOOT.



WARNING: BEWARE OF DANGEROUS PROCEDURES

- Be sure cam pin is installed in the bolt group. If it isn't, your rifle can still fire and **will explode**.
- If you are using a **blank firing attachment, never fire anything except blank rounds** (for safety, we recommend the visible military style blank firing attachment).
- If your rifle stops firing with a live round in the chamber of a hot barrel (a misfire), **remove the round fast**. However, if you cannot remove it within 10 seconds, remove magazine and wait 15 minutes **with the rifle pointing in a safe direction**. This way you won't get hurt by a possible round "cooking-off" (i.e. the round detonating just from the heat of the barrel). In any event, keep your face away from the ejection port while clearing a hot chamber.
- If your bolt fails to unlock, and you try to free it by banging the buttstock on the ground, **keep yourself clear of the muzzle**.
- If there's water in the barrel, do not fire the rifle. **It could explode**.
- If a noticeable difference in sound or recoil is experienced, **STOP FIRING**. Either condition could indicate an incomplete powder burn and/or a bullet stuck in the bore.

ALWAYS PRACTICE SAFE FIREARMS HANDLING!

1

FACTS ABOUT YOUR BUSHMASTER XM15 E2S RIFLE...

The Bushmaster XM15 E2S rifle system consists of a rifle, a magazine, and a sling. It is a lightweight, gas operated, air-cooled, magazine-fed, shoulder-fired weapon that can be fired in a semi-automatic mode - i.e., a single shot each time the trigger is pulled.

- The upper receiver and barrel assembly has a fully adjustable rear sight.
- The upper and lower receivers are easily opened for cleaning and inspection.
- The bolt group and barrel extension are designed with locking lugs that lock the bolt group to the barrel extension.
- The forged aluminum upper and lower receivers reduce the weight of the rifle.
- The bore and chamber are chrome plated for long life and ease of maintenance.
- Caliber: .223 Remington / 5.56 mm
- Weight: (depends upon model) 20" Bbl. Rifle = 8.27 lbs. / 3.75 kg
- Length: (depends upon model) 20" Bbl. Rifle = 38.25" / 97cm
- Barrel Rifling: R.H. twist; 1 in 9"; 6 lands & grooves
- Firing characteristics: muzzle velocity approx. 3,260 fps; chamber pressure 52,000 psi
- Maximum effective rate of fire: 45 rounds per min. / semi-automatic
- Max effective range: 550 meters (individual/point targets) / 800 meters (area targets)
- Maximum range: 3534 meters

2

TABLE OF CONTENTS

Rifle Parts and Where To Find Them.....	4	Preventative Maintenance Checks.....	29
Clearing Your Rifle.....	6	Safety Function Checks.....	30
Disassembling Your Rifle.....	8	Adjustable Front Sight Post.....	32
Cleaning / Inspection / Lubrication.....	13	Dual Aperture Rear Sight.....	32
Detailed Cleaning Techniques.....	14	Zeroing Your Sights.....	33
Cleaning the Upper Receiver.....	15	Zeroing Adjustments.....	34
Cleaning the Lower Receiver.....	16	25 Meter Zeroing Procedure.....	34
Cleaning the Ejector.....	17	A1 Sights - Differences / Adjustments.....	36
Inspection before Lubrication.....	18	Operation of Your Rifle / Loading.....	38
Lubrication / Upper Receiver.....	19	Operation / Inserting a Magazine.....	39
Lubrication / Lower Receiver.....	19	Operation / Chambering a Round.....	40
Lubrication / Bolt Carrier Group.....	20	Immediate Action in Case of Trouble.....	42
Lubrication / Adjustable Rear Sight.....	21	Remedial Action.....	44
Reassembly.....	22	Bullet Stuck in the Bore.....	45
Magazine Disassembly / Reassembly.....	28	Troubleshooting.....	46
		Parts Illustration.....	54
		Limited Warranty.....	55



WARNING: BEFORE USING THIS FIREARM, READ AND FOLLOW THESE INSTRUCTIONS. If there is anything you do not understand, get help from someone qualified in the safe handling of firearms.

RIFLE PARTS AND WHERE TO FIND THEM (Right Side)...

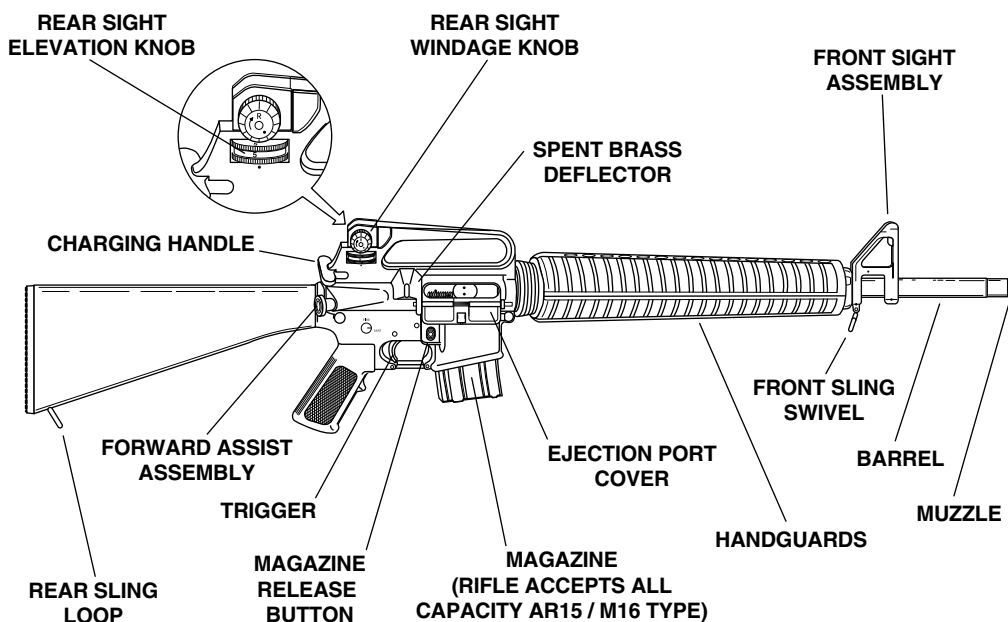

RIFLE PARTS AND WHERE TO FIND THEM (Left Side)...

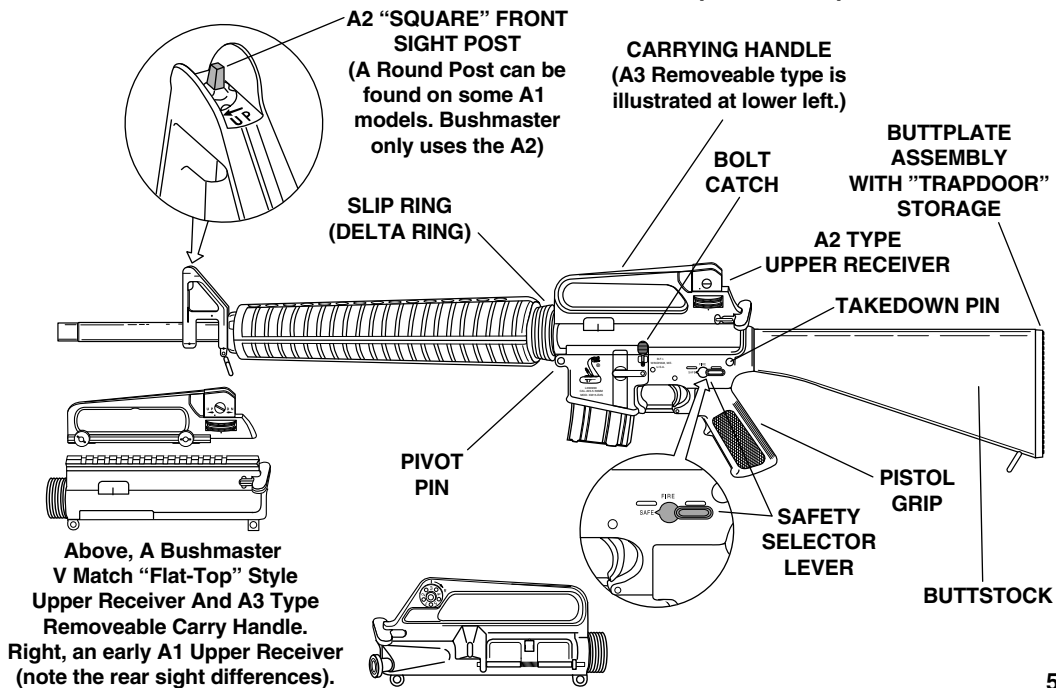

5

CLEARING YOUR RIFLE...

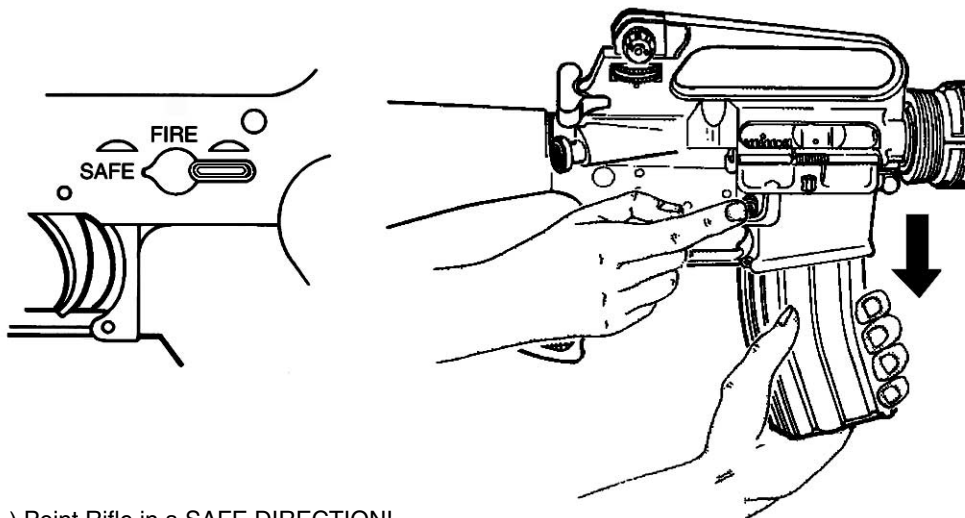

- 1.) Point Rifle in a SAFE DIRECTION!
Place Safety Selector Lever on SAFE.
(If the rifle is not cocked, the Selector Lever cannot be pointed toward SAFE.)

- 2.) Press Magazine Catch Button and pull Magazine down to remove.

6

CLEARING YOUR RIFLE (continued)...

- 3.) To Lock Bolt Open, Pull Charging Handle rearward. Press bottom of Bolt Catch and allow Bolt to move forward until it engages Bolt Catch. Return Charging Handle to forward. If you haven't before, place Safety Selector Lever on SAFE.

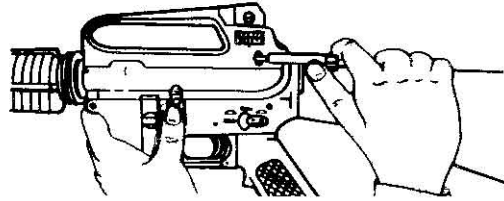

- 4.) Check Receiver and Chamber to ensure there is no ammunition in the rifle.

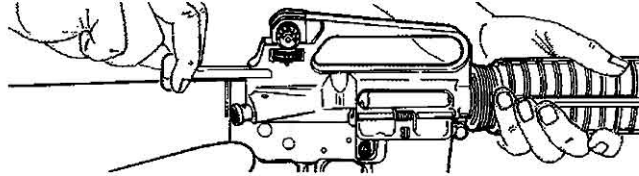

- 5.) With Selector Lever pointing toward SAFE, allow Bolt to go forward by pressing upper portion of Bolt Catch.

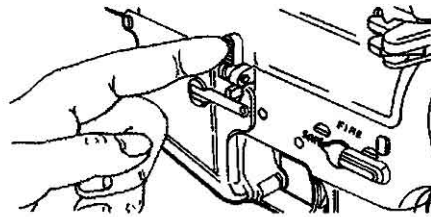

7

DISASSEMBLING YOUR RIFLE...

- 1.) Clear your Rifle and disconnect the Sling.

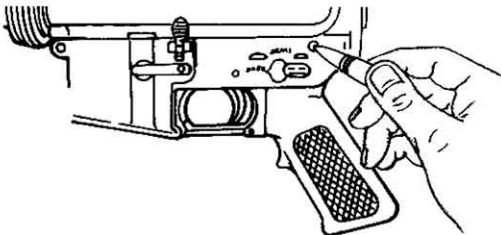

- 2.) Push in Takedown Pin as far as it will go. Pivot Upper Receiver away from Lower.

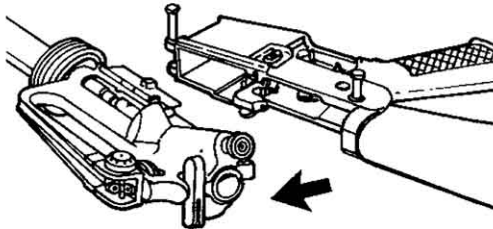

- 4.) Separate Upper and Lower Receivers.

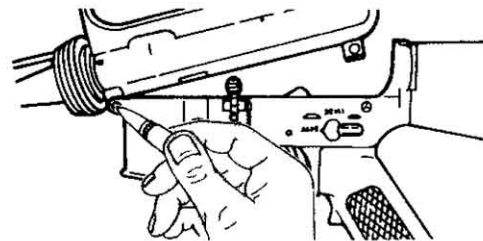

- 3.) Push in Front Pivot Pin.

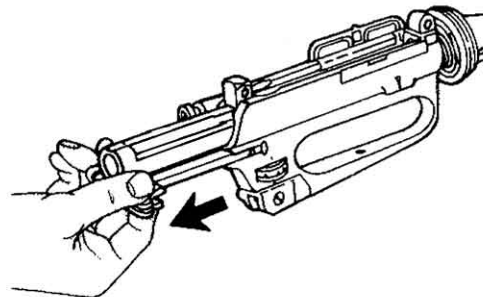

- 5.) Pull back Charging Handle and Bolt Carrier

8

DISASSEMBLING YOUR RIFLE (continued)...

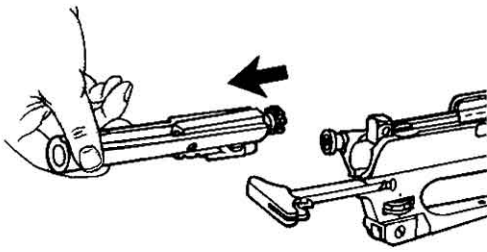

6.) Remove Bolt Carrier and Bolt

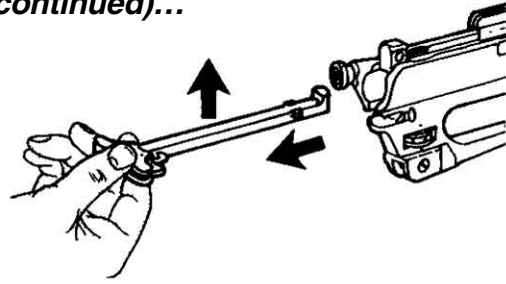

7.) Remove Charging Handle by pulling back and up

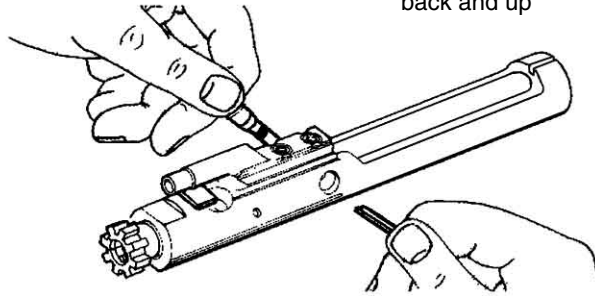

8.) Remove Firing Pin Retaining Pin.

DO NOT OPEN
OR CLOSE
SPLIT END
OF PIN

9

DISASSEMBLING YOUR RIFLE (continued)...

9.) Push Bolt in to locked position.

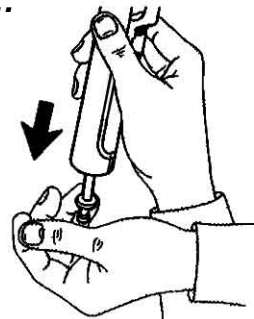
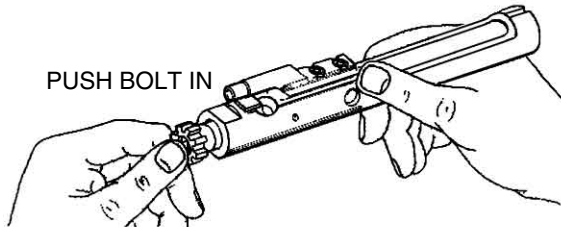

10.) Drop Firing Pin out rear of Bolt Carrier.

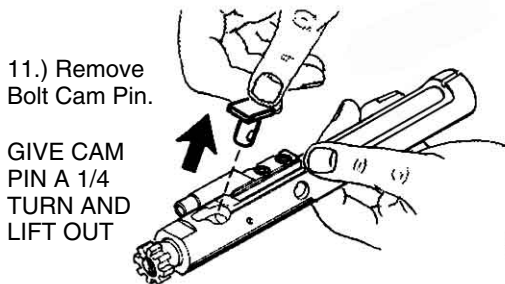

11.) Remove Bolt Cam Pin.

GIVE CAM
PIN A 1/4
TURN AND
LIFT OUT

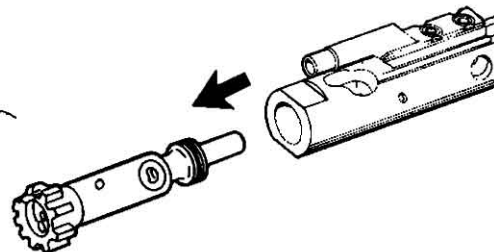

12.) Remove Bolt Assembly from Carrier.

10

DISASSEMBLING YOUR RIFLE (continued)...

DISASSEMBLE USING STEPS 13 THRU 16 ONLY WHEN DIRTY OR DAMAGED

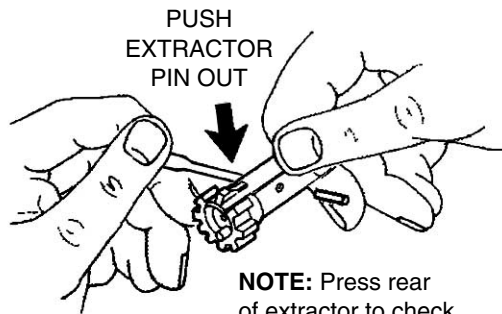

NOTE: Press rear of extractor to check spring function.

- 13.) Remove Extractor Pin by pushing out with a punch or the tip of a bullet.

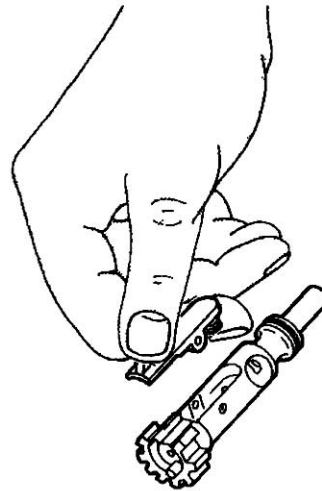

- 14.) Remove Extractor and Spring.
CAUTION: Extractor Spring may pop out and get lost!

11

DISASSEMBLING YOUR RIFLE (continued)...

- 15.) Press in Buffer, depress Retainer, and release Buffer.

- 16.) Remove Buffer and Action Spring.

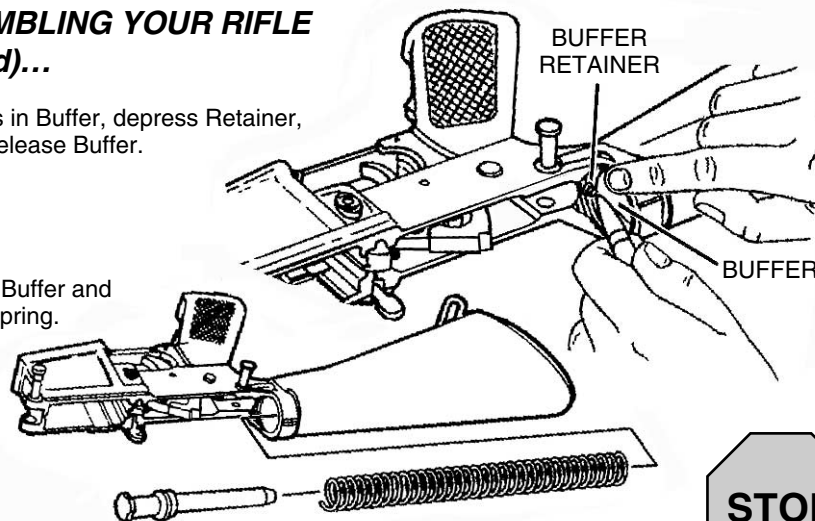

The **Handguards** may be disassembled at any point in your cleaning procedures as necessary (see Pg. 27 - "Buddy System" instructions).

If your Rifle is equipped with the **A3 Type Removeable Carry Handle**, that may be removed for cleaning by loosening the 2 thumbnuts. Clean as per instructions for aluminum Upper and Lower Receivers (see Pg. 16). Lightly lubricate the thumbnut threads and the Rear Sight mechanism (as described on Pg. 21 - Lubrication - Adjustable Rear Sight).

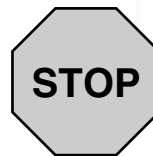

**BUSHMASTER
DOES NOT
RECOMMEND
ANY FURTHER
DISASSEMBLY**

CLEANING • INSPECTION • LUBRICATION...

After firing, clean your rifle as soon as possible to make the job easier and to avoid allowing the development of any corrosion.

When your firearm has not been fired, you should clean it at least once or twice a year if you live in a temperate climate, or as often as once a week in a tropical climate.

If you get your firearm wet, clean it as soon as possible.

Use a high quality rifle cleaning kit that includes a cleaning rod; swab holder; cotton flannel bore patches; pipe cleaners; a small toothbrush; brass wire bristle bore and chamber brushes and a Cleaner/Lubricant/Preservative (CLP in Army terminology).

After you have disassembled the rifle, thoroughly clean, inspect and lubricate all parts according to the techniques described on following pages.

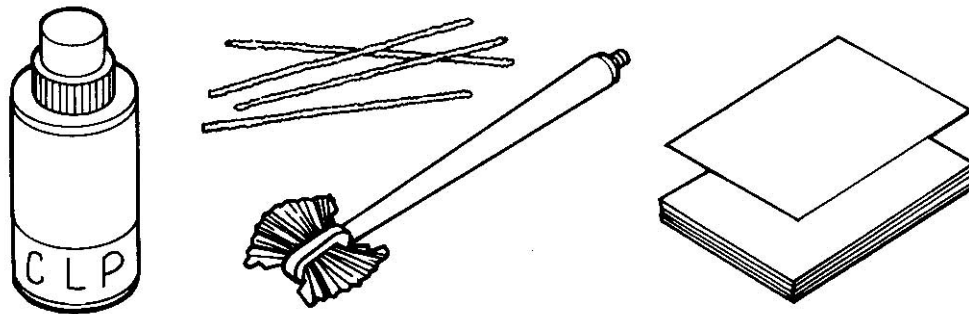

13

DETAILED CLEANING TECHNIQUES...

NOTE: The procedures below describe cleaning with a standard military issue multi-piece rod cleaning kit. Other commercial cleaning kits may include alternate cleaning instructions which may be just as effective.

CLEANING THE BORE: The bore of your Bushmaster rifle has lands and grooves called rifling. Rifling makes the bullet spin very fast as it moves down the bore and down range. It is difficult to **push** a new, stiff bore brush through the bore. You will find it much easier, and more effective, to **pull your bore brush through the bore**. Also, because the brush will clean better if the bristles follow the grooves (this is called tracking), you want the bore brush to be allowed to turn as you pull it through. Always clean from from chamber toward the muzzle. This is how you do it:

- 1.) Swab out the bore with a patch moistened with "CLP".
- 2.) Attach three rod sections together but leave each one about two turns short of being tight.
- 3.) Attach the bore brush but leave it two turns short also.
- 4.) Point muzzle down. Hold the upper receiver in one hand while inserting the end of the rod **without the brush** into the chamber. Guide the rod carefully through the bore. **CAUTION - do not let the rod or its threaded end scratch the Chrome Lining of the Bore or Firing Chamber.**

About 2 - 3 inches of the rod should protrude out of the muzzle.

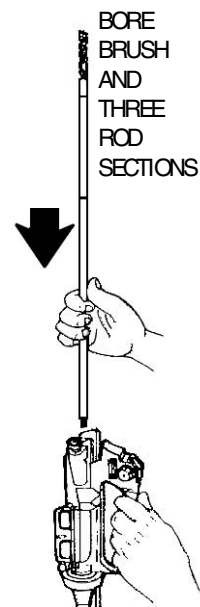

14

DETAILED CLEANING TECHNIQUES (continued)...

5.) Attach the handle section of the cleaning rod to the end of the rod sticking out of the muzzle.

6.) Pull the brush through the bore and out the muzzle. You should be able to see the rod twisting as you pull it - this is the brush "tracking" in the rifling. **Never reverse the direction of the bore brush while it is in the bore.**

7.) After one pull, take off the handle section and repeat the process. After three or four pulls, the three rod sections and the bore brush may become screwed tightly together. Loosen them up and repeat the process.

8.) Send a patch through the bore occasionally to help clean out the crud that the brush is getting loose. Just replace the bore brush with the rod tip (patch holder) and a wet patch. Pull it through. If you leave the rods loose again, the patch will "track" in the rifling as before. But remember, always have the bore **wet with cleaner** before trying to pull a brush through.

CLEANING THE UPPER RECEIVER...

NOTE: Check to ensure that there is no looseness between the Barrel and the Upper Receiver - if you detect any movement by twisting with your hands, the barrel nut must be retorqued. Bring the Rifle to a qualified gunsmith.

1.) Using a "CLP" type product, clean all areas of Powder Fouling, Corrosion, Dirt and Rust. Never use a wire brush or any type of abrasive to clean the Aluminum Upper Receiver - you'll scratch and damage the finish.

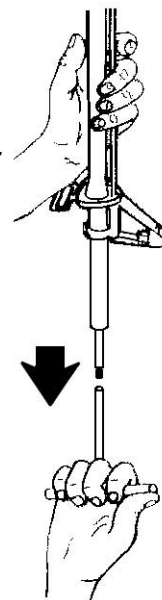

ATTACH HANDLE
AND PULL THROUGH
FROM CHAMBER
TO MUZZLE 15

CLEANING THE UPPER RECEIVER (continued)...

2.) Clean the Firing Chamber - dip the larger chamber cleaning brush in CLP and use at least five plunge strokes and three 360 clockwise rotations. Then swab out the bore as described previously to remove any contaminated solution or loosened crud.

3.) Use the bore cleaning brush, still wet with CLP, and clean carbon and powder residue from around the gas tube, run a pipe cleaner into the gas tube, clean the bolt locking lugs, bolt rings, firing pin, bolt cam pin, lip of the extractor, and inside the bolt carrier from both front and rear.

4.) Wipe all components clean and dry, and inspect for excessive wear, corrosion or mechanical damage. Replace any defective parts before firing again (call us at 1-800-998-SWAT for any parts needs.)

CLEANING THE LOWER RECEIVER...

1.) Clean all areas of Powder Fouling, Corrosion, Dirt and Rust. Again, never use a wire brush or any type of abrasive to clean the Aluminum Lower Receiver.

2.) Wipe any dirt from the Trigger Mechanism. Clean the Buffer, Action Spring, and inside the Lower Receiver Extension (the Buffer Tube).

A SMALL TOOTHBRUSH
WILL REMOVE BUILT-UP
DIRT

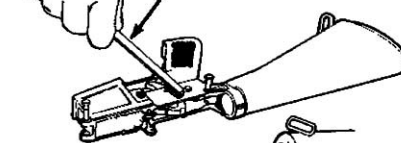

CLEAN THE DRAIN HOLE IN
THE BUTTPLATE SCREW



PIPE
CLEANER

WIPE INSIDE OF BUFFER
TUBE CLEAN
16

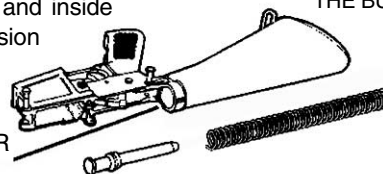

CLEANING THE EJECTOR...

The design of the Ejector makes its disassembly for cleaning somewhat impractical (i.e. we don't recommend it). Make sure your Bushmaster ejects empty cases efficiently by following these steps on a monthly basis (more frequently if firing blanks).

1.) Remove the Bolt from the Carrier (as described on previous pages). Hold it as shown with the Ejector down and the Extractor up.

2.) Dribble a few drops of CLP around the Ejector to form a puddle.

3.) Take a fired or dummy case and place it under the lip of the Extractor. With a rocking motion, press the case down against the Ejector. Since the Ejector is spring loaded, some resistance will be felt. Press on the case until it stops against the bolt face. Ease off with your thumb slightly and press down again. Repeat several times. **Replace the CLP frequently.** Once the spring action of the Ejector is smooth and strong, dry off any excess.

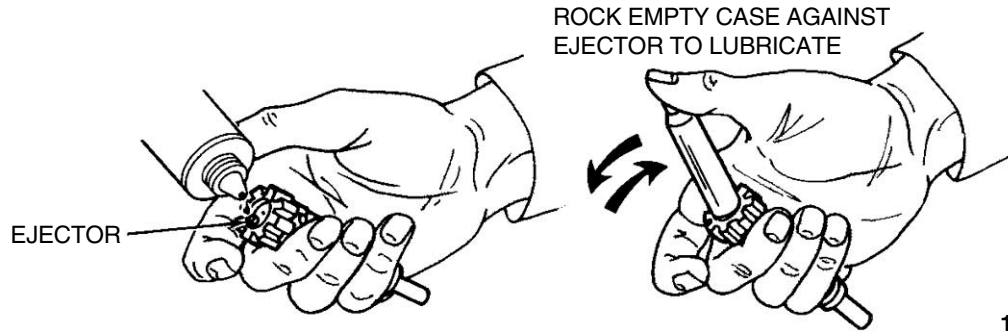

17

INSPECTION - Before Lubricating...

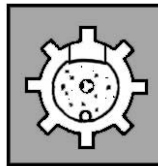
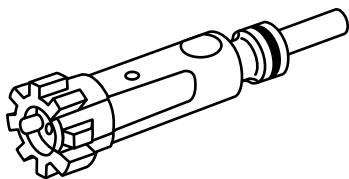

1.) Check the Bolt: Look for cracks or fractures, especially in the cam pin hole area. Bolts with pitting that extends into the firing pin hole should be replaced.

4.) Check the Cam Pin: If it is cracked, or chipped, it should be replaced.

WARNING: IF THE CAM PIN IS MISSING, DO NOT FIRE THE RIFLE - IT WILL EXPLODE.

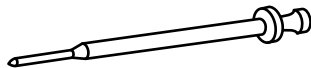

2.) Check the Firing Pin: If it is bent, cracked, too blunted or too sharp, it should be replaced.

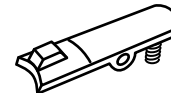

3.) Check the Firing Pin Retaining Pin: If it is bent, or badly worn, it should be replaced.

5.) Check the Extractor and Extractor Spring: If the Extractor is chipped, or has broken edges in the area of the lip that engages the cartridge rim, it should be replaced. Check that the rubber insert is inside the Extractor Spring.

18

LUBRICATION - Upper Receiver...

Lightly lubricate the inside of upper receiver, the bore and chamber (using the cleaning rod and a patch), the outer surfaces of barrel and front sight, and surfaces under the handguard. Be sure you lube in and around all the **Locking Lugs** (see illustration at right).

Depress the **Front Sight Detent** and apply two or three drops of CLP to it. Depress the detent several times to work the lubricant into the spring.

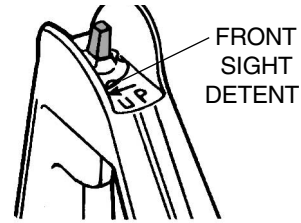
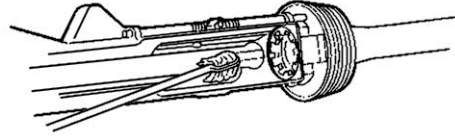

LUBRICATION - Lower Receiver...

Lightly lubricate inside the Lower Receiver Extension (Buffer Tube), the Buffer and the Action Spring.

Generously lubricate all moving parts inside the Lower Receiver (trigger, hammer, safety, bolt catch, forward assist, etc), and their various pins and detents. Don't forget the Takedown and Pivot Pins and their detents. Wipe any fingerprints (they can start the corrosion process) off the exterior surfaces with an oiled rag - a black cloth is best as it won't leave visible lint.

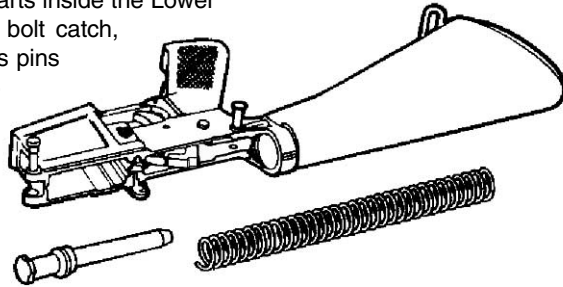

19

LUBRICATION - Bolt Carrier Group...

Lightly lubricate the Firing Pin with CLP - also the Firing Pin recess in the Bolt.

Generously lubricate the Bolt, its Cam Pin area, the Bolt Gas Rings. A lighter application is good on the Extractor and its Pin.

Lightly lubricate the Charging Handle and the inner and outer surfaces of the Bolt Carrier.

Generously lubricate the slide and Cam Pin area of the Bolt Carrier.

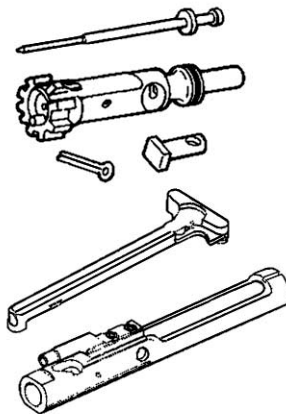

The inside of the **Carrier Key** on the Bolt Carrier should be dried with a Pipe Cleaner - then place one drop of CLP inside.

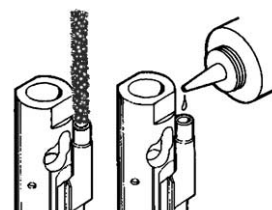

20

LUBRICATION - Adjustable Rear Sight...

Note: Record how far you move the rear sight so it can be returned to its original position upon the completion of this task.

Rear Sight Moving Parts: Use 1 or 2 drops of CLP. Rotate these parts to ensure that the lubricant is spread evenly above, below and around the threads of the:

- 1.) Elevation knob
- 2.) Elevation screw shaft
- 3.) Windage knob
- 4.) Windage screw
- 5.) Detent holes

Elevation Screw Shaft: Also lube from inside the upper receiver as follows:

- 1.) Turn upper receiver upside down
- 2.) Remove charging handle
- 3.) Put 2 or 3 drops on bottom of elevation screw shaft and in elevation detent spring hole
- 4.) Rotate the elevation dial back and forth a few times while keeping upper receiver upside-down

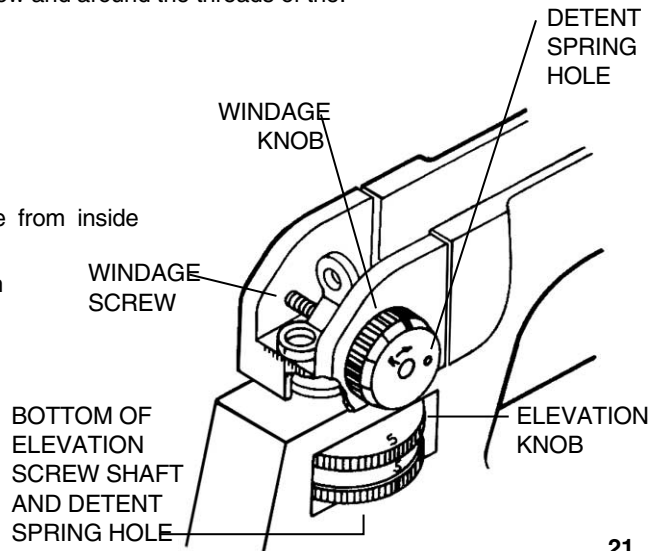

21

REASSEMBLY...

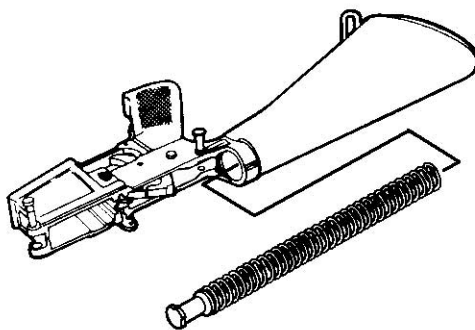

- 1.) Insert Action Spring and Buffer. Depress Buffer Detent and push Buffer in past the Detent, then release.

Note: Extractor Assembly has a Rubber Insert within the Spring. Be sure not to lose it. If the Spring comes loose, put the large end of the spring in the extractor and seat it (a bullet tip works well).

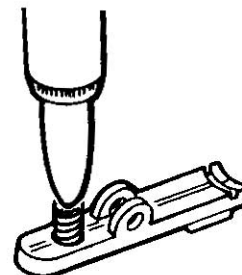
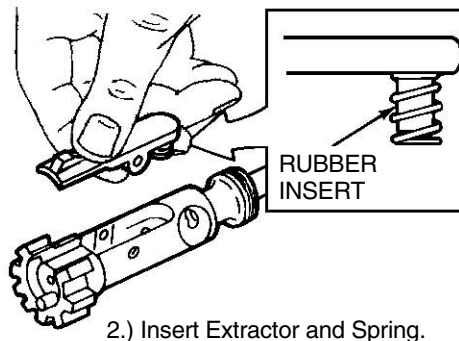

22

REASSEMBLY (continued)...

STAGGER THE GAS RING GAPS TO REDUCE GAS LOSS. Position the three ring gaps 120° apart around the bolt.

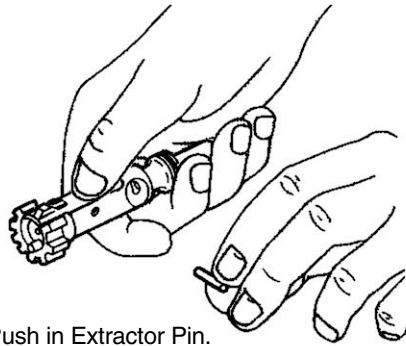

3.) Push in Extractor Pin.

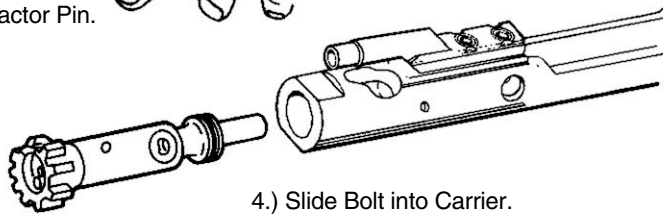
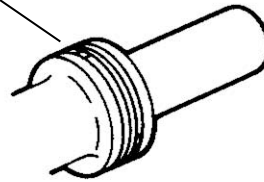

4.) Slide Bolt into Carrier.

REASSEMBLY (continued)...

WARNING: Be sure the Cam Pin is installed in the Bolt Group. If it isn't, your rifle can still fire and will explode!

NOTE: The Bolt is machined so as to allow insertion of the Cam Pin from one side only. This provision aligns the Extractor and Ejector properly within the Upper Receiver.

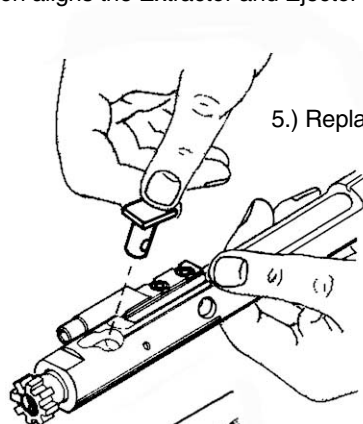

5.) Replace Bolt Cam Pin.

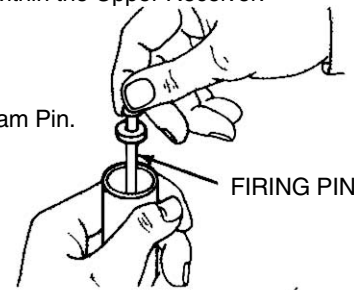

FIRING PIN

6.) Drop in and seat the Firing Pin.

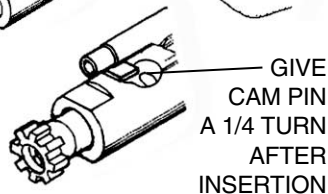

GIVE CAM PIN A 1/4 TURN AFTER INSERTION

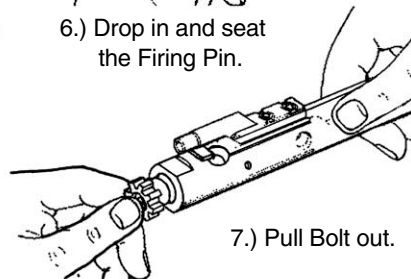

7.) Pull Bolt out.

REASSEMBLY (continued)...

NOTE: Firing Pin should not fall out when Bolt Carrier Group is turned upside down.

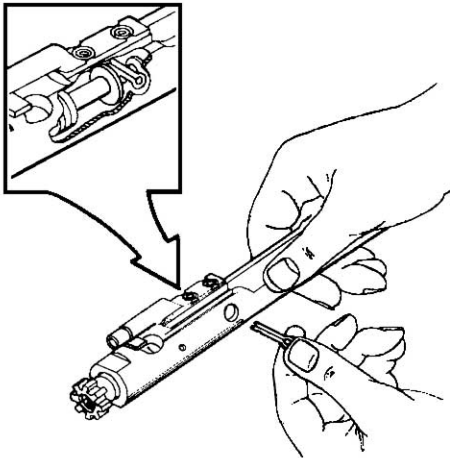

8.) Replace Firing Pin Retaining Pin.

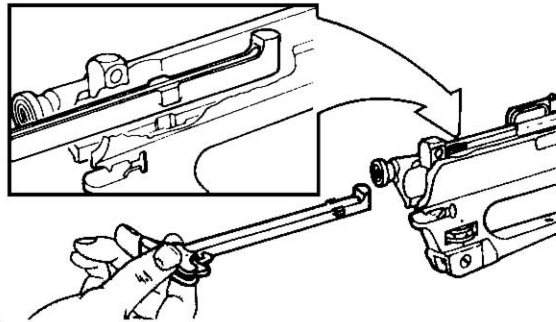

9.) Engage, then push Charging Handle part way.

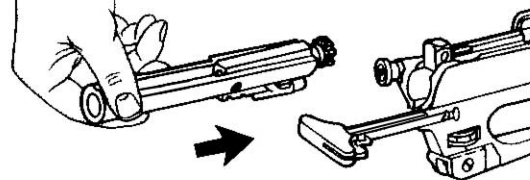

10.) Position Carrier Key in slotted bottom of Charging Handle. Slide in Bolt Carrier Group.

CAUTION: Bushmaster does not recommend the practice of swapping bolts between different rifles. Doing so could result in damage, personal injury or death.

REASSEMBLY (continued)...

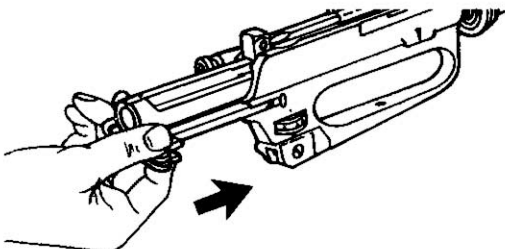

11.) Push Charging Handle and Bolt Carrier group into receiver together.

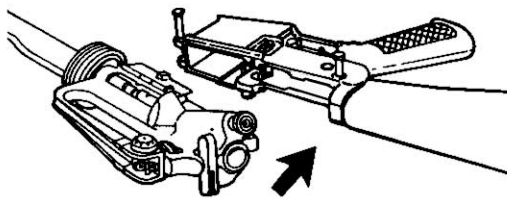

12.) Join Upper and Lower Receivers.

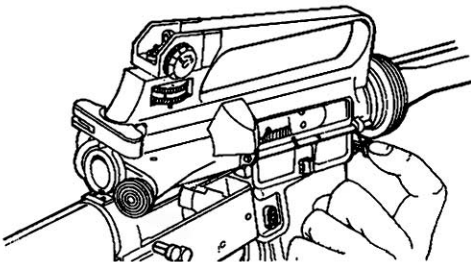

13.) Engage Receiver Pivot Pin.

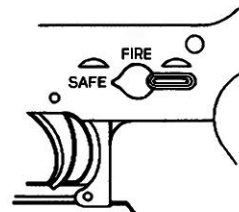

CAUTION: Selector Lever should be on SAFE before closing Upper Receiver.

REASSEMBLY (continued)...

- 14.) Close the Upper and Lower Receiver groups and push in the Takedown Pin.

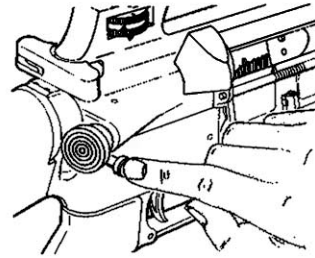

When re-attaching the Handguards, use **The "Buddy System"**:

- 15.) Place the Rifle on the Buttstock and press down on the Slip Ring with both hands. **Note:** The "Half-Round" Handguards are identical and can be used on top or bottom.
- 16.) Have your buddy install one handguard on top and the other on the bottom.

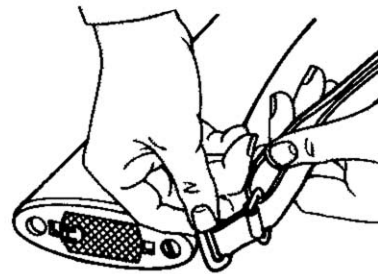
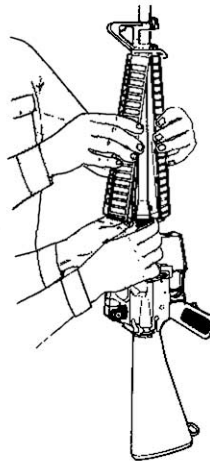

- 17.) Re-attach the Sling.

27

MAGAZINE DISASSEMBLY / REASSEMBLY ...

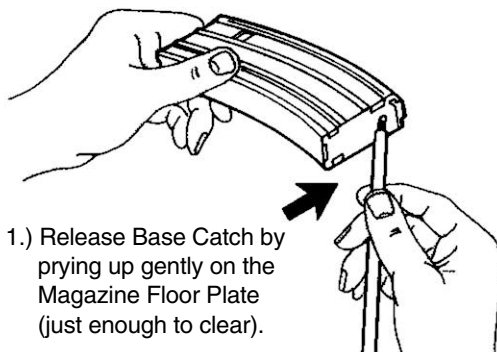

- 1.) Release Base Catch by prying up gently on the Magazine Floor Plate (just enough to clear).

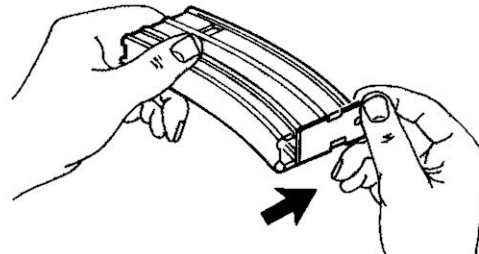

- 2.) Remove Magazine Floor Plate by sliding it out of the Magazine Body.

- 3.) Jiggle Spring and Follower to remove. Do not remove the Follower from the Spring.

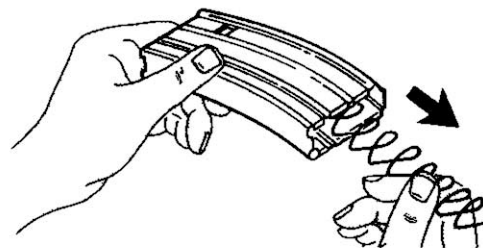

TO CLEAN and LUBRICATE, Wipe dirt from Magazine Body, Spring, and Follower. Then lightly lubricate the Spring.

REASSEMBLY is reverse of steps above. Make sure to slide the base under all four tabs until it snaps back under the catch.

28

PREVENTATIVE MAINTENANCE CHECKS & SERVICES...

CHECK BEFORE YOU FIRE! ...

1.) Check to see that there is no excessive oil in the Bore. If there is, swab it out with a patch and the cleaning rod.

2.) Retract the Bolt to ensure free movement between Bolt Carrier and Gas Tube.

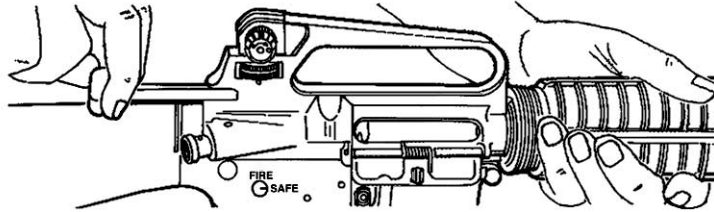

3.) Perform Safety Function Check to ensure that Safety Selector Lever works properly.



4.) Check to ensure that the Magazine is secure.

29

SAFETY FUNCTION CHECK...

UNLOAD RIFLE - REMOVE MAGAZINE - CHECK CHAMBER

1.) Remove magazine if installed. Pull Charging Handle assembly to rear. Check that Chamber is clear. Let Bolt and Bolt Carrier close. Do not pull Trigger. Leave Hammer in cocked position.

WARNING: If Rifle fails any of the following tests, continued use of the Rifle could result in injury to, or death of, personnel.

2.) Place Selector Lever in SAFE position and pull Trigger. **THE HAMMER SHOULD NOT FALL.**

3.) Place Selector Lever in FIRE position. Pull trigger. **THE HAMMER SHOULD FALL.**

NOTE: For the purpose of the following check, "SLOW" is defined as one fourth to one half the normal rate of trigger release.

4.) Hold Trigger to the rear, pull Charging Handle to the rear, and release pressure on the Trigger with a slow, smooth motion, without hesitations or stops, until the Trigger is fully forward. **AN AUDIBLE CLICK SHOULD BE HEARD - THE HAMMER SHOULD NOT FALL.**

5.) Repeat the FIRE position test five times. The Rifle must not malfunction during any of these five tests. If the Rifle malfunctions during any of these five tests, have the Rifle checked by a qualified gunsmith.

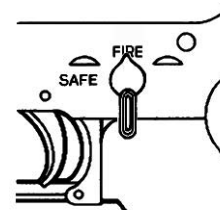
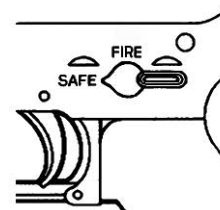

30

LOADING A MAGAZINE...

1.) Use only quality ammunition suitable for your firearm. Examine each cartridge - particularly around the primer. Look for dents, scratches, and other signs of damage. **Do not load damaged ammunition.**

2.) With the magazine facing forward as shown in the illustration, place a round between the lips of the magazine with the bullet tip forward. Push the round down until it is held by the magazine lips.

3.) If necessary, give the round a slight push backward to seat it against the back edge of the magazine lips. Place next round on top of previous round and repeat steps until desired number of rounds is loaded.

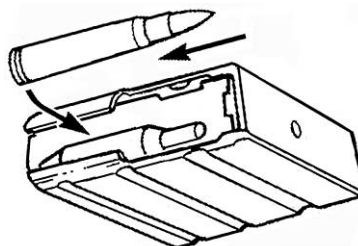

CAUTION: Safe firearms handling dictates that you ONLY LOAD LIVE AMMUNITION INTO YOUR RIFLE WHEN YOU ARE ABOUT TO SHOOT.

THE FORWARD ASSIST...

The forward assist helps lock the bolt into the barrel, but it will only be useful on rare occasions when the bolt fails to lock automatically. If you find that you need to use the forward assist, it is probably time you cleaned your rifle - pay particular attention to the locking lug areas in the chamber and on the bolt.

CAUTION: ALWAYS CHECK THAT AMMUNITION IS CLEAN AND UNDAMAGED BEFORE USING THE FORWARD ASSIST. Forcing dirty or damaged ammunition into the chamber could damage your rifle and could result in injury, death or property damage.

31

ADJUSTABLE FRONT SIGHT POST...

The Front Sight Post is moved up and down when "Zeroing" the Rear Sight. Once the Rear Sight is zeroed, the Front Sight Post should not be moved.

A2 DUAL APERTURE REAR SIGHT...

(See Page 36 for A1 Sight information)

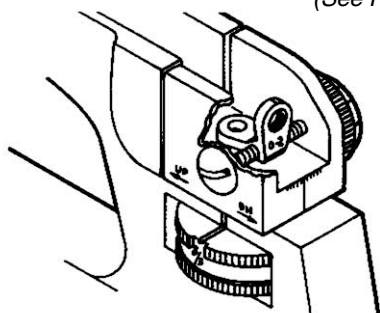
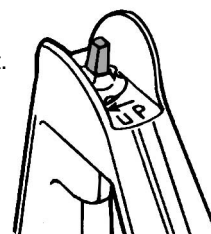

SHORT RANGE - This "larger" aperture is used for 0 - 200 meters range. As shown above, the sight is set for 0 - 200 meters. This larger aperture is only used when the **8/3** marking is aligned with the vertical mark on the left side of the upper receiver.

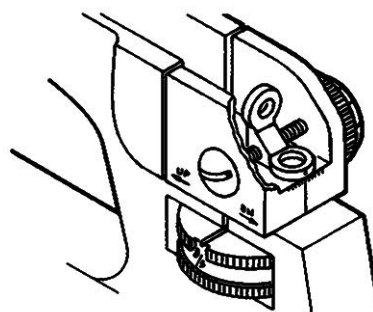

NORMAL RANGE - The smaller aperture is unmarked and is used for most firing situations. It is used in conjunction with the elevation knob for 300, 400, 500, 600, 700, and 800 meter targets.

32

ZEROING YOUR SIGHTS...

This is the procedure to follow in order to "Zero" your mechanical sights.

- 1.) In this procedure, the Front Sight Post and Rear Sight Windage Knob are adjusted so that you can hit your point of aim at 300 meters:
- 2.) Flip the unmarked (smaller) aperture to the up position (as shown).
- 3.) Set the Rear Sight so that the 300-meter mark is aligned with the mark on the left side of the receiver.

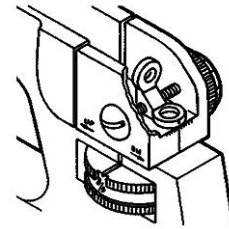

300 METERS
ON THE
ELEVATION KNOB
(dial rotated down)

ZEROING ADJUSTMENTS...

- 1.) During zeroing procedures, only the front sight post and windage knob are adjusted to move the strike of the bullet on the target.
- 2.) If you are zeroing on a 25-meter range, the rear sight elevation knob is adjusted to the 300-meter mark plus one "click" up.
- 3.) Also see the detailed zeroing procedures on the following pages.

FRONT SIGHT: To adjust elevation, depress detent and rotate post. To raise strike of bullet, rotate post in the direction of arrow marked UP. Reverse the direction of rotation to lower strike of bullet. Each graduation (notch) moves the point of impact of bullet as indicated.

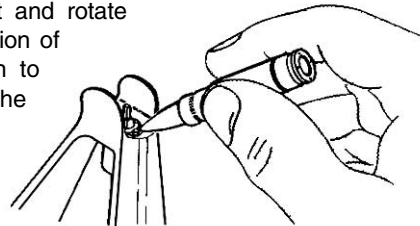

IMPACT	DISTANCE
0.9 cm (3/8 in.)	25 meters
3.5 cm (1 3/8 in.)	100 meters
7.0 cm (2 3/4 in.)	200 meters

ZEROING ADJUSTMENTS (continued)...

FOR WINDAGE KNOB (per click)*...

IMPACT	DISTANCE
0.3 cm (1/8 in.)	25 meters
1.25 cm (1/2 in.)	100 meters
2.50 cm (1 in.)	200 meters
3.8 cm (1 1/2 in.)	300 meters
5.0 cm (2 in.)	400 meters
6.3 cm (2 1/2 in.)	500 meters
7.6 cm (3 in.)	600 meters
8.8 cm (3 1/2 in.)	700 meters
10.0 cm (4 in.)	800 meters

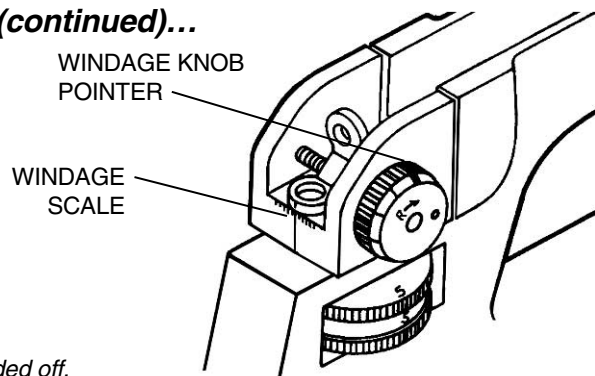

*All the above values have been rounded off.

To remember your correct zero windage, note location of Windage Scale and Windage Knob Pointer (heavy mark on outside of knob). Once you have established your correct zero windage leave your Windage Scale and Windage Knob Pointer on these settings at all times.

25 METER ZEROING PROCEDURES...

Place an appropriate 25 Meter Paper Sighting Target 25 meters downrange and follow the steps below to establish a "battlesight" zero.

- 1.) Do not move the front sight post on your Bushmaster XM15 E2S rifle at this time. It was set at the factory and should be very close to your zero.
- 2.) Center the rear sight aperture by turning the windage knob left or right. This is called "Mechanical Zero Windage".
- 34 3.) The Unmarked (smaller) Aperture should be up.

25 METER ZEROING PROCEDURES (continued)...

4.) Now rotate the elevation knob "up" one click past the 300-meter mark. From this point on, the elevation knob should not be moved. Any changes in elevation required in the following zeroing steps are made to the **front sight post only**.

5.) Carefully aim and fire at the center of the target bull's-eye.

6.) If your shot group is not in the center of the bull's-eye, use the squares on the target sheet to calculate the required "clicks" necessary to move your next shot group into the bull's-eye.

Remember - any changes in elevation are made by moving front sight post only!

7.) In order **to raise your next shot group**, rotate the front sight post clockwise. **One click of the front sight post will move the the bullet strike one vertical square on the target sheet.**

In order **to lower your next shot group**, rotate the front sight post counter-clockwise. One click of the front sight post, as above, equals one square.

Changes in windage are made with the windage knob. Three clicks will move the strike of the bullet one horizontal square on the target sheet.

In order to move the shot group to the **left**, turn the windage knob counterclockwise.

In order to move the shot group to the **right**, turn the windage knob clockwise.

8.) Carefully aim and fire another group at the center of the target bull's-eye.

9.) Repeat Steps 7 through 9, if required.

10.) If your group is on target, your sight is now "calibrated." To place your actual 300-meter zero on the rifle, you must rotate the elevation knob one click "down." (The range scale's 300-meter mark should now be aligned with the mark on the rifle's receiver.)

35

A1 TYPE RIFLE SIGHTS - DIFFERENCES & ADJUSTMENTS...

A1 Type Rifles have sights that differ a bit from the later A2 Style.

The A1 REAR SIGHT Has two apertures for differing ranges but does not offer any mechanical means of adjustment for elevation

- Use the unmarked aperture for targets from 0 - 300 meters.
- Use the aperture marked **L** for targets from 300 - 400+ meters.

The A1 FRONT SIGHT - Has five notches of elevation per revolution (instead of the four notches found on A2 square post type front sight - Bushmaster only uses the A2 type Front Sight Post in its current production models).

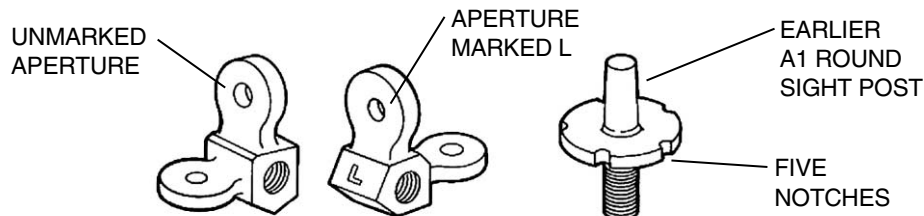

1.) Battlesight zero is that setting on the Rifle's sights which will cause the point of aim and strike of the bullet to be the same at 250 meters.

2.) When using the L-marked aperture, the path of the bullet will cross the line of sight at 25 meters. Hence, zeroing is now conducted with point of aim and point of impact being the same (see chart on next page).

36

A1 SIGHTS - DIFFERENCES & ADJUSTMENTS (continued)...

NOTE: To zero the rifle, adjust the front sight (elevation) and the rear sight (windage) so that you can hit the aiming point at a given range.

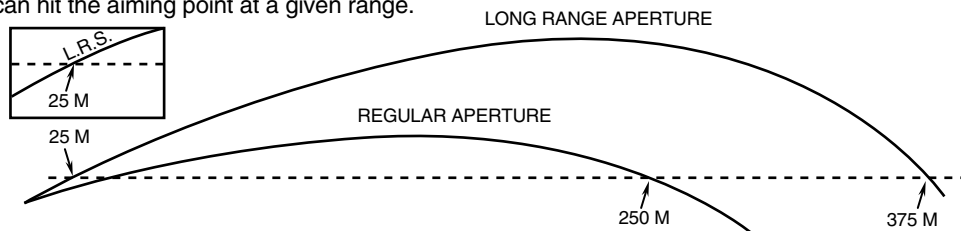

FRONT SIGHT - To adjust elevation, depress detent and rotate post as described previously for A2 Front Sight Post. The 5 notches of the A1 post allow for a finer adjustment than does the square A2 Post with 4 notches.

NOTE: Bushmaster uses only the newer A2 square front sight post.

REAR SIGHT - To adjust windage, depress detent and rotate drum to direction you want. Each notch moves the point of impact of bullet as indicated in chart.

- 1.) To move point of impact to right, turn drum clockwise in direction of arrow and letter R.
- 2.) To move point of impact to left, turn drum counterclockwise.

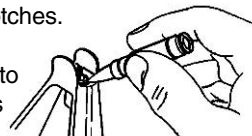

IMPACT	DISTANCE
0.7cm (17/64 in.)	25 meters
2.8cm (1-3/32 in.)	100 meters
5.6cm (2-13/64 in.)	200 meters

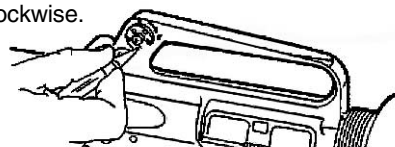

37

OPERATION OF YOUR RIFLE...

WARNING: If a noticeable difference in sound or recoil is experienced, STOP FIRING. Either condition could indicate an incomplete powder burn and/or a bullet stuck in the bore (Also see Page 45). **Retract the bolt slowly and remove the fired cartridge case. Clear the weapon and check for unburned powder grains in the receiver or bore, and for a bullet stuck in the bore. Clean out any unburned powder before resuming firing. If a bullet is stuck in the bore, do not attempt to remove it. Take the rifle to a qualified gunsmith.**

LOADING...

CAUTION:
**ALWAYS POINT THE MUZZLE
IN A SAFE DIRECTION!**

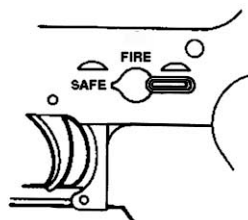

- 1.) With Hammer cocked, place Selector Lever on **SAFE**.

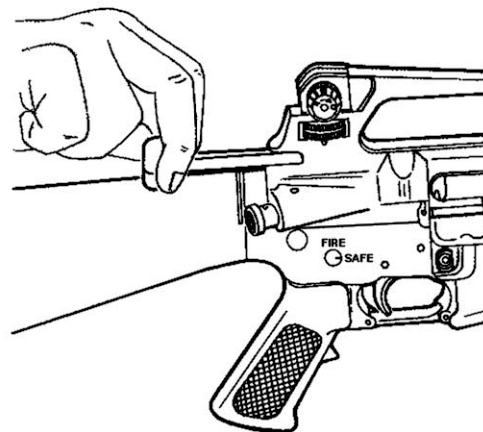

- 2.) Open Bolt and check Chamber. Make sure it is clear.

38

OPERATION OF YOUR RIFLE...

INSERTING A MAGAZINE...

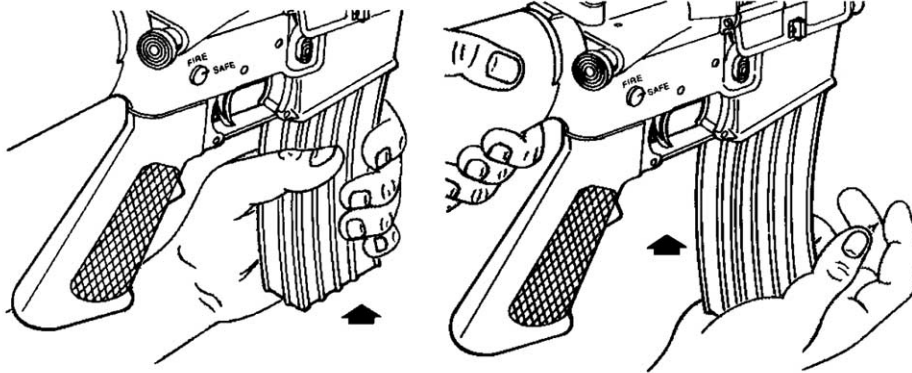

3.) Push Magazine up into Magazine Well until Magazine Catch engages and holds the Magazine.

4.) Tap upward on Magazine bottom to make sure it's seated correctly.

39

OPERATION OF YOUR RIFLE...

CHAMBERING A ROUND with Bolt Assembly Open...

NOTE: The Magazine may be inserted into the Rifle with Bolt Assembly open or closed.

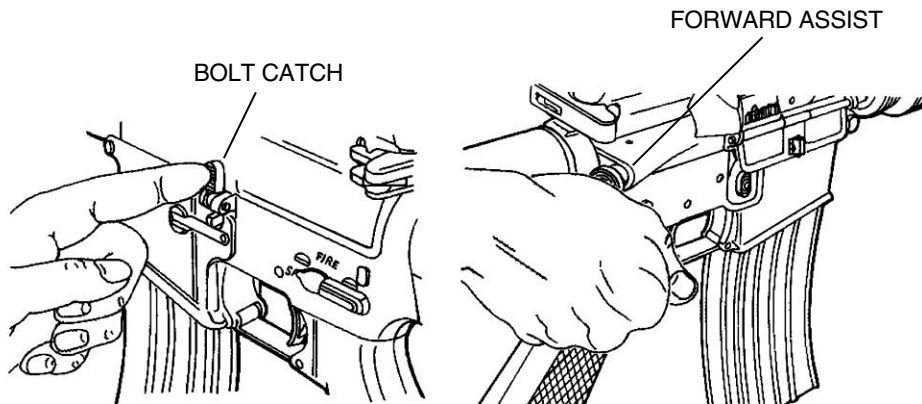

1.) Depress upper portion of Bolt Catch. Bolt should spring forward.

2.) TAP the Forward Assist to ensure Bolt is fully forward and locked.

40

OPERATION OF YOUR RIFLE...

CHAMBERING A ROUND with Bolt Assembly Closed...



1.) Pull Charging Handle fully to rear.

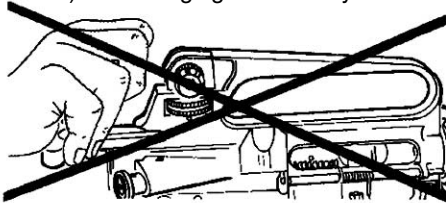

NEVER "Ride" (or push) the Charging Handle. Let it move forward on its own.

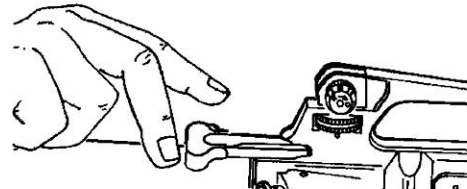

2.) Release the Charging Handle.

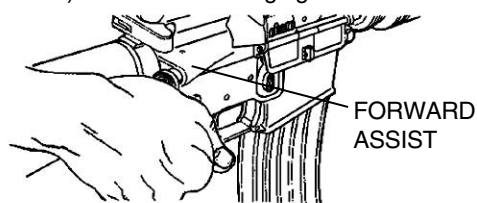

3.) TAP the Forward Assist to ensure Bolt is fully forward and locked.

NOTE: If the Rifle is not going to be fired immediately, make sure the Selector Lever is still on SAFE, and close the Ejection Port Cover to keep out dirt.

41

IMMEDIATE ACTION in case of trouble...

IF YOUR RIFLE STOPS FIRING: Perform the following immediate actions...

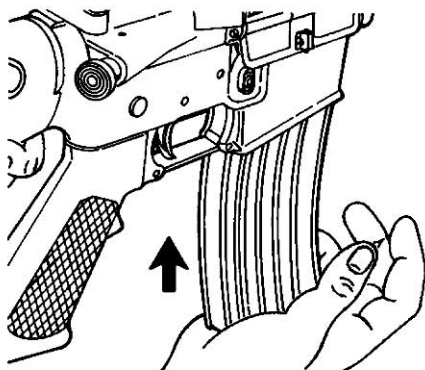

1.) SLAP upward on Magazine to make sure it's seated properly.

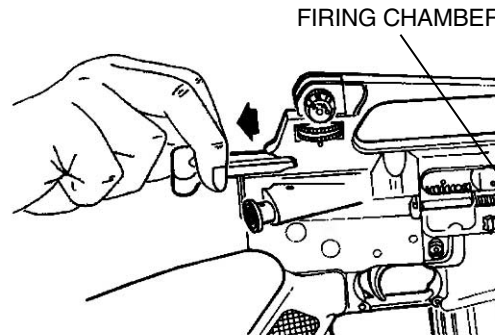

2.) PULL Charging Handle all the way back
Observe ejection of case or cartridge.
Check Chamber for any obstruction.

WARNING: DO NOT LOAD WITH A HOT CHAMBER. A ROUND MAY "COOK OFF"
(meaning it may fire from the heat of the chamber)

42

IMMEDIATE ACTION in case of trouble (continued)...

3.) If cartridge or case is ejected or chamber is clear, **RELEASE** Charging Handle to feed a new round. Don't "ride" the Charging Handle forward.

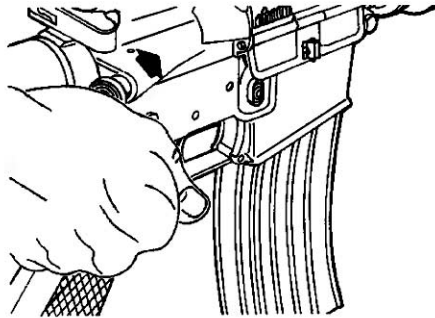
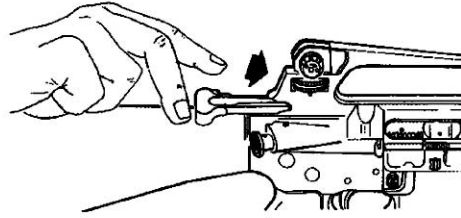

4.) TAP Forward Assist.

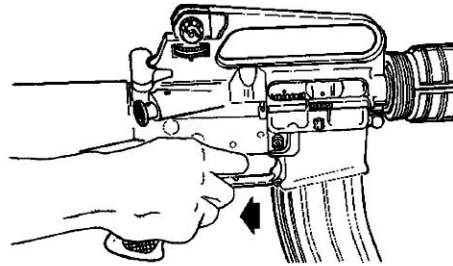

5.) Now FIRE. If the Rifle won't fire, look for trouble and apply remedial action. (See next page.)

REMEDIAL ACTION...

WARNING: If your rifle stops firing with a live round in the chamber of a hot barrel, remove the round fast. However, if you cannot remove it within 10 seconds, remove the magazine and wait 15 minutes with the rifle pointing in a safe direction (always check that the "SAFE" direction remains safe during that time). This way you won't get hurt by a possible round cooking off. **REGARDLESS, KEEP YOUR FACE AWAY FROM THE EJECTION PORT WHILE CLEARING A HOT CHAMBER.**

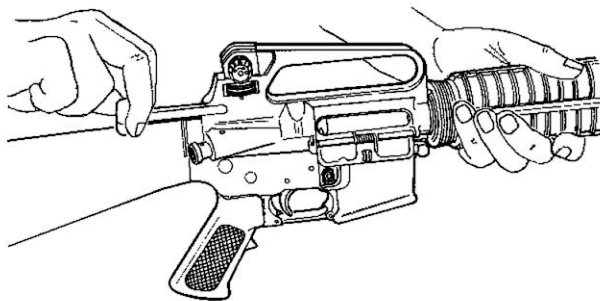

If your Rifle still fails to fire after performing Steps 1 through 5 on previous page, check again for a jammed cartridge case.

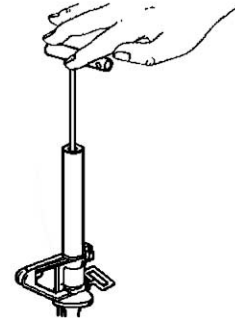

If a cartridge case is in the chamber, open the receivers, remove the bolt carrier, and try to tap out the case with a cleaning rod.

IF YOUR RIFLE STILL FAILS TO FIRE, CHECK THE TROUBLESHOOTING SECTION IN THIS MANUAL - OR TAKE THE RIFLE TO A QUALIFIED GUNSMITH.

BULLET STUCK IN THE BORE...

WARNING: If an audible "POP" or reduced RECOIL is experienced during firing, immediately CEASE FIRE: Then, (1) Remove the Magazine, (2) Lock the Bolt to the rear, (3) Place the Selector Lever on the SAFE position and (4) visually inspect and/or insert a cleaning rod into the bore to ensure there is not a bullet stuck in the bore.

1. Remove the Magazine

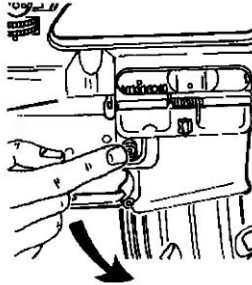

2. Lock the Bolt to the rear.

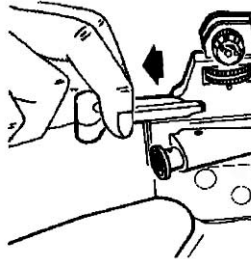

3. Place the Selector Lever on SAFE

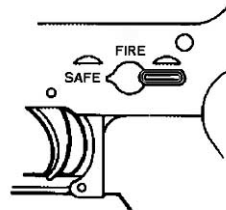

4. Check for a Bullet in the Bore

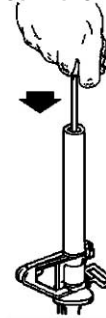

DO NOT APPLY THE "IMMEDIATE ACTIONS" PREVIOUSLY DESCRIBED ON PAGE 43.

IF A BULLET IS STUCK IN THE BARREL OF THE WEAPON, DO NOT TRY TO REMOVE IT. TAKE THE RIFLE TO A QUALIFIED GUNSMITH.

45

TROUBLESHOOTING...

PROBLEM	CHECK FOR:	WHAT TO DO
WON'T FIRE	Selector Lever on SAFE	Put it on FIRE
	Improper assembly of Firing Pin.	Assemble correctly. RETAINING PIN GOES IN BACK OF LARGE SHOULDER ON FIRING PIN.
	Too much oil in Firing Pin recess.	Wipe out with pipe cleaner.
	Defective Ammunition	Remove and discard.
Too much carbon on Firing Pin or in Firing Pin recess.		Clean.

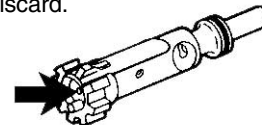
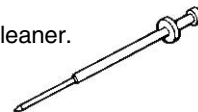
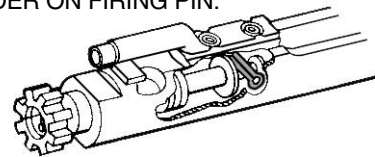

46

TROUBLESHOOTING (continued)...

PROBLEM	CHECK FOR:	WHAT TO DO
BOLT WON'T UNLOCK	Dirty or burred Bolt.	Clean or see a qualified gunsmith.
WON'T EXTRACT	Broken Extractor Spring.	See a qualified gunsmith.
	Dirty or corroded Ammo.	Remove stuck round - push out with cleaning rod.
	Carbon in Chamber.	Clean Chamber.
	Fouling or carbon in Extractor recess or lip.	Clean Extractor.

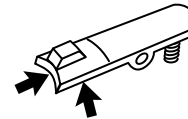
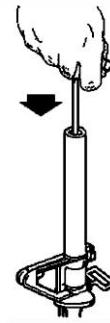

47

TROUBLESHOOTING (continued)...

PROBLEM	CHECK FOR:	WHAT TO DO
WON'T FEED	Dirty or corroded Ammo.	Clean.
	Dirty Magazine.	Clean.
	Defective Magazine.	Replace.
	Too many rounds in Magazine.	Take out excess.
	Action of Buffer Assembly is restricted.	Take out Buffer and Spring - Clean them.
	Magazine not fully seated.	Adjust Magazine Catch:

PRESS MAGAZINE CATCH BUTTON ON RIGHT SIDE

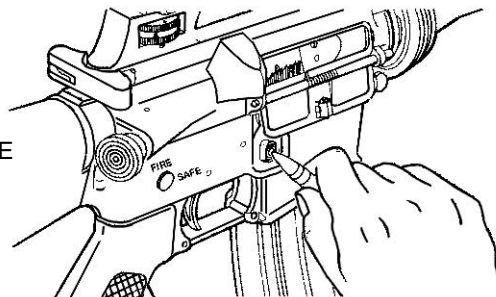

48

TROUBLESHOOTING (continued)...

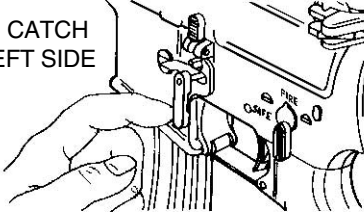
PROBLEM	CHECK FOR	What To Do
WON'T FEED (continued)		Turn Catch Clockwise to tighten and Counterclockwise to loosen
		
DOUBLE FEED	Defective Magazine.	Replace.
WON'T CHAMBER	Dirty or corroded Ammo.	Clean.
	Damaged Ammo.	Replace.
	Carbon in Chamber or on Gas Tube	Clean.

TROUBLESHOOTING (continued)...

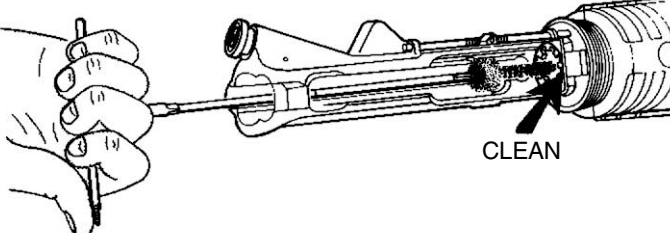
PROBLEM	CHECK FOR:	WHAT TO DO
WON'T LOCK	Dirt, corrosion, or carbon buildup in barrel locking lugs	Clean lugs.
		
WON'T EXTRACT	Frozen Extractor.	Remove and clean.
	Restricted Buffer Assembly.	Remove and clean.
	Restricted movement of Bolt Carrier Group.	Remove, clean, and lube. (Before putting Bolt back in, make sure Gas Tube fits into Carrier Key and that the Carrier moves freely.)

TROUBLESHOOTING (continued)...

PROBLEM	CHECK FOR	What To Do
----------------	------------------	-------------------

SHORT RECOIL	Correct alignment of Gaps in Bolt Gas Rings	"Gaps" in the 3 Gas Rings should be staggered 120 around the Bolt body for maximum effectiveness.
---------------------	---	---

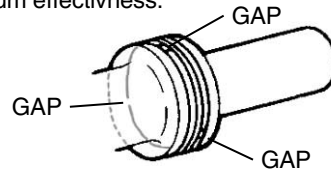

Carbon or dirt in Carrier Key or on outside of Gas Tube.	Clean Carrier Key or around area of the Gas Tube.
--	---

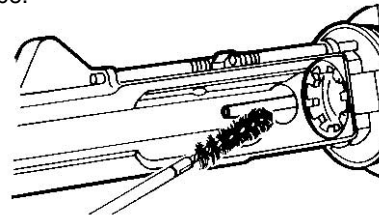

51

TROUBLESHOOTING (continued)...

PROBLEM	CHECK FOR:	WHAT TO DO
----------------	-------------------	-------------------

SHORT RECOIL (continued)	Q-Tip or Pipe Cleaner pieces stuck inside Carrier Key.	Clean out if possible or have Rifle checked by a qualified gunsmith.
---------------------------------	--	--

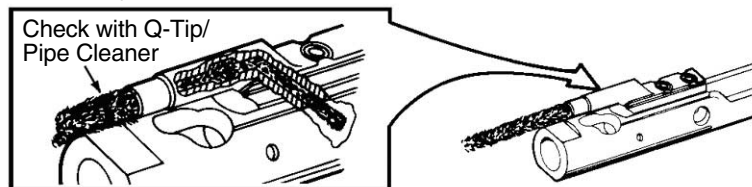

BOLT FAILS TO LOCK AFTER LAST ROUND	Dirty or corroded Bolt Latch.	Clean - or replace Bolt Catch. Check for Buffer Endcap backout or obstruction. Check for full travel of Bolt Carrier
--	-------------------------------	--

	Faulty Magazine	Replace.
--	-----------------	----------

SELECTOR LEVER BINDS	Needs oil.	Lubricate with CLP.
-----------------------------	------------	---------------------

	Dirt or sand under Trigger.	Clean.
--	-----------------------------	--------

52

TROUBLESHOOTING (continued)...

PROBLEM	CHECK FOR:	WHAT TO DO
---------	------------	------------

BOLT CARRIER "HUNG UP"

Round jammed between Bolt and Charging Handle and/or double feed

- 1.) Remove Magazine.
- 2.) Push in on the bottom of the Bolt Latch.
- 3.) While pulling down on Charging Handle, bang the Rifle Butt on the ground. Bolt should lock to the rear.
- 4.) While Bolt is held to the rear, round should fall through the Magazine well.

WARNING:
KEEP CLEAR
OF MUZZLE.

CAUTION:
AFTER ROUND
IS REMOVED,
BOLT IS UNDER
TENSION.

NOTE: If this procedure fails, use a section of cleaning rod to push the Bolt fully to rear through the Ejection Port.

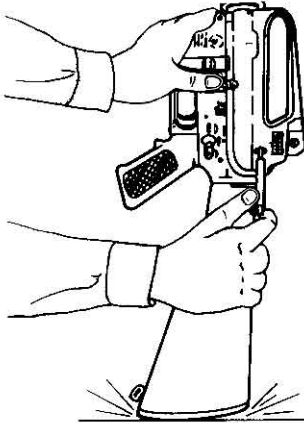

53

DISASSEMBLY VIEWS - Bushmaster XM15 E2S Rifle

Upper Receiver / Barrel / Bolt Carrier / Sight Groups

(See also next page)

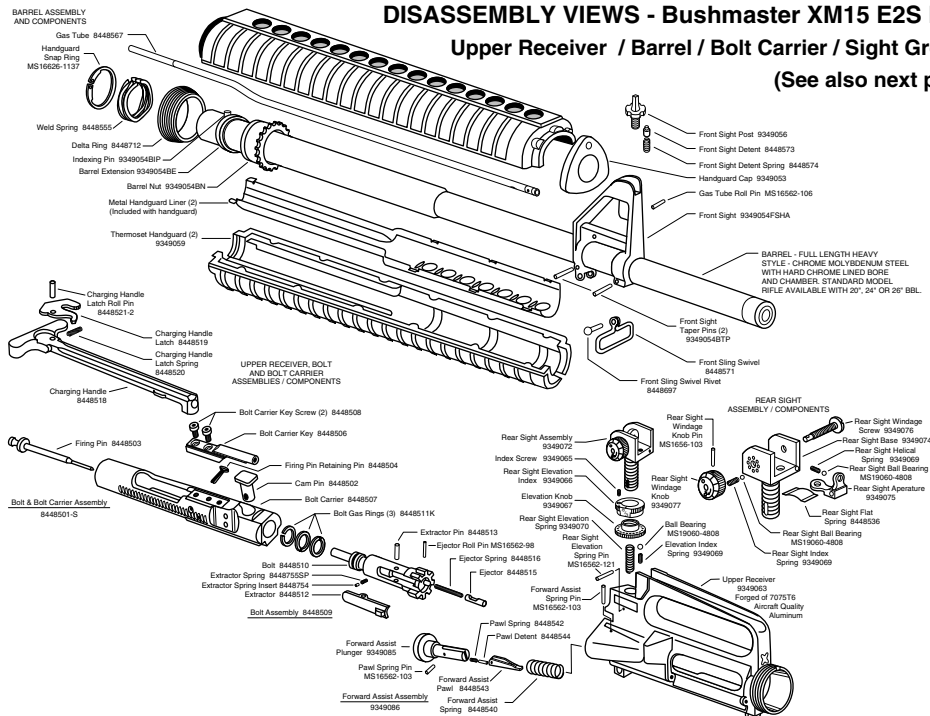

DISASSEMBLY VIEWS - Bushmaster XM15 E2S Rifle
Lower Receiver / Magazine Groups

- FOR 20" BARRELLED RIFLE**
 • Caliber .223 Rem. (5.56 Mm)
 • Mode of Fire: Safe / Semi-Automatic
 • 30 Round Magazine
 • 39.25" Length Overall
 • 20" Barrel Length
 • Rifling - 1 in 9" / Right Hand Twist
 • Weight w/o Mag. - 8.27 Lbs. (3.75 kg)

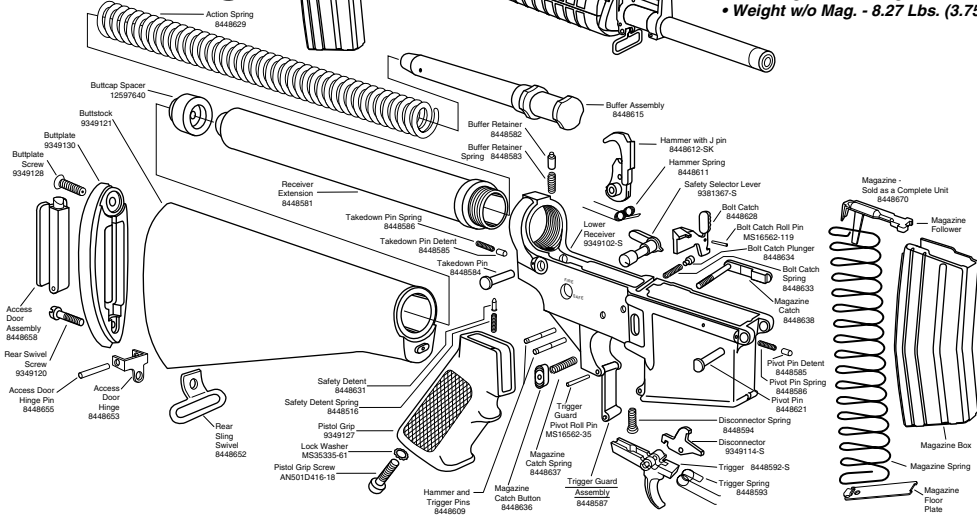

PLEASE PRACTICE SAFE FIREARMS HANDLING

If your Bushmaster Operation Manual is lost or destroyed, you can obtain a replacement by writing to **Bushmaster Firearms, Inc. 999 Roosevelt Trail, Windham, Maine 04062 USA** or by calling **1-800-883-6229**. When requesting a manual, include the serial number of your rifle.

This Operation Manual should always accompany this firearm. When you lend, give or sell this firearm, be sure this Manual goes with it.

Model: _____

Serial Number: _____

Purchased from: _____

Date Purchased: _____

PLEASE PRACTICE SAFE FIREARMS HANDLING!

LIMITED ONE-YEAR WARRANTY Bushmaster Firearms Inc. products are warranted to be free from defects in material and workmanship. Warranty cards are included with all firearms and should be completely filled out and sent to Quality Parts Company to activate the terms of the warranty. Any such defect of which Bushmaster Firearms Inc. is given written notice, as provided below, within one year and ten days from the date of first purchase by a customer will be remedied by Bushmaster Firearms Inc. without notice. This warranty is granted by Bushmaster Firearms Inc., 999 Roosevelt Trail, Windham, ME 04062. Warranty claims (in writing) and the firearm concerned should be directed (transportation charges prepaid), to the Warranty Service Department, Bushmaster Firearms Inc., 999 Roosevelt Trail, Windham, ME 04062.

Warranty claims should state the model and serial number of the gun concerned, a description of the difficulty experienced, and the date of purchase. It is recommended that shipment be insured by owner, since Bushmaster Firearms, Inc. will accept no responsibility for loss or damage in transit. Transportation and insurance charges for return to owner will be paid by Bushmaster Firearms Inc. if the related claim is a proper claim for warranty work.

A SAFETY NOTE REGARDING LEAD... Discharging firearms in poorly ventilated areas, cleaning firearms, or handling ammunition may result in exposure to lead, a substance known to cause birth defects, reproductive harm, and other serious physical injury. Have adequate ventilation at all times. Wash hands thoroughly after exposure.

CALL 1-800-998-SWAT FOR ALL REPLACEMENT PARTS AND ACCESSORIES

BUSHMASTER FIREARMS, INC. / QUALITY PARTS CO.
999 Roosevelt Trail P.O. Box 1479 Windham, Maine 04062 U.S.A.
CUSTOMER SERVICE: 1-800-883-6229 / Fax: 207-892-8068
Website: <http://www.bushmaster.com> E-mail: info@bushmaster.com



PLEASE PRACTICE SAFE FIREARMS HANDLING!

FUNDAMENTAL RULES FOR SAFE GUN HANDLING

ALWAYS KEEP THE GUN POINTED IN A SAFE DIRECTION.

NEVER LOAD THE GUN UNTIL READY TO USE.

KEEP YOUR FINGER OFF THE TRIGGER UNTIL READY TO SHOOT.



BUSHMASTER FIREARMS, INC. / QUALITY PARTS CO.

999 Roosevelt Trail • P.O. Box 1479 • Windham, Maine 04062 • U.S.A.

ORDERS: 1-800-998-SWAT • CUSTOMER SERVICE: 1-800-883-6229

Website: <http://www.bushmaster.com> • E-mail: customerservice@bushmaster.com