



BROWNING®

The Best There Is.

OWNER'S MANUAL

VERY IMPORTANT:

Save This Booklet. Carefully read this entire manual before using your new Browning firearm.

BAR MARK II SAFARI
SEMI-AUTOMATIC RIFLE

NEW GUN OWNERS RECORD

KEEP THIS RECORD FOR FUTURE REFERENCE

Browning Model

Serial Number

Gauge / Caliber

Purchase Price

Purchased From

Date of Purchase

We are pleased that you have chosen a Browning BAR Mark II Rifle.

The BAR Mark II Safari incorporates the very finest in materials and craftsmanship. From the receiver and stock, to the working mechanism — you can see and feel traditional Browning Belgium craftsmanship. The BAR Mark II has been designed with innovative features that result in improved performance and operating convenience. With just reasonable care, this gun should provide you with many years of pleasure and dependable service. Please feel free to write us immediately if you have any observations regarding its performance and operation.

Thank you.



Route One, Morgan, Utah 84050

Distributed in Canada by Canada Sports Ltd./Lee, St-Laurent, Quebec H4S 1W6

Printed in Portugal

98 - 06

BAR MARK II SAFARI SEMI-AUTOMATIC RIFLE

You Are Responsible For Firearms Safety

As a gun owner, you accept a set of demanding responsibilities. How seriously you take these responsibilities can be the difference between life and death.

There is no excuse for careless or abusive handling of any firearm. At all times handle your rifle and any other firearm with intense respect for its power and potential danger.

PLEASE READ AND UNDERSTAND ALL OF THE CAUTIONS, PROPER HANDLING PROCEDURES AND INSTRUCTIONS OUTLINED IN THIS BOOKLET BEFORE USING YOUR NEW FIREARM.

- 1 *ALWAYS KEEP THE MUZZLE OF YOUR RIFLE POINTED IN A SAFE DIRECTION*, even though you are certain the rifle is unloaded. Never point any firearm at anything you do not intend to

shoot. Be extremely alert and aware of all persons and property within the range of your ammunition.

- 2 *NEVER RELY TOTALLY ON YOUR RIFLE'S MECHANICAL "SAFETY" DEVICE.*

The word "safety" describes a gun's trigger block mechanism, sear block mechanism, hammer block mechanism or firing pin block mechanism. These mechanical devices are designed to place your gun in a **SAFER** status. No guarantee can be made that the gun will not fire even if the "safety" is in the "on safe" position. See "Operation of the Safety" on page 5 for instructions on operation of this gun's "safety."

LIKE ANY MECHANICAL DEVICE, A "SAFETY" CAN SOMETIMES FAIL; IT CAN BE JARRED OR INADVERTENTLY MANIPULATED INTO AN UNSAFE CONDITION.

Mechanical "safeties" merely aid safe gun handling and are no excuse for pointing your rifle's muzzle in an unsafe direction.

While it is a good idea to "test" your rifle's mechanical "safeties" periodically for proper function,

NEVER TEST IT WHILE YOUR RIFLE IS LOADED OR POINTED IN AN UNSAFE DIRECTION.

Safe gun handling does not stop with your gun's mechanical "safety" devices — it starts there. Always treat this rifle with the respect due a loaded, ready-to-fire firearm.

- 3 *WHENEVER YOU HANDLE A FIREARM, OR HAND IT TO SOMEONE, ALWAYS OPEN THE ACTION IMMEDIATELY, VISUALLY CHECK YOUR RIFLE'S CHAMBER, FEED MECHANISM AND MAGAZINE.*

Make certain that they do not inadvertently contain any ammunition. Always keep the chamber empty and "safety" in the "on safe" position unless shooting is imminent.

- 4 *DO NOT TRANSPORT YOUR RIFLE LOADED, WHETHER IN A SCABBARD, GUN CASE, OR OTHER CONTAINER.*

- 5 *HUNTING FROM ELEVATED SURFACES SUCH AS TREE STANDS IS DANGEROUS,*

and may increase the risk of handling a firearm. The following rules should always be observed by you and those you hunt with: **Always** make certain that the stand being used is safe and stable. **Always** make certain that your firearm is unloaded when it is being taken up and down from the stand. **Always** make certain that your firearm is not dropped from the stand, or dropped while it is being taken up or down from the stand. **Remember**, a loaded firearm may discharge when dropped, even with the safety in the "on safe" position.

- 6 *BEWARE OF BARREL OBSTRUCTIONS,*

for the safety of both your gun and yourself. Mud, snow, and an infinite variety of other objects may inadvertently lodge in a barrel bore. It takes only one small obstruction to cause

dangerously increased pressures that can ruin (swell or rupture) the finest rifle barrels.

BEFORE CHECKING FOR A BARREL OBSTRUCTION, BE CERTAIN NO LIVE ROUND IS IN THE CHAMBER AND THAT THE MAGAZINE IS REMOVED AND FEED MECHANISMS ARE COMPLETELY EMPTY. PLACE THE "SAFETY" IN THE "ON SAFE" POSITION

Look through the barrel to be sure it is clear of any obstruction. If an obstruction is seen, no matter how small it may be, clean the bore with a cleaning rod and patch as described in "Cleaning and Maintenance Suggestions" on page 10 and 11. Before the first firing, clean the bore with a cleaning rod and patch, and wipe away any anti-rust compounds in the action/chamber areas.

7 **ALWAYS UNLOAD YOUR RIFLE WHEN NOT IN USE. REFER TO PAGE 7 OF THIS INSTRUCTION BOOKLET EXPLAINING THE UNLOAD-**

ING OF YOUR RIFLE.

As a safety precaution, it is preferable to disassemble your gun for storage. Store your gun and ammunition separately—well beyond the reach of children. Take all safeguards to ensure your rifle does not become available to untrained, inexperienced or unwelcome hands.

8 **USE THE PROPER AMMUNITION.**

The barrel and action of this rifle have been made with substantial safety margins over the pressures developed by established American commercial loads. Nevertheless, Browning assumes no liability for incidents which occur through the use of cartridges of nonstandard dimensions which develop pressures in excess of commercially available ammunition which has been loaded in accordance with standards established by the Sporting Arms and Ammunition Manufacturers' Institute (SAAMI).

BE ALERT TO THE SIGNS OF AMMUNITION MALFUNCTION.

If you detect an off sound or light recoil when a cartridge is fired, **DO NOT LOAD ANOTHER CARTRIDGE INTO THE CHAMBER** Open the action and remove all cartridges from the magazine, chamber and action areas. With the action open, glance down the barrel to make sure that an obstruction does not remain in the barrel. If there is an obstruction, completely clear the barrel before loading and firing again. Failure to follow these instructions can cause extensive damage to your gun and possible serious injury to yourself and others.

9 **DO NOT SNAP THE FIRING PIN ON AN EMPTY CHAMBER — THE CHAMBER MAY NOT BE EMPTY!**

Treat every gun with the respect due a loaded gun, even though you are certain the gun is unloaded.

10 **KEEP YOUR FINGERS AWAY FROM THE TRIGGER WHILE UNLOADING, LOADING, UNTIL YOU ARE READY TO SHOOT.**

11 **BE SURE OF YOUR TARGET AND BACK-STOP.**

Particularly during low light periods. Know the range of your ammunition. Never shoot at water or hard objects.

12 **ALWAYS UNLOAD YOUR RIFLE'S CHAMBER BEFORE CROSSING A FENCE, CLIMBING A TREE, JUMPING A DITCH OR NEGOTIATING OTHER OBSTACLES.**

Refer to page 7 of this instruction book for instructions on the unloading of your rifle. Never place your loaded rifle on or against a fence, tree, car, or other similar object.

13 **WEAR EYE AND EAR PROTECTION WHEN SHOOTING.** Unprotected, repeated exposure to gunfire can cause hearing damage. Wear ear protectors (shooting ear plugs or muffs) to guard against such damage. Wear shooting glasses to protect your eyes from flying particles. Allow proper distance (eye relief) between the scope and your eye when firing a scoped rifle or shotgun. Always keep a safe distance between the muzzle of your firearm and any persons

nearby, as muzzle blast, debris and ejecting shells could inflict serious injury. Also, wear eye protection when disassembling and cleaning your shotgun to prevent the possibility of springs, spring-tensioned parts, solvents or other agents from contacting your eyes.

14 **DROPPING A LOADED GUN CAN CAUSE AN ACCIDENTAL DISCHARGE** even with the "safety" in the "on safe" position. Be extremely careful while hunting or during any shooting activity, to avoid dropping any firearm.

15 **IF YOUR RIFLE FAILS TO FIRE, KEEP THE MUZZLE POINTED IN A SAFE DIRECTION.**

Hold this position for a minimum of 30 seconds. Carefully open the action and remove the cartridge. If the primer is indented, the cartridge should be disposed of in a way that cannot cause harm. If the primer is not indented, your firearm should be examined by a qualified gunsmith and the cause of the malfunction should be corrected before further use.

16 **BE DEFENSIVE AND ON GUARD AGAINST UNSAFE GUN HANDLING AROUND YOU AND OTHERS.**

Don't be timid when it comes to gun safety. If you observe other shooters violating any of these safety precautions, politely suggest safer handling practices.

17 **BE CERTAIN YOUR RIFLE IS UNLOADED BEFORE CLEANING.** Because so many gun accidents occur when a firearm is being cleaned, special and extreme care should be taken to be sure your gun is unloaded before disassembly, cleaning and reassembly. Keep ammunition away from the cleaning location. Never test the mechanical function of any firearm with live ammunition.

18 **TEACH AND SUPERVISE FIREARMS SAFETY TO ALL MEMBERS OF YOUR FAMILY — ESPECIALLY TO CHILDREN AND NONSHOOTERS.**

Closely supervise newcomers to the shooting sports. Encourage enrollment in hunting/shooting safety courses.

19 **NEVER DRINK ALCOHOLIC BEVERAGES OR TAKE ANY TYPE OF DRUGS BEFORE OR DURING SHOOTING.**

Your vision and judgment could be dangerously impaired, making your gun handling unsafe to you and to others.

20 **READ AND HEED ALL WARNINGS** in this instruction book, on ammunition boxes and with all accessories that you install on your firearm. It is your responsibility to secure the most up-to-date information on the safe handling procedures of your Browning gun. Browning assumes no liability for incidents which occur when unsafe or improper gun accessories or ammunition combinations are used.

21 **PERIODIC MAINTENANCE — AVOID UNAUTHORIZED SERVICING.**

Your rifle is a mechanical device which will not last forever, and as such, is subject to wear and requires periodic inspection, adjustment, and service. Browning firearms should be serviced by a Browning Recommended Service Center or by Browning's service facility in Arnold, Mis-

souri. Browning cannot assume any responsibility for injuries suffered or caused by unauthorized servicing, alterations or modifications of Browning firearms.

22 **BROWNING RESERVES THE RIGHT TO REFUSE SERVICE ON FIREARMS THAT HAVE BEEN ALTERED, ADDED TO OR SUBSTANTIALLY CHANGED.**

Removal of metal from barrel(s), or modifications of the firing mechanism and/or operating parts may lead to Browning's refusal of service on such firearms. Browning will charge the owner for parts and labor to return the firearm to original Browning specifications.

DO NOT, UNDER ANY CIRCUMSTANCES, ALTER THE TRIGGER, SAFETY OR PARTS OF THE FIRING MECHANISM OF THIS OR ANY OTHER FIREARM. FAILURE TO OBEY THIS WARNING MAY RESULT IN INJURY OR DEATH TO YOURSELF OR OTHERS.

BE CAREFUL!

Figure 1

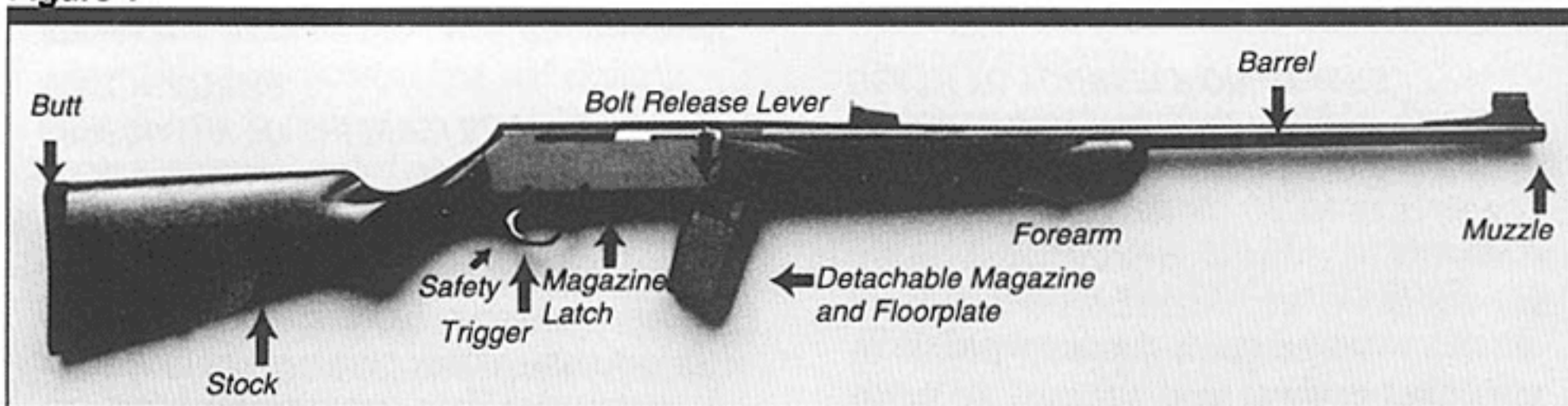
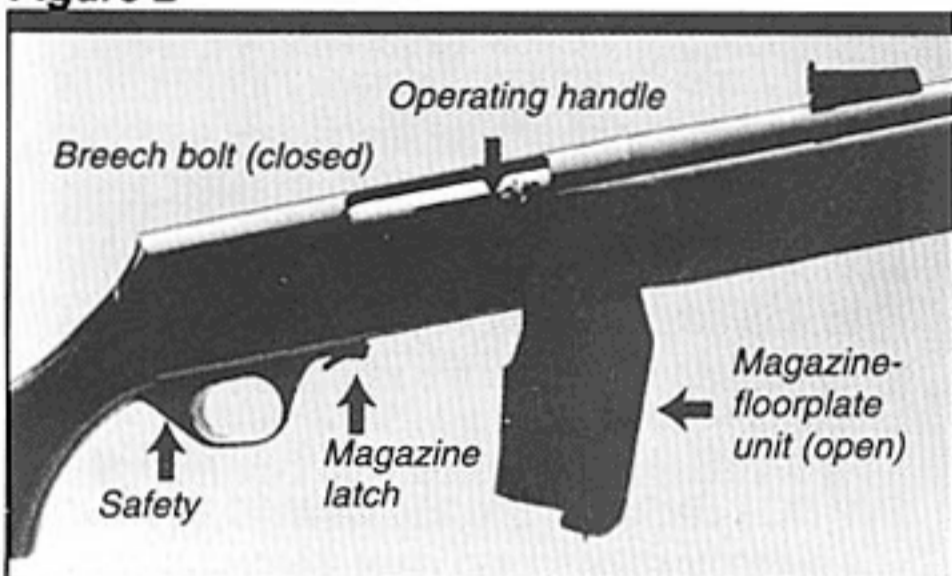

Figure 2



Nomenclature

In conventional gun terminology the position and movement of gun parts are described as they occur with the gun horizontal and in normal firing position; i.e., the muzzle is forward or in front; the buttstock is rearward or to the rear; the trigger is downward or underneath; the sights are upward or on top.

General Operating Procedure

Your new Browning BAR Mark II is a gas operated, semi-automatic repeating rifle. With cartridges in the magazine and the chamber and the safety in the OFF SAFE or FIRE position, the rifle will fire a single round with each successive pull of the trigger until the magazine and chamber are empty. When the last round has been fired, the bolt will be held in its rearward, or open position. This facilitates speedy, convenient loading. To close the bolt, simply depress the bolt release lever or pull the operating handle backward and release it. During this operation, exercise care that your fingers do not enter the ejection port in the receiver.

Operation of the Safety

CAUTION: THE "SAFETY" SHOULD BE KEPT IN ITS "ON SAFE" POSITION AT ALL TIMES EXCEPT WHEN ACTUALLY FIRING THE RIFLE. The crossbolt type safety is conveniently located on the trigger guard just rearward of the trigger. (See Figure 2) This is an ideal location for manipulation of the large safety head with the index finger of either hand. With the safety pushed completely to the right the rifle is ON SAFE and rearward movement of the trigger is completely blocked.

With safety pushed completely to the left the rifle is OFF SAFE and ready to fire. In this FIRE or OFF SAFE position a band of RED is visible on the safety where it projects beyond the left face of the trigger guard.

Whenever a cartridge is chambered, the rifle should be ON SAFE until it is ready to be fired.

Note: If a **left hand safety** is needed the safety can be reversed by a competent gunsmith or send it to our Arnold, Missouri Service Facility.

Loading the rifle

CAUTION: Keep your fingers clear of the ejection port at all times when the bolt is locked open. The bolt will close with considerable force, if you should depress the bolt release lever or pull the operating handle backward.

The Browning semi-automatic high power rifle utilizes a unique detachable box magazine. The capacity of the magazine is four rounds (three rounds for Magnum calibers). Another cartridge

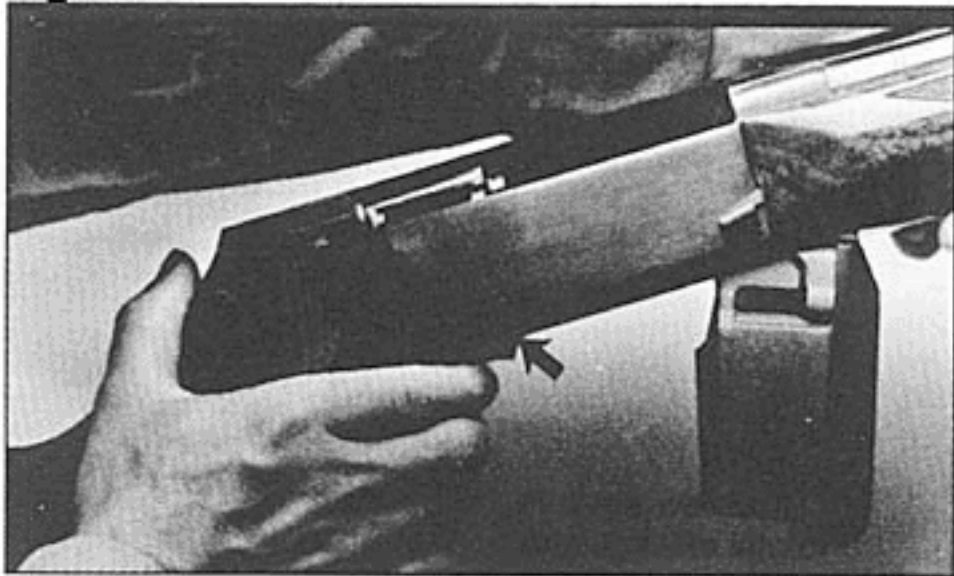
Figure 3

may be carried in the chamber, providing a total rifle capacity of five rounds (four rounds for Magnum calibers.)

To ready the rifle for loading, first insure that the safety is in the ON SAFE position.

Next, hold the rifle in a natural position with the barrel safely pointing at the ground. Holding the rifle at the forearm, pull rearward on the magazine latch with the index finger of the opposite

hand, allowing the hinged floorplate-magazine unit to swing downward. The magazine is now ready to be loaded. (See Figure 3)

If it is desired to load a round into the chamber prior to loading the magazine, the following steps should be taken. First, be sure the cross bolt safety is in the ON SAFE position. Hold the gun on its side with the barrel pointing safely downward with either hand at the rear of the forearm, as described earlier. With the rifle held in this position the ejection port in the receiver should be facing up. Next, with the magazine floorplate open and the bolt locked open, insert one round into the ejection port, allowing it to drop completely into the chamber. Then, close the bolt by depressing the bolt release lever. The bolt should be allowed to slam closed from its open position. If the bolt is not allowed to close in this manner, there is the possibility that it will not close completely, in which event the rifle will not fire.

Many sportsmen prefer to hunt with an empty chamber until in the presence of game. In this

Figure 4

situation, quietness in chambering a cartridge is sometimes of prime importance. To accomplish this, cycle the action slowly and quietly by pulling the operating to its full rear position and releasing it while keeping the operating handle controlled. You may want to first practice this with an empty chamber.

It is both convenient and fast to load the magazine while it is attached to the floorplate in the open position. However, some may prefer to load

the magazine after detaching it from the floorplate. Both methods will be described.

Loading the magazine with magazine attached to floorplate

Always be sure the gun is ON SAFE, and the muzzle is pointed in a safe direction, since there may be occasions when you will want to load or replenish the magazine while a round is chambered. Hold the rifle in a safe barrel down position, using either hand on the forearm and pull rearward on the magazine latch to allow the magazine floorplate to swing downward. Each cartridge should then be carefully inserted into the magazine against the pressure of the spring loaded follower, until it is retained by the metal rims of the magazine body. Care should be exercised in positioning each cartridge so that its base is to the rear of the magazine. If the nose of a cartridge protrudes beyond the end of the magazine, it could cause feeding problems or interfere with the closing of the magazine floorplate. (See Figure 4)

Figure 5

Loading the magazine with magazine detached from floorplate

Once again, place the rifle ON SAFE and be sure the muzzle is pointed in a safe direction. With the magazine-floorplate unit open the magazine may be detached by merely pulling it away from the hinged floorplate. To do so, grasp the sides of the magazine toward its rear with the thumb and middle finger of either hand. Then, pull the magazine away from the floorplate while at the

same time bearing against the projecting rear of the floorplate with the index finger. (See Figure 5)

The rifle may be supported in its barrel down position during this procedure with the opposite hand at the forearm. Once the magazine is detached it may be loaded with cartridges as described earlier. To re-attach, insert the small lip on the front face of the magazine into the matching groove in the forward end of the floorplate. Then snap the rear of the magazine firmly into place. Extra magazines may be carried loaded for rapid replacement of an empty magazine, using this same procedure.

After loading the magazine, attach it to the floorplate. Swing the magazine floorplate into place until retained by the magazine latch. If a round has not already been placed into the chamber, a round may be chambered by depressing the bolt release lever and allowing the bolt to slam closed.

Once a round has been chambered, the magazine-floorplate unit may again be opened at any time desired for refilling to capacity.

Unloading the rifle

With the rifle ON SAFE and pointed in a safe downward direction release the magazine-floorplate to its open position. Grasp the bolt operating handle and move it to the rear, thereby extracting and ejecting any live round in the chamber. The magazine may then be detached and either kept loaded or the cartridges may be stripped from it with the thumb of either hand. As is always good safety practice, visually inspect the chamber to be absolutely sure a round is not still present. Once this is determined the bolt may be allowed to close.

To unload the magazine merely push forward on the base of each round until it clears the retaining rims. The last step is to close the floorplate either

without the magazine or with an empty magazine in place.

Trigger

The trigger mechanism has been adjusted at the factory to provide a short crisp pull, yet one consistent with safety. The trigger is a single stage design with the weight of pull holding closely to 4 pounds. It is recommended that no attempt be made to change the weight of pull of the trigger.

Removing the Trigger Group

This procedure should rarely, if ever, need to be performed. However, if the receiver area of your BAR should become excessively dirty it may be helpful to remove the trigger group and expose the inner cavity of the receiver for cleaning.

DO NOT ALTER OR ATTEMPT TO DISASSEMBLE ANY PART OF THE TRIGGER GROUP OR REMOVE OR DISASSEMBLE THE BREECH BOLT MECHANISM.

BROWNING BAR MARK II SEMI-AUTOMATIC RIFLE

Schematic is provided for parts identification only and should not be used as a guide to assemble guns.

IMPORTANT: When ordering parts, list part number, part name, caliber, model and serial number.

(Do not order parts using key numbers.)

CAUTION: Browning parts are made exclusively for Browning guns and are not recommended for use in other guns even though models may be similar. Inadequately fitted parts may be dangerous.

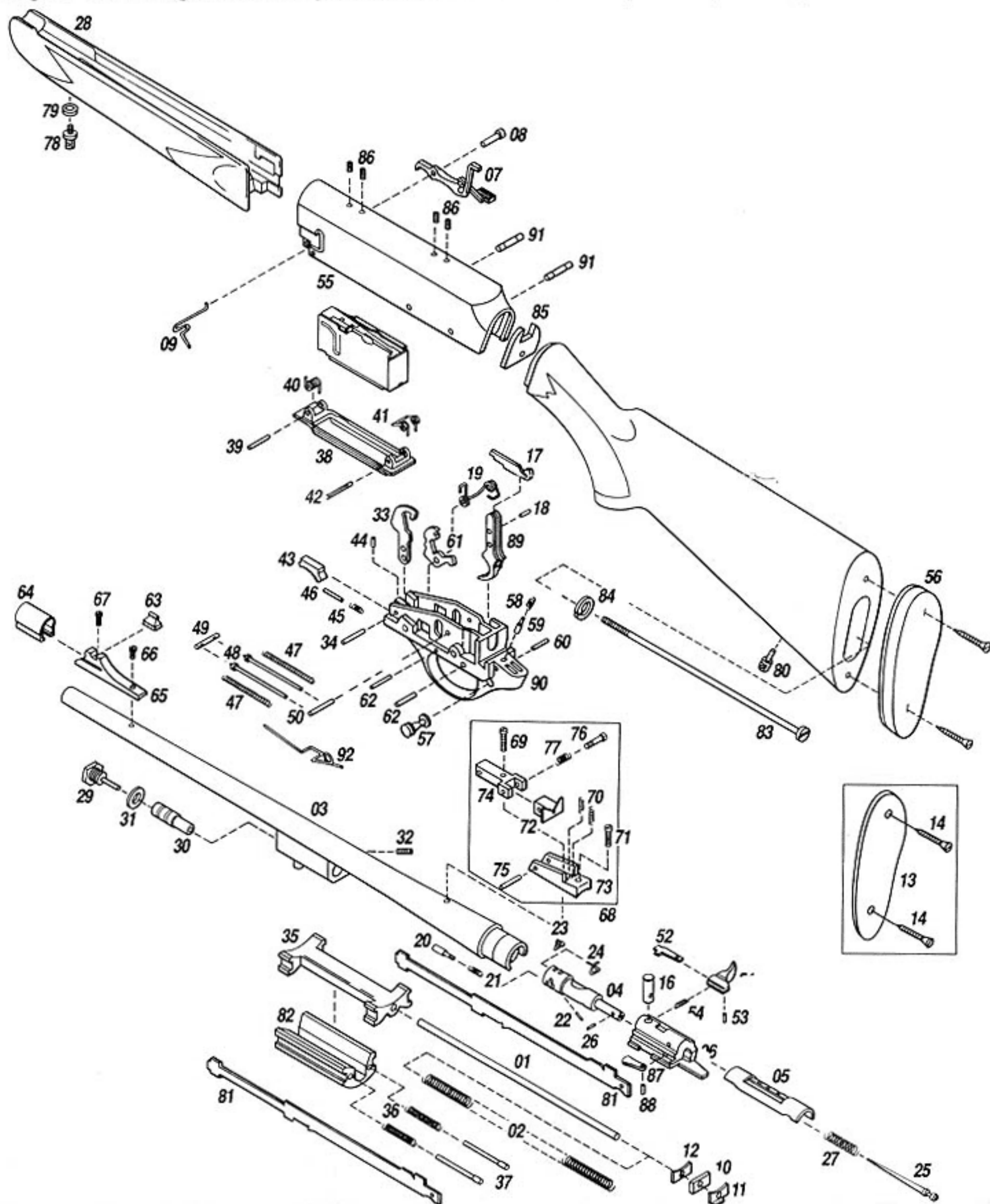

Parts List: Browning BAR Mark II Semi-Automatic Rifle

Standard Calibers—243 Win., 308 Win., 270 Win., 30-06 Sprg.

Magnum Calibers—7 mm Rem Mag., 300 Win. Mag., .270 Weatherby Mag.

If not specified—Fits All Calibers

Information on High Grade Rifles is available upon request.

Do not order parts using key numbers.

KEY#	PART NO.	DESCRIPTION	KEY#	PART NO.	DESCRIPTION	KEY#	PART NO.	DESCRIPTION
01	PO76760	Action Spring Guide BAR II	25	PO76110	Firing Pin BAR I & II	62	PO76813	Sear Pin/Trigger Pin BAR II
02	PO76006	Action Spring BAR I & II	26	PO76114	Firing Pin Retaining Pin BAR I & II	63	PO76603	Sight Gold Bead Front .327 BAR II
03	*PO76532	Barrel 22" W/O Sights or Front Ramp, 243 Win. BAR II	27	PO76117	Firing Pin Spring BAR I & II	63	PO76604	Sight Gold Bead Front .358 BAR II
03	*PO76540	Barrel 22" W/O Sights or Front Ramp, 270 Win. BAR II	28	*PO76968	Forearm—Standard Calibers BAR II	63	PO76605	Sight Gold Bead Front .390 BAR II
03	*PO76548	Barrel 22" W/O Sights or Front Ramp, 308 Win. BAR II	28	*PO76971	Forearm—Magnum Calibers BAR II	64	PO76621	Sight Hood Front BAR II
03	*PO76536	Barrel 22" W/O Sights or Front Ramp, 30-06 Sprg. BAR II	28	PO76124	Forearm Escutcheon BAR I & II	65	*PO76601	Sight Ramp Front BAR II
03	*PO76576	Barrel 24" W/O Sights or Front Ramp, 7 mm Rem. Mag. BAR II	29	PO76665	Gas Cylinder Cap BAR II	66	*PO76279	Sight Ramp Screw Short BAR I & II
03	*PO76572	Barrel 24" W/O Sights or Front Ramp, 300 Win. Mag. BAR II	30	PO76679	Gas Piston BAR II	67	*PO76278	Sight Ramp Screw Long BAR I & II
03	*PO76580	Barrel 24" W/O Sights or Front Ramp, 338 Win. Mag. BAR II	31	PO76670	Gas Regulator Gasket BAR II	68	PO76657	Sight Assembly Rear STD Caliber BAR II
04	*PO76038	Bolt—243 Win., 308 Win., 270 Win., 30-06 Sprg. BAR I & II	32	PO76671	Gas Regulator Screw BAR II	68	PO76656	Sight Assembly Rear MAG Caliber BAR II
04	*PO76040	Bolt—338 Win., 7 mm Rem. Mag., 300 Win. Mag. BAR I & II	33	*PO76830	Hammer BAR II	69	PO76653	Sight Elevation Screw Rear BAR II
			34	PO76834	Hammer Pin BAR II	71	PO76654	Sight Elevation Spring Rear (2) BAR II
			35	PO76770	Inertia Piece BAR II	71	PO76655	Sight Mounting Screw Rear BAR II
			36	PO76771	Inertia Piece Spring (2) Bar II	72	PO7665B	Sight Aperature BAR II
			37	PO76772	Inertia Piece Spring Rod (2) Bar II	73	PO7665C	Sight Base MAG BAR II
			38	PO76745	Magazine Floorplate All Caliber BAR II	73	PO7665E	Sight Base STD BAR II
						74	PO7665F	Sight Elevation bar BAR II
	*PO76045	Bolt Assembly—243 Win., 308 Win., 270 Win., 30-06 Sprg. BAR I & II	39	PO76184	Magazine Floorplate Pivot Pin All Caliber BAR I & II	75	PO7665G	Sight Elevation bar pin BAR II
	*PO76048	Bolt Assembly—338 Win., 7 mm Rem. Mag., 300 Win. Mag. BAR I & II	40	PO76713	Magazine Floorplate Spring BAR II	76	PO7665H	Sight Windage Screw BAR II
05	PO76759	Bolt Cover BAR II	41	PO76711	Magazine Retaining Spring BAR II	77	PO7665J	Sight Windage Screw Spring BAR II
06	PO76060	Bolt Sleeve—243 Win., 308 Win., 270 Win., 30-06 Sprg. BAR I & II	42	PO76712	Magazine Retaining Spring Pin BAR II	78	PO76284	Sling Eyelet Front BAR I & II
06	PO76062	Bolt Sleeve—7 mm Rem. Mag., 300 Win. Mag. BAR I & II	43	PO76886	Magazine Latch BAR II	79	PO76286	Sling Eyelet Washer BAR I & II
07	PO76784	Bolt Release BAR II	44	PO76890	Magazine Latch Pin BAR II	80	PO76288	Sling Eyelet Rear BAR I & II
08	PO76787	Bolt Release Pin BAR II	45	PO76204	Magazine Latch Spring BAR I & II	81	PO76752	Slide BAR Right or Left BAR II
09	PO76788	Bolt Release Positioning Spring	46	PO76205	Magazine Latch Spring Plunger BAR I & II	82	PO76754	Slide Head BAR II
10	PO76065	Buffer BAR I & II	47	PO14286	Mainspring A-500 & BAR II	83	PO14350	Stock Bolt A-500 & BAR II
11	PO76780	Buffer Plate Front BAR I & II	48	PO76838	Mainspring Guide—Right or Left BAR II	84	PO76294	Stock Bolt Plate BAR I & II
12	PO76779	Buffer Plate Rear BAR I & II	49	PO76840	Mainspring Guide Support BAR II	85	PO14358	Stock Bolt Washer A-500 & BAR II
13	*PO14080	Butt Plate A-500 & BAR I & II	50	PO76842	Mainspring Support BAR II	86	PO76310	Telescope Mount Filler Screws (4 Each) BAR I & II
14	PO14079	Butt Plate Screws A-500 & BAR I & II	51	PO76228	Operating Handle BAR I & II	87	*PO76314	Timing Latch BAR I & II
15	*PO76902	Butt Stock—Standard Calibers BAR II	52	PO76232	Operating Handle Lock BAR I & II	88	PO76316	Timing Latch Retaining Pin BAR I & II
15	*PO76905	Butt Stock—Magnum Calibers BAR II	53	PO76236	Operating Lock Pin BAR I & II	89	*PO76811	Trigger BAR II
16	PO76076	Cam Pin BAR I & II	54	PO76238	Operating Lock Spring BAR I & II	90	PO76800	Trigger Guard BAR II
17	*PO76872	Disconnecter BAR II	55	†PO76690	Receiver STD Standard Calibers BAR II	91	PO76878	Trigger Guard Retaining Pin (2) BAR II
18	PO76874	Disconnecter Pin BAR II	55	†PO76680	Receiver MAG Magnum Calibers BAR II	92	PO76882	Trigger Guard Retaining Pin Spring BAR II
19	PO76826	Disconnecter Spring BAR II	56	*P208453	Recoil Pad BAR I & II			
20	PO76090	Ejector BAR I & II	57	PO76860	Safety BAR II			
21	PO76096	Ejector Retaining Pin BAR I & II	58	PO76868	Safety Spring BAR II			
22	PO76099	Ejector Spring BAR I & II	59	PO76866	Safety Spring Plunger BAR II			
23	PO76101	Extractor BAR I & II	60	PO76870	Safety Spring Retaining Pin BAR II			
24	PO76105	Extractor Spring BAR I & II	61	*PO76818	Sear BAR II			

*Indicates part must be fitted by Browning Service Dept. or qualified gunsmith.

†Part may be purchased only by holders of current valid federal firearms license.

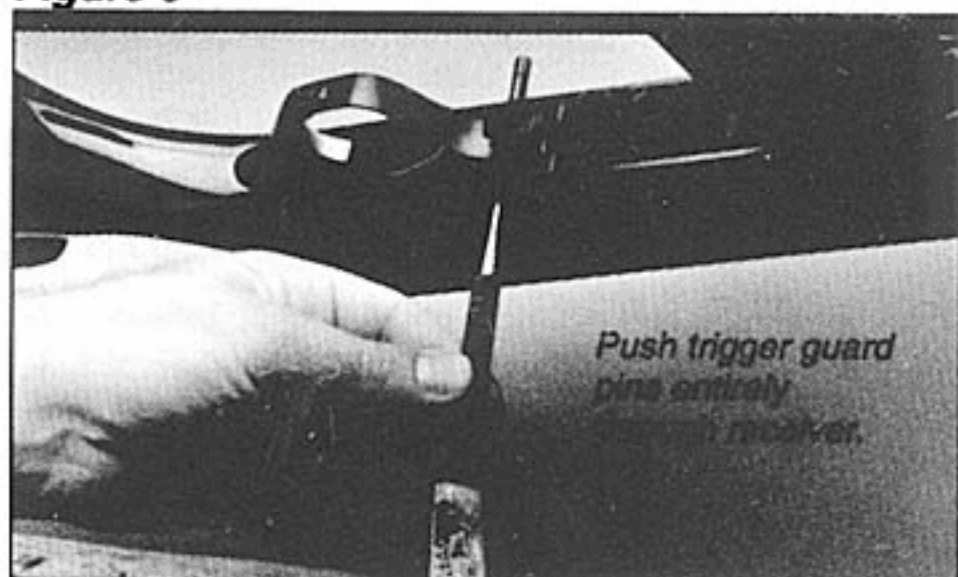
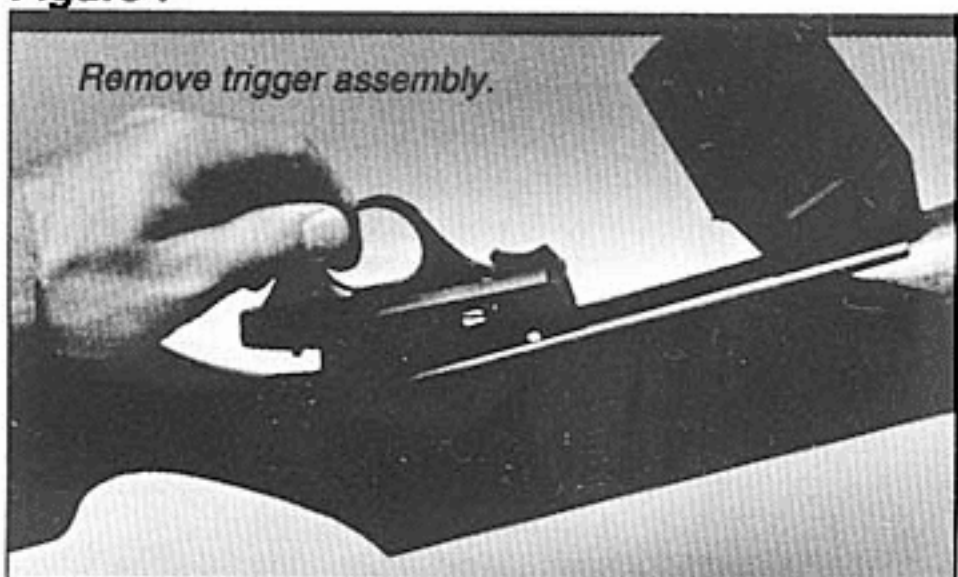
Figure 6**Figure 7**

If any service of the trigger group becomes necessary, take your BAR Mark II to a recommended Browning Service Center or send it to our service center in Arnold, Missouri.

Disassembly

- 1 First, make certain the gun is totally unloaded and the "safety" is ON SAFE.
CHECK THE MAGAZINE, FEED MECHANISM AND CHAMBER TO BE SURE THEY DO NOT CONTAIN ANY SHELLS.
- 2 Release the breechblock to its forward position by depressing the bolt release lever. Swing open the magazine.
- 3 Push in the two trigger guard pins from either the right or left side of the receiver. Use a drive punch or similar object, using caution not to scratch the gun's receiver. (See Figure 6) Push the trigger guard pins clear through the receiver.

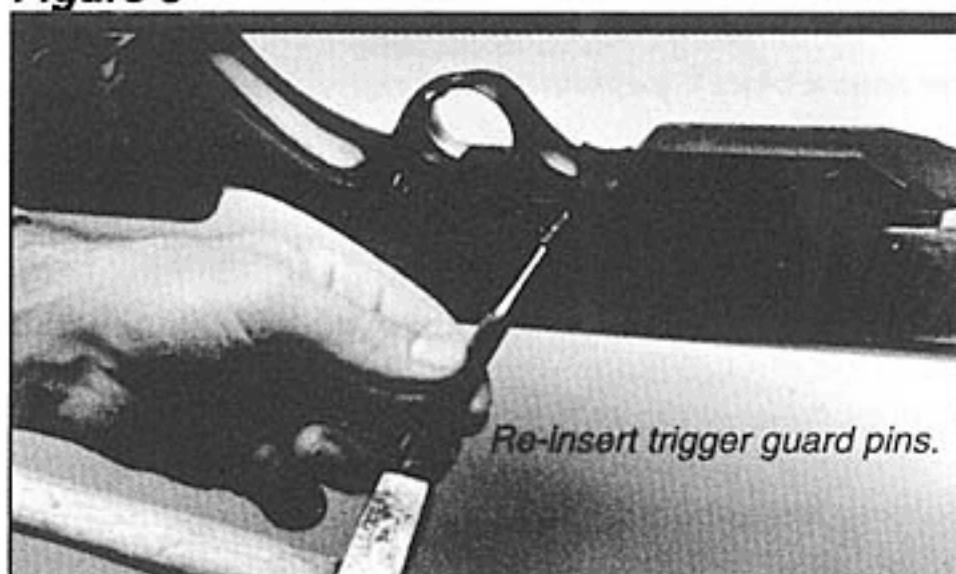
Figure 8

- 4 Grasp the trigger guard and pull the trigger assembly out of the receiver. (See Figure 7)
- 5 Perform any cleaning of the parts and receiver cavity as necessary.

DO NOT DISASSEMBLE THE TRIGGER GROUP BEYOND THIS POINT.

Trigger Group Reassembly

- 1 Before reinstalling the trigger group, make sure that the breech bolt is fully forward and engaged in the locked position.
- 2 Insert the trigger group back into the receiver, lining up the holes in the trigger assembly with the holes on each side of the receiver.
- 3 Re-insert the trigger guard pins from either side of the receiver and gently tap them into place again using caution not to scratch the receiver. (See Figure 8)

Cleaning suggestions

The correct procedure for cleaning your rifle is as follows:

- 1 **BE CERTAIN THE RIFLE IS UNLOADED AND THE SAFETY IS IN THE ON SAFE POSITION.** Again, to unload your rifle, eject any live round in the chamber by pulling the operating handle to the rear. Unload the magazine by pushing forward on the base of each round until it clears the retaining rims.

- 2 **PULL THE BOLT FULLY REARWARD WITH THE OPERATING HANDLE.** It will be held in this open position even with the magazine removed.
- 3 **USING A RIFLE CLEANING ROD WITH TIP AND PATCH LARGE ENOUGH FOR SNUG FIT IN BORE,** insert rod and patch in barrel from the muzzle end and run back and forth several times. Caution should be exercised to insure that the cleaning rod or handle does not strike the crown of the muzzle, as damage to this area can adversely affect the accuracy of the rifle.
- 4 **INSPECT THE CHAMBER AND BORE FOR POWDER FOULING.** A normal amount of powder residue can be expected and is not serious. It can usually be removed by repeating Step Number 3, using a patch saturated with nitro-solvent. If or when fouling should become heavy, it can be removed with a brass bore brush. Dip the brush in nitro-solvent and scrub

the chamber and bore until the fouling is removed. To prevent brass bristles from breaking off, the brush should be pushed completely through the bore before being withdrawn. Your BAR will operate smoother and more reliable with a clean bore and chamber.

- 5 **AFTER FOULING HAS BEEN REMOVED, THE BORE SHOULD BE WIPED DRY.** Then pass a slightly oiled patch run through it for preservation. A fine, light gun oil like Browning Oil is recommended.
- 6 **THE INTERIOR OF THE RECEIVER AND THE BOLT SHOULD PERIODICALLY BE WIPED OFF WITH A CLEAN RAG.** This is best done with the trigger group removed, see "Removing the Trigger Group", and with the magazine floorplate open and the bolt in its open position.

Any dried oil in these areas and on the magazine follower should be removed. Follow this cleaning by applying a very light film of oil on the affected parts. Do not pour large quantities

- of oil into the action. An excess of oil will run into the wood and cause it to soften or warp.
- 7 **WIPE ALL EXPOSED METAL SURFACES WITH AN OILED CLOTH, MAKING SURE TO WIPE GUN CLEAN OF ALL FINGER MARKS.** Finger marks should be removed because they provide a place where moisture can accumulate. Ordinary good judgment will, of course, indicate that the metal of the gun should receive a light film of oil any time the gun has been exposed to adverse weather or handling.
- 8 **THE WOOD SURFACES OF YOUR BAR CAN ALSO BE WIPED LIGHTLY WITH BROWNING OIL,** or you can apply a quality wood or furniture polish to the stock and forearm. Using one of these methods (not both), will enhance the beauty and durability of your BAR.
- 9 **CLEANING INSTRUCTIONS:** To insure proper functioning of your BAR it should be periodically inspected and cleaned. Any time when sluggish or incomplete operation of the action

is experienced while using commercial ammunition, the action should be cleaned. The following procedure should be followed:

Disassembly

NEVER ATTEMPT TO TAKE YOUR BAR APART FURTHER THAN EXPLAINED IN THIS MANUAL.

This is a specialized, finely fitted mechanism. You may permanently mar it by attempting to disassemble the inner mechanism assemblies. If further disassembly for service or cleaning is required, take your gun to a Browning recommended Service Center or a competent gunsmith, or send it to our Arnold, Missouri Service Facility as explained under "Service or Repair".

- 1 **BE CERTAIN THE RIFLE IS UNLOADED.**
With the rifle in the ON SAFE position and pointed in a safe downward direction, release the magazine floorplate to its open position. Grasp the bolt operating handle and move it smartly to the rear, thereby extracting and

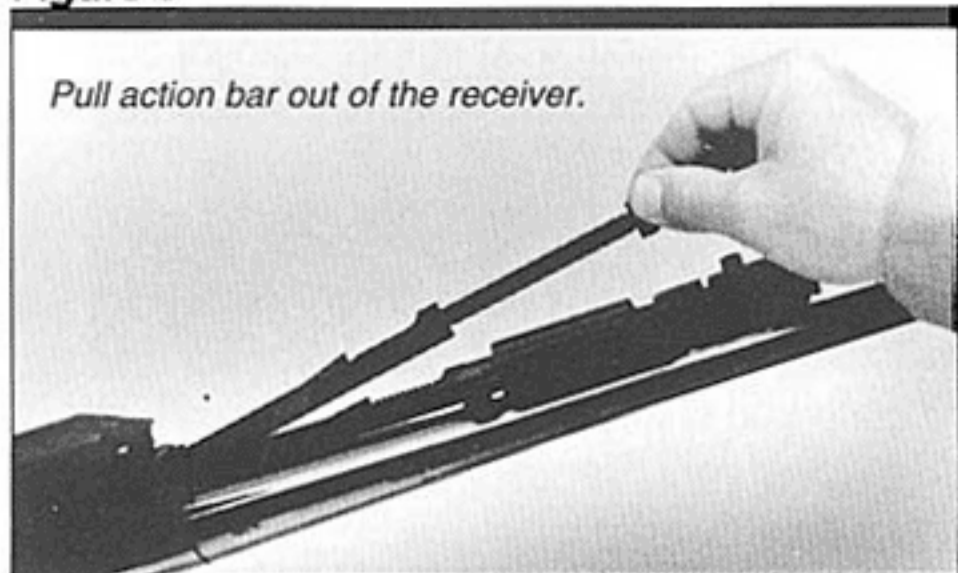
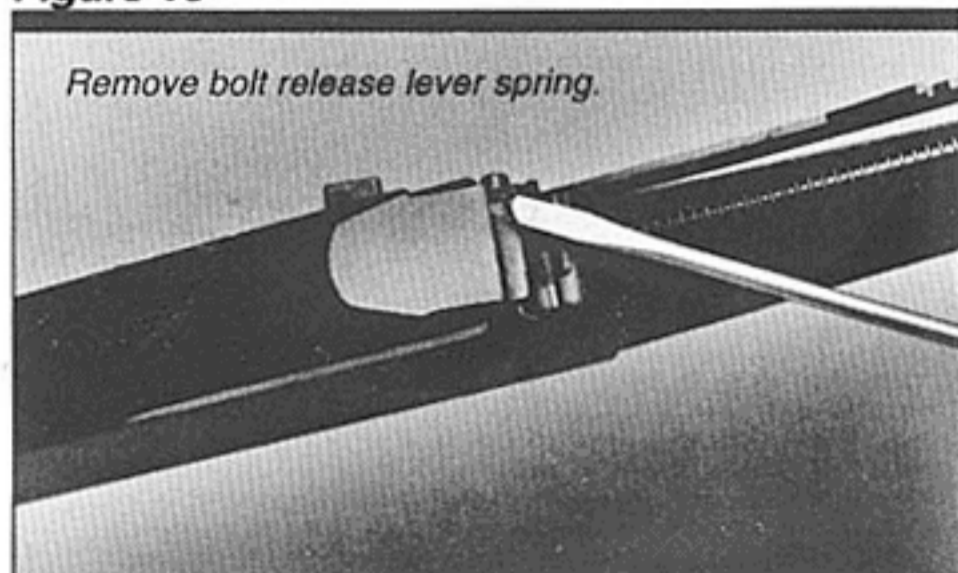
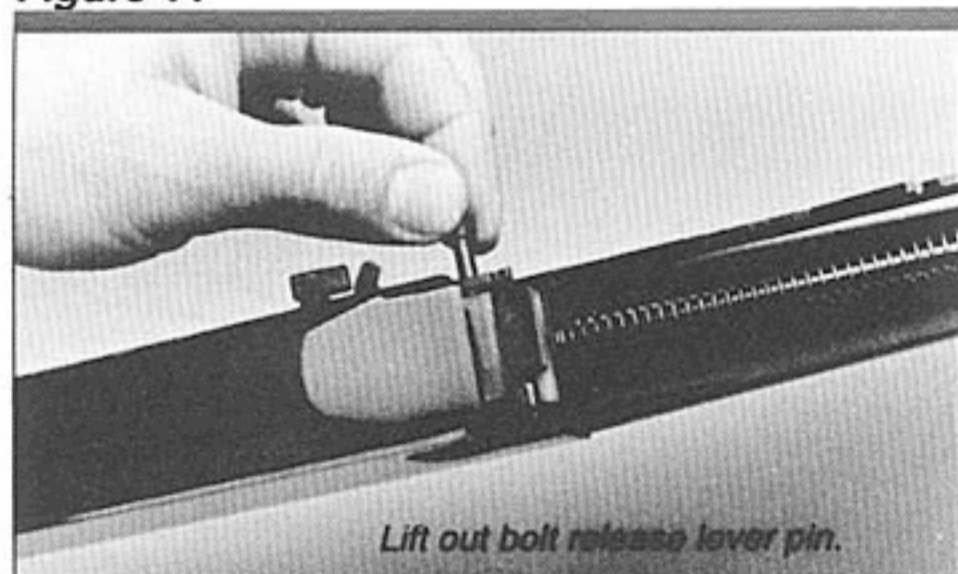
Figure 9**Figure 10****Figure 11**

ejecting any live round in the chamber. Remove all rounds from the magazine clip on the hinged floorplate. Always visually inspect the chamber to make sure there are no rounds present. (See page 7 for instructions on removing and unloading the magazine).

- 2 Remove forearm: Loosen and remove the forearm swivel eyelet with a small wrench by turning in a counter-clockwise direction. Care should be taken to prevent scratching the fore-

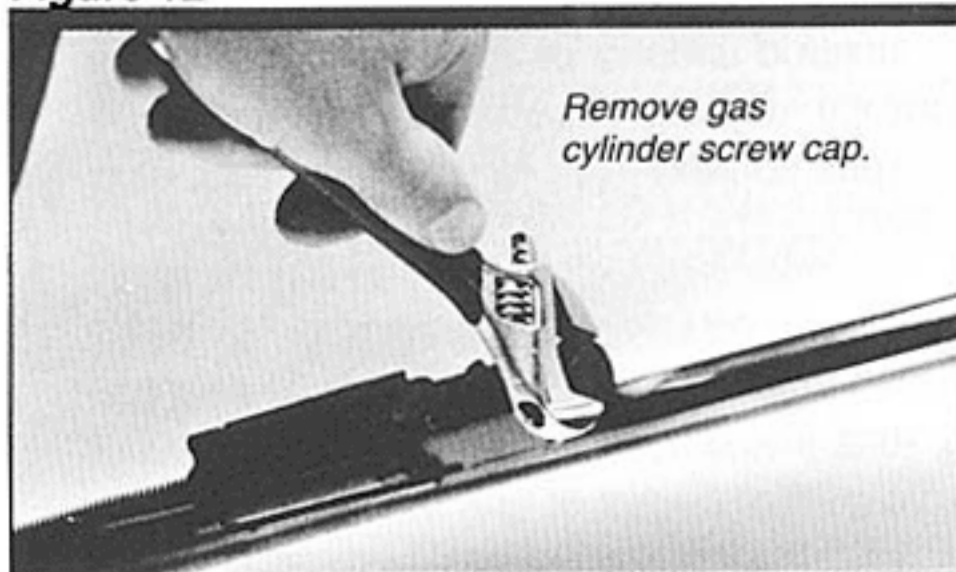
Figure 12

arm. Grasp the forward end of the forearm and pull away from the barrel carefully until firm resistance is felt. Then slide the forearm forward and off. (The forearm must be pulled away from the barrel so that the forearm will clear the bottom of the gas cylinder as the forearm is moved forward.) Note: The forearm cannot be removed unless the bolt is locked open. In order to lock the bolt open, the magazine clip must be on the hinged floorplate.

- 3 Remove action bars: Close the bolt by depressing the bolt release lever. To remove the left action bar pull the forward end away from its slot on the inertia piece. Then lower and pull the action bar forward and out of the receiver. (See Figure 9) Remove the right action bar by first releasing the bolt release lever spring from the bolt release lever and removing the spring from the receiver. (See Figure 10) Remove the bolt release lever pin and pull the bolt release lever forward and out of the receiver. (See Figure 11) You can then pull the forward end of the action bar away from the inertia piece and lower and pull the action bar out of the receiver.
- 4 Remove gas cylinder screw cap from the forward end of the gas cylinder: Turn in a counter-clockwise direction. (See Figure 12) Use a 11/16" wrench for this operation.
- 5 Remove the gas piston: The inertia block should be pulled back toward the receiver until rear face of the gas piston can be pushed for-

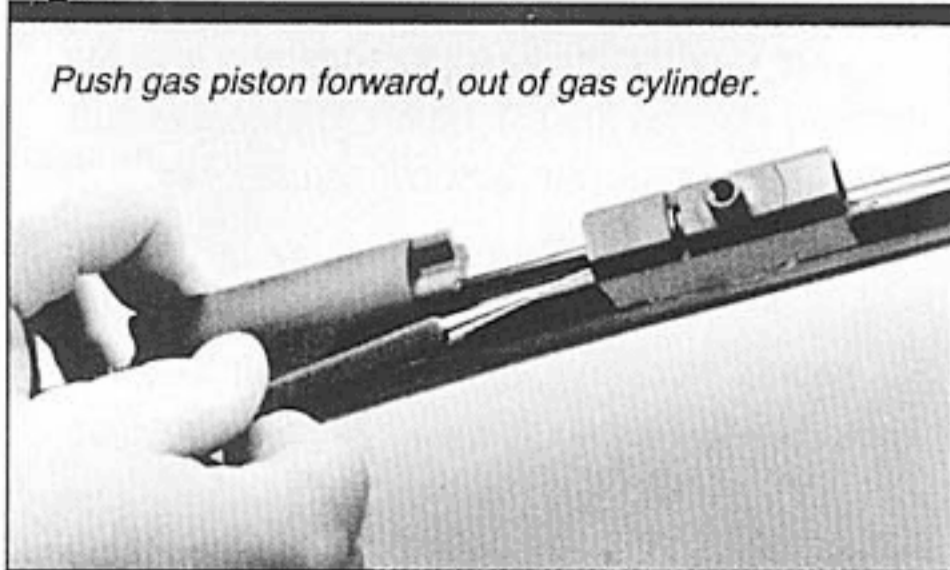
Figure 13

Push gas piston forward, out of gas cylinder.

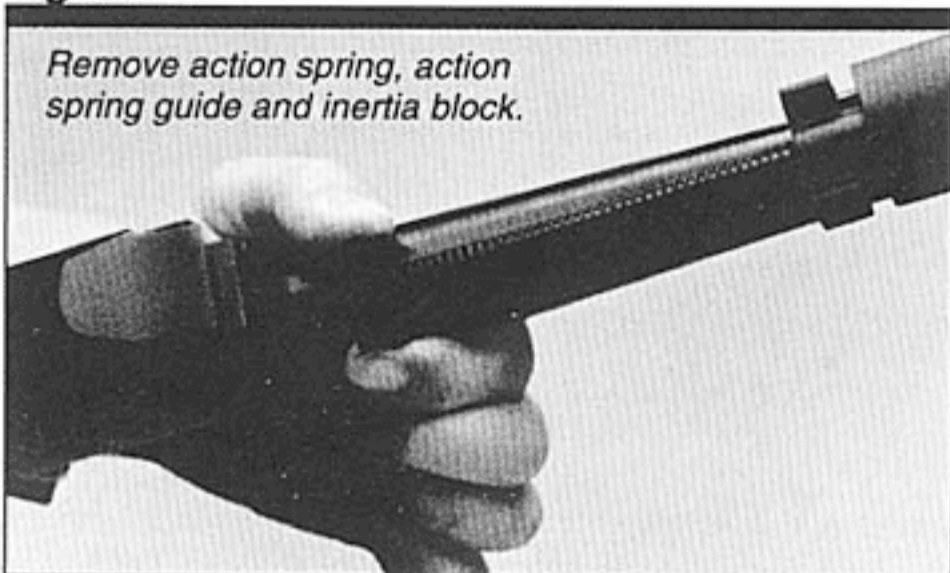
Figure 14

Remove action spring, action spring guide and inertia block.

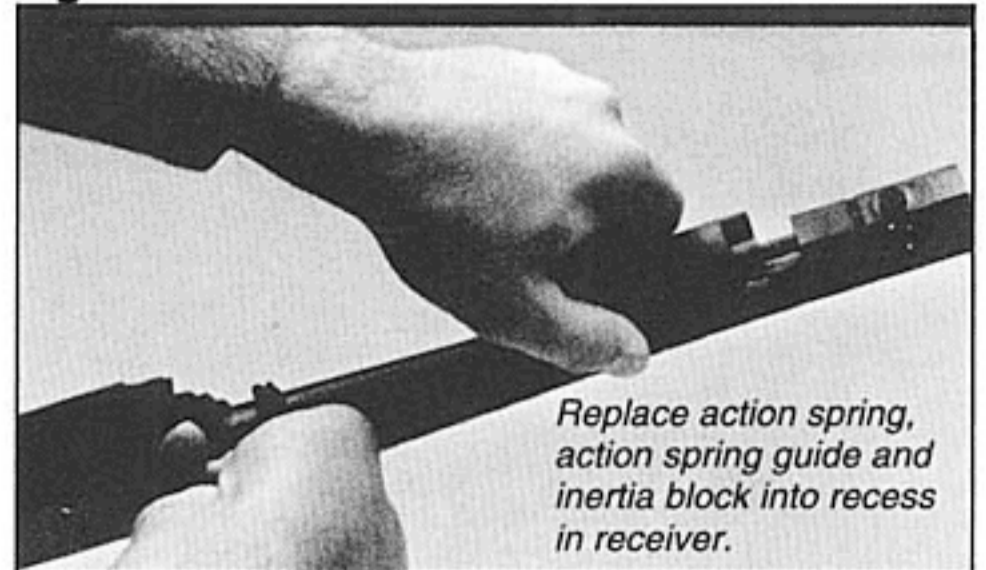
Figure 15

Replace action spring, action spring guide and inertia block into recess in receiver.

ward out of the gas cylinder with a small drive punch. (See Figure 13) *Note: An extremely dirty gas cylinder and gas piston may require forcefully moving the gas piston forward with a hammer and drive punch, and extreme care must be used to avoid scoring parts. If the gas piston will not move with moderate force, place a couple of drops of nitro-solvent around the gas piston, wait about 15 minutes, and then try to push the piston out with the drive punch. If the piston still will not move, put more nitrosolvent on the piston and allow it to set overnight before attempting to remove the piston.*

- 6 Remove the inertia block, action spring, and action spring guide: Tightly grip by hand the rear portion of the action and action spring guide and pull forward toward gas cylinder until the action spring guide is clear of its recess in the receiver. The rear end of the action spring guide can then be moved to one side of the receiver and then rearward to remove the

action spring, action spring guide, and inertia block. (See Figure 14)

The gas cylinder can now be examined for accumulations of residue. Residues in the gas cylinder and on the gas piston should be thoroughly removed with a good quality powder solvent or bore cleaner. If residues are heavy, they can be removed by scrubbing the gas cylinder with a 20 gauge shotgun bronze wire bore brush and a good solvent.

*Note: the gas cylinder screw located on the gas cylinder is set at the factory. **DO NOT CHANGE THE SETTING ON THE GAS CYLINDER SCREW.** Any changes to the gas cylinder screw may adversely affect the accuracy and operation of your rifle.*

The gas piston, gas cylinder, and other parts covered by the forearm should be wiped with a very lightly oiled cloth after cleaning. The gas cylinder interior and the gas piston **SHOULD NOT BE OILED** beyond this.

Reassembly

- 1 Replace the action spring, action spring guide, and inertia block: Grasp the action spring, action spring guide, and inertia block and push the action spring and guide forward until it fits into the gas cylinder. (See Figure 15) Position the other end of the action spring guide into the recess in the receiver.

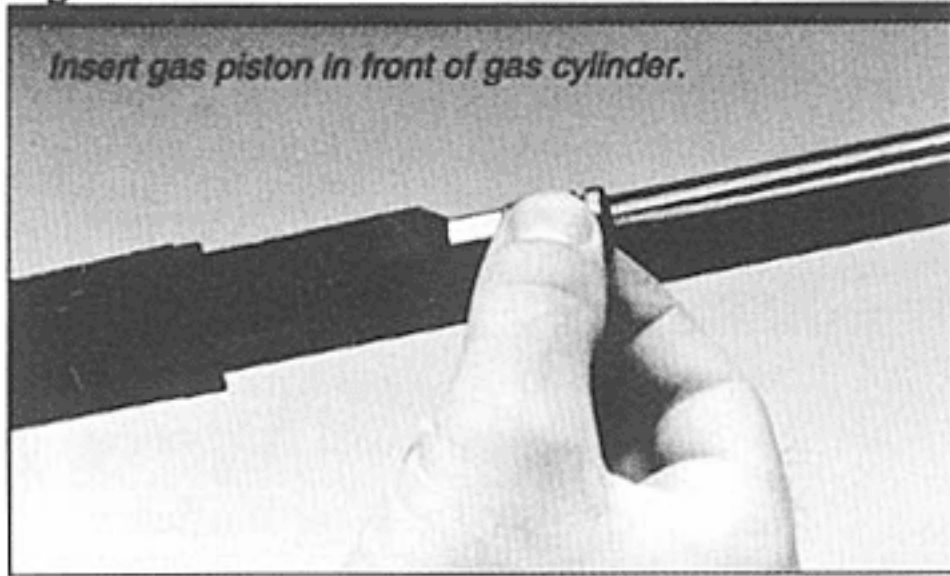
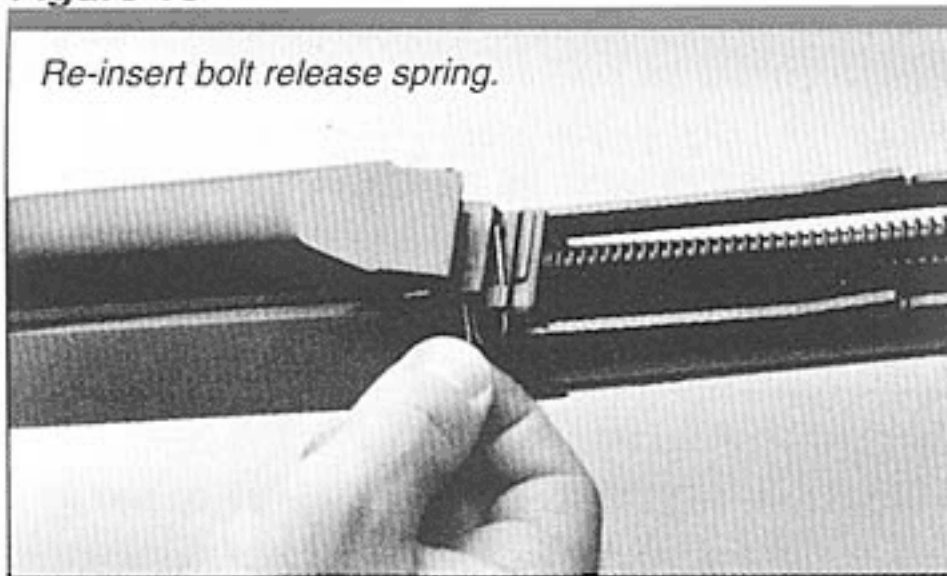
Figure 16**Figure 17****Figure 18**

- 2 Insert the gas piston into the front of the gas cylinder: Make sure the end of the gas piston with the hole goes in first. (See Figure 16) Push the gas piston rearward so the end of the action spring guide fits into the hole in the gas piston. To be sure that the gas piston is properly aligned in the gas cylinder, the gas piston should be able to be pushed partially out of

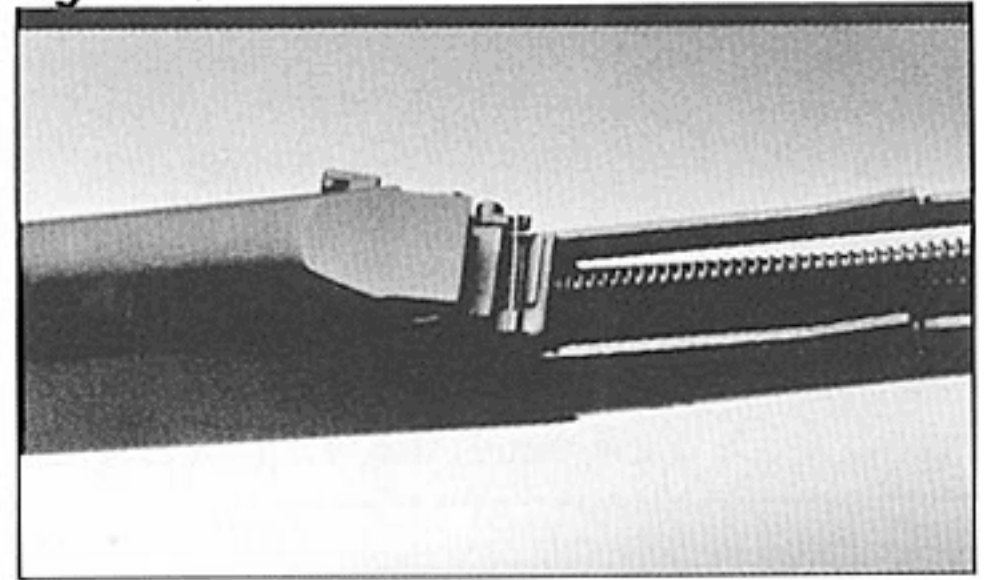
Figure 19

the rear end of the gas cylinder when the inertia block is pulled away from the gas cylinder.

- 3 Screw on and tighten the gas cylinder screw cap on the front of the gas cylinder.
- 4 Replace the action bars: Place the bolt in its forward position. It is helpful to release the magazine floorplate to the open position so you can check alignment of the action bars on the bolt. Place the projecting section of each action bar carefully in its corresponding slot in

the bolt before the action bar is fit onto the inertia piece. (See Figure 17) The action bars are interchangeable. It may be necessary to pull the inertia piece slightly rearward to engage the action bars.

- 5 Replace the bolt release spring and bolt release lever and pin: Close the magazine floorplate and keep the bolt in its forward position. Replace the bolt release spring. (See Figure 18) Replace the bolt release lever. Line the hole in the bolt release lever with the hole in the receiver and insert the bolt release pin. Lock the bolt release spring onto the bolt release lever. (See Figure 19)
- 6 With the bolt locked in the open position, slide the forearm all the way down until it fits onto the receiver. When fitting the forearm onto the receiver, grasp the forward end of the forearm

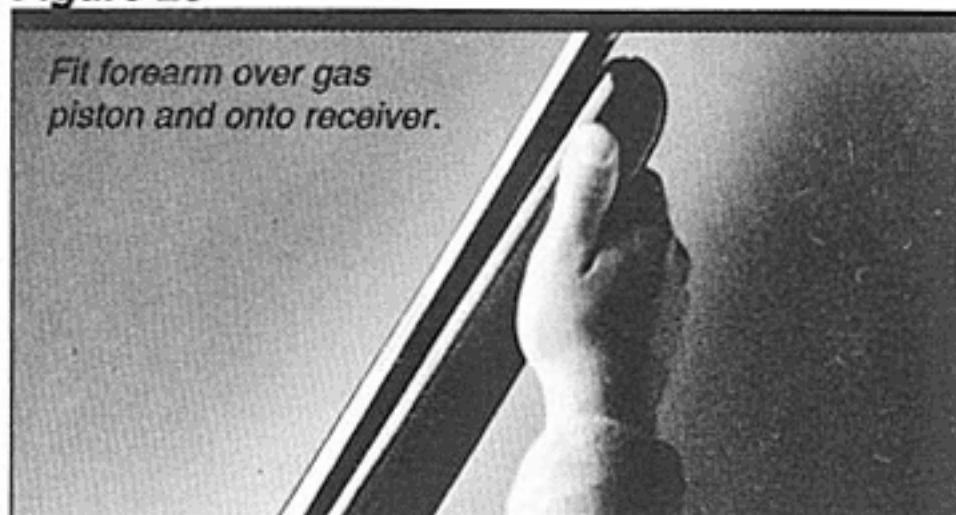
Figure 20

and pull it away from the barrel. (See Figure 20) Be very careful in reassembly of the forearm, since it can be broken if forced into position incorrectly.

Adjusting the Sight

The BAR is available with or without open sights. Always unload your rifle before making any alignment to the sights. Remember, always move your rear sight in the same direction you want the point of the bullet impact to move. If you want the point of bullet impact to move to the left, move the rear sight setting to the left. If you want to raise the point of impact, raise your rear sight setting.

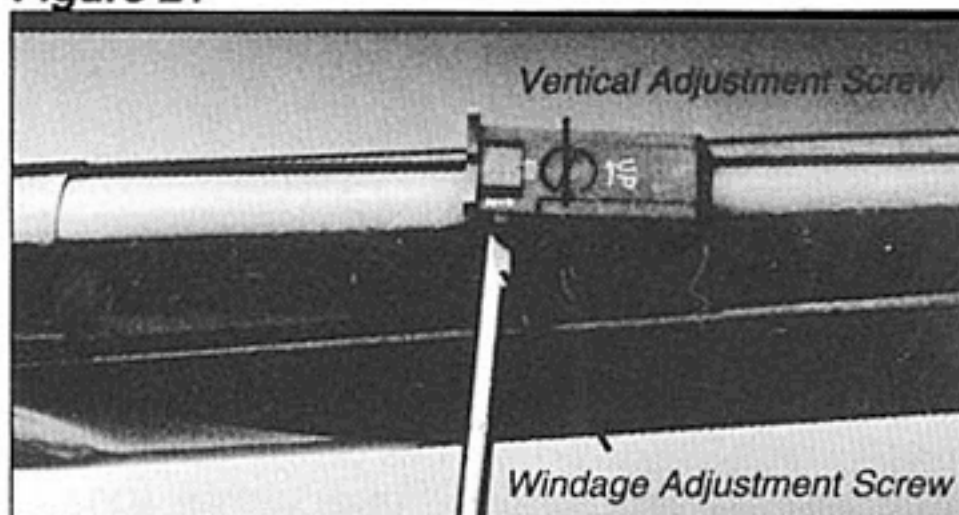
Figure 21

- 1 If horizontal or windage correction is desired, loosen or tighten the screw on the side of the rear sight notch to the desired setting (See Figure 21). Each calibration mark represents approximately 1/4 inches movement of the point of impact at 100 yards.
- 2 If vertical correction is desired, loosen or tighten the vertical adjustment screw located in front of the rear sight notch. Again, calibration marks on the sight represent approximately 1/4 inches at 100 yards.

Service or Repair

If your firearm should require service or repairs, we suggest you first contact a local recommended Browning Firearms Service Center. Contact your Browning sporting goods dealer or call our Service Department for the address of the Service Center nearest you. Otherwise, you may send your firearm directly to our own Service Department. For technical questions about your firearm or service call our Service Department.

Browning Service Department
3005 Arnold Tenbrook Road
Arnold, Missouri 63010-9406
Phone: 1-800-322-4626

Canadian Customers call or write:

Browning Canada Sports Ltd./Ltee,
5617 Chemin St-Francois
St-Laurent, Quebec H4S 1W6
Phone: (514) 333-7261

When returning your firearm for servicing, you *must* do the following:

- a. Be sure it is completely unloaded.
- b. Package it securely in a cardboard container.
- c. Enclose a letter with your firearm that clearly describes the trouble experienced and the repairs or alterations desired.
- d. If convenient, send a copy of the letter to us separately.
- e. Never return ammunition with your firearm. It is against postal and most commerce regulations.

If you have any questions about this manual or about any other Browning products, call or write our Consumer Information Department:

Browning Consumer Information
Morgan, Utah 84050
Phone: (801) 876-2711