

**B-92
FIELD
SERVICE
MANUAL**



BROWNING FIELD SERVICE MANUAL

B-92

This manual is written to assist trained gunsmiths in the repair and servicing of Browning products. It should never be used by an untrained person to repair any firearm. Read the entire manual carefully and pay special attention to the portions dealing with safety.

TABLE OF CONTENTS

SECTION	DESCRIPTION	PAGE
I	GENERAL DESCRIPTION AND FUNCTIONAL OPERATION	1
II	PARTS SCHEMATIC	2-3
III	INSPECTION AND DISASSEMBLY INTO SUB-ASSEMBLIES	4
	1. Pre-Disassembly Inspection	4
	2. Disassembly Into Sub-Assemblies	4
IV	DISASSEMBLY OF SUB-ASSEMBLIES INTO COMPONENT PARTS, INSPECTION AND REASSEMBLY OF SUB-ASSEMBLIES	4
	1. Disassembly of the Receiver Assembly	4
	2. Inspection of Components and Reassembly of the Receiver Assembly	5
	3. Disassembly of the Breech Bolt Assembly	6
	4. Inspection of Components and Reassembly of the Breech Bolt Assembly	6
	5. Inspection of the Butt Stock Lower Tang Assembly	6
	6. Inspection of the Cocking Lever Assembly	6
	7. Inspection of the Hammer Assembly	6
	8. Final Assembly	6
	9. Final Inspection	7
V	TROUBLESHOOTING/POSSIBLE CAUSES/SOLUTIONS	7
VI	SPECIAL INSTRUCTIONS	7
	1. Recommended Points of Lubrication During Reassembly	7
	2. Parts Information	7

BROWNING FIELD SERVICE MANUAL

IMPORTANT SAFETY WARNINGS

Before performing any instructions given throughout this manual, be certain to read the **NOTES** and **CAUTION** notes given in regard to those instructions. Generally, these precautionary notes follow the related instructions.



Failure to obey a Safety Warning **CAUTION** may result in injuries to you or to others.

Failure to obey a **NOTE** regarding the repair process may result in incorrect procedure which could cause malfunctions and/or damage to the firearm.



CAUTIONS:

1. Be certain the firearm is unloaded before proceeding with any service work.
2. Appropriate safety glasses should be worn by service personnel and bystanders when removing or reinstalling any springs or spring-loaded components.
3. As noted in the attached parts list on Page 2, some of the Browning supplied spare parts must be fitted by Browning Service Department in Arnold, Missouri or by qualified gunsmiths. No other persons should attempt to fit these specific parts.
4. If for any reason it becomes necessary to load and discharge this firearm, it is recommended that reference be made to the Owners Manual for proper loading, handling and safety procedures. These manuals are supplied with each new firearm and extra copies may be obtained by contacting Browning, Route # 1, Morgan, Utah 84050.
5. Read all of the instructions, cautions and notes on any step involving assembly or disassembly before proceeding with that step.
6. Section VI provides recommended points of lubrication and parts information.
7. **CAUTION:** Browning parts are made exclusively for Browning guns and are not recommended for use in other guns even though models may be similar. Inadequately fitted parts may be dangerous. All repairs should be done only by qualified gunsmiths.

SECTION I

GENERAL DESCRIPTION AND FUNCTIONAL OPERATION

The B-92 is a centerfire, tubular Magazine, lever action rifle. Magazine capacity is eleven rounds in both .357 and .44 Magnum models.

For functional operation explanation, assume the rifle is loaded and ready to fire. Rounds in the Magazine are pushed to the rear by pressure from the Magazine Spring. The next round to be chambered rests above the Carrier with its rim against a shoulder on top of the Carrier. The Cartridge Stop keeps the forward end of this round in the depressed position.

After the chambered round is fired and downward pressure is exerted on the Cocking Lever, the Friction Stud is forced inward from against the forward edge of the Butt Stock Lower Tang unlocking the Lever.

Slight downward movement of the Cocking Lever causes two shoulders on its forward end to cam the Firing Pin backward and blocks it there as long as the Cocking Lever is opened. (Thus the rifle cannot be fired unless the Action is locked by virtue of the Cocking Lever being completely closed.)

Continued downward movement of the Cocking Lever causes the two Locking Bolts to be withdrawn from the Breech Bolt to unlock the Action.

Further downward movement of the Cocking Lever causes the Breech Bolt to retract and extract the empty round, override and cock the Hammer.

Ejection occurs when the Breech Bolt has retracted sufficiently to clear the empty round from the Chamber. Ejection is caused by pressure against the base of the empty round exerted by the compressed Ejector Spring and Ejector.

Downward movement of the Cocking Lever is stopped when a protrusion at the forward end of the Lever strikes and causes the forward end of the Carrier to rotate upward.

When the forward end of the Carrier is rotated upward, it lifts the round above it for chambering. Additional rounds are retained in the Magazine by the forward end of the Carrier and the Cartridge Stop.

When the Cocking Lever is raised toward the closed position, the Breech Bolt is brought forward against the base of the fresh round above the Carrier. The round is further raised by making contact with the Left and Right Cartridge Guides and is chambered as the Breech Bolt is brought forward.

In moving forward, the lower edge of the Ejector, located in the face of the Breech Bolt, overrides and starts rotating the forward end of the Carrier downward. The forward end of the Carrier is finally rotated fully downward by a curved surface on the

forward end of the Cocking Lever. At this time, the next round to be chambered is released from the Magazine as the face of the Breech Bolt cams the forward end of the Cartridge Stop outward.

When the Cocking Lever has been fully closed, the two Locking Bolts have been lifted to lock the Action and the Firing Pin unblocked permitting the next round to be fired.

The Cocking Lever is finally locked again in the closed position by the Friction Stud coming to rest above the forward edge of the Butt Stock Lower Tang.

SECTION II

PARTS SCHEMATIC B-92

Browning 92 Lever Action Rifle

357 Magnum & 44 Rem. Magnum Calibers

PART NO.	PART NAME	PART NO.	PART NAME	
†*	PO72004	Barrel with Receiver, 44 Mag.	* PO72109	Ejector Stop Pin
†*	PO72006	Barrel with Receiver, 357 Mag.	PO72112	Ejector Stop Pin Plug Screw
*	PO72012	Breech Bolt, 44 Mag.	* PO72116	Extractor, 44 Mag.
*	PO72014	Breech Bolt, 357 Mag.	* PO72118	Extractor, 357 Mag.
	PO72016	Butt Plate	PO72120	Extractor Pin
	PO72018	Butt Plate Screw	* PO72124	Firing Pin
*	PO72024	Butt Stock	PO72130	Firing Pin Stop Pin
	PO72030	Butt Stock Lower Tang	* PO72135	Forearm
	PO72034	Butt Stock Tang Screw	* PO72142	Forearm Band
*	PO72038	Carrier, 44 Mag.	PO72146	Forearm Band Pin
*	PO72040	Carrier, 357 Mag.	PO72150	Friction Stud
	PO72042	Carrier Screw	PO72154	Friction Stud Spring
	PO72046	Carrier Striker	PO72158	Friction Stud Stop Pin
	PO72049	Carrier Striker Pin, 44 Mag.	* PO72162	Hammer
	PO72050	Carrier Striker Pin, 357 Mag.	PO72166	Hammer Screw
	PO72052	Carrier Striker Spring	* PO72170	Loading Gate Cover
*	PO72055	Cartridge Guide Left, 357 Mag.	PO72173	Loading Gate Cover Screw
*	PO72056	Cartridge Guide Left, 44 Mag.	* PO72176	Locking Bolt Left
*	PO72059	Cartridge Guide Right, 357 Mag.	* PO72180	Locking Bolt Right
*	PO72060	Cartridge Guide Right, 44 Mag.	PO72184	Magazine Follower, 44 Mag.
	PO72064	Cartridge Guide Pin	PO72185	Magazine Follower, 357 Mag.
	PO72068	Cartridge Guide Screw, 44 Mag.	PO72187	Magazine Plug
*	PO72069	Cartridge Guide Stop, 357 Mag.	PO72190	Magazine Plug Screw
	PO72070	Cartridge Guide Screw, 357 Mag.	PO72194	Magazine Spring
*	PO72072	Cartridge Stop	PO72198	Magazine Tube
*	PO72076	Cartridge Stop Spring	PO72202	Mainspring
*	PO72078	Cocking Lever, 357 Mag.	PO72206	Mainspring Guide Inner
*	PO72080	Cocking Lever, 44 Mag.	PO72210	Mainspring Guide Outer
	PO72079	Cocking Lever Attachment, 357 Mag.	PO72214	Mainspring Guide Stud
	PO72081	Cocking Lever Attachment Plunger, 357 Mag.	* PO72218	Muzzle Clamp
	PO72082	Cocking Lever Attachment Pin, 357 Mag.	PO72222	Muzzle Clamp Screw
	PO72083	Cocking Lever Attachment Spring, 357 Mag.	PO72232	Sight Assembly, Front, 44 Mag.
	PO72084	Cocking Lever Pin	PO72235	Sight Assembly, Front, 357 Mag.
	PO72086	Cocking Lever Stop Screw	PO72244	Sight Rear
*	PO72090	Ejector, 44 Mag.	PO72248	Sight Elevator Rear
*	PO72091	Ejector, 357 Mag.	* PO72252	Trigger
	PO72094	Ejector Collar	PO72256	Trigger Pin
	PO72098	Ejector Collar Stop	PO72260	Trigger Spring
	PO72102	Ejector Collar Stop Pin	PO72264	Trigger Spring Screw
	PO72106	Ejector Spring		

* Indicates part must be fitted by Browning Service Department or qualified gunsmith.

† Part may be purchased only by holders of current valid Federal Firearms License.

* Indicates part must be fitted by Browning Service Department or qualified gunsmith.

† Part may be purchased only by holders of current valid Federal Firearms License.

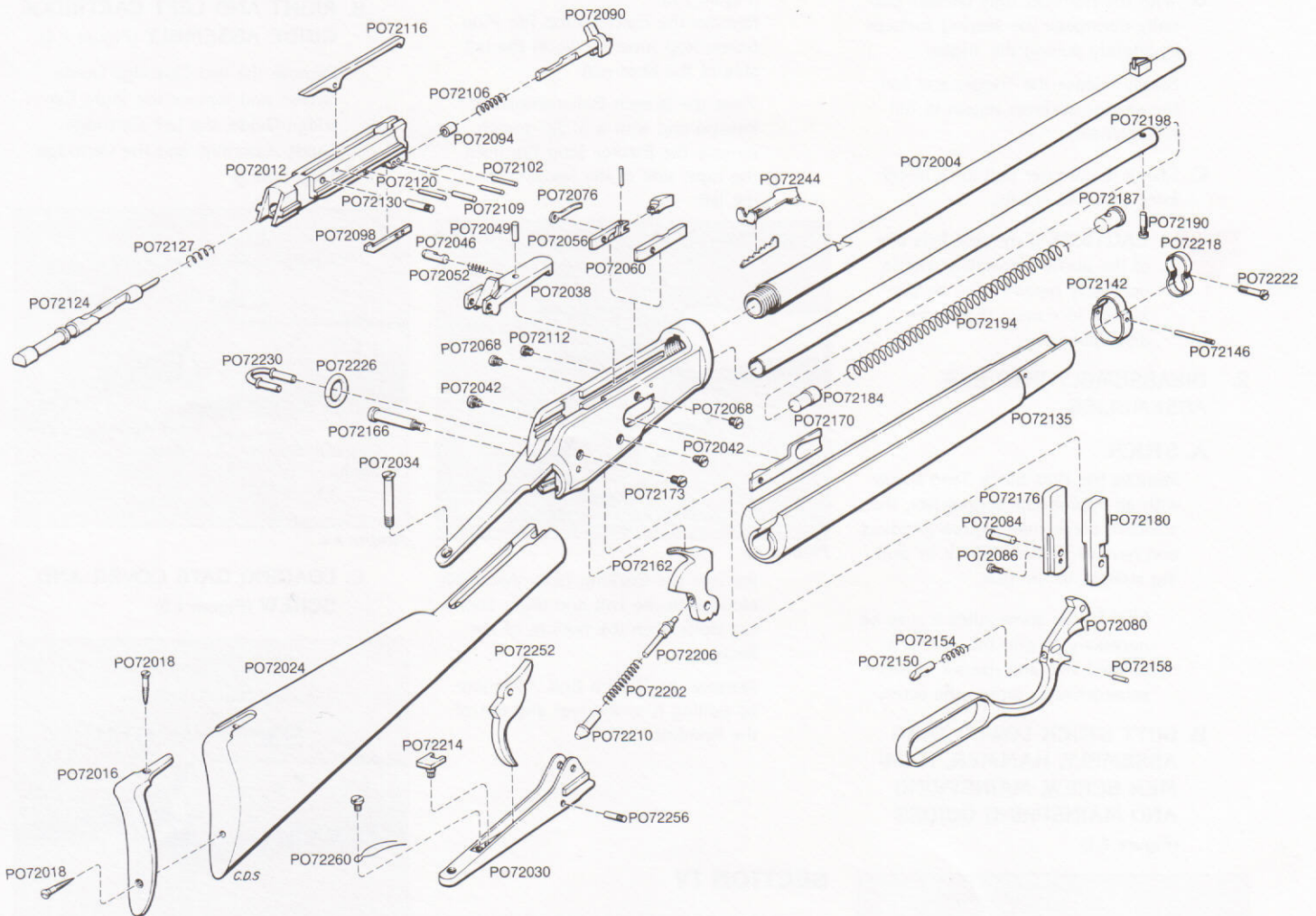
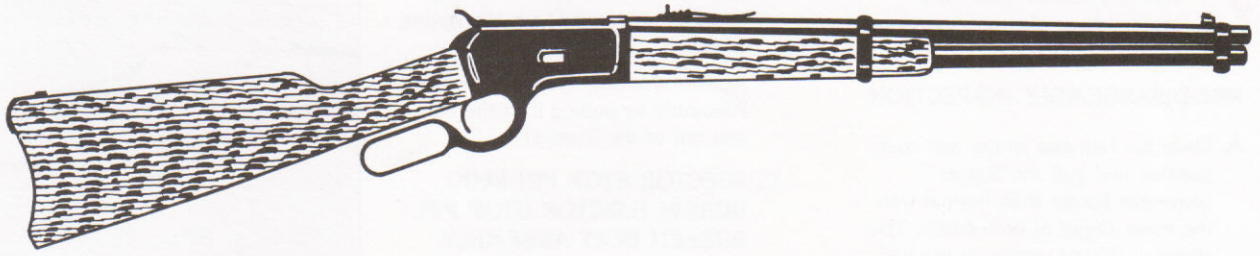

Schematic is provided for parts identification only and should not be used as a guide to assemble guns.

SECTION III

INSPECTION AND DISASSEMBLY INTO SUB-ASSEMBLIES



CAUTION: Make certain the rifle is unloaded before any inspection or disassembly operations are performed.

1. PRE-DISASSEMBLY INSPECTION

- A. Place the Hammer in the half cock position and pull the Trigger somewhat harder than normal with the index finger of both hands. The Hammer should remain in the half cock position during this procedure.
- B. With the Hammer fully cocked, partially disengage the searing surfaces by slightly pulling the Trigger.

Slowly release the Trigger and feel the searing surfaces regain to full engagement.
- C. Check the Trigger pull for a let-off force of 4.5 to 6.5 lbs.



CAUTION: If the rifle fails any of the above inspection criteria, necessary repairs must be performed to correct those discrepancies.

2. DISASSEMBLY INTO SUB-ASSEMBLIES

A. STOCK

Remove the Butt Stock Tang Screw with an appropriate screwdriver, the standard blade may require grinding, and remove the Butt Stock by pulling straight to the rear.

NOTE: On some rifles it may be necessary to grip the rifle in a padded vise and use an impact screwdriver to loosen the screw.

- B. BUTT STOCK LOWER TANG ASSEMBLY, HAMMER, HAMMER SCREW, MAINSPRING AND MAINSPRING GUIDES (Figure # 1)

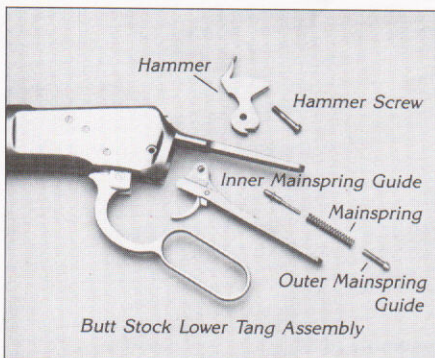

FIGURE # 1

Lower the Hammer to the fired position.

Remove the Hammer Screw from the left side of the Receiver.

Slightly lower the Cocking Lever and remove the Hammer, Mainspring and the Inner and Outer Mainspring Guides.

Remove the Butt Stock Lower Tang Assembly by pulling it to the rear and out of the Receiver.

C. EJECTOR STOP PIN PLUG SCREW, EJECTOR STOP PIN, BREECH BOLT ASSEMBLY, COCKING LEVER ASSEMBLY AND LOCKING BOLTS

(Figure #2)

Remove the Ejector Stop Pin Plug Screw, (top most screw on the left side of the Receiver).

Move the Breech Bolt completely forward and with a 3/32" punch, remove the Ejector Stop Pin from the right side of the Receiver to the left.

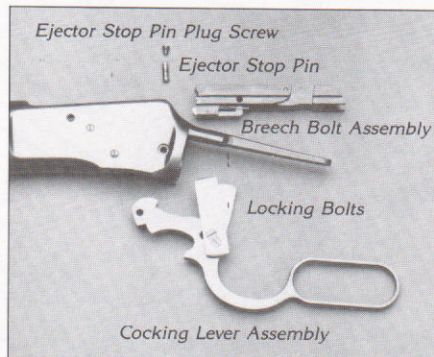

FIGURE # 2

Remove the Cocking Lever Assembly along with the Left and Right Locking Bolts from the bottom of the Receiver.

Remove the Breech Bolt Assembly by pulling it to the rear and out of the Receiver.

SECTION IV

DISASSEMBLY OF SUB-ASSEMBLIES INTO COMPONENT PARTS, INSPECTION AND REASSEMBLY OF SUB-ASSEMBLIES

1. DISASSEMBLY OF THE RECEIVER ASSEMBLY

A. CARRIER ASSEMBLY

(Figure #3)

Remove the left and right Carrier Screws and remove the Carrier by

prying it to the rear and out of the Receiver with a blade screwdriver.

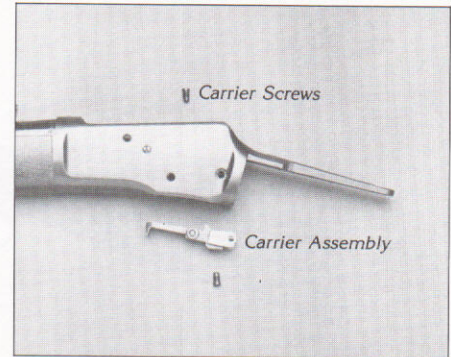

FIGURE # 3

B. RIGHT AND LEFT CARTRIDGE GUIDE ASSEMBLY (Figure #4)

Remove the two Cartridge Guide Screws and remove the Right Cartridge Guide, the Left Cartridge Guide Assembly and the Cartridge Stop Spring.

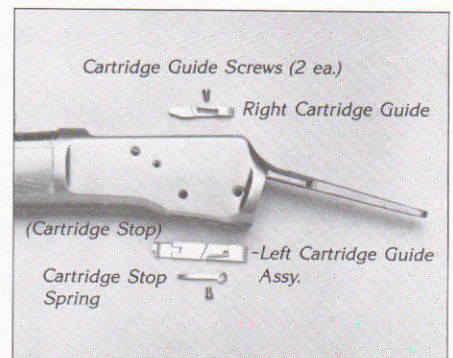

FIGURE # 4

C. LOADING GATE COVER AND SCREW (Figure #5)

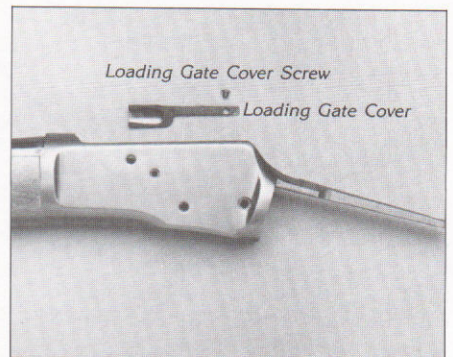

FIGURE # 5

Remove the Loading Gate Cover Screw and Loading Gate Cover.

D. MUZZLE CLAMP, MAGAZINE PLUG, SCREW, SPRING AND FOLLOWER (Figure #6)

Remove the Magazine Plug Screw, Magazine Plug and Magazine Spring.



CAUTION: Use care on removal of the Magazine Plug Screw not to let the plug fly out under pressure from the Magazine Spring.

Remove the Muzzle Clamp Screw and Muzzle Clamp.

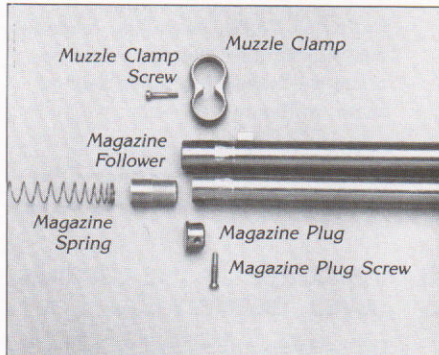

FIGURE #6

E. FOREARM BAND PIN, BAND, FOREARM AND MAGAZINE TUBE (Figure #7)

Remove the Forearm Band Pin with a 3/32" punch from left to right.

Slide the Forearm Band forward until it clears the Forearm.

Slide the Forearm forward approximately two inches.

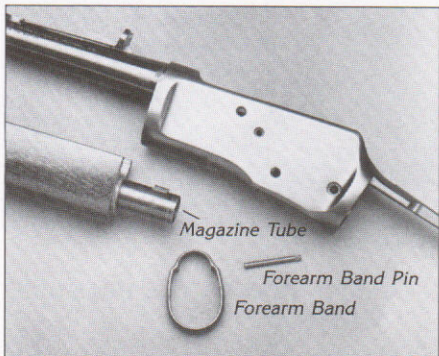

FIGURE #7

Rotate the Magazine Tube 90° in either direction and remove the Magazine Tube, Forearm and Forearm Band.

F. FRONT AND REAR SIGHTS

The only parts remaining on the Barreled Receiver are the sights and they may be removed by tapping out from left to right if desired.

NOTE: The .44 Magnum Front Sight is not removed since it is silver soldered to the Barrel.

2. INSPECTION OF COMPONENTS AND REASSEMBLY OF THE RECEIVER ASSEMBLY

A. FOREARM, BAND AND PIN AND MAGAZINE TUBE (Figure #7)

Position the Forearm Band on the Barrel with the side containing the knurled end of the Forearm Band Pin on the right side.

With the Magazine Tube installed through the Forearm, position the two parts for installation on the Barreled Receiver by placing the forward end of the Magazine Tube through the Forearm Band.

Position the Magazine Tube in the Receiver and turn to lock into position.

NOTE: Make sure the groove at the front end of the Magazine Tube is positioned directly on top of the tube.

Slide the Forearm into position, properly orient the Forearm Band and install the Forearm Band Pin from right to left.

B. MUZZLE CLAMP AND SCREW, MAGAZINE SPRING, FOLLOWER, PLUG AND SCREW (Figure #6)

Install the Muzzle Clamp and the Magazine Screw.

NOTE: The larger hole in the Muzzle Clamp is positioned on the bottom with the countersink for the Muzzle Clamp Screw located to the right. Make sure the groove in the Barrel and Magazine Tube align with the screw hole in the Muzzle Clamp.

Install the Magazine Follower, with orientation as shown in Figure #6, and install the Magazine Spring, plug and Magazine Plug Screw.

NOTE: Make sure the Magazine Plug Screw aligns with the corresponding hole in the bottom of the Barrel.



CAUTION: Use care not to let the Magazine Plug fly out of the Magazine Tube.

C. LOADING GATE COVER AND SCREW (Figure #5)

Reinstall the Loading Gate Cover and Loading Gate Cover Screw.

NOTE: If the Loading Gate Cover is to be replaced due to breakage, the new one will generally require fitting. Usually it is necessary to remove a small amount of material from the front end of the cover.

D. CARTRIDGE GUIDES AND CARTRIDGE STOP SPRING (Figure #4)

NOTE: If the rifle being repaired experienced feeding malfunctions, generally the problem can be cured by replacement of the Cartridge Guides.

Grip the rifle in a padded vise by the Barrel and Magazine Tube positioning the left side of the Receiver upwards.

Position the Cartridge Stop Spring on the Left Cartridge Guide with orientation as shown in Figure #8.

NOTE: The front end of the Cartridge Stop Spring is positioned under the rear end of the Cartridge Stop.

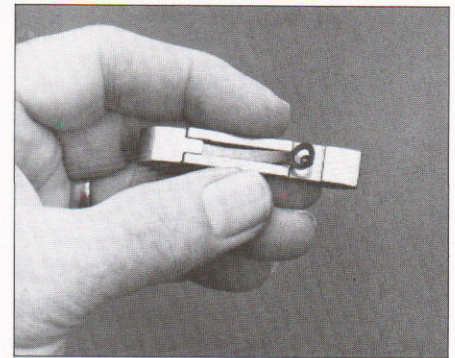

FIGURE #8

Place the spring and Left Cartridge Guide on the right side of the Receiver positioning the holes in the spring and guide directly beneath the Left Cartridge Guide Screw hole in the Receiver.

Using it as a guide, place a 3/32" punch through the Cartridge Guide Screw holes and the spring as shown in Figure #9.

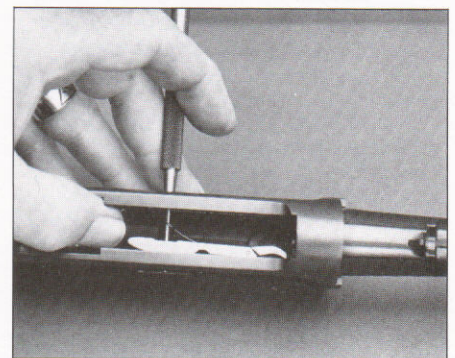

FIGURE #9

Lift the Left Cartridge Guide and spring to the left side of the Receiver, retain it there with the little finger, remove the punch and install the Left Cartridge Guide Screw as shown in Figure #10.

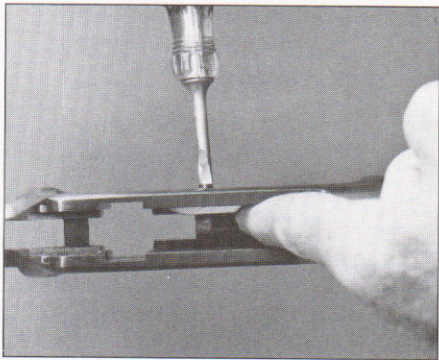

FIGURE #10

Rotate the rifle in the vise, position the right side of the Receiver upward and install the Right Cartridge Guide and Cartridge Guide Screw.

E. CARRIER (Figure #3)

Position the Carrier in the Receiver for installation with the Carrier Striker (plunger) located to the left side of the Receiver.

Install the two Carrier Screws.

3. DISASSEMBLY OF THE BREECH BOLT ASSEMBLY (Figure #11)

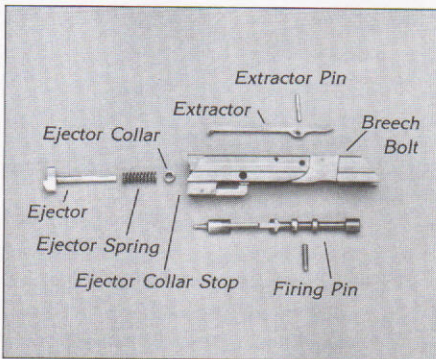

FIGURE #11

A. EJECTOR, EJECTOR SPRING AND EJECTOR COLLAR

Remove the Ejector, Ejector Spring and Ejector Collar from the face of the Breech Bolt if they have not already been removed.

B. FIRING PIN AND FIRING PIN STOP PIN

The Firing Pin may be removed without removal of the Firing Pin Stop Pin if desired. Rotate the Firing Pin 180° from its normal position and slide it to the rear and out of the Breech Bolt.

There should be no need to remove the Firing Pin Stop Pin. If necessary, remove with a 3/32" punch from left to right.

C. EJECTOR COLLAR STOP

The Ejector Collar Stop should not have to be removed.

4. INSPECTION OF COMPONENTS AND REASSEMBLY OF THE BREECH BOLT ASSEMBLY (Figure #11)

A. EXTRACTOR

Inspect the Extractor's engaging surface for a positive angle and sharp edge and make any corrections necessary.

Reinstall the Extractor and Extractor Pin.

B. FIRING PIN AND FIRING PIN STOP PIN

If misfires are being experienced on the rifle being repaired, inspect the Firing Pin for a length of 3.583 + .005 inches

Install the Firing Pin and the Firing Pin Stop Pin, if previously removed.

NOTE: The radiused edge of the rear end of the Firing Pin is positioned downward when installed in the Breech Bolt.

C. EJECTOR, EJECTOR SPRING AND EJECTOR SPRING COLLAR

Position the Ejector Spring and Ejector Spring Collar, in that order, on the shaft of the Ejector and position the three parts into the face of the Breech Bolt.

5. INSPECTION OF THE BUTT STOCK LOWER TANG ASSEMBLY (Figure #12)

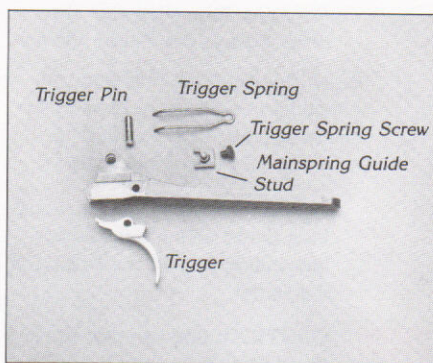

FIGURE #12

Disassembly of the Butt Stock Lower Tang Assembly should not be required except for rebluing.

Inspect the searing surface of the Trigger and replace if found altered.



CAUTION: If the Trigger pull was found to be out of the specified tolerance range of 4½ to 6½ lbs., adjust it only with the Trigger Spring.

If the Trigger pull was found below the specified minimum,

replace the Trigger Spring with a new one.

If the Trigger pull was found over the maximum specified, it may be lightened by slightly springing the two arms of the spring upward while installed in the Tang Assembly.

If the Butt Stock Lower Tang Assembly was disassembled during reassembly, orient the Mainspring Guide Stud as shown in Figure #12.

In addition, the Trigger Spring is oriented with the forward ends of the spring turned downward to rest on the Trigger.

6. INSPECTION OF THE COCKING LEVER ASSEMBLY (Figure #13)

Disassembly of the Cocking Lever Assembly should not be required except for rebluing. If disassembled, reassemble with orientation of the parts as shown in Figure #13.

Inspect the Friction Stud (and Cocking Lever Attachment Assembly in the .357 Mag. models only) for free movement.

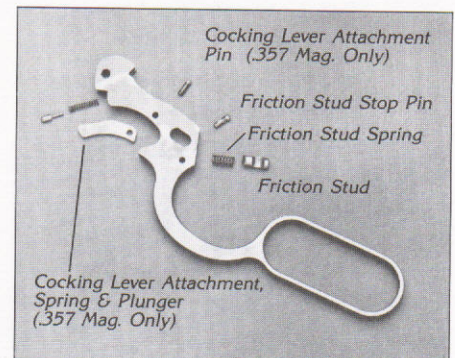

FIGURE #13

7. INSPECTION OF THE HAMMER ASSEMBLY

Inspect the engaging notches of the Hammer and replace if signs of damage or alteration exist.

8. FINAL ASSEMBLY

Grip the rifle, oriented horizontally, in a padded vise by the Barrel Magazine Tube.

Slide the Breech Bolt Assembly in the Receiver and position it approximately 1/4" from being fully forward in the Receiver.

NOTE: Throughout the reassembly process, the Ejector must not be allowed to protrude excessively from the face of the Breech Bolt. If allowed to do so, the Ejector Spring Collar will become dislocated.

Position the Left and Right Locking Bolts on the Cocking Lever Assembly with orientation as shown in Figure #14.

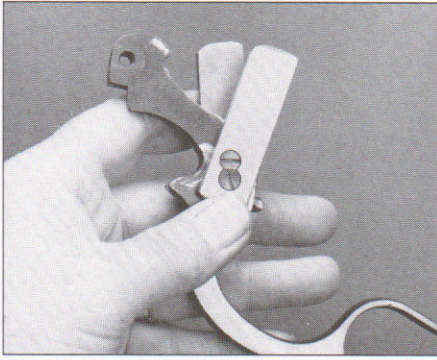

FIGURE #14

Install the Cocking Lever Assembly and Locking Bolts in the bottom of the Receiver as shown in Figure #15.

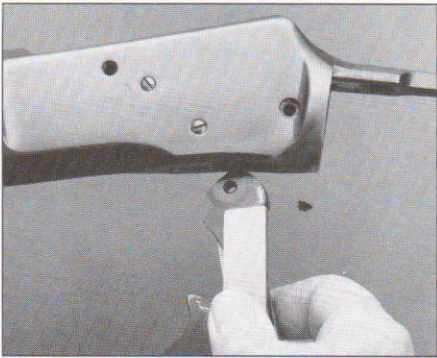

FIGURE #15

Keep the Ejector retained in the face of the Breech Bolt with a 1/8" punch and the Breech Bolt approximately 1/4" from being fully forward in the Receiver as shown in Figure #16.

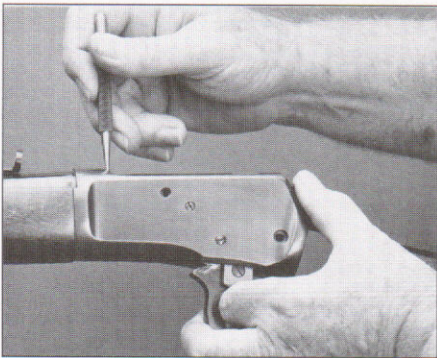

FIGURE #16

At the same time, push the Locking Bolts upward until they seem to bottom out, also shown in Figure #16.

Put upward pressure on the Cocking Lever closing the Breech Bolt on the 1/8" punch.

Withdraw the punch and close the Action.

Rotate the rifle in the vise positioning the left side of the Receiver upward.

Align the holes of the Cocking Lever, Receiver and Breech Bolt and install the Ejector Stop Pin (Figure #2).

Seat the Ejector Stop Pin with a 1/8"

punch and install the Ejector Stop Pin Plug Screw.

Open and close the Action to ascertain the assembly is correct.

With the Action completely open, install the Butt Stock Lower Tang Assembly by sliding it into the rear end of the Receiver.

Close the Action and keeping the Lower Tang Assembly fully forward, pull the Trigger to the rear and install the Hammer and Hammer Screw.

With the Hammer fully forward, position the Mainspring, and the Inner and Outer Mainspring Guides for installation with orientation as shown in Figure #1.

Compress the Mainspring by pushing forward on the rear end of the Outer Mainspring Guide, as shown in Figure #17.

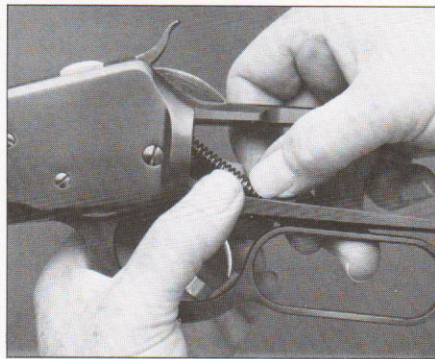

FIGURE #17

Position the Outer Mainspring Guide forward of the Mainspring Guide Stud.

Install the Butt Stock and Butt Stock Tang Screw.

9. FINAL INSPECTION

Cycle the Action to ascertain correct reassembly and perform the inspection sequences given in Section III, Para. 1 in its entirety.

SECTION V

TROUBLESHOOTING/POSSIBLE CAUSES/SOLUTIONS



CAUTION: Make certain the firearm is unloaded before performing any troubleshooting.

1. FAILS TO EXTRACT

- A. Broken Extractor or worn Extractor tip.
- B. Extractor binds in Bolt slot.

2. FAILS TO EJECT

- A. Broken Ejector.
- B. Missing Ejector Spring.

3. CARTRIDGES FAIL TO FEED FROM MAGAZINE

- A. Dents in Magazine causing the Magazine Follower to hang up.
- B. Top front edge of Carrier interfering with round in Magazine. Chamfer this edge to .025" to .035" below bottom of Chamber with the Action open.
- C. Burrs inside rear end of Magazine Tube.

4. CARTRIDGES FAIL TO FEED INTO CHAMBER

- A. Loose Cartridge Guide Screws.
- B. Improper Carrier and/or Cartridge Guides - Replace.

5. CANNOT LOAD MAGAZINE

- A. Loading Gate Cover hanging up on Receiver or the top edge of the Carrier. Chamfer the Receiver in front of the loading port and/or the Carrier.
- B. Forward edge of the loading port has insufficient clearance to allow passage of cartridge rim - Relieve as necessary.

6. FAILS TO FIRE

- A. Firing Pin too short.

SECTION VI

SPECIAL INSTRUCTIONS

1. RECOMMENDED POINTS OF LUBRICATION DURING REASSEMBLY

The use of Browning Gun Oil is recommended. Always use oil sparingly.

- A. Breech Bolt Guide Rails.
- B. Locking Bolts.
- C. Hammer Screw.
- D. Trigger & Hammer engaging surfaces.
- E. Ejector Stop Pin.

2. PARTS INFORMATION

A number of Centennial B-92 rifles were manufactured with oversized holes for the Hammer Screw, Carrier Screw and Ejector Stop Pin Plug Screw. These rifles cannot be identified by serial number. However, if replacement of these oversized parts ever becomes necessary, they are available from the Browning Parts Department, Arnold, Missouri.