

VERY IMPORTANT: Save this booklet. Carefully read all of the cautions and instructions in this manual before using your new Browning firearm.

B-80

**BROWNING B-80
B-80 PLUS
SEMI-AUTOMATIC
SHOTGUN**



New Gun Owner's Record

KEEP THIS RECORD FOR FUTURE REFERENCE

Browning Model

Serial Number

Gauge

Purchase Price

Purchased From

Dole of Purchase

Please fill out and mark the Market Survey Card at the back of the booklet

We are pleased that you have chosen a Browning B-80 Semi-Automatic Shotgun. It is certainly a gun that you can be proud of. It incorporates Browning's traditional quality and craftsmanship, and is made using the finest materials and manufacturing methods.

With a reasonable amount of care, your B-80 should give you many years of dependable, enjoyable service. Please feel free to write us immediately if you have any important observations regarding its performance and operation.

Also, please take a moment to complete the attached market survey card found on the back cover. It helps us considerably in our constant effort to provide you with better service.

Thank you.



Distributed in Canada by Canada Sports Ltd./Ltee, St. Laurent, Quebec H4S 1S0

You are responsible for firearms safety

As a gun owner, you accept a set of demanding responsibilities. How seriously you take these responsibilities can be the difference between life and death. Mistakes made with guns are final and cannot be paid for with money or regret.

There is no excuse for careless or abusive handling of any firearm. At all times handle this shotgun with intense respect for its power and potential danger.

PLEASE READ AND UNDERSTAND ALL OF THE PROPER HANDLING AND INSTRUCTION PROCEDURES OUTLINED IN THIS BOOKLET BEFORE USING YOUR NEW FIREARM.

1

ALWAYS KEEP THE MUZZLE OF YOUR SHOTGUN POINTED IN A SAFE DIRECTION even though you are certain the shotgun is unloaded. Never point your shotgun at anything you do not intend to shoot. Be extremely alert and aware of all persons and property within the range of your ammunition.

NEVER TRUST YOUR SHOTGUN'S MECHANICAL "SAFETY" DEVICE. The word, "safety," describes a gun's trigger block mechanism, sear block mechanism, hammer block mechanism or firing pin block mechanism. These mechanical devices are designed to place your gun in a SAFER status. No guarantee can be made that the gun will not fire even if the "safety" is in the "on safe" position. The B-80 has a 'cross bolt' "safety" which blocks the gun's trigger. See page 21 for instructions on operation of this gun's "safety."

Like any mechanical device, a safety can sometimes fail; it can be jarred or inadvertently manipulated into an unsafe condition. Mechanical "safeties" merely aid safe gun handling and are no excuse for pointing your shotgun's muzzle in an unsafe direction.

While it is a good idea to "test" your shotgun's mechanical "safety" periodically for proper function, **NEVER TEST IT WHILE YOUR SHOTGUN IS WADED OR POINTED IN AN UNSAFE DIRECTION.**

Safe gun handling does not stop with your gun's mechanical "safety" device — it starts there. Always treat this shotgun with the respect due a loaded, ready-to-fire firearm.

3

ALWAYS VISUALLY CHECK YOUR SHOTGUN'S CHAMBER AND MAGAZINE to be certain that they do not inadvertently contain any ammunition. Open the action, invert the shotgun and inspect the magazine and chamber. Be sure no live round is in the chamber, feed mechanism or magazine. Keep the "safety" in the "on safe" position.

4

WHENEVER YOU HANDLE A FIREARM, OR HAND IT TO SOMEONE, ALWAYS OPEN THE ACTION IMMEDIATELY, and visually check the chamber, receiver and magazine to be certain they do not contain any ammunition.

5

DO NOT TRANSPORT YOUR SHOTGUN LOADED, WHETHER IN A SCABBARD, GUN CASE, OR OTHER CONTAINER.

6

BEWARE OF BARREL OBSTRUCTIONS—for the safety of both your gun and yourself. Mud, snow and an infinite variety of other objects may inadvertently lodge in a barrel bore. It takes only one small obstruction to ruin (swell or rupture) the finest of shotgun barrels.

Before you load your firearm, open the action. **BE CERTAIN NO LIVE ROUND IS IN THE CHAMBER.** Then look through

the barrel to be sure it is clear of any obstruction. It takes only a small obstruction to dangerously increase pressures. Before the first firing, clean the bore with a cleaning rod and patch, and wipe away any anti-rust compounds in the action/chamber areas. See “Cleaning Suggestions” on page 32.

7

ALWAYS UNLOAD YOUR SHOTGUN WHEN NOT IN USE. REFER TO PAGE 30 OF THIS INSTRUCTION BOOKLET EXPLAINING THE UNLOADING OF YOUR SHOTGUN. As a safety precaution it is preferable to disassemble your gun for storage. Store your gun and ammunition separately—beyond the reach of children. Take all safeguards to ensure your gun does not become available to untrained, inexperienced, or unwelcome hands.

8

USE THE PROPER AMMUNITION. The barrel and action of this shotgun have been made with substantial safety margins over the pressures developed by established American commercial loads. Nevertheless, Browning assumes no liability for accidents which occur through the use of cartridges of non-standard dimensions or which develop pressures in excess of commercially available ammunition which has been

loaded in accordance with standards established by SAAMI (Sporting Arms and Ammunition Manufacturers Institute).

9

DO NOT PUT A 20 GAUGE SHELL IN A 12 GAUGE GUN. Store all shells of different gauges in completely separate and well-marked containers. Do not store shells of mixed gauges in a common container or in your pockets. **EXAMINE EVERY SHELL YOU PUT IN YOUR GUN!**

The most certain way to bulge or rupture a barrel is to drop a 20 gauge shell into a 12 gauge chamber. The 20 gauge shell, unfortunately, will not fall completely through the barrel; its rim is caught by the front of a 12 gauge chamber. Your gun will misfire. It is then possible to load a 12 gauge shell behind the 20 gauge shell. If the 12 gauge shell is then fired, the result will be a so-called “12-20 burst” which can cause extensive damage to your gun and possible serious injury to you.

10

DO NOT USE 3" SHOTGUN SHELLS IN A BARREL WITH A 2 3/4" CHAMBER. THE SIZE OF THE CHAMBER IS INSCRIBED, ALONG WITH CHOKE DESIGNATIONS, ON THE SIDE OF THE BARREL.

- 11** DO NOT SNAP THE HAMMER ON AN EMPTY CHAMBER—THE CHAMBER MAY NOT BE EMPTY! Treat every gun with the respect due a loaded gun—even though you are certain the gun is unloaded.
- 12** KEEP YOUR FINGER AWAY FROM THE TRIGGER WHILE UNLOADING, LOADING OR UNTIL YOU ARE READY TO SHOOT.
- 13** BE SURE OF YOUR TARGET AND BACKSTOP, particularly during low light periods. Know the range of your ammunition. Never shoot at water or hard objects.
- 14** ALWAYS UNLOAD ANY GUN'S CHAMBER AND MAGAZINE BEFORE CROSSING A FENCE, CLIMBING A TREE, JUMPING A DITCH OR NEGOTIATING OTHER OBSTACLES. Refer to page 30 of this instruction booklet for instructions on the unloading of your shotgun. Never lean a loaded gun against a fence, tree, car or other similar object.
- 15** WEAR EYE AND EAR PROTECTION WHEN SHOOTING. Unprotected, repeated exposure to gunfire can cause hearing

damage. Wear hearing protectors to protect your ears from loud noise and shooting glasses to protect your eyes from flying particles. Also, wear eye protection when disassembling and cleaning your shotgun to prevent the possibility of springs, spring-tensioned parts, solvents or other agents from contacting your eyes.

16

DROPPING A LOADED GUN CAN CAUSE AN ACCIDENTAL DISCHARGE even with the “safety” in the “on safe” position. Be extremely careful, while hunting or during any shooting activity, to avoid dropping a loaded firearm.

17

IF YOUR GUN FAILS TO FIRE, KEEP THE MUZZLE POINTED IN A SAFE DIRECTION. Hold this position for a minimum of 30 seconds. Carefully open the action and remove the cartridge. If the primer is indented, the cartridge should be disposed of in a way that cannot cause harm. If the primer is not indented, your firearm should be examined by a qualified gunsmith and the cause of the malfunction should be corrected before further use.

18

BE DEFENSIVE. BE ON GUARD AGAINST UNSAFE GUN HANDLING AROUND YOU AND OTHERS. Don't be

timid when it comes to gun safety. If you observe other shooters violating any of these safety precautions, politely suggest safer handling practices.

19

BE CERTAIN YOUR GUN IS UNLOADED BEFORE CLEANING. Because so many gun accidents occur when a firearm is being cleaned, special and extreme care should be taken to be sure your gun is unloaded before disassembly, cleaning and reassembly. Keep ammunition away from the cleaning location. Never test the mechanical function of any firearm with live ammunition.

20

EDUCATE AND SUPERVISE FIREARMS SAFETY TO ALL MEMBERS OF YOUR FAMILY, especially to children and non-shooters. Closely supervise newcomers to the shooting sports. Encourage enrollment in hunting/shooting safety courses.

21

NEVER DRINK ALCOHOLIC BEVERAGES OR TAKE ANY TYPE OF DRUGS BEFORE OR DURING SHOOTING. Your vision and judgment could be dangerously impaired, making your gun handling unsafe to you or to others.

22

READ AND HEED ALL WARNINGS in the instruction booklet and on ammunition boxes. It is your responsibility to secure the most up-to-date information on the safe handling procedures for your Browning gun. Browning cannot assume any responsibility when unsafe or improper arms and ammunition combinations are used.

23

PERIODIC MAINTENANCE—UNAUTHORIZED SERVICING. Your gun is a mechanical device and is subject to wear and requires periodic inspection, adjustment, and service. Browning firearms should be serviced by a Browning Recommended Service Center or by Browning's service facility in Arnold, Missouri. Browning cannot assume any responsibility for injuries suffered or caused by unauthorized servicing, alterations or modifications of Browning firearms. **IT CAN BE VERY DANGEROUS TO ALTER THE TRIGGER OR OTHER FIRING MECHANISM PARTS OF ANY FIREARM.**

BE CAREFUL!

Nomenclature

In conventional gun terminology, the position and movement of shotgun parts are described as they occur with the shotgun horizontal and in normal firing position; i.e., the muzzle is forward or front; the butt stock is rearward or rear; the trigger is downward or underneath; the sight is upward or on top. For general parts nomenclature, refer to Figure 1. All figures and schematics will refer to all 12 and 20 gauge E80 Shotguns unless otherwise noted.

FIGURE 1

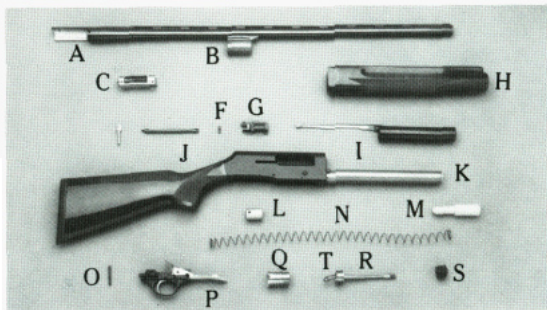

- | | |
|--------------------------------|--|
| A. Barrel | K. Magazine Tube |
| B. Gas Cylinder & Barrel Guide | L. Magazine Spring Follower |
| C. Breech Bolt | M. Magazine Plug |
| D. Operating Handle | N. Magazine Spring |
| E. Link | O. Trigger Guard Retaining Pin |
| F. Link Pin | P. Trigger Housing |
| G. Bolt Slide | Q. Gas Piston |
| H. Forearm | R. Magazine Spring Retainer & Forearm Cap Stud |
| I. Action Bar and Sleeve | S. Forearm Cap Assembly |
| J. Butt Stock | T. Magazine Spring Retainer Lock Spring |

Serial Number

The serial number of your B-80 shotgun can be found on the left side of the receiver.

The Browning B-80 is shown disassembled to the extent necessary in order to follow instructions contained in this book. (See Figure 1)

Ammunition

The B-80 was designed to function with all standard factory field loads and target loads. However, Browning can assume no responsibility for incidents which occur through the use of cartridges of non-standard dimension or those developing pressures in excess of SAAMI (Sporting Arms and Ammunition Manufacturer's Institute) established standards.

CAUTION: DO NOT USE 3" SHOTGUN SHELLS IN A BARREL WITH A 2 3/4" CHAMBER. THE SIZE OF THE CHAMBER IS INSCRIBED, ALONG WITH CHOKE DESIGNATIONS, ON THE SIDE OF THE BARREL.

With the E80 Plus barrels are inscribed 3" and 2 3/4". The E80 Plus barrel is designed to accept either sized shell.

General Operating Procedures

This shotgun is gas-operated. A portion of the expanding powder gases is bled off through gas ports and used to operate the mechanism.

During rearward travel, the bolt extracts and ejects the spent shell and cocks the hammer.

During the forward travel the next cartridge is fed from the magazine in the chamber. This operation is semi-automatic; the trigger must be released and pulled for each successive shot.

After the last cartridge has been fired, the bolt locks open. This facilitates fast reloading. To close the bolt, depress the cartridge stop / bolt release button which is located just below the ejection port on the right side of the receiver. (See Figure 2.)

FIGURE 2



CAUTION: KEEP YOUR FINGERS CLEAR OF THE EJECTION PORT AS THE BOLT CLOSSES.

If the bolt will not lock in the open position, press the carrier release which is located at the rear of the carrier just forward of the trigger guard as shown in Figure 3.

FIGURE 3

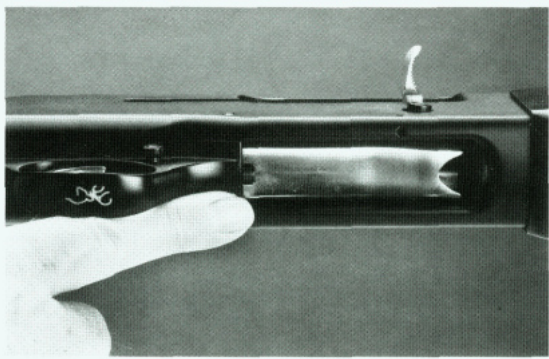

Initial Cleaning

Before assembling the B-80, anti-rust compounds should be removed from all metal parts, paying close attention to the barrel interior and the breech area. The various exposed metal parts of

your new B-80 have been coated with a rust preventative compound for protection. Browning Gun Oil is ideal for removing this compound and for giving your new gun its first lubrication; however, any quality gun oil may be used.

Recoil Adapters — Pre 1986 Guns

You may have to install a recoil adapter in your B80.

B-80's manufactured prior to 1987 used recoil adapters only on 2 3/4" models as described below.

In 1987 the B-80 Plus was introduced. A B-80 Plus is identical if the barrel is inscribed 3" and 2 3/4".

All B-80 Plus models require a recoil adapter as described below.

You may have to install a recoil adapter in your pre '87 12 gauge B-80. If you are going to use a 2 3/4" barrel, note the area where the magazine tube enters the receiver. If there is a thin spacer (recoil adapter) between the two forearm guide screws and the receiver, your B-80 shotgun is ready for a 2 3/4" barrel and 2 3/4" loads.

(See Figure 4.)

FIGURE 4

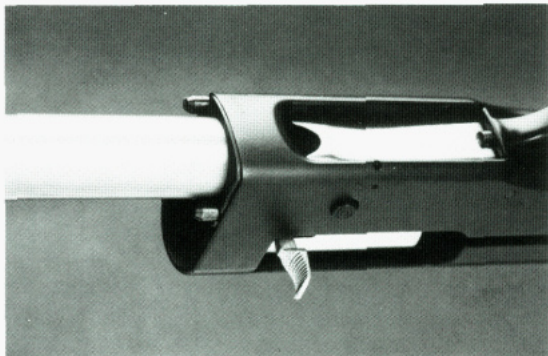

Replace the forearm and forearm cap assembly. If there has been no recoil adapter installed, and your individual gun will not function reliably with light target loads, you should proceed with the following:

Obtain a B-80 12 gauge recoil adapter (Part number PO13350) from your dealer, or from the Browning Parts Department in Arnold, Missouri. This adapter makes the B-80 one of the most versatile shotguns on the market; a shotgun that will shoot virtually every 2 3/4" 12 gauge load. Your dealer can install this adapter or, you may install it yourself by referring to this instruction booklet in the following manner:

1

Refer to the section “To Remove The Bolt Assembly,” page 37. After completing steps one through seven, you are ready to install the adapter.

2

Remove both forearm guide screws from the front of receiver, near the magazine tube. (See Figure 4.) Slide the recoil adapter over the magazine tube so that it conforms to the contour of the front of the receiver, and lines up with the screw holes.

3

Replace screws firmly, but do not overtighten. Refer to page 39 regarding reassembly of bolt assembly and trigger housing. When completed with step seven on page 42, your B-80 is ready to function with 2 3/4” light target loads. **REMEMBER:** When you plan on installing a 3” magnum barrel to shoot 3” shells, you should remove the recoil adapter.

As mentioned previously, the recoil adapter described above needs to be used only on those B-80s manufactured prior to late 1985.

How to Mount Your B-80 Barrel

- 1** Remove and set aside the forearm cap assembly which holds the forearm in position on the stock/receiver group. (See Figure 5.)
- 2** Slide forearm up and remove from the magazine tube. (See Figure 6.)
- 3** While holding your B-80 upright, note the position of the gas piston which is held in position by the forearm and forearm cap

FIGURE 5

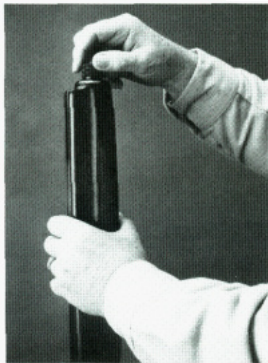
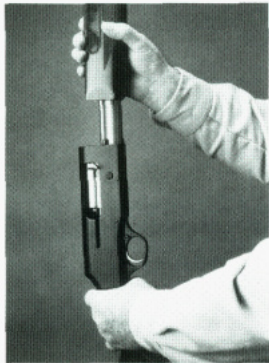

FIGURE 6



assembly. If you remove the gas piston, replace it so that it stands on its flanges atop the magazine tube.

4

Depress carrier release.

5

Pull the bolt to the rear by means of the operating handle until the bolt locks in the open position.

6

Carefully insert the barrel into the receiver while aligning the barrel guide with the magazine spring retainer and forearm cap stud. (See Figure 7.)

FIGURE 7

FIGURE 8

FIGURE 9



7

Align the forearm with the barrel and carefully slide it over the gas piston and magazine tube. **CAUTION: DO NOT APPLY FORCE AS DAMAGE TO THE FOREARM COULD RESULT. ANY RESISTANCE SHOULD BE FOLLOWED BY A VISUAL CHECK FOR ALIGNMENT.** (See Figure 8.)

8

Replace the forearm cap assembly. **BE CERTAIN THE FOREARM CAP ASSEMBLY IS SCREWED COMPLETELY DOWN SO THAT THE REAR END OF THE FOREARM IS IN FIRM CONTACT WITH THE FRONT END OF THE RECEIVER,** (See Figure 9.)

9

Close the bolt using the cartridge stop and bolt release button as shown in Figure 3. **NOTE: DO NOT SLAM THE BREECH BOLT HOME BY PRESSING THE CARTRIDGE STOP AND BOLT RELEASE BUTTON AFTER THE BARREL HAS BEEN REMOVED FROM YOUR GUN.** When the barrel is present on the gun, the breech bolt stops against the barrel extension. If the breech bolt is slammed home with the barrel removed, the operating handle will be driven against the front edge of the receiver's ejection port, causing damage.

For convenience in casing and carrying the dismantled gun, return the forearm to its position on the magazine tube and screw on the forearm cap assembly. You will then have two compact units. One is the barrel; the other is the action with forearm and stock.

Cross-Bolt Safety

The cross-bolt “safety” is designed to block the trigger from traveling. In the “off-safe” or “fire” position a red warning band is visible on the left side of the trigger guard alerting the shooter of the gun’s ready-to-fire status. To accommodate left-handed shooters, an optional left hand “safety” can be installed by a gunsmith. If an optional left hand “safety” is installed, the red warning band will then appear on the right side of the trigger guard.

DO NOT DEPEND ON THE RED COLOR ALONE TO INDICATE YOUR GUN'S SAFETY STATUS, as time, exposure to the elements, as well as the abrasive action of cleaning agents can erase it. The “safety” is located as shown in Figure 10.

FIGURE 10



Loading Your B-80

There are two basic methods for getting a loaded shell into the chamber of a B-80. First, the shell can be directly loaded through the ejection port. Second, a shell can be loaded manually from the magazine. Loading of the magazine is the same for both procedures.

CAUTION: AT ALL TIMES DURING THE LOADING PROCEDURE, BE SURE YOUR MUZZLE IS POINTING IN A SAFE DIRECTION AND THE SAFETY IS "ON SAFE."

DO NOT PUT A 20 GAUGE SHELL IN A 12 GAUGE GUN. Store shells of different gauges in completely separate and well-marked containers. See caution number 9 on page 6 of this booklet. Do not store shells of mixed gauges in a common container or in your pockets.

LOADING THROUGH THE EJECTION PORT—

- 1** Pull the operating handle to the rear until the bolt locks in the open position. If the bolt will not lock in rear, press the carrier release. Visually inspect the chamber, carrier, and magazine making sure they are clear.
- 2** Push the “safety” from left to right or to the “on safe” position. The red band indicating that the B-80 is ready to fire should not show.
- 3** While pointing the muzzle in a safe direction, insert a cartridge of the proper gauge through the ejection port into the chamber and push the cartridge stop / bolt release button to close the action. Your chamber is now loaded.
(See Figure 11.)

FIGURE 11



4

Insert the second cartridge through the loading port at bottom of receiver as shown in Figure 12. Note: **MAKE SURE THAT THE CARTRIDGE IS PUSHED PAST THE CARTRIDGE STOP, AND THE CARRIER IS FREE TO MOVE.** (See Figure 13.)

FIGURE 12

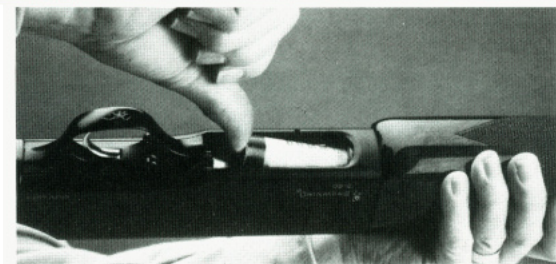
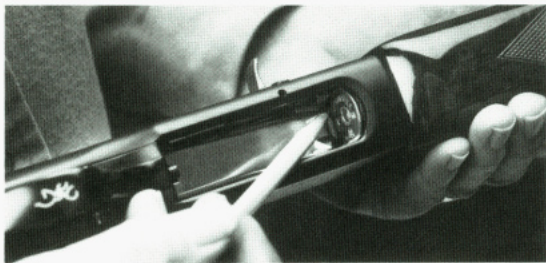

FIGURE 13



5

Repeat the above procedure until your gun is fully loaded. Your B-80 will hold three 3 inch or three 2 3/4 inch cartridges in its magazine plus one in its chamber. NOTE: A magazine plug restricting the B-80's magazine capacity to two cartridges is installed at the factory. Instructions for removing the magazine plug will be found on page 42.

LOADING MANUALLY FROM THE MAGAZINE—

1

Make sure the muzzle is pointed in a safe direction.

2

Open the bolt and visually inspect the chamber, carrier, and magazine making sure they are clear. NOTE: If the bolt locks

BROWNING B-80 SEMI-AUTOMATIC SHOTGUN

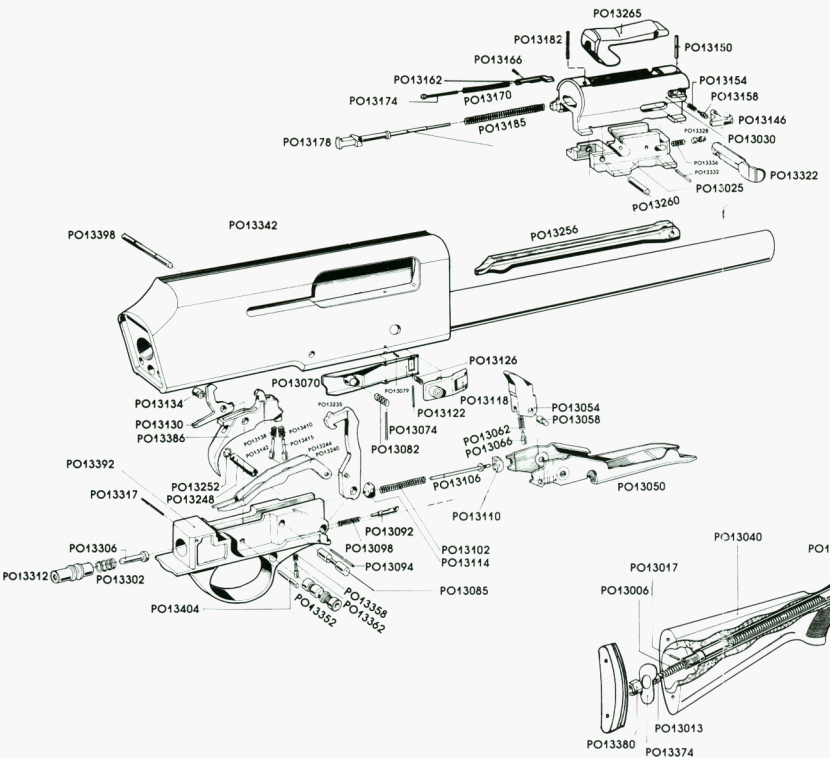

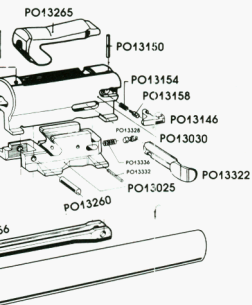

Schematic is provided for parts identification only and should not be used as a guide to assemble guns.

IMPORTANT: When ordering parts, list part number, part name, caliber, model and serial number.

CAUTION: Browning parts are made exclusively for Browning guns and should not be used in other guns even though models may be similar. Inadequately fitted parts may be dangerous.

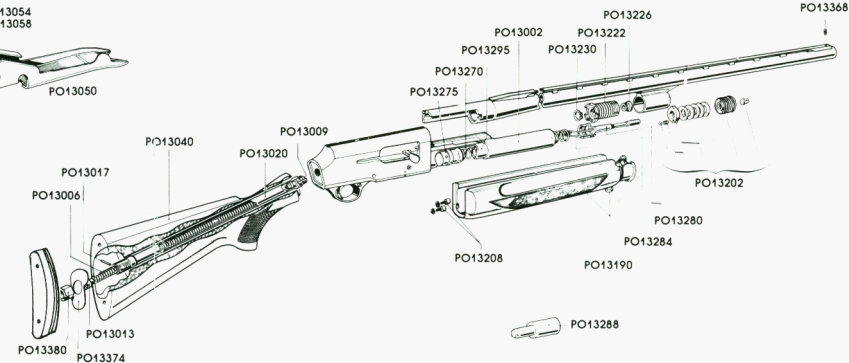

Parts List

B-80 Gas Operated Semi-Automatic Shotgun 12 and 20 Gauge

PART NO.	DESCRIPTION	PART NO.	DESCRIPTION
P013002	Action Bar & Sleeve 12 Ga.	P013118	Cartridge Stop Button 12 & 20 Ga.
P013004	Action Bar & Sleeve 20 Ga.	P013122	Cartridge Stop Pin 12 & 20 Ga.
P013006	Action Spring 12 & 20 Ga.	P013126	Cartridge Stop Spring 12 & 20 Ga.
P013009	Action Spring Follower 12 & 20 Ga.	*P013130	Disconnecter 12 & 20 Ga.
P013013	Action Spring Plug 12 & 20 Ga.	P013134	Disconnecter Pin 12 & 20 Ga.
P013017	Action Spring Plug Pin 12 & 20 Ga.	P013138	Disconnecter Spring 12 & 20 Ga.
P013020	Action Tube 12 & 20 Ga.	P013142	Disconnecter Spring Guide 12 & 20 Ga.
*P013025	Bolt Slide 12 Ga.	P013146	Extractor 12 Ga.
*P013027	Bolt Slide 20 Ga.	P013148	Extractor 20 Ga.
P013030	Breech Bolt 12 Ga.	P013150	Extractor Pin 12 & 20 Ga.
P013035	Breech Bolt 20 Ga.	P013154	Extractor Spring 12 & 20 Ga.
*P013040	Butt Stock 12 Ga. Field	P013158	Extractor Spring Plunger 12 & 20 Ga.
*P013043	Butt Stock 12 Ga. Superlight	P013162	Ejector 12 & 20 Ga.
*P013045	Butt Stock 20 Ga. Field	P013166	Ejector Pin 12 & 20 Ga.
*P013047	Butt Stock 20 Ga. Superlight	P013168	Ejector Pin 12 Ga. Superlight
*P013050	Carrier 12 Ga.	P013170	Ejector Spring 12 & 20 Ga.
*P013052	Carrier 20 Ga.	P013174	Ejector Spring Follower 12 & 20 Ga.
*P013054	Carrier Dog 12 & 20 Ga.	P013178	Firing Pin 12 Ga.
P013058	Carrier Dog Pin 12 & 20 Ga.	P013180	Firing Pin 20 Ga.
P013062	Carrier Dog Spring 12 & 20 Ga.	P013182	Firing Pin Retaining Pin 12 Ga.
P013066	Carrier Dog Spring Follower 12 & 20 Ga.	P013184	Firing Pin Retaining Pin 20 Ga.
P013070	Carrier Latch 12 & 20 Ga.	P013185	Firing Pin Spring 12 & 20 Ga.
P013074	Carrier latch Pin 12 & 20 Ga.	P013190	Forearm Field 12 Ga.
P013078	Carrier Latch Lock Pin 12 & 20 Ga.	P013192	Forearm Superlight 12 Ga.
P013079	Carrier Latch Lock Pin 12 Ga. Superlight	P013196	Forearm Field 20 Ga.
P013082	Carrier Latch Spring 12 & 20 Ga.	P013198	Forearm Superlight 20 Ga.
P013085	Carrier Pin 12 Ga.	P013200	Forearm Cap Assembly 12 & 20 Ga.
P013087	Carrier Pin 20 Ga.	P013202	Forearm Cap Assembly with eyelet 12 & 20 Ga.
P013092	Carrier Release 12 & 20 Ga.	P013208	Forearm Guide Screws 12 & 20 Ga. (2 Per Gun)
P013094	Carrier Release Pin 12 & 20 Ga.	P013222	Gas Piston 12 Ga.
P013098	Carrier Release Spring 12 & 20 Ga.	P013224	Gas Piston 20 Ga.
P013102	Carrier Spring 12 & 20 Ga.	P013226	Gas Piston Seal 12 & 20 Ga.
P013106	Carrier Spring Guide 12 & 20 Ga.		
P013110	Carrier Spring Guide Pivot Front 12 & 20 Ga.		
P013114	Carrier Spring Guide Pivot Rear 12 & 20 Ga.		

*Indicates part must be fitted by Browning Service Department or qualified gunsmith.

† Part may be purchased by holden of current valid Federal Firearms License.

Parts List

PART NO.	DESCRIPTION	PART NO.	DESCRIPTION
P013230	Gas Piston Seal Retaining Ring 12 & 20 Ga.	P013336	Operating Handle Retainer Spring 12 & 20 Ga.
*P013235	Hammer 12 Ga.	†*P013340	Receiver 12 Ga.
*P013237	Hammer 20 Ga.	†*P013342	Receiver 12 Ga. Superlight
*P013240	Hammer Bar Right 12 & 20 Ga.	†*P013346	Receiver 20 Ga.
*P013244	Hammer Bar Left 12 & 20 Ga.	†*P013347	Receiver 20 Ga. Superlight
P013248	Hammer Pin 12 Ga.	P013350	Recoil Adapter Standard 12 Ga. Only
P013250	Hammer Pin 20 Ga.	P013351	Recoil Adapter Alloy 12 Ga.
P013252	Hammer Pin Circlip 12 & 20 Ga.	*P013352	Safety 12 & 20 Ga.
P013256	Link 12 Ga.	P013353	Recoil Adapter 20 Ga.
P013258	Link 20 Ga.	*P013354	Safety, Left Hand 12 & 20 Ga.
P013260	Link Pin 12 Ga.	P013358	Safety Spring 12 & 20 Ga.
P013262	Link Pin 20 Ga.	P013362	Safety Spring Follower 12 & 20 Ga.
P013265	Locking Block 12 Ga.	P013368	Sight Bead Front 12 & 20 Ga.
P013267	Locking Block 20 Ga.	P013371	Stock Retaining Plate 45mm 12 & 20 Ga.
P013270	Magazine Spring 12 Ga.	P013372	Stock Retaining Plate 50mm 12 & 20 Ga.
P013272	Magazine Spring 20 Ga.	P013373	Stock Retaining Plate 55mm 12 & 20 Ga.
P013275	Magazine Spring Follower 12 Ga.	P013374	Stock Retaining Plate 60mm 12 & 20 Ga.
P013277	Magazine Spring Follower 20 Ga.	P013375	Stock Retaining Plate 65mm 12 & 20 Ga.
P013280	Magazine Spring Retainer & Forearm Cap Stud 12 Ga.	P013380	Stock Nut 12 & 20 Ga.
P013282	Magazine Spring Retainer & Forearm Cap Stud 20 Ga.	*P013386	Trigger 12 & 20 Ga.
P013284	Magazine Spring Retainer Lock Spring 12 & 20 Ga.	P013392	Trigger Guard 12 Ga.
P013288	Magazine Three Shot Adaptor 12 Ga.	P013395	Trigger Guard 20 Ga.
P013290	Magazine Three Shot Adaptor 20 Ga.	P013398	Trigger Guard Retaining Pin 12 Ga.
P013295	Magazine Tube 12 Ga.	P013399	Trigger Guard Retaining Pin 12 Ga. Superlight
P013298	Magazine Tube 20 Ga.	P013401	Trigger Guard Retaining Pin 20 Ga.
P013302	Mainspring 12 & 20 Ga.	P013402	Trigger Guard Retaining Pin 20 Ga. Superlight
P013306	Mainspring Guide 12 & 20 Ga.	P013404	Trigger Pin 12 & 20 Ga.
P013312	Mainspring Support 12 & 20 Ga.	P013410	Trigger Spring 12 & 20 Ga.
P013317	Mainspring Support Pin 12 & 20 Ga.	P013415	Trigger Spring Plunger 12 & 20 Ga.
P013322	Operating Handle 12 Ga.		
P013324	Operating Handle 20 Ga.		
P013328	Operating Handle Retainer 12 & 20 Ga.		
P013332	Operating Handle Retainer Pin 12 Ga.		
P013334	Operating Handle Retainer Pin 20 Ga.		

*Indicates part must be filled by Browning Service Department or qualified gunsmith.

† Furl may be purchased by holders of current valid Federal Firearms License.

open, push the cartridge stop button, making sure your fingers are clear of the ejection port.

3

Push the “safety” from left to right or to the “on safe” position. The red band indicating that the B-80 is ready to fire should not show.

4

Insert cartridge of the proper gauge through the loading port at the bottom of the receiver up into the magazine as shown in Figure 12. Make sure the cartridge is pushed past the cartridge stop and that the carrier is free to move.

5

Depress the carrier release and cycle the action by pulling the operating handle fully to the rear and releasing it. Your chamber is now loaded.

6

Repeat step four until magazine is loaded.

To Unload or Change Loads

CAUTION: AT ALL TIMES DURING THE UNLOADING PROCEDURE, BE SURE YOUR MUZZLE IS POINTING IN A SAFE DIRECTION AND THE SAFETY IS “ON SAFE.”

Pull the operating handle all the way to the rear and eject the chambered cartridge and lower the bolt on the empty chamber. NOTE: It is not necessary or recommended that the remaining cartridges be cycled through the action. That would necessitate depressing the carrier release after each cartridge is ejected. It is easier and safer to invert your B-80, insert your index finger into the loading port and while pushing slightly on the round in the magazine, depress the cartridge stop. (See Figure 14.) Ease each cartridge out until the magazine is empty.

FIGURE 14



VISUALLY CHECK THE MAGAZINE AND CHAMBER TO MAKE SURE THEY ARE EMPTY. Gather ejected cartridges and store

separately from the gun beyond the reach of children.

To change loads in your B-80, simply eject the chambered cartridge by pulling the operating handle all the way to the rear. Insert the desired cartridge (such as a goose load) of the same gauge through the ejection port into the chamber.

CAUTION: Repeated cycling of the bolt's operating handle alone is not assurance that the B-80 is unloaded. There still may be cartridges in the magazine. **ALWAYS CONDUCT A THOROUGH VISUAL INSPECTION OF THE CHAMBER, ACTION AND MAGAZINE AFTER UNLOADING.**

Cleaning Suggestions

The correct procedure for cleaning your B-80 is as follows:

BE CERTAIN YOUR SHOTGUN'S MAGAZINE AND CHAMBER ARE UNLOADED AND WEAR EYE PROTECTION.

1

Dismount barrel so that it can be cleaned from the breech end.

2

Inspect bore from both ends for leading by looking through bore toward light. **NOTE:** Dull longitudinal streaks, usually more

pronounced in the constriction area of the choke and just forward of the chamber, are caused by leading.

3

A normal amount of leading can be expected with today's high velocity loads and improved wads but this is not serious. If leading should become heavy, it can be removed with a brass bore brush. Spray the bore or the bore brush with a good powder solvent, and scrub the bore until leading is removed. To prevent brass bristles from breaking off, the brush should be pushed completely through the bore before being withdrawn.

4

After leading has been removed, the bore should be wiped dry and then a lightly oiled patch run through it for preservation.

5

If the gun has been exposed to dust, dirt, mud or water, the principal working parts should be wiped clean and lubricated with a light film of oil. Browning Oil is recommended.

6

The magazine tube on the B-80 should be wiped clean of all dirt and grit, and then lubricated lightly with an oiled patch.

7

Reassemble the barrel and wipe all exposed metal surfaces with an oiled cloth,

making sure to wipe gun clean of all finger marks.

8

The wood surfaces can also be wiped with Browning Gun Oil or they can be polished with any quality furniture wax (but not both).

Periodic Maintenance

Once a year, or after 1000 shots, it is advisable to soak the gas piston in solvent and scrub it with a brass-wire brush to remove accumulated deposits. The gas cylinder and barrel guide should also be thoroughly cleaned and wiped dry. Do not oil. If at any time your B-80 should fail to eject, thoroughly clean the gas system before seeking the services of a competent gunsmith.

The trigger and bolt assembly should be removed from the receiver as described on page 35, and thoroughly cleaned with nitro solvent and a toothbrush. Wipe the parts dry and lubricate with a few drops of high grade oil before reassembly.

Trigger Housing

REMOVING THE TRIGGER HOUSING—

- 1** WHILE POINTING THE MUZZLE IN A SAFE DIRECTION, MAKE SURE THE CHAMBER AND MAGAZINE ARE EMPTY.
- 2** Draw bolt fully to the rear and release it by depressing the cartridge stop and bolt release button.
- 3** Push “safety” to the “on safe” position.
- 4** With a punch or dowel push the trigger housing retaining pin from either side until it can be grasped and pulled free by hand. (See Figure 15.)

FIGURE 15

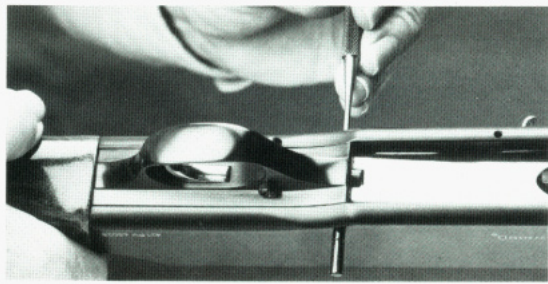

5

Depress the cartridge stop/bolt release button flush with the receiver and lift the trigger housing forward, up, and out of the receiver. (See Figure 16.)

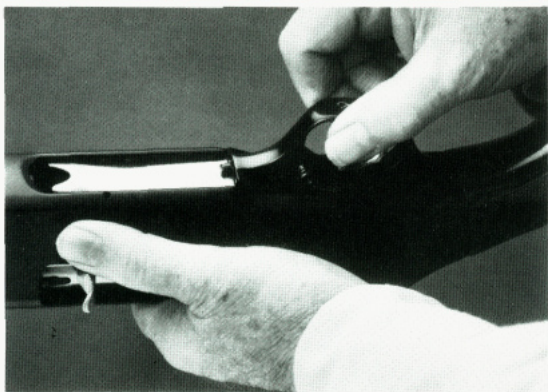
FIGURE 16

REPLACING THE TRIGGER HOUSING—

With the bolt closed, and the trigger housing hammer cocked, and the safety in the “on safe” position, insert the mainspring support into position by mating the projection at the rear of the trigger assembly into the recess inside the receiver. (See Figure 17.) Depress cartridge stop/bolt release button and align surfaces until flush, then replace the trigger housing retaining pin.

FIGURE 17

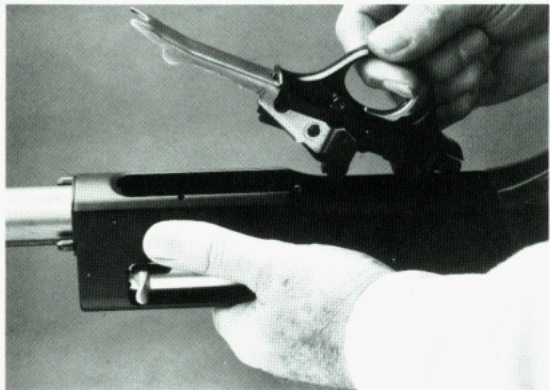

Bolt Assembly

HOW TO REMOVE THE BOLT ASSEMBLY—

- 1** While pointing the muzzle in a safe direction, make sure the magazine and chamber are empty.
- 2** Place the “safety” in the “on safe” position.
- 3** Remove forearm and barrel as previously described.

- 4** Remove the gas piston by pulling it up and off the magazine spring retainer and forearm cap stud.
- 5** Remove the trigger housing as previously described under “Trigger Housing.”
- 6** Remove the operating handle by pulling it straight out and free of the bolt.
- 7** Grasp the action bar and sleeve and ease assembly forward until bolt clears receiver. Be ready to catch bolt assembly as once it clears receiver it will be free to separate into its three basic components. . . the breech bolt, bolt slide, and action bar and sleeve. (See Figures 18 and 19.)

FIGURE 18

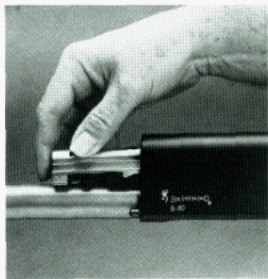
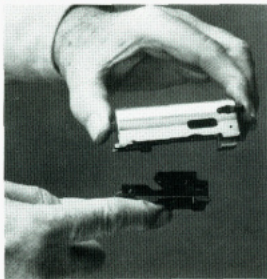

FIGURE 19



HOW TO REASSEMBLE THE BOLT ASSEMBLY—

1

Hold bolt with firing pin up and place bolt slide into position by inserting it into the bolt recess. Components should fit flush, as shown in Figures 20 and 21.

2

Insert the bolt and slide assembly approximately half way into the receiver and maintain their position with hand pressure from the side while the action bar and sleeve is slipped over the magazine tube and engaged in the bolt slide. (See Figures 22 and 23.)

FIGURE 20

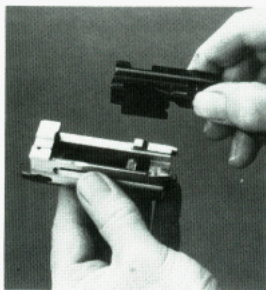

FIGURE 21

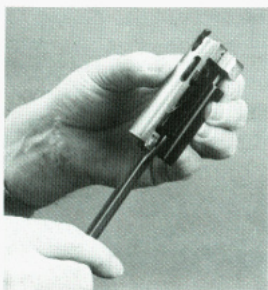

FIGURE 22

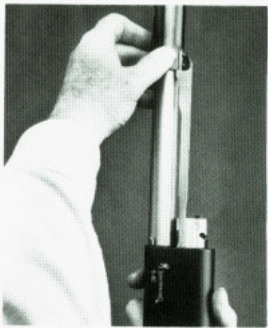
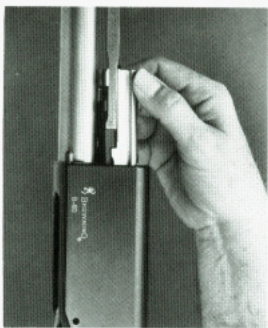

FIGURE 23



3

Engage the link into the action spring follower. See Figure 24 and be certain bolt

FIGURE 24a

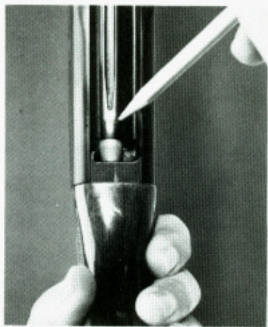

FIGURE 24b



will go all the way back before continuing assembly. If the bolt will not go back freely, remove the assembly and align all components carefully, then repeat procedure.

4

Replace the operating handle into the recess on the bolt. (See Figure 25.)

FIGURE 25

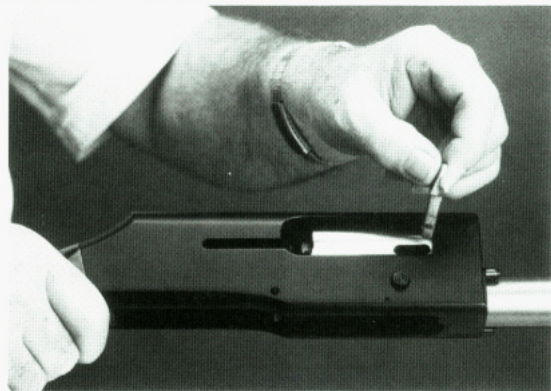

5

Install the trigger housing, being careful to insert the main spring support into the recess. Depress the cartridge stop and bolt release button. Align all components and replace the trigger assembly retaining pin. (See Figure 26.)

FIGURE 26

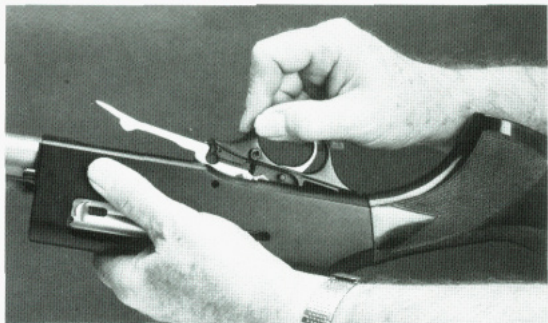

6

Depress the carrier release and draw the bolt rearward until it locks in the open position.

7

Replace the gas piston, barrel, forearm and forearm cap assembly.

To Remove the Magazine Three Shot Adapter

Your B-80 is shipped with a three shot adapter installed. If you want to remove the adapter to increase the magazine's capacity, proceed as follows:

1

BE CERTAIN THE GUN IS NOT LOADED AND "SAFETY" IS "ON SAFE." WE RECOMMEND THAT SAFETY GLASSES BE WORN.

2

Press the carrier release.

3

Lock the bolt to the rear.

4

Remove the forearm cap assembly, forearm, barrel and gas piston.

5

Place the receiver, loading port up, in a well padded vise.

6

Locate the tip of the magazine spring retainer which projects through its port in the underside of the magazine tube.

7

Using a 1/16 inch diameter punch, depress the magazine spring lock and use a screwdriver to turn the slotted head of the magazine spring retainer and forearm cap stud counter-clockwise 1/4 turn or enough to bypass the lock spring's function. (See Figure 27.)

FIGURE 27

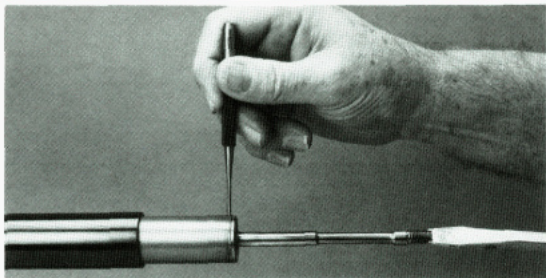

Remove the punch and continue turning the magazine retainer and forearm cap stud until three threads are exposed. At this point lay the screwdriver aside and proceed by hand. (See Figure 28.)

FIGURE 28

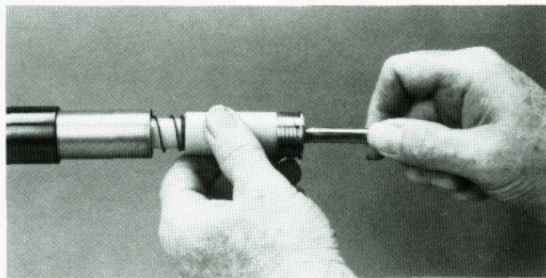

NOTE: The magazine plug is spring loaded and under tension. Be prepared to use both hands in guiding the spring out of, and back into, the magazine tube once the plug has been removed.

8

To reassemble, simply reverse the foregoing procedure taking care to depress the magazine spring retainer lock spring at the point where it prevents the final turns of the magazine retainer and forearm cap stud. (See Figure 29.) Be sure the lock spring is aligned with the hole in the magazine tube when you complete the reassembly.

FIGURE 29

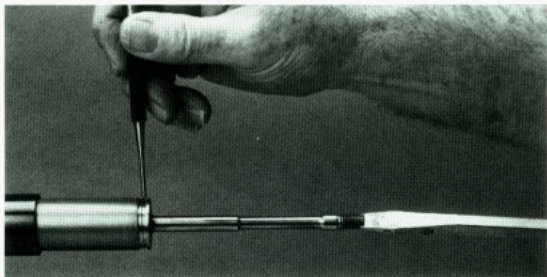

Invector Interchangeable Choke System

Your shotgun barrels may have been threaded to accept the Browning Invector Interchangeable Choke System. You may confirm this by glancing on the right side of your barrel where the specifications are inscribed, or on the left side of the B-80 breech area where the choke markings are normally located. The word, Invector, denotes that the barrels are threaded. If so, please follow these instructions.

1

DO NOT FIRE THIS SHOTGUN WITHOUT HAVING AN INVECTOR CHOKE TUBE INSTALLED. Permanent damage may result to the threads.

2

Use the special wrench provided to firmly hand tighten the choke tube.

3

The gauge and degree of choke are indicated on each Invector choke tube.

DO NOT USE BROWNING INVECTOR CHOKE TUBES IN ANY SHOTGUN BARRELS NOT SUPPLIED BY BROWNING, as described above.

DO NOT USE ANY OTHER CHOKING DEVICE IN ANY SHOTGUN BARRELS SUPPLIED BY

BROWNING. USE ONLY CHOKE TUBES MARKED INVECTOR.

Replacement or additional Invector choke tubes and wrenches are available from your Browning dealer, the Browning Service Center near you, or by writing to the Browning Consumer Department, Route 1, Morgan, Utah 84050. (801) 543-3200.

Canadian customers please call or write to Browning Canada Sports Ltd/Ltee, 3167 De Miniac, St. Laurent, Canada H4S 1S0. (514) 333-7261.

Choke Markings

The gauge and choke of your barrel are indicated by clearly defined marks stamped in the upper rear surface of the barrel. The code for the choke markings is as follows:

Full Choke		*
Improved	Modified	*—
Modified		**
Improved	Cylinder	**—
Skeet		**S
Cylinder		***
INVECTOR	system	INVECTOR

INVECTOR CODE—

To identify individual INVECTOR tubes, refer to the abbreviated indications on the side of the

tube, or use the identification marks located on the rim of each tube.

Full	I	Imp. Cyl.	III
Imp. Mod.	II	Skeet	IIII
Mod.	III	Cylinder	No marks

Use of Extra Barrels

As pointed out earlier, you do not need a separate gun to shoot 3-inch Magnum shells. Simply interchange barrels. You can use the same gun for multiple shooting conditions merely by changing from one barrel to another with a different choke, length and chamber. Barrels of the same gauge are completely interchangeable, and no special fitting or altering of the gas system is required. Thus, by merely buying another barrel, you have the utility of another gun at a fraction of the cost of a new gun. . . a duck gun becomes a skeet gun or a fine upland gun by the mere addition of an extra barrel. Please see your Browning dealer for barrel specifications available.

Buck Special Sight Adjustment

GUN SHOTS TO THE LEFT — Move the rear sight to the right by first loosening the small

screw on the right side of the sight. Then tighten the small screw on the left side of the sight. This is a process of trial and error. Make small adjustments, then check the effect on the point of impact.

GUN SHOOTS TO THE RIGHT — Do the same procedure as outlined above, except move the sight to the left by loosening the left screw and tightening the right screw.

GUN SHOOTS HIGH — Lower the rear sight by turning the large screw on top of the sight in a clockwise direction. Adjust a little at a time, then test point of impact.

GUN SHOOTS LOW — Turn the top screw in a counterclockwise direction.

Adjusting the Buttstock

Even though Browning shotguns are designed to fit the majority of shooters, the drop at the heel on your B-80 can be raised or lowered 0.20 of an inch. This is accomplished by installing an alternate stock retaining plate, available from the Browning Service department. It is highly recommended that a competent gunsmith make this adjustment, because a stock modification will be required. See your recommended Browning Service Center.

Service or Repair

If your B-80 should require service or repairs, we suggest you first contact a local recommended Browning Firearms Service Center. Your Browning Sporting Goods dealer can tell you the address of the Recommended Service Center nearest you or you may call or write our Consumer Information Dept. in Morgan, Utah —(801)543-3200.

Otherwise you may return your B-80 to our own repair facility for servicing. The address is:

Browning Service Department
3005 Arnold Tenbrook Road
Arnold, Missouri 63010-9406
(314) 287-6800.

Canadian Customers—Please call or write:

Browning Canada Sports Ltd/Ltee,
3167 De Miniac, St. Laurent, Canada H4S
1S0. (514) 333-7261.

When returning your B-80 for servicing, be sure it is unloaded, packaged securely in a strong cardboard container, and insured. Under no circumstances should ammunition be returned, as it is against postal and commerce regulations. Send a letter to our service department clearly describing the trouble experienced and the repairs or alterations desired. It is very helpful if you also enclose a copy of your letter with the gun.

You Are Responsible For Firearms Safety.

As a gun owner, you accept a set of demanding responsibilities. How seriously you take these responsibilities can mean the difference between life and death. Failure to follow any of these instructions can cause extensive damage to your gun and/or possible serious injury or death to yourself and others. There is no excuse for careless or abusive handling of any firearm. At all times handle any firearm with intense respect for its power and potential danger. **READ AND UNDERSTAND all of THE CAUTIONS AND PROPER HANDLING PROCEDURES OUTLINED IN THIS BOOKLET BEFORE USING YOUR NEW FIREARM.**

1. ***ALWAYS KEEP THE MUZZLE OF ANY FIREARM POINTED IN A SAFE DIRECTION.***

Do this even though you are certain the firearm is unloaded. Never point any firearm at anything you do not intend to shoot. Be extremely alert and aware of all persons and property within the range of your ammunition.

2. ***NEVER RELY TOTALLY ON YOUR SHOTGUN'S MECHANICAL "SAFETY" DEVICE.***

Always assume that your gun can be fired at any time, even with all the safety mechanism engaged. The word "safety" describes a gun's trigger block mechanism, sear block mechanism, hammer block mechanism or firing pin block mechanism. These mechanical devices are designed to place your gun in a **SAFER** status. No guarantee can be made that the gun will not fire even if the "safety" is in the "on safe" position. See "[Operation of the Safety](#)" in your owner's manual for instructions on operation of your gun's "safety."

3. ***LIKE ANY MECHANICAL DEVICE, A "SAFETY" CAN SOMETIMES FAIL; IT CAN BE JARRED OR INADVERTENTLY MANIPULATED INTO AN UNSAFE CONDITION.***

Mechanical "safeties" merely aid safe gun handling and are no excuse for pointing your shotgun's muzzle in an unsafe direction.

While it is a good idea to "test" your shotgun's mechanical "safeties" periodically for proper function, never test them while your firearm is loaded or pointed in an unsafe direction. Safe gun handling does not stop with your gun's mechanical "safety" devices -- it starts there.

Always treat this shotgun with the respect a loaded, ready-to-fire firearm. ***NEVER TEST THE MECHANISM OF ANY FIREARM WHILE IT IS LOADED OR POINTED IN AN UNSAFE DIRECTION.***

4. ***WHENEVER YOU HANDLE A FIREARM, OR HAND IT TO SOMEONE MAKE SURE IT IS COMPLETELY UNLOADED.***

Always open the action immediately and visually check the chamber magazine. Make certain the chamber does not inadvertently contain any ammunition. Always keep the chamber empty and the "safety" in the "on safe" position unless shooting is imminent.

5. ***DO NOT TRANSPORT ANY FIREARM LOADED. KEEP ALL FIREARMS UNLOADED DURING TRANSPORT, WHETHER IN A SCABBARD, GUN CASE, OR OTHER CONTAINER.***

6. ***HUNTING FROM ELEVATED SURFACES SUCH AS TREE STANDS IS DANGEROUS.***

Doing so may increase the risk of handling a firearm. The following rules should always be observed by you and those you hunt with: ***Always*** make certain that the stand being used is safe and stable. ***Always*** make certain that your firearm is unloaded when it is being taken up and down from the stand. ***Always*** make certain that your firearm is not dropped from the stand, or dropped while it is being taken up or down from the stand. ***Remember***, a loaded firearm may discharge when dropped, even with the safety in the "on safe" position.

7. **BEWARE OF BARREL OBSTRUCTION.**

Do this for the safety of both your gun and yourself. Mud, snow, and an infinite variety of other objects may inadvertently lodge in a barrel bore. It takes only one small obstruction to cause dangerously increased pressures that can ruin (swell or rupture) the finest shotgun barrel. **BEFORE CHECKING FOR A BARREL OBSTRUCTION, BE CERTAIN YOUR FIREARM IS FULLY UNLOADED.**

Make sure no live rounds are in the chamber. Place the safety in the "on safe" position, open the breech or action and look through the barrel to be sure it is clear of any obstruction. If an obstruction is seen, no matter how small it may be, clean the bore with a cleaning rod and patch as instructed for your particular firearm. Before the first firing, clean the bore with a cleaning rod and patch, and wipe away any anti-rust compounds in the action/chamber areas.

8. **ALWAYS UNLOAD ALL FIREARMS WHEN NOT IN USE.**

As a safety precaution, it is preferable to disassemble your gun for storage. Your responsibilities do not end when your firearm is unattended. Store your gun and ammunition separately -- well beyond the reach of children. Take all safeguards to ensure your firearm does not become available to untrained, inexperienced or unwelcome hands.

9. **USE THE PROPER AMMUNITION.**

The barrel and action of all Browning firearms have been made with substantial safety margins over the pressures developed by established American commercial loads. Nevertheless, Browning assumes no liability for incidents which occur through the use of cartridges of nonstandard dimensions which develop pressures in excess of commercially available ammunition with standards established by the Sporting Arms and Ammunitions Manufacturers' Institute (SAAMI).

BE ALERT TO THE SIGNS OF AMMUNITION MALFUNCTION.

If you detect an off sound or light recoil when ammunition is fired, **DO NOT LOAD MORE AMMUNITION INTO THE CHAMBER.** Open the action and remove all ammunition from the chamber. With the action open, glance down the barrel to make sure that a wad or other obstruction does not remain in the barrel. If there is an obstruction, completely clear the barrel before loading and firing again. Failure to follow these instructions can cause extensive damage to your gun and possible serious injury to yourself and others.

10. **MAKE SURE OF ADEQUATE VENTILATION IN THE AREA THAT YOU DISCHARGE A FIREARM. WASH HANDS THOROUGHLY AFTER EXPOSURE TO AMMUNITION OR CLEANING A FIREARM.**

Lead exposure can be obtained from discharging firearms in poorly ventilated areas, cleaning firearms or handling ammunition. Lead is a substance that has been known to cause birth defects, reproductive harm and other serious injury.

11. **NEVER INSERT A SHELL OF THE INCORRECT GAUGE IN ANY SHOTGUN.** The gauge of your shotgun is marked on the side of the barrel. Store all shells of different gauges in completely separate and well-marked containers. Never store shells of mixed gauges in a common container or in your pockets.

EXAMINE EVERY SHELL YOU PUT IN YOUR GUN. NEVER PUT A 20 GAUGE SHELL IN A 12 GAUGE GUN. The most common way to bulge or rupture a shotgun barrel is to drop a 20 gauge shell into a 12 gauge chamber. The 20 gauge shell, unfortunately, will not fall completely through the barrel; its rim is caught by the front of a 12 gauge chamber. Your gun will misfire (with the chamber appearing to be empty). It is then possible to load a 12 gauge shell behind the 20 gauge shell. If the 12 gauge shell is then fired, the result will be a so-called "12-20 burst" which can cause extensive damage to your gun and possible serious injury to you and others.

12. **USE SHELLS OF CORRECT LENGTH.**

The size of the chamber is inscribed, along with gauge and choke designations, on the side of the barrel. Do not use 3 1/2" shotgun shells in a shotgun or barrel with a 2 3/4" chamber or 3" chamber. Do not use 3" shells in a shotgun chambered for a 2 3/4" shells. Doing so can result in a build-up of dangerously high pressures that may damage your gun and possibly cause serious injury to yourself or others.

13. **DO NOT SNAP THE FIRING PIN ON AN EMPTY CHAMBER -- THE CHAMBER MAY NOT BE EMPTY!**

Treat every gun with the respect due a loaded gun, even though you are certain the gun is unloaded.

14. **KEEP YOUR FINGERS AWAY FROM THE TRIGGER WHILE LOADING AND UNLOADING UNTIL YOU ARE READY TO SHOOT.**

15. **BE SURE OF YOUR TARGET AND BACKSTOP.** Particularly during low light periods. Know the range of your ammunition. Never shoot at water or hard objects.

16. **ALWAYS UNLOAD THE CHAMBER AND MAGAZINE OF ANY FIREARM BEFORE CROSSING A FENCE, CLIMBING A TREE, JUMPING A DITCH OR NEGOTIATING OTHER OBSTACLES.**

Never lean or place your loaded shotgun on or against a fence, tree, car or other similar object.

17. **WEAR EYE AND EAR PROTECTION WHEN SHOOTING.** Unprotected, repeated exposure to gunfire can cause hearing damage. Wear ear protectors (shooting earplugs or muffs) to guard against such damage. Wear shooting glasses to protect your eyes from flying particles. Always keep a safe distance between the muzzle of your firearm and any persons nearby, as muzzle blast, debris and ejecting shells could inflict serious injury. Also, wear eye protection when disassembling and cleaning all firearms to prevent the possibility of springs, spring-tensioned parts, solvents or other agents from contacting your eyes.

18. **DROPPING A LOADED GUN CAN CAUSE AN ACCIDENTAL DISCHARGE.**

This can occur even with the "safety" in the "on safe" position. Be extremely careful while hunting or during any shooting activity to avoid dropping any firearm.

19. **IF ANY FIREARM FAILS TO FIRE, KEEP THE MUZZLE POINTED IN A SAFE DIRECTION.**

Hold this position for a minimum of 30 seconds. Carefully open the action and remove the shell. If the primer is indented, the shell should be disposed of in a way that cannot cause harm. If the primer is not indented, your firearm should be examined by a qualified gunsmith and the cause of the malfunction should be corrected before further use.

20. **BE DEFENSIVE AND ON GUARD AGAINST UNSAFE GUN HANDLING AROUND YOU AND OTHERS.** Don't be timid when it comes to gun safety. If you observe other shooters violating any of these safety precautions, politely suggest safer handling practices.

21. **BE CERTAIN YOUR SHOTGUN IS UNLOADED BEFORE CLEANING.**

Because so many accidents occur when a firearm is being cleaned, special and extreme care should be taken to be sure your gun is unloaded before disassembly, cleaning and reassembly. Keep ammunition away from the cleaning location. Never test the mechanical function of any firearm with live ammunition.

22. ***SUPERVISE AND TEACH FIREARMS SAFETY TO ALL MEMBERS OF YOUR FAMILY -- ESPECIALLY TO CHILDREN AND NONSHOOTERS.***

Closely supervise newcomers to the shooting sports. Encourage enrollment in hunting/shooting safety courses.

23. ***NEVER DRINK ALCOHOLIC BEVERAGES OR TAKE ANY TYPE OF DRUGS BEFORE OR DURING SHOOTING.***

Your vision and judgment could be dangerously impaired, making your gun handling unsafe to you and to others.

24. ***PERFORM PERIODIC MAINTENANCE -- AVOID UNAUTHORIZED SERVICING.***

Your firearm is a mechanical device which will not last forever, and as such, is subject to wear and requires periodic inspection, adjustment and service. Browning firearms should be serviced by a Browning Recommended Service Center or by Browning's service facility in Arnold, Missouri. Browning cannot assume any responsibility for injuries suffered or caused by unauthorized servicing, alterations or modifications of Browning firearms.

25. ***READ AND HEED ALL WARNINGS*** in these instructions, on ammunition boxes and with all accessories that you install on your firearm. It is your responsibility to secure the most up-to-date information on the safe handling procedures of your Browning gun. Browning assumes no liability for incidents which occur when unsafe or improper gun accessories or ammunition combinations are used.

26. Browning reserves the right to refuse service on firearms that have been altered, added to or substantially changed. Removal of metal from barrel(s), or modification of the firing mechanism and/or operating parts may lead to Browning's refusal of service on such firearms. Browning will charge the owner for parts and labor to return the firearm to original Browning specifications.

DO NOT, UNDER ANY CIRCUMSTANCES, ALTER THE TRIGGER, SAFETY OR OTHER PARTS OF THE FIRING MECHANISM OF THIS OR ANY OTHER FIREARM. FAILURE TO OBEY THIS WARNING MAY RESULT IN INJURY OR DEATH TO YOURSELF OR OTHERS.

BE CAREFUL!

Other Browning Products



SPORTSMAN'S

KNIVES

There is a folding or fixed blade Browning knife to match nearly every requirement — including fillet, pocket, skinning and general utility style knives. Every Browning knife is manufactured using the finest materials and the most hand-pleasing designs. Each Browning knife is distinctive in quality and style the way a good knife should be

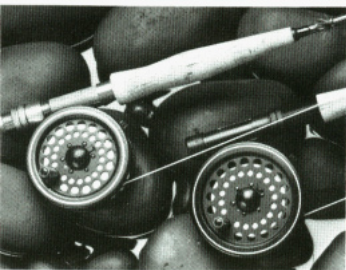

FISHING TACKLE

You'll catch more fish and have more fun with a quality Browning fishing rod or reel. There's a rod for every fishing trip — from pack rods for traveling, to heavy rods for deep sea action. Top quality reels come in sizes for practically any fishing situation. Also choose from Browning's complete line of quality accessories.



BROWNING OIL

Browning Oil is the best all-around oil for your guns. It cleans, lubricates, and protects metal and blueing. It is designed to function in extreme temperatures and provides excellent anti-rust protection. Browning Oil is also ideal for many other applications including household, automotive, and fishing tackle. Available in drip spout or aerosol can.

SPORTING ARMS

World famous for handcrafted quality and dependability, Browning Sporting Arms include a complete line of shotguns and high power or small bore caliber rifles and pistols.

BROWNING PRO-STEEL GUN SAFES

Protect your guns and other valuables from today's rising theft rate. No other safe gives you the protection you get from Browning Pro-Steel's Gold Series safes; reinforced door and door frame, extensive hard plate, heavy steel plate construction, and independent, active locking lugs.

INVECTOR CHOKE TUBE SYSTEM

Most Browning shotguns are available with the Invector Choke Tube system. Tubes for all popular chokes install in seconds and recess completely inside the muzzle. No projecting knurled rings or flanges to distract your aim or spoil the looks of your Browning shotgun.



SPORTSMAN'S CLOTHING

Hunting, fishing, or treks to the shopping mall. you know that your Browning clothing will do its job well. For the sportsman who spends time in wet, cold weather, Browning makes a complete line of waterproof GoreTex® clothing. Hats, gloves and handsome leather belts are also available.



ARCHERY EQUIPMENT

Browning has a complete line of compound bows suited for recreation and hunting. Handsome styling, coupled with exceptional speed and accuracy is something you can count on with every Browning bow. There is a draw weight, draw length, and bow size for nearly every shooter.

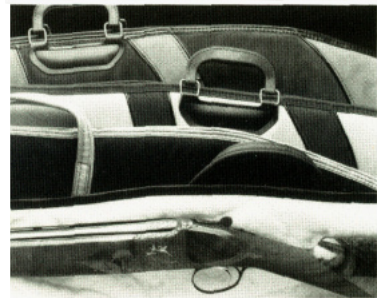

GUN CASES

Your guns are well protected in a Browning flexible gun case. Exteriors of genuine leather, attractive vinyl, rugged canvas or tough, water-repellent Cordura nylon are available for nearly any size gun. Soft inner linings protect your gun's finish. Our luggage cases are of scuff resistant, leather-textured vinyl and lined with polyester fleece fabric, giving you unmatched protection for your Browning shotguns and rifles.