



BROWNING®

The Best There Is.

OWNER'S MANUAL

VERY IMPORTANT:

Save This Booklet. Carefully read this entire manual before using your new Browning firearm.

AUTO-5

**SEMI-AUTOMATIC SHOTGUN
LIGHT 12 AND 20 GAUGE**

NEW GUN OWNERS RECORD

KEEP THIS RECORD FOR FUTURE REFERENCE

Browning Model

Serial Number

Gauge / Caliber

Purchase Price

Purchased From

Date of Purchase

We are pleased that you have chosen a Browning Automatic-5 shotgun.

It is certainly a gun you can be proud to own. For over 90 years the Auto-5 has been recognized as the most proven and reliable semi-automatic shotgun ever designed. The time-tested Auto-5 is one of the greatest inventions of John Moses Browning, and is a hallmark to his incredible genius. With a reasonable amount of care, your Automatic-5 shotgun should give you many years of dependable, enjoyable service. Please feel free to write us immediately if you have any observations regarding its performance and operation.

Thank You



One Browning Place, Morgan, Utah 84050

Distributed in Canada by Browning Canada Sports Ltd./Ltée, 5617 Chemin St-Francois, St-Laurent, Quebec, Canada H4S 1W6

Printed in Japan 960810

AUTO-5 SEMI-AUTOMATIC SHOTGUN LIGHT 12 AND 20 GAUGE

You Are Responsible For Firearms Safety

As a gun owner, you accept a set of demanding responsibilities. How seriously you take these responsibilities can be the difference between life and death.

There is no excuse for careless or abusive handling of any firearm. At all times handle your shotgun and any other firearm with intense respect for its power and potential danger.

PLEASE READ AND UNDERSTAND ALL OF THE CAUTIONS, PROPER HANDLING PROCEDURES AND INSTRUCTIONS OUTLINED IN THIS BOOKLET BEFORE USING YOUR NEW FIREARM.

1 ALWAYS KEEP THE MUZZLE OF YOUR SHOTGUN POINTED IN A SAFE DIRECTION,

even though you are certain the shotgun is unloaded. Never point any firearm at anything you do not intend to shoot. Be extremely alert and aware of all persons and property within the range of your ammunition.

2 NEVER RELY TOTALLY ON YOUR SHOTGUN'S MECHANICAL "SAFETY" DEVICE.

The word "safety" describes a gun's trigger block mechanism, sear block mechanism, hammer block mechanism or firing pin block mechanism. These mechanical devices are designed to place your gun in a **SAFER** status. No guarantee can be made that the gun will not fire even if the "safety" is in the "on safe" position. The Auto-5 has a cross bolt "safety" which blocks the gun's trigger. See "Operation of the Safety" on page 8 for instructions on operation of this gun's "safety."

LIKE ANY MECHANICAL DEVICE, A "SAFETY" CAN SOMETIMES FAIL; IT CAN BE

JARRED OR INADVERTENTLY MANIPULATED INTO AN UNSAFE CONDITION.

Mechanical "safeties" merely aid safe gun handling and are no excuse for pointing your shotgun's muzzle in an unsafe direction.

While it is a good idea to "test" your shotgun's mechanical "safeties" periodically for proper function,

NEVER TEST IT WHILE YOUR SHOTGUN IS LOADED OR POINTED IN AN UNSAFE DIRECTION.

Safe gun handling does not stop with your gun's mechanical "safety" devices — it starts there. Always treat this shotgun with the respect due a loaded, ready-to-fire firearm.

3 WHENEVER YOU HANDLE A FIREARM, OR HAND IT TO SOMEONE, ALWAYS OPEN THE ACTION IMMEDIATELY, VISUALLY CHECK YOUR SHOTGUN'S CHAMBER, FEED MECHANISM AND MAGAZINE

Make certain that they do not inadvertently contain any ammunition. Always keep the chamber empty and "safety" in the "on safe" position unless shooting is imminent.

4 DO NOT TRANSPORT YOUR SHOTGUN LOADED, WHETHER IN A SCABBARD GUN CASE, OR OTHER CONTAINER.

5 HUNTING FROM ELEVATED SURFACES SUCH AS TREE STANDS IS DANGEROUS, and may increase the risk of handling a firearm. The following rules should always be observed by you and those you hunt with: **Always** make certain that the stand being used is safe and stable. **Always** make certain that your firearm is unloaded when it is being taken up and down from the stand. **Always** make certain that your firearm is not dropped from the stand, or dropped while it is being taken up or down from the stand. **Remember**, a loaded firearm may discharge when dropped, even with the safety in the "on safe" position.

- 6 **BEWARE OF BARREL OBSTRUCTIONS**, for the safety of both your gun and yourself. Mud, snow, and an infinite variety of other objects may inadvertently lodge in a barrel bore. It takes only one small obstruction to cause dangerously increased pressures that can ruin (swell or rupture) the finest shotgun barrels.

BEFORE CHECKING FOR A BARREL OBSTRUCTION, BE CERTAIN NO LIVE ROUND IS IN THE CHAMBER AND THAT THE MAGAZINE AND FEED MECHANISMS ARE COMPLETELY EMPTY. PLACE THE "SAFETY" IN THE "ON SAFE" POSITION

(See page 12 and 13 for instructions on unloading). After assuring yourself that the shotgun is completely empty, again, open the breechblock, locking it to the rear, and look through the barrel to be sure it is clear of any obstruction. If an obstruction is seen, no matter how small it may be, clean the bore

with a cleaning rod and patch as described in "Cleaning and Maintenance Suggestions" on page 17. Before the first firing, clean the bore with a cleaning rod and patch, and wipe away any anti-rust compounds in the action/chamber areas.

- 7 **ALWAYS UNLOAD YOUR SHOTGUN WHEN NOT IN USE. REFER TO PAGE 13 OF THIS INSTRUCTION BOOKLET EXPLAINING THE UNLOADING OF YOUR SHOTGUN.**

As a safety precaution, it is preferable to disassemble your gun for storage. Store your gun and ammunition separately—well beyond the reach of children. Take all safeguards to ensure your shotgun does not become available to untrained, inexperienced or unwelcome hands.

- 8 **USE THE PROPER AMMUNITION.**

The barrel and action of this shotgun have been made with substantial safety margins over the pressures developed by established American commercial loads. Nevertheless,

Browning assumes no liability for incidents which occur through the use of cartridges of nonstandard dimensions which develop pressures in excess of commercially available ammunition which has been loaded in accordance with standards established by the Sporting Arms and Ammunition Manufacturers Institute (SAAMI).

BE ALERT TO THE SIGNS OF AMMUNITION MALFUNCTION.

If you detect an off sound or light recoil when a shell is fired, **DO NOT LOAD ANOTHER SHELL INTO THE CHAMBER.** Open the action and remove all shells from the magazine, chamber and action areas. With the action open, glance down the barrel to make sure that a wad or other obstruction does not remain in the barrel. If there is an obstruction, completely clear the barrel before loading and firing again. Failure to follow these instructions can cause extensive damage to

your gun and possible serious injury to yourself and others.

- 9 **DO NOT PUT A 16 OR A 20 GAUGE SHELL IN A 12 GAUGE GUN.**

Store all shells of different gauges in completely separate and well-marked containers. Do not store shells of mixed gauges in a common container or in your pockets.

EXAMINE EVERY SHELL YOU PUT IN YOUR GUN.

The most certain way to bulge or rupture a barrel is to drop a 20 gauge shell into a 12 gauge chamber. The 20 gauge shell, unfortunately, will not fall completely through the barrel; its rim is caught by the front of a 12 gauge chamber. Your gun will misfire (with the chamber appearing to be empty). It is then possible to load a 12 gauge shell behind the 20 gauge shell. If the 12 gauge shell is then fired, the result will be a so-called "12-20 burst" which can cause extensive damage to your gun and possible serious injury to you.

10 **CAUTION: DO NOT USE 3-1/2" SHOTGUN SHELLS IN ANY SHOTGUN OR BARREL WITH A 2 3/4" CHAMBER OR 3" CHAMBER. DO NOT USE 3" SHELLS IN A SHOTGUN CHAMBERED FOR 2 3/4" SHELLS. THE SIZE OF THE CHAMBER IS INSCRIBED, ALONG WITH GAUGE AND CHOKE DESIGNATIONS, ON THE SIDE OF THE BARREL.**

11 **DO NOT SNAP THE FIRING PIN ON AN EMPTY CHAMBER — THE CHAMBER MAY NOT BE EMPTY!**

Treat every gun with the respect due a loaded gun, even though you are certain the gun is unloaded.

12 **KEEP YOUR FINGERS AWAY FROM THE TRIGGER WHILE UNLOADING, LOADING, UNTIL YOU ARE READY TO SHOOT.**

13 **BE SURE OF YOUR TARGET AND BACK-STOP.** Particularly during low light periods. Know the range of your ammunition. Never shoot at water or

hard objects.

14 **ALWAYS UNLOAD YOUR SHOTGUN'S CHAMBER BEFORE CROSSING A FENCE, CLIMBING A TREE, JUMPING A DITCH OR NEGOTIATING OTHER OBSTACLES.**

Refer to page 13 of this instruction book for instructions on the unloading of your shotgun. Never place your shotgun on or against a fence, tree, car, or other similar object.

15 **WEAR EYE AND EAR PROTECTION WHEN SHOOTING.** Unprotected, repeated exposure to gunfire can cause hearing damage. Wear ear protectors (shooting ear plugs or muffs) to guard against such damage. Wear shooting glasses to protect your eyes from flying particles. Always keep a safe distance between the muzzle of your firearm and any persons nearby, as muzzle blast, debris and ejecting shells could inflict serious injury. Also, wear eye protection when disassembling and cleaning your shotgun to prevent the possibility of springs, spring-tensioned

parts, solvents or other agents from contacting your eyes.

16 **DROPPING A LOADED GUN CAN CAUSE AN ACCIDENTAL DISCHARGE** even with the "safety" in the "on safe" position. Be extremely careful while hunting or during any shooting activity, to avoid dropping any firearm.

17 **IF YOUR SHOTGUN FAILS TO FIRE, KEEP THE MUZZLE POINTED IN A SAFE DIRECTION.**

Hold this position for a minimum of 30 seconds. Carefully open the action and remove the cartridge. If the primer is indented, the cartridge should be disposed of in a way that cannot cause harm. If the primer is not indented, your firearm should be examined by a qualified gunsmith and the cause of the malfunction should be corrected before further use.

18 **BE DEFENSIVE AND ON GUARD AGAINST**

UNSAFE GUN HANDLING AROUND YOU AND OTHERS.

Don't be timid when it comes to gun safety. If you observe other shooters violating any of these safety precautions, politely suggest safer handling practices.

19 **BE CERTAIN YOUR SHOTGUN IS UNLOADED BEFORE CLEANING.** Because so many gun accidents occur when a firearm is being cleaned, special and extreme care should be taken to be sure your gun is unloaded before disassembly, cleaning and reassembly. Keep ammunition away from the cleaning location. Never test the mechanical function of any firearm with live ammunition.

20 **EDUCATE AND SUPERVISE FIREARMS SAFETY TO ALL MEMBERS OF YOUR FAMILY — ESPECIALLY TO CHILDREN AND NONSHOOTERS.**

Closely supervise newcomers to the shooting sports. Encourage enrollment in hunting/shooting safety courses.

Figure 1

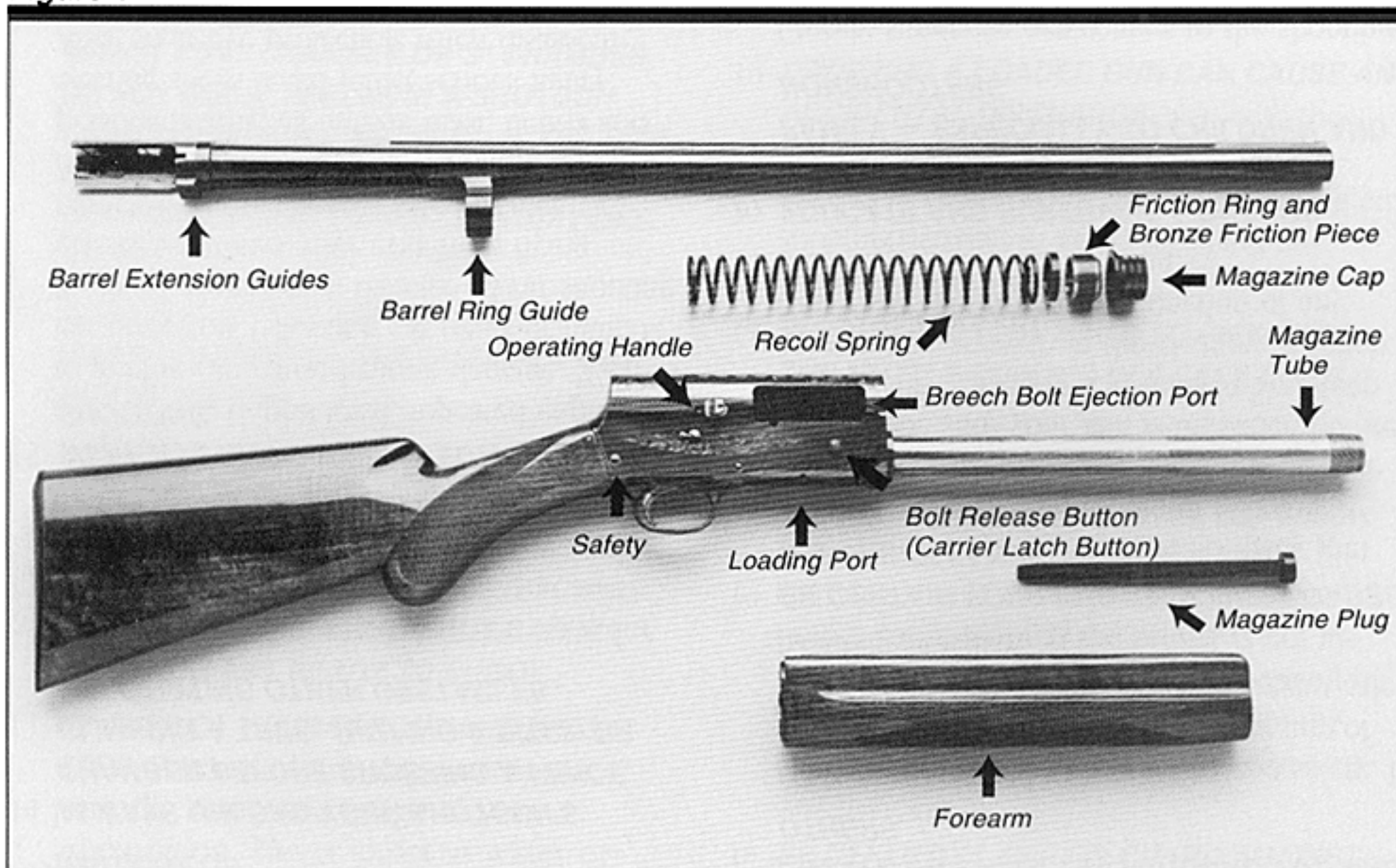

21 NEVER DRINK ALCOHOLIC BEVERAGES OR TAKE ANY TYPE OF DRUGS BEFORE OR DURING SHOOTING.

Your vision and judgment could be dangerously impaired, making your gun handling unsafe to you and to others.

22 READ AND HEED ALL WARNINGS in this instruction book, on ammunition boxes and with all accessories that you install on your firearm. It is your responsibility to secure the most up-to-date information on the safe handling procedures for your Browning gun. Browning assumes no liability for incidents which occur when unsafe or improper gun accessories or ammunition combinations are used.

23. PERIODIC MAINTENANCE — AVOID UNAUTHORIZED SERVICING.

Your shotgun is a mechanical device which will not last forever, and as such, is subject to wear and requires periodic inspection, adjustment, and service. Browning firearms should

be serviced by a Browning Recommended Service Center or by Browning's service facility in Arnold, Missouri. Browning cannot assume any responsibility for injuries suffered or caused by unauthorized servicing, alterations or modifications of Browning firearms.

IT CAN BE VERY DANGEROUS TO ALTER THE TRIGGER, SAFETY OR OTHER FIRING MECHANISM PARTS OF THIS OR ANY OTHER FIREARM.

BE CAREFUL!

Nomenclature

In conventional gun terminology, the position and movement of gun parts are described as they occur with the gun horizontal and in normal firing position; i.e., the muzzle is forward or front; butt stock is rearward or rear; trigger is downward or underneath; the rib is upward or on top. See (Figure 1) for names of all parts and assemblies covered in disassembly and cleaning procedures.

Serial Number

The serial number of your Automatic-5 shotgun is found on the underside of the receiver, just forward of the loading port.

Ammunition

Automatic-5 Light Models are designed to shoot and function with factory 2 3/4" lead and steel shot loads. However, Browning can assume no responsibility for incidents which occur through the use of cartridges of nonstandard dimension or those developing pressures in excess of standards established by the Sporting Arms and Ammunition Manufacturer's Institute (SAAMI).

General Operating Procedures

The Browning Automatic-5 shotgun is a recoil operated, semi-automatic shotgun. The breech bolt locks into the barrel. Upon firing, recoil causes the barrel and breech bolt to travel rearward, recocking the hammer. After full rearward

travel, the breech bolt unlocks from the barrel. The barrel begins forward movement an instant before the breech bolt begins forward travel. This split second delay lets the barrel "get ahead" of the breech bolt, which is holding the spent shell with dual extractors. This accomplishes extraction. Ejection occurs when the ejector, located in the barrel extension, strikes the rim of the spent shell during forward travel of the barrel. During forward travel of the bolt, a fresh round from the magazine is fed into the chamber. After the last shell has been fired, the breech bolt locks open, instead of returning fully home. This facilitates speedy, convenient reloading.

This operation is semi-automatic; the trigger must be released and pulled to fire each successive shot.

Initial Cleaning

Various exposed metal parts of your new Auto-5 have been coated with a rust preventative compound for protection.

Before assembling your Auto-5, clean the anti-rust compound from the barrel, receiver, magazine tube and the action-chamber areas. Browning Oil is ideal for removing this compound and for giving your new gun its first lubrication. However, any quality gun oil may be used.

Assembly Procedures

CHECK YOUR GUN CAREFULLY TO BE ABSOLUTELY CERTAIN THAT THE CHAMBER, FEED MECHANISM AND MAGAZINE CONTAIN NO SHELLS.

The Auto-5 is delivered, in the box, with the barrel removed and the forearm assembled on the magazine tube. Perform the following steps to assemble your Auto-5 and make it ready for shooting.

- 1 Pull rearward on the operating handle and draw the breech bolt rearward where it will remain locked back. Rest the butt end of the stock firmly on any convenient rigid surface. With the left hand, pull rearward on the forearm to counteract the forward thrust of the recoil spring around the magazine tube. With the right hand unscrew the magazine cap. Slide the wooden forearm forward off the magazine tube.

DO NOT SQUEEZE HARD ON THE OPEN REAR END OF THE FOREARM. TOO MUCH PRESSURE COULD CAUSE THE WOOD TO SPLIT.

- 2 The Automatic-5 is delivered with the magazine adaptor in the magazine which limits the gun to three shots total (to comply with Federal migratory bird regulations). If you do not want your gun to be so limited, merely take

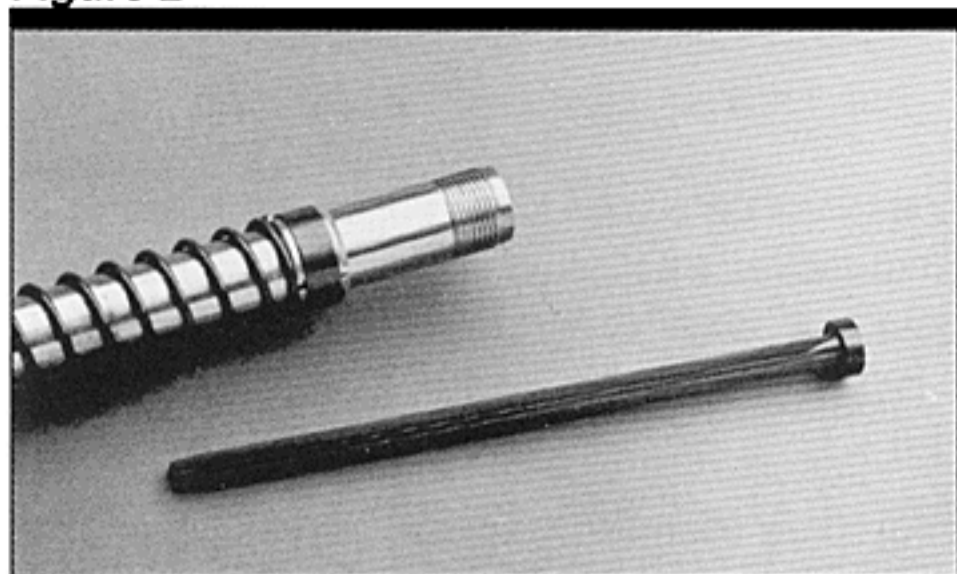
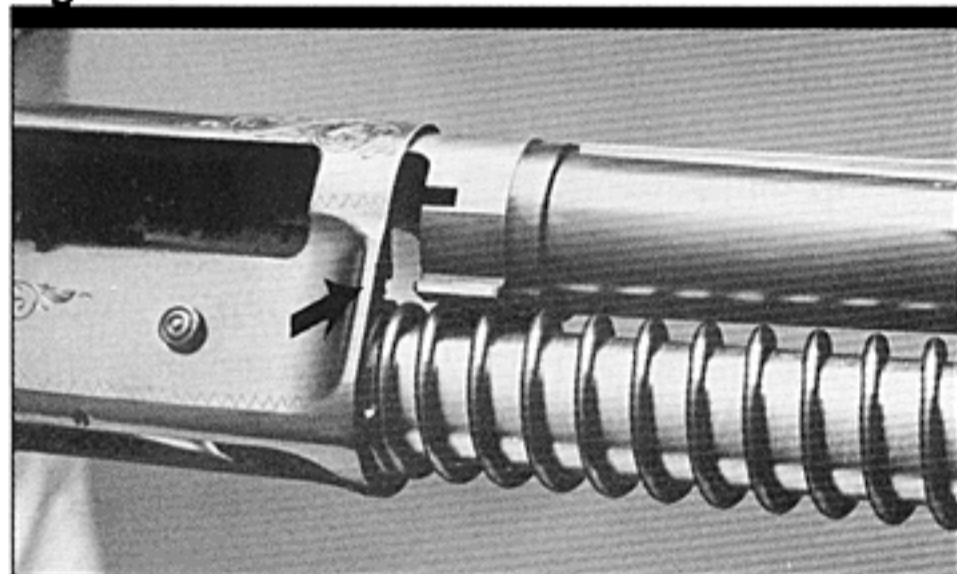
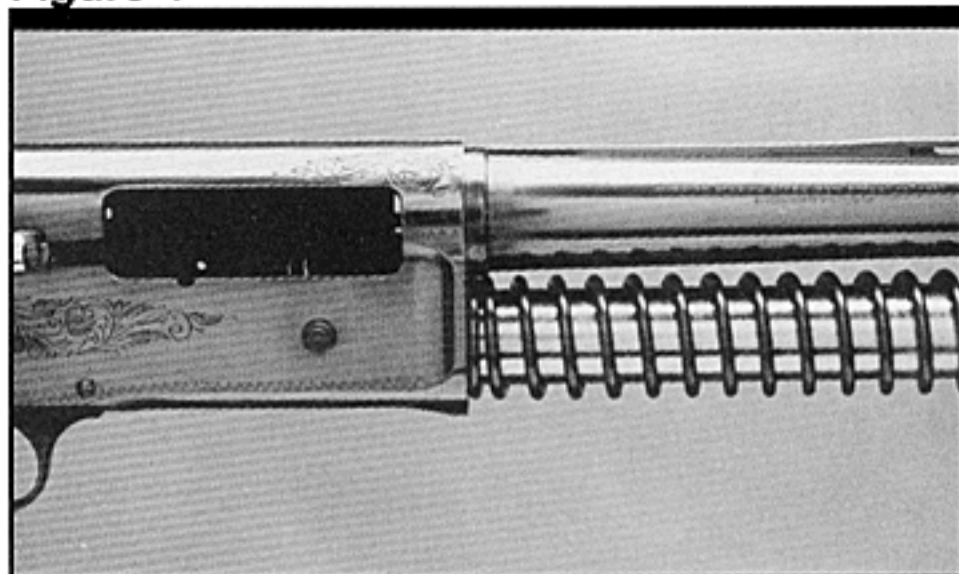
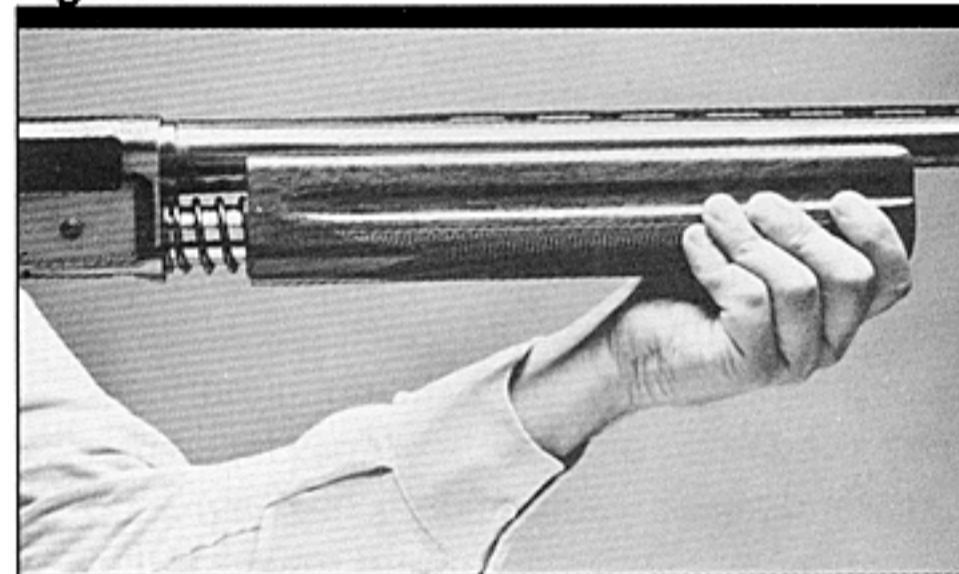
Figure 2**Figure 3****Figure 4****Figure 5**

out the plug, the end of which you will see in the exposed end of the magazine tube. The gun will then be a 5 shot semi-automatic. (See Figure 2.)

If at some future time you wish to limit your gun to three shots again, take the adaptor and pass the shaft through the hole in the magazine spring retainer which is exposed in the end of the magazine tube. With this shaft projecting into the magazine, press or lightly tap the head of the adaptor to force the magazine spring retainer downward until the head of the plug is on a level with the end of the magazine tube if it is not already so. Then proceed with assembly as follows:

- 3 Check the friction ring setting to be sure the friction rings are set according to the loads you plan to shoot. See page 9 for proper setting of friction rings. Place the barrel guide ring around the magazine tube and force the

barrel rearward against the resistance of the recoil spring while guiding the barrel extension into the receiver. Note the guides on the barrel extension which must be placed in the receiver tracks (See Figure 3).

- 4 With the left hand maintaining rearward pressure against the barrel to the point where the front end of the barrel extension is even with or slightly inside of the front end of the receiver (See Figure 4), replace the forearm over the magazine tube and screw the magazine cap on tightly. Be careful not to squeeze the rearward end of the forearm. Squeezing too hard may cause it to crack (See Figure 5).

BE CERTAIN THE MAGAZINE CAP IS SCREWED COMPLETELY DOWN FORCING THE REAR END OF THE FOREARM INTO FIRM CONTACT WITH THE FRONT END OF THE RECEIVER.

Figure 6

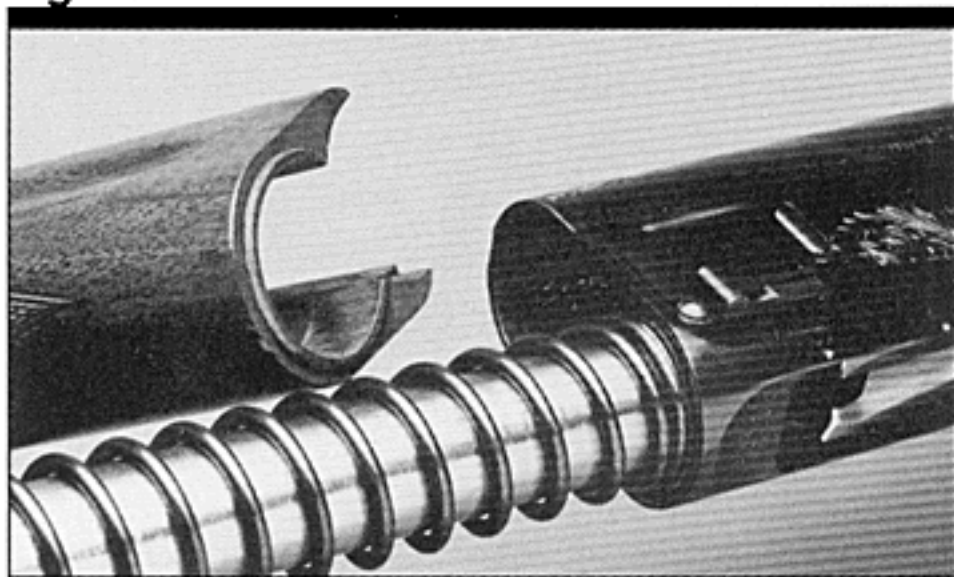
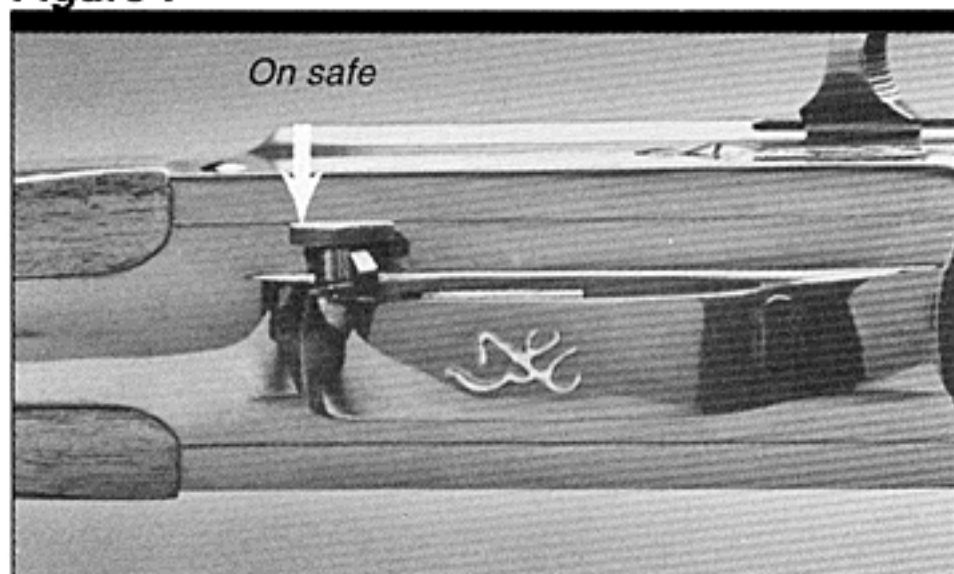

Figure 7



The semicircular wood ridge at the rear of the forearm should fit into the matching groove in the front of the receiver (See Figure 6).

Disassembly Procedures

CHECK YOUR GUN CAREFULLY TO BE CERTAIN THE CHAMBER, FEED MECHANISM AND MAGAZINE CONTAIN NO SHELLS.

- 1 Draw the breech bolt rearward and lock it open.
- 2 Rest the butt end of the stock on any convenient rigid surface. With the left hand apply rearward pressure to the barrel, then unscrew the magazine cap with the right hand. While maintaining rearward pressure on the barrel, remove the forearm from the magazine tube.
- 3 While continuing to hold the barrel firmly, gradually release pressure and slide the barrel directly forward off the magazine tube. ***DO NOT SUDDENLY RELEASE PRESSURE AGAINST THE BARREL.*** If this is done, the strong recoil spring may throw the barrel off the gun.

Figure 8



- 4 ***AFTER THE BARREL HAS BEEN REMOVED FROM YOUR GUN, LEAVE THE BREECH BOLT IN THE OPEN POSITION. DO NOT PRESS THE BOLT RELEASE BUTTON.***

If the breechbolt is released forward with the barrel removed, the operating handle will be driven against the front edge of the receiver ejection port, which will cause damage to the receiver.

- 5 For the convenience in casing and carrying the dismantled gun, return the forearm to its position on the magazine tube and screw on the magazine cap. You will then have two neat units. One is the barrel; the other is the action with forearm and stock.

Operation of the "Safety"

The cross bolt "safety" prevents the trigger from being pulled when in the "on safe" position. The safety is located conveniently at the rear of the trigger guard and has an enlarged head on the right side designed to be conspicuous "ON SAFE", hence, a shooter is not likely to lose a shot through failure to notice that his "safety" is on. The enlarged head also aids you to move the safety to FIRE position with unusual speed and convenience.

In the "off safe" or "fire" position a red warning band is visible on the safety button on the left side of the trigger guard. To place the gun "ON SAFE," press the "safety" button to the right. To move the "safety" to the **FIRE** position, press the "safety" to the left (See figures 7 & 8).

Figure 9

2 3/4" MAGNUM STEEL SHOT AND HIGH VELOCITY LOADS

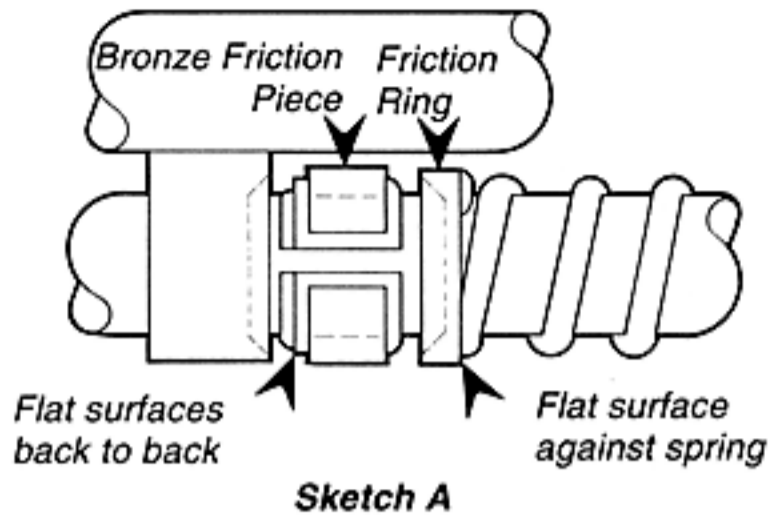
**Sketch A**

The safety is reversible and can be reversed from right to left-handed by a competent gunsmith. When installed, the left-handed "safety" will have the "safety" button's red warning band on the **Right** side of the trigger guard.

DO NOT DEPEND ON THE RED COLOR ALONE TO INDICATE YOUR GUN'S SAFETY STATUS.

Time, exposure to the elements, as well as the abrasive action of cleaning agents can erase it.

Friction Ring Adjustment for Auto-5 Light 12 and 20 Gauge Models

SETTINGS FOR SHOOTING 2 3/4-INCH MAGNUM, STEEL SHOT, AND HIGH VELOCITY LOADS —

THE FOLLOWING INSTRUCTIONS ARE ONLY FOR 2 3/4-INCH 12, SWEET 16 AND 20 GAUGE MODELS, NOT FOR THE 3" MAGNUM 12 GAUGE OR 3" MAGNUM 20 GAUGE SEMI-AUTOMATIC. SPECIAL INSTRUCTIONS ARE PROVIDED FOR THOSE MODELS IN A SEPARATE MANUAL.

A great deal of attention has gone into the design of the recoil absorbing mechanism to minimize the recoil of the magnum loads as much as possible. It is a mechanism specially arranged for those loads. As shown, it consists of a bronze friction piece and one coned friction ring (See Figure 9).

- 1 With the butt of the stock down and the magazine tube pointing up, one friction ring is placed on top of the spring with the beveled surface UP.

Figure 10

2 3/4" LIGHT LOADS

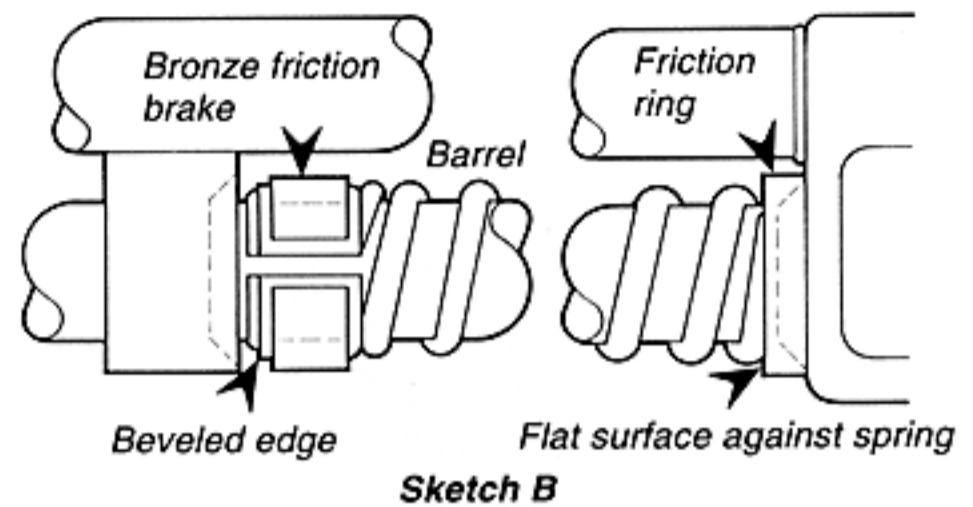
**Sketch B**

- 2 The bronze friction piece is then slipped over the magazine tube with its beveled surface up. **THE GUN SHOULD NEVER BE FIRED WITHOUT BRONZE FRICTION PIECE IN PLACE.**

If the correct position of the recoil components is not maintained you will get unnecessary recoil which will severely pound the mechanism of your gun.

NOTE: If steel shot loads will not function with the heavy load setting, then set friction ring adjustment for light load settings.

Friction ring setting for light loads

The single difference from the arrangement given for heavy loads is a change in the position of the friction ring. For light loads this friction ring is taken off and placed at the extreme rear end of the magazine tube, between the rear end of the recoil spring and the receiver with the beveled edge turned toward the receiver. (See Figure 10).

NEVER UNDER ANY CIRCUMSTANCES REMOVE THE BRONZE FRICTION PIECE FROM ITS POSITION REARWARD OF THE BARREL GUIDE RING.

If the gun is fired with either the friction ring or the recoil spring in direct contact with the barrel guide ring, the rear surface of the barrel guide ring will be deformed. Removal of the bronze friction piece permits an excess of recoil. You will be getting unnecessary recoil, thereby pounding the mechanism of your gun severely.

BROWNING AUTO-5 SHOTGUN LIGHT 12, SWEET 16 AND 20 GAUGE

Schematic is provided for parts identification only and should not be used as a guide to assemble guns.

IMPORTANT: When ordering parts, list part number, part name, caliber, model and serial number. **Do not order by key number.**

CAUTION: Browning parts are made exclusively for Browning guns and should not be used in other guns even though models may be similar. Inadequately fitted parts may be dangerous.

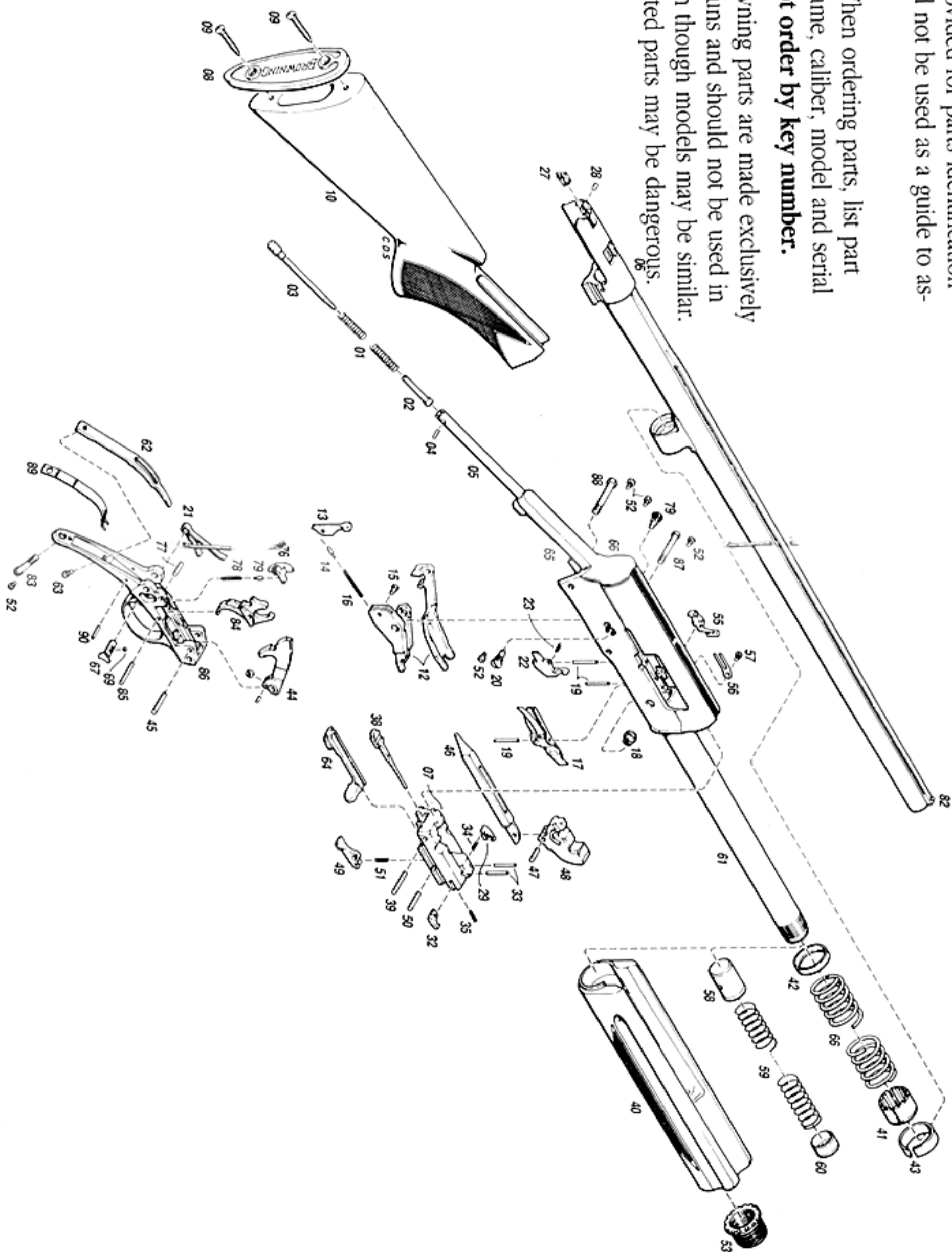

Parts List: Auto-5 Semi-Automatic Shotgun 12, 16 and 20 Gauge

PART NO.	DESCRIPTION	PART NO.	DESCRIPTION	PART NO.	DESCRIPTION	PART NO.	DESCRIPTION
01	P011001 Action Spring All Gauges	21	P011111 Carrier Spring Trigger Plate Type 16-20-20M	47	*P011252 Link Pin 12M-12	66	P011378 Recoil Spring 12
02	P011003 Action Spring Follower All Gauges	22	P011115 Cartridge Stop 12M 12	47	*P011254 Link Pin 16-20-20M	66	P011379 Recoil Spring 16
03	P011005 Action Spring Plug All Gauges	22	P011117 Cartridge Stop 16-20-20M	48	P011256 Locking Block 12M-12	66	P011381 Recoil Spring 20
04	P011007 Action Spring Plug Pin All Gauges	23	P011120 Cartridge Stop Spring All Gauges	48	P011261 Locking Block 16-20-20M	66	P011382 Recoil Spring Magnum 20 Gauge
05	P011009 Action Spring Tube All Gauges	24	P011121 Ejector & Ejector Rod Magnum 20 Gauge	49	P011264 Locking Block Latch Magnum 20 Gauge	67	*P011385 Safety Crossbolt Right All Gauges
06	*P011015 Barrel Extension Assembly, Magnum 12 Gauge	25	P011124 Ejector Spring Magnum 20 Gauge	49	P011265 Locking Block Latch Magnum 12 Gauge	68	*P011386 Safety Crossbolt Left All Gauges
06	*P011017 Barrel Extension Assembly, 12	26	P011126 Ejector Spring Retainer Magnum 20 Gauge	49	*P011269 Locking Block Latch 2-Piece Carrier 12	69	P011390 Safety Ball All Gauges
06	*P011022 Barrel Extension Assembly, 16	27	*P011127 Ejector 12 & Prewar 16	49	*P011272 Locking Block Latch 2-Piece Carrier 16-20	70	P011395 Sight Base-Rear-Buck Special 12-12M
06	*P011024 Barrel Extension Assembly, 20	27	*P011134 Ejector 16-20 & 12M	50	P011275 Locking Block Latch Pin All Gauges	70	P011397 Sight Base-Rear-Buck Special 16
06	*P011025 Barrel Extension Assembly, Magnum 20 Gauge	28	*P011136 Ejector Rivet 12	51	P011277 Locking Block Latch Spring 12M-12	70	P011398 Sight Base-Rear-Buck Special 20-20M
07	P011027 Breech Block 12M-12	28	*P011142 Ejector Rivet 12M 16 20	51	P011279 Locking Block Latch Spring 16-20-20M	71	P011399 Sight Body-Rear-Buck Special All Gauges
07	P011032 Breech Block 16	29	P011147 Extractor Left 12M-12-16-20	52	P011280 Lock Screw All Gauges	72	P011400 Sight Aperture-Rear-Buck Special All Gauges
07	P011035 Breech Block Magnum 20 Gauge	30	P011148 Extractor Spring Follower Magnum 20 Gauge	53	P011285 Magazine Cap-W/O Swivel Eyelet 12M-12	73	P011401 Sight Adjusting Screw-Windage-Buck Special All Gauge
07	P011036 Breech Block 20	31	P011149 Extractor Magnum 20 Gauge	53	P011287 Magazine Cap-W/O Swivel Eyelet 16-20-20M	74	P011403 Sight Adjusting Screw-Elevation- Buck Spec. All Gauge
08	*P011040 Butt Plate All Gauges	32	P011150 Extractor Right 12M-12-16-20	54	P011292 Magazine Cap W/Swivel Eyelet 12-12M	75	P011404 Sight Roll Pin-Buck Special All Gauges
09	P011042 Butt Plate Screws All Gauges	33	P011155 Extractor Pin Left & Right All Gauges	54	P011294 Magazine Cap W/Swivel Eyelet 16-20-20M	76	*P011405 Safety Sear 12M-12
10	*P011046 Butt Stock Magnum W/ Recoil Pad 1 5/8"x2 1/2" x 14 14" 12M	34	P011159 Extractor Spring Left 12M-12-16-20	55	P011295 Magazine Cutoff - Magnum 12 Gauge	76	*P011406 Safety Sear 16-20-20M
10	*P011048 Butt Stock Field 1 5/8"x 2 1/2"x14 1/4" 12	35	P011160 Extractor Spring Right 12M-12	55	P011297 Magazine Cutoff 12	77	P011408 Safety Sear Pin All Gauges
10	*P011056 Butt Stock Field 1 5/8"x 2 1/2"x14 1/4" 16-20-20M	35	P011162 Extractor Spring Right 16-20	55	P011298 Magazine Cutoff 16	78	P011410 Safety Sear Spring All Gauges
		36	P011163 Extractor Spring Magnum 20 Gauge	55	P011299 Magazine Cutoff 20-20M		
10	P011052 Butt Stock Composite 12M-12	37	P011164 Extractor Spring Follower Right 16-20	56	P011305 Magazine Cutoff Spring All Gauges	79	P011414 Safety Sear Spring Follower All Gauges
11	P011057 Butt Stock Swivel Eyelet (Buck Special)	38	P011165 Firing Pin 12M 12	57	P011310 Magazine Cutoff Spring Screw All Gauges	80	P011421 Sight Ramp-Front-Buck Special 12M-12-16
12	*P011062 Carrier Assembly Magnum 12 Gauge	38	P011167 Firing Pin 16-20-20M	58	P011315 Magazine Follower- 12 Magnum & 12 Gauge	80	P011422 Sight Ramp-Front-Buck Special 20M-20
12	*P011064 Carrier Assembly 2 Piece 12	39	P011168 Firing Pin Stop Pin 12M 12	58	P011319 Magazine Follower 16	81	P011423 Sight Gold Bead-Front-Buck Special All Gauges
12	*P011066 Carrier Assembly 2 Piece 16	39	P011169 Firing Pin Stop Pin 16-20-20M	58	P011321 Magazine Follower 20-20M	82	P011425 Sight Bead Plain & Vent Magnum 12M
12	*P011068 Carrier Assembly 2 Piece 20-20M	40	*P011170 Forearm 5-Shot Magnum 12 Gauge	59	P011325 Magazine Spring 12M-12	82	P011431 Sight Bead Plain & Vent 12-20-20M-16
13	*P011070 Carrier Dog 12M 12	40	*P011172 Forearm 5-Shot 12	59	P011329 Magazine Spring 16-20-20M	83	P011435 Tang Screw for Pistol Grip Stock All Gauges
13	*P011071 Carrier Dog 16-20-20M	40	*P011183 Forearm 5-Shot 16	60	P011330 Magazine Spring Retainer 12M-12	84	*P011444 Trigger-Crossbolt Safety-Gold Plated 12-16-20-20M
14	P011076 Carrier Dog Follower 12M-12	40	*P011191 Forearm 5-Shot 20	60	P011333 Magazine Spring Retainer 16-20-20M	85	P011445 Trigger Pin All Gauges
14	P011077 Carrier Dog Follower 16-20-20M	40	*P011192 Forearm Magnum 20 Gauge	61	P011335 Magazine Tube 5-Shot 12 & 12M	86	*P011466 Trigger Plate for Crossbolt Safety 12-12M
15	P011079 Carrier Dog Pin 12M-12	40	PO11175 Forearm Composite 12	61	PO11338 Magazine Tube 5-shot 12-M Only	86	*P011473 Trigger Plate for Crossbolt Safety 16-20-20M
15	P011080 Carrier Dog Pin 16-20-20M	40	PO11176 Forearm Composite 12M	61	P011339 Magazine Tube 5-Shot 16	87	P011475 Trigger Plate Screw-Front-12M 12
16	P011081 Carrier Dog Spring 12M-12	41	P011195 Friction Piece Bronze Magnum 12 Gauge	61	P011342 Magazine Tube 5-Shot 20M	87	P011477 Trigger Plate Screw-Front-16-20-20M
16	P011083 Carrier Dog Spring 16-20-20M	41	P011197 Friction Piece Bronze 12	61	P011343 Magazine Tube 5-Shot 20	88	P011480 Trigger Plate Screw-Rear-12M-12
17	P011085 Carrier Latch Assembly Magnum 12 Gauge	41	P011198 Friction Piece Bronze Magnum 20 Gauge	62	P011344 Mainspring All Gauges	88	P011481 Trigger Plate Screw-Rear-16-20-20M
17	P011086 Carrier Latch Assembly 12	41	P011199 Friction Piece Bronze 16-20	63	P011345 Mainspring Screw All Gauges	88	*P011486 Trigger Spring Pin Retained All Gauges
17	P011089 Carrier Latch Assembly 16	42	P011205 Friction Ring 12M-12	64	P011346 Operating Handle 12M-12	90	P011495 Trigger Spring Retaining Pin All Gauges
17	P011090 Carrier Latch Assembly 20-20M	42	P011207 Friction Ring 16-20-20M	64	P011347 Operating Handle 16-20-20M	91	P011499 Magazine Plug Adapter 3 Shot All Gauges
18	P011092 Carrier Latch Button 12	43	P011215 Friction Spring 12	65	†P011355 Receiver Magnum 12 Gauge		
18	P011093 Carrier Latch Button 12M-16	43	P011216 Friction Spring 16-20	65	†P011357 Receiver Magnum 20 Gauge		
18	P011094 Carrier Latch Button 20-20M	44	*P011225 Hammer Assembly Magnum 12 Gauge	65	†P011362 Receiver Lightweight 12		
19	P011098 Cartridge Stop-Carrier Latch-Magazine Cutoff Pin	44	*P011228 Hammer Assembly Lightweight 12	65	†P011368 Receiver Sweet 16		
20	P011103 Carrier Screw All Gauges	44	*P011232 Hammer Assembly Lightweight 16-20-20M	65	†P011372 Receiver Lightweight 20		
21	P011107 Carrier Spring Trigger Plate Type 12M-12	45	*P011235 Hammer Pin All Gauges	66	P011375 Recoil Spring Magnum 12 Gauge		
		46	*P011243 Link (Magnum) 20 Gauge				
		46	*P011245 Link (Magnum) 12 Gauge				
		46	*P011247 Link 12				
		46	*P011251 Link 16-20				

*Indicates part must be fitted by Browning Service Department or qualified gunsmith.
†Part may be purchased by holders of current valid Federal Firearms License.

Do not order by key number.

You will note, however, that the mechanism must receive a certain amount of force if it is to operate automatically. The addition of any sort of weight to a barrel will have somewhat the same effect. When such factors as these are introduced, care must be given to suitable adjustment of the friction ring setting. It is desirable to utilize the setting for heavy loads as long as the mechanism functions properly. When resistance to recoil is too great to permit proper ejection, the light load setting should be used.

Oil on the Magazine tube

Whether the friction ring is set for heavy loads or light loads, the amount and kind of oil on the magazine tube will, by varying the amount of friction, have an effect upon the amount of recoil. In general, the more oil that is put on the magazine tube (or bronze friction piece), the easier this friction piece will slide on the tube; hence, a greater degree of recoil will be obtained.

If you are firing a light load and the gun fails to eject, the addition of oil to the magazine tube in the region of the bronze friction piece will sufficiently increase recoil to a point satisfactory for good ejection.

Oil which congeals in cold weather or deposits gummy residue may reduce recoil to the point where the gun will fail to eject. Use a high quality lubricant. Occasionally clean the magazine tube and relubricate. If temperatures of ten to thirty degrees below freezing are likely to be encountered, it is best to utilize an oil which maintains its fluidity in such temperatures.

Browning Gun Oil is particularly well suited for this purpose.

At all times there should be a film of oil on the magazine tube except when 12 gauge, 2 3/4" magnum loads are being used. With this load it is desirable to wipe the magazine tube practically dry. Function will not be affected and you will find these heavy loads much more comfortable to shoot.

Should your gun at any time commence to give ejection trouble, one or more of the following is usually the cause:

- 1 Insufficient oil on the magazine tube, rust, gum, or hardened grease, any of which may interfere with normal operation of the recoil spring and friction pieces.
- 2 The friction rings are not properly set.
- 3 A slight swelling of the forearm (sometimes unavoidable under conditions of excessive exposure to moisture) may cause sufficient resistance to the barrel to affect normal operation. If a side of the barrel shows signs that it is rubbing against the forearm, the application of a fine piece of emery cloth to the interfering portion of the inside of the forearm will quickly rectify the problem.

Using the Speed Loading Feature

WARNING: WHENEVER LOADING, ALWAYS BE CERTAIN THAT THE MUZZLE IS POINTED IN A

SAFE DIRECTION AND THAT THE SAFETY IS "ON SAFE". KEEP YOUR HAND AWAY FROM THE EJECTION PORT TO AVOID BEING STRUCK BY THE BREECH BOLT, WHEN THE ACTION CLOSSES.

The Browning Auto-5 shotgun is equipped with the speed loading system. Its design will enable you to load faster and easier. It is not necessary to press the bolt release button on the right side of the receiver during the loading process, and the same procedure is used in loading the first shell into the chamber as in loading the remaining shells into the magazine.

CAUTION: WHENEVER A SHELL HAS BEEN CYCLED INTO THE CHAMBER—DURING LOADING OR ANY OTHER TIME, AUTOMATICALLY OR MANUALLY—THE SHOTGUN IS READY TO FIRE BY SIMPLY MOVING THE "SAFETY" TO THE OFF SAFE POSITION.

- 1 **BE SURE THE MUZZLE IS POINTED IN A SAFE DIRECTION AND THE "SAFETY" IS "ON SAFE".** If the breech bolt is not already

Figure 11

open, pull rearward on the operating handle until the breech bolt locks back. The gun is now ready to load.

- 2 Hold the gun with either right or left hand at the grip or forearm as you prefer or are accustomed. With the opposite hand, merely introduce the front end of the shell into the under side of the receiver and thrust completely forward as if loading the magazine — then release the pressure of your thumb.

(See Figure 11.) The shell is immediately and automatically driven rearward, tripping the feed mechanism, and delivered instantly into the chamber without further manipulation. The breech bolt automatically closes during the loading operation.

- 3 **THE GUN IS NOW LOADED AND READY FOR FIRING.**

To load the magazine, continue the same procedure, slipping shells past the carrier into the magazine until the latter is full. (Without the magazine plug, the magazine will hold 4 shells; 2 shells if the plug has been inserted.) Be sure to insert each shell completely into the magazine before releasing.

The speed loading system is equally convenient for right or left-hand shooters. The instant delivery of the first shell to the chamber in one simple operation eliminates entirely the conventional process of dropping the first shell into the open receiver port and then pressing the bolt release button on the right

side of the receiver to close the action. The bolt release button is still provided to close the action on an empty chamber, if desired.

CAUTION: DO NOT PRESS THE BOLT RELEASE BUTTON AND LET THE BOLT SLAM HOME WITH THE BARREL REMOVED FROM THE ACTION.

When the barrel is installed, the breech bolt stops against the barrel extension, preventing any damage. With the barrel removed, however, the operating handle will forcefully strike the front edge of the ejection port causing damage to the receiver. If you wish to close the bolt with the barrel removed, be sure to hold the operating handle as you depress the bolt release button. Let the bolt ride home slowly.

Unloading Your Auto-5

CAUTION: WHENEVER UNLOADING, ALWAYS BE CERTAIN THAT THE MUZZLE IS POINTED IN A SAFE DIRECTION AND THAT THE "SAFETY" IS "ON SAFE".

The recommended way to unload the Auto-5 is simply to grasp the operating handle and cycle the action until all rounds are ejected.

ALWAYS INSPECT THE CHAMBER, ACTION AND MAGAZINE VERY CAREFULLY AFTER UNLOADING TO BE SURE ALL LIVE ROUNDS ARE CLEARED FROM THE GUN.

Breech Remains Open After the Last Shot

The breech of the Auto-5 remains open after the last shot has been fired. This allows convenient and fast reloading as follows:

- 1 Place the "safety" in the "on safe" position.
- 2 Drop an appropriate shell into the open breech.
- 3 Close the action by depressing the breech-block release button.

EVEN WITH THE BREECH OPEN AFTER SHOOTING, DO NOT ASSUME YOUR

Figure 12

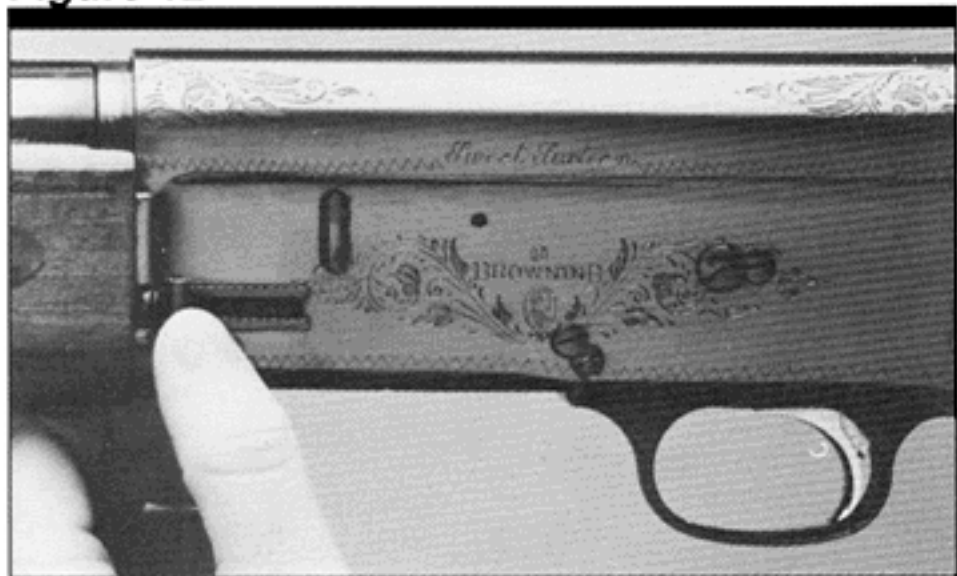

SHOTGUN IS UNLOADED. ALWAYS INSPECT THE CHAMBER, CARRIER AND MAGAZINE TUBE TO BE SURE THEY CONTAIN NO CARTRIDGES. THEN, REMEMBER TO ALWAYS TREAT ANY GUN AS IF IT WAS LOADED. ALWAYS HANDLE YOUR SHOTGUN WITH CAUTION.

Operation of the Magazine Cut-off

The magazine cut-off is located at the front end of the left side of the receiver (See Figure 12).

This cut-off has the purpose of locking the shells in the magazine so that they will not feed into the chamber. This permits you quickly to change the load in the chamber of the gun without going to the trouble of unloading the whole magazine. In this way a duck load can quickly be taken out and a goose load inserted, if the need arises.

To operate the magazine cut-off, merely pull the cut-off lever back (See Figure 13). This will lock the shells in the magazine. Push the cut-off lever forward when you desire to release the shells in the magazine so that they will feed automatically as the gun is fired.

With the magazine cut-off in operation, the chamber empty, and the breech bolt locked in the rearward position, a shell may be instantly delivered from the magazine to the chamber by merely pushing the magazine cut-off forward.

Figure 13

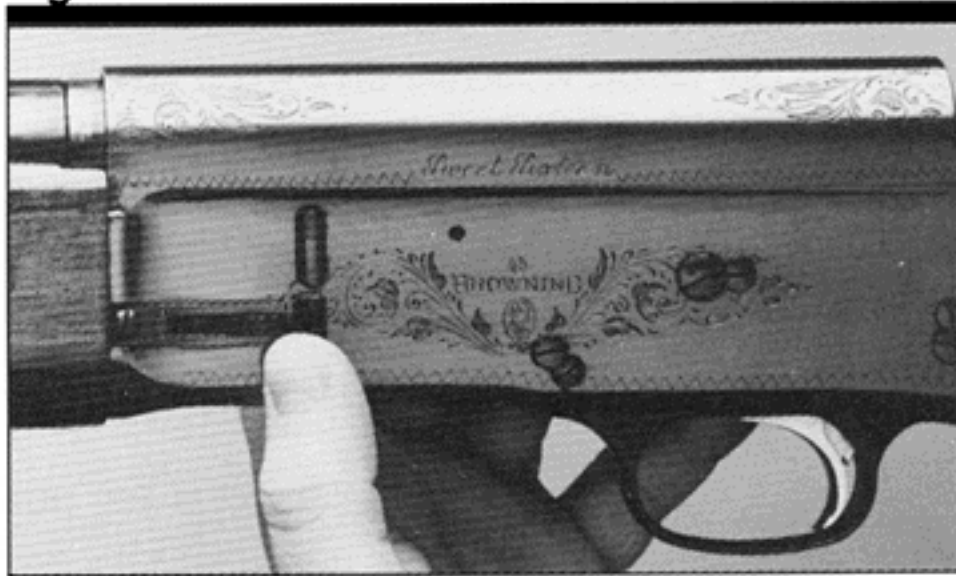

Invector Interchangeable Choke System

All current Auto-5 shotguns have barrels that are threaded to accept the Browning Invector-Plus Interchangeable Choke System. You may confirm this by glancing on the right side of your barrel where the specifications are inscribed, and where the choke markings are normally located. All older Auto-5 models and the Auto-5 Buck Special are conventionally choked. The word, **INVECTOR** denotes that the barrel is

threaded. The degree of choke tube is indicated twice on each choke tube: Inscribed on the side of the tube, and indicated with a "notch" code on the top rim of the tube. Invector Choke Tubes are made with tempered steel and are fully compatible with all **FACTORY AMMUNITION** (loaded in compliance with SAAMI specifications) including magnum lead and steel shot loads and rifled slug loads.

DO NOT FIRE THIS SHOTGUN WITHOUT HAVING AN INVECTOR CHOKE TUBE INSTALLED.

Permanent damage may result to the threads.

DO NOT USE BROWNING INVECTOR CHOKE TUBES IN ANY SHOTGUN BARRELS NOT SUPPLIED BY BROWNING. ALSO, DO NOT USE ANY OTHER CHOKING DEVICE IN ANY SHOTGUN BARRELS SUPPLIED BY BROWNING. USE ONLY CHOKE TUBES MARKED INVECTOR.

CAUTION: WHENEVER HANDLING ANY SHOTGUN FOR THE PURPOSE OF REMOVING OR INSTALLING A CHOKING DEVICE, MAKE ABSOLUTELY CERTAIN THE GUN IS FULLY

Figure 14

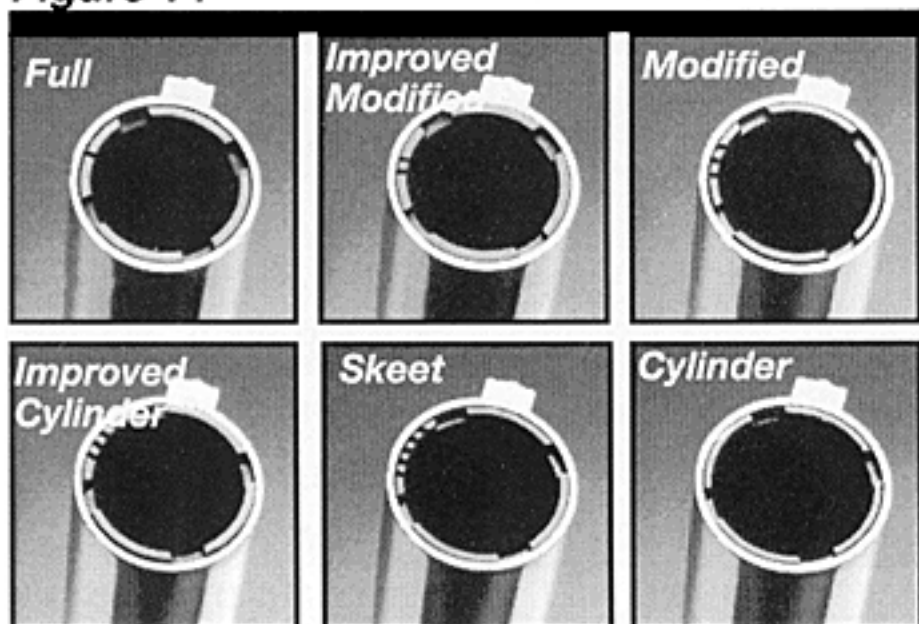

UNLOADED, AND THE BOLT OR BREECH IS OPEN! NEVER ATTEMPT TO REMOVE OR INSTALL A SHOTGUN CHOKING DEVICE ON A LOADED FIREARM!

TUBE REMOVAL—

- 1 **UNLOAD YOUR A-5 FULLY. INSPECT THE CHAMBER, FEED MECHANISM AND MAGAZINE TO MAKE SURE THEY DO NOT CONTAIN ANY SHELLS.**
- 2 Open the action, locking it rearward, and place the "safety" in the "on safe" position.
- 3 Use the Invector wrench to loosen the tube, turning it counterclockwise. Finger twist the tube the rest of the way out of the barrel.

TUBE INSTALLATION—

- 1 **UNLOAD YOUR A-5 FULLY. INSPECT THE CHAMBER, FEED MECHANISM AND MAGAZINE TO MAKE SURE THEY DO NOT CONTAIN ANY SHELLS.**
- 2 Open the action and place the "safety" in the "on safe" position.
- 3 Before installing a tube, check the internal choke tube threads in the muzzle, as well as the threads on the Invector choke tube to be sure they are clean. Lightly oil the threads with an oil like Browning Oil.
- 4 Using your fingers, screw the appropriate tube into the muzzle end of the barrel, tapered end first, notched end outward. When it becomes finger-tight, use the invector choke tube wrench to firmly seat the tube.

THE INVECTOR CHOKE TUBE SHOULD BE PERIODICALLY CHECKED TO ASSURE THAT IT IS TIGHT AND FIRMLY SEATED. BEFORE CHECKING, FOLLOW THE SAFETY GUIDELINES OUTLINED ABOVE.

Replacement and additional tubes and wrenches are available from your Browning dealer, or by writing to:

**Browning Consumer Department,
One Browning Place, Morgan, Utah 84050.
801-876-2711.**

Canadian customers please call or write to:

**Browning Canada Sports Ltd./Ltee,
5617 Chemin St-Francois,
St-Laurent, Quebec, Canada H4S 1W6.
(514) 333-7261.**

INVECTOR CHOKE TUBE CODE —

To identify individual Invector tubes, refer to the abbreviated indications on the side of the

tube, or use the identification mark(s) located on the top rim of each tube. (See Figure 14).

INVECTOR TUBE SELECTION

To help you choose the correct choke tube for each hunting situation, all Browning Invector choke tubes are inscribed on the side with the patterns they produce with both lead and steel shot. Each Invector tube also has notches in the top rim of the tube. These notches are a code to allow you to determine the choke designation while the tube is installed. Rim notches refer specifically to lead shot. You will need to use the chart below to cross-reference from lead to steel, and determine the appropriate tubes for your ammunition and hunting/shooting situation.

Several tubes are supplied with your Browning shotgun. The tubes listed are also available as accessories. Remember, Standard Invector and Invector-Plus tubes are not interchangeable. Invector-Plus tubes are for Browning guns with back-bored barrels, such as your new Auto-5. Older Auto-5 shotguns are Standard Invector. Before removing/installing tubes, or reading the rim

Figure 15

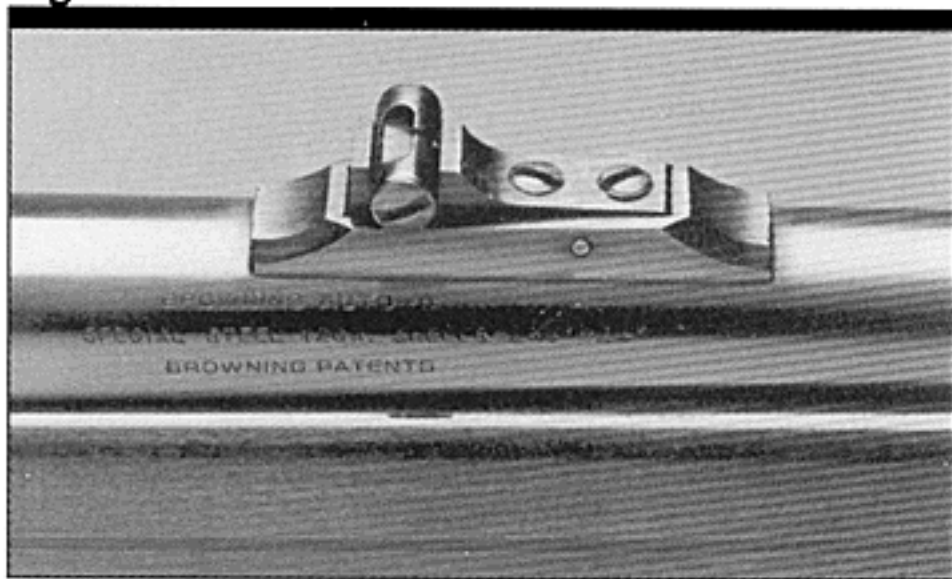

notch code, make sure your shotgun is fully unloaded.

12 Gauge Invector-Plus

Rim Notches	Pattern With Lead Shot	Pattern With Steel Shot
Knurled	X-Full Turkey Special	**
I	Full	*
II	Imp. Modified	Full***
III	Modified	Full***
IIII	Imp. Cylinder	Modified
IIIII	Skeet	Imp. Cylinder
No Notches	Cylinder	Cylinder

20 Gauge Invector-Plus

Rim Notches	Pattern With Lead Shot	Pattern With Steel Shot
I	Full	*
III	Modified	Imp. Modified
IIII	Imp. Cylinder	Modified***
IIIII	Skeet	Modified***
No Notches	Cylinder	Imp. Cylinder

*Not for use with steel shot. Using an over-tight choke constriction with steel shot will result in an ineffective, "blown" pattern.

**Extra Full Special with knurled rim and no rim code. Do not use with steel shot.

***When more than one choke designation is listed for a given steel shot pattern, use the more open choke listed for high velocity, larger shot size steel shot loads.

****Has knurled extension beyond muzzle.

CAUTION: DO NOT USE STANDARD INVECTOR CHOKE TUBES IN BARRELS MARKED INVECTOR-PLUS. DO NOT USE INVECTOR-PLUS CHOKE TUBES IN BARRELS MARKED INVECTOR. FAILURE TO FOLLOW ALL OF THE ABOVE WARNINGS CAN DAMAGE YOUR GUN AND CAUSE INJURY TO YOURSELF AND OTHERS.

Use of Extra Barrels

Your Auto-5 can be made suitable for multiple shooting conditions merely by changing from one barrel to another of different choke or length. On all Browning Automatic-5 shotguns, barrels of the same gauge and model are completely interchangeable and no special fitting is required. Thus, by merely buying another barrel, you have acquired the utility of another gun at a fraction of the cost of a new gun; a duck gun becomes a fine upland game gun, a pheasant gun becomes a rifled slug deer gun.

NOTE: 3-inch Magnum 12 gauge and 3-inch Magnum 20 gauge barrels will not fit or work in a Light 12 gauge or a Light 20 gauge action designed for 2 3/4" shells and vice versa because the feeding and ejection mechanisms are different.

Sight Adjustment for the Buck Special

The Buck Special is equipped with a precision rear sight which is screw adjustable for both horizontal and vertical correction (See Figure 15).

WINDAGE ADJUSTMENT—

To move point of impact to the **RIGHT**, loosen the small screw on the right side of the sight. Then tighten the small screw on the left side of the sight. To move point of impact to the **LEFT** loosen the small screw on the left side of the sight and tighten the screw on the right side. This is a process of trial and error. Make small adjustments then check the point of impact.

Figure 16

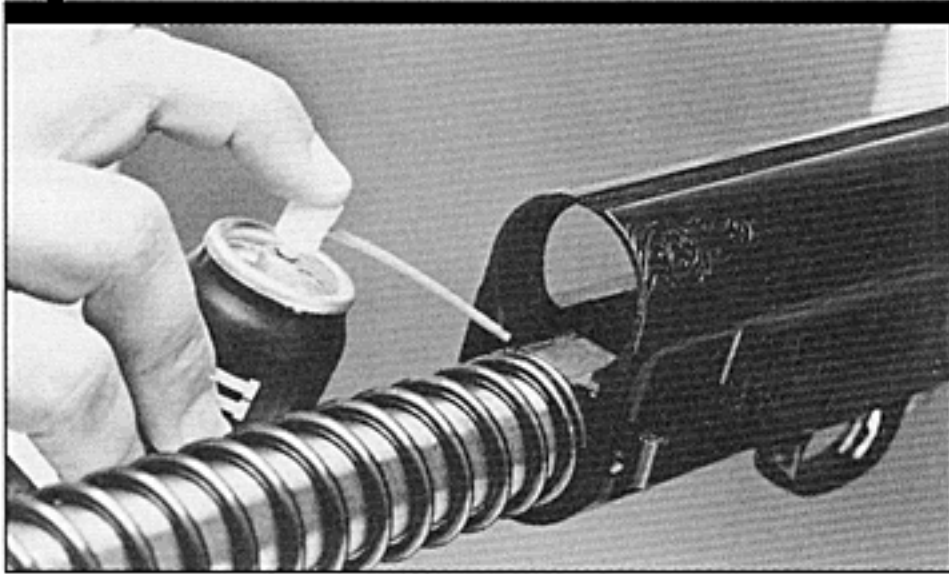

VERTICAL ADJUSTMENT —

Adjustment of the sight is controlled by the screw located on top of the sight. To **RAISE** the point of impact, turn the screw in a counter-clockwise direction. To **LOWER** the point of impact, turn the screw in a clockwise direction. Vertical adjustment is also a process of trial and error.

Cleaning and Maintenance Suggestions

PERIODIC OILING —

Ordinary good judgment will indicate that the metal parts of the gun should receive a light film of oil after the gun has been exposed to weather or handling.

Occasionally, a small drop of oil may be placed on each receiver track in which the breech bolt and barrel extension guides run during operation (See Figure 16). This will help to relieve friction and insure smooth operation.

DO NOT POUR LARGE QUANTITIES OF OIL INTO THE ACTION. A LARGE EXCESS OF OIL WILL RUN BACK INTO THE WOOD OF THE STOCK AND CAUSE SOFTENING OF THE WOOD, WITH CONSEQUENTIAL LOOSENING OF THE STOCK.

CLEANING YOUR AUTO-5

The correct procedure for cleaning your Auto-5 shotgun is as follows:

BE CERTAIN YOUR SHOTGUN'S MAGAZINE, FEED MECHANISM AND CHAMBER ARE UNLOADED. PLACE THE "SAFETY" IN THE "ON SAFE" POSITION AND LOCK THE BOLT TO THE REAR. ALWAYS WEAR PROTECTIVE SAFETY GLASSES DURING ALL DISASSEMBLY AND CLEANING PROCEDURES.

- 1 Remove the barrel so that it can be cleaned from the breech end.
- 2 Using a shotgun cleaning rod with tip and patch large enough for a snug fit in the bore, insert the rod and patch in the breech end of the barrel and run back and forth through the bore several times. Remove and wipe the Invector tube, tube threads and barrel threads, and lightly oil.
- 3 Inspect the bore from both ends for leading by looking through the bore toward light. Leading will appear as dull longitudinal streaks and is usually more predominate near the muzzle and just forward of the chamber.
- 4 A normal amount of leading can be expected with today's high velocity loads and improved wads but this is not serious. If or when leading should become heavy, it can be removed with a brass bore brush. Make sure a choke tube is installed. Spray the bore or the bore brush with a good powder solvent, and scrub the bore until leading is removed. To prevent brass bristles from breaking off, the brush should be pushed completely through the bore before being withdrawn.

- 5 After leading has been removed, the bore should be wiped dry with a clean patch, and then a lightly oiled patch run through it for preservation.
- 6 If the gun has been exposed to much dust, dirt, mud or water, the principal working parts should be wiped clean and lubricated with a light film of oil. Browning Oil is recommended.
- 7 The magazine tube on the Automatic-5 should be wiped clean of all dirt and grit, and then lubricated lightly with an oiled patch. The friction pieces should be assembled according to the loads to be used, as covered previously.
- 8 Reassemble barrel and wipe all exposed metal surfaces with an oiled cloth making sure to wipe gun clean of all finger marks where moisture will accumulate.
- 9 The barrel and action should be inspected to assure that all cleaning patches have been removed and not inadvertently left in the barrel or action.
- 10 The wood surfaces can also be wiped with Browning Oil or they can be polished with any quality furniture wax (but not both).

DO NOT TAKE YOUR GUN'S ACTION APART.

This is a specialized, finely fitted mechanism; and you may mar it for life by an attempt to remove the inner mechanism. It is unnecessary, and may do damage to the inner mechanism, to disassemble it for routine cleaning and oiling. Of course, misfortunes (such as dropping your gun in water) require appropriate attention, and in such circumstances we recommend you immediately take your gun to a competent gunsmith.

Service or Repair

If your firearm should require service or repairs, we suggest you first contact a local recommended Browning Firearms Service Center. Contact your Browning sporting goods dealer or call our Service Department for the address of the Service Center nearest you. Otherwise, you may send your firearm directly to our own Service Department. For technical questions about your firearm or service call our Service Department.

Browning Service Department
3005 Arnold Tenbrook Road
Arnold, Missouri 63010-9406
Phone: 1-800-322-4626

Canadian Customers call or write:

Browning Canada Sports Ltd./Ltee,
5617 Chemin St-Francois
St-Laurent, Quebec H4S 1W6
Phone: (514) 333-7261

When returning your firearm for servicing, you *must* do the following:

- a. Be sure it is completely unloaded.
- b. Package it securely in a cardboard container.
- c. Enclose a letter with your firearm that clearly describes the trouble experienced and the repairs or alterations desired.
- d. If convenient, send a copy of the letter to us separately.
- e. Never return ammunition with your firearm. It is against postal and most commerce regulations.

If you have any questions about this manual or about any other Browning products, call or write our Consumer Information Department:

Browning Consumer Information
Morgan, Utah 84050
Phone: (801) 876-2711