

R93



Blaser

Blaser

Blaser Jagdwaffen GmbH
D-88316 Isny
Germany

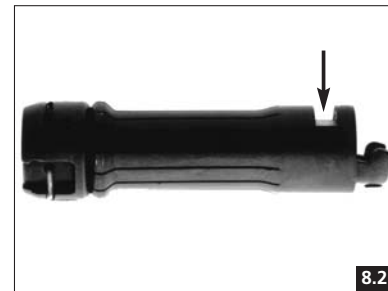
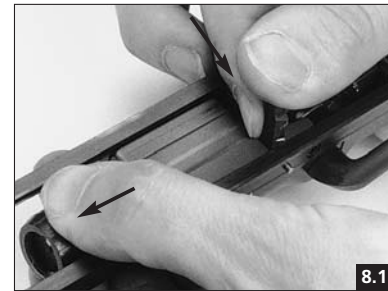
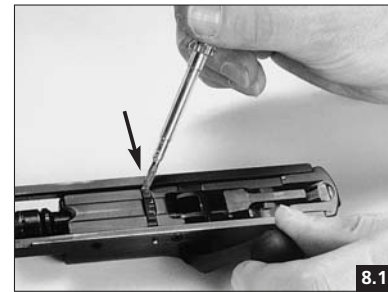

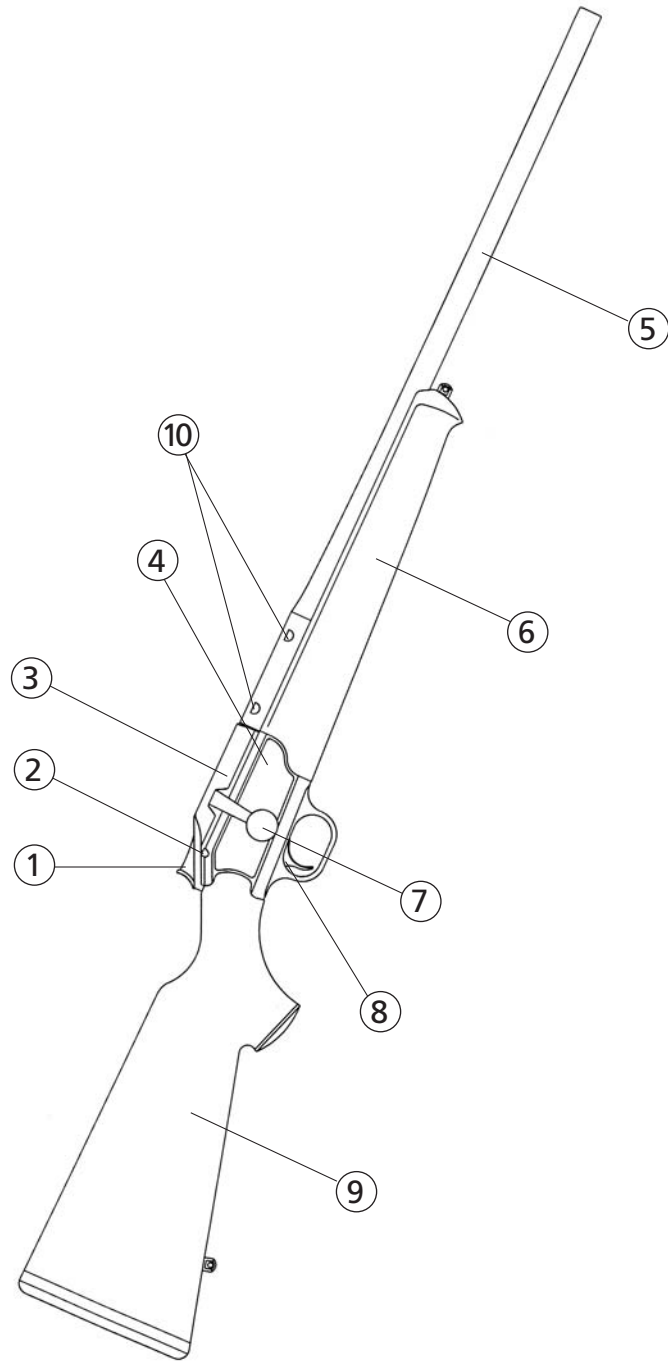
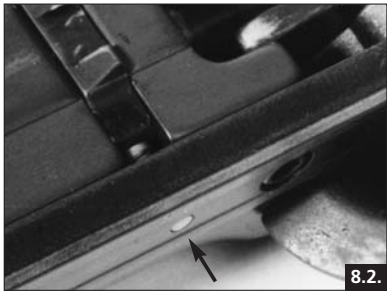
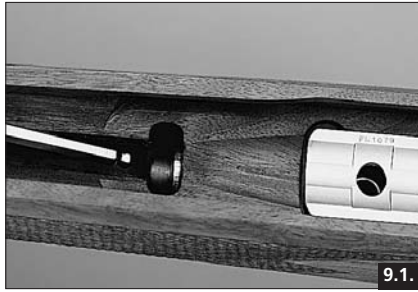
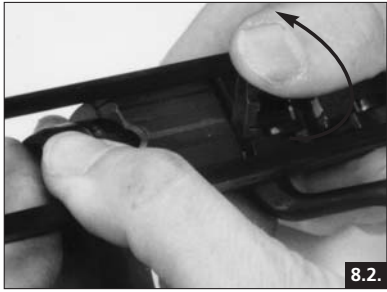

Description of parts

1	Safety slide (cocking slide)	6	Forearm
2	Bolt Stop	7	Bolt handle
3	Bolt Assembly	8	Trigger
4	Receiver	9	Buttstock
5	Barrel	10	Seat for Blaser saddle mount

Table of Contents

	Page
Description of parts	1
General Safety Rules	2/3
1. Assembly, Disassembly	4
2. Safety and Bolt Handle Lock	5
3. Loading the Rifle	6
4. Firing	6
5. Unloading	7
6. Removing and Installing Bolt Assembly	7
7. Exchanging Barrels	8
8. Exchanging the Bolt Head	9
9. Removal of Forearm /Exchange of Forearm	10
10. Open Sights	10
11. Mounting of Scope	11
12. Mounting the fixed scope mount (US-Type)	12
13. Table of Calibre Groups	13
14. Rifle case	14
15. Care and Maintenance	14
16. Warranty Conditions	15

General Safety Rules

Your new Blaser bolt action rifle model R 93 is characterised by special design features, making it very different from other bolt action rifles.

The enhanced safety features of your Blaser rifle should never induce you to ignore the necessary care and legal provisions with respect to handling arms. Please check first, whether you have the correct operating instructions: the model R 93 and the calibre are indicated on left side of the barrel, on its lower end.

CAUTION:

Please read these operating instructions completely, before using the rifle. Only hand on the rifle together with the operating instructions.

Please ask your specialised dealer for an in-depth explanation of your rifle and instruction in its use, as a supporting measure to these operating instructions.

General safety rules for handling firearms

- Ensure that firearm and ammunition never pass into the hands of unauthorised persons.
- Always keep firearm and ammunition separate, in a secured unit and inaccessible to unauthorised persons.
- Observe applicable legal provisions for carrying and storing arms and ammunition.
- Familiarise yourself thoroughly with the handling of your firearm and practise all functions and actions with the firearm unloaded, before starting to carry and use it.
- Consider every firearm as loaded and ready to fire, unless you have convinced yourself of the contrary by opening the action and checking the chamber (barrel). Even when unloaded, a firearm has to be handled like a loaded firearm.
- During any handling, always hold the muzzle in a direction where you can neither jeopardise nor damage persons or property.

General Safety Rules

- Before loading the firearm, always check, whether there are oil residues or other foreign matter in the chamber or barrel. Oil residues in chamber or barrel may cause distinct shifts in the point of impact! Foreign matter in the barrel (e.g. water, snow, soil) may cause a detonation of the barrel, leading to severe injuries of the shooter or persons in the vicinity! Ensure that no foreign matter can enter the barrel, also during use!
- Only use ammunition which meets the CIP requirements, in particular with regards to the maximum gas pressures P_{max} according to CIP regulations. Every Blaser rifle is controlled and tested by the state proof-house according to the requirements of the proofing-law and -regulations, using proof cartridges exceeding the maximal allowed gas pressure P_{max} by a minimum of 30%. If gas pressures exceed proof-level, the safety of the user and/or third parties can no longer be guaranteed. The same applies to cartridge cases, where the seal function is no longer correct through obturation.
- Load your firearm only immediately before use.
- Disengage from safe position (cock) your firearm only immediately before shooting. Hold barrel into a direction out of danger during disengaging (cocking).
- Check the surrounding area, before every shot.
- Point your firearm only at a target, which you have clearly identified.
- Only put your finger on the trigger, when you want to shoot.
- Only fire a shot, when a secure back stop exists.
- When a cartridge fails, wait approx. 60 seconds before opening the action, to avoid danger through hang-fire.
- Wear hearing protection during shooting.

Unload your firearm:

- before crossing obstacles,
- before climbing and leaving raised hides,
- before entering a building,
- before climbing into a vehicle,
- before entering a built area,
- and also, when you lay down or hand on the firearm temporarily.

1. Assembly, Disassembly

1.1. Assembly

- Insert barrel into receiver, with muzzle pointing upwards, and hold it there.
- Fasten the two barrel fastening nuts finger tight with the Allen key provided (SW4). Do not use extensions!
- Insert magazine into magazine well and press it downwards.
- Carefully put bolt with the two guide slide ends onto rear end of receiver, parallel to bolt guide rail.
- Press magazine downwards and slide bolt assembly forward, into receiver.

CAUTION:

When mounting the bolt assembly, the bolt handle has always to be locked in its rear position. I.e. in an angle of approx. 45°. If the bolt handle is in an almost vertical position, mounting of the bolt assembly is not possible. Turn the bolt handle back into the 45°-position, until it locks.

CAUTION:

Care has to be taken during assembly, that barrel, bolt assembly and magazine are appropriate for the calibre.

1.2. Disassembly

- Push safety slide (cocking slide) slightly forward with your thumb (approx. 2mm); at the same time, turn bolt handle backwards with your index and middle finger (unlock), then pull bolt assembly back in a straight line.
- Unload rifle (refer to Para. 5).
- Push in bolt stop and hold it there, at the same time, pull bolt assembly out towards the back, using your other hand.
- Loosen the two barrel fastening nuts with the Allen key provided (SW4).
- Remove barrel.

2. Safety and Bolt Handle Lock

Safety system

The safety system of the Blaser bolt action rifle model R 93 is based on an uncocked firing pin spring: the firing pin spring is cocked with the safety slide (cocking slide) immediately before the shot. When repeating, the rifle is cocked again automatically. In its secured (uncocked) position, the bolt handle is also blocked to prevent unintentional opening of the bolt assembly when moving the rifle, provided that the handle was fully closed.

2.1. Disengaging from safe position (cocking)

- Push safety slide (cocking slide) forward powerfully with your thumb, all the way to the stop, and lift thumb off. Doing so, the safety slide (cocking slide) locks into its cocked position.
- A red dot becomes visible behind the safety slide (cocking slide) as a signal. The rifle is now disengaged from safe position (cocked).

2.2. Returning to the safe position (locking/uncocking)

- To put the rifle on "safe", push the safety slide (cocking slide) forward/downward with your thumb (unlocking) and let it slide back into its starting position (the red signalling dot is not visible any more).

CAUTION:

Under no circumstances should you put your fingers into the trigger when disengaging (cocking) or locking (uncocking) your rifle (you may be used to do this from rifles with exposed hammers). This would trigger the shot, when the rifle is loaded!

2.3. Bolt handle lock

- Prevents unintentional opening of the bolt assembly. It becomes active automatically, when the rifle is put on "safe" (uncocked) and fully locked.

2.4. Opening the locked (uncocked) rifle

- Push the safety slide (cocking slide) slightly forward with your thumb (approx. 2mm).
- At the same time, turn bolt handle backwards with your index and middle finger (unlock), then pull bolt assembly back in a straight line.

3. Loading the Rifle

3.1. Loading

- Move safety slide (cocking slide) back (lock/uncock).
- Open bolt assembly. (Refer to Para. 2.4)
- Remove oil from barrel and chamber and check for foreign matter.
- Convince yourself under all circumstances that the ammunition corresponds with the calibre of your rifle.
- Put cartridges into the magazine and push them down through the magazine lips powerfully - if necessary with both thumbs.

Capacity of the magazine:
3 cartridges, Exceptions:

- Calibre group "Mini" = 4 cartridges
- Calibre group "Ultra Magnum" = 2 cartridges
- Calibre group "Schweiz", "Shot", "Hornet" = single shot
- Slide another cartridge into the barrel by hand, if applicable.
- Push cartridges in magazine down with your thumb; push the bolt assembly all the way to the front with your other hand, engaging it.

PLEASE CHECK:

Red dot not visible, bolt handle in front position. The rifle is now loaded, put on "safe" (uncocked) and locked against unintentional opening.

4. Firing

4.1. Firing and repeating

- Cock the rifle by pushing the safety slide (cocking slide) forward.
- Sight at target and fire.
- Reloading (repeating): Pull bolt assembly at bolt handle back all the way to the stop and then push all the way forward again. (With some practise, this can be done during pointing.)

NOTE:

If the bolt handle is not pushed forward all the way to the stop, the cartridge will, for safety reasons, be unable to ignite.

CAUTION:

As long as the safety slide (cocking slide) is in its forward, disengaged (cocked) position, the bolt of the rifle will cock automatically with each repetition. When you do not want to continue shooting, lock (uncock) immediately again by letting the safety slide (cocking slide) slide backwards.

CAUTION:

Always disengage (cock) rifle immediately before firing, at all times. When no shot is fired, lock (uncock) rifle again immediately. When a shot is fired and the rifle reloads (repeating), the rifle has to be locked (uncocked) again immediately.

CAUTION:

The Blaser bolt action rifle model R 93 is equipped with a direct pull trigger. Its setting can and may only be changed at the factory. Please check the trigger regularly for smooth movement, with the rifle unloaded and locked (uncocked).

Gummy oil and/or contaminations may affect proper functioning of the trigger and cause malfunctions.

5. Unloading

5.1. Unloading

- Lock (uncock) the disengaged (cocked) rifle by letting the safety slide (cocking slide) move backwards with your thumb.
- Open bolt assembly and pull it back (refer to Para. 2.4), at the same time, the cartridge is pulled out of the barrel and ejected.
- Push cartridges remaining in the magazine forward with your thumb (or the bolt assembly), until they jump out of the magazine lips. Remove cartridges.
- Make sure that barrel and magazine are empty.

6. Removing and Installing Bolt Assembly

6.1. Removing bolt assembly

- Unload rifle.
- Pull opened bolt assembly all the way back.
- Now push bolt stop in and hold it in this position. At the same time, pull bolt assembly out towards the back, with your other hand.

For the calibres .222 Rem., .222 Rem.Mag, .223 Rem., 5,6x50 Mag., .22-250, .243 Win., 6x62 Frères, 6,5x55, 6,5x57, 7x57, 7,5x55, .308 Win. and 8x57 IS, a movable bolt stop for reduced range cartridges is built into the magazine, at the right side, just outside the right magazine lip. To remove the bolt assembly from a rifle in one of the above calibres:

- Push right magazine lip in. This puts the bolt stop for reduced range cartridges out of function.
- Pull bolt assembly back until it reaches the regular bolt stop.
- Now push bolt stop in and hold it in this position. At the same time, pull bolt assembly out towards the back, with your other hand.

6.2. Installing bolt assembly

- Push magazine in the receiver all the way down and hold it in this position.
- Carefully put bolt assembly with the two guide slide ends onto rear end of receiver, parallel to bolt guide rail.
- Slide it forward into the receiver.

7. Exchanging Barrels

There are 8 calibre groups (refer to Table on p. 13). When changing from one calibre group to the other during a barrel exchange, the bolt head has to be changed as well, so that it corresponds to the calibre group of the interchangeable barrel actually mounted. Please refer to the table on page 20 for proper allocation of suitable interchangeable barrels. Furthermore, bolt heads and barrels are imprinted with a symbol for the respective calibre group. These markings have to agree after assembly is completed.

Within one calibre group, barrels may be interchanged at random, without having to exchange the bolt head.

Calibre groups:

Hornet	stamp HO
Mini	stamp MI
Standard	stamp ST
Medium	stamp ME
Magnum	stamp MA
Ultra Magnum	stamp UM
Schweiz	stamp CH
Shot	stamp 28

Make sure that a magazine of the corresponding calibre is installed, when performing a barrel exchange. The calibre denominations are marked on the side of the magazine.

NOTE:

With barrels of the calibres .22 Hornet, 28/70 and 10,3x60R, single shot inserts are supplied. Magazines are not available.

7.1. Exchanging the barrel

- Unload rifle.
- Remove bolt assembly.
- Remove magazine (possibly, the scope has to be removed for this, refer to Para. 12.2 and/or 13.2).
- Loosen both barrel fastening nuts completely, using Allen key (SW4). The nuts remain in their guide rails and cannot get lost.
- Lift barrel out of receiver.
- Put exchange barrel into its channel inside receiver.
- Fasten the two barrel fastening nuts finger tight with the Allen key.
- Insert the magazine corresponding to the calibre of the exchange barrel into the magazine well.
- Check, whether the calibre group marked on the bolt head ("HO", "MI", "ST", "ME", "MA", "UM", "CH", "28", refer to Para. 7 and Fig. 7.1.) corresponds with the calibre group of the exchange barrel.
- If the bolt head in the receiver has to be exchanged: refer to Para. 8.

NOTE:

Always ensure that the barrel channel is clean! Excessive oil or gun grease between barrel and receiver has a negative effect on the precision of the gun.

8. Exchanging the Bolt Head

8.1. Removing the bolt head

You should best ask your specialised dealer for a demonstration of this process.

- Unload rifle.
- Remove bolt assembly.
- Deposit bolt assembly on a flat surface, with the lower side pointing upwards.
- Use a small screw driver or similar object to push the retaining latch to the left, leverage it out and swivel it up.
- Hold the retaining latch with your thumb and index finger and push it, against the pressure of the spring, all the way to the left, until it touches the left rail. Now pull the bolt head out towards the front, using your other hand.

8.2. Installing bolt head

- Take the bolt head to be newly installed and match the two cut keyways of the expanding shell and bolt head by turning the two parts against each other.
- Lift the retaining latch in the bolt housing.
- Now push the bolt head to be installed, with the cut keyways pointing exactly upwards, over the firing pin until it touches the stop, and hold it in this position.

NOTE:

In order to facilitate threading in, you should move the firing pin nut at the back up and down with the thumb of your other hand, during this process.

- Tilt retaining latch down again and engage it against the pressure of the spring.

CAUTION:

If the retaining latch is not locked properly, a signalling pin emerges at the exterior side of the rails.

- The bolt assembly can only be inserted into the receiver, when the signalling pin has disappeared and the retaining latch has thus been locked properly.

NOTE:

Bolt heads for left-handed bolt assemblies are marked with an "L" underneath the symbol for the calibre group.

CAUTION:

The expanding shell enclosing the bolt head, being an essential part of the bolt assembly, is secured with a rivet. It is strictly forbidden to loosen this rivet! Removal of the expanding shell will, when a shot is fired, inevitably cause the bolt assembly to be blown out and thus lead to lethal danger for the shooter or bystanders!

9. Removal of Forearm/ Exchange of Forearm

The Blaser bolt action rifle model R 93 is, in the varieties Safari and Jagdmatch (hunting match), equipped with a special, wider forearm. When inserting a Safari or Jagdmatch barrel into a regular version of the R 93, the forearm has thus to be exchanged.

9.1. Removal of forearm

Loosen screw in forearm with Allen key (SW4) and pull forearm off towards the front.

Mounting forearm

Place forearm on receiver from the front and tighten screw in forearm.

10. Open Sights

10.1. Foresight with elevation adjustment

- Insert Allen key SW 1.5 into the bore of the foresight base from above, and turn Allen screw as needed:
- Foresight (spring-supported)
Turning out = shooting deeper,
Turning in = shooting higher.

10.2. Rear sight (sight) with lateral adjustment

- The rear sight leaf has bores for Allen key SW 1.5 at the right and left side.
- **When shooting to the left:**
Loosen right headless screw,
tighten left headless screw.
- **When shooting to the right:**
Loosen left headless screw,
tighten right headless screw.

11. Mounting of Scope

The Blaser bolt action rifle model R 93 is prepared for installation of the Original Blaser saddle mount (DBP). We assume that your scope has been mounted correctly by your specialized dealer on the barrel assigned to it.

11.1. Installing scope

- Open lid of rear and front holding elements and swivel both to the front/up with your thumb.
- Hold scope with your right hand at the centre tube, above the mount, so that you can reach the holding element at the front with your thumb.
- Hold rifle at the forearm with your left hand, support buttstock on your thigh.
- Insert the two round studs at the scope mount carefully into the two oval holes sunk into the upper right side of the barrel, tilt scope to the left onto the barrel and hold it in this position.
- Press the opened holding elements, first the one in front and then the one in the back, backwards/downwards with your thumb, until they reach their stop position (tension!). (If this is too easy or requires force, then the mount is maladjusted. Have your dealer correct this according to works instructions. The ideal pressure for closing the holding elements is roughly the same as the pressure required for the safety slide (cocking slide) of the rifle.)
- Now close the two lids of the holding elements.

Please ensure that the engaging surfaces are clean and free from grease!

11.2. Removing scope

- Hold the rifle with your left hand at the forearm and support it on your thigh.
- Open both lids of the holding elements.
- First swivel the rear holding element with your thumb all the way to the front/up - until it reaches the stop.
- Grip scope with your right hand at the centre tube and hold it.
- Now swivel the holding element at the front with your thumb all the way to the front/up - until it reaches the stop.
- Remove scope, moving it to the right side and up.

CAUTION:

If the distance between eye and scope is too short and if the rifle is not seated correctly at your shoulder, injuries are not to be excluded when shooting with large calibres. Especially in case of big calibres, care has to be taken that the distance between scope and eye is appropriate and that the rifle is seated correctly at the shoulder.

12. Mounting the fixed scope mount (US-Type)

12.1. Installing scope

- Turn both lateral Allen screws SW 1/8" at the mount CCW several turns.
- Hold scope with your right hand at the centre tube, above the mount.
- Hold rifle at the forearm with your left hand, support buttstock on your thigh.
- Insert the two round studs at the scope mount carefully into the two oval holes sunk into the upper right side of the barrel, tilt scope to the left onto the barrel and hold scope in this position with your left hand.
- Tighten both lateral Allen screws at the mount finger tight with Allen key SW 1/8".

Please ensure that the engaging surfaces are clean and free from grease!

12.2. Removing scope

- Grip around forearm and scope with your left hand and support rifle on your thigh.
- Loosen both lateral Allen screws at the mount with Allen key SW 1/8" several turns.
- Remove scope.

13. Table of Calibre Groups

Calibre groups:	Calibre:
Hornet "HO":	.22 Hornet
Mini "MI":	.222 Rem. .222 Rem. Mag. .223 Rem.
Standard "ST":	.22-250 5,6x57 .243 Win. 6 mm Rem. 6x62 Frères .25-06 6,5x55 6,5x57 6,5x65 RWS .270 Win. .280 Rem. 7x57 7x64 .308 Win. .30-06 8x57 IS 9,3x62 .45 Blaser
Medium "ME":	6,5x68 7,5x55 8x68 S 9,3x64
Magnum "MA":	.257 Weath. Mag. .264 Win. Mag. .270 Win. Short Mag. 7 mm Rem. Mag. .300 Win. Short Magnum .300 Win. Mag. .300 Weath. Mag. .338 Win. Mag. .375 H & H .416 Rem. Mag.
Ultra Magnum "UM":	7 mm STW .300 Rem. Ultra Mag.
Schweiz "CH":	10,3x60 R
Shot "28":	28/70

Please note that permanent availability of all calibres listed above cannot be warranted for technical reasons.

14. Case

In the double-shell special ABS transportation case with three locks, the R 93, plus exchange barrel, 2 scopes and accessories, is stored correctly when travelling.

Rifle case A

For all Blaser single shot rifles and Blaser bolt action rifle R 93, forearm disassembled, with scope.

External dimensions LxWxH: 70x26x9 cm

Rifle case B

For Blaser bolt action rifle R 93, with forearm and scope mounted.

Also suitable for all single shot rifles.

External dimensions LxWxH: 78x26x9 cm

Rifle case C

For all Blaser single shot rifles and Blaser bolt action rifle R 93 with forearm mounted. Featuring additional compartments for second interchangeable barrel and scope.

External dimensions LxWxH: 78x35x9 cm

15. Care and Maintenance

Only use products for the care of your rifle, which are destined for this purpose.

Barrel: Polish exterior and interior of chamber and barrel with a suitable gun oil after shooting, before storing the rifle for prolonged periods of time, and after carrying the rifle, especially in humid or wet conditions. Prior to shooting, barrel and chamber have to be thoroughly de-oiled again. In case of thick deposits of bullet residues, we recommend to use chemical barrel cleaners.

CAUTION:

Under all circumstances, observe instructions and warnings given by the product manufacturer for use of product.

Metal parts: Keep all metal parts of the rifle clean and slightly oiled at all times.

Stock preservative is not suitable for polishing metal parts!

Stocks: All wooden stocks of Blaser hunting rifles are oil-rubbed. We recommend to polish them regularly with standard stock care products.

Gun oil is not suitable for stock care!

Optics: Please refer to care instructions of the optics manufacturer.

CAUTION:

When oiling hunting rifles, care has to be taken that no oil or grease gets into the trigger and action system. Under certain conditions, oil and grease can resinify (harden), causing dangerous disruptions of functioning. Please have your rifle checked by your specialised dealer prior to each hunting season or hunting trip. Every rifle is a piece of technical equipment requiring regular checks.

16. Warranty Conditions

1. Manufacturer's warranty

Warranty of Blaser Jagdwaffen GmbH is provided in addition to statutory warranty claims by dealers, provided, that the enclosed firearms certificate is filled in completely and received by Blaser Jagdwaffen GmbH within ten days after the date of sale. Warranty is provided exclusively for the first purchaser having his residence in the country of purchase.

The warranty applies to the metal and plastic parts of the rifle only, including original Blaser rifle scope mounts, but not the rifle scope. Wooden parts of the rifle require special care and, being natural products, are subject to natural changes. Warranty for wooden parts is excluded.

The warranty period amounts to ten years, starting with the date of sale. It includes any defects of and damages to the rifle (metal and plastic parts), which are proven to be due to faulty material or manufacturing. Within this framework, the manufacturer shall bear the costs for material and working time. For performance of work under this warranty, the rifle has to be returned to the specialised dealer or the production company in Isny.

Risk and costs of transportation of the rifle (outward and return) shall be borne by the customer. Warranty is performed in the discretion of manufacturer by repair or replacement of defective parts; replaced parts pass into manufacturer's property.

2. Warranty for gun efficiency

The firing precision of a gun depends on a multitude of factors. The most important factor is the ammunition. Not every barrel fires equally well with every type of ammunition, there may be considerable differences in efficiency. The scope and its mount are of the same importance. Parallax, loose reticles, defects in reticle adjustment and faulty mounting are the most common causes for unsatisfactory gun efficiency. For these reasons, you should use branded scopes, mounted by a specialist, and you should tune in the ammunition to your rifle by testing several types of ammunition.

Ammunition of the same make and charge may exhibit different efficiency and impact point characteristics from one manufacturing run to the other and from one rifle to the other. When the optimum of ammunition, rifle scope and mount were selected, we provide a warranty for the excellent efficiency of our rifles. Complaints regarding gun efficiency have to be brought forward in writing within 20 days after the date of sale. We reserve the right to submit the rifle to an independent institution for verification (DEVA or Staatliches Beschussamt) [government proofhouse]. If excellent gun efficiency is confirmed there, we are entitled to claim the costs incurred for the tests from customer.

3. Scope of warranty

Work performed under warranty does not cause any prolongation or renewal of the warranty period for the rifle or built in spare parts. The warranty period for installed spare parts ends at the same time as the warranty period for the entire rifle.

4. Guarantee exclusion

The guarantee shall be excluded with:

- Damage that is caused as the result of normal wear and tear, with non-observance of the operating instructions or improper use or handling and if the gun shows mechanical damages of any kind.
- Damages that are the result of force majeure or environmental influences
- Repairs, treatment or changes to the gun performed by third parties
- Use of reloaded or non-CIP-permitted ammunition
- Blueing carried out by a third party

The guarantee does not apply for optical sight equipment and telescopic sight mounts of manufacturers other than Blaser Jagdwaffen GmbH. More extensive or other claims, especially those that refer to compensation for damages that go beyond the gun itself (consequential damages) shall be excluded (provided liability is not legally ordered as compulsory).