

U22 NEOS

U22 neos



Instruction Manual



BERETTA

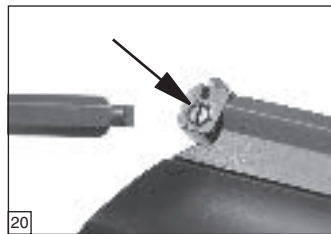
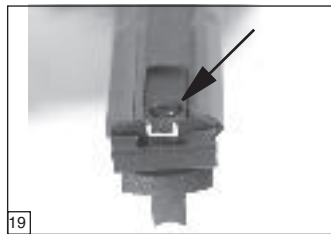
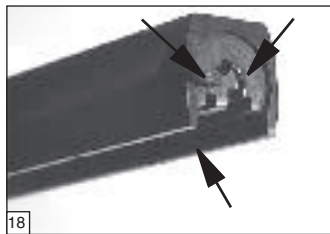
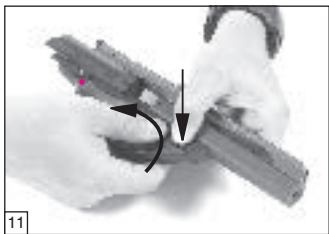
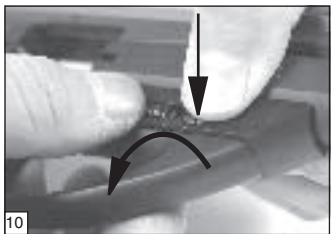
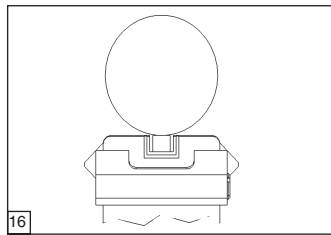
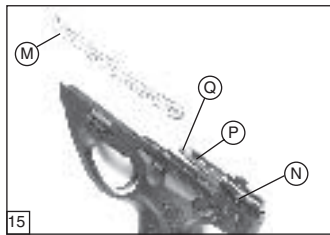
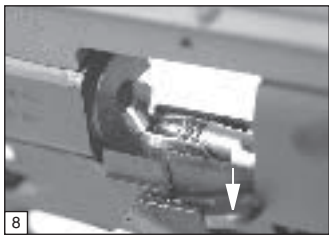
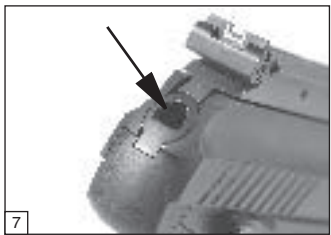
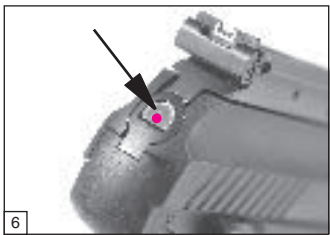
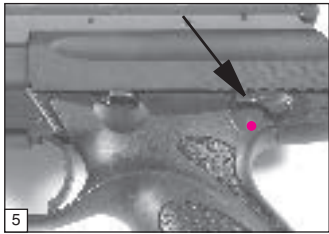
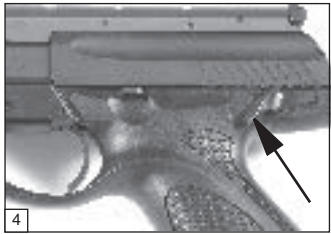

# CONTENTS

	Page
BASIC SAFETY RULES	6
• DESCRIPTION	14
• STANDARD FEATURES	14
• SAFETY FEATURES	14
• OPERATIONAL FEATURES	16
• SPECIFICATIONS	19
• GENERAL OPERATION	20
• LOADING AND FIRING	20
• LOADING THE MAGAZINE	21
• LOADING THE PISTOL AND THE FIRING CHAMBER	21
• FIRING	24
• UNLOADING THE PISTOL AND THE FIRING CHAMBER	26
• UNLOADING THE MAGAZINE	27
SPECIAL DLX INSTRUCTIONS	27
• TRIGGER ADJUSTMENT	27
• FRONT SIGHT REPLACEMENT	28
• REAR SIGHT REPLACEMENT	28
• MAINTENANCE	29
• FIELD STRIPPING	29
• CLEANING AND LUBRICATING	31
• ASSEMBLY	33
• TROUBLESHOOTING	33
• STORAGE	34

# BASIC SAFETY RULES

## 1. NEVER POINT A FIREARM AT SOMETHING THAT IS NOT SAFE TO SHOOT.

Never let the muzzle of a firearm point at any part of your body or at another person. This is especially important when loading or unloading the firearm. When you are shooting at a target, know what is behind it. Some bullets can travel over a mile. If you miss your target or if the bullet penetrates the target, it is your responsibility to ensure that the shot does not cause unintended injury or damage.



## 2. ALWAYS TREAT A FIREARM AS IF IT WERE LOADED.

Never assume that a firearm is unloaded. **The only certain way to ensure that a firearm is empty is to open the chamber and visually examine the inside to see if a round is present. Removing the magazine will not guarantee that a pistol is unloaded or cannot fire.** Shotguns and rifles can be checked by cycling or removing all rounds and by then opening the chamber so that a visual inspection of the chamber for any remaining rounds can be made.

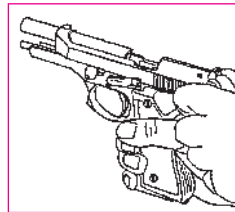

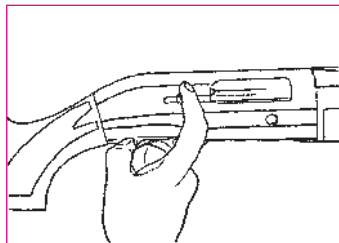
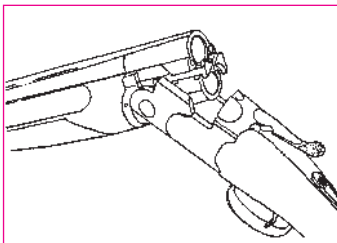

### 3. STORE YOUR FIREARM SO THAT CHILDREN CANNOT GAIN ACCESS TO IT

It is your responsibility to insure that children under the age of 18 or other unauthorized persons do not gain access to your firearm. **To reduce the risk of accidents involving children, unload your firearm, lock it and store the ammunition in a separate locked location.** Please note that devices

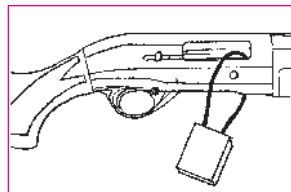
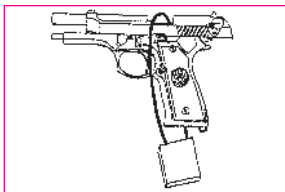

intended to prevent accidents—for example, cable locks, chamber plugs, etc.—may not prevent use or misuse of your firearm by a determined person. Steel gun safes may be more appropriate to reduce the likelihood of intentional misuse of a firearm by an unauthorized child or person.

#### 4. NEVER SHOOT AT WATER OR AT A HARD SURFACE.

Shooting at the surface of water or at a rock or other hard surface increases the chance of ricochets or fragmentation of the bullet or shot, which can result in the projectile striking an unintended or peripheral target.



#### 5. KNOW THE SAFETY FEATURES OF THE FIREARM YOU ARE USING, BUT REMEMBER: SAFETY DEVICES ARE NOT A SUBSTITUTE FOR SAFE HANDLING PROCEDURES.

Never rely solely on a safety device to prevent an accident. It is imperative that you know and use the safety features of the particular firearm you are handling, but accidents can best be prevented by following the safe handling procedures described in these safety rules and elsewhere in the product manual. To further familiarize yourself with the proper use of this or other firearms, take a Firearms Safety Course taught by an expert in firearms use and safety procedures.

#### 6. PROPERLY MAINTAIN YOUR FIREARM.

Store and carry your firearm so that dirt or lint does not accumulate in the working parts. Clean and oil your firearm, following the instructions provided in this manual, after each use to prevent corrosion, damage to the barrel or accumulation of impurities which can prevent use of the gun in an emergency. Always check the barrel prior to loading to ensure that it is clean and free from obstructions. **Firing against an obstruction can rupture the barrel and injure yourself or others nearby.**

In case you hear an unusual noise when shooting, stop firing immediately, engage the manual safety and unload the firearm. Make sure the chamber is free from any obstruction or possible bullet blocked inside the barrel due to defective or improper ammunition.



## 7. USE PROPER AMMUNITION.

Only use factory-loaded, new ammunition manufactured to industry specifications: CIP (Europe and elsewhere), SAAMI (U.S.A.). Be certain that each round you use is in the proper caliber or gauge and type for the particular firearm. The caliber or gauge of the firearm is clearly marked on the barrels of shotguns and on the slide or barrel of pistols. The use of reloaded or remanufactured ammunition can increase the likelihood of excessive cartridge pressures, casehead ruptures or other defects in the ammunition which can cause damage to your firearm and injury to yourself or others nearby.

## 8. ALWAYS WEAR PROTECTIVE GLASSES AND EARPLUGS WHEN SHOOTING.

The chance that gas, gunpowder or metal fragments will blow back and injure a shooter who is firing a gun is rare, but the injury that can be sustained in such circumstances is severe, including the possible loss of eyesight. A shooter must always wear impact resistant shooting glasses when firing any firearm. Earplugs help reduce the chance of hearing damage from shooting.



**9. NEVER CLIMB A TREE, FENCE OR OBSTRUCTION WITH A LOADED FIREARM.**

Open and empty the chamber of your firearm before climbing or descending a tree or before climbing a fence or jumping over a ditch or obstruction. Never pull or push a loaded firearm toward yourself or another person.



**10. AVOID ALCOHOLIC BEVERAGES OR JUDGMENT OR REFLEX IMPAIRING MEDICATION WHEN SHOOTING.**

Do not drink and shoot. If you take medication that can impair motor reactions or judgment, do not handle a firearm while you are under the influence or the medication.





## 11. NEVER TRANSPORT A LOADED FIREARM.

Unload a firearm before putting it in a vehicle. Hunters and target shooters should load their firearm only at their destination. If you carry a firearm for self-protection, leaving the chamber unloaded can reduce the chance of accidental discharge.



## 12. LEAD WARNING.

Discharging firearms in poorly ventilated areas, cleaning firearms or handling ammunition may result in exposure to lead and other substances known to cause birth defects, reproductive harm, and other serious physical injury. Have adequate ventilation at all times. Wash hands thoroughly after exposure.

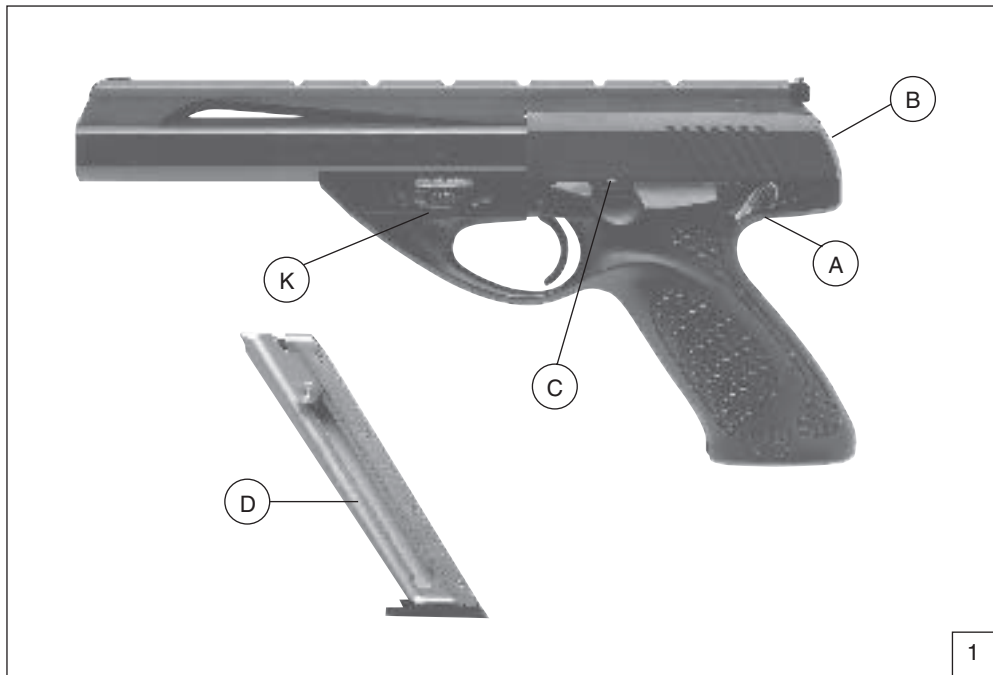

1



## DESCRIPTION

From the Greek word for “new”, the Beretta U22 NEOS represents a starting point for a complete line of pistols ideal for beginners but sophisticated in design and complete with features. Safety, affordability, modular construction, easy maintenance, performance (accuracy, reliability and durability), modern styling and innovation were all goals for Beretta’s first 100% American designed and manufactured pistol.

Styling and ergonomics were a result of close collaboration between Beretta and world renowned Giugiaro Design stylists. The U22 NEOS reflects a sleeker look and feel, guaranteed to appeal to a new generation of Beretta enthusiasts. The attention to details is evident in every component, from the easy-loading magazine to the attractive carrying case to the integral rail found on all U22 NEOS pistols.

The U22 NEOS is designed for ease of maintenance and cleaning. It easily disassembles into its basic subassemblies without special tools or complex procedures. It is the ideal gun for entry-level pistol shooters, but its modular design allows it to be adapted to the advanced shooter’s needs. The pistol features interchangeable barrel and grip units.

## STANDARD FEATURES

All current Beretta U22 NEOS pistols have the following important features:

## SAFETY FEATURES

**NOTICE:** The figure numbers noted below refer to the photographs on pages 3, 12, 13, 37 and 38.

**WARNING:** THE SAFEST PROTECTION AGAINST ACCIDENTS INVOLVING CHILDREN UNDER THE AGE OF 18 OR OTHER UNTRAINED, UNAUTHORIZED USERS IS TO STORE YOUR FIREARM UNLOADED AND LOCKED, WITH THE AMMUNITION IN A SEPARATE, LOCKED CONTAINER.

**WARNING:** A LOCK CANNOT REDUCE THE CHANCE OF UNAUTHORIZED USE IF THE KEY IS AVAILABLE TO CHILDREN OR OTHER UNAUTHORIZED PERSONS. KEEP ALL KEYS ON YOUR PERSON OR IN SOME OTHER LOCKED, INACCESSIBLE LOCATION.

**Safety:** (Fig. 1-A) The U22 NEOS features a manual ambidextrous safety that can be engaged either with the pistol in the cocked (ready to fire) or uncocked condition. To engage the safety, push the manual safety lever all the way downward to hide the red indicator mark. (Fig. 4) The visible red mark indicates that the safety is disengaged and ready to fire. (Fig. 5) The safety lever also acts as a tactile indicator, letting the user know by feel that the safety is engaged.

**Easy Loaded Chamber Inspection:** With the pistol uncocked and the safety engaged, the slide can be opened slightly to allow the user to check if there is a round in the chamber. (Fig. 3)

**Cocked firing pin indicator:** (Fig. 1-B) Is located in the rear of the receiver. When the indicator is visible (flush with the rear surface of the receiver) the firing pin is cocked (ready to fire). (Fig. 6) If the trigger is pulled and there is a round in the chamber, the pistol will fire. If the indicator is not visible (recessed into the rear of the receiver), the pistol is not cocked (not ready to fire). (Fig. 7)

**WARNING:** THE COCKED FIRING PIN INDICATOR DOES NOT TELL THE USER WHETHER THE PISTOL IS LOADED. A ROUND CAN BE IN THE CHAMBER WHETHER OR NOT THE INDICATOR IS VISIBLE. RETRACT THE SLIDE TO SEE IF THE PISTOL IS LOADED.

Chamber plug: Each pistol is provided with an orange chamber plug that can be used to visually indicate that there is no round in the chamber and to keep the slide partially retracted when the plug is inserted. (Fig. 17)

**WARNING:** THE CHAMBER PLUG SHOULD NOT BE USED AS AN ALTERNATIVE TO LOCKING THE PISTOL. THE SAFEST PROTECTION AGAINST ACCIDENTS INVOLVING CHILDREN UNDER THE AGE OF 18 OR OTHER UNTRAINED, UNAUTHORIZED USERS IS TO STORE YOUR FIREARM UNLOADED AND LOCKED, WITH THE AMMUNITION IN A SEPARATE, LOCKED CONTAINER.

## OPERATIONAL FEATURES

Slide catch: (Fig. 1-C) The slide catch is a lever which holds the slide open and rearward after the last round is fired. This allows the user to determine if the pistol has a round in the chamber or in the magazine.

**WARNING:** CLOSING THE SLIDE WHEN A ROUND IS IN THE MAGAZINE WILL CHAMBER THAT ROUND.

**Semi-automatic firing:** Model U22 NEOS pistols will automatically reload after each round is fired, as long as there are cartridges in the magazine.

**Removable ten round magazine:** (Fig. 1-D) Model U22 NEOS pistols have a quickly removable, ten round magazine which allows rapid reloading and extended use. The oversized magazine loading

button makes loading easy and comfortable. The magazine is a straight stack design, which will contain ten (10) rounds of 22 Long Rifle (22LR) ammunition.

**NOTICE:** 22 Short and 22 Long ammunition should not be used.

**Single-action/Semi-automatic:** The pistol is single action in design. The user must pull the slide all the way back and release it to cock the pistol and feed the first round into the chamber.

After the first round has been fired, the pistol will function in semi-automatic mode. This means that the spent shell will be ejected when the pistol is fired and a new round will be automatically inserted into the chamber, ready to fire. The pistol will continue to fire each time the trigger is pulled until the magazine is empty, at which time the slide will remain open until the slide catch is released. (Fig. 3)

**Simple field stripping and cleaning:** The pistol can be easily field stripped without tools for cleaning. (See FIELD STRIPPING section in this manual). Cleaning and proper maintenance helps ensure continued reliability (see CLEANING AND LUBRICATING section of this manual).

**Ergonomic grip frame:** (Fig. 2-E) The newly designed grip frame, made of fiberglass-reinforced technopolymer, accommodates and protects the hand, facilitating a correct grip of the pistol even under conditions of rapid fire. The special texturing pattern helps guarantee a firm hold with wet hands. The grip may be easily replaced with accessory grips.

**Barrel and accessory rail:** (Fig. 2-F) The pistol also incorporates a built-in Weaver® style rail designed to accommodate accessories and optics using standard mounts. Each barrel features a fully adjustable target rear sight. Since the sight system is mounted on the barrel unit, you don't lose zero when the barrel is changed or removed for cleaning. The barrel may be easily replaced with accessory barrels.

**Adjustable target sights:** The front and rear sights are designed for swift target acquisition. To aid sighting under low light conditions, the rear sight aperture has a white border, while the front sight is matte black for contrast. Both sights are removable and replaceable. (Fig. 2-G1 & G2)

**Accessories:** Each U22 NEOS is supplied with two magazines, attractive carrying case, cable lock, chamber plug, and sight adjustment/grip removal tool.

## SPECIAL DLX FEATURES

The U22 Neos DLX adds another level of performance to the U22 Neos product line. The following special features are included in the DLX:

**Adjustable trigger:** The DLX trigger may be adjusted for pre and overtravel. This allows the shooter to tailor the trigger movement to his or her preference.

**Sight set:** Every DLX comes standard with three replaceable colored front and rear sights. The set includes black, white and red colored sights. The sights may be mixed in any color combination to obtain the shooter's preferred sight picture and contrast.

**Front sight removal:** To facilitate front sight blade removal, a set screw has been added to the DLX.

**Rubber grip inlays:** The DLX grip features textured soft rubber inlays to further facilitate a firm and comfortable grip. The attractive inlays are colored to complement the finish and materials of the pistol.

**Slide engraving:** As a final touch, the DLX slide is engraved with the elegant and contrasting U22 Neos logo.



SPECIFICATIONS		4.5" BARREL	6.0" BARREL	7.5" BARREL
<b>Operation:</b>	<b>Semiautomatic, slide blow back</b>			
Action	Single action, semiautomatic			
Striker	Cocking indicator			
Rifling	R.H. 6 grooves, Pitch 350mm/13.8 in			
Sights	Front and rear, removable, adjustable rear			
Safety	Manual, ambidextrous, blocks sear			
Receiver	Fiberglass reinforced technopolymer			
Slide	Alloy steel, matte finish, stainless or blued			
Barrel	Alloy steel, matte finish, stainless or blued			
Caliber	22 LR (Long Rifle)			
Overall length (mm/in)		224/8.8	262/10.3	224/11.8
Barrel length (mm/in)		114/4.5	153/6.0	191/7.5
Sight radius (mm/in)		189/7.4	227/8.9	265/10.4
Overall height (mm/in)		132/5.2		
Overall width across safety levers (mm/in)		30/1.2		
Overall width across bottom of grip (mm/in)		37/1.5		
Magazine capacity (rounds)		10		
Weight unloaded (g/oz-approx.)		900/31.7	1025/36.2	1114/39.3

Note: All specifications subject to change without notice.

## GENERAL OPERATION

Beretta U22 NEOS semi-automatic pistols use a slide blow-back system. The breech is held closed by a recoil spring. The breech is not locked when closed. When the pistol is fired, the resulting energy pushes the slide rearward, extracting and ejecting the fired cartridge case.

Pushed by the recoil spring, the slide moves forward feeding the next cartridge from the magazine into the chamber and closing the breech. The slide is designed to stay open after the last round has been fired and the spent shell casing has been ejected.

## LOADING AND FIRING

**WARNING:** A pistol can have a live round in the chamber and can fire even if the magazine is empty or has been removed.

**WARNING:** Before loading the firearm, it is recommended that you become familiar with the following loading procedures without the use of ammunition. Never handle a loaded firearm until you are fully familiar with the loading procedures. Before loading the pistol, always engage the manual safety. Always point the firearm in a safe direction. (See points 1,2 and 4 of the BASIC SAFETY RULES).

**WARNING:** Always keep your finger away from the trigger whenever you do not intend to fire. Make sure the pistol is not already loaded by removing the magazine from the pistol by depressing the magazine release button (Fig. 2-H), then, keeping your finger away from the trigger, grasp the slide serrations with thumb and index fingers and retract the slide at least one inch (2 cm) to verify that the chamber is empty. (Fig. 3)

**NOTICE:** If the safety is engaged and the firing pin is forward (not cocked), the slide can only be retracted approximately 1/8 inch (3 mm).

## LOADING THE MAGAZINE

- To load the magazine, remove it from the pistol by depressing the magazine release button. (Fig. 2-H and 9)
- Hold the magazine in the left hand. With the left thumb, move the follower button to depress the spring sufficiently to insert one round in the top of the magazine completely back under the lips.
- Repeat until the magazine is fully loaded (10 rounds).

**CAUTION:** Do not try to force more than the maximum number of ten (10) rounds into the magazine. An overloaded magazine will not function properly.

## LOADING THE PISTOL and THE FIRING CHAMBER

**WARNING:** Always keep your finger away from the trigger whenever you do not intend to fire.

The firing chamber of the pistol is the portion of the barrel into which the cartridge is fed. The firing chamber may be loaded in one of two ways:

### 1. LOADING THE CHAMBER FROM MAGAZINE

- Grasp the slide serrations with thumb and index fingers and retract the slide until the slide catch engages. If the empty magazine is not inserted in the pistol, manually engage the slide catch by pushing it upwards with the slide fully rearward.
- Engage the manual safety, by pushing the safety lever downward so as to cover the red warning dot. (Fig. 4))
- Push the loaded magazine into the pistol completely to ensure magazine catch engagement.
- Press the slide catch down to release and close the slide and to load the chamber. (Alternatively, grasp the slide serrations with thumb and index fingers and retract the slide until the slide catch disengages. Release the slide). (Fig. 8)

**WARNING:** THE PISTOL IS NOW CHAMBER-LOADED, COCKED and READY TO FIRE. Always keep your finger away from the trigger whenever you do not intend to fire. If you are not ready to fire, rotate the manual safety lever downward to engage the safety and cover the red warning dot. (Fig. 4)

## 2. DIRECT CHAMBER LOADING

- Grasp the slide serrations with thumb and index fingers and retract the slide until the slide catch engages. If the empty magazine is not inserted in the pistol, manually engage the slide catch by pushing it upwards with the slide fully rearward.
- Engage the manual safety, by pushing the safety lever downward so as to cover the red warning dot. (Fig. 4)
- Insert a round into the chamber.
- Release the slide by pushing down on the slide catch. (Fig. 8)

**WARNING:** THE PISTOL IS NOW CHAMBER-LOADED, COCKED AND READY TO FIRE. Always keep your finger away from the trigger whenever you do not intend to fire. If you are not ready to fire, rotate the manual safety lever downward to engage the safety and cover the red warning dot. (Fig. 4)

A PISTOL WHICH IS LOADED AND FIRED WILL AUTOMATICALLY FEED THE NEXT ROUND INTO THE FIRING CHAMBER AS LONG AS THERE IS AMMUNITION IN THE MAGAZINE. THE PISTOL WILL BE AUTOMATICALLY COCKED AND READY TO FIRE SUBSEQUENT ROUNDS.

**NOTICE:** The manufacturer assumes no responsibility for injury or property damage resulting from improper or careless handling, intentional or accidental discharge of the firearm.

**WARNING:** REMEMBER YOU ARE HANDLING A LOADED FIREARM, WITH A LIVE ROUND IN THE CHAMBER. Always keep your finger away from the trigger, and the safety engaged, whenever you do not intend to fire. ALWAYS POINT THE PISTOL IN A SAFE DIRECTION.

## FIRING

**WARNING:** Only point a firearm at something safe to shoot. Never put your finger on the trigger unless you intend to shoot. Never disengage the safety on a firearm unless you intend to shoot.

**WARNING:** Always wear protective glasses and earplugs when shooting (See point 8 of the BASIC SAFETY RULES).

### WHEN READY TO FIRE:

- Aim the pistol and align the front and rear sight on the target. (Fig. 16)
- Release the manual safety by pushing the manual safety lever up all the way. The red warning dot, which is exposed when the safety lever is rotated completely upward, indicates that the safety is off. (Fig. 5)

**WARNING:** THE PISTOL IS NOW READY TO FIRE.

**NOTICE:** If the firing pin indicator is in the cocked position, squeezing the trigger releases the firing pin. After the first shot, the pistol will continue to fire in the single-action, semi-automatic mode each time the trigger is squeezed and as long as there is ammunition in the magazine or chamber and as long as the safety lever remains disengaged.

- Fire by squeezing the trigger.

**WARNING:** THE PISTOL IS NOW CHAMBER LOADED, COCKED AND READY TO FIRE AGAIN. Always keep your finger away from the trigger whenever you do not intend to fire. If you are not ready to fire, rotate the manual safety lever downward to engage the safety and cover the red warning dot. (Fig. 4)

**WARNING:** TO REDUCE THE CHANCE OF INADVERTENT DISCHARGE FROM TRIGGER PULL OR FROM DROPPING THE PISTOL, DO NOT CARRY THE PISTOL WITH THE FIRING CHAMBER LOADED AND WITH THE FIRING PIN INDICATOR IN THE COCKED POSITION. ALWAYS KEEP THE MANUAL SAFETY IN THE “ON” (SAFE) POSITION WHEN CARRYING THE PISTOL. (Fig. 4)

When the last round in the chamber has been fired, the slide will remain open. (Fig. 3) To fire again, remove the empty magazine and insert a loaded one following the above loading procedure. Press the slide catch down to release and close the slide and to load the chamber. (Fig. 8)

**WARNING:** THE PISTOL IS NOW CHAMBER LOADED, COCKED AND READY TO FIRE AGAIN. Always keep your finger away from the trigger whenever you do not intend to fire. If you are not ready to fire, rotate the manual safety lever downward to engage the safety and cover the red warning dot. (Fig. 4)

## SIGHT ADJUSTMENT

- To adjust the sight for elevation (up or down), turn the elevation screw counterclockwise to raise the point of impact, turn clockwise to lower the point of impact. (Fig. 19)

- To adjust the sight for windage (left or right) turn the windage screw counterclockwise to move the point of impact to the right, turn clockwise to move the point of impact to the left. (Fig. 20)

## UNLOADING THE PISTOL and FIRING CHAMBER

- Engage the manual safety, by pushing the safety lever downward so as to cover the red warning dot. (Fig. 4)
- Depress the magazine button and remove the magazine from the pistol. (Fig. 9)
- Pull the slide back to eject the round in the chamber.

**WARNING:** Always inspect the firing chamber to ensure that it is empty. The chamber is empty when no cartridge is visible when looking into the open chamber. (Fig. 3)

- When you are sure the chamber is empty and the cartridge has been ejected, release the slide.
- Unload the magazine following the instructions in the UNLOADING THE MAGAZINE section of this manual.
- Re-insert the empty magazine.

**WARNING:** Releasing a fully retracted slide when a loaded magazine is in the pistol will feed a cartridge into the pistol's firing chamber. The pistol can then be fired.

**NOTICE:** To increase the service life of the firing pin spring, it is advisable not to store the pistol with the firing pin cocking indicator in the cocked position.



## UNLOADING THE MAGAZINE

- To unload the magazine, grasp it with one hand around the magazine box, bottom down and front end forward. Press the follower button to partially depress the magazine spring. Push the top cartridge forward and out of the magazine lips.
- Repeat until the magazine is empty.

## SPECIAL DLX INSTRUCTIONS

### TRIGGER ADJUSTMENT

**NOTICE:** The trigger pull weight is pre-set at the Beretta factory and is not adjustable. Adjusting the pre and overtravel of the trigger will NOT change the trigger pull weight.

**WARNING:** Make sure that the pistol is unloaded. If not, unload it following the procedure in the UNLOADING THE PISTOL and FIRING CHAMBER section of the U22 Neos Instruction Manual.

### OVERTRAVEL

- Trigger overtravel is the rearward distance traveled by the trigger after sear release. Overtravel adjustment of the U22 Neos DLX is accomplished by turning the trigger overtravel screw using the supplied, 1.5 mm, hex key. (Fig. 21) Turning the screw clockwise will reduce overtravel, while turning the screw counterclockwise will increase overtravel.

**NOTICE:** The pistol will function even with the overtravel screw completely removed. In this case the pistol will be set at maximum overtravel.

**NOTICE:** If the screw continues to be turned clockwise, it will eventually block trigger movement altogether and prevent the pistol from firing. If this happens, turn the screw counterclockwise gradually until trigger operation is restored.

## PRETRAVEL

- Trigger pretravel is the rearward distance traveled by the trigger prior to sear movement. Pretravel adjustment of the U22 Neos DLX requires partial disassembly of the trigger mechanism. This operation should be performed by Beretta or by a competent gunsmith.

## FRONT SIGHT REPLACEMENT

Front sight replacement is accomplished by removing and replacing the front sight set screw using the supplied, 1.5 mm, hex key. (Fig. 22) The set screw only requires a half-turn of tightening once resistance is felt.

**CAUTION:** If the set screw is overtightened, it will damage the front sight.

## REAR SIGHT REPLACEMENT

Rear sight replacement is accomplished by first completely removing the windage adjustment screw by turning it counterclockwise using the supplied screwdriver. (Fig. 23)

Once this screw is removed, insert the supplied brass rear sight removal tool into the windage screw hole with the slot in the tool facing upwards. (Fig. 24)

You will feel spring resistance. Compress the spring completely. This will release the rear sight blade, which can then be lifted out of its seat. (Fig. 25)

To replace the rear sight blade, follow the procedure in reverse. Be sure to insert the left side of the blade (the one with the round “hook” shape) in first. (Fig. 26)

## MAINTENANCE

Clean and lubricate the pistol every day it is fired or at least once a month.

## FIELD STRIPPING

**WARNING:** Make sure the pistol is unloaded. If not, unload it following the procedure in the UNLOADING THE PISTOL and FIRING CHAMBER section in this manual.

**NOTICE:** Carry out field-stripping and the assembly operations over a table to catch components should they drop.

- Remove the magazine by depressing the magazine release button. (Fig. 9)
- Pull the slide back and visually check to ensure there is no round in the chamber. (Fig. 3)
- If there is a round in the chamber, eject it by retracting the slide rearward until the slide stops and the cartridge is ejected.

- Engage the manual safety, by pushing the safety lever downward so as to cover the red warning dot. (Fig. 4)
- Pull the slide rearward and engage the slide catch to hold the slide in the open position. (Fig. 3)
- Depress the barrel nut lock button (Fig. 2-J) to permit the barrel nut (Fig. 1-K) to turn. (Fig. 10)
- Unscrew the barrel nut (clockwise, if the pistol is held upright) to release the barrel from the receiver. (Figs. 11 & 12)
- Pull the slide rearward to release the slide catch. (Fig. 13)
- Hold the slide and allow it to move forward to remove it from the receiver. (Fig. 14)

**WARNING:** The slide is under tension from the recoil spring. Releasing the slide catch without controlling the slide will allow it to spring forward and off of the pistol which may cause damage or injury.

**WARNING:** If the safety is disengaged when the slide is off of the pistol, touching the trigger will disengage the firing pin. The firing pin is under spring tension and will be propelled forward, causing serious damage or injury.

**CAUTION:** No further disassembly should be necessary for proper cleaning and maintenance of the pistol. Any further disassembly is not recommended and should be done by a competent gunsmith.

## CLEANING and LUBRICATING

**CAUTION:** Do not use acids, water and chlorinated solvents.

**WARNING:** Oil and grease that obstruct the bore, even partially, are very dangerous when firing and may cause barrel rupture and serious injury to the shooter and bystanders. Never spray or apply oil to cartridges. Use lubricants properly. You are responsible for the proper care and maintenance of your firearm.

### MAGAZINE

- Make sure the magazine is cleaned thoroughly and that the follower slides easily downward if pressed.
- If necessary, lightly oil the walls of the magazine box with Beretta oil or another good grade gun oil. Run a dry, lint-free cotton patch through the box. Do not leave lubricant inside the magazine box.
- Due to various bullet lubricants used on some brands of ammunition, the inside of the magazine (especially the inside front radius) should be cleaned every 250 to 500 rounds.

### BARREL

- Spray a 22 caliber bore brush with Beretta oil or another good grade gun oil. Insert the brush into the barrel from the chamber and scrub the chamber and bore thoroughly. If necessary, first clean the bore with a gun solvent.

- Dry the chamber and bore by pushing a lint-free cotton patch through the chamber and bore with the brush. Keep changing the patch until it emerges clean.
- Lightly oil the threaded barrel stud.

## **RECOIL SPRINGS and SPRING GUIDE**

- Lightly oil the recoil spring (Fig. 15-M), firing pin guide (Fig. 15-N), firing pin spring (Fig. 15-P) and firing pin (Fig. 15-Q) with Beretta oil or another good grade gun oil. After long use, it may be necessary to clean these parts first using a good quality cleaning brush.

## **SLIDE**

- Clean the slide with Beretta oil or another good grade gun oil, paying special attention to the breech face, extractor and the slide surfaces that engage the receiver (Fig. 18). If necessary, use a good quality cleaning brush to remove built-up dirt. Dry the parts carefully with a clean, lint-free cotton patch.
- Lightly lubricate the slide by applying a small drop of oil to the slide surfaces that engage the receiver and the extractor.

## **RECEIVER**

- Clean the receiver with a soft, lint-free cotton patch.

**CAUTION:** Do not use acids, water and chlorinated solvents.

**CAUTION:** Do not apply excess oil. Accumulation of oil attracts dirt and dust, which can interfere with the functioning and reliability of the pistol.

## ASSEMBLY

Assemble the pistol by following the field stripping procedure in reverse order. When re-installing the barrel, start by fitting the rear dovetail into seat in the frame assembly, then rotate the barrel downward to engage the barrel nut. (Fig. 12)

**NOTICE:** When re-installing the barrel, the barrel nut (Fig. 1-K) should be tightened two (2) clicks beyond finger tight.

## TROUBLESHOOTING

**NOTICE:** Due to the variability and many types of 22LR ammunition on the market, you will find that your pistol may function more reliably with certain types of ammunition.

MALFUNCTION	PROBABLE CAUSE	REMEDY
Mis-introduction of a cartridge into the chamber	Defective cartridge	Inspect and replace cartridge
Mis-fire	Defective cartridge	Wait 10 seconds, keeping the barrel pointed in a safe direction. Extract and replace cartridge

Mis-extraction or defective extraction	Dirty cartridge chamber	Clean, lubricate cartridge chamber
	Defective or dirty ammunition	Replace or clean cartridges
	Dirt under the extractor	Clean the extractor housing

## STORAGE

To prepare the pistol for storage:

1. Remove the magazine from the pistol and empty it.
2. Open the slide and check to see if there is a round in the chamber. If so, eject the round by pulling the slide all the way rearward. The slide will close when released.
3. After ensuring that the chamber is empty, point the muzzle in a safe direction and decock the pistol by pulling the trigger.
4. Replace the empty magazine in the pistol.
5. Engage the manual safety, by pushing the safety lever downward so as to cover the red warning dot. (Fig. 4)
6. Note that the pistol will properly fit in the storage box only when the safety is engaged (downward position). (Fig. 4)

**NOTICE:** Beretta USA reserves the right to change specifications without prior notice.



# NOTES

---

---

---

---

---

---

---

---

---

---

---

# NOTES

---

---

---

---

---

---

---

---

---

---

---

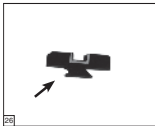
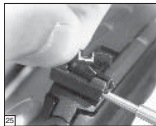
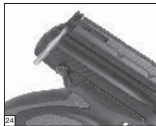



**BERETTA U.S.A. CORP.**

17601 Beretta Drive

Accokeek, MD 20607

Phone: 1-800-636-3420    FAX: (301) 283-0189

UD6A0277-04/04