



Beretta 92FS

Caliber 9mm Parabellum



Instructions for operation

Caution: Read this manual carefully before handling and loading the pistol.

WARNING: Always ensure that the safety is fully engaged until ready to fire. A safety is fully engaged only when the safety can move no further into the safe position. A safety which is not fully engaged will not prevent weapon discharge.

BASIC SAFETY

- A loaded firearm has the potential to kill. Intelligently handled it is safe.
- An accident is always the result of basic safety rules neglect.
- Accident prevention is user responsibility.
- Always treat a firearm as if it were loaded.
- Never point a firearm at anything you don't want to shoot.
- Before handling and loading a firearm, be sure you know how it functions.
- Be sure to use correct and undamaged ammunition.
- Be sure your firearm is clean — before loading inspect the barrel to insure it is perfectly clean and free of foreign objects. Shooting with an obstruction in the barrel such as dirt, mud, grease, lodged bullet or jacket, residues, etc., can cause barrel bulging and/or rupture.
- Never shoot at a flat surface or water.
- Avoid alcoholic beverages or drugs before and during shooting.
- Avoid hard hitting or dropping of a loaded firearm.
- Store firearms and ammunition separately, beyond the reach of children. Be sure cartridge chamber is empty.
- To avoid corrosion during storage, thoroughly clean the firearm and protect all metal surfaces with a light film of good grade gun oil. Store pistol unwrapped in a container placed in a ventilated area. Store ammunition in a separate container placed in a cool ventilated area.

Shooting glasses and earplugs: Shooting glasses are a must; chances of gas, gunpowder and dirt particle blow-back are remote but do exist. Earplugs reduce the chance of temporary or permanent loss of hearing when shooting.

Firearms Safety Course: To familiarize yourself with the proper use of firearms, attend a Firearms Safety Course in your area. Remember — only YOU are responsible for the firearm in your hands. Prevent accidents by knowing its function. HANDLE IT WITH RESPECT NOT FEAR. Safety devices on firearms are EXTRAS and are not substitutes for safe handling.

TABLE OF CONTENTS

	Page
BASIC SAFETY	1
INTRODUCTION	4
DESCRIPTION	
A. Locking System	4
B. Single/Double Action	4
C. Magazine	4
D. Safety Features	4
1. Ambidextrous Safety-Decocking Lever	4
2. Firing Pin Unit	5
3. Hammer Drop Catch (half-cocked)	5
4. Automatic Firing Pin Catch	5
5. Chamber Loaded Indicator	5
6. Slide Overtravel Stop	5
E. Field Stripping Simplicity	5
F. Functional and Mechanical Features	6
1. Slide Catch	6
2. Ambidextrous Safety-Decocking	6
3. Special Sights	6
4. V-Grooved Frame Serration	6
5. Reversible Magazine Release Button	6
6. Checkered Grips	6
7. Combat Trigger Guard	6
GENERAL FUNCTIONAL PRINCIPLE	7
LOADING AND FIRING	7
Loading the Magazine	7

Table of Contents (cont'd.)

	Page
Loading the Pistol	8
Loading to Maximum Pistol Capacity	9
Direct Chamber Loading	9
Firing	9
Firing After Manual Hammer Cocking	10
Unloading the Pistol	10
Unloading the Magazine	11
MAINTENANCE	11
Field Stripping	11
Recommended Safety Feature Inspection	13
What to Use for Cleaning	13
Barrel Cleaning and Lubrication	13
Slide Cleaning and Lubrication	13
Recoil Spring and Guide Lubrication	14
Frame Cleaning and Lubrication	14
Magazine Cleaning and Cartridge Rotation	14
After Field Stripping Assembly	14
AMMUNITION	15
Dry Firing/"DUMMY" Rounds	16
TROUBLE SHOOTING, CAUSE AND REMEDIES	17
TECHNICAL SPECIFICATIONS	18
PHOTO ILLUSTRATIONS	19-20
EXPLODED DRAWING	21
PARTS LIST	22
PARTS AND SERVICE	Back Cover
LIMITED WARRANTY	Back Cover

INTRODUCTION

The Beretta 92FS semiautomatic pistol is primarily designed as a personal defense sidearm for military and police use. Due to its highly advanced safety features and its excellent performance in competitive testings, it has become the choice of military and police forces throughout the world.

DESCRIPTION

A. LOCKING SYSTEM: The unique barrel-mounted falling locking block and short barrel recoil stroke ensures long service life and targeting accuracy. (Fig. 1-A)

B. SINGLE/DOUBLE ACTION: This system retains the advantages of the revolver combined with that of conventional single action semiautomatic pistols. After chambering the first round by pulling the slide to the rear and releasing it, the pistol is ready for discharge by the light single action trigger pull. Through appropriate hammer decocking, the shooter can fire the chambered round from the hammer's at-rest position by the more pronounced double action pull. This also insures the safety advantage of trigger pull repeat in case of misfire. (Fig. 1-B)

C. MAGAZINE: The staggered, strongly constructed, casehardened, steel magazine with hard coated aluminum follower and quick removable floor-plate, for ease of cleaning, almost doubles the firepower of the traditional single line magazine of same length to a 15 round capacity. (Fig. 1-C, Fig. 2)

D. SAFETY FEATURES:

- 1. Ambidextrous Safety-Decocking Lever:** Allows safe hammer lowering over a chambered round. The safety rotation interrupts and shields the firing pin unit from hammer strike. When the safety is OFF (wings straight forward) Red Warning Dots are visible. When the safety is ON (wings pointing downward) the dots are covered and the linkage between trigger and sear disconnected. A speed release cam aids the shooter in positive safety rotation from ON to OFF. (Fig. 1-D1)

Remember: Always lower the hammer by the safety-decocking lever.

- 2. Firing Pin Unit:** The two piece firing pin unit functioning on the inertia principle is designed to insure positive discharge combined with ultimate accidental discharge prevention during slide reciprocation chamber loading, hammer decocking and/or inadvertent handling impact. Since the firing pin unit is shorter than the slide breech, the pistol can be safely carried with the chamber loaded and the hammer fully-lowered to rest against the breach. During hammer lowering by the safety-decocking lever, the rear section of the firing pin is rotated out of hammer reach. (Fig. 1-D2)
 - 3. Hammer Drop Catch (half-cocked):** Since this is a double action pistol this device is intended as a safety OFF, emergency, accidental discharge preventive hammer drop catch. To counteract the remote chance of accidental discharge due to UNTRIGGERED sear/hammer notch disengagement from the fully-cocked position, failure of hammer cocking during slide recoil reciprocation, inadvertent hammer fanning or thumb slipping off the hammer spur during cocking, the hammer is caught half-cocked by the sear before striking the firing pin unit. To protect this device against hammer spur impact damage DO NOT carry the hammer half-cocked but fully-lowered.
 - 4. Automatic Firing Pin Catch:** This device positively prevents accidental discharge of a chambered round by firing pin inertia should the pistol inadvertently be dropped onto the ground. Also, it prevents firing pin inertia (primer ding mark) discharge of a cartridge during manual slide manipulation chamber loading as well as automatic slide recoil reciprocating chambering during shooting while the shooter keeps the trigger retracted. This device only becomes disconnected to permit pistol discharge at the last stage of either the double or single action trigger pull. Further, by being clearly visible in front of the rear sight the shooter can at a glance verify if the catch is engaged DOWN or disengaged UP. (Fig. 1-D2 and Fig. 3-D2)
 - 5. Chamber Loaded Indicator:** When a cartridge is chambered, the extractor head protrudes outside the slide breech, exposing a red warning signal. In the dark, the protrusion can be felt by touch. This makes it unnecessary to pull back the slide to verify if the chamber is loaded. (Fig. 4-D3)
 - 6. Slide Overtravel Stop:** The head flange of the hammer pin enters a matching travel groove cut into the underside of the left slide rail to stop the slide breech in case of recoil overtravel. (Fig. 1-D5)
- E. FIELD STRIPPING SIMPLICITY:** Advanced disassembly latch design allows for quick and simple field stripping, even by a fatigued user under hostile conditions. (Fig. 1-E1)

F. FUNCTIONAL AND MECHANICAL FEATURES:

- 1. Slide Catch:** As the last round is fired, the recoil reciprocating slide is automatically locked open by the slide catch, clearly signaling the magazine is empty. For slide closing by right shooting hand, push the catch down by the thumb. When using left shooting hand push the catch down by the index finger. (Fig. 1-F1)
- 2. Ambidextrous Safety-Decocking:** Allows for quick and easy right or left-handed operation. (Fig. 1-D1 and Fig. 5-12)
- 3. Special Sights:** Both the fixed front and drift adjustable rear sights are designed for swift target acquisition. To aid sighting under low light conditions, the sights are equipped with white inlays. (Fig. 1-F3)
- 4. V-Grooved Frame Serration:** The grip front and back straps are longitudinally serrated to secure a firm hold even with wet hands or under conditions of rapid, unaimed fire. (Fig. 1-F4 and Fig. 6-F4)
- 5. Reversible Magazine Release Button:** The thumb release button is factory installed for *right-handed operation*, conveniently located behind the trigger guard strap for quick combat release. If shooting *left-handed*, the button can be reached and depressed with ease by the left-hand index or second finger. (Fig. 1-F5)

A left-handed shooter may prefer the device installed with the button on the right for convenient operation. After removing both grip panels the device can simply be pushed out of its seat by applying finger pressure from the buttonless side for reverse installation. Armorer assistance recommended.

- 6. Checkered Grips:** The high impact resistant plastic grips (walnut grips on request) have thumb release for ease of safety-decocking lever reach and full grasp area checkered to ensure better hold with a touch of elegance. (Fig. 1-F6)
- 7. Combat Trigger Guard:** The trigger guard front strap is crosswise V-groove serrated to insure firm rest of the index finger when shooting with two hand hold. (Fig. 1-F7)

GENERAL FUNCTIONAL PRINCIPLE

All Beretta pistols of the 92 Series are semi-automatic, functioning on the delayed blowback, short barrel recoil stroke principle, utilizing a unique falling locking block system.

Considering the pistol magazine and chamber loaded, the hammer fully lowered and the safety OFF, the pistol is ready for discharge by the double-action trigger pull mode.

Upon trigger pull discharge of the chambered round the powder gas pressure recoils the locked together barrel locking block/slide unit, compressing the recoil spring. After a short run the locking block, via its plunger, smoothly disengages the locking system. As the barrel recoil stops, the disconnected slide completes its recoil stroke, during which the hammer is rotated into cocking motion, the spent cartridge case extracted and ejected and the next cartridge in the magazine lifted up in front of the slide breech ready for chambering. At the moment the slide recoil is halted, the compressed recoil spring pushes the slide forward chambering the next cartridge. As the slide leaves the hammer the sear retains it fully-cocked, ready for single action trigger pull mode. Upon chambering, the slide breech pushes the barrel unit forward, and as the locking block slides up the frame's lifting support cam, the slide closing stroke is completed. The shooter must allow the trigger to go forward and reingage to fire the next round.

After the last round is fired and the slide breech recoils past the magazine well, the spring activated magazine follower lifts the slide catch, which upon the slide's closing stroke locks the slide open, signaling the pistol is empty.

LOADING AND FIRING

Caution: Always keep finger off the trigger until ready to fire.

Make sure the chamber is not already loaded by inspecting the extractor's chamber-loaded indicator (Fig. 4-D3).

LOADING THE MAGAZINE:

To load the magazine, remove it from the pistol by depressing the magazine release button (Fig 7).

Hold the magazine in the left hand. With your right hand place a cartridge on the follower in front of the lips, press down and slide the cartridge completely back under the lips (Fig. 8). For ease of continued loading place the head of the next cartridge to be loaded on the front of the case, not bullet, of the

cartridge in the magazine as you press down for inserting. Holes on the back of the magazine marked 5-10-15 allow for quick counting.

NOTE: When brass of *ONE* cartridge only can be seen entering the lower hole the magazine is loaded to its full 15 rounds capacity. **DO NOT TRY TO FORCE AN EXTRA ROUND INTO THE MAGAZINE.** The felt additional space is needed to insure perfect functioning.

LOADING THE PISTOL:

Caution: Always keep finger off the trigger until ready to fire. Make sure the muzzle is pointing in a safe direction.

NOTE: For absolute insurance against accidental discharge due to inadvertent trigger pull, keep the manual safety (Fig. 1-D1) engaged "ON" (red warning dot covered) during loading or unloading.

- Push the loaded magazine into the pistol grip well to solid stop in one continuous, firm hand stroke to insure positive catch engagement, verified by a sharp click. (Make sure not to slam the magazine as it may result in feeding malfunctioning, magazine and/or ammunition damage.)
- Grasping the slide serrations with thumb and index finger, fully retract and without hesitation release the slide for energetic closing strike, insuring chamber loading and slide lock-up. (Fig. 9)

Caution: If manipulated with the safety engaged "ON," the pistol is now *CHAMBER LOADED, DECOCKED, SAFETY ENGAGED.* To fire the pistol by the double action trigger pull mode, disengage the safety. If manipulated with the safety disengaged "OFF," the pistol is now *CHAMBER LOADED, COCKED, AND READY TO FIRE* by the single action trigger pull mode.

Caution: Always keep finger off the trigger until ready to fire. Make sure the muzzle is pointing in a safe direction. (Fig. 10)

IF NOT READY TO FIRE engage the manual safety by downward thumb pressure rotation to solid stop. *When the safety is engaged "ON" and detent secured the left and right safety levers fully cover the red warning dots.* This safety "ON" rotation will separate the firing pin from the hammer path as the hammer automatically is lowered to rest against the slide breech at the last stage of the rotation during which the linkage between trigger and sear is interrupted.

NOTE: When the SAFETY is "ON" and the hammer down, willful or inadvertent hammer retraction or fanning will not make the hammer be sear retained either half- or fully-cocked. Since the firing pin plunger (rear section of the firing pin unit) is rotated and shielded within the breech, hammer fall cannot result in accidental discharge.

With the SAFETY "ON" and the hammer down, willful or inadvertent trigger pull will only make the trigger move freely to its rear-most stop, simultaneously lifting the firing pin catch. When releasing the trigger, its spring will return the trigger to its fully forward position and the firing pin catch spring re-engage the catch.

LOADING TO MAXIMUM PISTOL CAPACITY:

During normal chamber loading, as described above, the pistol contains one round in the chamber plus 14 rounds in the magazine. This is an advantage because the magazine spring is not fully compressed but under about the same tension as a 15-round loaded spare magazine.

- If the shooter after normal chamber loading from a 15-round loaded magazine prefers to load the pistol to its full 16-round capacity, take the following steps:
 1. Remove the magazine by depressing the magazine release button.
 2. Replenish the magazine with *one* round only to its full 15-round capacity.
 3. Push the magazine into the pistol grip insuring catch engagement.
- If the shooter, during firing, exchanges magazine before the pistol is fired empty and the exchanged magazine is fully loaded, the pistol will contain its maximum 16-round capacity.

DIRECT CHAMBER LOADING:

The major advantages of the pistol's open slide and extractor configurations are the remote chances of feeding, extraction and/or ejection malfunctionings. In the rare event of feeding and/or extraction jamming the design allows for simplicity and speed in clearing to continue firing. Further, the unique design principle makes it possible to fire the pistol single shot with ease of operation should the magazine be damaged. Also, it makes it possible to close the slide over a cartridge directly inserted into the chamber:

- Engage safety.
- With the magazine removed, manually retract the slide and engage the slide catch.
- With the muzzle pointing downward, directly and fully seat a cartridge in the chamber.
- Release the slide to closing.

NOTE: The pistol is now chamber loaded, safety "ON."

The pistol can be fired single shot.

By inserting a fully loaded magazine the pistol will be loaded to its 16-round capacity.

It is possible to direct chamber load with an *empty* magazine inserted. If shooting single shot without a magazine, the slide will remain closed over the empty chamber after discharge.

If shooting single shot with empty magazine inserted, the slide will stay open after discharge.

FIRING:

WHEN READY TO FIRE:

- With a brisk upward directed thumb push on the safety lever, rotate the safety to its fully "OFF" position (RED WARNING DOT visible).
Aim the pistol and align front and rear sight on target.

Fire by squeezing the trigger.

In the double-action trigger pull mode the hammer will be cocked and released to fall.

- The discharge pressure will recoil the locked barrel/slide unit, compressing the recoil spring, disengaging the locking system, extract and eject the spent cartridge case and cock the hammer. The recoil spring will push the slide forward chambering the next cartridge from the magazine and re-engage the locking system. After trigger finger ease-up permitting the trigger to move forward to its single action mode position the PISTOL IS READY TO FIRE AGAIN.
- Squeeze the trigger to continue firing. After the first shot is fired all remaining rounds in the magazine will be fired in the single action mode.
- When the last round has been fired, the slide is automatically held open by the slide catch (Fig. 11).
- To fire again, remove the empty magazine and insert a loaded one.
- Press the slide catch (Fig. 1-F1) to load the chamber and close the slide (Fig. 12).
- The slide can also be closed for chamber loading by simply retracting and releasing the slide.

Caution: THE PISTOL IS NOW LOADED, COCKED, AND READY TO FIRE.

FIRING AFTER MANUAL HAMMER COCKING:

If the safety is "OFF" and the hammer fully-lowered, and you prefer to fire the first shot by the single action mode, make sure your trigger finger is out of the trigger guard and then manually retract the hammer to its fully-cocked position. WHEN READY TO FIRE, squeeze the trigger.

UNLOADING THE PISTOL:

- Engage the manual safety (fully down, red warning dots covered).
- Depress the magazine release button as to remove the magazine from the pistol.
- Grasping the slide serrations with thumb and index finger, fully retract the slide to extract and eject the chambered cartridge.
- Holding the slide retracted, visually inspect through the open slide that the magazine well and chamber are clear. WHEN SURE THE CHAMBER IS EMPTY AND THE CARTRIDGE HAS BEEN EJECTED, quickly release the slide for closing.

WARNING: To prevent accidents due to wrongful unloading practice — remember:

First: REMOVE MAGAZINE
Second: CLEAR CHAMBER

UNLOADING THE MAGAZINE:

- To unload the magazine with ease, grasp with one hand around the magazine box, bottom down and front end forward. With the tip of the thumb firmly press down on the cartridge rim, to elevate the bullet nose, and push. As the bullet moves over the front wall, tip it slightly upward with the index finger to ease the cartridge over the front wall.
 - Repeat until the magazine is unloaded.
-

MAINTENANCE

In an emergency situation a properly maintained pistol loaded with quality ammunition may save your life. Always keep it clean and lightly lubricated.

Do not use the pistol's excellent capability to function under adverse conditions as a reason to relax normal maintenance procedures.

Every time the pistol is fired or at least once a month, cleaning and lubrication is recommended. Start with:

FIELD STRIPPING:

Caution: Make sure the pistol is unloaded. See paragraph "Unloading the Pistol."

NOTE: The pistol is designed for ease of field stripping under adverse conditions. The photos show the most illustrative method. The text will explain other methods of manipulation. With a little practice field stripping can be performed in seconds.

Use the grasping method most convenient for manipulation control and comfort.

The pistol can be disassembled and assembled with the safety "ON" or "OFF."

To avoid parts damage *DO NOT PULL THE TRIGGER* while removing and mounting the slide.

- Engage safety (warning dots covered) for ease of slide to frame dismantling and mantling.
- Remove magazine by depressing magazine release button.
- Hold pistol in the right hand, muzzle slightly elevated; with the left forefinger depress the disassembling latch release button and with the left thumb rotate the disassembling latch clockwise until it stops, wing pointing down (Fig. 13).

NOTE: The disassembling latch can be reached and depressed by the right hand index finger while using the left thumb to either pull or push down the latch wing.

When using the left hand to operate the disassembling latch system you can choose to place your left hand from below the frame pulling down the latch wing or place your left hand above the slide pushing down the latch wing by the thumb.

- In one smooth stroke pull the barrel/slide assembly forward off the frame (Fig. 14).

WARNING: The recoil spring guide is held under pressure by the recoil spring. Be careful not to inadvertently cause this unit to “shoot off” the barrel/slide assembly.

NOTE: The barrel/slide assembly can be pulled off the frame also by grasping the slide from above. That method has the advantage that the thumb can be swung under the slide, supporting the recoil spring/guide unit while pulling the barrel/slide assembly off the frame.

- To dismantle the recoil spring guide unit, rest the barrel/slide assembly turned upside down in the palm of your hand, muzzle forward (Fig. 15).

Caution: Spring and guide are under tension.

- Place the tip of the index finger at the front corner of the slide and the tip of the thumb on the head of the recoil spring guide and squeeze, just enough to obtain the spring pressure. Carefully swing up the recoil spring guide until its head clears the locking block and barrel lug. Ease up thumb pressure to relax spring tension and remove spring and guide.

NOTE: The recoil spring guide can also be dismantled by:

Grasping the head of the guide between thumb and index finger, push forward, lift and ease up spring tension.

By placing the thumb across the locking block, push forward, lift and ease up spring tension.

- To dismantle the barrel/locking block unit from the slide, proceed as follows: Keeping the slide in the palm of your hand as when removing the recoil spring and guide (Fig. 16), place the tip of the index finger in front of the front barrel lug and the thumb against the plunger protruding the rear barrel lug. Push the plunger forward to raise the locking block. When the locking block lugs clear the slide's locking block shoulders, push the barrel forward just enough for the barrel to clear the extractor head, lift the barrel to clear the breech and pull it out of the slide.

NOTE: If preferred, support the slide in the palm of your hand, muzzle toward yourself. Place the tip of the index finger on the plunger and the thumb against the barrel front lug (Fig 17 and 18), otherwise proceed as explained above.

WARNING: Avoid pulling the trigger to initiate hammer fall when the pistol is field stripped.

NO FURTHER DISASSEMBLY IS RECOMMENDED UNLESS DONE BY A COMPETENT GUNSMITH OR ARMORER.

RECOMMENDED SAFETY FEATURE INSPECTION:

To insure the highest degree of functional integrity and self-protection readiness, it is recommended that the pistol be submitted to a periodical cleaning and safety feature, etc. inspection by a competent gunsmith or armorer. This is particularly important when the pistol has been exposed to excessive shooting, adverse field condition usage, dropped against hard surface, sand, mud or into salt water.

WHAT TO USE FOR CLEANING:

For normal barrel cleaning purpose use a standard barrel brush and if necessary to brush out stubborn gunpowder residue and/or metal deposit, use a metal bore brush and standard flannel patches.

For general action cleaning use lint free cloth, a small brush, pipe cleaners, cotton swabs, toothpicks and a small wood applicator to remove stubborn dirt, etc. DO NOT use sharp instruments.

Use a good grade of CLP (cleaning-lubricant-preservative) gun oil.

Most guns and sporting goods stores can supply suitable cleaning kits.

BARREL CLEANING AND LUBRICATION:

Wet the brush with CLP gun oil. Insert the brush into the barrel from the chamber and scrub chamber and bore thoroughly.

Dry chamber and bore by pushing a tightly fitting flannel patch through the chamber and bore with the brush or cleaning rod. Keep changing patch until it emerges clean.

Clean the locking block with a cloth soaked in CLP gun oil; if necessary use a brush. Wipe clean.

Lightly oil chamber and bore by passing a clean CLP gun oil moistened flannel patch through from the chamber. Lightly oil exterior of barrel and locking block, making sure the rails are lubricated. Lightly oil the locking block, making sure its front and rear hinge surfaces are lubricated. Place a drop of oil around the locking block plunger. Check and make sure the locking block and plunger move freely.

NOTE: When cleaning barrel after shooting be sure to recheck the chamber and bore for possible gunpowder residue sweat-out a few days after the shooting/cleaning.

SLIDE CLEANING AND LUBRICATION:

Clean slide with cloth and/or brush soaked in CLP gun oil, paying special attention to the breech face and extractor, slide rails, underside of breech and the back surface around firing pin plunger, safety, etc. Wipe clean.

Lightly oil the slide. Place a few drops of oil on the slide rails and smooth it out throughout the length of the rails, likewise oil underside of breech. With the thumb push the extractor outward, drop a few drops of oil alongside the extractor and move it briskly to insure internal penetration. From below place a drop of oil around the firing pin catch and push and release to insure free movement and oil penetration. Place a few drops of oil to each side of the safety/decocking lever and to the safety bolt and firing pin unit from the rear of the breech, move lever repeatedly to insure oil penetration and free movement. Wipe off excessive lubrication.

- To check the functional relationship between firing pin unit and firing pin catch and to insure internal cleaning/lubrication, place the safety “OFF.” With a punch (ballpoint pen) push the firing pin unit forward. The tip of the firing pin must not protrude breech face.
- With the tip of the finger, from below the slide breech, push the firing pin catch fully up and hold it while pushing the firing pin unit forward. The firing pin tip must protrude the breech face and move freely back and forth under energetic spring force.

NOTE: For ease of pistol assembly place the safety “ON.”

RECOIL SPRING AND GUIDE LUBRICATION:

Wipe or brush clean the spring and guide. Lightly oil the guide rod. Wipe the spring clean only with an oily cloth.

FRAME CLEANING AND LUBRICATION:

With a CLP gun oil soaked cloth or bristle brush, thoroughly clean all areas covered with gunpowder residue and field dirt. Brush out the magazine well using the bristle bore brush only. In hard to reach areas use pipe cleaners or cotton swabs.

Wipe clean and lightly lubricate rails and moving parts. With a few drops of oil and parts movement to insure oil penetration, particularly lubricate the disassembling latch, magazine catch release button, slide stop, trigger system, hammer, sear, and the levers in front of the hammer.

NOTE: For ease of pistol assembly make sure the hammer is fully-lowered and the disassembling latch in take-down position, its wing pointing straight down.

MAGAZINE CLEANING AND CARTRIDGE ROTATION:

Be sure to thoroughly clean the magazine(s). After cleaning, wipe with a lightly oil moistened cloth.

NOTE: If the pistol is carried chamber and/or magazine loaded, it is important to avoid that the chamber round (due to repeated loading and unloading) and the top five cartridges in the magazine (due to vibration striking against the magazine taper guide ribs) are slightly indented, that the chambered round together with rounds in the magazine(s) be periodically inspected and position rotated during the after cleaning reloading.

This to insure that particular cartridges do not get damaged to such an extent that they may cause malfunctioning.

AFTER FIELD STRIPPING ASSEMBLY:

Assemble by following the field stripping procedure in reverse order. It is advisable to pay attention to the following points:

- Safety engaged “ON.”
- The barrel should rest perfectly flush against the slide (the extractor must lodge in its barrel groove).
- The locking block lugs must be in the slide’s locking lug shoulder slot (the locking block plunger must protrude from the rear barrel lug).

- The recoil spring and guide must be parallel to the barrel and slide side walls and particularly important, the head of the recoil spring guide perfectly seated into its half round cutout in the locking block. Thumb pressure on the head will insure perfect seating.

NOTE: If the recoil spring plunger head is not properly seated the slide cannot be pushed back on the frame to engage the disassembling latch.

- Before barrel/slide unit mounting to the frame insure that the disassembling latch is in its disassembly position (wing pointing straight down) and the hammer fully-lowered.

After assembly and *before loading* insure by manipulation that the slide reciprocates freely, the safety-decocking lever, trigger system, slide stop, and magazine catch release button function perfectly. Check all magazines in the pistol.

AMMUNITION

Using good quality ammunition combined with preventive maintenance will make the pistol perform flawlessly through years of service. To prevent malfunctioning always visually inspect each cartridge for external damage before loading.

The pistol is designed and proof tested to withstand continued shooting with all brands and types of commercial ammunition manufactured to standard S.A.A.M.I. specifications known as:

9mm Parabellum, 9mm Luger, 9 x 19mm

We do not recommend extended use of +P+ or submachine gun ammunition because the chamber pressure may reach or exceed proof load pressure, decreasing the major components service life expectancy.

The warranty does not cover the use of reloaded and/or hand loaded ammunition.

WARNING: If using reloaded cartridges containing solid lead bullets, take the following precautions:

DO NOT use any ammunition on which the case mouth is *CRIMPED* into the bullet.

Make sure the bullets are of the right caliber size according to S.A.A.M.I. specifications.

Avoid the use of bullets having sharp contour step close to case mouth.

Lead bullets have a tendency to cause bore leading which may dramatically increase the discharge pressure.

Make sure to remove all chamber and bore lead accumulation after each shooting.

DO NOT ever shoot cartridges with jacketed bullets through a barrel previously fired with lead bullets before the bore is thoroughly delead.

Repeated reloading will structurally weaken the case head/web section which may result in case rupture.

DRY FIRING/“DUMMY” ROUNDS:

If you want to practice aim and trigger pull, insert a FIRED cartridge case or “DUMMY” cartridge in the chamber to cushion the fall of the firing pin and eliminate the chance of firing pin breakage.

Hammer fall in connection with the normal use of the manual safety-decocking lever **DOES NOT** cause firing pin breakage.

Your dealer can supply different “DUMMY” cartridges:

NOTE: “DUMMY” cartridges with spring loaded “Primer” are excellent but expensive.

“DUMMY” cartridges with solid heads are good for loading/unloading and dry firing practice.

“DUMMY” cartridges with empty primer pockets are good for loading/unloading practice but *DOES NOT* protect the firing pin when dry firing.

TROUBLE SHOOTING, CAUSE AND REMEDIES

Failure	Cause	Action
Failure to feed	1. Defective cartridge, bent, indented, burred, etc.	Replace
	2. Dirty chamber and/or action	Clean, lubricate
	3. Dirty magazine	Clean
	4. Damaged, indented burred magazine lips, etc.	Replace, repair by armorer
Misfire/ Hangfire	1. Caution: A misfire could be a hangfire-delayed discharge. Keep hands away from slide in case of recoil.	Fire double action, wait 10 seconds before reloading.
	2. Safety not turned to its full "OFF" position.	Turn safety and fire double action
	3. Dirt prevents free and complete slide closing, hammer fall and/or firing pin strike.	Clean and lubricate
Failure to extract	1. Extractor jammed by powder residue or field dirt	Wash out in cleaning solution and lubricate
	2. Chamber dirty	Clean, lightly lubricate
	3. Defective cartridge	Replace
	4. Short recoil, defective cartridge, bullet may be lodged in bore	Inspect barrel bore
Failure to eject	1. Damaged ejector	Service by armorer
	2. Short recoil, defective cartridge, bullet may be lodged in bore	Inspect barrel bore

NOTE: When repair is needed contact our Service Department or a competent gunsmith or armorer.

TECHNICAL SPECIFICATIONS:

Caliber/Ammunition	9mm Parabellum, 9mm Luger, 9mm NATO or 9 × 19 mm
System of Operation	Semiautomatic, short stroke, delayed blowback recoil operated
Locking System	Straight barrel/slide unit reciprocation with oscillating locking block
Hammer	Exposed, with cocking spur and drop-catch feature
Trigger	Double/single action
Safety	Slide mounted manual ambidextrous safety-decocking lever with "OFF" position marked by vivid red warning dot
Trigger Linkage Interrupter	With the safety "ON" the trigger/hammer linkage is deactivated
Firing Pin Catch	Automatically engaged catch prevents accidental discharge by firing pin inertia. Deactivated only at the moment of trigger pull hammer fall.
Slide Catch	Automatically secures the slide open when recoiled or manually retracted over empty magazine
Grips	Black plastic or walnut
Rifling	6 grooves right hand, pitch 250mm (about 1 turn in 10 in.)
Front sight	Square post integral with slide, white dot
Right sight	Square notched bar, dovetailed to slide, with white post
<i>Note: Optional Trijicon 3-Dot Night Sights</i>	
Barrel Length	125mm (4.92 in.)
Sight Radius	158mm (6.22 in.)
Overall Length	217mm (8.54 in.)
Overall Height	140mm (5.51 in.)
Overall Width	38mm (1.50 in.)
Weight of Pistol (w/empty magazine)	960 g. approx. (33.86 oz.)
Weight of Magazine (empty)	107 g. (3.82 oz.)
Weight of Loaded Pistol (115 g. NATO BALL)	1145 g. approx. (40.89 oz.)
Weight of Loaded Magazine	292 g. (10.42 oz.)

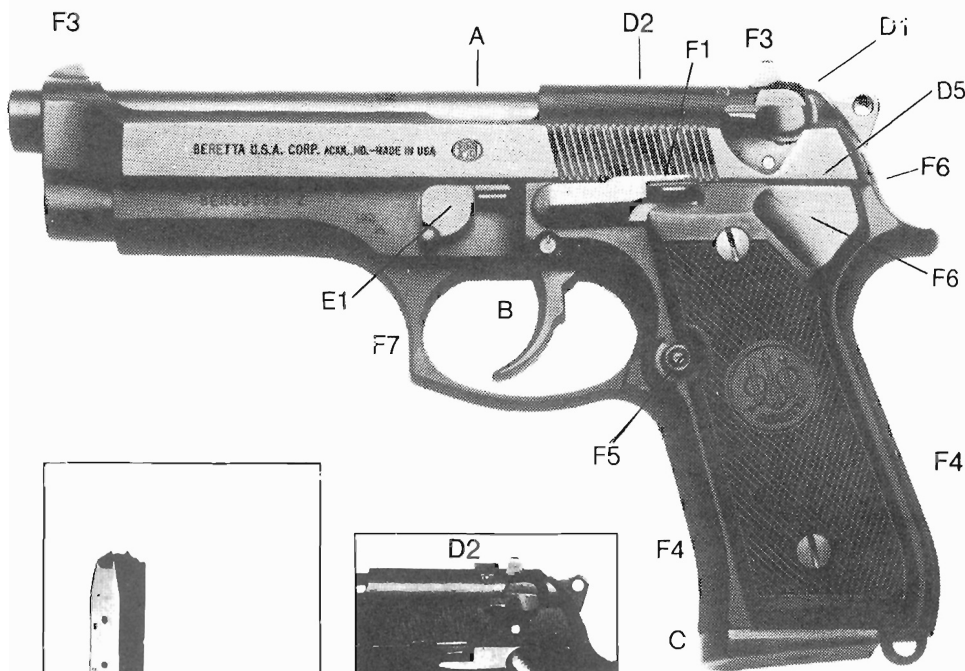

Fig. 1

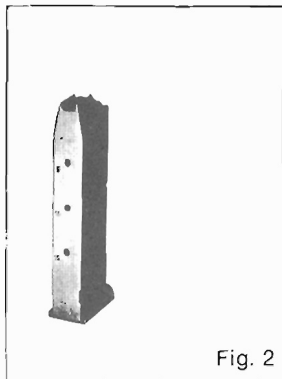

Fig. 2

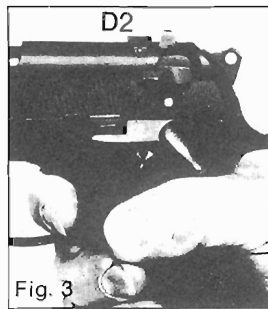

Fig. 3

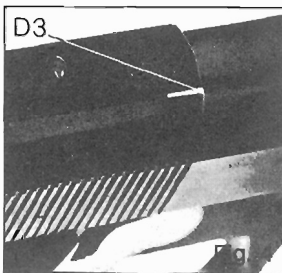

Fig. 4

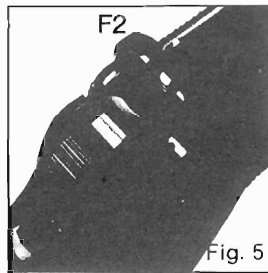

Fig. 5

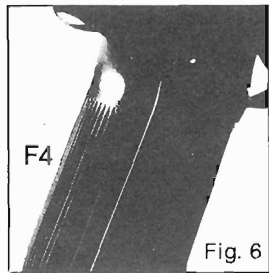

Fig. 6

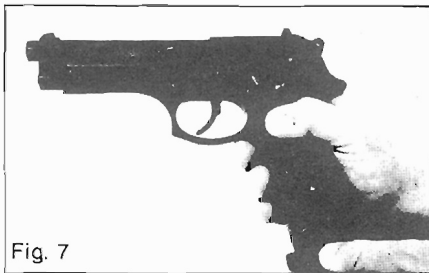

Fig. 7

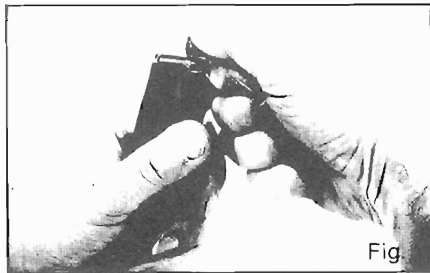

Fig. 8



Fig. 9



Fig. 10



Fig. 11



Fig. 12

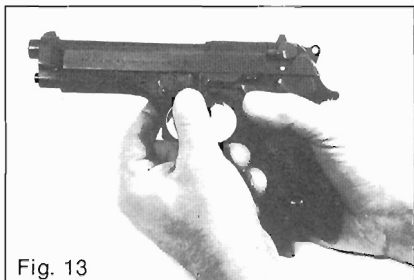

Fig. 13



Fig. 14

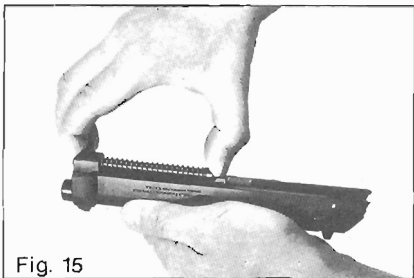

Fig. 15

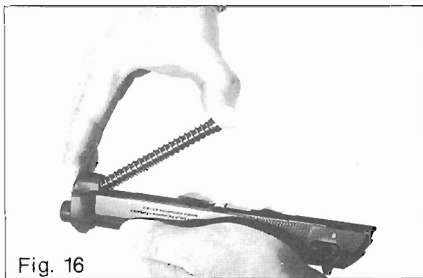

Fig. 16

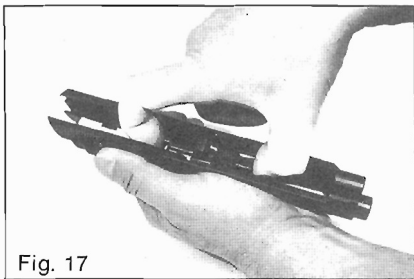

Fig. 17

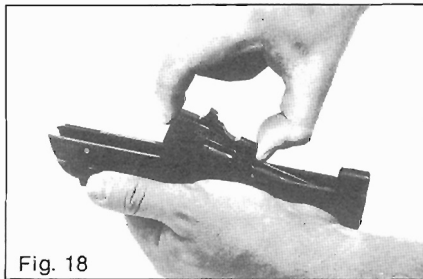

Fig. 18



Beretta U.S.A.

Model 92 FS

Caliber 9mm Parabellum

EXPLODED DRAWING

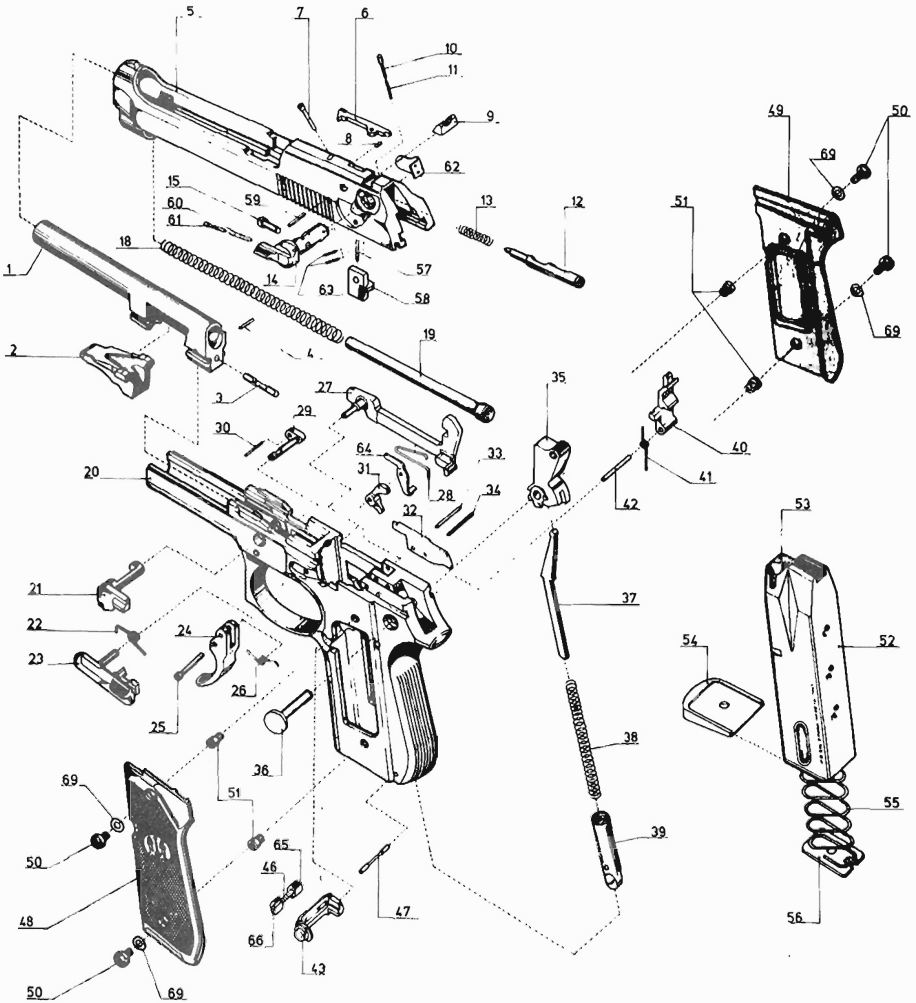

NOTE: Exploded drawing is provided to aid the user in understanding the pistol's functioning only and in aiding the gunsmith or armorer in ordering parts when needed for repair.



Beretta U.S.A.

PARTS LIST

MODEL 92 FS

Part # Nomenclature

1	Barrel (Factory Fitting Required)
2	Locking Block
3	Locking Block Plunger
4	Locking Block Plunger — Retaining Pin
5	Slide (Factory Fitting Required)
6	Extractor
7	Extractor Pin
8	Extractor Spring
9	Rear Sight (Fitting Required)
10	Trigger Bar Release Plunger
11	Trigger Bar Release Plunger Spring
12	Firing Pin
13	Firing Pin Spring
14	Safety
15	Firing Pin Plunger
18	Recoil Spring
19	Recoil Spring Guide
20	Frame
21	Disassembling Latch
22	Slide Catch Spring
23	Slide Catch
24	Trigger
25	Trigger Pin
26	Trigger Spring
27	Trigger Bar
28	Trigger Bar Spring
29	Disassembling Latch Release Button
30	Disassembling Latch Release Button Spring
31	Hammer Release Lever
32	Ejector
33	Hammer Release Lever Pin

Part # Nomenclature

34	Ejector Spring Pin
35	Hammer
36	Hammer Pin
37	Hammer Spring Guide
38	Hammer Spring
39	Hammer Spring Cap
40	Sear
41	Sear Spring
42	Sear Pin
43	Magazine Release Button
46	Magazine Release Button Spring
47	Hammer Spring Cap Pin
48/49P	Grips (Plastic) Pair
48/49W	Grips (Wood) Pair
50	Grip Screw
51	Grip Bush
52	Magazine Box*
53	Magazine Follower
54	Magazine Bottom
55	Magazine Spring
56	Magazine Lock Plate
57	Firing Pin Catch Spring
58	Firing Pin Catch
59	Firing Pin Catch Retaining Spring Pin
60	Safety Plunger Spring
61	Safety Plunger
62	Right Safety Lever
63	Right Safety Lever Spring Pin
64	Firing Pin Catch Lever
65	Magazine Catch Spring Bush (Short)
66	Magazine Catch Spring Bush (Long)
69	Spring Washer

*Sold only as complete magazine.

NOTE: Always specify Model 92 FS when ordering parts.

PARTS AND SERVICE

In-warranty as well as general repair and maintenance service is available from our Product Service Department.

In most instances your local dealer can assist with answers relating to maintenance and parts.

Parts price list and parts can be ordered from our Product Service Department.

Please read the WARRANTY — it gives valuable information concerning in-warranty service, or write to:

BERETTA U.S.A. CORP.

Product Service Dept.

17601 Beretta Drive

Accokeek, MD 20607

Phone: (301) 283-2191 FAX (301) 375-7677

LIMITED WARRANTY

THIS "LIMITED WARRANTY" HAS BEEN DRAFTED TO COMPLY WITH THE MAGNUSON-MOSS WARRANTY FEDERAL TRADE COMMISSION IMPROVEMENT ACT WHICH IS EFFECTIVE FOR GOODS MANUFACTURED ON OR AFTER DECEMBER 31, 1976.

Beretta U.S.A. Corp. warrants that this firearm was manufactured free of defects in material or workmanship; and for a period of one (1) year after date of purchase, the Manufacturer agrees to correct by repair or replacement (with same or comparable quality model) your firearm, without charge, if returned prepaid.

BERETTA ASSUMES NO RESPONSIBILITY FOR PRODUCT MALFUNCTION OR FOR PHYSICAL INJURY OR PROPERTY DAMAGE RESULTING IN WHOLE OR IN PART FROM CRIMINAL OR NEGLIGENT USE OF THE PRODUCT, IMPROPER OR CARELESS HANDLING, UNAUTHORIZED MODIFICATIONS, USE OF DEFECTIVE, IMPROPER, HAND-LOADED OR RELOADED AMMUNITION, CUSTOMER ABUSE OR NEGLIGENCE OF THE PRODUCT, OR OTHER INFLUENCES BEYOND BERETTA'S DIRECT AND IMMEDIATE CONTROL. THIS WARRANTY DOES NOT APPLY TO NORMAL WEAR OF ANY PARTS, INCLUDING METAL, WOOD, PLASTIC, RUBBER AND OTHER MATERIAL'S SURFACED FINISH OR IF UNAUTHORIZED REPAIR AND/OR ALTERATION HAS BEEN PERFORMED.

The terms of the warranty cannot be changed except in writing by an officer of Beretta U.S.A. Corp.

Wholesalers and Dealers (unless a Beretta U.S.A. Corp. Authorized Gunsmith) are not authorized to make any In-warranty repair or adjustment on behalf of Beretta U.S.A. Corp.

This warranty gives only the original retail purchaser specific legal rights; other rights may also be available which may vary from state to state.



Beretta

BERETTA U.S.A. CORP.

17601 Beretta Drive Accokeek, Maryland 20607

Phone: (301) 283-2191 FAX (301) 375-7677