

# Beretta

pistol



model **3032**

**Tomcat**

CALIBER: 32 AUTO

**BERETTA**

## Caution: Read this manual carefully before handling and loading the pistol.

**WARNING:** Always ensure that the safety is fully engaged until ready to fire. A safety is fully engaged only when the safety can move no further into the safe position. A safety which is not fully engaged will not prevent weapon discharge.

### BASIC SAFETY RULES

1. NEVER POINT A FIREARM AT SOMETHING THAT IS NOT SAFE TO SHOOT.

Never let the muzzle of a firearm point at any part of your body or at another person. This is especially important when loading or unloading the firearm. When you are shooting at a target, know what is behind it. Some bullets can travel over a mile. If

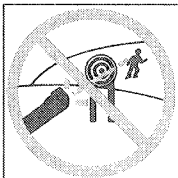
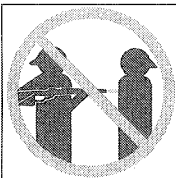

you miss your target or if the bullet penetrates the target, it is your responsibility to ensure that the shot does not cause unintended injury or damage.

2. ALWAYS TREAT A FIREARM AS IF IT WERE LOADED.

Never assume that a firearm is unloaded. **The only certain way to ensure that a firearm is empty is to open the chamber and visually examine the inside to see if a round is present. Removing the magazine will not guarantee that a pistol is unloaded or cannot fire.** Shotguns and rifles can be checked by cycling or removing all rounds and by then opening the chamber so that a visual inspection of the chamber for any remaining rounds can be made.

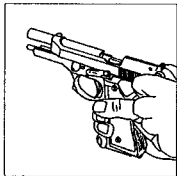

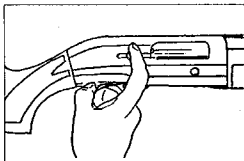
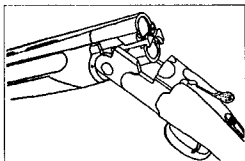

3. **STORE YOUR FIREARM SO THAT CHILDREN CANNOT GAIN ACCESS TO IT**  
It is your responsibility to insure that children under the age of 18 or other unauthorized persons do not gain access to your firearm. **To reduce the risk of accidents involving children, unload your firearm, lock it and store the ammunition in a separate locked location.** Please note that devices intended to prevent accidents—for example, cable locks, chamber plugs, etc.—may not prevent use or misuse of your firearm by a determined person. Steel gun safes may be more appropriate to reduce the likelihood of intentional misuse of a firearm by an unauthorized child or person.

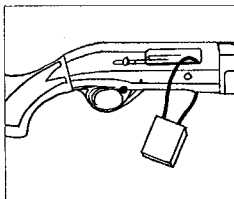
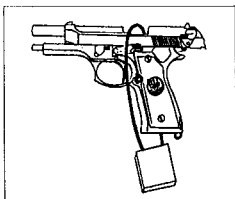

4. **NEVER SHOOT AT WATER OR AT A HARD SURFACE.**

Shooting at the surface of water or at a rock or other hard surface increases the chance of ricochets or fragmentation of the bullet or shot, which can result in the projectile striking an unintended or peripheral target.

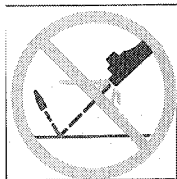

5. KNOW THE SAFETY FEATURES OF THE FIREARM YOU ARE USING, BUT REMEMBER: SAFETY DEVICES ARE NOT A SUBSTITUTE FOR SAFE HANDLING PROCEDURES.

Never rely solely on a safety device to prevent an accident. It is imperative that you know and use the safety features of the particular firearm you are handling, but accidents can best be prevented by following the safe handling procedures described in these safety rules and elsewhere in the product manual. To further familiarize yourself with the proper use of this or other firearms, take a Firearms Safety Course taught by an expert in firearms use and safety procedures.

6. PROPERLY MAINTAIN YOUR FIREARM.

Store and carry your firearm so that dirt or lint does not accumulate in the working parts. Clean and oil your firearm, following the instructions provided in this manual, after each use to prevent corrosion, damage to the barrel or accumulation of impurities which can prevent use of the gun in an emergency. Always check the barrel prior to loading to ensure that it is clean and free from obstructions. **Firing against an obstruction can rupture the barrel and injure yourself or others nearby.** In case you hear an unusual noise when shooting, stop firing immediately, engage the manual safety and unload the firearm. Make sure the chamber is free from any obstruction or possible bullet blocked inside the barrel due to defective or improper ammunition.

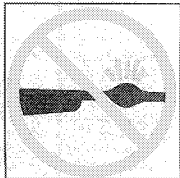

7. USE PROPER AMMUNITION.

Only use factory-loaded, new ammunition manufactured to industry specifications: CIP (Europe and elsewhere), SAAMI (U.S.A.). Be certain that each round you use is in the proper caliber or gauge and type for the particular firearm. The caliber or gauge of the firearm is clearly marked on the barrels of shotguns and on the slide or barrel of pistols. The use of reloaded or remanufactured ammunition can increase the likelihood of excessive cartridge pressures, casehead ruptures or other defects in the ammunition which can cause damage to your firearm and injury to yourself or others nearby.

8. ALWAYS WEAR PROTECTIVE GLASSES AND EARPLUGS WHEN SHOOTING.

The chance that gas, gunpowder or metal fragments will blow back and injure a shooter who is firing a gun is rare, but the injury that can be sustained in such circumstances is severe, including the possible loss of eyesight. A shooter must always wear impact resistant shooting glasses when firing any firearm. Earplugs help reduce the chance of hearing damage from shooting.



9. NEVER CLIMB A TREE, FENCE OR OBSTRUCTION WITH A LOADED FIREARM.

Open and empty the chamber of your firearm before climbing or descending a tree or before climbing a fence or jumping over a ditch or obstruction. Never pull or push a loaded firearm toward yourself or another person.



10. AVOID ALCOHOLIC BEVERAGES OR JUDGMENT OR REFLEX IMPAIRING MEDICATION WHEN SHOOTING.

Do not drink and shoot. If you take medication that can impair motor reactions or judgment, do not handle a firearm while you are under the influence of the medication.

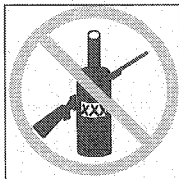

11. NEVER TRANSPORT A LOADED FIREARM.

Unload a firearm before putting it in a vehicle. Hunters and target shooters should load their firearm only at their destination. If you carry a firearm for self-protection, leaving the chamber unloaded can reduce the chance of accidental discharge.

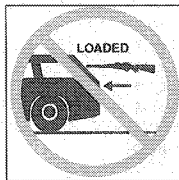

12. LEAD WARNING.

Discharging firearms in poorly ventilated areas, cleaning firearms or handling ammunition may result in exposure to lead and other substances known to cause birth defects, reproductive harm, and other serious physical injury. Have adequate ventilation at all times. Wash hands thoroughly after exposure.

**TABLE OF CONTENTS****PAGE**

Model 3032 Specifications	6
Introduction	7
Basic Safety	8
Safe Storage of Pistol and Ammunition	9
Ammunition	9
Safe Transportation	10
Dry Firing	10
Pistol Nomenclature	11
Loading the Magazine	11
To Load the Pistol by the Barrel Tilting Method	12
To Load the Pistol by Slide Manipulation	12
Unloading of Pistol and Magazine	13
How to Lower the Hammer	13
How to Cock the Hammer	14
Safety/Fully-Cocked Hammer Relationship	14
Safety/Fully-Lowered Hammer Relationship	15
Safety/Half-Cocked Hammer Relationship	16
Double Action Trigger Pull	16
Single Action Trigger Pull	17
Firing	17
Misfire and/or Hang-Fire	17
Jamming/Malfunctioning	18
Disassembly (Field Stripping of Unloaded Pistol)	18
Reassembly (From Field Stripping)	20
Cleaning	21
Model 3032 Parts Lists	23
Model 3032 Parts Illustration	24
Service	24
Limited Warranty	26

**MODEL 3032 SPECIFICATIONS 32 AUTO**

Weight of pistol w/empty magazine (approx.)	(14.5 oz.)
Overall length	124mm (4.9 in.)
Height w/magazine inserted	95mm (3.7 in.)
Width (max.)	29mm (1.1 in.)
Barrel Length	61mm (2.4 in.)
Sights	Fixed Front, Windage Adjustable Rear
Locking System	Straight Blowback

**BERETTA MODEL 3032 TOMCAT**  
**Double Action Semiautomatic Pistol**

---

**CAUTION:** Please read this manual carefully BEFORE loading the pistol.

Caliber ..... 32 Auto  
Rifling ..... 6 grooves R.H. twist, one turn in 10"  
Magazine Capacity ..... 7 Rounds

**INTRODUCTION:**

This Beretta U.S.A. Corp. manufactured pistol in caliber 32 Auto has features rarely found in sporting pistols. It has the strength, precision, sturdiness and safety devices usually characteristic of pistols in larger caliber, weight and dimensions. The Italian Beretta's world famous reputation for making the finest products continues to be maintained in the manufacturing of the Model 3032 in the United States.

Physical strength is not required in loading due to a unique barrel mounting system. By finger movement of a lever, the barrel is released for direct chamber loading. Close the barrel and the pistol is ready to fire, even if the magazine is not in the weapon. Insert a loaded magazine and you are ready to fire additional rounds. To fire, just disengage the safety and pull the trigger in the double action mode. No manual hammer cocking is required.

The Model 3032 has an INERTIA type firing pin which, when used with the hammer down, external safety engaged and with the double action trigger pull, assures the greatest degree of safety if it is necessary to carry the pistol chamber loaded (NOT RECOMMENDED).

The Model 3032 employs a MANUAL THUMB SAFETY. The Safety can quickly be engaged to its upward "ON" or downward "OFF" positions by a flick of the thumb. When the Safety is "OFF" (down), a Red Warning Dot in the slide lock notch is visible. The Safety, when "ON" (up), prevents trigger pull and locks the slide to prevent slide retraction. See paragraph BASIC SAFETY.

The Frame is machined from a high strength aluminum alloy forging, and its surface is black anodize finished.

**The Barrel** is machined from a special high grade barrel steel forging, and its surface is protected by a deep, durable hot blueing.

The Slide is machined from a cold drawn shape of high strength steel and blued by the same process as the barrel.

The small parts are manufactured of special selected high quality steel and hardened according to each part's individual function. All parts are made to strict tolerances to insure the highest degree of interchangeability.

## **BASIC SAFETY:**

**ALWAYS TREAT A FIREARM AS IF IT WERE LOADED.**

**ALWAYS POINT THE MUZZLE IN A SAFE DIRECTION.**

A firearm when loaded has the potential to kill. Intelligently handled, it is safe.

An accident is always the result of neglect of the basic safety rules.

Accident prevention is the responsibility of anyone handling a firearm.

Before loading a firearm be sure you know how it functions.

Be sure to keep your firearm clean—before loading inspect the barrel to insure it is perfectly clean and free of foreign objects. Shooting with an obstruction in the barrel such as dirt, mud, grease, lodged bullet or jacket, etc., can cause barrel bulging and/or rupture.

Never shoot at a hard flat surface or at water because of the risk of ricochets.

Avoid alcohol and drugs before and during shooting.

Extreme care must be taken to avoid hitting or dropping a loaded firearm. Even if on SAFE, accidental discharge may occur—some ammunition have very sensitive primers.

Shooting Glasses and Earplugs: Protective Glasses are a **MUST**; chances of gas, gunpowder and particle blowback are remote, but do exist and can cause eye injury. Earplugs reduce the chance of temporary or permanent loss of hearing when shooting—particularly on an indoor range.

Firearms Safety Course: To familiarize yourself with the proper use of firearms, attend a Firearm Safety Course in your area. Remember—only **YOU** are responsible for the firearm in your hands. Prevent accidents by knowing its function.



**HANDLE IT WITH RESPECT, NOT FEAR. Safety Devices on firearms are not substitutes for safe handling procedures.**

Discharging firearms in poorly ventilated areas, cleaning firearms, or handling ammunition may result in exposure to lead and other substances known to cause birth defects, reproductive harm, and other serious physical injury. Have adequate ventilation at all times. Wash hands thoroughly after exposure.

### **SAFE STORAGE OF PISTOL AND AMMUNITION:**

A loaded/unloaded pistol in an unlocked area is not safe from the curiosity seeker. If stored in an unlocked area, be SURE the pistol is unloaded and the ammunition is stored elsewhere.

To avoid corrosion during storage, the pistol should be thoroughly cleaned and all metal surfaces protected by a light film of a good grade of gun oil. Store pistol unwrapped in a container placed in a ventilated area.

Store ammunition in a container placed in a cool ventilated area.

### **AMMUNITION:**

The model 3032 Tomcat pistol is chambered for the 32 Auto caliber. The 32 Auto cartridge is also known as .32 Cal, .32 ACP and in Europe it is known as the 7.65 mm Browning. The 3032 Tomcat is not designed to shoot 7.65 Roth-Sauer, .32 S&W, .32 S&W Long, .32 H&R Magnum, .32 Long Colt, .32 Short Colt, .32 Winchester, 7.65 Mannlicher, 7.65 mm Luger, or 7.65 MAS French. Be sure of the caliber and use only ammunition which is designed for your pistol. Use only new, factory manufactured, ammunition which conforms to SAAMI or CIP specifications. Reloaded or remanufactured ammunition is more likely to be overcharged or defective and can present safety risks to the shooter.

Before leaving the factory, the pistol has been thoroughly inspected, proof load test-fired to check material strength and function tested with factory load 32 Auto ammunition.

After a "break in" period of shooting, you may find that your pistol (like most other semiautomatic pistols) shoots better with one or two particular brands of ammunition.

## **SAFE TRANSPORTATION:**

Unload your pistol for safe transportation (empty chamber, magazine removed, the hammer fully-lowered and the safety "ON").

IN THE FIELD, the pistol should be carried unloaded (empty chamber, magazine removed, the hammer fully-lowered and the safety "ON") in a holster, with the magazine in a pouch or pocket. It takes only a second to insert a loaded magazine and to retract and release the slide for chamber loading and cocking. If preferred, you can release the barrel for direct chamber loading, making the pistol ready to fire immediately by disengaging the safety.

Remember—keep your finger **OUTSIDE** the trigger guard until ready to fire.

ON THE RANGE, the hammer should be fully-lowered and the safety engaged "ON", the magazine removed and the barrel released until ready to fire. Always keep the chamber unloaded until you are ready to fire.

NOTE: The situation could arise in shooting (field or range) when the chamber is loaded and you want to lock the cocked hammer to prevent inadvertent discharge. Here the **THUMB** or **MANUAL** Safety should be used. Being careful to control muzzle direction, push the Safety fully into its upward position.

Remember—The pistol is still cocked and loaded! As soon as possible, **UNLOAD** the pistol.

Remember—The quick barrel release can also be used as a Safety device against accidental discharge. Flip the barrel release lever and, when the barrel springs to the tilted position, the pistol cannot be fired unless the barrel is returned to its downward locked position.

## **CAUTION:**

### **DRY FIRING:**

Dry firing can cause firing pin breakage which can cause unintended discharge or may prevent discharge. If you want to practice trigger pull, insert a **FIRE**d cartridge case in the chamber to cushion the fall of the firing pin and reduce chances of firing pin breakage.

## PISTOL NOMENCLATURE:

MODEL 3032 TOMCAT

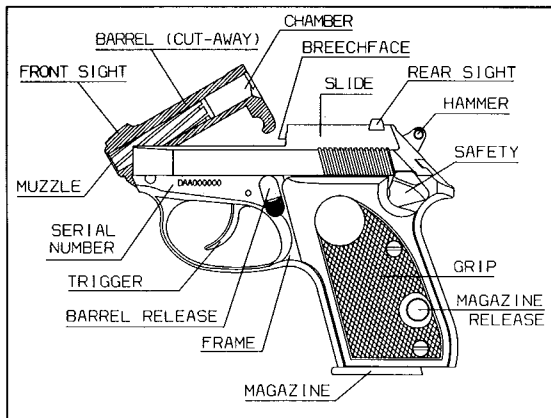

### LOADING THE MAGAZINE:

**CAUTION!!** Make sure the chamber is not already loaded.

To Remove the Magazine:

Depress the Magazine Release Button located on the left side's lower rear corner of pistol grip, and withdraw magazine.

To Load the Magazine:

Hold the magazine in one hand. With your other hand place a cartridge on the follower in front of the lips, press down and slide the cartridge completely back under the lips. Repeat loading until the magazine contains seven 32 Auto cartridges. **DO NOT** try to force an extra cartridge into the magazine.

## **TO LOAD THE PISTOL BY THE BARREL TILTING METHOD:**

Release the Barrel by a forward movement of the Barrel Lever, which is conveniently located on the frame's left side above the trigger. Insert a cartridge into the chamber, and push the barrel down. A sharp click indicates Barrel Lever Engagement. (As a precaution, visually inspect that the Barrel Lever is securely closed or pull lever toward its rear stop). The pistol is now chamber loaded, ready to be fired by trigger pull.

Push the fully loaded magazine into the grip's magazine well. A sharp click indicates magazine catch engagement. The pistol is now chamber and magazine loaded and ready to fire.

Remember—when the hammer is fully-lowered to rest against the slide, the pistol can be fired by double action trigger pull (direct trigger pull—no manual hammer cocking). Therefore, as a safety precaution, ENGAGE THE SAFETY by pushing up. The Safety locks the slide when the red warning dot is covered and the Safety can go up no further.

**NOTE:** Due to the unique barrel tilting system, the Model 3032 has no EXTRACTOR. As long as you use appropriate undamaged ammunition and keep the chamber clean you will not have loading and unloading problems.

## **TO LOAD THE PISTOL BY SLIDE MANIPULATION:**

Push the fully loaded magazine into the grip's magazine well. A sharp click indicates magazine catch engagement.

Remember—when the hammer is fully-lowered and Safety "ON" the slide cannot be pulled.

**DISENGAGE SAFETY** (push down—Safety unlocks slide/RED WARNING DOT visible).

Grasp the slide serration with thumb and index finger (keep finger outside the trigger guard), retract the slide to solid stop (activating the recoil springs and cocking the hammer). QUICKLY release the slide. The slide will automatically close, chambering the first cartridge from the magazine. The hammer is fully-cocked. The pistol is ready to fire.

**NOTE:** Exercise Extreme Caution. Always point the Muzzle in a Safe Direction. ENGAGE SAFETY unless you intend to shoot.

**CAUTION!!** Since the Slide has no Extractor the chamber cannot be unloaded by slide retraction, therefore, **DO NOT** retract and release the slide over a loaded magazine as the slide will jam the top cartridge from the magazine against the chambered cartridge.

### **UNLOADING OF PISTOL AND MAGAZINE:**

As a safety precaution, whether the hammer is fully-lowered, half-cocked or fully-cocked, **ENGAGE THE SAFETY**. Release the barrel by a forward movement of the Barrel Lever and remove the chambered cartridge.

**NOTE:** Quick barrel release may eject the chambered cartridge. If the barrel is released under finger support, the cartridge will remain in the chamber. Elevate the muzzle and the cartridge will fall out. Since the Model 3032 slide does not have an extractor, the chamber cannot be unloaded by slide retraction.

Depress the Magazine Release Button and remove the magazine. Disengage the Safety and fully-lower the hammer.

On the 32 Auto magazine, press down on the cartridge rim with your thumb and push, easing the bullet over the front wall. Repeat until unloaded.

Remember—to avoid malfunction, always keep the magazine clean. Dropping the magazine may dent the box, and bend and/or burr the lips.

### **HOW TO LOWER THE HAMMER:**

**WARNING!!** Even though the Model 3032 has an inertia Firing Pin (reduces chances of accidental discharge), a falling hammer (even from a short distance) may cause discharge, especially if the cartridge has a sensitive primer. We do not recommend lowering the hammer on a chambered round.

**NOTE:** The Model 3032 has an added safeguard: The barrel can be released (tipped up) before lowering the hammer on a chambered round.

To lower the fully-cocked or half-cocked hammer to the fully-lowered position, disengage the Safety. Manually retract the

hammer spur. Depress the trigger while cautiously allowing the hammer to move all the way forward under thumb control.

When the hammer is fully-lowered, **ENGAGE SAFETY** (push up—Safety locks slide, covering red warning dot).

If the barrel, as a safety precaution, was released during hammer lowering, push the barrel down, and insure that the barrel lever is securely closed.

### **HOW TO COCK THE HAMMER:**

Since the Model 3032 has a double action trigger mechanism, manual hammer cocking is not necessary unless the shooter prefers to fire the first round by the shorter and lighter single action trigger pull.

**WARNING!!** Even though the Model 3032 has an inertia Firing Pin and Half-Cocked hammer position, a falling hammer (even from a short distance) may cause discharge if the cartridge has a sensitive primer.

**NOTE:** The Model 3032 has an added safeguard: The barrel can be released before cocking the hammer on a chambered round.

To cock the fully-lowered hammer to fully-cocked position: Disengage the Safety. Keep finger away from trigger. Place the thumb on the hammer spur. Retract the hammer in a continuous motion to solid frame tang stop. A sharp click indicates the sear is in position to secure the hammer. Gradually ease up the thumb pressure, allowing the hammer to move forward a short distance to solid hammer/sear engagement. Remove thumb from spur and **ENGAGE SAFETY**.

### **SAFETY/FULLY-COCKED HAMMER RELATIONSHIP:**

Remember—when the pistol is chamber loaded by slide manipulation or automatically during the shooting cycle (but not direct hand loading of chamber), the hammer is fully-cocked and the pistol is ready to fire.

**WARNING!!** Careless handling of a loaded pistol, with or without the safety engaged, could result in accidental discharge. **DO NOT** check the mechanical functioning of the Safety when the **CHAMBER IS**

**LOADED**—check it with empty chamber. **DO NOT** try to override the Safety by asserting excessive trigger pull force.

A soft click from a spring plunger can be heard when the Safety is turned between “ON” and “OFF”. The spring plunger secures the Safety in either position.

The Safety is **ENGAGED “ON”** in its upward position. **NO Red Warning Dot** is visible.

The Safety is **DISENGAGED “OFF”** in its downward position. The **RED WARNING DOT** is visible.

The Safety, when engaged, securely blocks the Sear, preventing trigger pull and hammer fall.

The Safety, when engaged, locks the slide.

### **SAFETY/FULLY-LOWERED HAMMER RELATIONSHIP:**

Remember—the chamber may be loaded even though the hammer is Fully-Lowered to its “discharged” position.

**WARNING!!** If the pistol is carried chamber loaded (**NOT RECOMMENDED**) with the hammer fully-lowered **ENGAGE** the **SAFETY: DO NOT** try to override the Safety by asserting excessive trigger pull force. Also, the mechanism may be damaged by forceful manual hammer cocking.

A soft click from a spring plunger can be heard when the Safety is turned between “ON” and “OFF”. The spring plunger secures the Safety in either position.

The Safety, in its upward **ENGAGED** position locks the slide. **NO RED WARNING DOT** is visible.

The Safety is **Disengaged** in its downward position. The **RED WARNING DOT** is visible.

The fully-lowered Hammer with the Safety **ENGAGED** can be retracted into the half-cocked (Drop Catch) position by either a light and short trigger pull or manual hammer cocking.

**CAUTION!!** Should the fully-lowered Hammer with the Safety “ON” be retracted into its Half-Cocked (Drop Catch) position the hammer cannot be lowered. See section “**HOW TO LOWER THE HAMMER**”.

## **SAFETY/HALF-COCKED HAMMER RELATIONSHIP:**

To **REDUCE** the chance of untriggered discharge due to accidental hammer fall from the full-cocked position, the falling hammer is caught and secured in a half-cocked position by the Sear entering the Hammer's Drop Catch Notch.

When the Hammer is half-cocked and the Safety **ENGAGED**, the hammer cannot be retracted to its fully-cocked position.

With the hammer half-cocked and the Safety **DISENGAGED** "OFF", the pistol can be fired by double action trigger pull, the length of pull being slightly shorter than when fired from the fully-lowered position.

**WARNING** To avoid the remote risk of accidental discharge due to impact against the hammer spur **DO NOT** carry the pistol chamber loaded with the Hammer half-cocked. Should the pistol be inadvertently dropped and the hammer struck, the impact could damage or perhaps break either the Hammer notch, Sear Pin, and/or Sear, causing the hammer to strike the firing pin.

## **DOUBLE ACTION TRIGGER PULL:**

The Double Action feature is a safety device. It makes it possible to fire the pistol quickly from the hammer's fully-lowered position. It eliminates the necessity of manual hammer cocking.

Take advantage of the Double Action Trigger Pull:

- When the pistol is chamber loaded by the barrel release method and the hammer remains fully-lowered.
- If the hammer after shooting has been fully-lowered over a chambered round.
- In case of misfire and/or possible hang-fire.

**CAUTION!!** Always **ENGAGE SAFETY** when the hammer is fully-lowered—unless you are ready to shoot.

**NOTE:** During normal shooting with a loaded magazine, only the first shot requires Double Action trigger pull. The remaining rounds will be discharged by Single Action trigger pull. The Double Action pull is longer and slightly harder than the Single Action pull.



## **SINGLE ACTION TRIGGER PULL:**

The Single Action trigger pull is light, short and crisp. It is ideal for improved accuracy.

When the pistol is chamber loaded by slide manipulation or from firing, the reciprocating slide will full-cock the hammer and ready the pistol for Single Action trigger pull discharge.

**CAUTION!!** Always ENGAGE SAFETY when the hammer is fully-cocked—unless you are ready to shoot.

## **FIRING:**

Check that your target and backstop are safe.

Point the muzzle in a safe direction (toward backstop) and disengage the Safety if engaged. Grasp the pistol firmly with your shooting hand—if you prefer, use two hands support. Be sure to avoid finger rest against the Barrel Lever (inadvertent release), or safety (inadvertent engagement). Also, be sure to keep hand(s) below the frame's web guard tang to permit free slide recoil. Aim the pistol and align front and rear sight on target, fire by squeezing the trigger. Be sure to point the muzzle in a safe direction after discharge—and keep finger off trigger. The discharge will recoil the slide, eject the fired (spent) cartridge case, fully-cock the hammer and activate the recoil springs. The compressed recoil springs will automatically close the slide, feeding the next cartridge from the magazine into the chamber, and the pistol is ready to fire until empty.

**NOTE:** The slide will close after the last round has been fired, with the chamber empty and the hammer cocked. As a precaution, release the barrel, check the chamber and lower the hammer.

## **MISFIRE AND/OR HANG-FIRE:**

The Model 3032 has an exposed hammer for added safety. A shooter can see and feel the exposed hammer in three positions: Fully-Lowered (fired), Half-Cocked (hammer drop catch) or Fully-Cocked (ready to fire).

Remember—discharge of a chambered cartridge occurs when the hammer drives the firing pin into the primer.

Should you experience a misfire (no discharge) wait at least 15 seconds as a precaution against hang-fire (delayed discharge due to faulty ammo). If no discharge occurs, pull the trigger again in the double action mode (as a safety precaution, DO NOT thumb cock the hammer). On the second attempt, if no discharge occurs, wait 15 seconds and then release the barrel, remove cartridge from chamber and check firing pin indentation in primer. If normal, reload and continue shooting, but if minor or absent, leave gun unloaded and remove the magazine. Cock hammer and with a small instrument (pencil), push firing pin forward, check for damage and free movement and for hammer's free movement (hold thumb on spur, pull trigger and swing hammer back and forth).

### **JAMMING/MALFUNCTIONING:**

All Beretta firearms have been designed, manufactured and thoroughly tested to insure durability and trouble-free function. If properly maintained, operated, and loaded with good quality ammunition, malfunction is practically nonexistent.

**NOTE:** Should malfunction (jamming) occur while loading, unloading or shooting, DO NOT PANIC—simply keep finger away from the trigger, be sure to point the muzzle in a safe direction; and if possible

1. Remove the Magazine
2. Fully-cock the hammer and engage the Safety. Release barrel and remove the chambered cartridge.
3. Check pistol for damage and mechanical function.
4. Check ejected cartridge. Do not load with damaged (dented or deformed) ammunition.

### **DISASSEMBLY: (Field Stripping of Unloaded Pistol)**

1. Remove Magazine by depressing the magazine release button.
2. Release Barrel by pushing the barrel lever forward.
3. Swing the Barrel forward over its hinge to solid stop.
4. Fully-Cock the Hammer (Safety Off).
5. Grasp firmly around the front section of the slide with thumb and index finger. Retract the slide about one

eighth of an inch—lift the front end of the slide above the frame's barrel hinge (a click indicates recoil spring lever's disengagement from the slide), and pull the slide forward until it clears the frame's guide lugs.

6. Only if exceptionally dirty will it be necessary to remove the grips.

## FIELD STRIPPING

It is not necessary to remove grips for normal cleaning.

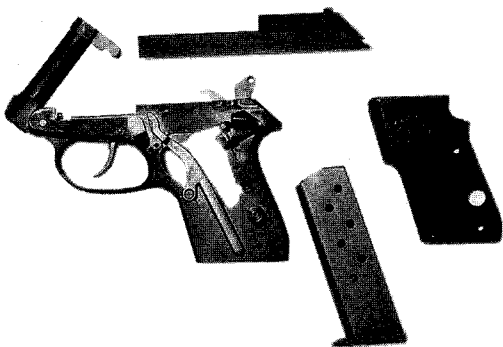

**CAUTION!!** Further Disassembly not recommended for cleaning.

**DO NOT** release the hammer to fall by activating the trigger when the slide and/or grips are removed.

## **REASSEMBLY: (From Field Stripping)**

Reverse of Disassembly.

1. If removed for extensive cleaning, carefully mount the right and left grip, tighten the grip screws snugly—DO NOT use excessive force.
2. Elevate the front end of the slide and place the rear end of the slide over the frame just in front of the frame's guide lugs. Carefully pull the slide rails back over the frame's guide lugs; simultaneously, lower the front end of the slide down to gently rest on the frame (top of the recoil spring levers), move the slide forward to stop against the frame's barrel hinge ears.
3. Place your thumb across the front section of the slide's sidewalls—PRESS DOWN—clicks indicates engagement between the recoil spring levers and slide cutouts. Visually check that the underside of the slide is resting flat against the frame's sliding surface (slide and frame parallel).
4. Swing the barrel back to closed position (check Barrel Lever closing).
5. Pull the slide and release to check for correct function.
6. Manually Lower the Hammer.
7. ENGAGE SAFETY.
8. Insert Magazine.

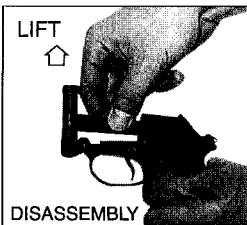
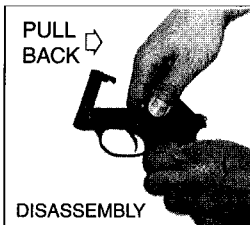

**DISASSEMBLY AND  
REASSEMBLY OF  
THE BERETTA  
MODEL 3032  
Double Action  
Semiautomatic Pistol**

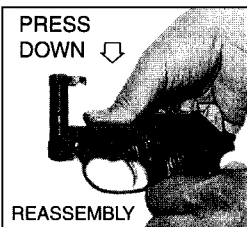

**NOTE:** It is important that a weapon be kept clean and properly oiled to insure perfect functioning, but weapons are often "worn out" or damaged more by unnecessary and excessive disassembly and assembly than by shooting.

**CLEANING:**

Clean pistol whenever a notable amount of gun powder residue, grease, cartridge metal particles, field dirt, etc. have accumulated in the action.

Use a good grade of CLP (Cleaner-Lubricant-Preservative) gun oil.

Use a lintfree cloth; a small brush, pipe cleaners, cotton swabs, toothpicks and a small wood applicator to remove dirt, etc.—DO NOT use a sharp instrument.

Always clean the barrel bore and chamber thoroughly after shooting using a cleaning rod with a patch, or brush fitting

tightly into the chamber and bore—clean the barrel from the chamber. If a bore cleaner is used, do not allow it to come in contact with external finishes or internal moving parts.

Always clean the breech/or bolt face of the slide. Be sure to check for free movement of the firing pin.

Oil moving parts, especially the frame rails, lightly.

For most effective exterior rust protection, rub a thin film of oil onto the surface with a cloth.

Your dealer can provide a small cleaning kit at little cost.

### Model 3032 Parts List

No.	Qty.	Component	Notes
1	1	Magazine Assembly .....	3
2	1	Frame .....	2
3	1	Barrel .....	1
4	1	Barrel Spring	
5	1	Barrel Pin	
6	1	Feed Ramp	
7	4	Feed Ramp & Ejector Spring Pin	
8	1	Hammer Spring Guide Assembly .....	3
9	1	Hammer	
10	1	Hammer Pin	
11	1	Plastic Grip-Set (not shown)	
12	4	Grip Screw	
13	1	Ejector	
14	1	Trigger	
15	2	Trigger & Barrel Release Spring Pin	
16	1	Trigger Spring	
17	1	Barrel Release	
18	1	Barrel Release Spring	
19	1	Magazine Release Button	
20	1	Magazine Release Catch	
21	1	Magazine Release Spring	
22	1	Sear	
23	1	Sear Spring	
24	1	Sear Pin	
25	1	Safety .....	4
26	1	Safety Plunger	
27	1	Safety Plunger Spring	
28	2	Recoil Spring	
29	2	Recoil Spring Cover	
30	2	Recoil Spring Plunger	
31	1	Recoil Bar-Right	
32	1	Recoil Bar-Left	
33	1	Trigger Bar	
34	1	Trigger Bar Spring	
35	1	Slide with Rear Sight Assembly .....	1
36	1	Rear Sight	
37	1	Firing Pin	
38	1	Firing Pin Retention Pin	
39	1	Firing Pin Spring	
40	1	Pistol Box (not shown)	

**Notes:**

- 1—Factory installation only.    3—Sold only as assembly.  
 2—Not for sale.                    4—Fitting required.

## MODEL 3032 PARTS ILLUSTRATION

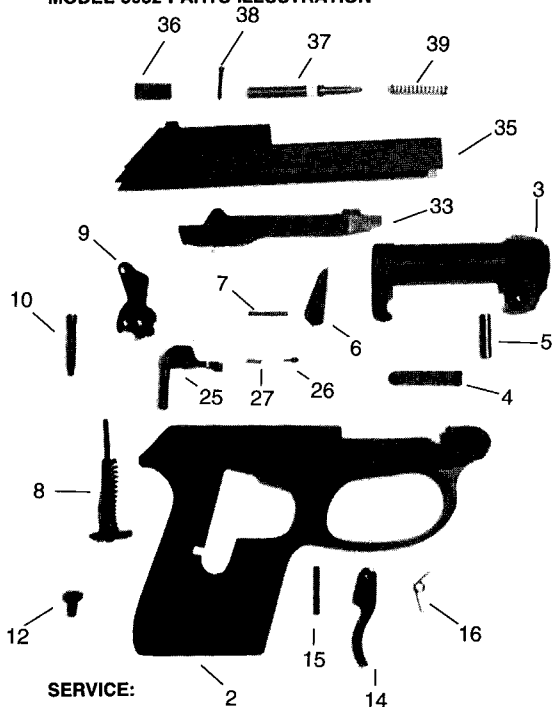

### SERVICE:

In most cases your local dealer can answer questions relating to maintenance and parts.

Parts price list and parts can be ordered from Beretta. Please read the Warranty—it gives valuable information concerning in-Warranty service, or contact:



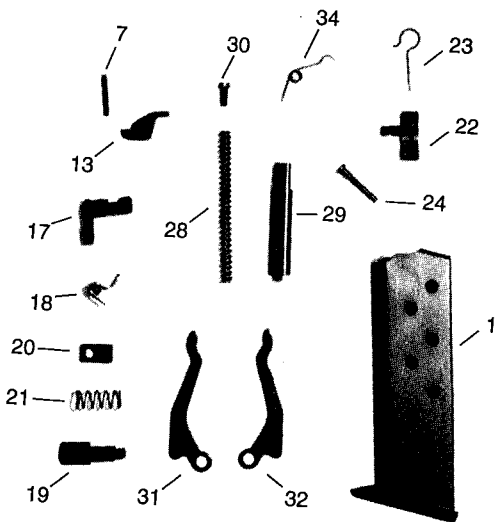

**BERETTA U.S.A. CORP.**

Product Service Dept.  
17601 Beretta Drive  
Accokeek, Maryland 20607  
Phone: (301) 283-2191  
Telecopier: (301) 375-7677

## LIMITED WARRANTY

THIS "LIMITED WARRANTY" HAS BEEN DRAFTED TO COMPLY WITH THE MAGNUSON-MOSS WARRANTY FEDERAL TRADE COMMISSION IMPROVEMENT ACT WHICH IS EFFECTIVE FOR GOODS MANUFACTURED ON OR AFTER DECEMBER 31, 1976.

Beretta U.S.A. warrants that this firearm was manufactured free of defects in material or workmanship and, for a period of one (1) year from date of original purchase, the Manufacturer agrees to correct any such defects in this firearm by repair or replacement (at Beretta's discretion and, if replaced, with the same or comparable quality firearm). Beretta does not warrant the wood or metal with respect to finish, matching of pieces, dents, scratches, cuts, dings, etc. which are or should be apparent to the purchaser when the product is purchased.

It is the customer's responsibility to inspect their particular product prior to purchase to ensure that it is free from defects or damage. Replacement of wood due to defects which could not have been detected prior to purchase will only be made within the regular warranty period.

A service and/or handling charge may be made for non-warranty repairs. Return product prepaid to Beretta U.S.A. Corp., Attn: Service Dept., 17601 Beretta Drive, Accokeek, Maryland 20607.

BERETTA ASSUMES NO RESPONSIBILITY FOR PRODUCT MALFUNCTION OR FOR PHYSICAL INJURY OR PROPERTY DAMAGE RESULTING IN WHOLE OR IN PART FROM CRIMINAL OR NEGLIGENT USE OF THE PRODUCT, IMPROPER OR CARELESS HANDLING, UNAUTHORIZED MODIFICATIONS, USE OF DEFECTIVE, IMPROPER, HAND-LOADED OR RELOADED AMMUNITION, CUSTOMER ABUSE OR NEGLIGENCE OF THE PRODUCT, OR OTHER INFLUENCES BEYOND BERETTA'S DIRECT AND IMMEDIATE CONTROL. THIS WARRANTY DOES NOT APPLY TO NORMAL WEAR OF ANY PARTS, INCLUDING METAL, WOOD, PLASTIC, RUBBER AND OTHER MATERIAL'S SURFACE FINISH OR IF UNAUTHORIZED REPAIR AND/OR ALTERATION HAS BEEN PERFORMED.

The terms of the Warranty cannot be changed except in writing by an officer of Beretta U.S.A. Corp.

Wholesalers and Dealers (unless a Beretta U.S.A. Corp. authorized warranty repair station) are not authorized to make any warranty repair or adjustment on behalf of Beretta U.S.A. Corp.

This Warranty gives only the original retail purchaser specific legal rights. Other rights may also be available which may vary from state to state.

Should service be required for this firearm, please return, giving full details of the defect or malfunction, stating date of purchase and dealer from whom the firearm was purchased, along with a copy of your sales receipt.

**BERETTA U.S.A. CORP.**

**Customer Service Dept.**

**17601 Beretta Drive**

**Accokeek, MD 20607**

**Phone: (800) 636-3420 Fax: (301) 283-0308**



**BERETTA USA CORP.**

**17601 BERETTA DRIVE • ACCOKEEK, MARYLAND 20607**

**Phone: (301) 283-2191    FAX (301) 283-0435**