

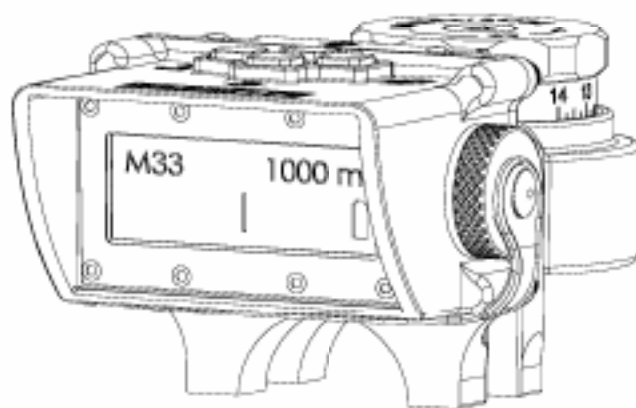

# Optical Ranging System (BORS)



**Operator's Manual**

**February 1, 2007**



## USE OF THIS MANUAL

Before you handle the Barrett Optical Ranging System (BORS), read this manual in its entirety. It is important that you understand the principles of its operation and installation procedures. Important safety topics and equipment care are also addressed. This manual should remain with the BORS and it should be transferred to subsequent owners. Additional manuals can be ordered from Barrett Firearms Manufacturing or can be downloaded from the company web site.

## SAFETY GUIDELINES

<p style="text-align: center;"><b>WARNING</b> <b>FAILURE TO FOLLOW SAFETY GUIDELINES MAY CAUSE INJURY OR DEATH.</b></p>
---

## WARRANTY AND SERVICE

Barrett Firearms Manufacturing Inc. (BFMI), warrants that this product was manufactured free of defects in materials and workmanship. For one year from the date of purchase by the original owner, BFMI agrees to correct any defect for the original purchaser by repair or replacement with the same or comparable model.

Technical specifications are subject to change without notice.

If you need factory service, whether made under warranty or not, please contact BFMI for instructions on how to have your BORS repaired.

Barrett Firearms Manufacturing Inc.  
P.O. Box 1077  
Murfreesboro, TN 37133-1077  
615-896-2938

[www.barrettrifles.com](http://www.barrettrifles.com)

## **TABLE OF CONTENTS**

Use of this manual/warranty	3
Table of contents	4
About the operator's manual	5
BORS description	6
Kit contents	6 - 7
Technical specifications	7
Installing the battery	8
Installing on a rifle telescope	9 - 13
Power the BORS on or off	14
Operator's screen	15 - 16
Keypad button functions	18-19
Selecting cartridge	20
Changing measurement basis	21
Calibrating the BORS	22
Changing settings	22-23
Cartridge information	24
Point of Impact Zeroing Procedure	26-27
Ranging with the BORS	28-29
Frequently asked questions	30

## About the Operator's Manual

The BORS manual is organized into 4 main sections:

**1. Description of the BORS and battery installation.**

This section explains the functions of the BORS. Battery installation is also explained. The section outlines operating specifications and storage capacity.

**2. Installation and mounting.**

This section describes how to install the BORS unit on Mil-Std 1913 rail and its host rifle telescope.

**3. Keypad usage and screen displays.**

This section describes each button on the keypad does and how to use the information on the display screens. This section also explains how to calibrate the unit, "zero" the BORS and scope with live fire, and use the BORS to determine range.

**4. Frequently Asked Questions.**

This section addresses common issues encountered by first-time users.

Explanation of format and terms used in this manual:

<p style="text-align: center;"><b>WARNING</b> A WARNING DESCRIBES AN ACTION THAT MAY RESULT IN SERIOUS INJURY OR DEATH.</p>
---

<p style="text-align: center;"><b>Caution</b> A caution describes an action that may result in damage to equipment.</p>
---

<p style="text-align: center;"><b>Note</b> A note is a recommended operating technique.</p>
---

Text describing a BORS screen display is "CAPITALIZED AND IN QUOTATIONS".

## **Barrett Optical Ranging System (BORS) Description**

BORS is a ballistic computer that mounts directly to the rifle telescope. The BORS is coupled to the telescope's elevation post. Its body serves as the rear upper scope ring cap.

The BORS continuously measures air temperature, barometric pressure, and bore line angle. Given these inputs, it automatically calculates a ballistic solution for a specific user selected cartridge. The user simply adjusts the BORS elevation knob to match the target's known range with the range displayed on the BORS display. This eliminates the need for "counting clicks" as target ranges change, allowing the shooter to focus on other environmental conditions, and quickly engage multiple targets at varying ranges.

The BORS memory is sufficient to hold 100 cartridge tables. Installation can be completed in about the same time as it takes to mount a rifle telescope.

### **Kit Contents**

The BORS kit, figure 2-1, includes the following:

- One Barrett Optical Ranging System Computer with factory installed cartridge tables.

- One set of Barrett black anodized aluminum telescope rings

- One lithium ion CR-123 battery

- One BORS operator's manual

- One BORS knob adapter with 3 set screws

- One BORS elevation knob with set screw

- One Tool Kit containing the following:

  - Four 8-32 x 1 1/2" T-25 Torx® socket head cap screws

  - One 10-24 x 1/2" flat head cap screw

  - One 3/32 L-shaped Allen Wrench

  - One T-25 L-shaped Torx® Wrench

  - One tube Loctite® 222 low strength adhesive

  - Four extra 10-24 x 1/4" set screws

(Some kits are delivered in a water and air tight case)

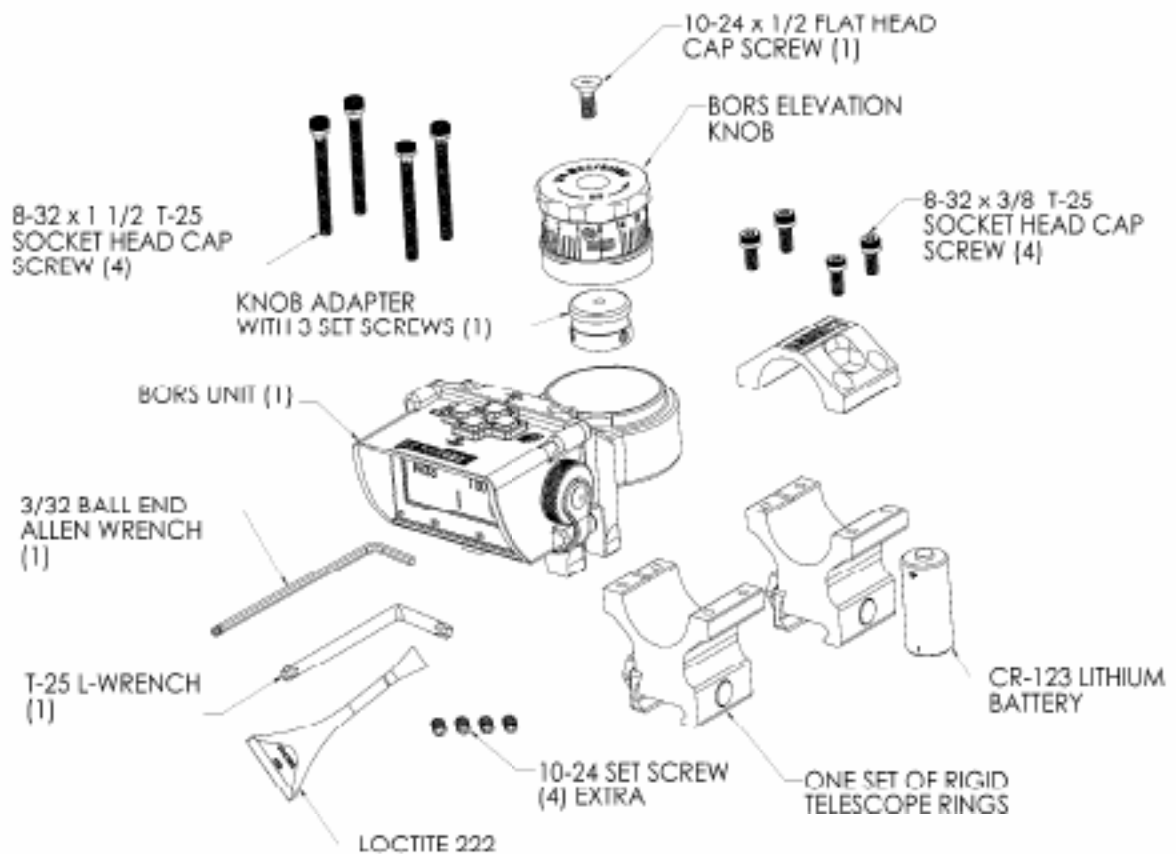

Figure 1-1

### BORS Technical Specifications

<b>Operating Temperature Range:</b>	-4° F thru 158° F (-20°C thru 70 °C)
<b>Weight:</b>	13 oz. (370 grams)
<b>Display:</b>	12 x 2 character liquid crystal
<b>Buttons:</b>	4 Button Keypad
<b>Operating Altitude Range:</b>	-1,000' thru 20,000' (-300 thru 6,100 meters)
<b>Tilt Range:</b>	-90° thru 90° (2° Tilt Resolution)
<b>Battery:</b>	CR-123 Lithium Ion Battery
<b>Battery Life:</b>	30 hours minimum

**WARNING**  
**MAKE CERTAIN THE FIREARM IS UNLOADED. REFER TO YOUR FIREARM'S OWNER'S MANUAL TO ENSURE THE FIREARM IS SAFE.**

### Installing the battery

One CR-123 lithium cell (3.2 Volts) battery is included with the BORS kit. This battery is commonly used for cameras and high-intensity flashlights.

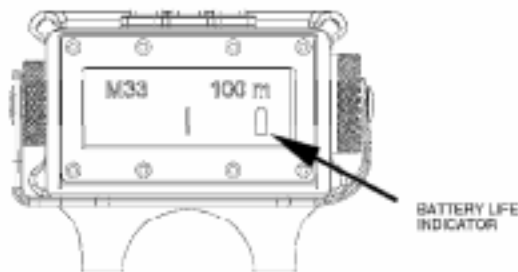

Figure 1-2

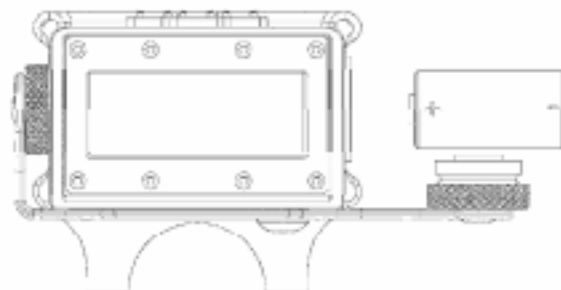

Figure 1-3

**Note**  
CR-123 Lithium batteries are recommended for maximum battery life.

**Note**  
Turn the BORS power off before removing the battery. This prevents the loss of previous user selected settings.

1. Rotate the battery cap counter-clockwise to remove the cap from the BORS.
2. Tilt the BORS to the right side to remove any battery in the case.
3. Insert the battery into the case, positive end first.

**Caution**  
Ensure battery cap threads are seated properly to avoid "crossthreading" the aluminum housing.

4. Reattach the battery cap by rotating the cap clockwise into case threads.

**Note**  
The BORS Battery Life Indicator displays a full battery icon when fully charged, a half-full icon when battery life drops below half, and an empty battery icon flashes when it is time to replace the battery.



## Installing the BORS on a typical rifle telescope

**WARNING**  
**MAKE CERTAIN THE FIREARM IS UNLOADED. REFER TO YOUR FIREARM'S OWNER'S MANUAL TO ENSURE THE FIREARM IS SAFE.**

### Note

Ensure that the ring clamp tightening nuts are on the left side. Orient the ring clamp so that the "step cut" side of the clamp bears on the ring and the "angle cut" of the clamp bears on the mounting rail. Do not attempt to remove the nut from the bolt. Figure 2-1.

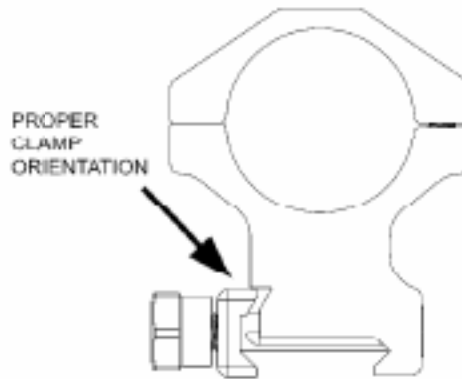

Figure 2-1

1. Place the rear ring (shipped only as a bottom half) on the M1913 optics mounting rail. Attach this ring on the mounting rail in a slot near the rear of the rail. Figure 2-2. (Proper eye relief may be achieved later by moving the entire assembly.)

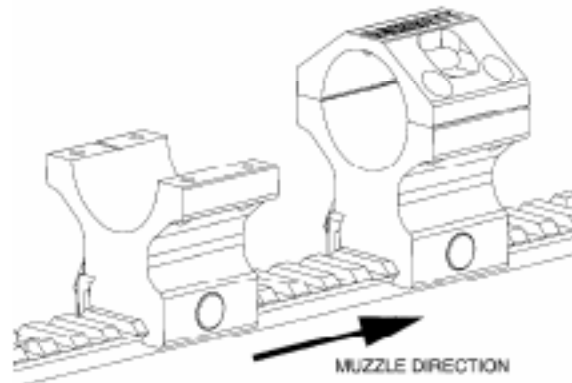

Figure 2-2

2. Place the front ring (shipped as an assembled top and bottom) on the M1913 optics mounting rail approximately eight slots forward of the rear ring. From the side view, approximately four complete mounting ridges are visible. Figures 2-2 and 2-3. (Some scope models may require different spacing between rings.)

3. Hand-tighten the cross bolt nuts on both rings to ensure a stable work platform.

4. Using the #25 Torx wrench, remove the top cap on the forward ring.



Figure 2-3

5. Place the scope in the bottom half of the rings. Remove the scope's elevation turret cover if the scope is so equipped. Lightly grasp the scope's elevation knob and rotate it until the knob itself is at the highest point in its adjustment travel. Figure 2-4.

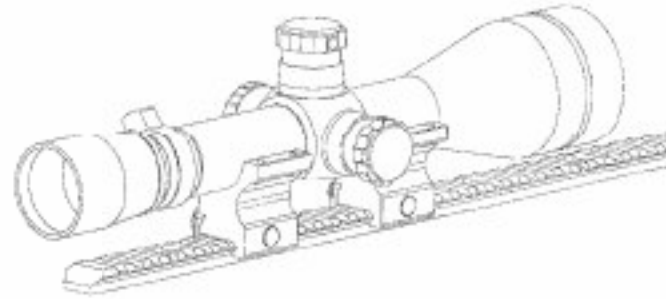

Figure 2-4

**Caution**  
**Do not attempt to rotate the rifle scope's elevation knob past its designed mechanical limit.**

6. Using the tool provided by the scope manufacturer, remove the screw(s) attaching the scope's elevation knob to its elevation post. Lift and remove the rifle telescope's elevation knob to expose the elevation post. Figure 2-5.

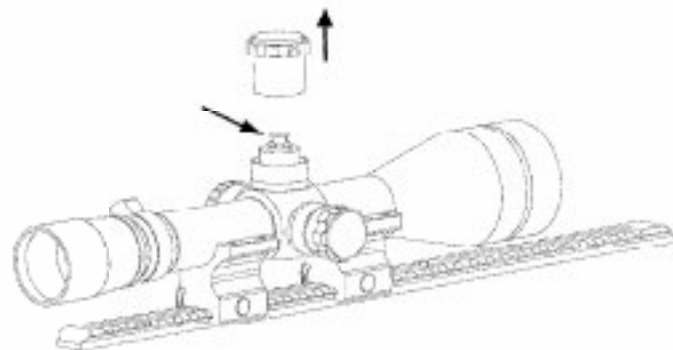

Figure 2-5

7. Place the BORS knob adapter over the elevation post. Apply a slight downward pressure and tighten the three equally spaced set screws located on the outside of the adapter. Ensure that all set screws are seated below the outside diameter of the knob adapter and are tightened evenly. Use Loctite® if desired. Figure 2-6.

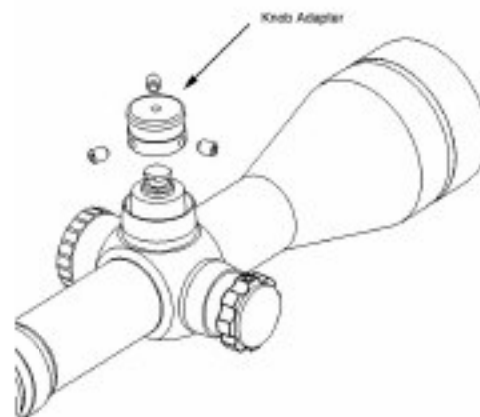

Figure 2-6

8. Place the BORS unit on top of the rear scope ring. Start, but do not tighten, the four socket head cap screws using the T-25 Torx® wrench. Use Loctite® if desired. Figure 2-7.

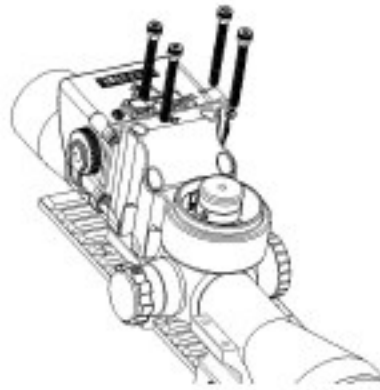

Figure 2-7

**Note**  
Do not attach the front ring cap until step 13.

9. Place the BORS elevation knob over the knob adapter. Push the BORS elevation knob down, seating the knob on the adapter. Ensure the knob rotates without binding. The elevation knob's o-ring serves to align the scope's reticle and align the BORS housing on the scope.

10. Install the flat head cap screw through the top of the BORS elevation knob engaging the threads in the knob adapter. Because this screw will be removed in a later procedure, only "snug" tighten the flat head cap screw with the T-25 L-shaped Torx® wrench. Figure 2-8. After tightening, rotate the BORS elevation knob to ensure there is no binding during rotation. "Snug" tighten the BORS knob set screw using the 3/32 L-shaped Allen wrench. Ensure that this set screw is seated below the outside diameter of the elevation knob.

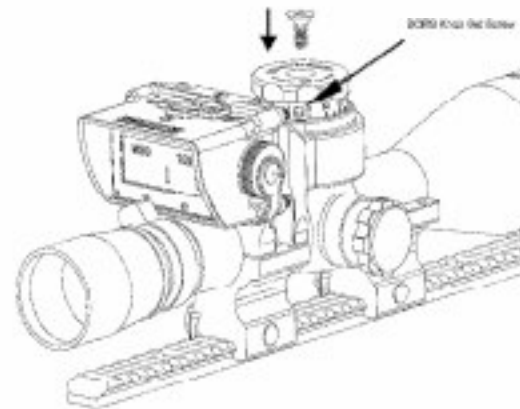
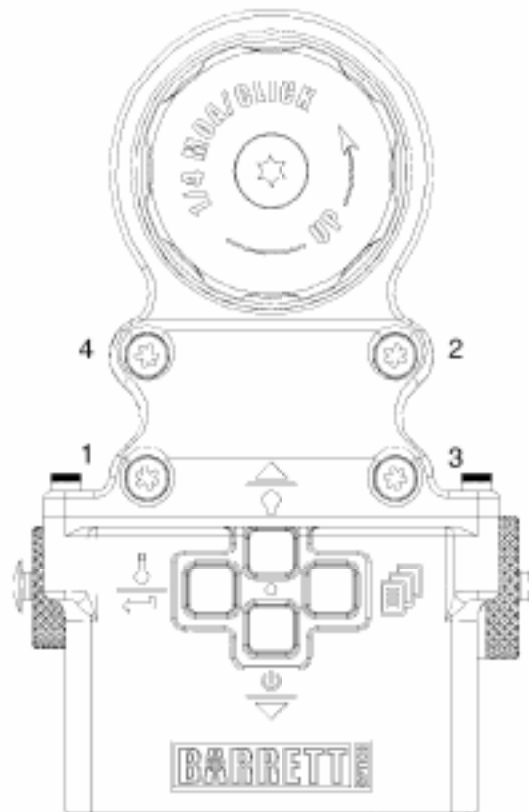

Figure 2-8

**Caution**  
Do not over-tighten the set screw.

11. After having ensured that the elevation knob rotates freely, evenly tighten all four Torx® socket head cap screws in the BORS unit. You must follow the illustrated tightening sequence for a successful installation. The goal is to bring the BORS housing straight down onto the rear ring base so that the BORS elevation knob does not bind. Use the tightening sequence as illustrated in Figure 2-9. Tighten to 35 in/lbs or 3.95 Nm.



**"Tightening Sequence"**

Figure 2-9

12. Ensure the BORS elevation knob rotates freely by turning it until the knob reaches its lowest point. If the elevation knob is binding, loosen the four socket head Torx® screws and repeat step 11.

**Caution**

**Do not attempt to turn the rifle scope's elevation knob past its designed mechanical limit.**

13. Fully tighten two socket head cap screws on the indexed side of the front scope ring. Use Loctite® if desired. Tighten to approximately 35in/lbs. The rings are designed to be fully tightened on the indexed side before tightening the opposite side screws. The "Barrett" logo on the top ring can be oriented in either direction. Next, tighten the remaining two socket head Torx® screws on the opposite or "gap" side of the scope ring to 35 in/lbs or 3.95 Nm. Use Loctite® if desired. See figure 2-10.

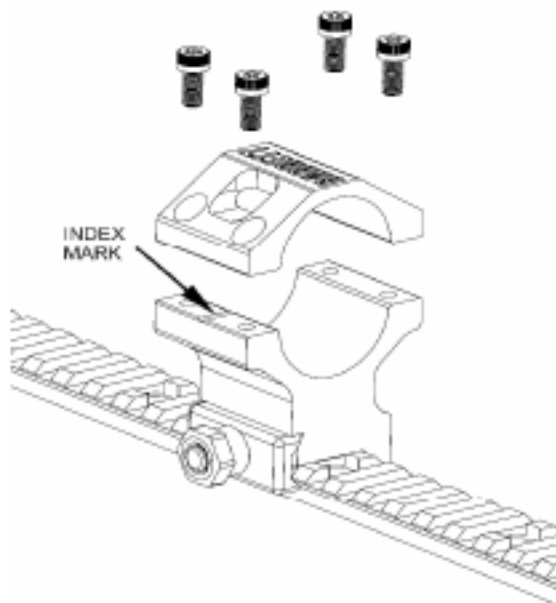

Figure 2-10

14. If eye relief needs to be adjusted, loosen the ring clamp nuts to allow the BORS and scope to be moved as a unit along the rail to the proper eye relief distance. Retighten the ring clamp nuts to 65 in/lbs or 7.34 Nm. Use Loctite® if desired.

## Powering the BORS on or off

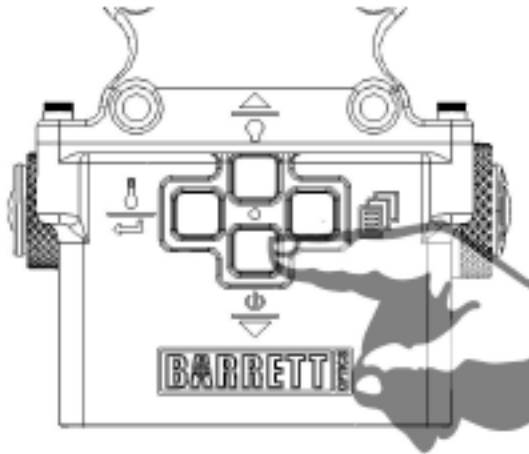



Figure 3-1

Press and hold the  button as illustrated in Figure 3-1. This will power the BORS on. Press and hold the button for 5 seconds to power off the BORS.

When the BORS powers up, it will display the rifle telescope and the version of BORS computer software. This is the "START-UP SCREEN". It reflects the ballistic tables programmed into the BORS memory chip and is unique to each rifle system type. This screen is displayed for approximately 5 seconds.

The "START-UP SCREEN" Figure 3-2 shows a BORS configured for a BARRETT M107 in .50 Caliber.



Figure 3-2

## Operator's Screen

The screen displayed immediately following the start-up screen is the "OPERATOR'S SCREEN". This screen displays the cartridge type that the BORS computer is using to calculate the bullet drop solution. The "OPERATOR'S SCREEN" is the BORS default screen.

Displayed in the upper left corner of the display is the selected cartridge type

Displayed in the upper right corner of the display is the numerical range at which the cartridge's bullet drop and the scope's horizontal reticle coincide. This range can be displayed in either yards, expressed as "y", or in meters, expressed as "m". The procedure used to change the measurement basis is described on page 21.

In the lower portion of the "OPERATOR'S SCREEN" is displayed either an "I", if the rifle is level, or a "■" if the shooter needs to pivot the rifle to achieve level. The "roll sensor" is calibrated at the factory.

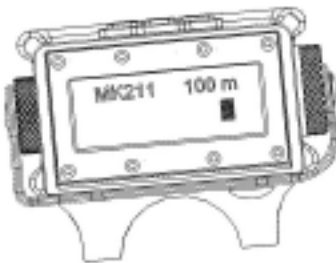

Figure 3-4

Figure 3-4 illustrates the BORS when the firearm is rolled to the left.

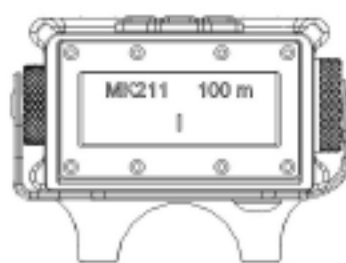

Figure 3-5

Figure 3-5 illustrates the BORS when the firearm is level.

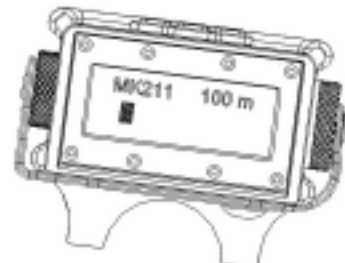

Figure 3-6

Figure 3-6 illustrates the BORS when the firearm is rolled to the right.

The BORS pitch sensor, which has no user display, senses the angle of inclination or declination of the rifle's bore line. The BORS automatically adjusts the ballistic solution to compensate for changes in this angle. The pitch sensor is calibrated at the factory.

**Note**

If the digital level is not working properly, contact Barrett for assistance.

**NOTE**

The displayed range on the operator's screen is only valid if the cartridge that is fired is the same as is selected in the BORS.

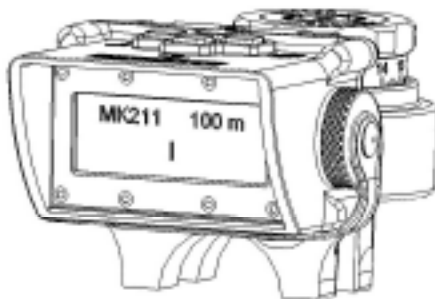

Figure 3-7

Figure 3-7 shows a BORS using a MK211 cartridge ballistic table that has calculated a bullet drop solution that provides bullet impact at 100 meters coincident with the horizontal reticle. The rifle is level.

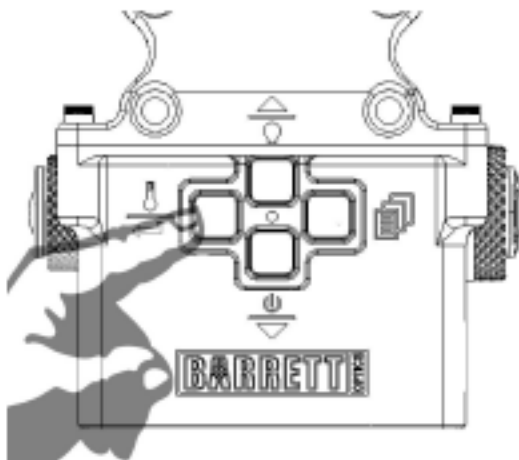



Figure 3-8

From the "OPERATOR'S SCREEN", press the  button illustrated in Figure 3-8. This will display the current temperature and barometric pressure.







**Intentionally Blank**





## BORS Button Functions





The four button keypad is used to access BORS information and displays. Their function depends on whether the cartridge identification screen is displayed when the button is depressed or another screen is displayed when the button is depressed.





The following commands are active if the "OPERATOR'S SCREEN" is displayed when a keypad button is depressed:

1.  Power On/Off.
2.  Display temperature and barometric pressure.
3.  Power on the LCD back light.
4.  Select display screen menus.

The following commands are active if any screen other than the "OPERATOR'S SCREEN" is displayed when the keypad button is depressed:

1.  Scroll menu down.
2.  Select menu item.
3.  Scroll menu UP.
4.  Select display screen menus.

Title	Icon	Function
<u>Menu</u>		Used to access BORS display menus.
<u>Temperature/Select</u>		Displays temperature, barometric pressure, and select menu item.
<u>Light/Scroll Up</u>		Illuminates the display and scrolls the menu up.
<u>Power/Scroll Down</u>		Powers the BORS on, off, and scrolls the menu down.

Press the  button as illustrated in Figure 3-9. This will allow access to one of six display screens. The screens are accessed by either scrolling up , or scrolling down . The screens are arranged in the following order: "ZERO CARTRIDGE", "DETERMINE RANGE", "SELECT CARTRIDGE", "CARTRIDGE INFORMATION", "CHANGE UNITS", and "CHANGE SETTINGS". If  is pressed again, the BORS computer will exit the current selection and return to its previous display.

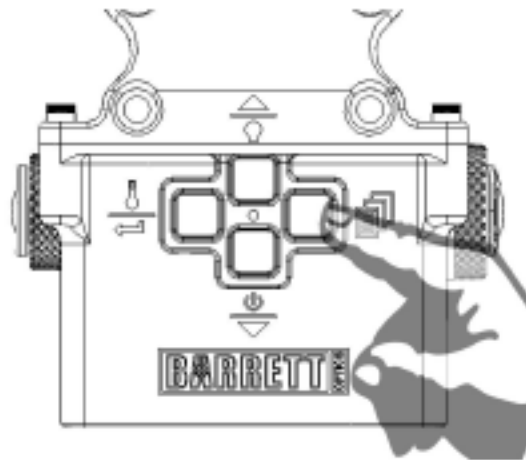

Figure 3-9

## SELECT CARTRIDGE









1. Press and release the  button.
2. Press and release the  button until the display reads "SELECT CARTRIDGE".
3. Press and release the  button to select the menu item. The currently selected cartridge will be displayed as illustrated in Figure 3-10. The cartridge description is displayed under the cartridge name. Depending on the length of the description, the words may scroll across the screen.
4. Using the scroll buttons ( or ) , scroll to the desired cartridge. Press and release the  button when the desired cartridge is displayed.



Figure 3-10





The screen will display "<-CONFIRM  
CANCEL->" as previously illustrated.

Press and release the  button to confirm or the  button to cancel. The selected cartridge will be displayed on the "OPERATOR'S SCREEN" after confirmation.

## CHANGE UNITS

### Changing Units of Measurement Basis

BORS displays units of measurement on all screens based on either Metric or U.S. equivalents. To change from the currently displayed basis to the other basis:

1. Press the  button.
2. Press the  or  button until the display reads "CHANGE UNITS".
3. Press the  button to change the basis from the current to the other basis.

#### Note

The user can confirm changing measurement basis by viewing the range units displayed on the "OPERATOR'S SCREEN" as either "y" or "m".

### Displayed Metric and U.S. Equivalents

Units	Range	Temperature	Barometric Pressure	Muzzle Velocity	Bullet Caliber	Bullet Mass	Target Size
US	Yards	Fahrenheit	Inches of Mercury	Feet per second	Inches	Grains	Feet
Metric	Meters	Celsius	Kilopascals	Meters per second	Millimeters	Grams	Meters

Figure 3-11

## CHANGE SETTINGS







### Note

Calibrating the BORS to your rifle telescope is necessary any time power is lost to the BORS unit.







### Caution

**Do not attempt to turn the rifle scope's elevation knob past its designed mechanical limit.**





### Calibrating the BORS to your rifle telescope

1. Rotate the BORS elevation knob clockwise until it reaches its lowest point.
2. Press the  button to enter the menu screen.
3. Press the  button until the screen displays "CHANGE SETTINGS".
4. Press the  button. The screen will display "ADJUST BACKLIGHT".
5. Press the  button once. The screen will display "DEVICE SETUP". Press the  button to select this screen.
6. Press the  button to display "ZERO ELEVATION".
7. Press the  button to confirm the selection. The BORS is now calibrated to your rifle telescope.

### Adjusting the Backlight

1. Press the  button to enter the menu screen.
2. Press the  button until the screen displays "CHANGE SETTINGS". Press the  button to select this screen.
3. The screen displays "ADJUST BACKLIGHT". Press the  button to select this screen.
4. The screen displays "BACKLIGHT SCROLL UP/DN". See Figure 3-12.
5. Press the  or the  button to adjust the display brightness.

### Checking the version of BORS

1. Press the  button to enter the menu screen.
2. Press the  button until the screen displays "CHANGE SETTINGS".
3. Press the  button. The screen will display "ADJUST BACKLIGHT".
4. Press the  button twice to display "VERSION INFORMATION".
5. Press the  button to display currently loaded hardware and firmware versions.

### Adjusting the Contrast







1. Press the  button to enter the menu screen.
2. Press the  button until the screen displays "CHANGE SETTINGS". Press the  button.
3. The screen will display "ADJUST BACKLIGHT".
4. Press the  button. The screen will display "ADJUST CONTRAST". Press the  button to select this screen.
5. The screen displays "CONTRAST SCROLL UP/DN". See Figure 3-13.
6. Press the  or the  button to adjust the display contrast.











Figure 3-12









Figure 3-13

### Adjusting the backlight timer (The length of time the backlight will illuminate)

1. Press the  button to enter the menu screen.
2. Press the  button until the screen displays "CHANGE SETTINGS".
3. Press the  button. The screen will display "ADJUST BACKLIGHT".
4. Press the  button. This will display "DEVICE SETUP".
5. Select this display by pressing the  button. "ZERO ELEVATION" will be displayed.
6. Now press the  button to display "BACKLIGHT TIMER".
7. Press the  button to select this screen.
8. Use the  or the  button to adjust the time the backlight remains illuminated.

## CARTRIDGE INFORMATION

1. Press and release the  button to enter the menu screen.
2. Press the  or the  button until the screen displays "CARTRIDGE INFORMATION".
3. Press and release the  button. "DESCRIPTION:" is shown on the top line of the display. Below "DESCRIPTION:" will be displayed a user-defined summary of the cartridge. Depending on the length of the description, the words may scroll across the screen.
4. Pressing the  or the  button will display the "CALIBER", "BULLET MASS", "BULLET B.C.", or "MUZZLE VELOCITY" of the cartridge selected.



**Intentionally Blank**

## ZERO CARTRIDGE

### Point of impact zeroing procedure for the BORS at the live fire range

The zeroing procedure for the BORS is similar to zeroing any common rifle telescope. The default distance for zeroing the cartridge point of impact is 100 meters or 110 yards. The following steps zero the BORS with a specific cartridge, rifle, and rifle telescope.

#### Step 1

Select the desired cartridge on the BORS "SELECT CARTRIDGE" screen. Fire a series of shots to obtain a representative group of point of impact with that cartridge type.

#### Step 2

Adjust the BORS elevation knob until the projectile's point of impact coincides with the rifle telescope's horizontal reticle. If desired, adjust the rifle scope's left/right knob until the projectile's point of impact coincides with the rifle telescope's vertical reticle. The BORS has no influence on windage adjustments.



Figure 3-14

### Step 3

Loosen the set screw and the flat head screw on the BORS elevation knob. Figure 3-15. The elevation knob will now rotate freely on the BORS knob adapter but will not move the reticle. Rotate the BORS elevation knob until its "0" mark index line is coincident with either index mark located on the outside of the BORS housing. (It is user preference whether the left or right side housing index line is used.) Hold the BORS elevation knob in position and retighten the set screw first and then retighten the flat head screw second. You have now set the cartridge and rifle telescope's reference zero.

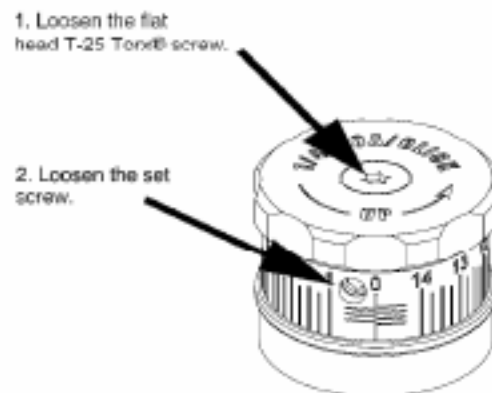





Figure 3-15

#### Note

Do not move the BORS knob when the BORS is powered off. If the BORS knob is moved while the unit is powered off, first return the BORS elevation knob to its reference zero position, then restore power to the BORS to accomplish "Calibrating the BORS to your rifle telescope" on page 21.

### Step 4

To initialize the BORS to a selected cartridge, press the  button. Press the  button until the screen displays "ZERO CARTRIDGE". Press the  button to select this screen.

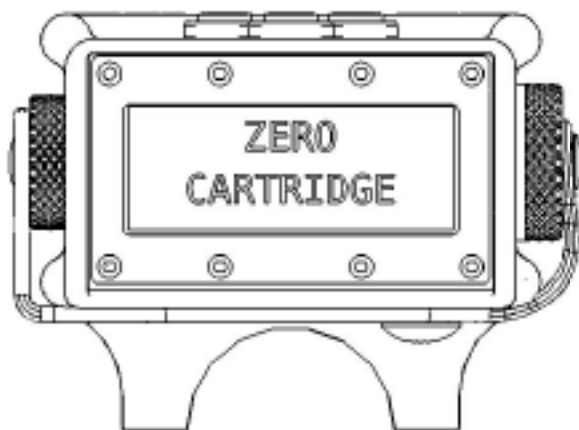



Figure 3-16

The screen will now display

"<-CONFIRM CANCEL->". Press the  button to confirm. Press the  button to return to the "OPERATOR'S SCREEN". After confirming, the displayed distance will indicate "100 m" or "110 y" depending on the measurement basis.

## DETERMINE RANGE

### Determining the Range to the Target with the BORS





BORS provides the user with the ability to measure and then display the range to a reference object or target. This distance can be expressed in either yards or meters. The known vertical dimension of the reference object is used to calculate the distance to that object.

#### Note

Range measurements will be most accurate when the rifle is held steady and a large reference object is selected.

Figure 3-17 shows the reference object as a vehicle known to be approximately 6 feet tall. The user selects "6 FEET" as the height of the reference object. Using the BORS elevation knob to scroll the elevation reticle along the height of the vehicle, the BORS is able to calculate the distance to the vehicle.

### Range Finding Procedure

1. Press the  button to enter the menu screen.
2. Press the  button until the screen displays "DETERMINE RANGE".
3. Press the  button to select this screen.
4. The screen will display "TARGET SIZE?" on the top line. The bottom line will display either "1 FOOT" or "1 METER" depending on selected measurement basis.
5. By pressing the  or the  button, the user can scroll to display the approximate vertical size of a reference object. If U.S. equivalents have been selected, "1 FOOT", "3 FEET", "6 FEET", "9 FEET", "12 FEET", "15 FEET", and "20 FEET" will be displayed. If metric units have been selected, ".5 meter", "1 METER", "2 METERS", "3 METERS", "4 METERS", "5 METERS", and "6 METERS" will be displayed.

1. From a steady rest, position the horizontal crosshairs at the top or bottom of the reference object. Press the  button to select the height of the reference object. "MEASURE TRGT USING ELEV" will be displayed.



Figure 3-17

2. Using the BORS elevation knob, move the horizontal crosshair either from the top of the reference object to its bottom, or from the bottom of the object to its top as illustrated in Figure 3-18.



Figure 3-18

#### NOTE

The measurement will be most accurate when the rifle is kept steady throughout the procedure.



3. Press the  button to display the range to the reference object. The distance to the reference object will be displayed as "TARGET RANGE 1012 YARDS" as illustrated in Figure 3-19.



Figure 3-19

4. Press the  button to return to the "OPERATOR'S SCREEN". Use the BORS elevation knob to dial the reference object's range. Your riflescope elevation crosshairs are now adjusted so that your point of aim is the point of impact at the reference object's calculated range.

## Frequently Asked Questions

### **Why are my bullets striking consistently higher or lower than my point of aim?**

Make sure the cartridge being used is the same one as displayed on the "OPERATOR'S SCREEN". If correct, reaccomplish the procedures on page 22, "calibrating the BORS". If the problem persists, reaccomplish the procedures on page 26, point of impact zeroing procedure for the BORS.

### **The BORS loses power, the battery fails, the display screen is unusable or the BORS unit fails. What should I do?**

The BORS is designed so that your rifle telescope is fully functional even in the event of battery or BORS unit failure. If time permits, remove and replace the battery, then follow the instructions on page 22, "calibrating the BORS". This will restore previous settings. If time does not permit, the user may visually reference an index mark and elevation graduations on the BORS knob to obtain the rifle telescope's internal elevation setting.

### **Why does the display range fluctuate?**

The BORS sensors are reacting to constantly changing environmental conditions. These changes are continuously updated and displayed as small changes in range.

### **Why does the display not change after an audible scope click?**

It is possible for the display to not change after a click. The BORS reacts for BORS elevation knob graduations, not internal scope clicks. The user can synchronize the clicks with the graduations by adjusting the index marks as illustrated Figure 3-15 on page 27.

### **What if the BORS knob is moved when the BORS is not powered?**

Moving the BORS elevation knob while the BORS is not powered requires the user to recalibrate the BORS. To recalibrate the BORS, first return the BORS elevation knob to reference zero, then restore power to the BORS. Now accomplish "calibrating the BORS" on page 22.

### **Can I set the BORS for multiple cartridges?**

Yes, the BORS can hold as many as 100 individual ballistic tables.



