

Nikon

No. 8888S

AF

INSTRUCTION MANUAL

CONTENTS

FOREWORD	3	SHUTTER-PRIORITY AUTO EXPOSURE MODE	36-38
NOMENCLATURE	4-7	APERTURE-PRIORITY AUTO EXPOSURE MODE	39-41
BASIC OPERATION	8	MANUAL EXPOSURE MODE	42-44
MOUNTING THE LENS	8	Bulb Setting	44
INSTALLING BATTERIES	9	PHOTOGRAPHIC TECHNIQUES	45-63
CHECKING BATTERY POWER	10-11	EXPOSURE METERING SYSTEMS	45-51
LOADING FILM	12-13	Matrix Metering	45
BASIC SHOOTING	14-18	Center-Weighted Metering	46
REWINDING FILM	19	Spot Metering	46
CONTROLS IN DETAIL	20-42	Metering System Setting	47
FILM SPEED SETTING	20-21	When to Use Matrix or Center-Weighted Metering ...	48-51
Using DX-Coded Film	20-21	EXPOSURE COMPENSATION	52-58
Manual Film Speed Setting	21	In Automatic Exposure Modes	52
FILM ADVANCE MODE	22	AE (Auto Exposure) Lock Lever	52-53
Mode Selection	22	Exposure Compensation Button	54-55
FOCUS	23-33	In Manual Exposure Mode	56-57
AUTOFOCUS	23-28	Auto Exposure Bracketing	58
Continuous Servo Autofocus Mode	24	DEPTH-OF-FIELD PREVIEW BUTTON	59
Focus Tracking	24-25	STOP-DOWN EXPOSURE METERING	59
Taking Pictures with an Off-Center Main Subject	26-27	SELF-TIMER	60-61
Autofocusing with Optional Autofocus Speedlights	28	Two-Shot Self-Timer	61
MANUAL FOCUS WITH		MULTIPLE EXPOSURE PHOTOGRAPHY	62-63
ELECTRONIC RANGE FINDER	29-30	FLASH PHOTOGRAPHY	64-72
Freeze Focus	31	Matrix Balanced Fill-Flash	66
MANUAL FOCUS USING CLEAR MATTE FIELD	32	Center-Weighted Fill-Flash	67
SPECIAL FOCUSING SITUATIONS	33	Spot Fill-Flash	67
EXPOSURE	34-44	Standard TTL Flash	67
Exposure Mode Setting	34	Shutter Speed/Aperture and Flash Mode	
PROGRAMMED AUTO EXPOSURE MODES	34	Combinations for Each Exposure Mode	68-69
Flexible Program	35	Matrix Balanced Fill-Flash Operation	70-71

Rear-Curtain Sync Flash Photography	72
Ready-Light Warnings	72
VIEWFINDER INFORMATION	73
LCD INFORMATION	74-75
LENSES	76-77
Lens Compatibility Chart	76-77
ACCESSORY COMPATIBILITY	77
INTERCHANGING FOCUSING SCREENS	78-79
CAMERA CARE TIPS	80-81
NOTES ON BATTERIES	82
SPECIFICATIONS	83-86

Warning: The voltage specification for AA-type Lithium batteries is different than the voltage specification for Manganese, Alkaline and NiCd AA-type batteries. As a result of the differences, and the lack of complete testing for reliability and performance, AA-type Lithium batteries should not be used in Nikon products. Use of AA-type Lithium batteries could damage the electrical components of the Nikon products. Nikon products which use Lithium batteries, other than the AA-type, are not affected by this warning.

Thank you for purchasing the Nikon N8008s. We're sure it will make photography a much more exciting part of your life.

With the N8008s, Nikon has taken the limits of SLR technology to new heights. Ultra-fast autofocus, focus tracking for moving subjects, versatile Matrix Metering with Center-Weighted and Spot Metering overrides, Matrix Balanced Fill-Flash and an unprecedented fast metal shutter with 1/8000 second top speed are just the beginning of what you'll discover in this sleek, ergonomically designed camera.

The other side of this success story is that while offering these breakthroughs, Nikon has maintained the integrity of its lens mount, giving long-time Nikon users an opportunity to upgrade to the most advanced photographic technology available, while providing new users with the largest selection of fine-quality lenses on the planet.

Get to know your N8008s, but before using it, be sure to read this manual thoroughly.

NOMENCLATURE

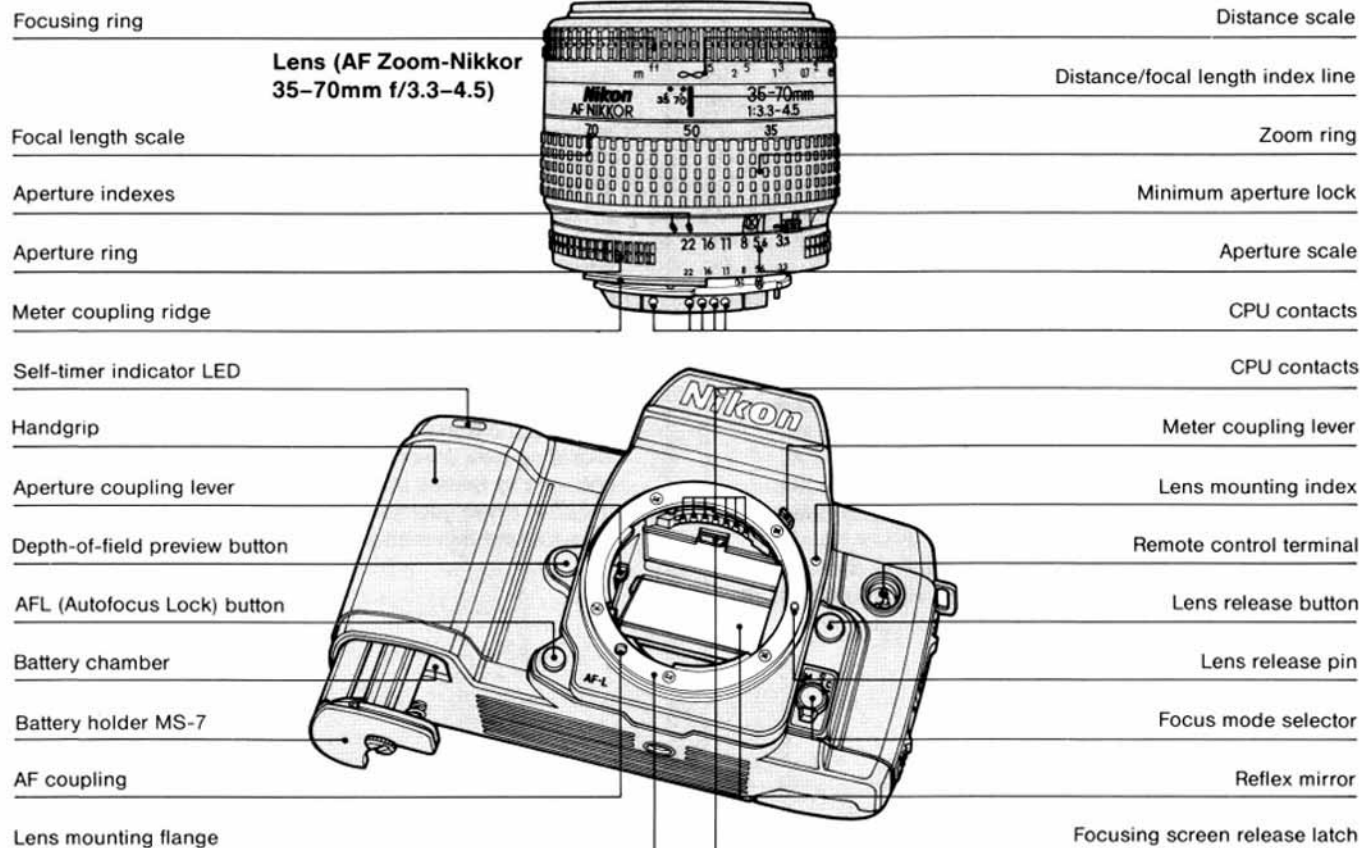

LCD illumination window

Accessory shoe

Metering system selection button

Exposure mode button

Film speed button

Camera strap eyelet

Film advance mode button

Multiple exposure/
film rewind button

Film cartridge confirmation window

Self-timer button

Film rewind button

Exposure compensation button

Shutter release button

Power switch

Camera strap eyelet

Command input control dial

LCD panel

AE (Auto Exposure) Lock lever

Viewfinder illumination button

Camera back

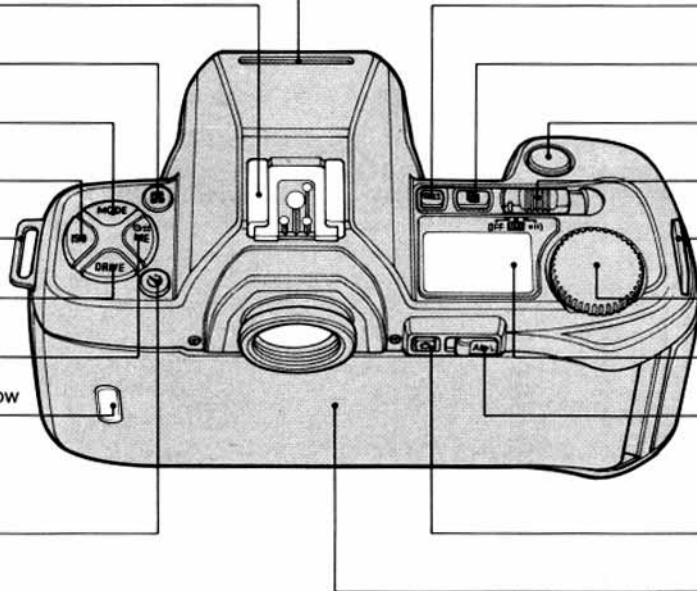

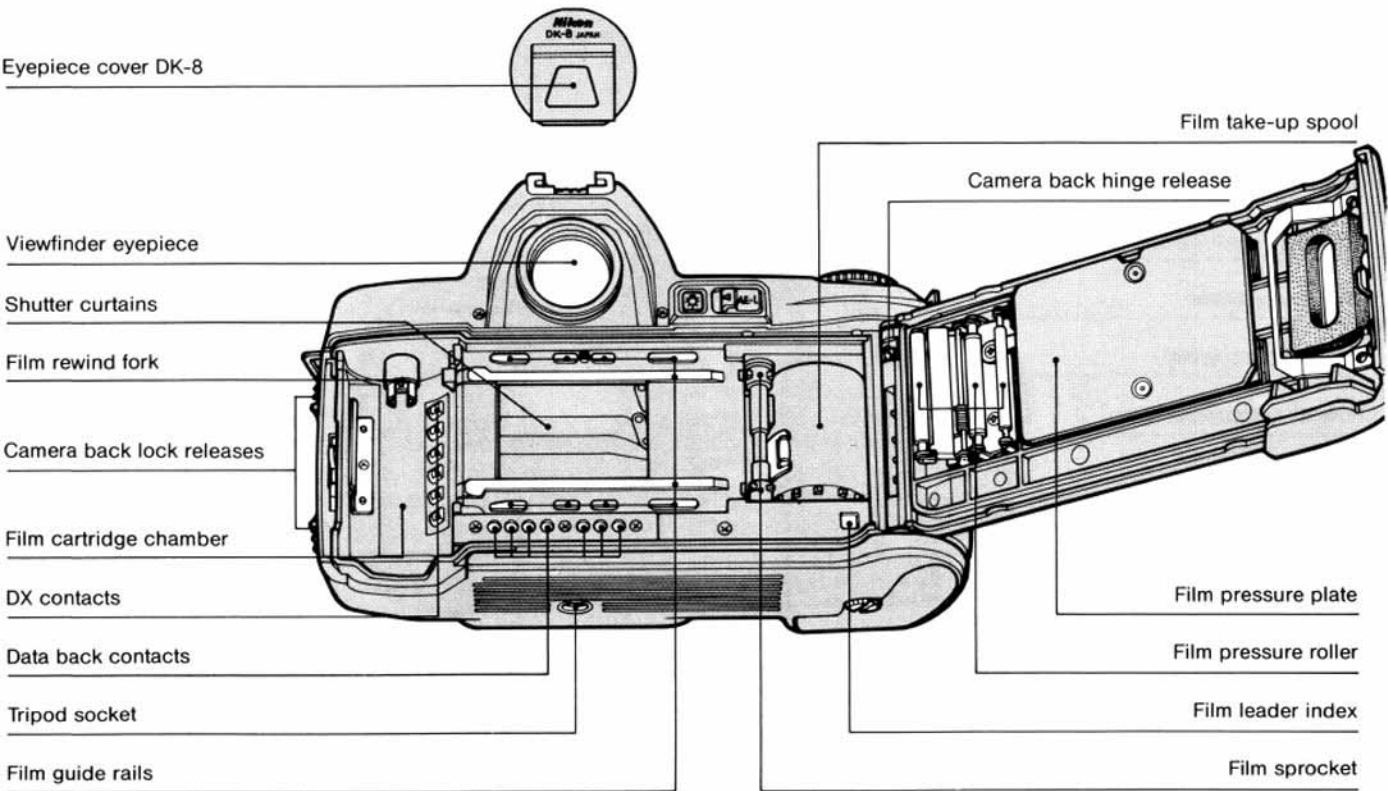

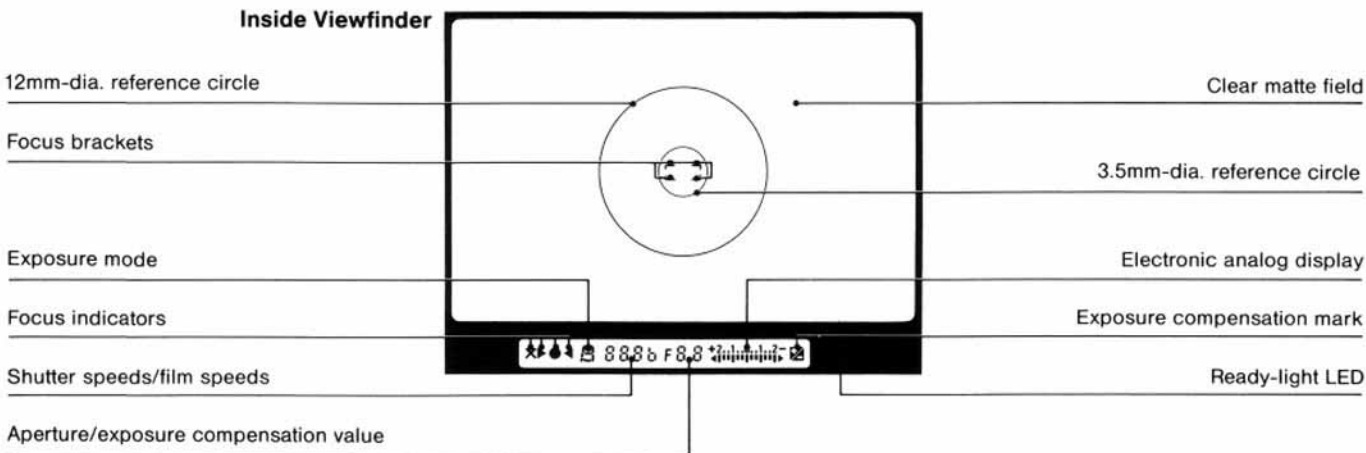
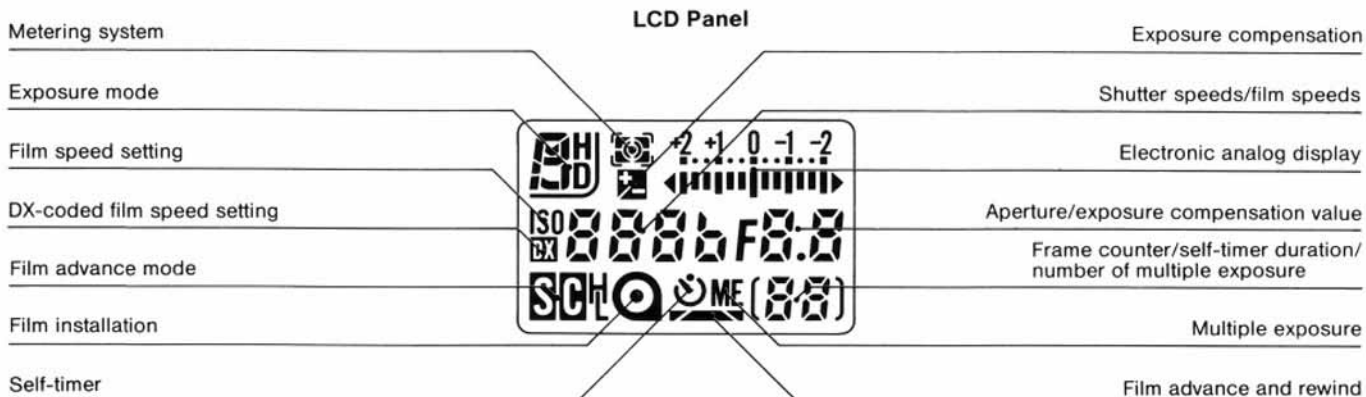

MOUNTING THE LENS

1

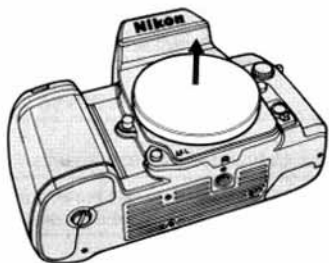

Remove camera body cap and front and rear lens caps.

2

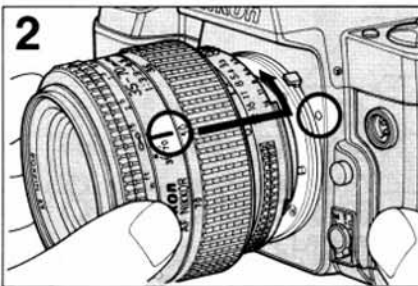

Position the lens in the camera's bayonet mount so that the mounting indexes on lens and camera body are aligned. Taking care not to press the lens release button, twist lens counterclockwise until it locks into place.

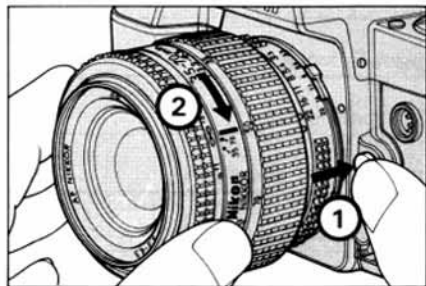

To remove

Push lens release button and turn lens clockwise.

See page 76 for Nikon lens compatibility chart.

- When mounting/removing lens, make sure that the camera's power is turned off and avoid direct sunlight.
- If you depress shutter release button without loading a film (e.g., for operation check), a whirring sound is heard; this is not a malfunction.

INSTALLING BATTERIES

3

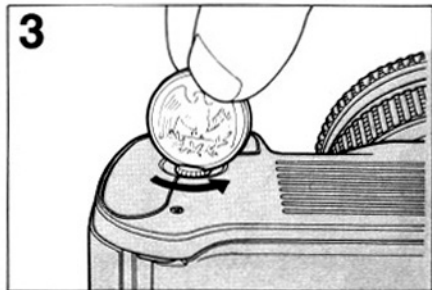

Using a coin, loosen battery holder lock screw.

4

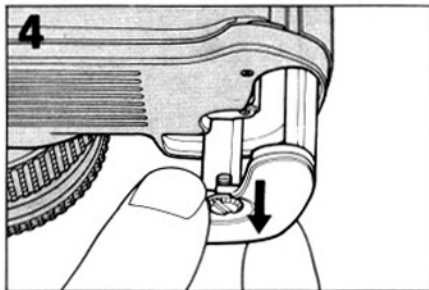

Remove battery holder.

5

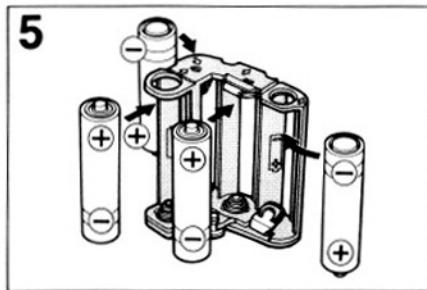

Install four AA-type batteries with "+" and "-" ends positioned as shown inside the holder.

6

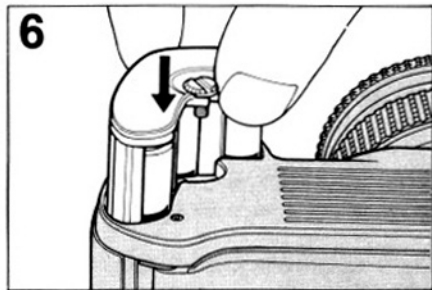

Return battery holder to battery chamber.

7

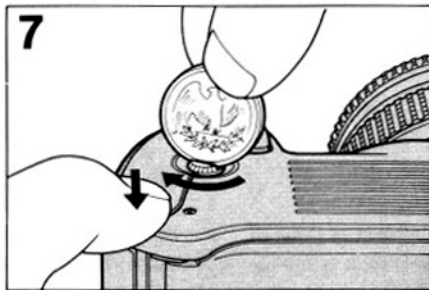

While pressing the holder into place, tighten lock screw.

- Batteries installed incorrectly (i.e., in reverse order) may result in leakage and even explosion.
- Batteries with a "+" terminal exceeding 6mm in diameter cannot be used.

CHECKING BATTERY POWER

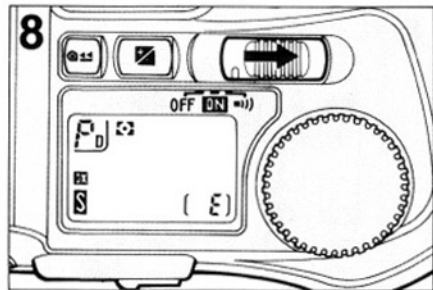

Slide the power switch to ON or  position so LCD panel and viewfinder LCDs appear as shown.

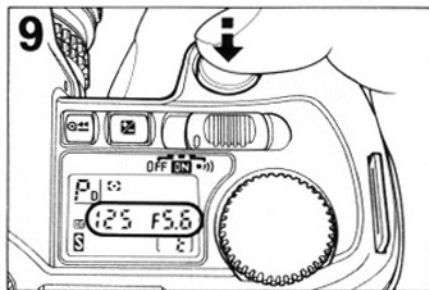

Next, lightly press the shutter release button and confirm shutter speed and aperture appear in the LCD panel and viewfinder. This indicates sufficient battery power.

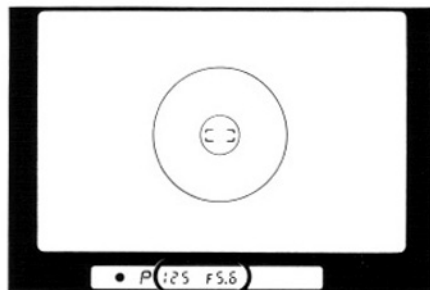

With the power switch at , the electronic beeper sounds in the following situations:

Operation signals:

- When you reach the end of the film roll.
- When film rewinding is complete.
- During self-timer operation.

Alert signals:

- When the automatically selected shutter speed is slower than 1/30 second and the shutter release button is lightly pressed. (Except when using Auto Exposure Lock or a Nikon speedlight*.)

* Beeper sounds when SB-24 is used in rear-curtain sync.

- When "HI" or "Lo" appears for over- or underexposure alert in Programmed Auto (PD, P, PH), Shutter-Priority Auto (S) or Aperture-Priority Auto (A) exposure mode.
- When lens is not set to the smallest aperture setting in PD, P, PH or S mode.
- When film speed selector is set at DX, and a non-DX film or film with a damaged or unacceptable DX code is loaded.
- When the camera detects abnormality such as torn or damaged film during film advance.

Shutter speed and aperture indicators remain on for approx. 8 sec. after you take your finger off the button, unless you release the shutter.

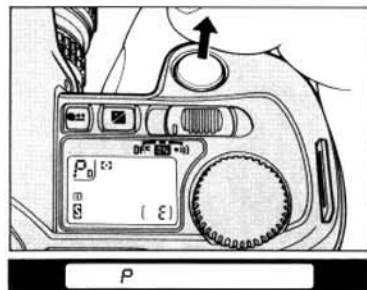
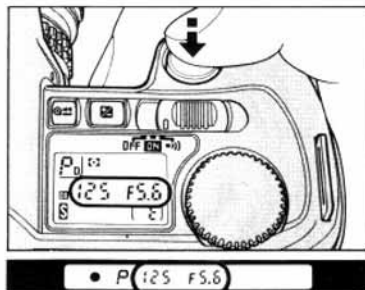

When not using the camera, to conserve battery power, be sure to turn the power switch off.

If it turns off immediately after you remove your finger from the button, replace batteries. (Even with sufficient battery power, the shutter speed and aperture indicators go off approx. 2 sec. after you remove your finger from button following shutter release.)

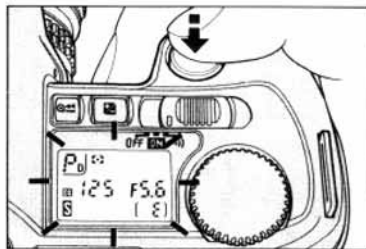

If the LCD panel blinks when you lightly press the shutter release button, battery power is not sufficient.

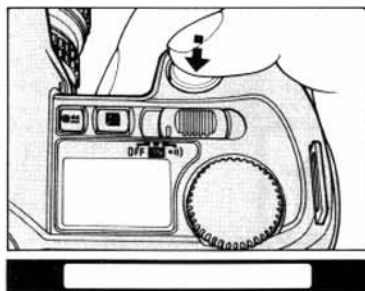

If the shutter does not operate and data does not appear in the LCD panel or viewfinder, batteries are exhausted or improperly loaded.

The batteries operate both auto-focus function and camera motor; when operation becomes noticeably slower, change batteries.

LOADING FILM

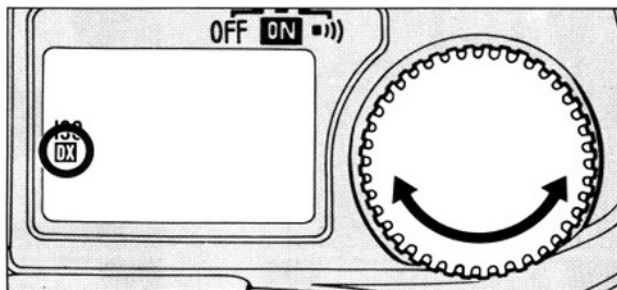
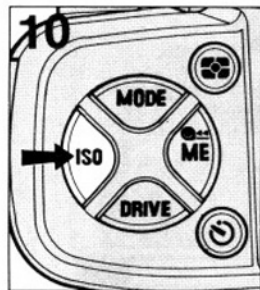

To select DX position for DX-coded film, rotate command dial while pressing film speed (ISO) button. DX position is located between **6** and **6400**. "DX" will appear in the LCD panel.

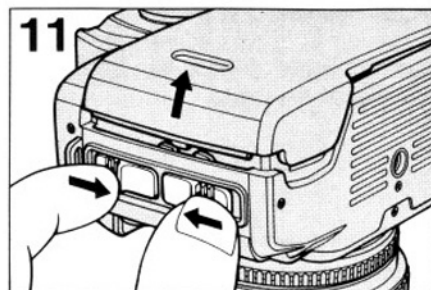

Slide camera back lock releases to open camera back.

- Usable film speed range for DX-coded film is ISO 25 to 5000.
- To avoid spoiling film (especially high-ISO film), do not load/unload film in direct sunlight.
- For details on manual film speed setting, see page 21.

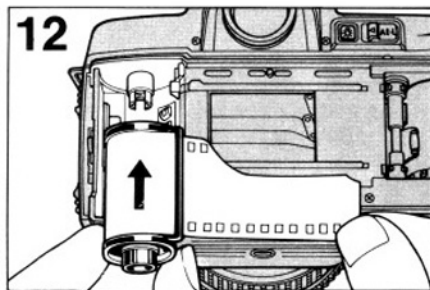

Insert film cartridge.

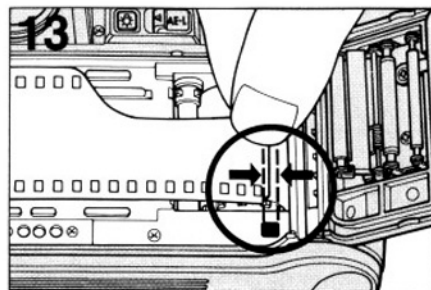

Pull film leader over to red index mark.

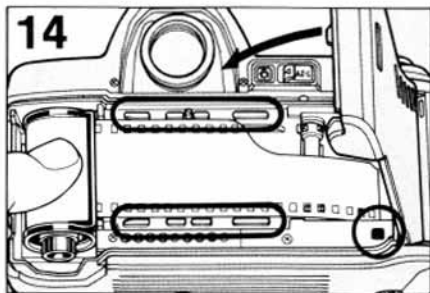

Check to ensure film is properly positioned with no slack. Close camera back and confirm lock releases snap closed.

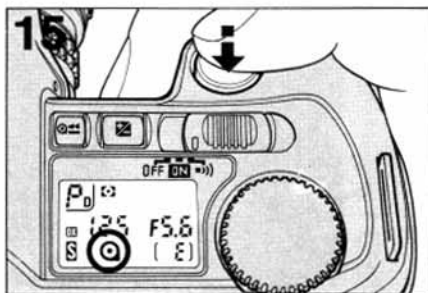

Lightly press shutter release button; film installation mark **1** will appear in the LCD panel.

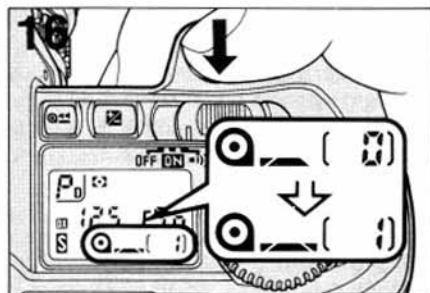

Fully depress shutter release button to automatically advance film to frame 1. Confirm frame "1" appears in the LCD panel. When film is correctly loaded, **1** mark appears.

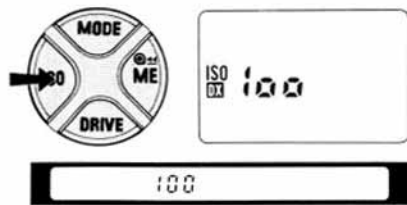
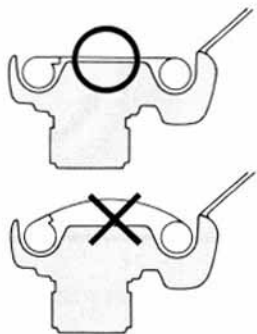

To confirm the ISO number of DX-coded film, press film speed button.

If film is not correctly positioned, **1** mark blinks, beeper sounds (if set), and shutter locks. Open camera back and reload film.

BASIC SHOOTING

The Nikon N8008s offers dual autofocus and manual focus modes, five auto exposure control modes with manual override, three exposure metering systems and three film advance modes. The following instructions provide the easiest setting for most picture-taking situations, using an AF Nikkor lens:

- Single Servo Autofocus Mode
- Dual Program Auto Exposure Control
- Matrix Metering System
- Single Frame Film Advance Mode

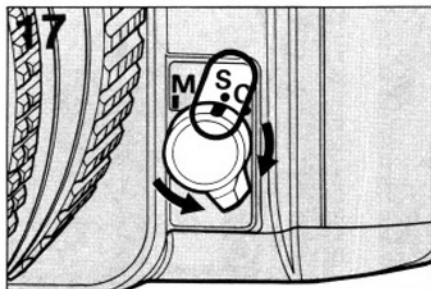

For Single Servo Autofocus:

Set focus mode selector to S.

If lens in use has an A-M switch, set the switch to A.

- For details on focus mode, see page 23.

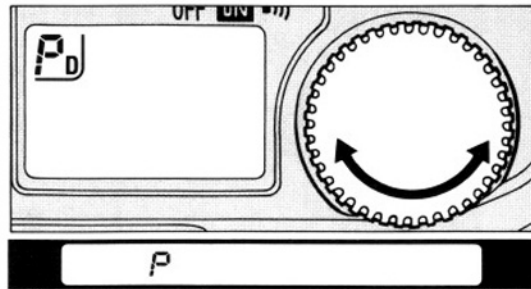
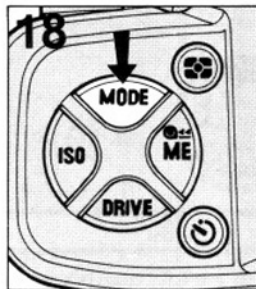

For Dual Program Auto exposure:

While pressing the exposure mode button (MODE), rotate command dial until P_D mark appears in the LCD panel.

- For details on exposure mode, see page 34.

If the camera stops operating, press the shutter release button to check the battery power. If the LCD panel blinks, turn the power switch off and replace the batteries with a fresh set.

If the camera has stopped during film advance: the film will complete its advance to the next frame as soon as you install fresh batteries. Turn the power switch on and continue shooting.

If camera has stopped during film rewind: you can continue rewinding the film after installing fresh batteries by turning the power switch on and pressing both the film rewind button and the multiple exposure/film rewind button.

Note that no indication appears in the LCD panel with completely exhausted batteries.

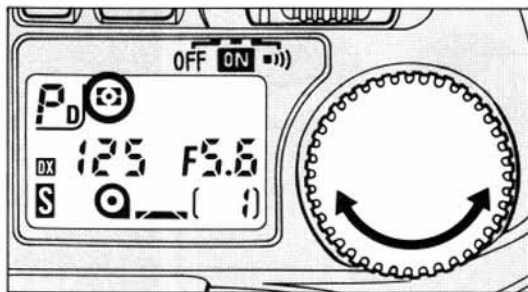
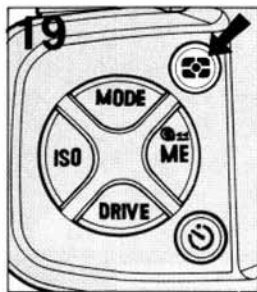

For Matrix Metering:

While pressing the exposure metering mode button, rotate command dial until the Matrix Metering mark  appears.

- For details on metering systems, see pages 45 to 46.

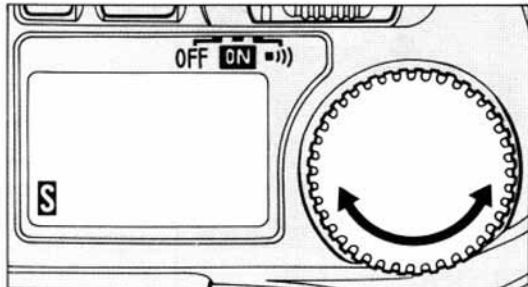

For Single Frame film advance:

While pressing the film advance mode button (DRIVE), rotate command dial until the  mark appears.

- For details on film advance mode, see page 22.

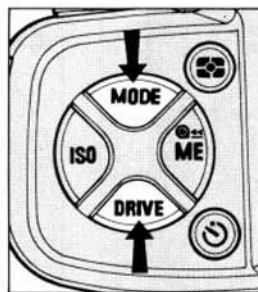

Instant Auto Mode

By pressing exposure mode (MODE) and film advance mode (DRIVE) buttons **simultaneously** for a few seconds, you can automatically set the exposure mode to Dual Program, film advance mode to Single Frame and exposure metering system to Matrix Metering. This cancels flexible program, exposure compensation and multiple exposure. For all other modes, prior settings remain the same. When using this technique, it is not necessary to rotate the command dial.

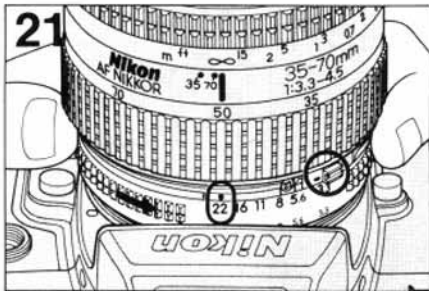

Set lens to its minimum aperture (largest f-number).
 With AF Nikkor lenses, lock lens aperture at its minimum setting. (See lens instruction manual.)



Position viewfinder focus brackets on main subject.

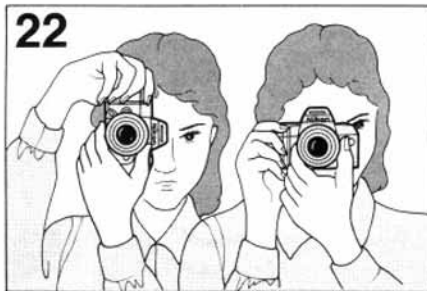

Aim camera at subject.

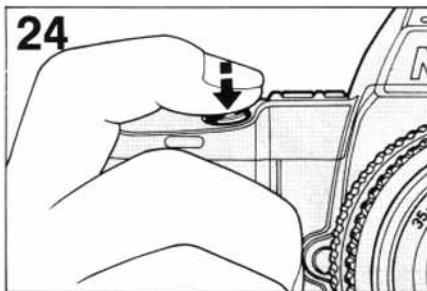

Lightly press shutter release button.
 Do not touch focus ring when the focus mode selector is set to S or C.



Confirm in-focus LCD indicator • appears in the viewfinder.

26

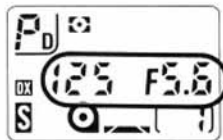

Confirm exposure.
 When exposure is correct, shutter speed and aperture appear in the viewfinder and in the LCD panel.

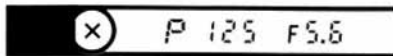

- If x appears in the viewfinder, autofocus is not possible with that subject. Set focus mode selector to M and focus on the clear matte field. See Focus section, pages 23 to 33.
- In S (Single Servo Autofocus) mode, shutter cannot be released until the in-focus indicator LCD appears; once it **does** appear, focus is locked as long as the shutter release button remains lightly pressed. If subject moves and focusing distance changes, refocus by briefly removing finger from shutter release button and lightly pressing again to reactivate autofocus operation.

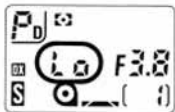
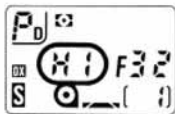
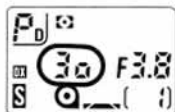

If a shutter speed of 1/30 sec. or slower appears in the LCD display panel, picture blur may occur due to camera shake or subject movement. Use a tripod to avoid camera shake, or consider using flash exposure.

If "HI" appears in the shutter speed position, it indicates overexposure; use film with a lower ISO speed.

If "Lo" appears, it indicates underexposure; use a Nikon speedlight.

If "FEE" appears in the aperture position, lens is not set to the smallest aperture setting and shutter locks. Set lens to smallest aperture.

- In all cases, beeper sounds (if set).

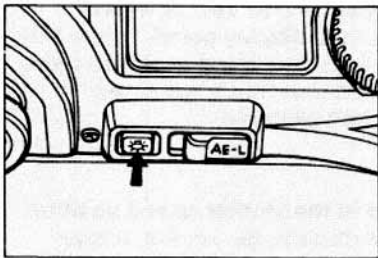

When shooting in dark situations, viewfinder display is automatically illuminated by lightly pressing the shutter release button. Whenever you want to illuminate the viewfinder display regardless of the light conditions, press viewfinder illumination button while viewfinder display stays on. In both cases, the illumination turns off as viewfinder display disappears. It also turns off during exposure.

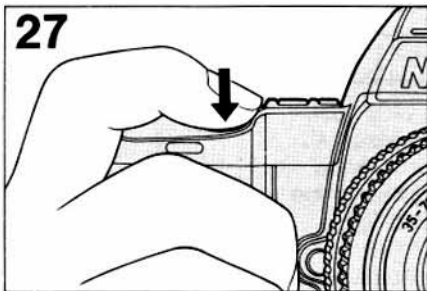



Fully depress shutter release button to take the picture and advance film by one frame. LCD panel frame counter increases by 1.

After shooting, in Single Servo Autofocus mode, you do not have to remove your finger from the shutter release button for the next shot even with film advance mode set at S. Slightly lift your finger off the button then fully depress it to release shutter again.

Shutter speed and aperture indicators turn off approx. 2 sec. after you release the shutter and remove your finger from the shutter release button.

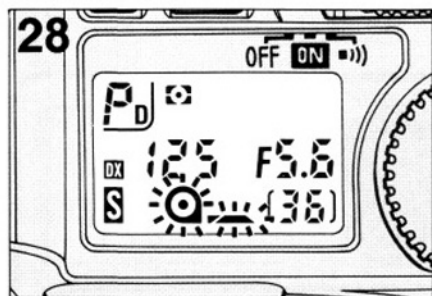
REWINDING FILM



28 Film advance stops automatically at end of roll and  mark blinks. Beeper sounds (if set).

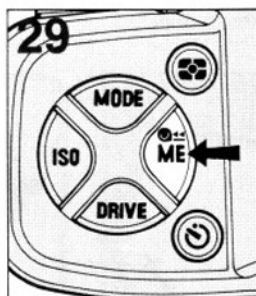

29 Press film rewind button and multiple exposure/film rewind button.  mark appears in the LCD panel, and the frame counter will count backwards until rewinding is complete.

- To rewind film before reaching the end of the roll, press both buttons.

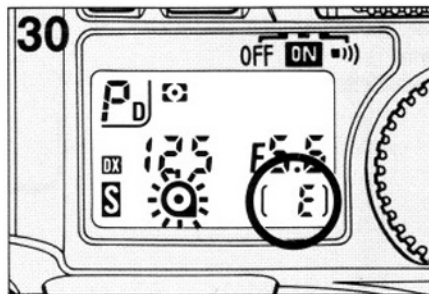
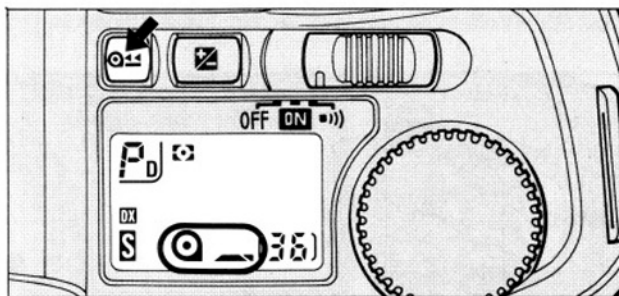

30 After rewinding stops (automatic), confirm frame counter shows "E," and film installation mark blinks.

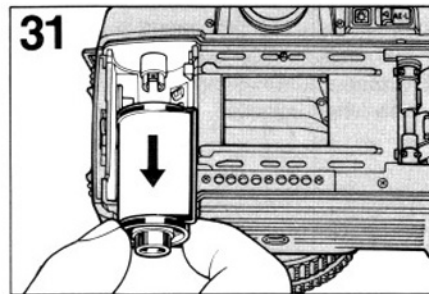

31 Open camera back and remove film cartridge.

If you do not rewind film when you come to the end of the roll, each time the shutter release button is depressed,  mark blinks for a few seconds and a beeper sounds (if set) to remind you to rewind film.

CONTROLS IN DETAIL

FILM SPEED SETTING

The N8008s offers two ways to set film speed, depending on film in use.

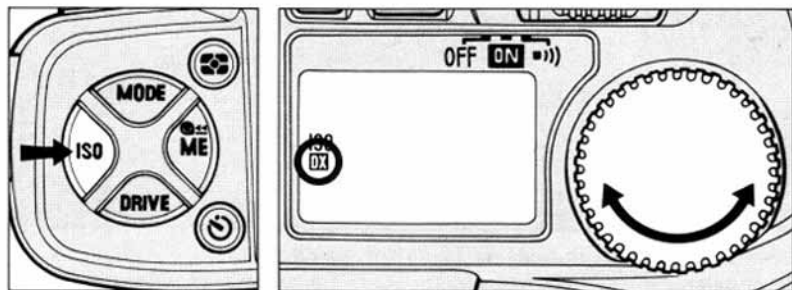

Using DX-Coded Film

Usable film speed range for DX-coded film is ISO 25 to 5000.

1. Slide power switch to ON or position.
2. While pressing film speed button (ISO), rotate command dial and set to DX position. "DX" will appear in the LCD panel.
3. Camera automatically senses film speed (ISO 25 to 5000) of DX-coded film when installed.

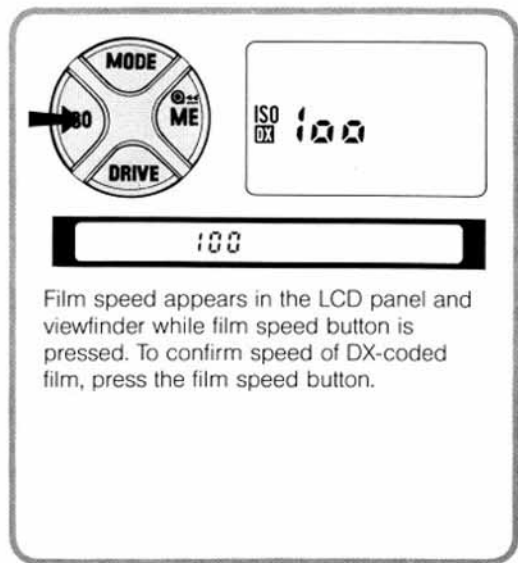

Film speed appears in the LCD panel and viewfinder while film speed button is pressed. To confirm speed of DX-coded film, press the film speed button.

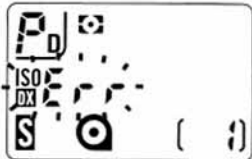

With dial set at DX position, use only DX-coded film. If non-DX-coded film or film with an unacceptable DX code is loaded, the Err, ISO and DX marks in the LCD panel blink, beeper sounds (if set) and the shutter locks. Set manually to the correct ISO setting.

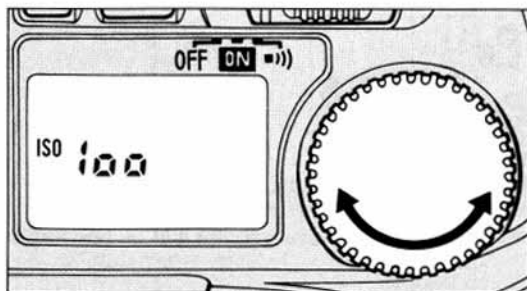
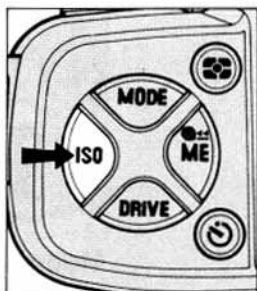

Manual Film Speed Setting

Usable range for manual film speed settings is ISO 6 to 6400.

1. Slide power switch to ON or position.
2. While pressing film speed button, rotate command dial and set to film's ISO number.
 - Film speed setting display changes as follows:
— ~~DX~~-6-8-10-12-16-20-25-32-40-50-64-80-100-125-160-200-250-320-400-500-640-800-1000-1250-1600-2000-2500-3200-4000-5000-6400—
 - After loading, you can confirm the ISO number by pressing the film speed button.
 - If DX-coded film is loaded, but the film speed is set manually, the camera gives priority to the manually set ISO number.

FILM ADVANCE MODE

Nikon N8008s has three automatic film advance modes.

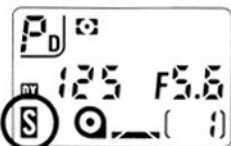

Single-frame shooting

Fully depressing the shutter release button takes one picture then automatically advances the film by one frame.

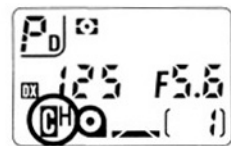

Continuous shooting

Shots are taken continuously as long as the shutter release button is depressed. High- or low-speed continuous shooting can be selected.

In CH (Continuous High) shooting mode, shooting speed is approx. 3.3 fps; in CL (Continuous Low) shooting mode, shooting speed is approx. 2.0 fps (in Continuous Servo Autofocus or manual focus mode, with new batteries at normal temperatures, and a shutter speed faster than 1/125 sec. in manual exposure mode). As the shutter speed becomes slower, the motor speed becomes proportionately slower.

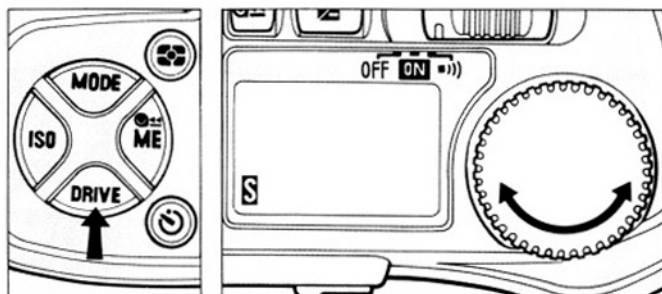
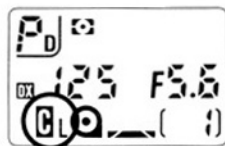

Mode Selection

While pressing the film advance mode button (DRIVE), rotate command dial to select film advance mode. S, CL or CH will appear in the LCD panel.

- The display changes as follows:

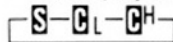

- With the autofocus mode set to Single Servo so the shutter is released only when the subject is in focus, continuous shooting speeds may vary.
- With the autofocus mode set to Continuous Servo, the autofocus lens does not operate between exposures in CH (Continuous High) shooting mode. It will work in CL (Continuous Low) shooting mode however, and to do so, requires a short lens operation time.

FOCUS

AUTOFOCUS

Nikon N8008s provides two autofocus modes, Single Servo Autofocus and Continuous Servo Autofocus.



Single Servo Autofocus mode

In Single Servo Autofocus mode (S), the shutter cannot be released until subject is correctly focused, and once in focus, the focus remains locked for as long as the shutter release button is lightly pressed.

- After shooting, you do not have to remove your finger from the shutter release button for the next shot. Slightly lift your finger off the button then fully depress it to release shutter again. In Single Servo Autofocus, focus remains locked even after shutter release unless you remove your finger from the shutter release button with film advance mode at S.

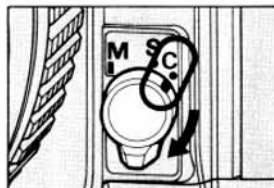

Continuous Servo Autofocus mode

In Continuous Servo Autofocus mode (C), the camera continues focusing for as long as you keep the shutter release button lightly pressed and the reflex mirror is in the viewing position. The shutter release button can be fully depressed anytime.

- In Continuous Servo mode, focusing sharpness depends on subject speed and direction; autofocus may not always operate fast enough to follow certain subjects.

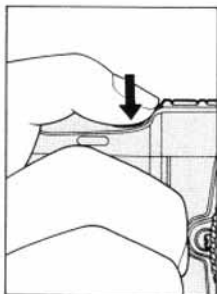

Focus Tracking

When shooting a moving subject, with the focus mode set to Continuous Servo Autofocus and the film advance mode to CL (Continuous Low), Focus Tracking is automatically activated to ensure focused images. In Focus Tracking, the camera analyzes the speed of the moving subject according to focus detection data, and drives the autofocus lens by anticipating the position of the subject at the exact moment of exposure.

Continuous Servo Autofocus Mode

1. Set focus mode selector to C for Continuous Servo Autofocus.
If the lens has an A-M switch, set switch to A.
2. Position viewfinder focus brackets on main subject.
3. Lightly press shutter release button to start Continuous Servo Autofocus function.
4. Confirm the viewfinder in-focus indicator appears, then fully depress shutter release button to take a correctly focused picture.

- When focus tracking is activated and a focused image is assured, ►◄ appears in the viewfinder. In Focus Tracking mode, the in-focus indicator (●) does not appear even if a correctly focused image is assured.
- If the subject speed becomes erratic, Focus Tracking will be automatically deactivated and standard continuous focusing will operate.
- Focus Tracking ability will vary according to subject's brightness and movement, lens in use and shooting distance.
- During Focus Tracking, the subject must remain within the focus brackets.
- In Focus Tracking with the film advance mode set at CL, the shooting speed is faster than 2.8 fps (specified speed for CL).

If in-focus indicator LCD does not appear and X appears, see page 33.

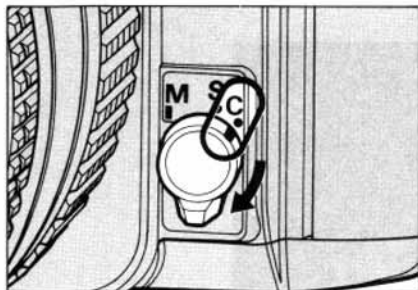

1. Set focus mode selector to C, and film advance mode to CL.

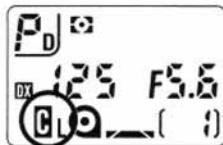

2. Position viewfinder focus brackets on subject.

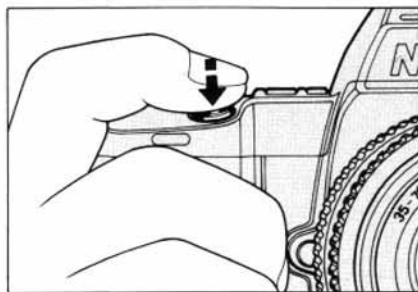

3. Lightly press shutter release button to start Focus Tracking.



4. Confirm both arrows (▶◀) appear in the viewfinder, then fully depress shutter release button to take an in-focus picture.

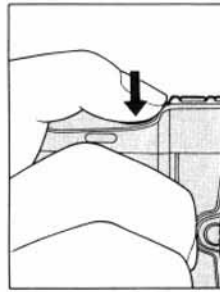

Taking Pictures with an Off-Center Main Subject Single Servo Autofocus mode

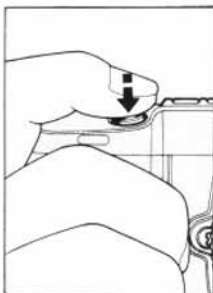

1. Position focus brackets on subject and lightly press the shutter release button.

2. Confirm in-focus indicator LCD appears in the viewfinder.

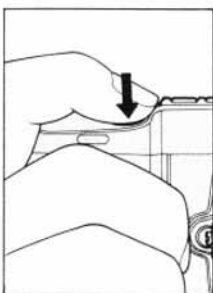

3. Keeping the shutter release button lightly pressed, recompose, then fully depress shutter release button.

Continuous Servo Autofocus mode Use AF-L (Autofocus Lock) button.

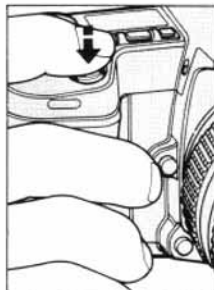

1. Position focus brackets on subject and lightly press the shutter release button.

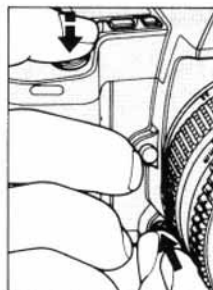

2. Keeping shutter release button lightly pressed, confirm in-focus indicator LCD appears, then depress AF-L button and hold in.

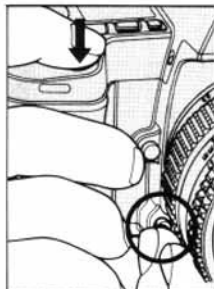
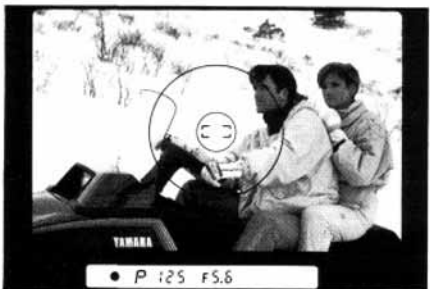

3. With AF-L button depressed, recompose as desired and fully depress shutter release button.

- With AF-L button depressed, focus will be locked even if you remove your finger from the shutter release button.
- AF-L button can also be used in Single Servo Autofocus mode.

Autofocusing with Optional Autofocus Speedlights



Although the N8008s's autofocus works at lighting levels as low as EV minus 1, performance may vary depending on subject detail and contrast. Under these dim conditions, however, you may want to use Nikon Speedlights during AF operation (1) if it is too dark, or (2) if it is dim and the subject has poor contrast.

The AF Illuminator lights up only in Single Servo Autofocus mode.

1. Mount Nikon Autofocus Speedlight SB-24, SB-23, SB-22 or SB-20 on the N8008s's accessory shoe.
2. Compose subject in viewfinder and lightly press shutter release button.
3. Speedlight's AF illuminator lights up and autofocus operation begins.

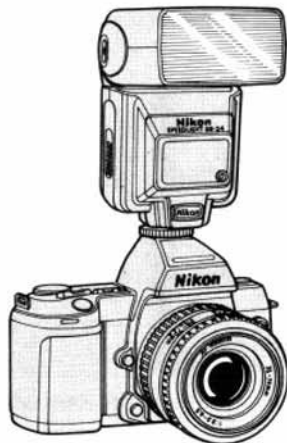

For details, see Nikon speedlight instruction manual.

MANUAL FOCUS WITH ELECTRONIC RANGE FINDER

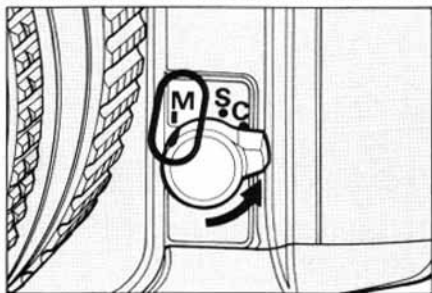

1. Set focus mode selector to M (manual). If lens has an A-M switch, set to M.



2. Look inside viewfinder and position focus brackets on the main subject.
Lightly press shutter release button.

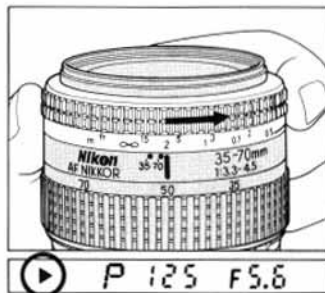
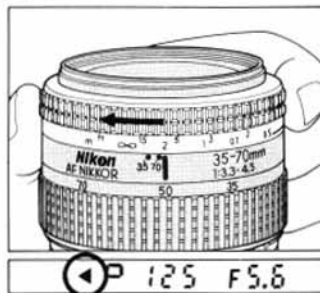
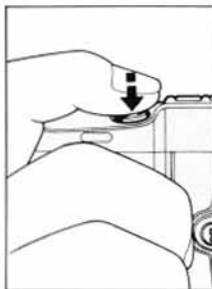

3. Keeping shutter release button lightly pressed, watch in-focus indicator LCD inside the viewfinder.
 - If focus-to-left arrow (rear focus) or focus-to-right arrow (front focus) appears, manually rotate lens focusing ring in the direction indicated until the in-focus indicator LCD appears.
 - If focus-to-left arrow does not disappear when you turn focus ring counterclockwise to the limit, subject is closer than lens' closest focusing distance. Move back from subject.
 - If focus-not-possible indicator x appears, use clear matte field for focusing. See page 32.

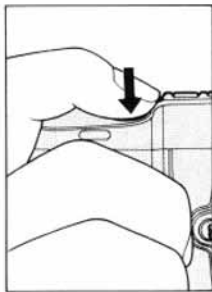

4. Confirm in-focus indicator LCD, then fully depress shutter release button.

- Manual focus using the electronic range finder works with all AF Nikkor and other Nikon lenses. (For a complete list of usable lenses, see lens compatibility chart, page 76.) Lenses with a maximum aperture slower than $f/5.6$ are not suitable for electronic range finder focusing, even though focus indicator LCDs appear. Focus on clear matte field or change focusing screen to J type.

Freeze Focus

The optional Nikon Multi-Control Back MF-21, when attached to the N8008s, offers a freeze focus function which automatically fires the shutter when subject is in a preset focus position. This feature is especially convenient for manual focus with electronic range finder. For details, see instruction manual of the MF-21.

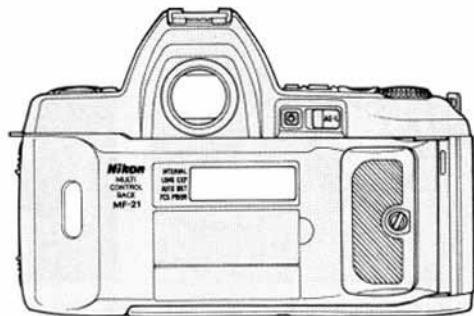

MANUAL FOCUS USING CLEAR MATTE FIELD

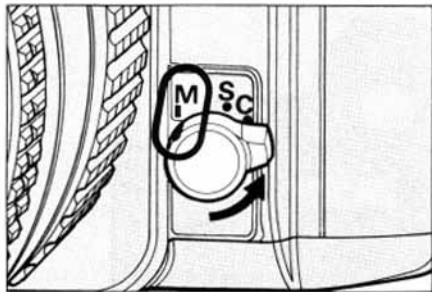

1. Set focus mode selector to M (manual).



2. Focus subject using clear matte field.

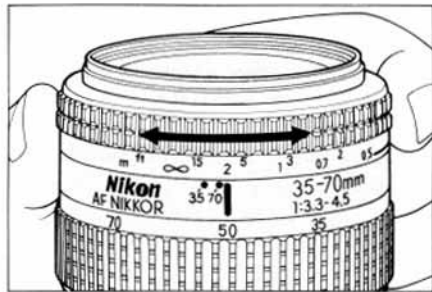

SPECIAL FOCUSING SITUATIONS

Autofocus operation and electronic range finder depend on general lighting, subject contrast and details, and other technical points. In situations where autofocus is not possible, we recommend manual focus using the clear matte field. Focus-not-possible alert x appears with the following subjects:

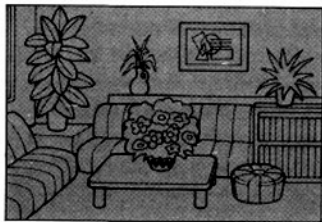

1. Very dark subject

Focus manually, or for autofocus, focus on another, brighter subject located at same distance and wait until the in-focus indicator LCD appears in the viewfinder. Or use a Nikon autofocus speedlight with AF illuminator.

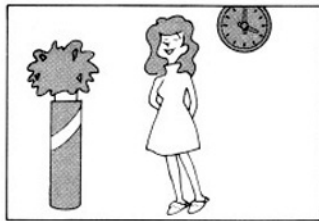

2. Low-contrast subject

Focus manually, or for autofocus, focus on another subject at the same distance but with more contrast, until in-focus indicator LCD appears.

in the following situations, ignore in-focus indicator LCD and focus manually using the clear matte field.

1) When shooting the following:

- Bright subject with a shiny surface, such as silver or aluminum.
- Strongly backlit subject.
- Scene with subjects located at different distances.

2) When using a linear polarizing filter, or special filter such as a soft-focus filter. (Circular polarizing filter can be used for autofocus operation.)

EXPOSURE

Exposure control consists of two parts – aperture and shutter speed control. Together, these determine the amount of light that strikes the film to ensure precise exposure control. Nikon N8008s offers three Programmed Auto modes plus Shutter-Priority Auto, Aperture-Priority Auto, and Manual exposure modes.

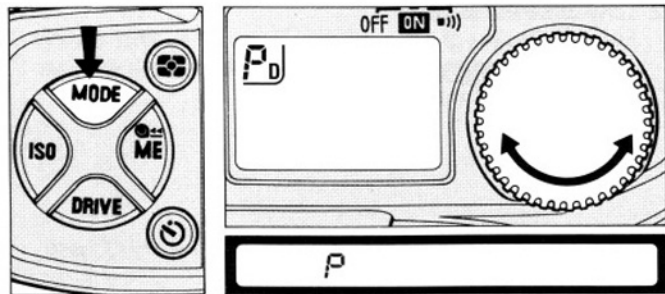

Exposure Mode Setting

While pressing exposure mode button (MODE), rotate command dial. Exposure mode changes in the following sequence.

—P DUAL(Dual Program)—S(Shutter-Priority Auto)—
A(Aperture-Priority Auto)—M(Manual)—
P HI(High-speed Program)—P(Normal Program)—

P_D, S, A, M, P^H, or P will appear in the LCD panel accordingly.
P (P DUAL, P, P HI), S, A, or M will appear in the viewfinder.

PROGRAMMED AUTO EXPOSURE MODES

Programmed Auto exposure modes can only be used with lenses having a built-in CPU such as AF Nikkors and the 500mm f/4 P. For lenses without a CPU, exposure mode is automatically set to Aperture-Priority Auto (A) and metering system to Center-Weighted. (Exposure mode indicator and Matrix Metering mark blink, if set.)

Three Programmed Auto exposure modes are provided – P DUAL for dual, P for normal, and P HI for high-speed program. In **P DUAL (Dual Program)** mode, the camera automatically selects either normal or high-speed program depending on the focal length of the lens in use. Normal is selected for lenses with focal lengths shorter than 135mm. High-speed is for lenses with focal lengths of 135mm or longer to reduce the possibility of blurred pictures due to subject movement or camera shake. With zoom lenses, depending on the focal length setting, either normal or high-speed program will be selected.

Setting the exposure mode to **P (Normal Program)** or **P HI (High-speed Program)** lets you choose normal or high-speed program. For a higher shutter speed, such as when using a telephoto lens or for shooting a fast-moving subject, P HI is recommended.

Dual Program Chart (e.g., AF 50mm f/1.4, ISO 100)

The EV (exposure value) chart demonstrates the difference between N8008s's normal and high-speed programs. Follow either colored line to where it intersects a diagonal line. This shows the combination of aperture (vertical line) and shutter speed (horizontal line).

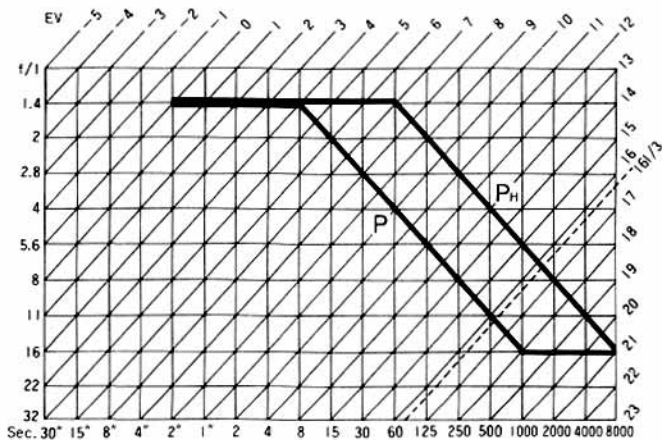

- Normal program
- High-speed program
- High-brightness limit for Matrix Metering

Flexible Program

In Programmed Auto (PD, P, PH) exposure modes, you can temporarily change an automatically set combination of shutter speed/aperture by 1 EV step while maintaining the correct exposure. This is particularly useful for selecting a specific shutter speed or aperture when you want to automatically return to standard programmed exposure control after.

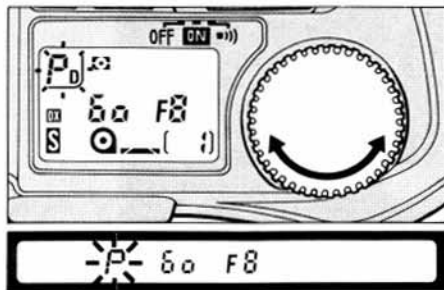

1. Lightly press shutter release button.
 2. Turn command dial until desired shutter speed or aperture value appears in the viewfinder and LCD panel.
- When program is shifted, exposure mode indicator blinks in the LCD panel and viewfinder.
 - As soon as the display in the LCD panel and viewfinder disappears, flexible program is cancelled.

SHUTTER-PRIORITY AUTO EXPOSURE MODE

This mode lets you choose shutter speeds manually to freeze the action with sharp, clear images using a fast shutter speed, or create motion effects by choosing slower shutter speeds.

N8008s's microcomputer automatically selects the correct aperture to match your shutter speed.

This mode is available with lenses having a built-in CPU such as AF Nikkors and the 500mm f/4 P.



At a fast shutter speed



At a slow shutter speed

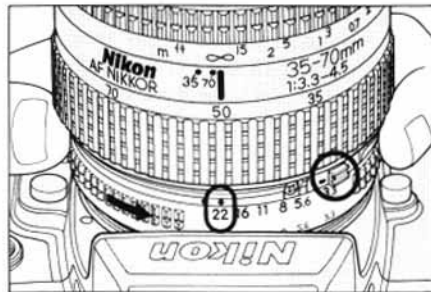

1. Set lens to its minimum aperture setting (largest f-number).
With AF Nikkor lenses, lock lens aperture at minimum setting.

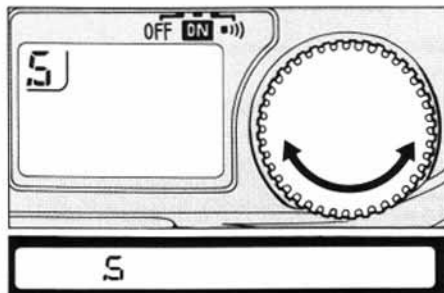
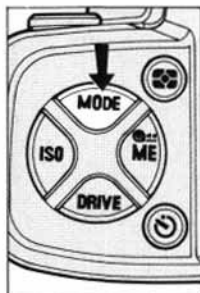

2. While pressing exposure mode button (MODE), rotate command dial until "S" appears in the LCD panel and viewfinder.

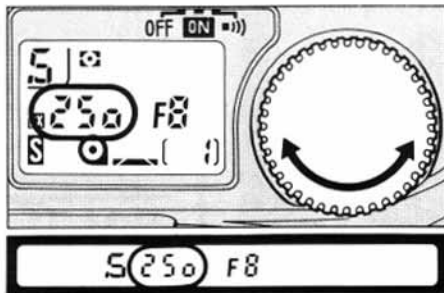

3. Remove finger from exposure mode button, and rotate command dial to select desired shutter speed.
- Shutter speed changes 1 step at a time in the following sequence:
30"-15"-8"-4"-2"-1"-2-4-8-15-30-60-125-250-500-1000-2000-4000-8000

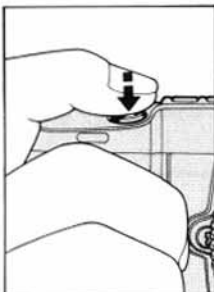

4. Look inside viewfinder and lightly press shutter release button.



5. Confirm aperture value.
Camera selects correct aperture to the shutter speed you set.

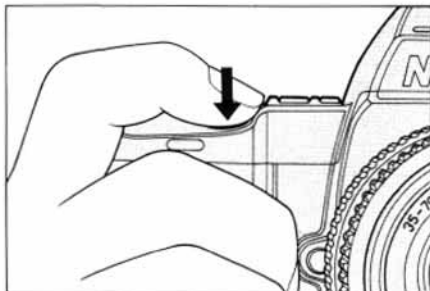

6. Fully depress shutter release button to take a picture.

If the following indication appears where the aperture value is shown:

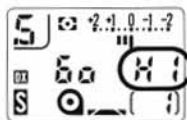

"HI" appears*

Select higher shutter speed or use Nikon ND filter.

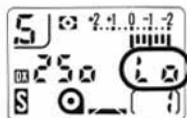

"Lo" appears*

Select slower shutter speed, or use a Nikon speedlight.



"FEE" appears

Set lens to smallest aperture setting. Shutter speed disappears and shutter locks.



* Electronic Analog Display appears to show value difference from correct exposure.

- In all cases, beeper sounds (if set).
- For lenses without built-in CPU, exposure mode is automatically set to Aperture-Priority Auto (A) and metering system to Center-Weighted. (Exposure mode indicator and Matrix Metering mark blink, if set.)

APERTURE-PRIORITY AUTO EXPOSURE MODE

The N8008s's microcomputer automatically selects the correct shutter speed to match the aperture you set. This is the recommended mode when depth of field is your prime consideration. For softer, less distinct backgrounds, as in portraits, use larger apertures. For overall sharp, clear pictures, such as scenic photography, use smaller apertures.



At wide aperture



At small aperture

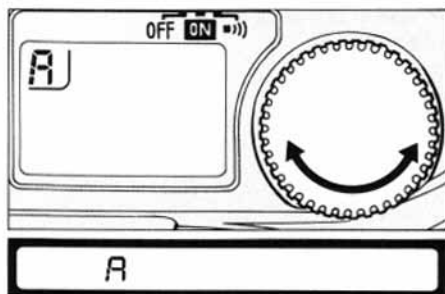
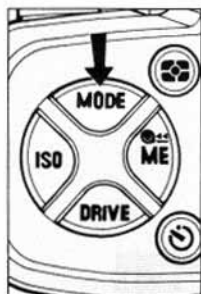

1. While pressing exposure mode button (MODE), rotate command dial until "A" appears in the LCD panel and viewfinder.

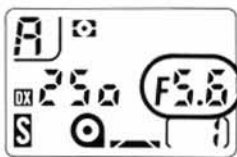
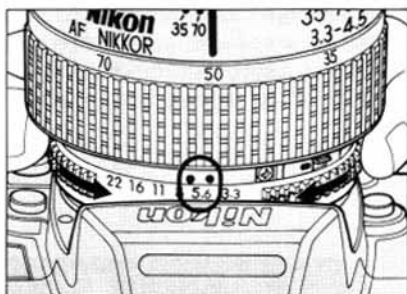

2. Remove finger from exposure mode setting button and set lens to desired f-number by rotating lens aperture ring.
- Aperture changes in the following sequence, as indicated in the LCD display panel.
F1-F1.4-F2-F2.8-F4-F5.6-F8-F11-F16-F22-F32-F45-F64
An intermediate figure (e.g. F1.8, F3.3) appears to indicate a lens' maximum aperture. Also, with zoom lenses, the maximum aperture for different focal length settings appears in 1/6 EV steps.

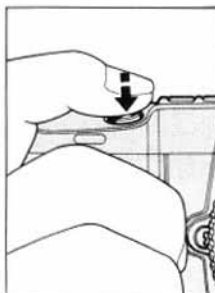

3. Look in viewfinder and lightly press shutter release button.



4. Confirm shutter speed.
Camera selects the correct shutter speed to match your aperture setting.

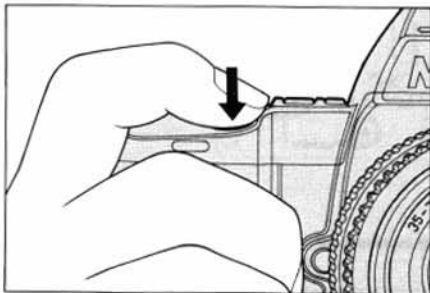

5. Fully depress shutter release button to take the picture.

If the following indication appears in the shutter speed position:

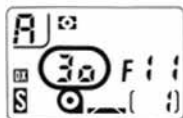

1/30 sec. or slower

Subject movement and camera shake may cause picture blur. Select faster aperture setting, or use tripod.

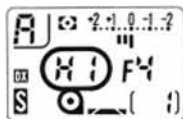
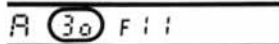

"HI" appears*

Select smaller aperture setting (larger f-number).

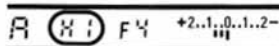

"Lo" appears*

Select larger aperture setting or use a Nikon speedlight.

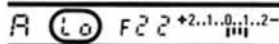

* Electronic Analog Display appears to show value difference from correct exposure.

- In all cases, beeper sounds (if set).
- For lenses without a built-in CPU, "F--" appears where the aperture value is shown in the LCD panel and viewfinder.

MANUAL EXPOSURE MODE

In Manual exposure mode, both shutter speed and aperture can be set manually to achieve your desired effect. Use fast shutter speeds to stop the action, slower speeds to create motion effects or less distinct outlines. Manually setting the exposure mode also lets you control depth of field, either by softening the background so the main subject of the picture stands out, or by creating overall uniform sharpness.

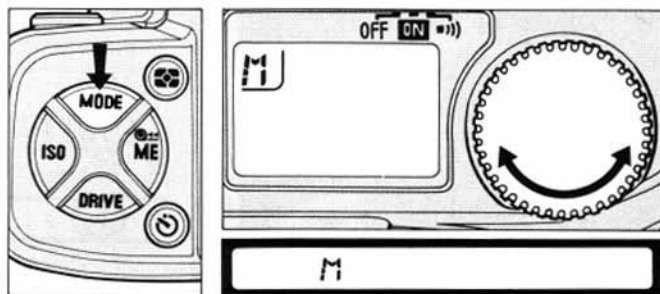

1. While pressing exposure mode button (MODE), rotate command dial until "M" appears in the LCD panel and viewfinder.

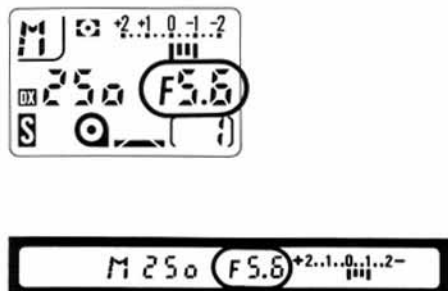
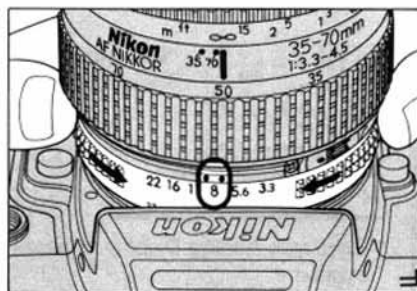
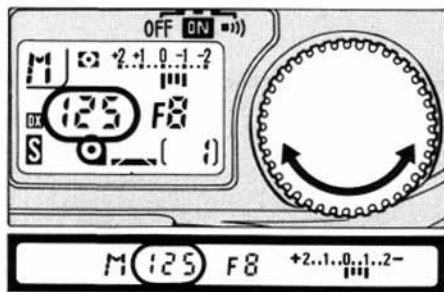

2. Remove finger from exposure mode button, and set shutter speed using the command dial, and aperture using the lens aperture ring.

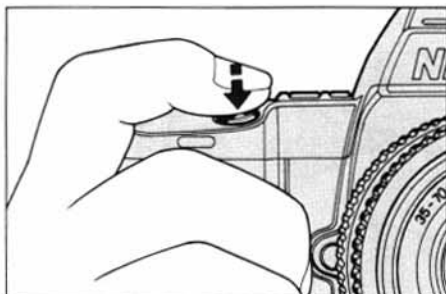

3. Look inside viewfinder and lightly press shutter release button.

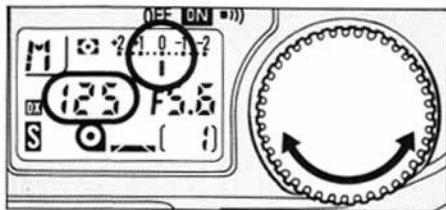

M 125 F5.6 +2..1..0..1..2-

4. Adjust aperture and/or shutter speed until the Electronic Analog Display indicates 0 or the desired exposure.

The Electronic Analog Display range is +2EV to -2EV, in increments of 1/3EV.

◀ and ▶ appear when exposure is beyond ±2EV.

Examples:

+2..1..0..1..2-
◀■■■■■

Over +2EV

+2..1..0..1..2-
■■■■■

+2EV

+2..1..0..1..2-
|

±0EV

+2..1..0..1..2-
■■■

-2/3EV

+2..1..0..1..2-
■■■■■▶

Below -2EV

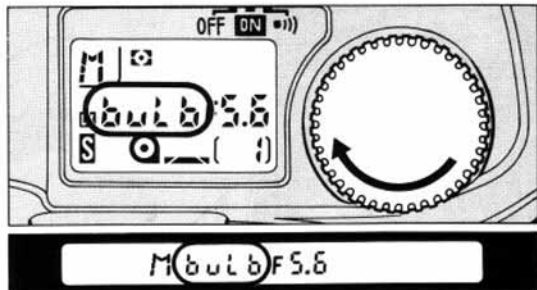
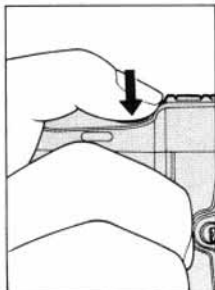

5. Confirm correct exposure and fully depress shutter release button to take the picture.

Bulb Setting

At Bulb setting, the shutter remains open as long as the shutter release button remains depressed. This setting can only be used in manual exposure mode. Rotate command dial clockwise until "bulb" appears.

For lenses without a built-in CPU, "F--" appears where the aperture value is shown in the LCD panel and viewfinder.

With the bulb setting, changing the exposure mode to shutter-priority auto causes "bulb" to blink, and shutter is locked.

PHOTOGRAPHIC TECHNIQUES

EXPOSURE METERING SYSTEMS

The Nikon N8008s provides three types of exposure metering systems – Matrix Metering, Center-Weighted Metering and Spot Metering.

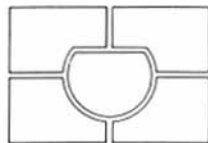

Matrix Metering

This system is ideally suited for quick operation and for the most dependable auto exposure control. It can also be used for manual metering and flash exposure control operation with any Nikon TTL Speedlight.

In Matrix Metering, the meter automatically provides the correct exposure of the main subject in virtually any lighting situation, without requiring manual exposure compensation. The Matrix Metering sensor determines scene brightness by dividing the scene into five areas, then analyzing each area for brightness and scene contrast.

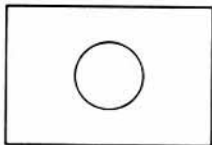

Center-Weighted Metering

Choose Center-Weighted Metering when you want to base exposure on either auto or manual exposure control for a centrally located subject. Selecting Center-Weighted Metering overrides Matrix Metering and concentrates 75% of the meter's sensitivity into the center of the viewfinder outlined by a 12mm-diameter circle.

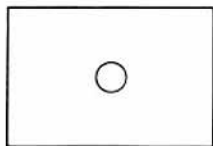

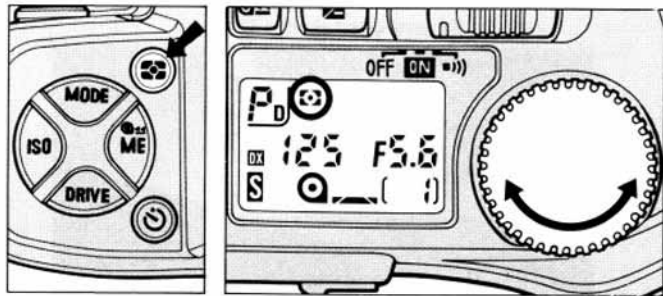

Spot Metering

For selective metering of tiny subjects or for advanced manual metering techniques, use Spot Metering. The area metered is represented by the approx. 3.5mm-diameter circle in the center of the viewfinder. This metering system is effective when precise measurement of a special portion of the subject is required.



Metering System Setting

1. Slide main switch to ON.
2. While pressing metering system button, rotate command dial until your desired metering symbol –  for Matrix Metering,  for Center-Weighted Metering or  for Spot Metering appears in the LCD panel.

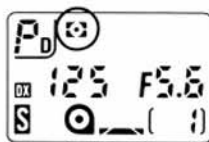

Matrix Metering

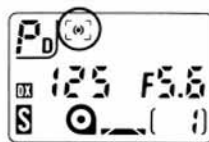

Center-Weighted
Metering

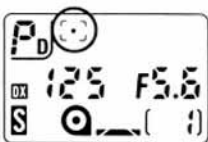

Spot Metering

For lenses without built-in CPU, the metering system is automatically set to Center-Weighted. If set to Matrix Metering,  blinks.

When to Use Matrix or Center-Weighted Metering

In scenes with both very bright and very dark areas, these two metering systems produce varying results. For example:

1. Scene containing the sun or scenes with high reflectivity

If a scene contains highlights, such as the sun, snow or bright reflections, Center-Weighted Metering renders the main subject as a silhouette. With Matrix Metering, however, the light value of darker parts is evaluated, resulting in an overall well-balanced exposure.

2. Outdoor backlit subject

With Center-Weighted Metering, a backlit subject or scene with people against a bright sky and/or clouds may lead to an underexposed shot. With Matrix Metering, however, the camera automatically gives more exposure to dark subjects to ensure a correct overall exposure.

3. Front-lit subject against dark background

If a brightly lit off-center subject is positioned against a dark background, Center-Weighted Metering places too much emphasis on the dark center of the picture. So although the background is correctly exposed, the main subject will be overexposed. Matrix Metering, however, automatically integrates a dark background with a bright subject to ensure the best overall exposure.

Scene containing the sun

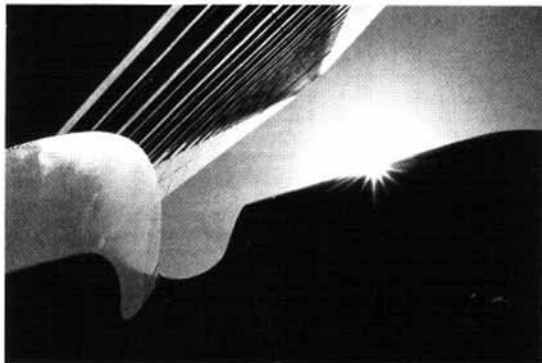

Matrix Metering



Center-Weighted Metering

Outdoor backlit subject



Matrix Metering



Center-Weighted Metering

Front-lit subject



Matrix Metering



Center-Weighted Metering

4. Small dark subjects against a bright background

A subject significantly smaller than any of the Matrix Metering sections may not be recognized and integrated into the automatic exposure evaluation. For such subjects, use AE Lock or Center-Weighted Metering with manual exposure compensation.



Center-Weighted Metering (w/AE Lock)



Matrix Metering



Center-Weighted Metering (w/o AE Lock)

5. Sunset scenes

When you want to emphasize a dramatic sunset but don't want Matrix Metering to lighten the scene for a dark foreground subject, use AE Lock or Center-Weighted Metering.



Matrix Metering



Center-Weighted Metering

EXPOSURE COMPENSATION

In Automatic Exposure Modes

AE (Auto Exposure) Lock Lever

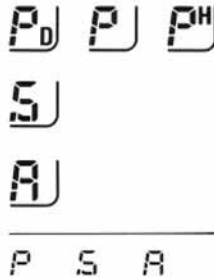
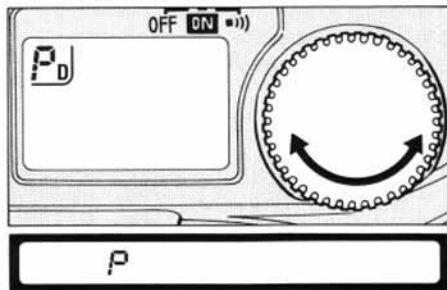
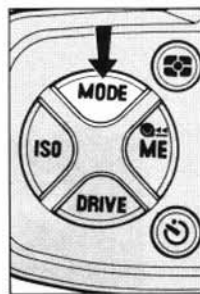

1. Set exposure mode to Programmed (P_D, P, P_H), Shutter-Priority Auto (S) or Aperture-Priority Auto (A).

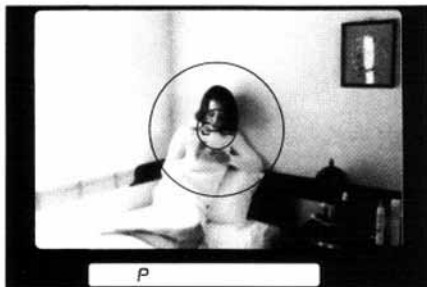

2. Center main subject inside viewfinder or move in closer.

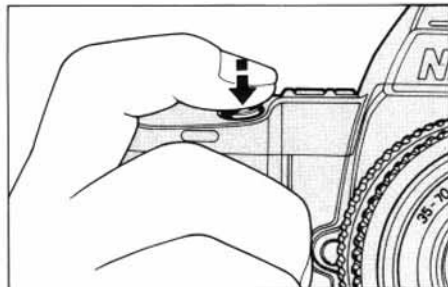

3. Lightly press shutter release button, and confirm shutter speed and aperture in the viewfinder.

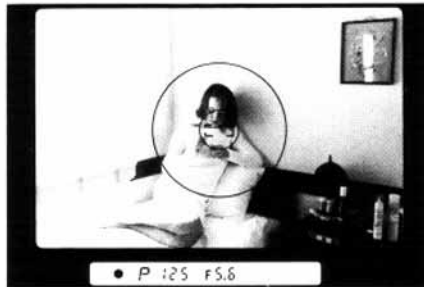

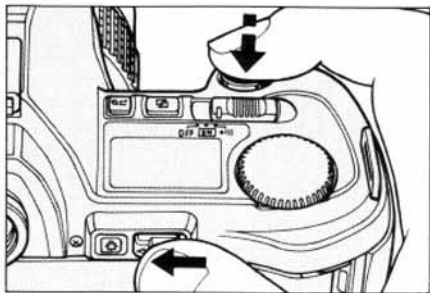

4. While lightly pressing shutter release button, slide AE Lock lever and hold in.

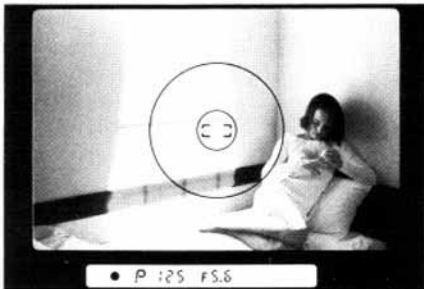

5. Recompose and shoot.

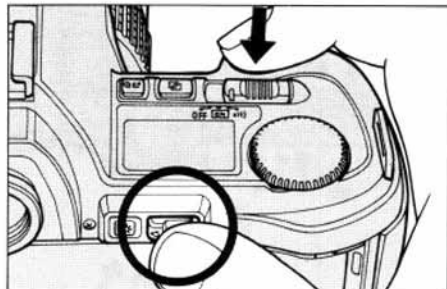

- In Single Servo Autofocus mode, when recomposing may change the subject-to-camera distance, refocus by briefly removing your finger from the shutter release button and lightly pressing it again.
- In Continuous Servo Autofocus mode, when recomposing may not change subject-to-camera distance, push and hold the AF-L button before recomposing.
- Center-Weighted Metering system is recommended.
- When using AE Lock lever, beeper does not sound for exposure.

Exposure Compensation Button

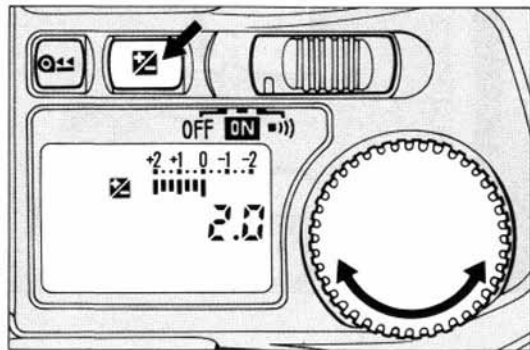

A close-up of the LCD display showing the exposure compensation settings. It displays the number '2.0', a scale from +2 to -2 in 1/3 steps, a bar graph, and a square icon with a diagonal slash.

Using the exposure compensation button, you can compensate exposure within the range of $\pm 5\text{EV}$.

While pressing exposure compensation button, rotate the command dial to set desired compensation value. The following display appears in the LCD panel and viewfinder:

☒ mark

Electronic Analog Display with indications from -2 to $+2$ EV in 1/3 steps

Compensation value (from -5 to $+5$ EV in 1/3 steps)

- ☒ mark stays on during compensation, but compensation value and Electronic Analog Display disappear after you remove finger from exposure compensation button. To confirm compensation value, press button again.
- Once set, exposure compensation remains fixed until set again.
- Exposure compensation can also be achieved by setting film speed manually. See page 21.

(In Center-Weighted Metering)



Without compensation

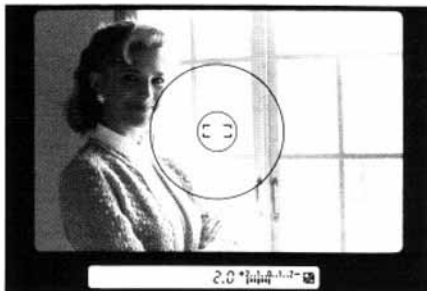

+2EV compensation

Examples:

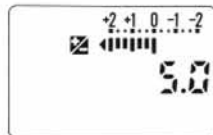

Over +2EV
(+5EV)

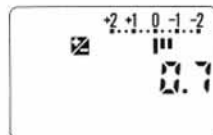

-2/3EV

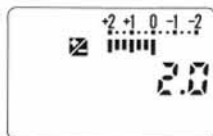
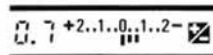

+2EV

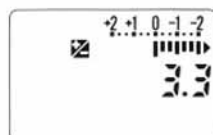

Below -2EV
(-3 1/3EV)

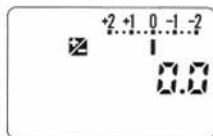
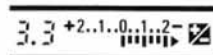

±0EV

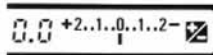

In Manual Exposure Mode

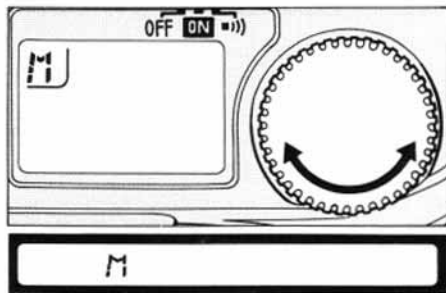
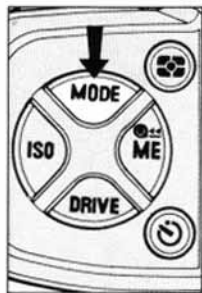

1. Set exposure mode to Manual (M).

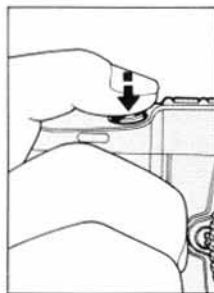

2. Center main subject inside viewfinder, and lightly press shutter release button.

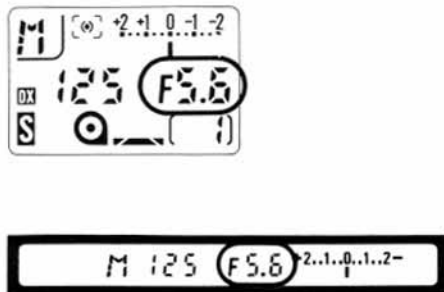
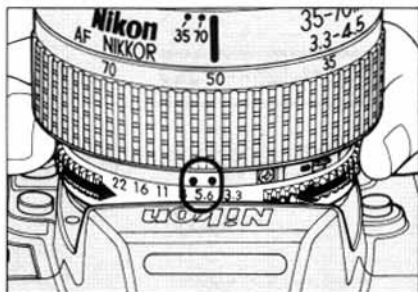
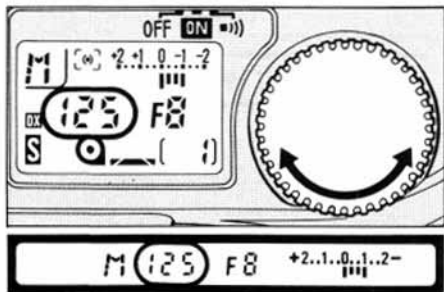

3. Adjust shutter speed and aperture until the Electronic Analog Display indicates 0 or desired exposure.

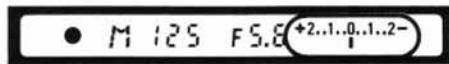

4. Confirm shutter speed and aperture in the viewfinder.

- In Single Servo Autofocus mode, when recomposing may change the subject-to-camera distance, refocus by briefly removing your finger from the shutter release button and lightly pressing it again.
- In Continuous Servo Autofocus mode, when recomposing may not change subject-to-camera distance, push and hold the AFL button before recomposing.

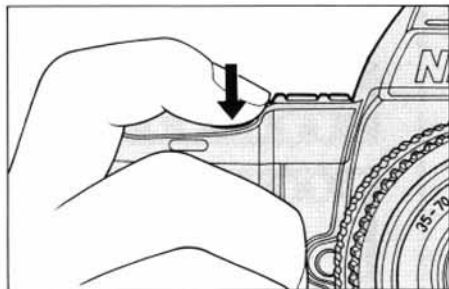

5. Recompose and shoot.

Auto Exposure Bracketing

By attaching the optional Nikon Multi-Control Back MF-21 to the N8008s you can take advantage of auto exposure bracketing to produce a variety of exposures for the same subject, each one suiting specific needs and/or tastes. This lets you shoot up to 19 continuous frames, each with a different exposure. For details, see the MF-21 instruction manual.

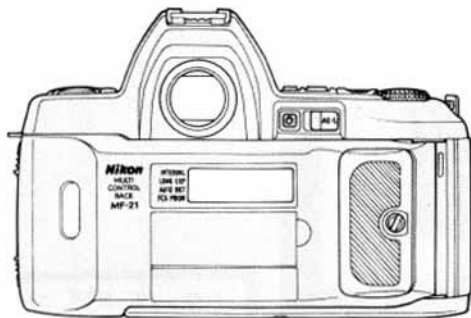

If N8008s is not mentioned in your MF-21 instruction manual:

Follow the same procedures as for the N8008 *except* for the explanation on the left of page 57. When the N8008s is in manual focus or continuous servo autofocus mode, depressing the shutter release button lets you perform auto exposure bracketing the same as in single servo autofocus, described on the right of the page.



DEPTH-OF-FIELD PREVIEW BUTTON

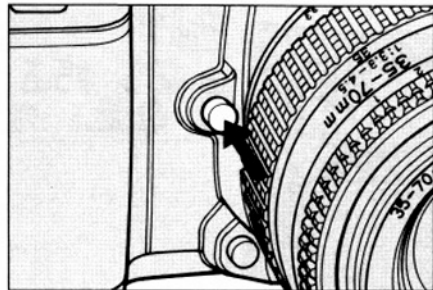

When a lens with an automatic diaphragm is used, the viewfinder image is viewed with the lens at maximum aperture. By depressing the depth-of-field preview button however, the lens is stopped down to the aperture set, enabling you to examine depth of field before shooting. The viewfinder image normally darkens as the aperture gets smaller. Those portions of the picture that appear in focus when the button is pushed down are in the zone of sharpest focus.

While the depth-of-field preview button is depressed, shutter speed disappears and F-- appears in the aperture position. Shutter locks. Depth of field can only be previewed in Aperture-Priority Auto (A) or Manual (M) exposure modes.

STOP-DOWN EXPOSURE METERING

For lenses without automatic diaphragm

When the automatic diaphragm ring does not couple with the meter coupling lever of the camera, such as when using a PC-Nikkor or bellows attachment, focusing should be done with the lens wide open while exposure measurement and shooting must be done with the lens stopped down.

In A mode:

Take a shot with the lens stopped down. With a PC-Nikkor, correct exposure must be determined before **shifting**. To do this, first use the AE Lock, then the lens can be shifted to take the shot.

In M mode:

Stop down the lens to determine the correct exposure, then take the shot.

For lenses with fixed aperture

Because aperture is fixed when using Reflex-Nikkor lenses, for photomicrography or for telescopic photography, it is impossible to change the exposure by varying the aperture.

In A mode:

Take the shot by simply depressing the shutter release button.



In M mode:

Select the appropriate shutter speed for correct exposure. If a correct exposure cannot be obtained, use either an ND filter (if the scene is too bright) or supplementary illumination (if too dark).

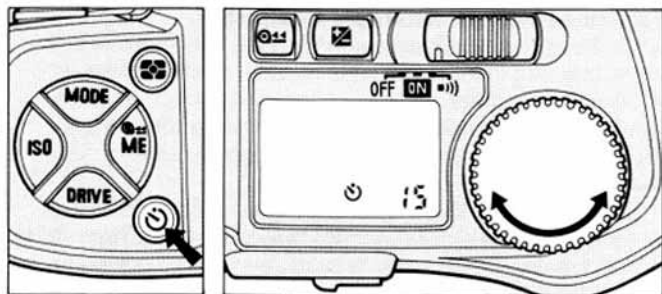
SELF-TIMER



Using the self-timer activates autofocus and auto exposure operation.

1. Slide power switch to ON or  .
2. While pressing self-timer button  , rotate command dial to set desired timer duration.
Timer duration can be selected between 2 to 30 seconds in one second increments.
3. Confirm self-timer mark  and timer duration in the LCD panel.

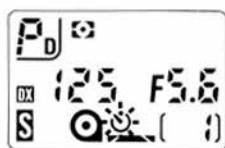
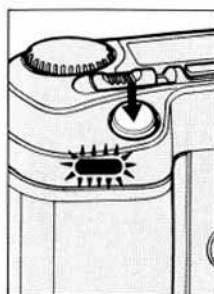
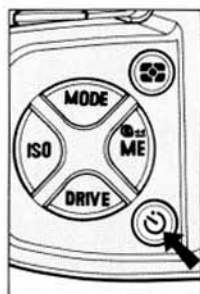

4. Compose picture and confirm focus and exposure.
5. While pressing self-timer button, fully depress shutter release button.
Self-timer LED starts blinking, beeper will sound (if set) and self-timer indicator blinks. For the final two seconds, the blinking LED and beeper speed up, telling you to get ready.

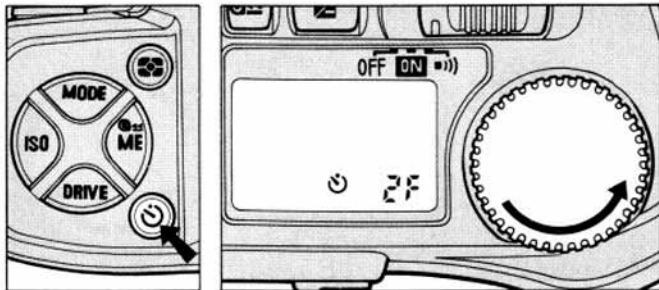

Two-Shot Self-Timer

It is possible to take two consecutive self-timer pictures. While pressing the self-timer button, rotate the command dial counterclockwise until "2F" appears at the timer duration position in the LCD panel. In consecutive self-timer shooting, the shutter is released for the first shot after approx. 10 sec., and the second shot is taken 5 sec. later.

- To cancel self-timer after activating, press self-timer button again.
- In self-timer operation, shutter is released whether subject is in focus or not, even in Single Servo Autofocus mode.
- In self-timer operation, when focus mode is set to either Single Servo Autofocus or Continuous Servo Autofocus, lightly pressing the shutter release button activates autofocus operation.
- Exposure is locked when self-timer operation starts.
- In Programmed, Shutter-Priority, or Aperture-Priority Auto exposure mode, use eyepiece cover DK-8 (provided) to prevent stray light from entering the viewfinder and affecting exposure.

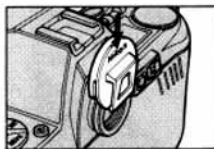

- Regardless of film advance mode setting, continuous-frame shooting is not possible (except for two-shot self-timer operation).

MULTIPLE EXPOSURE PHOTOGRAPHY

Multiple exposures are created by taking pictures of different subjects or successive pictures of one subject on the same frame. Up to 9 exposures can be set, using a variety of exposure techniques.

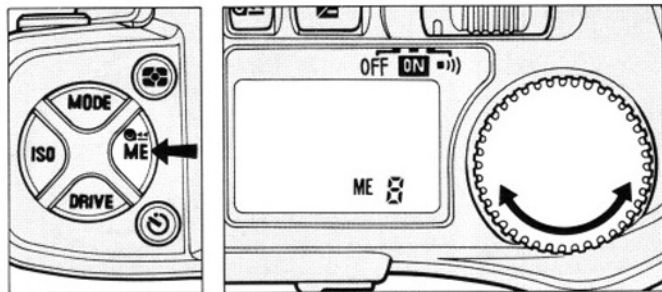

1. Slide power switch to ON or .
2. While pressing multiple exposure button (ME), rotate command dial to set desired number of exposures.
3. Confirm multiple exposure indication "ME" and number of exposures in LCD panel.

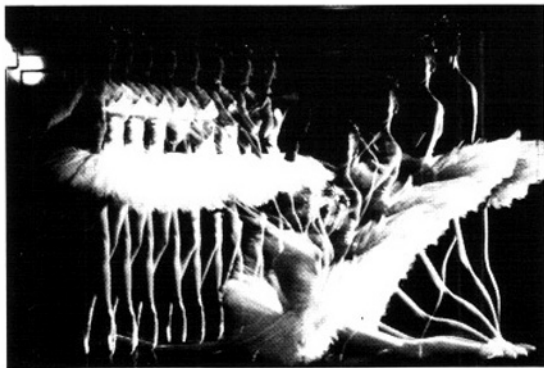

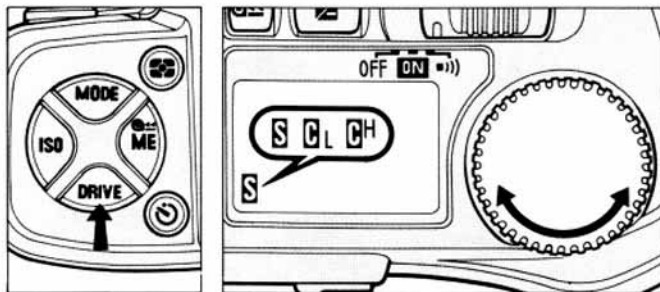

4. While pressing film advance mode button, rotate command dial to select S, CL or CH.

ME-S: For single exposure at one shutter release.

ME-C (CH or CL mode): For multiple exposures at a single shutter release.

Compose picture, confirm focus and exposure, and fully depress shutter release button. The exposures number indication in the LCD panel counts down with each exposure.

"ME" mark blinks during multiple exposures.

- In ME-C mode, exposures are taken continuously as long as the shutter release button is fully depressed. To stop shooting, remove finger from the button.
- When multiple exposure is complete, film automatically advances to next frame and multiple exposure is cancelled.
- To cancel multiple exposure midway, while pressing the multiple exposure button, rotate the command dial until no number shows. Film advances when you remove finger from the button.

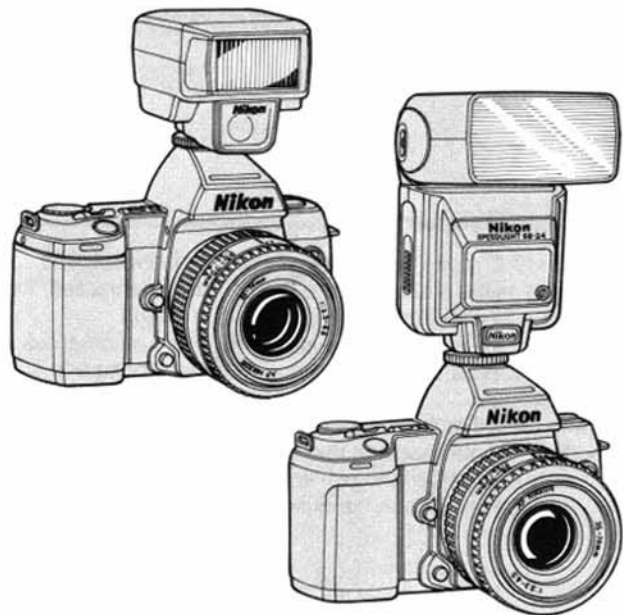



Matrix Balanced Fill-Flash in daylight

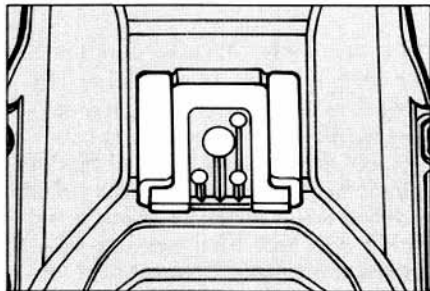

Matrix Balanced Fill-Flash at night



The Nikon N8008s's accessory shoe lets you directly mount a wide range of Nikon dedicated electronic Speedlights, including SB-24, SB-23, SB-22, SB-20, SB-18, SB-16B and SB-15. Each unit takes full advantage of the N8008s's built-in computer, which automatically synchronizes the camera's shutter and lens aperture to provide precisely controlled exposures. This means you can perform automatic balanced fill-flash in TTL mode in every flash shooting situation, for beautiful, naturally balanced foregrounds and backgrounds with a truly professional look. Automatic balanced fill-flash lets you choose any of the four different flash categories shown, matching your Speedlight TTL mode with the appropriate metering system and exposure mode.

		Speedlight setting	SB-24 at TTL 	SB-23/22/20/18/16B/15 at TTL	SB-24 at TTL 
Metering system	Exposure mode				
Matrix Metering	PD/P/PH/S/A	Matrix Balanced Fill-Flash			Standard TTL Flash
	M				
Center-Weighted Metering	PD/P/PH/S/A	Center-Weighted Fill-Flash			
	M				
Spot Metering	PD/P/PH/S/A	Spot Fill-Flash			
	M				

For details about Matrix Balanced Fill-Flash, Center-Weighted Fill-Flash and standard TTL flash, refer to the Nikon F-801/N8008 camera explanation in your Nikon Speedlight instruction manual.

Matrix Balanced Fill-Flash

When taking flash pictures, although the subject is usually well illuminated, background lighting can vary dramatically. This is especially true when the main subject is very close, and the background is relatively dark or only moderately bright.

Matrix Balanced Fill-Flash balances both the subject and background illumination, automatically. How? Matrix Metering adjusts for the background and the TTL flash exposure level, so the flash illumination is balanced and won't overpower the foreground subject. This creates a natural and pleasing effect, filling in harsh shadows and bringing out subject detail without losing the correct background exposure.

This system operates automatically: based on a combination of general scene brightness and contrast, the exposure value for the background is determined by one of five computation methods: Low-Brightness Weighted, Center-Segment, Average, High-Brightness Weighted, or Very-High-Brightness Weighted. Flash exposure value is controlled in a similar way. The combination of ambient light and flash light is balanced to produce a natural and pleasing effect.

In Programmed Auto (PD, P, PH) modes, the sync speed of 1/250 sec. has priority, but when the aperture reaches its largest limit (variable according to ISO film speed), the program line fixes the shutter speed at 1/60 second. Aperture is controlled between f/4 (at ISO 100) and the lens' smallest aperture. In Shutter-Priority Auto (S) mode, you can choose sync speeds from 1/250 to 30 sec., enabling you to shoot, for example, a city-scape of night lights, with automatic flash exposure for foreground subjects. Aperture is controlled between f/2.8 (at any ISO film speed) and the lens' smallest aperture.

In Aperture-Priority Auto (A) mode, you select aperture and the camera selects a suitable sync speed, within a range of 1/60 to 1/250 sec. (at any ISO film speed).

With Manual (M), you control both aperture and shutter speed while the flash exposure is determined by scene brightness and contrast, with Matrix Balanced Fill-Flash control throughout. In S and M modes, when you select a shutter speed faster than 1/250 sec. and then turn the flash unit ON, the N8008s automatically shifts to 1/250 sec.

Center-Weighted Fill-Flash

For flash photography in ordinary TTL, or to emphasize detailed background areas, use Center-Weighted Fill-Flash. In this mode, when value measured by center segment is within controlled shutter speed/aperture range, flash output compensation is automatically set 2/3 EV lower than standard TTL flash output, for natural fill-flash photography. (If the value is less than that of the controlled range, standard TTL flash without compensation is selected.)

Spot Fill-Flash

Automatic flash output compensation is performed in the same manner as in Center-Weighted Fill-Flash.

As the area measured is represented by the 3.5mm-diameter circle in the center of the viewfinder, Spot Fill-Flash is recommended when shooting a subject with high-contrast background and when you want to emphasize picture contrast. In this case, first measure exposure on the desired part of the background, recompose using auto exposure lock, and then shoot.





Standard TTL Flash

In this mode, although exposure for the background is metered by each metering system, flash output level is not determined automatically. However, you can manually select flash output compensation (on the SB-24) at levels from +1 to -3 EV, for greater personal creativity.

Nikon Speedlight SB-24 lets you take advantage of a special photographic technique called rear-curtain sync flash. For details, see page 72.

Shutter Speed/Aperture and Flash Mode Combinations for Each Exposure Mode

In Matrix Metering (With 50mm f/1.4 lens at ISO 100)

Speedlight Exposure mode	SB-24					SB-23/22/20/18/16B/15	
	Front-curtain sync			Rear-curtain sync		TTL	Non-TTL auto Manual
	TTL 	TTL 	Non-TTL auto Manual	TTL 	TTL 		
PD P PH	1/60-1/250 1/4-1/16 (1)	1/60-1/250 1/4-1/16 (1)	P, FEE blink Shutter locks Select A or M	30"-1/250 1/4-1/16 (1)	30"-1/250 1/4-1/16 (1)	1/60-1/250 1/4-1/16 (1)	P, FEE blink Shutter locks Select A or M
S	As set (3) 1/2.8-1/16 (2)	As set (3) 1/2.8-1/16 (2)	S, FEE blink Shutter locks Select A or M	As set (3) 1/2.8-1/16 (2)	As set (3) 1/2.8-1/16 (2)	As set (3) 1/2.8-1/16 (2)	S, FEE blink Shutter locks Select A or M
A	1/60-1/250 As set	1/60-1/250 As set	1/60-1/250 As set (4)	30"-1/250 As set	30"-1/250 As set	1/60-1/250 As set	1/60-1/250 As set (5)
M	As set (3) As set	As set (3) As set	As set (3) As set (4)	As set (3) As set	As set (3) As set	As set (3) As set	As set (3) As set (5)

 : Matrix Balanced Fill-Flash (background correctly exposed; TTL flash level automatically compensated)

 : Standard TTL flash

- (1) Maximum usable aperture varies according to film speed in use; minimum aperture is the smallest aperture of the lens in use.
- (2) Maximum usable aperture is $f/2.8$; minimum aperture is the smallest aperture of the lens in use.
- (3) When set from $1/250$ to $1/8000$ sec., the shutter is automatically set to $1/250$ sec.
- (4) Recommended background exposure is displayed. Extra flash level compensation not possible.
- (5) Recommended background exposure is displayed. Normal flash control.

- Usable film speed for TTL flash photography is ISO 25-1000; for non-TTL flash photography, it is 6-6400.
- For details on speedlight operation, see the speedlight instruction manual.
- Use Nikon Speedlights. Other units may damage the camera's electrical circuit due to incompatible voltage requirements, electric contact alignment or switch phase.
- When using a special speedlight with a time-lag provision or when using a speedlight with a long flash duration (i.e., Nikon Repeating Flash SB-6 at $1/2$ or full output or Medical-Nikkor 120mm $f/4$), adjust shutter speed down to $1/125$ sec. or slower.
- When using a speedlight that does not allow automatic sync speed setting, set the camera's exposure mode to Manual.

Matrix Balanced Fill-Flash Operation

The following instructions are for Matrix Balanced Fill-Flash shooting in Programmed (PD, P, PH) mode, the easiest way for normal shooting. For other exposure or TTL modes, or for non-TTL auto and manual flash shooting, see your speedlight instruction manual.

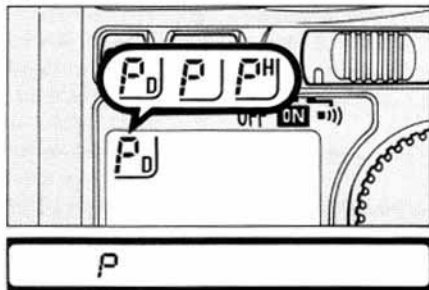

1. Set the N8008s to P DUAL, P or P HI mode.

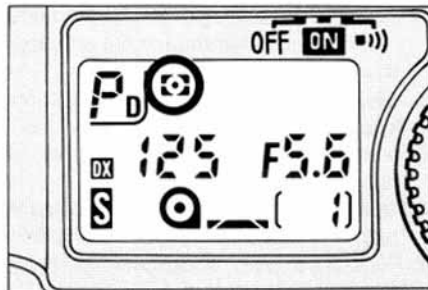

2. Set the N8008s to Matrix Metering system.

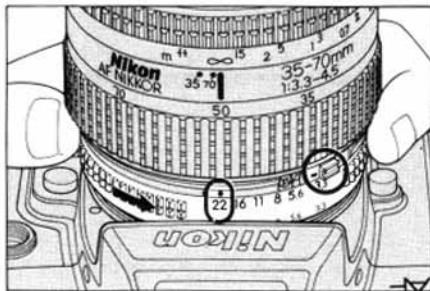

3. Set lens to its minimum aperture (largest f-number).

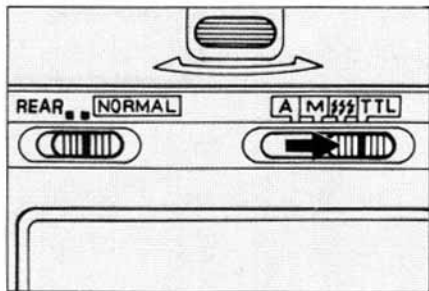

4. Set speedlight's mode selector to TTL. (With SB-24, set flash sync mode selector to NORMAL.)



5. Turn the speedlight on. (With SB-24, TTL  mark appears in the LCD panel.)



6. Look inside the viewfinder and lightly press the shutter release button. (With SB-24, angle of coverage is automatically adjusted.)
- When ready-light comes on but ambient light is insufficient for autofocus operation, AF illuminator turns on to start autofocus operation.

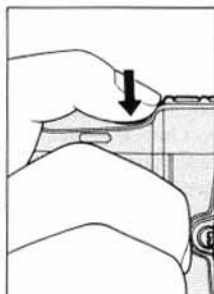
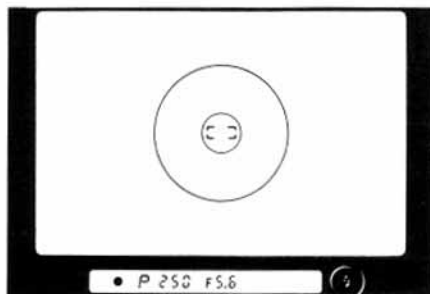

7. With the ready-light and in-focus indicator LCD on, as long as you have none of the following warning indications, you can shoot.

HI appears:	Overexposure alert.
F-- appears:	Non-CPU lens is used. Exposure mode is automatically set to A, and metering system to Center-Weighted.
FEE appears:	Lens is not set to minimum aperture. Shutter locks.

- If the ready-light blinks for a few seconds after shooting, move closer to the main subject or select a wider aperture by setting the camera to A or M exposure mode. For flash shooting distance range, see the speedlight instruction manual.

Rear-curtain Sync Flash Photography

When using the SB-24, you can synchronize the flash to the instant when the rear (second) curtain starts moving. Set the SB-24's flash sync mode selector to "REAR". This lets you turn available light into a stream of light that **follows** the flash illuminated subject.

Rear-curtain sync flash photography is most effective with slower shutter speeds. Although the slowest possible shutter speed for front-curtain sync flash photography in TTL mode, with camera at PD, P, PH or A, is only 1/60 second, with rear-curtain sync flash photography, you can slow the shutter down to 30 seconds, depending on background.

Ready-Light Warnings

When using Nikon dedicated Speedlights, the N8008s's viewfinder ready-light LED lights up when the flash is recycled. The following ready-light indications are used for warnings:

Before shooting: ⚡ disappears ⚡ blinks	Recharging Poor connection between camera and speedlight. (Keep speedlight and camera electrical connections clean.)
After shot: ⚡ blinks	Light may be insufficient for correct exposure; confirm shooting distance range.



Rear-curtain sync



Front-curtain sync

VIEWFINDER INFORMATION

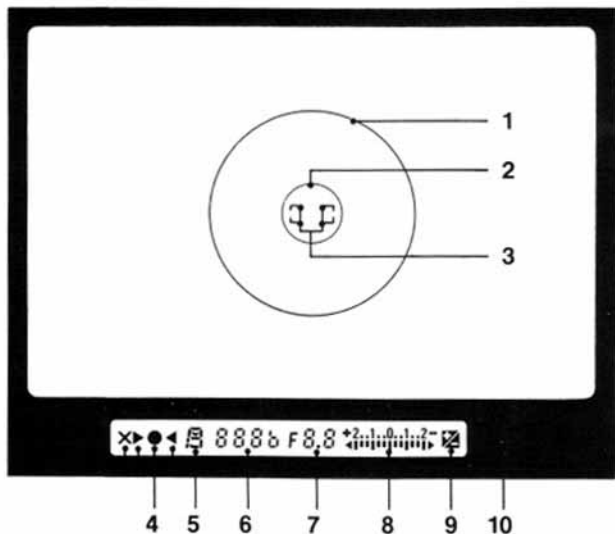

- 1 12mm-dia. reference circle for Center-Weighted metering
- 2 3.5mm-dia. reference circle for Spot metering
- 3 Focus brackets
- 4 Focus
 - In-focus indication for a stationary subject
 - ▶◀ Focus tracking
 - ▶ Focus-to-right arrow for manual focus
 - ◀ Focus-to-left arrow for manual focus
 - × Focus-not-possible alert
- 5 Exposure mode
 - Dual Program/Normal Program/High-speed Program
 - Shutter-Priority Auto
 - Aperture-Priority Auto
 - Manual
- 6 Shutter speed/film speed
 - Same as LCD panel.
- 7 Aperture/exposure compensation value
 - Same as LCD panel.
- 8 Electronic Analog Display
 - Same as LCD panel.
- 9 Exposure compensation mark
 - Same as LCD panel.
- 10 Ready-light LED

LCD INFORMATION

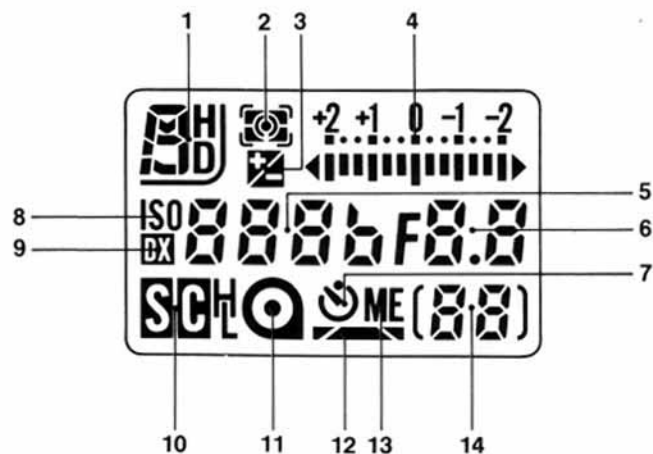

1 Exposure mode

- Dual Program
- Shutter-Priority Auto
- Aperture-Priority Auto
- Manual
- High-speed Program
- Normal Program

2 Exposure metering system

- Matrix Metering
- Center-Weighted Metering
- Spot Metering

3 Exposure compensation

- In use
- Off

4 Electronic Analog Display

Examples:

Over +2EV

+2EV

±0EV

-2/3EV

Below -2EV

5 Shutter speeds

buLb-30"-15"-8"-4"-2"-1"-2-4-8-15-30-60-125-250-
500-1000-2000-4000-8000

Alert indications

Hl, Lo, Err

Film speeds

6-8-10-12-16-20-25-32-40-50-64-80-100-125-160-
200-250-320-400-500-640-800-1000-1250-1600-2000-
2500-3200-4000-5000-6400

6 Aperture settings

F1-F1.4-F2-F2.8-F4-F5.6-F8-F11-F16-F22-F32-F45-F64

* An intermediate figure may appear in the case of a lens' maximum aperture value.

Alert indications

FEE, F--, HI, Lo

Exposure compensation values

0.0-0.3-0.7-1.0-1.3-1.7-2.0-2.3-2.7-3.0-3.3-3.7-4.0-4.3-4.7-5.0

7 Self-timer



In operation

– Off

8 Film speed setting

ISO When film speed is displayed

– Not displayed

9 DX-coded film speed setting

DX DX position selected

– Not selected

10 Film advance mode



Single



Continuous Low



Continuous High

11 Film installation



Installed

– Not installed

12 Film advance and rewind



Correctly loaded



Loading now



Rewinding

13 Multiple exposure

ME In operation

– Off

14 Frame counter

[E]-[0]-[1]-[2]-[3]-[4]-.....-[24]-.....-[36]-.....-[72]-.....-[99]

Self-timer duration

2-3-4-.....-28-29-30-2F

Number of multiple exposures

2-3-4-.....-8-9

Nikon N8008s is designed for autofocus photography with AF Nikkor lenses (except AF-Nikkor lenses for F3AF). However, most other Nikon lenses can be used for standard photography according to the conditions listed in the following chart.

Lens Compatibility Chart

	Focusing		Exposure mode				Metering system		
	Autofocus	Manual with electronic rangefinder	Programmed Auto	Shutter-Priority Auto	Aperture-Priority Auto	Manual	Matrix Metering	Center-Weighted Metering	Spot Metering
AF Nikkor lenses (except AF Nikkor lenses for F3AF)	○	○	○	○	○	○	○	○	○
AI-P-type Nikkor lenses	○*1	○*2	○	○	○	○	○	○	○
AI- or AI-S-type Nikkor lenses	○*1	○*2	×	×	○	○	×	○	○
AI-modified Nikkor lenses	×	○*2	×	×	○	○	×	○	○
Medical-Nikkor 120mm 1/4 IF	×	○	×	×	×	○*3	×	×	×
Reflex Nikkor lenses*	×	×	×	×	○*5	○*5	×	○	○
PC-Nikkor lenses*	×	×	×	×	○*6	○*7	×	○	○
Teleconverter TC-16A	○*8	×	×	×	○	○	×	○	○
AI- or AI-S-type Teleconverters (except TC-16A)	×	○*9	×	×	○	○	×	○	○
Bellows Focusing Attachment PB-6	×	○*9	×	×	○*10	○*10	×	○	○
K Ring Set (K1, K3, K4 and K5)**	×	○*9	×	×	○*11	○*11	×	○	○
Auto Extension Rings (PK-11A, 12, 13 and PN-11)***	×	○*9	×	×	○	○	×	○	○

* Some lenses cannot be attached to the N8008s.

** K1 ring cannot be attached to AF Nikkor lenses. The ring may damage CPU contacts. Use PK-11A or BR-6 instead.

*** PK-1, PK-2, PK-3 and PN-1 rings cannot be attached to the N8008s. PK-11 ring cannot be attached to AF Nikkor lenses. These rings may damage CPU contacts. Use PK-11A for AF Nikkor lenses instead of PK-11.

- Compatible
- × Incompatible
- *1 With maximum effective aperture of f/5.6 or faster when using the TC-16A Autofocus Converter.
- *2 With maximum aperture faster than f/5.6.
- *3 Set shutter speed to 1/125 sec. or slower.
- *4 Because the diaphragm is coupled to the focusing ring, determining exposure is independent from camera's metering system.
- *5 Aperture cannot be selected.
- *6 Set preset ring, then use AE-lock lever before shifting.
- *7 Set preset ring, then determine exposure before shifting.
- *8 With AI- or AI-S-type Nikkor lenses having maximum aperture of f/3.5 or faster.
- *9 With maximum effective aperture of f/5.6 or faster.
- *10 Shutter should be released after exposure is measured by stopping down PB-6.
- *11 Stop-down exposure measurement will be performed.

The following accessories cannot be used with the Nikon N8008s.

- * Close-up Attachments PK-1 – 3, PN-1, K2, BR-2
- * Body Cap BF-1
- * Eyepiece Accessories for F3HP/F3T
- PK-1, PK-11, BR-4 and K-1 Rings cannot be mounted directly on AF Nikkor lenses.
- The Nikon Matrix meter evaluates scene brightness and contrast using a five-segment sensor. Since colored filters and neutral density filters which have a high exposure factor will also significantly affect a scene's contrast rendition, they may cause the meter to incorrectly identify the scene's actual contrast/brightness condition. The blue (B12), orange (O56) and red (R60) filters are examples of such colored filters.
- Linear polarizers are not compatible with the viewing system used in Nikon AF cameras. For the best results and to maintain autofocus and exposure operation, we recommend using a circular polarizer, which is fully compatible with the Nikon system. Using a linear polarizer, however, will not damage the Nikon system, and it may be used for fully manual focusing and exposure settings made without using the built-in meter or electronic rangefinder.
- Special filters, such as soft focus filters, cannot be used for autofocus or for manual focus with electronic range finder.

INTERCHANGING FOCUSING SCREENS

In addition to the advanced B-type BriteView screen supplied with the N8008s, the Type E clear Matte/Fresnel screen with focusing brackets and grid is available as an option. Type E screen is suitable for copying and architectural photography.

Type J screen for Nikon N8008 cameras can also be used with the Nikon N8008s; with Type J screen, however, Spot Metering cannot be performed.

Be sure not to touch the focusing screen or reflex mirror with your fingers.

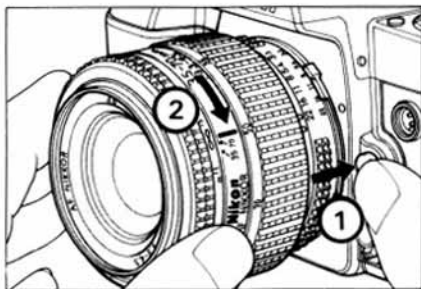

1. Remove the lens.

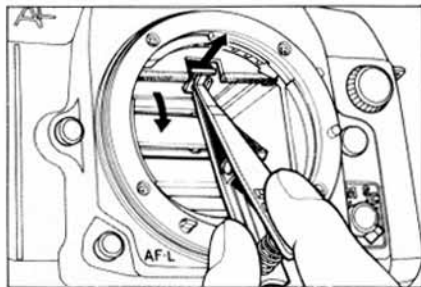

2. Slip the tip of the special tweezers (provided with optional screens) under the focusing screen release latch and pull outward to spring open the holder.

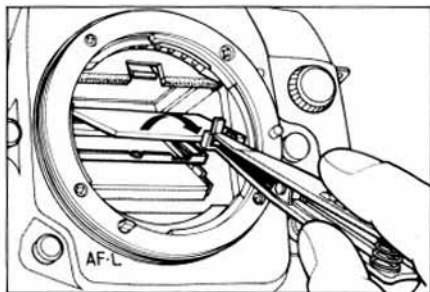

- 3.** Remove the screen by grasping the small tab with the tweezers.

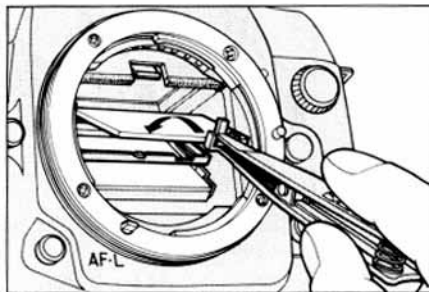

- 4.** Carefully position the replacement screen in place, making sure the flash side is facing down.

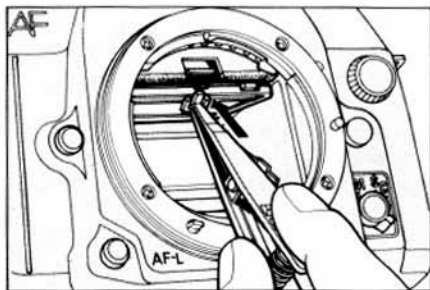

- 5.** Using the tweezers, push the front edge of the holder upward until it clicks into place. An improperly placed focusing screen causes unreliable focus information in the viewfinder.

CAMERA CARE TIPS



1. **Do not** touch the camera's reflex mirror or focusing screen. Remove dust with a blower brush.



2. **Do not** touch the shutter curtains.

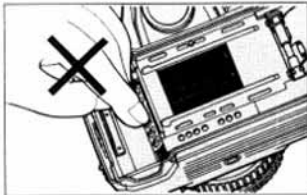

3. **Do not** touch the DX contacts. Keep them clean with a blower brush.

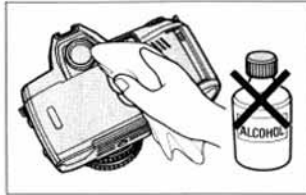

4. Clean the viewfinder eyepiece with a soft, clean cloth. **Do not** use alcohol.

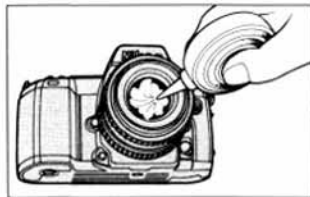

5. Clean glass surfaces, such as the lens with a blower brush; **do not** use lens tissue, silicon type eyeglass tissue, etc. To remove dirt and smudges, use soft cotton moistened with denatured alcohol and wipe surface in a spiral motion from center to periphery. **Do not** leave traces.

Caution!

A spray gun-type blower may damage the optical glass if used to clean the lens, especially if ED glass is used for the front lens element. To avoid damage, hold the blower upright with its nozzle more than 30cm (12 in.) from the lens surface, and keep the nozzle moving so the stream of air is not concentrated in one spot.

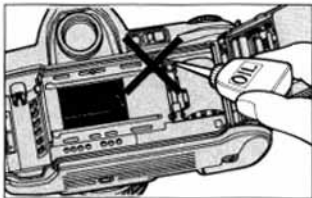

6. Do not lubricate the camera.

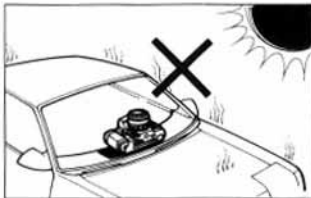

7. Do not leave the camera in an excessively hot place.



8. Keep the camera away from water or moisture. When using the camera near water, guard against splashes, especially salt water spray.



9. Make sure not to drop or bump the camera body/lens against a hard surface. Strong shock may cause malfunction.



10. If the camera malfunctions, take it immediately to an authorized Nikon dealer or service center.



11. Store the camera in a cool, dry place away from naphthalene or camphor (moth repellent). In a humid environment, store the camera inside a vinyl bag with a desiccant to keep out dust, moisture and salt. Note, however, that storing leather cases in vinyl bags may cause the leather to deteriorate.



NOTES ON BATTERIES



1. Keep batteries out of children's reach. If swallowed, call a doctor immediately.

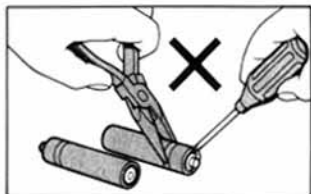

2. Never disassemble, short-circuit, heat or attempt to charge batteries.

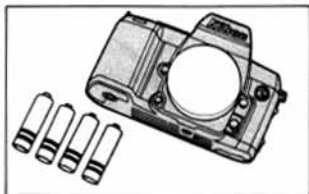

3. When not using the camera for a long period, remove batteries.



4. Battery power falls off in extremely cold temperatures — make sure batteries are new and keep the camera body wrapped in something warm.

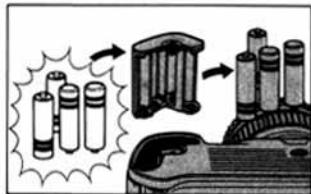

5. When replacing batteries, be sure to replace all batteries at the same time. Always use fresh batteries of the same brand.

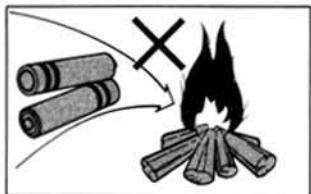

6. Do not throw used batteries into a fire.



7. If the battery chamber is contaminated by battery leakage, take the camera to an authorized Nikon dealer.

Compared with regular batteries, NiCd batteries provide greater efficiency at low temperatures. Before charging NiCd batteries, thoroughly read the instructions for batteries and battery charger.

SPECIFICATIONS

Type of camera	Integral-motor autofocus 35mm single-lens reflex	Exposure meter switch	Activated by lightly pressing shutter release button; stays on for approx. 8 sec. after lifting finger from button
Picture format	24mm x 36mm (standard 35mm film format)	Metering range	EV 0 to EV 21 (at ISO 100 with f/1.4 lens) for Matrix and Center-Weighted metering; EV 4 to EV 21 (at ISO 100) for Spot metering
Lens mount	Nikon F mount	Exposure modes	Programmed auto (PD, P, PH), shutter-priority auto (S), aperture-priority auto (A) and manual (M) modes
Lens	AF Nikkor lenses, and Nikon lenses with Nikon F mount (with limitation) available	Programmed auto exposure control	Both shutter speed and aperture are set automatically; flexible program in one EV step possible
Focus modes	Autofocus, and manual focus with electronic range finder	Shutter-priority auto exposure control	Aperture automatically selected to match manually set shutter speed
Autofocus		Aperture-priority auto exposure control	Shutter speed automatically selected to match manually set aperture
Autofocus detection system	TTL phase detection system using Nikon advanced AM200 autofocus module	Manual exposure control	Both aperture and shutter speed are set manually
Autofocus detection range	Approx. EV minus 1 to EV 19 (at ISO 100)	Shutter	Electromagnetically controlled vertical-travel focal-plane shutter
Autofocus actuation method	Single servo and continuous servo	Shutter release	Electromagnetic shutter by motor trigger
Focus Tracking	Focus tracking is automatically activated when the camera is set to Continuous Servo Autofocus and CL film advance mode.	Shutter speeds	Lithium niobate oscillator-controlled speeds from 1/8000 to 30 sec.; electromagnetically controlled long exposure at B setting
Autofocus lock	Possible by lightly pressing shutter release button in Single Servo AF mode or by using AF Lock button	Viewfinder	Fixed eyelevel pentaprism high-eye-point type; 0.75X magnification with 50mm lens set at infinity; 92% frame coverage
Electronic range finder	Available in manual focus mode with an AF Nikkor and other AI-type Nikkor lenses with a maximum aperture of f/5.6 or faster		
Exposure metering	Three types of exposure metering systems — Matrix Metering, Center-Weighted and Spot		

Eye point	Approx. 19mm	
Eye piece cover	Model DK-8 prevents stray light from entering viewfinder	
Focusing screen	Nikon advanced B-type BriteView screen with central focus brackets for autofocus operation	
Viewfinder information	The following LCD indications appear: focus indicators, exposure modes, shutter speeds/film speeds, aperture/exposure compensation value, electronic analog display, exposure compensation mark; ready-light LED; viewfinder display is illuminated automatically or by pressing the viewfinder illumination button	
LCD information	The following indications appear: exposure modes, metering types, exposure compensation, electronic analog display, shutter speeds/film speeds, aperture/exposure compensation value, film speed setting, DX-coded film speed setting, film advance mode, film installation, film advance and rewind, self-timer, multiple exposure, frame counter/self-timer duration/number of multiple exposure	Auto exposure lock Film speed range Film speed setting Film loading Film advance
Electronic beeper	With power switch at (●) , beeper sounds in the following cases: operation signals; (1) at end of film roll; (2) when film rewinding is com-	plete; (3) during self-timer operation; alert signals; (1) for over- or under-exposure and possible picture blur in PD, P, PH or A mode; (2) when lens is not set to the smallest aperture setting in PD, P, PH or S mode; (3) when non-DX-coded film, damaged film or film with an unacceptable DX-code is loaded; (4) such as torn or damaged film during film advance Available via sliding the AE Lock lever while the meter in on ISO 25 to 5000 for DX-coded film; ISO 6 to 6400 for manual setting At DX position, automatically set to ISO speed of DX-coded film used; with non-DX-coded film, ISO speed is set manually Film automatically advances to first frame when shutter release button is depressed once In S (Single-frame) shooting mode, film automatically advances one frame when shutter is released; in CH (Continuous High) or CL (Continuous Low) shooting mode, shots are taken as long as shutter release button is depressed; in CH mode, shooting speed is approx. 3.3fps, and in CL, approx. 2.0fps (in Continuous Servo Autofocus or manual focus

	mode, with new batteries at normal temperatures, and a shutter speed faster than 1/125 sec. in manual exposure mode)
Frame counter	Accumulative type: counts back while film is rewinding
Film rewind	Automatically rewinds by pressing film rewind button and multiple exposure/film rewind button; approx. 10 sec. per 24-exposure roll; stops automatically when film is rewound
Self-timer	Electronically controlled; timer duration can be selected between 2 to 30 sec. in one sec. increments; blinking LED indicates self-timer operation; two-shot self-timer is possible; cancellable
Exposure compensation	Possible using exposure compensation button within ± 5 EV range in 1/3 EV steps
Multiple exposure	Up to 9 exposures can be set
Depth-of-field preview button	Provides visual verification of depth of field; can be previewed in A or M mode
Reflex mirror	Automatic, instant-return type
Camera back	Hinged back; exchangeable with Nikon Multi-Control Back MF-21 or Data Back MF-20
Accessory shoe	Standard ISO-type hot-shoe contact; ready-light contact, TTL flash contact, monitor contact

Flash synchronization 1/60 to 1/250 sec. in PD, P, PH or A mode; in S or M mode, shutter fires at speed set, and when set from 1/250 to 1/8000 sec., shutter is automatically set to 1/250 sec.; down to 30 sec. shutter is available by using SB-24 in rear-curtain sync

Flash ready-light Viewfinder LED lights up when Nikon dedicated speedlight is ready to fire; blinks to warn of poor camera/speedlight connection or insufficient light for correct exposure

Autofocus flash photography Possible with Nikon Autofocus Speedlights SB-24, SB-23, SB-22 or SB-20

Power source Four AA-type batteries

Number of 36-(24-)exposure film rolls per set of fresh batteries (approx.)*

For Continuous Servo Autofocus with AF Nikkor lens covering the full range from infinity (∞) to the closest distance and back to infinity (∞) before each shot

Batteries	At 68°F	At 14°F
Alkaline-manganese (LR06)	105 (160)	15 (22)
Manganese	25 (38)	3 (5)
NiCd (KR-AA)	75 (110)	22 (33)

*Using AF Nikkor 50mm f/1.8 or AF Nikkor 35-70mm f/3.3-4.5, with film advance mode at CH and a shutter speed of 1/125 sec. or faster.

**Checking
battery power**

Battery power is sufficient if shutter speed and aperture indications appear in the LCD panel and viewfinder by lightly pressing shutter release button, and remain on for approx. 8 sec. after finger is removed from the button; insufficient if these indications turn off immediately after finger is removed from the button; if LCD blinks and shutter locks, batteries are exhausted; if no data appears and shutter does not operate, batteries are exhausted or improperly loaded

Dimensions (W x H x D) 6.1 x 4.1 x 2.6 in.

(154 x 103 x 67 mm)

Weight (body only) Approx. 24.5 oz. (695g)

With fresh alkaline batteries at normal temperature (68°F).
Specifications and designs are subject to change without notice.

This device complies with Part 15 of the FCC Rules. Operation is subject to the following two conditions:
(1) This device may not cause harmful interference, and
(2) this device must accept any interference received, including interference that may cause undesired operation.

"This equipment has been tested and found to comply with the limits for a Class B digital device in accordance with the specifications set forth in Part 15 of the FCC Rules. If this equipment does cause interference to radio or television reception which can be determined by turning the equipment on and off, use the equipment in another location and/or utilize an electrical outlet different from that used by the receiver."

For multiple flash photography using Nikon Speedlights, if the electric current in the synchro circuit exceeds a certain level, you may not be able to take a second shot after taking the first shot. Take care that the combined total of the coefficients (numbers shown in parenthesis below) for all of the speedlight's used at any one time does not exceed 20 at 68°F (13 at 104°F).

SB-24 (1) SB-23 (4) SB-22 (6) SB-21 (4) SB-20 (9)
SB-19 (2) SB-18 (16) SB-17 (4) SB-16 (4) SB-15 (4)
SB-14 (1) SB-12 (1) SB-11 (1)

If you are unable to take a second shot, disconnect master Speedlight from the N8008s, or turn each of the Speedlights off and on once.

In certain cases, due to static electricity or poorly loaded batteries, the N8008s's microcomputer may turn the camera off, even with fresh, properly installed batteries. For the same reason, film may not advance properly, or the film loading indication may start blinking before you come to the end of the film. In each of these cases, to resume operation, simply slide the power switch to OFF and turn on again, or remove batteries and install again.

Your Nikon camera requires precise electronic and mechanical matching between component products such as lenses and electronic flash. Nikon brand lenses and electronic flash units are made to Nikon's factory specifications and will operate properly and in accordance with the Nikon Limited Warranty provided. Damage to your Nikon product, as a result of malfunction or improper connections, caused by the use of non-Nikon brand products, **is not covered under the terms of the Nikon Limited Warranty and will void the Nikon warranty.**

Nikon cannot be held responsible for malfunction resulting from the use of the camera other than as specified in this manual.