

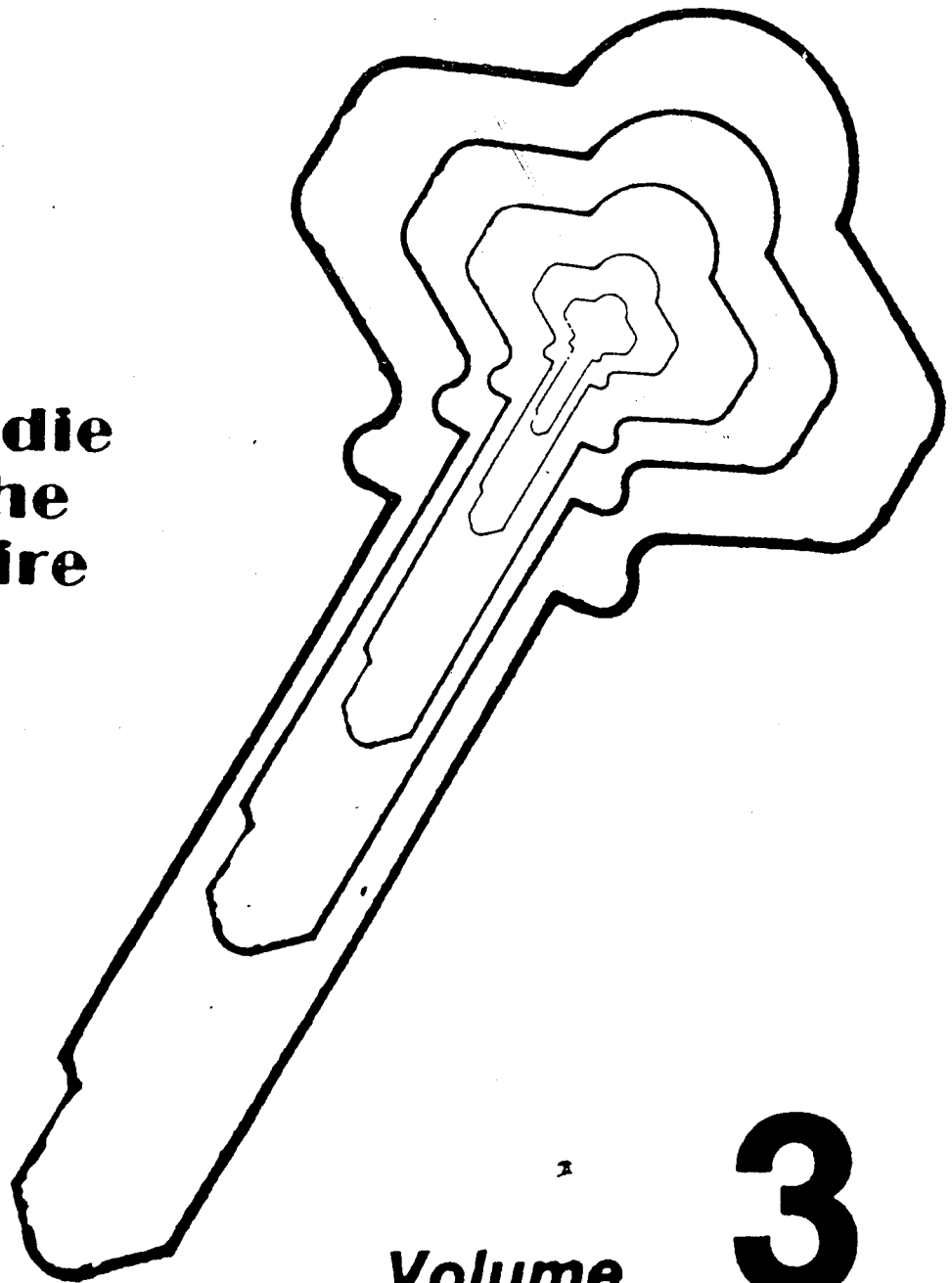

HOW TO MAKE YOUR OWN PROFESSIONAL LOCK TOOLS

**eddie
the
wire**



Volume

3

HOW TO MAKE YOUR OWN
PROFESSIONAL LOCK TOOLS

Volume Three

Eddie the Wire

Loompanics Unlimited

Port Townsend, WA

Other books by Eddie the Wire:
HOW TO MAKE YOUR OWN PROFESSIONAL LOCK TOOLS, Vol 1
HOW TO MAKE YOUR OWN PROFESSIONAL LOCK TOOLS, Vol 2
THE COMPLETE GUIDE TO LOCK PICKING
HOW TO BURY YOUR GOODS

HOW TO MAKE YOUR OWN PROFESSIONAL LOCK TOOLS, Vol 3
© 1981 by *Loompanics Unlimited*.

All rights reserved.
Printed in U.S.A.

Cover by **Michael Hoy**.
Illustrations by **Kevin Martin**.

Published by:
Loompanics Unlimited
PO Box 1197
Port Townsend, WA 98368

CONTENTS

The Pin Tumbler Simulator	4
Pick Guns	10
Weighted Tension Wrenches	13
Tension Wrenches for Lever Locks	17
Carrying Cases	22
A Tool for Picking Tubular Locks	26
Miscellaneous	33
Afterward	42

PREFACE

This is the third and final volume in the *How to Make Your Own Professional Lock Tools* series. The best is certainly the last in this case. The present volume is the most sophisticated and innovative of the series. Some concepts here are not even hinted at in any other literature, and point the way to even better tools and designs. Since this is the last of the series, all the odd bits of material will appear here.

Some of the tools and techniques described here may be in violation of local, state or federal statutes if built, possessed, or performed. The mere insertion of a lock tool into a keyway may constitute illegal entry. The author and Loompanics assume no responsibility whatever, either stated or implied, for any consequences resulting from the use of material in this series. As interpretation of the laws governing "intent" gets broader, the possibility of jeopardy increases, so be careful.

-Eddie the Wire

CHAPTER ONE

THE PIN TUMBLER SIMULATOR

This tool alone is worth more than the price of this book. The pin tumbler simulator gives instant and visual feedback as to the exact position of the pick tip and shank while in the lock. It is invaluable for practice.

If you don't already have a cheap five-pin tumbler lock in your collection, get one. Try to get one that has a spring retainer that can be easily removed, like a clip. (*Note: if you don't know what I'm talking about, you should study my previous book, THE COMPLETE GUIDE TO LOCK PICKING.*)

To prepare the lock, have five letter envelopes ready. Insert the key and turn the plug 90°. Hold the lock upright and remove the spring well retainer, allowing the springs to release tension gradually. With fingers or tweezers, remove the five springs and place in one envelope. Now hold your finger over the spring well holes, invert the lock, and uncover a hole at a time, dropping each top pin into a different envelope. Label the envelopes. Now tape the plug in its 90° position and set aside.

The diameter of the pins should be .115 inches, but there are variations. You need five pieces of rod as close to the pin diameter as possible, and at least four inches long. Possible sources include:

- Drill rod (at industrial supply or machine shop supply stores)
- Regular drills (wood or metal twist)
- Music wire (the old standby, but hard to get exact diameters)
- Nails (usually 16d)
- Welding rod
- Any metal rod that will fit with *precision*.

A sloppy fit will greatly degrade the simulator's performance.

If you don't have measuring equipment (a micrometer is best) take along the taped lock casing and use it as a fit gauge. Drill rod or drills will probably be the easiest choice. With the drill rod you may buy a long piece and grind off appropriate lengths. In fact, once you have the rod, grind one end (the non-spiral end on a drill) perfectly flat, to mate with the bottom pins in the lock.

Next, the lock must be mounted. It can be clamped in a vise, or a "C" clamp. If it is a rim cylinder, the mounting hardware it came with can be used. Just get a board 4" x 4" x 1/2" (dimensions not critical) and drill two holes through it to screw the lock end-first to the board.

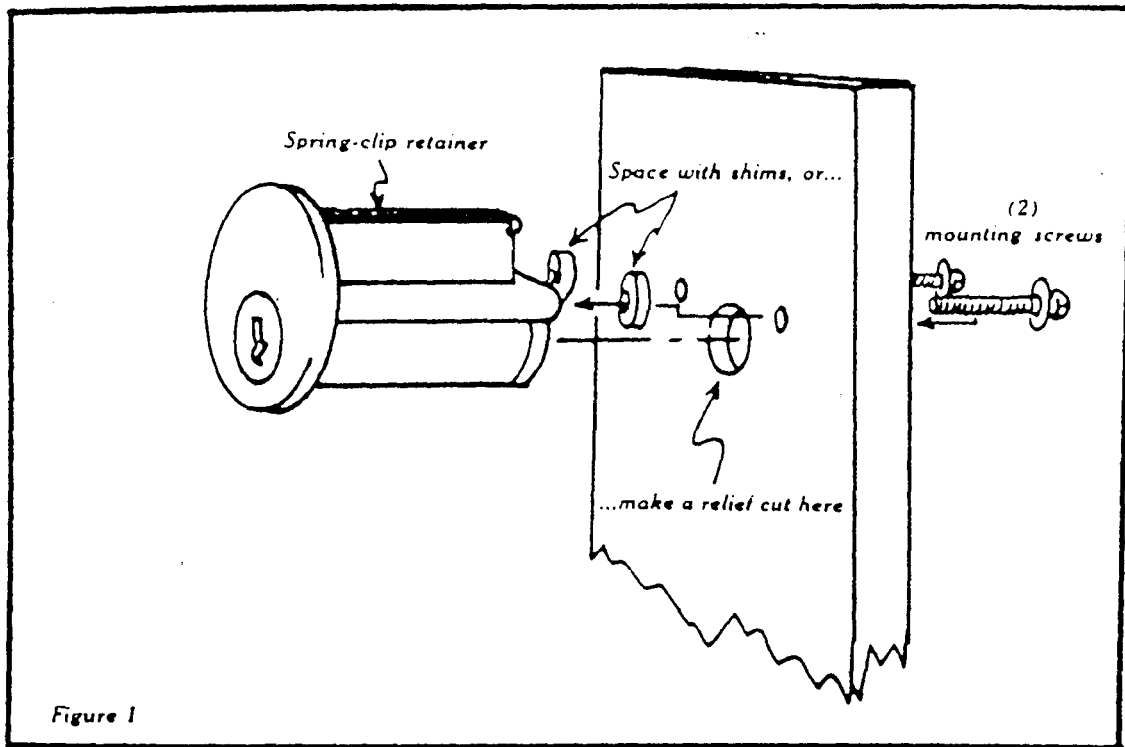
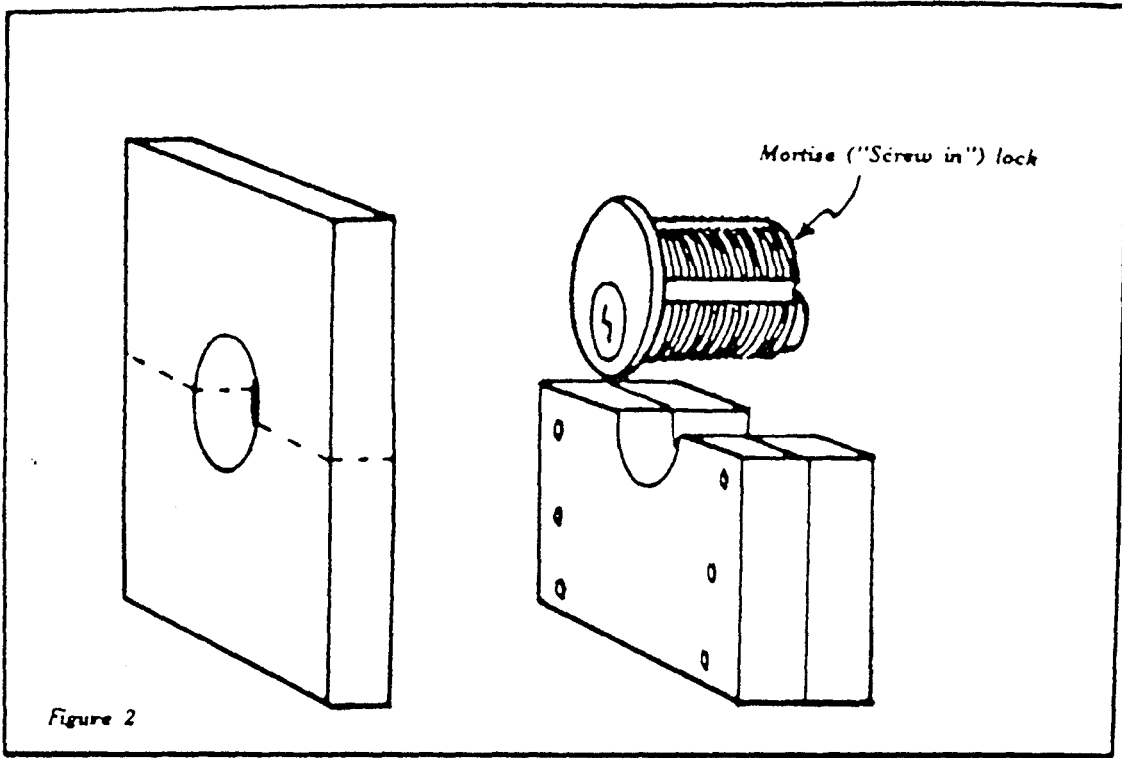

Figure 1

If needed, the board can be cut away slightly to allow the plug end to rotate freely, or the lock can be spaced from the board with washers or paper shims. This board can in turn be vise-clamped, or screwed to any vertical surface, even your regular practice board (see THE COMPLETE GUIDE TO LOCK PICKING).

If the lock is a mortise type, get a board 4" x 8" x 1/2" and cut or drill a hole in the exact center the same diameter as the lock. Next, saw the board at the middle of the hole and get two pieces 4" x 4" with a half-circle in the top. Glue and nail these together and glue the lock in the half-circle with contact cement. ✂



Mount as before. After mounting is completed, untape and return the plug to full-up position. Note that five bottom pins are now laying in the pin wells, held in by gravity. Place one prepared rod in each of the five holes, making sure that they bottom. Wiggling the plug may help, and be sure the rod has no burrs or grinding sprue to impede fit or jam the lock.

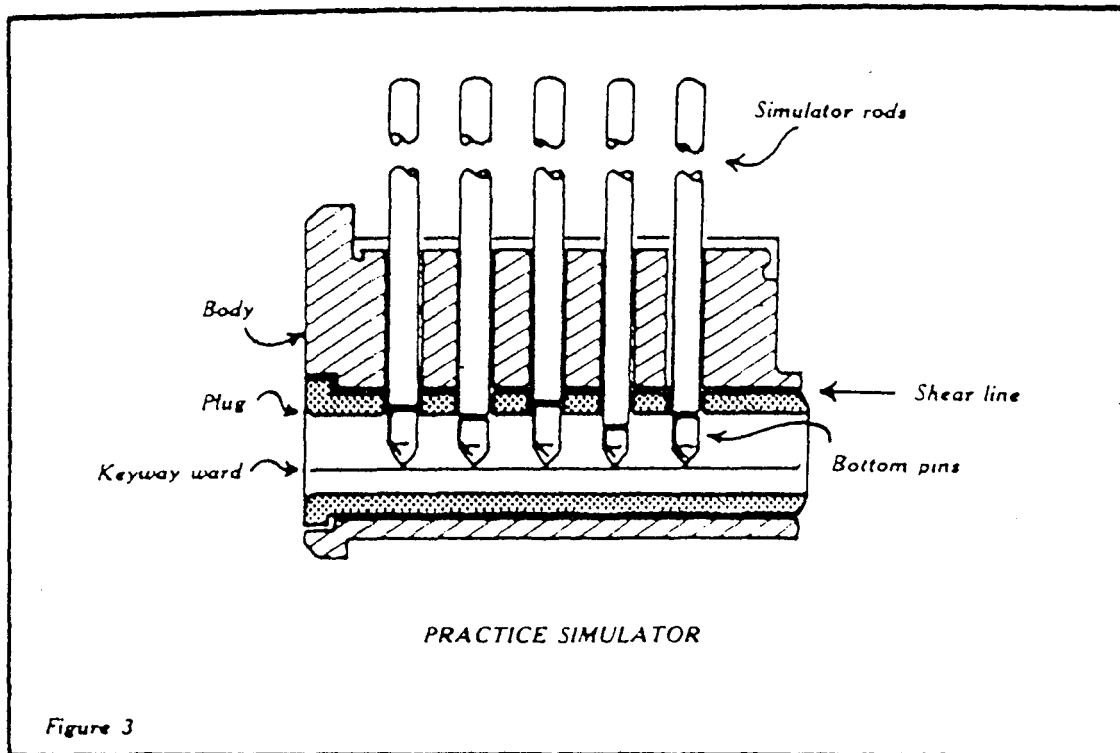

Once the rods are seated, put a drop of oil in each pin hole. The simulator is now complete -- how does it operate? Insert the individually-lifting pick in the keyway and attempt to lift each rod in turn from front to back. Notice that the weight of the top rod simulates the spring tension as normal. If the weight of the rod seems excessive, cut or grind off a little from the top of the rod. Also notice that if the shank of the pick contacts a pin stack (a real no-no) the simulator will show it. This lock can be picked as usual (concentrate on individually-lifting techniques). When working the lock, keep your eye on all the rods. Remember that gravity alone holds the lock together. For transport, tape all the rods down securely.

The concept can also be applied to the lever lock. Obtain a lever lock with three or four levers and a small case. Carefully grind off the top of the case, allowing the levers top access. Now get some clear celluloid, plastic, or paper. It should be as rigid, and as thin, as possible. Fit a flag cut from the stock so that it is glued to the face of one of the lever tumblers, and protrudes from the top of the case (ground off).

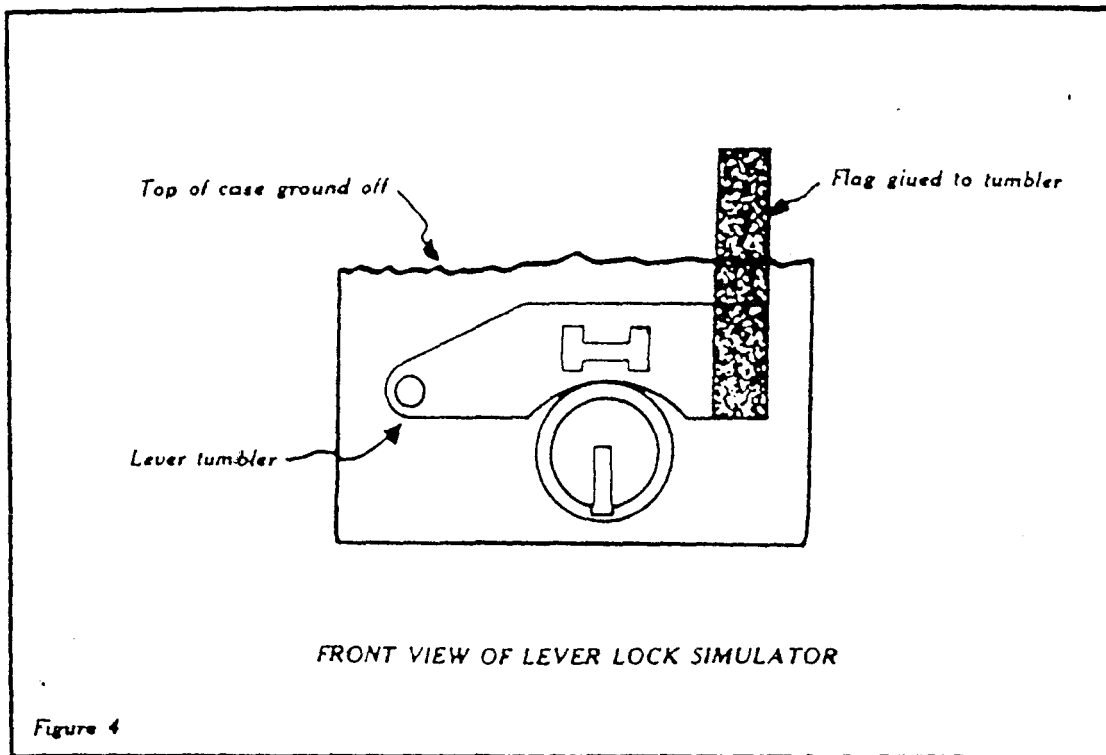

Cut this flag until it fits properly and then use it as a pattern for the others. It may be necessary to cut tiny washers from the same material to thread over the pivot post that the tumblers are on, in order to "space" the tumblers. If this is done it will prevent the levers from binding against each other due to the increased thickness caused by the flags. Experimentation will determine where to put the washers.

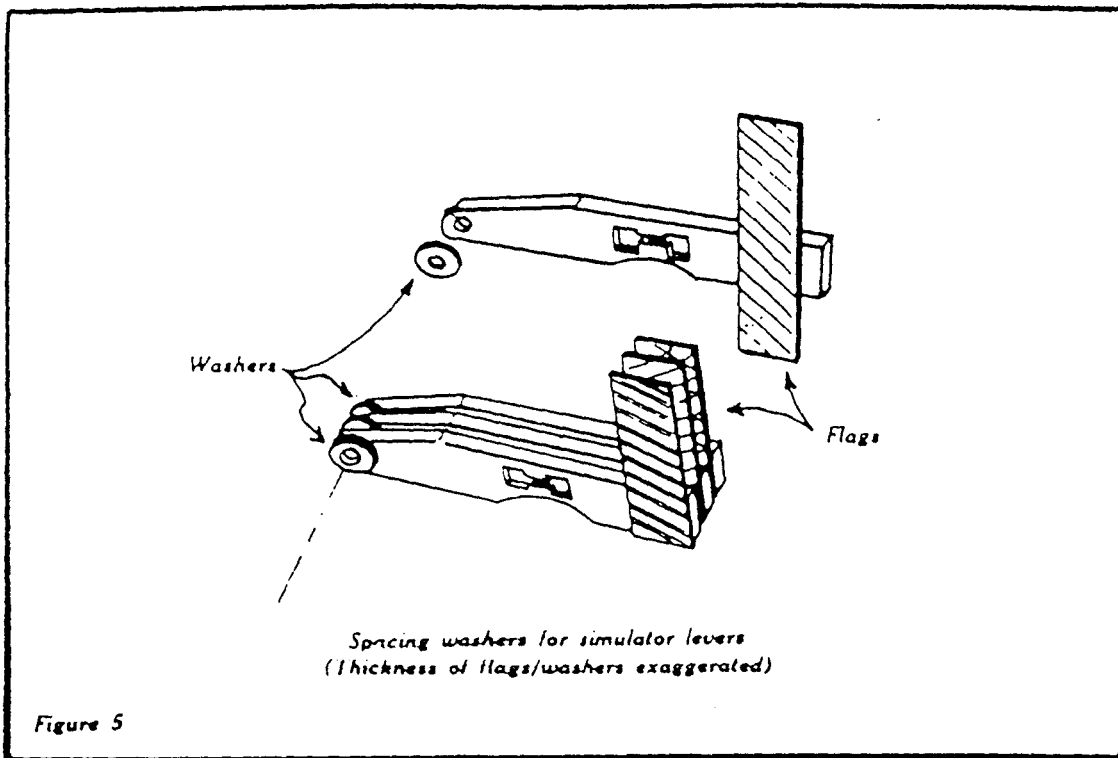

Once all of the flags have been cut and applied (use contact cement), the lock should be reassembled (with washers, if necessary) and then the flags should be cut off flush with each other about a half inch above the case. Trim them to the same height *only* with the proper key inserted and turned to the top dead center position. This means that when the tumblers are next aligned so as to unlock the bolt, their tops will all be at the same height. Obviously, if a tumbler has been over-lifted (a real problem) it will also show up. This system can be further improved by color-coding the flags, and also by providing a "standard" flag attached to the case that never varies in height. With paper flags this is especially important.

Professional lock experts will greatly appreciate this simulator because lever locks are the hardest to practice individually-lifting techniques on, yet their use is widespread in high-security applications, such as mail and security boxes.

I

CHAPTER TWO

PICK GUNS

The mail order suppliers often tack on a 120% increase on prices of lock-pick guns. The average guy doesn't have access to locksmith suppliers (if you have the first two volumes in this series, you don't need 'em) so how to get a pick gun? Figure 6 shows the side view of a manually operated model.

Cut the two side pieces by tracing onto a piece of masonite, heavy metal sheet, or plastic -- you need two pieces. You can also photocopy the figure twice, and glue the copies onto the stock. Make sure to center-punch for all holes to be drilled. Once you have two gun halves with holes drilled, purchase the rest of the materials listed, and drill the holes in the X-acto knife handle. If you have a "V" block, that will help in getting them perfectly aligned. The next step is to cut the cam, which can be made from 1/4" thick plexiglass or plywood or masonite. I prefer the plastic. The needles that chuck into the knife can be cut from extra length blades that fit the knife -- just grind the blade down to a straight tool like your feeler pick.

The next step is to begin assembly by threading a washer on the cam bolt, putting this assembly through one gun half, then a nut locked on with Loctite (a compound that permanently "freezes" threads in position). Now coat both cam and nut with contact cement and install the cam, then a washer, then the other gun half, then a washer and a nut with more Loctite. Into this assembly, install the X-acto knife, the blocks for the spring and stop mechanisms, the spring and stop screw, and finally the crank handle.

The crank handle is bent from the music wire and is inserted into a hole drilled through the end of the cam bolt, just like the holes drilled in the X-acto handle.

Notice that the thickness of the spring and stop blocks must be adjusted with the addition of washers or paper spacers to their holding bolts to ensure no warping strain is put on the gun. Once all the other bolts are installed and Loctited, regulation is next. (Note: Loctite and its releasing compound are available in most cycle supply shops. Because of the vibration of both cycles and lock-pick guns, it is necessary for all bolts that may work loose.)

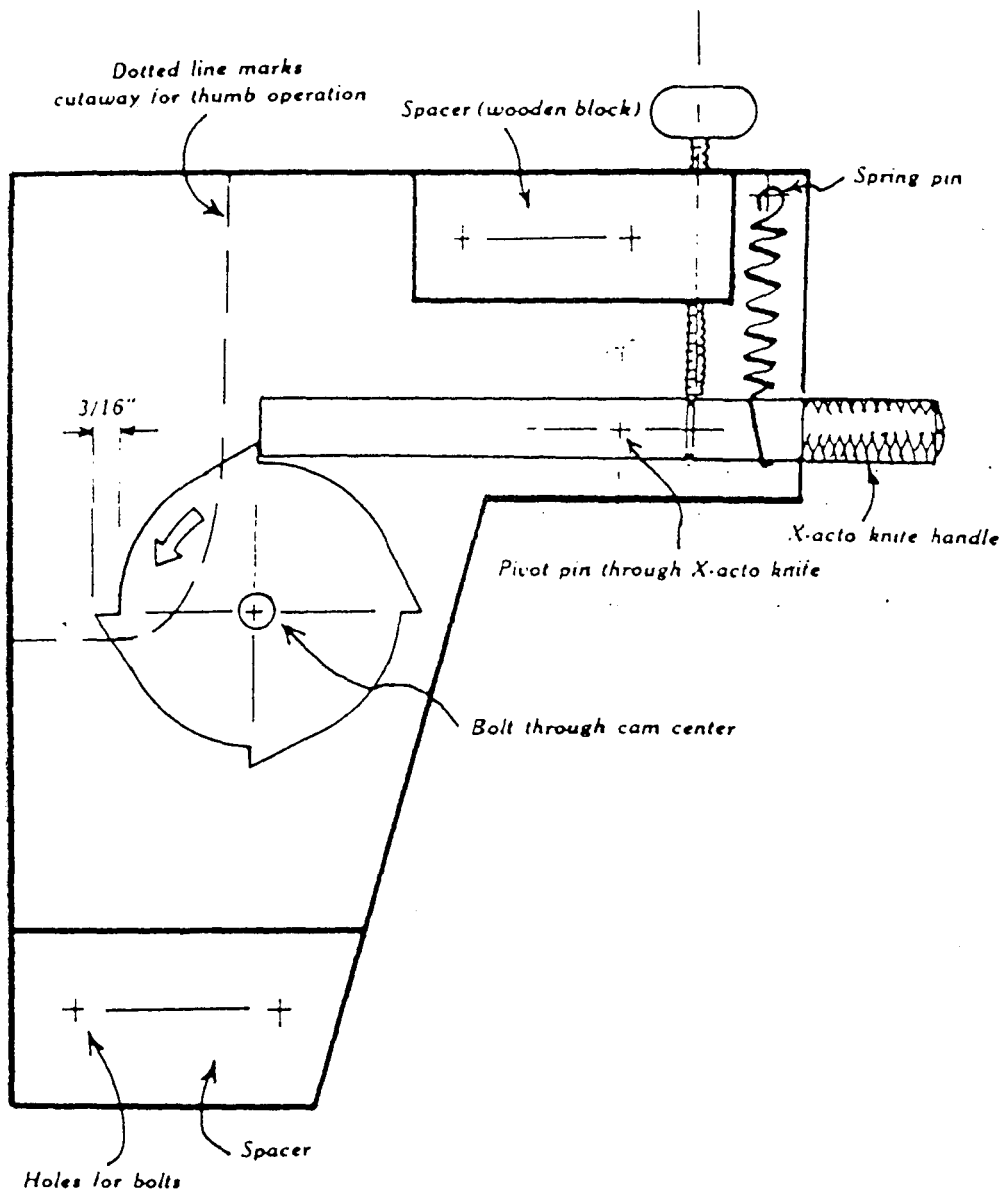

Figure 6

BILL OF MATERIALS FOR A PICK GUN

- (1) X-acto knife
- (1) 1/2" thumbscrew
- (1) Expansion spring
- (7) 1/8" x 1" machine bolts with nuts & washers
- (1) 1/4" x 2" machine bolt with nut & 5 washers
- (1) Plexiglass piece 1/4" x 6" x 12"
- (1) Wood block 1/4" x 1 7/8" x 1/4"
- (1) Music wire 1/16" diameter x 10"
- (1) Tube Loctite

Regulation is accomplished by inserting a small strip of paper between the cam and knife handle where it bears on the cam. Turn the stop screw until the paper is just free. This ensures that the screw, not the cam face, takes all of the jar of the knife handle as it snaps up. This adjustment should be periodically repeated as the gun "settles."

Now adjust the spring to provide slight tension with the knife in the rest position (on the stop screw). You may want to vary the spring tension as you work the gun to provide different results. It all depends on your style and the lock in question. Generally, more tension is more controllable, though.

In use, the needle is clamped in the chuck, and then a moderate-weight tension wrench is inserted in the keyway (see next Chapter for weighted tension wrenches). Then the needle is pushed in straight under all the pins, and the operator turns the crank with a steady speed. The cam alternately pushes and releases the knife, and the spring tension is transmitted via the knife and needle to the bottom pins, which in turn slam the top pins up. At some point, there is a gap between both sets of pins, and the tension weight turns the core, opening the lock. Varying cranking speed may help. Another possible variation is to turn the stop screw in even more, which will reduce the travel of the needle, but more travel is usually better. Heavy tension on the core is definitely to be avoided.

If you feel that you must have hand control of the tension wrench, your gun can be modified by cutting away the rear portion, exposing the outer perimeter of the cam for at least a 120° sector of travel. Then you can use the holding hand thumb to actuate the cam surface with one hand free for the tension wrench. A real enthusiast could convert this gun to clockwork or electrical operation, allowing you to be elsewhere if necessary while the gun operates -- but that is a little too much "James Bond" for me.

CHAPTER THREE

WEIGHTED TENSION WRENCHES

There are many advantages to using a tension wrench that has additional weight added to the handle:

- (1) Better control because of more sensitive feel
- (2) Very consistent tension levels
- (3) Possible standardization of tension levels for various locks and techniques.

The actual weighting of the wrench is easy. Your local fishing store can provide a wide assortment of fishing sinkers of two styles -- cigar-shaped and teardrop-shaped -- with wire loops on the ends.

We are using the music-wire type of wrench with flats ground on one end. Try to get cigar-shaped sinkers with a middle hole that will accept the wrench handle. To attach the weight, measure the sinker length, add $\frac{1}{8}$ inch and put a 30° bend in the wrench handle at the point of your length computation. Slip the sinker over the handle up to the bend, and the $\frac{1}{8}$ inch of handle protruding from the end is then bent over with a hammer to lock the weight on.

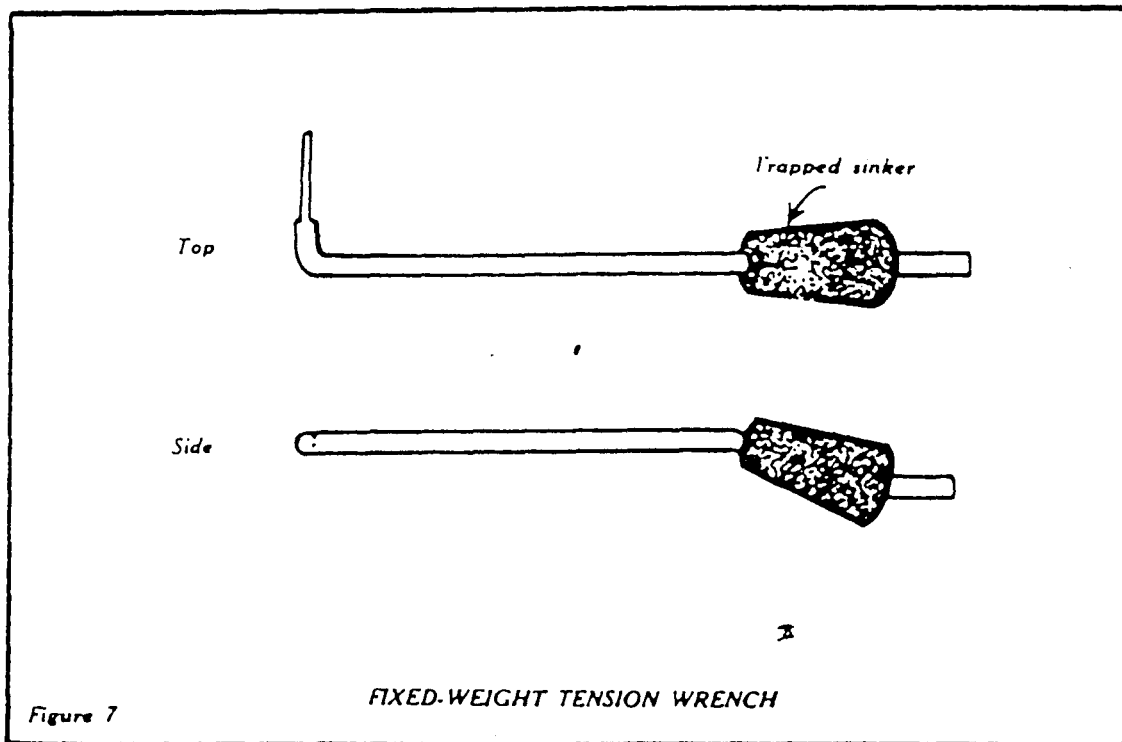

Alternatively, the weight may be friction fitted by swedging it while on the handle. "Swedging" simply means to squash it with a vice or hammer blows. Contact cement also works well for a permanent application.

One interesting variation of this is to produce a tension wrench with an extra-long handle, slip a weight on, and bend up $\frac{1}{8}$ inch of the end of the wrench as usual, leaving the weight trapped, but free to slide. This wrench is very useful in places where lock-to-jamb clearance is not critical. Merely sliding the weight along the shank provides fine graduation of the amount of tension exerted on the core, and can substitute for several fixed-weight wrenches. Any effort to standardize tension levels must involve easily changeable weights of fixed increment, like scale weights.

To experiment along these lines, make a "V" groove in the surface of one of your tension wrenches by laying the shank over an open space, like the opened jaws of a vise, and tapping the unsupported middle with a hammer, making a "V" bend. The rest of the shank can be further straightened to pronounce the groove.

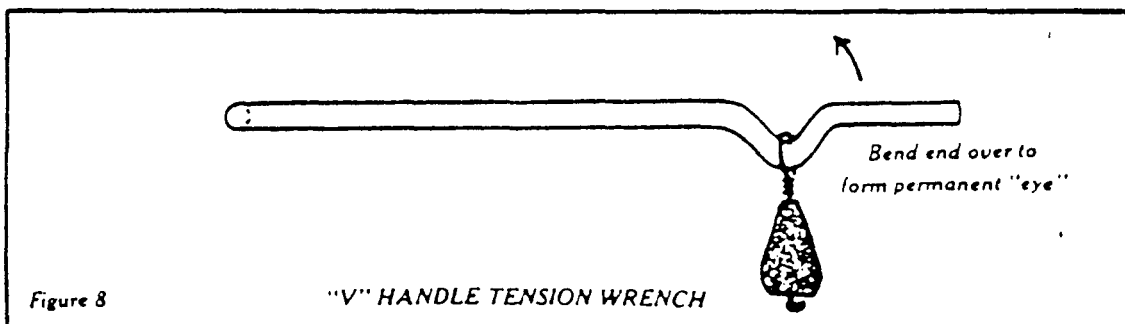

Now insert this wrench in a practice lock, and hang the lightest teardrop sinker you have on the "V" groove. Attempt a "jerk" opening of the lock, keeping track of the time and strokes involved. Now switch to the next biggest weight, and so on.

You will find that one weight is noticeably better. Now try this weight on other brands of locks, or using other opening techniques (like the pick gun). Eventually you will have a "best" set of weights. To make up wrenches for these weights, simply bend an "eye" in the wrench at the same point where the "V" bend was, insert the proper weight (you really insert the wire hanger of the teardrop) and close the eye, permanently trapping the weight on the wrench, yet allowing it to rotate 180° for left and right hand openings on doors.

I consider weighted wrenches so essential that they should be added to any basic set of opening tools in place of regular wrenches. Even if you have a regular wrench, be sure to put a slight *double "V"* bend in it and carry a sinker so that if you must leave the scene or take your hand away from the wrench during an opening, the weight can be attached to the appropriate "V" bend to hold any trapped pins in the lock. This is a lot easier than starting over.

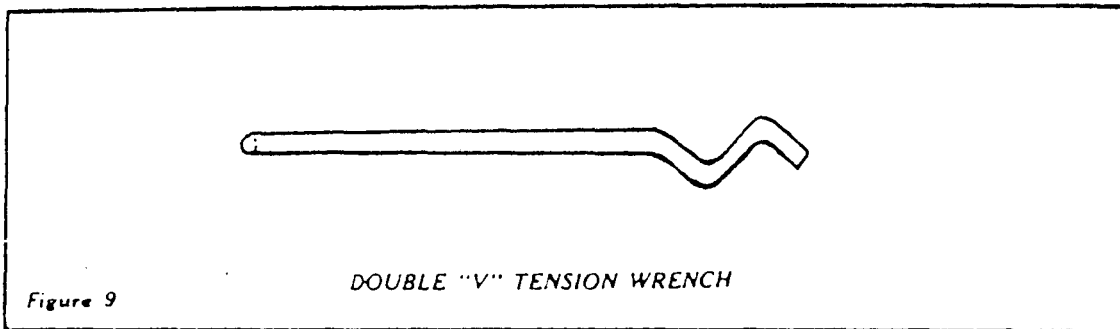

A recent publication listed a tool consisting of a beam with two suction cups on the ends, and a sliding finger on the beam, the whole apparatus to be attached to a door and the finger to exert pressure on the tension wrench for just such emergencies. My tool is better and faster, and also \$13.50 cheaper.

Weighting the handles of flat-cut tension wrenches is also possible. These wrenches are the ones you grind out of feeler stock and use for shallow keyway insertions. For ease of operation, the only practical weighting is by adding sheets of thick mild steel which is traced to the same width as the wrench, and cut out with hacksaw or grinding wheel. It is attached with contact cement, but be sure to degrease the metal's surfaces before applying glue. Any other weighting scheme will put the wrench drastically off balance in the keyway.

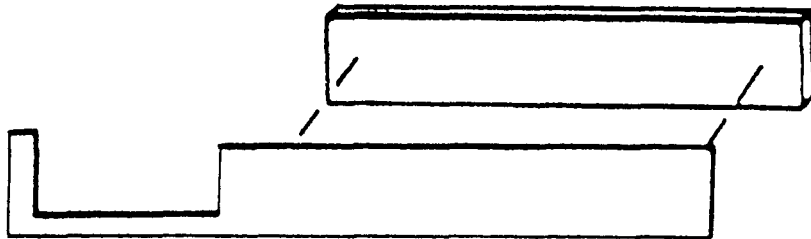

WEIGHTING A PROFILE-CUT TENSION WRENCH

Figure 10

CHAPTER FOUR

TENSION WRENCHES FOR LEVER LOCKS

Tension wrenches for lever locks are often hard to get from the mail order ripoff people, so let's explore precision production in your shop at home.

Tracing on flat stock would take a lot of cutting, so I bend music wire to contour, and then grind flats on the working ends to allow keyway access. If you don't have a vise, buy one, and mount it so the jaws extend over the workbench edge. "V" grooves may be cut in the jaws by closing the jaws and then drilling straight down throughout the join, or by marking the join with the jaws closed, then opening them and filing the groove with a triangular file. Either way, the resulting groove should hold wire securely and allow the wire to extend down to the floor below the jaws. This permits easy stock feed.

Next, get a piece of 2" x 2" clear white pine, and cut a groove into its edge with a circular saw -- go about 1/2 inch deep. This will form the various height gauges.

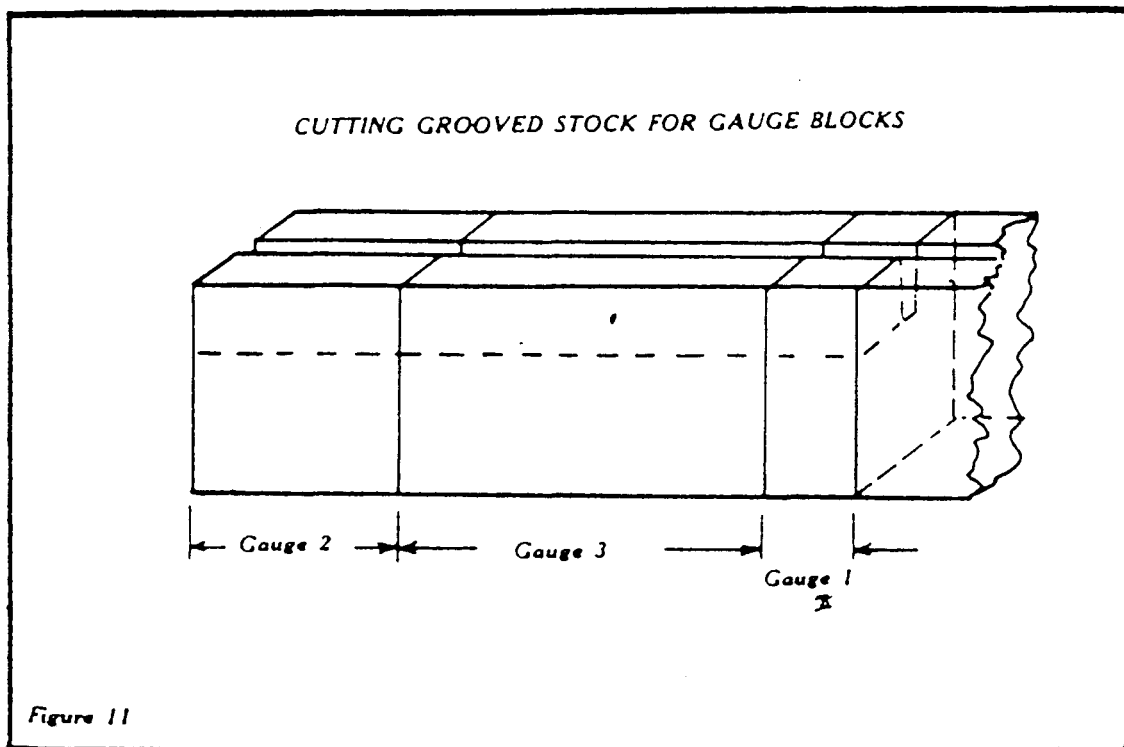

- The dimensions of the lever lock tension wrench are generated by:
- (1) The height of the keyway
 - (2) The number of tumblers in the lock (really the only variable)
 - (3) The length of the working handle.

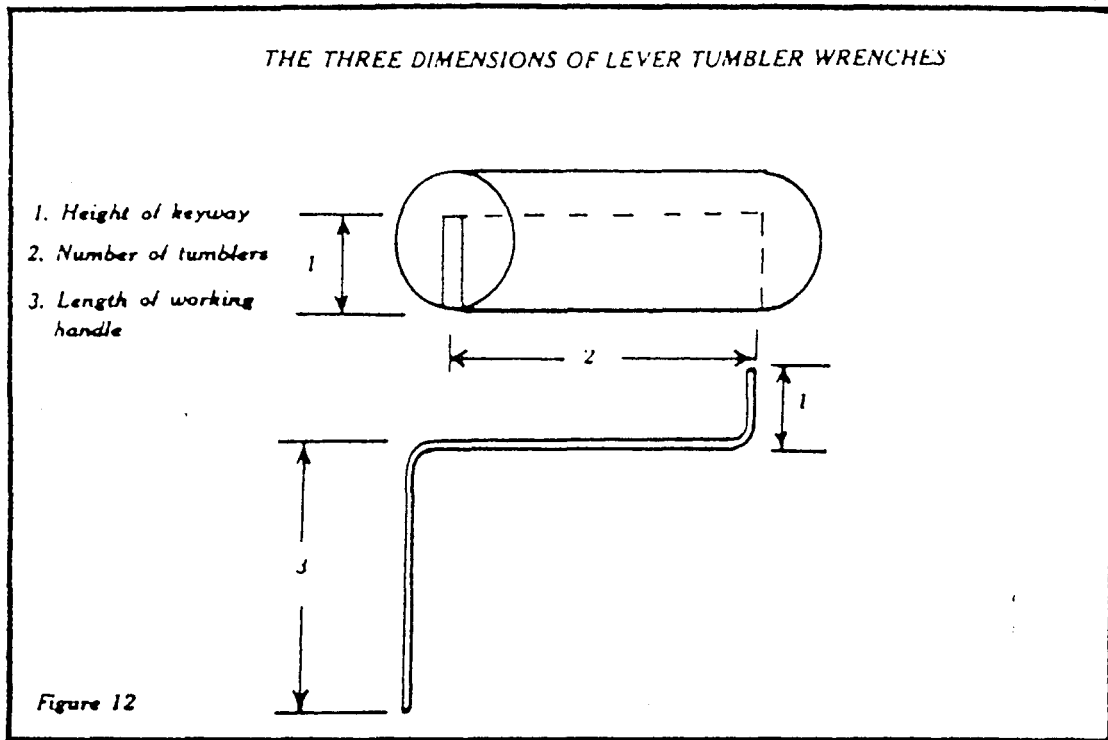

It is strongly recommended you acquire a set of locks and use them to directly size your tools. Some of the high number tumbler locks must be obtained from locksmiths who do bank safety deposit box work. They will probably have several junkers around.

After measuring for the first dimension, cut off a length of grooved wood exactly equal to this dimension. It is used by clamping the music wire stock in the "V" groove, then loosening the vise slightly, allowing the wire to slide up.

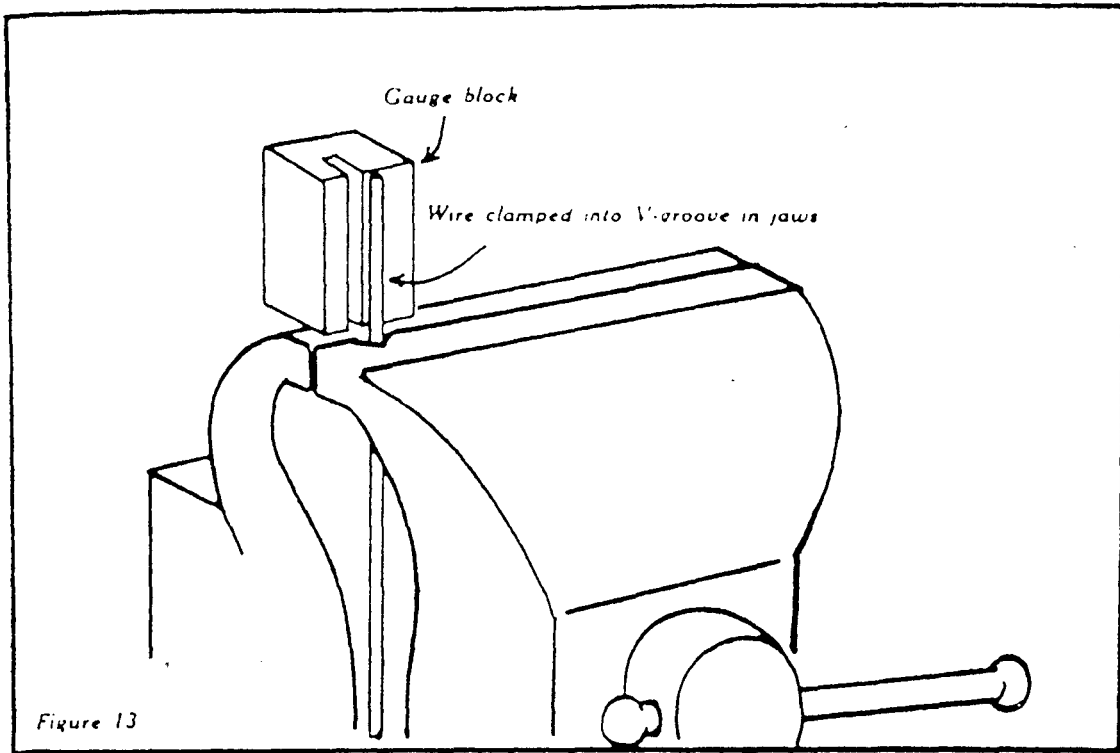

The block groove is slipped over the wire, the end of the wire made flush with the top of the block, and the vise then re-clamped. Then the wire block gauge is removed from the wire, and a regular face hammer is used to bend the protruding wire over 90°.

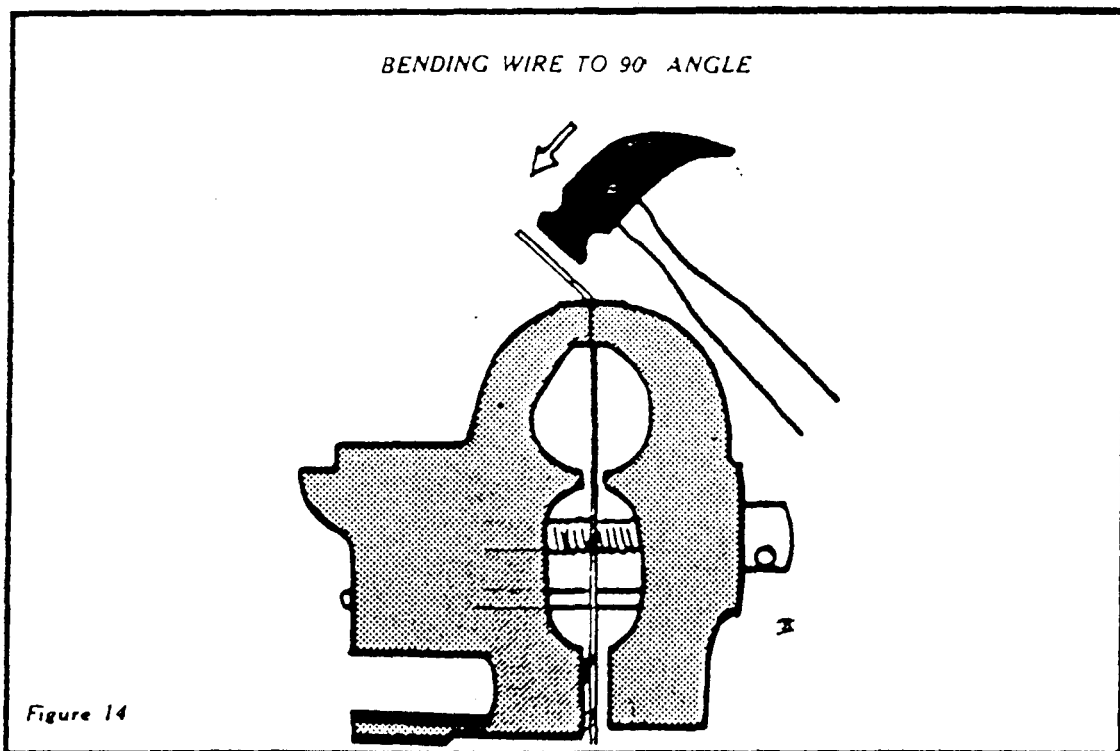

Then the vise is loosened again, and the next thickness of gauge block is inserted around the stock. Now you can let the stock fall, since the bent end will automatically hit the gauge block top and stop at the proper height. Tighten the vise, remove the block, make a final check for angular relationship, and make the next 90° bend. ("Angular relationship" means that the finished wrench must have all of its bends in a straight, flat plane when viewed from the side. If not, the tool is more bulky to carry. There are times, however, when bends must be made in all three dimensions, and a protractor is helpful here.) After making the next bend, the routine is repeated with the third and final spacing block, and the wire is cut off flush instead of being bent. Flush-cutting wire cutters or a hacksaw may be used. Finish the cut-off wire end with a file, since the end of one tool is the beginning of another.

Some further refinement will speed up the process even more. For instance, one piece of wood can be cut with three or even more "stations" or spacing lengths on it, so only one gauge block has to be handled.

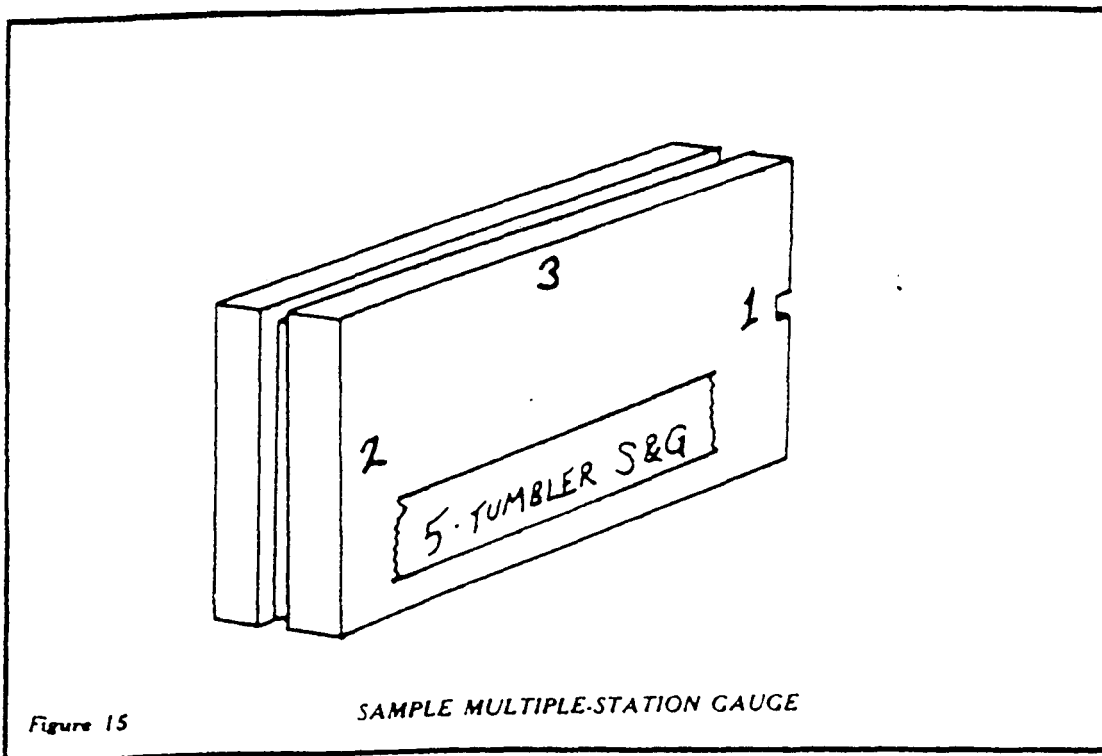

If three blocks are used, they can be loosely wired together, or color-coded for easy access. Also, the blocks can be sanded down if too large, and built up with cardboard glued on, if too small. If you can fabricate blocks with three equal dimensions, you can eliminate the groove, speeding up operations still further.

Once you have stacks of profiles bent up, the next step is to grind equal flats on the wrench working end only (the part that must enter the keyway) until the wrench easily enters the keyway. (Techniques described in Volume 2 of this series will also work for this operation, or it can be done by hand.) A micrometer or "go/no-go" gauge (a piece of metal with a slot cut in it) will aid in determining when the tip is slim enough. After grinding, the end should be file finished to remove rough grooves, and can be stoned and blued if desired. Remember to cut the flats on the proper sides of the wrench.

Lifter picks for lever locks can be produced with this method also, if a loop is made in the end to act as a handle, but the flat stock profile grinding technique is usually easier. Complex profiles for snake picks may be profitably produced by bending and slimming, however. Note also that all manner of tools for warded locks, "Z" wires for slipping latches and hooking panic bars, and slim jims, may be bent using similar techniques. The longer bends require rulers, yardsticks or paint stir sticks cut to length for gauge blocks. Quite a profitable business can develop if the tools can be turned out at a fairly rapid rate. As I said earlier, lever tools are almost unobtainable.

CHAPTER FIVE

CARRYING CASES

The ultimate lock tool case -- made of vinyl, padded, zippered all the way around -- impossible, you say? Nonsense, just take a trip down to the local Bible book store and look at the wide variety of Bible cases. I found several that were just the right dimension to hold two sides full of picks placed side by side. While you are there, pick up a generous assortment of tracts and pamphlets if your "cover" needs bolstering. Maybe even a lapel pin or button.

While you are out shopping, stop at the fabric store. They should carry a device called a "butoneer." This is a little gun that inserts T-shaped holders into two or more layers of cloth or vinyl via a hollow needle. Get a good supply of the T-shaped fasteners as well. In fact, pick up about six feet of one-inch-wide vinyl prepared belting in a color to match the Bible case, and a couple of "D" rings.

After reading the directions for using the butoneer, just make pockets in the side flaps of the case by outlining the pocket with T's.

If your case does not have an inner flap (used for holding the book covers), then bop out to a department store and pick up a couple of vinyl/foam rubber placemats. They usually have pictures of duckies and horsies on them, and are about a sixteenth of an inch thick. These mats can be easily cut to form the missing leaf for your carrying case, or even form two leaves for later spot-tacking inside the case, which will also provide a third pocket if you leave the top not tacked down.

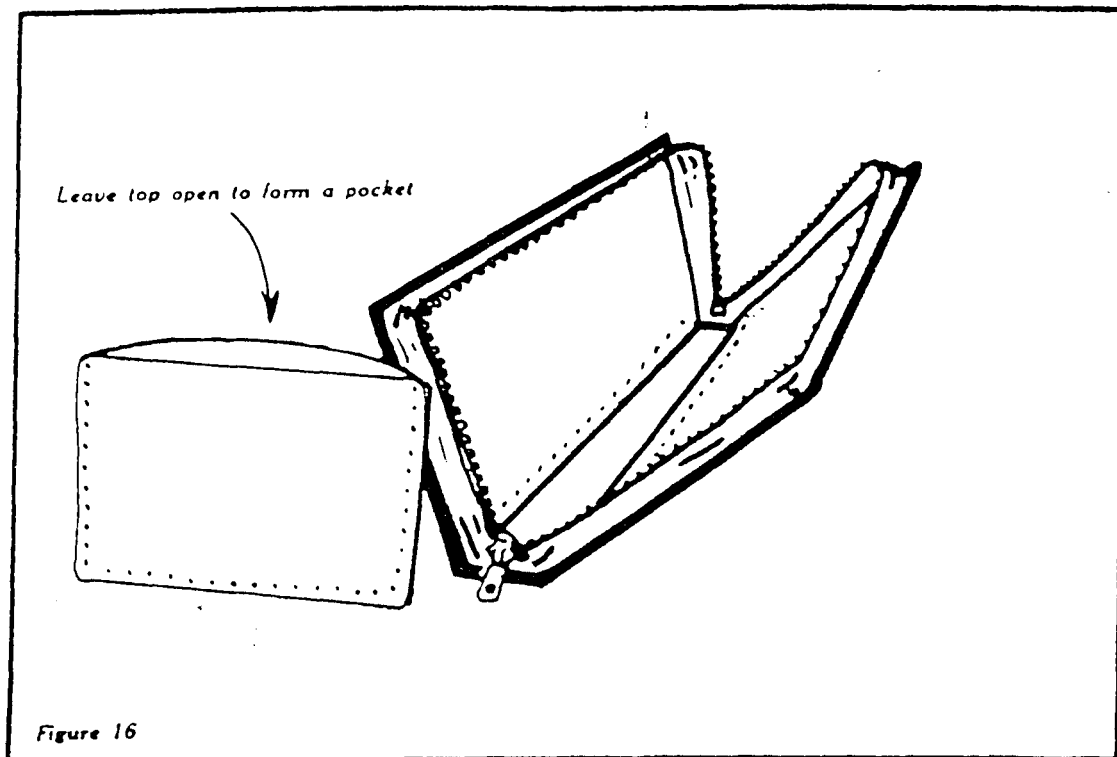

Remember to keep the duckies and horsies on the inside when cutting out the leaves -- after all, you have an image to maintain. If you want alternatives, pockets can be formed by threads of vinyl, glue, crazy glue (cyanoacrylate), or whatever works. Sewing is also possible, or the case can be left undivided.

The placemat material can also be cut and joined to make its own carry case. The easiest way to do that is to paper clip two thicknesses together and draw or use drafting methods on one to produce the desired cut lines.

LAYOUT OF MULTIPLE CASES

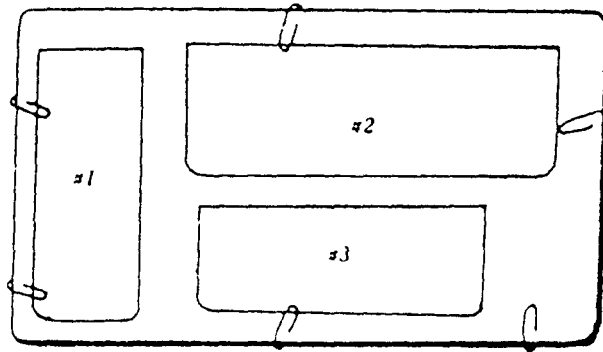

Figure 17

The cut-out halves may then be joined with tape, butoneer, lacing, sewing, or glue. For a nice edge finish, use some of the vinyl prepared belting folded over the edges and glued or butoneered.

USES FOR PREPARED VINYL BELTING

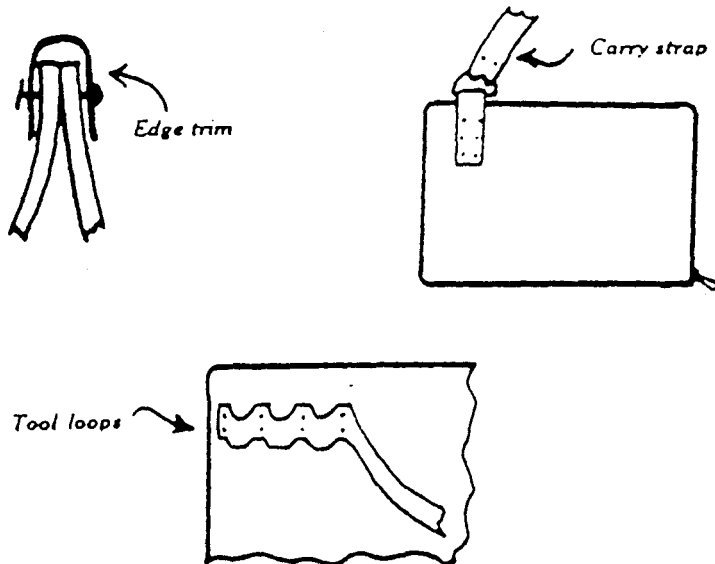

Figure 18

The belting has many other uses as well, like using a strip of it at one edge of the carry case, tacked down in loops as a tool holder. The belting can also be used to make straps for other carry cases.

To make a proper strap attachment, cut a two-inch piece of belting, loop it over the "D" ring you purchased, and attach the strap ends to the case. Then cut the rest of the belting to length and loop it over the "D" ring in similar fashion. An easier approach is to sew or butoneer the strap directly to the case, but it will tear in time.

"D" rings can also serve as hitches, just like on life jackets. If you use this method, you can strap a case to your wrist, leg, or torso for a concealed carry.

Points to remember when buying the strap/belt and rings or other hardware include matching the widths of belting to the hardware size (most stores have this well marked), and getting belting that is holed at regular intervals, if you choose hardware like a belt buckle.

Not only do the fabric stores carry vinyl belting, they have a wide variety of woven cloth belting of various colors and widths. Some of these may need their cut ends basted or dipped in glue to prevent ravel. Any synthetic materials may be scorched with a flame to seal the cut end. The butoneer/placemat/belting system is one you should try, because you can assemble a carry to order in less than a half hour, and it will last and look professional besides.

That just about concludes the material on carry and cases, except for one last item. Body/concealment carries are covered in Volume 2, but recently I have experimented with the double-faced tape used for laying carpet. This material is excellent for a low-profile carry, just apply to your body in a non-wrinkling or flexing area, then apply the pick. I advise non-handled picks. After sticking the pick down, apply talcum powder over the remaining area for obvious reasons.

CHAPTER SIX

A TOOL FOR PICKING TUBULAR LOCKS

Eddie does it again! Lock tools to pick tubular locks are always expensive and hardly ever mentioned. Let's build one for five dollars.

First, are you up on elementary tubular lock theory? These locks are the kind with circular keyholes that show up on vending machines. Close examination shows that the pin tumbler principle is used, but the pins are placed end-forward in a circle. The outer portion is fixed, and holds the top pins in the bottom. The inner portion is movable, rotates around a center fastened to the outer portion (at the bottom), and holds the bottom pins whose ends you see in the keyway.

In operation, the tubular key is inserted to fit over the inner post (inner portion), and a lug protruding from the key fits into a slot cut in both inner and outer portions of the lock.

The key is then pressed in, and while the outer lug clears the slot, the inner one stays bearing on the groove cut for it in the movable portion. Simultaneously, different depth cuts on the edge of the key (corresponding to bitting on a regular key) push in the bottom pins to their respective shearlines. Once shear is reached, the inner portion can be turned, and it is the inner lug of the key riding on the slot that does the turning. If this is a little unclear, it is because I am trying to condense. Get a tubular lock and study it to be sure you understand this theory.

The most important thing to remember in all this is that unlike a pin tumbler lock where the bottom pins are trapped and perform no further function as the core is rotated, in the tubular lock the bottom pins must be held at shear line continually, or when the lock inner portion rotates over exactly one pin hole, the top pin will snap into the hole and relock the tubular lock. Therefore, even if you were to individually pick each pin stack and begin rotation of the core (inner portion), the entire set of pin stacks would relock as the next pin hole came up. Theoretically, you would need to repick each pin stack eight times to get one complete rotation. Furthermore, since many of the locks are in applications where nine or ten turns are needed to

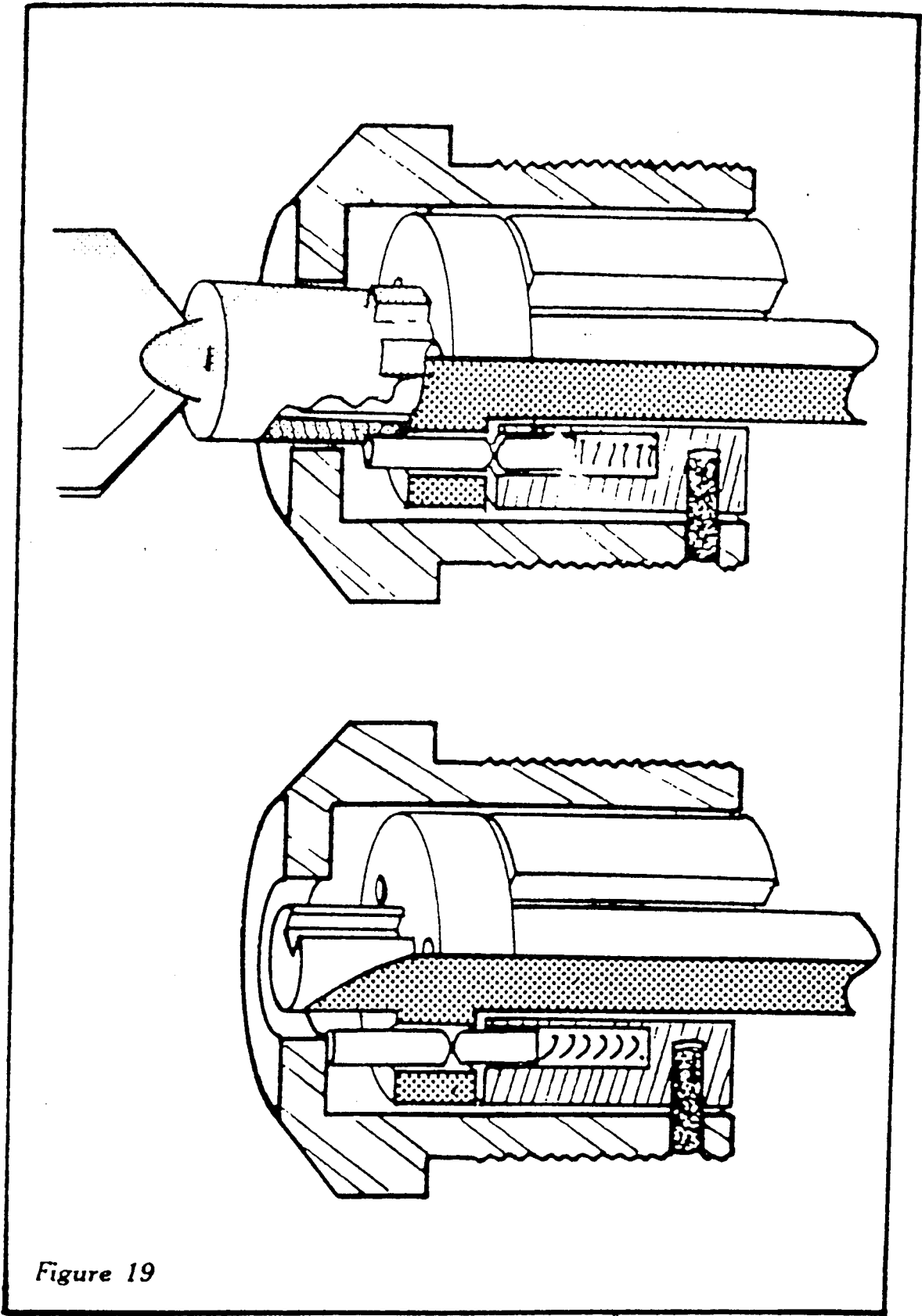
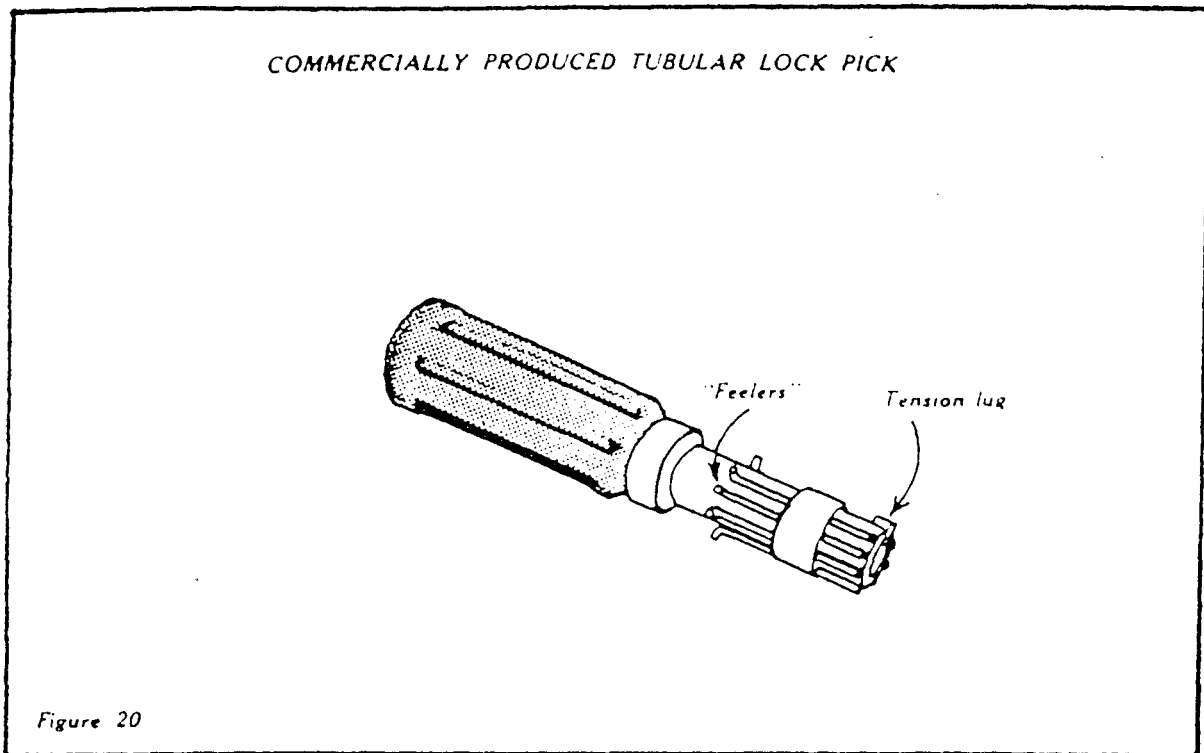

Figure 19

fully unscrew the locking mechanism, the individual pick artist can be in real trouble. That is why tubular lock picks are configured as shown.



In practice, the operator puts tension on the core via the lug protruding from the inner face of the tube. Once tension is applied, the operator begins to exert a wiggling downward push on the tool, and its eight fingers begin to push on each pin end simultaneously, driving them all to the shear line. The amount of pressure each feeler exerts on the pin stacks is adjusted by adding or removing turns from the rubber band around the feelers and rod. It must be enough to counteract the opposite push of the pin springs, but not so much that it pushes the pins past shear. This pressure is the analog to lifting pressure with the regular lock pick.

To begin producing the pick, purchase a tubular lock -- regular eight pin with center keyway (the most common) to use as a gauge for buying brass tubing. You need one piece that snugly fits over the inner portion just like the key, and the next telescoping size smaller. You also need a length of music wire one-sixteenth inch in diameter and 36 inches long, and a 20 inch piece of brass tubing that the wire telescope-fits into.

These materials with telescope fit can be purchased at hobby stores that sell to model airplane hobbyists. Begin by cutting a piece of the music wire, bending it double, and using epoxy or super-glue to attach it to the edge of the tube fitting over the lock's inner portion (called a nose). Make sure that the wire extends the full depth of the lock on the inside tube edge, and only half that outside.

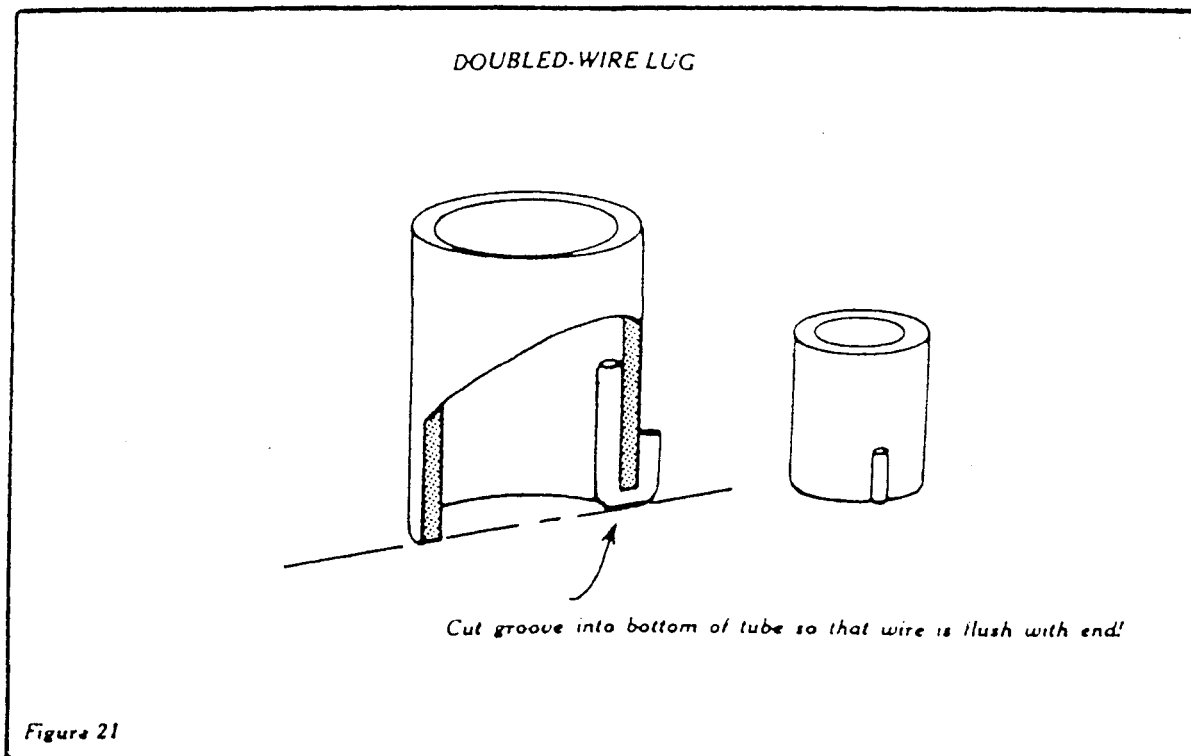

This will be the lug that engaged the groove to put tension on the nose. When the glue is dry, cut the tube exactly double the length that it bottoms in the lock. It should protrude the same amount outside of the lock as it goes in. Also cut the other, smaller, tube to a four inch length. Cutting both tubes requires finesse and a fine-toothed saw (hacksaw). Go slowly and try to avoid bending the tube. When finished, carefully de-burr the end and file square if you goofed and cut it on an angle. The tubes *must* be flat and square. Leave yourself a little over-length if necessary.

Now slip the two tubes together, insert this assembly into the lock, bottom both tubes, and mark the point where the larger tube and the smaller tube meet by scribing a line on the smaller tube. Remove the assembly, spread superglue or epoxy on the join and re-join the tubes, using the scribed line to properly position the two. Tape them together in this relationship and let dry.

Now comes the hard part. You need to cut eight lengths of the smallest brass tube, and eight lengths of the music wire that telescopes into the tube. Each tube should be 1½ inches long. The music wire segments should be 2¼ inches long. Be very careful when cutting the tubing, as the wire must later slide freely inside it.

When the tubes and wires are all cut and deburred, insert the dry, glued tube assembly (large tubes) into the lock and run tape from the end of the tube to the sides of the lock, effectively pushing it into the lock. Now spread some very thick epoxy glue onto the first inch and a half of the large tube assembly above the lock face. Only apply the glue to the area where one of the small tubes will stick.

Now apply one of the tubes pointing exactly in line with the pin tumbler axis. If necessary, slide a piece of music wire inside the tube and down to the pin to precisely align the tube. Once it is roughly aligned, put tape around the assembly to hold the small tube in place. Let dry. Do this entire procedure for each of the other seven tubes, and be sure to precisely align each one in turn. If even one is canted and not parallel with the pin tumbler axis, excessive friction will result as the pick is operated.

Once all eight are mounted and dry, insert one of the music wire rods into the tube and see if it will clear the outside rim of the lock and contact the pin end. If it will, fine. If not (this may vary with different locks), grind a flat on each rod until they will all clear to contact the pin end and not touch the rim. The flat must extend far up enough on the rod to allow the rod to bottom the pin. Remember to touch up the grind a little with a file to prevent metal slivers from jamming the lock.

The final step is to insert all the rods into their respective tubes, and put a doubled or tripled rubber band around the whole assembly to hold the rods.

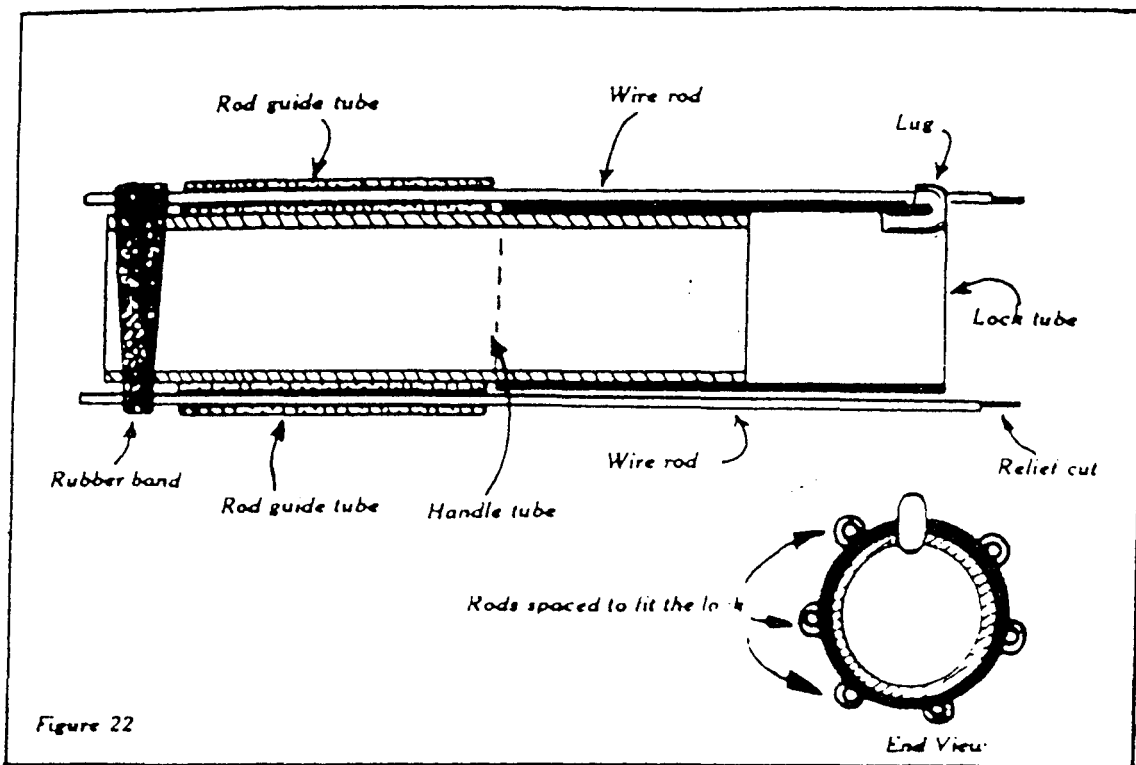

Lubricate each rod with a drop of oil. To prepare the pick for use, push or pull each rod (called a "feeler") below the bottom of the tube assembly, and then push the assembly end down on a flat surface to get all the rods flush with the tube assembly end. The tool is now ready for use.

As already stated, engage the lug in the nose groove, apply tension to the nose, and gently begin to push/wiggle the tool down into the lock. As each pin reaches shear line, it should hang up and stop moving. Eventually all the pins will be at shear and the lock will turn. At that point, it is worthwhile to add another rubber band around the assembly to more securely hold the rods in their proper position.

Notice that the pick now becomes 'exactly like a key, and can be removed and re-inserted at any later time. With the proper equipment, the pick can even be "read" and a key fit or cut to match. If you have trouble getting the lock to open at first try, don't be surprised. This tool does not substitute for skill -- it only makes it possible to open the lock. Skill in use must be acquired as with any other lock tool -- by practice.

One of the biggest variables is the tension exerted by the rubber bands on the feelers. It cannot be too tight or too loose -- only experience will provide the proper adjustment.

One final word: there are many variations of the tubular lock -- different pin counts, nose sizes, and especially the position of the keyway slot relative to the pin array. If you want tools to open the left and right keyway locks, just obtain a lock of each type and build a tool as before. The angular relationships between keyway and pins will be correct when the feeler tubes are glued. Also, it may pay to shop around for a handle. There are many handled tools like nut drivers and screw drivers on the market, and one may have a shank of suitable diameter to cut off the tool end and glue the lock pick on. You may need to have a longer tube.

CHAPTER SEVEN MISCELLANEOUS

This is cleanup -- bits and pieces from my files.

First of all, I put plastic laminate handles on all my tools now. This material has various trade names like "Formica" or "Wilson art," and comes in an unlimited variety of colors, and even textures. It can be ordered in various sizes -- your best bet would be to get cut-offs from large sheets. If you have a table saw, set it to cut strips the same width as your picks, if they are half-inch wide. If you cut picks from plumbing snake stock, adjust accordingly, although the handle material can overlap the pick for easier handling.

Once the width is cut, cut strips to length, remembering to leave clearance between the handle and the lock face, for obvious reasons. Finally, apply contact cement to both handle halves and the pick, and bond together.

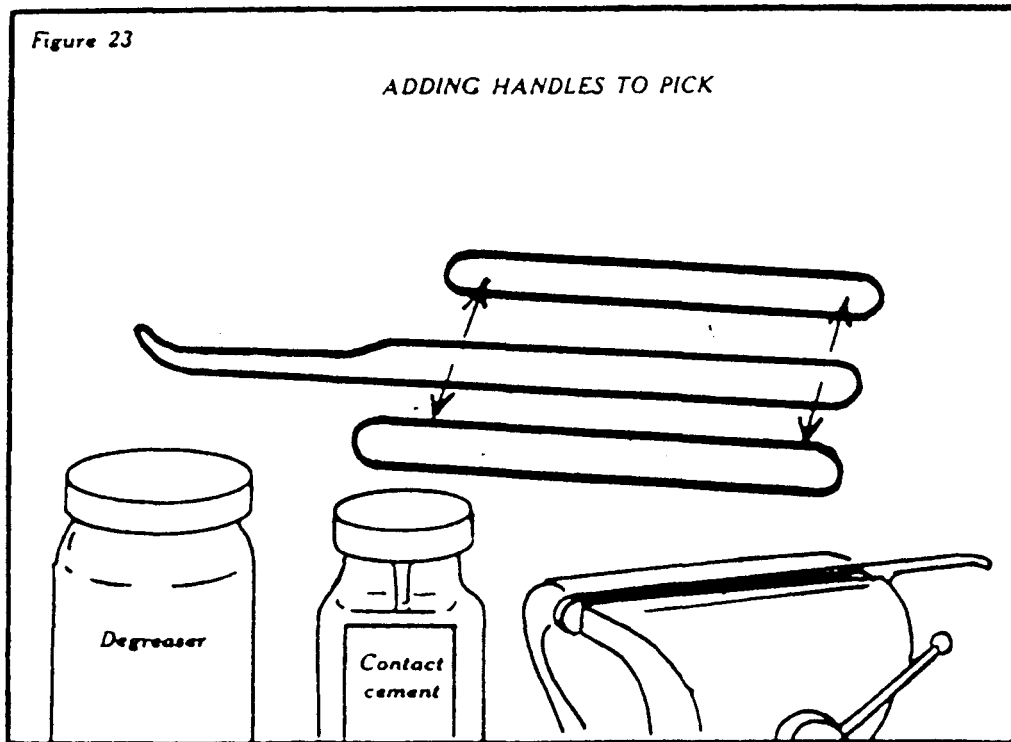

Remember to degrease the pick if it has been pre-lubricated. You can experiment with handles that are wider than the pick stock, and are contoured to fit the hand, or any other profile that seems better for pick control.

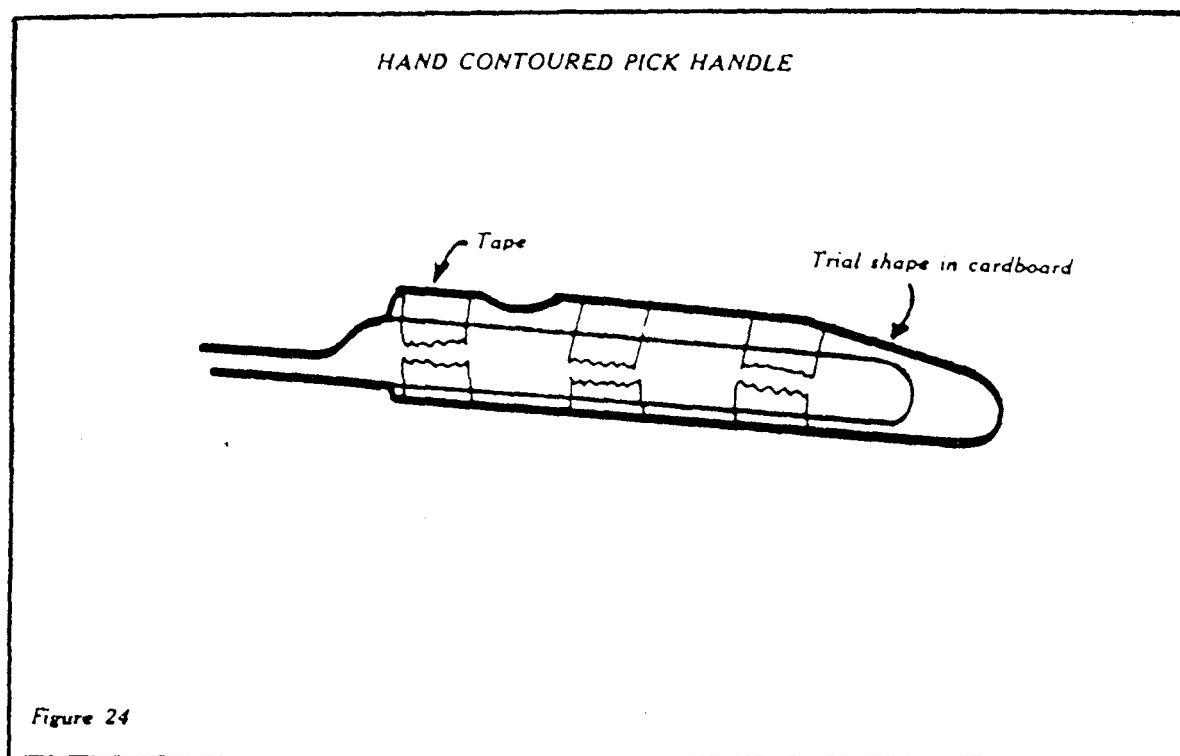

To decide on a contour, try cutting a piece of thick cardboard to your guess at profile, and then tape this onto a pick. Try working with it in a lock. If it feels funny, just cut it down or even tape on another piece until the feel is comfortable. Once you have evolved a good shape, trace it onto a sturdy material like sheet metal, or even formica. Once this material has been cut to shape, it can serve as a template to draw cut-out outlines on the handle material for short runs.

For larger production runs of contoured handles, cut out a template from plywood or plastic about $\frac{1}{4}$ to $\frac{1}{2}$ inch thick, and attach this to a larger piece of plywood using contact cement or screws. Now cut a second piece of plywood to act as a support and mask. It should have a hole large enough to allow the router bit to trace around the handle outline, yet not touch the mask at all. This entire jig can then be nailed to a workbench.

USING JIGS FOR CUTTING MULTIPLE HANDLES

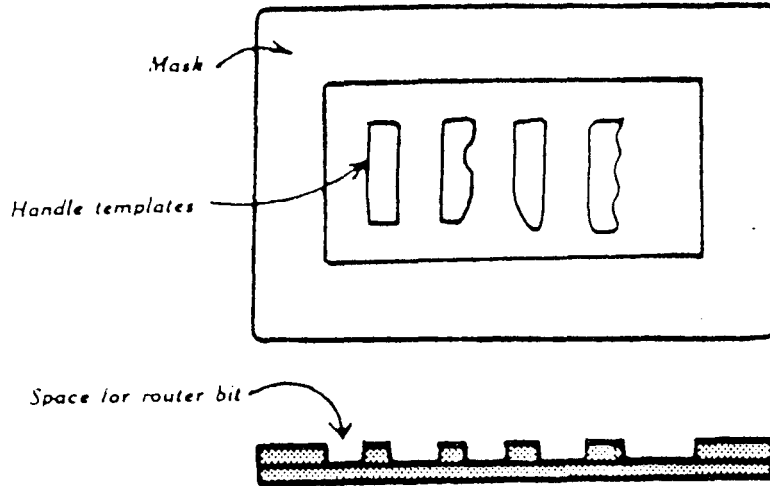

Figure 25

To use, a sheet of formica large enough to almost cover the mask is placed over the mask, and then clamped down. Place the clamps in positions that will not obstruct the router tool base. Find your starting point on the plastic by tapping for a hollow spot, and plunge the router in. *Note:* if your router bit has a pilot or roller on the end, this will not work. You can instead run the router bit from the plastic edge to starting point while the plastic is still unclamped, or you can drill a series of starting holes prior to clamping. If you drill, use a router bit in the drill to avoid cracked plastic. There are also router bits available that can plunge cut but have a pilot also. Check these out.

For really large/quick production runs, several handle templates (they could even be different shapes) can be attached to the plywood, with a mask to accommodate them all. Then a complete set of handles can be cut at one pass, using a freehand tracing technique with the router, and removing each handle as it separates.

On the subject of handle-coding: different pick shapes may be keyed to different handle profiles, or handles may be drilled with a series or pattern of small (one-sixteenth inch) holes for identification by touch. Handles may also be color-coded and even coordinated

with case color (this really looks professional). All the material you need can be picked up from the nearest kitchen shop, cabinet shop, or redecorator and remodeling shop. Many such shops have sample chip boards of each color and pattern, and a quick trip through this will yield enough material for several sets of picks. These chips are small, however, and cannot be "production run."

Although I have not experimented with them, the plastic laminates used to make lapel badges and desk signs may also provide excellent handle stock, with the added advantage of being able to have information inscribed on the handle by the sign shop. Make sure they cut the info in before you profile the handle. This handle stock is also much thicker.

Using plumbing snake stock for picks? If you do, remember it comes in two widths -- the smaller is ideal for picks, and the larger is good for slim-jims. If you are cutting either, though, remember that the steel used for these snakes is not as high a carbon content as the auto shim stock, and thus it loses temper a lot quicker during grinding, and is much weaker after losing temper. Be *very* careful when cutting from such stock. If you like the idea of getting a whole roll of stock, remember that auto shim stock also can be purchased in large (25 foot) rolls.

Having trouble with some keyways not providing enough pick tool access? Many high-security locks have paracentric keyways. This means that the side wards extend beyond the middle of the keyway from either direction. Some keyway profiles also place the lower ward very low in the keyway, further restricting access.

One good way around this is with a fitted low-end wrench. Notice that at the very bottom of most such keyways, you can see it broaden out, and also see the shoulder cut in the cylinder, which will limit the depth of insertion of any tool in the extreme bottom of the keyway. A wrench to fit here must be appreciably larger in cross-section, and tightly fitted since it will rely on a mechanical and not a wedge or spring fit for security in such a shallow location. Figure 26 shows how to cut the wrench.

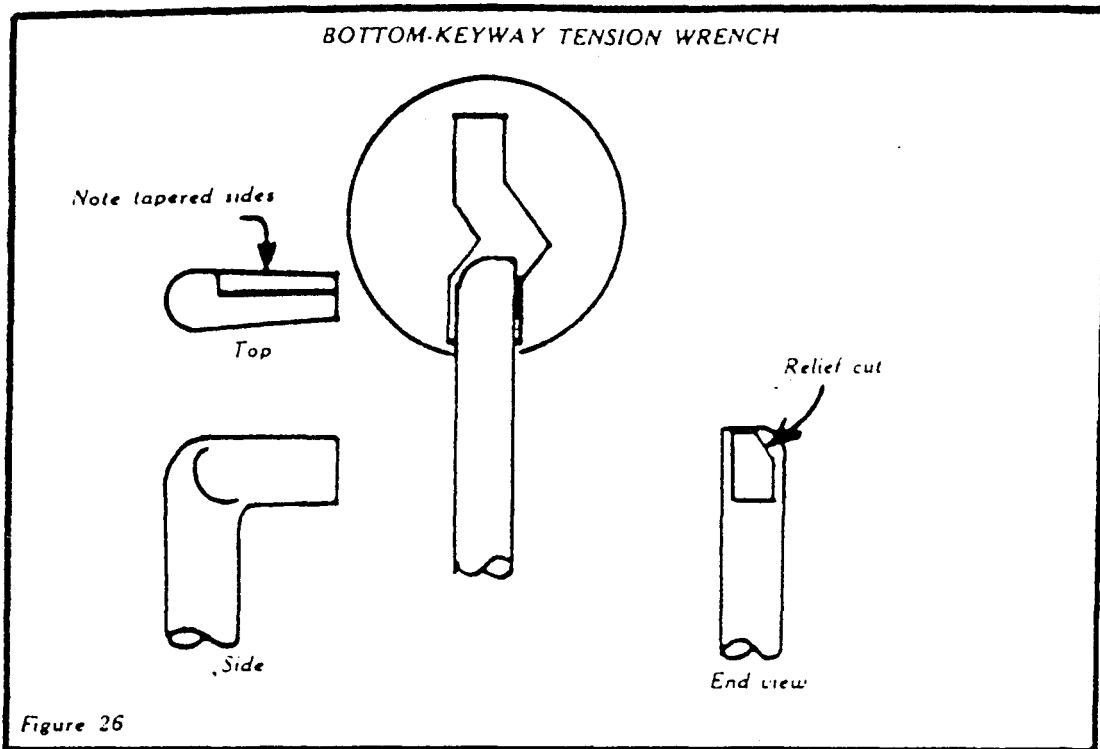

Start with music wire rod considerably larger than the usual, since the keyway here is very large. Grind two opposing flats as usual, but make them at least $\frac{3}{4}$ " long and tapered from small at tip to large at handle. They should form a wedge when viewed from the side, and the degree of wedge should be such that the tip fits loosely in the keyway, and the back won't fit at all.

Once this is done, try to fit the wrench tip into the keyway. If it is loose, as it should be, grind off a portion of the tip end, and try again. Eventually, if the wedge is sloped correctly, the wrench tip will wedge tightly into position. If there is a lot of tip left before the handle makes its right-angle bend, recut the wedge angle. If the bend is very far from the plug surface, the wrench will torque sideways as you apply tension, and may even pop out of the lock.

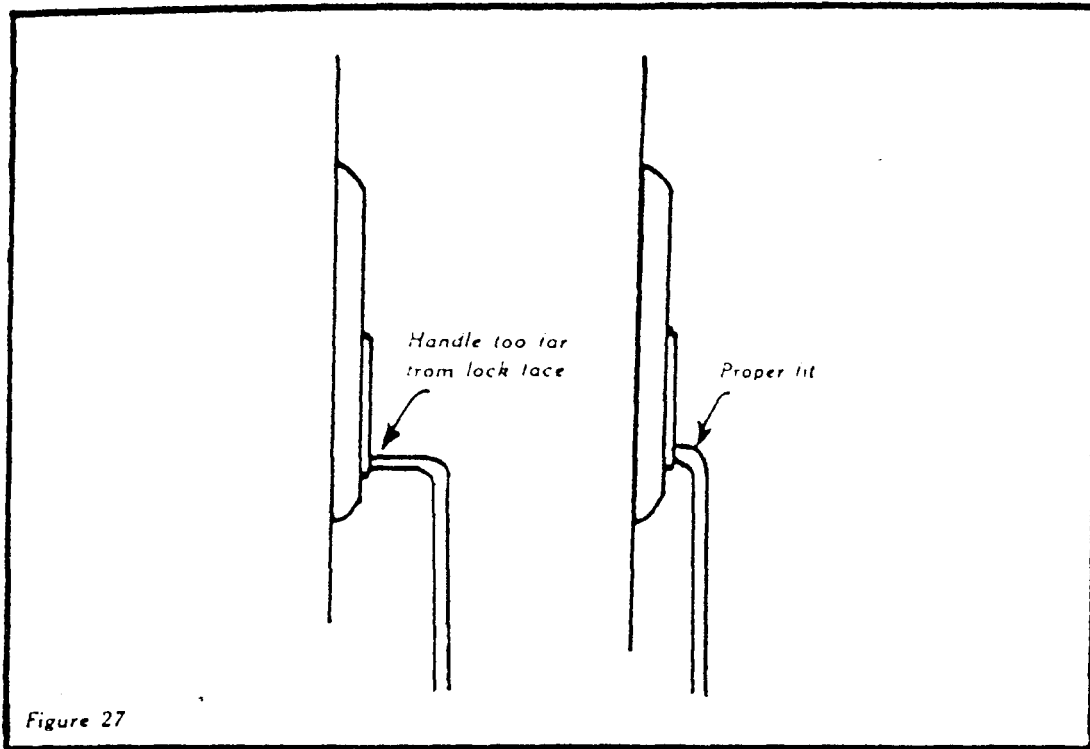

Should you also find that the keyway is shaped with an obstruction at the top of where the wrench inserts, the tip must be ground off to permit it to be fully inserted. Such "relief" cutting should be done very carefully and sparingly until the wrench bottoms out in the keyway. It may help to coat the wrench with soot from a candle flame and insert. The shiny edges will show how much of the wrench needs to be removed.

If all goes well, the wrench will fit well at all surfaces, and wedge tightly just as it bottoms out. You can even use a tool to give it a seating tap. Since the cross-section of this wrench is large, and it must withstand mechanical strain, it is wise to temper it.

A lot has already been written about tempering, so I will only give the basics. Any gas torch will heat the wrench (end only) to the required temperature. When the steel glows dark red, it is ready. For that matter, two or three pieces of charcoal and a length of hose to convey a stream of breath to same will also heat up the steel nicely. After the proper temperature is attained, quickly plunge and swirl the wrench in a can of water or motor oil. Leave it in a minute and remember to swirl after plunging.

The wrench should still fit after tempering, but if not, use a file to refit. Also, bend the handle before tempering as this makes the tool very brittle. Aha, you say, can't we bend the handle during heating when it is much more pliable? As a matter of fact, you say, why can't we do more hot forming? The answer is simple -- most picks have very delicate cross-sections, and heat will warp these beyond hope, so stick to cold forming.

One quick item on improvised tools: just about anything that is reasonably tempered steel can be cut into a pick profile. The key word here is "tempered," since soft steel will not hold up in small cross-section. For instance, cotter keys can be cut into picks or tension wrenches. Typewriter type bars can be cut into excellent wrenches. Tweezers can be cut into tweezer-type tension wrenches. Kitchen knives can be traced and cut into picks. The list is really endless. The only requirement is that the steel be tempered.

Having trouble cutting smooth curves on the inside of your individually-lifting picks? It does take a light touch, but there is a better way. You need a grinding wheel dresser, a tool that should be periodically used to remove the surface skin clogged with metal that the grinding wheel develops. Instructions for use come with most tools -- just hold it square against the wheel and press lightly. Periodic testing with the wheel surface still, will indicate when the job is done.

What we are going to do, however, is use the wheel dresser on an edge of the wheel, to round it off into a radius that can be used to cut individually-lifting picks. Start slowly, and test the radius frequently by using the wheel to grind into a piece of shim stock (don't worry if you burn it). Eventually, you will achieve a radius that can be used for the curved surfaces that are hard to grind on a straight-edge. With some care, the radius you shape on the wheel will exactly match the layout line, making your job easy. Remember to periodically check the wheel profile, and redress as necessary.

How do you measure a lock for pick dimensions if the lock is in service (mounted)? You need a special probe with calibrations on its surface. The local tool supply or industrial supply store will have inexpensive metal rules, usually about .020 inch thick, 4 - 6 inches long, and 1/4 inch wide. Layout and cut this rule as you do regular pick stock, but grind a shallow wedge at the tip.

"IN-SERVICE LOCK" MEASURING PROBE

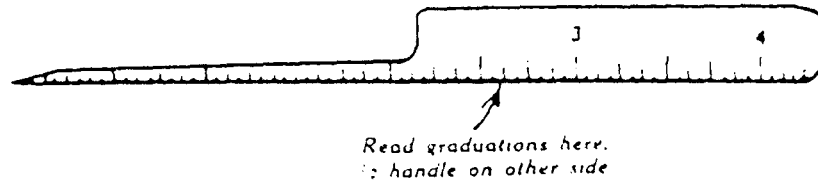

Figure 28

We get a lot of our materials from the hobby shop (e.g., music wire) but suppose you are in a real hurry? I find that a first-quality tension wrench can be improvised from a standard hex wrench. All hardware stores carry these, either individually or in sets at low prices. Since the bend is already made, cutting the flats on the working end can be difficult. If your grinding wheel is open (no wheel guard) then it is easy to hold the wrench end (the inside face) to the wheel with a pair of vise-grips. The outside wrench face is cut merely by grasping the existing long hex wrench handle and working freehand. For commercial grinding wheels with limited access, cut the opposing flats on the sides of the short wrench end. The sides are alternately facing you, as you lay the wrench on a table and turn it over. These sides can be easily cut by the same technique of holding the hex wrench in a vise-grip. With skill, you can use hands too, one on the long wrench handle, one fingertip pushing the wrench into the wheel.

For that matter, you could cut flats on the long end (notice you have three sets already started) and use as is or rebend the wrench. As usual, do not burn the steel or it will soften. Use a water quench frequently.

All of the handle materials we have used up to now have been mostly smooth. Recently, I saw 3-M non-skid rubber tape in 1/2" and 1" widths, and tried some on a pick. The results are good, the control is excellent. This tape has a very lumpy grey rubber surface, and pressure-sensitive backing with release paper. The one-half inch width fits auto shim stock picks without cutting. If you operate in adverse environments (e.g., dripping water), this is nice. There is also room for experimenting with common sandpaper, preferably waterproof. If your pick case or hideout pocket has a pick that forever slips out, this is the answer.

AFTERWARD

The complete set of my books as of September 1981 is *HOW TO MAKE YOUR OWN PROFESSIONAL LOCK TOOLS*, Volumes 1, 2, and 3; *THE COMPLETE GUIDE TO LOCK PICKING*; and *HOW TO BURY YOUR GOODS*. Armed with a set like that, if you can't get into 90% of the locks you encounter, you're just not trying. As always, the key to successful entry is research and practice.

Build up a lock collection, one of every kind you can find. Disassemble them, size tools to fit them, then practice mount them and attempt to bypass them. Work under actual conditions (usually adverse). Always carry a set of tools. If you stick with this system, success will inevitably follow.

Finally, let me say a word about lock tools in general. I have at least fifteen books on lock picking and tools, and they are all the same. They all show the same pick profiles, give the same techniques. Now don't say I didn't warn you if you secure other books that have no new material in them. I really feel that my series covers most if not all of the data, tools, techniques, and tricks that you will ever need.

Good luck and practice!