

\$30.00

**SCIENTIFIC PRINCIPLES
OF IMPROVISED
WARFARE AND HOME
DEFENSE
Volume 4**

**Incendiaries: The science of
using fire as a weapon**

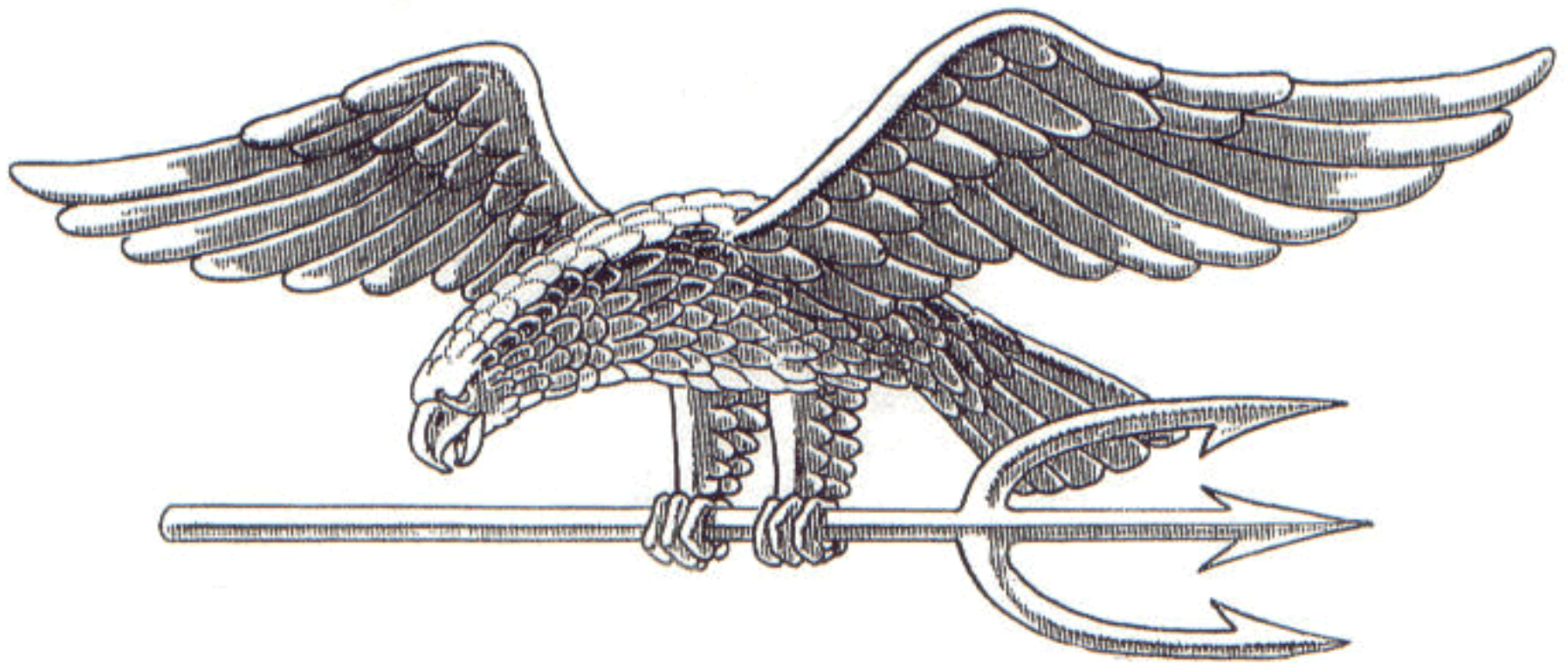

**While Nero fiddled, the real history makers
were burning Rome to the ground**

**SCIENTIFIC AND TECHNICAL INTELLIGENCE PRESS © 1997 BY
TIMOTHY W TOBIASON**

For Academic Purposes Only

**Scientific Principles of Improvised
Warfare and Home Defense**

Copyright 1996 ISBN #
by Scientific and Technical Intelligence Press
and Timothy W. Tobiason

Printed in the United States of America

Published by
Scientific and Technical Intelligence Press
P.O. Box 59
Silver Creek Nebraska 68663

All rights reserved.
Except for use in a review, no portion
of this book may be reproduced in any
form without the express written permission
of the publisher.

This book is intended for academic use only.
Niether the publisher or the author assumes
any responsibility for the use or misuse
of information contained in this book.

Incendiaries, The Science of Using Fire as a Weapon

Table of Contents

Chapter 1: The Science of Combustion	
Combustion	1-1
Oxidation	1-1
Flammable substances	1-2
List of the Elements	1-3
Table of the Elements	1-4
Solids	1-5
Liquids	1-8
Gases	1-9
Principles & Behavior of fire	1-9
Fire phases	1-11
Weather	1-13
Chapter 2 Primary Incendiary Chemicals	
Metallic fuels and thermites	2-2
Metal fuels and oxides	2-4
Thermates	2-6
Sparking & Pyrophoric Fragmenting	2-6
Barium	2-7
Boron	2-8
Cadmium	2-8
Calcium	2-8
Carbon Disulfide	2-9
Cerium	2-9
Cesium	2-9
Copper & Copper Phosphide	2-9
Diisopropyl peroxydicarbonate	2-10
Dimethyl Cadmium	2-10
Erbium	2-10
Europium	2-10
Ferric Nitrate	2-10
Fluorine	2-10
Furfuryl Alcohol	2-11
Lanthanum	2-11
Lithium	2-11
Magnesium	2-11
Misch Metal	2-11
Molybdenum	2-12
NaK Alloy	2-12
Nickel	2-12
Nitrogen Trichloride	2-12
Nitryl Fluoride	2-12

Incendiaries, The Science of Using Fire as a Weapon

Phosphorus	2-13
Phosphorus Pentasulfide	2-13
Platinum	2-13
Potassium	2-14
Potassium Chlorate	2-14
Rhenium	2-14
Rhodium	2-15
Rubidium	2-15
Sodium	2-15
Strontium	2-15
Tantalum	2-15
Thorium	2-16
Titanium & Salts	2-16
Trichloromalamine	2-16
Tungsten	2-17
Uranium	2-17
Uranium Dioxide	2-17
Yttrium	2-17
Zinc	2-17
Zirconium & Carbide	2-18
Air Reactive Igniters	2-18
Raney Nickel	2-19
Boranes	2-19
Triethylborane	2-19
Silanes	2-19
Calcium Silicide	2-20
Trisilane	2-20
Tetrasilane	2-20
Phosphines	2-20
Calcium Phosphide	2-20
Cobaltous Resinate	2-20
Dibromoacetylene	2-20
Diethyl Zinc	2-21
Lithium Metal	2-21
Aromatic compounds	2-21
Lithium compounds	2-22
Chloride compounds	2-22
2-ethylhexaldehyde	2-22
Magnesium Amide	2-22
Triethylaluminum & Salts	2-23
Water Reactive Igniters	2-23
Aluminum Carbide	2-23
Aluminum Hydride	2-24
Bromium Pentafluoride	2-24

Incendiaries, The Science of Using Fire as a Weapon

Butyllithium	2-24
Calcium Carbide	2-24
Copper Phosphide	2-24
Diethylaluminum chloride	2-24
Phosphorus Pentasulfide	2-24
Phosphorus Trisulfide	2-25
Sodium Aluminum Hydride	2-25
Sodium Borohydride	2-25
Sodium Dithionate	2-25
Sodium Hydride	2-25
Zinc Selenide	2-25
Non Nitrate Oxidizers	2-26
Sodium Chlorate	2-27
Potassium Chlorate	2-33
Manganous Carbides *	2-34
Acetyl Benzoyl Peroxide	2-34
Acetyl Peroxide	2-34
Aluminum Chlorate	2-34
Ammonium Chlorate	2-34
Ammonium Perchlorate	2-34
Ammonium Permanganate	2-34
Aqua Regia	2-35
Barium Chlorate	2-35
Barium Perchlorate	2-35
Barium Permanganate	2-35
Barium Peroxide	2-35
Bromine	2-35
Calcium Chlorate	2-35
Calcium oxidizer salts	2-36
Cesium perchlorate	2-36
Chloric acid	2-36
Chromic acid	2-36
Cobaltous Perchlorate	2-37
Hydrogen Peroxide	2-37
Lithium oxidizers	2-37
Magnesium oxidizers	2-37
Manganese dioxide	2-38
Perchloric acid	2-38
Perchloryl fluoride	2-38
Performic acid	2-38
Potassium oxidizers	2-39
Silver oxidizers	2-39
Sodium oxidizers	2-40
Strontium oxidizers	2-41

Incendiaries, The Science of Using Fire as a Weapon

Urea peroxide	2-41
Zinc oxidizers	2-42
Dusts	2-42
Aluminum dusts	2-42
Ammonium hypophosphate	2-43
Antimony dusts	2-43
Benzoyl peroxide	2-43
Cadmium	2-43
Calcium hydride	2-43
Calcium dusts	2-44
Camphor	2-44
Charcoal	2-44
Chlorobenzoyl peroxide	2-44
Cotton dust	2-45
Lead dioxide	2-45
Phosphorus dusts	2-45
Potassium dusts	2-45
Sodium aluminum hydride	2-45
Sodium dusts	2-46
Stannic phosphide	2-46
Sulfur	2-46
Titanium hydride	2-46
Zirconium hydride	2-46
Mixtures for fuel air explosives	2-47
Liquids and gases listed	2-48
Liquid fuels	2-56
Thermal cracking	2-57
Butadiene	2-57
Xylenes	2-59
Ethylene derivatives	2-60
Liquids-alphabetical	2-60
Nitrate based explosives	2-72
Gelled fuels and Napalm	2-75
Lye systems	2-78
Lye alcohol systems	2-79
Soap alcohol system	2-80
Egg system	2-81
Latex system	2-82
Wax system	2-83
Animal blood system	2-84
Chapter 3 Incendiary Formulas and Devices	3-1
Improvised fire starting	3-1
Small arms and large gun shell design	3-4

Incendiaries, The Science of Using Fire as a Weapon

Hand Thrown Incendiaries	3-13
Chemical fire bottle	3-14
Igniter from book matches	3-16
Mechanically initiated fire bottle	3-18
Acid delay incendiary	3-21
Air Dropped and Positioned Bombs	3-23
Floating Bombs	3-24
Truck Bombs	3-28
Fuel air explosives	3-30
Blast pressure	3-30
Fragmentation	3-31
Fire effects	3-32
Frag. & Incend. bomb design	3-35
Rockets and Missiles	3-37
Primary explosives & Incendiarys	3-41
Electrical, mechanical & laser light	3-52
Booby trap and delay devices	3-55
Fire bottle launcher	3-58
Electric bulb initiator	3-62
Watch delat timer	3-66
No flash fuse igniter	3-68
Dried seed timer	3-70
Fuse cords	3-72
Clothespin time delay switch	3-74
Can liquid time delay	3-76
Time delay initiators	3-78
Aerosol & pump delivery systems	3-79
Chapter 4 Attacking fuel based targets	4-1
Autoignition temperatures-vapors	4-3
Autoignition temps- dusts	4-4
Explosibility comparisons	4-7
Attacking combustible fuel targets	4-11
Chapter 5 Attacking non liquid combustible targets	5-1
Chemical industries	5-3
Solid fuels	5-3
Grain elevators	5-4
Record keeping centers	5-5
Plastic and rubber	5-5
Wastewater treatment	5-5
Solvent processing plants	5-6
Warehouses	5-6

Incendiaries, The Science of Using Fire as a Weapon

Materials processing	5-6
Public assembly	5-6
Hotels and public occupancy	5-6
Mines	5-7
Wildland fires	5-7
Chapter 6 Non Combustible "Hard" targets	
Thermal conductivity	6-1
Refractory metals	6-2
Target types	6-4
Tank trucks	6-5
Rail tank cars	6-7
Aircraft	6-8
Ships	6-10
Armored vehicles	6-12
Chapter 7 Attacking Firefighting Infrastructure	7-1
Water supply systems	7-1
Wells and reservoirs	7-3

Incendiaries, the science of using fire as a weapon

Chapter 1

The Science of Combustion

In order to use fire as a weapon, you need to learn how to start a fire and how to make it do the greatest amount of useful damage or harm to an enemy. There is a basic language or words that you need to know in order to learn the sciences of using fire as a weapon. We will start with a few definitions.

Combustion: is an exothermic (creates its own heat) chemical oxidation reaction. The result of basic elements going through "combustion" is that they form oxides. Organic compounds usually form carbon dioxide and water because the carbon in them reacts with oxygen and heat to form new molecules. This process is called oxidation. When this oxidation takes place, chemicals are broken apart, the bonds holding them together are ruptured causing them to form new compounds. This reforming generates new heat of "combustion" which continues to drive the reaction of more chemicals. As long as there is fuel and oxygen (or other oxidizer) available to support these reactions, and the heat to break apart the bonds holding them together, the fires of combustion continue.

An example is the reaction of two hydrogen (2H_2 's) and oxygen (O_2). When these are brought together they form 2 molecules of water ($2\text{-H}_2\text{O}$). This reaction generates its own heat.

Chemicals vary greatly in the temperatures at which their bonds will rupture to "catch fire" and form new chemical bonds. For solids and gases this temperature is called their ignition points. For liquids, it is also called their flash points which is the temperature where they begin to give off gases that form ignitable mixtures with air. Carbon Disulfide, a liquid, has a flash point of -30C and an auto ignition temperature of 100C . This means it gives off ignitable gases into the air at -30C and when the liquid reaches 100C it "catches fire" and burns continuously. In the case of carbon disulfide, the reaction generates so much new heat so quickly that it burns almost explosively. Materials like rubber hydrocarbon and nylon are difficult to ignite at almost any temperature because their chemical bonds are so strong that they require continuous addition of outside heat to break apart the bonds holding them together.

Oxidation: is any chemical reaction in which electrons are transferred. Chemical atoms will react with each other when energy (usually heat) is applied. When they exchange electrons to form new materials, this process is called oxidation. Oxygen is not a combustible but it supports combustion because it easily accepts electrons from other chemical atoms. This means it is an "oxidizer". The element chlorine is also considered an oxidizer because it easily accepts electrons. Many chemical substances contain oxygen or chlorine in their molecular formula in such a way that they easily accept electrons in reactions. These molecules are called **oxidizers**. Chemicals with the names of **chlorates, perchlorates, nitrates, peroxides, and permanganates** are all considered oxidizers. That is because all of them contain chemical oxygen that is available to easily accept electrons from other chemicals. This means that they all can be combined with a combustible fuel source to easily burn when ignited.

Incendiaries, the science of using fire as a weapon

If the combustion takes place all at once so the reactions are nearly instantaneous, a huge volume of combustion gases are produced. When the surrounding air cannot absorb and cool these gases fast enough, a shockwave is formed that expands outward. This shockwave is called an **explosion**.

Oxidation can take place very slowly. The chemical reaction of the metal "Iron is a good example. Over time, when exposed to air and moisture, it donates electrons to the oxygen in the air forming a new molecule called "Iron Oxide" because the metal Iron has now been oxidized. This iron oxide is the red rust we see on iron metals that have reacted with the air. Because this process is so slow, we do not see the heat from it. When iron oxide, now an oxidizer because it contains oxygen, is mixed with a metal fuel like powdered aluminum metal, you can produce another reaction called a **thermitic** reaction. When this mixture is ignited, it reacts to exchange electrons very quickly producing a huge volume of heat (about 2,200 C) which softens steel.

When a material donates electrons, it is called a **reducer** because the electrons it has are transferred to other chemicals "reducing" the electric charge of the other chemical. When reducers and oxidizers are brought together, they usually react immediately creating a lot of heat (fire) and often produce explosions.

Combustibles are any substances that will burn. A **Flammable** substance is any material that burns rapidly and ignites easily. The physical state of the material will often determine if it is a combustible or if it is flammable. Pyrophoric metals such as depleted uranium, titanium, or zirconium will easily ignite and burn rapidly in the form of powder or flakes and are considered flammable. Most of these are non-combustible when in solid bulk form. Cellulose is considered combustible when it is made into a fabric like textiles or paper. When it is finely divided in a form like cotton linters where the oxygen in the air is mixed with it, it is considered flammable. Many substances will melt and burn (like nylon), but will not produce a flame from their breakdown reactions and are not considered combustibles. Many plastics only ignite at high temperatures and produce toxic fumes (like PVC and Polyurethane). Plastics like the acrylics and cellulose based polymers easily ignite and are considered combustible and in some forms are flammable. Glass is considered non-flammable in all its forms.

The actual definition for classifying a material as flammable are those substances which have a flash point of less than 100 degrees F (37.7 C) and a vapor pressure of not over 40 psi at 100 F. Flammable gases ignite very easily and burn so quickly that they often produce explosions, especially if the gas is confined. The most common flammable gases are hydrogen, carbon monoxide, acetylene, and almost any other hydrocarbon based gas. Oxygen by itself is not combustible or flammable but will quickly make its combustible surroundings flammable if leaked out in large volume.

These definitions are important to know when weapons of war are to be constructed. If you plan on using incendiary weapons, it is helpful to know which materials are the most easily ignitable. These would be the flammable chemicals. The best targets in war are the flammable ones followed by the combustibles. If the targets are military, such as bunkers or tanks, you need to know the temperatures necessary to damage the metal surfaces, intake filters, and so on. You need to know how much fuel and oxidizer is necessary to do the job.

Incendiaries, the science of using fire as a weapon

The basic chemical names and reactions are easy to understand once you know a few basic terms. Each chemical atom has its own symbol and name which can be seen on the following chart and on the periodic table of elements.

Element	Symbol	Atomic Number	Element	Symbol	Atomic Number
Actinium	Ac	89	Mercury	Hg	80
Aluminum	Al	13	Molybdenum	Mo	42
Americium	Am	95	Neodymium	Nd	60
Antimony	Sb	51	Neon	Ne	10
Argon	Ar	18	Neptunium	Np	93
Arsenic	As	33	Nickel	Ni	28
Astatine	At	85	Niobium	Nb	41
Barium	Ba	56	(Columbium)		
Berkelium	Bk	97	Nitrogen	N	7
Beryllium	Be	4	Nobelium	No	102
Bismuth	Bi	83	Osmium	Os	76
Boron	B	5	Oxygen	O	8
Bromine	Br	35	Palladium	Pd	46
Cadmium	Cd	48	Phosphorus	P	15
Calcium	Ca	20	Platinum	Pt	78
Californium	Cf	98	Plutonium	Pu	94
Carbon	C	6	Polonium	Po	84
Cerium	Ce	58	Potassium	K	19
Cesium	Cs	55	Praseodymium	Pr	59
Chlorine	Cl	17	Promethium	Pm	61
Chromium	Cr	24	Protactinium	Pa	91
Cobalt	Co	27	Radium	Ra	88
Copper	Cu	29	Radon	Rn	86
Curium	Cm	96	Rhenium	Re	75
Dysprosium	Dy	66	Rhodium	Rh	45
Einsteinium	Es	99	Rubidium	Rb	37
Erbium	Er	68	Ruthenium	Ru	44
Europium	Eu	63	Samarium	Sm	62
Fermium	Fm	100	Scandium	Sc	21
Fluorine	F	9	Selenium	Se	34
Francium	Fr	87	Silicon	Si	14
Gadolinium	Gd	64	Silver	Ag	47
Gallium	Ga	31	Sodium	Na	11
Germanium	Ge	32	Strontium	Sr	38
Gold	Au	79	Sulfur	S	16
Hafnium	Hf	72	Tantalum	Ta	73
Helium	He	2	Technetium	Tc	43
Holmium	Ho	67	Tellurium	Te	52
Hydrogen	H	1	Terbium	Tb	65
Indium	In	49	Thallium	Tl	81
Iodine	I	53	Thorium	Th	90
Iridium	Ir	77	Thulium	Tm	69
Iron	Fe	26	Tin	Sn	50
Krypton	Kr	36	Titanium	Ti	22
Lanthanum	La	57	Tungsten (Wolfram)	W	74
Lawrencium	Lr	103	Uranium	U	92
Lead	Pb	82	Vanadium	V	23
Lithium	Li	3	Xenon	Xe	54
Lutetium	Lu	71	Ytterbium	Yb	70
Magnesium	Mg	12	Yttrium	Y	39
Manganese	Mn	25	Zinc	Zn	30
Mendelevium	Md	101	Zirconium	Zr	40

Incendiaries, the science of using fire as a weapon

Chemicals can be made up of two or more different types of molecules with different CAS identifying numbers. These types of chemical mixtures are called compounds. A good example of a compound is the intimate mixing of charcoal, potassium nitrate, and sulfur. When these are mixed together intimately, they are very easy to ignite and they burn together so fast that they produce a low velocity explosion. This mixture or "compound" is known as gunpowder.

Chemicals can burn very slowly as in the earlier example of the iron rust, they can be faster such as the burning of a piece of paper, they can be very fast such as the burning of a tank of gasoline, or they can be nearly instantaneous as when ammonium nitrate burns all at one and detonates in an explosion like the Oklahoma City bombing.

The amount of heat given off by burning substances varies greatly depending on how fast they burn and the chemistry of the burning. If materials generate extra heat as they burn, they are called exothermic. These add to the temperature of a fire. If they produce reactions and gases that absorb heat, they are called endothermic. If gases are produced that absorb heat, they have the effect of cooling the fire. Many of the gases formed by the burning of ammonium nitrate actually take heat away from the reaction by forming cool carbon monoxide and carbon dioxide gases. This cooling effect lowered the temperature and maintainability of the high temperatures at the center of the explosion and was responsible for the fact that many nearby combustibles were not set on fire. The explosion did not produce enough heat for a long enough time to achieve the auto ignition temperatures for many of the combustible substances in adjacent buildings, vehicles, and plants. Another good example is using fire to change water into steam. It takes a lot of hot fire to convert liquid water into steam without the water itself actually increasing in temperature. This is why firefighters use water to fight fires.

Some chemicals act as catalysts. A catalyst is a substance that doesn't become part of the reaction, but it drastically speeds up the reaction rates of the materials around it. Water acted as a catalyst in the earlier example of Iron converting to Iron Oxide rust. It speeded up the reaction and caused the metal to rust faster. Sunlight acts as a chemical catalyst on human skin, speeding harmful chemical reactions that can lead to sunburn or cancer. Many catalysts will speed up combustion and are often incorporated into weapons for this purpose.

The physical state of the material affects how it burns or how it can be attacked with fire.

Solids

Because solids are physically dense, they usually burn very slowly and cannot mix with air on their own to speed up the rate of burning. Finely divided solids still burn only on their surfaces but have much more surface area exposed to the air and other chemicals and so can react thousands of times faster than a solid block of the same material. Many solids are combustible that are used in construction like wood, cellulose, plastics, roof shingles (made with asphalt) and insulation sheets. These usually have low ignition temperatures and require small amounts of fuel and heat to ignite. Military vehicles and bunkers are made out of things like concrete, steel, iron, zinc, tin, and other metals that are non-combustible, and must be attacked with much hotter weapons in order to melt them to reach the target sensitive targets inside. The density of a solid affects its ability to resist or slow down the rate of burning of a fire or how fast the heat of a fire is conducted through it to the inside.

Incendiaries, the science of using fire as a weapon

Weapons used against non-combustible solids can affect them by softening the metal so that projectiles can penetrate them more easily (depleted uranium rounds used by the A-10 in the Persian gulf war against the Iraqi tanks are a good example), they can be used to melt the metals so they flow away from center of the fire, or they can be heated so they expand and cause stress damage. Heat expansion can change the shape of metals and effectively destroy electrical connections, bearings, support joints, and weapon barrels.

The thermal conductivity of solids play a role in weapons construction. A steel plate will transfer or conduct heat from a fire next to it much more rapidly than a piece of plywood. If the heat is high enough it can ignite materials on the other side without being destroyed by the heat itself. This is important in incendiary attacks against steel tanks holding flammable gases and liquids like oil, propane, natural gas, gasoline, etc. The piece of plywood would not conduct heat through it although if it reaches its autoignition temperature it may readily burn through and once destroyed, the fire may ignite combustibles on the other side.

Very few solid materials actually burn. Most of the time, solid materials get so hot that they begin to give off vapors and it is these vapors that actually burn. Wood is a good example. When the kindling temperature of the wood is reached (the temperature needed to ignite and keep the wood burning - another name for ignition temperature used for wood fires) a process called pyrolysis begins in which the heat causes combustible vapors to form from the chemicals that the wood is made up of.

When you strike a match to ignite a fire, a chemical in the match head (usually potassium chlorate) reacts to generate high heat. This reaction is very fast and results in the large flare of fire when the match is first struck and lighted. The heat from this match head causes carbon in the wooden part of the match to evolve gas which then burns and keeps the match on "fire". Arson investigators can often tell what was used to start a fire by looking at the combustibles which burned and did not burn. This will tell them how hot the fire was. Each solid combustible generates a measurable amount of BTU's and by comparing the BTU's available as fuel to the actual damage a building experienced, an investigator can tell if a fire was started and provided with outside fuel. If it was, then they determine it was a deliberate act of arson.

In war, it is important to know how much fuel and temperature is required to reach the auto ignition temperatures of the target. The physical characteristics of several fire fuel sources are -

<u>Substance</u>	<u>BTU's/Cu Ft.</u>	<u>Ignition Temp. F</u>	<u>Flash Point F</u>
Wood	320,000	500	
Coal	650,000	600	
Natural Gas	462,000	900-1170	
Propane	685,700	871	
Gasoline	965,500		-45
Kerosene	1,010,000		110
Diesel Fuel	1,035,000		110

It is also known how fast materials burn on their own. Wood burns at 3/4" per hour. If the rate of burning exceeds that additional fuel, oxygen, or heat is required to increase the reaction rate.

Incendiaries, the science of using fire as a weapon

The melting points (F) of construction materials used in military vehicles, buildings, and electronics are -

Soft Solder	374-421	Brass	1710-1810
Tin	450	Bronze	1910
Lead alloys	550	Copper	1980
Silver solder	580	Cast iron	2150
Electrical fuses	700	Stainless steel	2550
Zinc	780	Wrought Iron	2750
Aluminum	1150	Steel	2760
Glass	1200	Tungsten filament	6100
Silver	1600-1650		

When a material melts, it first softens and then it turns from a solid to a liquid. Glass softens at about 1000 F and melts at 1200 F. At the atomic level, the atoms become so hot that they are pushed apart and cannot remain connected in a crystalline structure. This causes them to liquefy and flow. When they flow they assume the shape of any container they are in or they flow like lava wherever gravity takes the liquid.

Because many wooden solids do not conduct heat, they must be burned through completely before adjacent materials can catch fire. If it is desired to burn a building to the ground by a fire bomb thrown through a window, the interior furniture and panels of the room will burn first and rapidly. The wooden support studs will not be damaged until the fire burns through the paneling completely. If emergency showers put out the fire before the panels are burned through the supports are unaffected and the paneling can be easily replaced. The attempt to burn the building down fails. The use of materials to accelerate the rate of burning and the use of projectiles or pyrophoric shrapnel to create holes through the panels will drastically increase the spread of the fire and are important tools for incendiary weapons designs.

Steel supports, if unprotected by thick fireproof materials can be weakened by fire at much lower temperatures than their melting points. Tensile strength's of all metals decline significantly as the core temperature it reaches increases. Stone and concrete materials can actually explode or experience spalling from the trapped, heated moisture still inside its pores and converted to steam. The effect is like a boiler explosion.

Most building supports are designed to experience four times the mechanical stresses they normally sustain. To cause a building to collapse due to incendiary attack, about 3/4 of the support structure must be destroyed or degraded.

The melting point of steel used in buildings, bunkers and armoured vehicles is about 2700 F. Certain aircraft use very high temperature metals and ceramics that can sustain up to 4000 F. Jets of burning gas, thermite metal reactions, jelled fuels to keep combustion on a specific point, and other high temperature combustion is required to cause heat damage to these types of metals.

Incendiaries, the science of using fire as a weapon

Metal pipes containing liquids in buildings and vehicles can experience loss of strength of up to 90% as their core temperature rises above 700 F. These can rupture from the pressure of the compressed gases formed inside them. If the pipes contain fuel, they can add to the fire and produce explosions as well inside the target.

Concrete is brittle and has no tensile strength (no ability to resist pulling or pushing out of shape). That is why steel reinforcing is added to highway, building, and bunker constructions. A concrete covering of 1-3 inches protects steel from the corrosive effects of moisture and atmospheric acids. In high temperature fires, the concrete may conduct enough heat to the steel to weaken it, while simultaneously suffering damage from moisture expansion itself. This combination can lead to structural failures.

[The recent bombings of the World Trade Center and the Federal building in Oklahoma City provide good applied examples. Both had clear objectives of destroying the entire structures with maximum loss of life. Both must be considered failures because of the lack of basic knowledge of explosives and incendiaries. If even a little incendiary science had been applied to the bombs, both would have been surrounded by several tons of gasoline or other high temperature combustibles. The resulting explosions would have acted as primers for very large, high temperature incendiary explosions. The high temperatures could have weakened the structures to produce total collapse while igniting the surrounding areas. If the temperature rise was sufficient in the core around the vehicles, the identifying metal parts would have melted leaving no reliable, identifiable trace or track of the vehicles used.]

Liquids

The main difference between liquid and solid fire is how much easier liquids are to ignite. The reason for this is that solids have to be heated to the point where they physically break apart and emit vapors which are flammable. This usually requires a lot of external heat energy to start. Flammable liquids usually require little energy to ignite. The flash point is usually reached at or slightly above room temperature and once vapors are emitted, the auto ignition point is easily attained. The flash point is usually slightly higher than the boiling point. Most flammable liquids boil at low temperatures and form explosive mixtures with the surrounding air. The flash point is the minimum temperature at which the vapor can ignite but it often requires the higher auto ignition temperatures to actually self-sustain the combustion. These temperatures are usually 10-50 degrees F higher.

The flash and ignition points of liquids are based on normal atmospheric oxygen and the effects of any confinement. If the pressure is higher due to confinement, it raises the ignition temperature. This also happens if vapor dilutes out the available oxygen and the ranges in which liquids will still ignite in air mixtures will be included with many of the flammable liquids we will describe.

The energy content as measured by BTU's can give an idea of how much energy is generated by the same amounts of a particular substance. Kerosene produces more BTU's than gasoline and less of it can be used to support the same amount of combustion.

Incendiaries, the science of using fire as a weapon

Gases

As the temperature of a liquid increases, the heat raises the energy level of the atoms pushing them further apart until they finally cannot be held together any longer. They then leave the liquid, escaping as a gas at the surface. If it is contained, the gas assumes the shape of the container and builds up pressure against the walls of the container. This pressure is called the vapor pressure of the gas.

The heat content of a gas is much smaller than that of a liquid. That is why gases are usually compressed and stored as liquids. Their volume is reduced as much as 30:1 making it easier and cheaper to transport and store greater volumes of energy. This also applies to incendiary weapons. It is much cheaper and easier to make more powerful liquid based weapons than vapor based weapons because the liquids concentrate much more energy in a much smaller space than gases can.

Many of the gases have a specific range of concentrations in air in which they will ignite. If you flood the carburetor of a car with too much gas, it can't start because the "explosive limit" range of the gas when mixed with air has been exceeded. If the minimum limit is not reached the gas-air mix will not ignite. The gas must be mixed in the required range to be ignitable.

As a liquid is heated and turns into a gas it rapidly mixes with and forms a homogenous mixture with the air and any other gases present in its surroundings. Some gases are lighter than air and rise. Helium is a good example and it is used to support the weight of and make balloons rise in air. Propane is heavier than air and quickly sinks to the ground and separates from the air. This makes it a good candidate for incendiary attack against underground tunnels and bunkers because it would displace the air as it descended into the cavities. The prevailing drafts, air convection's, and thermal currents quickly displace, dilute, and carry off gases into the atmosphere. In order to be effective the gas must be sufficiently concentrated and quickly ignited. These principles are used to good effect in military fuel air explosives which will be described later.

The Principles and Behaviors of Fire

All fires require 3 things in order to occur.

1. Fuel which can exist as a solid, liquid, or gas.
2. Oxygen or other oxidizer which can also be a solid, liquid, or most often a gas.
3. Heat to reach ignition temperature for self sustaining combustion

The process of combustion of solid fuels is often called **pyrolysis**. Once a solid fuel such as wood is ignited, it begins to pyrolyze and the moisture in it turns to water vapor. Once most of the water is driven off as vapor, the solid begins to decompose from the heat and they give off combustible vapors. This process of breakdown of the solid and production of combustible vapors is called pyrolysis. It is the vapors above the fuel that burn, not the solids. Solids like wood, plastic, and coal do not burn, they pyrolyze.

Incendiaries, the science of using fire as a weapon

Wood pyrolysis is a good example to teach since most construction of buildings in the world are based on wood products. Wood is made up mostly of cellulose with some hemicellulose and lignin. These substances account for almost all of the non-water weight of the wood. When the wood is subjected to heat, the heat is radiated into the wood which yields the following-

1. Water absorbs much of the heat and turns to vapor carrying away this first heat energy into the air. Once the wood reaches 212 F, all of the free water will be driven off, and this dries out the wood. Once the wood reaches about 500 F it will autoignite.
2. When the wood becomes dehydrated, the cellulose and hemicellulose breaks down into carbon monoxide, carbon dioxide, and hydrogen gases. The CO and H are combustible and burn in the air. Some water vapor comes out the cellulose as waters of hydration and goes into the air carrying some heat away with it.
3. Finally, when the available oxygen in the cellulose and adjacent air runs out, the carbon left in the wood turns to charcoal. The charcoal has a large surface area and burns slowly as it takes time for atmospheric oxygen to diffuse into its pores and continue to support further combustion. Charcoal has been known to continue to pyrolyze (produce gases) for months and even years at very low temperatures.

The combustion continues as long as heat, air, and available carbon is present to support formation of CO gas. This gas reacts in the air with oxygen to produce CO₂. You can often see this type of pyrolysis by looking at the glowing embers of charcoal or fireplace logs after the flame has died out. Solids continue to pyrolyze and give off gas as long as sufficient heat is available, until only ash is left.

Chemically, the results of the burning of a carbohydrate looks like this -

C₆ H₁₀ O₅ (a carbohydrate molecule) is heated in the presence of air which contains O₂ (oxygen). These are heated together and form 6 CO₂'s (carbon dioxide) and 5 H₂O's (water) as water vapor

Virtually all fuels, whether they are solid, liquid, or gas, contain large amounts of carbon and hydrogen in their chemical structures. This allows the sustained chemical burning reactions to continuously produce water vapor from the hydrogen and oxygen, and carbon gases from the carbon and oxygen reactions (plus a lot of heat of combustion).

Liquid fuels also pyrolyze, burning only where the gases are coming off of the surface of the liquid. Most liquids are volatile, that is, they turn to gas vapors quickly when heated and it is these vapors that rise off of the liquid that actually burn. Because their boiling points are almost always lower than their pyrolysis temperature, few liquids will ever pyrolyze. They turn to vapors and are completely consumed without leaving solid unburned residues behind. In effect the liquids are distilled into the fire as combustible gas which is then the fuel for the fire to continue to burn.

Incendiaries, the science of using fire as a weapon

The best example to see how this works is to fill a glass jar with kerosene and light the surface. Then look carefully with your eye level parallel to the top of the kerosene. You will see that the flame is actually a little bit above the surface of the kerosene and there is small space between the kerosene and the flame. This is the area that the kerosene is changing from a liquid to a gas. This gas has to mix with the air to reach flammable limits so that the oxygen in the air can burn with it. This mix of hot vapors rises as it burns and the height of the flame represents the time it takes for all the vapor fuel to burn up.

The visible flame from the burning mix of vapors gives off visible light and considerable heat which are the product of the exothermic chemical reactions we described earlier.

Another rule in chemistry, is that the rate of burning or consuming of available fuel doubles for every 10 degree C rise in temperature. This is why fires rage out of control. Once most of the available fuel is used up or the supply of oxygen in the air runs out, the process runs out of energy and the fire begins to die out.

Heat is energy that results from chemical reactions. It can be transmitted in 3 forms.

1. Radiation, where the heat is transmitted through the air in the form of waves. Heat from the sun reaches us in this manner over millions of miles where we feel it on our skin.
2. Convection, where the air around a fire is heated and is forced outward by the heat of expansion, and upward because hot gas is thinner due to the expansion and rises. The hot air warms its surroundings and continues to mix with the cooler air around it.
3. Conduction, where heat is transferred through a solid because the molecules get hot on one side and "conduct" heat molecule by molecule through the solid. Each solid material has a rate at which it will conduct heat through it. Metals tend to be good conductors and are used in auto and industrial heat radiators. Insulating materials are poor conductors and do not easily transfer heat. Copper heats faster than steel. Steel heats much faster than wood.

A fire usually consists of three phases.

1. Incipient phase where the fire begins in a room or vehicle or wooded area at a temperature of 400-800 F. Most of the pyrolysis products are water vapor and CO₂ during this phase.

Incendiaries, the science of using fire as a weapon

2. Free burning phase where the fire consumes the surrounding fuel and air, builds up heat, and produces a thermal column of rising hot gases. The base of the fire reaches 800-1000 F, and the hot gases, if enclosed raise the ceiling temperatures to 1200-1600 F. Solids adjacent to this high heat begin to pyrolyze and char. Once the heat causes the ignition of these adjacent solids, a "flashover" occurs.

3. Smoldering phase where the available oxygen and/or fuel run out. When the oxygen content drops below 13%, it will no longer support the combustion of vapors from solids (this is why certain volatile liquids are used in weapons-they can burn at much lower oxygen levels, and in the case of ethylene oxide used in fuel air explosives, it requires no oxygen at all).

The temperature inside a room or vehicle drop and the ceiling temperature will usually be about 1000-1300 degrees F. The charring materials continue to slowly produce combustible vapors that are not being burned. These build up increasing the air pressure with a high fuel mixture. Most of this mix is carbon monoxide which comes off the smoldering charcoal and doesn't burn until 1125 F.

With a lack of oxygen and plenty of smoke, the CO₂ in the room will often react with the smoke to produce more CO which is now available as a flammable fuel.

The fire which consumed the Apollo astronauts trapped in their capsule on the launch pad in the 1960's is a good example of the course a fire can take in an enclosed space.

If there is no venting of these superheated and pressurized gases that have built up, the opening of a door will introduce a fresh oxygen supply and this often causes the area to explode as all the hot fuel now has a combustible mixture with a low ignition point. This condition is called a backdraft and a Hollywood motion picture of the same name was used to depict this condition which often confronts firefighters.

Firefighters usually try to vent the build up of gases from the roof so that the pressure can be released without an inflow of oxygen. This gets rid of both the pressure and some of the CO while leaving the charring fuels without an immediate oxygen supply to support combustion.

Air flow has a great effect on fires. Many fires inside of enclosures may burn themselves out quickly due to using up the available oxygen supply. Having entrance openings (preferably where the wind is coming from) and exit openings on the side the wind is blowing towards insures a stable supply of oxygen to feed the fires.

The mass bombing raids on Japan and Germany physically generated their own huge inbound drafts of air to feed the enormous fires that were started. These produced superheated flames that rapidly spread and could not be put out until all the available fuel was consumed. Its effect was to virtually destroy the entire towns that were bombed with the incendiaries and were the first to produce their own wind patterns.

Incendiaries, the science of using fire as a weapon

Weather can have an effect on how effective fire warfare can be conducted. Fires in subzero weather are not much harder to start than in normal weather. They can be much harder to put out because of frozen water lines and the general discomfort and difficulties of the firefighters due to the weather. Rain will have little effect on most fires unless it is very heavy.

Other factors affecting the use of incendiary weapons in fires is the use of chemicals that burn when mixed in water or directly ignite with water, chemicals that are air reactive, and chemicals that produce toxic gases when heated. All these add to the effectiveness of incendiary weapons and will be covered in great detail later in this book.

The science of using fire as a weapon is to figure out how best to ignite fires, and get the starter fires to reach the ignition point of its surroundings in the most rapid manner possible so as to cause the greatest amount of damage. These methods can be enhanced by the use of many additives to accelerate the spread of the fires, raise the temperatures for easy ignition or specific damage to metals such as armor, add hazardous materials that make fighting fires or being in their vicinity dangerous, and so on.

Incendiaries, The Science of Using Fire as a Weapon

9) Aerosol, Compressor and Pump Based Delivery Systems

Aerosol cans often contain flammable liquids and propellant. These can be used to quickly initiate fires. The valve on top is depressed releasing the pressurized flammable contents and only require an ignition source to spread a fire. These can make easily improvised flame throwers. By breaking the spring, the cans contents can be released all at once increasing the propagation of the fire.

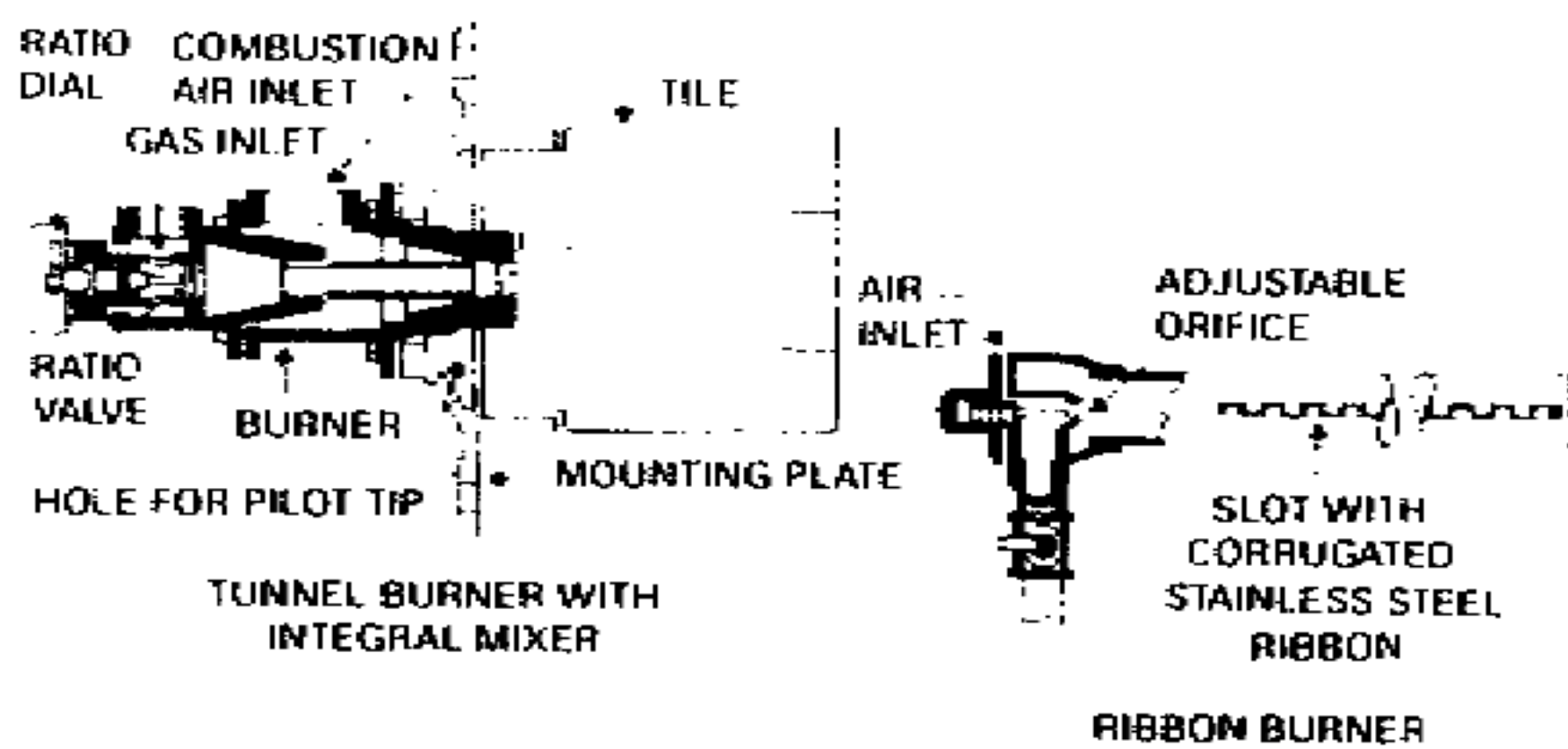
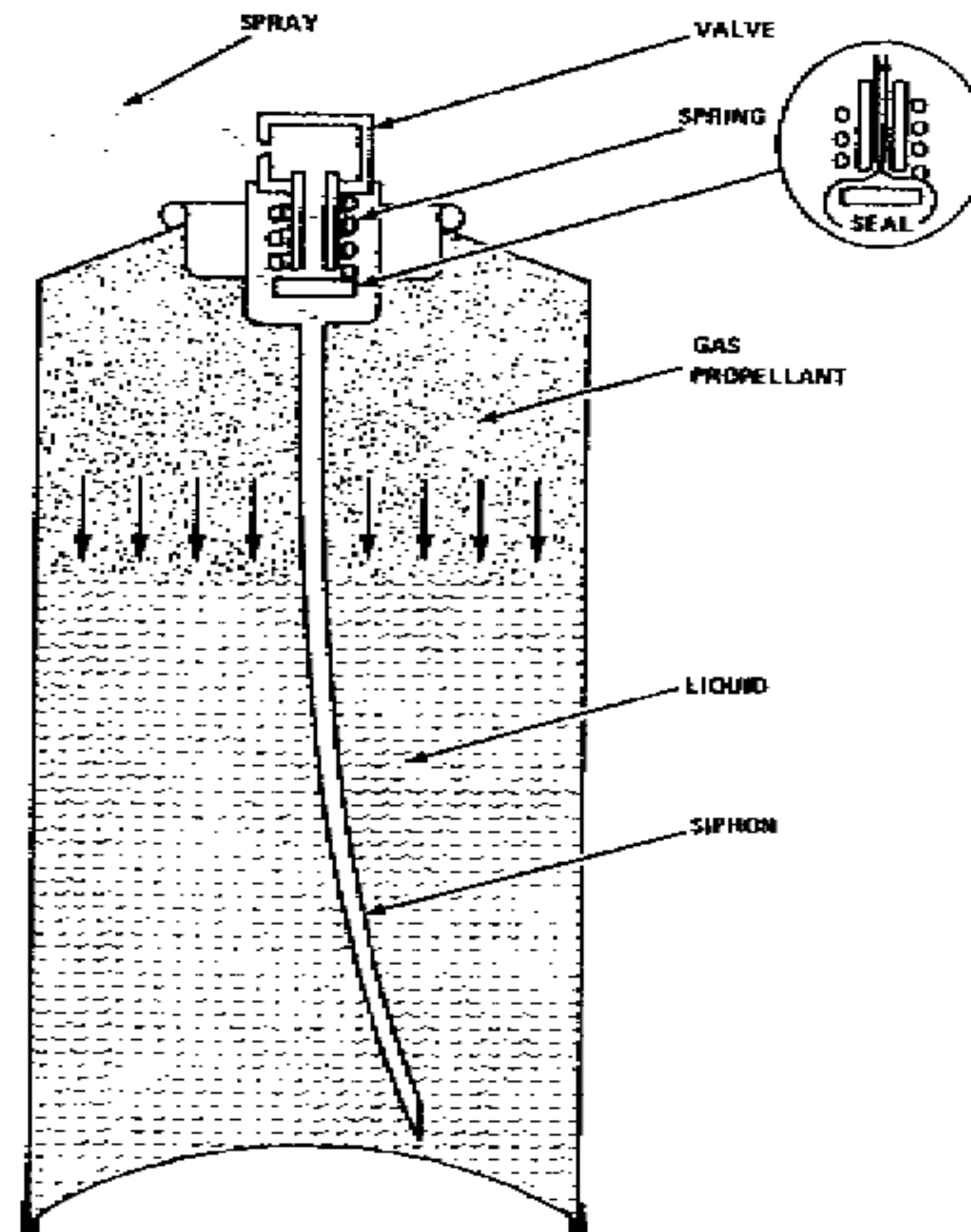

A wide range of industrial and commercial gas burners are available to mix fuel and air in the form of a direct burner. By increasing the inflow of fuel and air, these can be converted for use as flame throwers. These often use a fireproof hose and pump to deliver fuel to the nozzle.

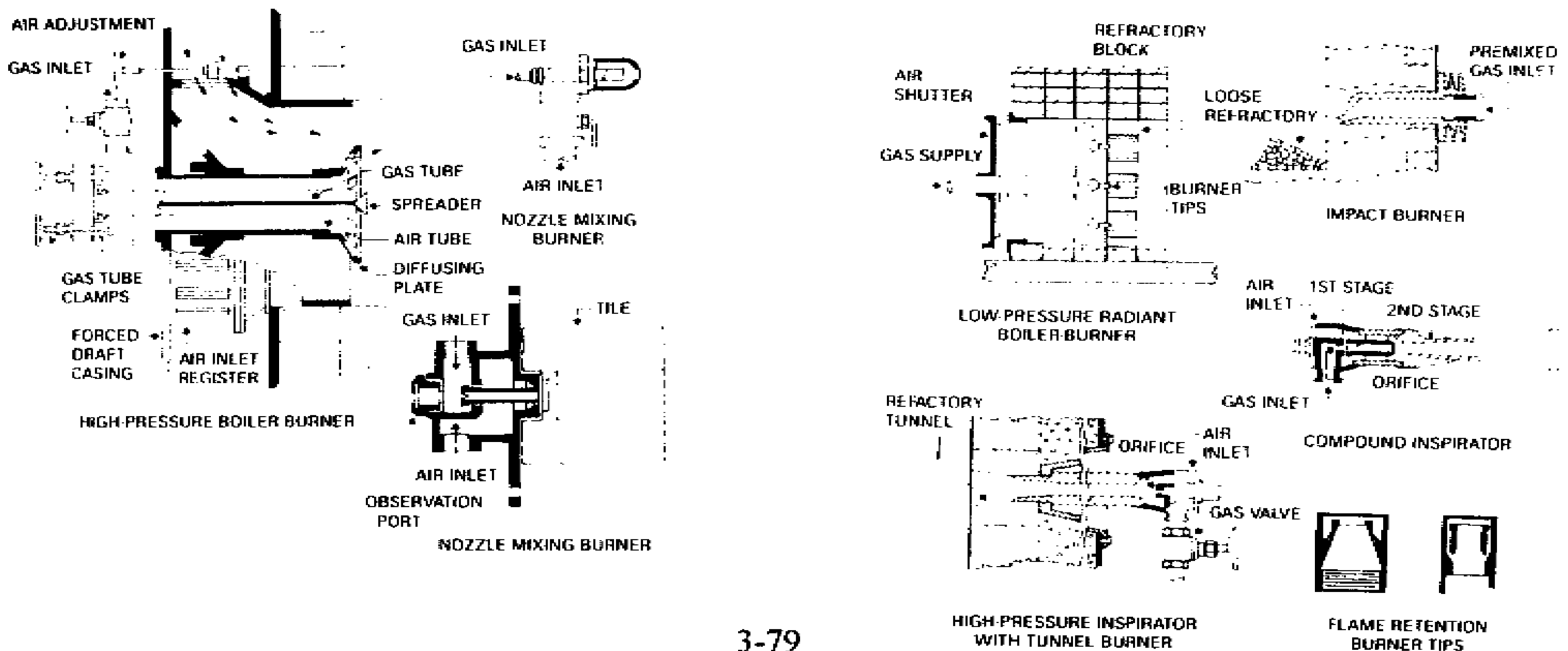

Incendiaries, The Science of Using Fire as a Weapon

Military flame-throwers were developed during WW1 to project and ignite flammable liquids. They were found to be especially well suited to reducing bunkers and other enemy fortifications and are a favorite weapon of invaders without scruples who practice scorched earth policies. They usually don't leave anything standing. Assault engineers are usually assigned the job of using these devices.

The flame-throwers can be mounted in vehicles, on a persons back, or carried on a hand dolly type apparatus. It consists of a fuel reserve of one or two tanks and a pressure reserve to force the fuel out. An air compressor ressupplies the pressure tank. The fuel tanks are connected by a flexible hose to a nozzle similar to those on the previous page. Most are designed to project flame up to 150'. A 40# fuel tank will usually last about 6 seconds at this level of fuel projection. It can also be used to flood bunkers with unignited fuel which vaporizes and is then ignited to burn the targets out. The US military has replaced its flame-throwers with incendiary rockets while the former Soviet nations still issue them, mostly to improve troop morale. Flame-throwers can be placed in the expected path of an enemy as part of positioned weapons defense and set off by tripwire. Field improvised flame-throwers are made by filling ammunition canisters with gasoline (fougasses) and used as an anti-personnel mine.

Special tanks with mounted flame throwers are used by assault engineer units to reduce enemy fortifications but are vulnerable because of the large fuel reserve they carry. Vehicle mounted flame throwers can project flame to 150 yards.

Commercial air compressors and fuel pumps can be mounted together to quickly project fuel in vehicle or individual carried systems. The Soviet LPO-50 has 3 app. 1-gallon tanks which supply 2-3 second flame bursts each.

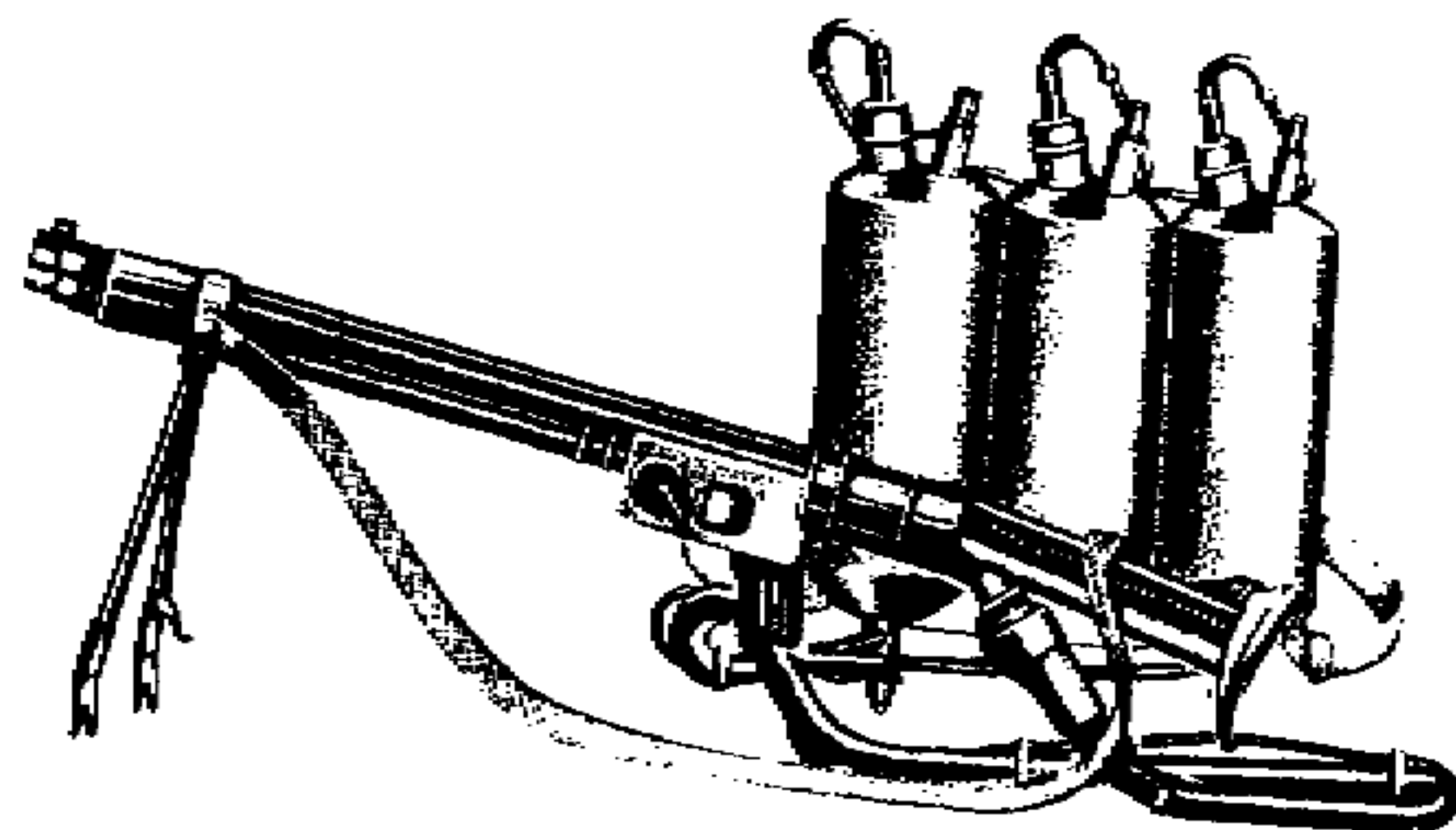

Incendiaries, The Science of Using Fire as a Weapon

Incendiary grenades of both antipersonnel and antitank are used in modern warfare.

anti personnel are designed with an impact (1) or delay fuse which ignites a bursting charge (2) rupturing the container wall (3) and igniting the incendiary contents (4).

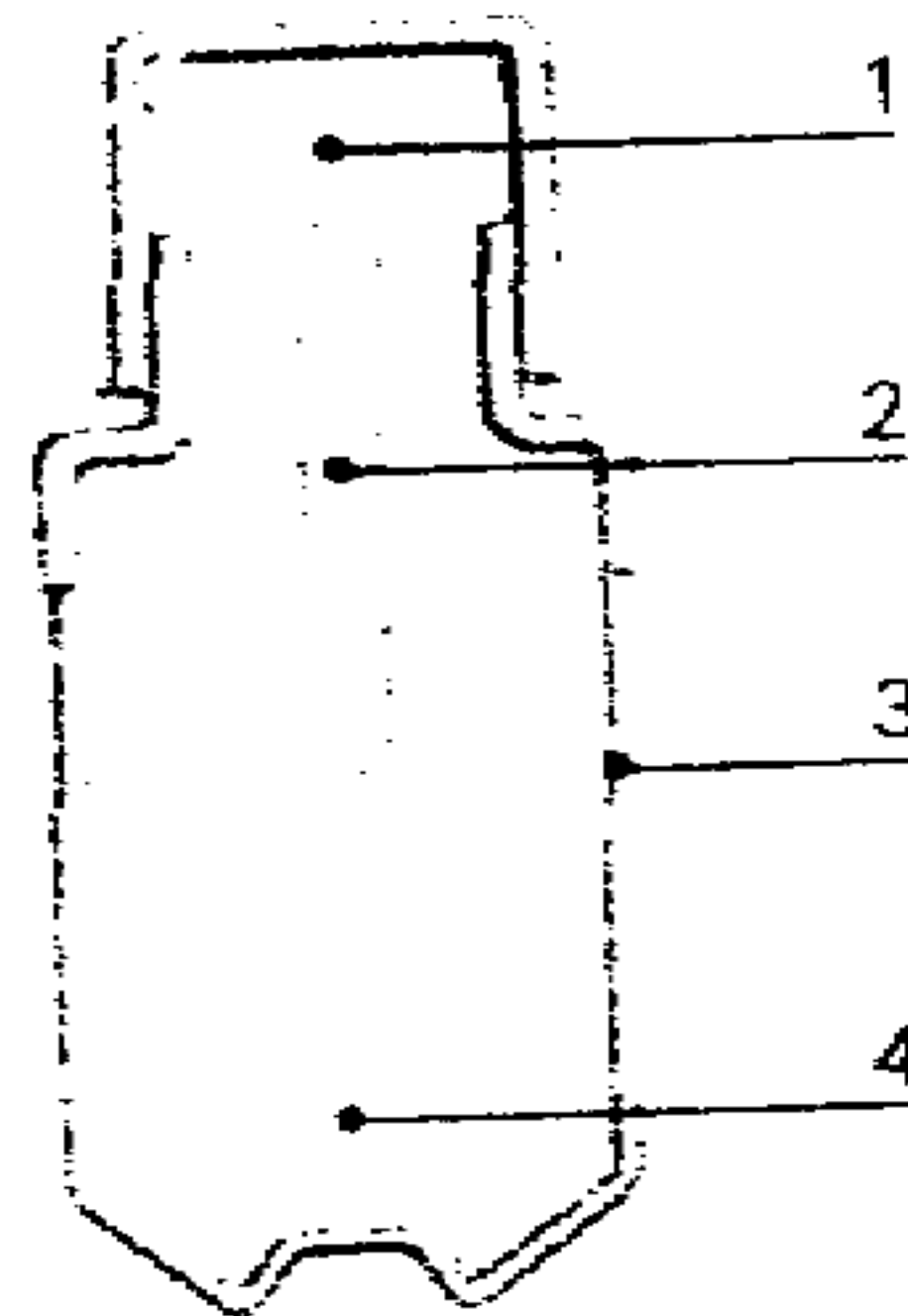

Anti tank grenades usually use thermitite or Thermitite typed formulas and are designed to be thrown and fly fuse first. On impact, the fuse ignites the incendiary charge.

Concussion and flash grenades are filled with light intense incendiaries with air reactive igniters that burn with a brilliant light to temporarily blind enemy personnel. They are usually used in hostage situations where direct assault applying extreme force is not an option. These are often accompanied by large noise making bursts to deafen and confuse the targets as well.

4) Air Dropped and Positioned Bombs

A wide range of incendiary ordnance has been devised that take the form of bombs which are air dropped or can be vehicle delivered in the form of positioned bombs. The first has been widely used by military forces since WW2 with the massive dropping of Napalm on cities and jungle targets. The second has been the favorite method of terrorists, arsonists, and behind the lines commandos. Most of the positioned bombs have been of the explosive variety, however, incendiaries offer very effective means of extending the potential property destruction and loss of life.

Conventional bombs have already been described in detail in the first 3 volumes. These have included a wide range of explosives in air dropped, mail delivered, and positioned weapons in the form of booby traps and mines. These will not be repeated here. Incendiaries can be substituted as the core elements of any of these designs. We will instead cover uses and designs that have not been described to date. These include -

- Floating bombs for use as markers or igniting oil spills on oceans and lakes
- Truck Bombs and carried Bombs - Airlines, public places
- Fuel-Air explosives
- Fragmentation Bombs

Incendiaries, The Science of Using Fire as a Weapon

Floating Bombs

Early incendiary designs to combat oil slicks by igniting them with air dropped ordnance met with limited success. The earliest efforts involved dropping napalm bombs into the heaviest concentrations of oil. While this would ignite the slick at the target center, the fire would quickly burn itself out without consuming much of the widespread fuel in the slick. This was due to -

1. The slick is spread in such a thin layer that the heat output necessary to support combustion is lost to the unlimited water source that acts as a heat sink. This makes autoignition very difficult.
2. The oil is chemically weathered in the sea water so that more volatile components are isolated or separated out. This has the effect of raising the autoignition and flash point temperatures. Remember that most sea water, especially in places like Alaska where the Exxon Valdez leaked its cargo, is very cold and it has the effect of lowering the flash point of the oil to where little or no vapor is evolved to catch fire. This requires sustained heating to produce the ignitable vapors necessary for flammability in air and autoigniting.
3. Ocean action physically separates the slick into thousands of mini slicks which are isolated from each other. This requires separate incendiary action to ignite each separate pool.

These conditions led to using napalm in air burst's which would spread the ignited fuel over large areas. White phosphorus would be added to the formula so the napalm gel would ignite in the air and rain fire onto the many pools of oil. The gel worked with some success because it would burn for the several minutes which were often required to ignite the cold oil.

A German company developed a cylinder device that is filled with calcium carbide and has a sodium metal bar running down the center. Once it hit the water, the sodium reacted to produce hydrogen gas and the calcium carbide reacts with the water to produce acetylene gas. The hydrogen ignites the acetylene on contact and this very intense flame (burning much hotter than the napalm) would ignite the oil.

Other combinations like raining granules of Teflon and Magnesium igniters onto the slicks have been used with limited success. Others have tried priming the slicks with more volatile fuel that is easier to ignite such as rags, straw, and commercial wicking agents. The main problem with most incendiaries has been the short duration of the burn and lack of wide distribution to reach all parts of a slick.

Incendiaries, The Science of Using Fire as a Weapon

One of the better designs for floating incendiary bombs that can be dropped from aircraft involves a patented (1983-4,422,383) device that is basically a solid rocket fuel that is ignited between two plywood discs surrounded by polystyrene which makes the entire assembly float.

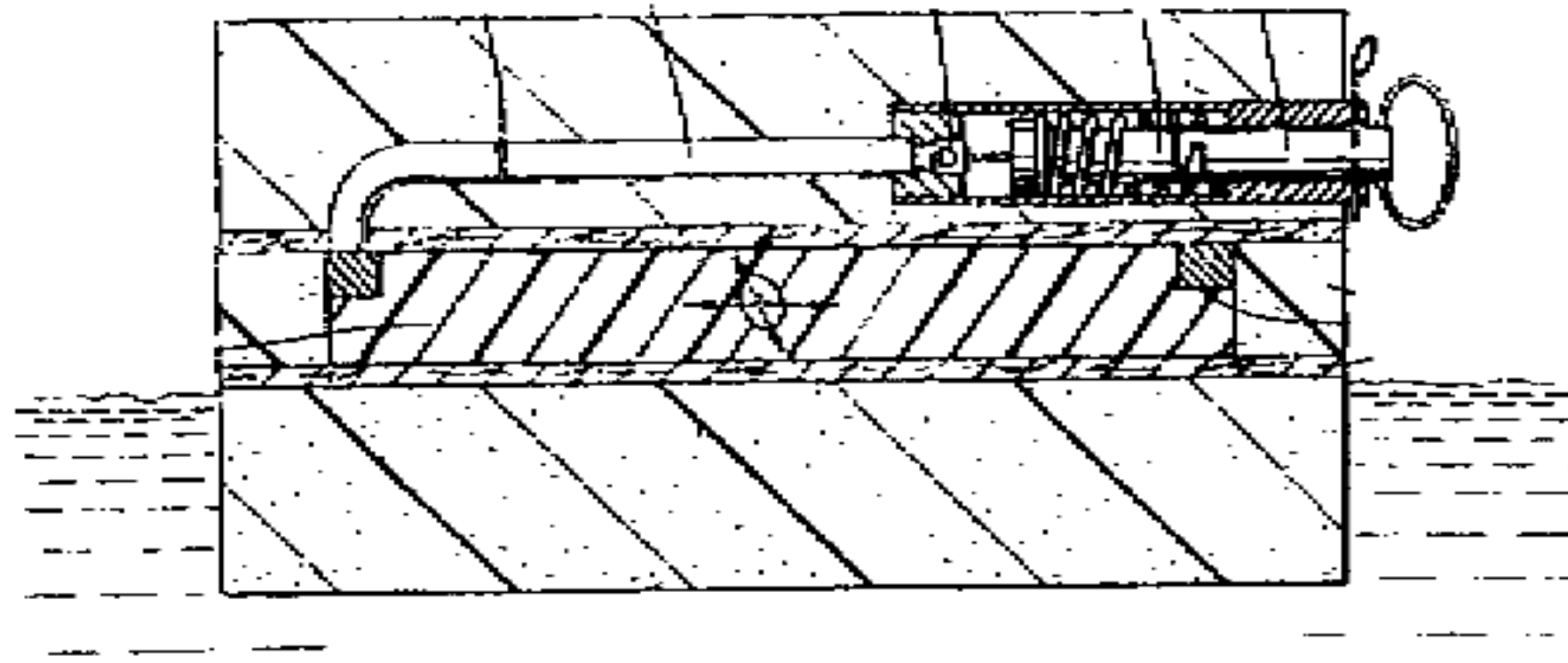

A built in delay igniter is casted inside the composition. A safety pin is pulled and a spring based striker is armed and released which pulls on a firing clip. The striker initiates a 9mm primer cap which then ignites a delay fuse that burns at .5 cm per second and lasts about 20 seconds. Once the delay fuse burns down to the end it ignites an incendiary powder. A curved copper tube directs the hot blast into the main incendiary charge and ignites it. The charge burns outwardly at a moderate rate spraying fire in all directions around the discs. The delay igniter is identical to that used in hand grenades except that the fuse is longer.

The long burn time aids in reliably igniting the targets and consumes the surrounding plywood and polystyrene as it burns down to its core. Hundreds of these discs can be mounted on a wire which can be used to deploy them by the hundreds and simultaneously pull the pins as they are discharged out of the aircraft.

The incendiary formulas can be changed to adjust burn times as follows -

Ignition composition for a fast burn and hot flame

80-85% Boron Potassium Nitrate or Black Powder (1/3 fine F Type, 2/3 Coarse FFF Type)

15-20% Binder consisting of 85% epoxy resin and 15% amine type curative or polybutadiene with a diisocyanate curing agent

The incendiary compositions resemble standard solid fuel rocket propellants and are formulated as follows -

40-70% Ammonium Perchlorate (oxidizer)

10-30% Solid Metal Fuel (magnesium or Aluminum work best)

12-22% Binder of dextrin or colloidal silica used to thicken the mix viscosity so the composition does not separate or settle during curing.

Incendiaries, The Science of Using Fire as a Weapon

This mix produces hot flame of 1450-2300 C and burns at a rate of 4-7 cm per minute.

55% Ammonium Perchlorate
30% Aluminum
15% Binder
Burns at 5.6 cm/sec at 2250 C

60% Ammonium Perchlorate
20% Aluminum
20% Binder
Burns at 4.5 cm/sec at 1450 C

57% Ammonium Perchlorate
25% Magnesium
18% Binder
Burns at 6.5 cm/sec at 2350 C

62% Ammonium Perchlorate
20% Magnesium
18% Binder
Burns at 6 cm/sec at 2350 C

56% Ammonium Perchlorate
25% Aluminum
18% Polybutadiene cured with diisocyanate
1% Thixotropic agent
Burns at 4.5 cm/sec at 1800 C

The addition of magnesium increases the temperature while decreasing burn time (it burns faster). The binder should be plasticized with 20-30% of an ester like isodecyl pelargonate.

[Authors note- the above discs make good decoys against infra red guided missiles because they burn rocket propellant and distribute heat in a much more intense fashion than jet engines]

Another floating incendiary composition involves the use hollow microspheres mixed into an oxidizer, fuel, and rubber binder so that the composition floats. It is basically a foam equivalent that has a specific gravity of less than one. This allows it to float while burning without using nonincendiary materials.

[Authors Note - The use of microspheres or hydrogen producing metals can be used to create foamed metals that have very low specific gravity and easily float on water. My great idea was to build a standard steel hulled, giant aircraft carrier which would be supertanker sized and large enough to land and take off aircraft without the need of arresting cables and catapults. The huge size would allow much of the US Air Force inventory on navy carriers. The interior compartments on all sides of the ship would be filled with heavily foamed metal using microspheres or hydrogen or CO2 gas that would hold the ship up and prevent its sinking in the event of an enemy making Swiss cheese out of it with missiles. The 20-30' thick metal foam armor would also provide considerable protection from most enemy ordnance. The ships could be standardized and mass produced with the idea of rolling weapons systems on and off like patriot missiles for defense and crane lifted modern electronic systems. This saves having to tear the ship apart every time a new invention comes along. It also allows the Navy to use and fight with most standard Army ordnance. Tanks and Howitzers on the deck could substitute for destroyers while mobile missiles launchers would yield portable missile cruisers. As usual, the military doesn't listen to outside ideas- its called the "not invented here syndrome".]

Incendiaries, The Science of Using Fire as a Weapon

A castable floating composition can be made as follows -

Magnesium, Aluminum, or other metal fuel powder
Oxidizer such as Iron Oxide, Manganous Dioxide, Titanium Oxide to yield a thermite. or-
Salt based oxidizer like Potassium or sodium chlorate
or commercial polytetrafluoroethylene molding powder
Elastomeric silicone (liquids curable to silicone rubber-may require heating)
Hollow plastic microspheres (or glass if heat curing is used)

Oxidizers commonly used in flare compositions can be used if colors are required. The metal is first mixed and wetted with the liquid. This coats the magnesium particles so they do not react with the oxidizer. Then the oxidizer is added. The microballoons are then added. The viscosity at this point may be too great to get a good mix so a volatile solvent may be added to thin the mix down. This can be naphtha, xylene, or toluene. It is added to the desired thinness of the mix. The curing agent is added just before pouring the mix into the desired mold shape. It is then cured in this shape with the solvent evaporating off. The final shape can be extruded, molded, or rolled into other configurations and used if desired as an initiator for high explosives or other incendiaries. It can also be placed in a canister, fused, and used as a flare or infra red decoy. Explosives can be used to break it into pieces after ignition which spreads out the pieces over a large area producing a widespread incendiary effect.

Example formulas include -

70 # Magnesium powder
20# Vulcanizing organopolysiloxane sealant dispersed into
50# Naphtholite solvent to decrease viscosity
20# Glass microspheres
10# Potassium chlorate
1# of stannous octoate added as a catalyst

The mixture is poured into molds to form canisters and then cured at 160 F in an oven where the solvent evaporated off. Fuses are inserted in the canisters and the material burns brightly while floating.

An alternative formula used

70# Magnesium
20# Organopolysiloxane
30# Solvent
10# Microballoons
5# Potassium chlorate

The oxidizer level in this formula produced incomplete burning in some deployed canisters and should be increased in actual formulas.

Incendiaries, The Science of Using Fire as a Weapon

Truck Bombs

Explosive bombs have recently made the headlines after their use in the New York World Trade Center, Oklahoma City, and possible use in the highly publicized TWA crash. In addition to these domestic acts of terrorism, they have been used in the middle east for decades and often sponsored by the fundamentalist governments as political instruments.

Several suppositions can be made from the news reports and examination of the results.

1. The use of incendiaries to enhance and add to the effects of the explosives could have easily and inexpensively been included. Surrounding the bombs with 8-10 tons of gasoline would have produced extensive combustion that would have caused spalling of the concrete and weakening of the steel reinforcement. It would have also ignited numerous fires at considerable distances from the bomb center. The gasoline could have been obtained by using sump pumps to draw gasoline from filled tanks on the trunk into plastic tanks placed on all 4 sides of the explosives.

Explosives lose their shockwave strength at the square of the distance from the center of detonation. In other words, at 5 ft from the detonation center it exerts X force. At double this distance (10'), it exerts $1/4 X$. At $20' = 1/16 X$, and at $40' = 1/64 X$. By the time you reach 80 feet, the shockwave is reduced to less than 1% of its original power ($1/128$)

Incendiaries will extend their effect at considerably greater distances from the center of delivery as long as fuel can be propelled and is ignited as it reaches its target.

2. Much has been made in the militia press of the second explosion at Oklahoma City. It is the authors opinion that, as much as I like good conspiracy theories, a secondary explosion is quite common from ruptured gas mains and the pyrolysis of combustibles in the vicinity of the primary explosion. The gas from pyrolyzed or vented vapors accumulate and when coming into contact with a spark or heat source, and fall into flammable limits in air, will detonate. It would have been surprising to me if their were not secondary explosions at Oklahoma city or the world trade center.

3. The TWA flight had several widely publicized theories of what caused the crash. The use of explosive would have likely left a residue of explosive salts or caused structural damage consistent with the massive expansion of gases. These were not definitely found. The use of a missile required what would have been a highly luminous launch that the author thinks is impossible from the ground or sea without thousands of people recognizing it. [An air launch was possible though unlikely]. Remember, a great deal of propellant has to be burned to lift rocket or missile components to an altitude of several miles. The propellant in a pop bottle rocket lifting itself a couple hundred feet is reliably observed by thousands of onlookers and even TV viewers during the 4th of July celebrations.

Incendiaries, The Science of Using Fire as a Weapon

The point of this observation is that an incendiary that burns a small hole through the fuel tank wall does not cause shockwave damage and does not normally leave traceable residue salts (depending on its composition). The incendiaries can be casted in plastic forms that resemble everyday objects carried in luggage, do not yield good X-Ray contrasts unless they use metal fuels, and are capable of burning with sufficient heat to melt holes through aircraft aluminum sheet. This makes an incendiary a much more likely, or possible candidate for a munition capable of causing the downing of an aircraft in this manner. The other advantage of using incendiaries is that they do not need to use nitrate oxidizers to produce high temperatures that can melt metal plate and ignite fuel. This allows the easy transport of these types of devices onto public transportation. Such materials can be casted or prepared as gels inside of tubes of toothpaste and other common items carried by passengers. [Nitrates and nitrogen based gas by-products are often easily detected when attempts are made to smuggle explosives onto airlines and into public places].

Incendiaries offer many opportunities for clandestine attack because they do not produce explosions themselves and their effects are often unnoticed until the damage is done. This makes them ideal candidates for behind the lines operations. Since their effects can be magnified by using them to ignite combustible targets, they offer greater potential as weapons than many explosives. Details of target selection and attack will be covered in later chapters.

One other comment the author will inject here is about the fire at Waco, Texas during the assault by law enforcement on the branch davidians. I have described chemicals in the last chapter that are not only good candidates for incendiary weapons, but are also used as lachrymators. They are used as tear gas or irritating agents in crowd control. If the particular chemical used by law enforcement was identified as having a low autoignition point and flammable limits in air consistent with the volume of gas used, then it is quite possible that it contributed or may have caused the fire that destroyed the compound and killed the occupants. It may have been ignited by the use of a flash grenade normally used to blind opponents during armed assaults. The presence of flammable gas pumped into the compound could have made a very deadly and widespread fire just by its presence. The authors ideas in volume one to use anesthesia gases to overcome resistance would have encountered the same problems had any sources of ignition been used by assault forces or were encountered inside. A pilot light on a stove could easily ignite most lachrymators or anesthesia gases making their use a potentially serious incendiary problem.

Incendiaries, The Science of Using Fire as a Weapon

Fuel Air Explosives

We have already described the basic concepts for fuel air explosives. The requirements for a fuel to explode in air are its conversion to a vapor cloud at operating temperatures, its low autoignition point, and its wide flammable limits in air.

Conventional air dropped Fuel-air explosives used by the US military consist of clusters of bomblets of 71.8# (32.6 Kg) of ethylene oxide. Each bomblet forms a cloud 8' high and 50' in diameter which detonates on ignition with a blastwave force of 5 times that of TNT. It was widely used in the Persian Gulf war against hard targets and to clear minefields by the overpressure generated by the blast. The military use of explosive vapors is a relatively new development in warfare.

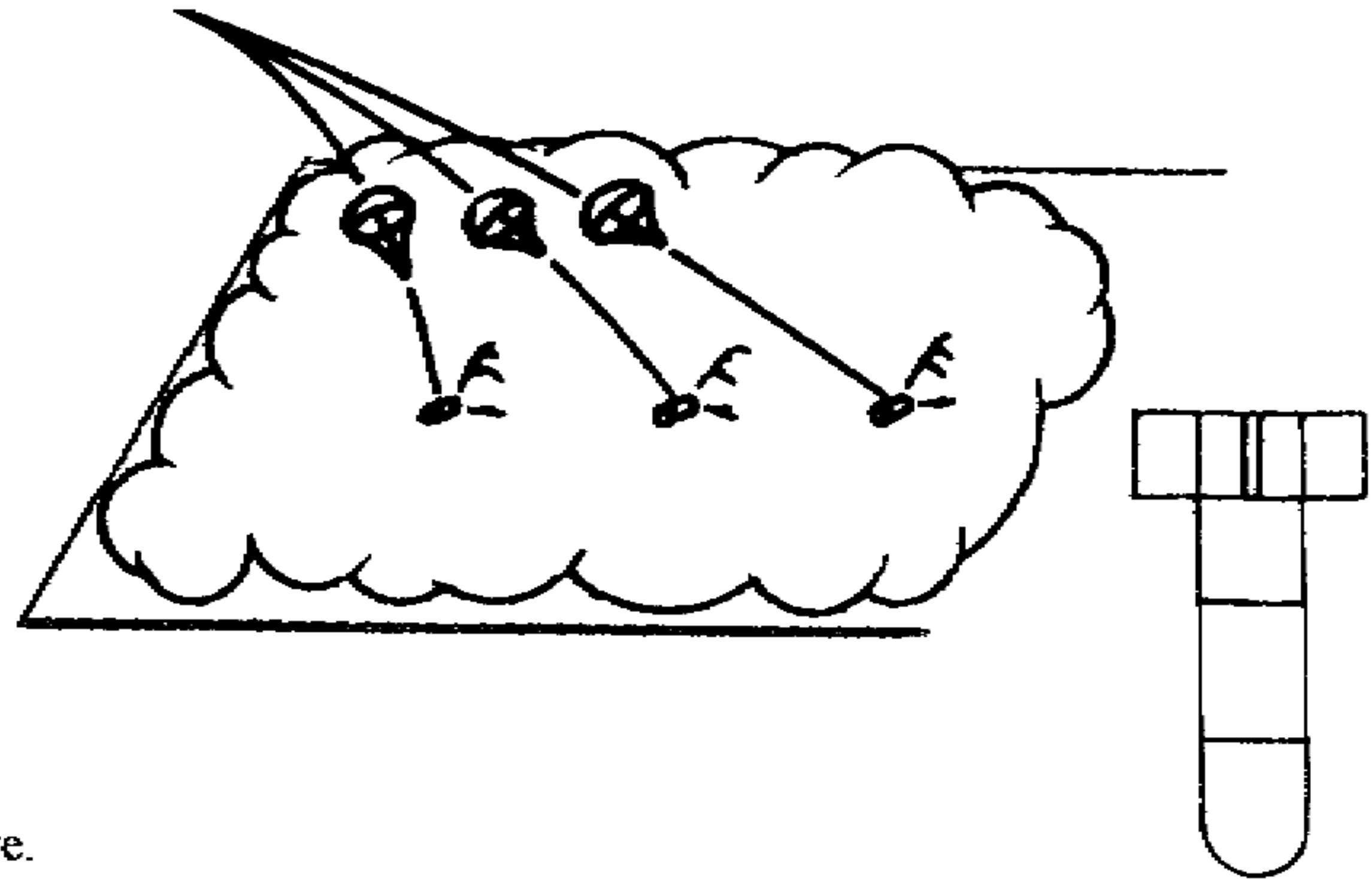

To understand how to use incendiary vapor as a combined explosive and fire weapon there are several concepts that need to be understood about explosives. When vapors are detonated, any solids and all gas is rapidly heated into an expanding mass of very hot gas. Once detonated, there are three effects that produce the desired damage to the target. These are blast pressure which reaches very high levels in vapor based explosions, incendiary which spreads the fire, and fragmentation which sprays pieces from any encasing and area debris along with the shock wave.

Blast Pressure: is the formation of app. 700 tons per sq. in. of atmospheric pressure that forms at the core of most explosions in the first 1/10,000 of a second. This core of hot gas then moves outward at velocities up to 13,000 miles per hour at these pressures compressing the surrounding air in the form of a giant wave weighing many tons and destroying anything in its path. The force of the wave usually diminishes at the square of the distance it travels from its core until it disappears.

Two types of pressure are actually formed. The first is the actual outward bound pressure wave that compresses the surrounding air and forms a "shock front" that is only a fraction of an inch thick. The thinness of this wave is due to the compression forces that accumulate before the air is actually set in motion. This shock front applies a hammering, sudden blow to all the objects in its path. If it hits a wall it delivers a massive blow over the entire surface and instantly follows through the collapsed portions with the strong winds of the pressure wave. This positive pressure wave lasts only a fraction of a second (it doesn't travel the full 3.6 miles in the first second) because it attenuates as it moves out over a distance because of the greater volume of area it has to cover. Most non nuclear explosives expend all their power within a few hundred feet of the detonation center.

Incendiaries, The Science of Using Fire as a Weapon

Once the pressure wave forms and pushes away from the center of detonation, it pushes the surrounding air out creating a partial vacuum in the center of detonation and spreading outward behind the wave front. This partial vacuum exists behind the wavefront so that as the pressure wave dissipates, this broad partial vacuum causes the air to reverse its movement and rush inward to fill the void. This is called the vacuum wave (from the negative air pressure). Although its velocity in its movement back towards the center of detonation is much lower, the air still has great force and will strike and move objects in its path. It will suck windows out of buildings and pull other objects back in towards the detonation center. This negative pressure wave is less powerful than the pressure blast wave but lasts about three times as long and delivers a devastating 1-2 punch to any objects in its path. This 1-2 punch is the most destructive effect of fuel-air (or any other high) explosives.

Fragmentation: is an effect usually observed when a bomb is encased in a pipe or other metal container or is surrounded by easily ruptured or pre designed pieces (like nails, ball bearings, or fence staples). These are torn apart by the force of the explosion at its peak location (the center of detonation) and are propelled outward by the blast pressure wave as fragments or as nearby debris. These fragments have a torn, stretched, or thinned appearance, and they would be a lot smaller and in a lot more individual pieces (broken apart) because of the enormous heat and pressure produced by the explosion and delivered at its maximum strength directly onto it. When these pieces are deliberately attached to the outside of a bomb they are called shrapnel. The advantage of using pre-formed shrapnel on the outside of a bomb instead of a strong casing is that energy expended in actually breaking the casing and creating fragments is now used in propelling the many fragments (not counting the energy from the pressure build up when using a casing and shattering it).

The use of fragmenting materials adds to the blast damage by cutting, slicing, or punching holes through any materials in their path. The heat of the detonation will also be absorbed into fragments and this heat is carried with them into other materials and if it is hot enough can cause or spread secondary fires (the incendiary effect if it is designed to do this). Using good candidate materials that absorb heat and communicate it over distances and time so it can reliably ignite target combustibles is part of the science of making incendiary munitions. That is also why the author spends so much time describing different candidate materials in other parts of this book.

The total heat developed by the fragments can come from -

- The heat generated at the core of the detonation (hot gases which transfer heat)
- Stretching and tearing of solid materials by the pressure and vacuum waves
- Air friction
- Impact friction

Incendiaries, The Science of Using Fire as a Weapon

Fire effects: are produced by explosion resulting in thermal damage to the targets. When an explosion of vapor takes place, especially at the upper limits of the flammable or explosive limits in air, a lot of hydrogen and carbon monoxide is formed from the initial reaction and can reexplode or ignite once more oxygen becomes available because the gases are still hot enough to support combustion. Take gasoline for example. If it explodes at its lower limits (1-2%) most of the gas consumed has adequate oxygen available to form CO₂ or water from the burned carbon and hydrogen. At the upper limits, an excess of carbon and hydrogen is still there because there wasn't enough oxygen from the air to use it all up. This means that CO is formed instead of CO₂, and the CO is a flammable gas. Combined with available left over hydrogen, it supplies an ignitable mixture in air (the backdraft effect), and this is very likely what happened to account for the second explosion at Oklahoma City. Once fresh oxygen becomes available to support combustion from the intruding air, all that is needed is an autoignition temperature at any point in the air-vapor mixture for a second powerful explosion.

When solids are pyrolyzed, they also give off (distill) hydrogen first from their chemical compositions and add to the potential fuel in the atmosphere. A low explosive like black powder produces shock waves that travel slower but carries many hot solid salts as a byproduct of the combustion and these hot solids can communicate incendiary effects very effectively. High explosives produce much higher temperatures which quickly mix into the surrounding air and cool as the pressure wave moves outward. Solids absorb and retain heat much longer than air and make more effective pyrophoric munitions. If high explosives that yield only gas are used and are burned up, they need to be delivered near the combustible targets to deliver the necessary heat to ignite them. If not, they need to be enhanced with other materials that can absorb and retain heat while being propelled the necessary distances to the targets. Fuel air explosives produce a more powerful shock wave than conventional high explosives. These can cause more pressure wave damage and will actually carry the hot gas further than ordinary explosives before the heat is lost to the atmosphere. Surrounding explosives with solid combustible debris is a good way to enhance the fire damage it can cause.

One other concept we have not yet covered which needs to be addressed is the effect of "Vapor Density". Air is used as the reference material and is give a value or density of 1.000. Any other vapor or gas will have a density based on its comparison to air. If it is lighter than air it will have a density of less than 1.000, and if it is heavier than air it will have a density greater than 1.000. This is important in using flammable gases as weapons because it allows you to attack in vertical directions. Take the following densities of common materials as examples -

	<u>Vapor density</u>	<u>Flammable limits</u>
Hydrogen	.0695	4-75%
Natural Gas (methane)	.6	5-15%
Ethylene Oxide	.8711	3-100%
Acetylene	.899	3-82%
Carbon monoxide	.97 or 1=air	12.5-74%
Propane	1.56	2.2-9.5%
Carbon disulfide	2.6	1-44%
Gasoline	3-4	1.4-7.6%

Incendiaries, The Science of Using Fire as a Weapon

There are slight differences in the chart above and the chemical descriptions earlier. They depend on which reference is being used by the author at the time of summarizing these ideas. The idea behind using vapor density is that hydrogen is a gas that can be pumped into target areas above your position (like the floor above in a building) and ignited. Hydrogen as a fuel rises, while propane or gasoline vapors will sink making them good vapor weapon candidates for tunnels, underground bunkers, and basement areas. Carbon monoxide generally mixes into and stays in the same area as the air it is mixed with.

When using vapor based weapons it is important that they be ignited at the levels nearest their peak flammable limits in air so that secondary combustible gases can also form and ignite. This will maximize the effect of the explosive. The air force munitions experts take this into account in their fuel air explosives by using cluster attacks to saturate an area and displace the surrounding air with ethylene oxide clouds that push the air away from their impact points and then ignite. Explosions taking place at the lower flammable limits cause building damage but often produce little fire related damage and casualties.

One other concept that is important in the design of fuel air explosives is that be ignited while still under pressure. When the ethylene oxide bomblets are dropped, they hit the target area and the casing is cracked allowing the liquefied (under storage pressure) material to instantly boil into the surrounding air. This boiling produces pressure that pushes outward forming the vapor cloud. This cloud must be ignited while still exerting outward pressure to achieve the maximum of 3,000 to 12,000 feet per second detonation velocity that gives it the nickname of the poor boy atomic bomb. This is why the bombs are not dropped as large one or two ton munitions. They force vapor outward, but by the time the interior liquid finally boils off, much of the cloud has lost its pressure and has dissipated into the wind. The ignition has to take place quickly while the cloud is still pushing outward producing pressure. This pile-pressure effect adds the power of the detonation wave at its center to that of the unexploded pressurized gas that is being added to, and exploding on, the leading edge of the wavefront.

These pressure effects on vapors and how they explode are different with increases in pressure over that of one atmosphere (14.7 psi) and can be described as follows -

Pile pressure in detonation raises the detonation wave pressures

Initial pressure of 115 psig = 2,000 psig added detonation pressure
1,000 psig = 5,000 psig+

The initial higher pressures of the gas will also increase the flammable limits in air.

Natural gas	1 atmosphere =	5-15%
	500 psig =	4-44%
	1,000 psig =	4-53%
	3,000 psig =	4-60%

Incendiaries, The Science of Using Fire as a Weapon

[Liquid compressed gases expand to considerable volumes in air. 4,000 gallons of LPG will yield 146,000 cu.ft. of pure gas. If mixed into air at its lower explosive limits, this yields over 6 million cubic feet of explodable gas. A 24" mainline of natural gas with a valve at every 8 miles will contain 6,316,000 cu. ft. at 700 psig. If mixed into air at its lower explosive limits of 4-5%, it will yield over 140 million cubic feet of explosive gases.]

The effect is that gases become more chemically reactive under pressure (which is one of the reasons why detonating the nerve gas shells in a bunker under pressure during the Persian gulf war was not a good idea for the US Army, and I will cover this in volume 5). Pressurized gases, especially ones that are mixed with air are extremely dangerous and make powerful explosions.

The surrounding atmosphere quickly absorbs the effects and pressures of explosions. For explosives to be effective they must very quickly so that all of the combined energy is used together to maximize the forces in an explosion. It isn't the total release of energy, it is the speed of its release that determines the peak force of a fuel air explosive.

An explosive set off in the main lobby of a building will have most of its energy absorbed into the nearby atmosphere, walls, ceiling, and floor. If the fuel is distributed instead as a vapor throughout the building and then detonated, the force is applied throughout the building and will cause much greater damage as a result. This makes fuel air explosives capable of being more effective weapons than ordinary explosives because they can reach areas and cover much larger areas with blast pressure waves and thermal effects that ordinary explosives are capable of. This is why many of the liquid fuel materials already described with low vapor and boiling points can make effective munitions in many circumstance.

Blast waves behave like sound and light waves in that they bounce off of reflective surfaces. For example, we already stated that if an explosive is detonated in the open, most of its force is dissipated at about 100' in every direction in the open air. If you place the same explosive in a cave or sewer pipe, the blast wave will reflect off of the surfaces surrounding it (while expending some of its energy damaging it) and will still be measurable at 200' away. If the angles are correct, the waves will overlap and reinforce each other making a more powerful shock effect than the original wave itself. This is called the Munroe effect and is covered in volume 3.

The pressure waves will expand outward striking objects and then moving around them and reforming. The wave continues to push outward with diminished force. This tells you that the best place to hide from an explosion is immediately behind a very thick and heavy object that is not likely to be punctured by debris or pushed over on top of you. These unusual wave effects can knock down walls on one side of a building while leaving a mirror on the opposite wall hanging and uncracked. This should be taken into account by the conspiracy theorists when evaluating events like Oklahoma City and the world trade center bombings.

Incendiaries, The Science of Using Fire as a Weapon

Special explosive applications include underground and underwater which have different effects. The ground or earth can only be compressed by a shock wave a small amount and then transmits its effects in the form of a wave similar to that of a sharp earthquake. A good example is the effect of burying a 50# explosive about 10' deep and anywhere within 50' of a target structure. The detonation produces a shockwave that breaks cast iron pipes at 30' away, sewer lines at 40', and will damage and collapse foundations of buildings up to 50' away (which is why terrorists don't actually need access to target buildings to knock them down). If the walls buckle from the shock, it can bring the building down just like earthquake waves.

Water does not compress at all and will transmit the full force of the shockwave outward at very fast rates of speed and cause greater damage than its equivalent effects in normal atmospheres.

Fragmentation and incendiary distribution bomb design

-Most military fragmentation incendiary bombs are designed with pyrophoric fragmenting materials (described in chapter 2) mixed into a plasticizer or contained freely inside a bomb. This material surrounds an explosive core and may be fused in the nose with a contact, radar proximity, altimeter, or other applicable detonating system. Once detonated, the casing shatters and the fragmentary particles ignite and are propelled in all directions from the core in accordance with the design and orientation of the bomb.

One of the more modern fragmenting designs is made by -

1. Making a spherical carrier body for the incendiary materials in the form of ribs and grooves. The ribs act as a flight stabilizing force on the main body of the bomb. The carrier body is made from round steel wire which are cut as cylinders of 4mm diameter and 4mm lengths. These are cold pressed to yield the form shown.

2. This carrier body is degreased and lightly etched with diluted nitric acid which creates a rough surface that increases adhesion of the incendiary.

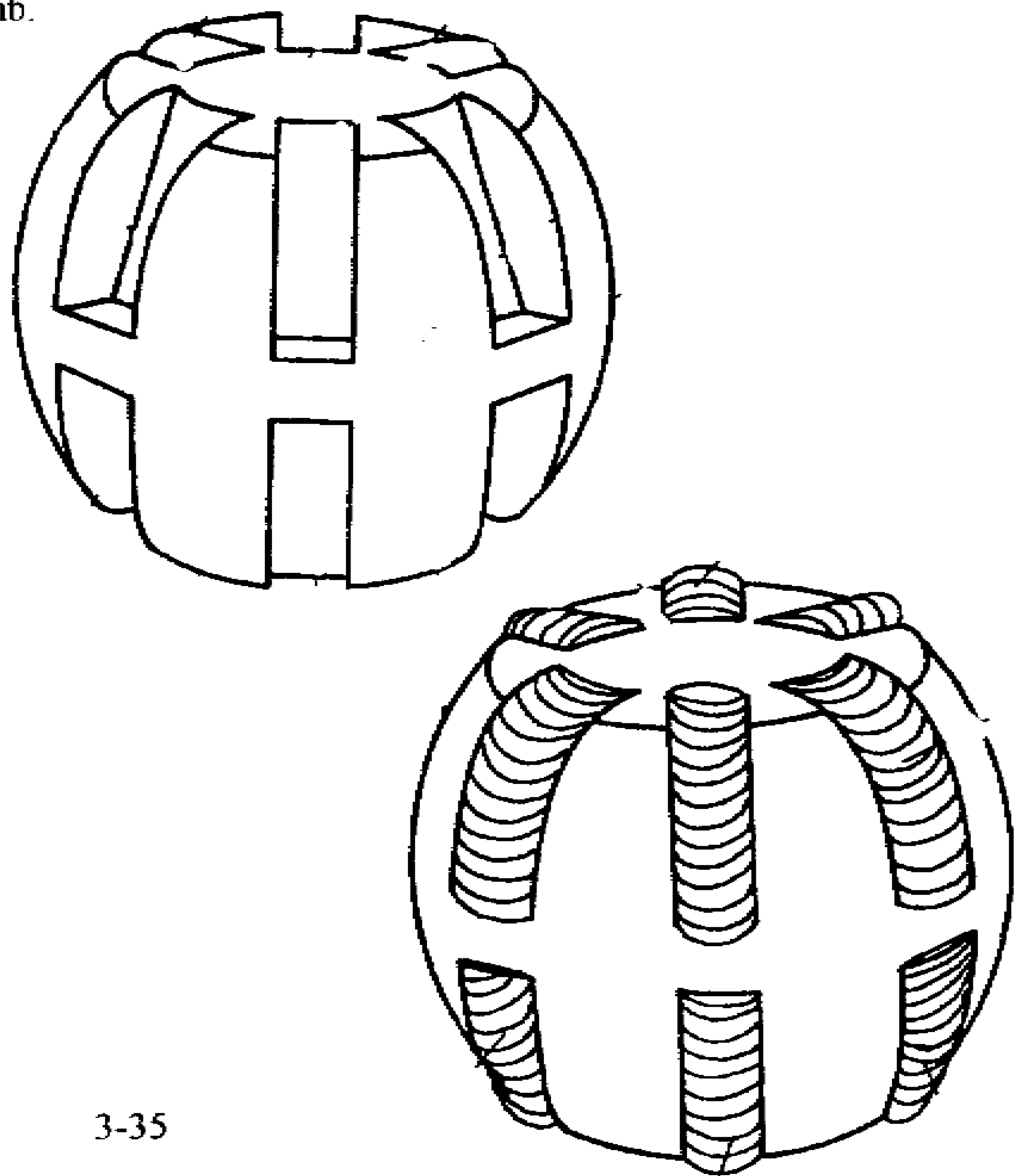

Incendiaries, The Science of Using Fire as a Weapon

3. The curing agent of a two part epoxy resin is applied at room temperature to the inside surfaces of the carrier body. The resin is mixed with the pyrophoric material and heated to 120 C. These are then mixed together and vibrated at 70 Hz to insure homogeneity.

4. The body is then transferred to a press and compacted to force the resin-powder mixture into the grooves. This triggers a polymerization reaction and forms an incendiary fragment mass that has sticking ability and fragments easily.

5. The mass is compressed into the desired shape to fit around an mild explosive core and inside a body. Stabilizing tail fins are added and a light metal alloy or impact and temperature resistant plastic is used to jacket the munition.

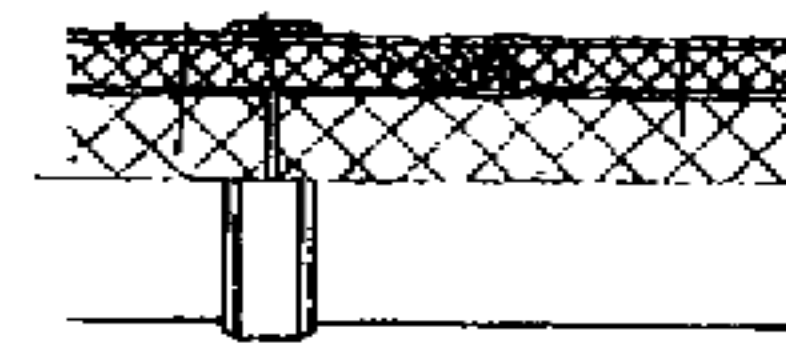
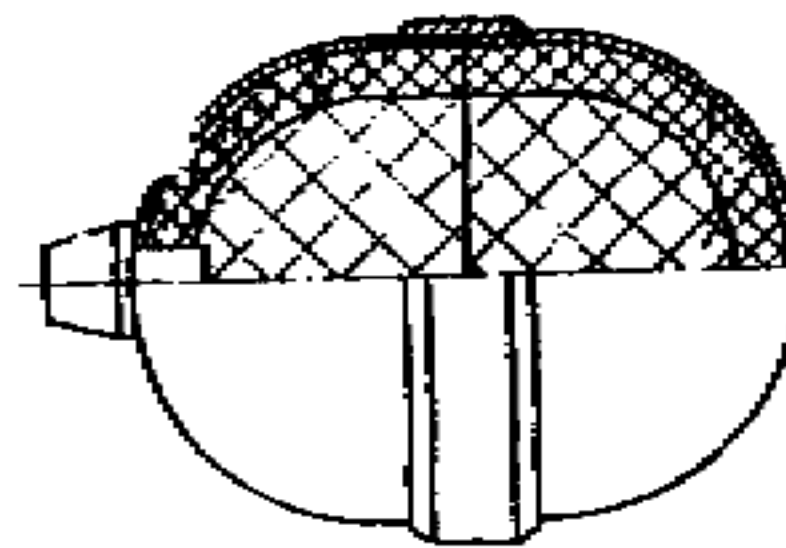
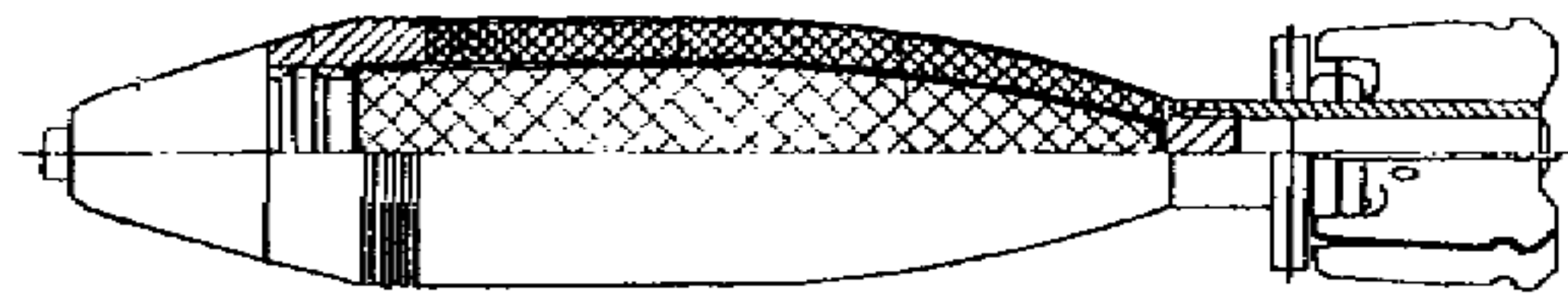

The final radial fragmentation bomb ignites and ejects the particles on detonation.

Another method of distributing incendiaries is the standard dropping of napalm. The problems with this is that these munitions tend to not be aerodynamically stable, and their precision on target in the unguided form is poor. On impact with the ground the incendiary distribution is random whereby the napalm is splashed out of the bomb casing on breakup of the jacket. It is ignited by an impact fuse using white phosphorus to spread and ignite some of the splashes.

Improvements on these munitions are included in the following design ideas -

An incendiary gel mixture of hydrocarbons and gelatinizing agent is premixed and incorporated into a bomb casing. Inside the casing also near the center is located a series of mini ignition capsules which ignite on contact with the ground. The contents of the bomb are distributed as the bomb drops. A parachute opens and slows the descent of the bomb.

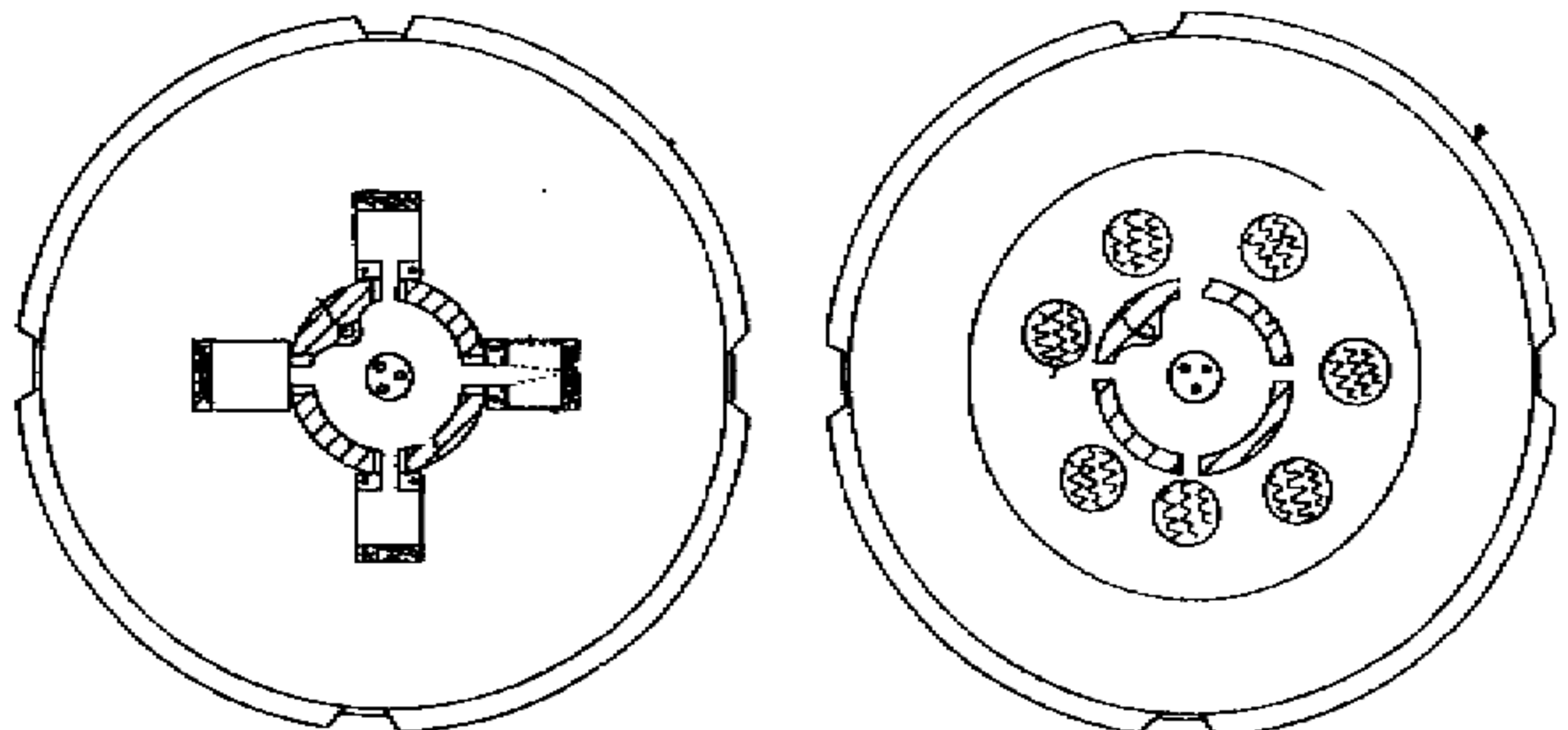

Incendiaries, The Science of Using Fire as a Weapon

Several means of distribution may be used -

1. A cartridge is activated pushing the contents out and dispersing them by propeller action.
2. A detonating cord can run the length of the bomb and burst it spreading the gel and capsules.
3. The munition can be fused to burst on impact or at altitude depending on targeted area.
4. The device can be fuseless and hardened to penetrate a structure and then release its self igniting contents.
5. Mechanical ejection rearward or forward by explosive or mechanical means.
6. Gas generating grains in place of the capsules may be used to provide propellant on ignition and distribute the gel.

Once the gel with self igniting capsules reach the ground, the capsules release white phosphorus or other reactive igniter which starts the munitions burning. This saves burning up gel unnecessarily during the descent and all these methods aid in distribution over the target areas.

5) Rockets and Missiles

Incendiary rockets and missiles consist of the main body of the rocket or missile which guides and propels the machine, and a warhead which carries the weapon. This warhead can be a bomb, spraying device, delay bursting device, or any other conceivable contrivance.

One of the early rocket artillery designs used by the French in the 1870's delivered a warhead that weighed 15.43# (7 Kg).

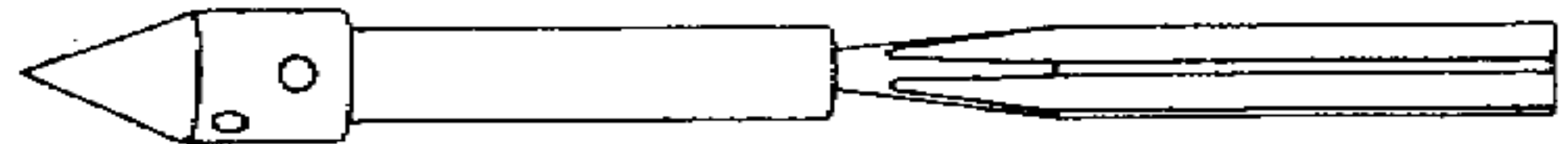

All modern designs use standard delivery systems to carry and deliver the payloads or warheads. Some detailed design information on rockets and missiles has already been described in volumes 1 and 3 and a future detailed volume is planned. Our main intent here is to describe recent designs of the payload or warhead carrying incendiary materials.

Incendiaries, The Science of Using Fire as a Weapon

All these characteristics have allowed lasers to be developed that can concentrate energy of up to a million watts per square centimeter. This makes it useful in welding and cutting metals. It also makes it useful for setting combustible targets on fire. YAG (Yttrium-Aluminum-Garnet) and CO₂ (Carbon Dioxide) lasers are commercially available for short range cutting and welding applications. These are capable of emitting pulses lasting a hundred millionth of a second that can pierce the sides of fuel storage tanks. A 500 watt CO₂ laser can cut 1mm steel sheet at a rate of 10cm per second.

The gas jet formed by lasers cuts and welds metals. This makes them a candidate as an anti armor weapon at short range.

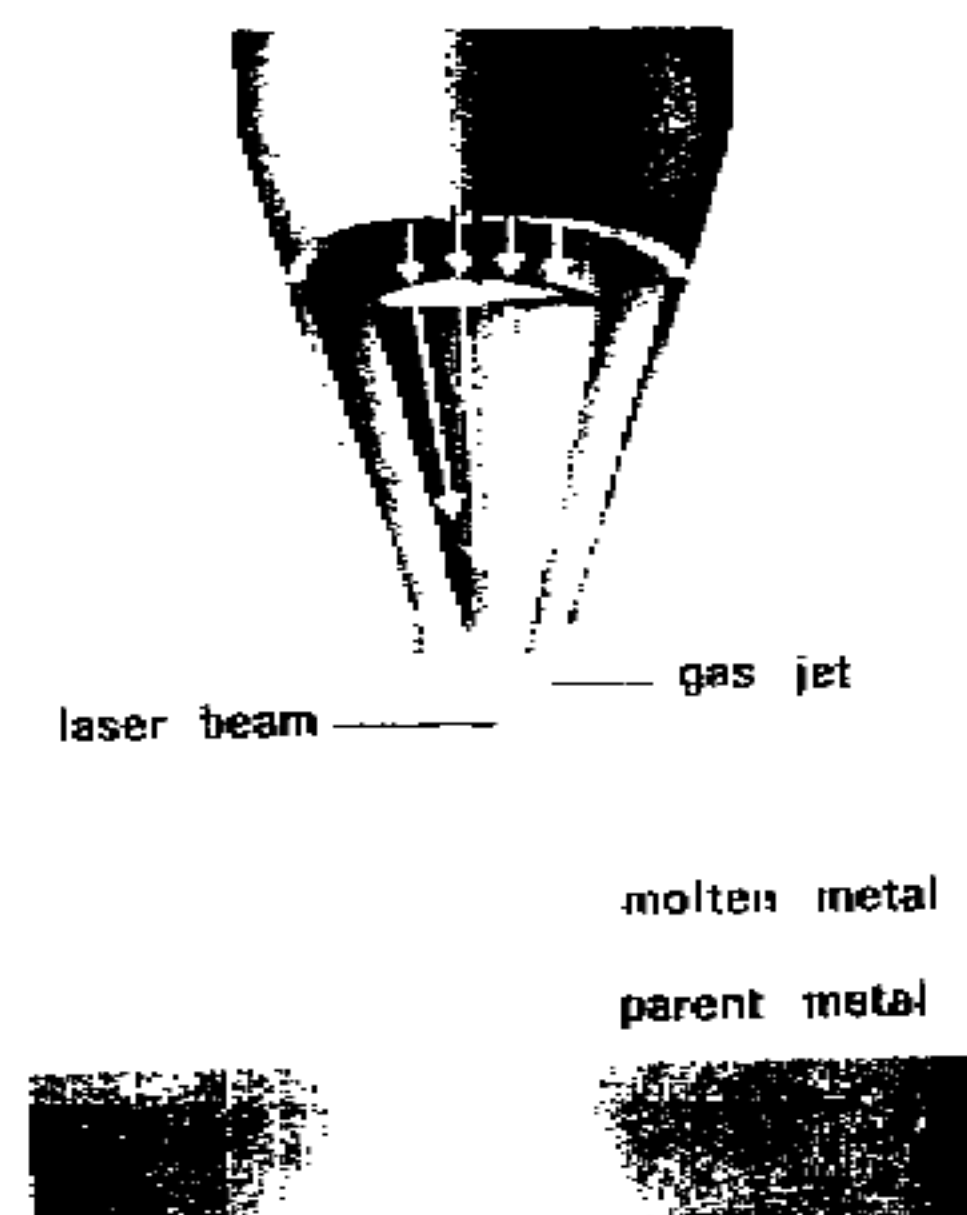

Although death rays have not yet been produced that are effective battlefield weapons, many of them are excellent as commando weapons for destroying fuel supplies and igniting other stored combustible liquids and many solids. They are also used in low power application as targeting aids in many small arms and most large military direct fire weapons.

Other commercial uses of lasers include reading the computer CD's and music CD's, reading the bar codes in supermarkets, and a variety of medical surgery's.

8) Booby Trap and Delay Devices

Booby traps, mines and positioned weapons are a class of weapons that are used to fight a superior enemy without having to be personally present or to defend or inhibit free movement over selected territory. The advantages of these types of weapons are -

1. They are cheap to build
2. They are easy to train troops to construct and set
3. Your troops don't have to be present and get shot at while the enemy is attacking

Incendiaries, The Science of Using Fire as a Weapon

Incendiaries make excellent ordnance choices for shock effect and attacking combustibles as remote munitions. The use of delay devices permit incendiaries to ignite and destroy targets long after the troops have placed them.

It is also important that the correct type of incendiary munition be married to each target type. Combustible wooden structures are best attacked with widely dispersed fuel based materials. Hard targets like tanks and armored vehicles are attacked with higher temperature incendiaries like thermites that concentrate most of their heat on one spot to maximize penetration and damage to a small area. Fuel storage and vehicle or aircraft tanks are best attacked with small arms munitions designed to penetrate the tanks and ignite vapors.

Incendiaries are often good choices for clandestine attack because they can easily be smuggled into target areas and are often made of common materials that are readily available. They initiate damage that spreads by using the targets susceptibility to burn. A thimbleful of incendiary fuel can destroy buildings where explosives are somewhat limited in their ability to destroy by the bomb size.

Having knowledge of how incendiaries work is also crucial. Many individuals who commit arson use gasoline to ignite their targets. Most do not realize that it is the vapors that ignite and not the liquid. Many of these individuals are caught as they show up at hospitals for treatment of burn injuries or at barber and beauty shops to remove or camouflage singed hair.

The above is the best reason for incorporating delay mechanisms into prepositioned incendiary ordnance. Volume 2 Chapter 10 covers the basic types of delays and traps that can be used. Some of these will be repeated here with modifications suitable to incendiary use.

One of the earliest delay incendiary devices used to provide time for the assault team to escape is the candle. It is set vertically in combustible materials such as wood shavings or newspapers soaked in kerosene. The burning rate is established by the rate of burn and height of the candle. Seed grains have also been commonly used as a delay. The seeds are soaked in water and swell up in a container which raises a wire to make contact with another wire and completing a circuit. The amount of water and seeds can be adjusted to accurately provide the time delay.

White phosphorus and other air reactive materials can be used in a water leaking delay system. A full bucket of water or other liquid inside a container is allowed to leak out through a pinhole. The phosphorus or other igniter is uncovered when all the fluid leaks out and ignites in the open air. A floating material can hold an additional combustible to help fuel and expand the fire. The size of the leak and the quantity of water determine the delay.

Any mechanical means of bringing an oxidizer and reactant together after a suitable delay will also work well. Electrical delays are already wired in to alarm clocks and the firing mechanism need only be wired into the alarm or speaker circuit. Batteries can provide a delay because they lose power when stored in a freezer. They can be placed in a device and slowly regain power as they thaw. Once warmed sufficiently the battery has enough power to send current and voltage to activate a circuit or other device.

Incendiaries, The Science of Using Fire as a Weapon

A battery can also be used to drain power such as holding a gas valve or solenoid closed. Once the power reserve is gone, the battery fails to hold the circuit closed, a spring moves and releases the fuel and mechanically ignites the vapors or other combustibles. Both these actions can be separate with the battery holding the fuel source with a stronger spring and failing there first. A short time later, the second spring overcomes the weakened battery and sets off an ignition device. These can be made adjustable by the power reserve of the battery and the strength of the springs or power consumption of the solenoid.

Another means of improvised delay circuitry involves filling a light bulb with gasoline and inserting it into a timed electrical circuit. This is done by drilling a small hole in the bulb and filling it through a funnel. The hole is sealed with a piece of tape and then inserted in a table or other lamp. When the circuit is turned on by a clock timer or enemy targets entering the room and switching the light on, the filament ignites the gasoline vapors and explodes rapidly dispersing fuel around the lamp. [Authors note- do not forget to turn the lamp on when using a delay circuit]

Trailers are used to spread fire rapidly from one location to another. A trail of gasoline or kerosene soaked paper or rags is used to spread fire through buildings or from one fuel storage area to another. Breaking a light bulb and placing a kerosene soaked rag around it while using the above described delay systems is a good way to ignite trailers. The switch is turned on and the circuit shorts across the filaments igniting the rags and any trailer that has been placed. There are many actions that can be taken to enhance fires. These will be covered by target group in the coming chapters. It should be remembered that all fires require large volumes of oxygen to sustain combustion and should be ventilated at a low level. A venting near the roof of a fire has a chimney effect by allowing hot combusted gases an escape which draws fresh oxygen in. This allows the fire to continue as long as combustible fuel is available and ignition temperatures are maintained.

Another delay that can be quickly set is to start a small fire on a floating object with sufficient fuel. A large amount of flammable fuel that floats on water also works. Place it in a sink with the water running slowly. Once the sink overflows, the fire and fuel are dispersed. Other common fuels that burn slowly include animal and vegetable fat, many cosmetics and perfumes, and most household solvents.

The following methods of improvising delay mechanisms in the field are derived from the US Army handbook on the same subject.

Incendiaries, The Science of Using Fire as a Weapon

Fire Bottle Launcher

A device using 2 items (shotgun and chemical fire bottle) that can be used to start or place a fire 80 yards from launcher.

Material required

Standard 12 gauge or improvised shotgun
Improvised fire bottle (Incendiary chapter)
Tin can, about 4" in diameter and 5-1/2" high
Wood, about 3" x 3" x 2"
Nail, at least 3" long
Nuts and bolts, or nails, at least 2-1/2" long
Rag
Paper
Drill

If Standard Shotgun is Used

Hard wood stick, about the same length as shotgun barrel and about 5/8" in diameter. Stick need not be round.
2 washers, having outside diameter of 5/8"
Rubber disk, 3/4" in diameter and 1/4" thick. Leather or cardboard can be used.
12 gauge shotgun ammunition

If Improvised Shotgun is Used

Fuse, safety or improvised fast burning
Hard wood stick, 3/4" in diameter and about same length as the shotgun barrel
Black powder- 9 grams (135 grains)

Incendiaries, The Science of Using Fire as a Weapon

Procedure

Method 1 - If Improvised Shotgun is Used

1. Drill 2 small holes in center of wood block app. 1" deep. Hole should have app. the same diameter as the wooden stick.

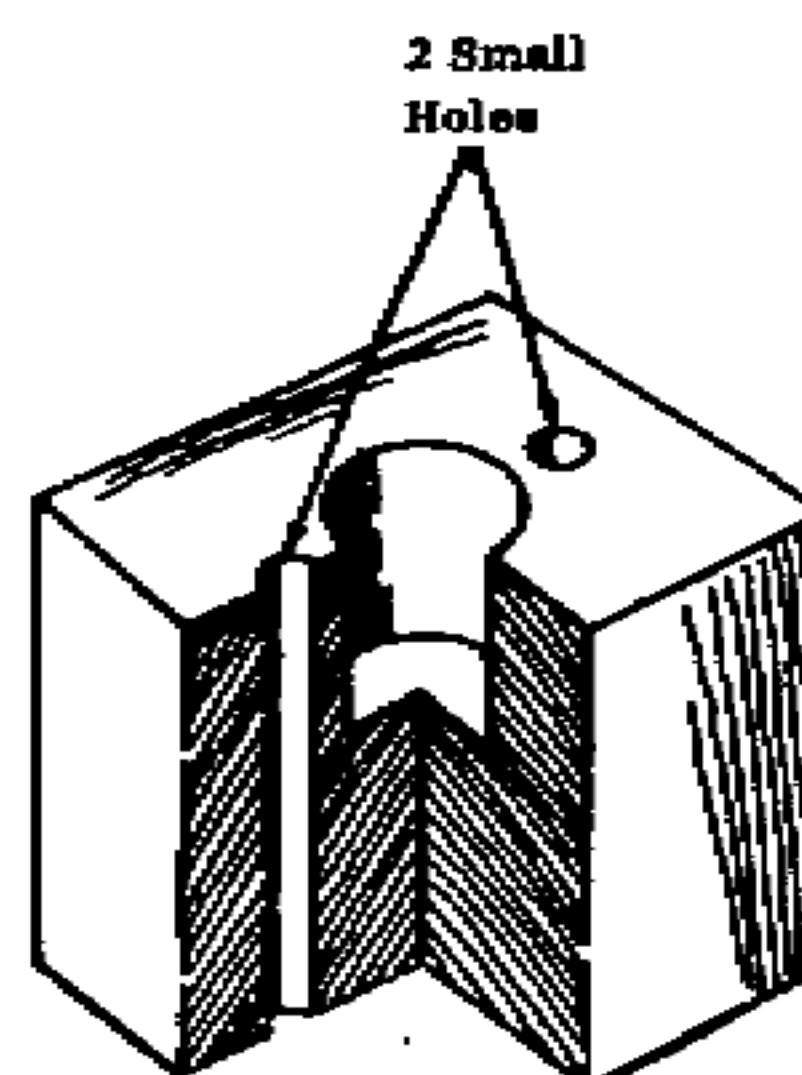

2. Drill 2 small holes on opposite sides of the wooden block. Hole should be large enough for bolts to pass through.

3. Fasten can to block with nuts and bolts.

NOTE: Can may also be securely fastened to block by hammering several nails through can and block. Do not drill holes, and be careful not to split wood.

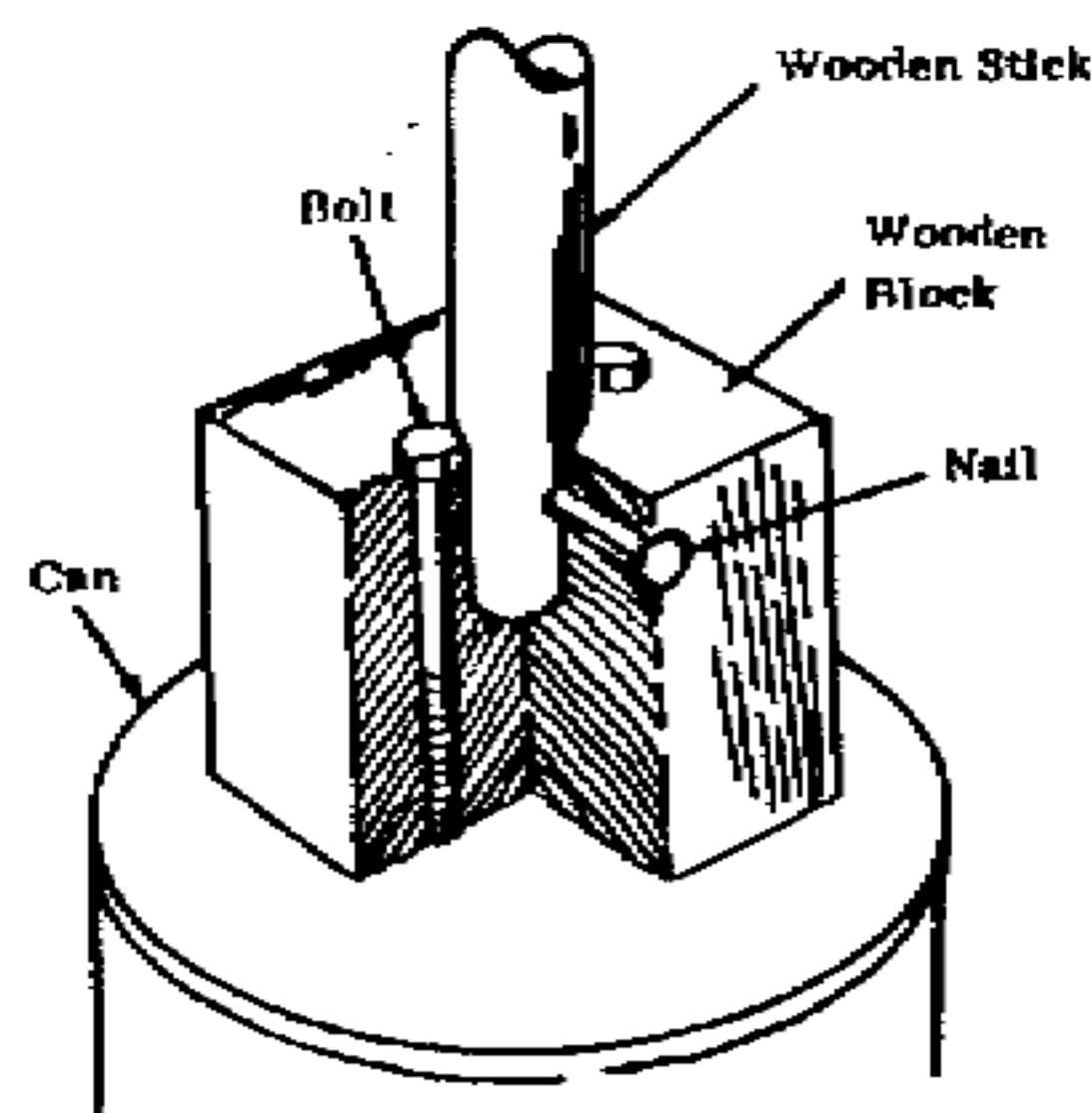

4. Place wooden stick into hole in wooden block. Drill small hole (same diameter as that of the 3" nail) through wooden block and through wooden stick. Insert nail in hole.

Incendiaries, The Science of Using Fire as a Weapon

5. Crumple paper and place in bottom of can. Place another piece of paper around fire bottle and insert in can. Use enough paper so that bottle will fit snugly.

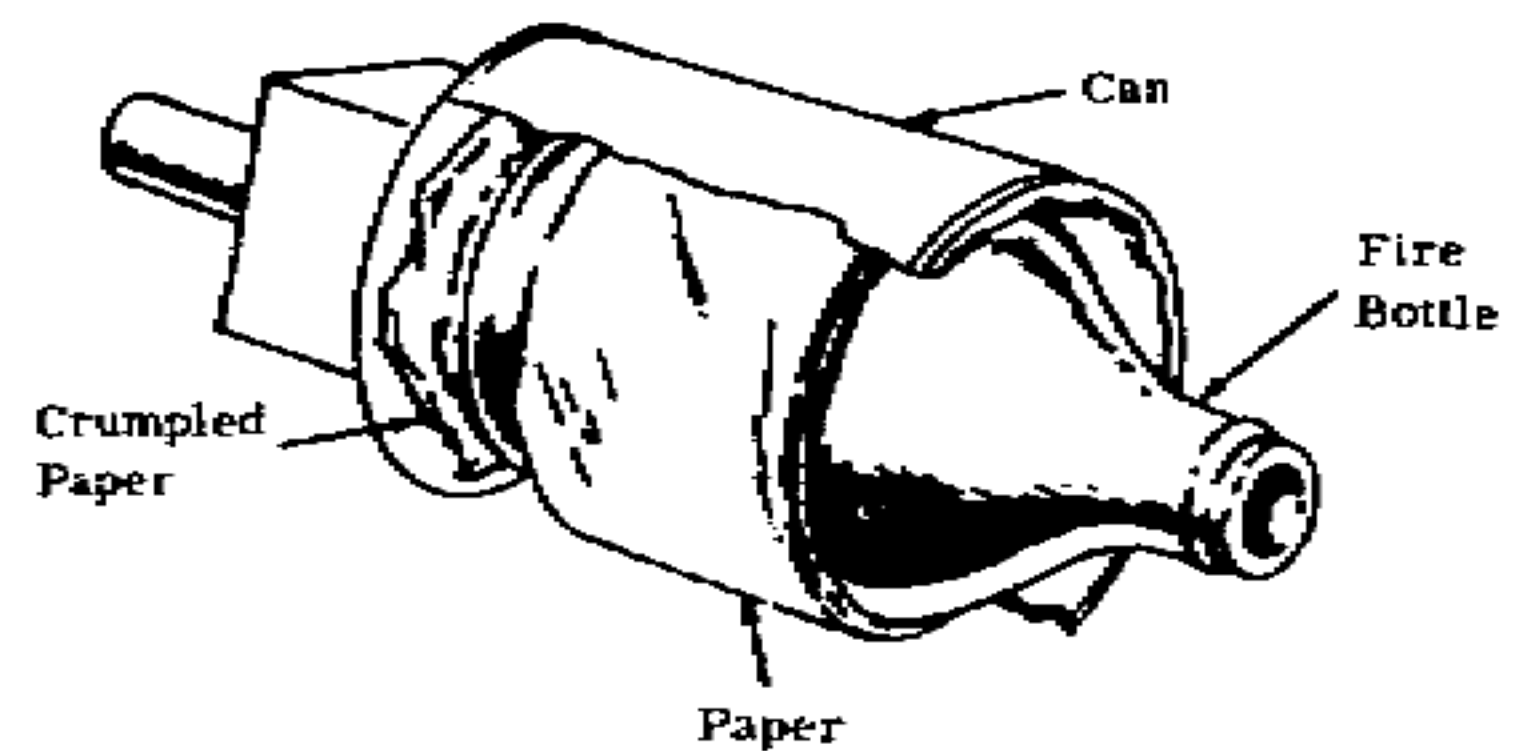

6. Place safety fuse and black powder on paper. Tie each end with string.

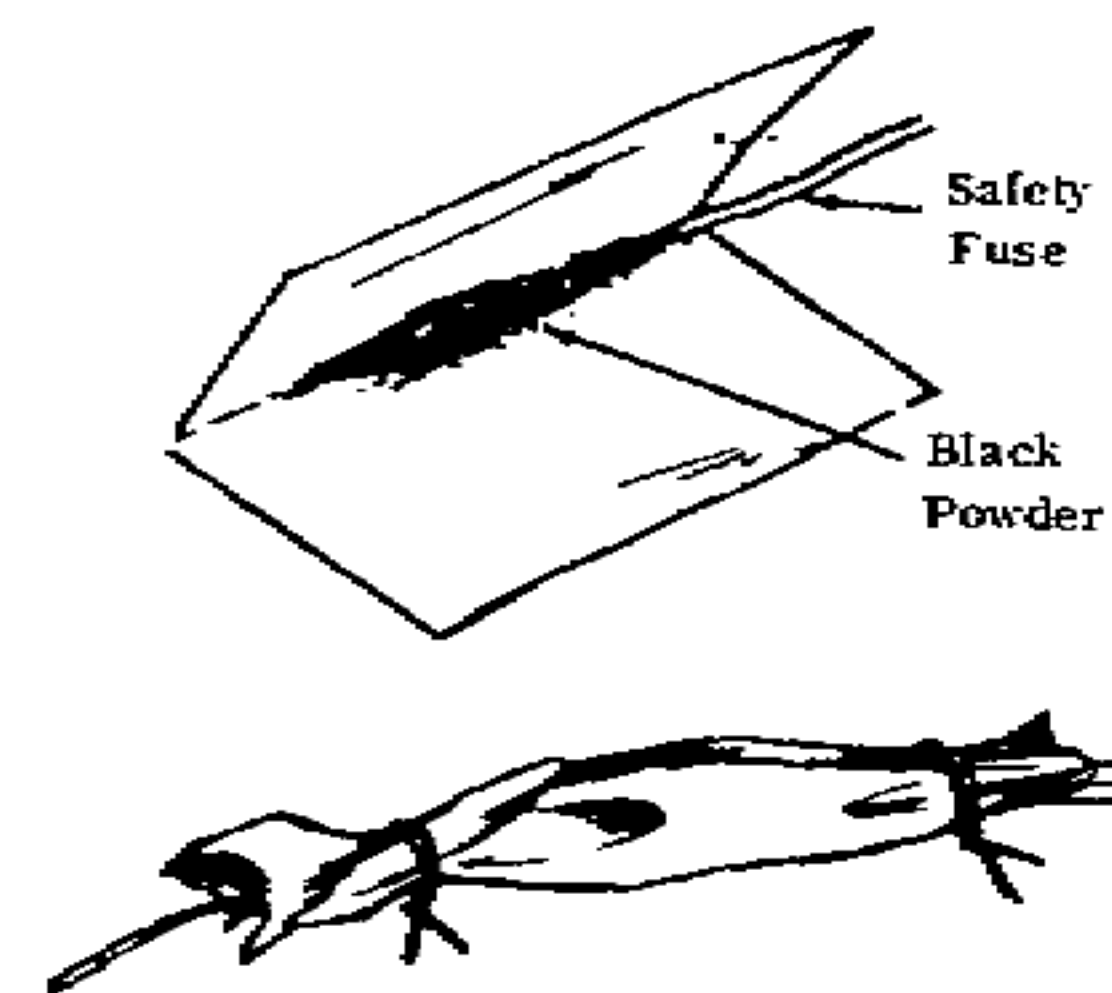

7. Thread fuse through hole in plug. Place powder package in rear of shotgun. Screw plug finger tight into coupling.

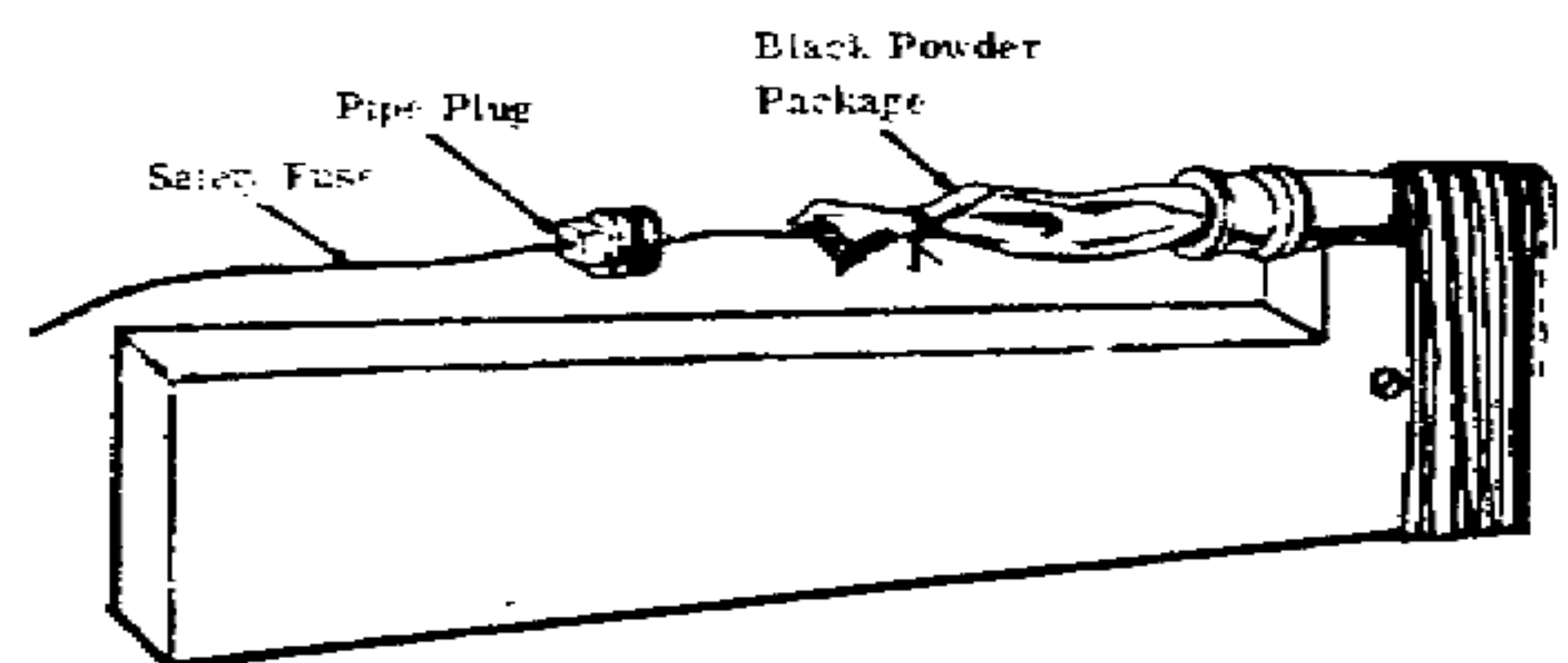

NOTE: Hole in plug may have to be enlarged for fuse.

8. Insert rag into front of shotgun. Pack rag against powder package with stick.
USE CAUTION.

Incendiaries, The Science of Using Fire as a Weapon

Method II - If Standard Shotgun is Used

1. Follow steps 1 and 2 of shotgun grenade launcher
2. Follow procedure of method 1, steps 1-5.
3. Follow steps 9-11 of shotgun grenade launcher (chapter 4) using 1/3 of total propellant instead of 1/2.
4. Load cartridge in gun.

How to use

1. Insert stick and holder containing chemical fire bottle.

Caution: Do Not tilt muzzle downward

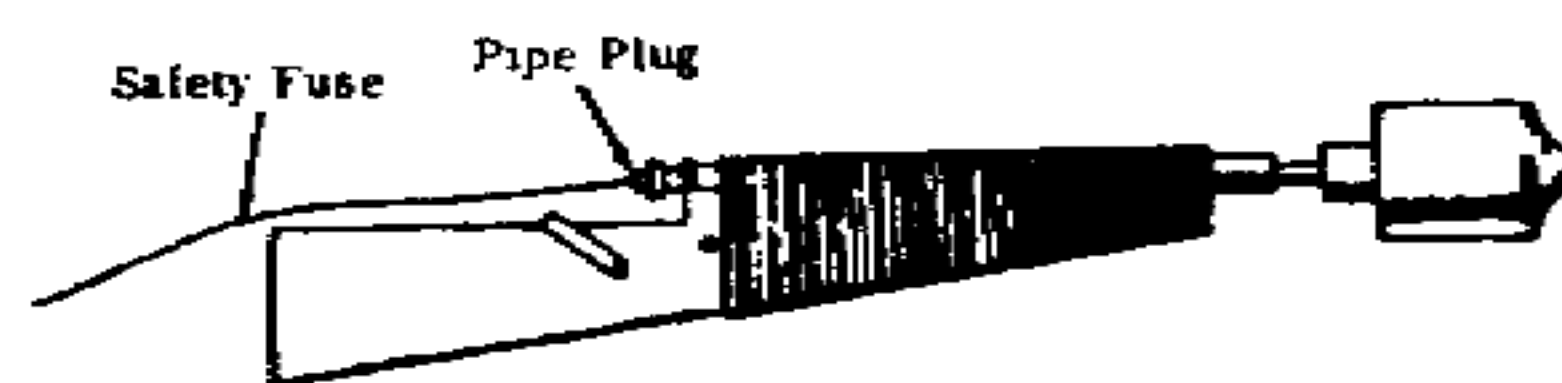

2. Hold gun against ground at 45 degree angle and light fuse.

Caution: Severe burns may result if bottle shatters when fired. If possible, obtain a bottle identical to that being used as the fire bottle. Fill about 2/3 full of water and fire as above. If bottle shatters when fired instead of being launched intact, use a different type of bottle.

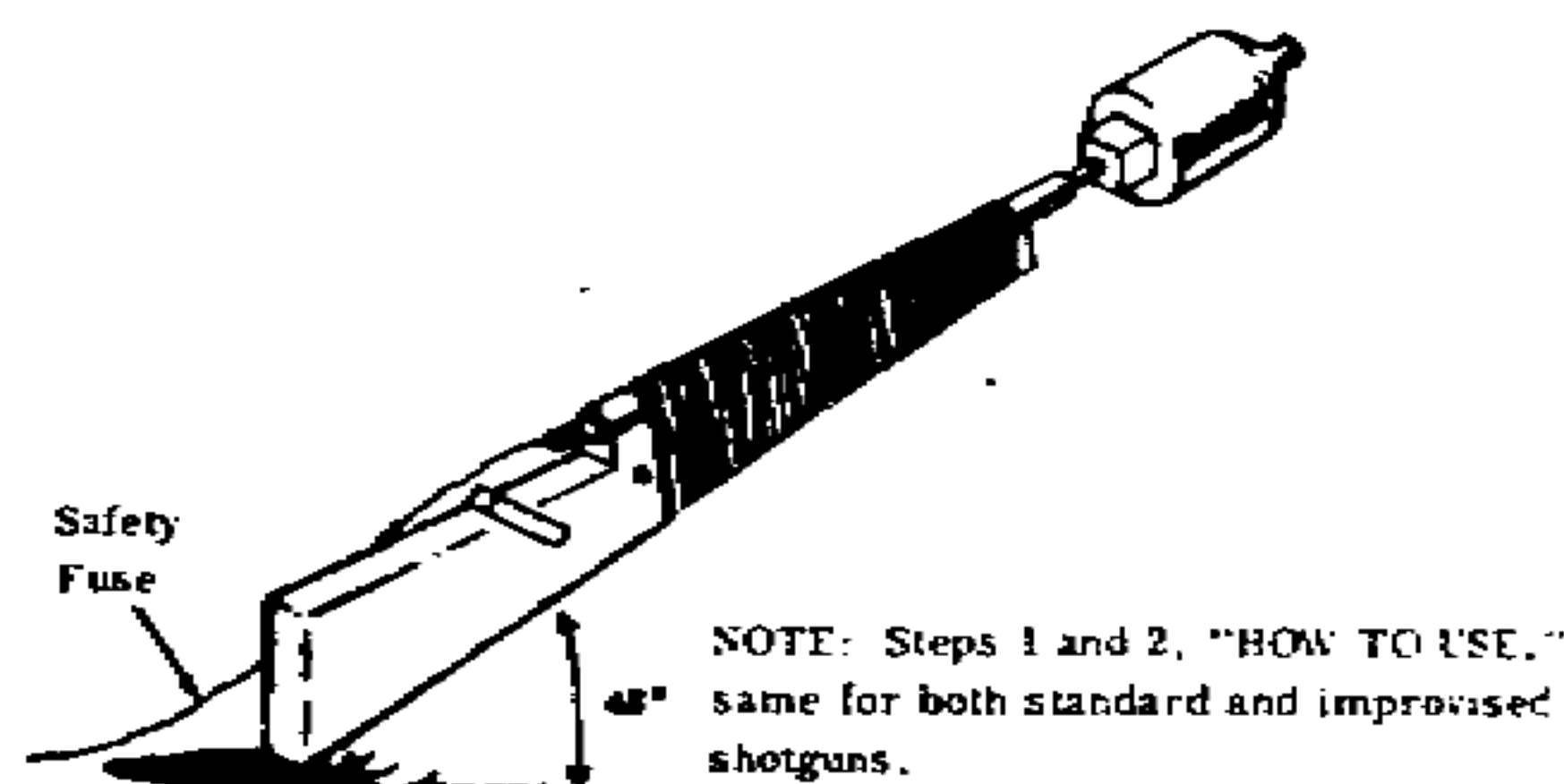

Incendiaries, The Science of Using Fire as a Weapon

Electric Bulb Initiator

Mortar, mines and similar weapons often make use of electric initiators. An electric initiator can be made using a flashlight or automobile electric light bulb.

Material Required

Electric light bulb and mating socket
Cardboard or heavy paper
Black Powder
Adhesive tape

Procedure

Method 1

1. Break the glass of the electric light bulb. Take care not to damage the filament. The initiator will not work if the filament is broken. Remove all glass above the base of the bulb.

2. Form a tube 3-4" long from cardboard or heavy paper to fit around the base of the bulb.

3. Fit the tube to the bulb base and tape into place.

Make sure that the tube does not cover that portion of the bulb base that fits into the socket.

4. If no socket is available for connecting the initiator to the firing circuit, solder the connecting wires to the bulb base.

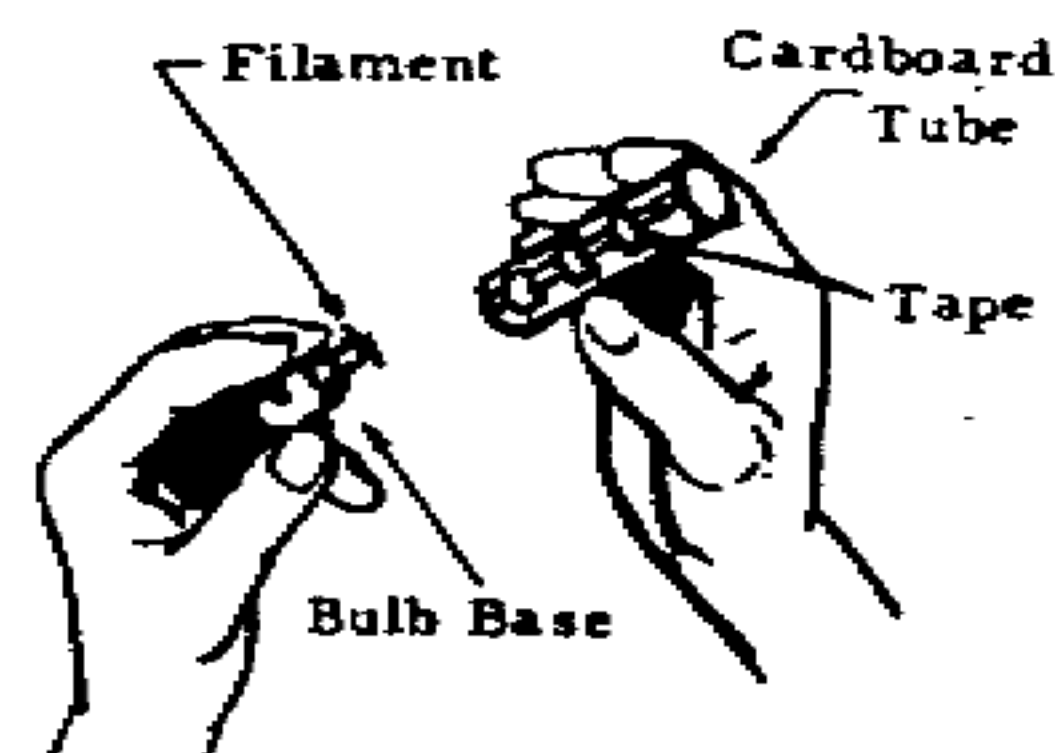
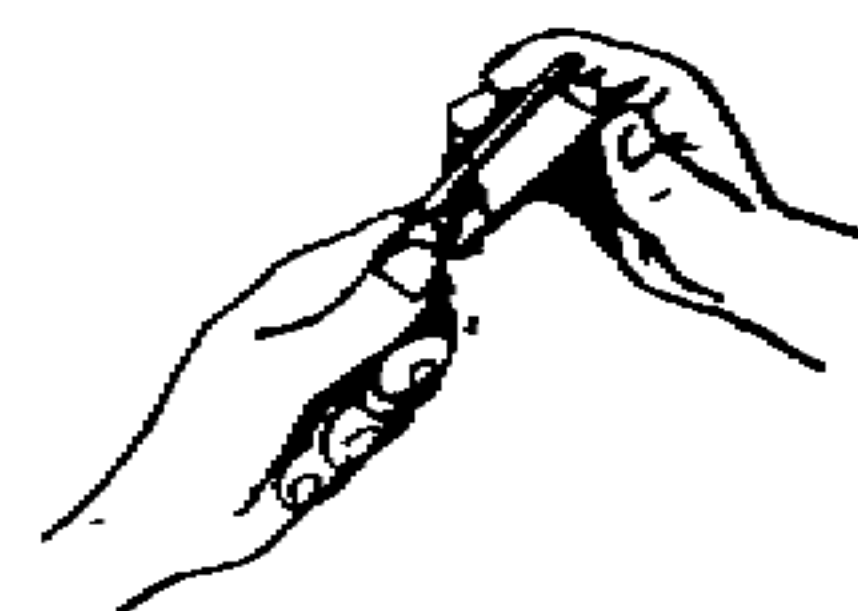
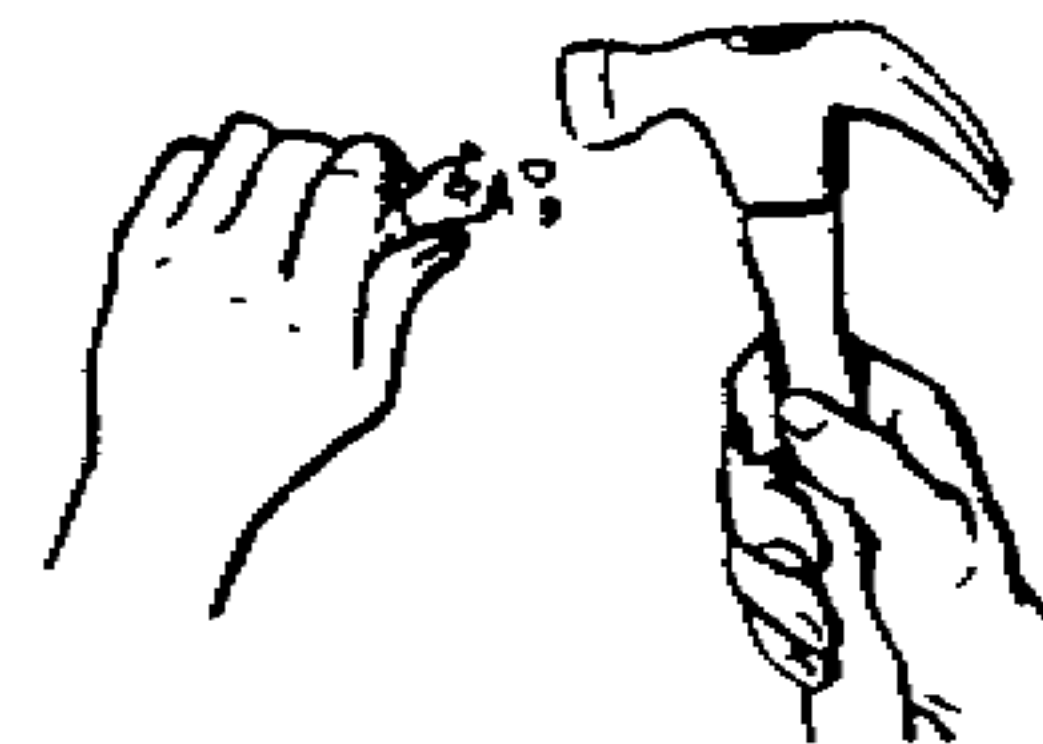
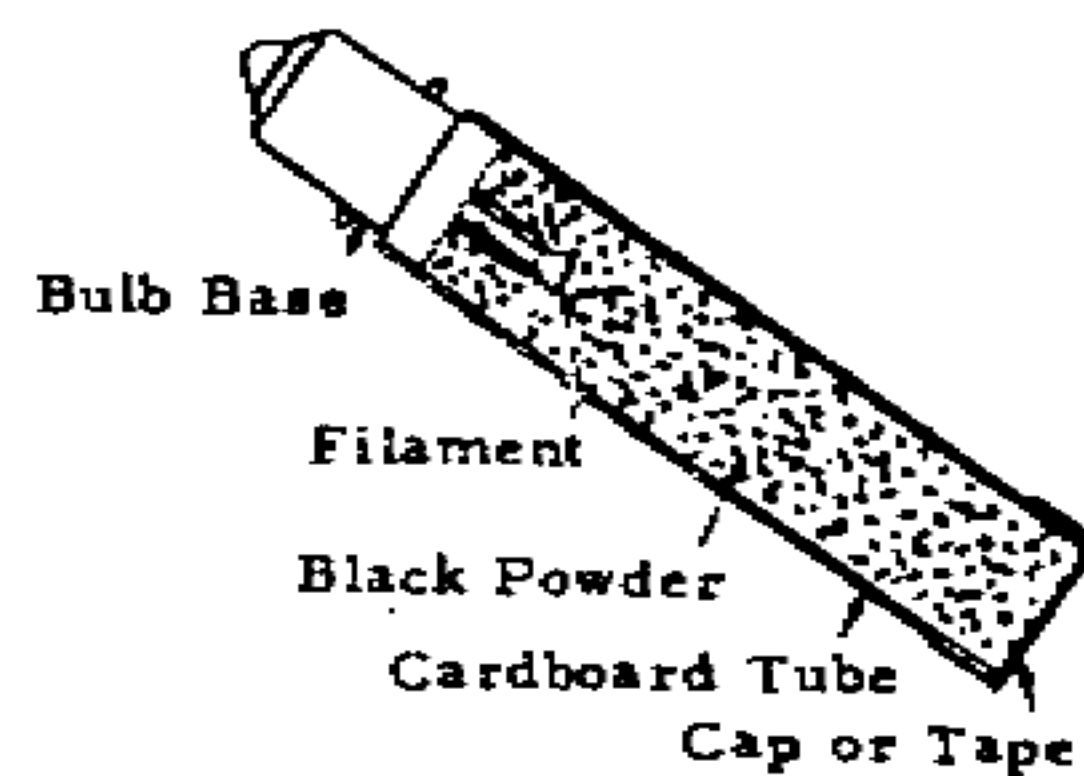

Incendiaries, The Science of Using Fire as a Weapon

CAUTION: Do not use a hot soldering iron on the completed igniter since it may ignite the black powder.

5 Fill the tube with black powder and tape the open end of the tube closed.

Method II

If the glass bulb is large enough to hold the black powder, it can be used as the container.

Procedure

1. Fill a small hole in the top of the bulb.

2. Fill the bulb with black powder and tape the hole closed.

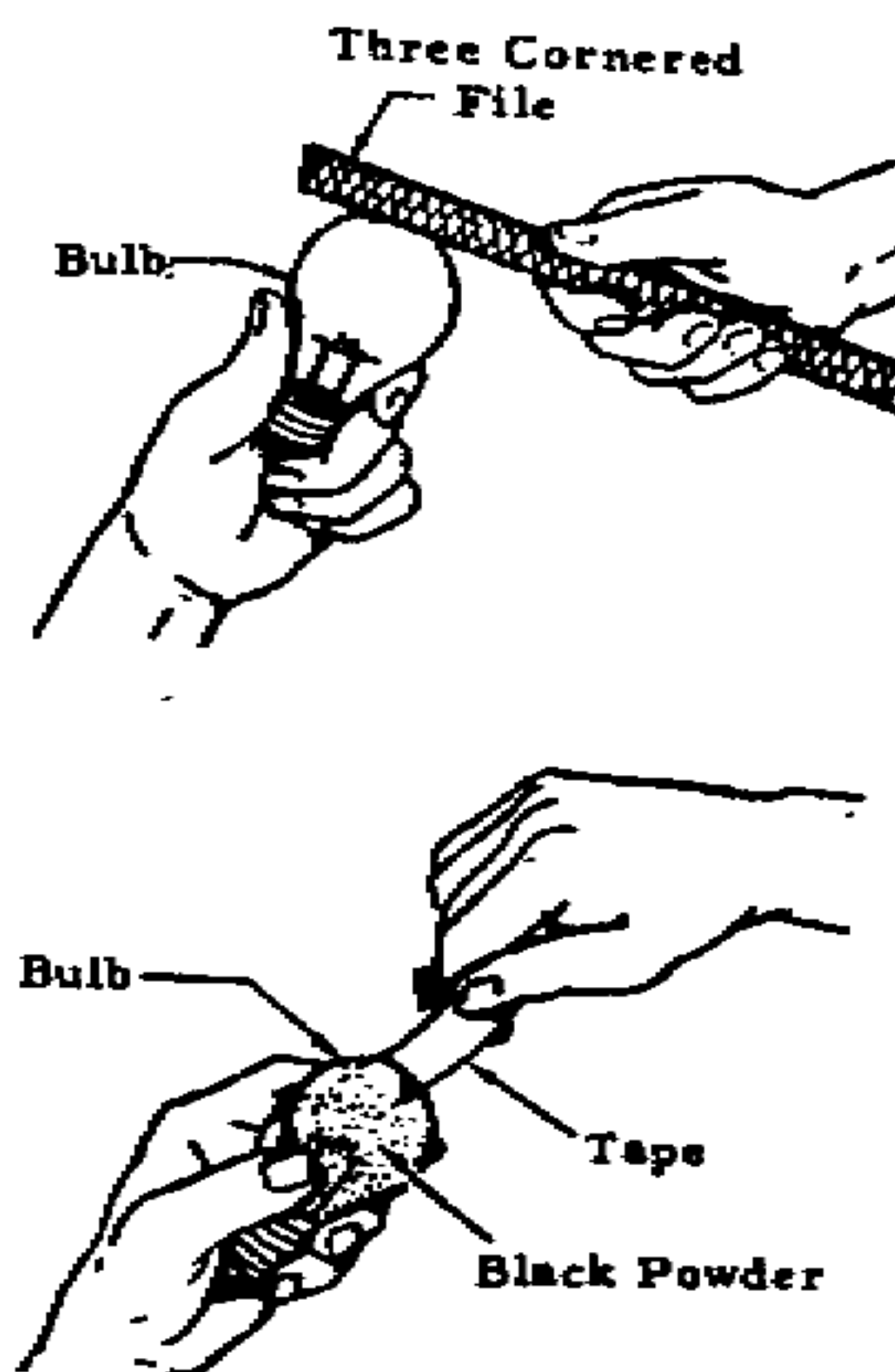
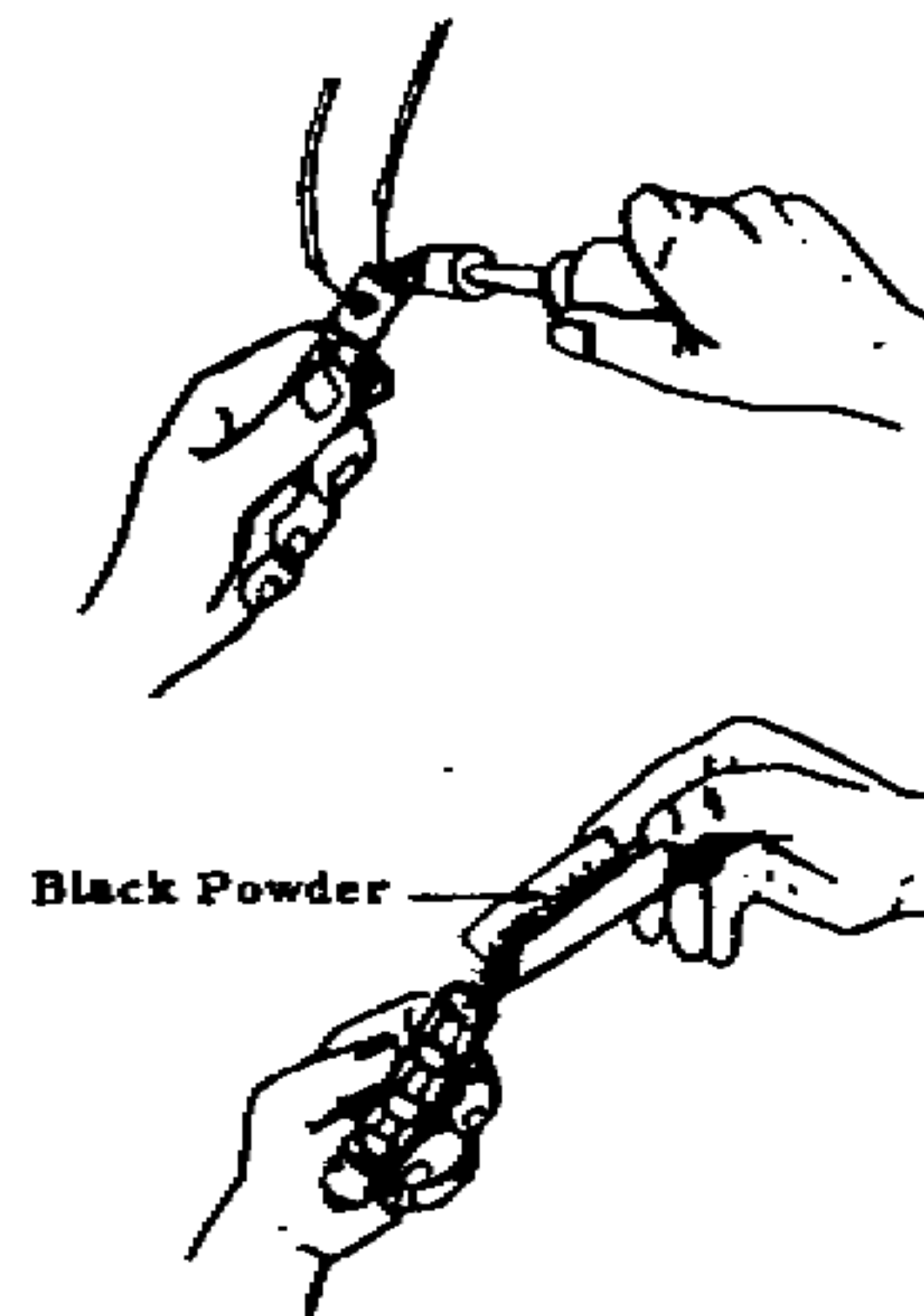

Incendiaries, The Science of Using Fire as a Weapon

[**Authors note:** Many years ago, as part of a Halloween prank, a friend placed a lighted cigarette into the end of an M-80 fireworks explosive which he then placed under the windshield wiper of a police car parked in front of the local police station. He returned to work (the rest of us were to be his alibi, hey I was 16 years old at the time) and when we went off our shift a short time later we drove by the police station where a lot of angry looking officers were watching their patrol car being towed away. The window had a 6" hole in it with cracks all the way across. I guess when they read this they can remove that from their unsolved mystery folder. It was a good thing the M-80 was not placed near the gas tank with its cap slightly loosened.]

Delay Igniter From Cigarette

A simple and economical time delay can be made with a common cigarette

Materials Required

Cigarette
Paper match
String (shoelace or similar cord)
Fuse Cord (improvised or commercial)

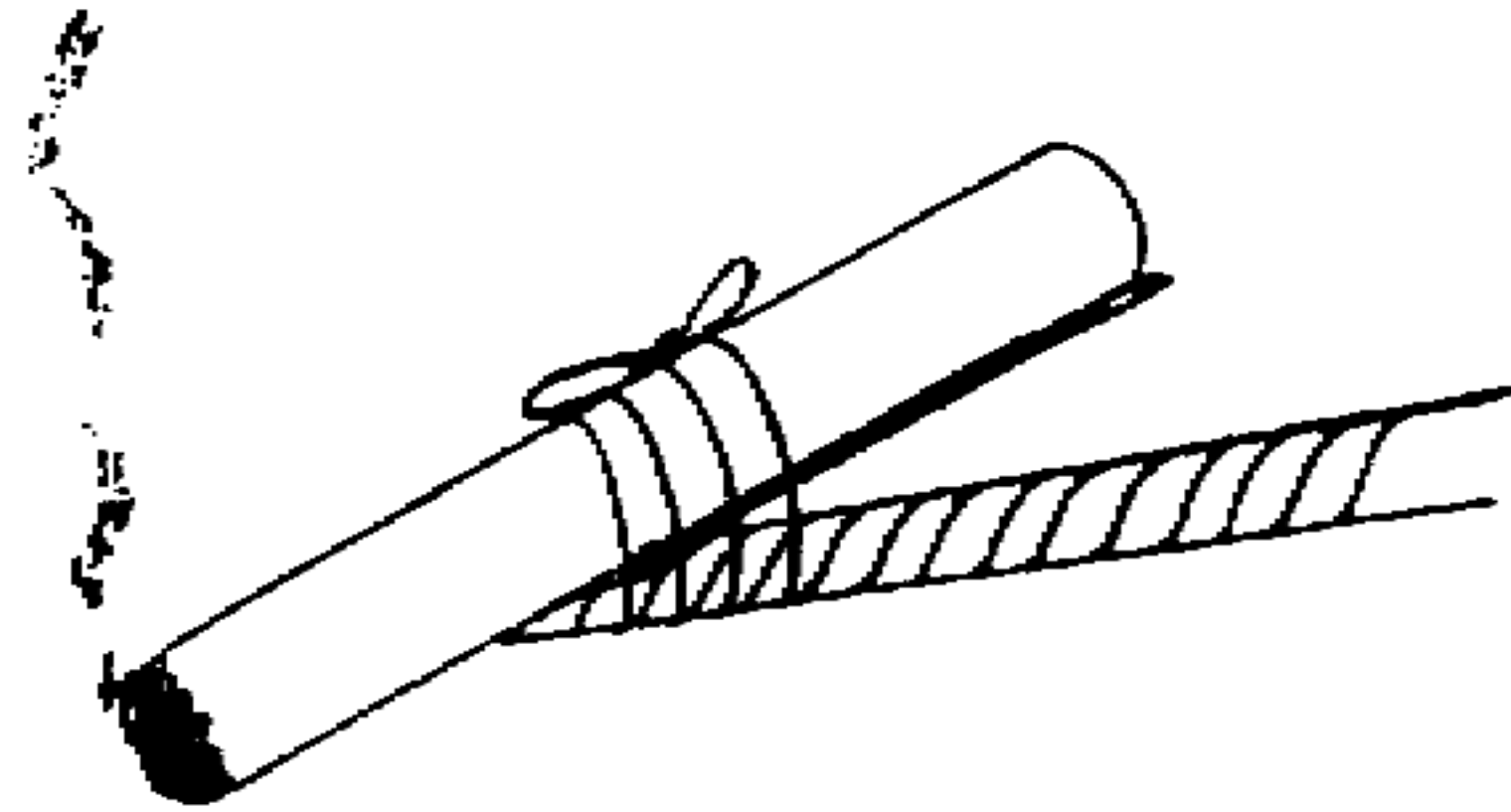

Procedure

1. Cut end of fuse cord to expose inner core.

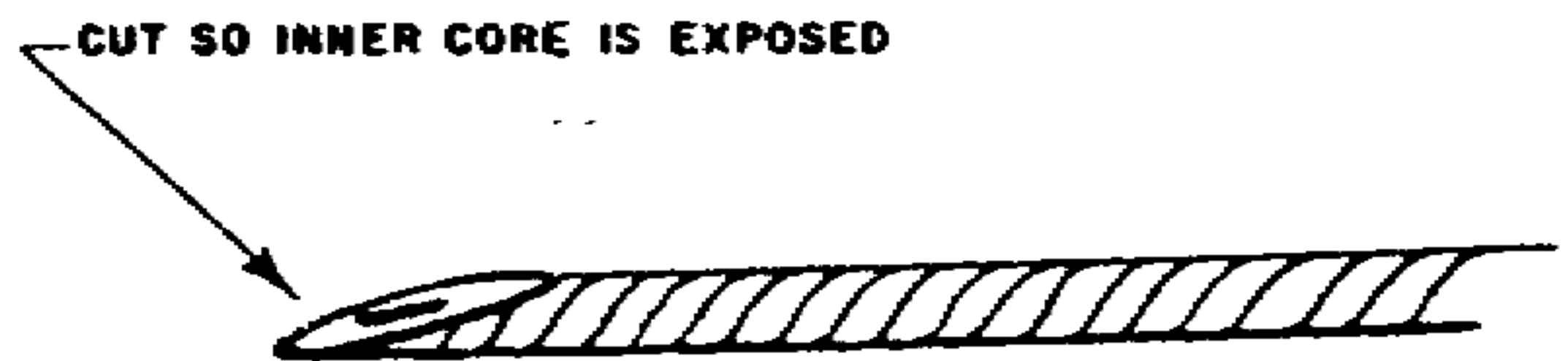

2. Light cigarette in normal fashion. Place a paper match so that the head is over exposed end of fuse cord and tie both to the side of the burning cigarette with string.

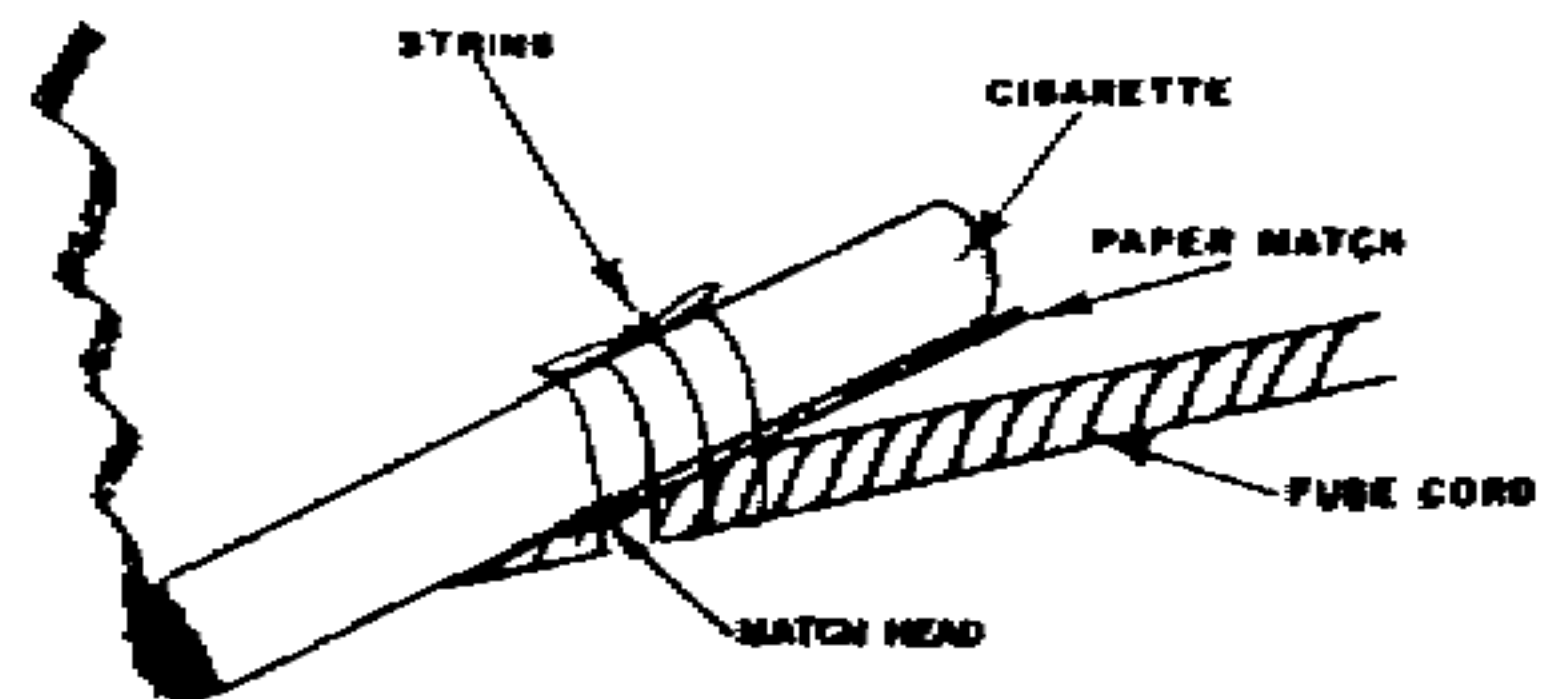

Incendiaries, The Science of Using Fire as a Weapon

3. Position the burning cigarette with fuse so that it burns freely. A suggested method is to hang the delay on a twig.

NOTE: Common dry cigarettes burn about 1" every 7 or 8 minutes in still air. If the fuse cord is placed 1" from the burning end of the cigarette a time delay of 7-8 minutes will result.

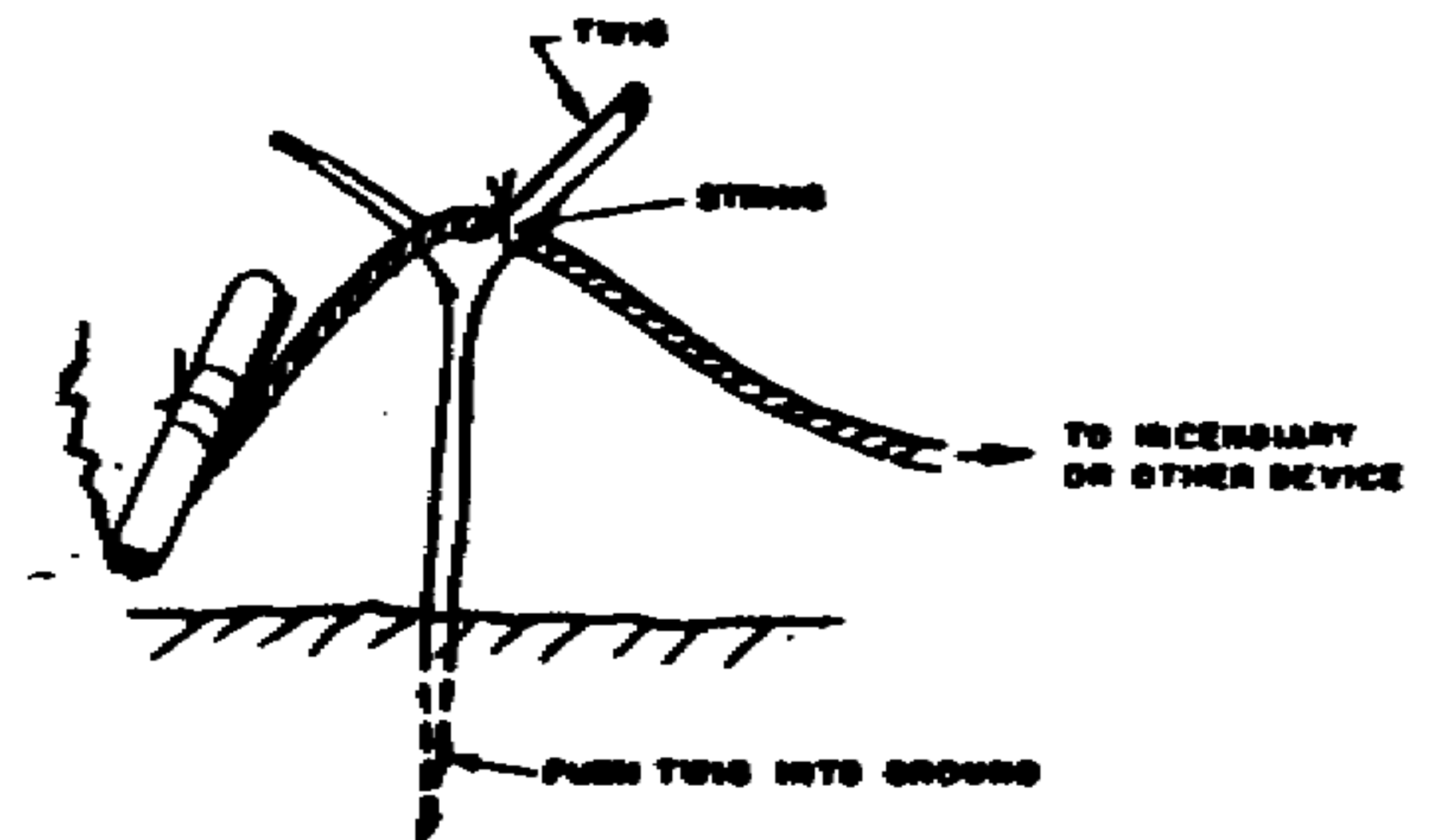

Delay time will vary depending upon type of cigarette, wind, moisture, and other atmospheric conditions.

To obtain accurate delay time, a test run should be made under use conditions.

Incendiaries, The Science of Using Fire as a Weapon

Watch Delay Timer

A time delay device for use with electrical firing circuits can be made by using a watch with a plastic crystal.

Material and equipment required

Watch with plastic crystal
Small clean metal screw
Battery
Connecting wires
Drill or nail

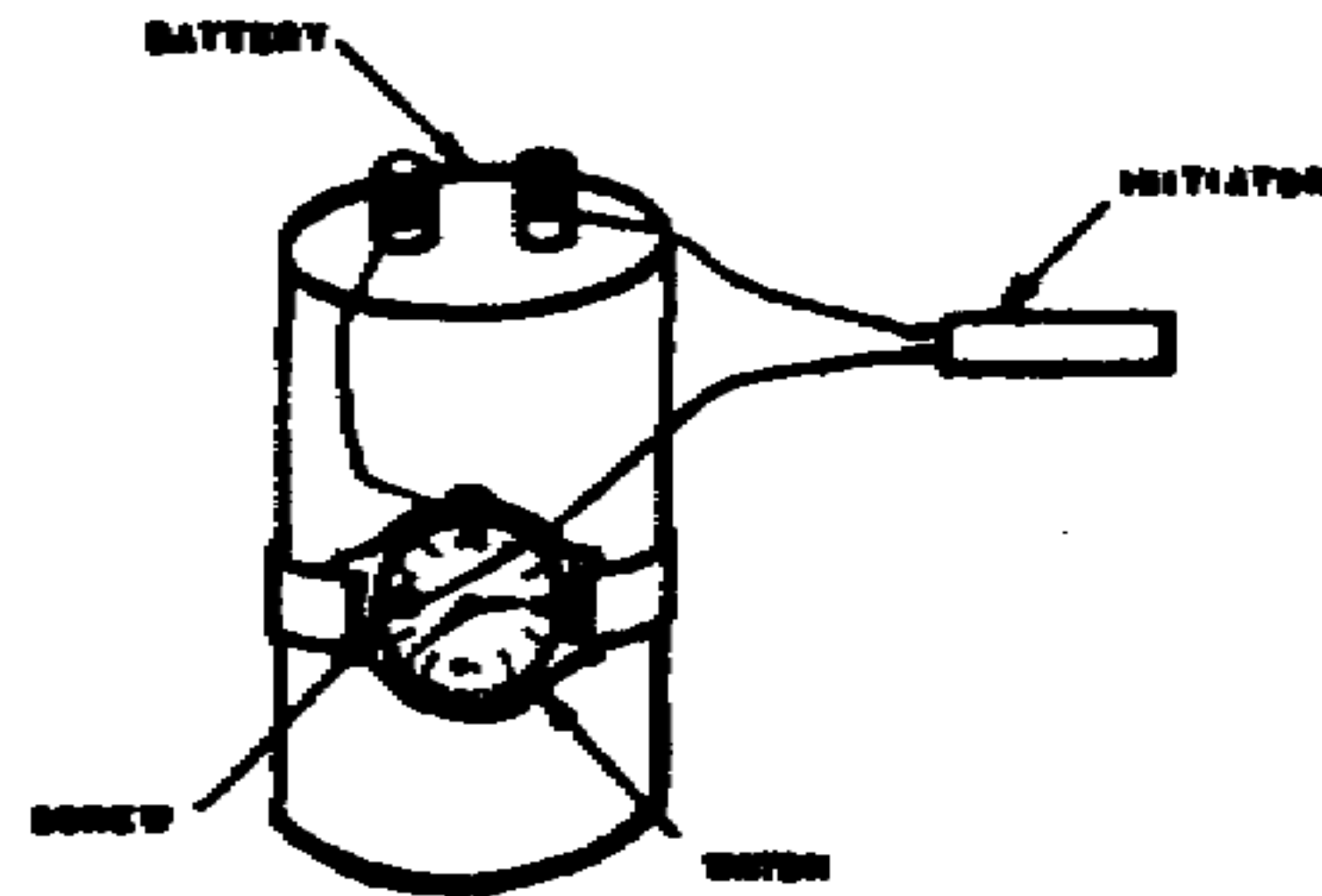

Procedure

1. If watch has a sweep or large second hand, remove it. If delay time of more than hour is required, also remove the minute hand. If hands are painted, carefully scrape paint from contact edge with knife.

2. Drill a hole through the crystal of the watch or pierce the crystal with a heated nail. The hole must be small enough that the screw can be tightly threaded into it.

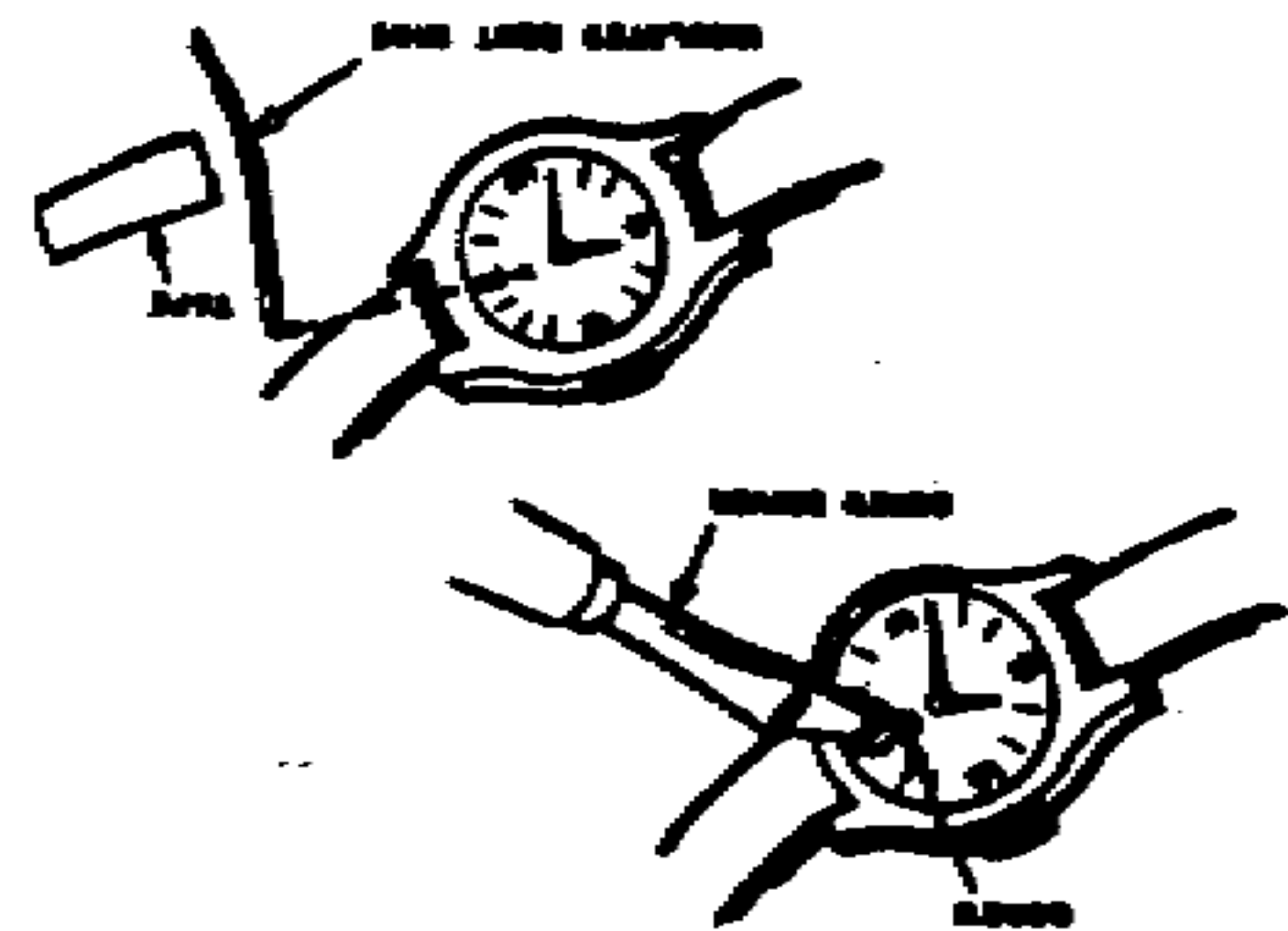

3. Place the screw in the hole and turn down as far as possible without making contact with the face of the watch. If screw has a pointed tip, it may be necessary to grind the tip flat.

If no screw is available, pass a bent stiff wire through the hole and caps to crystal.

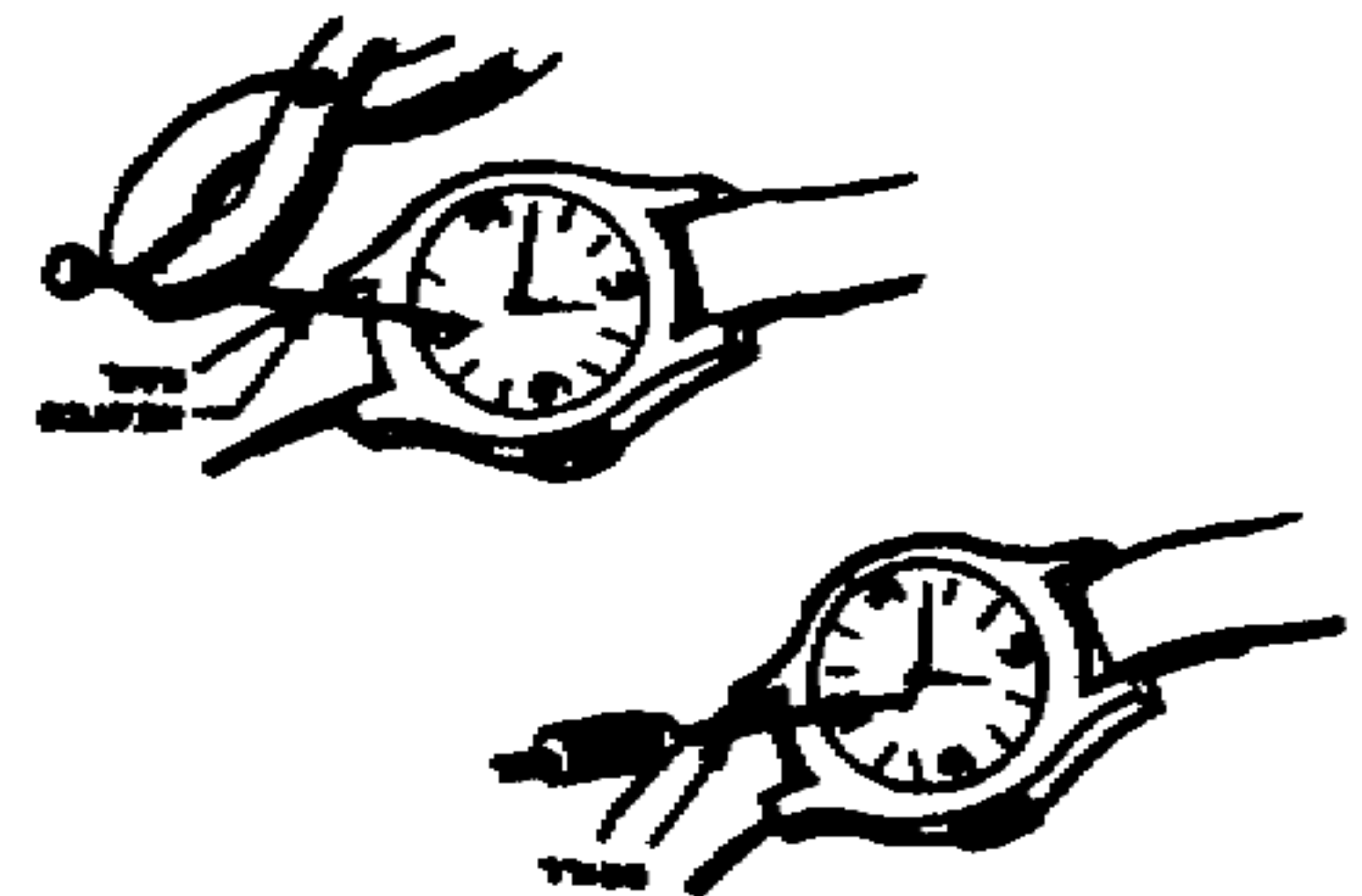

IMPORTANT: Check to make sure hand of watch cannot pass screw or wire without contacting it.

Incendiaries, The Science of Using Fire as a Weapon

How to use

1. Set the watch so that a hand will reach the screw or wire at the time you want the firing circuit completed.

2. Wind the watch

3. Attach a wire from the case of the watch to one terminal of the battery.

4. Attach one wire from an electric initiator (blasting cap, squib or alarm device) to the screw or wire on the face of the watch.

5. After thorough inspection is made to assure that the screw or the wire connected to it is not touching the face or case of the watch, attach the other wire from the initiator to the second terminal of the battery.

CAUTION: Follow step 5 carefully to prevent premature initiation.

Incendiaries, The Science of Using Fire as a Weapon

No Fuse Flash Igniter

A simple no-flash fuse igniter can be made from common pipe fittings

Material Required

1/4" Pipe cap
Solid 1/4" Pipe plug
Flat head nail about 1/16" in diameter
Hand drill
Common "strike anywhere" matches
Adhesive tape



Procedure

1. Screw the pipe plug tightly into the pipe cap.

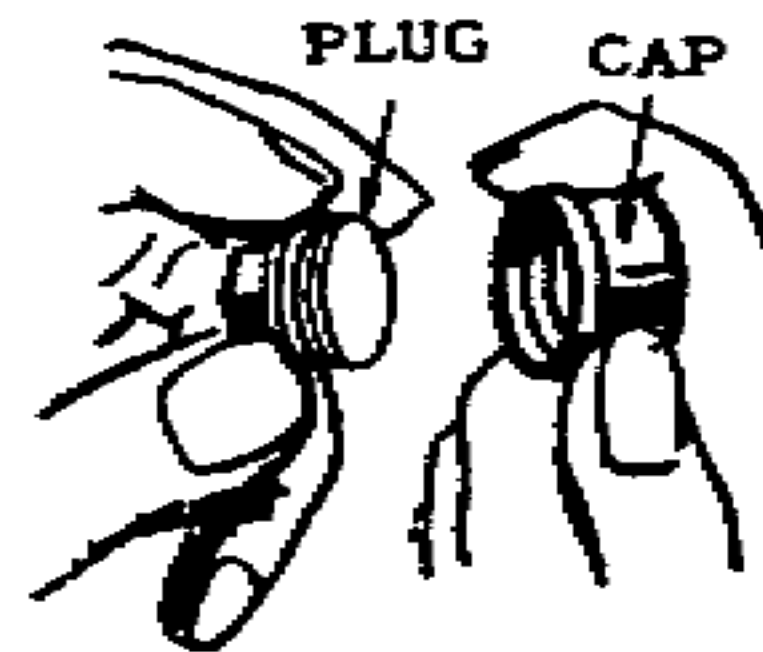

2. Drill hole completely through the center of the plug and cap large enough that the nail fits loosely.

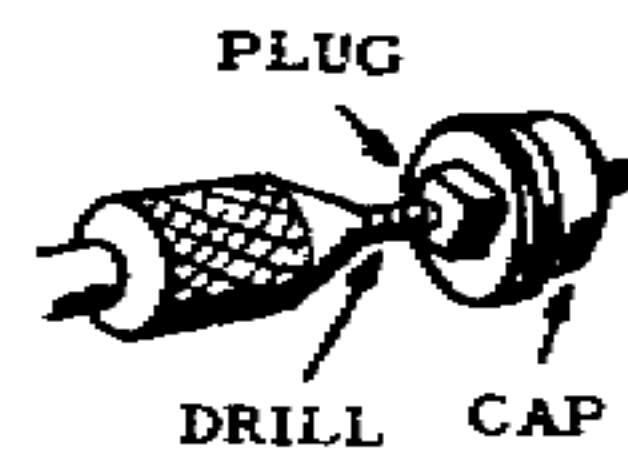

3. Enlarge the hole in the plug except for the last 1/8" so that the fuse cord will just fit.

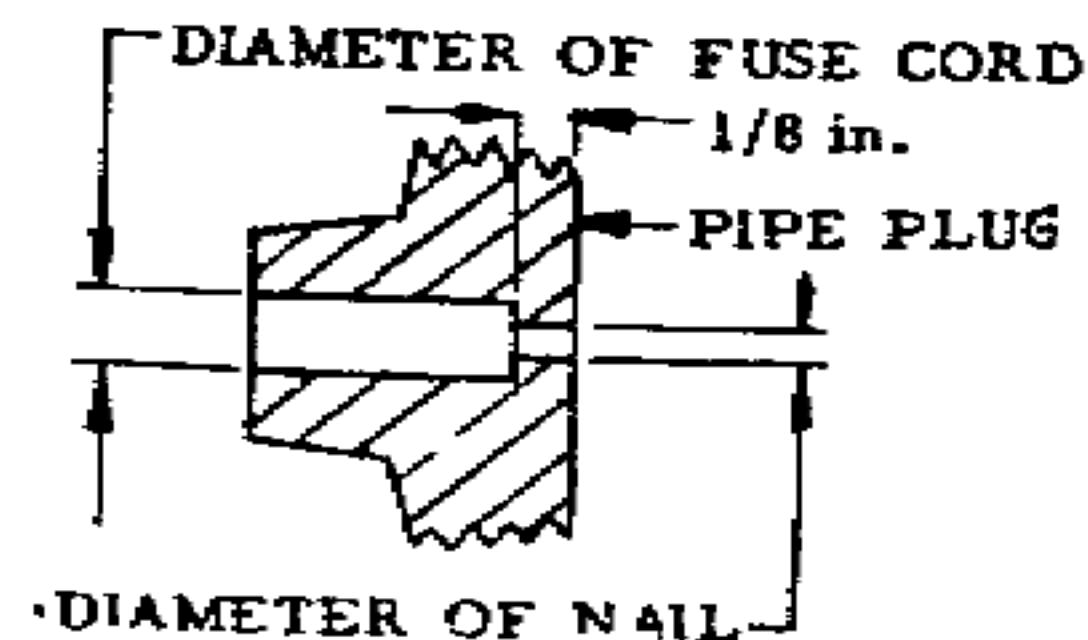

4. Remove the plug from the cap and push the flat head nail through the hole in the cap from the inside.

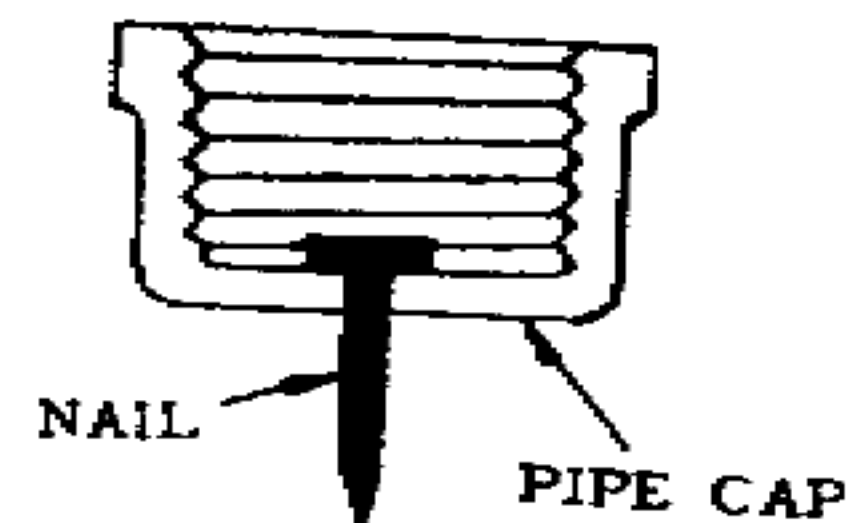

Incendiaries, The Science of Using Fire as a Weapon

5. Cut the striking tips from app. 10 striking matches. Place match tips inside pipe cap and screw plug in finger tight.

How To Use

1. Slide the fuse cord into the hole in the pipe plug.

2. Tape igniter to fuse cord.

3. Tap point of nail on a hard surface to ignite the fuse.

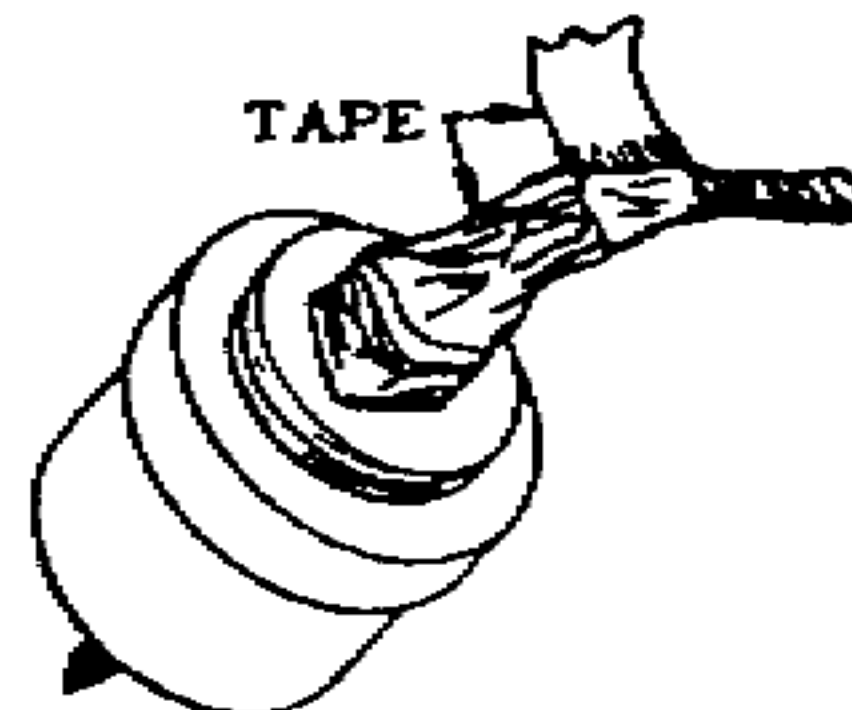
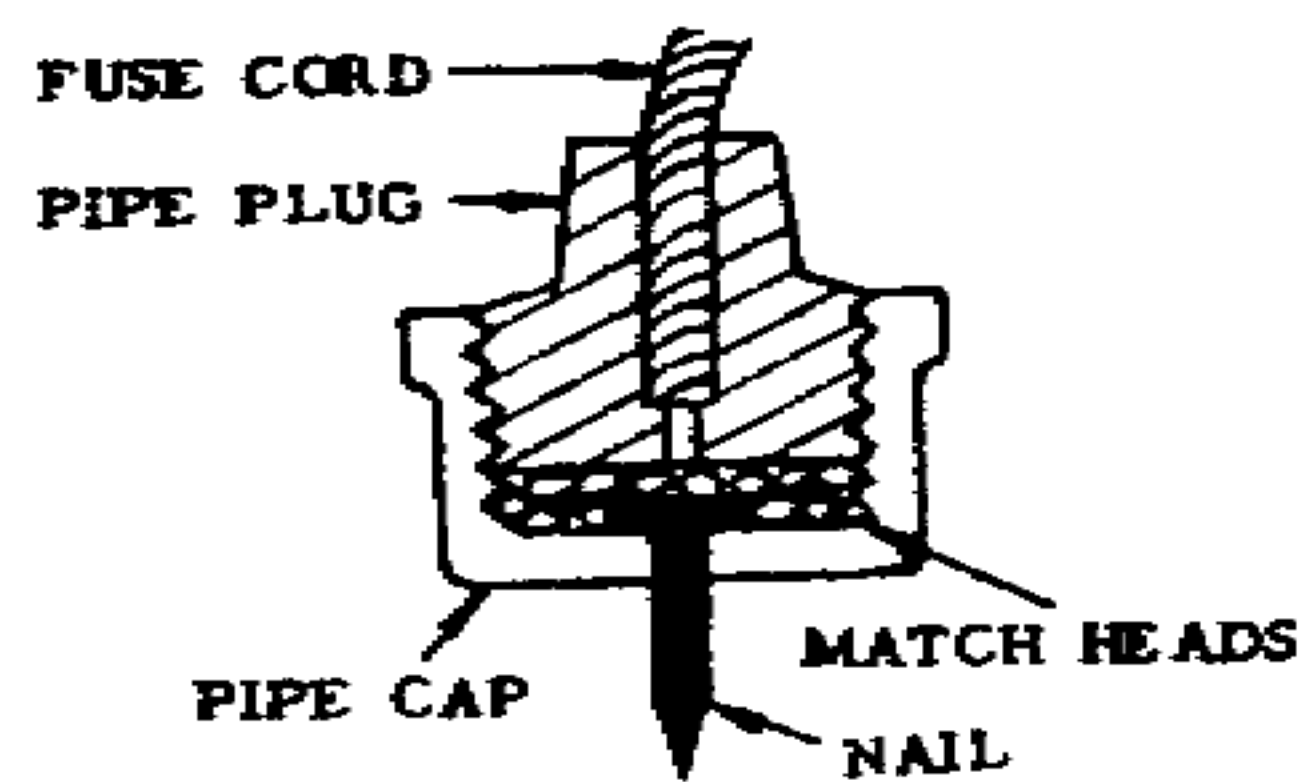

Incendiaries, The Science of Using Fire as a Weapon

Dried Seed Timer

A time delay device for electrical firing circuits can be made using the principle of expansion of dried seeds.

Material Required

Dried peas, beans, or other dehydrated seeds
Wide mouth glass jar with non-metal cap
Two screws or bolts
Thin metal plate
Hand drill
Screwdriver

Procedure

1. Determine the rate of rise of the dried beans selected. This is necessary to determine delay time of the timer.
 - a. Place a sample of the dried seeds in the jar and cover with water.
 - b. Measure the time it takes for the seeds to rise a given height. Most dried seeds increase 50% in one to two hours.
2. Cut a disc from thin metal plate. Disc should fit loosely inside the jar.

NOTE: If metal is painted, rusty, or otherwise coated, it must be scraped or sanded to obtain a clean metal surface.

3. Drill two holes in the cap of the jar about 2" apart. Diameter of holes should be such that screw or bolts will thread tightly into them. If the jar has a metal cap or no cap, a piece of wood or plastic (NOT METAL) can be used as a cover.

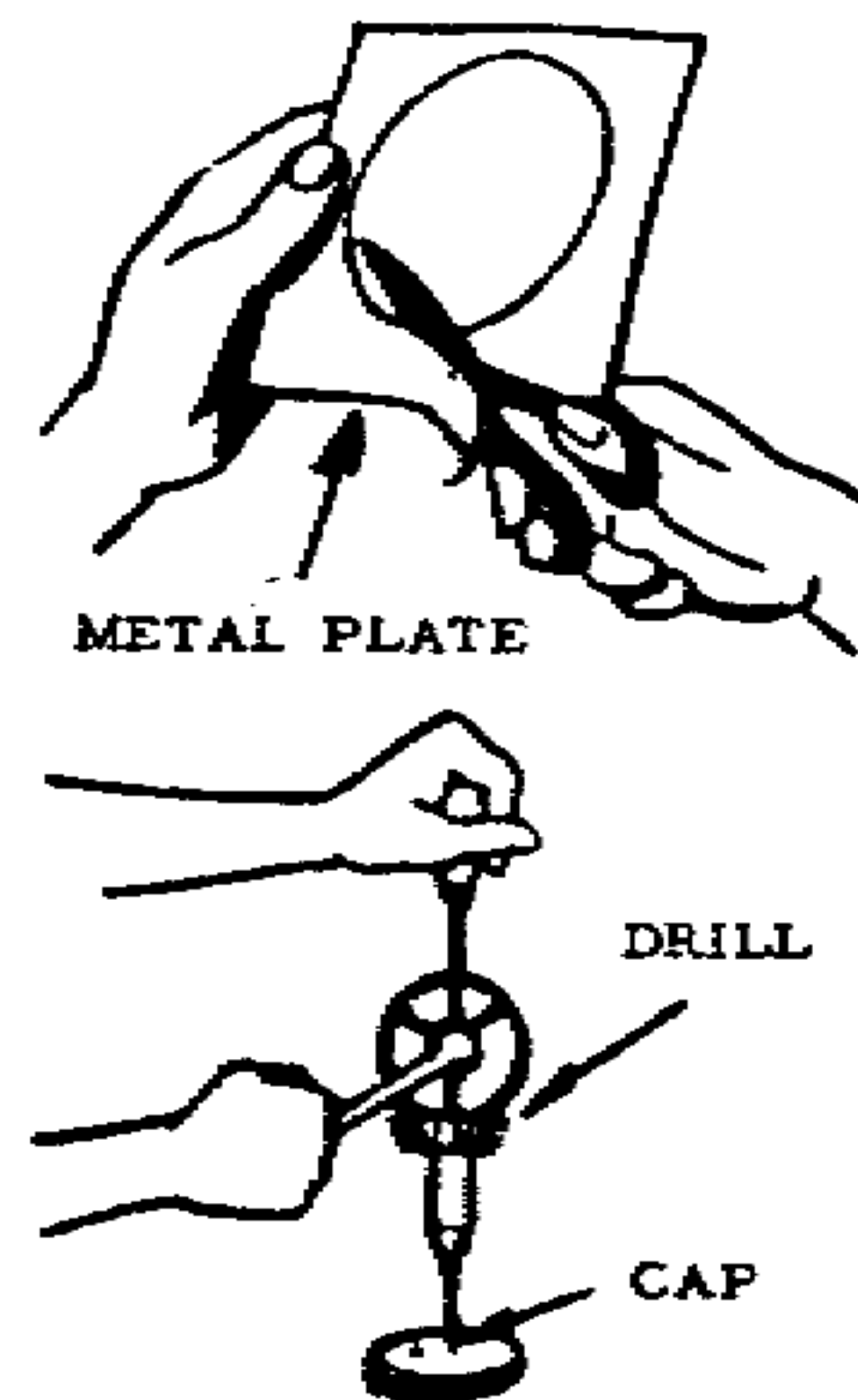
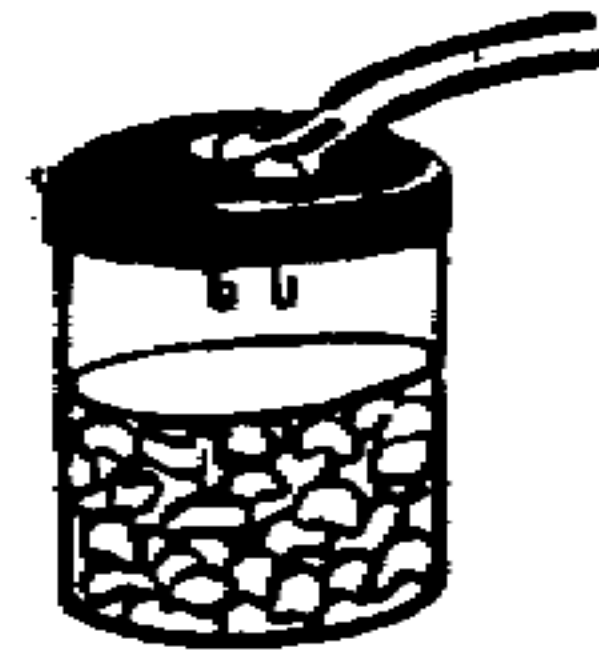

Incendiaries, The Science of Using Fire as a Weapon

4. Turn the two screws or bolts through the holes in the cap. Bolts should extend about 1" into the jar.

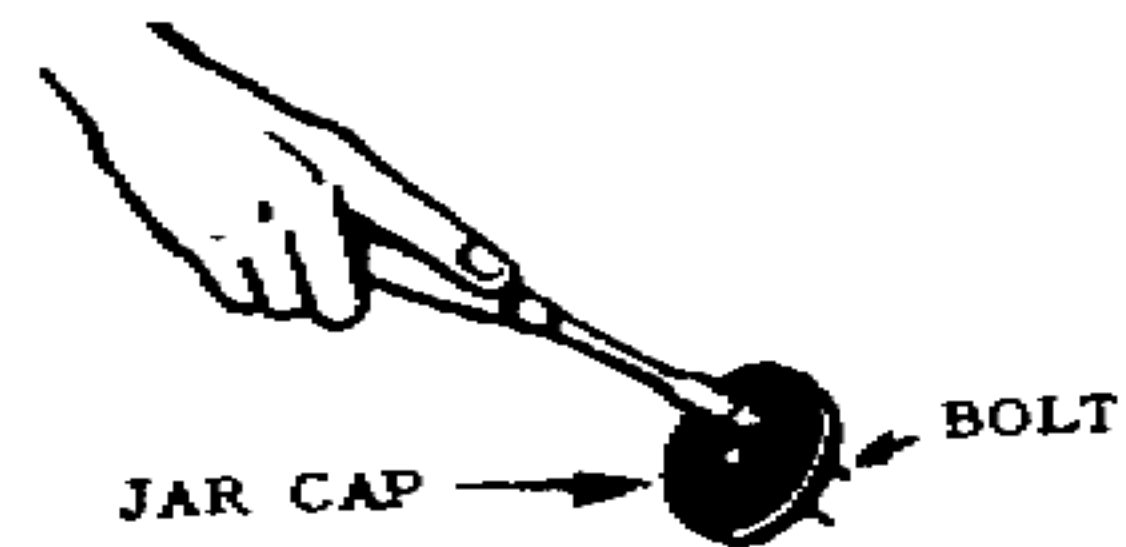

IMPORTANT: Both bolts must extend the same distance below the container cover.

5. Pour dried seeds into the container. The level will depend upon the previously measured rise time and the desired delay.

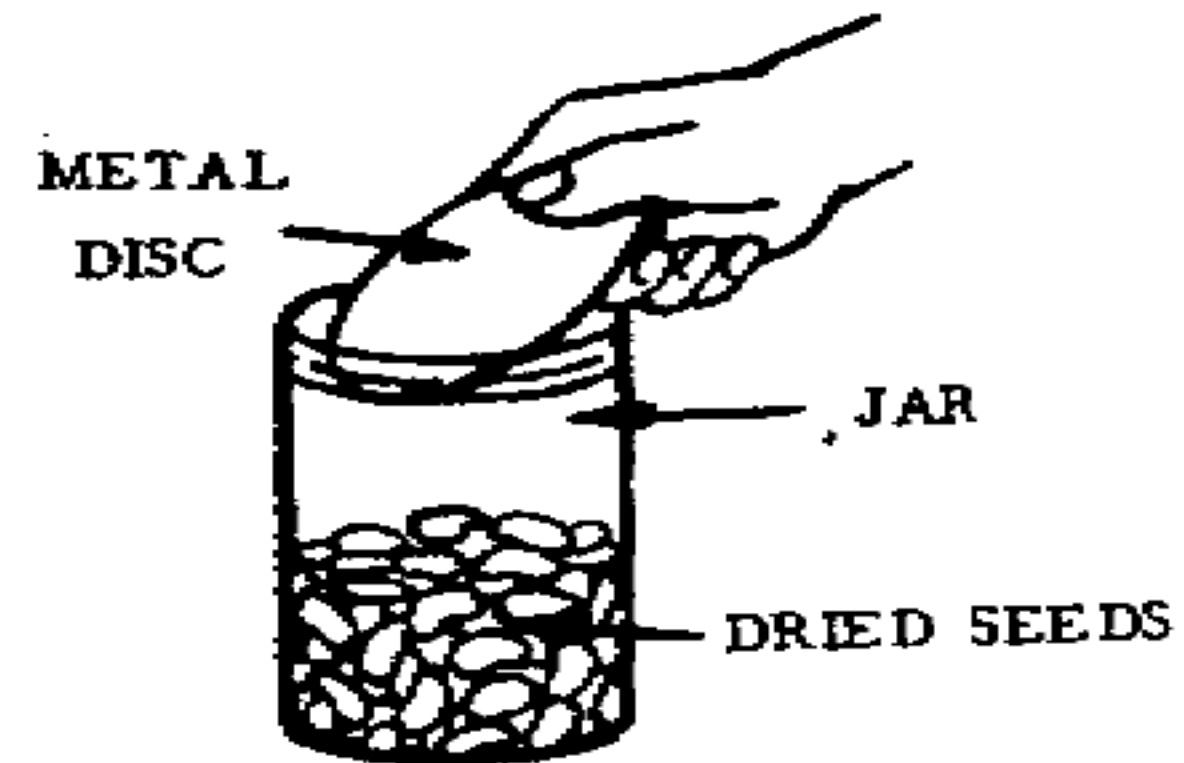

6. Place the metal disc in the jar on top of the seeds.

How to Use

1. Add just enough water to completely cover the seeds and place the cap on the jar.

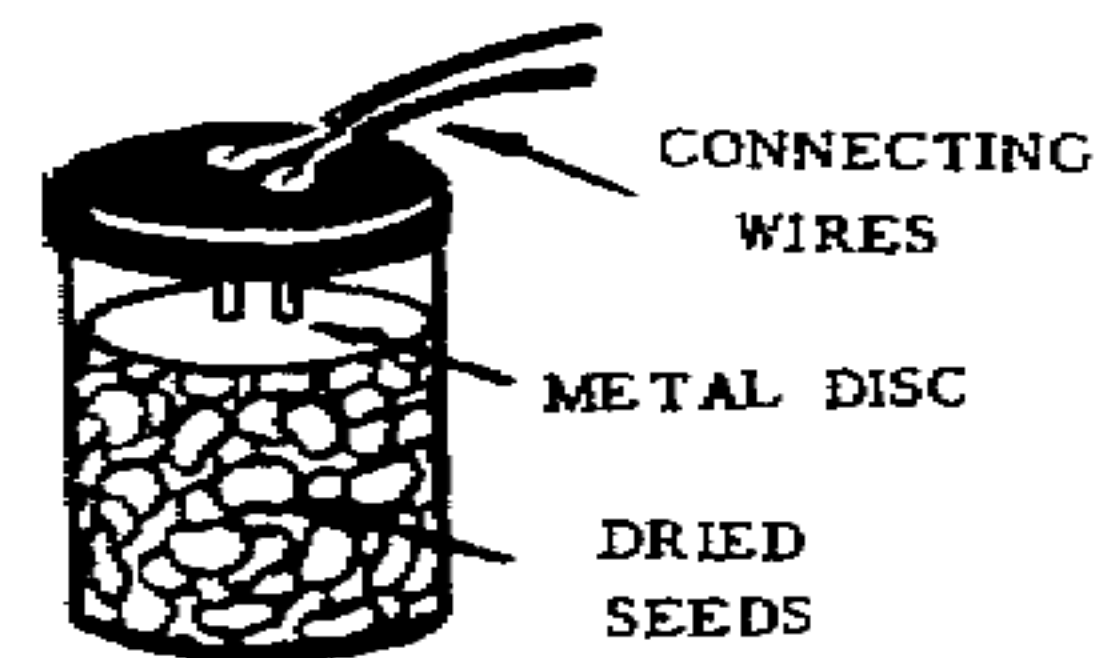

2. Attach connecting wires from the firing circuit to the two screws on the cap.

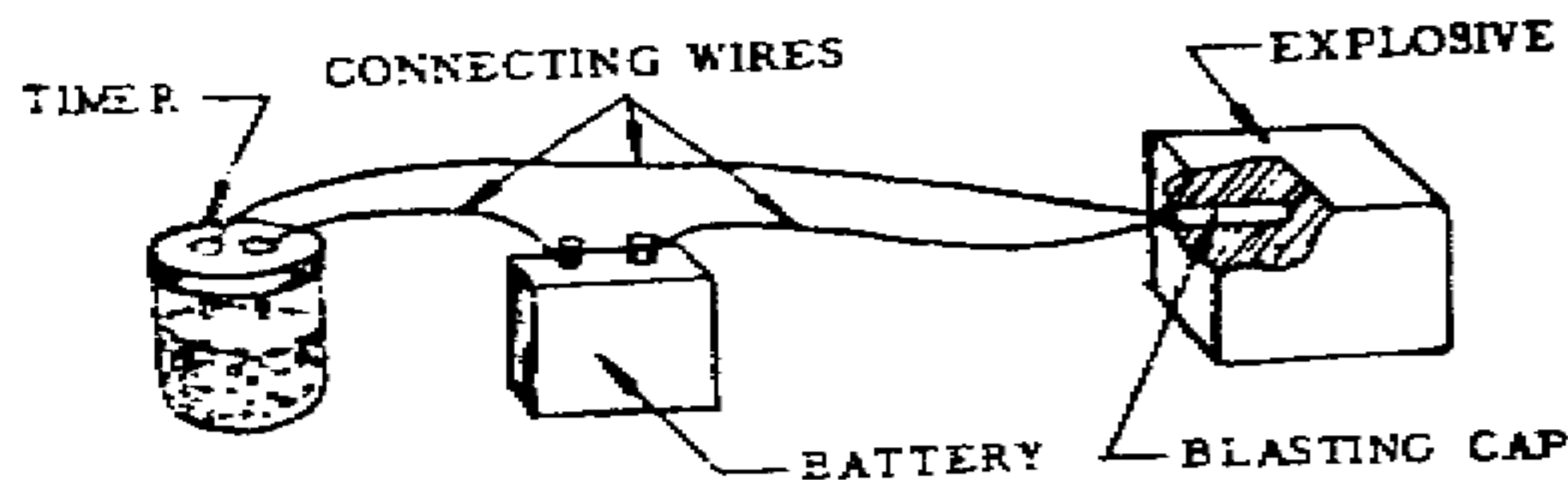

Expansion of the seeds will raise the metal disc until it contacts the screws and closes the circuit. This can also be used to bring incendiary chemical combinations into contact with each other.

Incendiaries, The Science of Using Fire as a Weapon

Fuse Cords

These fuse cords are used for igniting propellants and incendiaries or, with a non-electric blasting cap, to detonate explosives.

FAST BURNING FUSE

The burning rate of this fuse is app. 40" per minute

Material Required

Soft cotton string		(Potassium Nitrate	25 parts
Fine Black Powder	or	(Charcoal	3 parts
Piece of round stick		(Sulfur	
Two pans or dishes			

Procedure

1. Moisten fine black powder to form a paste or prepare a substitute as follows:

- a. Dissolve Potassium Nitrate in an equal amount of water.
- b. Pulverize charcoal by spreading thinly on a hard surface and rolling the round stick over it to crush to a fine powder.
- c. Pulverize sulfur in the same manner.
- d. Dry mix Sulfur and Charcoal
- e. Add Potassium Nitrate solution to the dry mix to obtain a thoroughly wet paste

2. Twist or braid three strands of cotton string together.

3. Rub paste mixture into twisted string with fingers and allow to dry.

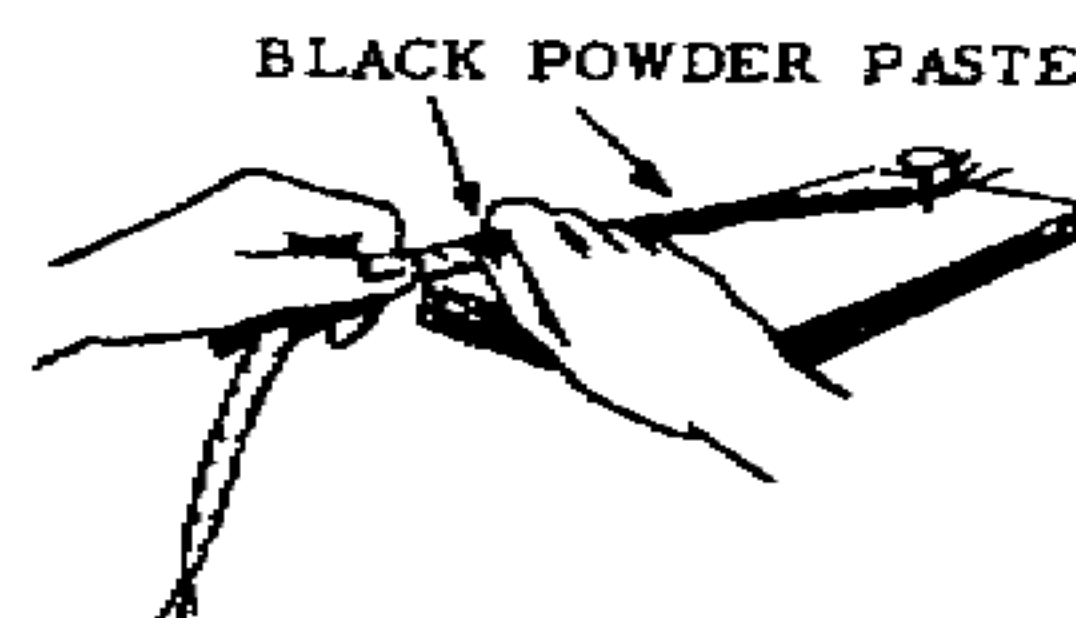
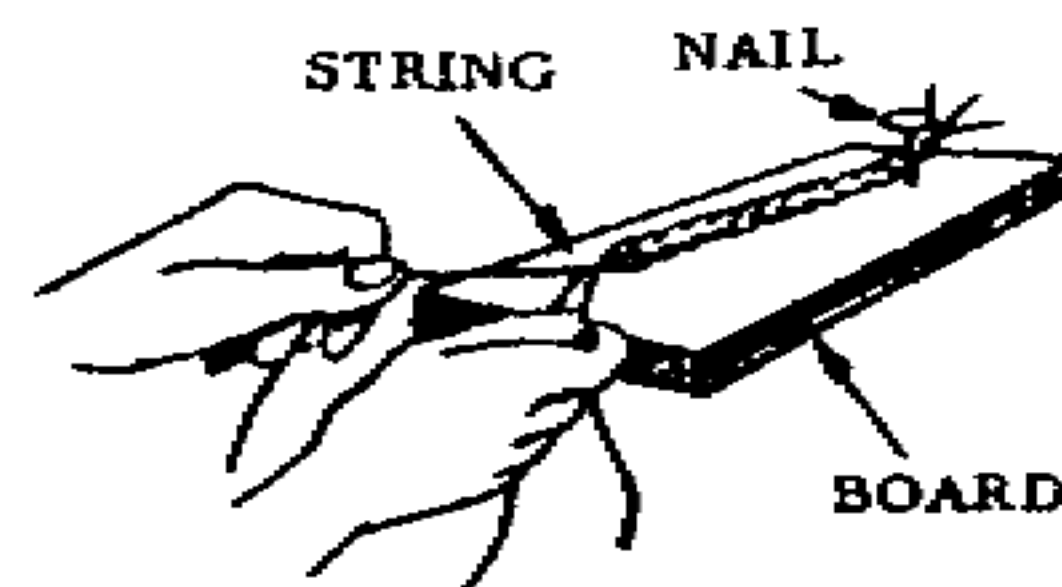

Incendiaries, The Science of Using Fire as a Weapon

4. Check actual burning rate of fuse by measuring the time it takes for a known length to burn. This is used to determine the length needed for a desired delay time. If 5" burns for 6 seconds, 50 inches of fuse cord will be needed to obtain a one minute (60 second) delay time.

SLOW BURNING FUSE

The burning rate of this fuse is app. 2" per minute

Material Required

Cotton string or 3 shoelaces
Potassium Nitrate or Potassium Chlorate
Granulated Sugar

Procedure

1. Wash cotton string or shoelaces in hot soapy water; rinse in fresh water.
2. Dissolve 1 part Potassium Nitrate or Potassium Chlorate and 1 part granulated sugar in 2 parts of hot water.
3. Soak string or shoelaces in solution.
4. Twist or braid three strands of string together and allow to dry.
5. Check actual burning rate of the fuse by measuring the time it takes for a known length to burn. This is used to determine the length needed for the desired delay time. If 2" burns for 1 minute, 10" will be needed to obtain a 5 minute delay.

NOTE: The last few inches of this cord (the end inserted in the material to be ignited) should be coated with the fast burning black powder paste if possible. This **MUST BE DONE** when the fuse is used to ignite a blasting cap.

REMEMBER: The burning rate of either of these fuses can vary greatly. **DO NOT USE** for ignition until you have checked their burning rate.

Incendiaries, The Science of Using Fire as a Weapon

Clothespin Time Delay Switch

A 3-5 minute time delay switch can be made from a clothespin switch and a cigarette. The system can be used for initiation of explosive charges, mines and booby traps.

Material Required

Spring type clothespin

Solid or stranded copper wire about 1/16" in diameter (field or bell wire is suitable)

Fine string, about 6" in length

Cigarette

Knife

Procedure

1. Strip about 4" of insulation from the ends of 2 copper wires. Scrape copper wires with pocket knife until metal is shiny.

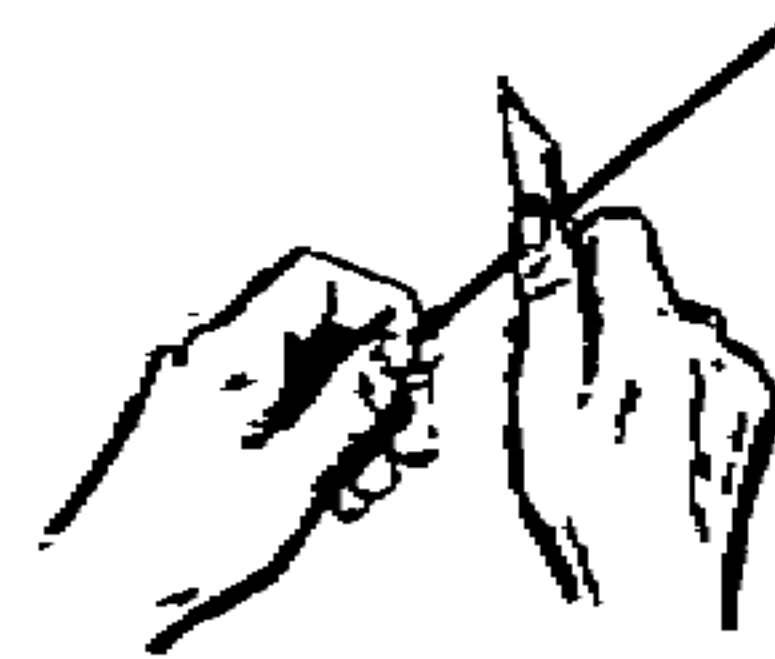

2. Wind one scraped wire tightly on one jaw of the clothespin, and the other wire on the other jaw so that the wires will be in contact with each other when the jaws are closed.

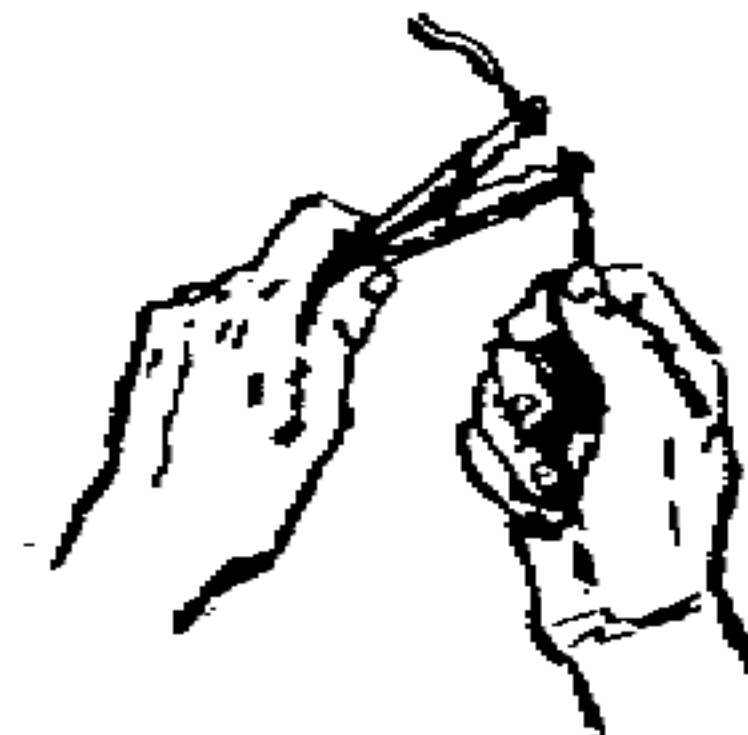

3. Measuring from tip of cigarette, measure a length of cigarette that will correspond to the delay time desired. Make a hole in cigarette at this point, using wire or pin.

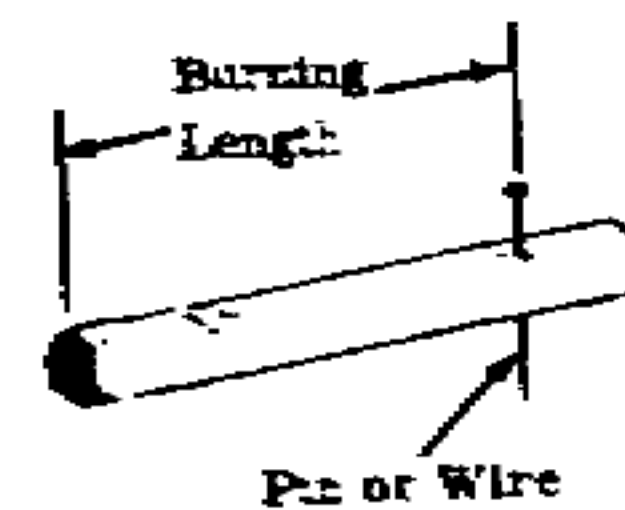

NOTE: Delay time may be adjusted by varying the burning length of the cigarette. Burning rate in still air is app. 7 minutes per inch. Since this rate varies with environment and brand of cigarette it should be tested in each case if accurate delay time is desired.

Incendiaries, The Science of Using Fire as a Weapon

4. Thread string through hole in cigarette.

5. Tie string around rear of clothespin, 1/8" or less from end. The clothespin may be notched to hold string in place.

NOTE: The string must keep the rear end of the clothespin closed so that the jaws stay open and no contact is made between the wires.

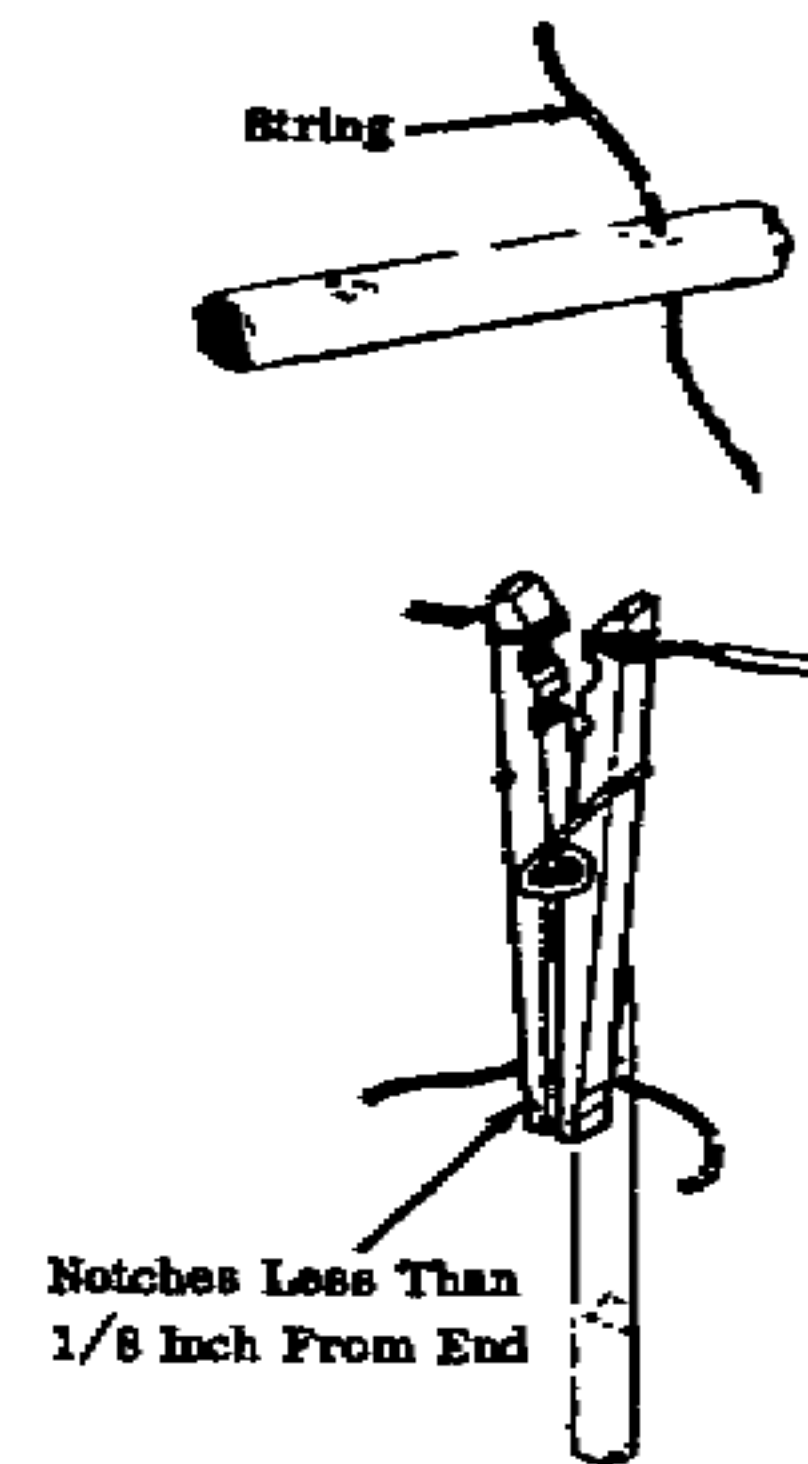

How to Use

Suspend the entire system vertically with the cigarette tip down. Light tip of cigarette. Switch will close and initiation will occur when the cigarette burns up to and through the string.

NOTE: Wires to the firing circuit must not be pulled taut when the switch is mounted. This could prevent the jaws from closing.

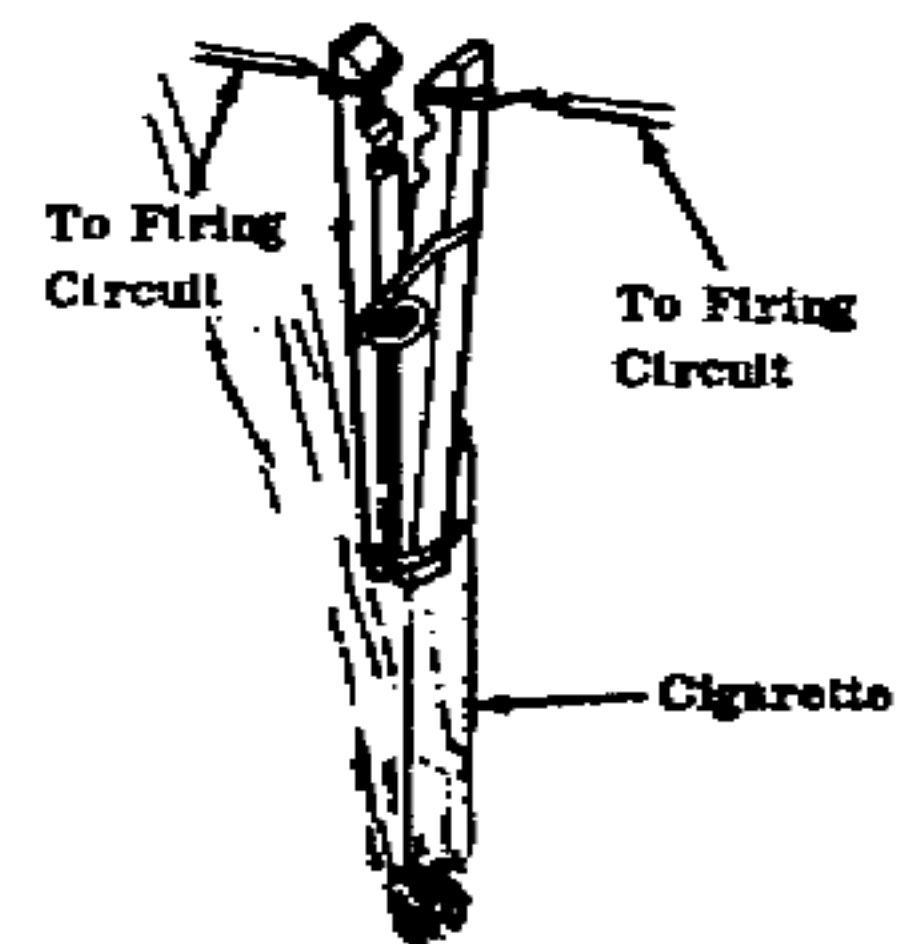

Incendiaries, The Science of Using Fire as a Weapon

Can-Liquid Time Delay

A time delay device for electrical firing circuits can be made using a can and liquid.

Material Required

Can

Liquid (water, gasoline, etc.)

Small block of wood or any material that will float on the liquid

Knife

2 pieces of solid wire, each piece 1 foot or longer

Procedure

1. Make 2 small holes at opposite sides of the can very close to the top.

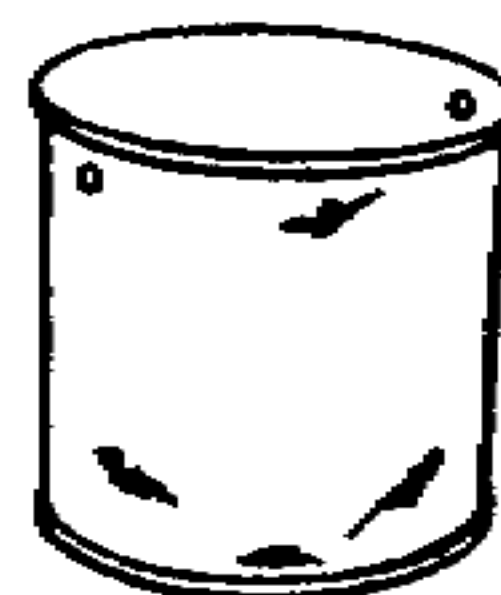

2. Remove insulation from a long piece of wire for a distance a little greater than the diameter of the can.

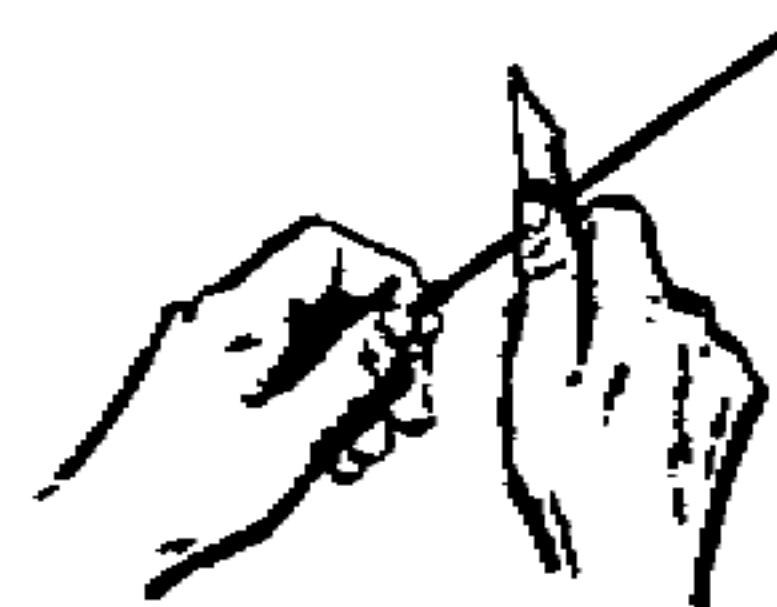

3. Secure the wire in place across the top of the can by threading it through the holes and twisting in place, leaving some slack. Make loop in center of wire. Be sure a long piece of wire extends from the end of the can.



4. Wrap a piece of insulated wire around the block of wood. Scrape insulation from a small section of this wire and bend as shown so that wire contacts loop before wood touches bottom of container. Thread this wire through the loop of bare wire.

Incendiaries, The Science of Using Fire as a Weapon

5. Make a very small pinhole in the side of the container. Fill container with a quantity of liquid corresponding to the desired delay time. Since the rate at which liquid leaves the can depends on weather conditions, liquid used, size of hole, amount of liquid in the container, etc., determine the delay time for each individual case. Delays from a few minutes to many hours are possible. Vary time by adjusting liquid level, type of liquid (water, oil) and hole size.

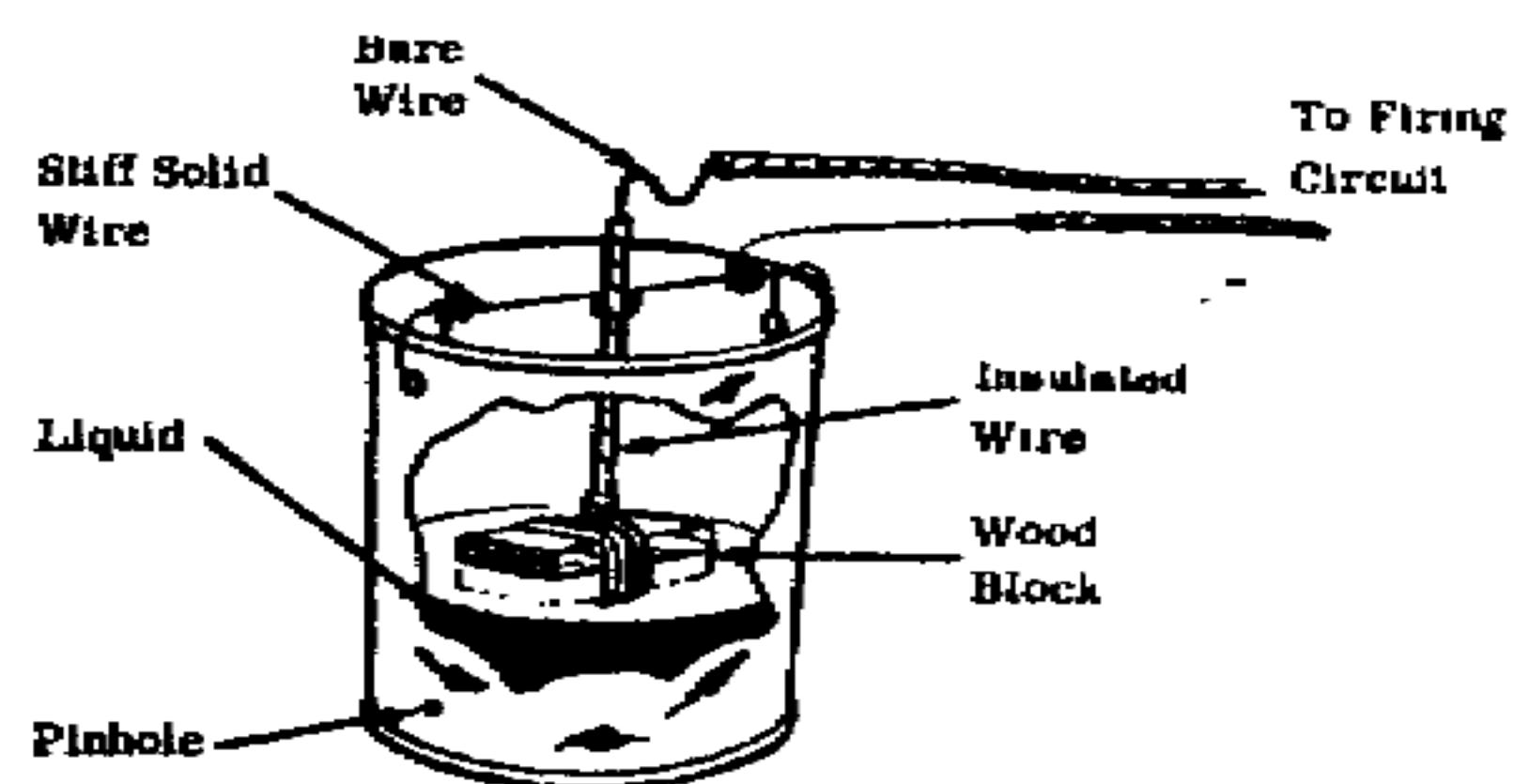

How To Use

1. Fill can with liquid to the same level as during experimental run. Be sure that wooden block floats on liquid and that wire is free to move down as liquid leaves the container.

2. Connect wires to firing circuit.

NOTE: A long term delay can be obtained by placing a volatile liquid (gasoline, ether, etc.) in the can instead of water and relying on evaporation to lower the level. Be sure that the wood will float on the liquid used. **DO NOT MAKE PINHOLE IN SIDE OF CAN.**

Incendiaries, The Science of Using Fire as a Weapon

Time delay initiators are used in grenades, bombs used against bunkers, aircraft ejection systems, missile separation and so on. Black powder fuse cord has been used for centuries to provide a reliable delay. Once lit, it can be depended on to continue to burn at predicted rates because of the presence of hot solid by products (its hard to put out the fuse). Operating conditions in the high atmosphere, under water, or in other difficult conditions brought about new fuse delay formulations. These include -

			<u>Burn time s/cm</u>
Manganese delay	Mn	29%	.8-5.4
	PbCrO4	26%	
	BaCrO4	45%	
"T-10"	B	3-15%	.23-.32
	BaCrO4	97-85%	
Zirconium-Nickel	Ni-Zr	26%	.8 for 70%Zr-30%Ni
	BaCrO4	60%	4.6 for 70%Ni-30%Zr
	KClO4	14%	
	CeO2	up to 10%	
Tungsten-Viton	W	30%	.8-6.2
	BaCrO4	55%	
	KClO4	10%	
	Fullers Earth	4%	
	Viton	1%	
Tungsten delay	W	30%	.04-16 / up to 24 with CaF2
	BaCrO4	55%	
	KClO4	10%	
	Fullers Earth	5%	

Mn	=	Manganese
PbCrO4	=	Lead Chromate (Yellow chrome)
BaCrO4	=	Barium Chromate (Lemon chrome)
B	=	Boron
Ni	=	Nickel
Zr	=	Zirconium
KClO4	=	Potassium Chlorate
CeO2	=	Cerium Dioxide
W	=	Tungsten
Fullers Earth	=	Diatomaceous earth

Incendiaries, The Science of Using Fire as a Weapon

7) Electrical, mechanical, and laser light related ignition

Methods of igniting incendiary ordnance or igniting target combustibles includes a variety of electrical, mechanical, and laser based means.

Fires may be initiated using electricity in a number of ways. The most common method of commercially producing fires using electric current are -

1. Spark plugs in which a current is passed through a wire and is made to arc across metal elements in order to complete its circuit. Although this principle has been the cause of many accidental household and industrial fires, it is used to reliably ignite gasoline mixtures in car and other engine type cylinders. A portion of a fluid is converted to vapor within its flammable limits in air. The electric current is then fired at the right time to ignite the mixture, an electric arc generates heat, and the fuel then ignites from this heat and burns the fuel air mixture. Many improvised methods of igniting vapors can be created using plug wire, spark plugs and any electrical source such as a house plug in, auto current, or any portable battery. All that is needed is a combustible liquid with a flash point below room temperature to act as the fuel, air, and a combustible target that will catch fire from the initial combustion. Electric arcs backed up by household current can reach 7,000 F easily for the duration of its arc. This is sufficient to pyrolyze any combustible solid and melt many metals.

2. Passing a current through a conducting element like copper or aluminum metal will increase the metals heat sufficiently to pyrolyze solids and ignite combustibles. The hot plate and stove elements, household electric heater elements, soldering iron elements and anything else commercially produced to conduct heat from electricity can be converted to portable ignition and incendiary use. Passing current into a light bulb causes it to heat rapidly and pyrolyze combustibles like paper and textiles eventually igniting them. [Arsonists favorite use of laying a lamp on its side with the bulb in contact with combustibles like cotton lintens or cooking grease which pyrolyze easily]. Incandescent lamps generate a great deal of heat. The filaments of bulbs generally reach 2,900 C at 100+ watts rating. The outside of the bulb reaches 250-570 C with increases corresponding to wattage size.

Incendiaries, The Science of Using Fire as a Weapon

The temperature depends on the orientation of the bulb and its surface location. This chart provides a comparison for a 100 W and 500 W bulb.

Temp = F with (C)

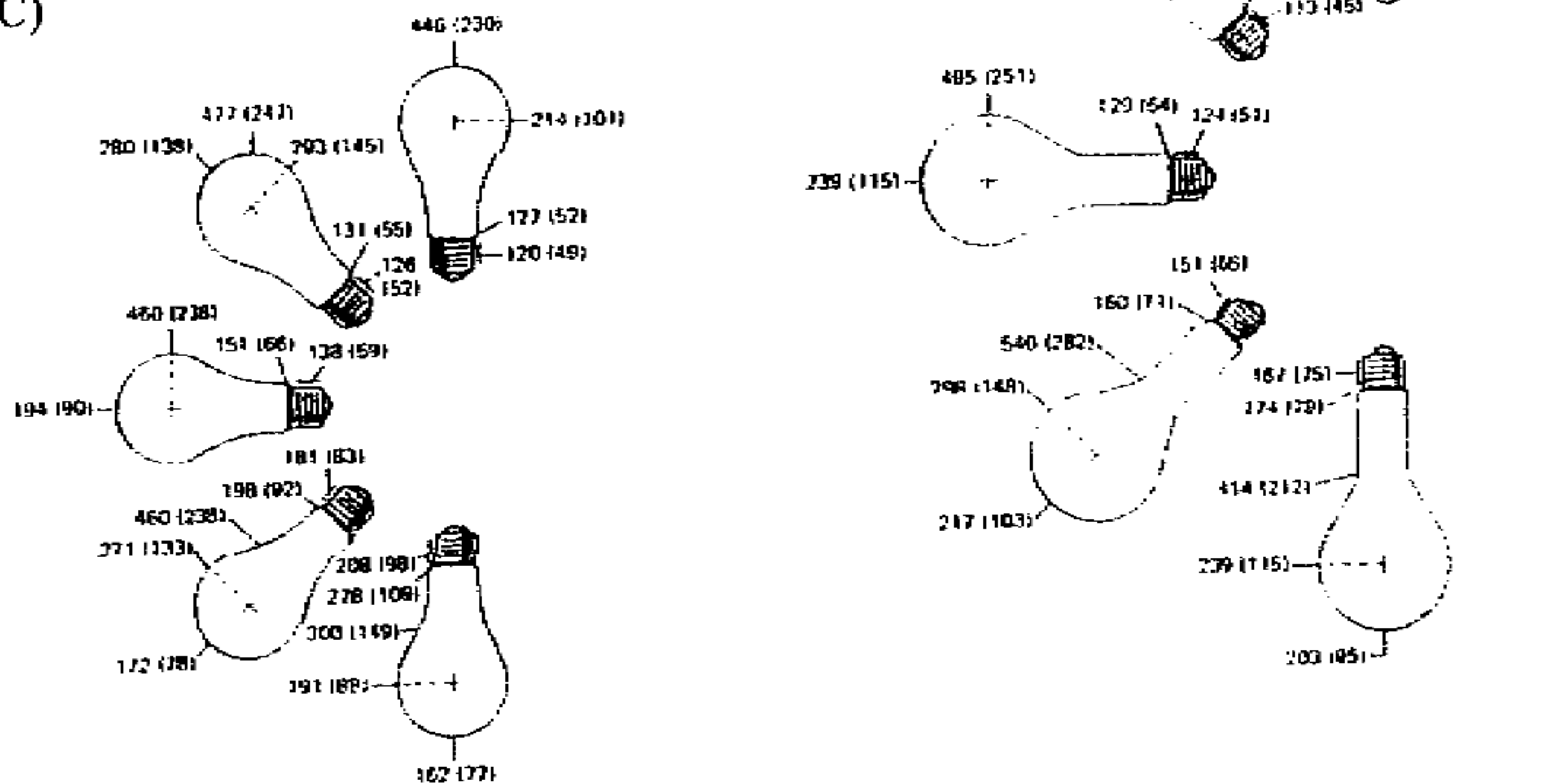

3. Other household appliances that generate heat from current include irons, heating pads, water heaters, coffee machines, etc. Many everyday items may be converted to incendiary munitions on short notice. Welding and cutting equipment are designed to produce high heat and generate sustained fires. They can be used to create glowing metals that can be delivered as incendiary ordnance as can sparking tools like the grinder wheels already described.

A number of metals have already been described that are used as alloys to generate sparks and ignite other materials by mechanical means. Special formulas are prepared to produce both sparks and ignitable vapors and are generally called first fires. Match heads are treated with a first fire composition and are used to ignite the wood they are applied to. Black powder is another first fire because its hot solids communicate flame and heat to its surroundings. Other first fire compositions include -

Incendiaries, The Science of Using Fire as a Weapon

	<u>1</u>	<u>2</u>	<u>3</u>	<u>4</u>	<u>5</u>	<u>6</u>
Aluminum						13
Boron				10		
Charcoal						4
Magnesium					25	
Silicon	20	25				26
Titanium		25				
Zirconium			20			
Zirconium Hydride	15					
Barium Nitrate	50			90	75	
Iron oxide		50				22
Lead oxide			80			35
Tetranitracarbazole	5					
Laminac Binder	5					

These mixtures are usually ignited by some sort of striking or friction mechanism which is common to match lighter boxes. Other mechanical systems include delay devices that create friction or other striking motions. These are actuated by cartridges or pressure (from gas) and use the acronyms CAD/PAD. Sound can also be used to focus and generate a high temperature ignition source.

Lasers and masers are newer methods of communicating heat by creating a beam of concentrated light or electromagnetic radiation. The maser, invented in the early 1950's is an acronym for "Microwave Amplification by Stimulated Emission of Radiation". The basic science behind this is that when atoms of different chemicals is irradiated, it goes from one energy level to another. It normally emits this radiation at random as heat in all directions. The maser or laser device causes these atoms to all emit their energy together at one time in one concentrated direction. The devices that have been built to make chemicals behave this way are complex and cannot be improvised. Lasers that generate heat sufficient for use as incendiary weapons are readily available from their civilian uses. At the time of this writing, the military has developed "star wars" lasers that have effective ranges of up to 200 miles that are capable of cutting through metals of missile fuel tanks and destroying them on the launching pads through unclouded atmospheres.

Lasers are made by amplifying light signals since these are forms of electromagnetic radiation as well. Their wavelength was much shorter than the forms used in masers and required the use of ruby crystals to emit the light in pulses. This was soon followed by gas lasers capable of emitting a continuous beam. Laser light is made into a coherent beam (this means that the waves are all in step). This allows a great concentration of heat energy. It is also light that is beamed at a single wavelength instead of a mix of wavelengths, and it can be focused into a very narrow pencil thin beam that does not spread until it passes over great distances. A single beam may be only a foot wide by the time it reaches a distant object like the moon.

Incendiaries, The Science of Using Fire as a Weapon

All these characteristics have allowed lasers to be developed that can concentrate energy of up to a million watts per square centimeter. This makes it useful in welding and cutting metals. It also makes it useful for setting combustible targets on fire. YAG (Yttrium-Aluminum-Garnet) and CO₂ (Carbon Dioxide) lasers are commercially available for short range cutting and welding applications. These are capable of emitting pulses lasting a hundred millionth of a second that can pierce the sides of fuel storage tanks. A 500 watt CO₂ laser can cut 1mm steel sheet at a rate of 10cm per second.

The gas jet formed by lasers cuts and welds metals. This makes them a candidate as an anti armor weapon at short range.

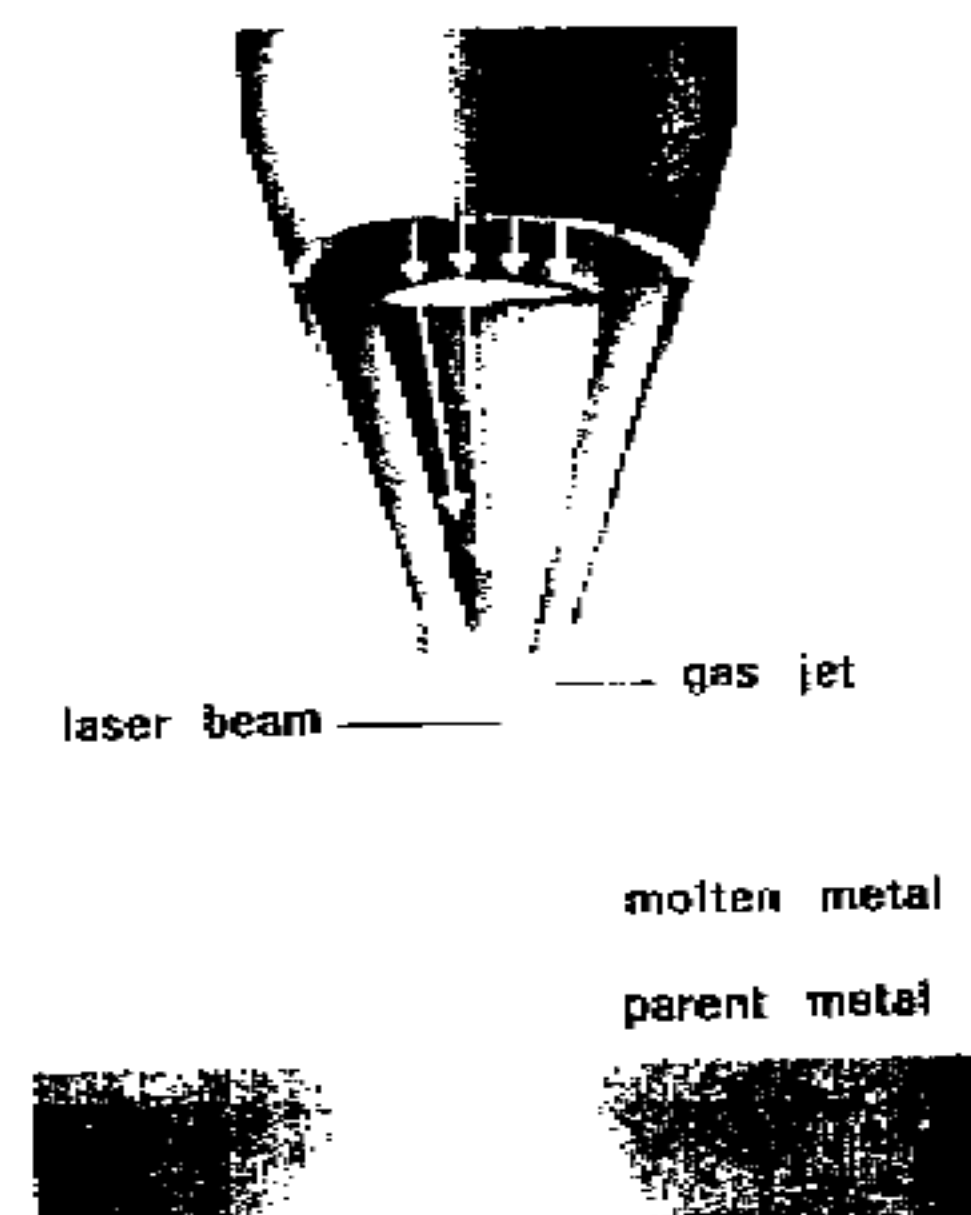

Although death rays have not yet been produced that are effective battlefield weapons, many of them are excellent as commando weapons for destroying fuel supplies and igniting other stored combustible liquids and many solids. They are also used in low power application as targeting aids in many small arms and most large military direct fire weapons.

Other commercial uses of lasers include reading the computer CD's and music CD's, reading the bar codes in supermarkets, and a variety of medical surgery's.

8) Booby Trap and Delay Devices

Booby traps, mines and positioned weapons are a class of weapons that are used to fight a superior enemy without having to be personally present or to defend or inhibit free movement over selected territory. The advantages of these types of weapons are -

1. They are cheap to build
2. They are easy to train troops to construct and set
3. Your troops don't have to be present and get shot at while the enemy is attacking

Incendiaries, The Science of Using Fire as a Weapon

The rear section of the grenade or shell contains 5 grams of a suitable incendiary like zirconium as well as 7.5 grams of an explosive charge behind it (#14 and 15). Behind that, another 7.5 gram explosive charge (#16). The preferred explosive charges are -

30%	Aluminum Powder
66%	RDX/Cyclonite
4%	Binder or plasticizer

The projectile body tip (#12) is surrounded by a hood (#21). A forward incendiary charge is located at in a hollow cylinder (#22). A base fuse (#16) ignites the explosive chain.

The forward incendiary ignites and softens the metal armor. The body tip strikes the soften armor and the impact shock sets off the fuse which detonates the explosive propelling the penetrator and its incendiary package through the armor and into the interior of the armoured structure.

3) Hand Thrown Incendiaries

Most of the hand thrown incendiaries are of the improvised molotov cocktail variety (1) or are professionally manufactured grenades (2) which usually contain self igniting air reactive materials like white phosphorus.

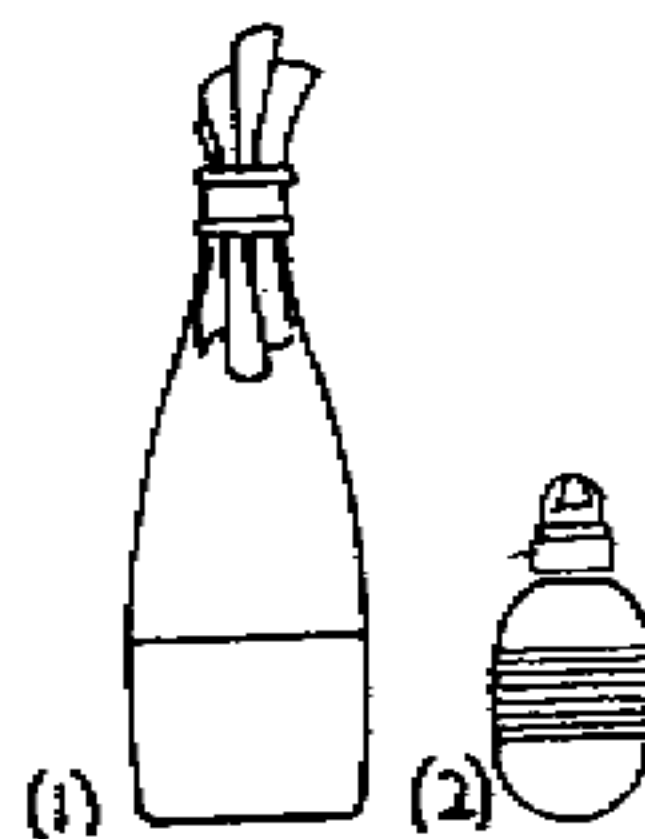

Field Improvised Hand propelled Incendiaries developed by the US Army include -

Incendiaries, The Science of Using Fire as a Weapon

Chemical Fire Bottle

This incendiary bottle is self igniting on target impact

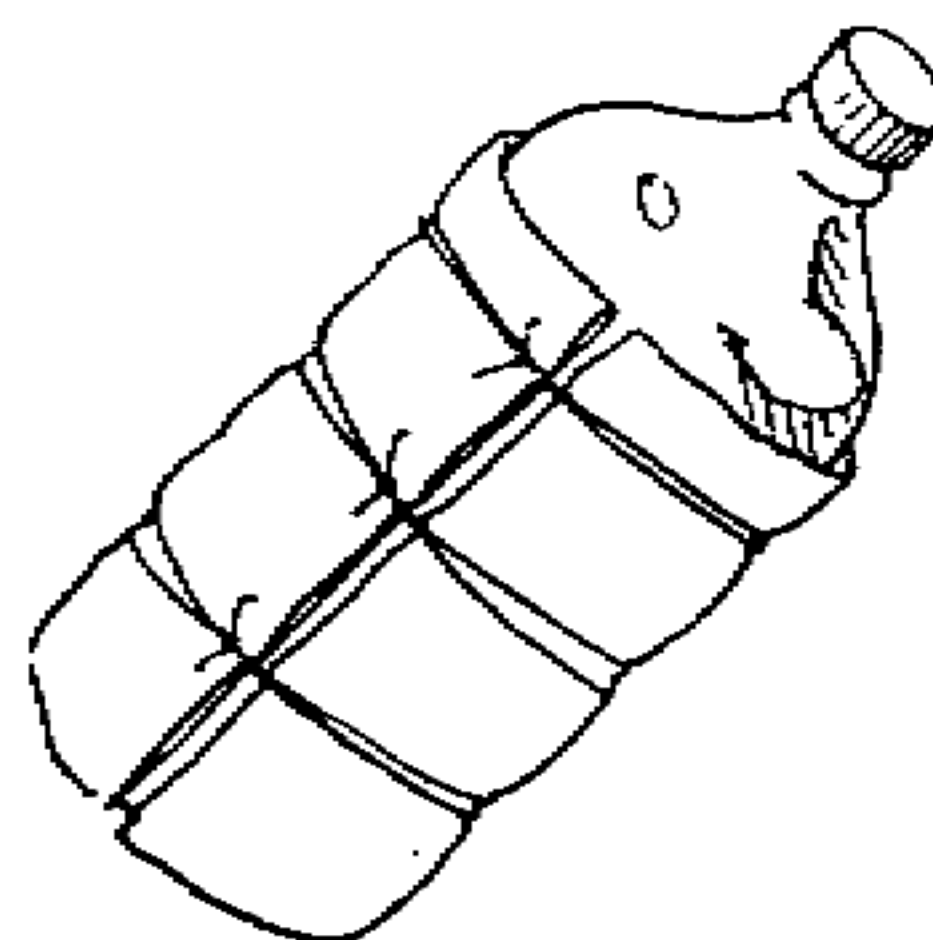

Materials Required

Sulfuric Acid

Gasoline

Potassium Chlorate

Sugar

Glass Bottle with stopper (1 quart)

Small bottle or jar with lid

Rag or absorbent paper such as paper towels or newspaper

String or rubber bands

Procedure

1. Sulfuric Acid must be concentrated. If battery acid or other dilute acid is used, concentrate it by boiling until dense white fumes are given off. Container used should be of enamel ware or oven glass.
2. Remove the acid from heat and allow to cool at room temperature.
3. Pour gasoline into the large (1 quart) bottle until it is app. 2/3 full.
4. Add concentrated sulfuric acid to gasoline slowly until the bottle is filled to within 1" to 2" from top. Place the stopper on the bottle.
5. Wash the outside of the bottle thoroughly with clear water.

Caution: If this is not done the bottle may be dangerous to handle.

6. Wrap a clean cloth or several sheets of absorbent paper around the outside of the bottle. Tie with string or fasten with rubber bands.

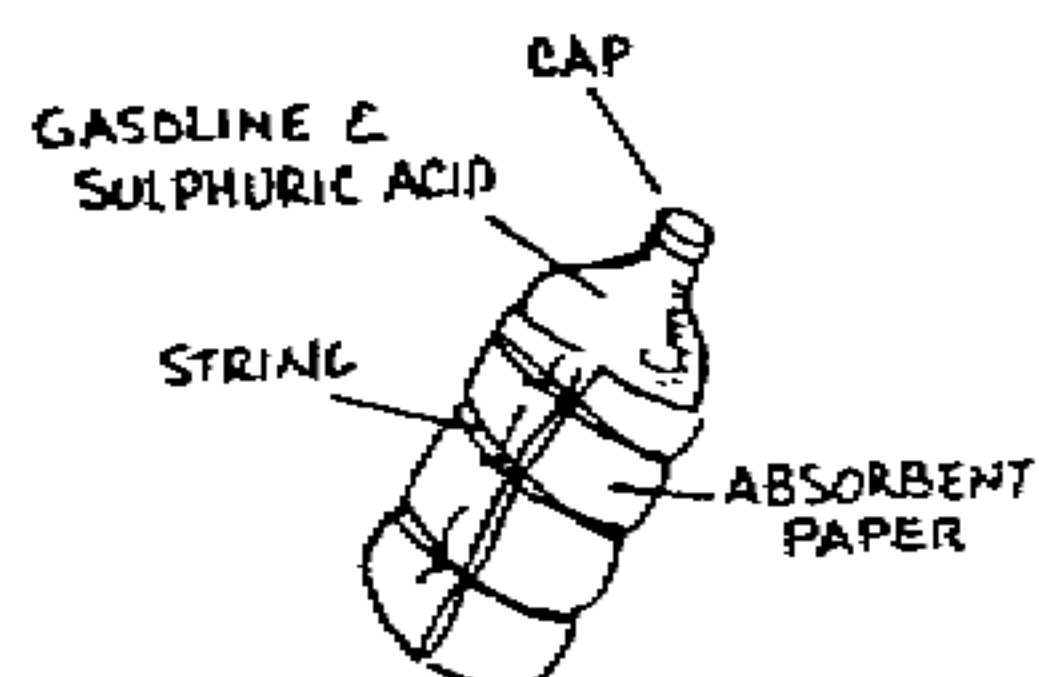

Incendiaries, The Science of Using Fire as a Weapon

7. Dissolve 1/2 cup of potassium chlorate and 1/2 cup of sugar in one cup of boiling water.

8. Allow the solution to cool, pour into the small bottle and cap tightly. The cooled solution should be 2/3 crystals and 1/3 liquid. If there is more liquid than this, pour off excess before using.

Caution: Store this bottle separately from the large bottle.

How to use

1. Shake the small bottle to mix contents and pour onto the cloth or paper around the large bottle.

Bottle can be used wet or after solution has dried. However, when dry, the sugar-potassium chlorate mixture is very sensitive to spark or flame.

2. Throw or launch the bottle. When the bottle breaks against a hard surface (target) the fuel will ignite.



Incendiaries, The Science of Using Fire as a Weapon

Igniter from book matches

This is a high temperature igniter made from paper book matches for use with Molotov cocktail and other incendiaries.

Materials Required

Paper book matches
Adhesive or friction tape

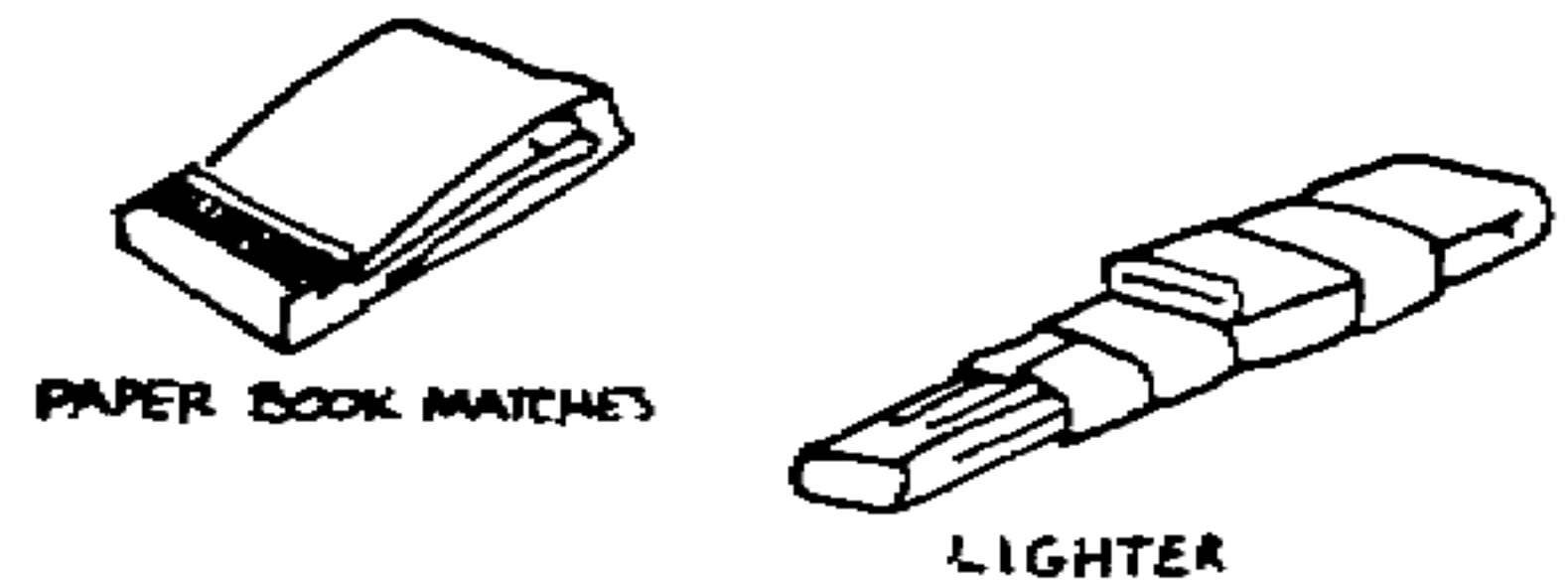

Procedure

1. Remove the staples from match book and separate matches from cover.

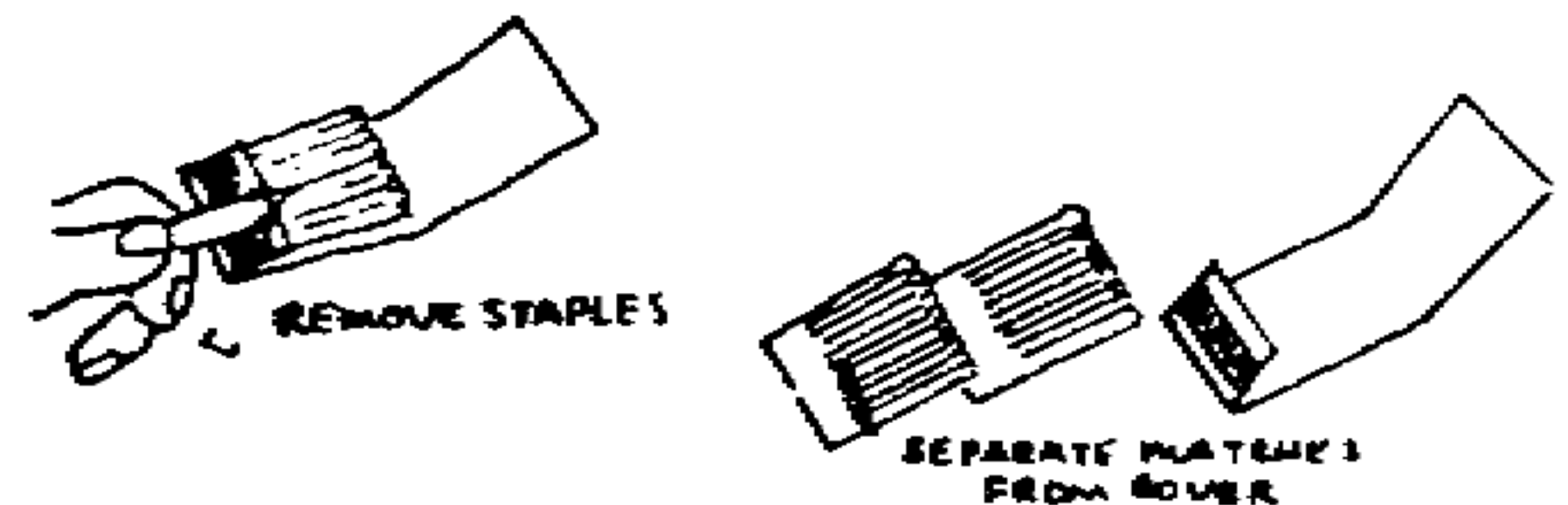

2. Fold and tape one row of matches.

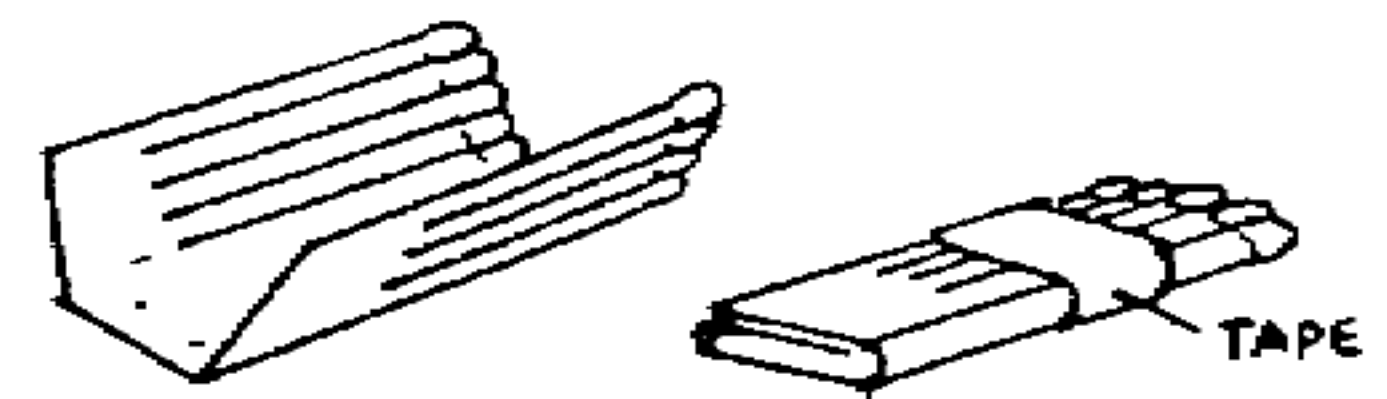

3. Shape the cover into a tube with striking surface on the inside and tape. Make sure the folded cover will fit tightly around the taped match heads. Leave cover open at opposite end for insertion of the matches.

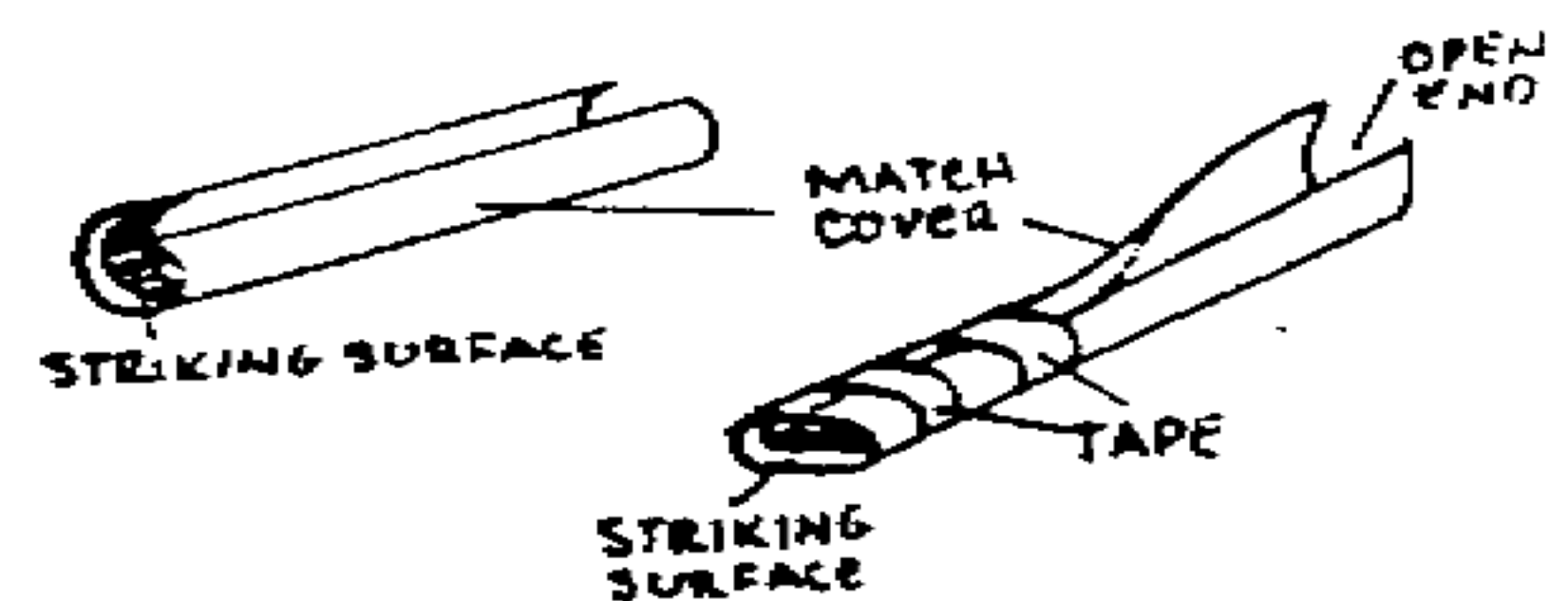

4. Push the taped matches into the tube until the bottom ends are exposed about 3/4".

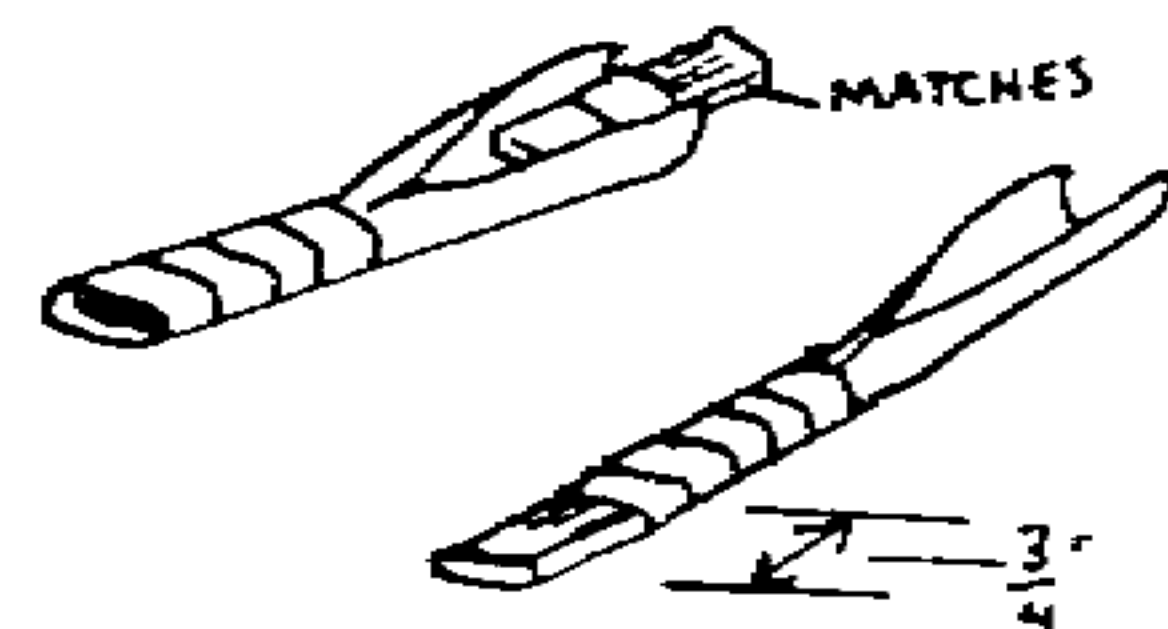

5. Flatten and fold the open end of the tube so that it laps over about 1" and tape in place.

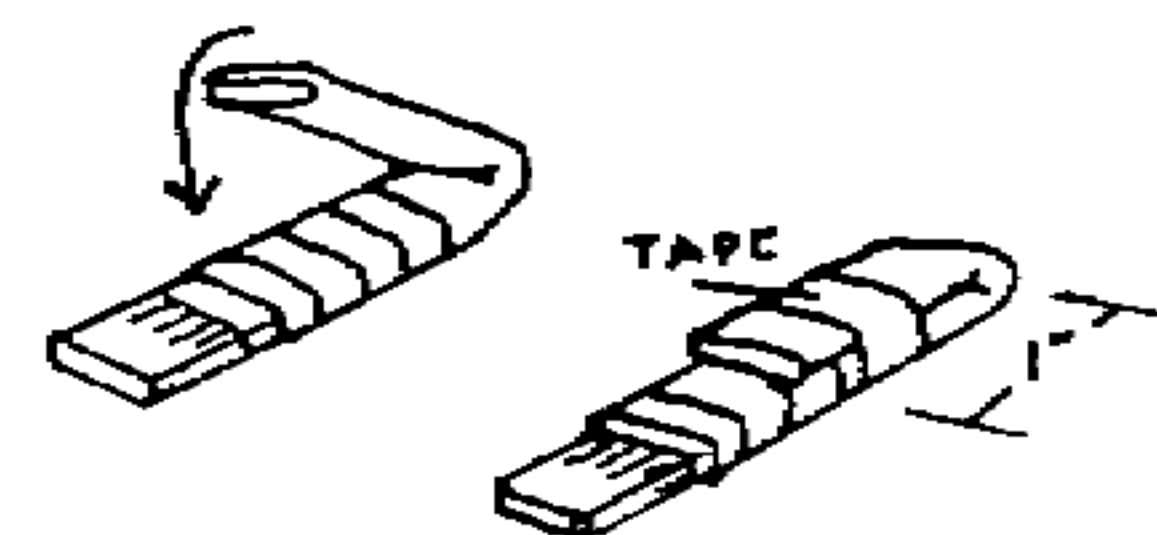

Incendiaries, The Science of Using Fire as a Weapon

Use with Molotov Cocktail

Tape the "match and tab" of the igniter to the neck of the molotov cocktail.

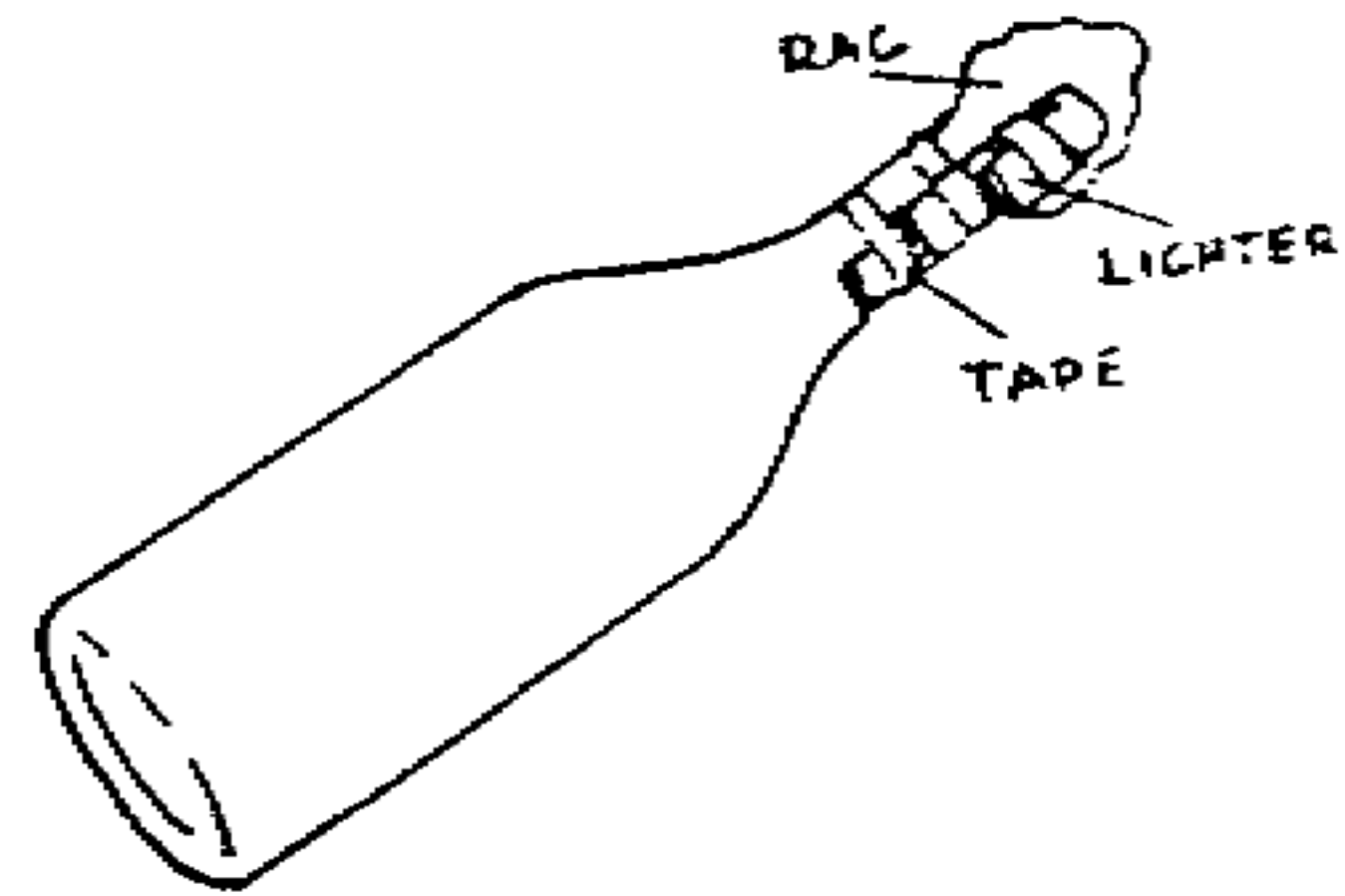

Grasp the "cover and tab" and pull sharply or quickly to ignite.

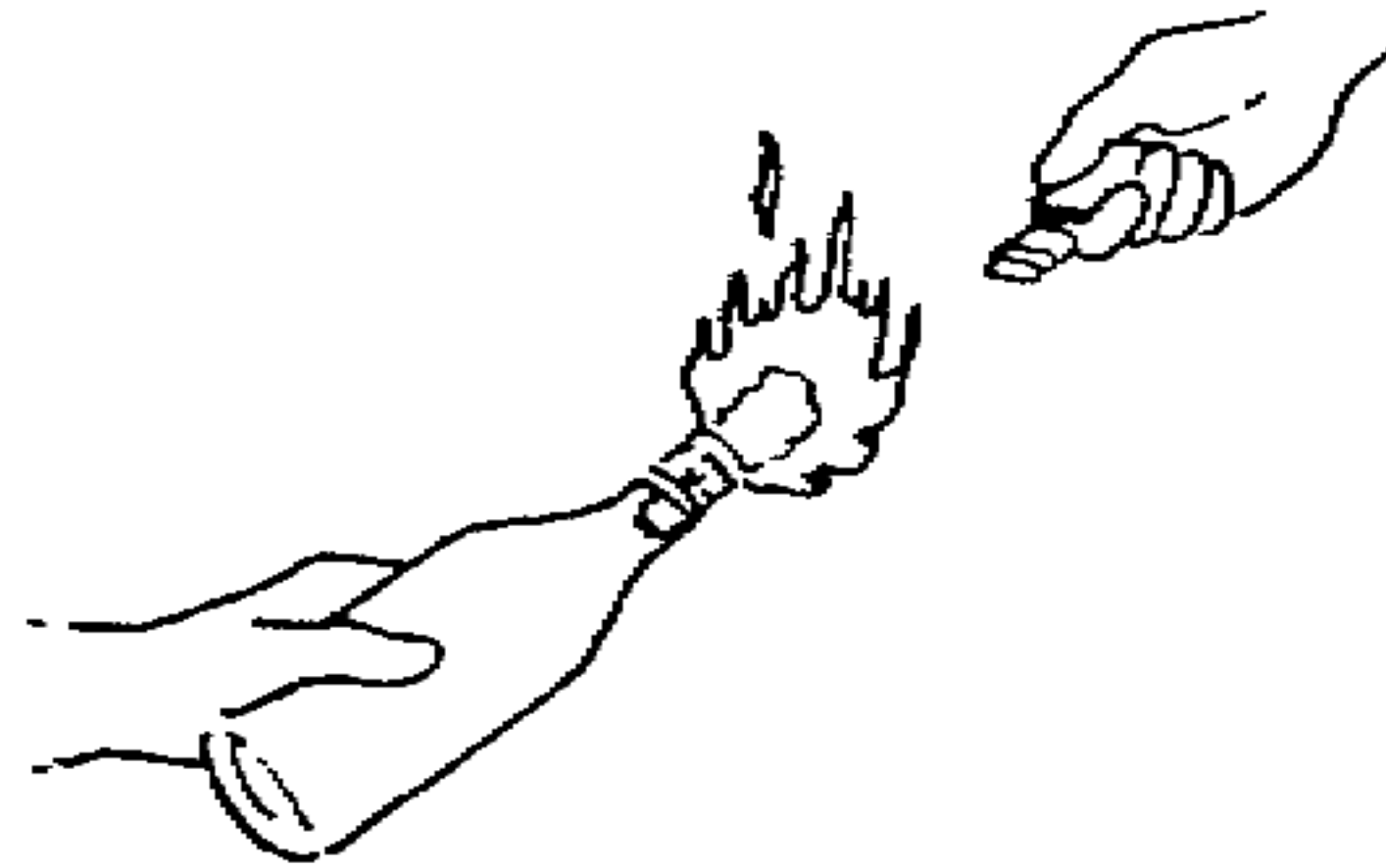

General Use

The book match igniter can be used by itself to ignite flammable liquids, fuse cords and similar items requiring hot ignition.

Caution: Damp or wet paper book matches will not ignite.

Incendiaries, The Science of Using Fire as a Weapon

Mechanically Initiated Fire Bottle

The mechanically initiated fire bottle is an incendiary device which ignites when thrown against a hard surface.

Materials Required

Glass jar, or short necked bottle with a leakproof lid or stopper
Tin can or similar container just large enough to fit over the lid of the jar
Coil spring (compression) app. 1/2 the diameter of the can and 1-1/2 times as long
Gasoline
Four blue tip matches
Flat stick or piece of metal (1/2" x 1/16" x 4")
Wire or heavy twine
Adhesive tape

Procedure

1. Draw or scratch 2 lines around the can- one 3/4" and the other 1-1/4" from the open end.

2. Cut 2 slots on opposite sides of the tin can at the line farthest from the open end. Make slots large enough for the flat stick or piece of metal to pass through.

3. Punch 2 small holes just below the rim of the open end of the can.

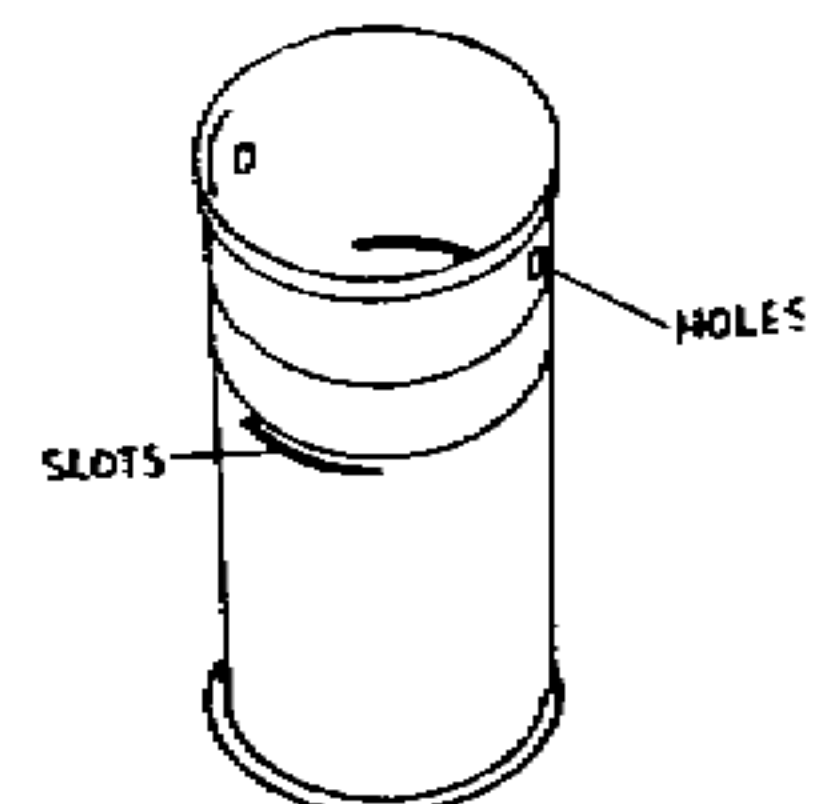
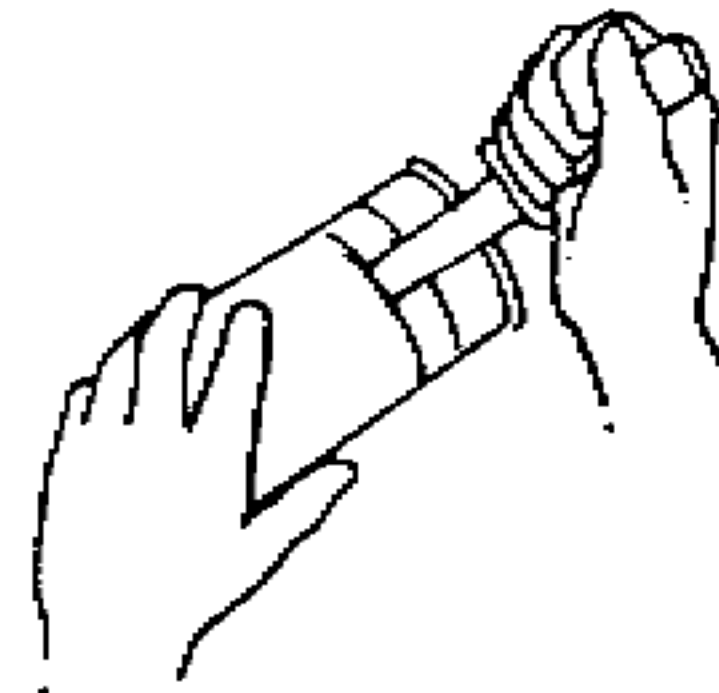
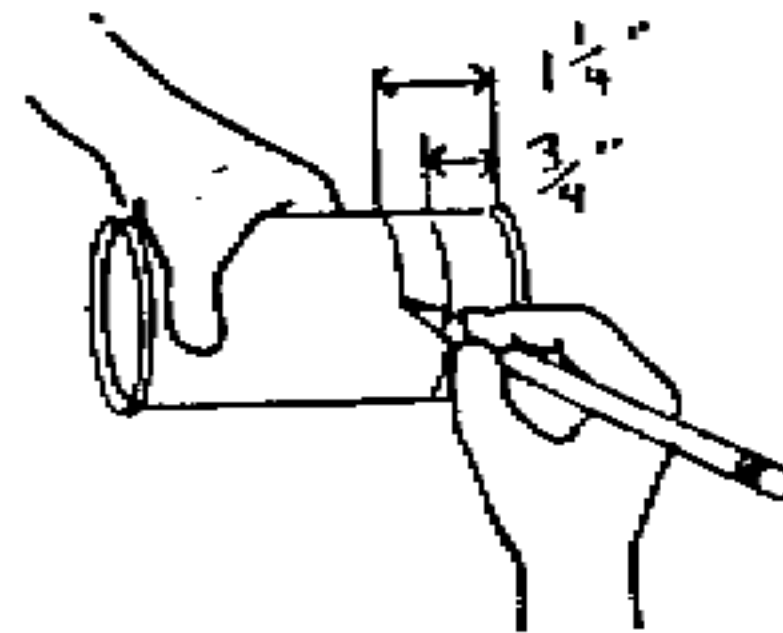
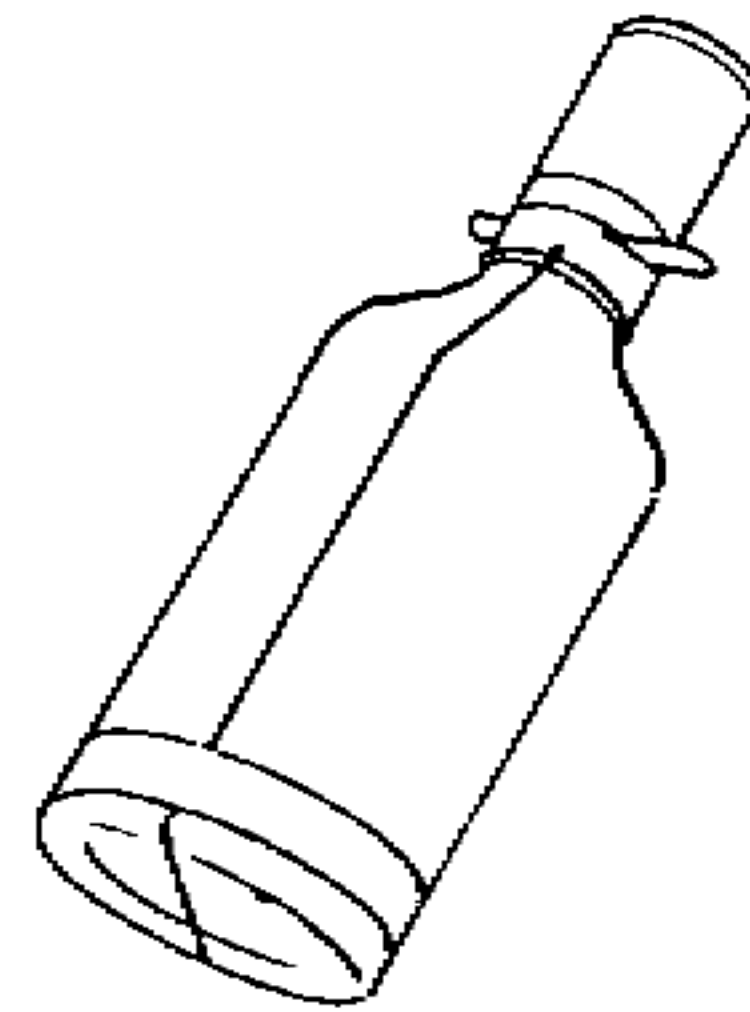

Incendiaries, The Science of Using Fire as a Weapon

4. Tape blue tip matches together in pairs. The distance between the match heads should equal the inside diameter of the can. Two pairs are sufficient.

5. Attach paired matches to second and third coils of the spring, using thin wire.

6. Insert the end of the spring opposite the matches into the tin can.

7. Compress the spring until the end with the matches passes the slot in the can. Pass the flat stick or piece of metal through slots in can to hold spring in place. This acts as a safety device.

8. Punch many closely spaced small holes between the lines marked on the can to form a striking surface for the matches. Be careful not to seriously deform can.

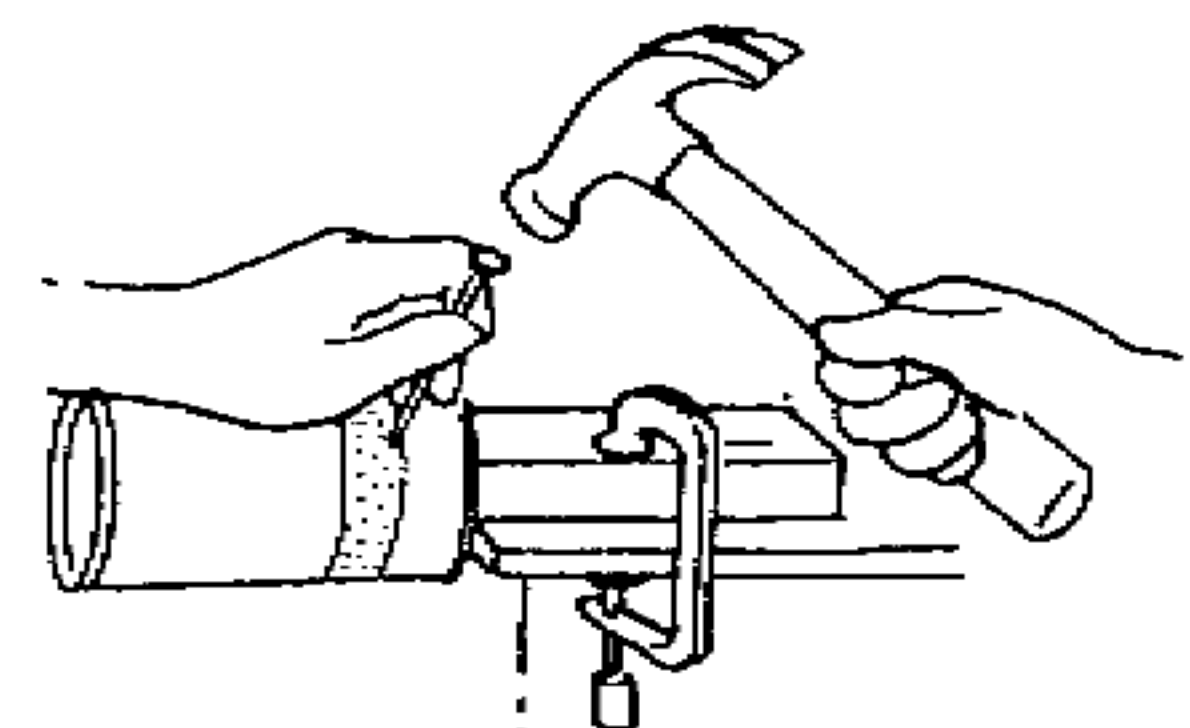
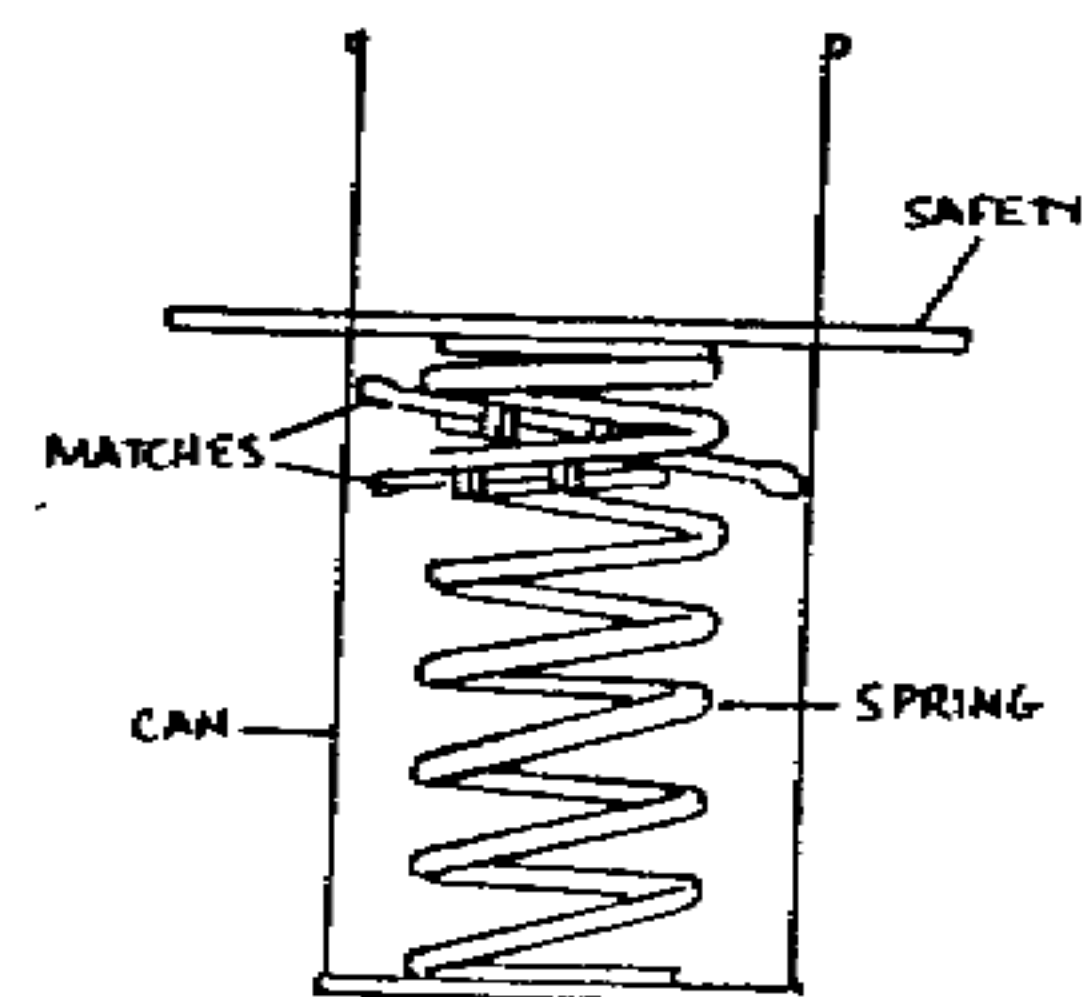
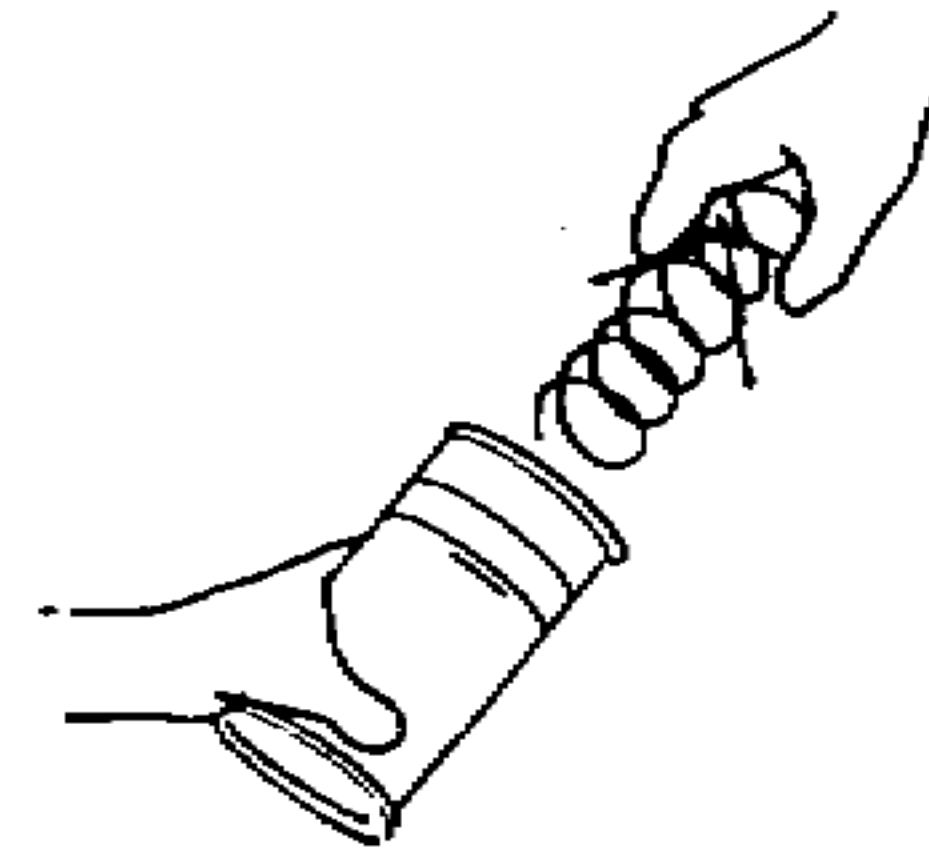
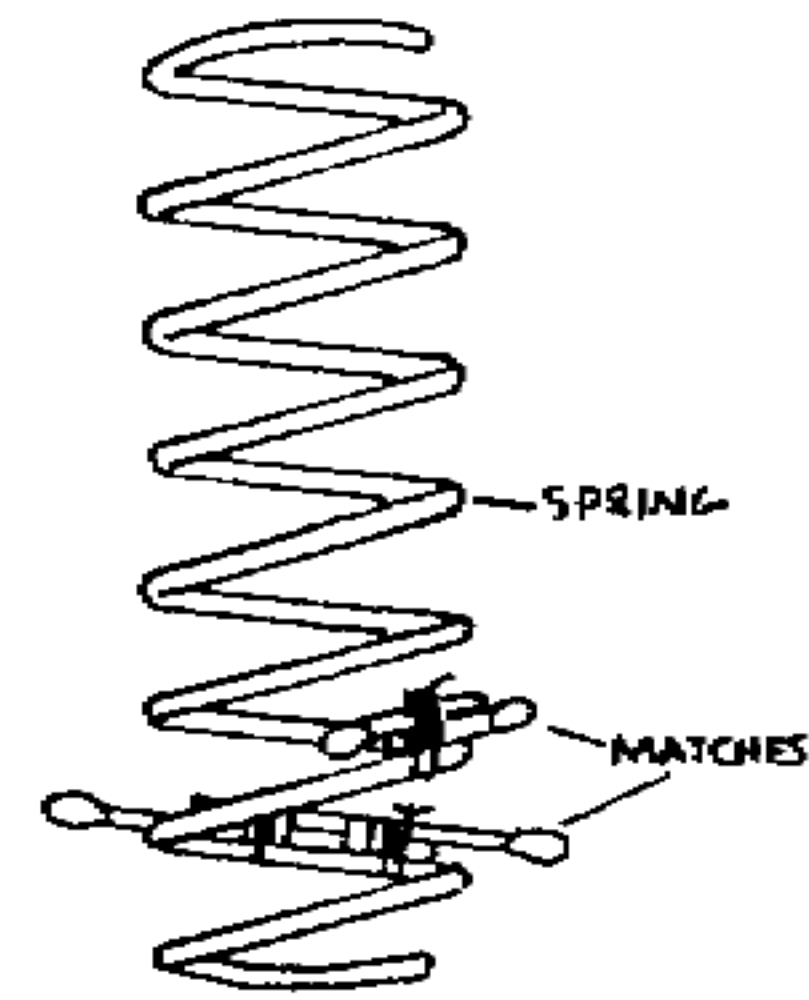

Incendiaries, The Science of Using Fire as a Weapon

9. Fill the jar with gasoline and cap tightly.

10. Turn can over and place over the jar so that the safety stick rests on the lid of the jar.

11. Place wire or twine around the end of the jar. Thread end through holes in can and bind tightly to jar.

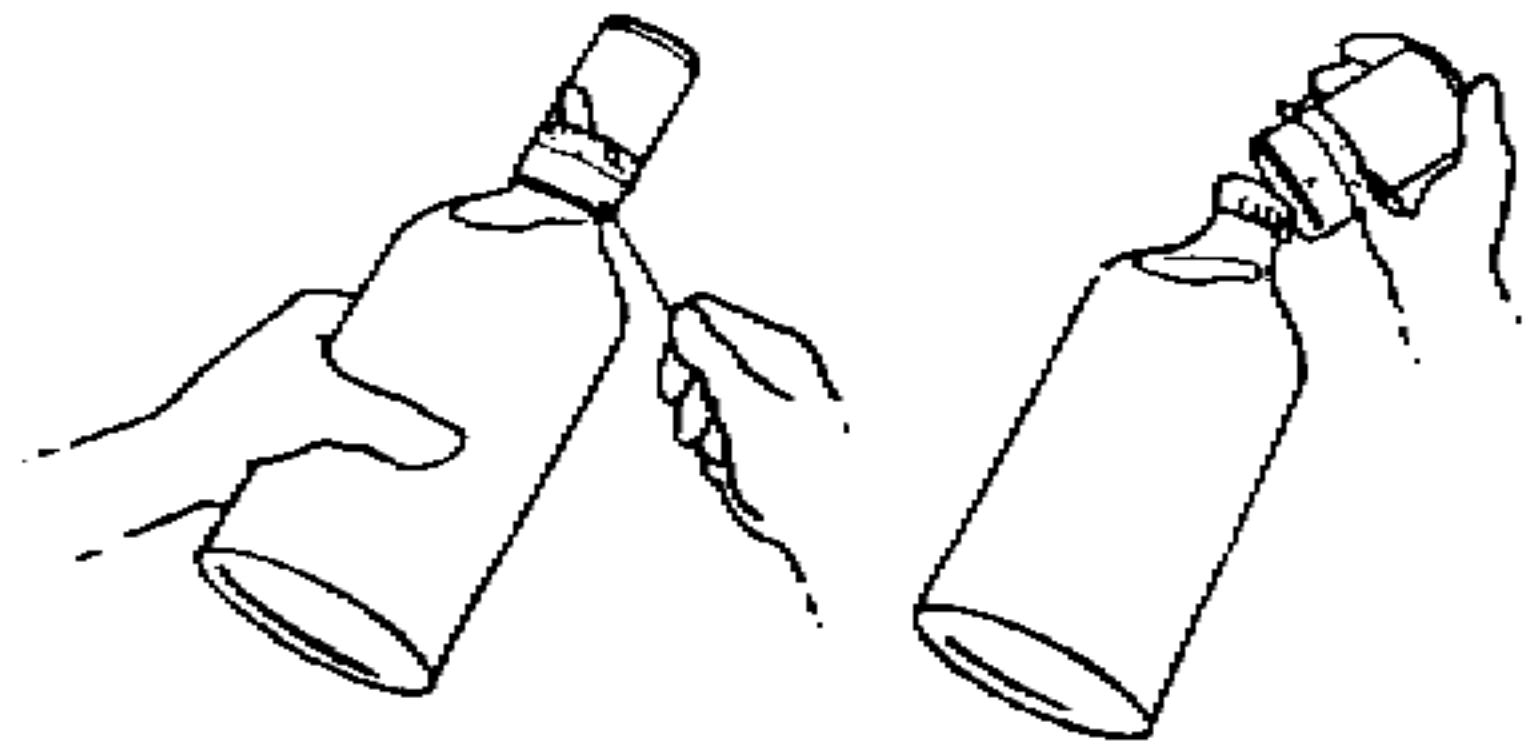

12. Tape wire or cord to jar near the bottom.



How to use

1. Carefully withdraw flat safety stick.



2. Throw jar at hard surface.

[Authors note- 3. Run like crazy. (See, I still have a sense of humor).]

Incendiaries, The Science of Using Fire as a Weapon

Acid Delay Incendiary

This device will ignite automatically after a given time delay.

Materials Required

Small jar with cap
Cardboard
Adhesive Tape
Potassium Chlorate
Sugar
Sulfuric Acid
Rubber sheeting (auto inner tube)

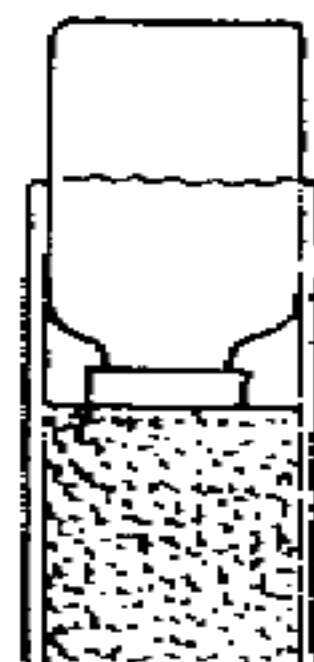

Procedure

1. **Sulfuric Acid must be concentrated.** If battery acid or other dilute acid is used, concentrate it by boiling. Container used should be of enamelware or oven glass. When dense white fumes begin to appear, immediately remove the acid from heat and allow to cool at room temperature.
2. Dissolve 1 part by volume of Potassium Chlorate and one part by volume of sugar in 2 parts by volume of boiling water.
3. Allow the solution to cool. When crystals settle, pour off and discard the liquid.

4. Form a tube from cardboard just large enough to fit around the outside of the jar and 2-3 times the height of the jar. Tape one end of the tube closed.

5. Pour the Potassium Chlorate sugar crystals into the tube until it is about 2/3 full. Stand the tube aside to dry.

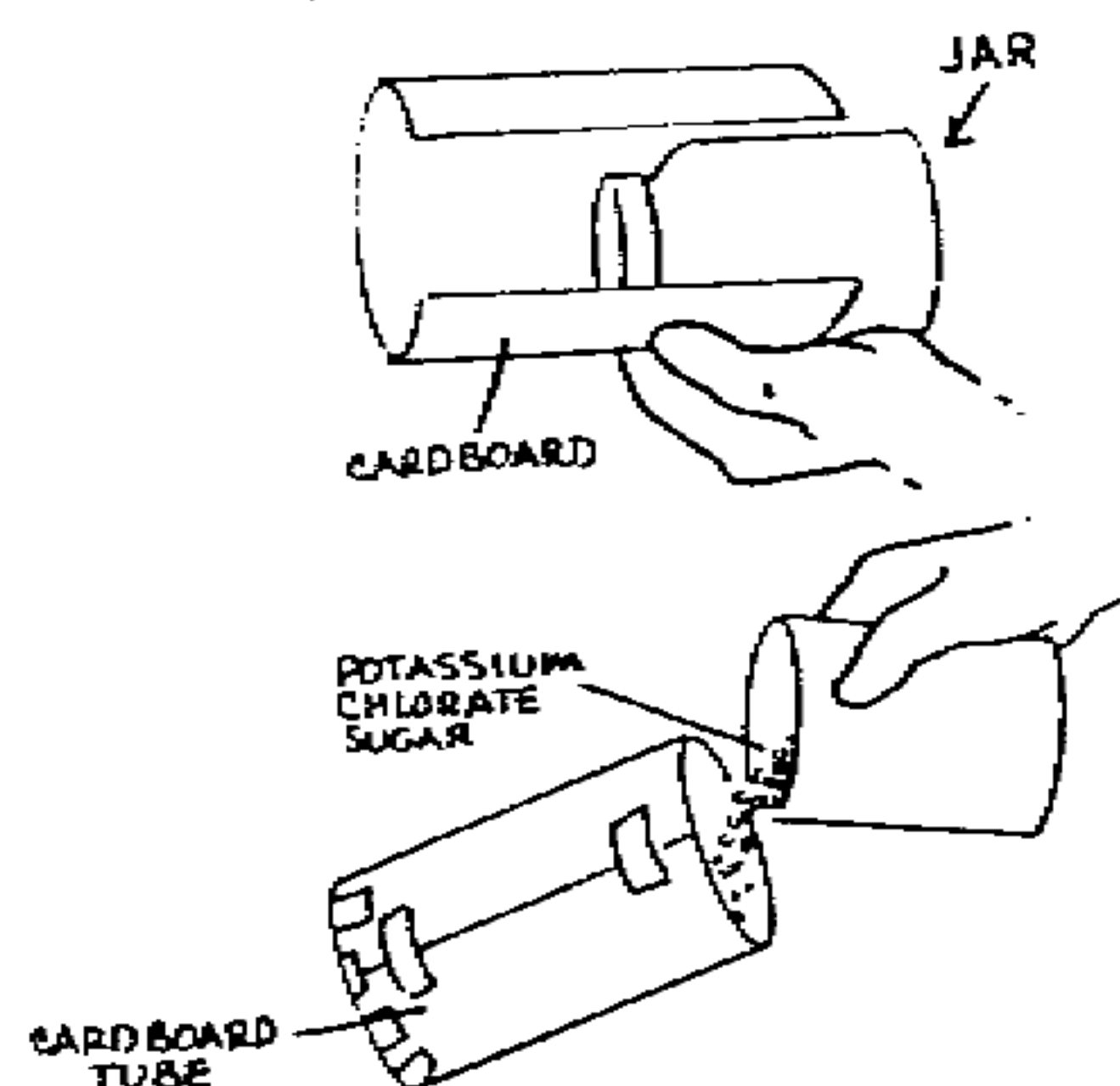

Incendiaries, The Science of Using Fire as a Weapon

6. Drill a hole through the cap of the jar about 1/2" in diameter.

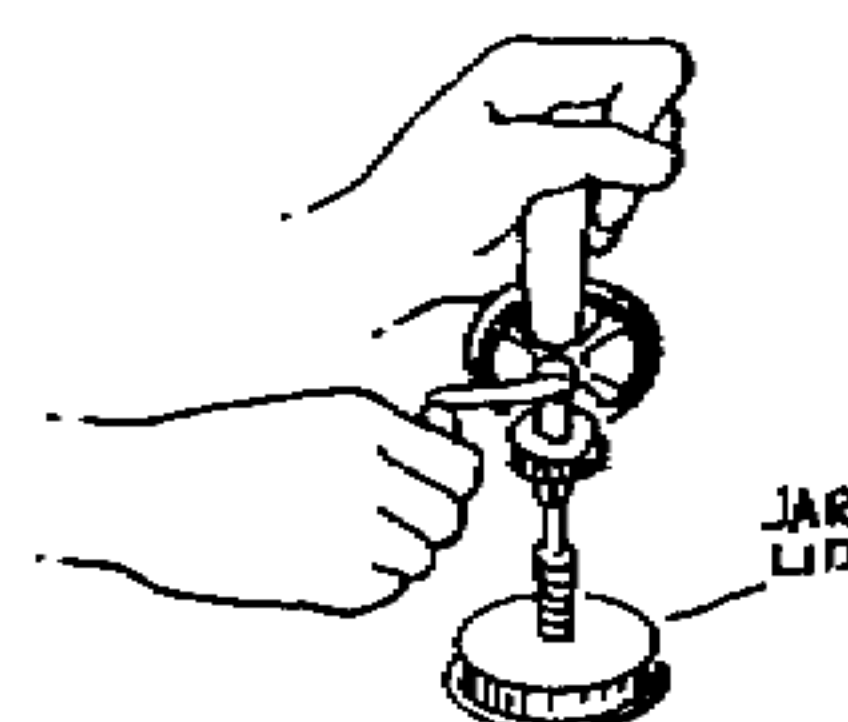

7. Cut a disc from rubber sheet so that it just fits snugly inside the lid of the jar.

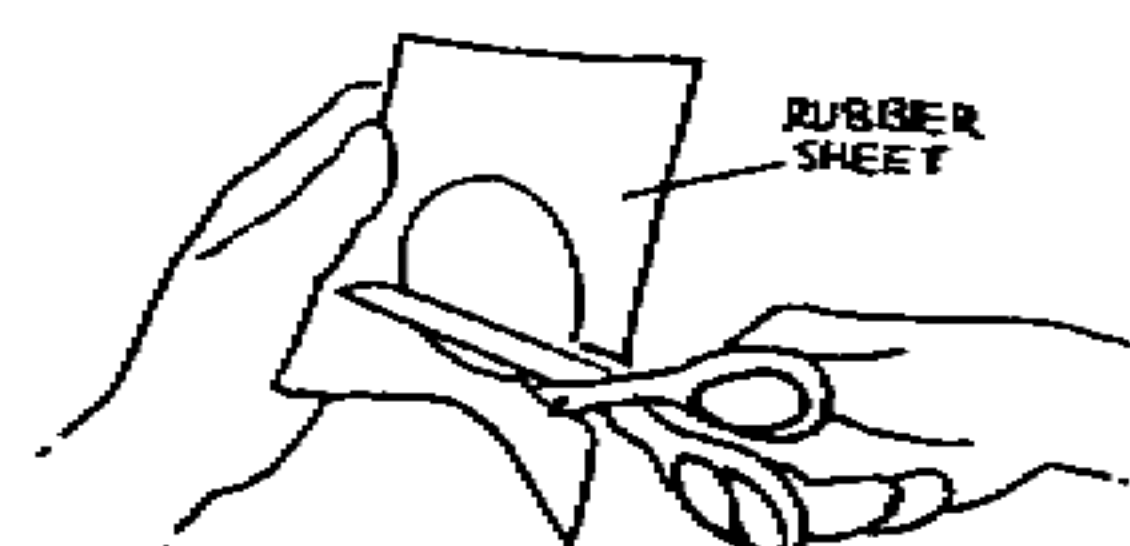

8. Partly fill jar with water, cover with rubber disc and cap tightly with the drilled lid. Invert bottle and allow to stand for a few minutes to make sure that there are no leaks. This is extremely important.

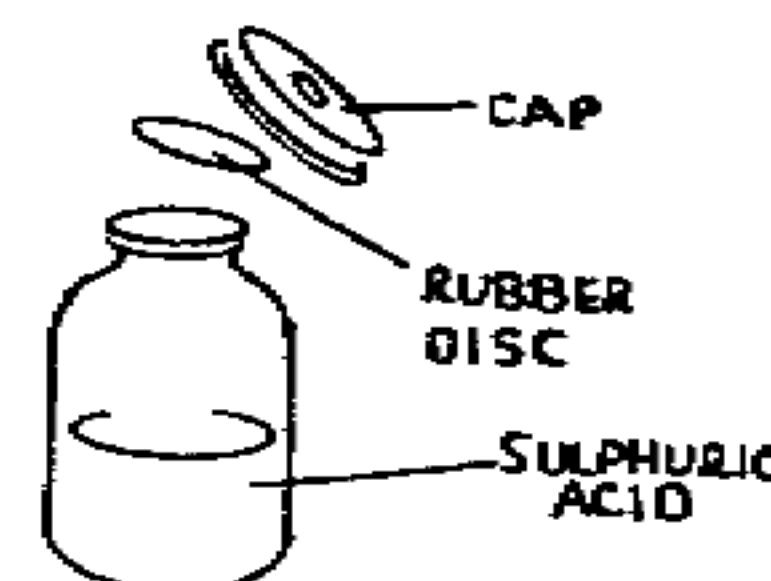

9. Pour water from jar and fill about 1/3 full with concentrated sulfuric acid. Replace the rubber disc and cap tightly.

Important: Wash outside of jar thoroughly with clear water. If this is not done, the jar may be dangerous to handle during use.

How to use:

1. Place the tube containing the Sugar Chlorate crystals on an incendiary or flammable material taped end down.

2. Turn the jar of sulfuric acid cap end down and slide it into the open end of the tube.

After a time delay, the acid will eat through the rubber disc and ignite the sugar chlorate mix. The delay time depends on the thickness and type of rubber used for the disc. Before using the device, tests should be conducted to determine the delay time that can be expected.

Note: A piece of standard auto inner tube (1/32" thick) will provide a delay time of about 45 minutes.

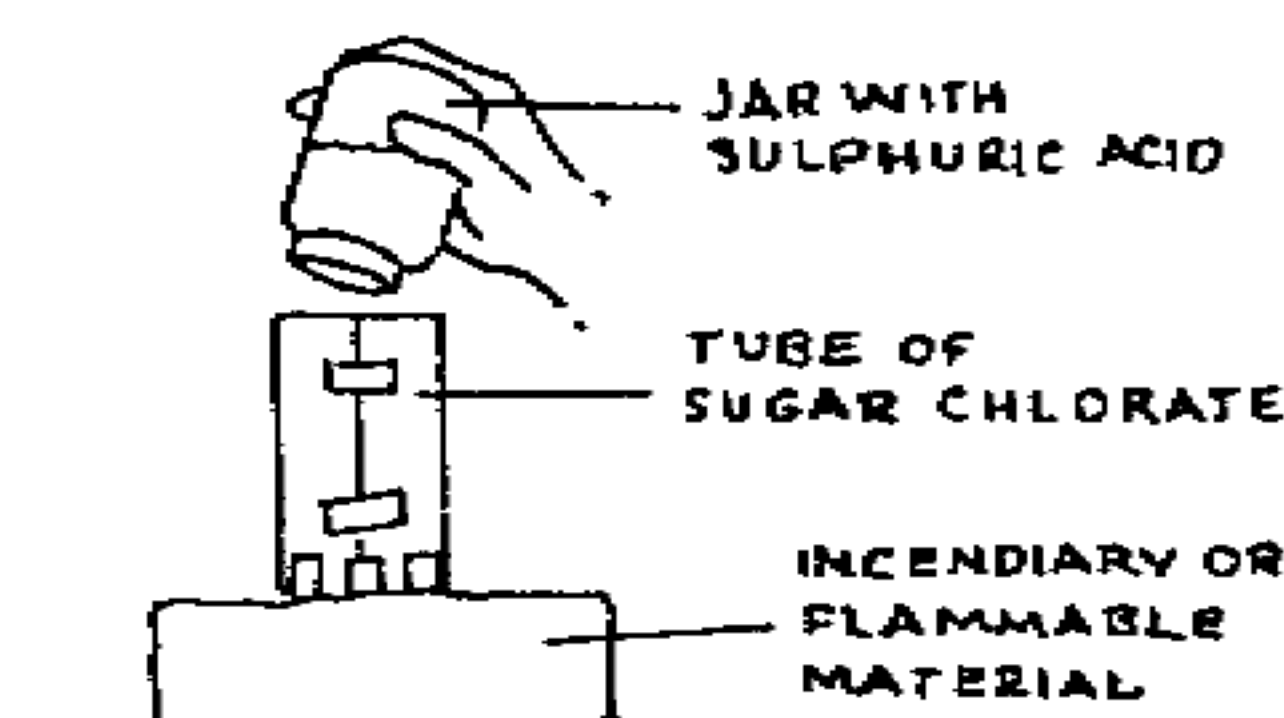

Incendiaries, The Science of Using Fire as a Weapon

Incendiary grenades of both antipersonnel and antitank are used in modern warfare.

anti personnel are designed with an impact (1) or delay fuse which ignites a bursting charge (2) rupturing the container wall (3) and igniting the incendiary contents (4).

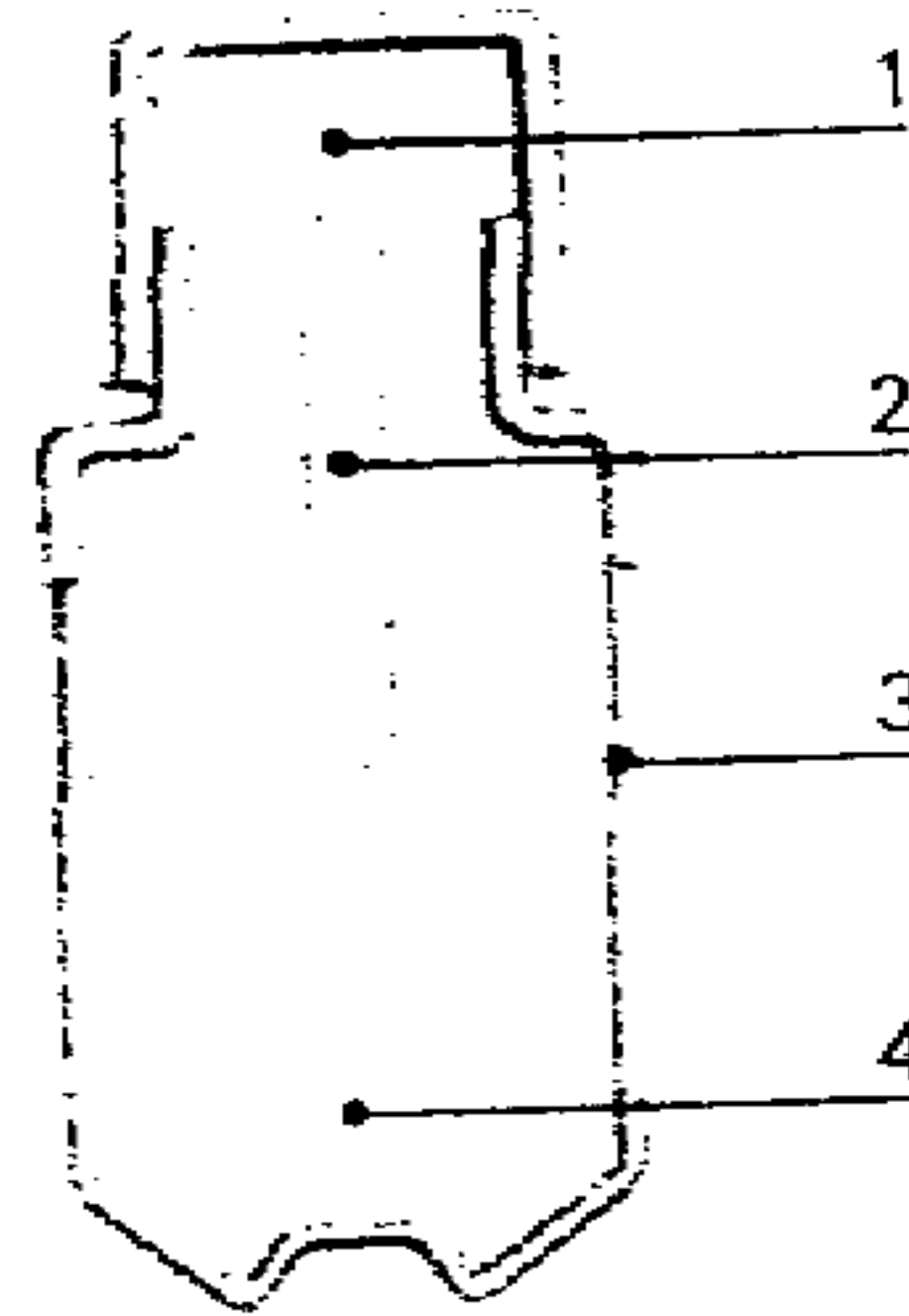

Anti tank grenades usually use thermitite or Thermitite typed formulas and are designed to be thrown and fly fuse first. On impact, the fuse ignites the incendiary charge.

Concussion and flash grenades are filled with light intense incendiaries with air reactive igniters that burn with a brilliant light to temporarily blind enemy personnel. They are usually used in hostage situations where direct assault applying extreme force is not an option. These are often accompanied by large noise making bursts to deafen and confuse the targets as well.

4) Air Dropped and Positioned Bombs

A wide range of incendiary ordnance has been devised that take the form of bombs which are air dropped or can be vehicle delivered in the form of positioned bombs. The first has been widely used by military forces since WW2 with the massive dropping of Napalm on cities and jungle targets. The second has been the favorite method of terrorists, arsonists, and behind the lines commandos. Most of the positioned bombs have been of the explosive variety, however, incendiaries offer very effective means of extending the potential property destruction and loss of life.

Conventional bombs have already been described in detail in the first 3 volumes. These have included a wide range of explosives in air dropped, mail delivered, and positioned weapons in the form of booby traps and mines. These will not be repeated here. Incendiaries can be substituted as the core elements of any of these designs. We will instead cover uses and designs that have not been described to date. These include -

- Floating bombs for use as markers or igniting oil spills on oceans and lakes
- Truck Bombs and carried Bombs - Airlines, public places
- Fuel-Air explosives
- Fragmentation Bombs

Incendiaries, The Science of Using Fire as a Weapon

Chapter 3

Incendiary Formulas and Devices

Fire has been used as a weapon, in war, for revenge, hatred, and about any other motive imaginable since the dawn of man. The methods of starting, delivering, and communicating fire are nearly limitless and constantly added to by mans imagination. For our purposes we will attempt to classify the methods used into the following categories.

1. Improvised fire starting
2. Small and Large Arms Incendiaries
3. Hand Thrown Incendiaries
4. Air Dropped and Positioned Bombs
5. Rockets, and Missiles
6. Primary explosives and incendiary chemical systems
7. Electrical, mechanical, and laser light related ignition
8. Booby trap and delay devices
9. Aerosol, compressor, and pump based delivery systems

There are many weapons whose designs have already been described in detail in Volumes 1-3. Most will not be described here although their basic designs may be useful in delivering incendiaries instead of explosive or other ordnance. A few will be repeated here for the purpose of teaching the basic concepts.

1) Improvised Fire Starting

There are many ways of starting and communicating fire that use materials already at hand and do not require fabrication of any kind. Most of these do not fit into the categories of manufactured weapons and will be described here.

The simplest ways of starting a fire is to use the ignition sources sold in many stores.

These include

Butane and other **liquid fuel lighters** sold at convenience stores. These are usually equipped with a manufactured friction wheel and metal sparking apparatus at the point where the fuel is discharged. The fuel valve is opened and the vapors from the fuel ignite producing a flame whose size can be controlled by opening or closing a valve on the outlet of the fuel container. Increasing the opening size releases a greater volume of vapors. As the flame enlarges and generates more heat, it causes an increase in vapor pressure of the fluid fuel supply.

Incendiaries, The Science of Using Fire as a Weapon

Matches, made in a wide variety of shapes, sizes, and purposes. These include strike anywhere and safety designed matches. A basic formula for production of matches using Potassium Chlorate as the primary ingredient has already been described on page 2-14. Matches are usually designed to be ignited with friction by striking the chemical coated head of the match against an abrasive surface that generates sparks and ignites the chemical mixture. A large flame burns generating sufficient heat to begin the pyrolysis of the wood in the main body of the match itself. The wood chars, producing combustible gases which keep the flame burning once the chemical fuel runs out.

Charcoal briquettes normally require outside heat to catch fire. If the briquettes become water soaked, they will often self ignite from the increased effect of oxidation caused by the presence of water in its pores. This has been the cause of a number of spontaneous fires in storage areas of homes and garages.

Vegetable Oil and Animal Fat have been implicated in the spontaneous ignition of fires in a number of cases. Oil soaked rags, soaked in an vegetable or animal fat can slowly oxidize and ignite over time. [Petroleum based oils do not oxidize and oil rags soaked in petroleum cannot spontaneously ignite because they do not generate their own chemical heat.] Several grocery chain stores suffered major fires because employees had soaked up the oils from deep fat fryers and other spilled lards and had used a particular brand of kitty litter. The litter acted as a catalyst which sped up the oxidation of the fats which ignited in the garbage cans.

Chemical Oxidizers which have already been described can be store bought and ready to use to ignite fires. Calcium Hypochlorite (Pg 36) can be bought from most swimming pool supply companies and many store chains. It is used to chlorinate swimming pools and kill bacteria in water by supplying chlorine. It is also a powerful oxidizer. [Any chemical containing available oxygen, chlorine, bromine, or fluorine are considered oxidizers for fire purposes.]

When it is mixed with most hydrocarbon fuels such as brake fluid or gasoline, it ignites. About 2 tablespoons of brake fluid poured into 2 cups of calcium hypochlorite ignites from the chemical reaction in 30 seconds to 5 minutes and sends bright red-orange flames 4-6 feet in the air. This makes this combination an effective improvised flare or usable in binary larger scale weapons.

Chlorates, already described in chapter 2 and above can be scattered in powder form on floors made of combustible materials like wood. The friction from people walking on the powder will ignite the chlorate and any combustible materials they are in contact with. Potassium permanganate, purchased in drug stores as germicide and medicine will also ignite from contact with fuels. Most of the oxidizers in chapter 2 can be formulated with some reducer or fuel to self ignite. All oxidizer enhanced fires produce hotter burning flames than those produced by normal combustion of materials.

Incendiaries, The Science of Using Fire as a Weapon

Strikers are mechanical devices which contain a sparking alloy against which a metal wire is scratched to generate sparks. They are most commonly used with welding equipment and portable propane torches and are widely available at stores and industrial supply houses. They are usually designed so that the sparks are generated several inches from the hand so that the operator is not subjected to burns from ignition. The welding and torch equipment, once lit, can also be used to communicate fire.

Mirrors and Lenses have long been used to ignite combustibles. Basic Boy Scout training teaches the use of telescope lenses, mirrors, and other curved glass to focus the sun's rays on kindling or other easily ignited fuel. This method has long been a reliable method of starting fires in the backwoods and the cheap plastic lens devices have even been offered as prizes in cereal boxes.

Grinding and Sanding Equipment convert electrical energy into rapid revolving abrasive surfaces that generate large volumes of sparks when brought into contact with most metals. Any of these sparks usually are sufficient to autoignite combustible vapors and pyrolyze many solids.

Light Bulbs produce an exterior temperature of 250-600 F depending on the wattage. The greater the watt output, the greater the temperature. This is sufficient to pyrolyze paper, and cardboard cartons, and ignite many vapors with low autoignition points. Solid materials usually have to be in direct contact with the hot bulb for some length of time after which they begin to smolder and eventually accumulate enough temperature to ignite the vapors.

Spark Plugs are used to communicate electricity in the form of an arc jumping across metal and used to ignite gasoline vapors inside an engine cylinder. This communicates fire reliably to vapors in all conditions.

Some general information on chemicals that may be useful in improvised flares or explosive - incendiary compositions include -

Ammonium Nitrate, made from nitric acid and ammonia or ammonium bicarbonate is both hygroscopic in that it draws moisture from the air, and it is deliquescent, that is, it absorbs so much moisture that it turns to a gel and then a liquid. In this form it can mix into and be absorbed by many combustibles such as paper, cloth, cardboard, and sawdust. It easily burns and explodes when ignited, even with the moisture present. [Slurried ammonium nitrate with 10% water and more is used in many explosive formulas.] The mixing into these combustibles also sensitizes the ammonium nitrate to ignition.

Incendiaries, The Science of Using Fire as a Weapon

The colors of a flame are affected by the salts in the fuel. These can be used to make improvised incendiary flares of different colors in the field. Natural fire = blue-yellow.

Violet or purple	Potassium
Reddish-Yellow	Calcium
Greenish-Yellow	Magnesium
Yellow	Sodium

The colors produced by pyrotechnic and fireworks chemicals are covered in Volume 3.

2) Small Arms and Large Gun Shell Design

Small arms fire bullets while larger guns fire shells. The bullets propellant is ignited by a mechanical action which sets fire to a primer incendiary composition. This mechanical striking action starts a fire which ignites a powder charge that propels the bullet or shell out the end of the gun barrel towards the target (or wherever the gun is pointed).

Formulas for early friction primers used to start the first fire are -

Potassium Chlorate	2	56.2	44.6	14
Antimony Sulfide	1	24.6	44.6	
Sulfur		9	3.6	
Meal Powder			3.6	
Ground Glass		10.2	3.6	
Charcoal				1.6
Calcium carbonate	.02	2	2	
Dextrin				.3

A typical bullet functions as follows -

- 1) The firing pin dents the cap
- 2) The cap in the cartridge case crushes a detonating compound against a brass anvil
- 3) The flash of the small primer ignites the main charge
- 4) The main charge explodes, burning rapidly. The temperature reaches 2700 degrees C and after .0005 seconds from ignition the propellant expands to 14,000 times its own volume in gas. The chamber pressure reaches 51,000 ft lbs. per sq.in.
- 5) The expanding gases force the sides of the cartridge case to seal so tightly against the walls of the chamber that no gas leaks to the rear
- 6) The pressure forces the bullet up the bore and out of the muzzle at very high velocities

Incendiaries, The Science of Using Fire as a Weapon

6) Primary Explosive's and Incendiary Chemical Systems

Explosive materials are widely used in incendiary packages. This is because the sciences of combustion are applied in near identical fashion. The unique aspect of explosives is the addition of solid or liquid oxygen sources to drastically speed up what the oxygen in the air usually does. The use of chemical oxidizers commonly used in explosives has the effect of increasing the flame temperature (due to increased rates of combustion), and produces larger flames which spread the fire more readily by pyrolyzing nearby solids and liquids. It is quite easy to combine many organic combustibles like alcohol's with oxidizers to produce binary self igniting munitions capable of producing furious fires. The possible numbers of formulations could run into the thousands.

A number of incendiary formula improvements were patented in the 1970's that have shown themselves to make more effective weapons. We will describe a handful of these in detail so that more effective mixtures can be understood and applied by prospective weapons designers.

The early thermite formulas had many ignition problems. They were hard to light and did not always completely burn as desired (sometimes too fast or too slow). This led to a variety of additives to make them easier to light and either burn faster or slower. These included flake aluminum, sulfur, hydrocarbon oils, zinc powder, magnesium powder, and many oxidizers like barium nitrate, potassium chromate, and potassium permanganate. These became known as Thermates.

By 1970, it became known that any of a group of ferrocene-type compounds could be added to the thermite or Thermate formulas and improved the ignition and burning of the compositions. Ferrocene compounds are made up of Iron which has four attached molecules of alkyl groups or hydrogen in its formula as R1-R4 -

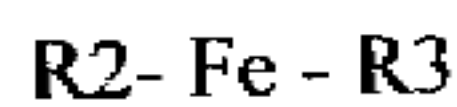

The compounds formed by this are known as

bis(cyclopentadienyl) iron
(cyclopentadienyl) (methylcyclopentadienyl) iron
(cyclopentadienyl) (ethylcyclopentadienyl) iron
bis(propylcyclopentadienyl) iron
bis(isopropylcyclopentadienyl) iron
bis(butylcyclopentadienyl) iron
bis(tert-butylcyclopentadienyl) iron
bis(hexylcyclopentadienyl) iron
bis(methylcyclopentadienyl) iron
(cyclopentadienyl) (dimethylcyclopentadienyl) iron
bis(ethylcyclopentadienyl) iron
(cyclopentadienyl) (diethylcyclopentadienyl) iron

Incendiaries, The Science of Using Fire as a Weapon

The polymer forms of the above materials can also be used in thermitic designs. The materials above are added at 2-50% of the formulations with 10-35% preferred. Magnesium ribbon is most often used to ignite the thermites but in a series of comparisons below, toluene was used to soak and ignite a thermite with a base formula of 25.2% aluminum and 74.8% iron oxide.

<u>Thermite= 1 part is mixed with</u>		<u>added 1 part ferrocene</u>
1 part potassium chromate	did not burn	Brief flare, very little burned
1 part BN and 1 part AF	did not burn	Small flare, little burned
1 part Zinc Powder	did not burn	Burned completely
1 part Zinc Powder	with only 1/2 ferrocene	= 85% burned
1 part BN	did not burn	plus 1 part magnesium burned completely

BN = Barium Nitrate, AF = Aluminum Flake

In other tests, ferrocene improved burning and ignition in all combinations.

The form of the thermite has an impact on how easily it lights and burns. As a powder in the above example it is difficult to ignite and burn completely without special ignition conditions and materials. When the thermites are pelletized and formed with a hollow core, either by drilling out of a casting or by casting or curing in this shape, they are much more easily ignited and burned. The hollow core pellets are 7/16" OD, 3/16 ID, and 5/16" thick. When these are soaked in toluene and ignited as in the above tests the following results were obtained.

1 part thermite and 1 part potassium permanganate	
plus .25 part ferrocene =	Ignited and burned in 1 second
plus .5 part ferrocene =	Ignited and burned completely in 3 seconds
plus 1 part ferrocene =	Ignited and burned in 5-7 seconds

The pellets without any ferrocene did not burn at all. When magnesium strips are used to ignite the thermites or other additives are mixed in, the results fall in between the ferrocene additives and no additives.

A commercial napalm - thermite aerial bomb has been used with the following composition.

65% gasoline, benzene, and polystyrene	
35% Thermite of	1 part 74.8% Iron oxide and 25.2% powdered aluminum
	1 potassium permanganate
	1 part ferrocene

The above composition ignites and burns reliably with a magnesium strip. The use of ferrocene compounds consistently improves virtually all thermite and Thermate formulas for burning and ignition properties.

Incendiaries, The Science of Using Fire as a Weapon

Other forms of aluminum as a group known as alkyl aluminum hydrides produce an excellent alternative to thermites and napalms for incendiary compositions. Some of them have already been described in chapter 2. These aluminum compounds contain an alkyl group. The word alkyl simply means an alcohol or its equivalent hydrocarbon. Methanol is an alcohol (methane is the hydrocarbon) that is reacted with aluminum to form a methyl aluminum hydride. The hydride is hydrogen.

The following compounds as a group have been incorporated into effective incendiary weapons.

methylaluminum dihydride
dimethylaluminum hydride
trimethylaluminum
propylaluminum dihydride
dipropylaluminum hydride
tripropylaluminum
isobutylaluminum dihydride
diisobutyl hydride
triisobutylaluminum

ethylaluminum dihydride
diethylaluminum hydride
triethylaluminum
butylaluminum dihydride
dibutylaluminum hydride
tributylaluminum

The higher alkyls such as amyl and hexyl or the aromatic hydrocarbon derivatives such as phenyl, tolyl, and xylol can also be compounded with aluminum to form similar incendiaries.

The formulas prepared for weapons use involve mixing the aluminum compound at 80-98% weight, with 2-20% of a thickening gelling agent, or a diluent, both of which should be a combustible.

These mixtures ignite on contact with air, and organics that contain active hydrogen like alcohol's, amines, organic and inorganic acids, and to some extent materials like paper and wood. They also react violently with water. The advantage of self igniting materials is that all parts of the distributed incendiary reliably ignites everywhere it is released. When napalm is distributed and ignited, parts of it may not burn if ignition is not achieved everywhere. The gasoline in it may vaporize and disseminate into the air without ever contributing to the attack.

The materials used with these compounds must not react with the aluminum. It must make a mixture pourable into aerial bomb casings, hand thrown bombs, or flame thrower reservoirs and then sealed to prevent contact with air.

Incendiaries, The Science of Using Fire as a Weapon

Diluents and other additives used include -

Gasoline	Tar	Asphalt	Petroleum Jelly
Kerosene	Heavy Oil	Mineral Oil	Iron
Magnesium	Aluminum	Zinc	Boron
Lithium	Sodium	Diethyl Zinc	Tributyl Borine
Ferrocene Iron	Sodium Hydride	Ferrocene Manganese	

and most other sodium or alkali metal hydrides

A jelly like consistency is preferred over thickened liquids and are usually added at 4-12%. The gelling agents most suitable for mixing into the incendiary compounds are -

Polyethylene	Polypropylene	Polybutylene	Polyisobutylene
Polybutadiene	Isobutylene-Styrene	Polystyrene	Polyvinyl Styrene

Latex, gum, and other synthetic and natural rubbers

Solvents are used sometimes to aid in the gelling process by swelling the polymeric fibers and forming a more compact gel. These may include -

Pentane	Hexane	Heptane	Isohexane and other aliphatics
Benzene	Toluene	Xylene and other aromatic solvents	

The effect of gelling also delays ignition of the composition in air which reduces burning before reaching the target when it is distributed in open air. Actual mixtures used include -

69 parts of triethylaluminum

73 parts of cement consisting of 16% rubber dissolved in toluene. The solvent is dissolved off at 100mm of mercury at 80 C.

This thick mixture reliably adheres to metal targets and self ignites in 2-3 after contact.

Kerosene can be mixed in to make thinner mixtures suitable for use in flame throwers although the range is shorter than gelled gasoline mixtures. Small portions of these mixtures may also be incorporated into other incendiaries in the form of small frangible capsules to act as igniting agents when they are distributed in air.

The flames of these types of incendiaries burn intensely hot and are difficult to extinguish. Metal soaps in combination with metal fuel also produce super hot temperatures when ignited. Special combinations of mixes produce very long burn times. Some of these involve the mixing of metal hydrides or heavy metals with solid fluorocarbon polymer acting as an oxidizer.

One of the more effective long burning designs involves the mixing of powdered heavy metal fuels mixed with solid polymers that contain available oxygen. These weapons have a specific gravity of 2-4.5 and will burn in air for 30 minutes to 2 hours or longer

Incendiaries, The Science of Using Fire as a Weapon

These types of materials consist of

50-93% Heavy Metal

Strontium
Barium
Radium
Zinc
Cadmium
Mercury
Scandium
Yttrium
All Lanthanum series metals
All Actinium series metals
Titanium
Zirconium
Hafnium
Vanadium
Niobium
Tantalum
Radioactive metals are usable but are generally barred by international treaty.

Acrylic ester
Organic Polymer w/ copolymer of
Glycidyl Methacrylate
Trimethylolpropane Trimethacrylate
2-ethylhexyl acrylate
2-nitro-2methylpropyl methacrylate
1,3-butylene dichloroacrylate
methyl 2-chloroacrylate
ethyl fluoroacrylate
glycol diacrylate
1,3-butylene dimethacrylate
2-nitrobutyl acrylate
2,2-nitrohexyl methacrylate
trifluoromethyl methacrylate
propyl *a*-bromoacrylate
methyl methacrylate
ethyl methacrylate
butyl methacrylate
methyl acrylate
hexyl acrylate
octyl acrylate
vinyl methacrylate
B-amino ethyl acrylate
N,N-dimethyl aminoethyl acrylate acetate
allyl methacrylate
methacrylic acid
acrylic acid
2-chloroacrylic acid
acrylamide
methallyl acrylate
pentafluorophenoxy acrylate

The oxygen containing polymers serve as oxidizers and binders. The groups listed above generally belong to one of the following classes of polymers-

Acrylic	Vinyl Ester
Allyl Ester	Vinyl Ether
Vinyl Ketone	Epoxy Resin

Incendiaries, The Science of Using Fire as a Weapon

The copolymer of Glycidyl Methacrylate is mixed in at 90-99% by weight with 1-10% of one or more of the above materials. This may also be replaced or partially substituted from the following -

Vinyl Acetate	Vinyl Methyl Ether	Divinyl Ether
Vinyl Hexyl Ketone	N-Vinyl Pyrrolodine	Itaconic Acid
Crotonic Acid	Diethyl Fumarate	Acrolein
Vinyl Stearate	Maleic Anhydride	Dimethyl Maleate
Diallyl-3,5-dimethyl Phthalate		Diallyl Phthalate

Other additives may be added to harden the copolymer by cross linking which renders them elastomeric, to modify the burning rate, to decrease the polymerization rate, etc.

Vinyl Chloride	Vinylidene Chloride	Propylene
Methyl Styrene	Cyclopentadiene	Acrylonitrile
2-vinyl Pyridine	Styrene	2,5-dichlorostyrene
Tetrafluoroethylene	4-vinyl cyclohexane	Divinyl Pyridine
Divinyl Benzene	Divinyl Toluene	

The formulas made be simple mixtures like Oxygen Polymer mix 5-80 parts
Powdered Metal Fuel 100 parts

Better compositions are based on Acrylate type polymer 10-80 parts
Lanthanide Series Metal 100 parts
Zinc 10-100 parts

An example of a good acrylate type polymer for the above formula would be

Glycidyl Methacrylate	100 parts
Trimethylolpropane Trimethacrylate	2-8 parts

The most effective metal fuels are the Lanthanum series metal alloys including Misch metal as well as zinc, zirconium, tantalum and vanadium. This metal fuel should be powdered between 1 and 300 microns in size. It may be precoated with a thin layer of ignition or primer material or the monomer at .1-.5%.

This metal is then mixed with the monomer and or its mixture. The catalysts or other additives are added at .01-3% of the mix and the mixed material is cast into the desired mold and cured. The curing should take place at a low temperature to avoid premature ignition. The oxygen containing polymer not only provides oxygen for combustion, it also provides strength for the mix to remain coherent as an ash during its combustion. The compressed metal without the polymer gives a non coherent ash.

Incendiaries, The Science of Using Fire as a Weapon

These compositions may be ignited by heat alone or by chemical igniting materials. These incendiaries burn reliably leaving a coherent incandescent ash that can ignite combustibles for up to 2 hours and longer that they come in contact with. The zirconium mixtures reach incandescence slowly and form a secondary reaction with air that burns vigorously about 10 minutes after the initial combustion. The residue of the exothermic alloys are capable of cutting or welding metal after ignition.

The following mixtures were cast into molds and polymerized (cured) to solid bodies. Each one burned on ignition leaving an ash that continued to burn in air for more than an hour. Other alloys containing 50-75% lanthanide elements and 20-50% Zinc also formed incendiaries that burned with similar properties.

Glycidyl Methacrylate	72.62	18	18
Trimethylol propane trimethacrylate	.41		
2-ethylhexyl acrylate	4.15		
Butylene dimethacrylate		.43	.43
Benzoyl Peroxide (catalyst)	1	.3	.35
Benzoyl toluidine (promoter)	.1		
Barium Nitrate		10	
Potassium Nitrate			8
Alloy of 67.5% Lanthanide elements and 32.5% Zinc (alloy 675 L)	336.9	71.27	74.32

Another formula that burns in air for 90 minutes with intense heat radiation and is ignited by application of direct heat (in tests this was a butane flame)

2-ethylhexyl acrylate	4 parts
2-nitro-3-methyl-propyl methacrylate	30 parts
trimethylolpropane trimethacrylate	1 part
Alloy 675 L	65 parts

This mix is catalyzed with 1 part benzoyl peroxide and promoted with .1 part of N,N-dimethyl-toluidine and then cured to a tough solid mass.

The following mixture burns slowly for 5 minutes until the binder is exhausted and an exothermic reaction begins. The entire mass is heated to incandescence in 15 seconds and burns in air for 2 hours. This exceptionally long burn time makes this type of incendiary an unprecedented weapon of long term effect and will find future use in replacing standard thermite and Thermate ordnance in attacking metal; targets.

2-nitro-2-methyl-propyl methacrylate	34 parts
trimethylolpropane trimethacrylate	1 part
Zirconium	65 parts

This mix sets to an elastic solid in a few hours.

Incendiaries, The Science of Using Fire as a Weapon

Most of the possible mixtures can be cast in molds that contain a prepared detonator, fuse and igniter to make a ready to use bomb, and can also be machined to a final form to fit the ordnance package.

The following formulas can be cured at room temperature and burn for 30+ minutes.

Glycidyl Methacrylate	1800	1700
Trimethylolpropane trimethacrylate	43	40
Benzoyl Peroxide	30	30
Potassium Nitrate	650	
Sodium Oxalate		300
Mischmetal 50-96%/Zinc 4-50% Alloy	7,477	7,080

The use of the above formulations in a wide range of ordnance has very real military potential and is a measurable improvement over thermite and Thermate munitions where long burn times are required. They were developed in the early 1970's.

Also developed in the 1970's were a series a metal fuels formulas using aluminum and/or magnesium powder in mixtures with fluorocarbon oil (pat # 3,156,596) which was useful against hard targets and produced little gas during reaction. These materials could not be mixed as a fluid form and casted into a desired shape. This made them difficult to use as munitions.

Soon afterwards, liquid polymerizable fluorocarbons (such as Teflon) were developed in formulations that could be used to form solids. In patent 3,565,706, the metal powders are mixed with dodecafluoroheptyl methacrylate and other methacrylates and acrylates, which could be cast in the desired shape and cured using a benzoyl peroxide catalyst with an amine activator. These formulas usually took time to reach the desired high temperatures needed in attacking "hard" targets like tank armor.

In 1977, a new high reaction speed and temperature incendiary was developed using magnesium or aluminum powders mixed with a class of oxidizers called "fluoroalkyl phosphoric acid esters". Additives were added so this mix could be turned into a paste that could be cast into a desired shape for ordnance and cured at app. 135 F to a solid state. Once ignited, this material would burn rapidly and vigorously melting holes in thick steel alloy sheet metals.

The fluoroalkyl phosphate esters used are made by reacting phosphoric acid with chemicals called fluoralkanols. The resulting mixes can be mono and di esters and the ones containing 5-11 carbon atoms work most effectively. Some of the commercial trade names of these esters used to make this incendiary class are known as Zonyl S-13, TLF 1914 and TLF 1916. Patent # 3,083,224 describes how to make these esters. The alcohol's used to react with phosphoric acid to make the esters include -

Incendiaries, The Science of Using Fire as a Weapon

1,1,7-trihydrododecafluoroheptyl
1,1,5-trihydrooctafluoropentyl
1,1,9-trihydrohexadecafluorononyl
1H,2H,2H2H-pentadecafluorononyl
1H,1H,2H,2H-heptadecafluorodecyl
1H,1H-pentadecafluorooctyl

When these esters are mixed with metal fuels like aluminum and especially magnesium, they become attached chemically by a chemisorption process. On ignition, a condensed phase reaction occurs that produces a very high combustion temperature that burns through metals. Because there is no evolution of combustion gases, no heat is carried away as a gas and the high temperatures radiate the heat into the contacted metal targets very efficiently.

The perfluoroalkyl phosphate esters mixed with magnesium have exceptional properties in that they can be mixed together to form a paste that quickly self hardens in a mold to the desired form.

Other chemicals may be added that also react with magnesium fuel to generate heat without gases that would carry the heat away. These include iron oxides, manganese dioxide, and elemental silicon. The use of the thermite reaction of magnesium and iron oxide creates a molten iron flux that improves heat transfer to the targeted metal surfaces. Powdered silicon metal and coarse potassium perchlorate also improves the ability of the mix to burn holes through metal targets. The elemental silicon forms a silicate that combines with the oxidized magnesium to form a melting flux that conducts heat more effectively into target metals. Using coarse potassium perchlorate (150-300 microns) works better than powdered potassium perchlorate in munitions tests.

The amounts of material used in these formulas varies widely.

Magnesium	35-75%
Esters	25-65%

additives mixed into the above include -

Ferric Oxide	28-35%
Magnesium	24-32%
Silicon	10-15%
Potassium Perchlorate	10-25%
Esters	25-65%

Incendiaries, The Science of Using Fire as a Weapon

All the ingredients except the magnesium powder are mixed together in a mechanical mixer while being heated to 80-130 F to help liquefy the fluoroalkyl phosphate ester. The magnesium powder is added after 5-10 minutes and mixed for 10 more minutes. This composition is then poured into the desired mold or cast into shape and cured at 135 F for 3 hours. These are easily ignited by hot wires, igniter squibs, torch flame, or other pyrogen mixtures.

The following formulas were tested and were found that it took 3 grams of incendiary to burn through 2 tin plate cans. To burn through mild steel plate (.041") equivalent to that used in 55 gallon drums, a 25 gram amount was required.

	<u>1</u>	<u>2</u>	<u>3</u>
Fluoroalkyl Phosphate Ester [Zonyl S-13]	32	32	29
Ferric Oxide	12	12	11
Magnesium Powder	28	28	26
Silicon	12	12	11
Potassium Perchlorate Coarse	16		
Lithium Perchlorate		13	23

Throughout the 1970's, several methods were developed to use heavy metal sponge particles to quickly manufacture reliable incendiary munitions. The metal sponge forms (2.5-300#) of hafnium, titanium, and zirconium were ductile enough to be pressed into a die and plastically deform under pressure so they would assume the shape of the die. The greater the pressure, the stronger the end shape was.

It was also known that when ignited with a mixed in fluorocarbon like Teflon, the warhead would project fragments of the sponge over greater distances than other metal fuel incendiaries. The fluorocarbon also formed metal tetrafluorides in the first reactions which help sustain the burning of the metal in air. When Teflon binder was used with the metal sponge, it would form strong compacted shapes that had close tolerances, physical strength, and a smooth surface finish making it easy to fit into warheads and other ordnance.

Teflon is the most tested fluorocarbon, but others may also be used such as -

- Perfluoropropylene (Teflon 100)
- Chlorotrifluoroethylene homopolymers (Kel-F wax)
- Vinylidene Fluoride (Kel-F elastomer)

and Copolymers such as

- Viton A
- Viton A-HV
- Fluorel

Incendiaries, The Science of Using Fire as a Weapon

The metals are produced by various means. Zirconium ore is refined from beach sands as Zircon (Zirconium Silicate), converted to zirconium oxide by liquid extraction (Kroll process), reacted with hydrochloric acid to yield zirconium chloride and then reduced by molten magnesium in a furnace to yield the sponge particles.

Zirconium metal sponge and Teflon mixed together in different % and particles sizes to yield a 1/2" OD x 1/4-1/2" pellet produced the following results. [Compared to pure zirconium sponge ignited by torch with 100% burn.] Compacting pressure was 12,000 psi.

<u>Zirconium Mesh size</u>	<u>%</u>	<u>Teflon micron size and %</u>		<u>Static/Explosive ignition</u>	
-1/4 +6	70	400	30	50%	0%
-1/4 +6	85	400	15	80	30
-1/4 +6	90	400	10	80	50
-6 +10	70	400	30	90	
-6 +10	85	400	15	100	
-6 +10	90	400	10	100	85
-10 +20	70	400	30	100	
-10 +20	85	400	15	100	
-10 +20	90	400	10	100	100
-1/4 +6	70	200	30	65	15
-1/4 +6	85	200	15	100	
-1/4 +6	90	200	10	100	100
-6 +10	70	200	30	80	100
-6 +10	85	200	15	100	
-6 +10	90	200	10	100	100
-10 +20	70	200	30	100	100
-10 +20	85	200	15	100	
-10 +20	90	200	10	100	100
1/4 +6	70	100	30	75	50
1/4 +6	85	100	15	100	
1/4 +6	90	100	10	100	100
-6 +10	90	100	10		100
-6 +10	95	100	5		100
-10 +20	90	100	10		100
-10 +20	95	100	5		100
-6 +10	98	100	2	100	100
The last formula was tested at 9,000 and 15,000 psi =				100	100

Incendiaries, The Science of Using Fire as a Weapon

Several means of distribution may be used -

1. A cartridge is activated pushing the contents out and dispersing them by propeller action.
2. A detonating cord can run the length of the bomb and burst it spreading the gel and capsules.
3. The munition can be fused to burst on impact or at altitude depending on targeted area.
4. The device can be fuseless and hardened to penetrate a structure and then release its self igniting contents.
5. Mechanical ejection rearward or forward by explosive or mechanical means.
6. Gas generating grains in place of the capsules may be used to provide propellant on ignition and distribute the gel.

Once the gel with self igniting capsules reach the ground, the capsules release white phosphorus or other reactive igniter which starts the munitions burning. This saves burning up gel unnecessarily during the descent and all these methods aid in distribution over the target areas.

5) Rockets and Missiles

Incendiary rockets and missiles consist of the main body of the rocket or missile which guides and propels the machine, and a warhead which carries the weapon. This warhead can be a bomb, spraying device, delay bursting device, or any other conceivable contrivance.

One of the early rocket artillery designs used by the French in the 1870's delivered a warhead that weighed 15.43# (7 Kg).

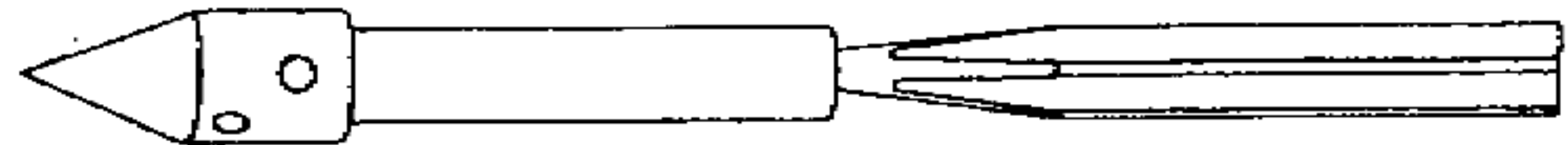

All modern designs use standard delivery systems to carry and deliver the payloads or warheads. Some detailed design information on rockets and missiles has already been described in volumes 1 and 3 and a future detailed volume is planned. Our main intent here is to describe recent designs of the payload or warhead carrying incendiary materials.

Incendiaries, The Science of Using Fire as a Weapon

One of the more easily improvised modern designs is a portable rocket artillery device that has its own discardable launching tube. It can quickly be carried, set up, and used anywhere in large volumes. A hand carried shovel can be used to secure its rear section in the ground. The azimuth and elevation be set as desired using wing bolts. The launching tube itself is made of cheap and disposable paper board or plastic and is used to both transport and launch the rocket.

This ground to ground weapon can be used to deliver any type of ordnance. In this case it is designed to improve on the delivery of incendiary materials like napalm or thermitic type materials.

The rocket carries a cylindrical tank as the warhead filled with an incendiary charge. This charge is usually composed of kerosene or gasoline that has been jelled, usually with polystyrene. A bracket on the front of the rocket carries a contact or proximity fuse assembly. An explosive (#19) is pointed into the main body holding the incendiary. When the fuse is ignited by proximity or contact, it ignites the explosive which drives its shell like a piston or spear into the body. This has the effect of igniting the incendiary and rupturing the cylinder wall. The incendiary is sprayed in all directions radially, dispersing the flaming material over a wide area. The rear of the device carries a standard rocket motor (25) assembly and tail fins for stabilization in flight. Most early napalm weapons relied on the force of impact to disperse its contents which often resulted in a crater being formed and most of the incendiary burning in the hole rather than being widely disseminated.

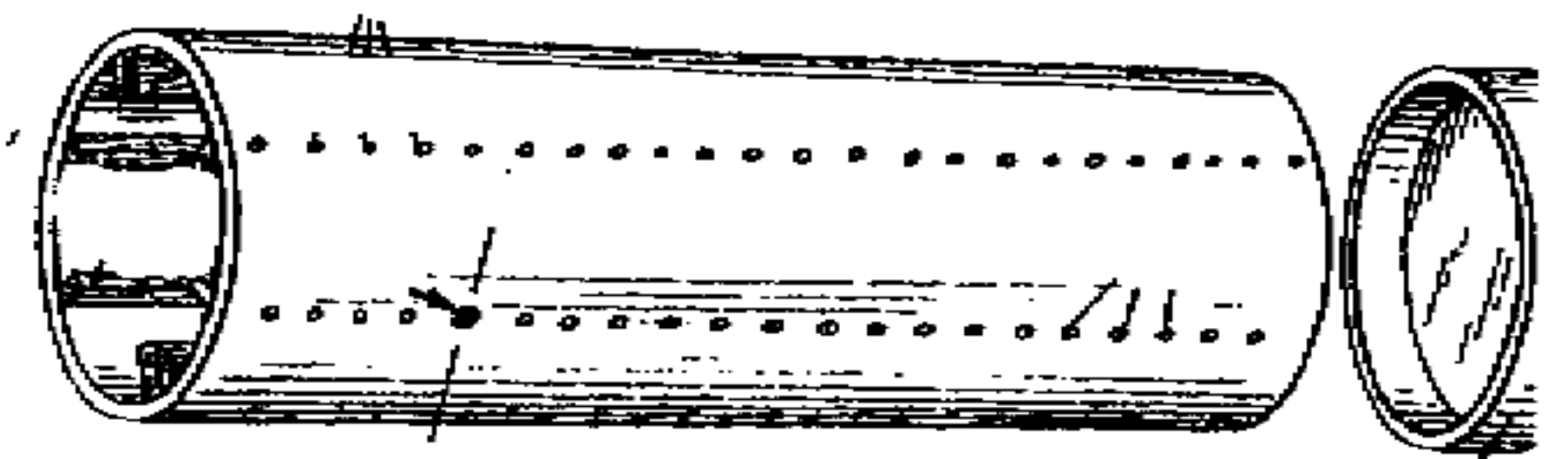
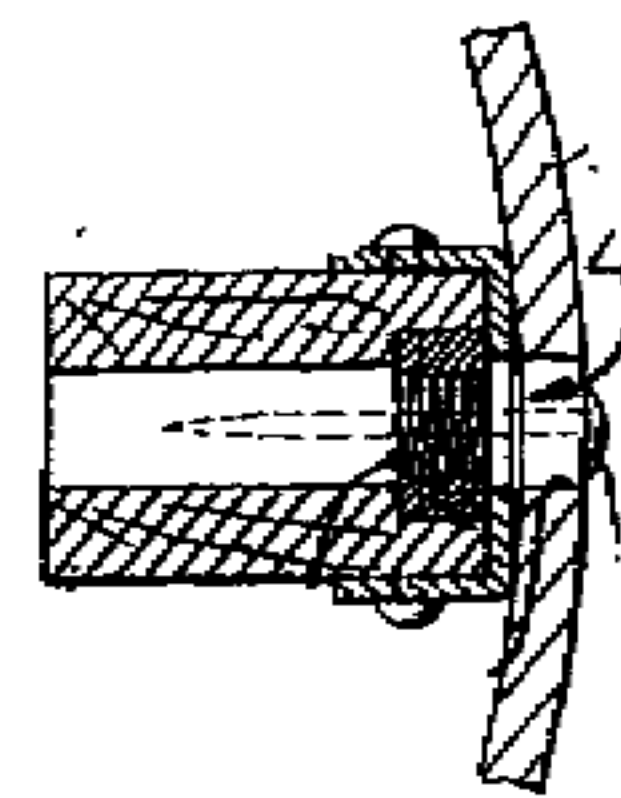
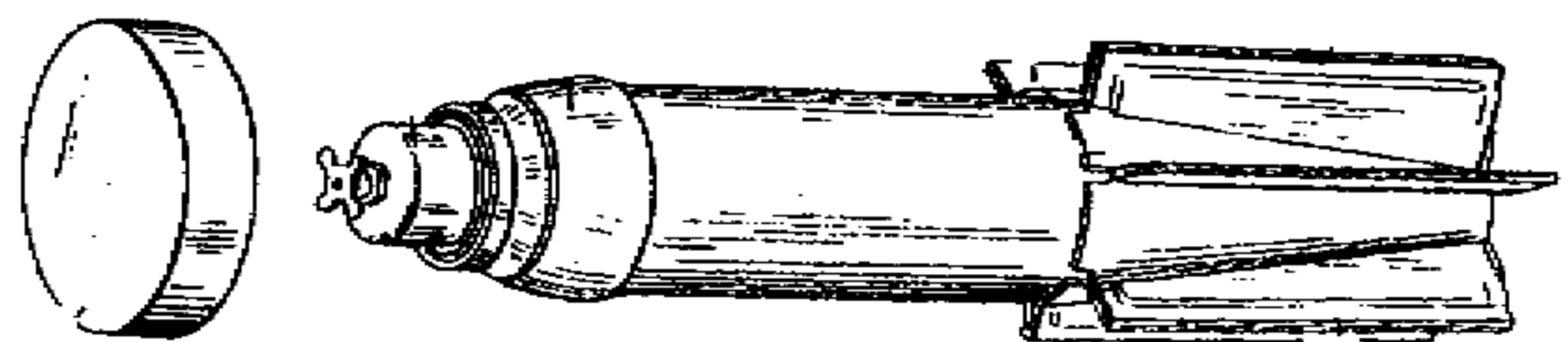
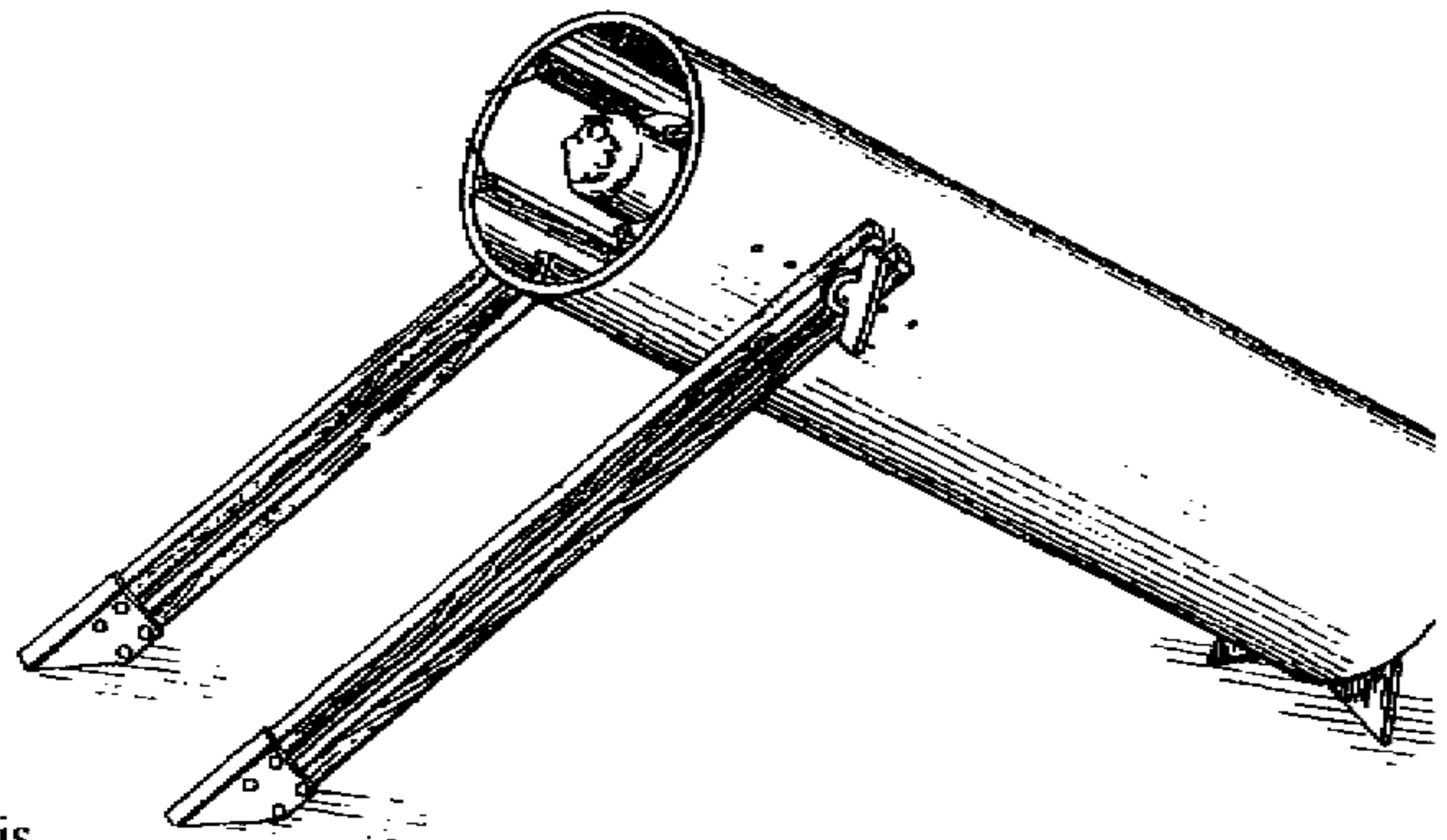
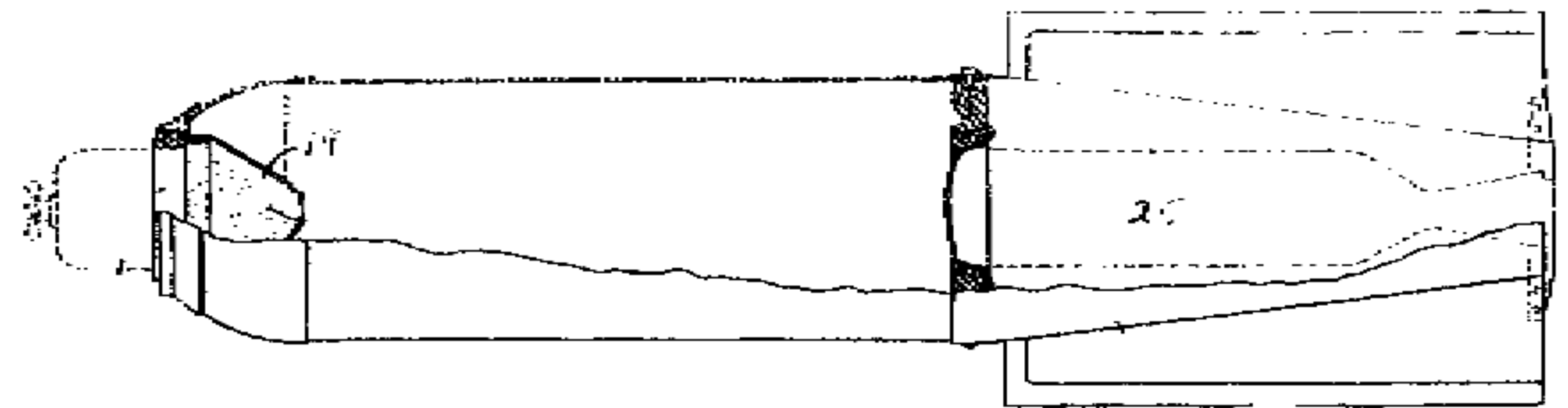

Incendiaries, The Science of Using Fire as a Weapon

Another concept for releasing incendiary payloads during flight is illustrated here. A number of designs have been developed to disperse incendiary contents out of the rear of a ballistic shell during flight. These shells can be artillery fired, or act as the warhead on missiles and rockets.

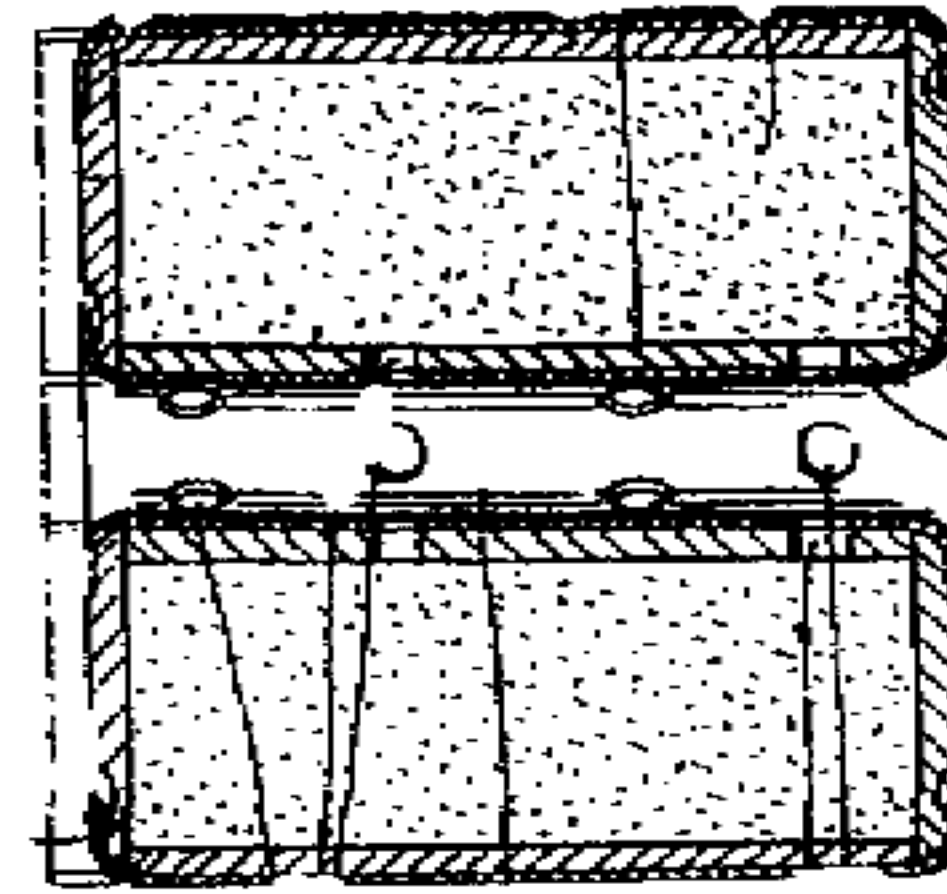

The incendiary usually exists in the form of briquettes situated around a central ignition channel. A fuse in the nose ignites an explosive which communicates force and fire down the ignition channel. This explosive force ejects the lighted briquettes out the rear (or out the nose in some designs) spreading them in a ring like fashion over the terrain it is passing above. A piston is actually driven by the explosive which forces the briquettes out. The fire from the explosive passes down the center channel and ignites each briquette as it is being propelled down the tube. The tube itself must be strong enough to contain the radial forces of the explosive. The incendiary can be thermitic in nature and designed to burn for a long time. This is most often accomplished by containing the briquette in a metal casing with holes that restrict the amount of air that can pass into and feed the ignited mixture. This slows the rate of burning and maintains the fuel for extended fire. The compositions can also be designed to emit light, smoke, be made to float, or even self explode directly above their targets to spray fuel over a wider area. Usually light metal alloys of high strength are used for the casings and are machined to fit each other and slide down the tube in the final assembly.

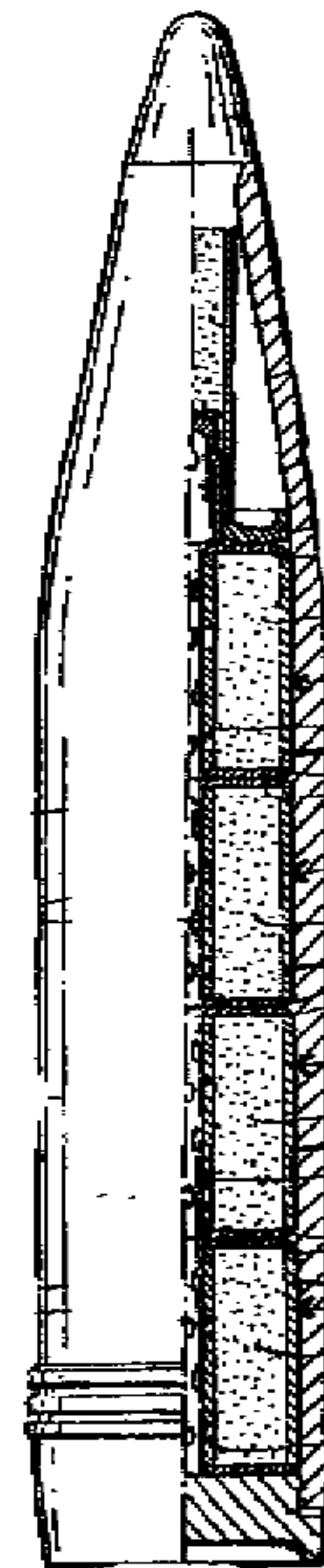

Convention fragmentary warheads have long been designed using an interior core of high explosive and surrounding it with steel ball bearings, cubes, nails, or rods which are propelled outward as thousands of fragments when the explosive is detonated. A number of improvements are incorporated into modern warhead design using incendiary metals in place of iron or steel.

Incendiaries, The Science of Using Fire as a Weapon

A warhead section is prepared by casting an explosive charge inside the warhead casing while leaving a space as shown for fragment material which is thicker in depth at the nose of the device.

Fragmentation cubes are prepared by cutting steel from rectangular extruded bar stock and are often coated with plastic in standard fragmentation bombs. In these designs, 2-12% of the cubes are replaced with incendiary cubes made of 90% Zirconium and 10% Tin alloy. All the cubes are cut to .145" size square. Commercial Incedaloy 501 alloy may be used. The steel and incendiary cubes are then mixed together in a mixer and are then poured into the cavity around the explosive charge. Once these are poured in and vibrated to aid in compacting the cubes, a plastic is poured into the cubes to fill the spaces and form a solid stabilized continuous mass. Insulating and rubber compounds are also acceptable.

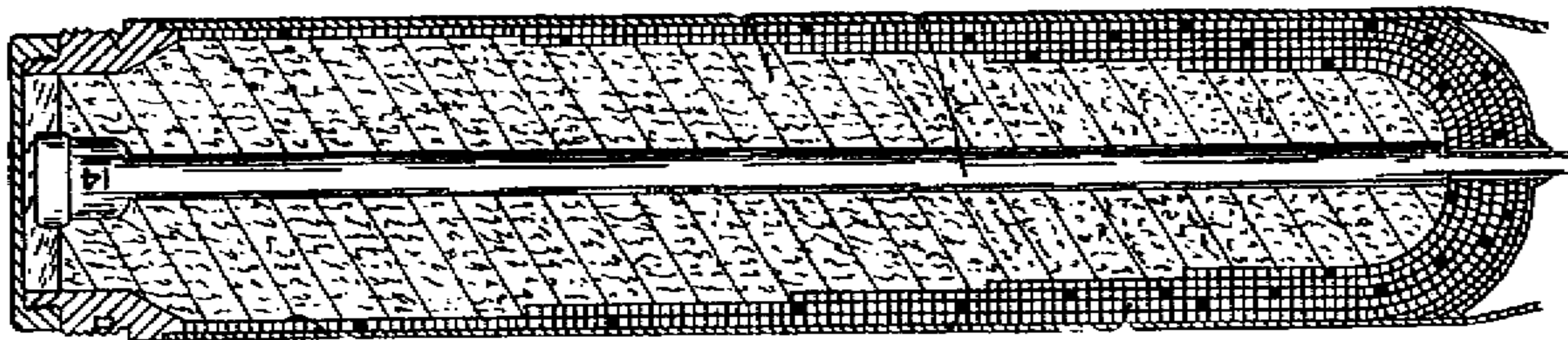
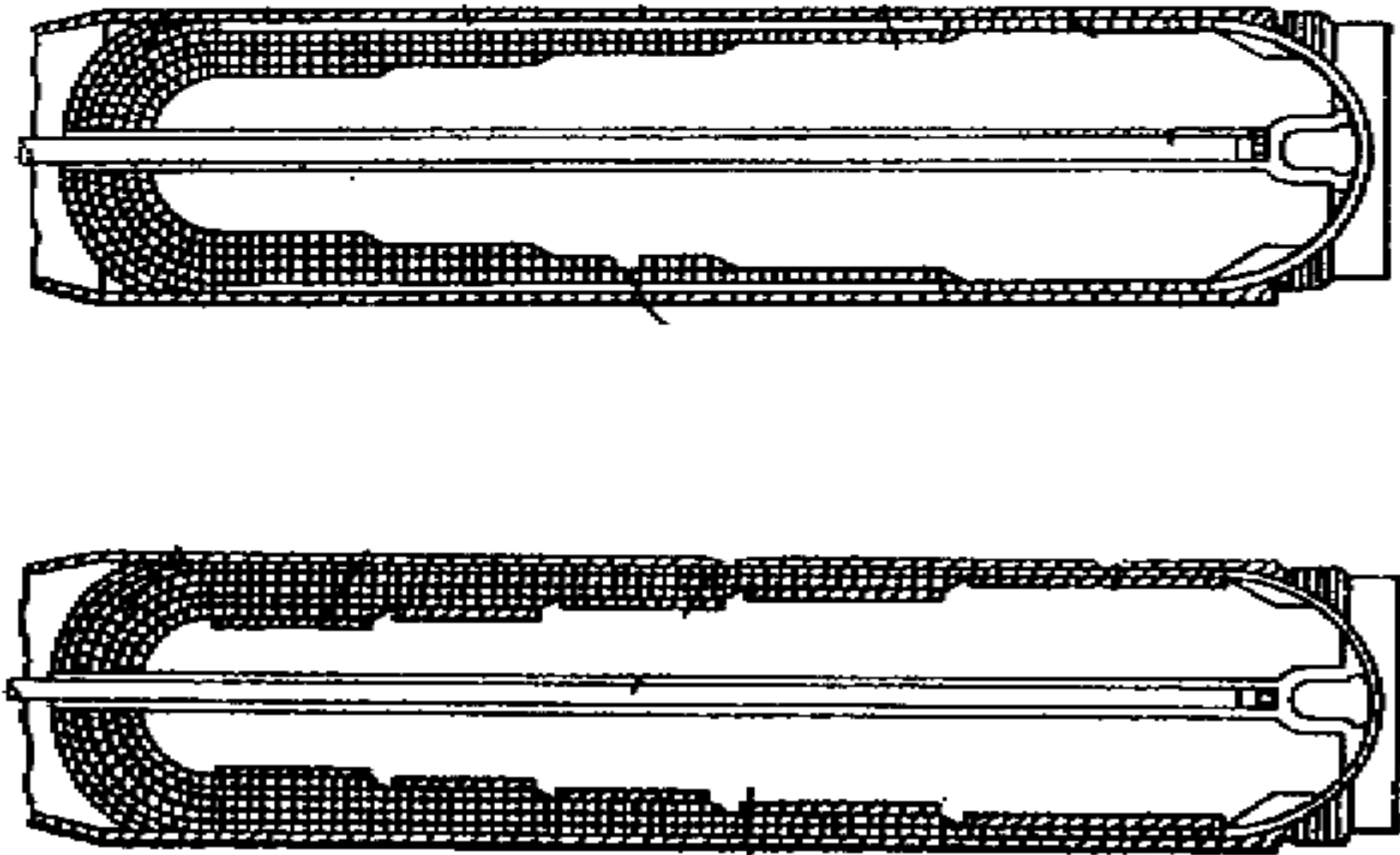

Many other pyrophoric configurations and ideas can be used in these designs. In testing of the above designs it was found by the patenting companies that the use of explosive fragments alone did not ignite fuel barrels located at 30-70 feet from the warhead detonation, while the zirconium-tin combination reliably set some on fire at 2% to most or all at 12% in the fragmenting mix. When air detonated the barrels were tested at 60-120 degrees from the longitudinal plane of the missile.

Incendiaries, The Science of Using Fire as a Weapon

The colors of a flame are affected by the salts in the fuel. These can be used to make improvised incendiary flares of different colors in the field. Natural fire = blue-yellow.

Violet or purple	Potassium
Reddish-Yellow	Calcium
Greenish-Yellow	Magnesium
Yellow	Sodium

The colors produced by pyrotechnic and fireworks chemicals are covered in Volume 3.

2) Small Arms and Large Gun Shell Design

Small arms fire bullets while larger guns fire shells. The bullets propellant is ignited by a mechanical action which sets fire to a primer incendiary composition. This mechanical striking action starts a fire which ignites a powder charge that propels the bullet or shell out the end of the gun barrel towards the target (or wherever the gun is pointed).

Formulas for early friction primers used to start the first fire are -

Potassium Chlorate	2	56.2	44.6	14
Antimony Sulfide	1	24.6	44.6	
Sulfur		9	3.6	
Meal Powder			3.6	
Ground Glass		10.2	3.6	
Charcoal				1.6
Calcium carbonate	.02	2	2	
Dextrin				.3

A typical bullet functions as follows -

- 1) The firing pin dents the cap
- 2) The cap in the cartridge case crushes a detonating compound against a brass anvil
- 3) The flash of the small primer ignites the main charge
- 4) The main charge explodes, burning rapidly. The temperature reaches 2700 degrees C and after .0005 seconds from ignition the propellant expands to 14,000 times its own volume in gas. The chamber pressure reaches 51,000 ft lbs. per sq.in.
- 5) The expanding gases force the sides of the cartridge case to seal so tightly against the walls of the chamber that no gas leaks to the rear
- 6) The pressure forces the bullet up the bore and out of the muzzle at very high velocities

Incendiaries, The Science of Using Fire as a Weapon

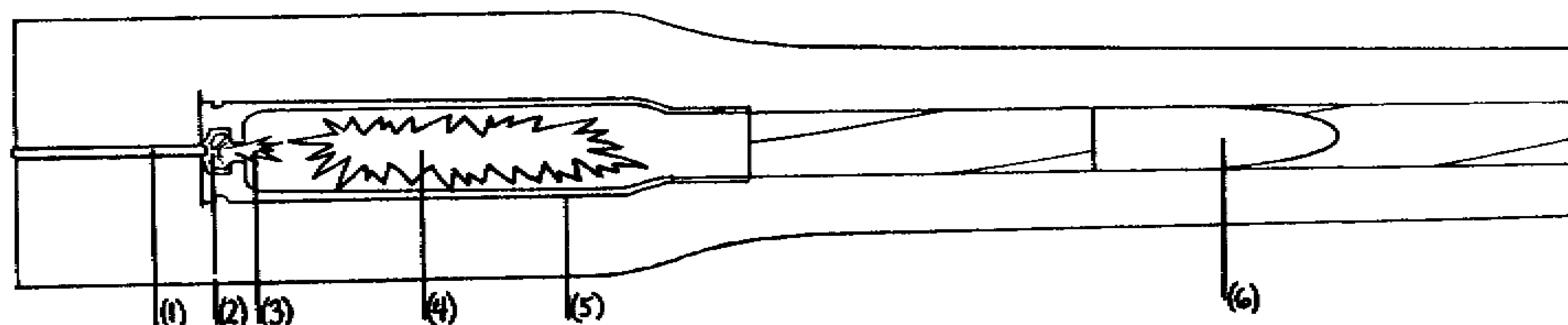

Modern percussion primers are designed to also produce fire when struck by the firing pin of a pistol, rifle, or cannon. It may also be used in the nose of a bullet or shell to initiate a fire on impact with a target. The early formulas used -

Mercury Fulminate	To produce the first explosion with heat and flame
Antimony Sulfide	To keep the flame burning longer
Potassium Chlorate	Provides oxygen for the combustion

TNT, Tetryl, PETN, or other high explosives may be added to make them burn hotter. Ground glass is sometimes added to make them more sensitive to the percussion by throwing hot particles of glass into the black powder charge. The hotter explosives are used for smokeless propellants. The formulas were usually mixed wet with a gum arabic solution. They were loaded into the caps like blasting caps are loaded, and then are pressed into place with the anvil inserted and pressed in over it.

Mercury Fulminate	10	28	48.8	4	5	2	
Potassium Chlorate	37	35.5	24.4	2	9	3	50
Antimony Sulfide	40	28	26.2	3	3	3	20
Ground Glass	13	8.5		5			
Ground Coke					1		
Tetryl					2		
TNT							5
Lead Peroxide							25

The last formula uses no fulminate and relies on the reaction of well mixed particles.

Incendiaries, The Science of Using Fire as a Weapon

Special military primer compositions use different materials. These include lead salts that communicate "hot" lead combustion products into the main propellant charge and thiocyanate that acts as an antacid. The PA-101 is non-corrosive and uses lead styphnate as the main explosive. The FA-70 uses the chlorate combustion to form the combustion reaction. The final formula G-11 was developed for use in aircraft guns used at high altitudes where the bullets reached temperatures of more than 200 C without misfiring.

	<u>FA-70</u>	<u>PA-101</u>	<u>G-11</u>
Lead Styphnate		53	
Barium Nitrate		22	
Potassium Chlorate	53		51
Antimony Sulfide	17	10	26
Calcium Silicide			13
Tacot*			10
Lead Thiocyanate	25		
TNT	5		
Aluminum Powder		10	
Tetracene		5	

* Tetranitro benzotriazolo benzotriazol - Tacot is the trade name (Du Pont)

Incendiary tracer munitions are produced to -

- Mark target impacts
- Identify nighttime combat participants
- Estimate range
- Guide the direction of fire
- Act as incendiaries

Tracer bullets are designed to leave a clearly visible trail, usually red for the best visibility in bad weather. Green tracer formulations are made by using barium salts in the formula. Daylight tracers include using dry powders, sublimed organic dyes, and the combustion of phosphorus, or cadmium and sulfur (yellow smoke). Adding magnesium to the tracer increases visibility.

	Delay igniter	Dim Igniter	Bright Day Igniter	Red Tracer
Strontium Peroxide	90			
Magnesium		6	15	28
Delay action igniter		94		
Calcium Resinate	10			4
Barium Peroxide			83	
Zinc Stearate			1	
Strontium Nitrate				40
Strontium Oxalate				8
Potassium Perchlorate				20
Toluidine Red Identifier			1	

Incendiaries, The Science of Using Fire as a Weapon

Special bullets are constructed in many different forms (and formulas) to communicate incendiary effects to a target. The idea behind using special designs and formulations in bullet and artillery rounds (and in air dropped bombs) is that they easily start destructive and dangerous fires. They are usually used against flammable targets such as fuel depots and aircraft fuel tanks. The larger artillery rounds carry fuses and are used to spray the incendiary metal fragments inside enemy tanks to ignite fuel tanks and munitions. Against other targets that do not ignite easily, the military uses napalm and thermite mixtures that adhere to the target and burn at length, forcing an ignition.

Most aircraft use aluminum as the primary structural material for their fuel tanks. This is done as a weight saving measure. Special antiaircraft bullets have been developed for use against aluminum aircraft fuel tanks and structural parts. These involve the features of -

*Teflon tip (tetrafluoroethylene resin) or nosecone which strikes the target point first. Because of the kinetic energy of the high velocity impact, the Teflon produces an violent exothermic reaction with aluminum paneling. An aluminum fluoride compound is produced from this reaction which reduces the metal to a hot powder which can ignite fuel vapors.

*A plastic jacket and rotating band of glass reinforced 6/12 nylon, 43% filled with glass, is fabricated so that the interior cavity is octagonal in shape. This provides a flight stable and accurate projectile. The advantages of this is that it is easy and cheap to manufacture, can be mass produced, and does not require the use of strategic metals. It also ruptures on impact more easily than metal jackets making the impact more pyrophoric from the kinetic energy of the collision.

*The interior cavity is filled with a Misch metal/aluminum alloy that fits the octagonal core and that breaks up on contact with the target spreading lethal pyrophoric fragments throughout the target and ignites the fuel vapors over a large area. The alloy is composed of

87% Commercial Misch Metal of	50% Cerium
	25% Lanthanum
	25% mixture of other rare earth metals
+ 13% Aluminum metal	

The overall design produces less erosion to gun barrels and less overall weight.

Incendiaries, The Science of Using Fire as a Weapon

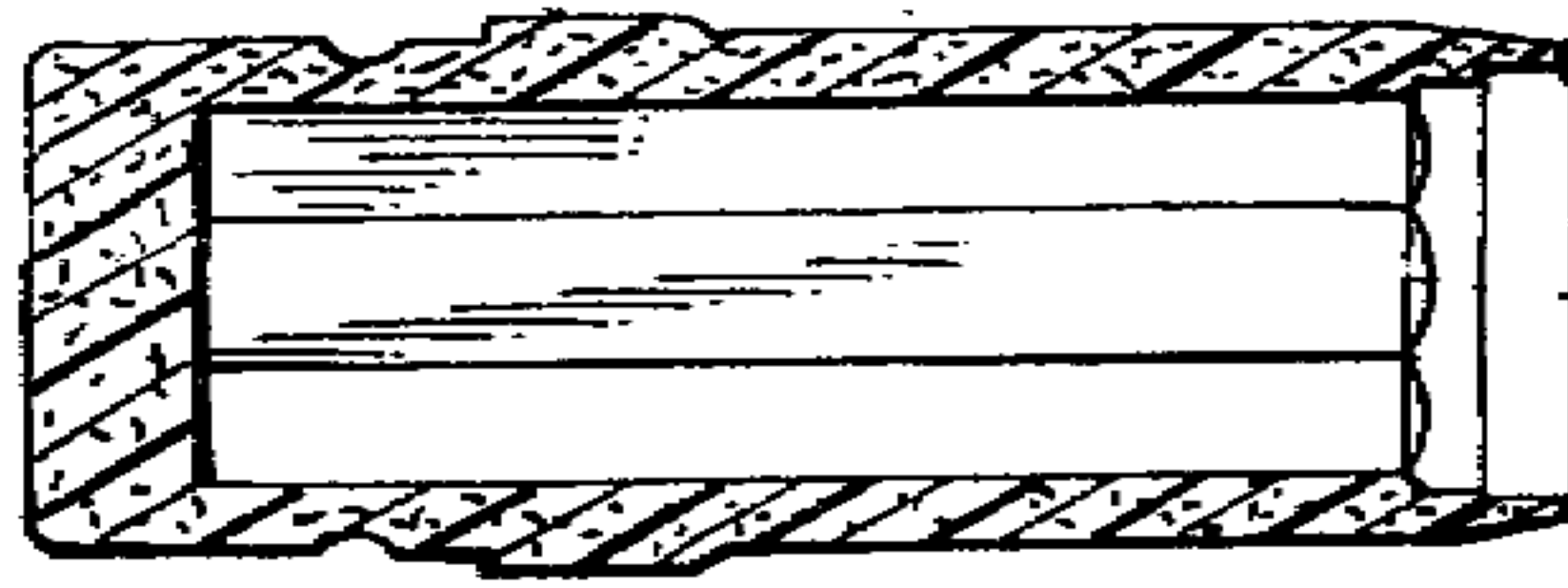

A standard artillery shell used for delivering incendiary material usually contain the pyrophoric material surrounding a core of bursting explosive. Quite often, the casing is weakened to make bursting and distribution of the chemical easier.

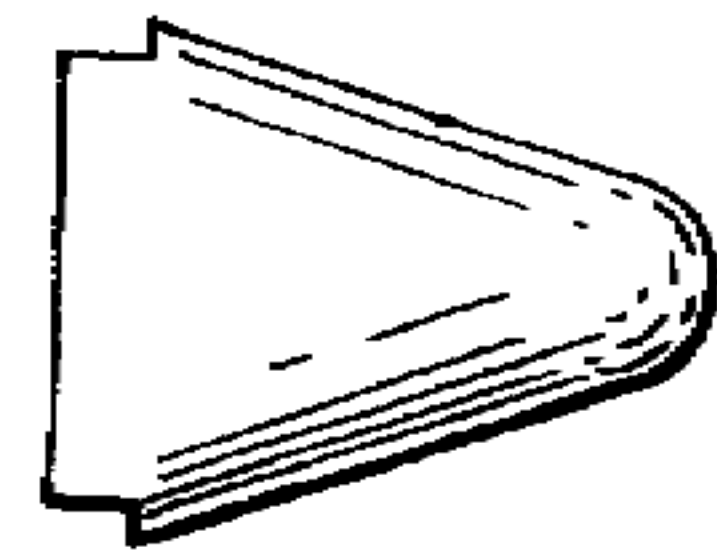

Pyrophoric fragment generating bullets have been developed using Misch metal as a coating on incendiary projectiles. In 1992, a patent was issued to a group of German inventors on applying a cerium based Misch metal coating onto projectiles that splinters into pyrophoric fragments on impact.

An ordinary or hollow projectile (hollow is preferred because it deforms and produces splinters more readily) has a cerium Misch metal alloy applied as an exterior casing. This casing is then pre fractured, or the steel body can be formed with splinters, so that the projectile self fragments on impact spraying hot pyrophoric fragments throughout the target.

The steps used to create and apply variations of this coating are -

1. Preparation of projectile casing splinters. These are made of steel, hard metal, or heavy metal. They are produced in the desired shapes of the splinters. The metal will contain an adhesion promoter in it, usually a metal like cobalt, nickel, manganese, silver, copper, or cadmium. The hard metals are usually made of tungsten carbide, titanium carbide, or tantalum carbide. Heavy metals can be chromium-molybdenum, tungsten-vanadium-niobium, tantalum-titanium-zirconium, or hafnium, or cobalt-nickel alloys. The adhesion promoter is usually applied in a thickness of 5-50 μm , with a thickness of 15-20 μm being the best. It is usually mixed into the base alloy at 22-27%. The surface is then sandblasted to provide a clean, rough surface for the coating.

Incendiaries, The Science of Using Fire as a Weapon

2. The casings splinters are then made pyrophoric by the application of a metallic alloy coating using cerium Misch metal wire which is melted and spray coated onto the base metal at low pressure. The wire formula used is -

Cerium	45-60%
Lanthanum	15-30%
Neodymium	10-20%
Praseodymium	4-7%
Yttrium	2-4%
Samarium	1-2%

3. This mix is available as coiled wire of 2-3mm thickness. If the wire can be obtained with 3-5% lead then this is preferred. The lead acts as a flowing agent and increases the ductility of the Misch metal. The lead may be replaced with tin or germanium. All these metals partly segregate and rise to the surface of the cooling alloy forming a protective coating on the metal.

4. Another useful additive is including calcium or magnesium imbedded in the form of tiny wire mesh into the cesium at a rate of 3-5%. When the coating strikes the target, these metals act as moderators on the rate of burn which increases the burn time. They also lower the ignition point and increases the sensitivity to ignition. This makes the Misch metal very easy to reliably ignite on impact and helps maintain the burn time to insure ignition of the target combustibles.

5. The coating is applied by using a low pressure wire spraying method where it is turned to a molten mass under an arc from two wires (or one wire being a non-alloy such as tungsten). The Misch metal is finely atomized and propelled onto the surface by an inert gas (argon). The entire chamber in which this is done should be a complete vacuum followed by filling the chamber with an inert argon atmosphere. This is to prevent the oxidation and ignition of the Misch metal.

The wire is 2-3mm and is applied in a direct current of 30-35 volt and current intensity of 40-60 ampere. The metal surface should be kept at a temperature of 250-400 C during the spraying to achieve the best results.

6. After the coating is applied, the projectile is tempered for 20 minutes to several hours at 600 C.

7. The projectile is then coated with an anti-corrosive layer to prevent oxidation of the metal. This layer is usually made of a rubber fluoride, cold zinc, silicone resin, polyethylene, or polyurethane.

8. The final projectile can be "prefragmented" into special shapes and sizes to maximize the pyrophoric effect. This is done by milling or lathing the coatings at the desired outline, or using electron or ion beams to cut the outline.

Incendiaries, The Science of Using Fire as a Weapon

When the projectile strikes the target, the bullet fragments into the splinter shapes which ignite from the force of impact and spread throughout the target area igniting combustibles on contact. More information is available from the German publication DE-A 20 59 753, or US Patent 5,096,507.

An armor piercing incendiary projectile for 20-35mm weapons, patented in 1995 (#5,442,989), is produced as follows.

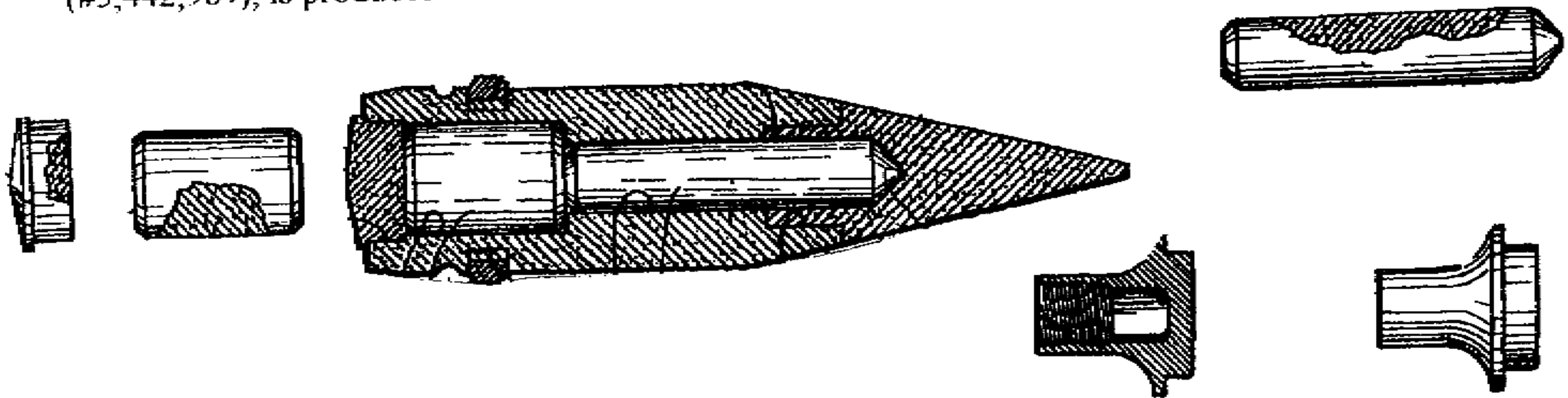

1. An exterior frangible body made of a brittle, porous, molded, sintered powder is prepared from 60-100% stainless steel #316, and 0-40% iron. The powder may contain 2-2% graphite (.8% ideal). The powder is compressed into a casing mold to a density of .21-.24#/Cu.in.

2. The molded powder is sintered in an inert atmosphere at 1500-1700 C for several hours to produce a frangible casing that fragments into thousands of granules upon impact with the target. The graphite powder vaporizes and escapes during this step. A rotating band is added in the casing mold for use with the desired rifling in the gun barrels of the shell size.

3. A penetrator rod made of very hard and dense material such as tungsten or tungsten carbide (sintered from the powdered metal) is inserted into the casing and machined if necessary for the desired fit.

4. An incendiary pellet is placed directly behind the penetrator rod and is larger in diameter than the rod. The pellet is made of zirconium metal (or other incendiary metal) in an epoxy matrix which is molded into the casing. A large rear stainless steel plug is inserted behind the pellet.

The projectile is designed to be fired from 20-35mm cannons at the highest muzzle velocity (chamber pressure) that the gun can safely be operated at. The frangible body acts as a sabot to carry the penetrator rod. Its stainless steel construction allows it to survive the firing forces and because of its velocity, it produces a highly energetic collision with the target and fragments into many pea sized granules that continue forward. The penetrator rod continues forward and is guided and supported by the casing and its fragments as it punches a hole through the target. The casing prevents bending or shattering of the rod and its fragments accompany the rod to the interior of the target where the granules spread outward causing damage.

Incendiaries, The Science of Using Fire as a Weapon

The incendiary pellet follows the rod to the interior, is ignited by the collision energy and epoxy oxygen, and spreads out in the interior of the target igniting combustibles.

Thin armor plating of most lightly armoured vehicles, aircraft, and structures is easily penetrated by these sabot projectiles. Engine blocks are damaged and fuel tanks ignited from the force of the impact which makes this an effective weapon. Other advantages include the absence of explosives, fuses, detonators, and other components used in anti-armor projectiles previously deployed. This makes these projectiles less costly to produce and safer to handle, manufacture, and ship.

Armor piercing anti-tank incendiary shells can be prepared in several ways. Early designs included placing incendiary material in a hollow nosecone of a shell, usually backed with armor penetrating devices and explosive behind a ballistic cap. The ballistic cap was usually made of a cushioning material such as aluminum, lead, or similar alloys. These are used to reduce the shear or rupture of the penetrating nose cone. It acts as a lubricant in aiding penetration of thick armor. The incendiaries were conventional mixtures of magnesium/aluminum alloy, barium nitrate, ammonium perchlorate, and so on. These early munitions also had the disadvantage of releasing most of the incendiary on the entry side of the armor when the nosepiece would strike and rupture on the target.

In many circumstances, the incendiary would ignite and be completely consumed before any of it reached the interior of the armor. High speed photography was used to identify the process where the incendiary was consumed before affecting the contents of armoured structures and vehicles.

Two patented improvements were made to yield incendiaries that would ignite during or after penetration and would aid in penetration. The first improvement, patented in 1978 involved the use of incendiary metals in the nosepiece, followed by a penetrating device. The second, patented in 1984 involved adding an incendiary mixture behind an explosive.

In the first improvement, a metal of consisting of -	Zirconium
	Titanium
	Thorium
is interspersed with a metal (or mix) of	Hafnium
Tin	Uranium
and/or Lead	or mixtures of the above

The mixture of the above metals produces a cushioning lubricating effect for the penetrator and it ignites during and after penetration of the target armor. It also has the effect of instantly liquefying steel armor in contact with the burning metal which forms a low melting eutectic alloy of zirconium (or other metal) and steel. This reduces the friction on the penetrator and the rest of the incendiary alloy which passes through the liquefied armor.

Incendiaries, The Science of Using Fire as a Weapon

The ideal formula is 80-95% of the first metal, preferably Zirconium, and 5-20% of the second metal, preferably Tin. They are shaped into the desired form by arc welding under an inert atmosphere or vacuum and usually encased in an iron jacket while heated at 1,720 C. The metal mixtures would not ignite until fired into target armor at a minimum of 1,700 to 2,000 feet per second. The ignition would yield temperatures of 4,000-9,000 F which produces an explosive type of burning and sprays the incendiary particles outward. These temperatures are sufficient to melt holes in thin armor plate by themselves. The nosecone of a penetrating metal follows the incendiary charge into and through the armor.

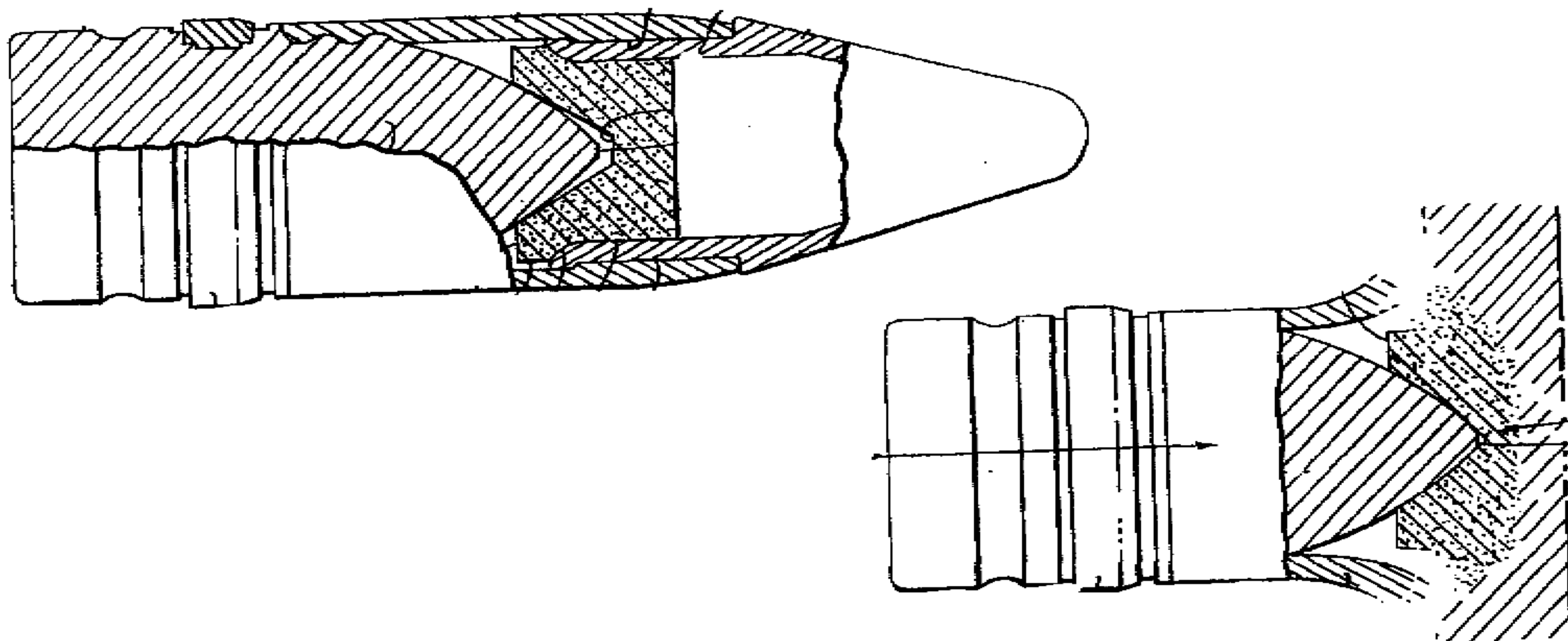

The second shell improvement, developed in Switzerland, is a multiple component weapon involving the fitting of a separate incendiary grenade or shell in front of an explosive projectile following it.

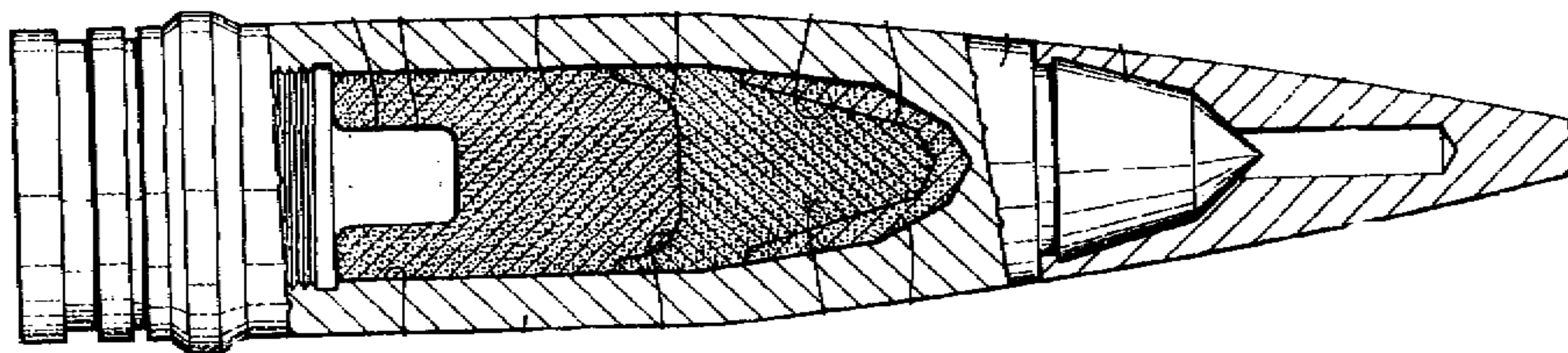

Incendiaries, The Science of Using Fire as a Weapon

The rear section of the grenade or shell contains 5 grams of a suitable incendiary like zirconium as well as 7.5 grams of an explosive charge behind it (#14 and 15). Behind that, another 7.5 gram explosive charge (#16). The preferred explosive charges are -

30%	Aluminum Powder
66%	RDX/Cyclonite
4%	Binder or plasticizer

The projectile body tip (#12) is surrounded by a hood (#21). A forward incendiary charge is located at in a hollow cylinder (#22). A base fuse (#16) ignites the explosive chain.

The forward incendiary ignites and softens the metal armor. The body tip strikes the soften armor and the impact shock sets off the fuse which detonates the explosive propelling the penetrator and its incendiary package through the armor and into the interior of the armoured structure.

3) Hand Thrown Incendiaries

Most of the hand thrown incendiaries are of the improvised molotov cocktail variety (1) or are professionally manufactured grenades (2) which usually contain self igniting air reactive materials like white phosphorus.

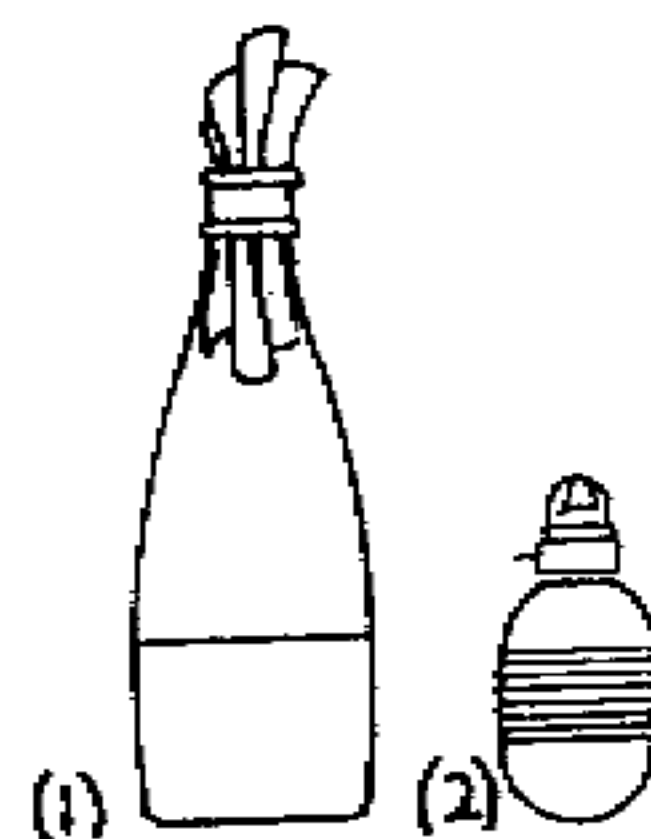

Field Improvised Hand propelled Incendiaries developed by the US Army include -

Incendiaries, the Science of Using Fire as a Weapon

Chapter 4

Attacking Fuel- Based Targets

Success in attacking targets with incendiaries depends on many factors. Among these are the ability to close on the target, especially if it is well guarded, if it is armored, what incendiary ordnance is available, is the target combustible, and so on. Several new basic terms will be covered in this chapter since it will also serve as an introduction to attacking all types of targets as well as fuel based materials.

Attacking fuel based and other targets where explodable vapors are produced rapidly produces opportunities to greatly expand potential losses to the enemy far beyond the capabilities of the ordnance alone. We have already provided some basic information on the physical and chemical characteristics of many materials and the behavior of explosives. We will add to these concepts now.

When flammable or explodable vapors are mixed into the air, they have a range at which they may explode. If the fuel-air mixture is too lean or too rich it will not explode or even catch fire. Once it falls into the combustible range, it will ignite and support combustion until the fuel or oxygen is again out of balance. As a mixture is ignited in its lower flammability limits in air, it immediately heats up the mixture from the combustion creating a pressure increase. The temperature of natural gas exploding near its lower limits of 4-5% results in a temperature rise of 2,500 F and upward to nearly 4,000 F instantly. This produces an increase in pressure from about 20 pounds per square inch gauge (psig) with the lean mixture to an increase in pressure to 100+ psig near the middle of its flammability limits which is a near perfect mixture chemically (about 9-11%), then the pressure drops again to about 20 psig at its upper flammability limits of app. 15%. This rise and fall in pressure applies to nearly all fuel-air mixtures which require some added oxygen from the air. It is then beneficial to know how to attack vapor producing targets in such a manner that the maximum damage can be produced from such mixtures.

Gas mixtures that are ignited near the center of their flammability limits produce much more heat and pressure and as a result, much greater damage. The pressures used to measure gas is usually in psig. The pressures that buildings use to measure thier ability to stand up to are calculated in pounds per square foot (psf). A force of 1 psig = 144 psf (12 inches x 12 inches). A force of 2 psig = 288 psf. A force of the 20 psig at the lower flammability limits equals 2,880 psf. Few buildings are designed to withstand this amount of force at ground zero.

If the ignition is confined, the pressures that build from thermal expansion alone can become so great that they reach explosion forces. This is how a very small amount of vapor mixed with air is capable of blowing out walls of buildings in gas explosions. If you have two rooms filled with gas in a building and they explode, it is not uncommon for the wall between the rooms to be left standing while the walls are blown out. This is because the pressure created by the exploding gases mixed in both rooms was app. equal and created balancing pressures. The walls had great pressure on the inside with only ambient air on the outside to push against.

Incendiaries, the Science of Using Fire as a Weapon

As we have already described, if a room where a fire has broken out runs out of oxygen, the high temperatures continue to pyrolyze solids in the room creating hot combustible gases and increasing pressures. When someone opens a door, the oxygen mixes into the room and ignites instantly producing an explosion with further mixing of gases as the walls collapse and the fire reignites.

To further teach this idea or concept, we can use a liquid propane (LP) burner that is used to heat a room in a home. If the burner from a tank is lit, the velocity of the burning gas as it escapes the pilot light is typically 1.5 feet per second or about 1 mile per hour. If the gas is not confined as in the form of a free burning fire, the velocities can reach to tornado levels.

A typical water heater may burn propane at 30,000 BTU's per hour with a flame front velocity of 1.5 feet per second. At this rate it has consumed 30,000 BTU's worth of fuel. If this amount of vapor is discharged into the room without being ignited and without ventilation, it now forms a fuel air mixture. A source of ignition at the end of this one hour can be used to ignite this mixture. All of the BTU's of fuel are burned in a microsecond producing an expansion of gases and pressure buildup of the hot flaming mixture. This results in a fuel air explosion that knocks out the windows ventilating the room and providing a fresh and renewable source of oxygen. The flame pyrolyzes the solids, the fuel source may rupture, and the fire expands.

If portions of this cloud of vapor become too rich or are too lean to support combustion, the portion within its flammable limits will only ignite. If its force is sufficient to knock down barriers and carry the vapors into more air (oxygen), then a "rolling" explosion occurs. This explosion may take place over several seconds and often sounds like an earthquake with a continuous rumbling and shaking of the ground. This type of explosion does not build up to its maximum explosive potential. This type of explosion uses up its fuel more slowly, producing more heat, and as a result is able to set more combustibles on fire. Having a window open to provide some ventilation in a room eliminates the confinement pressures which reduces the explosion damage but increases the fire potential.

In the earlier chapters you saw many references to the flammable and explosive limits in air. The factors which determine if an explosion or only a fire occurs are the amount of gas available and the confinement of the gas at the point of ignition. This is demonstrated when a person attempts to light a pilot light. A fire occurs at the point of discharge when the escaping gas is lit. If the pilot light does not have an ignition source and fills the area around the outlet, then it will produce a small explosion after 2-3 seconds worth of fuel is dispersed into the surrounding air. This flame will usually flash back to the burner igniting it and then it burns properly as the vapor rate of discharge is regulated.

As heated gases burn, they create the pressure of expanding gases. As these gases push against more unburned gas, they compress it which increases the temperature of the gas (pressure alone increases temperature). With great pressures, the autoignition temperatures are reached causing another explosion. This effect is seen in pipes and tunnels where the length that the expanding gases travel is much greater than the diameter.

Incendiaries, the Science of Using Fire as a Weapon

Autoignition Temperatures of vapors and gases of liquids with flash points below 100 F (37.8 C)

Material	Group	°F	°C	Material	Group	°F	°C
Acetaldehyde	C*	347	175	2-Hexanone	D	795	424
Acetone	D*	869	465	Hexenes	D	473	245
Acetonitrile	D	975	524	Hydrogen	B*	752	400
Acetylene	A*	581	305	Hydrogen cyanide	C*	1000	538
Acrolein (inhibited) ^a	B(C)*	455	235	Hydrogen selenide	C	—	—
Acrylonitrile	D*	898	481	Hydrogen sulfide	C*	500	260
Allyl alcohol	C*	713	378	Isoamyl acetate	D	680	360
Allyl chloride	D	905	485	Isoamyl alcohol	D	662	350
Ammonia	D ^{ab}	928	498	Isobutyl acrylate	D	800	427
n-Amyl acetate	D	680	360	Isobutyraldehyde	C	385	196
sec-Amyl acetate	D	—	—	Isoprene	D*	743	395
Benzene	D*	1040	560	Isopropyl acetate	D	860	460
1,3-Butadiene ^a	B(D)*	788	420	isopropylamine	D	756	402
Butane	D*	550	288	Isopropyl ether	D*	830	443
1-Butanol	D*	650	343	Isopropyl glycidyl ether	C	—	—
2-Butanol	D*	761	405	Liquefied petroleum gas	D	761-842	405-450
n-Butyl acetate	D*	790	421	Manufactured gas (containing more than 30% H ₂ by volume)	B*	—	—
iso-Butyl acetate	D*	790	421	Mesityl oxide	D*	652	344
sec-Butyl acetate	D	—	—	Methane	D*	999	537
Butylamine	D	594	312	Methanol	D*	725	385
Butylene	D	725	385	Methyl acetate	D	850	454
Butyl mercaptan	C	—	—	Methylacetylene	C*	—	—
n-Butyraldehyde	C*	425	218	Methylacetylene-propadiene (stabilized)	C	—	—
Carbon disulfide ^c	—*	194	90	Methyl acrylate	D	875	468
Carbon monoxide	C*	1128	609	Methylamine	D	806	430
Chlorobenzene	D	1099	593	Methylcyclohexane	D	482	250
Chloroprene	D	—	—	Methyl ether	C*	662	350
Crotonaldehyde	C*	450	232	Methyl ethyl Ketone	D*	759	404
Cyclohexane	D	473	245	Methyl formal	C*	460	238
Cyclohexene	D	471	244	Methyl formate	D	840	449
Cyclopropane	D*	938	503	Methyl isobutyl ketone	D*	840	440
1,1-Dichloroethane	D	820	438	Methyl isocyanate	D	994	534
1,2-Dichloroethylene	D	860	460	Methyl mercaptan	C	—	—
1,3-Dichloropropene	D	—	—	Methyl methacrylate	D	792	422
Dicyclopentadiene	C	937	503	2-Methyl-1-propanol	D*	780	416
Diethyl ether	C*	320	160	2-Methyl-2-propanol	D*	892	478
Diethylamine	C*	594	312	Monomethyl hydrazine	C	382	194
Di-isobutylene	D*	736	391	Naphtha (petroleum) ^d	D*	550	288
Di-isopropylamine	C	600	316	Nitroethane	C	778	414
Dimethylamine	C	752	400	Nitromethane	C	785	418
1,4-Dioxane	C	356	180	Nonane	D	401	205
Di-n-propylamine	C	570	299	Nonene	D	—	—
Epichlorohydrin	C*	772	411	Octane	D*	403	206
Ethane	D*	882	472	Octene	D	446	230
Ethanol	D*	685	363	Pentane	D*	470	243
Ethyl acetate	D*	800	427	1-Pentanol	D*	572	300
Ethyl acrylate (inhibited)	D*	702	372	2-Pentanone	D	846	452
Ethylamine	D*	725	385	1-Pentene	D	527	275
Ethyl benzene	D	810	432	Propane	D*	842	450
Ethyl chloride	D	966	519	1-Propanol	D*	775	413
Ethylene	C*	842	450	2-Propanol	D*	750	399
Ethylenediamine	D*	725	385	Propionaldehyde	C	405	207
Ethylene dichloride	D*	775	413	n-Propyl acetate	D	842	450
Ethylenimine	C*	608	320	Propylene	D*	851	455
Ethylene oxide ^a	B(C)*	804	429	Propylene dichloride	D	1035	557
Ethyl formate	D	851	455	Propylene oxide ^a	B(C)*	840	449
Ethyl mercaptan	C*	572	300	n-Propyl ether	C*	419	215
n-Ethyl morpholine	C	—	—	Propyl nitrate	B*	347	175
Formaldehyde (gas)	B	795	429	Pyridine	D*	900	482
Gasoline	D*	536-880	280-471	Styrene	D*	914	490
Heptane	D*	399	204	Tetrahydrofuran	C*	610	321
Heptene	D	500	260				
Hexane	D*	437	225				

Incendiaries, the Science of Using Fire as a Weapon

Material	Group	°F	°C
Toluene	D*	896	480
Triethylamine	C*	—	—
Tripropylamine	D	—	—
Turpentine	D	488	253
Unsymmetrical dimethyl hydrazine (UDMH)	C*	480	249
Valeraldehyde	C	432	222
Vinyl acetate	D*	756	402
Vinyl chloride	D*	882	472
Vinylidene chloride	D	1058	570
Xylenes	D*	867-984	464-529

Dust of combustible solids can also produce explosions and massive fires when mixed into or suspended in air. The dust must exceed a lower explosive limit in air, its concentration in air must be large enough to support sustained combustion. The minimum amount for most combustible dust is .065 ounces per cubic foot. Dust is suspended in air because its tiny size allows it to be propelled into its surroundings in all directions, and because of its tiny size and the friction of the air, the effects of gravity which pull it toward the ground is negligible. The dust eventually settles on surfaces where it represents a fire hazard.

Once a dust explosion begins, the force of the deflagration stirs up more surrounding and settled dust which can result in a rolling explosion. Unlike vapors, dusts have no upper explosive limits in air and will continue to burn and explode as long as there is dust available in contact with air.

The following charts give the autoignition temperatures of dusts from various industries.

Material	Minimum Cloud or Layer Ignition Temp. ^a	
	°F	°C
AGRICULTURAL DUSTS		
Alfalfa meal	392	200
Cellulose	500	260
Cinnamon	446	230
Cocoa, natural, 19% fat	464	240
Corn	482	250
Corn cob Grit	464	240
Corn dextrine	698	370
Cornstarch, commercial	626	330
Cork	410	210
Cottonseed meal	392	200
Garlic, dehydrated	680	NL 360
Malt barley	482	250
Milk, skimmed	392	200
Potato starch, dextrinated	824	NL 440
Rice	428	220
Rice bran	914	NL 490
Rice hull	428	220
Safflower meal	410	210
Soy flour	374	190
Soy protein	500	260
Sucrose	662	CI 350
Sugar, powdered	698	CI 370
Wheat 428		220
Wheat flour	680	360
Wheat starch	716	NL 380
Wheat straw	428	220
Woodbark, ground	482	250
Wood flour	500	260
Yeast, torula	500	260

CHEMICALS

Acetoacetanilide	824	M	440
Adipic acid	1022	M	550
Anthranilic acid	1076	M	580
Azelaic acid	1130	M	610
2,2-Azo-bis-butyronitrile	662		350
Benzoic acid	824		440
Benzotriazole	824	M	440
Bisphenol-A	1058	M	570
Chloroacetoacetanilide	1184	M	640
Diallyl Phthalate	896	M	480
Dihydroacetic acid	806	NL	430
Dimethyl isophthalate	1076	M	580
Dimethyl terephthalate	1058	M	570
3,5-Dinitrobenzoic acid	860	NL	460
Diphenyl	1166	M	630
Ethyl Hydroxyethyl cellulose	734	NL	390
Fumaric acid	968	M	520
Hexamethylene tetramine	770	S	410
Hydroxyethyl cellulose	770	NL	410
Isotoic anhydride	1292	NL	700
Paraphenylene diamine	1148	M	620
Paratertiary butyl benzoic acid	1040	M	560
Pentaerythritol	752	M	400
Phthalic anhydride	1202	M	650
Salicylanilide	1130	M	610
Sorbic acid	860		460
Stearic acid, aluminum salt	572		300
Stearic acid, zinc salt	950	M	510
Sulfur	428		220
Terephthalic acid	1256	NL	680

Incendiaries, the Science of Using Fire as a Weapon

Material	°F		°C
DRUGS			
Aspirin	1220	M	660
Gulasonic acid, diacetone	788	NL	420
Mannitol	860	M	460
I-Sorbose	698	M	370
Vitamin B1, mononitrate	680	NL	360
Vitamin C (ascorbic acid)	536		280
DYES, PIGMENTS, INTERMEDIATES			
Green base harmon dye	347		175
Red dye intermediate	347		175
Violet 200 dye	347		175
PESTICIDES			
Crag No. 974	590	CI	310
Dieldrin (20%)	1022	NL	550
Dithane	356		180
Ferban	302		150
Manganese vancide	248		120
Sevin	284		140
THERMOPLASTIC RESINS AND MOLDING COMPOUNDS			
Acetal resins			
Acetal, linear (polyformaldehyde)	824	NL	440
Acrylic resins			
Acrylamide polymer	464		240
Acrylonitrile polymer	860		460
Acrylonitrile-vinyl chloride-vinylidene chloride copolymer (70-20-10)	410		210
Methyl methacrylate polymer	824	NL	440
Methyl methacrylate-ethyl acrylate copolymer	896	NL	480
Methyl methacrylate-ethyl acrylate-styrene copolymer	824	NL	440
Methyl methacrylate-styrene-butadiene-acrylonitrile copolymer	896	NL	480
Methacrylic acid polymer	554		290
Cellulosic resins			
Cellulose acetate	644		340
Cellulose triacetate	806	NL	430
Cellulose acetate butyrate	698	NL	370
Nylon (polyamide) resins			
Nylon polymer (polyhexa-methylene adipamide)	806		430
Polycarbonate resins			
Polycarbonate	1310	NL	710
Polyethylene resins			
Polyethylene, high-pressure process	716		380
Polyethylene, low-pressure process	788	NL	420
Polyethylene wax	752	NL	400
Polymethylene resins			
Carboxypolymethylene	968	NL	520

Material	°F		°C
Asphalt, (blown petroleum resin)	950	CI	510
Charcoal	356		180
Coal, Kentucky bituminous	356		180
Coal, Pittsburgh experimental	338		170
Coal, Wyoming	—		—
Gilsonite	932		500
Lignite, California	356		180
Pitch, coal tar	1310	NL	710
Pitch, petroleum	1166	NL	630
Shale, oil	—		—

Material	°F		°C
Polypropylene resins			
Polypropylene (no antioxidant)	788	NL	420
Rayon resins			
Rayon (viscose) flock	482		250
Styrene resins			
Polystyrene molding compd.	1040	NL	560
Polystyrene latex	932		500
Styrene-acrylonitrile (70-30)	932	NL	500
Styrene-butadiene latex (>75% styrene; alum coagulated)	824	NL	440
Vinyl resins			
Polyvinyl acetate	1022	NL	550
Polyvinyl acetate/alcohol	824		440
Vinyl chloride-acrylonitrile copolymer	878		470
Vinyl toluene-acrylonitrile butadiene copolymer	936	NL	530
THERMOSETTING RESINS AND MOLDING COMPOUNDS			
Allyl resins			
Allyl alcohol derivative (CR-39)	932	NL	500
Amino resins			
Urea formaldehyde molding compound	860	NL	460
Urea formaldehyde-phenol formaldehyde molding compound (wood flour filler)	464		240
Epoxy resins			
Epoxy	1004	NL	540
Epoxy-bisphenol A	950	NL	510
Phenolic resins			
Phenol formaldehyde	1076	NL	580
Phenol formaldehyde molding compd. (wood flour filler)	932	NL	500
Polyester resins			
Polyethylene terephthalate	932	NL	500
Styrene modified polyester-glass fiber mixture	680		360
Polyurethane resins			
Polyurethane foam, no fire retardant	824		440
SPECIAL RESINS AND MOLDING COMPOUNDS			
Ethylene oxide polymer	662	NL	350
Ethylene-maleic anhydride copolymer	1004	NL	540
Petroleum resin (blown asphalt)	932		500
Rubber, crude, hard	662	NL	350
Rubber, synthetic, hard (33% S)	608	NL	320

^a Normally, the minimum ignition temperature of a layer of a specific dust is lower than the minimum ignition temperature of a cloud of that dust. Since this is not universally true, the lower of the two minimum ignition temperatures is listed. If no symbol appears between the two temperature columns, then the layer ignition temperature is shown. "CI" means the cloud ignition temperature is shown. "NL" means that no layer ignition temperature is available and the cloud ignition temperature is shown. "M" signifies that the dust layer melts before it ignites; the cloud ignition temperature is shown. "S" signifies that the dust layer sublimates before it ignites; the cloud ignition temperature is shown.

Incendiaries, the Science of Using Fire as a Weapon

Material ^b	°F	Minimum Cloud or Layer Ignition Temp. ^a	°C
Aluminum, atomized collector fines	1022	Cl	550
Aluminum, A422 flake	608		320
Aluminum - cobalt alloy (60-40)	1058		570
Aluminum - copper alloy (50-50)	1526		830
Aluminum - lithium alloy (15% Li)	752		400
Aluminum - magnesium alloy (downmetal)	806	Cl	430
Aluminum - nickel alloy (58-42)	1004		540
Aluminum - silicon alloy (12% Si)	1238	NL	670
Boron, commercial- amorphous (85% B)	752		400
Calcium silicide	1004		540
Chromium, (975) elec- trolytic, milled	752		400
Ferromanganese, medium carbon	554		290
Ferrisilicon (885, 9% Fe)	1472		800
Ferrotitanium (19% Ti, 74.1% Fe, 0.06% C)	698	Cl	370
Iron 98% H ₂ reduced	554		290
Iron 99% carbonyl	590		310
Magnesium, Grade B, milled	806		430
Manganese	464		240
Tantalum	572		300
Thorium, 1.2% O ₂	518	Cl	270
Tin, 96%, atomized (2% Pb)	806		430
Titanium, 99%	626	Cl	330
Titanium hydride (95% Ti, 3.8% H ₂)	896	Cl	480
Vanadium, 86.4%	914		490
Zirconium hydride (93.6% Zr, 2.1% H ₂)	518		270

Incendiaries, the Science of Using Fire as a Weapon

The following chart provides a comparison for the power of an explosion produced by combustible dusts. The first chart provides some liquid vapors as a reference. The rise in psi when the material is ignited is given, along with the minimum concentration in air required to support an explosion. The explosibility index is a comparative value with Pittsburg coal dust = 1. Explosibility of 1-10 is classified as a strong explosion while a 10+ produces a severe explosion.

	<u>Max Pressure-psi</u>	<u>psi/sec. Max rate of rise</u>	<u>oz/cu. ft. Concentration</u>	<u>Explosibility</u>
Acetone	83	2,000	6%	-
Acetylene	150	12,000	13%	
Butane	97	2,300	5%	
Ethyl alcohol	99	2,300	12%	
Hexane	92	2,500	2.5%	
Hydrogen	101	11,000	35%	
Naphtha	94	2,500	2.5%	
Propane	96	2,500	5%	
Toluene	92	2,400	4%	
<u>Agriculture</u>				
Alfalfa	66	1,100	0.100	.1
Casein	66	1,000	0.045	.6
Cinnamon	114	3,900	0.060	5.8
Coffee	44	500	0.085	0.1
Corn	95	6,000	0.045	8.4
Corn Cob	110	5,000	0.030	12.2
Corn Starch	115	9,000	0.040	35.6
Cottonseed	104	3,000	0.050	2.2
Flax, shive	81	800	0.080	.2
Grain, mixed	115	5,500	0.055	9.2
Grass seed	76	1,000	0.060	0.4
Gums	80	2,800	0.030	22.9
Hemp hurd	103	10,000	0.040	20.5
Malt, brewers	92	4,400	0.055	6.5
Milk, skim	83	2,100	0.050	1.4
Nut, shells	106	4,700	0.030	13.8
Pectin	112	8,000	0.075	10.3
Pits, fruit	104	4,400	.030	7.4
Potato starch	97	8,000	0.045	20.9
Rice	93	3,600	0.045	4.5
Safflower	84	2,900	0.055	5.2
Soy beans	99	6,500	0.035	7.5
Sugar	91	5,000	0.035	13.2
Wheat	103	3,600	0.055	2.5
Wheat starch	105	8,500	0.025	49.8

Incendiaries, the Science of Using Fire as a Weapon

<u>Metal Powders</u>	<u>Max Pr. psi</u>	<u>Rise/psi/sec</u>	<u>Concentration</u>	<u>Explosibility</u>
Aluminum powder	73	20,000+	0.045	10
Aluminum-cobalt alloy	78	8,500	0.180	0.4
Aluminum-copper alloy	68	2,600	0.100	0.3
Aluminum-lithium alloy	96	3,700	0.100	0.6
Aluminum-magnesium alloy	86	10,000	0.020	10
Aluminum-nickel alloy	79	10,000	0.190	0.6
Aluminum-silicon alloy	74	7,500	0.040	3.6
Boron	90	2,400	0.100	0.8
Calcium silicide	73	13,000	0.060	2
Chromium	55	4,000	0.230	0.1
Coal, Pittsburg	83	2,300	0.055	1.0
Ferromanganese	47	4,200	0.130	0.4
Ferrotitanium	53	9,500	0.140	1.3
Iron, carbonyl	41	2,400	0.105	1.6
Magnesium	90	9,000	0.040	10
Manganese	48	2,800	0.125	0.1
Silicon	82	12,000	0.110	0.9
Tantalum	50	2,600	0.200	0.1
Thorium	48	3,300	0.075	10
Thorium Hydride	60	6,500	0.080	10
Tin	37	1,300	0.190	0.1
Titanium	70	5,500	0.045	10
Titanium hydride	96	12,000	0.070	6
Uranium	53	3,400	0.060	10
Uranium hydride	43	6,500	0.060	10
Zirconium	55	6,500	0.045	10
 <u>Plastics</u>				
Acetal-linear	113	2,900	2.00	10
Acrylonitrile	85	2,600	1.00	10
Allyl alcohol	91	7,500	0.50	10
Cellulose	117	4,100	1.00	10
Epoxy	94	5,000	1.00	10
Lignin-wood fines	102	5,000	0.50	10
Methyl methacrylate	84	3,100	1.00	10
Nylon	95	3,600	1.00	10
Phenol formaldehyde	77	3,500	0.50	10
Polycarbonate	96	3,300	1.00	8.6
Polyethylene	80	5,500	0.50	10
Polypropylene	76	5,000	0.50	10
Polystyrene	77	5,000	0.50	10
Polyurethane foam	87	3,700	1.00	10
Vinyl chloride	95	3,300	1.00	10

Incendiaries, the Science of Using Fire as a Weapon

The point of these charts is that they allow the improvising ordnance personnel to select the best materials for attacking targets using combustible and explosive dusts. If flammable liquids are not available, or will give away their presence, or cannot be easily delivered as liquid or vapor, then dusts provide good options and are often already at the target site. A device suitable for delivery of these types of dusts is an air compressor feeding a valve which drops the dust into a hose. This hose can be free standing or can be delivered into target areas through windows or underground means by use of a sewer rod which can be taped to the hose and used to guide it into targeted premises. A separate ignition source can be used to ignite the dust and cause an explosion or fire.

Some of the interesting aspects of the chart is the close correlation between explosive fuels like aluminum, magnesium, grain and saw dusts, and most plastics, with the dust-air mixtures. Even the polycarbonate that we use in bulletproof armor can be made explosive by extremely fine grinding. The point is that by very fine grinding alone, you can make effective explosive and incendiary ordnance (and chemical weapons - see Vol 5) out of ordinary everyday foodstuffs, construction materials, and even metals.

Liquid fuels with vapor pressures below that of room temperature still make the best choice for attacking walled targets (if explosives are not available). Volatile liquids like naphtha, gasoline, alcohol, paint thinners, and solvents produce vapors that are usually heavier than air and their vapors will form rich mixtures close to the floor. By covering a floor with a thin layer of liquid, the vapors come off quickly creating a much more explosive atmosphere than an open container.

The longer a container is open in an unventilated room, the more likely it is to diffuse its contents into the atmosphere and form a bomb, especially near the floor. The vapors of a pint of gasoline will entirely fill a 10x12x8 foot room with a mixture within the flammable limits. Once ignited, it will demolish the room where simply pouring it on the floor and igniting it makes a fire that can be put out easily.

Using fuels to attack targets

Gasoline is the most common fuel used in clandestine incendiary attacks. Care must be taken because gasoline can explode and its vapors form in volume at room temperature. Setting fires where you must be near the fuel requires a safer material. Training fires are usually set using fuel oil because it produces vapors much more slowly than gasoline and in less volume. A small amount of gasoline is added to help ignite it and keep it burning. A 50/50 mix produces powerful fires. Soap flakes or other gelling agents can be used as earlier described for use in warheads of deliverable ordnance that is widely dispersed. When used at close range it is most often intended as an anti-personnel munition with the intent of killing or causing deep burns that incapacitate an enemy. It is also used against lightly armored vehicles where the thin armor may be penetrated by the concentrated burning. The jelly like sticky consistency causes most of the fuel to burn in one spot causing great tissue damage to personnel and melting thin alloyed steel.

Incendiaries, the Science of Using Fire as a Weapon

If liquid fuels are used "as is", it is best to spread the liquid in a thin film around the target if possible and use a delay igniter. This gives the attacker time to leave without risk of harming himself. The wide spread of liquid produces both explosions and fires which increases damage to the targets.

Fuel oil and other less volatile fuels are difficult to ignite and do not spread the fire with the same speed as the more volatile fuels. Using the fuel oil with tiny amounts of gasoline in the fire starting area and using a trailer to reach the more volatile concentration is an effective combination practice.

Alcohols are also easily ignited and volatile, they have the problem of not communicating nearly the volume of heat that other combustibles do and larger volumes must be used to cause accelerated pyrolysis and spread the fire. Alcohol gives off no smoke which aids in concealing the fire at its start. It is also water soluble making it easy to put out (or spread if the water is limited).

Almost any flammable liquid can be used for incendiary attacks. Those that are difficult to ignite or communicate less heat can be enhanced with stronger primers. The distribution of the fuel is important also. If destroying the target is all that is necessary, then a wide distribution of the fuel throughout the target is most desired. Where clandestine attacks are required and the desired cover needs to leave a question as to how the fire started, it is best to lightly douse the materials above the floor such as drapes, curtains, furniture and so on. This produces patterns that do not shout arson [most fires originating on the floor produce easily identifiable patterns that shout arson]. Delay devices that can be used if secrecy is not essential include

Gasoline soaked napkins with a heat lamp layed on them. Ignition time app. 1 hr, 20 min's.

Using circuit chips from radio shops with programmable delays wired to glow plugs or other fire starter.

Using a model airplane radio control with the receiver in a pile of combustibles with matches. The controller can be used to ignite the matches which light the combustibles.

Standard fuze leading to black powder or other combustibles such as bottles of gasoline.

If a clandestine or secret cause link is desired, it is best to use small amount of a less volatile fuel to insure that suspicious explosions and accelerated rates of burn are hard to identify.

Incendiaries, the Science of Using Fire as a Weapon

Attacking combustible fuel targets

The easiest target to attack with incendiaries is combustible fuels. That is because they are incendiary themselves and can mix with surrounding air to produce fires and explosions potentially millions of times greater than the primary incendiary ordnance. They are usually stored inside of metal tanks, often underground, and transported in metal tanks on trucks or in underground pipes. The storage and transportation arrangements are easy to identify and locate. Tanker trucks are easily observed and marked about their contents. They can be followed to source of supply and delivery. Underground tanks can also be identified by observing the unloading of fuels. Underground pipelines are usually identified with warning signs to not dig in the vicinity because of the pipes. The targets are easy to find and fuels are also ideal targets in wartime because of the cost and difficulty in replacing quickly to use as needed. [The enemy cannot run its supply trucks and aircraft today if they have to wait 3 days for fresh supplies to be shipped in].

LPG (liquid petroleum gases), such as propane and butane make the best targets because they leak easily from pipe joints which have been moved by earthquakes or tampering, they change almost instantly to gas from liquid and at pressure (gasoline remains a liquid and only slowly evaporates unless heated), their expansion ratio is 270:1, when confined their vapor pressure rises rapidly with moderate levels of temperature which increases the potential for vessel failure and resulting explosions and fires, and both butane and propane are heavier than air meaning they will not float away in the atmosphere. They will travel along the ground making them easy to ignite and keeping them in areas they can do damage. Direct flame on the container of LPG causes both structural weakening and increases pressure on the weakened area.

<u>Vapor pressure</u>	<u>psi</u>	
<u>Temperature</u>	<u>Propane</u>	<u>Butane</u>
-44F	0	0
0 F	24	0
32 F	54	0
70 F	124	31
100 F	192	59
130 F	260	67

LPG is widely used in the US and is stored in enormous volumes. Many industries and homes are dependent on its availability and have no ready substitutes (especially in winter). A book was written a decade or so ago on the potential hazard of an atomic bomb like explosion that could occur from the catastrophic leak and explosion of a seagoing tanker carrying 50,000 tons of LPG. This makes these types of vessels high priority targets in wartime, especially in port. One only needs to look at old newsreel footage of the Texas City explosion in 1947 where app. 2,000 tons of ammonium nitrate leveled the city spreading fires for miles in every direction.

Incendiaries, the Science of Using Fire as a Weapon

Almost every industry and municipality stores large volumes of oils and fuels for heating, cooking, quenching in metal processing, welding, and motor transportation. These are stored in a variety of holding tanks above ground, below ground, and inside buildings. Most of the liquid fuels in these tanks expand by about .07% or more for every 10 degree rise in temperature. Above ground tanks are often painted with aluminum or white paint to reflect heat away to minimize expansion. Many have built in floating roof tanks to reduce the fire hazard. Many use pressurized tanks to store gases as liquids under pressure. The space in tanks storing flammable liquids with vapor pressure above 4 psi is normally too rich in the vapors to burn (except at low temperatures of -10 to -50 F). During loading and unloading, the tanks often have areas that fall within flammable limits because of the exchange of gases with air.

The vapor spaces in tanks with low vapor pressure liquids like kerosene (less than 2 psi) is normally too lean to burn. These require the liquid to be heated to their flash points in order to produce enough vapors to reach flammable limits in air. Please keep in mind that it is the temperature of the liquid and not the temperature of the vapor that produces more vapors.

Vapors of methyl and ethyl alcohol, JP-4 and Jet B Turbine fuel, and other liquids in the 2-4 psi pressure range fall within flammable limits in the air space above their liquids. These produce easily ignitable targets.

Various atmospheric and pressure storage tanks -



ORDINARY CONE ROOF TANK



VAPORDOME ROOF TANK

Flexible diaphragm in hemispherical roof moves in accordance with vapor volume changes.

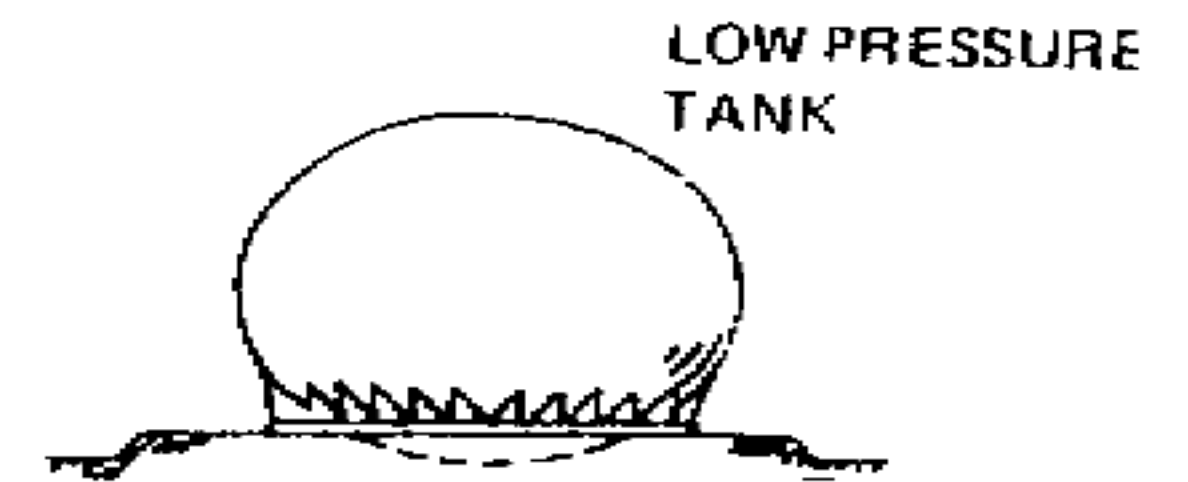

SPHEROID

LOW PRESSURE TANK



LIFTER ROOF TANK

liquid sealed roof moves upward and downward with vapor volume changes.

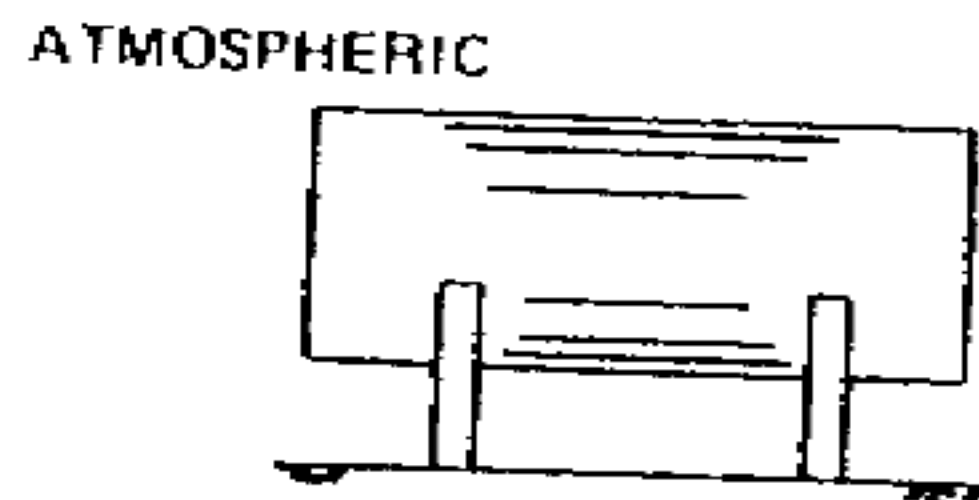

HORIZONTAL TANK

ATMOSPHERIC

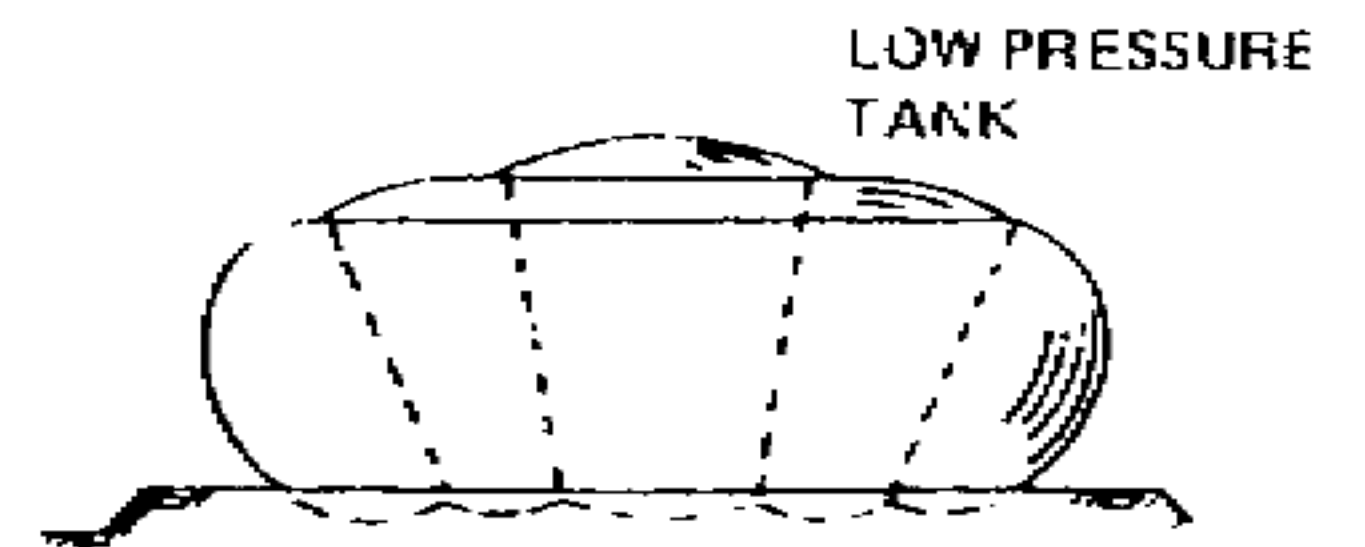

NODED SPHEROID

LOW PRESSURE TANK

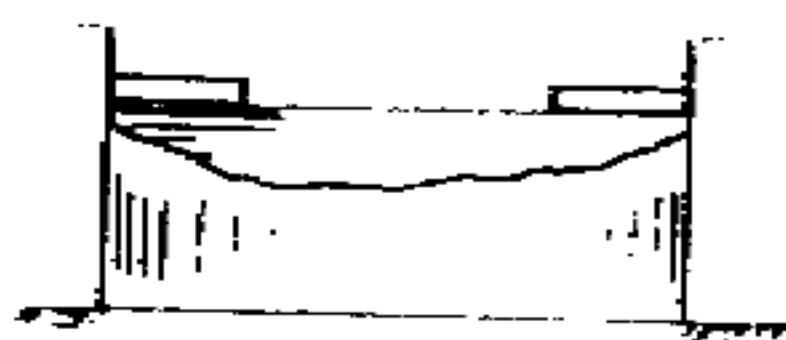

FLOATING ROOF TANK

roof deck rests upon liquid and moves upward and downward with level changes.

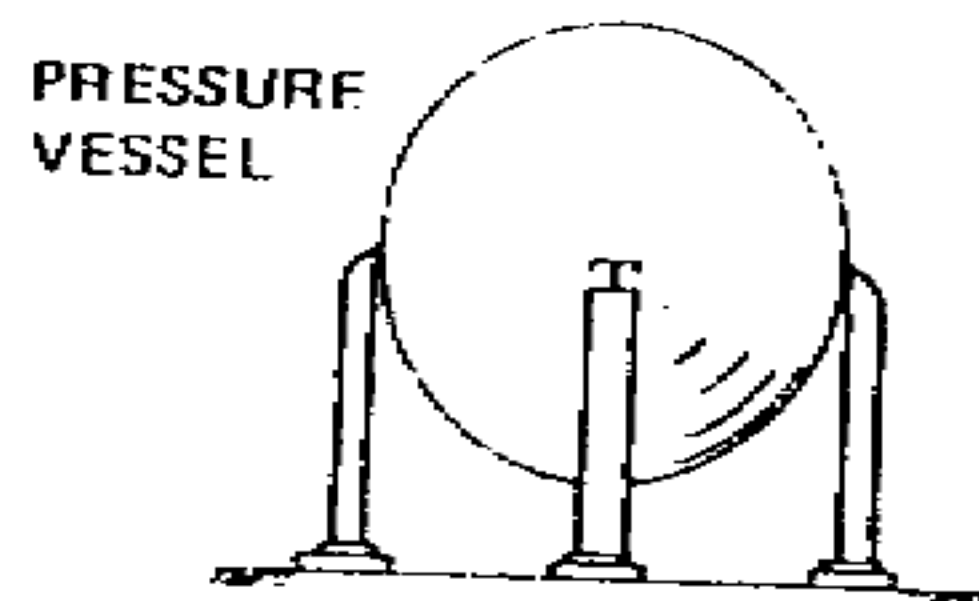

SPHERE

PRESSURE VESSEL

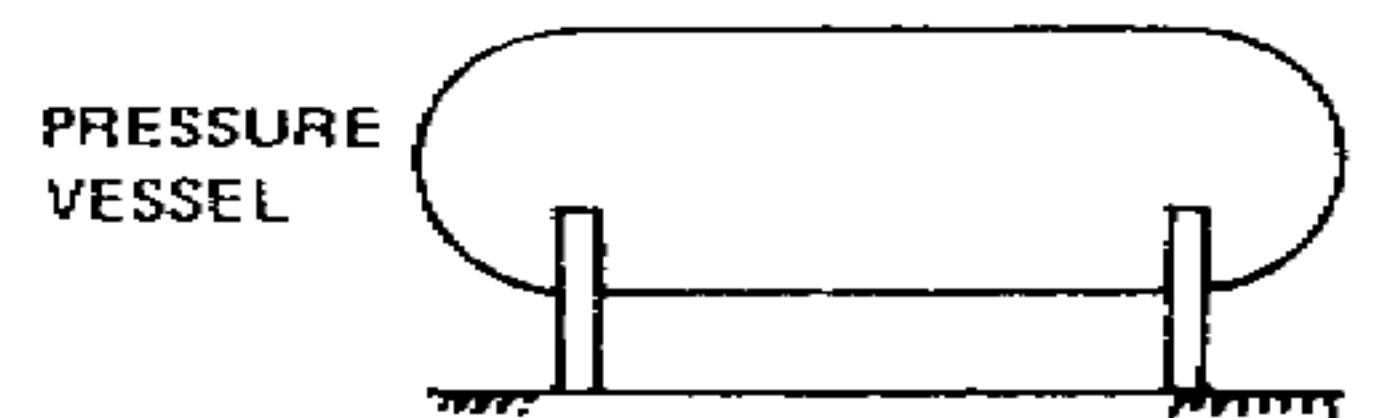

PRESSURE VESSEL

Incendiaries, the Science of Using Fire as a Weapon

The storage tanks are designed for

Atmospheric	0-.5 psi
Low pressure	.5-15 psi
Pressure	15 + psi

The metal thickness of the tank is based on the pressures and weights of the liquid as well as an allowance for corrosion over time. Some tanks use special liners for corrosive liquids. The above ground tanks are usually made of welded steel or shell plate, or concrete (no pressure).

<u>Tank Diameter</u>	<u>Thickness of steel</u>
< 50'	3/16"
50-120'	1/4"
120-200'	5/16"
> 200'	3/8"

Most modern cities no longer permit above ground storage of flammable liquids near congested or high traffic area. All storage tanks must be fitted with a suitable vent for loading and unloading their contents. These allow for equalizing air pressures during filling and emptying so that they do not collapse from pressure or vacuum created during handling. The vapors are usually vented down a pipe and is equipped with valves or arresters to prevent flashback into the tanks. Wire mesh of 40# or metal plates are used to stop flame from penetrating back into the tanks.

Tanks are also designed with deliberately weakened roof to shell seams at the joints that under great pressure will rupture and provide an effective explosion relief valve.

Thermal or mechanical damage to the tanks at any position sufficient to rupture it and cause it to release its contents is adequate to destroy the target. The roof may have a floating roof underneath it and is not the best attack site because of this. Once its contents are released, the tank is unusable and the value of the contents is gone. If the contents are ignited by incendiary bullets or other means, the destruction is often spread to other targets.

Underground storage tanks are much harder to attack because they are surrounded not only by metal, but by a thick layer of dirt and oftentimes concrete. Underground explosives set off near the tanks often rupture them from the force of the communicated shock wave (soil will not compress very much). The only other method of attack is bombing, or destroying the protective devices on the access pipe so its contents can be exposed through the pipe to the air. Any form of oxidizer added down the throat of the tank will rapidly ignite its contents and rupture the tank, spreading the fire and leaking any remaining contents as well as making the tank useless for future use.

Incendiaries, the Science of Using Fire as a Weapon

Shut off valves usually have a shear section for valve seat if discharge faucet breaks

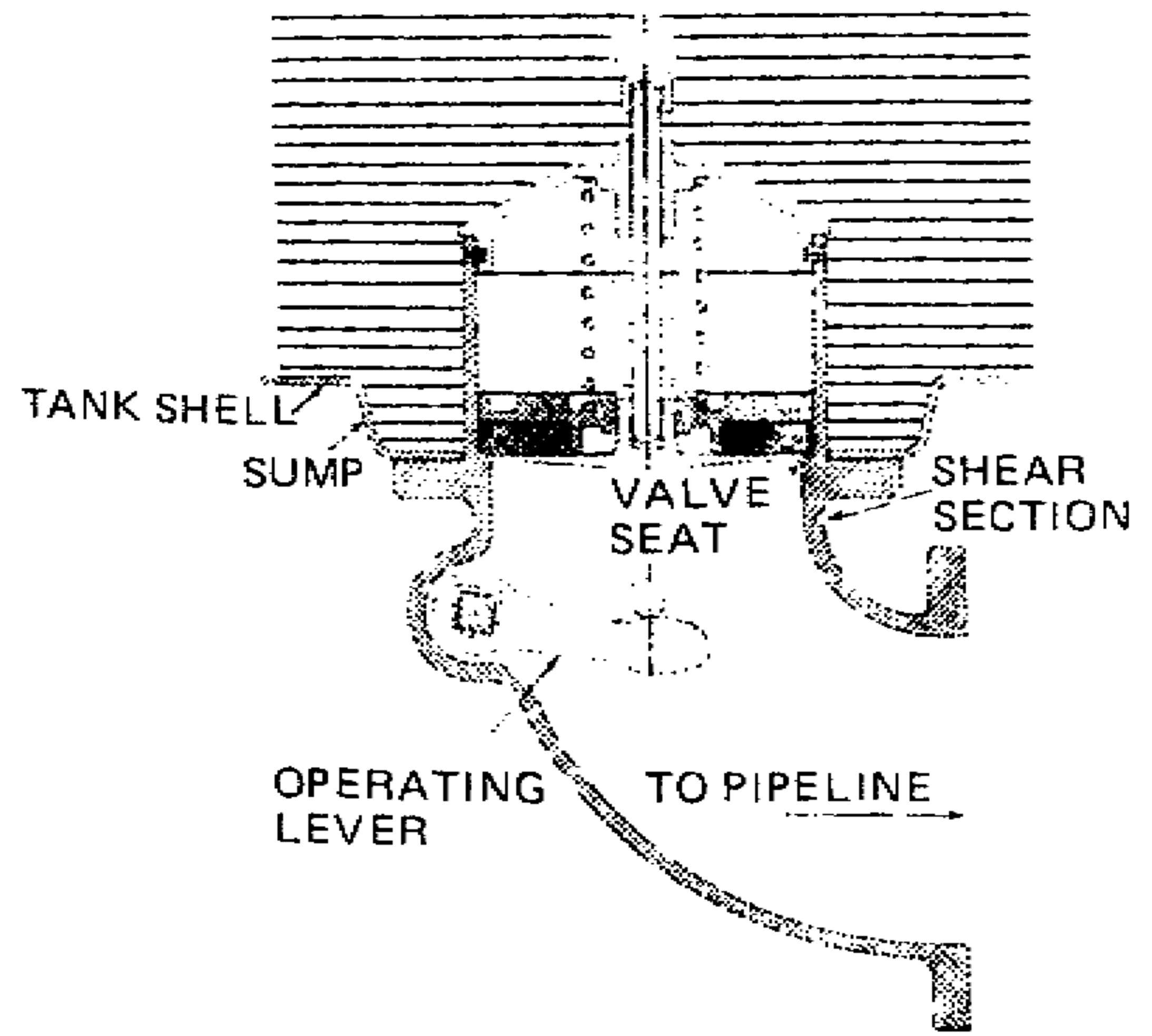
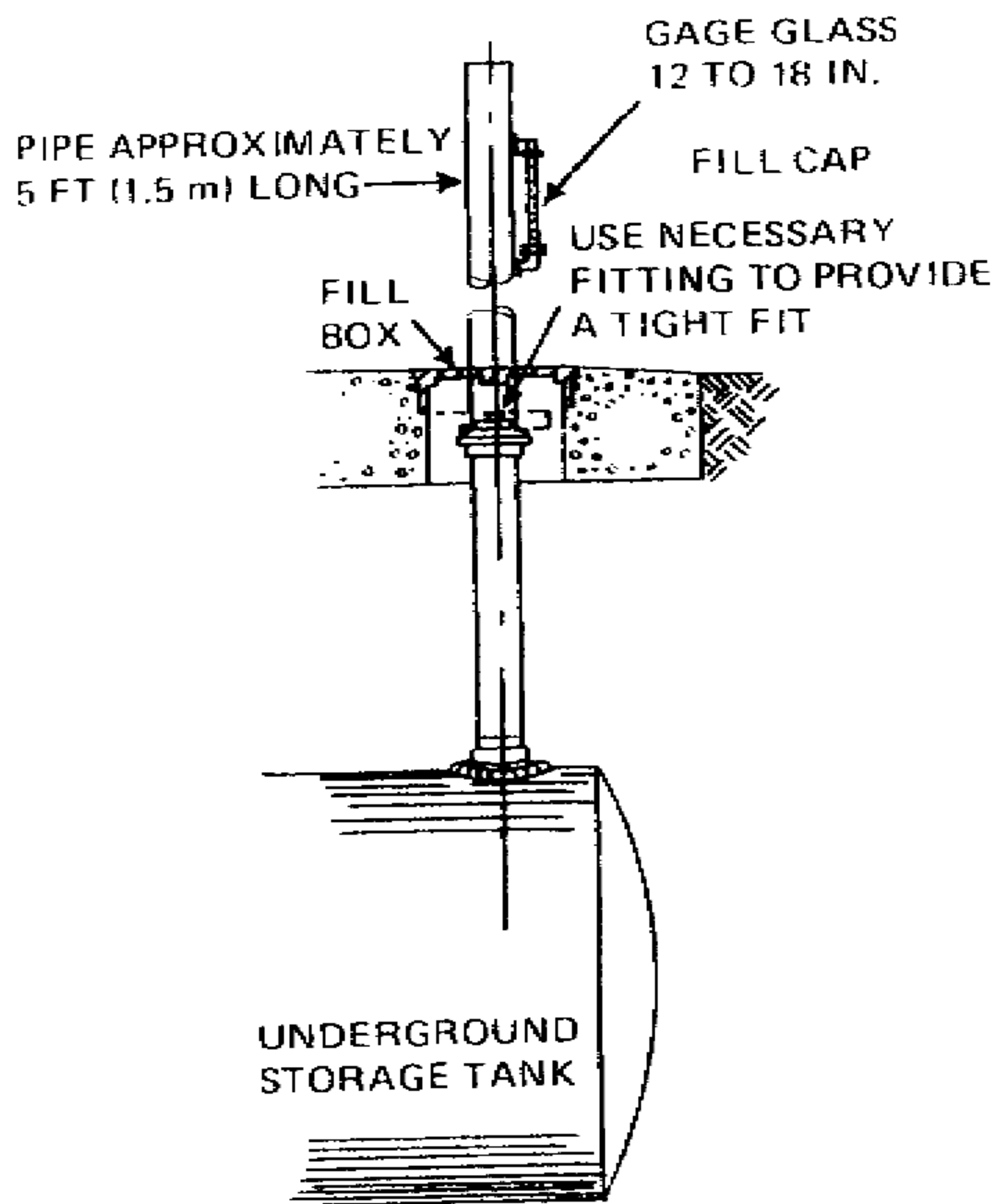

Bulk liquid tanker vehicles utilize the above internal shut off arrangement. Generally, the ability to destroy storage tank targets of liquid fuels depends on the ability of the primary ordnance to penetrate the exterior surfaces from explosive or incendiary effect. All further effects are usually produced by the fire and explosion of the tanks contents. Many napalm and small thermate formulas are sufficient for the thinner walled steels employed.

Incendiaries, the Science of Using Fire as a Weapon

Other important characteristics of burning liquids include -

Nitrogen and oxygen mixtures generally burn or explode with more force.

The longer the carbon chain or carbon content of the fuel, the lower the autoignition temperature

If the contents of a tank are burning from the top, gasoline burns at a rate of 6-12" per hour, kerosene at 5-8" per hour. Heavier liquid fractions burn slower.

Small amounts of water added to burning petroleum can result in boilover in which the force of the water converting to steam ejects a large volume of the unburned liquid into the surrounding area which then ignites.

Other liquified gases, particularly oxygen can easily add to a potential incendiary assault because they increase the rate of burn and temperatures of the combusted materials.

As the atmospheric pressure increases, the more available molecular oxygen there is to support combustion

Industrial sites that produce flammable fuels are among the highest priority in war. If the enemy has no fuel for its vehicles, it cannot maneuver or move its equipment to fight you.

Incendiaries, the Science of Using Fire as a Weapon

Chapter 5

Attacking Non-Liquid Combustible Targets

Most of the buildings we live and work in, the vehicles we drive, and the businesses we frequent are largely constructed of combustible materials. All other parts can usually be melted or damaged by spalling when close to a major fire. Since wood is the primary building material for most structures, we will begin with wood structures.

As we have already stated, wood and other solids do not burn, they pyrolyze. In effect, they decompose or break down from the heat and in so doing evolve combustible gases. This process is called pyrolysis, where the solids distill off flammable vapors and leave behind a solid ash or "char". Most wood distills off vapors in a normal fire once its autoignition temperature is reached (and no other accelerants are used) at a rate of 1.54 inches per hour or about 1 inch per 40-45 minutes. The wood sustains itself burning at temperatures of 1400-1600 F, and if gasoline is added will burn at up to 3,000 F which increases the distilling and char rate as long as adequate oxygen is available.

When a fire is started in a wooded structure, it burns in an upward pattern from its ignition source because heat rises and the point of greatest temperature produces the largest volume of pyrolysis which continues to feed vapor into the flame as fuel. As heat is communicated by convection, conduction, and radiation, it causes combustible gases to form from all solids that are capable of distilling gases and are heated to their flash points. This fuel is distilled into the air where it continues to heat until its autoignition temperature is reached at which point it is consumed. If there is a shortage of oxygen which happens in many fires in enclosed rooms, the fire goes out while the temperature rises with the pressure increases until a wall or window blows out or a door is opened. At this point, fresh oxygen rushes in and the flammable mixture reignites. If the pressure is vented with a small hole at the roof with no other openings to supply the fresh oxygen, it acts like a chimney, the temperature and pressure are gradually reduced and the room drops below the autoignition temperature becoming safe to open.

The ideal method of attacking wood based constructions is to have a ventilated room at the source of ignition, preferably with a hole at a high level to vent off the combustion gases so the fire does not easily smother itself with combusted gases. The military accomplishes this by dropping incendiary bombs through the roof which produces a natural chimney. The force of the bomb exploding and discharging its contents knocks out windows and puts holes in the walls which provide ventilation and the distribution of napalm greatly accelerates the rate of pyrolysis of the wood materials because the flame temperature is much hotter than that normally sustained by the wood combustion alone. This produces a larger flame that spreads from structure to structure more easily and produces a more destructive overall effect than simply dropping explosives. Shock wave damage usually only effects the target. Fires will usually spread well beyond their point of origin making them more cost effective weapons than explosives in attacking combustible targets. That is why the allies used fire bombing to reduce the major cities of the axis in WW2.

Incendiaries, the Science of Using Fire as a Weapon

When a fire is producing hot expanding gases, they often force their way into adjacent rooms with the hottest gas usually igniting at the ceiling. This produces the common pattern of burning spread with the fire rising to the highest points. To maximize damage, accelerants must be used to spread the fire to low surfaces and to all points in the structure so that maximum overall volume and spread is accomplished rapidly. The phenomenon of fire spread from room to room along the ceiling with a bursting into flames without an actual flame igniting it is called "flashover". Windows and doors must be open or broken to ensure ventilation and a high point of exhaust should be drilled or otherwise produced to spread the fire from floor to floor and produce a chimney. Some buildings use forced circulation systems where fans can feed the fires that are started if they are still intact. The fire temperature is important because at 1500 F, with additional oxygen, CO₂ which is not combustible can be reacted to form CO (carbon monoxide) which is combustible and can continue to feed the fire or explode.

Most other articles inside of buildings are combustible as well. Furniture, carpeting, plastics of all types, appliances, drapes, clothes, and anything else not made of metal or minerals will add to the fuel load. Even materials that have been treated with fire retardent materials will pyrolize when adequate temperatures are reached because their basic structure is still made of the elements necessary to produce the flammable vapors. This makes targets that store large amounts of combustible solids useful primary targets. A maintenance shop for military vehicles may not be an easy target to destroy with incendiaries. The lumber yard next to it set on fire and producing a huge inferno may easily get the job done and can be targeted instead.

Conducting incendiary warfare on windy days has the disadvantage of making fires harder to start, but once started a strong wind aids in the spread of the fires by adding considerably to ventilation and communicating flame from one building to another. Fires also spread through buildings and to adjacent structures from drafts produced by the hot gases and infiltration in and around doors, vents, cracks, and windows.

Many structures can be ignited or detonated simply by providing a source of flammable gas. This can be done by directly venting gases from heated liquids from a small compressed air tank, through a hose, and into the desired structure. If no access is available, a wall can easily be drilled or the gases can be blown in through the sewer lines by using compressed air. Once in the structure in volume, the gases can be ignited by the pilot lights on the furnace, water heater, stove or other appliance. By breaking fittings to gas lines running into the building and allowing the gas to be freely discharged, the same effect can be achieved. Other hot surfaces such as light bulbs, irons, gas dryers, or sparks from electric motors and other devices can also ignite gases.

It may take as long as half an hour for a normal fire to burn through a sheet of 3/4" plywood in a wall. If accelerants are used this time may be cut in half. JP-4 jet fuel will considerably increase the rate of burning. If a tiny hole is drilled through the panel and a small trail of accelerant placed up to and into it, the fire can pass through in a matter of seconds and will burn on the other side as long as fuel and oxygen is present. A man with a drill and a little kerosene (a pint or less) can create a huge inferno in a matter of minutes.

Incendiaries, the Science of Using Fire as a Weapon

When attacking structures where important equipment or personnel are out of reach in hardened basements or bunkers, pouring gasoline into vents or into loose portions of the construction can easily communicate fire into these areas as well. It is common practice for engineering troops to fill non combustible areas with flammable gases by pumping them into vents and cracks or around fittings and then igniting the gas and burning the enemy out. This is an easily improvised method of attack using any container for fuel and having a hand or compressor pump to force the liquid into the desired area. Car wash spraying equipment with wand extensions and pressure pumps work well in this regard.

There are also many already manufactured fire starters that are useful for starting and spreading fires that are packaged and sold as cooking and fireplace combustibles. Improvised fire communicators can also include cotton rope or other combustible formed as a long trailer and soaked in kerosene or gasoline.

Specific Targets by group

Chemical industries offer primary targets because many of their products are flammable, their plants are often filled with or made of combustibles, and their chemicals often evolve toxic gases making them hard to extinguish and add to the destruction inflicted on an enemy. Any company producing, transporting, storing, or using any of the flammable chemicals already listed in this book are goods targets because they need only a small fire starter to produce an enormous fire. Any explosive materials like ammonium nitrate fertilizers, or other oxidizers are easy ignited targets that are capable of considerable damage spread. Fluorine, chlorine, acids, alkalis, and other dangerous chemicals pose extreme hazards to neighbors, firefighters, and operating personnel. Although these are not combustible, the production of gases from the heating of these materials in a fire create the equivalent of military poison weapons. The effects of boiling acid or alkali on skin or in the lungs resembles that of mustard gas. The evolution of hydrogen chloride or fluorine from hot fires produces deadly gases that quickly kill or maim and act similarly to many WWI poison gases. Serious fires at plants that handle radioactive material pose very serious hazards, particularly nuclear power plants as was seen at Chernobyl. Most of these are housed in protected, non combustible structures that do not burn.

Solid fuels that sustain combustion easily on their own include lumber, charcoal, coal, flour mills, dry forests and brush, paper processors, and any finely milled cellulose products. All of these ignite and increase their own burning rates with large volumes of distilled gas as long as there is oxygen available. Since they provide massive amounts of their own fuel, they are easy to start and maintain and hard for an enemy to extinguish. Coal is stored in large piles at mines, in open rail cars during transport and at the source of consumption. It is easily ignited and self sustaining and if it is not compacted usually contains 35% oxygen mixed in. Its dust represents explosion opportunities as well. Gas accumulation above coal when stored inside is easily ignitable. Wood, in all its forms as paper, pulp, and building products represents easy to start incendiary targets.

Incendiaries, the Science of Using Fire as a Weapon

As wood products pyrolize, they produce gas products as follows.

<392 F/200 C	Water vapor, carbon dioxide, formic and acetic acids- all noncombustible.
392-536F	Less water vapor, some Carbon monoxide
536-932 F	CO, flammable particles and other vapors plus some charcoal combustion occurring
+ 932 F/500 C	Charcoal combustion with catalytic action.

Most wood products ignite at 370-430 F (190-220 C) and generates 7,000 to 10,000 BTU's per pound. Other solid fuels like asphalt and coke produce 15,000-18,000 BTU's.

Grain elevators present a ready made target because they regularly explode or burn down from accidental ignition such as electrical or mechanical sparks or careless workers who smoke. They produce a ready made dust cloud primed for ignition when they unload grain into elevator bins. The dust is suspended during the loading process providing a perfect air-fuel mixture.

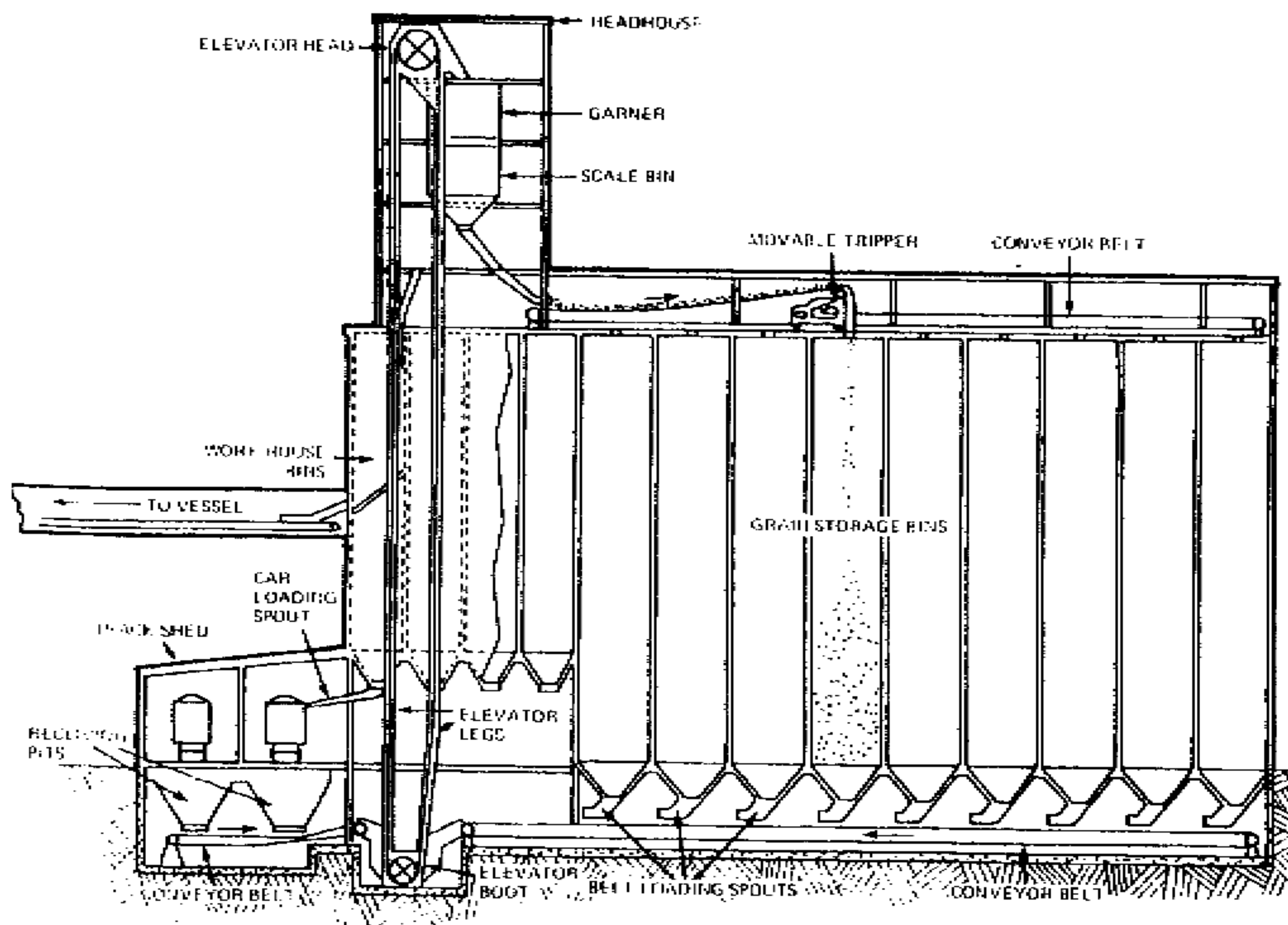

Incendiaries, the Science of Using Fire as a Weapon

At any point where grain is moved, dust is produced and suspended in air such as the bucket elevators and around grinding equipment. This makes them highly susceptible targets. Grain fires are hard to put out and the use of water on some grains produces swelling that can rupture and destroy the facility. Most grain elevators cannot stand more than a 25 psi pressure on its concrete surfaces and is easily collapsed if the dust explodes. Most grain elevator explosions due to dust occur in the bucket elevator area. The destruction of grain mills causes economic losses as well as hunger in enemy areas.

Record keeping centers usually store large volumes of hard to replace information. Key targets include libraries, court houses, government archives, museums and military records buildings. Most of these buildings are constructed of concrete and metal, however, their contents of mostly paper, tape, microfilm, and disc records are combustible and present in large volumes. The structure can be left standing with valuable information lost forever. Many of these facilities have sprinkler systems so it is a good idea to interrupt the water supplies prior to attack.

Plastics and Rubber offer interesting targets. Anyone who has seen rubber tire piles burn on for months without being able to be extinguished are aware of the problems this can inflict on an enemy. Many of these produce toxic gas and are widely used as building and vehicle parts materials. These tend to be harder to ignite than wood and other combustibles but generally burn vigorously and spread at up to 10 times the rate across surfaces that other cellulose materials do, with rubber being an exception.

These materials produce sooty, dense, black smoke and often will evolve toxic gases like hydrogen cyanide, sulfur dioxide, and phosgene. The melted plastic drips often aid in spreading the fire from one area to another.

Wastewater Treatment systems generates combustibles that are easily ignited at several stages of the system. Sewer lines often generate methane gases at points where solids build up and flow is restricted. The sewers can often become effective clandestine targets because they are hard to protect and can be entered at almost any point or time through manholes. Floating incendiary devices like those already described can flow down the line until they reach and ignite methane accumulations. These can often result in huge explosions that disrupt the handling of human wastes and create disease problems, destroy expensive and hard to replace infrastructure, and often destroy nearby targets. The destruction of many businesses in Guadalajara, Mexico from a sewer line explosion in the early 90's demonstrates the effectiveness of this strategy (and this was accidental). If the incendiaries reach and ignite methane in the waste treatment plant itself, the ability of the targeted city to maintain its public health along with that of downstream communities is diminished.

Besides the methane produced by bacterial fermentation of solid wastes, sludge buildups, dehydrated urea from liquid wastes, and dusts from processing and filtering. The most common gases found are methane at up to 5%, ammonia with explosive limits of 16-25%, nonflammable chlorine, gasoline, hydrogen sulfide (4.3-46%), natural gas, and various other sewer and sludge vapors.

Incendiaries, the Science of Using Fire as a Weapon

Solvent oil processing plants, such as those used to extract soy oil from soybeans. These plants use hexane as a solvent in which they soak the soybeans. The solvent dissolves the bean oil and this is filtered off. The solids are sold as animal feed soybean meal and the solvent is distilled off and recovered for use again while leaving behind the soy oil which is sold for vegetable fat uses. The hexane is highly flammable and a leak of solvent into the sewer system of Louisville Kentucky in 1981 resulted in 6 miles of sewer lines being blown up when it ignited. The soy oil is also flammable and in combination with the hexane makes a large, unprotected, fuel-based target. The solvent is stored in tanks and is combined in extraction towers with the ground soybeans.

Warehouses for most industries contain products stored in boxes and large volumes of other combustible packaging. All these are generally unguarded, easy to penetrate, and burn according to the volume of combustible (mostly paper or plastic), and all usually have an excess of oxygen from the large volumes of air available. These are usually filled with miles of shelves stacked 3 or 4 rows high.

Materials processing such as food, hospital supplies, electronic parts, and almost any other enterprise that modifies materials almost always has combustible chemicals stored in tanks on the premises. Food processors may use ethylene oxide to ripen fruit (it is used in military fuel-air explosives. Combustible plastics are stored by the truckload in tanks adjacent to plants which utilize plastic packaging for their products. Hospitals use oxygen and other flammable gases in volume. A careful reconnaissance of the potential target often produces surprises.

Public assembly facilities such as sports arenas, passenger terminals, exhibit halls, restaurants, night clubs, theaters, and so on will house large numbers of people with limited means of escape in the event of fires. These make effective targets for terrorists. Most have more than adequate ventilation to feed a fire and require only an easily ignitable fuel source and ignition. Incendiaries are more easily carried into these areas than explosives or projectile weapons because they leave no electromagnetic signature, have low or no X-Ray contrast, and do not normally smell like explosives to guard dogs. They can often cause more destruction than either of these if trailers and concealed plants are used. By restricting the egress of the mass of people through the use of padlocks and chains already provided by the authorities, huge casualties can result as has often been the case in accidental theater fires.

Hotels and public occupancy buildings represent targets that are constructed of combustibles and/or are filled with combustible furnishings. Because of the large volume of customer traffic and unrestricted access to most parts of these facilities, especially at night, fires can be easily and clandestinely set. Multi story hotels are notorious for yielding great property and casualty losses because the fires are often beyond the reach of firefighters and there is a great dependency on sprinklers to work in the event of fires. Water storage is generally located near the top floor in order to provide reliable water supplies. If these are taken out simultaneous to an incendiary attack, the fire will not be easily extinguished. Apartment buildings represent the same potential. Means of evacuation can be blockaded by various methods which increases the psychological effect of the attackers (especially terrorists).

Incendiaries, the Science of Using Fire as a Weapon

Mines represent major industrial investments to most countries. They supply important minerals and produce massive volumes of combustible dusts if the mineral is a fuel like coal and metal sulfides. Some coal fires from the 1950's are still burning today which illustrates the potential for damage that incendiary attacks represent. Surface strip mining provide easy access to the fuels and since oxygen is readily available in the open air, all that is required is an ignition source. These fires can be set easily by incendiary rockets or other propelled ordnance.

Underground mines represent access problems. If access is gained, mine fires are easy to start. These fires are usually initiated by ignition of methane gas which forms flammable mixtures with air at 5% and can be ignited by the static electricity of a person walking on a carpeted floor. Coal dust can also be ignited with suspensions of as little as .05 oz per cu. ft. These suspensions require more energy from sparks or explosives, but when mixed with small amounts of methane gas are easily ignited as well. The shock wave of fires and explosions helps suspend settled dust adding to the conflagration. Flame temperatures of 3,600 F and static pressures of 50 psi are common in mine explosions.

Wildland fires represent a separate class of incendiary targets in that they do not target specific enemy constructions. These fires often do massive amounts of property damage when they burn in dry and windy conditions, especially if the fuel source is dried out. The lack of moisture in the wood and brush eliminates a heat sink that reduces the rate of pyrolysis by lowering the burning temperature. [The water evaporates and carries heat away].

Brush and forest fires provide enormous volumes of fuel with air readily available for combustion. If the fire is started upwind of enemy centers of commerce, industry, or housing, great destruction can be achieved in a short period of time with little risk of loss from capture (in clandestine operations) or from anti-aircraft fire in incendiary bombing runs. Many small fires can be started over large areas making them difficult to contain. There is also a lack of available stored water in many of these locations. If fires are started in trees and brush in mountain areas, they tend to be more destructive on the southern and southwestern slopes (in the US and northern hemisphere). Fires also burn more rapidly on steeper slopes due to increased radiation and convection.

Ground fuels like Duff (partially decayed vegetable matter), Roots, Dead Leaves, Dead Wood, Downed logs, stumps, and limbs, and low brush each have their distinctive combustive properties.

Duff is usually moist and presents a low surface area that slows the rate of fire spread. Their smoldering characteristics may make a fire difficult to keep extinguished.

Roots can provide a source of creeping fires that are hard to extinguish because they continue underground.

Incendiaries, the Science of Using Fire as a Weapon

Leaves, especially dry ones add to the rate of fire spread and increase according to size.

Grass slows fire if moist, and accelerates it if dry. The fire spreads faster with dry grass cover than with ordinary brush and trees.

Downed logs, stumps, and limbs are heavy fuels that take longer to dry out but produce hotter fires. They have less surface area exposed to air and burn more slowly.

Fine dead Wood ignites more easily and spreads fire more rapidly providing a high surface area for combustion. Granulated dead wood is very easily ignited (kindling) and if present in large volumes will produce violent fires.

Low Brush is moist during the early spring and slows the rate of fire spread. As the summer dries out the brush, it speeds up the rate of burning. It also carries fire to aerial fuels such as tree branches and crowns, snags, and moss. The aerial fuels are most effected by the relative humidity and speed or slow fires according to their moisture content. Their exposure to the wind speeds the drying process.

Incendiaries, The Science of Using Fire as a Weapon

Chapter 6

Non Combustible "Hard" Targets

The final group of targets we will discuss are those that are made of mineral and metal materials that are intended to resist the thermal effects of fire. Stone, mortar, concrete, and a wide range of metals and combination alloys are used in both ancient and modern constructions to provide structural strength to buildings and vehicles. In addition to strength to resist physical assault, they would not burn or melt at the ordinary temperatures generated by the wood and oil based incendiary weapons until the advent of modern chemical industries and the application of scientific and technical competencies to design and construct the modern fire weapons used in war. These modern chemical compounds and the devices to contain and deliver them have been described in earlier chapters. Our intention in this chapter is to describe various hard or noncombustible targets and acquaint the reader with the designs, weak points, and physical properties of these targets that may be exploited in war.

The following chart will provide some useful information on the thermal conductivity of a number of materials. The BTU's that are conducted through a square foot of each material per hour is listed.

Silver	245	Bakelite	9.7
Copper	227	Marble	1.5
Gold	129	Porcelain	1.3
Aluminum	128	Glass	0.59
Tungsten	116	Fire clay brick	0.58
Brass	69-87	Concrete	0.54
Platinum	39.9	Limestone	0.54
Tin	37.5	Plaster	0.43
Iron, wrought	34.9	Brick, building	0.4
Nickel	34.4	Gypsum	0.25
Iron, cast	27.6	Asbestos	0.092
Steel	26.2	Hardwood	0.09
Lead	20.1	Paper	0.075
Bronze	17	Softwood	0.07
		Dry earth	0.037
		Cellulose	0.033
		Charcoal	0.03
		Felt	0.03

Those materials with high conductivity's can be heated to very high temperatures and yet will not cause combustibles in contact with them to easily ignite. This is because they conduct so much heat away so rapidly that it is hard to cause these materials to reach and hold on to the necessary autoignition temperatures necessary to ignite adjacent combustibles. They just keep carrying the heat away.

Incendiaries, The Science of Using Fire as a Weapon

An example would be to heat aluminum on one side and try to ignite wood on the other side with a small airspace in between. Air and wood are poor conductors of heat and will reflect the heat away. This effectively prevents the wood from igniting.

Boy scouts learn quickly that it is much easier to start a fire with two logs instead of one. They have learned that the second log can be used to stop the loss of heat by radiation, convection, and conduction. Because it is such a poor conductor, the logs continually reflect the heat between themselves until the heat buildup is sufficient from this recycling that both logs temperatures are raised until the autoignition temperatures are reached and they produce sustainable distilled vapors. With only one log, the air permits the rapid loss of heat and it is much harder to ignite. This low thermal conductivity of wood makes it hard to ignite even with a blowtorch. It will immediately start a glowing fire but if the blowtorch is pulled away, the fire puts itself out. The temperature of the entire piece of wood must be raised sufficiently to reach and sustain autoignition. This is why small kindling is easier to ignite as well.

This same principle is also why it is very hard to apply incendiaries to one side of a high conductivity metal and make it ignite combustibles on the other side. You often have to melt a hole completely through the target metal so the heat can be directly applied to the combustibles inside before these combustibles will actually ignite. This is because most metals conduct the heat away so rapidly that the autoignition temperatures are never reached. It is also the reason that incendiaries are often used in combination with explosives in modern munitions. The incendiary can soften the metal while the explosive punctures it and directly exposes its contents to the heat source. Even a tiny hole that lets the heat directly contact combustibles inside is sufficient to ignite the materials.

These general rules allow the construction of buildings and vehicles that are highly resistant to incendiary effects. By covering vulnerable combustible materials with materials that are not combustible and that reflect heat away, or conduct it away, parts like fuel tanks, ammunition storage, and troops can be protected.

Refractory Metals

Modern alloys have been developed for use in weapons systems that make them highly resistant to thermite and related incendiary attack. These involve the use of "refractory metals" and are usually incorporated into vehicles where weight and size are limiting factors. Buildings and bunkers are generally constructed with massive amounts of low thermal conductivity materials like concrete, limestone, and earth. The huge volumes of heat necessary for incendiary effect on these types of constructions make the use fire weapons impractical and impossible. They must be combined with projectiles or explosives to penetrate these types of materials first so that the interior can be exposed.

Vehicles such as tanks, armored personnel carriers, fuel trucks and other transportation constructions often use at least a small layer of a high temperature alloy or refractory material to protect its contents from heat attack. The preferred material is usually a refractory metal alloy that retains a high tensile strength and hardness at elevated temperatures. These types of metals are-

Incendiaries, The Science of Using Fire as a Weapon

<u>Metal</u>	<u>Melting Point C</u>		
Tungsten	3,370	Tantalum	2,997
Molybdenum	2,620	Columbium	2,500
Hafnium	2,227	Zirconium	1,852
Chromium	1,810	Vanadium	1,710
Titanium	1,660		

Precious metals have melting points higher than most thermite combustion temperatures but are so expensive that they cannot normally be used for this application.

Platinum	1,769
Rhodium	1,966
Rhenium	3,180
Osmium	3,000

Many thermites produce temperatures of 2,200 C. Some of the modern Thermates and combination munitions can reach temperatures approaching 3,000 C for short burn periods. Many of these are incorporated into projectile type weapons where the incendiary produces thermal softening of the metal which allows a high velocity fragment to penetrate through and into the interior.

On the defensive side, layers of alloys are used, with high temperature alloys that do not melt at thermitic temperatures being used to protect projectile resistant alloys and bulletproof plastic-fiber structural armor.

One commercial example of mass produced refractory alloy suitable for incorporation in vehicle armor is a Molybdenum-Tungsten alloy called TZM. It contains .5% titanium, .07% zirconium, and .05% carbon. Cold worked TZM has tensile strengths of over 800 MPa at 2,000 F.

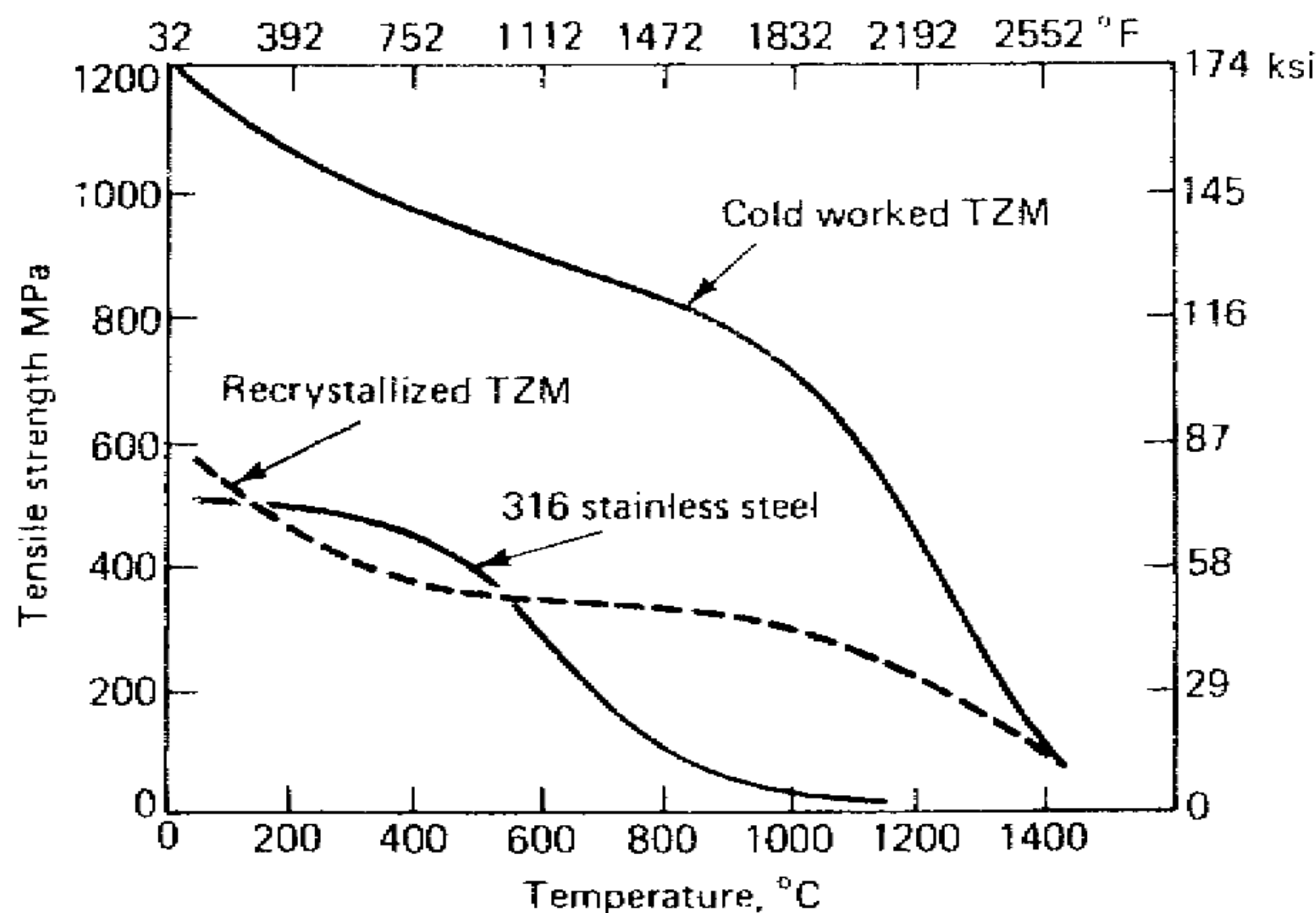

Incendiaries, The Science of Using Fire as a Weapon

All metals lose structural strength as their temperatures rise. This makes the use of heat generating weapons useful for this purpose.

Tungsten has the highest resistance to heat and is the hardest pure metal, but it is the heaviest engineering material. It is also expensive and has poor fabricability so other materials are usually preferred. Some tungsten-nickel-copper alloys are produced for special applications in small amounts in some vehicles.

Target Types

Automobiles are the most common type of transportation and are not considered hard targets because much of their construction is made of combustibles that are easily exposed to munitions. Because they are used as the normal mode of transportation, we will make a few comments on their vulnerability.

Most automobiles have an engine in the front (some in the rear) with a firewall separating the passenger compartment from the engine. A fuel tank is mounted in or around the vehicle in various locations depending on the particular design. A fuel line runs to a fuel pump mounted on and driven by the engine which then delivers the fuel to the carburetor.

In volume 1, we described the improvised weapon of using a spark plug to ignite fuel in the gas tank. If the fuel tank is not locked or is accessible, and if it is not full, then this is an effective means of attack. It is important to understand that fuel vapors formed in a gas tank almost always exceeds the flammable limits in air and will not normally explode or even ignite because the high volume of vapors smothers any spark. It is important to use a hose to blow outside air into the tank to insure a suitable fuel-air mixture above the liquid gasoline. The plug should be placed near the outlet since this is usually the highest spot in the tank and since gasoline vapors are heavier than air, this area will have the leanest mixture that will most likely explode or burn.

Any spot along the fuel line or on the outside of the fuel tank is also suitable for incendiary attack because the fuel supply will burn in open air and aid in causing the destruction of the vehicle and its contents.

Vehicle contents are often hard to ignite and often require the use of accelerants to sustain a destructive fire. This is most often accomplished by hurling molotov cocktails or comparable munitions through the window of the vehicle.

One of the other possible means of starting a clandestine fire in an occupied vehicle is to produce a pinhole leak in the fuel line near the engine or its exhaust. This will cause gas to leak and quickly vaporize. As the engine heats up, hot parts and sparks can easily ignite the vapors producing a fire or explosion. The plastic molded parts of a carburetor that hold gasoline in, can be removed or caused to leak as well producing the same effect.

Incendiaries, The Science of Using Fire as a Weapon

Tank Trucks represent high priority military targets in that they haul valuable materials which are often combustible such as fuels, solvents, gases, corrosives, and other dangerous or flammable materials. These tanks may be standard cargo vessels or may be specialized pressure tanks. They have certain design features and are required by law to carry placards describing their contents which makes target selection easy. Examination of the placards and tires to see if the tanker is filled make it easy to determine if the target is suitable. Chemical companies and states supply the hazardous placard numbering system to identify a cargo.

The cargo carriers come in many forms depending on their purpose and intended cargo.

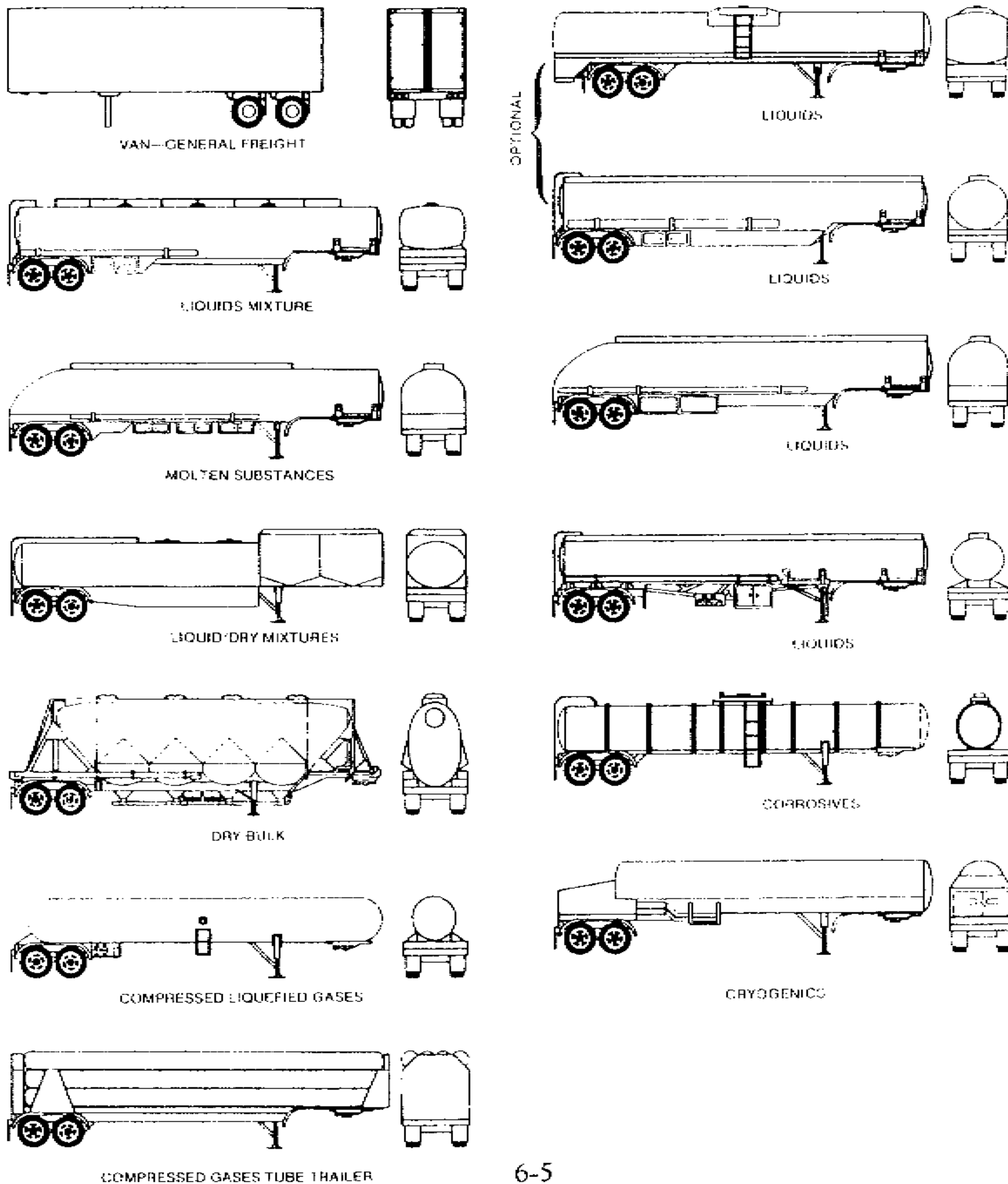

Incendiaries, The Science of Using Fire as a Weapon

As you can see, there are many configurations to the trailer/tanker designs. The tank construction is very similar to that described earlier for storage tanks and the metal thickness to overcome is usually the same. For highway transportation, you will rarely see thicknesses greater than 1/2" and the use of refractory metals is non-existent due to expense and weight considerations. Attacking parts of the vehicle that are not sheet metal is possible. The tankers are often equipped with valves, hoses, observation manholes, vents, and other vulnerable parts. The following diagrams give an idea of the layouts and designs of typical tankers.

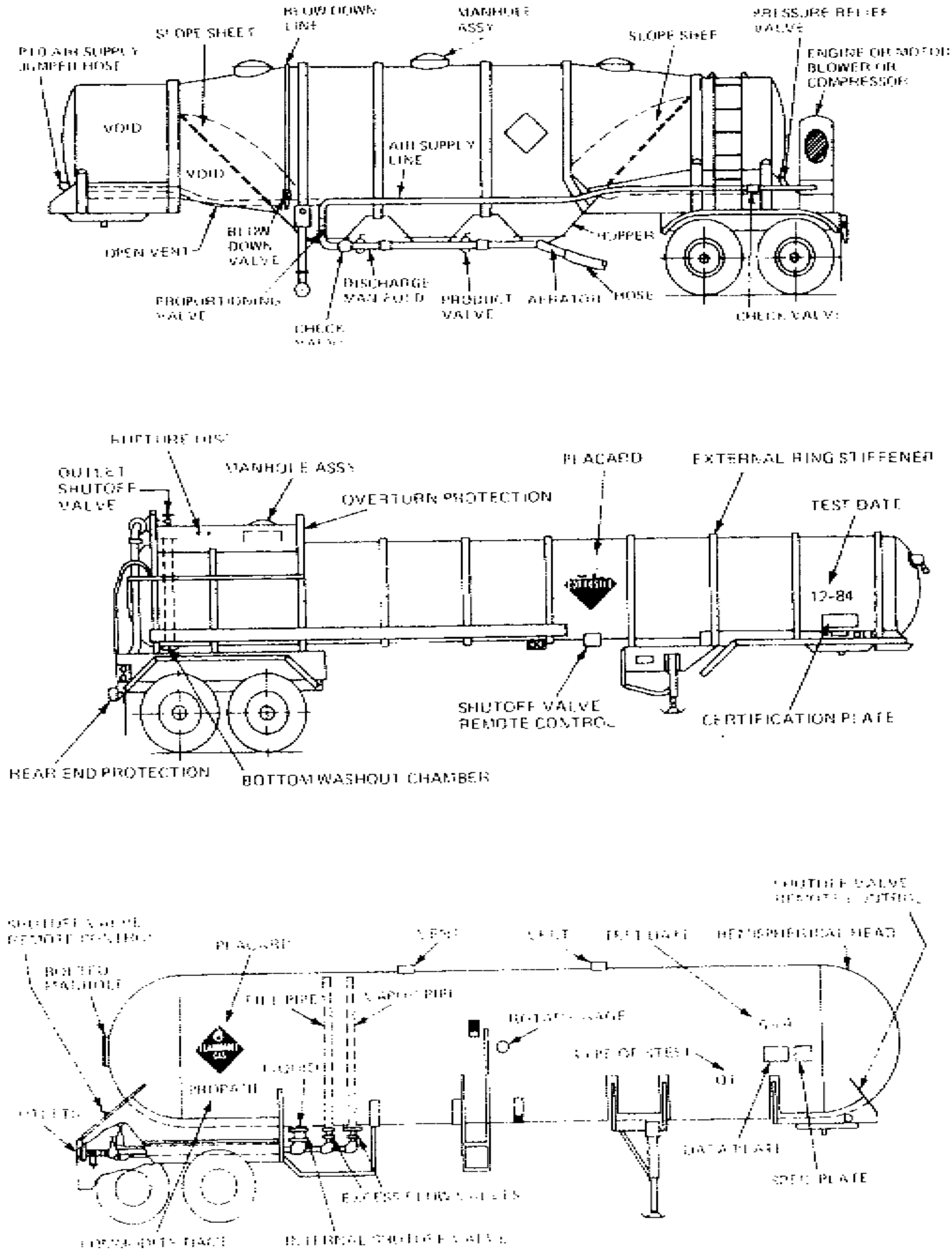

Incendiaries, The Science of Using Fire as a Weapon

Rail Tank Cars are used to transport the same types of materials as tanker trucks> The main differences are the volume and thickness of the tank walls. Semi trailers are generally limited to a maximum of 24-28 tons of material it can transport. A railcar will hold 80-100 tons and is often part of a train that may represent over 10,000 tons of valuable cargo. Destruction of a flammable cars contents produces not only the loss of the car, but possibly an entire train due to derailment and will often tie up major transportation routes for several days that are necessary to clear the tracks and repair damage to the rail line.

Because of this vulnerability, the rail tankers use ellipsoidal shell designs that re stronger, fusion welded together, and heated at 1,100 F for 1 hour to relieve metal stresses caused by welding.

Standard cars use 11 gauge (1/8") steel or aluminum
Nonpressure and double lined tanks use 7/16" steel
Head portions use puncture resistant 1/2" steel
Steel pressure tanks (200 psi) use 9/16" steel
Steel pressure tanks (300 psi) use 11/16" steel
Steel pressure tanks for chlorine use 3/4" steel because chlorine is a deadly military use poison as well as a valuable commercial chemical.

Aluminum is used at 1/2" to 5/8" for heavier applications.

An incendiary must be capable of penetrating the metal thicknesses of the steel it is used on. Most of the rail tank car designs do not use refractory alloys. All rail cars are marked with placards or stencils describing their contents.

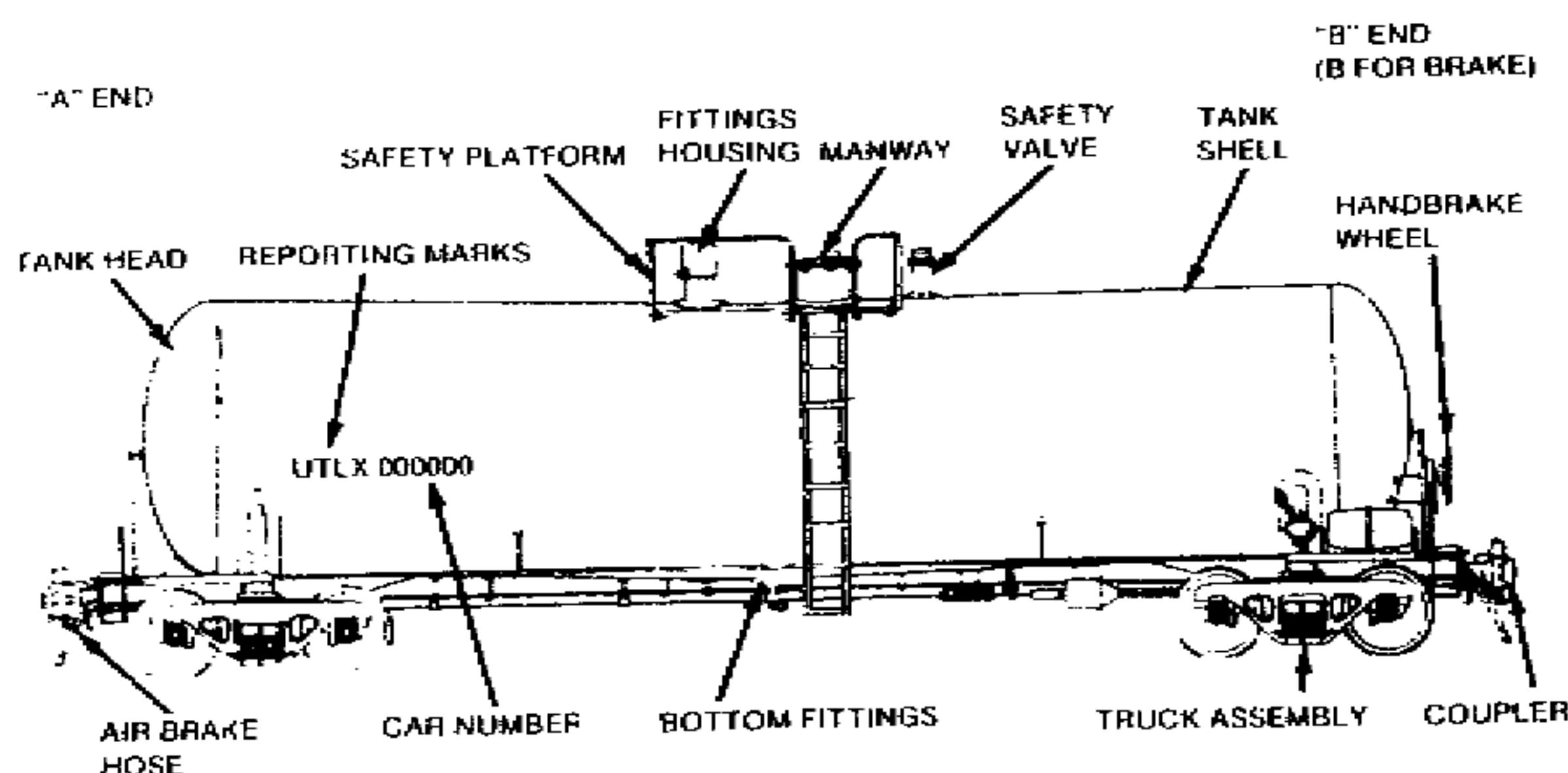

Incendiaries, The Science of Using Fire as a Weapon

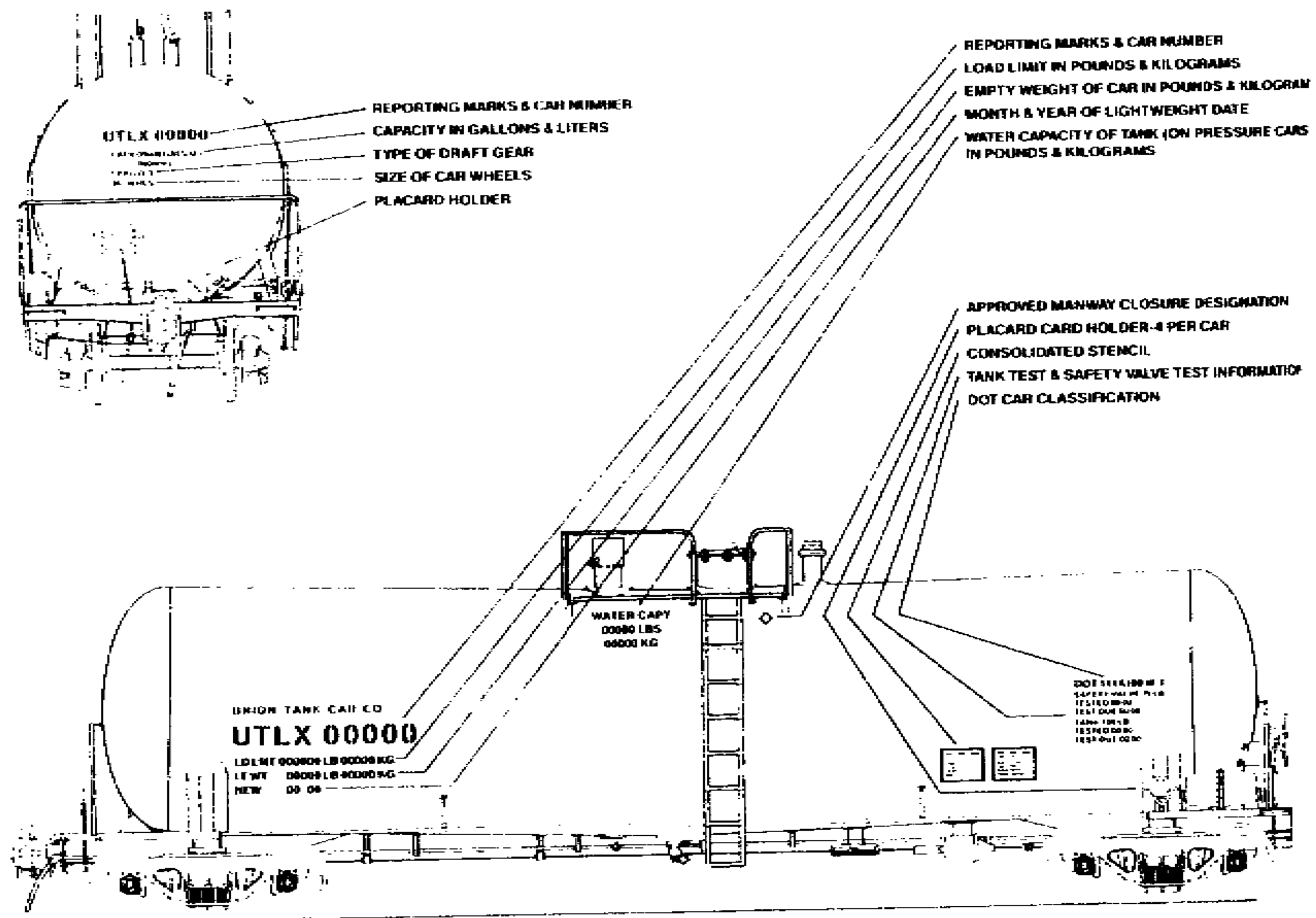

Railroad bridges and trestles can also be attacked by using incendiaries to weaken supports. These have the advantage of not giving away their use from noise and pressure waves like explosions do, and their effect may not be noticed or felt until a train passes over and collapses the weakened structure. Many of these structures have combustible materials that may add to their vulnerability such as wooden railroad ties.

Railroad and truck transportation targets are often given secondary priority over military targets as was seen in the gulf war, but the effects of their destruction can literally starve an army in the field. Since the defending army cannot be everywhere, they make easy behind the lines targets for commandos and saboteurs.

Aircraft offer unique opportunities for incendiary attack. TWA flight 800 captured the interest of the public. The general assessment at the time of this writing is that a mechanical failure was likely the cause. It is clear from the melting of metals that burning of the fuel had some hand in helping to bring the plane down (the parts could not have melted underwater).

Incendiaries, The Science of Using Fire as a Weapon

Aircraft travel at widely different altitudes and very different temperatures during the course of each flight. The conditions in which flammable vapors may form in the fuel tanks will accordingly be very different during the flight. The fuel "Jet A" is normally too lean at 70 F (21 C) at sea level to support combustion if the tank is sparked on its inside. As the aircraft gains altitude, air friction heats the skin, dissolved oxygen can come out of the fuel (outgassing), and sloshing of the fuel in the tank occurs from the motion of the aircraft which forms foam in the fuel. These all have an effect on the flammable limits in air. The following chart illustrates the flammable ranges for the fuels listed inside the darkened boundaries.

	<u>Flammable Limits</u>	<u>Autoignition Temp.</u>	<u>Boiling Points</u>	<u>Vapor Pressure</u>
Gasoline	1.4-7.6%	825-960 F	110-325 F	5.5-7.0 psi
Kerosene Grades	.74-5.32%	440-475 F	325-450 F	.1 psi
Blends JP-4/Jet B	1.16-7.63%	470-480 F	135-485 F	2-3 psi

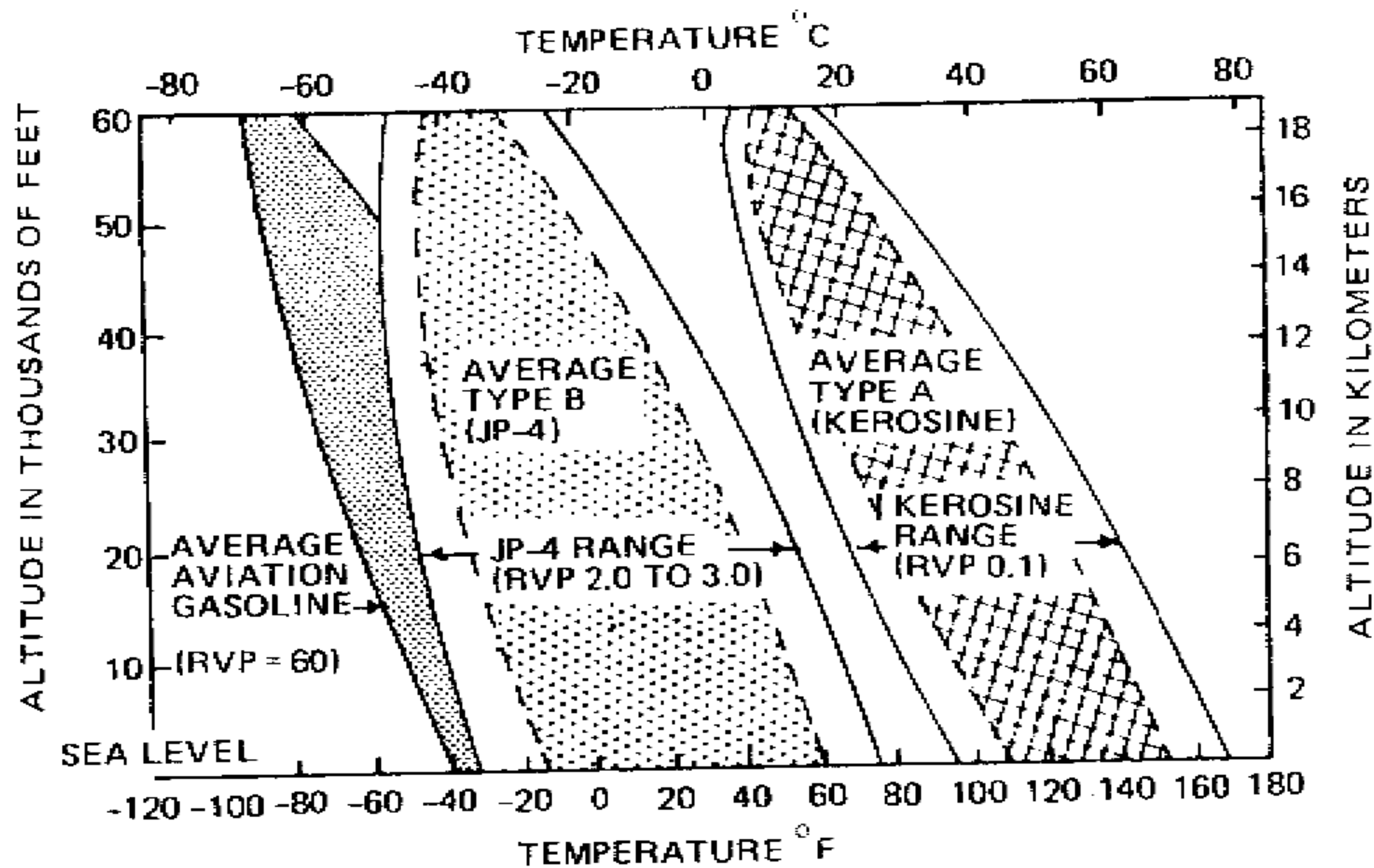

If an aircraft fuel tank becomes damaged, the fuel often becomes discharged as a mist due to the tanks motion, splashing, and wind shearing. It is very easily ignited in this form from any sparking or heat such as hot engine or brake parts, shorting electrical circuits, lightning, or other source. This results in a fireball that ignites other non-fuel combustibles and liquid fuels.

The Jet A kerosene grade fuels have been the hardest to ignite in airline crashes, however, once ignition takes place, all are deadly. The main reason for this is that the flash point of gasoline is -50 F while the kerosene doesn't produce vapors until 95-145 F.

Most of the aircraft fuel is usually stored in the wings with an extra tank under the center of the aircraft. This tank usually contains a flexible bladder that prevents free tank vapors from forming in flight by retracting in size with the reduction of fuel as it is consumed.

Incendiaries, The Science of Using Fire as a Weapon

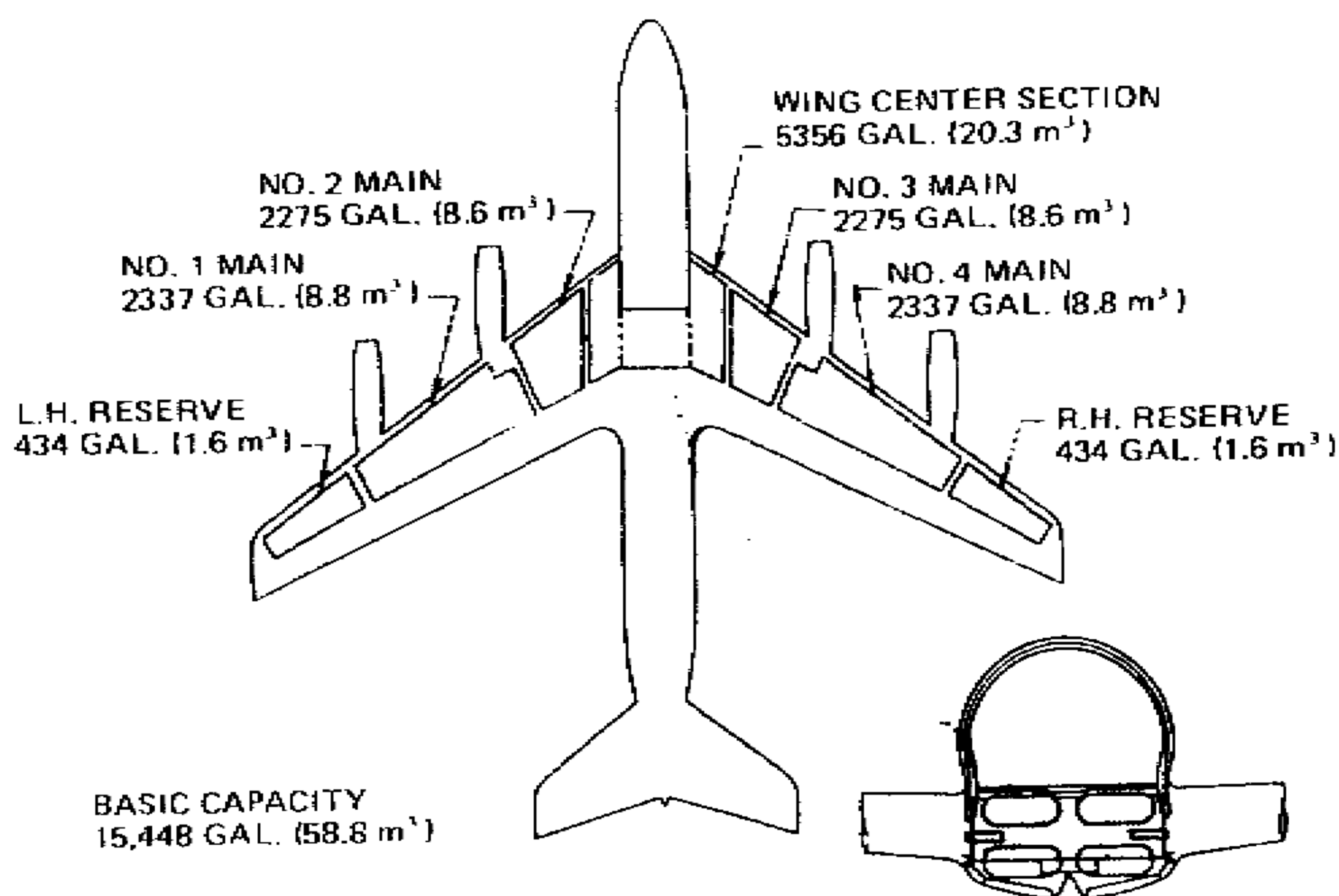

Military helicopters have recently used a special type of crash resistant tank similar to pressure vessels with dry break fittings and automatic fuel shutoffs. In more than 800 accidents with this type of tank, no thermal injuries due to fire ever occurred at all. These have not been adopted commercially or in high speed aircraft because of the loss of fuel volume and greater weight.

Open cell foam blocks are used in military aircraft to provide explosion protection and limit available fuel for incendiary bullets, rockets, and missiles. These drastically reduce the vapor space available for incendiary effects to spread through the tank. They also reduce fuel volume and hinder tank maintenance. These have been effective in stopping internal tank fires in which a fire had started and only charred the foam in the vapor space.

Newer aircraft use a double walled center tank with a honeycomb core in the center wing section which provides additional structural protection. This combination theoretically reduces the potential for fire from explosives igniting the tank fuel and vapors or from incendiaries in the center part of the aircraft. All of this information indicates the best parts to conduct incendiary attacks against an aircraft is by firing incendiary projectiles into the wings or center tanks. Thermate may be used internally over the center tank if it is large enough.

Aircraft, hangars, fuel depots, and terminals all represent enormous investments and are premium targets in any warmaking operation.

Ships also represent large investments by enemies and are accordingly among the highest priority targets. Sinking ships is a little more difficult to do and because of their construction, almost always require explosives. Some successful strikes have been carried out using cannon and incendiary fire which ignited the storage magazine or onboard fuel. This often resulted in the sinking or total incapacitation of the vessel.

Incendiaries, The Science of Using Fire as a Weapon

Ships are built of steel in a huge box-girder arrangement. The shell plating along the sides and running up to the main deck form the a water tight exterior. These run down to the keel, which is a rigid fabrication of plates and structures running from for and aft along the centerline of the ship. Frames are built on the inside of the ship and act as a rib cage. This entire structure must stand up to the water pressure and the constant shoving and buffeting of waves. It must support the entire weight of the ship in its center or on its ends when waves pick up the ship and support it at narrow points. All the compartments inside add to the strength of the vessel and reinforce each other. They all have watertight doors that can be quickly closed in the event of flooding.

Because the entire ship is basically built of high melting point and very strong steel, with several layers protecting cargo and munitions, it is very hard for incendiaries alone to cause damage. The most effective ways of attack are missile or rocket carried explosives, or also commando teams going aboard and placing incendiaries and/or explosives in magazines and fuel storage.

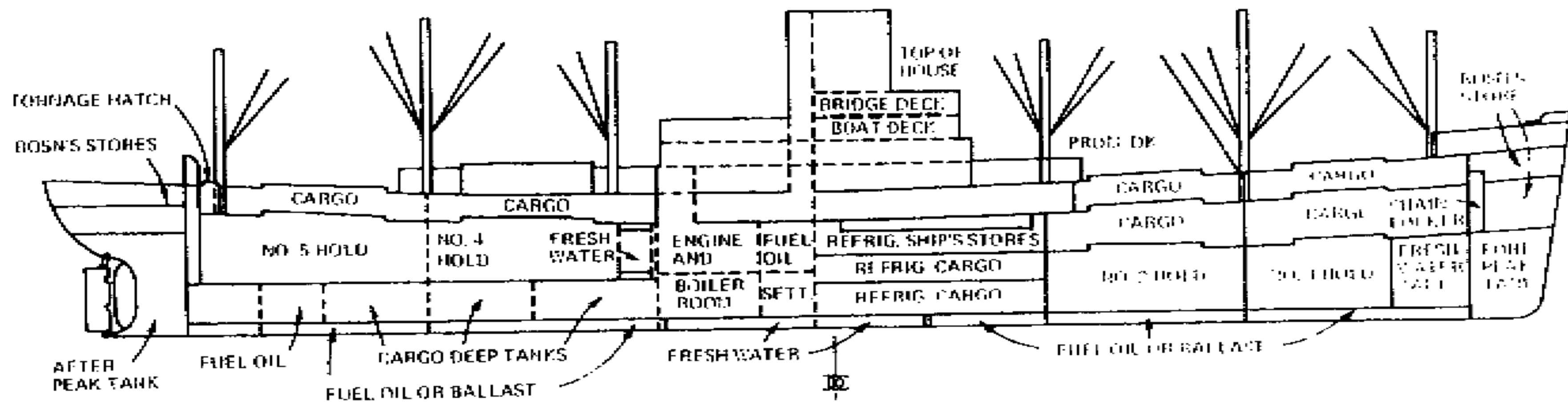

One of the modern methods used to protect flammable cargo in commercial vessels is to fill the storage tank with inert gas. The flammable liquid such as oil or LPG is then loaded into the tank leaving the vapor space filled with inert gas so no oxygen can be present to form explosive vapor mixtures. This would of course necessitate the use of ordnance or projectiles that would pierce the tank, releasing its contents and allowing the flammable vapors to form. These may then be ignited by any available ignition source.

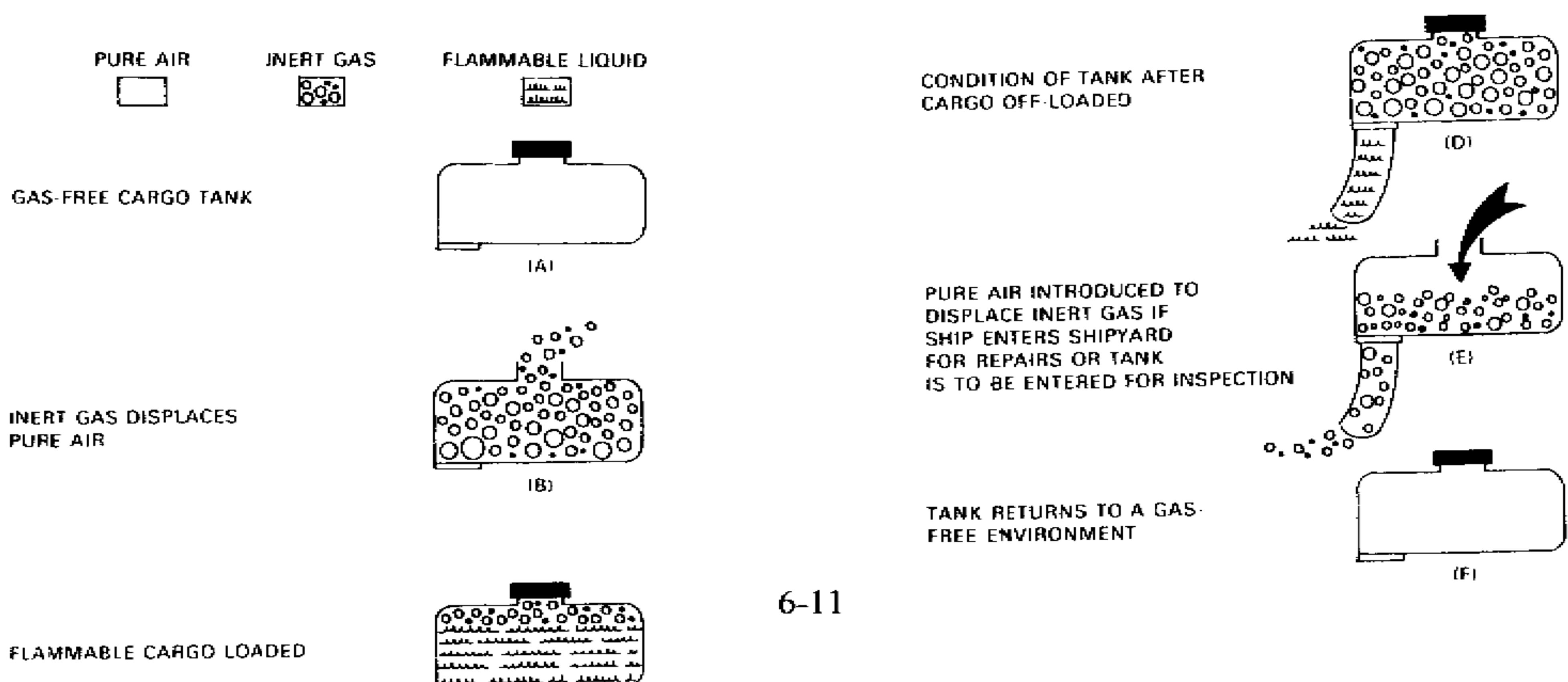

Incendiaries, The Science of Using Fire as a Weapon

Armored vehicles are among the toughest to attack with incendiary weapons. In WW1, thermites had some effect because the tanks were thinly armored and used standard plate steel. Modern battle tanks and other vehicles use -

1. Sacrificial armor such as the skirting seen on the British Challenger 1 (below) and the reactive armor that is added to the frame of many modern tanks. Incendiaries are useless against this type of armor
2. An outside layer of plate steel to absorb the initial impact of enemy ordnance.
3. An internal sheet of refractory metal alloy or ceramic to mitigate the melting and softening effect of incendiaries.
4. A layer of fiber reinforced polycarbonate that acts as a butterfly net to collect projectiles that penetrate. This material gives slightly while slowing the fragments.
5. A wide range of other alloys may be included in the design to defeat particular enemy explosive munitions and shaped charges.

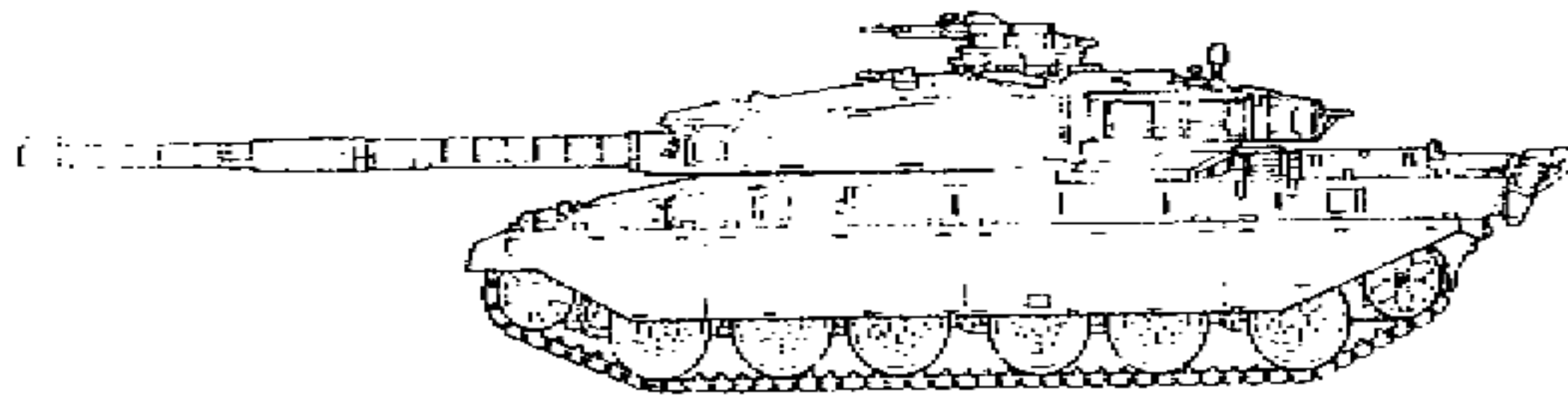

All these materials make incendiary attack alone a very difficult proposition. Molotov cocktails are nearly useless unless you can close on the tank and place the contents into vulnerable spots. The current trend is to use combined ordnance like that already described where an incendiary is used to soften metal so that an explosive can pierce the interior.

Incendiaries, The Science of Using Fire as a Weapon

Vulnerable parts to attack on the exterior of a tank are -

1. Internal and external portions of the barrel. If the metal is weakened it may cause the barrel to explode when the next shell is fired.
2. The base where the turret revolves on the frame. The metal may weld, expand, or otherwise thermally damage the armor so that it does not smoothly rotate.
3. Any external fuel tanks
4. All optical observation ports and windows. These can be temporarily blinded by using car wash type spraying devices with extensions (possibly camouflaged in their path) to spray paint all the surfaces as the tank passes. This obscures their vision of a foot assault.
5. Gun plugs
6. Communications antenna
7. Edges of hatches
8. Air intakes
9. The insides of the drive wheels

A photograph of a WW2 German Panther under construction with the tracks and wheels removed.

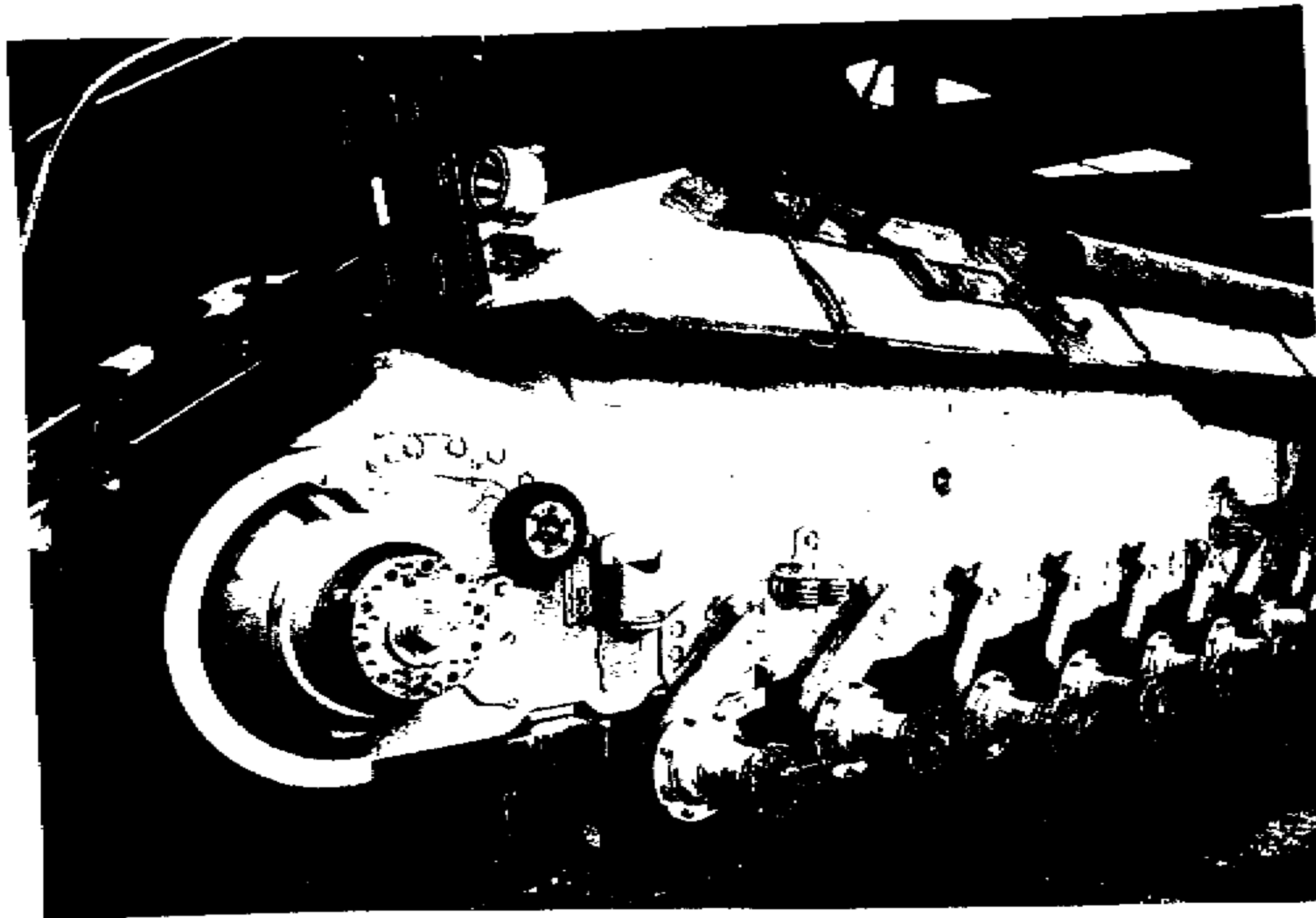

Incendiaries, The Science of Using Fire as a Weapon

Chapter 7

Attacking Firefighting Infrastructure

**"Next time your cat is stuck in a tree and the fire department will not come
Just set the tree on fire"**

The principal means of limiting and stopping loss due to incendiary attack is the use of trained and equipped firefighting organizations. In order to maximize the losses inflicted by incendiary attack, it is often advantageous and easy to interdict the firefighters efforts. We will cover this subject lightly here.

The main resource used to fight fires is the local water supply. This supply is enormous due to the demands the public makes for water for personal use. The average daily consumption of water per person ranges from a low of 100 GPD (gallons per day) to a high of 1,000 GPD depending on the area and industry needs. This means that a city of 100,000 people will actually use 10 million to 100 million gallons of water each day. The city then organizes its intake and distribution of water to meet these needs. Peak demand may use most of this water in only a few hours of each day so the system is designed to deliver these quantities to homes and businesses at their peaks and still maintain a reserve for firefighting.

Engineers usually design the system to provide app. 10,000 gallons per minute to fire hydrants in excess of peak demand for a city of 100,000 to combat a major fire. In many cases, this figure is doubled so that 2 major fires may draw on this amount of system resources simultaneously.

This water is made available in the form of water carried on fire trucks that can be replenished from area fire hydrants, and the location of fire hydrants nearby so that water can be hosed directly onto a fire. Without water to cool fires and drop fuels to below the autoignition temperature, the fires will burn until the available fuel runs out.

Water Supply Systems

The amount of water that must be stored to meet these demands borders on the fantastic. Not only must this water be stored, it must be in the form of deliverable quantities when it is needed. Since it is delivered by pipes, it must be stored at elevations higher than the users so that static pressure will cause the water to flow to the points of consumption.

The earliest source of water reserve for cities in the US was in the form of cisterns which would hold rain or pumped in water in a reservoir until needed. Then, wooden logs were hollowed out to form the first water mains used to deliver water to the consumer. They added wooden basins that could act as local reservoirs for fire departments to draw on. These were soon replaced by cast iron pipes, then cement pipes, and today many of the pipes use plastic. These are maintained under pressure so that water is always available on demand.

Incendiaries, The Science of Using Fire as a Weapon

Primary water mains are 20-48" in diameter and are used to carry water to the neighborhood. These feed into reduced size secondary mains of 12-20" diameter pipes. These feed the distributor pipes that go directly to the consumer and are 6-8" in diameter. These usually have gate valves so that they can be shut off in the event of burst lines. They also feed the local fire hydrants. They are designed in loops so that water can flow in 2 directions to the area it is needed.

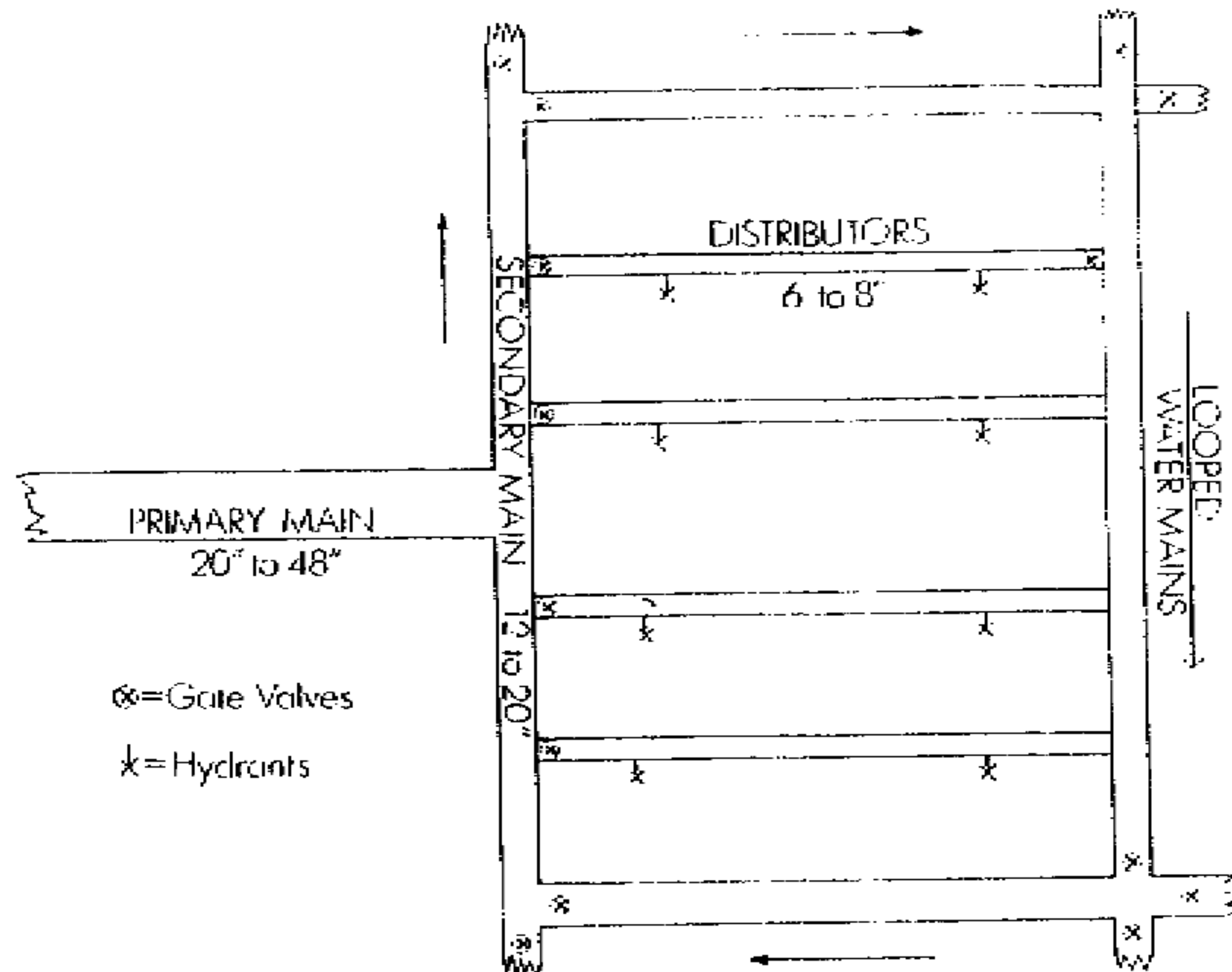

Sometimes a separate main will be installed that is dedicated solely to firefighting needs. The fire hydrants are usually laid out so that they are not more than 500' from any possible fire. The hydrants are designed with a wet barrel and are valved at the top, or have a dry barrel and are valved at the bottom.

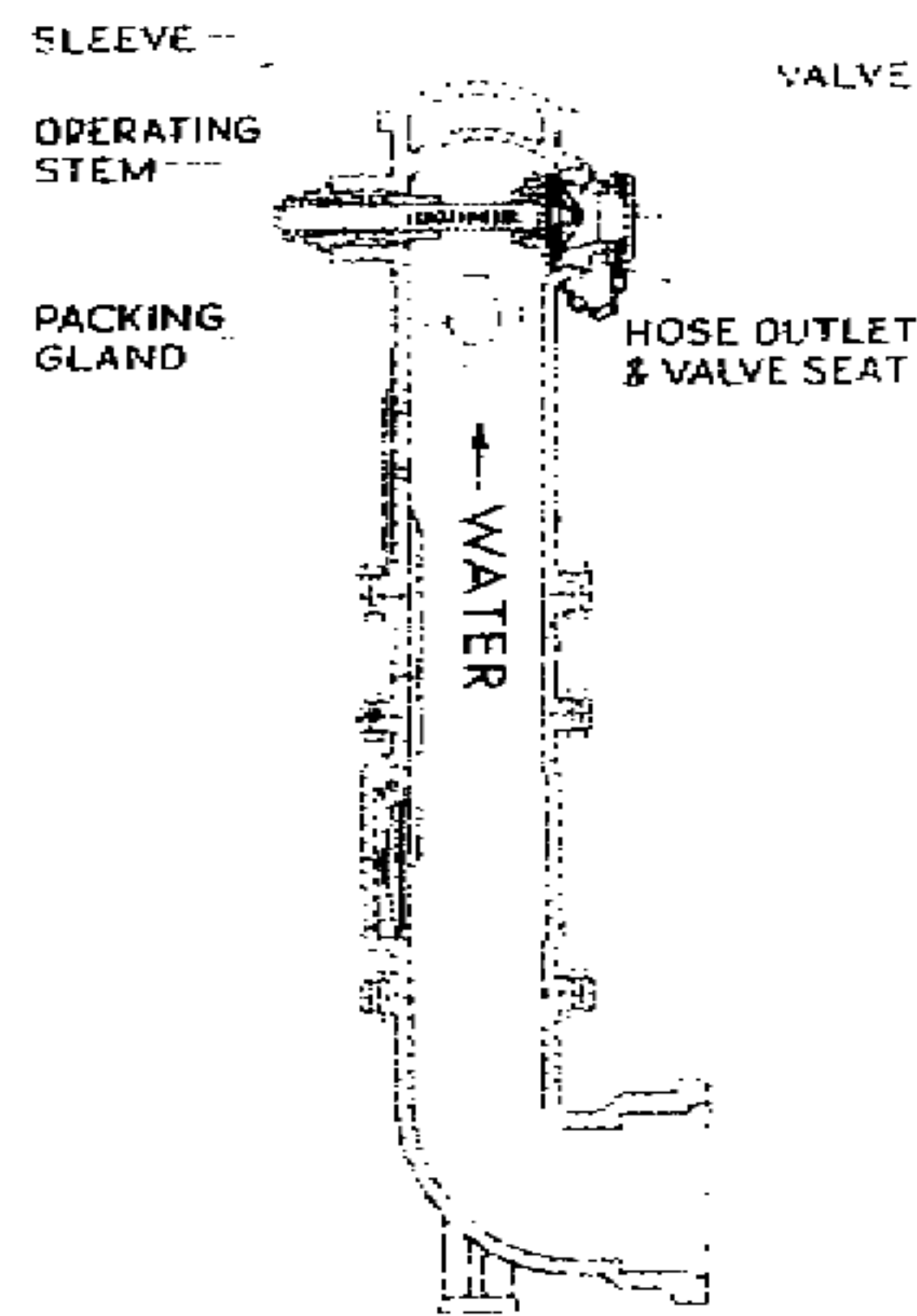
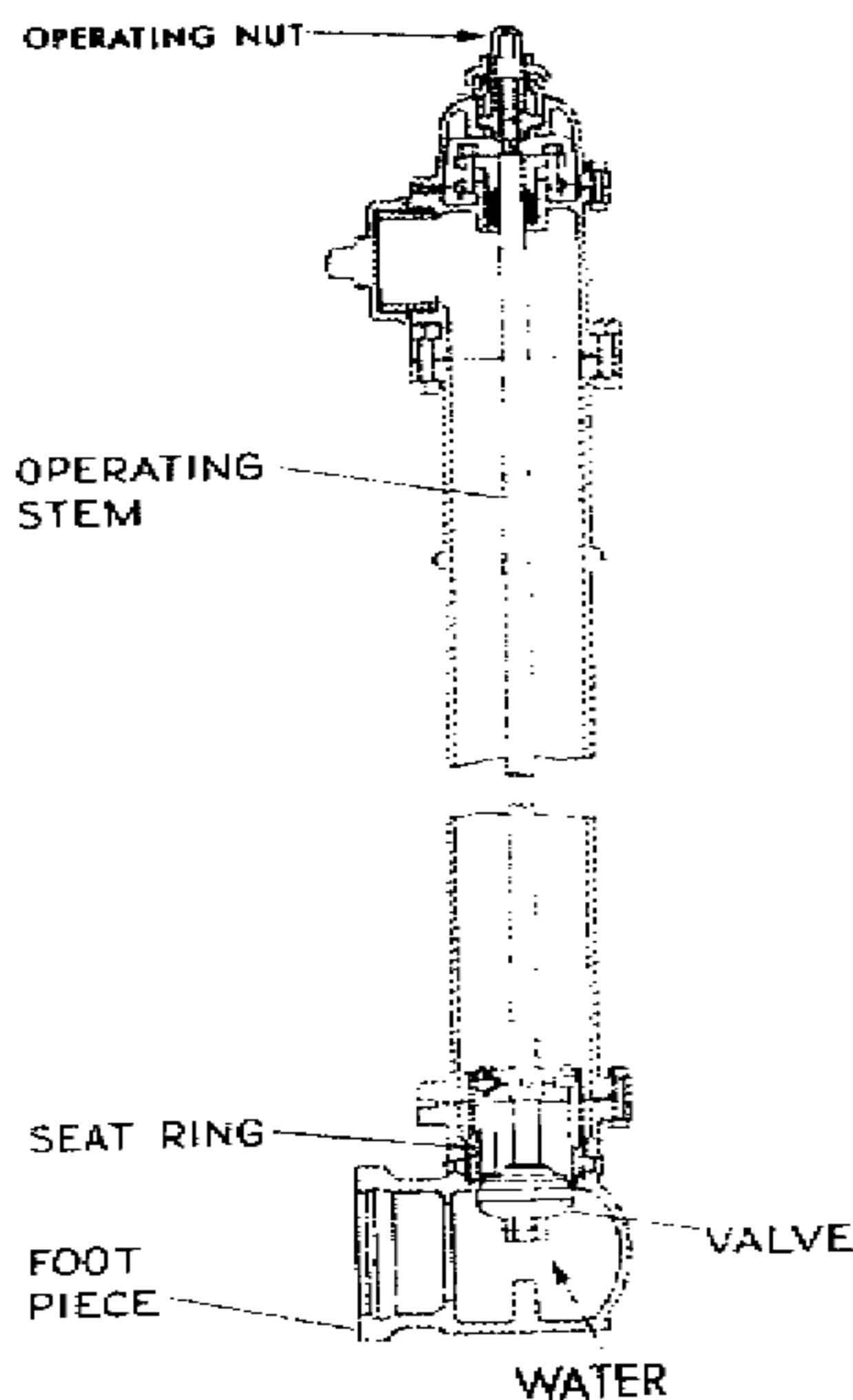

Incendiaries, The Science of Using Fire as a Weapon

The fire hydrants act as water faucets that can be turned on or off. They can also be damaged or destroyed so that they gush water reducing available pressure and provide no means of supplying water through any physical attachments. The loss of water forces the shutdown or cutting off of the main and cuts off water to the area that needs it.

In clandestine incendiary attacks, destroying area water hydrants will drastically reduce the ability of firefighters to combat a large fire. The dry barrel hydrants must be damaged down at the level of the valve underground in order to effectively incapacitate the system. This can be accomplished by opening the hose outlet with the valve closed and dropping explosives into the barrel. These will usually rupture the pipe sufficiently to cause free water flow.

If access to gate valves and mains can be obtained, these can be destroyed as well. In large scale attacks, the entire water supply can be interdicted by destroying dams which hold back water creating reservoirs that are used by cities. These destruction of these dams usually cause flood damage as well. Holding reservoirs are also used in the form of elevated storage tanks that receive water from lakes and streams. This water is usually filtered, settled, and chlorinated before it is stored. These supplies are often easily spotted by aerial and ground surveillance and are destroyed by using projectile weapons or explosives. This produces a catastrophic drop in static water pressure and physical loss of water reserves.

Wells are often a source of supplemental water, especially in rural and industrial areas. If these can be located and damaged, then they cannot contribute to the firefighting effort. In military assaults, an effort is usually made to destroy or interrupt the electrical power grid so that well pumps, lights, and phones do not work. This prevents electric pumps from operating, calls to firefighters are delayed, and small fires are not as easily spotted and reached in their early phases. These combined efforts are often undertaken at night to create the most difficulties for the defending cities.

Many cities use ground level water and provide this supply to the public by means of a pumping station. These stations can be identified and destroyed prior or simultaneously to incendiary attacks. These pumping stations are used to refill elevated storage tanks during times of lowered demand.

In the end, a successful incendiary large scale attack will include plans to interdict and destroy most of the firefighting capability. All important targets should be hit and accelerated simultaneously so as to swamp the ability of the entire system to deal with multiple outbreaks of fire. In addition, all elevated and ground level tank reservoirs can be taken out, mains and hydrants subjected to demolition, pumping stations bombed, dams destroyed, and this can combine for both flood and fire related destruction. Firefighters that only have one tank of water reserve will not be successful in dealing with large conflagrations. Attacks that successfully combine all of these methods of attack are the most effective. You need only look at the successful fire bombings of previous wars to understand this concept.

When you need to know absolutely, positively, how to destroy it by tomorrow- Call STIP!

Published By STIP
PO Box 59
Silver Creek, Nebr. 68663

Scientific Principles of Improvised Warfare and Home Defense \$30/Volume

Volume 1 Basic Training

Hand Held Weapons
Chemistry, Manufacture and Use of Explosives
Mounted Weapons

Properties and Improvisation of Firearms
Hand Held Firearms and Explosives
Non Explosive Chemical Weapons and Incendiaries

Volume 2 Basic Training

Bio Toxic Weapons
Armor, Personal Protection, and Material Handling
Combat Support, Skills, and Equipment

Defensive Obstacle Construction and Countermeasure
Booby Traps, Mines and Positioned Weapons
Strategies, Tactics, Resistance, and Countermeasures

Volume 3 History, Design, and Manufacture of Explosives

Volume 4 Incendiaries: The Science of Using Fire as a Weapon

Volume 5 Advanced Chemical Weapon Design and Manufacture

Volume 6-1 Advanced Biological Weapons Design and Manufacture

Biological Entry
Bacteria Based Weapons