

\$35.00

**SCIENTIFIC PRINCIPLES  
OF IMPROVISED  
WARFARE AND HOME  
DEFENSE  
Volume 3**

**History, Design, and  
Manufacture of Explosives**

**Powders and Propellants, Aromatic Nitro Materials, Nitric Esters, Nitroamines, Dynamite and  
Related High Explosives, Specials, Explosive Ordnance and Shaped Charges, Pyrotechnics,  
Formulations, Uses, Material Handling, and Storage**

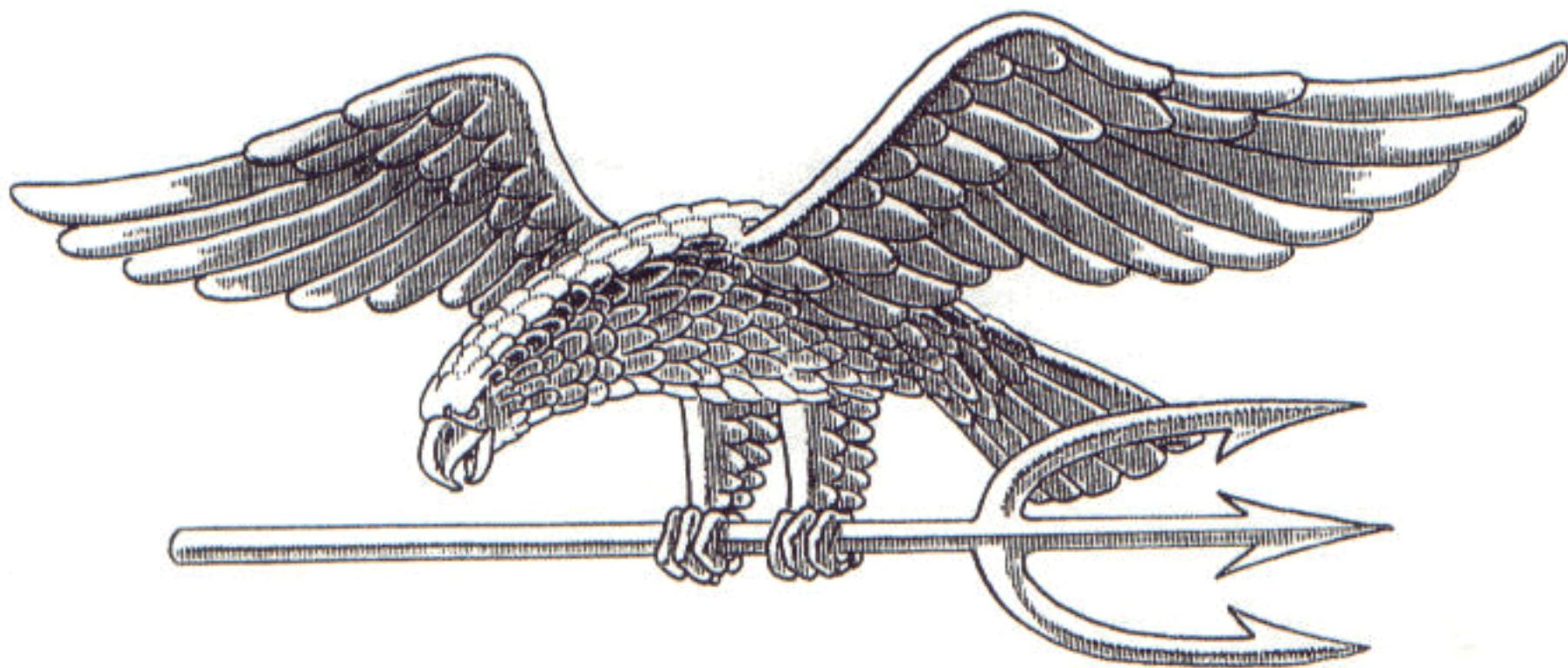

**There are few problems that cannot be solved  
with the use of high explosives**

**SCIENTIFIC AND TECHNICAL INTELLIGENCE PRESS © 1997 BY  
TIMOTHY W TOBIASON**

**For Academic Purposes Only**

Scientific Principles of Improvised  
Warfare and Home Defense  
Volume 3

**Copyright 1997**  
by Scientific and Technical Intelligence Press  
and Timothy W. Tobiason

Printed in the United States of America

Published by  
Scientific and Technical Intelligence Press  
P.O. Box 59  
Silver Creek Nebraska 68663

All rights reserved.  
Except for use in a review, no portion  
of this book may be reproduced in any  
form without the express written permission  
of the publisher.

This book is intended for academic use only.  
Neither the publisher or the author assumes  
any responsibility for the use or misuse  
of information contained in this book.

# History, Design, and Manufacture of Explosives

## Table of Contents

Introduction	I-1
Chapter 1 Black Powder and Propellants	1-1
Making Black Powders	1-3
Charcoal	1-3
Sulfur	1-4
Potassium Nitrate	1-5
Formulations	1-5
Commercial Manufacture	1-7
Improvised Potassium Nitrate	1-10
Nitric Acid for Explosives	1-13
Field Improvised Nitric Acid	1-14
Improvised Black Powder	1-16
Other Powder and Propellants	1-18
Guanidine Nitrate	1-19
Benite	1-20
Red/White Powder Propellant	1-22
Chapter 2 Nitric Esters	2-1
Alkyl Nitrates	2-2
Ethyl Nitrate	2-2
Methyl Nitrate	2-2
n-Propyl Nitrate	2-3
Isopropyl Nitrate	2-3
Nitroglycerin	2-4
Dinitroglycerin	2-7
Mononitroglycerin	2-8
Nitroglycide	2-8
Dinitrochlorohydrin	2-8
Acetyldinitroglycerin	2-8
Formyldinitroglycerin	2-9
Tetranitrodiglycerin	2-9
Nitroglycol	2-9
Dinitrodiglycol	2-10
Trinitrophenoxyethyl Nitrate	2-10
Nitration of Ethylene	2-10
Diethylene Glycol Dinitrate	2-11
Triethylene Glycol Dinitrate	2-11
Pentryl	2-11
Hexanitrodiphenylaminoethyl Nitrate	2-11
Trimethylene Glycol Dinitrate	2-12
Propylene Glycol Dinitrate	2-12

## History, Design, and Manufacture of Explosives

Butylene Glycol Dinitrate	2-12
Metriol Trinitrate	2-12
Butanetriol Trinitrate	2-12
Nitroerythrite	2-13
Nitromannite	2-13
Nitrated Sugars	2-14
Improvised Sugar/Aluminum Explosive	2-15
Nitrated Carbohydrates	2-16
Nitrocellulose	2-19
Pyrocellulose	2-20
Guncotton	2-21
Nitrostarch	2-23
Formaldehyde based explosives	2-24
PETN	2-25
Dipentaerythrite Hexanitrate	2-27
Nitroisobutylglycerin trinitrate	2-27
Nitropentanone	2-27
Improvised explosives from nitric esters	2-28
Chapter 3 Smokeless Powders and Propellants	3-1
Ballistite, Cordite, and Indurite	3-4
Single Base Powder/ Solvent Extrusion Process	3-6
Pyrocellulose	3-6
Single base/ Continuous Solvent Extrusion	3-8
Solventless Extrusion Process	3-9
Nitrocellulose Cast Propellants	3-10
Polymer based Cast Propellants	3-10
Stabalizers	3-10
Antacid	3-11
Rate of burning additives	3-12
Grain shape and casting	3-13
Gelatinizing agents	3-15
Flash Suppression	3-17
Improvised Nitrocellulose Explosive	3-19
Ball Powder	3-21
US Artillery and gun propellant formulations	3-23
Nitrocellulose propellant and additives	3-24
Cast Propellants	3-25
Binders	3-26
Ballistic Modifiers	3-27
Nitrocellulose Cast Propellant Formulas	3-29
Plastisol	3-30
Polymer propellant formulas	3-31

## History, Design, and Manufacture of Explosives

Chapter 4 Nitro Aromatics	4-1
Aromatic Compounds	4-1
Nitrated Aromatics	4-2
TNT - Trinitrotoluene	4-3
Trinitrostilbene	4-6
Hexanitrostilbene	4-6
Nitrated Benzenes	4-8
Nitrobenzene	4-8
Improvised Nitrobenzene Explosive	4-9
Dinitrobenzene	4-11
Trinitrobenzene	4-11
Aminonitrobenzenes	4-12
Nitrated Chlorobenzenes	4-12
Trinitroxylene	4-13
Hexanitrobiphenyl	4-14
Picric Acid	4-14
Picric acid from aspirin	4-16
Commercial Picrates	4-19
Dinitrophenol	4-20
Ammonium Picrate	4-20
Guanidine Picrate	4-20
Nitrated Nphthalenes	4-21
Trinitrocresol	4-22
Trinitroresorcinol	4-22
Trinitroanisol	4-22
Trinitroaniline	4-23
Ethyl Tetryl	4-24
Butyl Tetryl	4-25
Hexanitroazobenzene	4-25
Hexanitrodiphenylamine	4-25
Hexanitrodiphenyl Sulfide / Sulfone	4-26
Hexanitrocarbanilide	4-26
Mixed aromatic nitro explosives	4-27
Chapter 5 Nitramines	5-1
RDX and HMX	5-1
HMTD Improvised Primary Explosive	5-4
Guanidine Nitrate and Nitroguanidine	5-6
Nitrosoguanidine	5-10
Nitroamide	5-11
Methylnitramine	5-12
Ethylenedinitramine	5-12
Dinitromethyloxamide	5-12
Dinitromethylsulfamide	5-13

## History, Design, and Manufacture of Explosives

Urea Nitrate	5-13
Nitrourea	5-13
Improvised Urea Nitrate explosive	5-14
Chapter 6 The rest of the High Explosives	6-1
Dynamite	6-1
Judson Powder	6-3
Dynamite Formulas	6-4
Blasting Gelatin	6-5
Gelatin Dynamites	6-6
Low temperature explosives	6-7
Ammonium Nitrate Dynamite	6-8
Cold salt additives	6-9
Initiator for dust explosions	6-10
Methyl Nitrate Dynamite-Improvised	6-12
Additive formulations for dynamites	6-15
Ammonium Nitrate Explosives	6-16
Slurry formulas	6-17
ANFO formulas	6-18
AN / Aluminum explosive	6-19
Improvised fertilizer explosive	6-20
Non-nitrate explosives	6-22
Oxygen based explosives	6-24
Chlorate based explosives	6-26
Improvised Sodium Chlorate	6-27
Potassium Chlorate	6-32
Cheddites	6-33
Gasoline	6-35
Fuel air explosives	6-36
Human wastes explosives	6-36
Chapter 7 Primary Explosives and Fuses	7-1
Primers and Detonators	7-1
Mercury Fulminate	7-2
Improvised Mercury Fulminate	7-6
Lead Azide	7-8
Silver Azide	7-10
Lead Styphnate	7-10
Diazonium Salts	7-11
Diazobenzene Nitrate	7-11
Trinitroazidobenzene	7-12
Tetracene	7-13
Guanyl Azide	7-13

## History, Design, and Manufacture of Explosives

Cyanuric Triazide	7-14
PETN	7-15
Nitrogen Sulfide	7-15
<b>Chapter 8 Pyrotechnics</b>	<b>8-1</b>
Fireworks	8-1
Theatrical Effects	8-8
Rockets	8-8
Utility Flares	8-9
Photography	8-11
Smoke	8-11
Tracer Munitions	8-12
Incendiaries	8-13
Time Delay Initiators	8-13
<b>Chapter 9 Explosive Devices</b>	<b>9-1</b>
Friction, Percussion, Primer, & Bullet Design	9-1
Reusable primer and rifle cartridge	9-3
Thrown Explosives	9-7
Pipe Hand Grenade	9-8
Nail Grenade	9-10
Artillery, Propellant, and Shell Design	9-11
60 mm Mortar launcher	9-14
Rocket, Missile, and Warhead Design	9-16
Land Mines	9-19
Grenade Tin Can Land Mine	9-22
Mortar Scrap Mine	9-24
Booby Traps, Blasting Caps, and Positioned Explosives	9-26
Field Improvised Detonator	9-27
Booby Trap Activators	9-29
Letter Bombs	9-33
Flash and Electric Bulb Initiators	9-35
Fuse Cords	9-36
Delay Devices	9-38
Positioned Explosives	9-39
Air Dropped Bombs	9-40
Naval Torpedoes, Mines, and Depth Charges	9-41
Shaped, Plastic, and Slurry Explosives	9-43
PBX Explosives	9-43
C-4 / Semtex	9-44

## History, Design, and Manufacture of Explosives

Plastic Explosive Filler	9-45
Wine Bottle Cone Charge	9-46
Coke Bottle Shaped Charge	9-49
Cylindrical Cavity Shaped Charge	9-51
Funnel Shaped Charge	9-54
Linear Shaped Charge	9-56
HESH / HEAT	9-59
Chapter 10 Safety and Material Handling	10-1
Table of Distance for storage of explosives	10-2
Table of Distance - AN / Blasting Agent	10-4



# **History, Design, and Manufacture of Explosives**

## **Chapter 1 Black Powders and Propellants**

The first true explosive invented and used by mankind is the black powder or original "gun powder". This invention is considered by many to be the greatest invention in history because it allowed man, for the first time, to do massive amounts of useful and heavy work without using animals or human labor. Large scale mining, obstacle clearing, and nearly all the major engineering achievements since are the result of the invention of explosive powders.

To start learning the science of explosives, we will teach the basics of the chemistry, and technology beginning with the history of black powder.

Most explosives use two kinds of chemicals to create an explosion

1) A combustible that burns when ignited, with oxygen in the air or mixed with it. This can be the paper this book is written on, the clothes you are wearing, the wood your house is built with, the fuel you put in your cars gas tank, coal that is mined from the ground, and even the grain dust in your local farm elevator

2) An oxygen source such as liquid oxygen that welders use, or some chemical that supplies oxygen as a solid, liquid, or gas that can be mixed with a combustible. These are called oxidizers and include chlorates and nitrates.

When combustibles are exposed to high heat, they ignite and burn as fire. You can start wood, paper, your own clothes, and even gasoline on fire without causing an explosion. This is because the combustible chemicals that they are made of consist of layers of combustible materials on the chemical-atomic level that can be tens of thousands of layers thick. When the combustible catches fire, only the layer that is exposed to the oxygen in the air will burn at that instant. Once it is consumed in the chemical reaction of burning, created gases and solids that come off the fire now let the air reach the next layer so that layer can now burn. This "fire" burns so fast that on the atomic level, the layers burn off at a rate of tens of thousands every second. As the fire burns, you can feel the hot gases coming off of the fire as they expand and push outward. This is because heat causes gas to expand rapidly and to a large volume.

By intimately mixing an oxygen source in between many of these combustible layers, mankind learned how to burn all the combustible mixture instantly. When all the parts of a chemical mix catch fire and burn nearly instantaneously, we have an explosion. This is because the expanding gases cannot all leave the burned material gradually like you see in an ordinary fire. They are all created at once creating a huge pressure because so much of the solid or liquid is turned into a hot gas in a tiny space instantly. The result is a shock wave that travels outward at a high velocity sometimes reaching several miles per second.

## History, Design, and Manufacture of Explosives

This is what you see when an empty gas tank filled with vapors only, explodes. All the gas is burned at once instead of a small amount burning only at its surface where air can reach the liquid. The vapors are now all intimately mixed at the atomic level in the air so that the burning is nearly instant and complete. A gas fire can burn for several minutes before all the fuel is finally reacted with oxygen in the air. Huge amounts of hot gas rise and travel away from the fire and fresh air rushes in to continue providing more oxygen to sustain the burning. When the gas is mixed completely in the air as a vapor, it burns all at once, not leaving enough time for the expanded hot gases to drift off. All the gas explodes outward all at once, producing the shockwave we call an explosion.

This is the principle in which tiny amounts of gasoline are fed and partially vaporized in your car engines cylinders. The small explosion from the ignited gasoline push the piston down the cylinder at a special time, much like ignited powder pushes bullets down a gun barrel. This same principle applies to nearly all explosives and explosions.

[ The exceptions can include a water boiler exploding from the pressure of boiling water converted to a gas. Water doesn't burn and is not an explosive, yet it was converted to a gas under pressure by heating it, and when it cannot be contained by the steel of a modern boiler, it explodes outward with a shock wave from the hot expanding gase's that produces the same effects as an explosive based explosion.]

The first explosive discovered (invented) by man is black "blasting" or "gun" powder. It is made up of three chemicals. These are

Potassium Nitrate or ( $\text{KNO}_3$ ) which stands for one atom of Potassium (K), one atom of Nitrogen (N), and three atoms of Oxygen (O). This provides the oxygen source for the explosive, as well as the combustible Nitrogen which comes off of the reaction as a gas.

Charcoal or (C) which is a Carbon (C) source that in this form burns in the presence of oxygen.

Sulfur or (S) which is also a combustible that burns in the presence of oxygen.

The perfect or complete burning mixture by the chemical reaction of this mix is

Potassium Nitrate ( $\text{KNO}_3$ )	20 moles (a mole is a complete molecule of the material)
Charcoal (C)	30 moles
Sulfur (S)	10 moles

## History, Design, and Manufacture of Explosives

If this is mixed perfectly so it all burns completely and instantly, you get a burning reaction that causes the carbon to become Carbon Dioxide gas (CO<sub>2</sub>), or if the oxygen is limited, it will form Carbon Monoxide (CO) gas. The result of the above reaction when ignited is-

6 K<sub>2</sub>CO<sub>3</sub> (Solid) This is a solid residue of Potassium Carbonate  
K<sub>2</sub>SO<sub>4</sub> (Solid) This is a solid residue of Potassium Sulfate  
14 CO<sub>2</sub> This is carbon dioxide gas  
10 CO This is carbon monoxide gas  
10 N<sub>2</sub> This is Nitrogen gas

As you can see, a large part of the chemical weight of the solid powder that you ignited has been converted instantly to gas and the explosive reaction also gives off a great deal of heat which reaches 2000-3000 degrees instantly at the center of the explosion.

By changing the formula of how much of each ingredient you use, you can force formation of different amounts of gas, leaving unreacted solids behind, or producing more of one gas over another. The effects that these changes have on the explosion include hotter and faster burning, and slower and cooler burning that does less damage to artillery barrels.

You can see from this reaction that you didn't need oxygen from the air to burn all the charcoal and sulfur instantly. If you mix the powder perfectly as a dust, the mix will burn properly as a controlled explosion. These first explosions powered early pyrotechnics in ancient China and soon were used to propel steel bullets down a gun barrel. It allowed mass mining of important minerals and assisted in the digging of canals.

The work that explosives could do changed the course of world history. The nations that could produce the most and best guns and more powerful explosives to use in these guns would often win wars and decide how the conquered people would live (or die).

### Making Black Powders

The three ingredients for making black powders are Charcoal, Sulfur, and Potassium Nitrate (also known as saltpeter or niter). All can be obtained from chemical houses and can be field improvised as well.

**Charcoal:** has been used by man as a portable fuel for fire since ancient times. It is made by burning wood in the presence of too little oxygen. In the middle ages charcoal burners would build a furnace by piling wood up around a central pole, sometimes leaving a hole in the middle. The entire pile is covered with a clay made up of clay soil and powdered charcoal dust. This covering holds down the combustion so the end product is charcoal instead of ashes.

## History, Design, and Manufacture of Explosives

A workman lights the furnace through the top and lets it burn. As it burns, it needs more air and vents are opened on the sides. The wood eventually turns into a small heap of charcoal. The carbon making up the charcoal has been reduced from the mix of chemicals in the wood to a pure state that can be burned slowly in the presence of air.

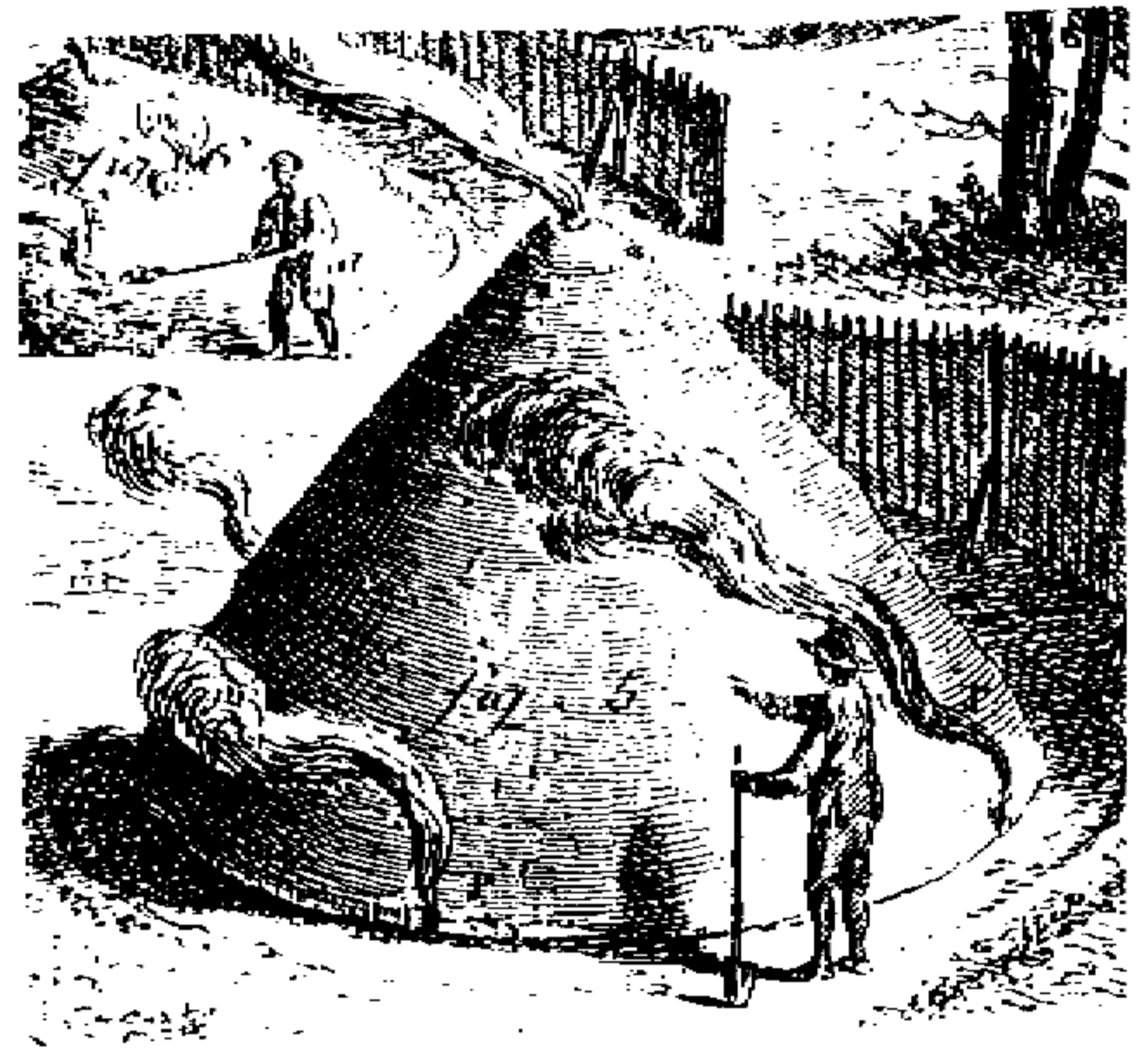
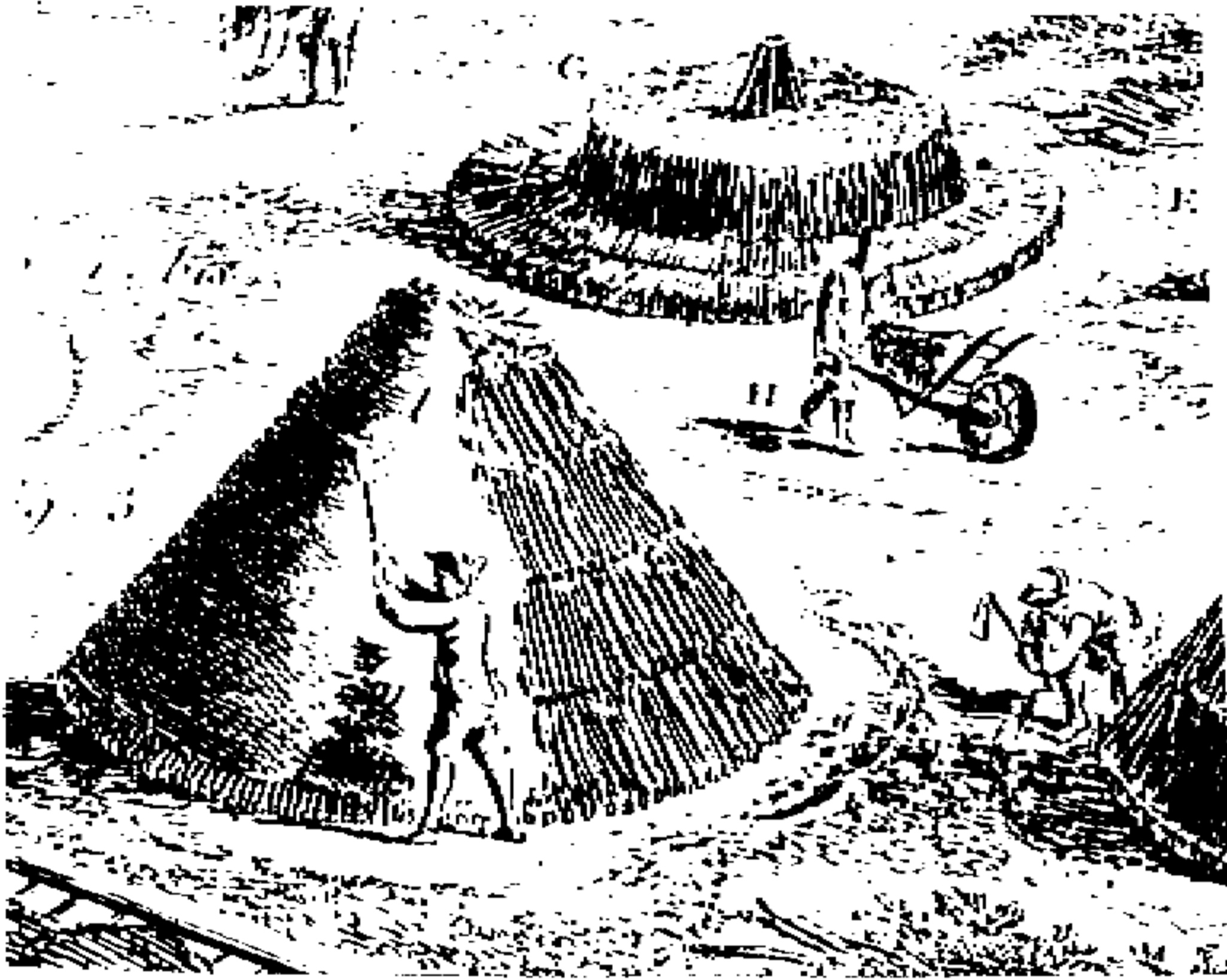

A modern way of making your own charcoal is to dig a large trench, fill it with wood, and set it on fire. When it is blazing fiercely, throw a covering over it to cut off the air supply abruptly. Covering it with corrugated steel panels used in steel buildings will work. Don't use anything that will catch fire. Shovel earth on the steel to completely bury and seal it underground. Leave it for several days to cool, and then open it up and shovel it into bags. You can now use it anytime you need a slow burning fire, such as cooking food, making bricks, or for making explosives.

The reason that charcoal burns slowly in this form is that it becomes porous when heated forming a "char". The oxygen from the air diffuses slowly into the pores allowing it to "smolder". This provides you with the slow burning "char-coal"

**Sulfur:** also known as brimstone, is one of the worlds largest mineral and chemical industries and makes up about .05% of the worlds crust. Elemental sulfur is mined from the earth as is, usually mixed with other contaminants. It is found in volcanic rocks and over salt dome structures and in evaporated basins. Large mining companies dig it up from the ground and purify it. Sulfur is insoluble in water and separated from other minerals by distillation, flotation, filtration, solvent extraction or a combination. In the US elemental sulfur can be purchased from fertilizer dealers in any volume desired or from chemical supply houses. It is used in various fertilizers, making sulfuric acid, refining gasoline, leaching copper and uranium ores, and making paints, pigments, pulp and paper. It is also sold in small amounts in drug stores and hardware stores for small scale fertilizer use in gardens and sweet corn plots.

## History, Design, and Manufacture of Explosives

Many countries restrict access to elemental sulfur because of its use in explosives. If mixed fertilizers can be obtained that are high in elemental sulfur, the sulfur can usually be separated from the other ingredients because by mixing in water and letting the other materials dissolve into solution. Sulfur is insoluble in water and will settle out to the bottom. The water can be poured off and the remaining sulfur dried by evaporation.

**Potassium Nitrate (Saltpeter or Niter):** Until the creation of nitrogen based chemical industries prior to world war one, virtually all nitrate salt used in all wars was obtained from the mixtures of manure and soil found in pig sties, chicken coups, horse stables, and sewage lagoons for human waste. Bacterial action on the manure from the various microbes in the soil (or that float in from the air) act on the Nitrogen in the solid and liquid wastes by combining it with oxygen from the air and converting it to nitrate salts. Since potassium is the most common alkali present in the soils and in human waste, most of the nitrate is produced in this salt form, although small amount of sodium nitrate may be formed. Potassium Carbonate or other Potassium salts may be added to the soil in advance to aid in the production of the saltpeter.

After several days or weeks of fermenting in the soil, the mix is boiled in vats of water sometimes with additional potash or lime. This boiling extracts all the water soluble salts from the manure-soil mix, and the water is poured off. The solids from the bottom are discarded, and the water is then boiled down and concentrated to where most of the ordinary salts precipitated out to the bottom. The solution left over is poured into a separate container and allowed to cool. When this final solution cools, crystals of fairly pure niter would fall out of solution and be harvested and dried for use in explosive powders.

### Formulations

Mixing these three ingredients has always been a difficult and dangerous undertaking. At first, artillerymen in the field mixed their own powders, but professional mills soon sprang up to mass produce the powders and ordnance. The powder was kept wet during mixing to avoid the risk of explosion. At first only fine powder was used. Later, the fines were used as primer while the coarse granules were separated while wet by passing through sieves, and were used in the main charges. The Potassium Nitrate was also used to impregnate twine so it could be used as a slow burning fuse in cannons and would not burn out in the wind.

The production of flying fire (the first incendiary rockets) was accomplished by mixing

9 parts niter  
3 parts charcoal, preferably from grapevine or willow trees,  
1 part sulfur.

## History, Design, and Manufacture of Explosives

These were mixed together, poured into a hollow reed or piece of wood and would fly where it was pointed when lit, or if in a metal mounted tube that could be held steady, it could be aimed at an enemy and the flying fire as well as anything in the tube in front of it would fly at the target and light it on fire.

A later formula of 6 parts niter, 5 parts willow charcoal, and 5 parts sulfur was used with marginal success in firearms but led to the modern pyrotechnic formulas. In the following centuries various mixtures were studied and used in war.

	<u>Saltpeter</u>	<u>Charcoal</u>	<u>Sulfur</u>
8th Century Marcus Graecus	66.6	22.2	11.1
" "	69.2	23.1	7.7
1252 Roger Bacon	37.5	31.2	31.3
1560 Whitehorn	50.0	33.3	16.7
1635 British Govt	75.0	12.5	12.5
1781 Bishop Watson	75.0	15.0	10.0

Black Powders used in military and sport use ratios very similar to the last two formulas above. Almost everyone uses the 6:1:1 or 6:1.2:0.8 ratios when preparing black powders today.

Since Charcoal and Sulfur are both combustibles, some people ask why both are needed in the formula. Sulfur doesn't produce gas by itself (it becomes solid potassium sulfate), but it catches fire more quickly and at lower temperatures than the other components, and spreads the fire through the powder faster. It also fills in the spaces between the grains of the other parts. The Charcoal provides all the carbon for the gas conversion, and the niter (Saltpeter) provides the necessary oxygen.

The grains of black powders are poor conductors of heat. When they are lighted and begin to burn, they burn up the outer layers of the grains first. This means that as each grain burns from the outside in, it becomes smaller and smaller and produces less and less gas until it is used up.

Larger grains, which needed to burn longer were used in big guns so that all the powder would not burn at once. This allowed the gases to move the artillery shells so there would be less instant, and more gradual pushing pressure to accelerate the big shells down the barrel. The grains were manufactured in cubes, lozenge shapes, and as hexagonal prisms to find better burning shapes.

The hexagonal prisms were eventually made with a hole running the length of the prism down its center. When these caught fire and burned, the outsides became smaller and rate of gas production reduced, however, the insides of these grains would grow in size producing more gas. This allowed an even greater production of gas continuously, and provided a smooth acceleration to artillery shells as they were pushed down the heavy gun barrels. This resulted in greater range, and higher muzzle velocities.

## **History, Design, and Manufacture of Explosives**

By creating multiple perforations in the powder grains, the burning surface area could increase as the burning took place and create increases in the gas production. This added even more velocity to the shells, as the pushing power increases after the shell is already in motion going up the tube. Once again this resulted in higher muzzle velocities, and longer ranges. It also produced less wear and damage to the gun barrels from the higher back pressures and temperatures of burning all at once in a small cavity behind the shell casing while it was still at rest.

The most successful powder for long range rifled guns was "cocoa powder" which used a partially burned brown charcoal made from rye. It had colloidal properties and flowed under pressure. The grains were effectively cemented together with little sulfur in the formula, and they would burn slowly. The disadvantage was that it was friction sensitive and might even catch fire from shaking in a bag. The formula used was 77-80% saltpeter, 17-20% Brown Charcoal, and 0-5% Sulfur.

When black powders explode, they produce a white smoke. This is because the solid particles left over from the burning are accelerated out the gun barrel with the projectile and are suspended in the air by the hot gases that are produced. When most powders burn, about 43% of its weight converts to gas, 1% becomes water vapor, and the remaining 56% are discharged as suspended solids. This smoke is often objectionable because the hot solids irritate the nose, eyes, throat and lungs. It also gives away the firers position.

One gram of exploding powder normally yields 781 calories and 271 cc. of gas with a temperature at its center during the explosion of 3,880 degrees.

### **Commercial Manufacture**

In order to produce the large quantities of powders required for war, countries organized their chemical industries to efficiently produce it by the trainloads. By the 18th century, stamp mills would be used to mass produce a uniform, quality powder. Before the stamp mills the gunpowder was pressed through sieves in a wet state and resulted in grains that varied in their density and composition. This meant that the bullets and shells would not have the same ballistic path each time the gun was fired.

In the stamp mills the powder was mixed together by hand or with a mechanical mixer like the modern cement mixers. A small amount of water was added to prevent dust. The most intimate mixing was achieved by pouring the charcoal and sulfur into a solution of water and niter at about 130 degrees. The hot mass evaporates the water and all the parts precipitate together in a very intimate mix which is spread out on a floor to cool and the lumps are broken up.

## History, Design, and Manufacture of Explosives

The stamp mill uses a mill with wheels that weigh 8-10 tons apiece and continuously rotates over the powder mass for 3 hours at about 10 turns per minute. Heat from the "milling" evaporates the water which requires replacement to keep the powder from drying and igniting. The wheel cake and clinker formed by the pressure is broken up into small pieces and sent to the presses.

A horizontal hydraulic press then applies pressure to powder packed between its plates of about 1200 pounds per square inch producing two foot square press cakes.

The next and most dangerous step is the "corning" or granulating. The granulator is set up at a distance away from all the other buildings and all its machinery is operated by remote control. The press cake is broken up and granulated between crusher rolls and then the grains are dropped onto shaker screens. The dust goes into a bin for use as fuse powder and fireworks. The oversize grains are recrushed until all are the right size. By making a powder uniform in size, density, and mix, the ballistic effects are consistent when ordnance is fired and the aiming can be depended on.

The final grains are tumbled and dried in a revolving wooden cylinder with warm air. A surface glaze can be added by adding a small amount of graphite while tumbling. The final desired moisture is 1-1.5% for best shelf life.

The powder is rescreened and graded according to size from coarse (C) to fine (F)

In the final analysis, black powder is simply a mechanical mixture of Sulfur, Charcoal, and Potassium Nitrate. The more intimate the mixing, the better the powder performance. You want the maximum mutual contact between these 3 parts and so the manufacturing procedures and processes involve doing this mixing in the best possible manner.

On the next page is a general flow diagram of the plant process for the manufacture of black powders.



# History, Design, and Manufacture of Explosives

## Commercial plant flow-thru for black powders

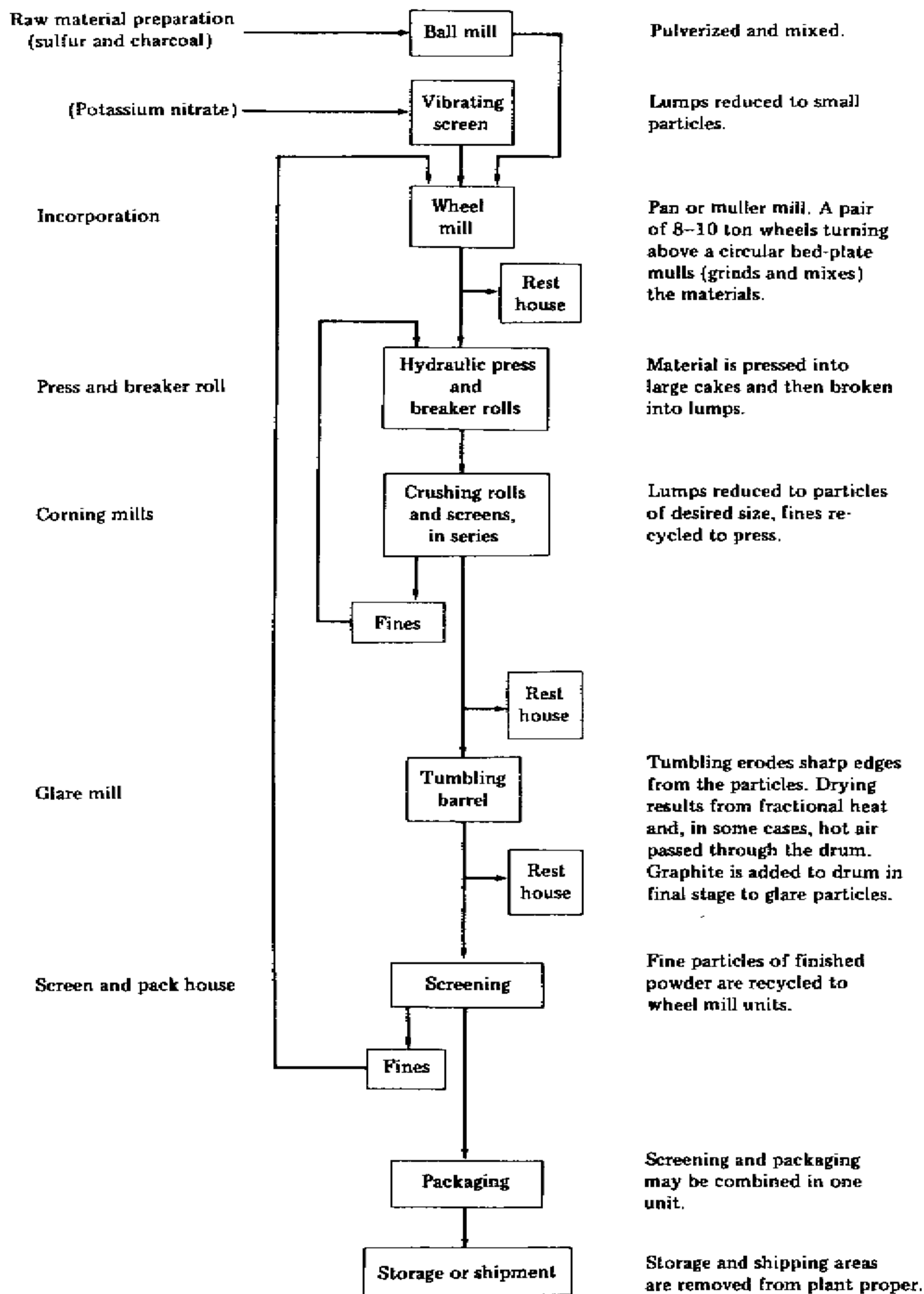

## History, Design, and Manufacture of Explosives

Modern manufacture of **Potassium Nitrate** is accomplished by mixing Nitric Acid with Potassium Chloride (a mined fertilizer) to yield a solution of Hydrochloric acid and a Potassium Nitrate salt.

Potassium Nitrate is only slightly soluble in alcohol. In the following directions for the Improvised field manufacture of Saltpeter from soil, the US Army incorporates this property in its directions from the Improvised Munitions Handbook.

### Field Improvised Potassium Nitrate

Potassium Nitrate (saltpeter) can be extracted from many natural sources and can be used to make nitric acid, black powder and many pyrotechnics. The yield ranges from .1 to 10% by weight, depending on the fertility of the soil.

#### Materials

Nitrate bearing earth or other material,  
about 3.5 gallons (13.5 litres)

Fine wood ashes, about 1/2 cup

Bucket - 5 gallons (19 litres) capacity

2 pieces of finely woven cloth, each  
slightly larger than the bottom of the bucket.

Shallow pan or dish as wide as bucket bottom

Shallow heat resistant container

Water - 1-3/4 gallons (6-3/4 litres)

Awl, knife, screwdriver or other hole producing  
instrument

Alcohol, about 1 gallon (4 litres)

Heat source

Paper

Tape

#### Source

Soil containing old decayed vegetable or  
animal matter

Old Cellars or farm dirt floors

Earth from old burial grounds

Decayed stone or mortar building foundation

Totally burned whitish wood ash powder

Totally burned paper (black)

## History, Design, and Manufacture of Explosives

### Procedure

1. Punch holes in bottom of bucket. Spread one piece of cloth over holes inside of bucket.

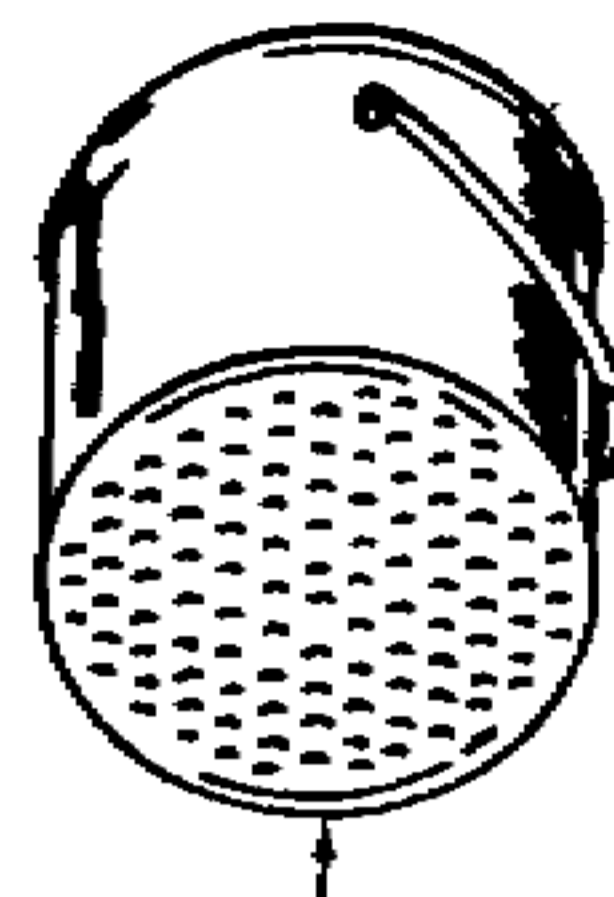

Bottom of bucket

2. Place wood ashes on cloth and spread to make a layer about the thickness of the cloth. Place second piece of cloth on top of ashes.

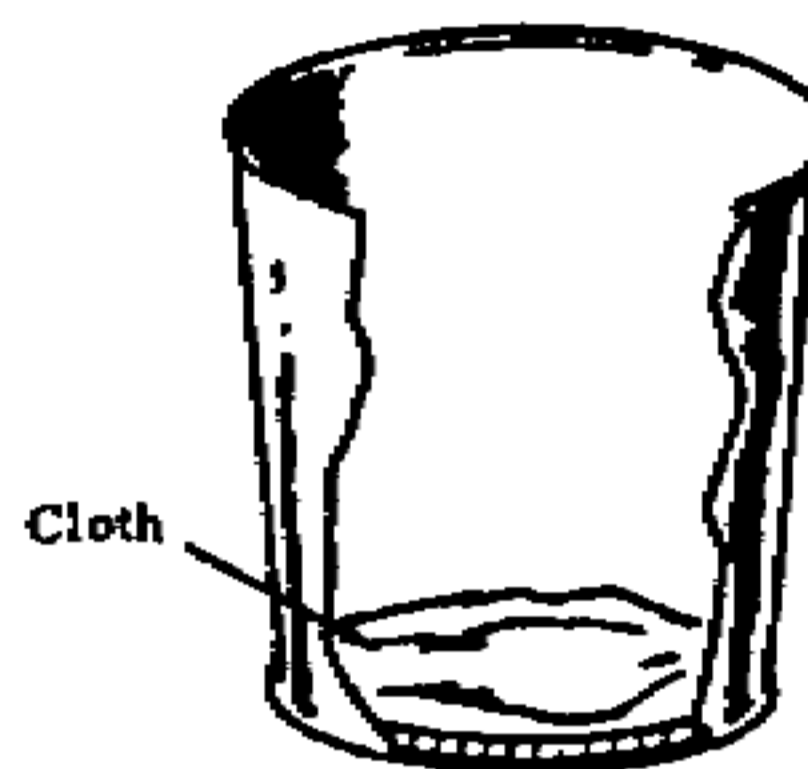

Cloth

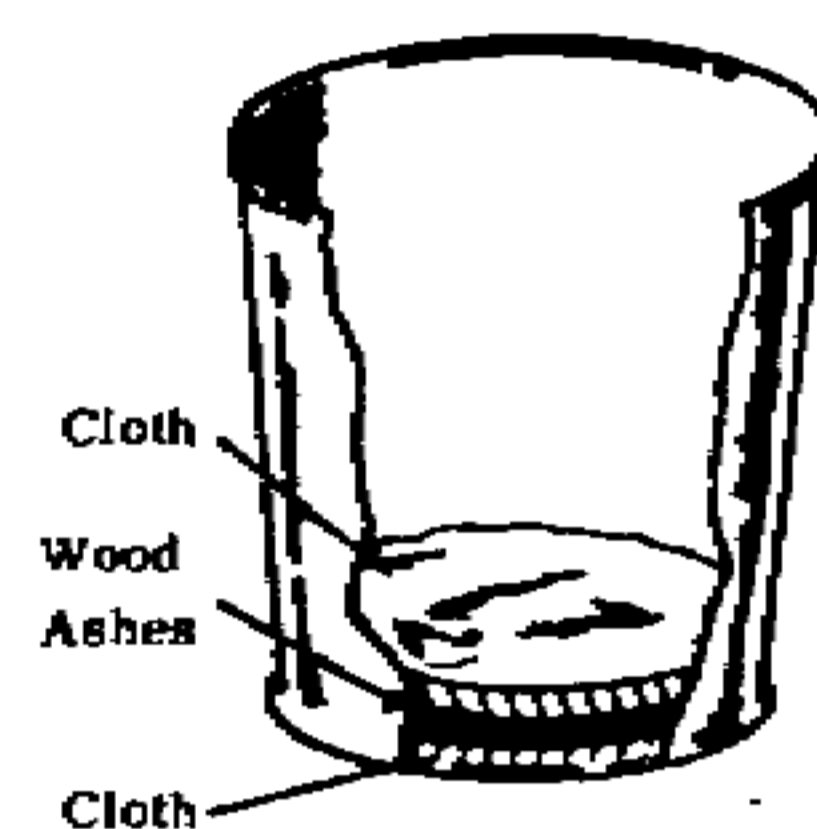

Cloth

Wood Ashes

Cloth

3. Place dirt in bucket.

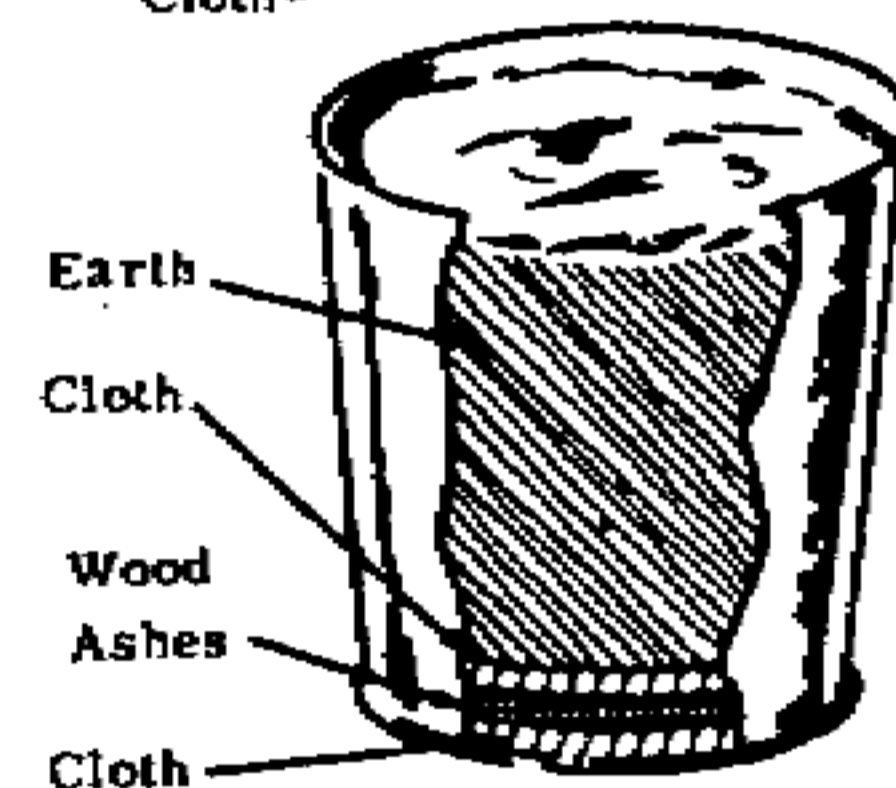

Earth

Cloth

Wood Ashes

Cloth

4. Place bucket over shallow container. Bucket may be supported on sticks if necessary.

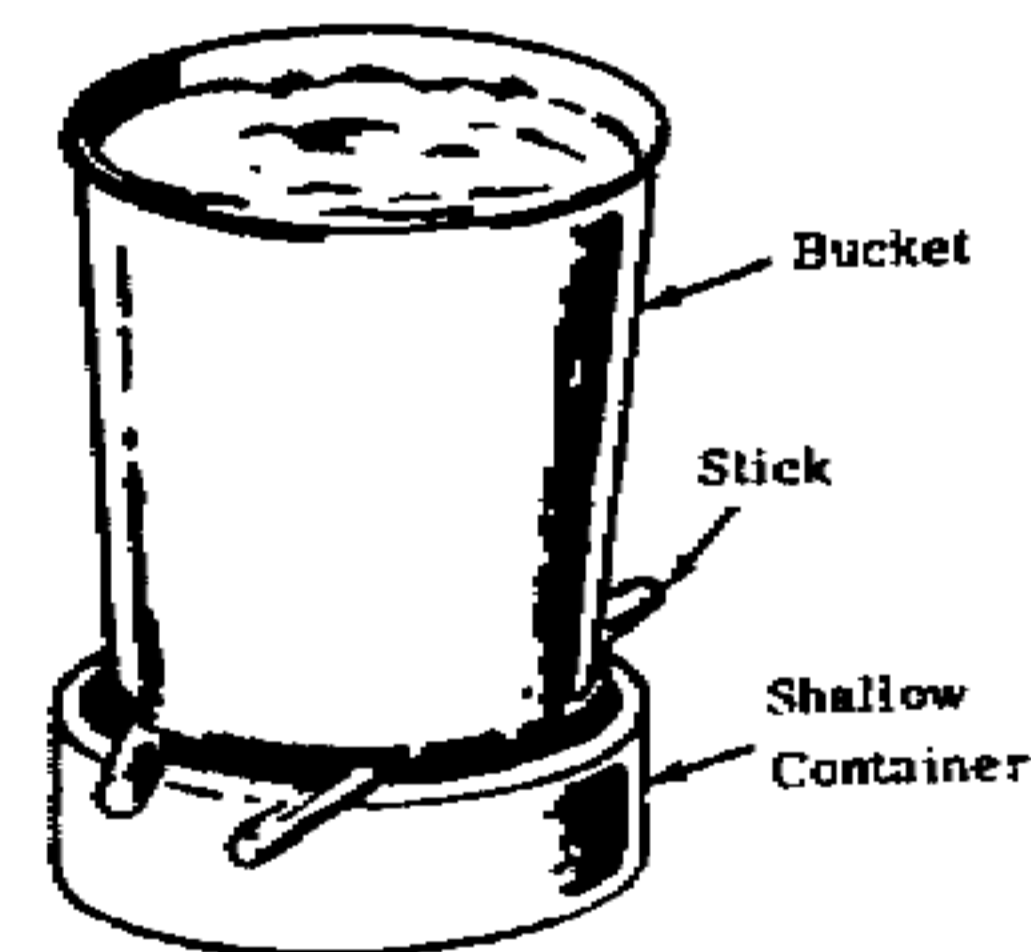

Bucket

Stick

Shallow Container

5. Boil water and pour it over earth in bucket a little at a time. Allow water to run through holes in bucket into shallow container. Be sure water goes through all of the earth. Allow drained liquid to cool and settle for 1-2 hours.

**Note:** Do not pour all the water at once, since this may cause stoppage.

6. Carefully drain off liquid into heat resistant container. Discard any sludge remaining in bottom of shallow container.

## History, Design, and Manufacture of Explosives

7. Boil mixture over hot fire for at least 2 hours. Small grains of salt will begin to appear in the solution. Scoop these out as they form using any type of improvised strainer.

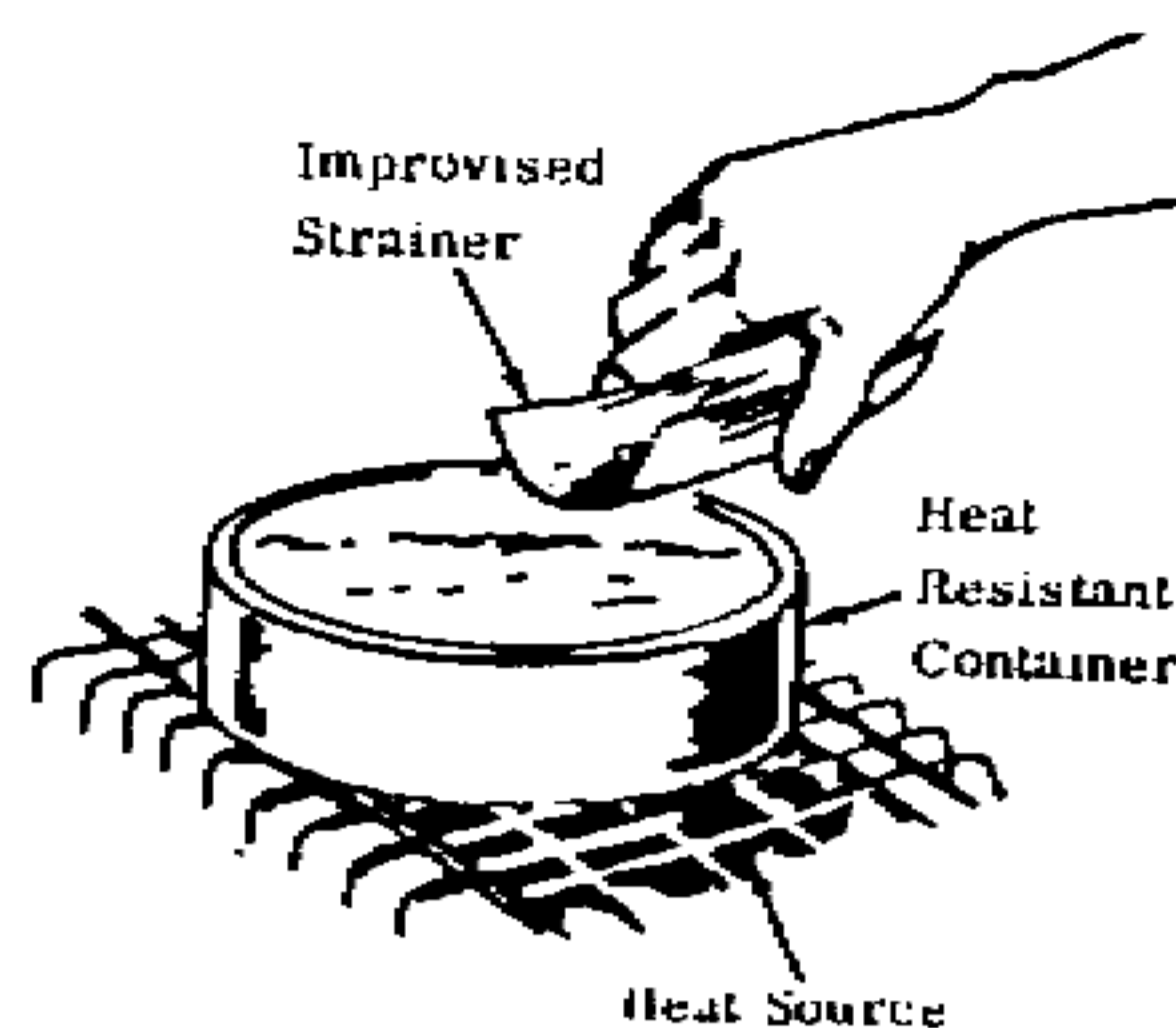

8. When liquid has boiled down to 1/2 its original volume remove from fire and let sit. After 1/2 hour add an equal volume of alcohol. When mixture is poured through paper, small white crystals will collect on top of it.

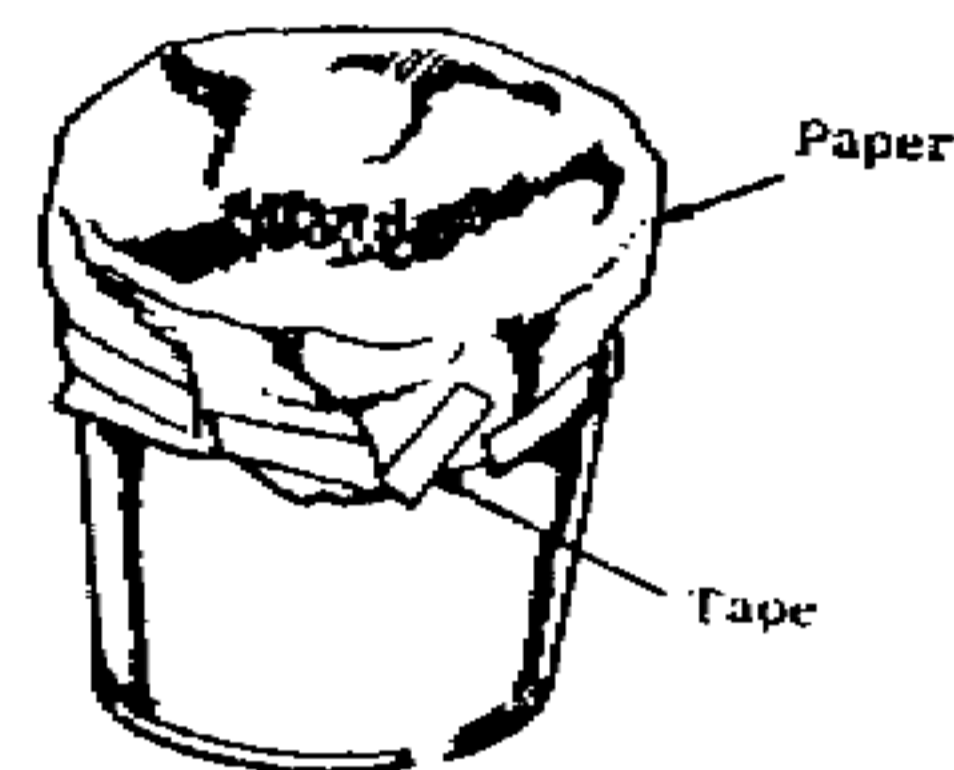

9. To purify the potassium nitrate, re-dissolve the crystals in the smallest amount of boiled water. Remove any salt crystals that appear (Step 7); pour through an improvised filter made of several pieces of paper and evaporate or gently heat the concentrated solution to dryness.

10. Spread crystals on a flat surface and allow to dry. The potassium crystals are now ready to use.

A safe but effective (and expensive) way of making Potassium Nitrate if you have access to Nitric Acid is to simply neutralize the acid directly with Potassium Carbonate or Bicarbonate until the solution reaches a neutral pH. Then it is allowed to dry.

## History, Design, and Manufacture of Explosives

### Nitric Acid for Explosives

Most other explosives are built around Nitric Acid and it is the foundation for almost all explosive and related ordnance industries in modern civilization. It is impossible to improvise a major acid factory in the field, but I will briefly describe the various ways that Nitric Acid is produced.

Most Nitric Acid is produced

- 1) by oxidizing Ammonia ( $\text{NH}_3$ )  
with Oxygen ( $\text{O}_2$ )  
to form Nitric Oxide ( $\text{NO}$ ) and water ( $\text{H}_2\text{O}$ ).

This is often done by mixing or bubbling ammonia through liquid oxygen or bubbling the  $\text{O}_2$  gas through ammonia water solution.

- More Oxygen ( $\text{O}_2$ ) is added  
to form Nitrogen Dioxide ( $\text{NO}_2$ )  
which is a deadly poisonous gas by itself.

By adding water ( $\text{H}_2\text{O}$ ), the nitric acid ( $\text{HNO}_3$ ) is formed with some  $\text{NO}$  which is recycled back into the plant.

This is how the oxygen is built into the chemicals to provide the oxidizer in modern explosives in the form of Nitric Acid. In essence, it is oxygen taken out of the air and turned into a liquid as the Nitric Acid, and then ultimately this is reacted to form solid nitrate salts for use in black and blasting powders. This same idea applies to all the other explosives.

- 2) Nitrogen and Oxygen can be reacted directly in a nuclear reactor in the presence of enriched uranium. About one gram of Uranium with the necessary N and O yields app. two tons of Nitric Acid.

- 3) High pressure oxidation of Nitrogen Tetroxide

If you have access to Sulfuric Acid, you can make Nitric Acid for other explosives from Potassium Nitrate as described in the Improvised Munitions Handbook of the US Army.

## History, Design, and Manufacture of Explosives

### Field Improvised Nitric Acid

Nitric acid is used in the preparation of many explosives, incendiary mixtures, and acid delay timers. It may be prepared by distilling a mixture of potassium nitrate and concentrated sulfuric acid.

#### Materials Required

Potassium Nitrate (2 Parts by volume)  
Concentrated Sulfuric Acid  
2 glass or ceramic bottles (narrow necks preferred)  
Pot or Frying Pan  
Heat Source (Wood coal or charcoal)  
Tape- Electrical or masking NOT Cellophane tape  
Paper or rags

#### Sources

Drug store/ Fertilizer outlets  
Chemical Supply Stores/Auto Batteries

**Important:** If Sulfuric acid is obtained from auto battery, concentrate it by boiling until white fumes appear. Do not inhale fumes.

The amount of Nitric acid produced is equivalent to the amount of Potassium Nitrate. For 2 parts Nitric Acid use 2 parts Potassium Nitrate and 1 part Sulfuric Acid.

#### Procedure

1. Place dry potassium nitrate in bottle or jug. Add sulfuric acid. Do not fill bottle more than 1/4 full. Mix until paste is formed.

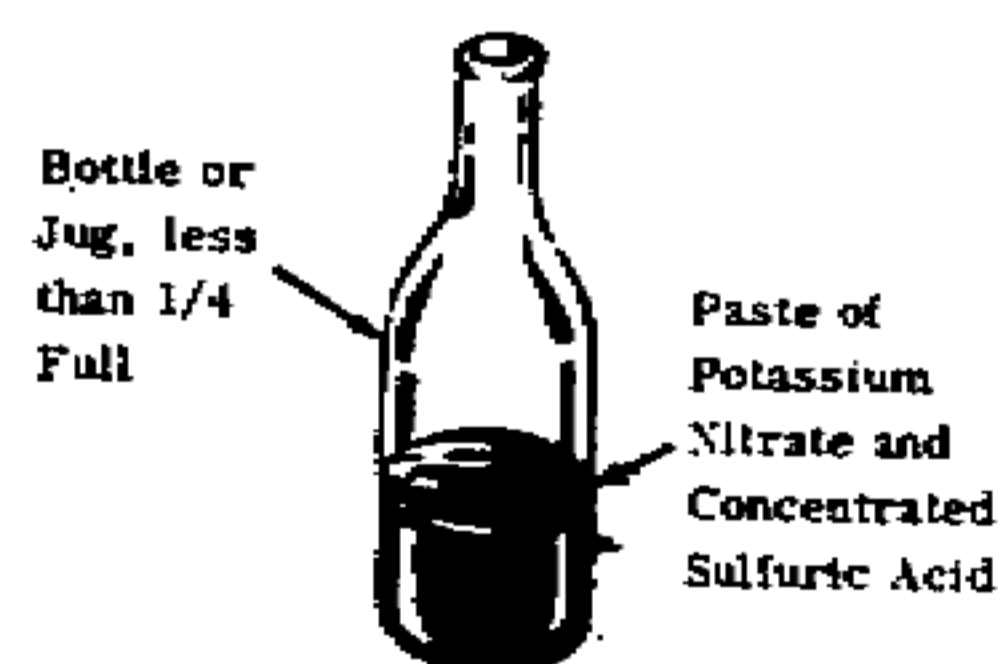

**Caution:** Sulfuric and Nitric Acid will burn skin and destroy clothing. If any is spilled, wash it away with a large quantity of water. Fumes are also dangerous and should not be inhaled.

2. Wrap paper or rag around necks of 2 bottles. Securely tape necks of bottles together. Be sure bottles are flush against each other and that there are no air spaces.

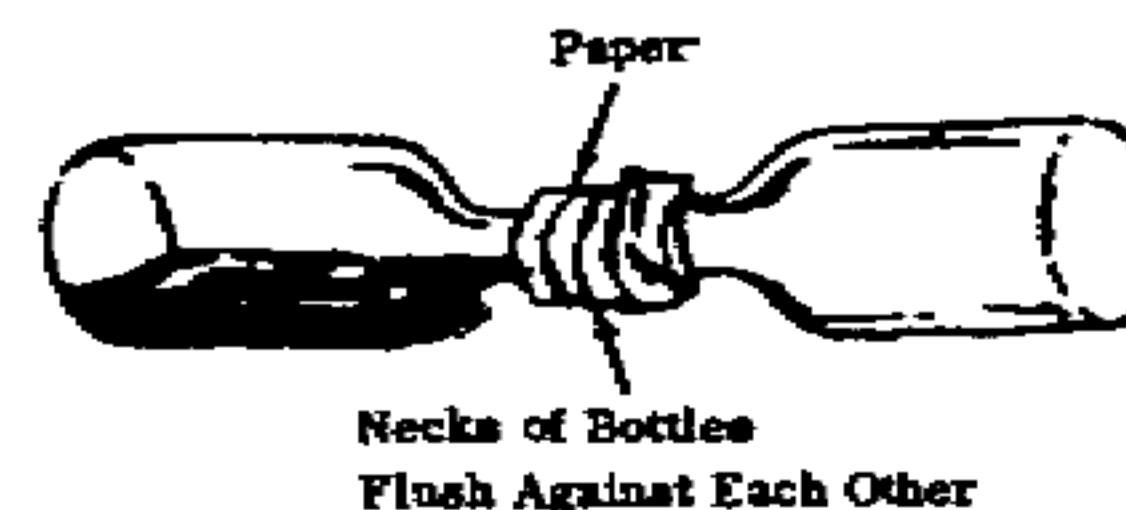

## History, Design, and Manufacture of Explosives

3. Support bottles so that empty bottle is slightly lower than bottle containing paste so that nitric acid that is formed in receiving bottle will not run back into paste bottle.

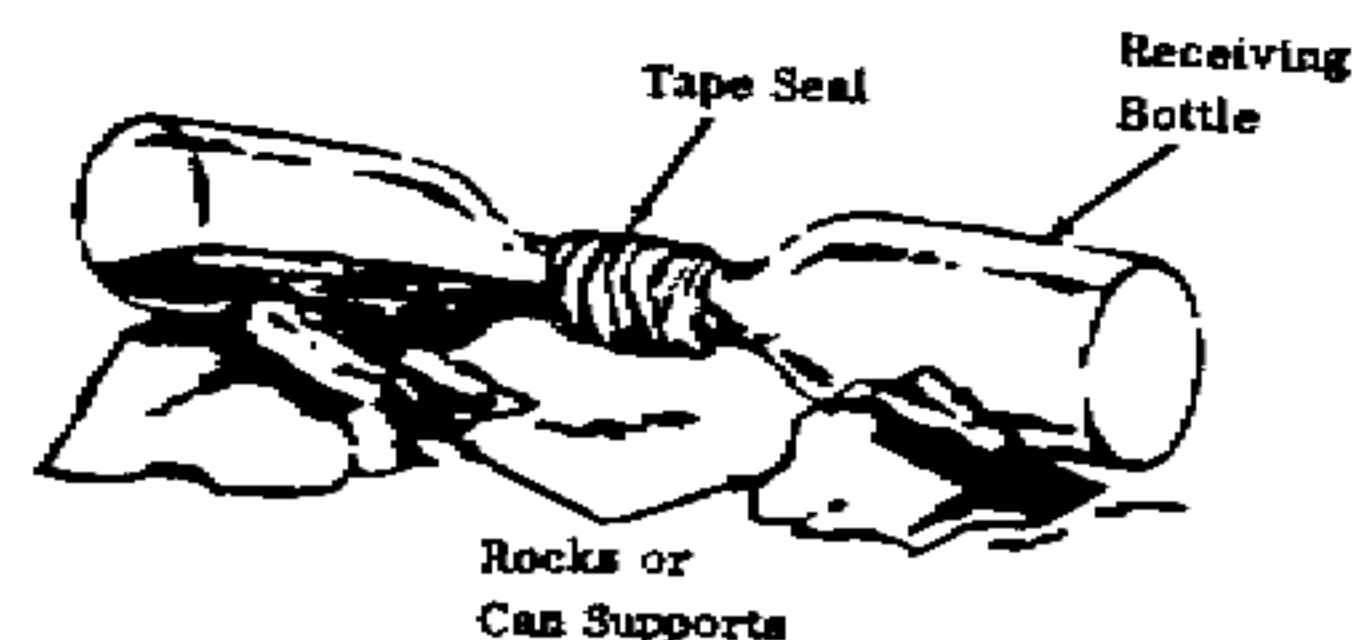

4. Build fire in pot or frying pan.

5. Gently heat bottle containing mixture by moving fire in and out. As red fumes begin to appear periodically pour cool water over empty receiving bottle. Nitric acid will begin to form in the receiving bottle.



**Caution:** Heat bottle slowly or it may shatter. If necessary place bottle to be heated in container filled with sand or gravel. By heating this outer container the heat transfer is gradual.

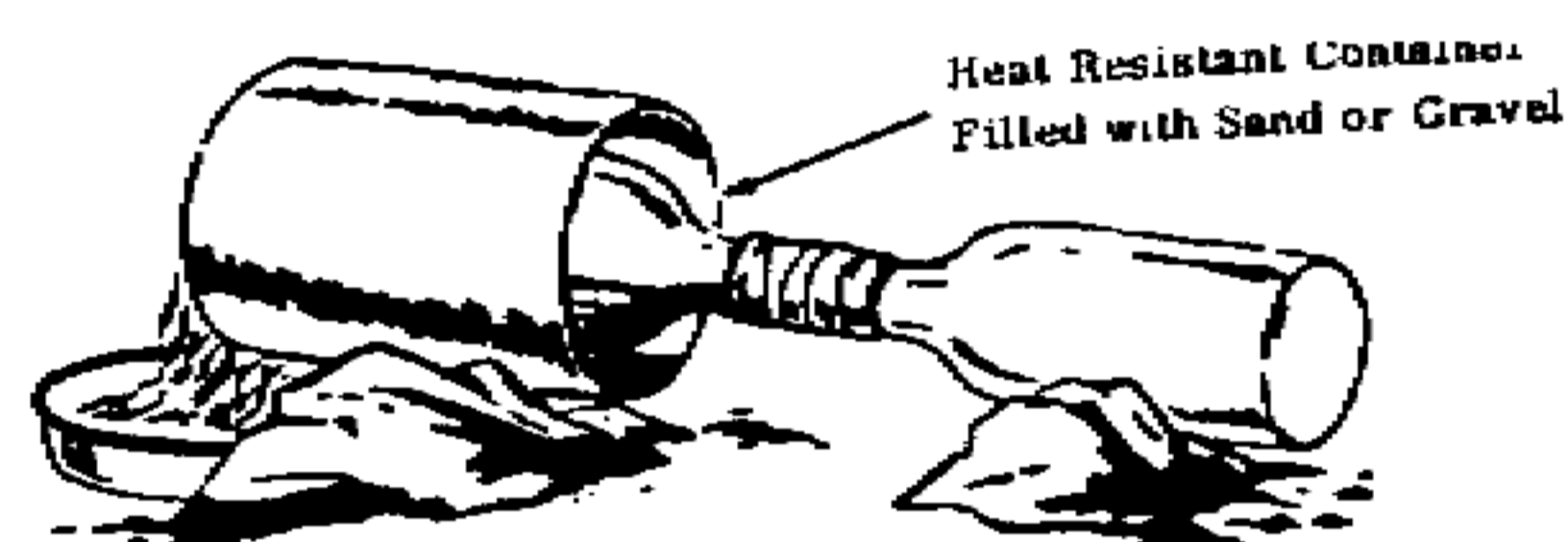

6. Continue heating until no more red fumes are formed. If the nitric acid is cloudy (not clear) pour into clean bottle and repeat steps 2-6.

Nitric Acid should be kept away from all combustibles and should be kept in a sealed glass or ceramic container.

## History, Design, and Manufacture of Explosives

Finally, black Powder can be field improvised as follows from the US Army Improvised Munitions Handbook.

### Improvised Black Powder

Black powder can be prepared in a simple, safe manner. It may be used as blasting or gun powder.

#### Material Required

Potassium Nitrate, granulated, 3 cups (3/4 litre)  
Wood charcoal, powdered, 2 cups (1/2 litre)  
Sulfur, powdered, 1/2 cup (1/8 litre)  
Alcohol, 5 pints (2.5 litres)  
Water, 3 cups  
Heat source  
2 buckets - each 2 gallon (7.5 litres) capacity, one must be heat resistant  
Flat window screening  
Large wooden stick  
Cloth 2 sq. ft. (60cm)

**Note:** The above amounts will yield 2 # (900 grams) of black powder. To double the amount, double all quantities used in manufacture.

#### Procedure

1. Place alcohol in one of the buckets
2. Place Potassium Nitrate, charcoal and sulfur in the heat resistant bucket. Add one cup water and mix thoroughly with wooden stick until all ingredients are dissolved.
3. Add remaining water (2 cups) to mixture. Place bucket on heat source until small bubbles begin to form.



## History, Design, and Manufacture of Explosives

4. Remove bucket from heat and pour mixture into alcohol while stirring vigorously.



5. Let alcohol mixture stand about 5 minutes. Strain mixture through cloth to obtain black powder.

Discard liquid. Wrap cloth around black powder and squeeze to remove all excess liquid.

Cloth Filter



6. Place screening over dry bucket. Place workable amount of damp powder on screen and granulate by rubbing solid through screen.

**Note:** If granulated particles appear to stick together and change shape, recombine entire batch of powder and repeat steps 5 and 6.

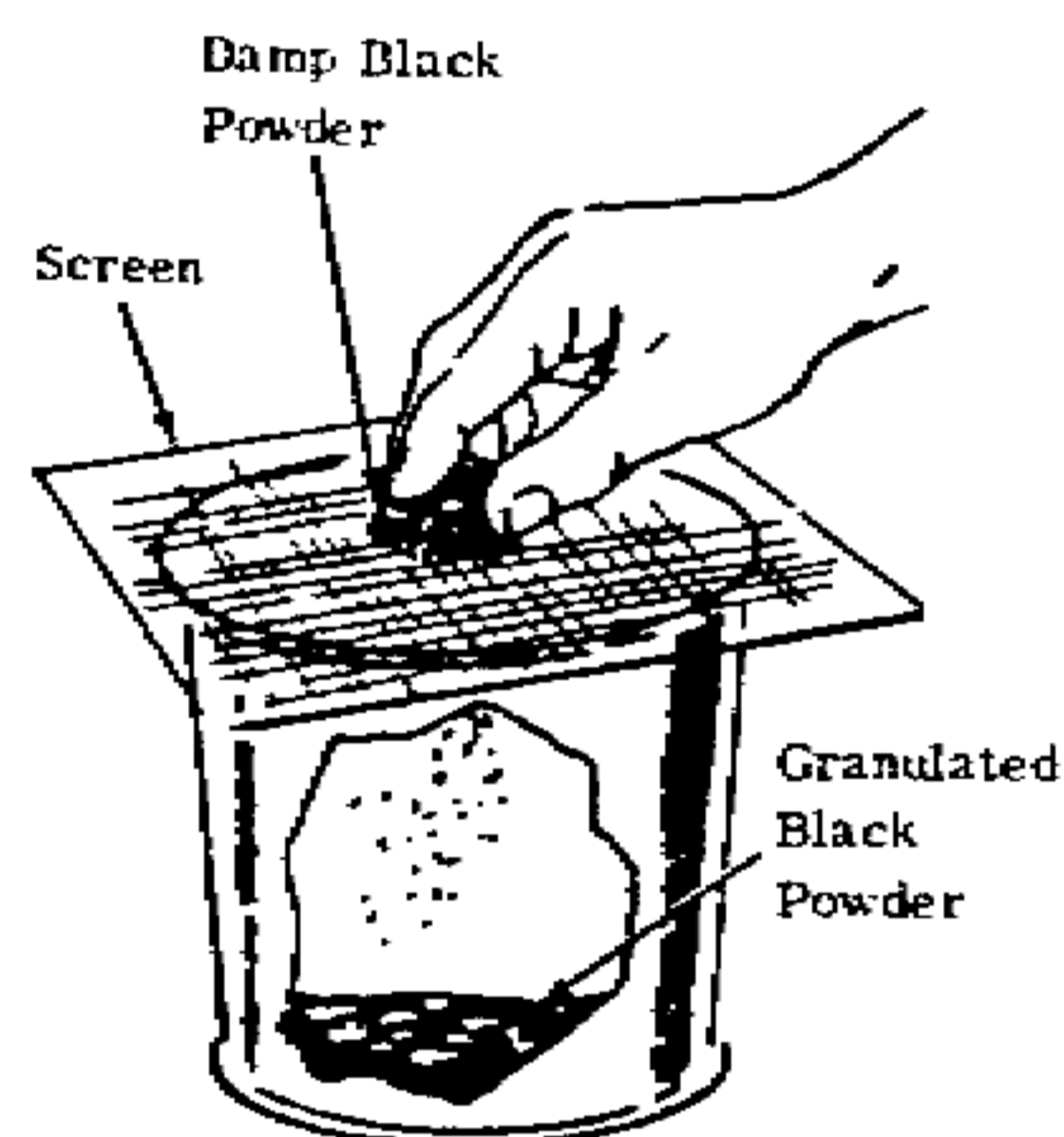

7. Spread granulated black powder on flat dry surface so that layer about 1/2 inch (1-1/4 cm) is formed. Allow to dry. Use radiator, car heater or direct sunlight. It should be dried in 1 hour. The longer the drying period, the less effective the black powder.

8. Remove from heat as soon as powder is dry. It is now ready to use.

[Authors Note: This method is superior to simply mixing the ingredients together. When granules are mixed, all the parts are physically separated by a large physical distance (in chemical terms). When they are dissolved and crystallized together the individual molecules are mixed much closer together making the powder much more effective.]

## History, Design, and Manufacture of Explosives

Sometimes slower and cheaper blasting powders are desired and can be achieved by reducing the amount of Saltpeter in the formula as follows

<u>Saltpeter</u>	<u>Charcoal</u>	<u>Sulfur</u>
72%	15%	13%
40%	30%	30%
62%	18%	20%

Currently, most military black powder consists of - Commercial users (slower burning)

Potassium Nitrate	74 %	Sodium Nitrate	71%
Carbon	15.6%		16.5%
Sulfur	10.4%		12.5%

Sodium Nitrate is used in blasting powder instead of Potassium Nitrate in many formulations containing 67-77% of the Sodium Nitrate, 9-14% Charcoal, and 8-22% Sulfur. It is also used to make pellet powders which resemble dynamite wrapped in paper cartridges. The cartridges contain small holes for inserting a fuse.

Sodium Nitrate can be made by simply neutralizing Nitric Acid with Sodium Bicarbonate (Baking Soda) which yields the Sodium Nitrate salt.

### Other Powders and Propellants

Propellant powders can be made using Ammonium Nitrate. This salt is a common fertilizer for agricultural use. It can also be made by buying ammonium carbonate or bicarbonate at the chemical supply companies or even using household ammonia to react with and neutralize the nitric acid. Once neutral (or slightly acidic) the salt is ready to be used.

In 1885, a new propellant called **Ammonpulver** was invented and patented in Germany. This new propellant got its name from using

35-38% Ammonium Nitrate  
40-45% Potassium Nitrate  
14-22% Charcoal

This formula had the advantage of not requiring any Sulfur and was sold under the trade name "Amidpulver".

## History, Design, and Manufacture of Explosives

An improved version which produced little smoke (most of it converting to gas), and producing a flashless discharge (so it wouldn't give away the firers position) was developed and consisted of

Ammonium Nitrate	37%
Potassium Nitrate	14%
Charcoal	49%

A mixture of 85% Ammonium Nitrate and 15% Charcoal burns almost completely leaving only a thin bluish-gray smoke and is also flashless. Burning Ammonpolver mixtures of 80-90% Ammonium Nitrate and 10-20% Charcoal produce gases that reach only 900 degrees (compared to 3000-4000 degrees with many other explosives) which make it useful in larger artillery guns where the higher temperatures damage the gun barrels. These are also useful in chemical and biological warheads as bursting charges where the low temperatures cause the liquid components to convert to vapor without incinerating as much of the dispersed gases. As a propellant, it has ballistic properties similar to other propellants containing 1/3 nitroglycerin.

Ammonpolver explosive has the advantages of being insensitive to shock and friction, is cheap and easy to make, and is powerful, flashless, and smokeless. This propellant can be made in paper cartridges like dynamite and used as artillery charges directly, however, there are problems that must be addressed. First, the Ammonpolver must be sealed in the cartridges so it does not draw moisture from the air (it is very hygroscopic). Secondly, the Ammonpolver cannot be allowed to reach temperatures above 90 degrees F or it changes its crystalline state to a form that crumbles the big grains and results in powders that produce high velocity gases. This can result in blowing apart the gun barrels from the greater pressures. This propellant should be stored and maintained in air conditioned rooms until ready for use if used in artillery.

**Guanidine Nitrate** is a stable and non-hygroscopic salt (it doesn't draw moisture and can be stored in open air). It burns cooler than Ammonium Nitrate and is a flashless explosive. Guanidine is a strong organic base (baking soda and ammonia are also strong bases). It is similar to urea or carbamic acid in its formula.

Its formula is  $\text{HN}=\text{C}(\text{NH}_2)_2$  and is considered a combustible. (Remember that explosives are things that burn on their own and have oxygen sources called oxidizers mixed in so it all burns at once.) Guanidine is manufactured commercially by heating ammonia under pressure, or by heating calcium cyanamide with ammonium iodide.

A Guanidine carbonate is made commercially and is used in industry in soap and cosmetic products. It can be used to directly form Guanidine Nitrate by neutralizing Nitric Acid to the salt form. It can also be made from the direct reaction of ammonium nitrate and urea. If it comes in contact with organic material like an alcohol, it can generate heat on its own and explode. It is also somewhat sensitive to shock and heat.

## History, Design, and Manufacture of Explosives

Guanidine Nitrate has been used in blasting powder formulas of

Potassium Nitrate	40-60%
Guanidine Nitrate	24-48%
Charcoal	12-16%

Another blasting powder has been made from mixing

Sodium Nitrate	65%
Sodium Cresol Sulfonate	35%

in water and running it into a heated steel drum to evaporate the water. When it was dry, the powder was scraped off the side of the drum and wrapped in waterproof paper as cartridges. It is safe to handle and is an inexpensive powder.

The Sodium Cresol Sulfonate comes from the sulfonation of Cresol. Cresol is a coal tar or petroleum derivative that can also be produced from Toluene and is used in a wide range of industries. The Cresol is sulfonated by reacting with sulfuric acid or sulfur trioxide, and then is neutralized to the sodium form by reacting with Sodium Carbonate or baking soda.

[Authors Note: Wherever a sodium atom is required to complete a reaction, I have chosen to use sodium carbonate and bicarbonate. When these are reacted, they give off CO<sub>2</sub> gas and this carries the potential heat energy of the reaction away with it. Sodium Hydroxide (Caustic Soda or Lye) is the lowest cost sodium material that can be used and is used in many cases commercially. The reason I don't recommend it, is that it generates heat and might catch a combustible on fire or detonate explosive material in runaway reactions.]

A blasting powder more powerful than black powder that produces little smoke and is stable and non-hygroscopic can be made from grinding together

Potassium Nitrate	46%
Ammonium Picrate	54%

Ammonium Picrate will be described in detail in the Aromatic Nitro Compound chapter.

**Benite** is a more recent propellant powder that is made by mixing

Potassium Nitrate	60%
Plasticized Nitrocellulose	40% (covered in a later chapter)

This formula also reduces smoke and when mixed, and it can be extruded as strands.

## History, Design, and Manufacture of Explosives

Modern manufacture of Black Powders involve improvements on the mechanical mixing to acheive the most intimate form of the components. Most plants follow the following steps.

1. Dry Potassium Nitrate is pulverized in a ball mill to make it as fine as possible.
2. Sulfur is milled into cellular charcoal in a separate ball mill till perfectly mixed.
3. The two materials are then screened and the powders loosely mixed in a tumbling mixer
4. The material is passed through a magnetic seperator to remove any metal particles.
5. The mix is then tranferred to an edge runner wheel mill similar to those already described
6. The wheel mills run over the powders to increase the density of the grains. Water is added to keep it cool, reduce dust, and improve the mixing. This lasts 3-4 hours.
7. The powders are placed into hydraulic presses to form cakes (density of 1.6 to 1.8)
8. The cakes are then passed through a corning mill, crushed, screened, and formed into the final sized products.
9. The grains are then polished, dried, and mixed with graphite to form a protective glaze.

The final powders must be kept sealed and dry. They will draw moisture from the air in humid conditions and lose ignitability at 3-4% moisture.

A modern improvement on the above procedure has been the development of the "Jet Mill". This type of mill has no moving parts. High pressure air jets remove the black powder mix from the bottom of a storage bin and inject them into the jet mill. This high velocity stream forces the particles to collide and breaks them apart until they can pass through a seive or cyclone seperator. The coarse particles are continuously recycled. The mill can be adjusted for the production of various grain sizes. This system has replaced many of the wheel mill systems in the US.

## History, Design, and Manufacture of Explosives

A reliable small arms powder propellant can be field improvised by following the US Army improvised munitions instructions as follows -

### Red/ White powder propellant

Red or white powder propellant may be prepared in a simple, safe manner. The formulation described below will result in app. 2 1/2 # of powder. This is a small arms propellant and should only be used in weapons with 1/2 inch diameter or less, such as the match gun or 7.62 carbine, but not pistols.

#### Material Required

Heat source  
2 gallon metal bucket  
Measuring cup (8 ounces)  
Wooden Spoon or rubber spatula  
Metal sheet or aluminum foil ( at least 1 sq. ft.)  
Flat window screen (at least 1 sq. ft.)  
Potassium Nitrate ( granulated 2 1/3 cups)  
White Sugar ( granulated 2 cups)  
Powdered Iron Oxide (rust) 1/8 cup if available  
Clear water, 3.5 cups

#### Procedure

1. Place the sugar, potassium nitrate, and water in the bucket. Heat with a low flame, stirring occasionally until the sugar and potassium nitrate dissolve.

2. If available, add the iron oxide to the solution. Increase the flame under the mixture until it boils gently. ( The mixture will remain red)



## History, Design, and Manufacture of Explosives

3. Stir and scrape the bucket sides occasionally until the mixture is reduced to one quarter of its original volume, then stir occasionally.

4. As the water evaporates, the mixture will become thicker until it becomes the consistency of breakfast cereal or homemade fudge. At this stage of thickness, remove the bucket from the heat source, and spread the mass on the metal sheet.



5. While the material cools, score it with the spoon or spatula in furrows about 1 inch apart.

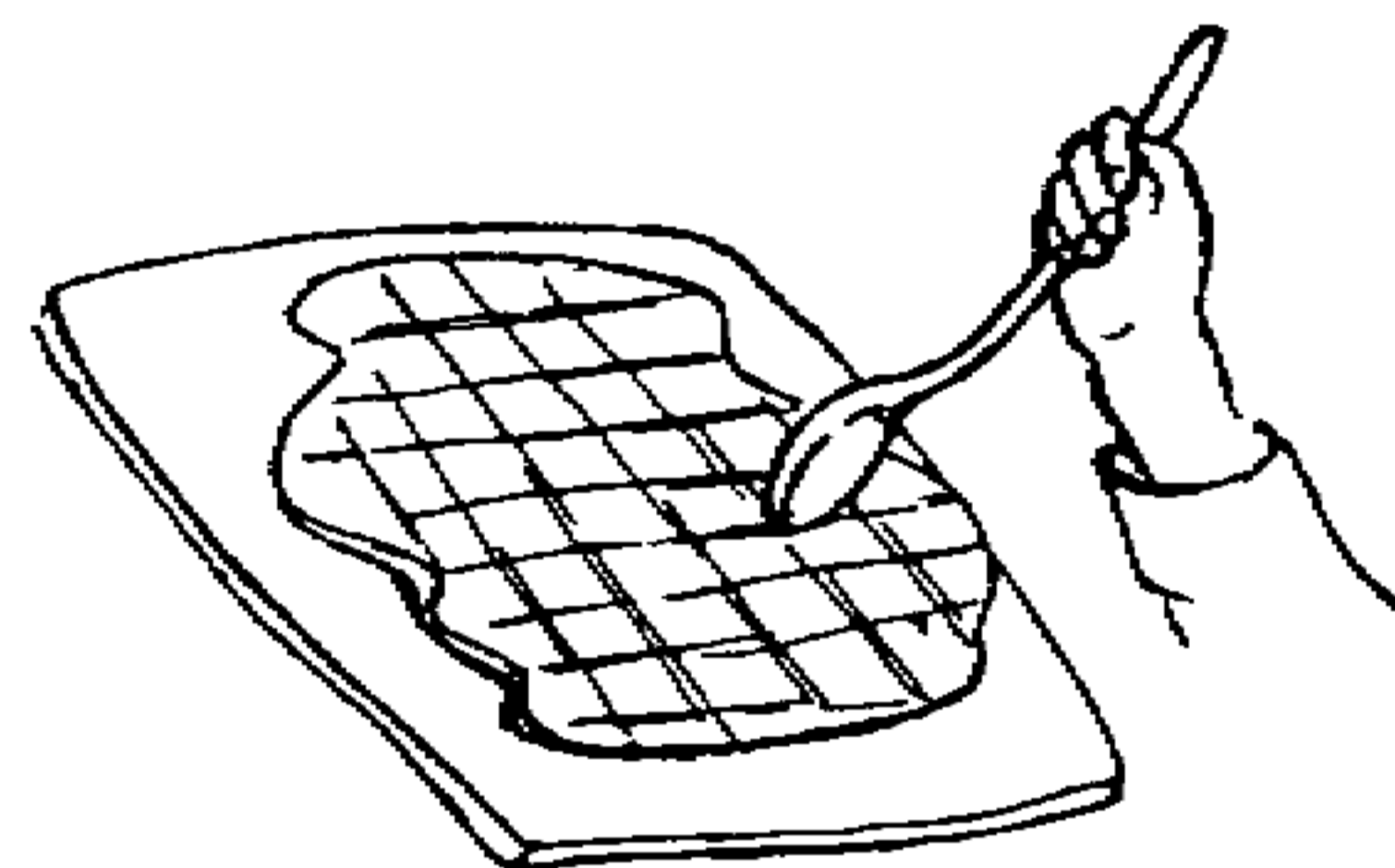

6. Allow the material to air dry, preferably in the sun. As it dries, rescore it occasionally ( about every 20 minutes) to aid drying.

7. When the material has dried to a point where it is moist and soft, but not sticky to the touch, place a small spoonful on the screen. Rub the material back and forth against the screen mesh with spoon or other flat object until the material is granulated into small wormlike particles.

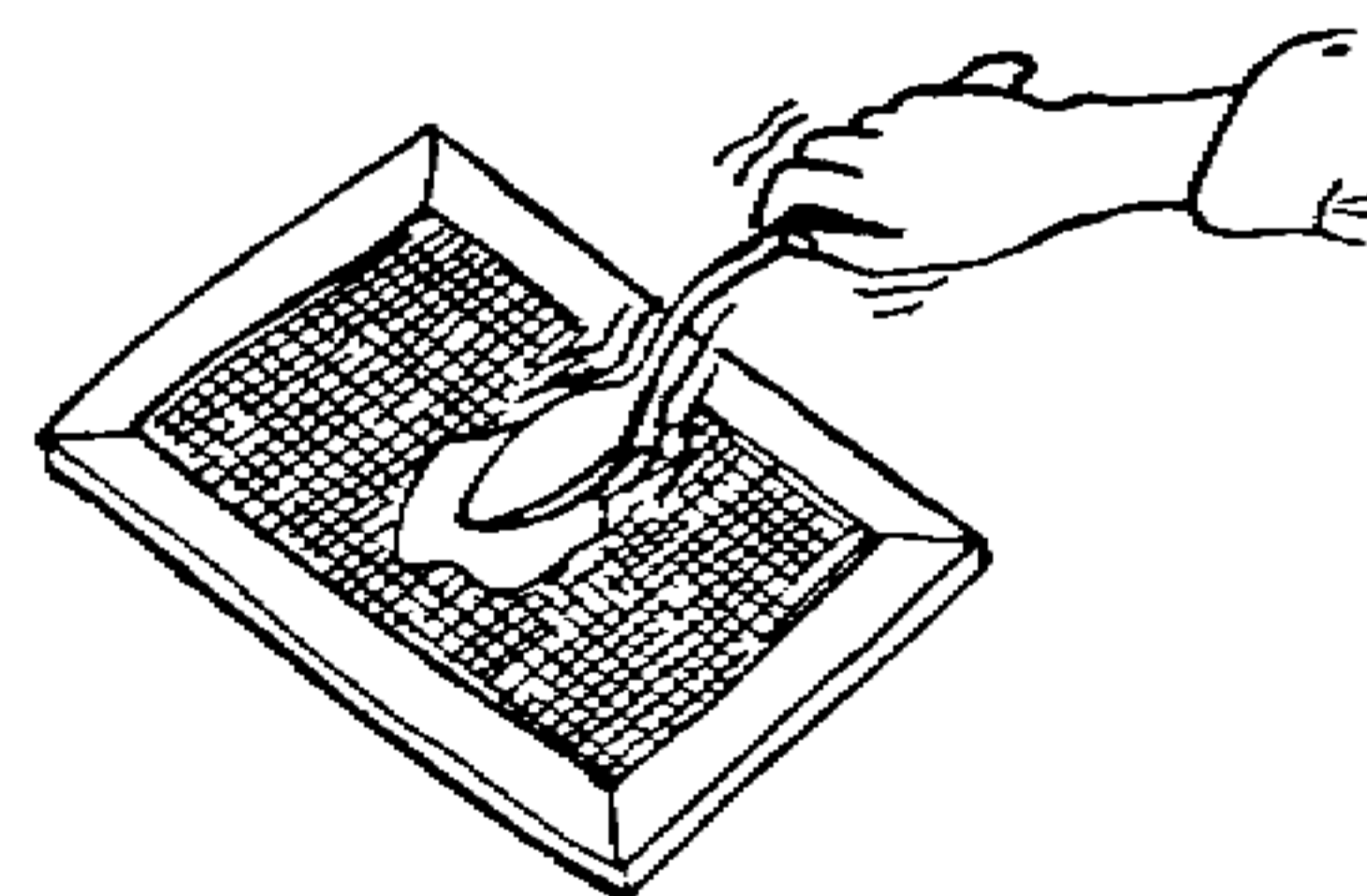

8. After granulation, return the material to the sun to dry completely.

# History, Design, and Manufacture of Explosives

## Chapter 2 Nitric Esters

If you are a layman and are intimidated by the use of chemical names and terms, don't worry. In this book we will take the time to explain everything. The words "Nitric Esters" come from

"Nitric" - which means that nitric acid was used to make this material into a nitrate.  
"Ester" - is a name chemists use to describe or name a compound that was made from both an acid (like nitric acid) and an organic material like an alcohol.

We call the reaction of an acid and an inorganic base a "salt". Potassium Nitrate is a salt of the inorganic base Potassium and the acid Nitric which we learned how to mix and make in the last chapter. This is the same thing, only using an organic alcohol in place of the base. Another name for this group could also be "organic nitrates" or alcohol nitrates.

The words Nitric Ester in this case means nitration of an ester or alcohol. In the last chapter we nitrated several bases like potassium and sodium so that they would provide the oxygen from the nitric acid to the powders combustibles. This allowed them to burn instantly and explode. Here, we take advantage of the idea that alcohols are combustibles. Alcohol will burn when ignited. That is why ethanol (ethyl alcohol) is used in place of some of the gasoline in your cars. When it is mixed with the oxygen in the air, it will burn instantly and explode.

It became interesting to explosive chemists to see if the Nitric Acid could be combined directly with these combustible alcohols so that single chemical explosives could be produced. The ideas were that the explosive could be made to burn up completely without leaving behind solid residues, and they could burn more efficiently than the powders.

It was discovered during the making of these early Nitric Esters that the new material would resemble the properties of the alcohol that was used to make it. Glycerin for example is a viscous oil. Nitroglycerin is also a viscous oil. Methyl and Ethyl alcohols are volatile liquids that quickly evaporate into the open air. Ethyl and Methyl Nitrates are also volatile liquids.

Many of the nitric esters are used as plasticizers in many nitrocellulose formulations which will be covered in later chapters.



## History, Design, and Manufacture of Explosives

### Alkyl Nitrates

*Ethyl Nitrate*: is prepared by heating a mixture of Ethyl Alcohol, Urea Nitrate (described in chapter 5 - Nitroamines), and Nitric acid and distilling the gases that come off of it.

[ For those that do not understand, I will describe here what distilling is. When you want to separate liquid materials you can often simply heat the materials until one of them reaches a point where its chemistry causes it to change to a gas. In a moonshine still, the alcohol is separated from the water used to extract it by heating it until the alcohol turns to a gas. This gas comes off, leaving the water behind and is transferred down a tube and into a receiving container where it cools and condenses back into a liquid. Gasoline and Kerosene are produced from oil by the same principle.]

Ethyl Nitrate has a boiling point of 87 degrees C so must be kept cool in storage. It has about 48% of the explosive energy of Nitroglycerin, but has a greater initial detonation velocity. Blasting caps will not detonate Ethyl Nitrate unless the explosive is tamped (confined) so that pressure is created to start the explosion. When Ethyl Nitrate is mixed with "Fullers Earth" in proportions of 70/30 or 60/40 it yields a "Brisant" explosive that will detonate without confinement.

["Fullers Earth" is an absorbent first used by Alfred Nobel to make a safe to handle dry explosive from dangerous liquids. Fullers Earth is also known as Diatomaceous Earth, and it is dug up from the ground, separated and sold for many industrial uses such as filter aids, oil absorbents, etc. The first use of it was to absorb Nitroglycerin to make Dynamite and was sold as "Nobels Safety Powder". Charcoal is also used as an absorbent of liquid explosives.

"Brisant" or Brisance is a measure of how much shock is produced during the detonation of an explosive. A Brisant explosive is one that produces a powerful shock wave.

"Ethyl Alcohol" or Ethanol is the alcohol distilled from fermented grains (corn squeezings) and is usually safe to drink.

"Methyl Alcohol or Methanol is distilled from wood or trees or produced from methane gases. It is poisonous and not safe to drink (causes blindness).]

*Methyl Nitrate*: is produced by first mixing nitric acid with urea. This is done to remove the last traces of nitrous acid. The mixture of this is then mixed with methanol and carefully distilled.

Its vapors smell like chloroform and the liquid is colorless and less viscous (thick) than water. Methyl Nitrate dissolves colloidal nitrocotton to produce an explosive jelly from which the Methyl Nitrate then evaporates.

Methyl Nitrate has a greater energy content and explosive effect than Nitroglycerin. It turns to vapors (explosive) at only 60-65 degrees F and is much more shock and heat sensitive (it catches fire and explodes at only 150 degrees) than Nitroglycerin which makes it nearly impossible to use in practical explosive applications.

## History, Design, and Manufacture of Explosives

The reason Methyl Nitrate is of interest here is that a set of tests measuring the velocity of detonation of Methyl Nitrate in different kinds of confined tubes led to new ideas of how to make more powerful explosives by increasing the confinement strength.

Scientists found that by confining this same explosive in different diameter tubes, they could increase the velocity of detonation. By using thicker tubing to confine and hold in the explosive they could add even more power. The confining or "tamping" effect is used today in mining and many military ordnance designs. Generally, the stronger the confinement, the more powerful the explosive effect.

<u>Tube Material</u>	<u>Inside Diameter</u>	<u>Outside Diameter</u>	<u>Thickness</u>	<u>Velocity m/s</u>
Glass	5mm	7mm	2mm	1990
Glass	3mm	7mm	4mm	2191
Glass	3mm	12mm	9mm	2482

The velocity in meters per second increased by app. 10% for each doubling of the thickness of the glass confinement. Adding large diameters of confinement to explosives adds considerably to the speed of the explosive detonation wave. The amount that the velocity of detonation can build up to depends on how much pressure you can build up before the container ruptures. Many explosives require confinement to even be able to detonate at all. This makes them safer to store in bulk.

These ideas also led to the creation of concepts of using the explosive itself to oppose itself and prevent the instantaneous escape of the explosive gases. By using tamped (greater density of loading) explosives, and in some designs, detonating them from the outside in, which in effect compresses the mass of the core, a much more powerful detonation wave can be created. You use the outside mass of gases of exploding materials to oppose themselves in the core, creating stronger confinement and more powerful explosions.

*n-Propyl Nitrate*: is manufactured by mixing Propyl Alcohol and Nitric Acid and carefully distilling. Propyl Alcohol is made by oxidizing natural gas and it is used as a solvent for waxes, vegetable oils, resins, brake fluids and solvent degreasing. It is also an antiseptic. The preparation of this explosive is very hazardous. If the Nitric Acid has a specific gravity of  $> 1.42$  or the acid is mixed, it will likely explode no matter how effective the cooling system is. When mixed with Fullers Earth at a 10/4 ratio, it yields a powerful explosive that requires a blasting cap to detonate. This has been used in rocket propellant formulations.

*Isopropyl Nitrate*: is prepared by mixing Isopropyl Iodide with Silver Nitrate to yield Silver Iodide and the explosive. The alcohol is oxidized if you attempt to nitrate it directly with Nitric Acid, which is why the nitrate and isopropyl are reacted to the above materials first. This explosive will ignite or catch fire easily if brought into contact with other organic materials.

## History, Design, and Manufacture of Explosives

### Nitroglycerin

The proper name of this explosive is glyceryl trinitrate and is abbreviated as NG. An Italian Chemist named Ascanio Sobrero invented NG, nitromannite, and nitrolactose in 1846-1847. Sobrero, in his attempts to nitrate glycerin (glycerin is a syrupy alcohol derived from soap manufacture and various chemical processes), found that when mixing strong acid into the glycerin, it produced a violent reaction and yielded toxic red fumes. Through experimenting, he found that if he mixed the Nitric Acid (one part) into two parts Sulfuric Acid and kept it cold by encasing the container in ice (keeping the liquid below 0 degrees C) he could add the glycerin safely. The glycerin dissolved into the acid mix. When this entire mix was poured into water, an oily precipitate formed that was the chemical Nitroglycerin.

Sobrero scraped the oil into another container and washed it repeatedly with water until it was free of any residual acid and then dried it in a vacuum over sulfuric acid (which aids in removing moisture from the air). He also found that he could dissolve the NG in alcohol, and reprecipitate it again with water. He also observed that it exploded when brought into contact with metal Potassium or Phosphorus. It would ignite and burn if placed on Platinum foil. If heated gently, it decomposes, however, if touched by a red hot piece of wire, it would detonate instantly. NG also has the effect of causing severe toxicity by inhaling its fumes, swallowing a tiny amount (a single drop can kill and cause violent illness even if it isn't swallowed), or getting a few drops on the skin.

Sobrero kept his original sample from his lab a guarded secret until 1886, almost 40 years later, when he took some of his original sample to Nobel where they found it was still an effective explosive. It was re-tested in 1913, 66 years after being produced, and found to still be as powerful as when it was first tested.

Alfred Nobel would finally make NG safe for everyone to store and handle by mixing it with Fullers Earth to produce Dynamite (chapter 6).

When soap is manufactured, animal and vegetable fats are warmed up in water with Lye (caustic soda) and soap is produced. The soap is the alkali salt of the fatty acids and it forms a precipitate. Glycerin remains dissolved in the liquid and is recovered from the evaporation of the water. The glycerin will not evaporate, and will absorb moisture from the air. Commercially purified glycerin (99%) is the ideal to use for manufacturing a pure, water-white NG.

During WW1, Germany could not produce enough glycerin from fats to meet its explosive manufacturing needs. As a result, they developed a process of adding sodium sulfite to alcohol fermentation and found that this encouraged the production of generous amounts of glycerin as a byproduct through bacterial action.

By WW2 many countries experimented with various chemical means of increasing Glycerin and Nitroglycerin production. Most of these involve the use of byproduct gas from the petroleum industries.

## History, Design, and Manufacture of Explosives

Commercial production of NG for most of its history involved the premixing of a mixture of 40% Nitric Acid, with 60% Oleum (which is sulfuric acid containing some sulfur tri-oxide).

One part of glycerin is slowly added to 6 parts of this mixed acid. During mixing, compressed air is pumped into the mix to keep it from reaching more than 22-25 degrees C. More modern methods involved using cooling coils inside the mixer with salt solutions circulated to keep the mix cool and mixing with impellers. If the temperature rises above 25 C or red fumes start to rise from the mix, the factory workers quickly dump the mix into a vat of cold water underneath it so it doesn't explode and blow up the plant.

Once the entire mix is complete, it is cooled until it reaches 15 degrees C and the mix is transferred to a separator where the NG rises to the top (because it is lighter than water and separates from it) and is scraped off into a separate tank. Here it is placed in a drowning wash to remove the 10% of acid left over. This wash water and NG mix is agitated with compressed air and if the water is warmer (38-43 degrees C) it does a better job of removing the residual acid. The NG is heavier than the water and sinks to the bottom. The washings continue with 2-3% sodium carbonate solution, until pH paper tests on the NG show it to be neutral. Vacuum filtering removes the final wash water. Using a table salt solution on the final wash usually helps remove the last bit of moisture.

Nitroglycerin explodes at 218 degrees C. It is completely soluble in most alcohols. Although toxic in small amounts, it relaxes arteries when administered in tiny amounts and is used for a variety of medical purposes. NG is very sensitive to shock, and this sensitivity increases as its temperature rises. Placing a drop on a countertop, by itself, or absorbed on filter paper, it will explode if struck by a hammer.

NG is used as a plasticizer for nitrocellulose in propellant formulas. It is usually mixed with other liquids such as triacetin or dibutyl phthalate to desensitize it before transport. Mixing it into absorbent solids or nitrocellulose has the same effect, although it may become more sensitive to friction as a solid. NG is also used as a solvent for many other explosive ingredients. It has a high freezing point (13.2 C) which created problems in NG dynamite until formulas were developed to overcome this. NG may burn if present as a thin layer on a countertop, but will always explode if confined.

Drop tests have been made on shock sensitive detonators to compare their sensitivity. A 2 Kg weight dropped at the following heights will ignite the following explosives.

Mercury Fulminate	4.5 cm
Lead Azide	9 cm
Nitroglycerin	10-12 cm
Blasting Gelatin	12-15 cm
Tetryl	30-35 cm

## History, Design, and Manufacture of Explosives

For comparison, when the temperature of NG is raised to 90 degrees F, the drop required to ignite it is 5-6 cm. The velocities of detonation were found to change under different conditions of loading and initiation.

<u>Material</u>	<u>Material Diam.</u>	<u>Velocity of Detonation</u>
Lead Tube	3mm Internal Diameter	1300 m/s
Lead Pipe	30 MM " "	1525 m/s
Iron Pipe	30 MM " "	2050 m/s

It has since been found that with extremely powerful detonators, and a diameter of 25-37.5mm the velocities of NG can reach 6,700 to 8,500 m/s.

In 1864 Nobel patented several ways of detonating NG so it could be useful for work. These included placing a small glass vial of black powder into the NG and detonating it, using an electric spark like a modern day spark plug to spark just above the liquid, heating a wire immersed in the NG, and using percussion caps.

Later improvements in detonators included a mixture of black powder and mercury fulminate, fulminate by itself, and finally in copper detonators. The invention of the blasting cap would bring about certain and safe detonation of all types of explosives and are used today for most commercial explosive requirements.

These patents allowed Nobel to begin mass production of NG and by 1886, he had opened major explosive manufacturing plants in the US and all the major European countries. The NG was initially used in tunneling operations and clearing roadcuts. During the early operations, they discovered that frozen NG could not be detonated normally, and they began the practice of freezing it before and during all transporting. In order to explode the frozen NG, they would thaw out one cartridge and use it to detonate the rest of the frozen material.

Liquid Nitroglycerin is mainly used today in making dynamite, and cordite/ballistite propellants. It also finds occasional use in oil well drilling. Most modern processes for making NG are continuous flow and considered safer than the batch processes.

### *Biazzi process*

1. The mixed acid and glycol are metered into a nitrator. This nitrator is made of stainless steel and has highly polished inner surfaces to reduce friction. It is a small cylindrical shaped vessel with many banks of spiral, closely packed cooling coils and a high speed turbostirrer.
2. The mixed acid and glycerol are quickly submerged and mixed with 3 parts water to form an emulsion and are forced past the cooling coils.
3. There is an overflow pipe attached 10 cm from the top. Part of the NG overflows into a separator, while part recycles and flows back into the vortex to add cooling by dilution. The temperature is kept at 10-20 C.

## History, Design, and Manufacture of Explosives

4. In the separator, a slow moving propeller at the top gently breaks up the emulsion and prevents overheating. The heavier spent acid flows continuously out the bottom while the NG flows out the top. The NG may also be separated by centrifuge.
5. The NG flows into a soda washer, and then into water washers until neutral.

The nitrator contains a large bottom outlet to allow its mix to drop quickly into a drowning pool if a runaway reaction begins. It also has an exhaust pipe for fumes at the top. This same process has been used for many of the other nitric esters.

### *Nitro Nobel Injector Process*

A specially designed injector is used to mix the precooled acid mixture and the glycerin. The injector nozzle forces the mixed acid in past a special nozzle that contains the alcohol glycerin. As it passes by the nozzle, it creates a vacuum (designed for 4.4mm Hg) which draws or sucks the glycerol (at 48 C) into the acid mix where it mixes and reacts instantly to form an emulsion. This emulsion is quickly cooled to 15 C over cooling coils and flows by gravity to a centrifuge where it is continuously separated from the spent acid. The spent acid is recycled while the NG is emulsified immediately in a jet water spray to form a nonexplosive mix which is then neutralized in soda water and washed. The final NG is mixed by an injector into water to form a storable emulsion that is safe to store and transport.

## Dinitroglycerin

Known chemically as Glyceryl dinitrate, it is very soluble in water, is similar to NG in its explosive properties, and while it is more expensive and difficult to make, it can be mixed into NG to lower its freezing point and was used in Germany to make non freezing dynamites. Other materials are used for that purpose today.

Di-NG is produced in the same manner as NG except that more glycerin is used. For 3-4 parts Nitric Acid, one part of glycerin is used. It also forms if a shortage of sulfuric acid is used in the batch because there is insufficient dehydrating action. The Di-NG is separated from any other NG in the mix by separating off the trinitrate as usual, extracting it from the water with ether and washing the ether with diluted sodium carbonate. The remaining water and ether are removed by evaporating them off in a vacuum.

Di-NG can be used to gelatinize nitrocotton and when it is washed out with water it leaves a tough stiff mass for use as nitrocellulose explosive.

Di-NG is a thinner oil than NG, and is colorless and more volatile. Di-NG can be treated with a 30% solution of caustic soda (lye or sodium hydroxide) to produce nitroglycide. This is then boiled in water to yield "mononitroglycerin".

## **History, Design, and Manufacture of Explosives**

### **Mononitroglycerin (Mono-NG)**

Mono-NG is separated from Di-NG by its greater solubility in water. It is a colorless oil which is very hygroscopic and completely miscible with water and alcohol. It is not freely soluble in NG and does not make good nitrocellulose gel. It is insensitive to shock and in its oil form cannot be detonated with a #8 blasting cap. If mixed into fullers earth, it detonates at low power, from 10cc to 75cc expansion. In its crystalline form it expands from 10cc to 245 cc and detonates easily.

### **Nitroglycide**

Nitroglycide is made by mixing Di-NG in a 30% solution of sodium hydroxide in water. A colorless precipitate forms that is washed with water, extracted by mixing into ether, and dried to yield nearly pure nitroglycide. It is a very mobile liquid that is more sensitive to shock and heat than NG (due to its mobility). It does not freeze at -20 degrees, is miscible with alcohols and NG, forms excellent gels with nitrocotton and even guncotton at room temperatures, and it explodes on contact with concentrated sulfuric acid.

### **Dinitrochlorohydrin**

has been used in admixtures to lower the freezing point of NG and dynamite. It is prepared by autoclaving (steam heating) a mix of limited hydrochloric acid and glycerin to form chlorohydrin which can also be made from a warmed mixture of glycerin and sulfur chloride. The chlorohydrin is then vacuum distilled from the mixes while heating. At 12-15mm of atmospheric pressure produced by the vacuum, the chlorohydrin vaporizes at 130-150 degrees, while the glycerin doesn't vaporize until 165-180 degrees.

Once recovered, the chlorohydrin is nitrated the same way as the NG. The dinitrochlorohydrin is yellow-brown in color, has a specific gravity of 1.541 at 15 degrees, and boils at 190 degrees at atmospheric pressures. It is non hygroscopic and nearly impossible to freeze. NG and Dinitrochlorohydrin can be manufactured together by nitrating both together at the same time. It is also hard to ignite by fire and shock although it is readily detonated by Fulminate. It is unsuitable for mining without additives because it produces hydrogen chloride on detonation which is a lethal gas. By adding sodium or potassium nitrate in sufficient amounts, solid salts are formed with the chlorides during detonation making it safe from the gas.

### **Acetyldinitroglycerin**

has been recommended for lowering the freezing point of NG. It is produced by mixing dinitroglycerin with acetic or acetyl oxide or by nitrating monoacetin. This is a comparable explosive to dinitrochlorohydrin, but is more expensive to manufacture.

## **History, Design, and Manufacture of Explosives**

### **Formyldinitroglycerin**

can be prepared in combination with nitroglycerin by warming glycerin with oxalic acid to produce monoformin which is then nitrated with the glycerin to yield a non freezing mix of NG. This mixture is also too expensive to be adapted commercially.

[Oxalic Acid is a deadly poisonous weak acid used to clean radiators and other metals. It is the poisonous material found in rhubarb leaves and can be extracted from the leaves in water solutions. It is also manufactured commercially in large amounts]

### **Tetranitrodiglycerin**

By mixing a small amount of concentrated Sulfuric Acid with Glycerin and heating it, ether and water is formed with diglycerin and polyglycerin. If you heat the glycerin without acid, but in the presence of .5% sodium sulfite or other alkali (which acts as a catalyst) and distill out the water while condensing the higher boiling materials, then most of the material formed and recovered is diglycerin with only a few percent formed as polyglycerin. With this technique you can make a mixture of diglycerin 50-60%, polyglycerin 4-6%, and unchanged glycerin 34-46%. This mixture can be directly nitrated to form a mixture of tetranitrodiglycerin which can be used to make non freezing dynamite.

The diglycerin can be vacuum distilled off of the mixture at 245-250 degrees at 8mm pressure. It is more viscous and dense than glycerin and is very hygroscopic. It is nitrated with the same acid mix as glycerin, but requires less total acid for nitration. The material is washed with a salt water solution (the salt is used to speed up the separation).

The resulting tetranitrodiglycerin is a very thick, non hygroscopic oil that is soluble in alcohol and ether, but is insoluble in water. It does not gelatinize cotton alone but will do so slowly when mixed with nitroglycerin. It is less sensitive to shock than nitroglycerin but is easily detonated with fulminate. Dynamite produced with this material was equivalent to 85.6% of the explosive force of NG based dynamite.

### **Nitroglycol**

One of the early ideas to make non freezing dynamite was to attempt to nitrate anti-freeze materials. Ethylene Glycol is a combustible alcohol and anti-freeze which catches fire at 775 degrees F (412 C). To make ethylene glycol, ethylene is first obtained. It is sold commercially as a gas and is the six highest volume chemical produced in the US (1985). It is produced by dehydrating ethanol, by thermal cracking of hydrocarbon gas, and other chemical methods. The ethylene glycol is then produced by air oxidation of the ethylene followed by hydration (adding water) of the ethylene oxide. There are several other processes to chemically make ethylene glycol and it is sold in large volume in the US as anti-freeze and coolant, foam stabilizer, solvents, and other industrial processes.



## **History, Design, and Manufacture of Explosives**

Nitroglycol is produced using the same mixed acid as NG. The reaction is kept cooler than NG with less compressed air agitation (this reaction generates more heat). Using an ice bath is recommended. The washing is done with small amounts of cold wash water because the Nitroglycol is more soluble and much more volatile than NG (when a liquid is described as volatile, it means it turns to a gas in open air easily. The gasoline you pump into your car is a volatile liquid). Nitroglycol is a colorless, non hygroscopic liquid that yields a slightly greater explosive force than NG (590cc to 650cc expansion). It is less sensitive to shock than NG and harder to ignite by heat.

Nitroglycol gelatinizes collodion cotton much faster than NG and at room temperatures (NG has to be warmed). It makes excellent dynamite but should not be used with ammonium nitrate explosives in warm environments. It is too volatile for use in these types of double base smokeless powders and will evaporate in warm weather which affects the ballistic properties of the fired artillery shells.

Ammonium Nitrate-Fuel Oil (ANFO) explosives have replaced most of the historical demand for nitroglycol based dynamite.

### **Dinitrodiglycol**

Diethylene glycol can also be nitrated in the same way to produce Dinitrodiglycol. It results in a viscous, colorless, odorless oil that is slightly hygroscopic and can be mixed with NG. It is hard to ignite and a small amount cannot be detonated with heat. When mixed 50/50 with NG or nitroglycol it will detonate properly and explodes with energy comparable to NG.

### **Trinitrophenoxyethyl Nitrate**

is an explosive made by converting glycol to its sodium derivative, and mixing it with dinitrochlorobenzene at 130 degrees which yields dinitrophenoxyethyl alcohol. This is then nitrated with mixed acid to yield the Trinitrophenoxyethyl Nitrate powder. This white powder is insoluble in water, soluble in acetone, it gelatinizes collodion nitrocotton and is an excellent primer similar to picric acid and tetryl in sensitivity to mechanical shock.

### **Nitration of Ethylene**

A number of patents have been issued for the production of explosives based on the idea of mixing ethylene gas into the mixed acids. These usually yielded a material called Kekule oil that was used to make pure nitroglycol.

## **History, Design, and Manufacture of Explosives**

A Swedish inventor named Ohman developed a way of producing nitric esters from electrolysis, principally nitroglycol and dinitroglycol. He used a platinum gauze anode immersed in acetone solution of calcium nitrate. Ethylene is bubbled over the surface of the gauze. An aluminum cathode is immersed in a nitric acid and calcium nitrate solution that moves to the anode compartment during the electrolysis and is replenished with nitric acid as required. The anode liquid is neutralized with slaked lime, distilled in vacuum to recover and reuse the acetone, and the residue is separated from the calcium nitrate to yield a mixture of nitroglycol and dinitroglycol. This has been sold under the name "oxinite" and its dynamite is similar to NG dynamite.

### **Diethylene Glycol Dinitrate (DEGN)**

made by nitrating diethylene glycol, it is the most widely used explosive plasticizer (other than NG) in making gun propellants. It burns cooler than NG which decreases erosion of gun tubes and eliminates muzzle flash. It is used in some double cast rocket propellants but suffers some deterioration if stored at high temperatures for a long time. It has a detonation velocity of 6,750 m/s and detonates at 240 C.

### **Triethylene Glycol Dinitrate (TEGN)**

is made from nitrating triethylene glycol, and is also a plasticizer for nitrocellulose propellants when used with metriol trinitrate. This desensitizes the TEGN because it explodes easily from friction and shock.

### **Pentryl**

also produced from ethylene, Pentryl (for 2,4,6-trinitrophenylnitraminoethyl nitrate) falls into several chemical categories of nitro compounds. It was first produced by mixing ethanolamine with dinitrochlorobenzene in a solution of alcohol and sodium hydroxide which yielded 2,4-dinitrophenylethanolamine. This was then nitrated by mixed acid. It was later made by directly nitrating phenylethanolamine. The tiny cream colored crystals are soluble in NG and has detonating properties similar to tetryl and is much more sensitive to friction than picric acid and TNT. Its explosive power is similar to these materials.

### **Hexanitrodiphenylaminoethyl Nitrate**

one of the byproducts of commercial Pentryl production is tetranitrodiphenylethanolamine. By nitrating in mixed acid, yellow plates of this material were produced. The crystals were precipitated from acetone by adding alcohol. It is similar to other detonators in shock sensitivity and ignites at 390-400 degrees.

## **History, Design, and Manufacture of Explosives**

### **Trimethylene Glycol Dinitrate**

When glycerin is produced from fermentation, it also yields trimethylene glycol which can be left in the mix for explosives or fractionally distilled out. The liquid is syrupy, clear, soluble in water, and is nitrated by the same method already described for nitrating other alcohols. The temperature is lowered by 10 degrees during nitration to prevent oxidation. Trimethylene glycol can also be made from Acrolein (a war gas) and is used to make polyesters.

The explosive forms a good gelatin with nitro cotton, is less sensitive to shock than NG and is much more stable in storage. It has about 90% of the expansion power of NG but produces a greater Brisance (due to its lower viscosity). It is also known as 1,3-propanediol dinitrate and has found modern use as a propellant coolant in rockets and artillery formulations.

### **Propylene Glycol Dinitrate**

Propylene is produced from thermal cracking of ethylene and has been used to produce glycerin for NG production. It is turned to propylene oxide by peroxidation, or by chlorohydration of propylene followed by saponification with lime. This is then hydrated to yield the propylene glycol which is used as anti-freeze, in polypropylene resins, as a solvent, etc. It is nitrated the same and yields the same properties as its chemical isomer, Ethylene Glycol Dinitrate.

### **Butylene Glycol Dinitrate**

Butylene Glycol is produced by the direct reduction of aldol. It can be nitrated directly at temperatures of -10 degrees and yields a colorless liquid that does not freeze. It produces good gelatin with nitro cotton, is insensitive to shock but detonates on initiation. Its explosive power is 65-75% of NG.

### **Trimethylolethane Trinitrate (Metriol Trinitrate)**

is widely used to desensitize other nitric esters. It is not a good plasticizer and must be used with others plasticizers like metriol triacetate to make good nitrocellulose. It is made by nitrating Trimethylolethane (which is used to make varnishes, polyester resins, and synthetic drying oils) by the usual mixed acid method.

### **Butanetriol Trinitrate**

is obtained by nitrating Butanetriol (used an emulsifier for cosmetics, ink, paper, cork, and textiles) by the mixed acid. It has been used as an good explosive cellulose plasticizer and as a coolant in propellant formulas because of the large volume of cool gas it produces on ignition.

## History, Design, and Manufacture of Explosives

### Nitroerythrite

is made from erythritol, which is a tetrahydric alcohol found and extracted from lichens and algae. The Erythritol Tetranitrate (its chemical name) is produced by dissolving erythrite in strong nitric acid kept at below 0 degrees during the entire process (by encasing in ice). Its precipitated by adding concentrated sulfuric acid (see the following Nitromannite instructions). Its as powerful as NG, and because its a solid, it can be used as a smokeless powder and primary explosive.

### Nitromannite

Mannitol occurs in nature as a plant sap or exudate. It is hexahydric alcohol also known as manna sugar, and can be synthetically made by hydrogenating corn sugar or glucose. It can be nitrated by using the same mixed acid used for NG, or it can be dissolved directly in Nitric Acid as follows.

1. Place 50 grams of Nitric Acid in a 300cc flask and cool to below 0 degrees C.
  2. Add 10 grams of Mannitol very slowly and stir with a thermometer making sure the temperature does not rise above 0 degrees.
  3. When all of the Mannitol is dissolved, add 100 grams of Sulfuric Acid 93% slowly while stirring and keeping cold.
  4. Filter the porridge like mass, and wash with water once, and then wash again with a dilute solution of sodium bicarbonate and water, and finally with water again to remove all the acid.
  5. Boil this crude product in alcohol to dissolve it, and filter off while hot. The filtered alcohol is allowed to cool and the white needle nitromannite crystals form. These are filtered off.
  6. The remaining alcohol can be boiled while adding water until turbid in appearance. This is then also filtered to yield additional crystals.
- Final yield is about 23 grams.

Nitromannite is only slightly soluble in cold alcohol but very soluble in hot alcohol and is insoluble in water. It is stable at ordinary temperatures, but care must be taken to avoid high temperatures. It will begin to decompose and give off red fumes. It should be stored in a cool location. Nitromannite detonated in a column 12.8mm in diameter and at a density of 1.73 (compressed) yields a velocity of 8,260m/s or over 1 1/2 miles per second. it is about as sensitive to friction and heat as NG and is used as a high explosive in compound detonators with diazodinitrophenol. Nitromannite mixed with Tetracene form a powerful and brisant primary explosive, which needs only moderate heat to ignite.

Two other hexanitrate, Nitrodulcite and Nitrosorbite are produced by the same methods from Dulcite (from Madagascar manna) and *d*-Sorbite (from berries of the mountain ash). Commercial sources of both these are available.

## History, Design, and Manufacture of Explosives

### Nitrated Sugars

As a group, the nitrated sugars share many common properties. The sugars are polyhydric alcohols which yield nitric esters that are difficult to purify and are harder to stabilize than other nitric esters. The nitrated sugars have characteristics of the sugars from which they are made. When warm they become sticky and resinous, they do not crystallize easily, and if left in their precipitated state, they contain decomposition products, mainly nitrous acid, which causes continued decomposition and destroys its explosive properties. By adding wood meal at 1-2% or diphenylamine at .1-.2% to the nitrated sugars, they can be stabilized so that the nitrous acid is taken up and decomposition is arrested.

One of the earliest nitrosugars commercially produced was a mixture of 20-25% cane sugar with 75-80% glycerin nitrated directly and repeatedly washed with baking soda solutions and concentrated salt solutions. The final product is has been sold as Nitrodyrene and contains 86% nitroglycerin and 14% nitrosucrose.. Wood meal was added to dynamite made from nitrohydrene to stabilize it.

The nitrosugars are usually all soluble in alcohol, acetone, and acetic acid and are insoluble in water. All produce solid crystals on precipitation. All are made in pure form by mixing the sugar in concentrated nitric acid at 0 degrees C, in the required amounts and then, concentrated sulfuric acid is added drop by drop to form the corresponding nitrosugars.

<u>Nitrosugar</u>	<u>Chemical Name</u>	<u>Nitrated and derived from</u>
Nitroarabinose	<i>l</i> -Arabinose tetranitrate	<i>l</i> -Arabinose
Nitroglucose	<i>d</i> -Glucose pentanitrate	<i>d</i> -Glucose
Nitromannose	<i>d</i> -Mannose pentanitrate	<i>d</i> -Mannose
Nitromaltose	Maltose octonitrate	Maltose
Nitrolactose	Lactose octonitrate	Lactose
	Glucosan Trinitrate	Glucosan / <i>d</i> -glucose
	Lactose hexanitrate	Lactose
Nitrosucrose	Sucrose octonitrate	Sucrose
	<i>d</i> -xylose tetranitrate	<i>d</i> -xylose
	<i>l</i> -Rhamnose tetranitrate / trinitrate	<i>l</i> -Rhamnose
	Methylglucoside tetranitrate	Methylglucoside
	Methylmannoside tetranitrate	d-methylmannoside
	<i>d</i> -Galactose pentanitrate	<i>d</i> - Galactose
	Fructosan trinitrate	<i>d</i> -fructose
	Sorbosan trinitrate	<i>d</i> -sorbose
	<i>d</i> -Glucoheptose hexanitrate	<i>d</i> -glucoheptose
	Trehalose octonitrate	trehalose
	Raffinose hendecanitrate	raffinose
	Tetraamylose octonitrate	tetraamylose
	Diamylose hexanitrate	diamylose or tetraamylose
	Triamylose hexanitrate / enneanitrate	triamylose / hexaamylose

## History, Design, and Manufacture of Explosives

Early explosive designs contained	Nitrolactose	25%
	Ammonium Nitrate	65%
	Sodium Nitrate	6%
	Vegetable absorbent	4%
And using an acetone solution of	78% Nitrolactose	
to treat	9% DNT (dinitrotoluene)	
plus	13% wood pulp	
	.2% diphenylamine	

The US Army developed the following improvised explosive from sugar, using Sodium Chlorate as the oxidizer. Aluminum powder can also be used in place of the sugar as the combustible. Although this is not a nitrated explosive or nitric ester, I included it here because the principles are similar and should be included with sugar based explosives. (see chlorate explosives in the dynamite and high explosives chapter).

### Sugar/Aluminum Explosive

An explosive munition can be made from sodium chlorate combined with granular sugar, or aluminum powder. This explosive can be detonated with a #8 commercial or a military blasting cap.

#### Material Required

Sodium Chlorate  
Granulated Sugar  
Aluminum powder  
Wooden rod or stick  
Bottle or jar  
Blasting Cap  
Steel Pipe threaded at one end, end cap and tape  
Wax  
Measuring container

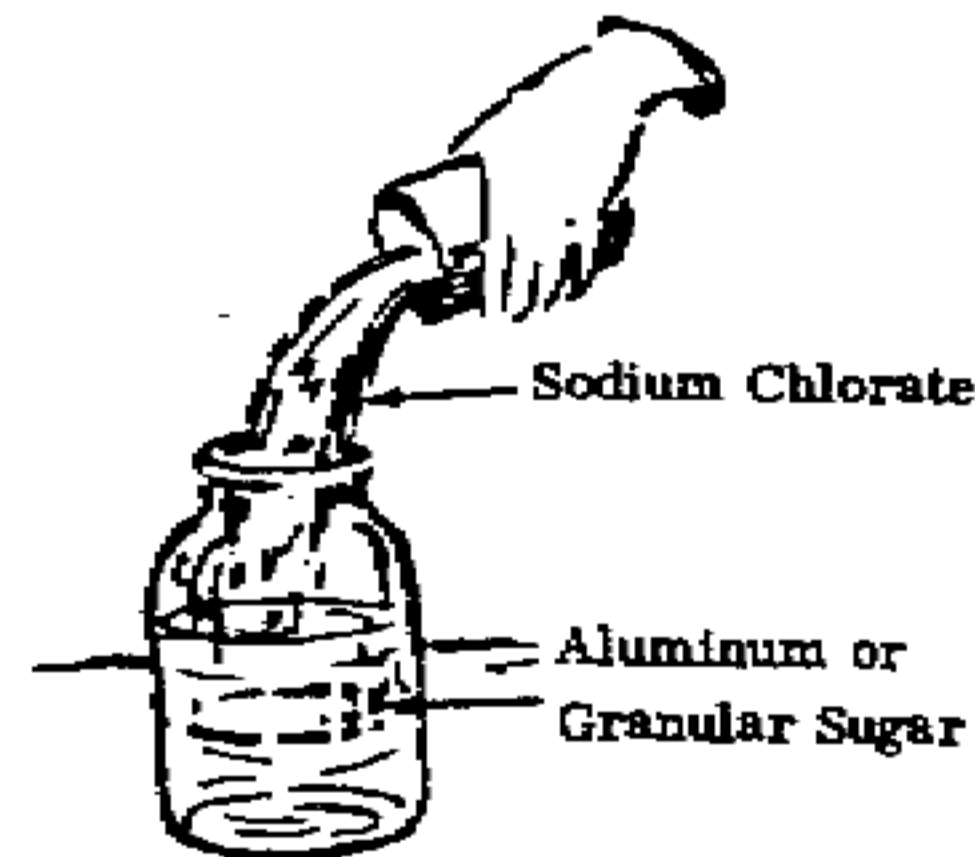

## History, Design, and Manufacture of Explosives

### Procedure

1. Add three volumes sodium chlorate to one volume aluminum, or two volume granular sugar, in bottle or jar.
2. Mix ingredients well by stirring with the wooden rod or stick.



### How to use

1. Wax blasting cap, pipe and end cap.
2. Thread end cap onto pipe.
3. Pour mixture into pipe.
4. Insert and tape blasting cap just beneath surface mixture.

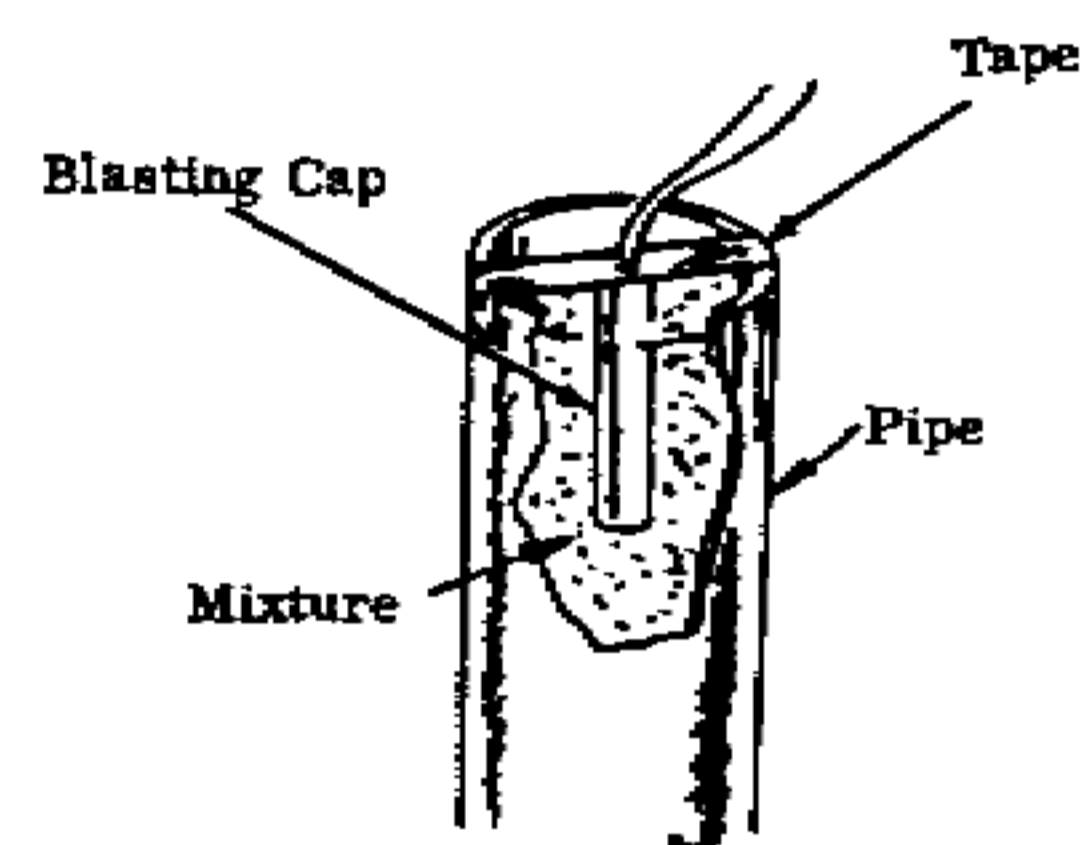
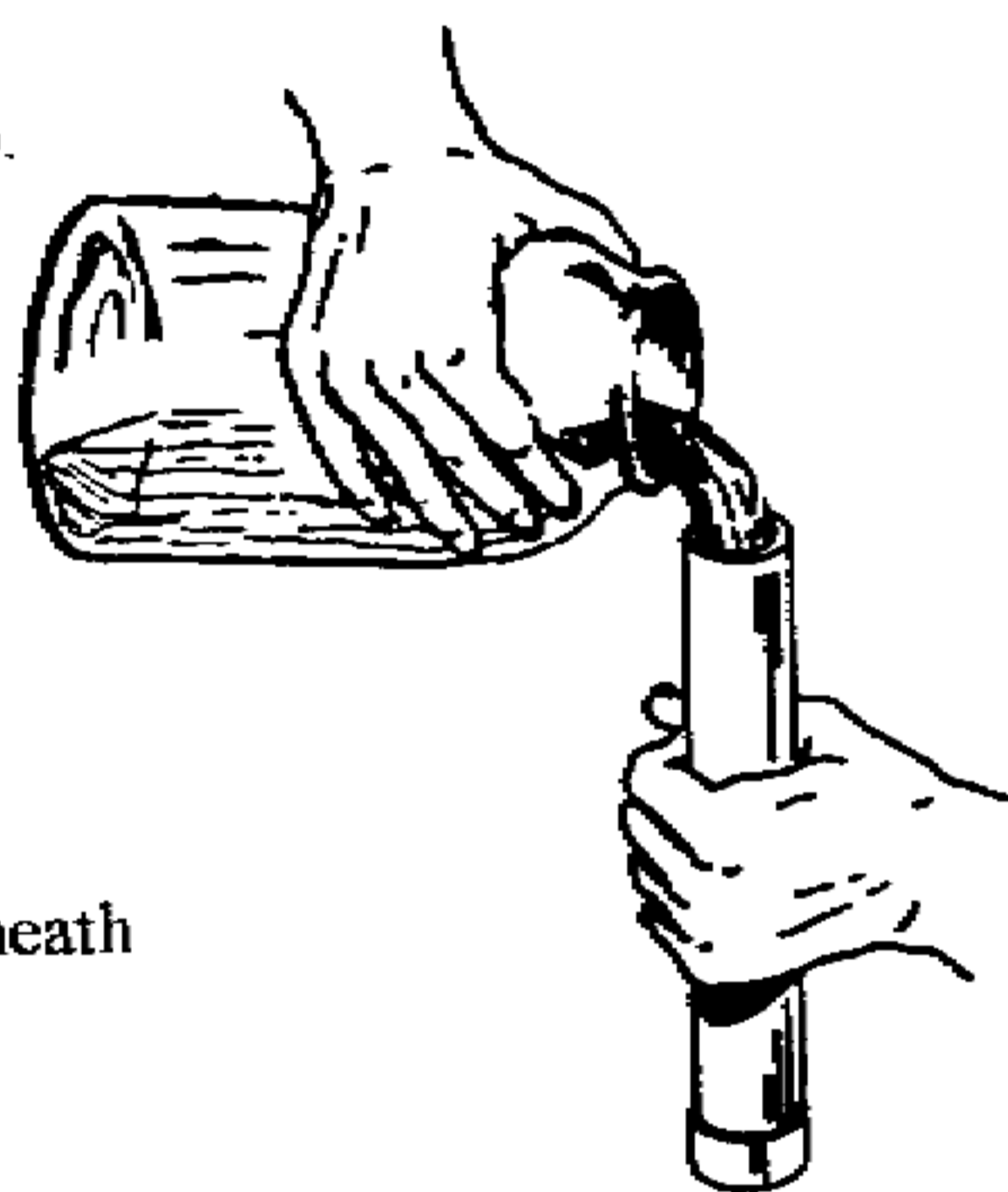

### **Nitrated Carbohydrates**

At the same time nitroglycerin was discovered and developed, chemists began to nitrate combustible materials such as cotton, paper, starch, and other carbohydrate based substances. This led to several new classes of explosives.

In 1833, Braconnot dissolved starch in nitric acid and when he added water to the mix, curds of a white precipitate formed. After filtering and washing it with water he found that it would not redissolve in boiling water, or dilute sulfuric acid. It did dissolve in concentrated sulfuric acid and could not be recovered. He called this new material "xyloidine". When he added this material to a paper or cloth it left a brilliant, varnish like, waterproof coating on it. When it was heated on cardboard or heavy paper, it carbonized or liquefied leaving the paper undamaged. This would eventually lead to the invention of celluloid for photography and filmmaking. The experiment would be repeated with sawdust, cotton and linen with similar results.

## History, Design, and Manufacture of Explosives

By 1838, Pelouze would nitrate paper by dipping it into Nitric Acid for 2-3 minutes, removing and washing it in water. He produced a parchment like material that was waterproof and very combustible - It was the worlds first true nitrocellulose because it was nitrated thoroughly, not just on the surface as Braconnot had done.

In 1846, several chemists presented their discovery of Guncotton to the world. Among many substances tested, cotton would be dipped in nitric acid and pressed between glass and stirred to insure it was soaked thoroughly. It was then washed until it was free from acid and dried. By immersing for 12 hours, a strong explosive could be directly produced provided that it was washed to completely remove all the acid. If this was not done, the guncotton would deteriorate in storage and would not explode properly by burning all its material. This would effect and yield unreliable ballistic properties if used as a propellant or as an explosive.

By using a mixture of equal parts of concentrated sulfuric and nitric acids, cotton could be soaked for several minutes and yield good explosive material that was easier to dry. Sawdust was also treated in this way about the same time and produced an explosive that some thought could be used to replace gunpowder.

In 1846, Pelouze made the distinction between the xyloidine of Braconnot, and his guncotton which he called "Pyroxylin".

100 parts starch dissolved in nitric acid and precipitated immediately yields 128-130 parts xyloidine.

100 parts cotton or paper immersed in nitric acid for several minutes or days yields 168-170 parts pyroxylin after washing and drying.

An English patent of John Taylors disclosed in 1846 refined this process. Cotton was immersed in one part Nitric Acid, and three parts Sulfuric Acid at 50-60 degrees F for 1 hour. It was then washed under a stream of water until free from acid, pressed (squeezed) to remove the water, dipped in a dilute solution of potassium carbonate (1 oz. in one gallon of water), to neutralize any imbedded acid and again pressed dry. He rerinsed in a solution of potassium nitrate (1 oz. to one gallon of water) which he said added explosive power to the product, pressed it again, spread it out on a tray and dried it at 150 degrees F. His guncotton was ready to use. He also included the ideas of using other vegetable matter containing cellulose with this process.

In 1853, the Austrian government built the first factory for production of guncotton. After the cotton was nitrated, they purified it by

1. washing the nitrated cotton for 3 weeks
2. boil it in the potassium carbonate solution for 15 minutes
3. wash again for 3-5 days
4. impregnate with waterglass (sodium silicate)
5. Dry at 150 degrees F.



## History, Design, and Manufacture of Explosives

12 pounder guns test fired the new guncotton as a propellant and the barrels were seriously damaged and some burst by even single firings. In 1860, bronze guns were tried with the shell explosive also being made of guncotton. The shock of the firing exploded many of the shells in the barrel, destroying the barrels. When propelling charges of gunpowder were used, the guncotton based shells could be fired without detonating in the barrels.

During the early 1860's while the US Civil War was raging, several guncotton storage magazines in Europe exploded killing numerous workers and by 1865, the production of guncotton was outlawed in much of Europe. The problems of its impurity was caused by tiny amounts of residual acid which made it unsafe to store and handle. Its too fast burning for use in artillery was also a problem but both these difficulties were soon overcome with new patented ideas.

The first improvement involved making the guncotton as usual, and then taking the fiber while wet and pulping it (beating it with knives in cylindrical mills) so its fibers were broken to tiny pieces. This allowed the washing to remove tiny traces of acid that soaked into the insides of the fibers and would not ordinarily wash out. The guncotton could now be made stable and safe.

The second improvement involved forming the guncotton into pressed blocks for use as solid artillery propellant. Although this was still too powerful a charge, it could be used effectively for blasting.

By 1867, the researchers, by use of pulping, could make the guncotton free of acid. Moisture would not effect it. Sunlight would not affect it. Only by elevating the temperature considerably could any decomposition be started. By pulping to a very fine powdery size, all the capillaries and cells of the fiber would be exposed and all the acid would be washed out or neutralized by the carbonate soakings. It was critical to pulp, wash for 20 hours, and neutralize in carbonate solution to produce a stable, safe, and compressible guncotton with good shelf life.

In 1868, it was discovered that guncotton could be detonated very powerfully by using the fulminate detonator that Nobel had used with nitroglycerin. It was also found that a small amount of dry guncotton could be sealed in a naval mine, and be used as a booster to detonate a large charge of wet guncotton. The water had no effect on the explodability of the guncotton as long as a large enough dry booster charge was used. This began the science of naval underwater explosives and mine warfare.

## History, Design, and Manufacture of Explosives

### Nitrocellulose

Almost every plant on earth produces cellulose for its cell walls and wood fibers. Cotton fiber is nearly pure cellulose which made it ideal for the guncotton explosives, but wood is also nearly as pure and can be used to make excellent smokeless powder and explosives.

Cellulose can yield trinitrate on complete nitration because it contains 3 hydroxyl groups for each anhydroglucose unit. This means that if each group reacts during the chemical nitration, it produces complete trinitrate forms that will test at 14.15% Nitrogen (N). This is important because the measure of how effective the nitration has been is usually determined by testing for N after all other acid and residual is removed. Most commercial Nitrocellulose runs 13.75-14% N, and it is difficult to achieve perfect nitration.

A *Collodion* is a nitrocellulose that contains 8-12% nitrogen and is also soluble in ether alcohol. The first celluloid was made in 1870 by dissolving collodion nitrocellulose in camphor under heat and pressure.

Collodion was made by nitrating tissue paper with a mix of 35.4% nitric acid, 44.7% sulfuric acid, and 19.9% water. 22 pounds of this acid are used per pound of paper and it was nitrated at 55 degrees for 30 minutes and contained 11-11.2% N.

Camphor and castor oil were added to yield tough and flexible films.

Salicylic acid was added at 2% to make "corn remover".

and Nitroglycerin was added to make the first blasting gelatin.

By 1895, Mendeleev produced the first "pyrocellulose" that contained 12.6% N which could be used to make a military smokeless powder. The higher US grades containing 13.2-13.4% N were called high grade nitrocellulose and were prepared by

1. Pour 1 part sulfuric acid into one part nitric acid while stirring, and allow to cool.
2. Add 5 grams of cotton (dried at 100 degrees for 2 hours) into 150cc of this mixed acid and stir occasionally over 30 minutes using a glass rod.
3. Remove the cotton and press it to remove as much acid as possible.
4. Add quickly to a beaker of cold water and stir to dilute the residual acid.
5. Remove and wash the nitrocotton under running water and then boil it for an hour in a beaker of distilled water.

## History, Design, and Manufacture of Explosives

6. Boil 3 more times with fresh distilled water each time for 1/2 hour each.
7. If the water from the last boiling shows the slightest trace of acidity with pH paper or meter, rinse it and boil again.
8. When pH neutral, wring out the water, and dry in a paper tray for 48 hours.

**Pyrocellulose** was made commercially from purified cotton linters, or wood cellulose. In scaled up production, a stainless steel or iron nitrator with mixing paddles was used.

1. A 1500 # mix of 21% nitric acid, 63% sulfuric acid, and 16% water is prepared.
2. A charge of 32# of cellulose is added while mixing or stirring for 20-30 minutes while keeping the temperature at 30-34 degrees F.
3. Open the nitrator at the bottom letting the slurry gravity flow into a centrifuge.
4. Separate the slurry quickly by centrifuging, send the acid to the recovery tanks to refortify the acid for reuse, and the nitrated product is wringed dry and dumped into a basin where it is mixed into and "drowned" in a fast moving stream of water.
5. Transfer to the guncotton line for purifying and stabilizing.

### Stabilizing and shipping preparation

1. "Sour boiling" in large wooden tubs by steam heating (boiling) in a water solution containing .25-.5% sulfuric acid for 16 hours.
2. Decant the solution, fill with fresh water, and boil again for 8 hours. Repeat 3 more times for a total of at least 40 hours of boiling with 4 changes of water.
3. To remove the fibers that still have acid inside of them, they are pulped in a mill to break the fibers apart by shredding and into a beater to break into short lengths.
4. A weak solution of sodium bicarbonate is added during pulping to neutralize the liberated acid.
5. Remove remaining acid absorbed or occluded on the fiber surfaces by reboiling it again (poaching) for 4 hours with a dilute sodium carbonate solution, and then twice more with fresh water for 2 hours each.
6. Wash 8 more times with agitation in cold water and decant at least 40% of the water each time.

## History, Design, and Manufacture of Explosives

7. After the final washing, screen the material so it passes sieves of .022" in size, wring out the material to reduce its moisture to 26-28% and pack in hermetically sealed containers.

Guncotton was prepared the same way by using a stronger acid of

- 24% nitric acid
- 67% sulfuric acid
- 9% water

140# of this acid is used for every 4# of dry cotton and is stabilized the same way except that it is not pulped.

By 1930, scientists had finally figured out that if they pulped the nitrocellulose before they washed it, they could cut down on the hydrolyzing washes (to about 20 hours total from the original 52 hours). They had also discovered by this time that they could displace the tiny amounts of acid still clinging to the fibers by adding a new material that had greater adhesion tension than the acids. These substances were aniline red, bismark brown, methyl orange, *m*-phenylenediamine, urea, substituted urea's such as diethyldiphenylurea, and diphenylamine. In fact, washing the nitrocellulose for 1/2 hour in either .5% urea in water or diphenylamine in alcohol gave more stability than 20 hours of repeated water washes.

Modern nitrocellulose is produced according to a desired Nitrogen (N) content.

Trinitrate	14.15% N
Dinitrate	11.11%
Mononitrate	6.76%

Most propellant nitrocellulose today contains 12.6-13.1% N while blasting gelatin uses 11-12% N material. Some commercial products may contain only 8-11.5% N.

Nitrocellulose is inherently unstable and it decomposes to a number of gases at 125 C. At 50 C the rate of decomposition is noticeable and increases at a rate of 3.5 times for each 10 C raise in temperature.

Dry nitrocellulose burns furiously and rapidly. It usually needs to be present in large quantities or be confined in order to detonate. In its dry state it is sensitive to friction, static electricity, impact, and heat. Because of this it is always shipped wet in alcohol or water. Even nitrocellulose shipped in 40% water can detonate in confinement with a large initiator.

## History, Design, and Manufacture of Explosives

Several modern processes for manufacture of Nitrocellulose are used. All use cotton linters or wood pulp, are treated with mixed acid, hot acidified water, pulped, neutralized, and washed. These include-

### *Mechanical Dipper Batch Process:*

1. A pump or conveyor moves all the raw materials to the top floor of the plant.
2. Linters and/or wood pulp are passed through picking rollers to form a fluffy mass and then dried at 80-100 C to less than 1% moisture to minimize dilution of acid and the chance of a fire in the nitrator.
- 3 The ingredients are fed into a battery of mechanically stirred nitrators (called dipping pots) with a ratio of 20-50 parts acid mix per part of cellulose depending on the desired N content and whether you are using cotton or wood. The mixers are stirred at high speed and the cellulose is rapidly submerged and mixed for 15-20 minutes.
4. The mix is dropped out the bottom by gravity into a centrifuge where the spent acid is separated from the nitrocellulose. One centrifuge usually services several batch nitrators and is timed for continuous use.
5. The cake is passed to a wringer to press out more water and then the filter cake is washed to remove absorbed acid in a slurry tank.
6. It is then pumped to a mixer for addition of the stabilizer.

### *Semicontinuous:*

1. The cellulose is continuously and automatically fed into a series of pots at a controlled rate. It falls into the slurry of acid and is submerged by a turbine agitator.
2. The first pot feeds by gravity into a second pot by a series of under and overflow pipes which ensure adequate retention time in each pot. Each pot increases the nitration.
3. The discharge from the last pot is fully nitrated cellulose.
4. The product is discharged into a horizontal basket centrifuge below the pot, and dried to a cake.
5. This is discharged to a slurry for washing in a tank below, and for stabilization.

The purification process for both these methods is the same. The materials are submerged in water and heated to 98 C with live steam. This boil is continued for 40-60 hours for pyrocellulose (12.6% N), and 60-96 hours for guncotton (13.15% N). This is followed by several washings and neutralizing boils, pulping, and a final neutralizing with sodium carbonate solution. After poaching and more washings, the slurry is screened and blended to the final desired N content.

In actual practice, the manufacturing plants produce so much material that the exhaust fumes and water discharges must be treated to avoid serious pollution problems.

## History, Design, and Manufacture of Explosives

### Nitrostarch

At first, nitrostarch was nitrated and dissolved in nitric acid. It was then precipitated out with sulfuric acid or spent acid from nitroglycerin manufacture. It was similar to xyloidine and had very poor stability. By mixing the starch in mixed acid so it would not dissolve, it could be made stable and the starch would retain the appearance of the starting material after nitration.

Tapioca and potato starch was first used but by 1917 all nitrostarch was produced from corn starch in the US. There were several processes used, all using the same basic principles.

1. Fats and pectic acid were removed from the starch by washing with dilute caustic soda solution, and then in water.
2. It was dried to <.5% moisture.
3. Acid was mixed containing 38% nitric acid and 62% sulfuric acid.
4. 800# of acid was added to the nitrator, then 200# of starch added while mechanically stirring. Starting temperature was 32 degrees and was kept at a maximum of 40 degrees F
5. After nitrating for at least 30 minutes, the entire contents were gravity fed into a tub of water.
6. Repeated cold water washings were used without boiling. The first washing used ammonia to neutralize the acid and added greatly to its stability.
7. The final nitrostarch was dried at 35-40 degrees.

Nitrostarch is not very hygroscopic, is insoluble in water, and does not form a good colloid as nitrocellulose does. Trojan explosives for hand and rifle grenades, and mortars used in WWI used these formulas containing Nitrostarch.

Nitrostarch	25%
Ammonium Nitrate	33%
Sodium Nitrate	38%
Charcoal	2%
Heavy hydrocarbons	1%
Antacid	1%
Diphenylamine	.3%

This mix was prepared by fine grinding and drying and then adding the materials together in a mixing barrel with the nitrostarch added last while the mixer is turning. Mortar shells were loaded by stemming and grenades were filled by shaking the mix down funnel tubes.

## History, Design, and Manufacture of Explosives

Some grenades were made with 97% nitrostarch and 1.5% each of Arabic gum and petroleum oil as a binder and coating added to the mixer while running. The granules were free running and loaded easily into the grenades.

Nitrostarch was used in blasting explosives in the following patented formulas

Nitrostarch	30%	39%	30%	40%	40%	40%
Ammonium Nitrate & TNT mix	15%	20%	-	-	-	20%
Sodium Nitrate	46.8%	37.25%	58%	37.7%	34.7%	17.7%
Barium Nitrate	-	-	-	20%	20%	20%
Charcoal	3%	-	5%	-	-	-
Paraffin Oil	.7%	.75%	.5%	.8%	.8%	.8%
Sulfur	3%	2%	5%	-	3%	-
Antacid	1.5%	1%	1.5%	1.5%	1.5%	1.5%
Urea	.2%	.2%	.2%	.2%	.2%	.2%

### Formaldehyde Based Explosives

Formaldehyde was originally produced from methyl alcohol by oxidation. The methyl alcohol was entirely derived from the distillation of wood. During WW1 both came into short supply for production of methylamine used to make tetryl and other uses. It was in fact too expensive for serious use as an explosives raw material. By WW2 synthetic methyl alcohol could be produced

first, by passing steam (water) over coke which yielded Carbon Monoxide and Hydrogen

second, additional hydrogen is provided by the action of iron on steam or by electrolysis of water

thirdly, by heating carbon monoxide and hydrogen in the presence of zinc or chromium oxide catalyst

This enabled a nearly unlimited supply of cheap methanol (with cheap energy), and as a result, formaldehyde, for use in commercial explosives production.

The formaldehyde was produced by mixing the methyl alcohol vapor with air and passing it over a red hot catalyst of metallic copper or silver gauze. Oxidation occurs and formaldehyde is formed.

When formaldehyde is reacted and condensed with acetaldehyde, nitromethane, cyclopentanone, or cyclohexanone, they form polyhydric primary alcohols which can be nitrated to produce powerful nitric ester explosives.

## History, Design, and Manufacture of Explosives

**PETN (Pentaerythrite tetranitrate)** is produced by

1. Mixing 4 moles (or more for an excess) of formaldehyde with one mole of acetaldehyde in a warm water solution containing weak calcium hydroxide or other alkali at 65-70 degrees. This yields pentaerythritol in a mixed solution

2. The calcium hydroxide is precipitated as calcium sulfate by mixing in sulfuric acid and the mixture is filtered, and then concentrated by vacuum evaporation. A white powder of crystals is formed and dried.

3. 400cc of nitric acid is placed in a large beaker and 100 grams of pentaerythrite is added while keeping the mix at 25-30 degrees. 400cc of sulfuric acid is added slowly while stirring and cooling to precipitate the PETN.

4. The crude PETN is filtered off and washed with 50% sulfuric acid, then washed again with water.

5. The PETN is then dissolved in hot acetone with a small amount of ammonium carbonate to neutralize the remaining acid and precipitate it. The hot liquid is filtered off into a solution of 90% alcohol of large volume which precipitates pure needle crystals of PETN.

PETN can be made directly from Nitric Acid without the use of Sulfuric acid by

1. Adding a small amount of urea to 400cc of fuming Nitric Acid to react out any free nitrous acid and bubbling dry air through it until it is completely decolorized.

2. Cool in a 600cc beaker in a freezing salt and ice mixture.

3. 100 grams of pentaerythrite, ground to pass a 50 mesh sieve is slowly added to the acid while stirring and keeping cool (below 5 degrees C). Continue to stir and cool for 15 minutes after the final portion is added.

4. The mixture is "drowned" by adding 3 liters of cracked ice and water.

5. The precipitated crude PETN is filtered off, washed free from acid, and added to a liter of hot 5% sodium carbonate solution. It is again filtered and washed.

6. The final material is dried, and then mixed into and recrystallized from acetone.

Commercial quality PETN melts at 138-138.5 degrees

Pure PETN melts at 140.5-141 degrees



## History, Design, and Manufacture of Explosives

All this seems like a lot of processing, however the formaldehyde raw materials come from the air which reduces the cost and they can be mass produced in wartime. The end product PETN is one of the most powerful explosives known as well as being one of the most stable and least reactive nitric esters. This makes it an ideal and extremely reliable explosive for a wide range of munitions.

PETN is insensitive to friction but is exploded easily by tiny amounts of initiator (only .01 gram of lead azide is required to initiate PETN). It detonates at 5,330 meters per second, when loaded at a density of .85 in a 25mm pipe. When compressed to 1.62, the detonation velocity increases to 8,000 meters per second. Its great brisance and sensitivity make it ideal for use in compound detonators.

When pressed under high pressure and broken into grains, the PETN is a powerful smokeless powder and works well with the primers in small arms ammunition. PETN has also been mixed with TNT, nitroguanidine, and guanidine picrate to form compressed two and three part mixtures of high explosive that are less sensitive to shock and heat than other smokeless powders and reliably detonate on initiation. It dissolves in TNT with as much as 2/3 of the final mix as PETN. Rich mixtures are used as propellant powders and less rich mixtures are used as brisant and powerful high explosives.

By mixing 10-30% of one of the fluid nitric esters (such as nitroglycerin or nitroglycol) into PETN, a "plastic" mass or explosive can be made that can be shaped into desired forms or granulated to easily load into shells and detonators.

It is important that the PETN be purified because as little as .01% occluded acid or alkali can speed its decomposition. If pure, it can be stored for 18 months at 65 C without deteriorating.

More modern processing methods include

1. Nitrating in large stainless steel mixers (at 15-25 C) with agitators and cooling coils.
2. Discharging to a jacketed dilution tank where the acid is diluted to 30% and the temperature is kept at 15-25 C. The PETN crystals precipitate out here.
3. The crystals are vacuum filtered and washed with water, then soda water, and finally cold water.
4. The water wet PETN is then dissolved in acetone at 50 C with a small amount of sodium bicarbonate or ammonia and then reprecipitated with water.

PETN is shipped wet in a water-alcohol packing. It is easily initiated and is used as a pressed charge in blasting caps and detonators, and as the core explosive in commercial sheet explosives and detonator cord. In recent years it has been replaced by RDX for most military uses.

## History, Design, and Manufacture of Explosives

A dynamite equivalent called Ammonpenthritit has been tested in the early 1930's using the following formulas

	AMMONPENTHRINIT	GELATIN DYNAMITE
PETN	37%	-
Nitroglycerin	10%	63%
Nitrocotton	-	2%
Dinitrotoluene	5%	-
Wood meal	-	5%
Ammonium Nitrate	48%	30%
Expansion Test	430cc	465cc
Velocity	6,600m/s	7,025m/s
Loading Density	1.36	1.47

**Dipentaerythrite Hexanitrate** - Dipentaerythrite is formed during production of pentaerythrite and its explosive nitrate is formed with the PETN during nitration. It is recovered from the crude PETN in moist acetone by fractional crystallization when the mixture is drowned in water. The crystals precipitate and are recovered by filtration. It is less sensitive to shock and heat than PETN but is less stable, especially at high temperatures.

**Nitroisobutylglycerin trinitrate** made by nitrating a mixture prepared from

1. 3 parts formaldehyde and 1 part nitromethane mixed and condensed in a solution of potassium bicarbonate to yield trimethylolnitromethane.
2. This is recrystallized from water to 150 degrees and is nitrated in a mix of 40% nitric and 60% sulfuric in the same manner as NG, or with very strong nitric acid as with PETN

This explosive is a thick yellow oil, soluble in alcohol, less soluble in water and does not gelatinize nitrocotton very well.

### **Nitropentanone**

Explosive tetranitrates are formed from the condensing of cyclopentanone and cyclohexanone with formaldehyde. By reducing these, their respective pentanitrates are formed. They are less sensitive to shock than PETN and 3 of the 4 melt at low temperatures which allow them to be conveniently loaded into ordnance by pouring and allowing to cool to a solid.

	<u>Melting point</u>	<u>Velocity of Detonation at low to high density</u>
Nitropentanone	74 C	4,630-7,940
Nitropentanol	92 C	5,060-7,360
Nitrohexanone	66 C	5,710-7,670
Nitrohexanol	122.5 C	5,470-7,670

## **History, Design, and Manufacture of Explosives**

### **Improvised Instant Explosives from Nitric Esters**

Sometimes, there is a need for an instant built and ready to use explosive that does not allow for the preparation of quality controlled and precision made munitions. The following idea comes from the authors observations.

Several decades ago at TVA (Tennessee Valley Authority), a rail car exploded while it was being loaded with nitric acid. It killed several nearby workers and sent debris from the rail car nearly 2 miles. Some parts of the rail car were never found. The car had previously been used to haul an organic alcohol and after it was unloaded, someone failed to check the car for residue or leftovers. It was estimated that only a few hundred pounds of alcohol had been left in it.

From the safety and mixing directions in this chapter, combined with this last story, it should be obvious that a truckload or rail car size explosive can be quickly improvised and prepositioned for use in warmaking.

The explosive design can be any size and would use the following same principles.

1. A tank containing a few pounds up to 10 tons of nitric acid can be placed onto the bottom of a semi trailer running down its length. The tank will have its top removed when positioned, so the acid is uncovered and completely exposed from the top. It will also have sufficient clearance to hold an additional few pounds to 10 tons of alcohol.
2. A similar tank would be positioned directly over the bottom tank and supported sufficiently to contain 10 tons of alcohol suitable for an explosive as described in this chapter. It will generate considerable heat on direct addition with the acid and self detonate.
3. Theoretically, it should be possible to have the top tank sufficiently valved to drain its contents into the bottom tank in a matter of seconds. In reality, this may not be practical or even possible. In this event, small explosives can be placed along the bottom of the tank as a bursting charge so that it would rupture the tank causing its contents to drain rapidly into the acid below. The rapid mixing and rise in temperature would cause the self detonation of the nitrated alcohol and result in a potential 20 ton explosion. Mechanical means of tipping over the top tank or other means of releasing its contents quickly may also be devised. It is obvious that this type of self mixing can be accomplished much more easily with smaller amounts and can be easily devised as a self igniting booby trap.

## **History, Design, and Manufacture of Explosives**

4. The final weapon needs to be prepositioned in the expected advance of the enemy or as close as possible to a selected target.

5. The bursting charge should be fused to detonate by time, proximity, radio, or other means as necessary and desired to have the greatest possible effect on the enemy.

An explosive of this volume should be able to destroy an area app. equal to that of a city block. I originally intended to add this to the weapons design chapter, but I thought it would be more instructive coming on the heels of learning the science of nitrated alcohol explosives.

# History, Design, and Manufacture of Explosives

## Chapter 3 Smokeless Powders and Propellants

In 1864, a captain with the Prussian artillery made what many believe was the first smokeless powder. He prepared fine grains of wood by washing, boiling, bleaching, then nitrating and purifying it as nitrocellulose at the time. He then impregnated the grains with potassium nitrate and with a combination of both potassium and barium nitrate salts.

The mixture was impure and would not burn perfectly and in fact burned slower than guncotton, but it still burned too fast for use in artillery. In fact it still burned too fast to be used in large caliber rifles but became popular for use with shotguns.

By 1870, researchers found they could partially gelatinize the powder by soaking it in a mixture of ether-alcohol. This was manufactured and sold as "Collodin". The next smokeless powder was made of nitrocotton mixed with the potassium and barium nitrate and improved by adding a dye and formed into grains made from the gelatinized mass, produced by the ether-alcohol treatment.

These new powders had about the same power as black powders, produced little or no smoke and burned quickly. They were used in shotguns, hand grenades, and used to ignite the dense colloided propellant artillery charges of the time.

A wide variety of formulas were used, all of them built around nitrocellulose fibers that were stuck together, not completely colloided, and containing added potassium and barium nitrates, camphor, vaseline, paraffin, starch, dextrin, potassium dichromate or another oxidizing or inhibiting salt, a stabilizer like urea or diphenylamine, and finally, a dye made from coal-tars.

Basic formulas for early bulk powders were very similar

Nitrocellulose	84%	87%	89%
Potassium Nitrate	7.5%	6%	6%
Barium Nitrate	7.5%	2%	3%
Starch	-	-	1%
Paraffin oil	-	4%	-
Diphenylamine	1%	1%	1%

## History, Design, and Manufacture of Explosives

The powders were prepared by

1. The mixed batch (above) would be added to a wheel mill like the one used for black powders. The wheels in this mill don't have to reach the huge compression levels that the black powder mills do so they are much lighter and were made of wood. App. 200# of powder would be added with 100# of water and 90 grams of a bright colored dye such as rosaniline. This mix is milled for about 45 minutes.

2. The product is run through a lumpbuster made of wooden blocks that rub the material over a perforated zinc plate. The blocks rotate in a fashion to break up the material and force it through the perforations.

3. About 50# of this material is placed in a "sweetie barrel" which is a large rotating copper pan that remotely resembles a cement mixer. The lower part of the barrel is immersed in a vat of near boiling water that heats the vat and its contents while it rotates. The copper pan rotates at about 15 RPM and wooden scrapers mounted inside the pan keep the sides cleaned continuously. This tumbling motion and scraping action has the effect of granulating the powder into spherical grains. It takes about 40 minutes for the drying grains to no longer stick to the sides and be ready screening.

4. The grains are passed through a 12 mesh sieve with all the oversize left on the screen recycled back to the wheel mill.

5. The 12 mesh and smaller material is conveyed into a horizontal mixer with a mixed solvent of

1 part acetone  
6 parts alcohol

one gallon of this solvent is added per 15 pounds of powder grains. The acetone dissolves the nitrocellulose and the alcohol does not. The end effect that this mix has is to cause the fibers to swell, soften, and stick together.

Hot air is blown down the cylinder while it rotates raising the temperature to 50-55 degrees C. The solvent evaporates and is distilled for reuse while the product now consists of hardened grains.

6. The product is screened again with the grains between 12 and 50 mesh being sent to drying and packaging for use. The outside material is recycled to the wheel mill or horizontal mixer.

## History, Design, and Manufacture of Explosives

The bulk sporting powder was also manufactured by the "still" process.

1. Pulped Nitrocellulose (500# - 12.6%N) is added to a still containing 700 gallons of water, 10# of potassium nitrate, and 30# of barium nitrate dissolved in it.
2. The mix is stirred and agitated while 145 gallons of a mixed solvent of
  - 2 parts butyl acetate
  - 3 parts benzene
  - and about 3# of dissolved diphenylamineis added to the mix.
3. The stirring must be violent enough to break up the solvent into small droplets with globular clusters of nitrocellulose forming and building up on each drop.
4. While stirring continuously, the mix is distilled under vacuum at about 30 degrees C.
5. The liquid is fractionally distilled so that the solvent is condensed into a storage tank and the water is recycled back to the still.
6. The globules are broken up into grains by violent stirring, then they are drained from the still into a centrifuge where they are filtered off and then dried.

The final powder contains 1-1.5% potassium nitrate and app. 3.5% barium nitrate. The water which contains leftover nitrates is recharged and recycled.

The first true smokeless colloid powder, used for 65mm cannon in test firings on 23 Dec. 1884, produced the same barrel pressures and ballistic effects with the charge weighing only about 1/3 of the previous powders. The velocity of the projectiles increased by about 100m/sec and increased considerably in velocity and power with only small increases in charge size.

This new powder was made by treating a mix of soluble and insoluble nitrocotton in ether-alcohol and kneading the mass to produce a thick jelly. This was rolled into thin sheets, cut into squares, and then dried. As equipment improved, the jelly would be forced through a die into desired shapes such as strips and cartridges to fit cannon. These were cut to length and dried. A glaze of graphite was added to slow down the rate of surface burning and prevented the buildup of static electricity. This new powder produced no smoke on firing. By using strips as the cannon charges, they could get them to burn in such a way that the entire surface area remained uniform from the start to the finish of the burning. This produced a smooth, continuous push for the artillery shells.

## History, Design, and Manufacture of Explosives

In 1888, Alfred Nobel produced his "ballistite" for artillery which he made by mixing Nitroglycerin and soluble nitrocellulose in 1 to 2 and 2 to 1 ratios in a solvent. By replacing all the camphor in his previous formulas with nitroglycerin, he could produce a "gelatin". The next year he figured out that by using all soluble nitrocellulose, he could make his ballistite without the use of a solvent. To do this, he mixed the NG and soluble nitrocellulose together under water and then heated the mix to 80 degrees C to gelatinize it. He then rolled it into thin sheets, cut it with a knife or scissors to the shapes and sizes his customers wanted, and additives would be included such as chlorate or picrate to improve its explosive and ignition properties.

The gelatinizing could be speeded up by using an excess of NG and removing it after mixing with 75% methyl alcohol.

In 1889, a British patent disclosed the alternative method of placing the parts in hot water and mixing by pumping compressed air into the liquid. When the gelatin formed, it was removed, and pressed between hot (50-60 degrees C) rollers which squeezed out the water. The sheet was folded and repeatedly passed through the rollers until the desired consistency was achieved. It was then rolled to the required thickness, cut into desired shapes, and glazed with graphite.

At the same time, the British Gov't decided to use a powder for its guns which were made from a different process. Guncotton and NG were mixed together in acetone, and vaseline (mineral jelly) was mixed in as well to help form a plasticizing and moldable mass. It was then pressed through dies to form the gov't requested shapes of oval or circular cords and the product was heated to dry the cords and distill the acetone solvent. The product was called **cordite**, and the process using vaseline would be the forerunner of modern plastic (moldable) explosives. The idea of using vaseline was actually intended to try and lubricate the barrel and add to the projectile velocity while reducing wear in the barrel. The vaseline was actually burned up in the explosion and had the effect of lowering the temperature of the burning so that it would produce less barrel damage with the same ballistic effect. It also had a stabilizing effect by absorbing nitric oxide and prevent its decomposing effects.

The first cordite used a formula of - A cooler burning formula for less barrel damage was

Guncotton	37%	65%
NG	58%	30%
Vaseline	5%	5%

Cordite was also made in flakes as well as cords, and also in sized perforated tubes ready to use in artillery.

The next invented smokeless powder was "**Indurite**". It was a colloid made by mixing guncotton with nitrobenzene (an aromatic nitro). The final product was shaped and hardened or "indurated" by treating it with hot water or steam. The heat vaporized most of the nitrobenzene, leaving a very hard mass and was used in 1" to 6" artillery (app. 10-70mm).



## History, Design, and Manufacture of Explosives

By 1897, the pyrocellulose and nitrocellulose were being used alone by colloidizing in ether-alcohol and forming cylinders that were multi-perforated and ready to use. The US used this as the main artillery propellant during WWI.

The pyrocellulose and other straight nitrocellulose such as those just described are called single base powders. These are simple colloidized powders with only one explosive base. Some solvents can be added, both explosive and non explosive, that remain in the product, and that effect the temperature, burning rate, and power of the final powder.

The Aromatic Nitros described in the next chapter dissolve nitrocellulose or dissolve into it, which results in two explosives in the same powder. These are still referred to by many people as single base propellants.

Double base propellants are those which contain both NG as a liquid explosive plasticizer and nitrocellulose.

Multi base propellants are those that involve NG, nitrocellulose, and other crystalline explosives in combination with double base formulas. An example would be adding nitroguanidine which does not absorb into the explosive base mix but is mixed in as a finely subdivided additive throughout the explosive.

Additives are added to control the hygroscopicity, gelatinizing, gun flash, ballistic properties, and temperature.

Rocket propellants may use polymeric binders like polysulfides, polyurethanes, and polybutadienes in place of the nitrocellulose. Rockets do not use single base propellants because of their low energy and poor combustion. Composites using the plastic binder with an inorganic oxidizer like ammonium perchlorate and a combustible metal fuel like aluminum are usually used. Plasticizers, extenders, rate of burn catalysts and other additives are included in the formulas. The rocket formulas are not used in guns because they erode the gun barrels and leave behind too much residue inside the barrel to be practicable.

Some explosives alter the properties by themselves such as

1. Mixing 10-15% nitroguanidine with 85-90% pyrocellulose. When colloidized in ether-alcohol it can be extruded through dies and produces a flashless powder.
2. PETN is insoluble in Nitrocellulose colloids but can still be mixed in to yield a hotter and more brisant explosive powder.

## History, Design, and Manufacture of Explosives

### Single Base Powder Manufacture/ Solvent Extrusion Batch Process

The earliest mass manufacture of **pyrocellulose** proceeded generally as follows.

1. Pulped pyrocellulose of 25% moisture is squeezed in a press at app. 250# per square inch for several seconds. The pressure is released and alcohol is pumped into the cavity and is then pressed into the pyrocellulose mass at about 3500 PSI. The alcohol and pyrocellulose are added here at a 1:1 ratio. A cylinder shaped block is produced that is saturated with the correct amount of alcohol to colloid the pyrocellulose. The block is placed into a vulcanized fiber canister and covered with a lid to prevent the loss of solvent to evaporation.

2. The compressed block is broken up by hand or with wooden spatulas in the mixer. These mixers are similar to double arm bread dough machines used in bakeries to knead the material. The mixer is jacketed so cool water can be pumped through continuously to maintain the low temperature of the batch. Diphenylamine is mixed into ether so it represents 1% of the weight of the final product. The mixed ether (at twice the weight of the alcohol) is added rapidly and mixed in thoroughly at high speed. The final mass looks like churned brown sugar that you can squeeze in your fingers like putty, making thin films or colloids.

3. The loose mass is then re-pressed in a "preliminary" block press at 3500 PSI. The formed block is then placed in a "macaroni" press where it is pressed through -

1-12 mesh steel plate screen  
2-24 mesh steel plates screens  
1-36 mesh steel plates screen  
and finally through a brass plate with the macaroni perforations at 3000-3500 PSI.

These macaroni pieces then drop directly into a cylinder where it is squeezed to the right size for the "graining" press. This cylinder is called a final blocking press where the product is pressed at 3,500 PSI for 1-2 minutes and completes the colloid.

This final pyrocellulose block is translucent, amber colored, dense, elastic and very tough.

4. This colloid block is forced through the dies of a hydraulic press to form single and multiple perforated tubes. These dies have centrally fixed steel wires, one for the single perforation and seven for the multiperforation tubes. The mass is forced into the dies at 2500-3800 PSI and emerge in the form of a tube with the desired perforations. The press head may contain up to 36 dies to produce small caliber (diameter) ammunition. A single die would be used to make the propellant powder tubes for 16 inch guns.

## History, Design, and Manufacture of Explosives

The resulting perforated rope or cord is passed through troughs as it is pushed out the press into rotary cutters which cut it into short cylinders of 2-2.5 times the diameter for direct use in the intended guns or munitions. It is also coiled up into fiber canisters and taken to other rooms for custom cutting.

5. The final green powder contains much of the ether-alcohol solvent which is removed by placing it in drying ovens with circulated air heated to 55-65 degrees C forced through it. This air picks up the evaporating alcohol and ether and condenses it in refrigerated receiving tanks. The air is then reheated and recycled through the powder. This process requires attention and patience because the powder can form a skin on its surface during drying that resembles drying glue and it prevents the escape of the solvent.

Recovery of the solvent is improved by scrubbing the air after refrigeration with cresol or other liquid to recover leftover ether and it is then distilled for reuse.

6. The material is then "water dried" by soaking the powder in hot water (65 degrees C) which causes tiny pores and cracks. This allows the remaining alcohol and ether to dissolve directly into the water which then evaporates back out of the water. When the solvent is reduced to required levels (the time required varies with the size of the powder), the grains are sent to a continuous dryer and dried at 55-65 degrees C.

The final solvent in the product is 3-7.5% depending on the diameter of the grain "web" and has .9-1.4% moisture in a surface coating and filling the pores and cracks. This amount of water is important because it actually provides stability to the finish product by inhibiting further moisture absorption and inhibiting evaporation, both of which can cause deterioration of the powder. This effect was so important that the French soaked their powders for several days in hot water before drying.

The final powder for small munitions is usually coated with graphite to prevent moisture changes and static electricity (it conducts electricity away instead of letting it build up). It also makes it flow easier which improves its loading characteristics. The final powder is blended into uniform sizes so the final ballistic characteristics are also uniform. Its easy to blend small grains, however, strips, cords and tubes are difficult or impossible to blend. The finished product is placed in airtight boxes weighing 100-150# each.

## History, Design, and Manufacture of Explosives

Modern improvements on this basic process include-

Adding ballistic modifiers, stabilizers, and liquid plasticizers as desired during the mixing in the water jacketed bread dough mixers (step 2).

Using an inert gas such as CO<sub>2</sub> or Nitrogen to "purge" the press chambers of the vertical block press before adding the powder (step 3) to avoid explosive mixtures of air and solvent.

Allowances for shrinkage during drying is made with each size of munitions in the die design.

During the ramming of the material through the extruder dies, care is taken to avoid and exclude explosive air and solvent mixtures by adequate ventilation (step 4)

### Continuous Solvent Extrusion Process (single base propellants)

The newer continuous processes for making solvent based artillery propellants allow manufacturers a considerable reduction in labor, air and water pollution and explosive hazards.

The main differences of these processes are -

1. **Thermal dehydration:** by placing the received water soaked nitrocellulose on a continuous vacuum belt filter where it is dried under vacuum followed by direct infusion of hot air at 80 degrees C. This effectively reduces the moisture to 2%.

2. **Compounding:** which is a continuous weigh belt that receives alcohol wet nitrocellulose from a surge feeder and moves it to a compounder. While on the belt, other ingredients are metered and added automatically. This forms a loosely mixed paste that is fed down the conveyer and into a heavy duty reciprocating screw mixer that maintains the desired hot temperature and that thoroughly works and mixes the mass into a paste. The paste is forced past pins and out through a die plate, cut into small pellets, and continuously fed to water jacketed screw extruders.

As the material comes out of multiple dies, the strands are cooled to assist cutting in an adjustable roll cutter.

3. **Solvent recovery:** The cut grains are screened to remove clusters and group in uniform sizes. The pellets are then treated with hot inert gas which is distilled, and then soaked in hot water which is managed as previously described, and then air dried to reduce moisture from 12 to .8%.

# History, Design, and Manufacture of Explosives

## Solventless Extrusion Process

This process is mainly used for making double based rocket propellant grains with web thicknesses of 1.35-2 cm, for thin sheet mortar (M8) propellant, and some artillery propellants in Europe.

1. Explosive and non-explosive liquid plasticizers and water insoluble materials are mixed into nitrocellulose suspended in a slurry of hot water.
2. The water is vacuum filtered or centrifuged, and the wet mass is partially dried by various means.
3. The mass is then passed through heated rolls to completely mix the colloid into sheets of uniform propellant, and dried to .8% moisture
4. These sheets are then cut and rolled into scrolls for feeding into the extruder which produces the propellant grains. Sometimes the sheets are used as a sheet propellant directly, or cut up and used as flake propellant.

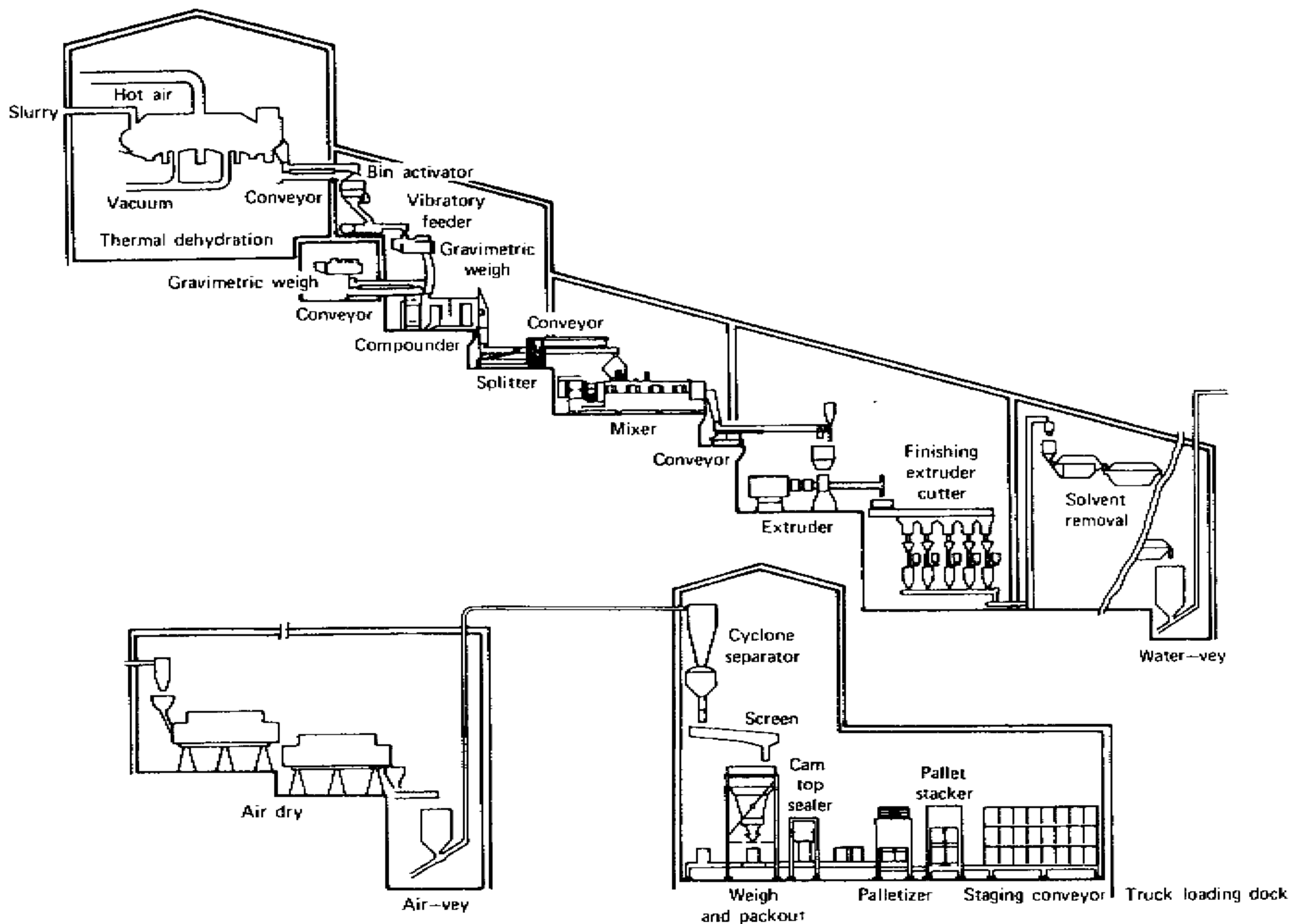

Continuous process for solvent-extruded single-base propellant (automated single base line).

## History, Design, and Manufacture of Explosives

**Nitrocellulose cast propellants** may also be made by first making small grain propellant powder by the above described solvent extrusion method. This casting powder is then mixed with a fluid plasticizer that fills the air spaces between the granules and diffuses into the grains. This causes a swelling of the grains and a coalescing of the granules into a single monolithic mass. The plasticizer is usually a mix of an explosive liquid and an inert or combustible liquid or gel which does not chemically react with the nitrocellulose.

**Polymer based cast propellants** are made the same way as the nitrocellulose cast propellants except that polymeric (plastic) binders are used. Metal fuel and other solid additives and oxidizers may be used other than nitrocellulose.

### Smokeless Powder and Propellant Additives

**Stabilizers** may be added to prevent the decomposition of nitrocellulose. When exposed to air, nitrocellulose produces nitrous and nitric acids that speed further decomposition. When stored in open air in cool temperatures, this decomposition is very slow and nearly impossible to measure in the short term. When temperatures rise, the decomposition rate increases dramatically and becomes measurable.

If the acids are removed during processing, neutralized, or prevented from forming, then the rate of decomposition, even at high temperatures, proceeds almost imperceptibly.

Substances can be added to nitrocellulose which reacts with the acids to remove or neutralize them. These substances must not react with the explosive nitrocellulose, and the reaction products it produces cannot react with the explosive materials as well. In the early 1900's amyl alcohol was used by France to stabilize its nitrocellulose. The explosion of the magazines and sinking of the battleships Jena in 1907 and Liberte in 1911 was attributed to the decomposition and resulting spontaneous combustion of the stored nitrocellulose powders.

The powders became unstable because the amyl alcohol produced reaction products that converted the alcohol to nitrous and nitric esters that broke down, produced red fumes, and yielded valerianic acid. The presence of this bad smelling acid was used as a sign that the stored explosives had become unstable.

Aniline was also used in early stabilizer formulations, but it too formed Nitro compounds that attacked nitrocellulose and was discontinued.

As we described earlier, the use of diphenylamine was found to be effective, and by 1909 it was used worldwide in smokeless powders and is still being used today.

## History, Design, and Manufacture of Explosives

An antacid such as powdered limestone or chalk (calcium carbonate) is used as a stabilizer in dynamite. Urea is used in celluloid and dynamite because it reacts with nitrous acid forming harmless CO<sub>2</sub> and Nitrogen gas and this prevents the acids further decomposing the explosive. When its use was attempted in nitrocellulose, the gases broke up the uniformity of the colloid and, although it would still detonate, the rate of burning was affected which altered the actual ballistic course of the shells that it propelled. The small gas bubbles were welcomed in the celluloid application because they caused it to have a whiter appearance which the customers preferred (it prevented the appearance of aging or yellowing).

Various materials have been tested for their ability to stabilize nitrocellulose. These include

Nitrogen Dioxide: which speeds decomposition

Pyridine: which not only sped up decomposition, at 2-3% of the formula, it caused detonation when heated to 110 degrees C.

Tetryl: which being an explosive was examined for its potential to add power and stabilize the explosive. It turned out to be very unstable.

Trinitronaphthalene: at 10% of the formula produced stability roughly equal to that of 2% diphenylamine.

Diphenylnitrosamine: is an excellent stabilizer at ordinary temperatures, but decomposes itself at 110 degrees C.

[It is desired to be able to store explosives in magazines without detonators, and formulas are devised so that small fires will not easily ignite the main explosive charges stored in the magazines. This is also why you do not store detonators, primers and initiators in the same magazine as the main charges and propellants.]

Carbazol: stabilizes well at high temperatures, but does poorly at room temperatures.

Diphenylamine: while the best overall stabilizer at 1-2% produces unstable nitrocellulose if added at 10%. Diphenylamine reacts with the decomposition products of nitrocellulose (which always form in tiny amounts due to aging and heat) to form Diphenylnitrosamine which we have already mentioned is an excellent stabilizer by itself. Under further nitration from the decomposition acids, this forms *p*-nitrosodiphenylamine, which in turns reacts further to form 2,4'- and 4,4'-dinitridiphenylamine. Both of these on further reaction with more Nitro decomposition products form 2,4,4'-trinitrodiphenylamine which is the final form that can be nitrated.

## History, Design, and Manufacture of Explosives

Nitrocellulose is hygroscopic and its ability to absorb moisture can be influenced by additives. The amount of moisture in the powders is important because it affects the ballistic properties of shells fired with it. The following chart shows the effects of moisture from the open air on nitrocellulose, on barrel pressure and velocity.

Hours left open	External moisture	Velocity ft/sec	Pressure #/sq.in.
0	1.02%	1,706	31,100
24	1.15%	1,699	31,236
48	1.4 %	1,685	30,671
72	1.47%	1680	29,636
96	1.57%	1,669	28,935

When Nitrocellulose is colloided with nitroglycerin without using a solvent, it is not hygroscopic, even in humid conditions. Colloiding with ether-alcohol causes moisture absorption because the alcohol-ether itself is hygroscopic and the residual solvent in the product will draw moisture. In the water dried powder, the surface solvents are mostly displaced or removed by the water so the surface shows little hygroscopicity while the interior is cut off by the "skin" covering the powder so it draws little moisture.

Coatings are often added or surface layers altered so they will repel moisture or seal the interior off from atmospheric influences. These have include graphite, lead stearate, and wax.

The aromatic Nitro compounds discussed in the next chapter have a considerable effect on reducing moisture absorption, and since they are explosive solvents of their own right, they add to the explosive power of the powders.

Non-hygroscopic smokeless powder can also be made by using guncotton in place of all or part of the nitrocellulose, and gelatinizing it with non-explosive solvents (described shortly).

**Rate of Burning** can be controlled by the shape of the propellant. Strips, flakes and tubes of powder present a burning surface that is nearly constant from start to finish if the shapes are longer and thinner. By adding multiperforations from the wire in the dies described earlier, the burning surface increases as the burning proceeds. This results in a gas whose production accelerates and this results in a greater velocity of the bullet or shell that is being projected from the barrel.

Progressive burning ballistite (high Velocity) can be made by

1. Forming a central slab or strip made of 50% soluble nitrocellulose made without volatile solvent and 50% nitroglycerin. This slab burns at about 3,000 degrees.
2. An outer layer made of strips formed by a mix of 50% soluble nitrocellulose and 50% crystalline solid dinitrotoluene made without volatile solvent. This burns at about 1,500 degrees.



## History, Design, and Manufacture of Explosives

3. These material are pressed between warm rollers to the desired thickness and then combined by pressing in their respective layers between the warm rollers again as a laminate.

Flakes or single perforated short grains or cylinders can be made progressive burning by

1. treating the grains with a gelatinizing agent as follows
2. treating nitrocellulose with a non-volatile, non-explosive solvent, dissolved in benzene or acetone
3. Tumbling the grains and the treated nitrocellulose together in a sweetie barrel while heating to evaporate off the solvent.

This material is called a "deterrent" or "moderant" and is applied as a coating.

During WW1, *sym*-dimethyldiphenylurea was used as a deterrent for high velocity ammunition and was called "centralite". The ethyl analog, called diethyldiphenylurea was an improvement over the methyl form and the ethyl version was called Centralite #1. The methyl form Centralite #2. The butyl form produces better nitrocellulose gelatin than either of these and is used more frequently.

Other modern deterrents include dibutyl phthalate, and dinitrotoluene (DNT) which are applied to the surface in small gun propellants to force more progressive burning. [ The surface areas are forced to burn more slowly ].

Additives such as lead acetyl salicylate, lead stearate, and lead stannate at 1-2% of the formula will increase the burning rates and are used in some rocket propellant formulas.

Gun and rocket propellants as we have seen, normally burn in parallel layers so that the surface recedes (burns up) in all directions from the original surface. As grains increase in surface area during burning, they burn progressively and increase in air volume produced and pressure.

The grain shapes and castings on the following page demonstrate the effect of the burning cross section on the rate of burning. The first set are artillery propellants. The second set are rocket propellants.

# History, Design, and Manufacture of Explosives

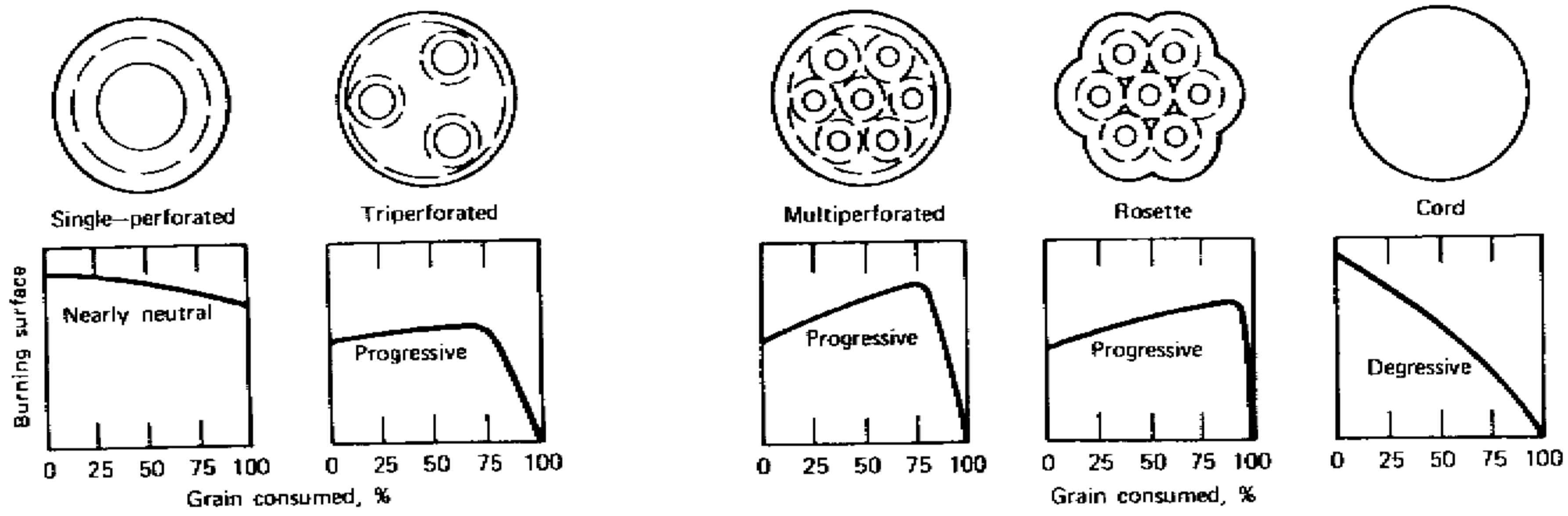

(a)

Effect of grain shape on (a) surface exposed during burning of gun propellants, and (b) time traces of rocket propellants. To convert kPa to psi, multiply by 0.145.

A  
Propellant cross-section

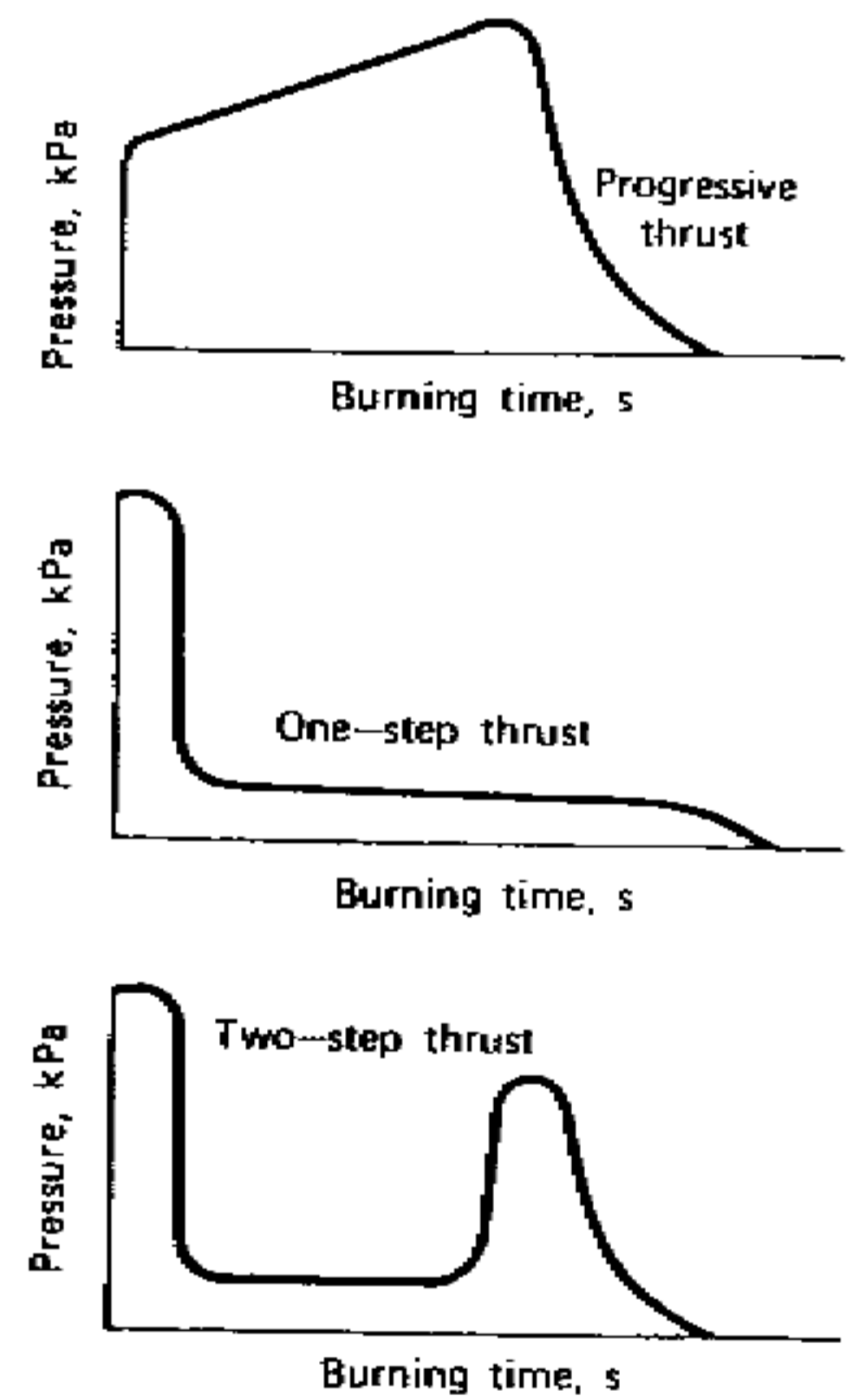
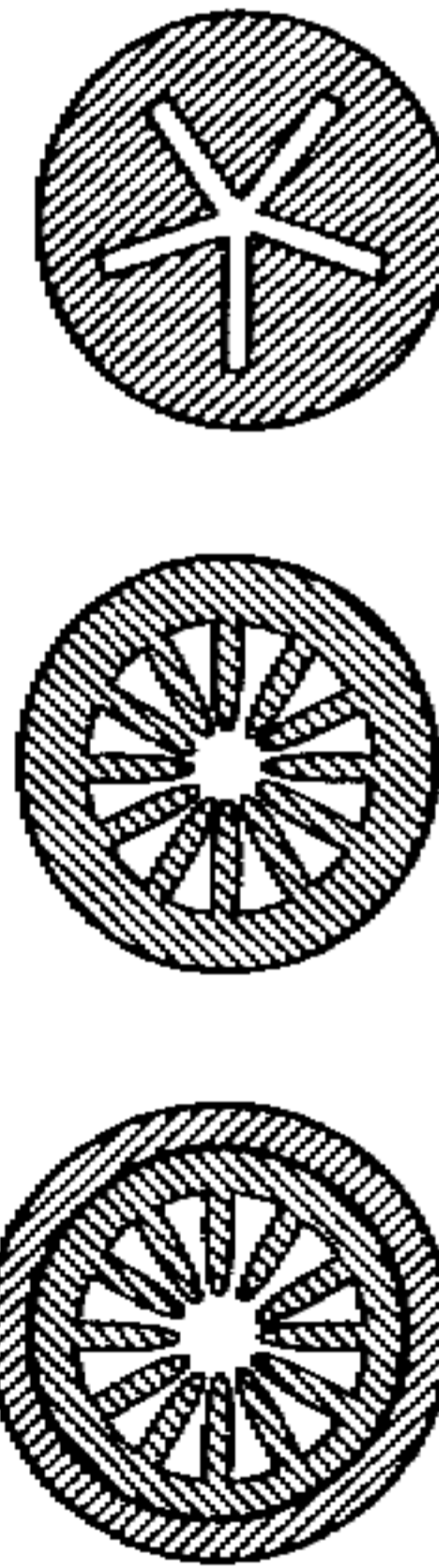
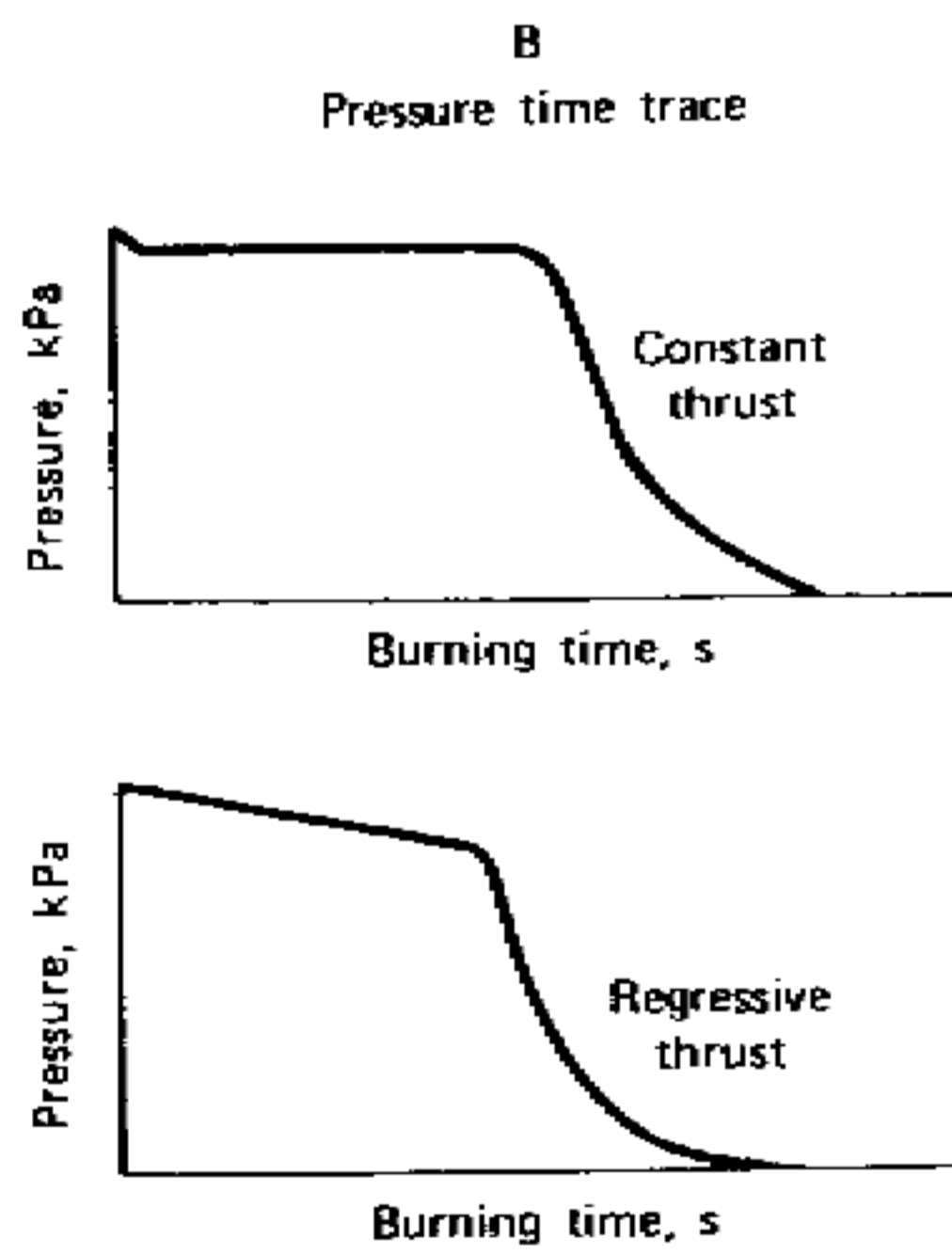
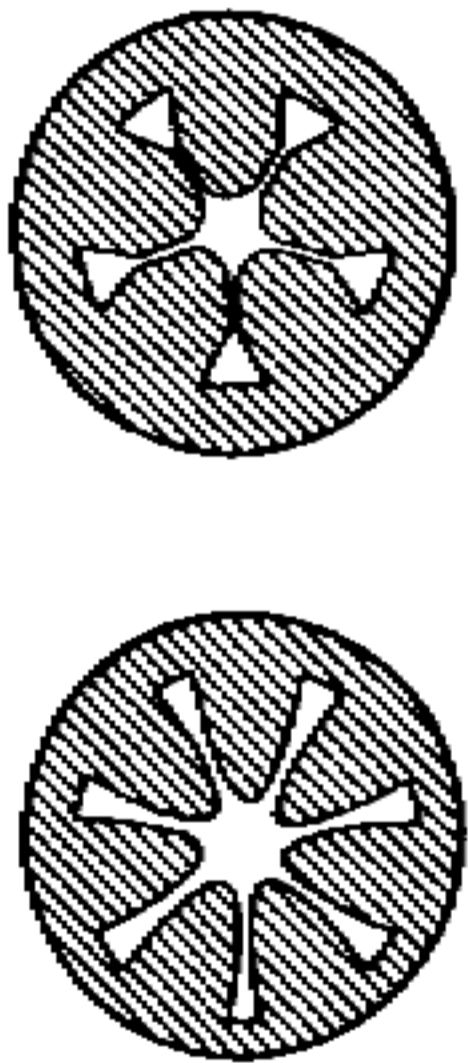

(b)

## History, Design, and Manufacture of Explosives

**Gelatinizing** agents have many uses in double base and nitrocellulose powders.

- They act to reduce powder flash
- They slow down the rate of powder burn
- They suppress the uptake of moisture
- They reduce the amount of volatile solvent needed for nitrocellulose powders
- They eliminate the need for volatile solvent completely in double base powders

The centralites described earlier, in addition to the above properties are also good stabilizers.

There are many gelatinizing agents used to gelatinize nitrocellulose and the patents number in the thousands. The amount of agent needed to complete (100%) the gelatinizing of nitrocellulose depends on its form - soluble or insoluble. Insoluble nitrocellulose usually takes substantially more agent to complete gelatinization.

Different chemical groups including esters, amides, urea derivatives, halogen compounds, ketones, and alcohols have been tested as gelatinizing agents.

Gelatinizing agents for insoluble nitrocellulose and the amounts needed to complete 100% of the gelatinization in 95% alcohol include

Ethyl Sebecate	320 parts
Dimethylphenyl-o-tolyurea	260
Ethyl Succinate	400
Ethyl phthalate	360
Triphenyl phosphate	400
Ethyl malonate	400 incomplete
Ethyl oxalate	400 incomplete

## History, Design, and Manufacture of Explosives

Soluble nitrocellulose requires much less material to gelatinize its 100% of its mass

Ethyl Sebecate	65 parts
Dimethylphenyl-o-tolylurea	65
Dimethyldiphenylurea	80
Ethyl Succinate	90
Ethyl phthalate	95
Ethyl Citrate	90
Benzyl Benzoate	90
Ethyl malonate	90 incompletely
Ethyl Oxalate	90 more incompletely
Ethyl stearate	90 incompletely
Ethyl acetoacetate	90 partial

If you use different solvents to gelatinize the nitrocellulose, the amounts of agent to complete the gelatinization changes. As a general rule, Benzene is most effective followed by Alcohol, and finally Ligroin [Ligroin is a flammable solvent distilled from petroleum].

Parts necessary to gelatinize 100 parts of pyrocellulose in the following solvents

	<u>Benzene</u>	<u>Alcohol</u>	<u>Ligroin</u>
<i>Sym</i> -dimethylurea	70	60	
<i>Sym</i> -diethylurea	50	50	
Tetramethylurea		80	
Triphenylurea	35		
<i>a,a</i> -diphenyl- <i>p</i> -tolylurea	40		
Tetraphenylurea	30	No action	
Ethyltriphenylurea		80	
<i>Sym</i> -dimethyldiphenylurea	25	70	
<i>Sym</i> -diethyldiphenylurea	30	70	
<i>Sym-di-n</i> -butyldiphenylurea	20	60	
<i>Unsym</i> -dimethyldiphenylurea		60	
Carbamic acid ethyl ester	80	140	
Methylcarbamic acid ethyl ester	60	90	
Ethylcarbamic acid ester	60	90	
Phenylcarbamic acid ethyl ester	90	20	
Diphenylcarbamic acid phenyl ester	70	80	
Methyl sebecate	70	80	105
Ethyl sebecate	50	80	90
Iso-amyl sebecate	95	70	90
Methyl phthalate	70	95	115
Ethyl phthalate	50	95	100
Iso-amyl phthalate	50	95	80
DNX oil	130	120	330
Trinitrotoluene	300		

## History, Design, and Manufacture of Explosives

Many other materials have been tested that produce gelatinization under a wide range of conditions and completeness.

**Flash suppression** is important because the flash of the guns both large and small allows enemy units to locate the firers position and produce accurate counterbattery fire. This can be a serious problem at night where the discharge of 12" guns can be seen 30 miles away. When powder is burned during firing, hot gases exit the end of the gun barrel with some of the gas still combustible and these gasses catch the air "on fire" by providing heat and combustible to mix with the air. The fire sometimes extends to half a football field in length in the old battleship guns of WW2.

To suppress flash in nitrocellulose and nitrocellulose-nitroglycerin powder, there are a number of additives and special formulas that have been used. These include

1. Adding salts to lower the temperature of the gas leaving the barrel. These include

Added in a bag placed on top of the charge

- Potassium Chloride
- Potassium Hydrogen Tartarate
- Powdered Tin
- Black Powder
- Potassium Nitrate (4 parts) and Crystalline DNT (1 part)

Mixed into the powder

- Starch
- Hydrocellulose
- Anthracene
- Diethyldiphenylurea
- Dibutyl Phthalate
- The aromatic Nitro compounds (next chapter)

2. Adding carbonaceous material to the powder. This causes more and cooler gas to be formed which reduces flash

- Oxinilide
- Hydrocellulose
- Charcoal

## History, Design, and Manufacture of Explosives

3. Using or adding a cool burning explosive such as

Ammonium Nitrate  
Guanidine Nitrate  
Nitroguanidine

4. Changing the granule shape to affect rate of burning

When flash suppressing agents are added in a bag on top of the main charge, they are usually powdered or pelleted in form and weigh from .1# to 1# depending on the gun size. Guns as large as 155mm have been satisfactorily suppressed.

Two of the patented, smokeless, flashless, nonhygroscopic powders was made with the following formulas

Nitrocellulose	76-79%	Soluble Nitrocellulose	30%
Dinitrotoluene	21-24%	Insoluble Nitrocellulose	30%
Diphenylamine	1%	DNT	15%
		Nitroglycerin	25%

The application of modern processes to the particular propellant used today are

Solvent Extrusion	Cannon Fast Burning Rockets Casting Powder Ignition Powder Rifles, Small caliber weapons, Expulsion Charges
Solvent Emulsion	Rifles and Small caliber weapons
Solventless Extrusion	Small Rockets Cannon
Solventless Rolling	Mortars
Casting	Small and Large Rockets

## History, Design, and Manufacture of Explosives

The US Army provides the following instructions for produced nitrocellulose explosives in the field from common materials

### Improvised Nitrocellulose Explosive

An acid type explosive can be made from Nitric Acid and white paper or cotton cloth. This explosive can be detonated with a commercial #8 or any military blasting cap.

#### Material Required

Nitric Acid  
White unprinted, unsized paper  
Clean white cotton cloth  
Acid resistant container  
Aluminum foil or acid resistant material  
Protective gloves  
Blasting Cap  
Wax

#### Source

Chemical supply 90% (sp. gravity 1.48)  
Paper towels, napkins  
Clothing, sheets, etc.  
Wax coated pipe or can, ceramic, glass jar

#### Procedure

1. Put on gloves
2. Spread out a layer of paper or cloth on aluminum foil and sprinkle with nitric acid until thoroughly soaked. If aluminum foil is unavailable use an acid resistant material (glass, ceramic, or wood).

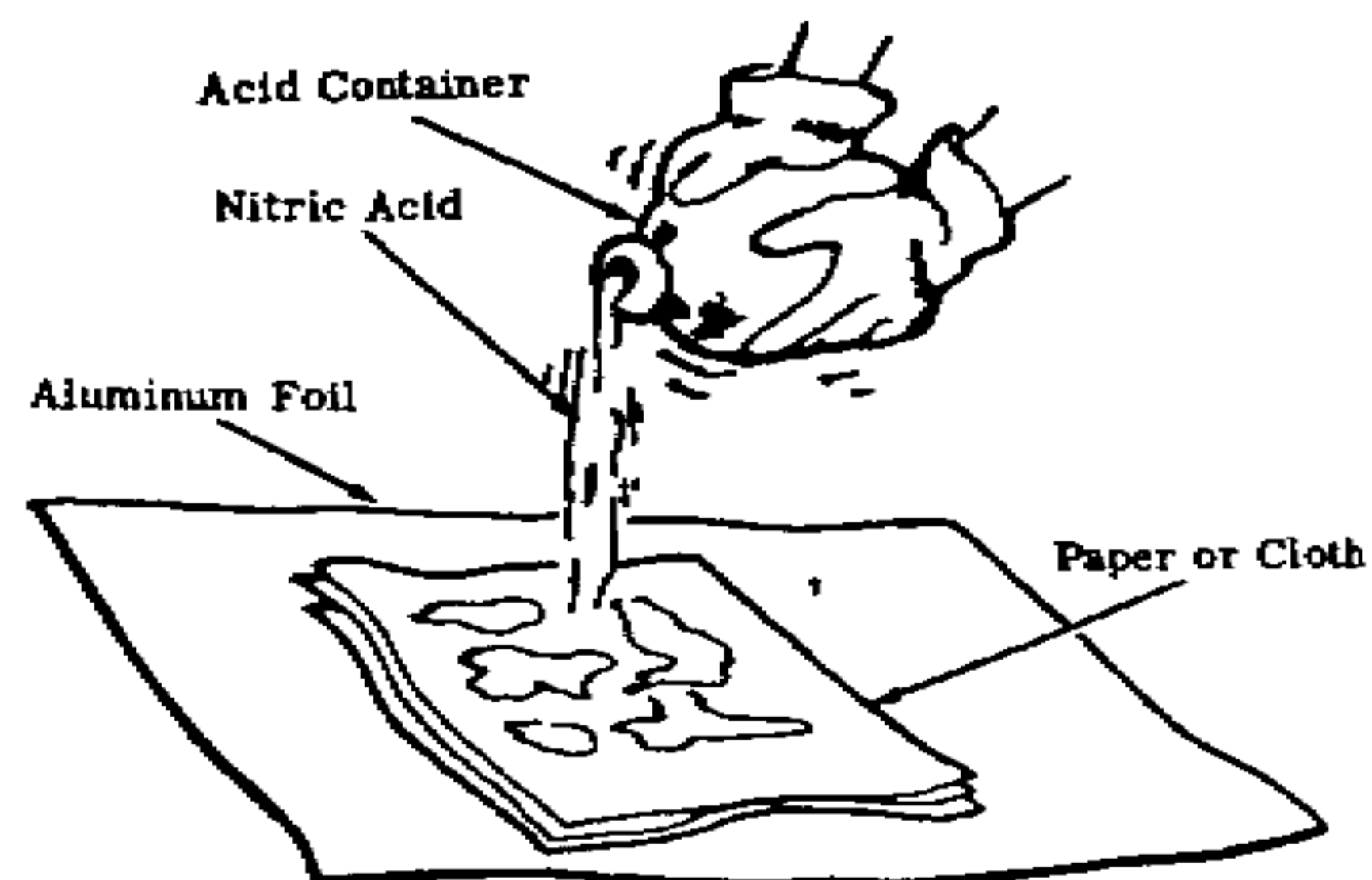

## History, Design, and Manufacture of Explosives

3. Place another layer of paper or cloth on top of the acid- soaked sheet and repeat step 2 above. Repeat as often as necessary.

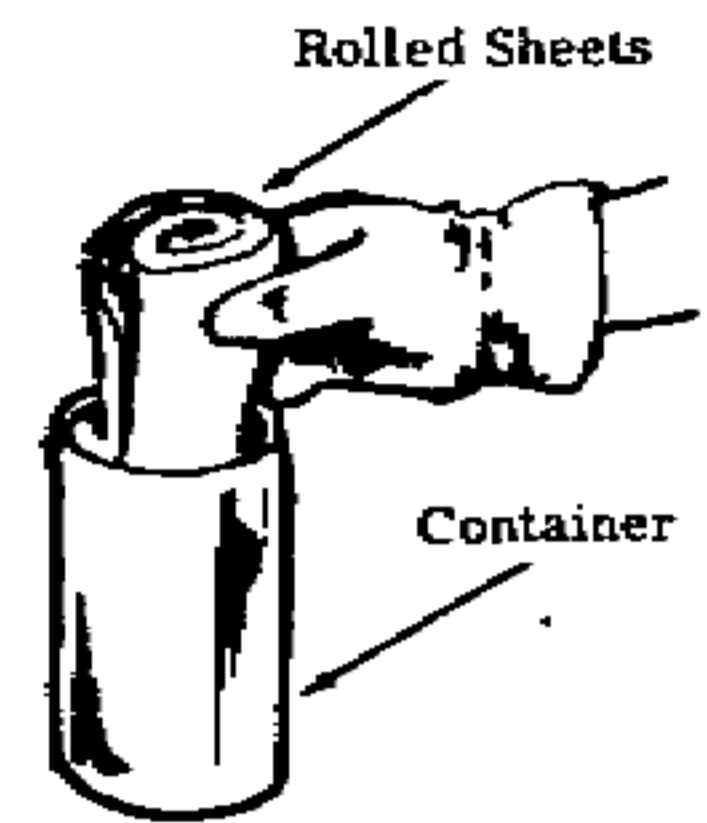
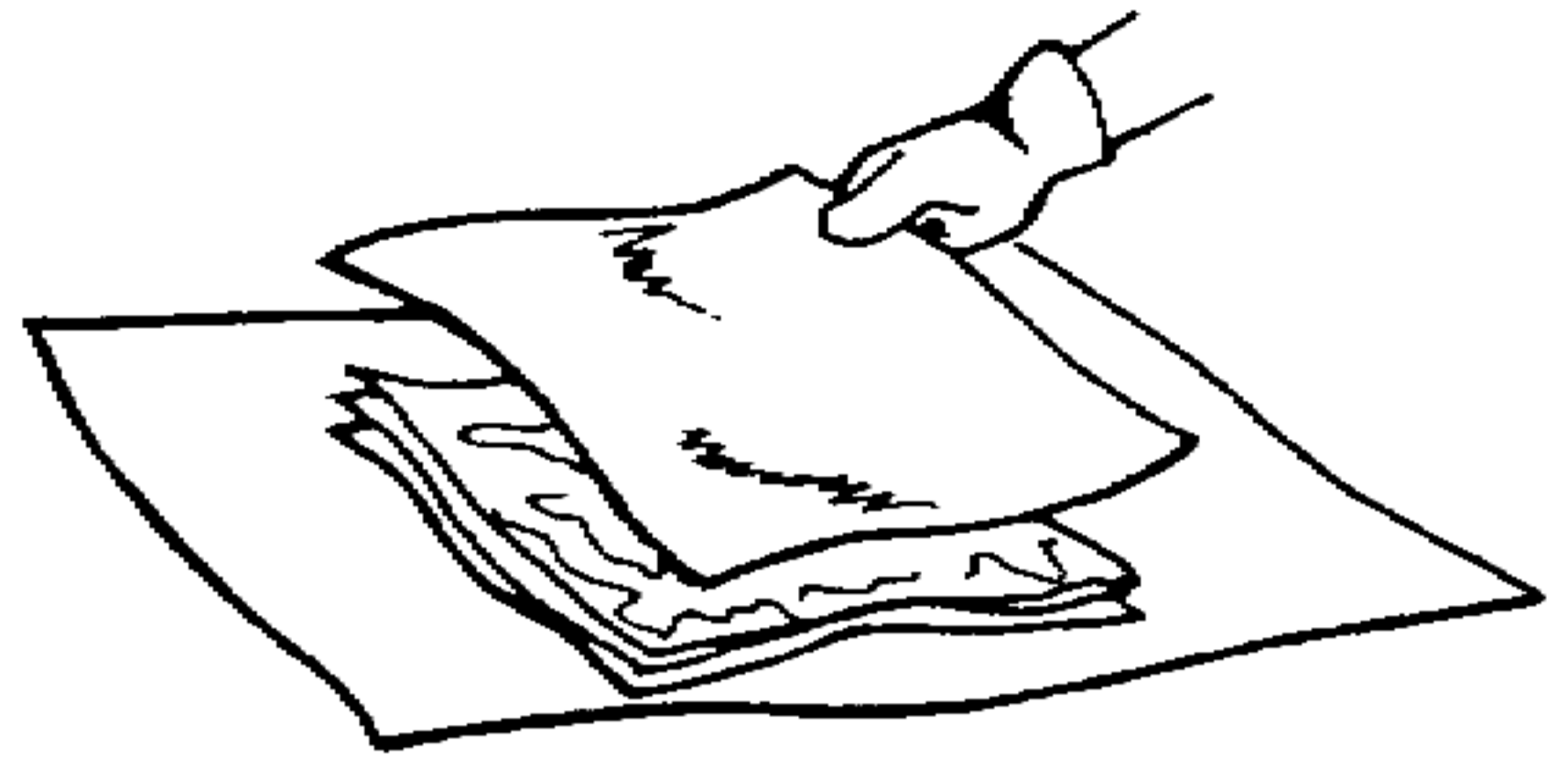

4. Roll up the aluminum foil containing the acid soaked sheets and insert the roll into the acid resistant container.

**Note:** If tray is used instead of foil, carefully roll up and move with wooden sticks or tongs.

5. Wax blasting cap.

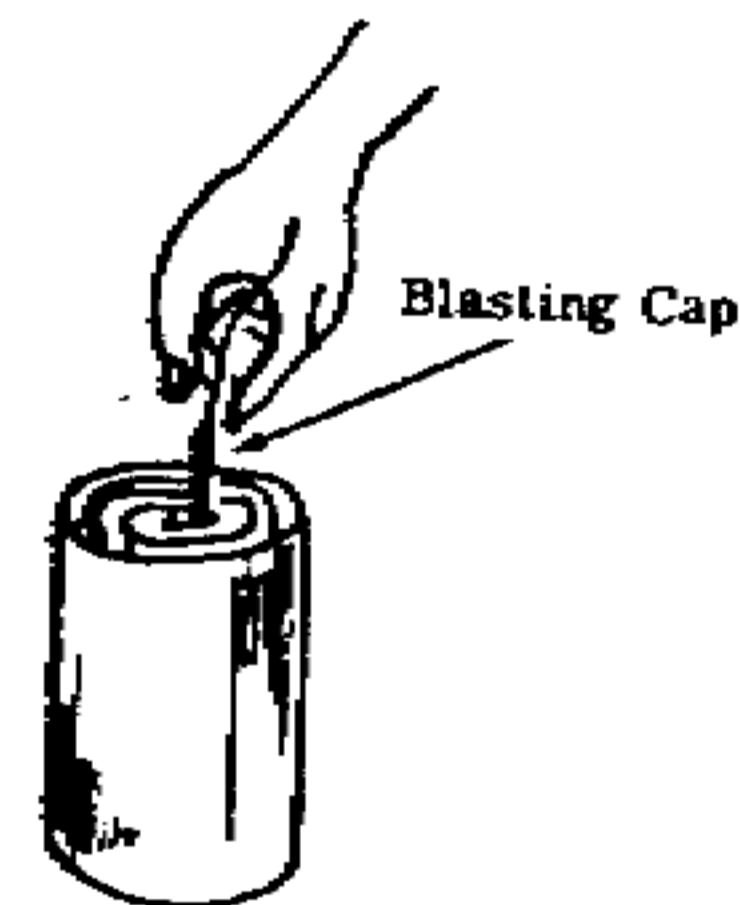

6. Insert the blasting cap in the center of the rolled sheets. Allow 5 minutes before detonating the explosive.



## History, Design, and Manufacture of Explosives

### Ball Powder

Ball grain powder, used mostly in small caliber weapons and primarily for shotguns, is spherical or flattened ellipses of grains resembling small balls.

It is manufactured as follows

1. Pulped nitrocellulose is supplied from the plant, or from obsolete granular propellant that is ground in a hammermill underwater to a powder.
2. Calcium carbonate, usually in the form of chalk, is added to the water (1-2%) to neutralize any free acid given off by the nitrocellulose.
3. The nitrocellulose solution is pumped into a still.
4. Diphenylamine is dissolved into a solution of ethyl acetate (diphenylamine drives the remaining acid in the nitrocellulose out into the water), this mix of which is then added to the nitrocellulose. Any other desired additives such as DNT or centralite are also added at this time.
5. The mix is heated to 70 degrees C and agitated for 30 minutes to form a heavy syrup or "lacquer" and to dissolve the nitrocellulose.
6. When the correct consistency is reached, starch or gum Arabic solution is added to form an emulsion of spherical nitrocellulose globules and prevents their coalescing into larger lumps.
7. Sodium sulfate is added to the water in the still. This causes the free water around the globules to have a different osmotic pressure than the water inside the globules.
8. The still is closed and the water is extracted. The mixture is agitated vigorously under pressure so the globules form the correct size.
9. The pressure is reduced and the ethyl acetate is distilled off and recovered. This must be done slowly to insure the grains are round. If done too quickly, they form teardrop shapes. By doing it slowly, it gives the solvent inside the grains time to reach the surface without affecting its shape.
10. Once the grains are cooled, they are transferred in a water slurry to another still where they are coated. This coating is an emulsion of nitroglycerin dissolved in toluene (or another explosive dissolved in a solvent in which the nitrocellulose is insoluble). The coating is mixed over the grains and the mix is distilled to remove the solvent. This leaves a coating of nitroglycerin or other explosive on the surface of the grains. This coating is usually applied up to a maximum of 15% of the total weight. A coating of centralite was sometimes placed over it. The grains are passed through sieves underwater to uniform sizes, and oversize material is passed through rollers to reduce the web diameter.

## History, Design, and Manufacture of Explosives

11. The material is dried, glazed with graphite, sized, and used in shotgun shells and small caliber rifles.

The chief advantage of this process is that it is done underwater until drying, and does not pose an explosion hazard until the final stages.

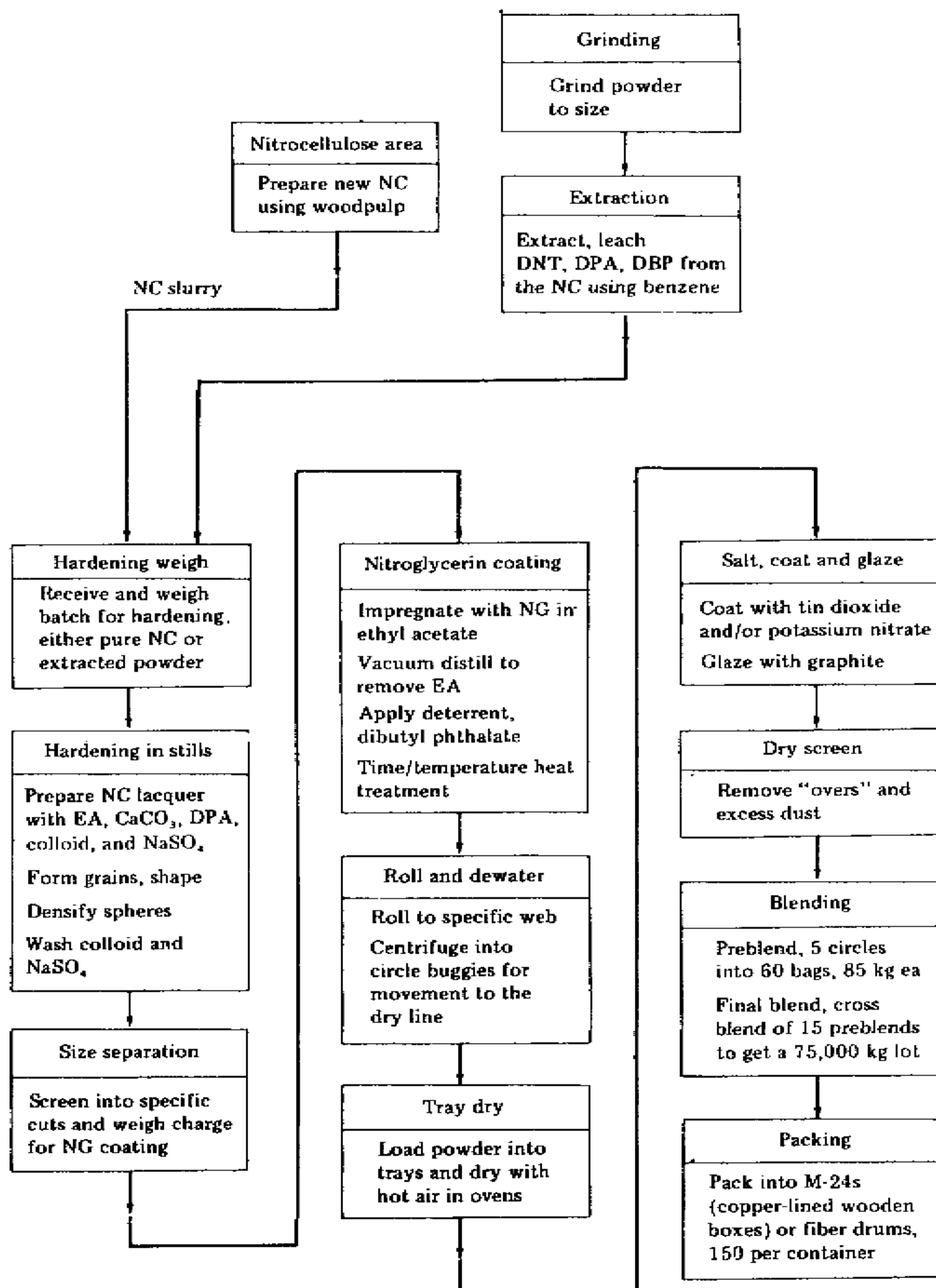

Ball powder batch process. NC = nitrocellulose, EA = ethyl acetate, DPA = diphenylamine, NG = nitroglycerine, DNT = dinitrotoluene, DBP = dibutylphthalate.

## History, Design, and Manufacture of Explosives

### U.S. Artillery and Gun Propellant Formulas (in %)

<b>Material</b>	<b>M1</b>	<b>M2</b>	<b>M5</b>	<b>M6</b>	<b>M8</b>	<b>M9</b>	<b>M10</b>	<b>M14</b>	<b>M15</b>
Nitrocellulose	85	77.5	82	87	52.2	57.8	98	90	20
N %	13.15	13.25	13.25	13.15	13.15	13.25	13.15	13.1	13.15
Nitroglycerin		19.5	15		43	40			19
Nitroguanidine									54.7
Ethyl Centralite		.6	.6		.6	.7			6
Diphenylamine	1			1			1	1	
2-nitrodiphenylamine									
Dinitrotoluene	10			10				8	
Dibutyl Phthalate	5			3	3			2	
Potassium Nitrate		.7	.7		1.2	1.5			
Barium Nitrate		1.4	1.4						
Potassium Sulfate	1			1			1		
Lead Carbonate	1								
Cryolite									.3
Graphite		.3	.3			.1	.1		
n-Butyl stearate									
Heat of Explosion	3140	4522	4354	3182	5192	5422	3936		3350
Burning rate at 20,000 psi in cm/s	7.6	12.7	14	8.4	17.8	23	11.4		10.2
<b>Material</b>	<b>M17</b>	<b>M26</b>	<b>M30</b>	<b>M31</b>	<b>Naco type 1</b>	<b>1MR</b>			
Nitrocellulose	22	67.5	28	20	93.6	100			
N %	13.15	13.15	12.6	12.6	12	13.15			
Nitroglycerin	21.5	25	22.5	19					
Nitroguanidine	54.7		47.7	54.7					
Ethyl Centralite	1.5	6	1.5		1.2				
Diphenylamine						.7			
2-nitrodiphenylamine				1.5					
Dinitrotoluene							8 (as a coating)		
Dibutyl Phthalate				4.5					
Potassium Nitrate		.75							
Barium Nitrate		.75							
Potassium Sulfate					1.2	1			
Lead Carbonate					1				
Cryolite	.3		.3	.3					
Graphite	.15								
n-Butyl stearate					3				
Heat of Explosion	4019	4082	4082	3370		3601			
Burning rate at 20,000 psi in cm/s	14	11.4	12.2	7.9					

## History, Design, and Manufacture of Explosives

### Current Use Nitrocellulose Propellant and Additives

<u>Material</u>	<u>Application or use</u>
Nitrocellulose	Explosive Binder
Nitroglycerin, Metriol Trinitrate, Diethylene glycol dinitrate	Plasticizers
Triethylene glycol dinitrate, Dinitrotoluene, Dimethyl, diethyl, or dibutyl phthalates	High explosive plasticizers
Triacetin	Fuel
Diphenylamine, diethyl centralite, 2-nitrodiphenylamine	Stabilizers
Lead salts- Lead stannate, lead stearate, lead salicylate	Ballistic modifiers
Carbon Black	Dye
Lead stearate, graphite, wax	Lubricants
Potassium sulfate, Potassium nitrate, Potassium-Aluminum Fluoride (cryolite)	Flash reducers
Ammonium Perchlorate, Ammonium Nitrate	Inorganic oxidizers
RDX, HMX, Nitroguanidine, other nitroamines	Organic oxidizers
Aluminum	Metallic fuels, catalysts
Lead Carbonate, Tin	Defouling Agents

## History, Design, and Manufacture of Explosives

### Cast Propellants

- After WW2, the US found that its nitrocellulose propellants were inadequate for use in large ballistic rockets and missiles. The new solutions involved the development of large casted propellants where the ingredients are

1. Mixed together
2. Cast into a mold
3. Cured into rigid forms

Some of these propellants have been cast as single forms of 15-20' in diameter, and 100-150' high and weighing up to 1,500 tons. The energy output of these propellants was increased dramatically over nitrocellulose by adding aluminum as the combustible fuel and high energy explosives like HMX as oxidizers (from the extra oxygen available during their detonation).

The development started at the California Institute of Technology in 1942 with new formulas containing 25% asphalt and 75% potassium perchlorate. With the invention of the new polymers, a family of elastomer-based propellants was soon born using 90% crystalline explosive ingredients and 10% plastic binders.

The polysulfides were the first ones developed in the late 1940's and early 1950's. These were cured by adding compounds like p-quinone-dioxime, and sulfur to oxidize the polymer. Dibutyl phthalate was added as a plasticizer, magnesium oxide to provide thermal stability, ferrocene and iron oxide as burning rate catalysts, and copper phthalocyanine as a burning rate suppressor.

In the mid 1950's, the polyurethanes, manufactured from long chain polyalcohols became available in a wide range of molecular weights. By adding diisocyanates to form stable polymers, they could be used in large case bonded rocket motors. Ferric acetyl-acetonate was added as a cure catalyst, dioctyl adipate and dioctyl sebacate as plasticizers, sodium lauryl sulfate to inhibit foam formation, carbon black as a radiant heat diffuser, metal oxides and copper chromite as ballistic modifiers, and magnesium oxide and phenyl-naphthylamine as stabilizers.

During high temperature storage and high humidity, the polyurethanes would begin to degrade with serious results. Several rocket explosions on the launching pads due to deterioration occurred and quality control as well as possible new polymers were intensely scrutinized.

By the late 1950's, acrylic acid and the liquid copolymer of butadiene were cured together by epoxides and/or polyfunctional imines to produce the first polybutadienes (PBAA). These were soon improved by making terpolymers of butadiene, acrylonitrile, and acrylic acid (PBAN). The PBAN's have been used extensively ever since for high performance rockets. Hundreds of new polymer based formulations have been developed and patented since then.

## History, Design, and Manufacture of Explosives

Nitrocellulose based cast propellants were developed as well during WW2. Small cylinders of "casting powder" grains are joined in a partial solution of casting solvent to form a single monolithic grain. Inorganic oxidizers and fuels were added, and lead stearate was incorporated to control the burning rate. A plasticizer (glyceryl triacetate) was added to improve the low temperature burning performance.

It was learned that rocket propellants could not contain cracks, pores or cavities so rigid quality standards were developed that involved X-ray and ultrasound inspections and repeated testing of the raw materials and final products. When the rocket formulas began to incorporate high energy explosives like HMX, ammonium perchlorate, and aluminum, more launch pad explosions occurred because the explosive force was so great that during ignition, parts of the casting could be blown apart and would break up the casting so it all burned and exploded at once. Or it would fly through the wall of the rocket resulting in the escape of gas out the side of the rocket and causing it to head in unpredictable directions.

Similar problem would occur in gun propellants as higher energy formulas were used to propel the shell to greater distances. Longer barrels and slower burning formulas were devised to achieve the greater distances. Because of this many of the gun propellants incorporated large amounts of nitroguanidine and RDX to lower the flame temperature and achieve high energy at the same time. This minimized the gun tube wear and muzzle flash.

Modern composite rockets use a variety of materials in their design for propellants. These find wide use in today's rocket artillery and missiles. A polymer binder holds materials in a plastic matrix and provides mechanical strength. These will be summarized in the following chart.

### Binders

Polysulfides

cured by oxidation reactions, low solids loading capacity

Polyurethanes

Polyethers

Polyesters

cured with isocyanates, medium solids loading capacity

Polybutadienes

Copolymer, butadiene  
and acrylic acid

cured with epoxies or aziridines, better loading capacity, less cure stability and mechanical properties

Terpolymers of butadiene,

Acrylic acid and acrylonitrile

superior properties and storability

## History, Design, and Manufacture of Explosives

Carboxy-terminated Polybutadiene	cured with epoxies or aziridines, very good solids loading capacity, good properties and performance
Hydroxy-terminated Polybutadiene	cured with diisocyanates, very good solids loading, properties, performance, and storability
<u>Oxidizers</u>	
Ammonium Perchlorate	Most common, high density, produces smoke in cold or humid conditions, burning rate can be varied
Ammonium Nitrate	Hygroscopic, and changes phases. Special use only Low burning rate, forms smokeless combustion products
RDX-HMX (High Energy Explosives)	High energy and density, smokeless, difficult for low burning rates
<u>Fuels</u>	
Aluminum	High density, most common. Smoky and produces corrosive combustion products
Metal hydrides	Very high impulse, low stability, low density, smoky
<u>Ballistic Modifiers</u>	
Metal oxides	Iron Oxide most commonly used
Ferrocene derivatives	Significant increase in burning rate
Various coolants	For low burning rate
<u>Physical Modifiers</u>	
Plasticizers	Improves processability and physical handling properties in low temperatures. Increases energy if nitrated. Can vaporize or migrate.
Bonding agents	Improves adhesion of binders to solids

## History, Design, and Manufacture of Explosives

The first step in making a high energy nitrocellulose cast propellant is to prepare a casting powder by conventional solvent extrusion. A typical formula mix would be-

30%	Nitrocellulose
10%	Plasticizer
30%	Solid Oxidizer
28%	Metallic Fuel
2%	Stabalizer

This powder is then mixed with a fluid plasticizer (33%) that diffuses into the powder and fills the interstices of the granules. The granules swell and coalesce into a single monolithic grain. The plasticizer is usually a mix of nitroglycerin or other explosive liquid and an inert fluid such as triacetin.

The final composition contains-

22%	Nitrocellulose
32%	Plasticizer
20%	Solid Oxidizer
20%	Fuel
2%	Stabalizer

This final mix will not directly bond to the wall of the rocket, so an adhesive resin is sprayed into the interior while the rocket motor is rotated and a small amount of the casting powder is sprayed on to form a liner. The liner is cured and the rocket is placed in a casting pit where the casting powder is poured directly into the liner while vibrating it to maximize the loading density.

The solvent plasticizer is pressurized and passed slowly upward (from the bottom) into the powder bed while it is being held stationary by a pressure plate on the top. It fills the spaces between the granules and swells the grains to form a single casting inside the rocket tube and this is cured at 45-60 C for as long as 2 weeks. The final casting should be a tough, pore free, sturdy structure.



## History, Design, and Manufacture of Explosives

### Nitrocellulose Cast Propellant Formulas

<u>Material</u>	<u>Low Energy</u>	<u>High Energy A</u>	<u>B</u>
Nitrocellulose (12.6% N)	59	20	22
Nitroglycerin	24	30	30
Triacetin	9	6	5
Dioctyl Phthalate	3		
Aluminum		20	21
HMX		11	
Stabalizer	2	2	2
Ammonium Perchlorate		11	20
Lead Stearate	2		
Burning Rate at 1,000 psi in cm/s	.65	1.4	2.0
Heat of Explosion	2,931	7,718	7,432

"Slurry Cast" propellants are manufactured in two types

Nitrocellulose based	(Nitrosols)
PVC based	(Plastisols)

The Nitrosols use microspheres of fine powdered nitrocellulose of 5-50  $\mu\text{m}$  in diameter made by a solution and graining process similar to that used for ball powder grains. These granules are more dense than normal and resist plasticization until cured at higher temperatures. The particles are dispersed under vacuum in a sigma blade mixer into an explosive based plasticizer like nitroglycerin, metriol trinitrate, or triethylene glycol dinitrate. These materials are premixed beforehand with the other formula ingredients. A powdered metal such as aluminum may be added during mixing followed by a solid oxidizer. While under vacuum and at a temperature of 40 C, the slurry is poured into a mold and cured at elevated temperatures to a solid grain.

#### Nitrasol Formulations

Nitrocellulose	15-30%
Pentaerythritol trinitrate (PETN)	0-50%
Ammonium Perchlorate	20-30%
Aluminum	15-20%
Liquid explosives & inert plasticizers	10-30%
Stabalizer	1-2%

## History, Design, and Manufacture of Explosives

To make plastisol, the dense spherical particles of PVC are mixed at 1:1 with a plasticizer like dibutyl sebacate or 2-ethylhexyladipate to form a creamy uniform mix. The slurry is then poured into the mold with the oxidizer, fuel, wetting agents, stabilizer, and rate accelerators and then heated to 150-180 C. The PVC dissolves into the plasticizers to form a gel that becomes a solid at low temperatures. These high viscosity mixes can be formed directly into grains by screw extruders which cure during the extruding itself.

### Plastisol Formulations

PVC	10%
Dibutyl sebacate	10%
Ammonium Perchlorate	65%
Aluminum	15%
Stabalizers, carbon black, etc	.5-2%

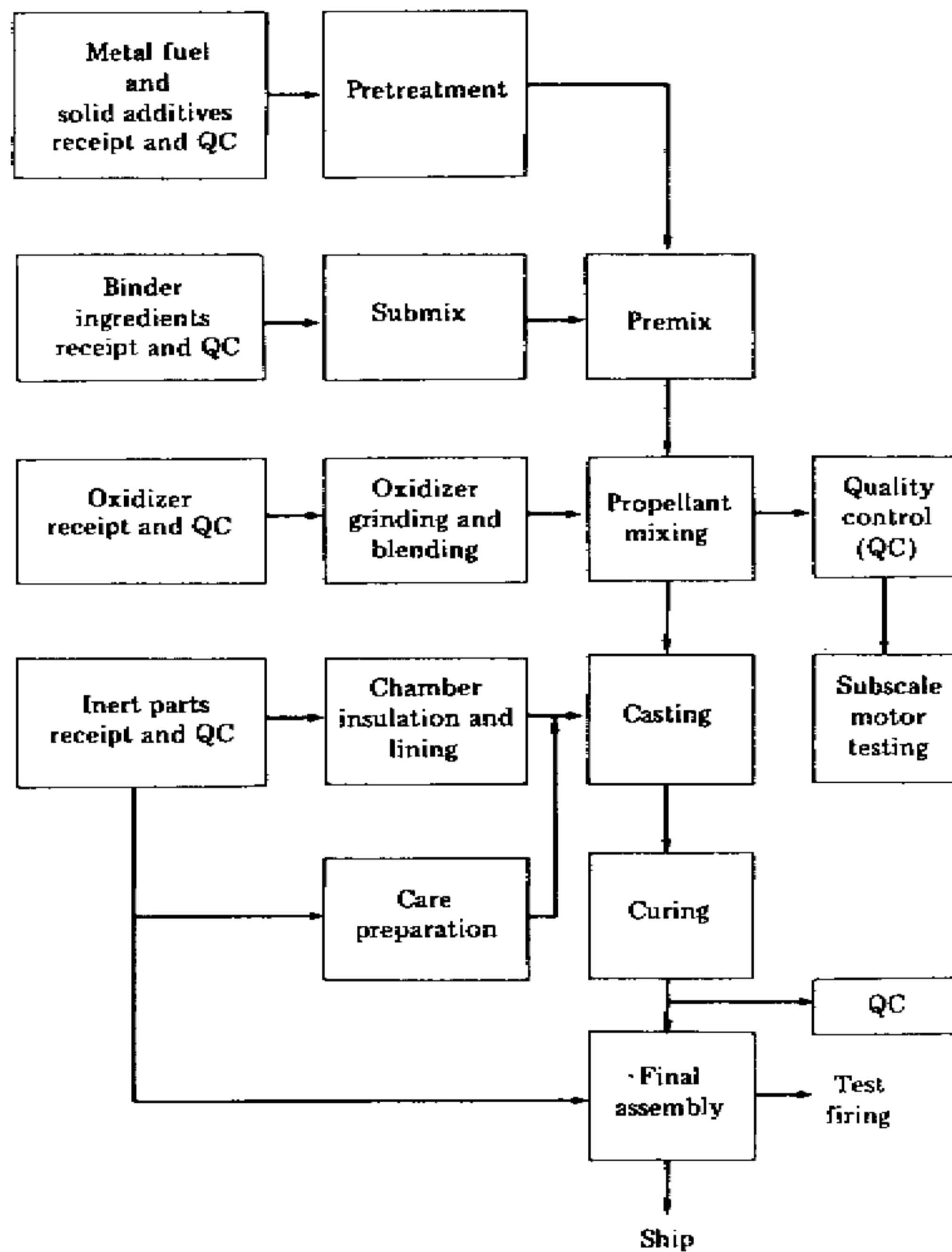

Batch process for cast-composite polymer-based propellants.

## History, Design, and Manufacture of Explosives

The other polymers which we mentioned earlier were also built into cast propellant formulas. The pouring into molds is similar to the methods already described, with the humidity being reduced to less than 40% during processing. It is critical that all the components be ground to a fine powder (like talcum powder) by various grinders and pulverizers. The final material should flow like water.

	<u>Propellant Type</u>						
	<u>Polysulfide</u>	<u>Polyurethane</u>	<u>CTPB</u>	<u>HTPB</u>	<u>PBAN</u>	<u>PBAA</u>	<u>Butadiene</u>
Ammonium Perchlorate	63	70	73	70	69	68	
Binder (above)	36	21	12	12	11	15	14
Magnesium Oxide	1						
Sulfur	.2						
Aluminum		8	15	18	15	16	
Other fuel		1					6
Dioctyl adipate					4		
Iron catalyst					1	1	
Ammonium Nitrate							80
Burning rate at 100 psi in cm/s	.9	.8	.98	.6	1.37	1.7	.3
Heat of Explosion		4,543	6,280	6,448	5,966		2,721

# History, Design, and Manufacture of Explosives

## Chapter 4

### Nitro Aromatics

The aromatics are a group of chemicals produced from petroleum and coal tar that mostly produce a strong and not unpleasant odor. Chemically, they are defined as a group of unsaturated cyclic hydrocarbons containing one or more rings. Most of these have a benzene with a 6 carbon ring containing 3 double bonds.

Nitroaromatic explosives are usually made by nitrating the aromatics three times to the "tri" nitro stage. This yields explosives containing three NO<sub>2</sub> groups. As a group, these are the most important and generally most powerful military explosives.

The **Aromatic Compounds** are derived from

1. **Coal:** which is subjected to distillation by heating in the absence of air.

This yields   Coke  
                  Light Oil  
                  Ammonia Liqueur  
                  Coke-oven gas  
                  Tar (about 120# per ton of coal)

One ton of **Tar** is then distilled to yield (WW2 recovery-Europe)

Light Oil	for 32# of benzene, 5# of toluene, and .6# of xylene
Middle Oil	for 40# of phenol and cresols, and 100# of naphthalene
Heavy Oil	for concentrated cresols and phenols
Green Oil	for 10-40# of anthracene
Pitch	1,200#

One ton of dry **coke oven tar** in the US (1980's) contains on average

Medium-Soft Pitch	1270#	Naphtha	19.4#
Benzene	2.4#	Naphthalene	176#
Toluene	.5#	methylnaphthalene	18#
o-xylene	.8#	acenaphthene	21#
m-xylene	1.4#	flourene	12.8#
ethylbenzene	.4#	anthracene	15#
styrene	.4#	phenanthrene	53#
phenol	12.2#	carbazole	12#
cresol (all)	20#	Tar bases	41#
xlenols	7.2#	Tar acids	16.6#

## History, Design, and Manufacture of Explosives

Since WW2, most of the aromatics now come from the fractional distillation of crude oil. Most of these are produced and sold by the major petroleum refiners for a wide range of chemical uses. Many of the aromatics have been nitrated for use as explosives or explosive additives and we will describe the major categories here.

When countries go to war, they try to maximize production of the aromatics so that they can be combined chemically with nitric acid to mass produce explosives. The most important of these has been toluene to produce trinitrotoluene (TNT). At the same time this is produced, large volumes of the other aromatics are produced, and as the prices of these drop with the increase of their supply, new processes were developed to convert these to useful military explosives.

The best example of this is benzene, which was converted to chlorobenzene, after which Dow corporation invented a way to convert it to aniline and phenol which produces "picric acid". In addition, the chlorobenzene can be nitrated to yield dinitrochlorobenzene which is easily converted to the explosives **picric acid**, **tetryl**, and others.

Several of the most powerful nitrated aromatics have been tested as follows

At .3 grams density per cubic centimeter (density of loading) they produced the following pressure in Kgs/sq. cm.

Trinitrobenzene	4,105
Trinitroaniline (picramide)	3,940
Trinitrophenol (picric acid)	3,865
Trinitrotoluene (TNT)	3,675
Tri-nitro-m-xylene	2,980
Trinitroresorcinol (styphnic acid)	2,840 (at a density of .25 grams/cu.cm.)
Trinitromesitylene	2,780
Trinitronaphthalene	2,670

All the nitrated aromatics are very poisonous by inhalation of their vapors when heated, by ingestion of tiny amounts, and by dermal eye or skin exposure. In fact, nitrobenzene is so deadly that small amounts spilled on clothing that was not immediately removed has killed the workers in the manufacturing plants. It has been considered for use as a chemical weapon because of these properties.

## History, Design, and Manufacture of Explosives

### Trinitrotoluene (TNT)

TNT is a dry, nonhygroscopic powder that can be stored indefinitely at room temperatures without deteriorating. It is relatively insensitive to impact, friction, shock, and electrostatic charges. In test firings in high acceleration guns, it produces premature (in barrel) detonations at less than one in a million.

TNT can be safely melted and handled at 80.8 degrees C, it can be poured into bombs and projectiles as a liquid (steam melted) and cooled for ready to use munitions. Melted TNT can easily be mixed and used as a liquid carrier with RDX, HMX, aluminum, ammonium nitrate, and other ingredients with high melting points to form castable explosives (from the slurries). This allows mass production of the shaped charges used in anti-armor weapons. TNT expands by 10-20% on melting to a liquid and then contracts on cooling and solidifying. This leaves cracks and cavities in the castings which require special manufacturing methods to prevent.

TNT is prepared in a 3 stage batch nitration which is described as follows -

#### Stage one

1. A mix of 2 parts of concentrated Sulfuric Acid and 1 parts of Nitric Acid is added to toluene slowly while stirring vigorously and maintaining the mixing container in a cold water bath at between 30-40 degrees C (A water jacketed mixer is used in modern practice. The ratio is 440 parts of mixed acid into 100 parts of the toluene. The addition of acid may take several hours.
2. After all the ingredients are mixed, continue to stir for 30 more minutes without cooling and allow the mix to stand overnight in a separator vessel (funnel).
3. The product is now in two layers. The lower layer of spent (used up) acid is drawn off.

#### Stage two

4. The mononitrotoluene left over is dissolved with 1 part mononitrotoluene into 2.2 parts sulfuric acid while keeping cooled in a water bath or jacketed mixer.
5. A mixed acid of concentrated sulfuric and nitric acids is prepared at a 1:1 ratio and warmed to 50 degrees C.

## History, Design, and Manufacture of Explosives

6. One part of this mixed acid is then added drop by drop, to 1.5 parts of the mononitrotoluene-sulfuric acid mix which becomes hot and is maintained at a constant temperature of 90-100 degrees C. This may take several hours. On completion, this mixture is stirred for 2 hours more at the same temperature to complete its nitration.

7. This mix is again allowed to stand and separate. The upper layer is mostly dinitrotoluene (DNT) with some TNT mixed in. The bottom layer of spent acid is drawn off.

### Stage Three

8. One part of this dinitrotoluene is stirred vigorously while 2.2 parts of fuming sulfuric acid 115% (oleum) is slowly added and the temperature is kept at 90 degrees C.

9. A mixed acid of 1 part nitric acid and 1 part of 115% Oleum is added drop by drop to the dinitrotoluene-oleum mix which has been kept and stirred vigorously at 100-115 degrees C. This generates its own heat but after about 3/4 of the acid has been added, it will be necessary to add heat to it while completing the nitration. This will take several hours.

10. After the mix is completed, continue stirring for 2 more hours with the temperature maintained at 100-115 degrees C. while stirring. This keeps the mixture liquid and allows the nitration reaction to complete.

11. Let the material stand overnight. The TNT layer on top will have turned into a solid cake. The lower layer of spent acid contains precipitated crystals of TNT and still contains TNT in solution. The cake is removed, and a large volume of water is added to the spent acid which precipitates the remaining TNT (TNT is insoluble in water).

12. The water is filtered off, rinsed with water, and the crystals are added to the main batch of TNT cake.

13. The TNT is melted in hot water and is agitated vigorously, and filtered off. This is done 3-4 times to remove all the acid in the liquid TNT.

14 The TNT is then granulated by allowing it to cool slowly under hot water while it is being stirred. The crystals precipitate and are filtered off leaving a crude commercial sample.

[ Commercial TNT has been precipitated by running the solution over refrigerated metal surfaces and scraping it off, or simply letting it stand and cool on its own in large tubs and then draining the water.]

## History, Design, and Manufacture of Explosives

This material is usable in many explosives in this form but contains impurities of isomers and TNB/TNX which segregate in high explosive artillery shells. This leaves a cavity in the shell which can cause the shell to detonate during the shock of firing or failing to detonate during fuse initiation if the cavity is under the booster for the fuse.

### Purification

15. Prepare a solution of 5% sodium hydrogen sulfite and mix 5 parts of this solution with one part of the TNT crystals at 90 degrees C which produces a melted mixture. Vigorously stir this mix (because the parts do not mix on their own) for 1/2 hour at this temperature. The sodium sulfite reacts with the impurities to form water soluble materials that are red in color. Then draw off the water and wash with hot water until the washings are colorless.

When TNT is mixed with organic bases, brightly colored explosive powders are produced.

<u>TNT to</u>	<u>Mix Ratio</u>	<u>Base</u>	<u>Melting Point</u>	<u>Color</u>
	1 : 1	Aniline	83-84 C	Brilliant Red
	1 : 1	Dimethylaniline		Violet
	1 : 1	O-toluidine	53-55 C	Light Red
	3 : 2	Carbazole	160 C	Yellow
	1 : 1	Carbazole	140-200 C	Dark Yellow

Commercial mass production of TNT generally follows the procedures already described. The manufacturers use nitrators made of stainless steel equipped with propellers, thermometer wells, concentric cooling water coils, and fume ducts. Drowning tubs are positioned beneath each nitrator in case of runaway reactions. Production is accomplished in the batch process by-

1. Charging the 1st nitrator with mixed acid fortified to 60% from the 2nd dinitration stage and cooled to 46-52 C.
2. Toluene is added by gravity flow over a period of 20 minutes with the temperature kept at 57 C. It is digested and agitated for 15 minutes more and allowed to settle and cool.
3. The spent acid at the bottom is drained off and recovered. The acid from the trinitration is fortified and pumped into the nitrator and the temperature is raised to 77 C.



## History, Design, and Manufacture of Explosives

4. The mononitotoluene is added while the temperature is maintained at 85 C. This is allowed to settle and cool. The dinitrotoluene oil is pumped under pressure to the trinitrator while the spent acid is fortified and sent to step 1 for reuse.

5. The mixed acid in the trinitration is concentrated nitric and sulfuric acid with oleum heated to 91 C. The dinitrotoluene is fed into the mixer over 45 minutes at 91 C while agitating. The temperature is then increased to 113 C to digest the mix while agitating for 50 minutes. The TNT is then seperated with the TNT going to purification and the spent acid being forified and sent to step 3.

6. The TNT is purified by crystallization, water washing, neutralization, sellited (treating with a 16% sodium sulfite solution to remove impurities), and filtered. This takes about 25 minutes.

[The spent sellite solution is highly toxic and cannot be discharged without treatment. This is usually done by filtering through diatamaeaceous earth and activated carbon.]

7. The TNT cake from the filter is washed, reslurried, pumped to the melter and liquified with live steam. The melt is decanted with some water into a drier which bubbles hot air (100 C) through the melt to remove the moisture. The dry, molten TNT is then poured onto a brass faced surface which is cooled by coils. This causes the TNT to turn solid and it is scraped off in flakes. The flakes are packaged and ready to ship.

TNT is also made by continuous processes, most of which have the nitration flowing in one direction in the plant, while the acid materials run countercurrent. The spent acid from the 3rd stage is cycled to the 2nd stage, and this spent acid is cycled to the 1st stage. Usually, six stages are involved using 8 separate nitrators.

Stage 1	Mononitration	55-60 C
Stage 2	Dinitration	70 C
Stage 3	Dinitration	80-85 C
Stage 4	Trinitration	90 C
Stage 5	Trinitration	95 C
Stage 6	Trinitration	100 C

TNT can be used to make **Trinitrostilbene (TNS)** and ultimately **Hexanitrostilbene (HNS)**. These are very insensitive to shock, heat, friction, and impact and can be used in explosive ordnance that requires burrowing through walls and other solid material before detonating.

## History, Design, and Manufacture of Explosives

**Trinitrostilbene** is prepared by

1. Dissolving 10 grams of TNT in 25cc of benzene in a 100cc flask equipped with a reflux condenser.
2. Add 6cc of benzaldehyde and .5cc of piperadine, this mix is refluxed in a water bath for 1/2 hour.
3. While still hot, pour the material into a beaker and allow the material to cool and crystallize. The crystals are filtered and collected.
4. The crystals are washed twice with alchohol, redissolved in 2/3 alchohol and 1/3 benzene and then cooled and recrystallized.

**Hexanitrostilbene (HNS)** is used in cast explosives as a crystal modifier. When combined with Hexanitrobenzene, it is used in aluminum covered detonation fuses designed for storage and placement in 150-175 C heat. HNS is prepared by-

1. Mixing a solution of tetrahydrofuran and methanol with TNT and cooling to 5 C
2. Adding and mixing this solution into aqueous sodium hypochlorite.
3. To this, add a 20% solution of trimethylamine hydrochloride at 5-15 C.
4. The HNS precipitates and is filtered and then washed with methanol and acetone solution.

TNT, as well as the other nitrated aromatics are extreme fire and explosion risks when brought in contact with alkali. There should be no ammonia, or caustic soda, potash, or other alkaline substances stored, or even located on the premises to avoid the risks and dangers of accidents.

TNT can be safely distilled in vacuum without any decomposition.

TNT is soluble in acetone and toluene. It is insoluble in cold water and alchohol.

TNT is stable and safe when stored in air tight, and lightproof containers and does not require monitoring in storage like nitrocellulose and powders require.

## History, Design, and Manufacture of Explosives

### Nitrated Benzene's

**Nitrobenzene** is one of the most toxic substances known. Also called "Oil of Mirbane", it is a yellow liquid with a boiling point of 208 degrees C. Its vapors are absorbed through the skin, eyes, and by inhalation and can kill with just a few PPM continuous concentration.

It is used in some explosive formulations, to make aniline, and to produce dyes and medicines. It is prepared by -

1. Premixing 100 grams of nitric acid and 150 grams of concentrated sulfuric acid in a 500cc beaker and allow to cool to room temperature.
2. Add 51 grams of benzene slowly with considerable shaking to prevent local overheating and if the reaction exceeds 50-60 degrees C, cool with tap water quickly.
3. Once all the benzene has been added, attach an air condenser to the flask and heat the material in the water bath at 60 degrees for 1 hour (keep a thermometer in the water).
4. Allow to cool. The upper layer is Nitrobenzene which is separated off from the spent acid, and then washed once with water. Stir vigorously. The nitrobenzene is now the lower layer.
5. Wash several times with dilute sodium bicarbonate solution until free from acid (clear).
6. Wash once more with water, add calcium chloride to dry, and distill off at 206-208 degrees.

## History, Design, and Manufacture of Explosives

The US Army provides the following improvised munitions instruction for making a nitrobenzene based explosive.

### Nitrobenzene and Nitric Acid Explosive

An explosive munition can be made from mononitrobenzene and nitric acid. It is a simple explosive to prepare. Just pour the mononitrobenzene into the acid and stir.

#### Material Required

Nitric Acid

Mononitrobenzene (nitrobenzene)

Acid resistant measuring container

Acid resistant mixing rod

Blasting Cap

Wax

Steel Pipe, end cap and tape

Bottle or jar

#### Sources

Field grade or 90% Conc.

( specific gravity 1.48)

Drug store (Oil of mirbane)

Chemical and industry supply (solvent)

Glass, clay, etc.

**Note:** Prepare mixture just before use.

#### Procedure

1. Add 1 volume nitrobenzene to 2 volumes Nitric Acid in bottle or jar.

2. Mix ingredients well by stirring with acid resistant rod.



**Danger:** Nitric acid will burn skin and destroy clothing.  
Nitrobenzene is toxic - Do not inhale fumes.

## History, Design, and Manufacture of Explosives

### How to use

1. Wax blasting cap, pipe, and end cap.

2. Thread end cap onto pipe.

3. Pour mixture into pipe.

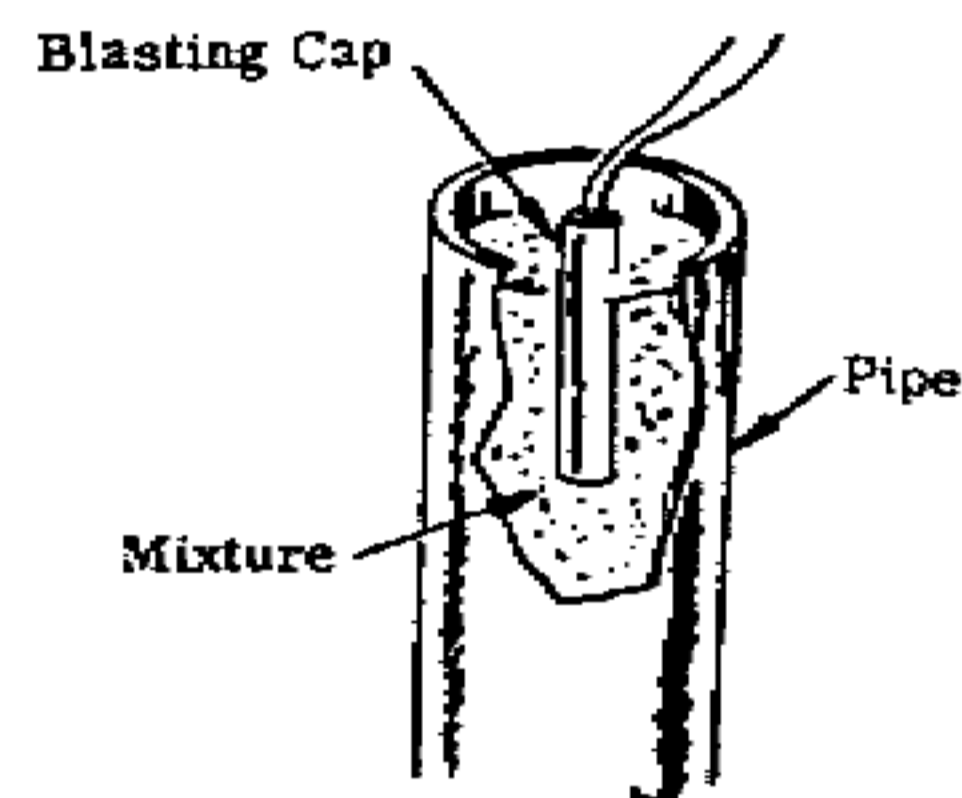
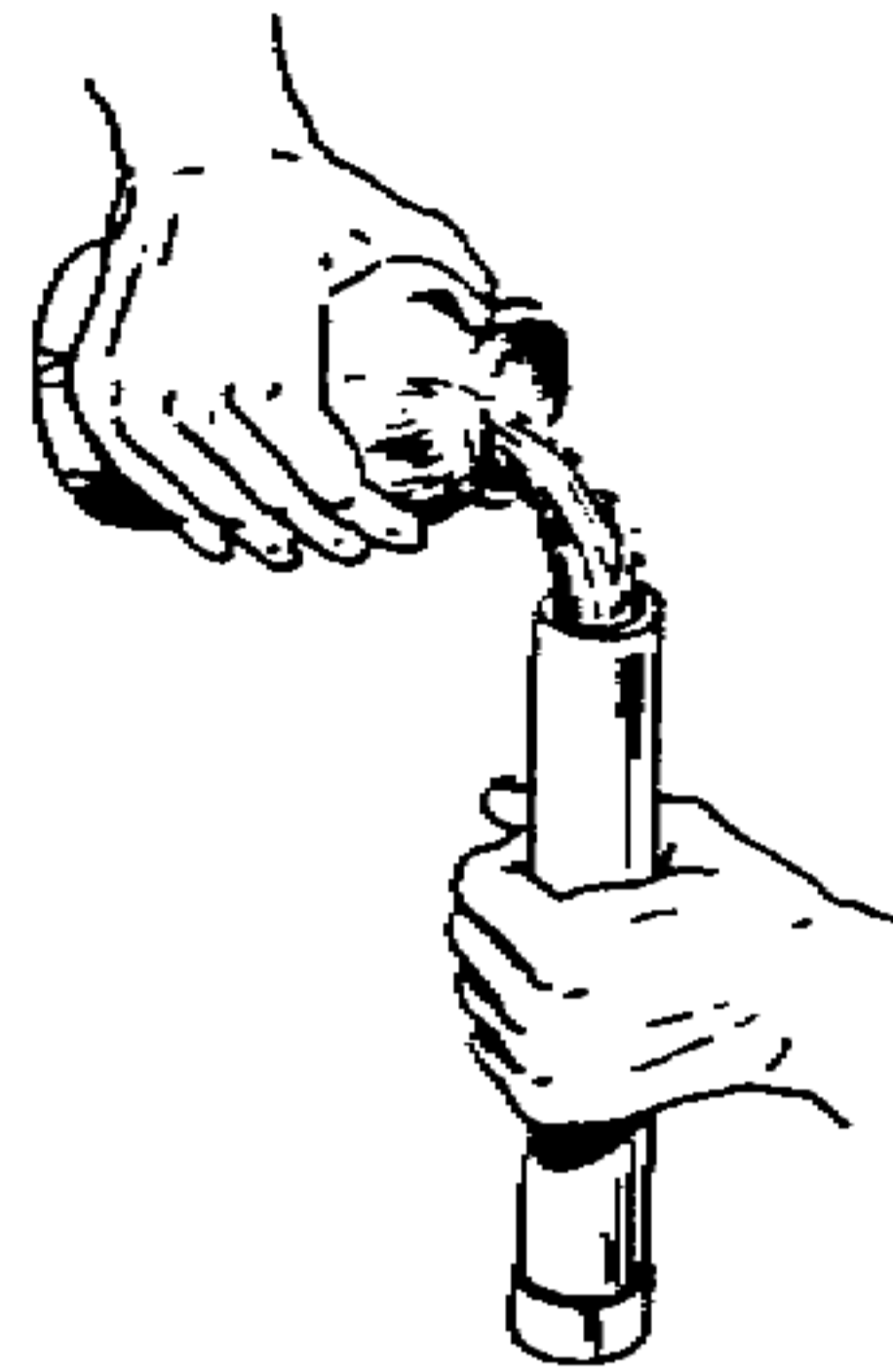

4. Insert and tape blasting cap just beneath surface of mixture.

5. Use wax to seal end of the pipe.

Note: Confining the open end of the pipe will add to the effectiveness of the explosive

## History, Design, and Manufacture of Explosives

**Dinitrobenzene** can be mixed with ammonium nitrate and other mixtures for shell and bomb filling. Dinitrobenzene is made by nitrating nitrobenzene as follows -

1. Concentrated sulfuric acid - 25 grams, and nitric acid - 15 grams, are mixed in an open flask in a boiling water bath under a hood.
2. 10 grams of nitrobenzene is added gradually over a half an hour.
3. The mixture is cooled and then cold water is added. The dinitrobenzene separates out as a solid. After filtering off, it is crushed and washed with water again.
4. The crystals are then mixed into hot nitric acid or alcohol and recrystallized by cooling.

Dinitrobenzene melts at 90 degrees, can explode if heated rapidly or under shock, is slightly soluble in water or benzene, and soluble in ethyl acetate or chloroform. It is very toxic.

**Trinitrobenzene (TNB)** can be prepared from dinitrobenzene, but the process is so difficult and expensive that other ways have been developed to commercially produce it..

Manufacture of TNB by nitrating TNT with sodium dichromate.

1. Sulfuric acid (300cc) is mixed with 30 grams of purified TNT in a tall beaker in a basin.
2. The mix is stirred vigorously with an electric stirrer while powdered sodium dichromate is added in tiny amounts. No lumps are allowed to form and none is allowed to float to the surface. As the reaction raises the temperature to 40 degrees C, a cold water bath is added to the basin to keep the temperature between 40-50 degrees. When 45 grams has been added, keep stirring for 2 more hours maintaining the temperature.
3. Allow to cool and stand overnight. Trinitrobenzoic acid crystals are formed and are filtered off in an asbestos filter. The solid crystals are rinsed with cold water and then dissolved in hot water at 50 degrees.
4. The solution is filtered and then boiled until all the trinitrobenzene precipitates. The liquid is cooled and the crystals rinsed with water. They are very nearly pure.

TNB is soluble in acetone, ether, and benzene, and insoluble in water. It formed colorful compounds with organic bases that are dangerous explosives when dry. After acidification, they can be reacted with copper and other metal salts to form primary explosives.

## History, Design, and Manufacture of Explosives

TNB can be reacted with hydroxylamine in cold alcohol solution to form Trinitroaniline (picramide) which is also a very powerful explosive. TNB can be oxidized in mild alkali solution by potassium ferricyanide to yield picric acid.

TNB is significantly more powerful and brisant than TNT and is less sensitive to impact. The shock wave from TNB is more capable of knocking down walls of buildings than almost all other explosives. It usually requires an initiator of .5 grams of mercury fulminate used to detonate 80 grams of dynamite, which then detonates the TNB. TNB detonates at 7,347 m/s at a density of 1.64 or greater.

[ Velocity of detonation depends on the explosive, how dense it is packed in the charge, with the more dense packing being more powerful, and how strong the container is that holds it. Pipe bombs are often used in explosives in place of paper cartridges because strongly confining the explosive allows it to build pressures that force the more complete detonation of all the confined materials before the container ruptures. In fact, many materials will not even detonate without confinement.]

### Aminonitrobenzenes

The di and tri-aminotrinitrobenzenes can withstand very high temperatures for long periods of time without degrading or detonating. They are also insensitive to impact. They are mixed into cast molding powders by similar methods used to make PBX (last chapter), and are used in special high temperature applications.

**DATB** (1,3-Diamino-2,4,6-trinitrobenzene) is produced by nitrating *m*-phenylenediamine at 120-140 C.

**TATB** (1,3,5-Triamino-2,4,6-trinitrobenzene) is made by nitrating trichlorobenzene with mixed acid followed by treatment with ammonia in alcohol.

### Nitrated Chlorobenzene's

Economics drive the production choices of explosive manufacture. The abundance of chlorine from caustic soda and ash production combined with cheap, mass produced benzene from toluene production, resulted in the development of cheap and abundant chlorobenzene which could be nitrated. The results were dinitrochlorobenzene which could be produced by directly nitrating the chlorobenzene, or by chlorinating dinitrobenzene.

## History, Design, and Manufacture of Explosives

The dinitrochlorobenzene could be nitrated to produce Trinitrochlorobenzene (picryl chloride), but this is expensive in acid and does not produce economic explosive yields.

The dinitrochlorobenzene however can be used to produce

- dinitrophenol (picric acid) by hydrolysis
- dinitroaniline by reaction with ammonia
- dinitromethylaniline by reaction with methylamine

All of these are powerful and useful (and economic) explosives which we will cover.

### Trinitroxylene (TNX)

The xylenes produced from coal tars come in 3 isometric forms, only one of which can be properly nitrated. All the xylenes are sulfonated together which yields the m-xylene sulfonic acid that can be nitrated. The steps are -

1. One part of the mixed xylenes are mixed with one part of 93% sulfuric acid at 50 degrees C for 5 hours.
2. The liquid is filtered off from any solids and diluted with the addition of 33% water. This is autoclaved at 130 degrees for 4 hours. This forms the m-xylene precipitate. The remaining o-xylene sulfonate can be converted by autoclaving at 200 degrees to o-xylene.
3. The m-xylene is nitrated in the 3 steps directly with nitric and sulfuric acid. It is precipitated from benzene in large colorless needles which melt at 182.3 degrees C.

TNX has been used in commercial dynamites. It contains a large excess of carbon and can be formulated as an oxidizer for use with other high combustible materials. It has accordingly been fine ground and mixed with ammonium nitrate (77%) and TNX (23%) for use as a high explosive shell filling (loaded under compression to insure detonation). Mixes of 45% TNX, 45% TNT, and 10% Picric acid form a semi solid at warm temperatures that can be easily poured into shells as a castable filling. A mix of TNX 10%, TNT 40%, and Picric acid 50% can be melted under water yielding powerful, pourable, explosives.



## History, Design, and Manufacture of Explosives

### Nitrated Phenols and Picrates

**Hexanitrobiphenyl** is prepared by boiling picryl chloride (trinitrochlorobenzene) with copper powder in a solvent of nitrobenzene for a few minutes. Without the solvent, this mix explodes at 127 degrees C from the heat of reaction. The crystals are precipitated from toluene and contain 1/2 molecule of toluene of crystallization. They are insoluble in water, and slightly soluble in alcohols, most solvents, and melts at 263 degrees. It produces a yellow color with sulfuric acid, and red with alcohol with added alkali.

This material cannot be prepared by directly nitrating Biphenyl, but can yield tetranitrobiphenyl precipitated from benzene. Both of these are powerful explosives.

**Picric Acid** (also known as Trinitrophenol, piconitric acid, nitroxanthic acid, carbazotic acid, phenoltrinitrate, melinite, lyddite, pertite, shimose, and many others) is one of the most important explosive substances ever discovered. It was originally recovered by nitrating Indigo and used as a fast dye for silk and wool.

Nitric acid attacks phenol violently and quickly oxidizes part of it to oxalic acid (which is a useful acid for radiator cleaning and is the highly poisonous material found in rhubarb leaves) and some resinous byproducts. Using mixed acid on phenol produces a poor yield of a mix of mononitrophenols. These can be nitrated to dinitrophenol (m.p. 114-115 degrees), and then to picric acid, but the end yields are so poor that this process is not used commercially.

The production of picric acid is accomplished by -

1. Sulfonation: 25 grams of phenol and 25 grams of concentrated sulfuric acid are heated together in a round bottom flask equipped with an air condenser for 6 hours in an oil bath at 120 degrees C.
2. After cooling, the mix is diluted with 75 grams of 72 % sulfuric acid. This mix is transferred to an Erlenmeyer flask under a hood.
3. Nitration: Add 175cc of 70% nitric acid slowly, one drop at a time. When it has all been added and the reaction has subsided, heat the mixture on the steam bath for 2 hours.

[ When acid of less than 93-98% strength is called for, it is prepared by simply adding the right amount of water to dilute it. This takes away some of the heat energy of dilution and makes it safer to use for subsequent reactions]

## History, Design, and Manufacture of Explosives

4. Allow it to sit and cool overnight. The picric acid crystals are filtered off in a porcelain filter (picric acid is a strong acid itself and reacts with metals to form explosive salts), washed with small amounts of water until the sulfate is removed, and air dried.

5. Purification: 15 grams of picric acid is added to 1 liter of water, boiled, filtered hot, and allowed to cool slowly. Heavy drops of brown oil during the boiling should be removed. Pure picric acid precipitates from the cool water in yellow needle crystals.

6. White crystals (m.p. 122.5 degrees) can be obtained by recrystallizing from 30% hydrochloric acid.

An additional step of using less nitric acid to produce dinitrophenol, and then to picric acid has also been used commercially.

A catalytic process using mercuric nitrate, yields picric acid as follows -

1. 10 grams of mercuric nitrate is dissolved into 600cc of nitric acid.
2. 200 grams of benzene in a 2 liter round bottom flask equipped with a sealed-on condenser is refluxed with the nitric acid solution on a sand bath for 7 hours.
3. The material is transferred to another flask and distilled with steam. Benzene distills first, followed by nitrobenzene, then last, a mixture of dinitrobenzene and dinitrophenol.
4. The leftover liquid is filtered hot and allowed to crystallize as impure picric acid. This can be purified by using the hot water described earlier.

## History, Design, and Manufacture of Explosives

The US Army has used the following improvised field method for producing Picric Acid

### Picric Acid from Aspirin

Picric Acid can be used as a booster explosive in detonators, a high explosive charge, or as an intermediate to preparing lead picrate or DDNP.

#### Material Required

Aspirin Tablets ( 5 grains per tablet)

Alcohol, 95% pure

Sulfuric Acid, concentrated from battery acid boiled till white fumes appear

Potassium Nitrate

Water

Paper Towels

Canning Jar, 1 pint

Rod (glass or wood)

Glass containers

Ceramic or glass dish

Cup

Teaspoon

Tablespoon

Pan

Heat Source

Tape

#### Procedure

1. Crush 20 aspirin tablets in a glass container.  
Add 1 teaspoon of water and work into a paste.

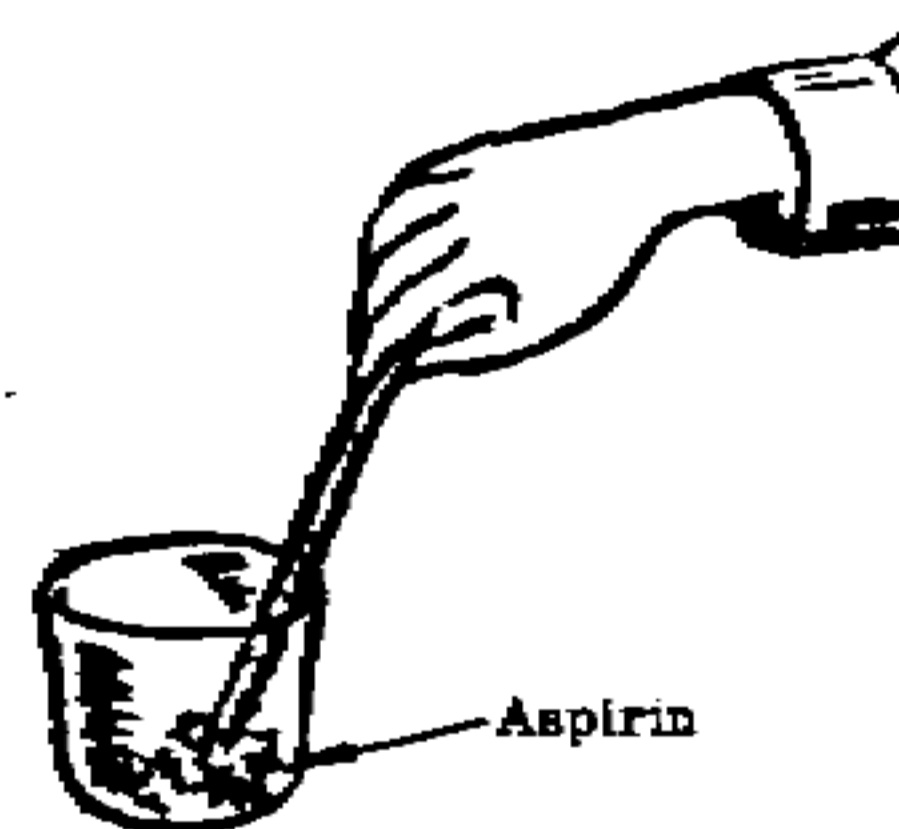

2. Add app. 1/3-1/2 cup of alcohol (100 ml.)  
to the aspirin paste, stir while pouring.

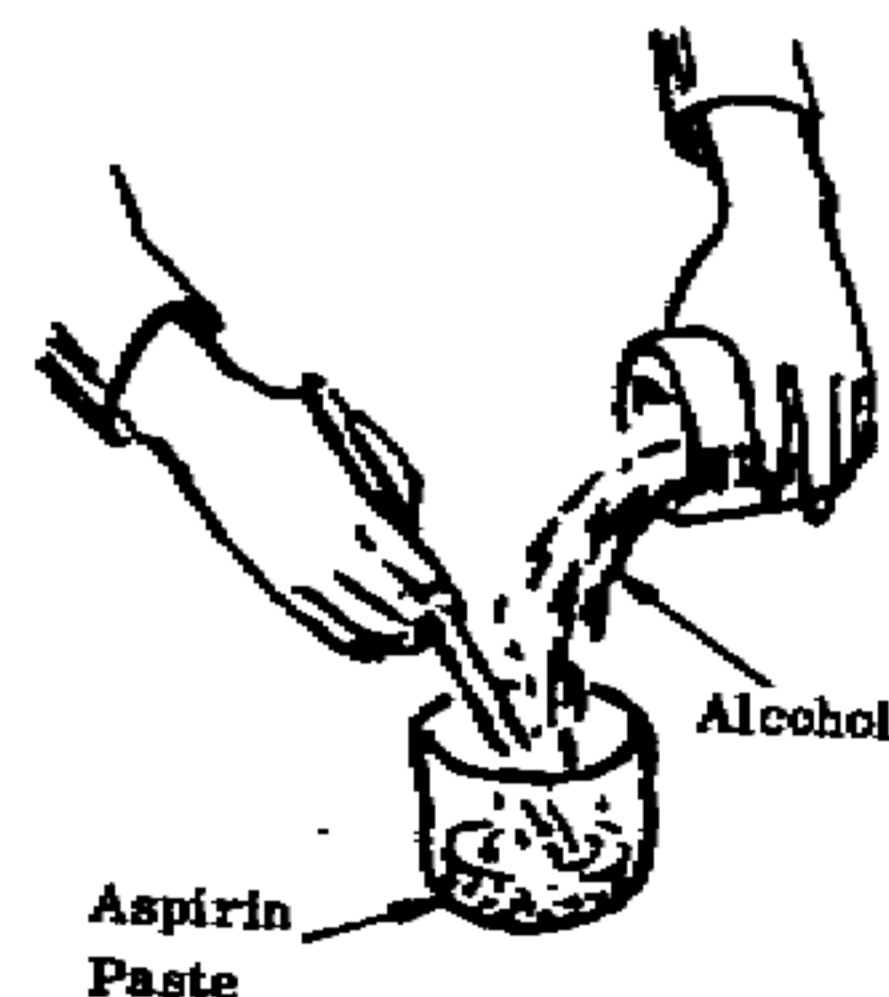

## History, Design, and Manufacture of Explosives

3. Filter the alcohol-aspirin solution through a paper towel into another glass container. Discard the solid left on the paper towel.



4. Pour the filtered solution into a ceramic or glass dish.

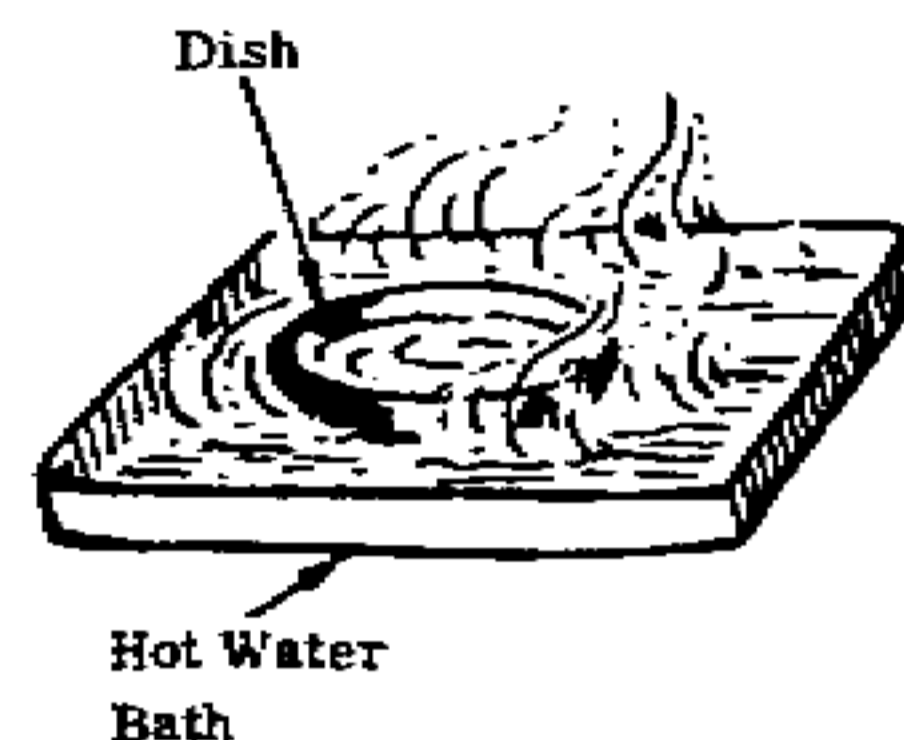

5. Evaporate the alcohol and water from the solution by placing the dish into a pan of hot water. White powder will remain in the dish after evaporation.

**Note:** Water in pan should be at hot bath temperature, not boiling, app. 160-180 degrees F. It should not burn the hands.

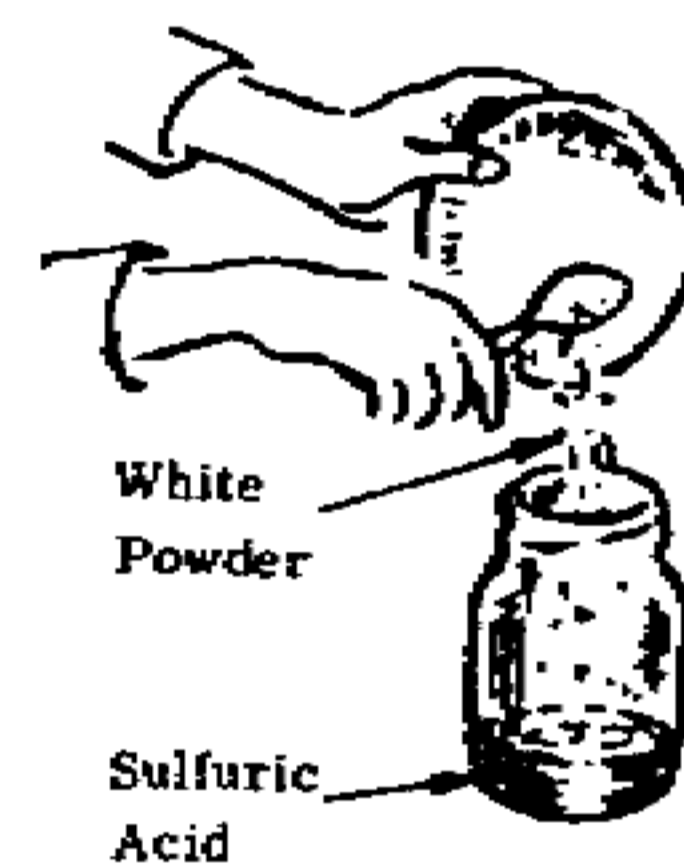

6. Pour 1/3 cup (80 ml.) of concentrated sulfuric acid into a canning jar. Add the white to the sulfuric acid.

7. Heat canning jar of sulfuric acid in a pan of simmering hot water bath for 15 minutes; then remove jar from the bath. Solution will turn to a yellow-orange color.

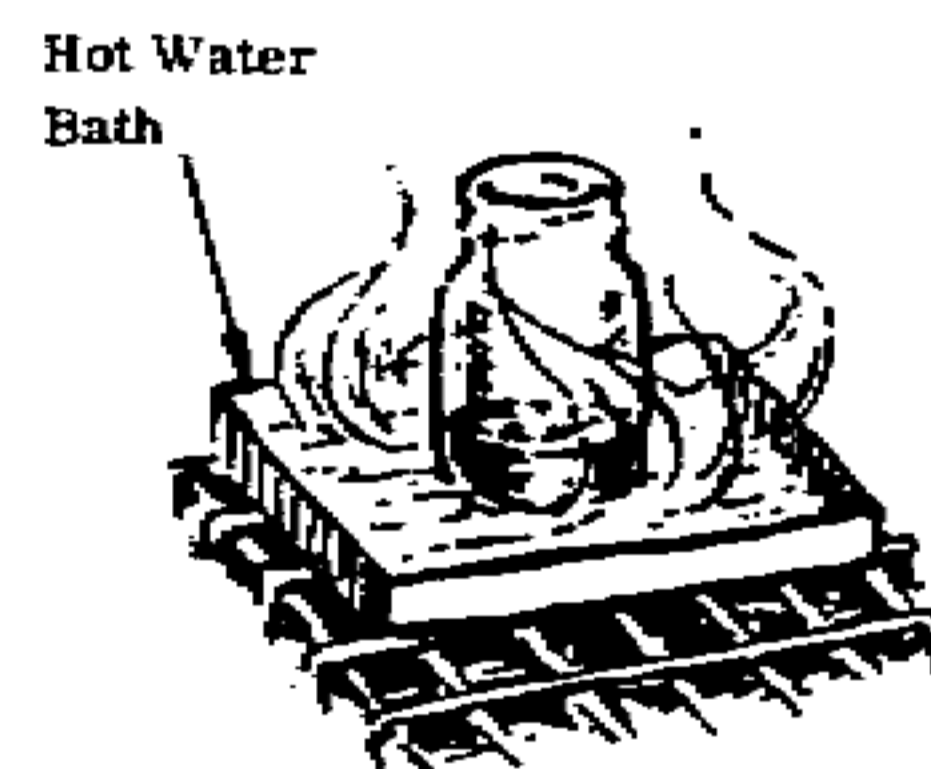

8. Add 3 level teaspoons (15 grams) of potassium nitrate in 3 portions to the yellow-orange solution; stir vigorously during additions. Solution will turn red, and then back to yellow-orange.

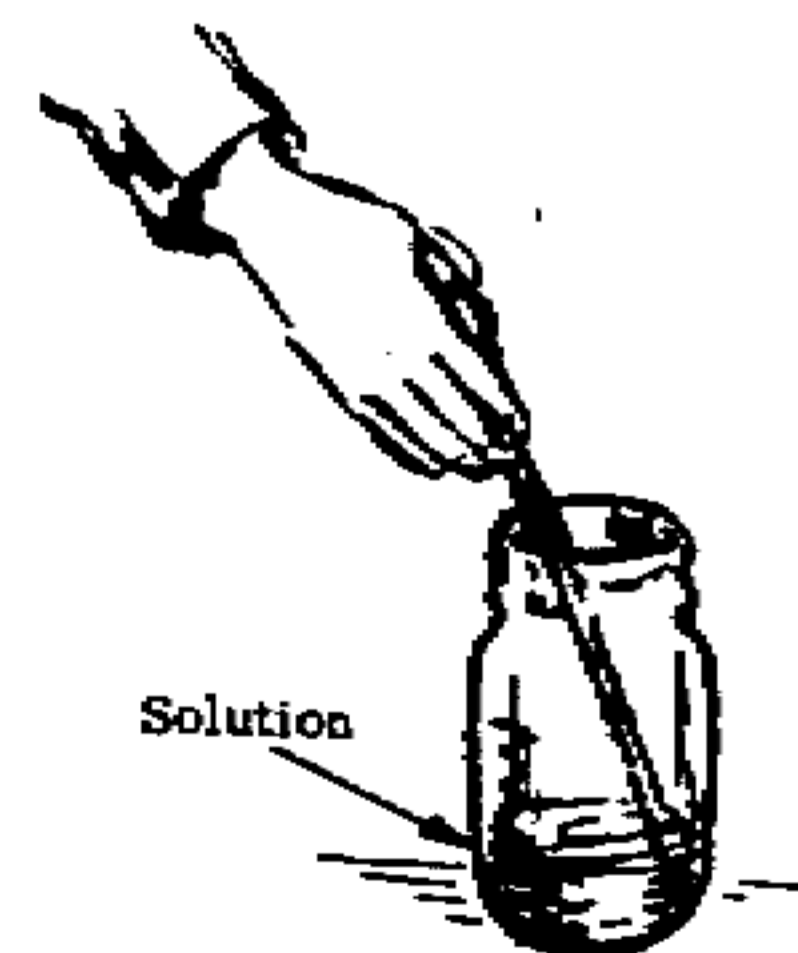

## History, Design, and Manufacture of Explosives

9. Allow the solution to cool to ambient or room temperature while stirring occasionally.

10. Slowly pour the solution, while stirring, into 1-1/4 cup (300 ml.) of cold water and allow to cool.

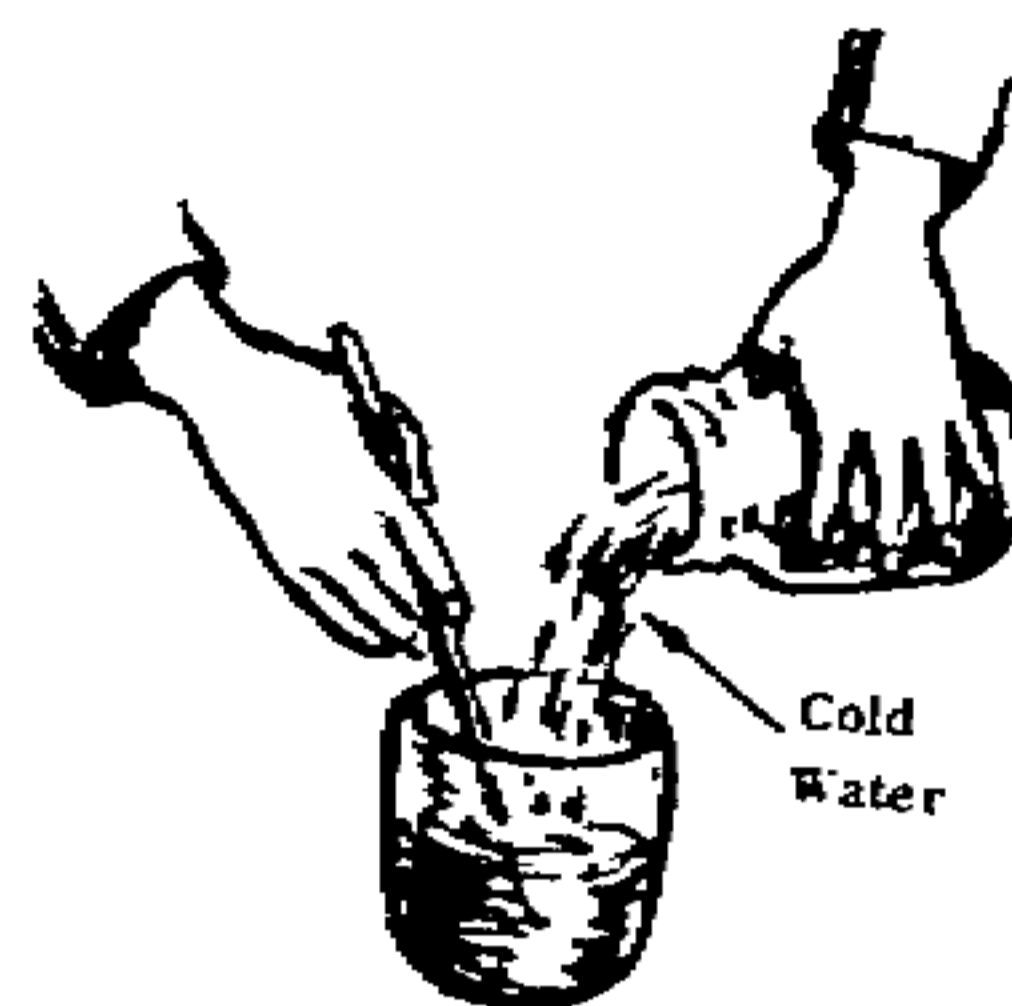

11. Filter the solution through a paper towel into a glass container. Light yellow particles will collect on the paper towel.

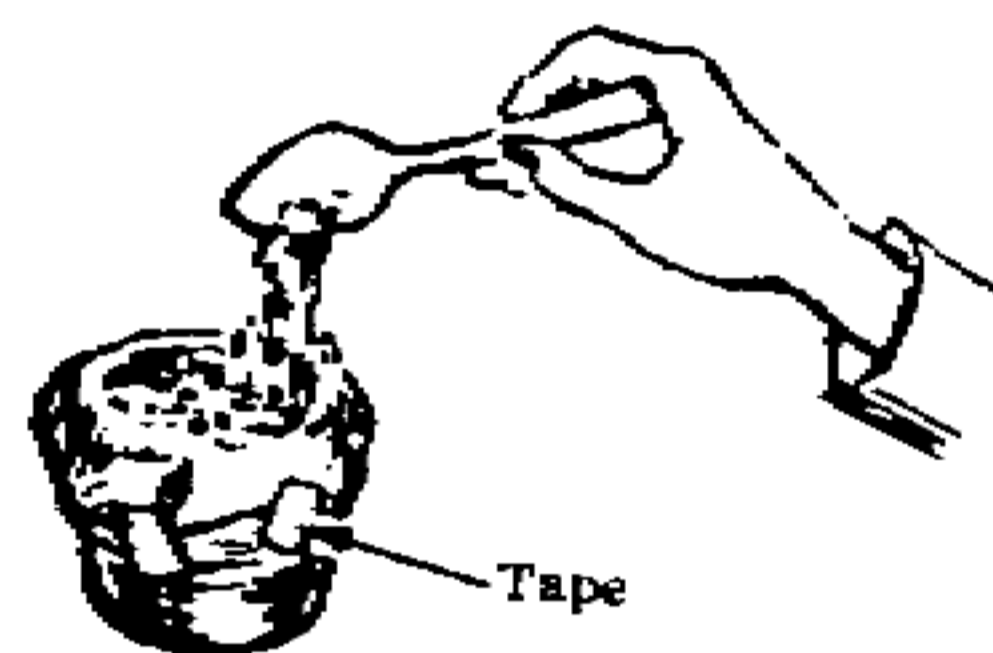

12. Wash the light yellow particles with 2 tablespoons (25 ml.) of water. Discard the waste liquid in the container.

13. Place particles in ceramic dish and set in a hot water bath, as in step 5, for 2 hours.

Picric acid has been used as a yellow dye for silk and wool. It is a strong acid and attacks metals, forming explosive picrates. It could not be used in explosive devices without first lining the interior surfaces of the shell or bomb with asphalt or ceramic material that would not react with the acid.

## History, Design, and Manufacture of Explosives

Commercial production of the "picrates" is accomplished usually by melting the picric acid and adding the powdered metal or material to the melt with the appropriate amount of water. The following chart describes the amount of hydration (water) in the formula, and its sensitivity to shock and heat detonation. The less water in the formula, the more sensitive the picrate. They are compared to other detonators.

<u>Material</u>	<u>Hydration</u>	<u>2 Kilo drop test-Inches</u>	<u>Explosion Temp C.</u>
Mercury Fulminate	none	2	210
Tetryl	none	8	260
TNT	none	14	470
Picric Acid	none	14	320
Ammonium Picrate	none	17	320
Sodium Picrate	1 H <sub>2</sub> O	17	360
Sodium Picrate	none	15	-
Copper Picrate	3 H <sub>2</sub> O	19	300
Copper Picrate	none	12	-
Nickel Picrate	6 H <sub>2</sub> O	26	390
Nickel Picrate	none	4	-
Aluminum Picrate	10 H <sub>2</sub> O	36	360
Aluminum Picrate	2 H <sub>2</sub> O	16	-
Aluminum Picrate	none	16	-
Chromium Picrate	13 H <sub>2</sub> O	36	330
Chromium Picrate	none	10	-
Ferrous Picrate	8 H <sub>2</sub> O	36	310
Ferrous Picrate	none	14	-

Picric acid, besides being an excellent initiator for explosions, is an excellent main explosive when mixed with other oxidizers. It can be compressed, and melted for casting in shells and cartridges. Cast charges usually required the use of compressed picric acid or tetryl to initiate. When explosives are melted for casting, it is desired that they be melted at 70-100 degrees. Below 100 so that hot water can be used to melt it, above 70 to prevent formation of exudates or material separations. Because picric acid by itself melts at 122.5, it is usually mixed with other materials to lower its melting point. Some of these mixtures include -

- Picric acid 60% and Dinitrol Phenol 40%
- Trinitro-m-cresol 60% and picric acid 40%
- Picric acid 55%, dinitrophenol 35%, and trinitro-m-cresol 10%
- or the above with TNT in place of the nitrodiphenol

## History, Design, and Manufacture of Explosives

All these melt at 80-90 degrees under water in wooden tanks treated with steam. The water is usually treated with sulfuric acid to remove any chance of formed metal picrates.

Dry picric acid (88%) can be mixed into melted stearic acid or paraffin and then is rolled, and grained. It can be compressed for a powerful explosive less sensitive to shock and nearly as brisant as picric acid itself.

Picric acid based cast charges found extensive use as a burster in gun projectiles, however, it is no longer used in military explosives because of its formation of sensitive salts with metals.

**Dinitrophenol** is a powerful explosive that has been mixed with picric acid to produce pourable explosive filling for shells and bombs. It can also be made by autoclaving dinitrochlorobenzene in the presence of caustic soda. It is precipitated on acidification with sulfuric acid or can then be nitrated to yield picric acid.

**Ammonium Picrate** is less sensitive to shock than picric acid and is not easily detonated by mercury fulminate. It does not react to form metal salts and is very stable in storage. Powdered and compressed picric acid or tetryl have been used to initiate it. Two forms of ammonium picrate crystals can be formed which are lemon yellow and brilliant red in color respectively.

Ammonium picrate is produced by mixing a suspension of picric acid and hot water and adding a large excess of ammonia and stir until everything is dissolved. The solution is allowed to cool and the red ammonium picrate crystals precipitate. When stored in an airtight container, it is stable for years. If stored in water it forms the yellow crystals after several months, or can be formed quickly by recrystallizing in water several times.

Ammonium Picrate is a high explosive, insensitive to shock, and is used primarily for those applications. It is used in compressed form as a burster in naval projectiles for maximum armor penetration against enemy ships. It is also used in armor piercing artillery projectiles.

**Guanidine picrate** is produced by mixing guanidine nitrate and ammonium picrate in a warm solution. Fine yellow guanidine crystals precipitate out. It is even less sensitive to shock and friction than ammonium picrate and cannot be detonated by mercury fulminate. It requires a picric acid booster. It can be recrystallized from water or alcohol and cannot be melted for pouring.

## History, Design, and Manufacture of Explosives

### Nitrated Naphthalenes

Up to 4 nitro groups can be added to naphthalene to form the mono, di, tri, and tetra naphthalenes. Mixed acids are used with an excess of nitric acid each time, and the temperatures are increased for each nitration to 130 degrees for the tetra form.

The mononitronaphthalenes are not considered explosives. The dinitronaphthalenes, which melt at 140 degrees, show a small explosive capacity. The trinitronaphthalenes (naphtite) melts at 110 degrees. The tetranaphthalenes melt at 220 degrees.

None of these are sensitive to shock, and they rise in power with more nitration. The tetra form is as powerful as TNT and much less impact sensitive.

At a loading density of .3, the following firing pressures in Kilos/ sq. cm. were reported.

Mononitronaphthalene	1,208
Dinitronaphthalene	2,355
Trinitronaphthalene	3,275
Tetranitronaphthalene	3,745

Nitrated naphthalenes have found wide historical use in safety explosives and dynamites. Mixed with other aromatics, chlorate oxidizers, and ammonium nitrate, it would form powerful high explosives.

In WW1 extensive production of shell filling contained

7 parts ammonium nitrate  
1 part dinitronaphthalene

Mixed by grinding in a black powder mill  
and loaded into shells by compression

7 parts picric acid  
3 parts mononitronaphthalene

Melted together under water and used in  
air dropped large bombs.

This was so insensitive that the impact of a rifle bullet could not detonate it.

1 part Dinitronaphthalene  
4 parts picric acid

Melts together at 105-110 degrees under water

This is more powerful than the last formula and is less sensitive to shock than the picric acid.



## History, Design, and Manufacture of Explosives

A German land mine formula was used consisting of

Potassium perchlorate	56%
Dinitrobenzene	32%
Dinitronaphthalene	12%

Small caliber shells were made using

TNT	66%
Trinitronaphthalene	33%
Compressed Picric Acid	1 % as a booster

The trinitronaphthalene found use as a stabilizer for nitrocellulose in place of 2% diphenylamine when added at 10%. At this amount it also reduced the combustion temperature and moisture absorption.

### Other Nitrated Aromatics

**Trinitrocresol** is made by sulfonating and then substituting the nitro groups (the same way picric acid is made) into m-cresol. It is soluble in water and alcohol. It has been used as a large shell artillery filling when made into its ammonium salt (ammonium trinitrocresol) and mixed with ammonium nitrate.

**Trinitroresorcinol**, also known as **styphnic acid**, is used to make strong explosive metal salts that are more powerful than the picrates. Lead styphnate has been used to initiate lead azide and other materials in initiators. It (resorcinol) is easily nitrated to the trinitro as yellow crystals precipitated from alcohol or water, and is a strong dibasic acid.

**Trinitroanisol** has similar properties to picric acid but does not attack metals to form the dangerously explosive salts. It can be colloided with nitrocellulose and has been used to make flashless strip powder (which decomposed over time to produce picric acid and yellow stain everything and everybody it touched). It melts at 67-68 degrees.

It can be directly nitrated, but is incredibly dangerous to attempt and must be kept below 0 degrees C. A drop of anisol into 10cc of nitric acid yields color changes of yellow to green to blue to reddish purple. The bluish purple color readily detonates.

Trinitrochlorobenzene (picryl chloride) is used to make it commercially.

1. Dissolve 35 grams of picryl chloride in 400cc of methyl alcohol with warming under reflux and allow to cool to 30-35 degrees.
2. Mix 23 grams of caustic soda to 35cc of water and add this solution slowly through the condenser while the liquid is cooled and prevented from boiling. Allow it to stand 2 hours.

## History, Design, and Manufacture of Explosives

3. Filter off the red precipitate, wash with alcohol, and stir into a water solution while adding strong hydrochloric acid until all the red color is gone.

4. The yellowish-white precipitate is washed with water to remove sodium chloride, and dried, and then recrystallized from methyl alcohol or other anhydrous solvents to yield pure tinitroanisol.

It has been used as a booster charge in 75mm artillery shells and in combination with other explosives in air dropped bombs. Less sensitive than picric acid to shock, tinitroanisol has a substantially higher velocity of detonation than TNT (7,640 m/s compared to 6,880 m/s).

**Tritroaniline** also known as picramide, is prepared by nitrating aniline in glacial acetic acid solution, or using the mixed nitric-sulfuric acid solutions. It is a strong explosive, but better ones can be made from aniline and its compounds as follows.

**Tetranitroaniline (TNA)** is an extremely reactive chemical substance that is difficult to handle and store. It is prepared by

1. Reducing m-nitrobenzene with polysulfide to yield m-nitroaniline sulfate.
2. Directly nitrating this with nitric acid to yield yellow or greenish brown crystals from acetone. It is soluble in glacial acetic acid. It melts and decomposes at 226 C.

TNA is substantially more powerful than TNT. By adding a small amount of water to TNA in acetone, it is converted to trinitroaminophenol (m.p. 176 degrees) that will attack metals similar to picric acid. If TNA is boiled in sodium carbonate solution, trinitroresorcinol is formed. Water alone attacks and decomposes TNA within hours to days which makes it unsuitable as a military explosive.

**Tetryl** ( tetralite, pyronite, nitramine) for 2,4,6-trinitrophenylmethylnitramine, has been prepared by nitrating dimethylaniline as follows -

1. Dissolve 20 grams of dimethylaniline in 240 grams of concentrated sulfuric acid.
2. Drip this solution from a funnel into a beaker of 160 grams of nitric acid (80%) which has been warmed to 55-60 degrees and stirred continuously. The reaction temperature should be kept between 65-70 C. This will take an hour.

## History, Design, and Manufacture of Explosives

3. Allow to cool while stirring and then filter on an asbestos filter, wash the solids with water, and boil in 240cc of water for one hour, replacing water lost by boiling.
4. The crude tetryl is filtered off, ground under water and passed through a 150 mesh sieve.
5. This is mixed in 12 times its weight of water and boiled for 4 hours, then repeated with fresh water.
6. The solid crystals are dried and dissolved in benzene
7. The solution is filtered and allowed to evaporate, the residue is recrystallized from alcohol.

Tetryl melts at 129.4 and with impurities present, at 128.5 C.

Commercial tetryl can also be made from the following raw material stream.

1. Methyl alcohol + Ammonia at high temperature in the presence of a thorium oxide catalyst will form methylamine.
2. Methylamine reacts with dinitrochlorobenzene to form dinitromonomethylamine
3. This can be directly nitrated with nitric acid to form Tetryl.

It is commercially manufactured today by first dissolving dimethylanisidine in 98 % sulfuric acid. This is then nitrated with mixed acid.

Heating tetryl alone produces picric acid. Heating it in solvents yields methyl picramide.

Tetryl is stable at ordinary temperatures, it is more powerful and brisant than TNT and picric acid, and much more sensitive to shock. It has been used as a booster and in reinforced detonators.

**Ethyl Tetryl**, similar to tetryl in its explosive properties, has been produced by the nitration of both mono and di-ethylaniline. It is purified by recrystallizing 2 times from nitric acid and once from alcohol.

## History, Design, and Manufacture of Explosives

**Butyl Tetryl** is prepared by nitrating n-butylaniline and crystallizing from alcohol. It produces sodium picrate when boiled in a solution of baking soda. Its yellow plate crystals melt at 98 degrees C. It has been used in boosters, primers, and detonating fuse. It requires .2 grams of mercury fulminate to detonate it. It explodes at 210 degrees and is more powerful than TNT.

All the above Tetryl compounds are considered chemically to be nitramines as well.

**Hexanitroazobenzene (HNAB)** is prepared from mixing hydrazine into hot water with sodium or calcium carbonate and adding dinitrochlorobenzene. This yields tetranitrohydrazobenzene that is nitrated and oxidized to the explosive in mixed acid. The orange crystals precipitate from acetone and melt at 215 C. It is a powerful explosive with excellent stability at high temperatures, and low sensitivity to shock, friction, and impact.

**Hexanitrodiphenylamine**, is a high explosive prepared from dinitrochlorobenzene or direct nitration of diphenylamine. It is also effective as a chemical weapon because of the severe blisters it forms on skin while being a direct poison, and the damage its dust causes to the mucous membranes of the lungs, nose, and throat.

1. 32 grams of powdered chalk or precipitated calcium carbonate are added to 70 grams of aniline to form a uniform suspension in water and heated to 60 degrees.
2. Melted dinitrochlorobenzene (150 grams) is added slowly to the mix while stirring and heated gradually to 90 degrees from the reaction.
3. The crystals are washed with hydrochloric acid to remove the aniline and calcium, then washed with water until free from the resulting chlorides.
4. Dry in an oven at 100 degrees to yield dinitrodiphenylamine.
5. 50 grams of ground powdered, dinitrodiphenylamine is added in small amounts to 420 grams of nitric acid while stirring vigorously and maintaining at 50-60 degrees. The color of the solution will change from red (dinitro) to yellow (tetranitro).
6. Once complete, the temperature is raised for 2 hours while stirring at 80-90 degrees.
7. The solution is cooled and filtered, washed with water until free from acid, and air dried or oven dried at 100 C.
8. The tetranitrodiphenylamine (50 grams) is added slowly while stirring to a mix of 250 grams each of sulfuric and nitric acid.

## History, Design, and Manufacture of Explosives

9. Allow to stand for 3 hours at room temperature.
10. Drown in ice water to precipitate the hexanitrodophenylamine, filter, wash the crystals in water, and air dry.
11. Purify by recrystallizing by dissolving in cold acetone and adding ether to precipitate it

**Hexanitrodiphenyl Sulfide** is produced by mixing trinitrochlorobenzene (picryl chloride) and sodium thiosulfate in a solution of alcohol and magnesium carbonate. Soluble in acetone, insoluble in alcohol, it is nonpoisonous and melts at 234 C. Its explosion yields poisonous and combustible sulfur dioxide gas making at a useful filling for weapons aimed at enclosed spaces such as buildings, ships, and underground bunkers.

It can also be nitrated further to produce **Hexanitrodiphenyl Sulfone** which is powerful, and less sensitive to shock.

**Hexanitrocarbanilide** is prepared by nitrating diphenylurea (carbanilide). Carbanilide is prepared by heating urea and aniline together at 160-165 C.

1. Add 40 grams of carbanilide to 60 cc of sulfuric acid.
2. Add this, one drop at a time to 96cc of nitric acid. This will take 4 hours. Stir vigorously and maintain it a 35-40 degrees C.
3. While stirring raise the temperature to 60 degrees over 1/2 hour and keep it there for 1 more hour.
4. Allow to stand overnight.
5. Precipitate with cracked ice and cold water and filter.
- 6 This yields crude tetranitrocarbanilide - wash with water and air dry.
7. Add 10 grams of this to 16 grams of sulfuric acid mixed with 24 grams of nitric acid and heat on a steam bath for 1 hour with constant stirring.
8. Allow to cool to room temperature, drench in cracked ice and water, and filter.
9. Wash with 500cc of hot water and air dry.

## History, Design, and Manufacture of Explosives

It produces picric acid if warmed in dilute sulfuric acid, and trinitroaniline if boiled in ammonia and water. It has been used in primers, boosters, detonating fuse, and as a high explosive in armor piercing formulas. It explodes at 345 degrees.

### Mixed Aromatic Nitro Explosives

Many explosive mixes are produced using TNT and other aromatic nitros. In fact, TNT is far and away the most heavily produced explosive in the world today. The military and commercial buyers use it "as is", combined with other high melting powder explosives as a base in a binary slurry, or mixed into a binary with aluminum to form a high temperature ternary explosive.

Most military munitions are filled with TNT or TNT based slurry mixtures. These are usually melted and then directly pour-cast into the ordnance.

The most widely used binary munition has been "composition B". It is made by mixing water wet RDX to a melt of TNT at 95-100 C and then decanting the excess water while evaporating the remainder. Additives are included to increase the casting strength, and decrease sensitivity and exudation.

Composition B is the starting material for making aluminized explosives which burn at very high temperatures (7,000 C+). When ternary mixtures with aluminum are made, the aluminum is powdered and screened. This is then added to a melted RDX-TNT slurry and is stirred until the mix is uniform. Calcium chloride is added with a small amount of desensitizer and the mix is cooled to 85 C and then poured into its mold.

#### Aluminum based explosives include

Tritonals	TNT + Aluminum
Ammonals and Minols	TNT + Aluminum + Ammonium Nitrate
HBX's	TNT + RDX + Aluminum

#### Other explosive combinations include

Octols	TNT + HMX
Cyclotols	TNT + RDX
Pentolites	TNT + PETN
Tetrytols	TNT + Tetryl
Amatols	TNT + Ammonium Nitrate
Picratols	TNT + Ammonium Picrate

## History, Design, and Manufacture of Explosives

### Comparisons of High Explosive Combinations

	<u>Detonation Velocity Km/s</u>	<u>Explosive Energy as % TNT</u>		
		<u>Lead Block</u>	<u>Ballistic Mortar</u>	<u>Sand Mortar</u>
HBX 1	7.22		135	100
HBX 3	6.92		110	
H 6	7.19		135	105
Tritonal	6.7		130	95
Minol	6.2	165	145	95
<u>Explosives without aluminum</u>				
Composition B	7.9	130	135	120
Cyclotol 75/25	8.17		140	120
Octol 75/25	8.38			
Pentolite 50/50	7.52	120	135	125
Amatol 80/20	5.2	125	130	80

# History, Design, and Manufacture of Explosives

## Chapter 5

### Nitramines

Nitramines are made by nitrating a nitrogen base or salt. This is usually done by treating the nitrogen material with sulfuric acid first, and then adding nitric acid.

The most important commercial and military nitramine explosives are

<b>RDX</b>	Cyclotrimethylenetetranitramine (cyclonite)
<b>HMX</b>	Cyclotetramethylenetetranitramine
<b>NQ</b>	Nitroguanidine (which we briefly covered in chapter 1)
<b>Tetryl</b>	which is considered to be a nitroaromatic as well and was covered in the last chapter.

### RDX and HMX

**Cyclotrimethylenetetranitramine (RDX)** also known as "Cyclonite, Hexogen, and T4" . It is prepared from the basic raw materials of Coke, Air and Water which are used to form ammonia and formaldehyde which we have described earlier.

The formaldehyde and ammonia are mixed together in water and then evaporated together. This yields the compound "**Hexamethylenetetramine**", also known as Methanamine, Hexamine, and Urotropine. It has found uses as an oral medication, in vulcanization of rubber, and in plastics manufacture.

The Hexamethylenetetramine can be nitrated directly to yield a hydrated nitrate. This nitrate can be further directly nitrated to yield the RDX. By cooling the hexamine during the reaction, it was discovered that both nitrations could be accomplished in one step in what is called the direct nitrolysis or "Woolrich" process.

1. Nitric acid (550 grams of 100%) is maintained at 30 degrees or less. 50 grams of the hexamine is added slowly over 15 minutes while keeping the reaction cool.
2. The mix is then cooled to 0 degrees C and then held there for at least 20 minutes.
3. The mix is then drowned in water.

The cyclonite is formed as white crystals which melt at 202 degrees C. It is insoluble in alcohol, water, and ether. It is soluble in hot aniline, nitrobenzene, phenol and ethyl benzoate. It is partially soluble in hot acetone, from which it can be precipitated as it cools in the form of transparent prisms with excellent filtering and handling characteristics.



## History, Design, and Manufacture of Explosives

When the cyclonite is formed in the above mix, some formaldehyde is liberated by the reaction which is oxidized by the nitric acid if allowed to stand or become warm. It is also hard to separate out the formaldehyde from the nitric acid so the acid can be reused.

A newer process called the Bachmann process uses a partial nitration with the addition of ammonium nitrate. This results in less loss of formaldehyde and results in yields of 80-84% RDX and also yields 5-10% HMX.

1. A solution of 1 part hexamine is mixed with 1.65 parts acetic acid, and a solution of 1.5 parts ammonium nitrate is dissolved in 2 parts nitric acid.
2. These are added continuously to two stainless steel, jacketed mixers which are temperature controlled (65-72 C). At the same time, 5.2 parts of acetic anhydride is also added. The mixture is cycled in a loop between the 2 reactors.
3. A slurry overflow of RDX from the 2nd reactor feeds continuously into the first of 3 aging tanks at 65-72 C and takes about 24 minutes to pass through all three.
4. The aged slurry then passes to the first of 7 temperature controlled simmer tanks. Dilution liquor is added to the first tank to yield an acetic acid concentration of 63%.
5. The hot slurry moves through the tanks while gradually cooling. This precipitates the RDX and hydrolyzes the undesirable by products.
6. The Acetic Acid and RDX slurry is filtered and water washed. The spent acetic acid is recovered and fortified for reuse.
- 7 The RDX is recrystallized from cyclohexanone with the crystal sizes controlled to produce the castable slurries with TNT.

RDX can also be produced by the continuous "Biazzi" process where the hexamine and nitric acid are fed continuously into a series of jacketed, freon cooled (refrigerated), stainless steel nitrators. The mix from the last nitrator is fed to a series of decomposers which take the decomposition products and form nitrous gases which are converted to 55% nitric acid in a later stage after the RDX is separated in a vacuum filter. The gases are collected in a gas absorption unit and scrubbed to form the acid which is recycled. The RDX is water washed and purified.

The HMX can be produced in quantity by the Bachman process describe above. The first reactor contains the acetic acid in which the other 2 mixes are added (hexamine in glacial acetic acid and ammonium nitrate in nitric acid) and it is mixed at 44 C instead of the 68 C for RDX. When the HMX slurry moves to the aging tanks, it is held at 44 C for 30 minutes and then transferred to the simmer tanks. Here the concentration is reduced to 80% acetic acid. Upon dilution, the temperature is raised to 110 C to decompose the by products and to improve the HMX crystals form so that they filter easier.

## History, Design, and Manufacture of Explosives

The slurry is then filtered at 60 C which keeps the RDX that is present in the mix in solution. The filtered liquid contains about 99% HMX which are washed with cold water and recrystallized from acetone, cyclohexanone, or both. This converts the crystals to the higher density beta form and makes the particle sizes better for mixing into castable explosives. The RDX is recovered and purified for use in other explosives.

RDX and HMX are both powerful high explosives. They are less toxic than TNT and can be handled safely with only a minimum of precautions. Both detonate to form mostly low molecular weight gaseous by products (no solids formation) which are generally not toxic in enclosed areas. They are less sensitive to impact than PETN.

HMX is the most powerful commercially produced solid high explosive produced in volume for the military today. Its detonation velocity is app. 8,500m/s. Although they are sensitive to shock and friction and can be detonated by a 2 Kg weight dropped 9 inches, they can be mixed to desensitize each of them.

RDX is mixed with TNT to form the "cyclotols"

HMX is mixed with TNT to form the "octols" or PBXN-5 Hi Performance explosives

60% RDX , 40% TNT (1pt wax) form Composition B & accounts for most of RDX use

91% RDX and 9% wax is mixed to create Composition A3

Both are coated with waxes, elastomeric binders, and synthetic polymers to make them safer to handle "as is".

Both require about .2 gram of mercury fulminate to detonate in the final form.

## History, Design, and Manufacture of Explosives

An improvised explosive (HMTD) may also be prepared from hexamethylenetetramine

### HMTD Primary Explosive

HMTD is a primary explosive that can be made from hexamethylenetetramine, hydrogen peroxide, and citric acid. This explosive is to be used with a booster explosive such as Picric Acid or RDX in the fabrication of detonators.

#### Material Required

Hexamethylenetetramine

Hydrogen Peroxide

Citric Acid

Containers

Paper towels

Teaspoon

Pan

Water

Tape

#### Sources

Drugstores as Urotropine, Hexamin, Methenamine. Army heat tablets, camping or chemical suppliers  
Improvised from reaction of Ammonia on formaldehyde

6% hair bleach or pharmaceutical store  
Drug stores

#### Procedure

1. Measure 9 teaspoons of hydrogen peroxide into a container.
2. In 3 portions, dissolve 2.5 teaspoons of crushed hexamethylenetetramine in the peroxide.
3. Keep the solution cool for 30 minutes by placing container in a pan of cold water.

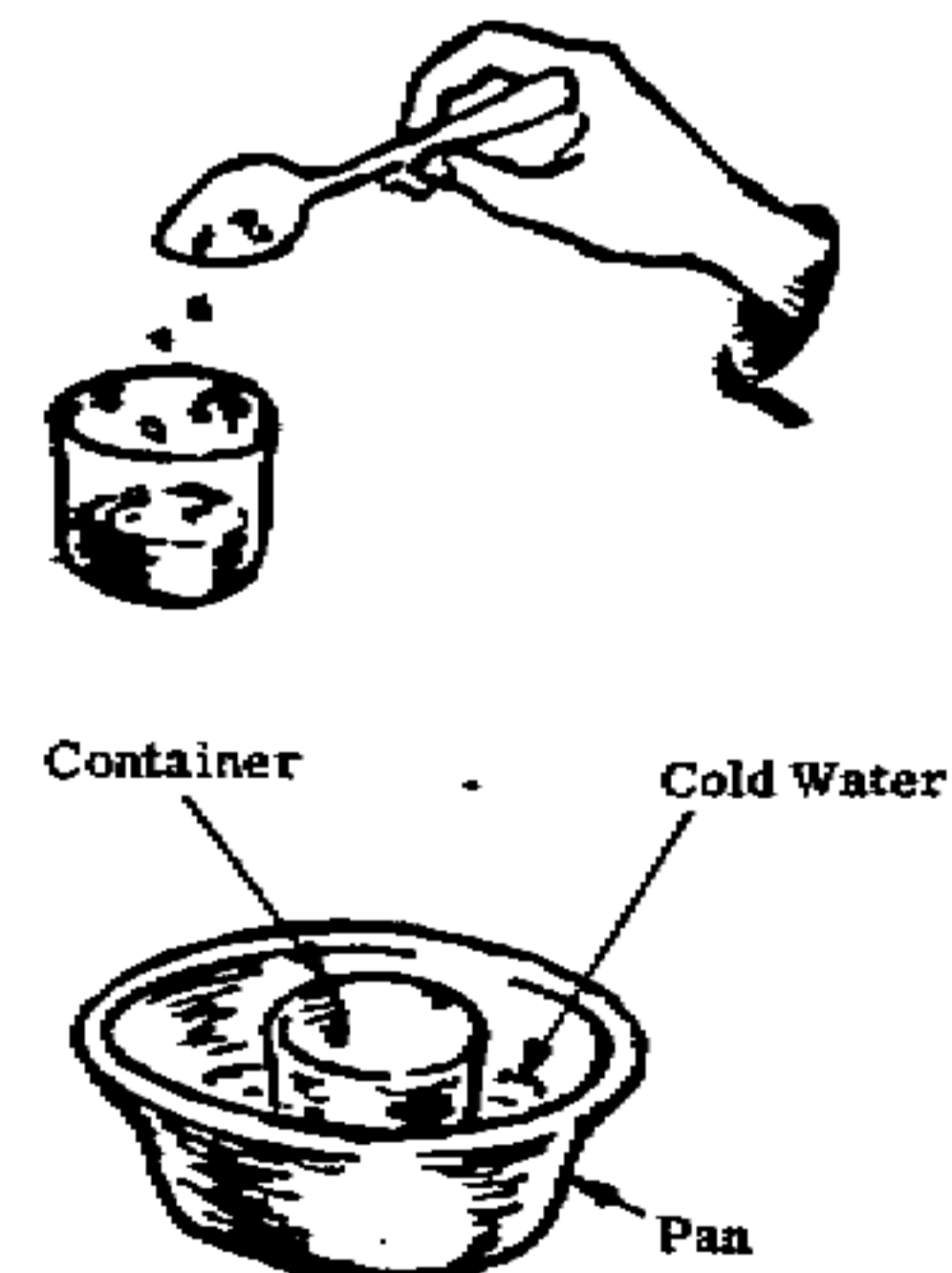

## History, Design, and Manufacture of Explosives

4. In 5 portions, dissolve 4.5 teaspoons of crushed citric acid into the solution.

5. Permit solution to stand at room temperature until solid particles form at the bottom of the container.



**Note:** Complete precipitation requires 8-24 hours

**Caution:** At this point the solution is a primary explosive. Keep away from flame

6. Filter the mixture through a paper towel into a paper to collect the solid particles.

7. Wash the solid particles collected in the paper towel with 6 teaspoons of water by pouring the water over them. Discard the liquid in the container.



8. Place these explosive particles in a container and allow to air dry.

**Caution:** Handle dry explosives with great care. Do not scrape or handle roughly. Keep away from sparks and open flame. Store in a cool dry place.

## History, Design, and Manufacture of Explosives

### Guanidine Nitrate and Nitroguanidine

Guanidine nitrate is an explosive, it is used in explosive mixtures, and is used to make the more powerful nitroguanidine. Guanidine is a combustible that can ultimately be derived solely from the air. It is a strong base with properties similar to caustic potash (potassium hydroxide).

Urea (carbamide) is the white crystal recovered from urine and has been used in the manufacture of explosives for centuries. It is now massed produced in enormous volumes for use as lawn and crop fertilizer by reacting liquid ammonia and liquid carbon dioxide under pressure (1700-3000 psi), and heat (160-200 C) which yields ammonium carbamate. When the pressure is dropped to 80 psi it decomposes to urea and water and the urea is recovered by dehydration.. Both the ammonia and CO<sub>2</sub> are derived from the air by chemical processing.

Guanidine is produced by treating urea with ammonia under high pressures which allows its mass production in large volumes, and with all its chemical parts from the air. It can also be derived from other chemical combinations.

1. By heating a solution of calcium cyanamide and ammonium iodide and removing the calcium iodide salt.
2. Reacting chloropicrin with ammonia water at 150 degrees C.
3. Reacting carbon tetrabromide or cyanamide with alcoholic ammonia at 100 degrees C under pressure in a sealed tube..
4. Cyanamide plus an ammonium salt placed in a sealed tube with alcohol at 100 C.
5. By heating ammonium thiocyanate at 170-190 degrees for 20 hours or until the last of the hydrogen sulfide comes off. Guanidine Thiocyanate is formed in good yields. It is deliquescent (turns into a liquid by absorbing moisture from the air) and dissolves filter paper.

This last method was used to make nitroguanidine in the early years by nitrating in mixed acid. It would contain traces of sulfur compounds that could not be easily processed out and these attacked nitrocellulose which eventually eliminated its potential use in smokeless powders.

Cyanamide offers large scale guanidine production opportunities because it can be made by heating coke and limestone (calcium carbonate) in an electric furnace. This yields calcium carbide which is heated to 800-1000 degrees and fed into a stream of nitrogen gas (with added calcium chloride as a catalyst). This results in a dark mixture of calcium cyanamide and lime nitrogen. By adding water to this, and an acid to react with and remove the calcium, a solution of dicyandiamide is produced.

## History, Design, and Manufacture of Explosives

[By treating the dicyandiamide with hydrogen sulfide, part of it forms thiourea which is used by the rail car in the rubber industries]. The crystals precipitate from the water in easy to handle large needles or plates and melt at 208 degrees C.

The dicyandiamide can be mixed with 61% sulfuric acid to form guanylurea which hydrolyzes to CO<sub>2</sub> gas, guanidine sulfate and ammonia sulfate. This is directly nitrated to form guanidine nitrate which was then used to directly nitrate (in mixed acid) and produce a nitroguanidine without the impurities. This could now be used for nitrocellulose powders.

The above process was expensive in mixed acid cost and in the early 1920's, a way was found to yield guanidine nitrate directly from dicyandiamide and ammonium nitrate.

1. One mol of dicyandiamide and two mols of ammonium nitrate are mixed, heated, and melted at 160 C.
2. A colorless liquid of guanilguanidine forms as a melt, and then begins to precipitate crystals of guanidine nitrate.
3. Heat for 2 hours at 160 to a complete and solid mass of 100% converted guanidine nitrate.

Some ammonia comes off the reaction and interferes with the reactions. A slight excess of ammonium nitrate is usually used to counter this effect. The process may also be done with water or alcohol as the solution rather than the dry state.

The lab procedure for this process is -

1. 440 grams of ammonium nitrate and 210 grams of dicyandiamide is mixed and placed in a 1 liter round bottom flask.
2. The flask is placed in an oil bath and heated to 160 degrees where it remains for 2 hours
3. The flask is then removed, allowed to cool and then melted into hot steam and water.
4. This solution is filtered while hot to remove insoluble ammeline and ammelide, and then boiled down to a liter (to salt out), and allowed to cool and crystallize.
5. This last process is repeated with small amounts of hot water used to dissolve and then filtering and cooling to yield purer crystals. The small amount of contaminating ammonium nitrate is allowable because it is removed by sulfuric acid in the preparation of nitroguanidine.

Guanidine nitrate is soluble in water and alcohol and insoluble in ether. It melts at 215 C.

## History, Design, and Manufacture of Explosives

**Nitroguanidine** exists in two forms, which have different methods of production. They behave the same explosively, but produce crystals with different handling characteristics.

***a*-nitroguanidine** is produced from guanidine nitrated that is dissolved in sulfuric acid and is then poured into water. This is the form usually used in explosives. It precipitates from water as long, thin, flat, lustrous, needles that are hard to grind to a powder.

1. 500 cc of concentrated sulfuric acid is placed in a 1 liter beaker which is placed in cracked ice to cool.
2. 400 grams of guanidine nitrate is added a little at a time while stirring and maintaining the temperature at 10 C or less.
3. Once all the crystals have dissolved, the now milky liquid is poured into 3 liters of cracked ice and water and allowed to stand until all the crystals have precipitated.
4. The product is collected on a filter, rinsed to remove sulfuric acid, and dissolved in boiling water. This stands overnight as the pure crystals precipitate on cooling.

The yield is about 300 grams or 90% of theoretical. This process yields small coarse needles that cannot be easily colloided in nitrocellulose powders. Commercial production is accomplished by spraying the hot solution on a cold metal surface and continuously scraping off, or simply spraying down a tall cooling tower through cold air. This yields a tiny, fine powder suitable for use in smokeless powders.

***b*-Nitroguanidine** is produced by nitrating a mix of guanidine sulfate and ammonium sulfate which is the result of the hydrolysis of dicyandiamide (described earlier) by sulfuric acid. It crystallizes from water as small fernlike clusters of thin elongated plates. It can be converted to the alpha form by dissolving in sulfuric acid and pouring into water.

Both forms of nitroguanidine melt at 232 C if heated slowly and decompose almost immediately. They are very soluble in hot concentrated sulfuric acid of 45% or more, but become very insoluble as the solution is cooled and diluted with water. They are insoluble in water. On reduction in water, they are converted to nitrosoguanidine, then aminoguanidine, which is used in the manufacture of tetracene. Both are interesting explosives.

## History, Design, and Manufacture of Explosives

### Preparation of beta-nitroguanidine

1. Place 20 grams of dicyandiamide in a 300 cc round bottom flask equipped with a reflux condenser.
2. Pour 25 cc of 61% aqueous sulfuric acid into the flask which heats up and froths
3. Once the reaction has subsided, heat in an oil bath at 140 C for 2 hours.
4. Add 20 cc fuming nitric acid to 10 cc of sulfuric acid and chill to ice cold.
5. Chill the reaction mass (steps 1-3) in ice. Then add the ice cold mixture (#4).
6. Once the red fumes subside, heat the mixture for 1 hour in a boiling water bath.
7. Allow to cool, and drown with 300 cc of cracked ice and water.
8. Collect the precipitate on a filter, rinse with water to remove acid, and recrystallize from fresh water.

When nitroguanidine explodes, it produces solid decomposition products while are seen as a lot of gray smoke. The gas smells from ammonia and nitrocellulose powders produce more smoke from this than from other powders.

### The advantages of nitroguanidine are

1. It produces no flash or visible light when it explodes. Because it produces so many cool gases, it produces flashless propellant powders when included in nitrocellulose formulas. It has found wide use in this regard worldwide and is usually added to nitrocellulose at 10-15%. In formulas of 100% detonated with blasting caps, it yields no visible light.
2. Nitroguanidine burns at very low temperatures which has many advantages.

First, the low temperatures are partly responsible for the flash reduction. This is because the decomposition gases dilute and carry away heat.

Secondly, the low burning temperatures drastically reduce the erosion of firing guns. Every time a gun is fired, the heat and pressures of the explosions cause small amount of barrel erosion. This is due to the combination of higher temperatures and chemical corrosion. Tests at the turn of the century reveal the differences when using different explosive propellants.



## History, Design, and Manufacture of Explosives

Losses are calculated at mm of metal. Force was recorded on a crusher gauge.

<u>Explosive</u>	<u>Grams</u>	<u>PressureKg/Sq.m.</u>	<u>Metal erosion-gms</u>	<u>Force</u>
Poudre BF	3.45-3.55	2,143-2,403	20.1-25.5	9,600
Cordite	3.55	2,500	64.2	10,000
Ballistite	3.47-3.55	2,360-2,509	83.2-90.2	10,000
Military-Black	10.0	2,167	22.3	3,000
Sport-Black	8.88	1,958	40	3,000
Blasting Gelatin	3.35	2,458	105	10,000
Nitromannite	3.54	2,361	83.5	10,000
Nitroguanidine	3.9	2,019	8.8	9,000

The exploding temperature of nitroguanidine was found to vary depending on the density of loading. As it is compressed, its density increases and its detonating temperature rises from a low of 907 C to a high of about 2,098 C.

Ammonium Nitrate	1,125 C	
NO-explosive	2,970 C	(78.7% amm. nitrate, 21.3% TNT)
N4	1,725 C	(90% amm. nitrate, 5% trinaphthalene 5% potassium nitrate)

Nitroguanidine detonates completely when initiated by 1.5 grams of mercury fulminate. It has been incorporated in mortar formulas at 50% NG, 30% ammonium nitrate, and 20% paraffin.

The explosive pressures produced in Kgs/ sq.cm. at different loading densities have been determined for NG and guanidine nitrate.

<u>Density of Loading</u>	<u>Guanidine Nitrate</u>	<u>Nitroguanidine</u>
.15	1,083	1,435
.2	1,486	2,091
.25	2,098	3,080
.3	2,941	4,078
.35	3,699	N/A

**Nitrosoguanidine** is produced by the reduction reactions of nitroguanidine. It is a very sensitive, cool, flashless explosive that will not burn or injure the body in small amounts making it a very safe primer to handle. It is a pale yellow powder that detonates on contact with sulfuric acid or being heated to 165 C. A blow from a carpenters hammer will set it off. It can be stored indefinitely if kept dry and cool.

## History, Design, and Manufacture of Explosives

It is prepared by

1. Adding 250 cc of water to an 800 cc beaker. Then stir into the water, 21 grams of nitroguanidine, 11 grams of ammonium chloride, 18 grams of zinc dust, while keeping the mix in ice and keeping the temperature of reaction below 20-25 C.
2. After about 2 hours the gray color of the zinc disappears, the mix turns yellow and the beaker is cooled by placing in a mix of ice and salt.
3. Once cooled to 0 C., filter the mix and discard the liquid filtrate.
4. The yellow residue is a mix of nitrosoguanidine and zinc oxide/hydroxide and zinc chloride.
5. These contaminants are removed by 4 successive water extraction's (250 cc) at 65 C.
6. The combined extracts are allowed to stand overnight at 0 C.
7. The deposited nitrosoguanidine is collected, rinsed with water, and dried at 40C.

An interesting demonstration can be done with material.

Place .5 gram on the back of your hand in a dark room. Light a match and let it burn till the head is red hot. Shake the match to extinguish it, and touch the explosive with match head. It explodes with noise and no visible flash. It causes no injury to the hand.

Other nitramines considered potentially useful explosives include

**Nitroamide** is considered the simplest nitroamine. It is most easily made by first nitrating urethane and then reacting it with an alcoholic potassium to yield potassium nitrocarbamate. This is then treated with dilute acid to produce nitroamide. It also occurs in volume when ammonium nitrate (or a mixed solution of nitrourea and nitroguanidine) is dissolved in concentrated sulfuric acid and allowed to stand. It explodes on contact with sulfuric acid making it easily initiated by this method. It decomposes to nitrous oxide and water on standing and has no shelf life, which is why it has no useful applications.

## History, Design, and Manufacture of Explosives

**Methylnitramine** is produced by

1. nitrating methylurethane with 100% nitric acid, drowning in water, neutralizing with sodium carbonate, and extracting with ether to yield methylnitrourethane. Ammonia gas is bubbled into the ether solution and stirred to produce ammonium methylnitramine. This is dissolved in alcohol, and boiled to drive off the ammonia and concentrate the solids. These are then vacuum dried over sulfuric acid to yield the pure methylnitramine.
2. Mixing ammonia water or barium hydroxide with dinitromethyloxamide.
3. Reacting aniline with tetryl in benzene.

Methylnitramine is a strong acid, soluble in water, benzene, and alcohol, and less soluble in ether from which it precipitates as flat needles. It melts at 38 C, and distills to dimethylnitramine which melts at 57 C. It explodes on contact with concentrated sulfuric acid.

**Ethylenedinitramine** is produced by nitrating ethyleneurea in mixed acid, or refluxing dinitroethyleneurea with water. It melts at 175 C, and is an acid that reacts to explosive salts. It is insoluble in cold water and does not decompose in it. It explodes at 180 C reliably making it a heat sensitive initiator like mercury fulminate or nitroglycerin. It has about the same sensitivity to shock as picric acid.

**Dinitromethyloxamide** is made by first mixing methylamine with an alcohol oxalate to yield dimethyloxamide. This is then dissolved in chilled nitric acid, and then adding fuming sulfuric acid and then pouring the entire mix into ice.

It is slightly soluble in water and ether, and soluble in alcohol from which it crystallizes on evaporation. It melts at 124 C and decomposes slightly higher. It is very stable in storage at high temperatures but becomes acid with any moisture which creates storage and stability problems. It must be kept dry in sealed containers.

When mixed at 30% with 70 % PETN, it forms a eutectic which melts at 100 C and can be poured into shells or other castings. These cast explosives detonate at 8,500 m/s making it one of the most powerful explosives. The melting point can be lowered to 82 C by adding 10% dimethyl oxalate or camphor. This detonates at 7,900 m/s, which is greater than cast picric acid.

## History, Design, and Manufacture of Explosives

**Dinitromethylsulfamide** is made by first mixing methylamine and sulfur chloride in chilled absolute ether to produce dimethylsulfamide. This is added in one part, to 10 parts of 100% nitric acid and then drowned in water. It is soluble in water and hot alcohol, and moderately soluble in benzene from which it is crystallized. It melts at 90 C, explodes at 160 C, and can be mixed with PETN to produce pourable, cast explosives.

**Urea Nitrate**, and other explosives made from **urea** are important because they burn at low temperatures, and they can be produced in massive amounts from the air. Some 100 million tons of urea are produced each year in the US alone. It is made from the air by heating ammonia and CO<sub>2</sub> together under pressure making it one of the least expensive, mass produced combustibles known.

It has the special property of being slightly soluble in cold water and is able to react with nitric acid to form nitrates and precipitate when a mix of dissolved urea in water are treated with an excess of nitric acid and chilled. The urea nitrate crystals melt at 152 C with decomposition, but is stable and does not draw moisture. It becomes corrosive if mixed with moisture.

It is a powerful explosive that burns without flash and has been added to blasting mixtures for to lower the temperature of the explosions and to stabilize powders.

**Nitrourea** is also a cool and powerful explosive that has not seen widespread use because it decomposes spontaneously when exposed to moisture. It breaks down rapidly to cyanic acid, ammonia, and nitroamide when warmed in contact with water.

It is prepared by mixing 200 grams of urea nitrate to 300 cc of sulfuric acid while stirring and keeping below 0 C in an ice bath. The resulting milky mixture is quickly poured into a mix of ice and water. The fine, white, precipitate is vacuum filtered as dry as possible and then immediately dissolved in boiling alcohol. The acid that is still in the crystals keep it from decomposing in the boiling alcohol. On cooling, pearly leaflets of nitrourea precipitate. The mix is chilled, filtered, rinsed with cold alcohol, and air dried. If the purifying is repeated, the alcohol cannot be heated above 60 C or it will decompose the explosive.

The final product melts at 146-153 with decomposition, and can be stored for years if kept completely moisture and alkali free. It can be recrystallized from benzene, ether, and chloroform. It decomposes rapidly in water. It reacts with alcohols at 120-130 C to form urethanes.

## History, Design, and Manufacture of Explosives

The US Army describes the following improvised method of making urea nitrate explosive in the field.

### Urea Nitrate Explosive

Urea nitrate can be used as an explosive munition. It is easy to prepare from Nitric Acid and urine. It can be detonated with a blasting cap.

#### Material Required

Nitric Acid 90%  
Urine  
2 one gallon heat and acid resistant containers  
Filtering material  
Aluminum powder  
Heat source  
Cup and spoon for measuring  
Water  
Tape  
Blasting Cap  
Steel Pipe and end caps

#### Source

Supply house, field improvised from Niter  
Human or animal discharge (undiluted)

Paper towel or fine textured cotton cloth  
Paint stores

**Note:** Prepare mixture just before use.

#### Procedure

1. Boil a large quantity of urine (10 cups) to app. 1 cup in volume in one of the containers over the heat source.
2. Filter the urine into the other container through the filtering material to remove impurities.

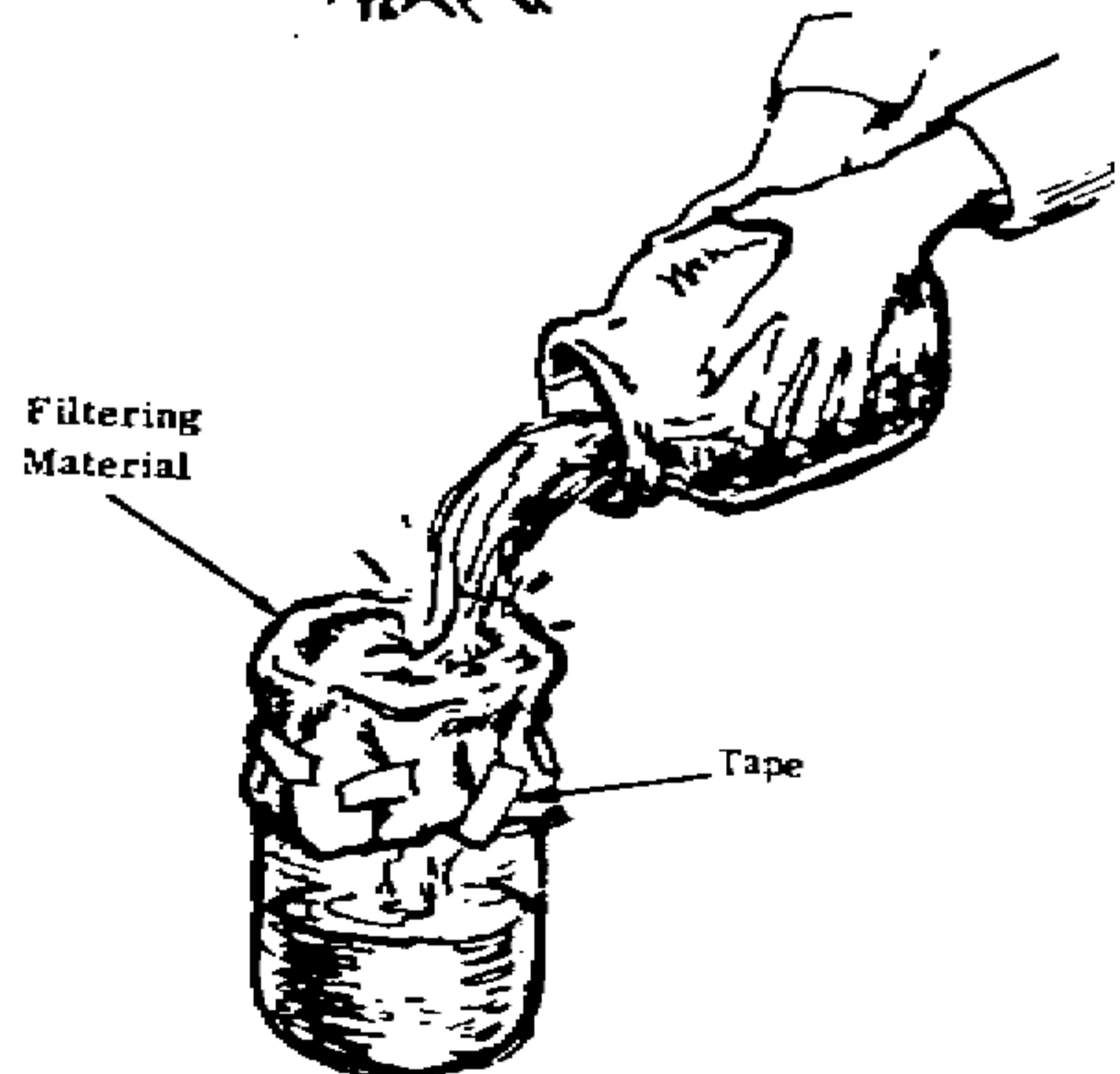

## History, Design, and Manufacture of Explosives

3. Slowly add 1/3 cup of nitric acid to the filtered urine, and let mixture stand for 1 hour.

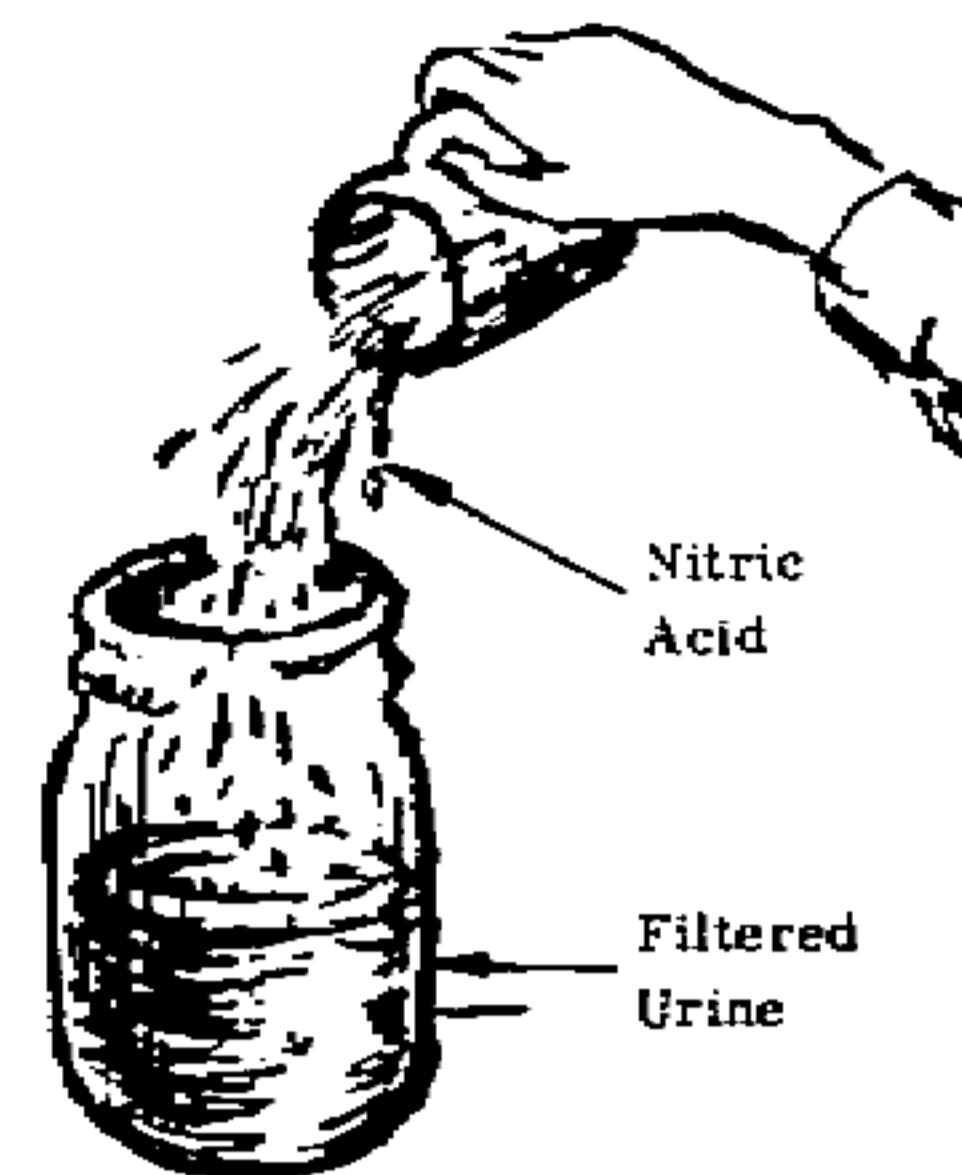

4. Filter mixture as in step 2. Urea nitrate crystals will collect on the paper.

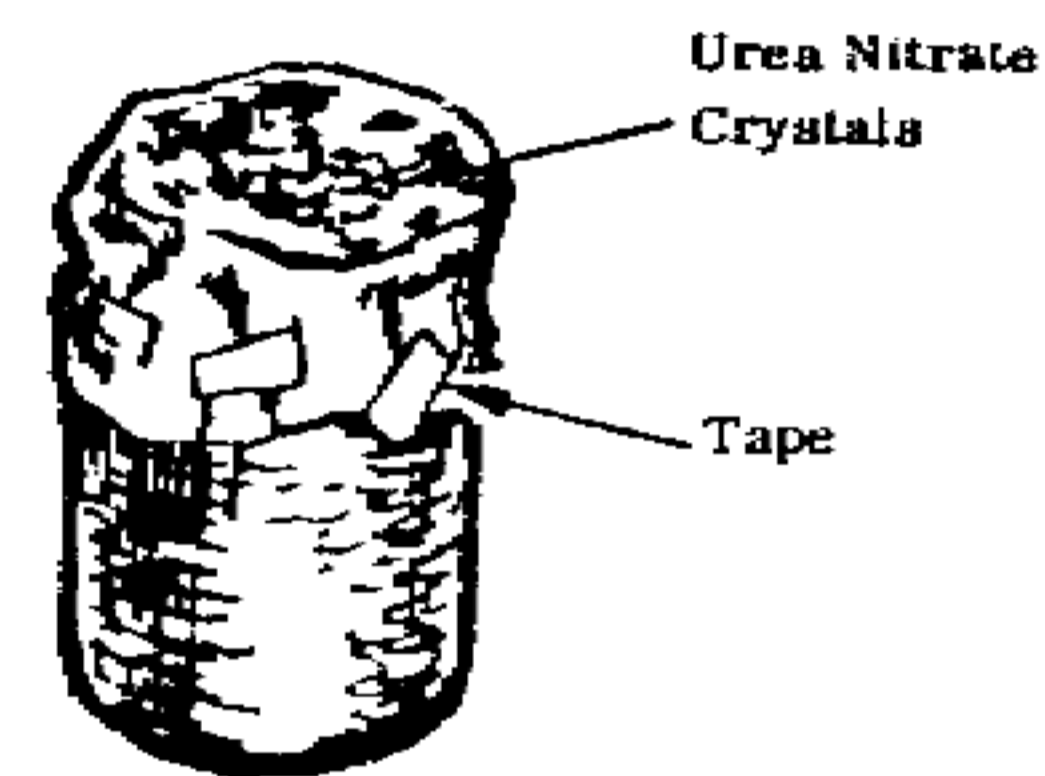

5. Wash the urea nitrate by pouring water over it.

6. Remove urea nitrate crystals from the filtering material and allow to dry thoroughly (app. 16 hrs.).

**Note:** Use a hot (not boiling) bath to dry in 2 hours.

### How to use

1. Spoon the urea nitrate crystals into an iron or steel pipe with an end cap threaded on one end.

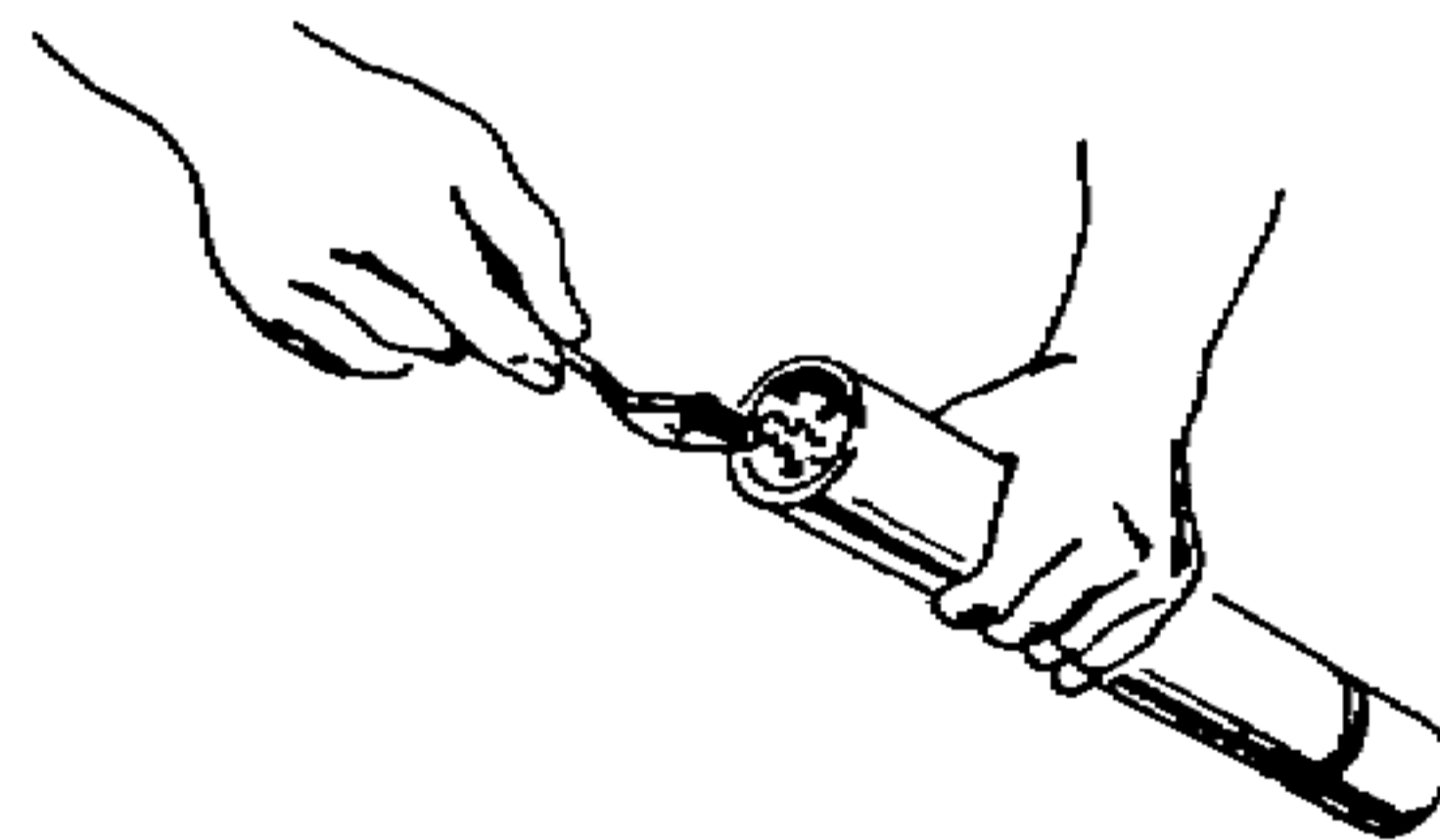

2. Insert blasting cap just beneath the surface of the urea nitrate crystals.

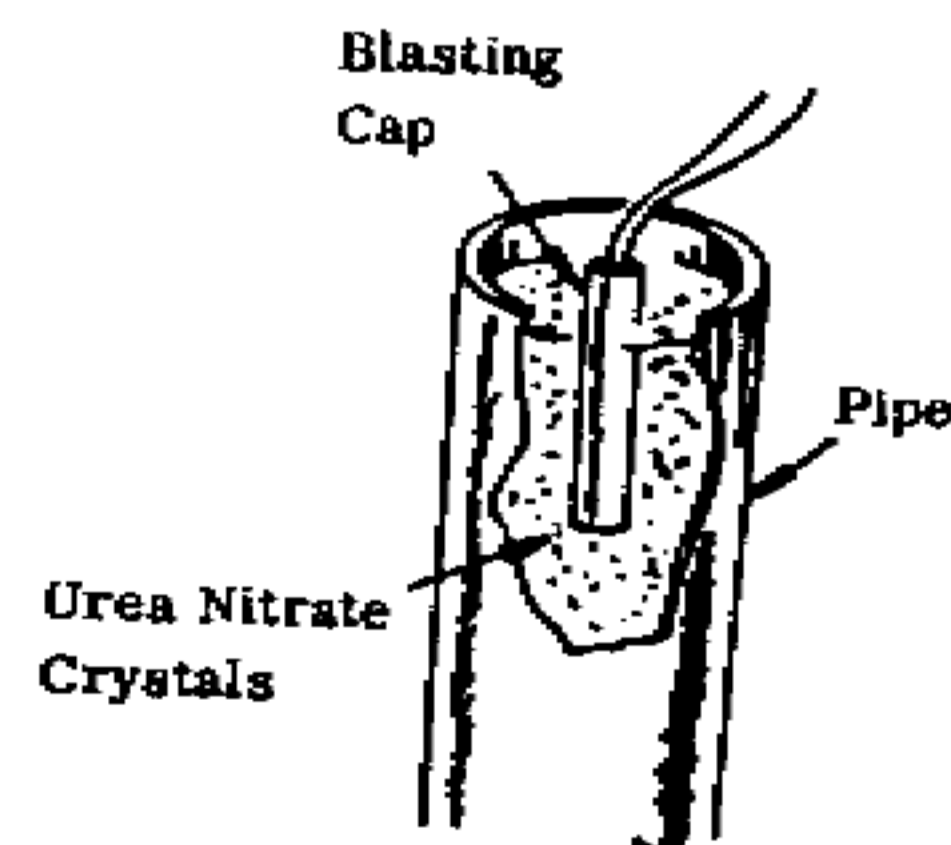

Option: 3. Add and mix 1 cup Aluminum Powder to 4 cups Urea Nitrate to make a more powerful explosive.

Confine end of explosive leaving no open space for maximum power of detonation.

# History, Design, and Manufacture of Explosives

## Chapter 6

### The rest of the High Explosives

The remaining chemical explosives fall into the category of initiators, primers, and detonators (which we will cover in chapter 7) , or could be considered in a wide range of other classifications. It is easier to lump them all together in this chapter and describe their different properties.

### The Dynamites

**Dynamite** was invented by Alfred Nobel and patented in 1863. It was a result of many experiments to make nitroglycerin safe. He had already experimented with mixing small amounts of NG into black powders and saltpeter but could not add the large amounts he wanted to because the powders needed to be dry and granular. He also found that the NG slowed down the rate of burning. He experimented with hundreds of substances to find improved combinations that would be useful and sellable. He could detonate the NG with a black powder firecracker but wanted to find a final mix that would not detonate easily without a "blasting cap".

One of the early discoveries he made was that he could use NG as a protective coating in saltpeter that uses sodium nitrate. The sodium nitrate could not be easily used before this because it would draw moisture from the air and deteriorate the powder. By adding a coating of the NG, it would seal the moisture out and make it a stable, dependable explosive. Because NG was non-hygroscopic and insoluble in water, Nobel felt he could find some solid material that would absorb the NG and still have the water repelling and explosive properties.

By 1867, he received his patent for accomplishing this. He had mixed NG with charcoal as an absorbent, and then tried diatomaceous earth (guhr or fullers earth). This would become known as **guhr dynamite**. He found he could absorb a mix of 75% NG into about 25% guhr and the NG was substantially desensitized. This dynamite could be ignited under confinement with an electric spark or fire from a match or fuse. Nobel wanted something that could ignite his new invention under any and all conditions and this led to his development of a special exploding cap or "blasting cap". This was originally a charge of mercury fulminate crimped tightly on the end of a fuse. The initiating shock wave from the explosion of the confined fulminate was powerful enough to detonate dynamite under nearly all conditions (except freezing).

The guhr dynamite was much safer to handle than the NG from which it was made. In its paper cartridges, it is detonated by cartridge to cartridge and could be detonated by rifle bullets. The velocity of detonation increases in the dynamites as the density of the loading and the diameter of the charge are increased.

## History, Design, and Manufacture of Explosives

Several tests show that

At a density of loading of 1.3 NG guhr dynamite achieved a velocity of 5,650 m/s.

Under the same conditions, Nitroglycol guhr dynamite achieved 6,000 m/s.

At density of 1.5, the NG guhr dynamite achieved 6,650-6,800 m/s.

To detonate adjacent cartridges, the guhr dynamite produced the following results.

Guhr dynamite of 30mm diameter will detonate cartridges at 30cm distance.

Regular 40% dynamite at 1.25" diameter detonated cartridges at 16" distance.

Some of the other observed characteristics include-

Liquid water contacting the guhr dynamite was absorbed by the absorbent and displaces the NG which separates into an oily liquid. This liquid could be easily detonated if it seeped out of the cartridges and into fissures in mines, and if struck by a drill or pick, would cause serious catastrophes.

If a small amount of the dynamite were set on fire in the open, it would burn without detonating. It needed to be confined to explode.

It wasn't long before Nobel realized that he could make more powerful dynamite by finding explosive bases that would absorb his NG and form solid mixtures. The early explosive dynamites involved materials that were usually not explosive by themselves. These included mixtures with potassium, ammonium, and sodium nitrates which were mixed with wood meal, sugar, starch, rosin, and the charcoal mentioned earlier. The nitroglycerin would form a coating on these solid substances and could cause them to detonate when initiated with the fulminate.

One of the earlier patented formulas used the example of

Barium or other Nitrate salt	70%
Rosin or Charcoal	10%
Nitroglycerin	20%
Sulfur could be added in various amounts	



## History, Design, and Manufacture of Explosives

The other nitrate salts in the above formula had the problem of separating in warm and humid conditions and would form exudates that would self detonate from friction such as shaking in a bag or rough handling. To solve this problem, Nobel experimented with a number of materials and found that he could coat the final mixed particles and prevent the absorption of the moisture and the exudation problem. Most of these materials were fatty acids or substances with similar properties that exist as solids at normal temperatures. These included naphthalene, stearine (or stearic acid), mineral or fossil wax, and paraffin.

The dynamite that was manufactured with an "active" base became known as **straight dynamite**. This was based on the idea that all the components contributed to the explosion. The long term standard formula for straight 40% dynamite (that contained nitroglycerin) used by the US Bureau of Mines has been

Sodium Nitrate	44%
Nitroglycerin	40%
Calcium Carbonate	1% (antacid)
Wood Pulp	15% (added combustible)

A mixture of materials into the nitroglycerin beforehand to lower its freezing point yields a 40% non-freezing dynamite. This usually consisted of mixing a nitrated batch of glycerin, glycol, or glycerin and sugar, together, and then into the dynamite.

Most of the commercial formulas (pre-WW2) for the straight dynamites involved mixing

Nitric Esters at	20-60% absorbed on wood pulp
Potassium or Sodium Nitrate	40-80% to provide enough Oxygen to burn all the wood pulp

A low grade dynamite was invented that fell between straight dynamite and black powder in explosive power. It was called "**Judson Powder**" and was made by mixing ground coal, sodium nitrate, and sulfur and then heating them together until the sulfur melted. This produced a melt that cooled into hard grains which were broken apart, screened, and sized.

Nitroglycerin by itself can be frozen without affecting its ability to be detonated. Blasting gelatin becomes more sensitive on freezing. Straight dynamite becomes less sensitive to shock and detonation and this has been a problem. When it was thawed to make it usable, it would exude some of the NG which made it dangerous to handle. This resulted in efforts to produce the non-freezing dynamites and ethylene glycol dinitrate became the usual additive to accomplish this.

The dynamites were usually made by simply mixing the explosive oil (NG) with the absorbent. The loose, greasy mass that results, should not exude the NG if it is squeezed gently. The finished mix is filled into cartridges or cylinders that are wrapped in paraffined paper to keep moisture out and then dipped into paraffin wax to seal them.

## History, Design, and Manufacture of Explosives

The grades of dynamite were based on how much NG was included in the formula. The 40% standard was already described. If a dynamite was described as 40% ammonia dynamite, it was supposed to have the explosive equivalent of the 40% NG product. An example of formulas of different strength dynamites manufactured in the US in the early 1900's include

	<u>15%</u>	<u>20%</u>	<u>25%</u>	<u>30%</u>	<u>35%</u>	<u>40%</u>	<u>45%</u>	<u>50%</u>	<u>55%</u>	<u>60%</u>
Nitroglycerin	15	20	25	30	35	40	45	50	55	60
Sodium Nitrate	64	60	56	52	48	44	40	35	29	23
Combustible	20	19	18	17	16	15	14	14	15	16
Ca. or Mg Carbonate	1	1	1	1	1	1	1	1	1	1.

The combustible was usually a mix of sulfur, wood pulp, and flour. A more bulky formula that had a lower velocity of detonation might use rice hulls, saw dust, or wheat bran.

The velocities of detonation of these formulas in 1.25" cartridges were-

30%	4,548 m/s
40%	4,688 m/s
60%	6,246 m/s

The ammonia dynamites which incorporated ammonium nitrate used the wood pulp, flour, and sulfur mixtures as their combustibles. The low freezing versions would use nitroglycol or nitrosugar (in the US), or dinitrochlorohydrin, tetrachlorohydrin, or other nitric esters (in Europe).

	<u>Regular</u>					<u>Non-Freezing</u>				
	<u>30%</u>	<u>35%</u>	<u>40%</u>	<u>50%</u>	<u>60%</u>	<u>30%</u>	<u>35%</u>	<u>40%</u>	<u>50%</u>	<u>60%</u>
Nitroglycerin	15	20	22	27	35	13	17	17	21	27
Nitro Anti-freeze						3	4	4	5	6
Ammonium Nitrate	15	15	20	25	30	15	15	20	25	30
Sodium Nitrate	51	48	42	36	24	53	49	45	36	27
Combustible	18	16	15	11	10	15	14	13	12	9
Ca. Carb./Zinc Oxide	1	1	1	1	1	1	1	1	1	1

The combustibles could be charcoal, wood, or cereal meals.

## History, Design, and Manufacture of Explosives

Nobel would soon discover that by dissolving his NG into collodion cotton, it would form a stiff jelly. This new and powerful high explosive would become known as gelatin dynamite or "**blasting gelatin**". In cold weather, Nobel had to use a solvent such as acetone, ether-alcohol, or nitrobenzene to get the NG dissolved. He soon figured out that he could preheat (gently) the NG in a water bath and he could get good dissolving of the cotton colloid without the solvents.

**Blasting gelatin** is a yellowish, translucent, elastic mass that retains its explosive strength even with prolonged contact with water. It is less sensitive to shock, friction, and blows than the other dynamites. Its elasticity allows it to absorb blows without easily detonating, however, if it freezes, it loses this property and becomes a hard white mass which is more sensitive to shock.

The gelatin will catch fire easily from the flame or spark of a fuse and burns violently. If a large enough volume catches fire, it will turn into a runaway explosion (even if it is frozen).

The physical state of the explosive affects its explosive properties. A powdered mixture is usually easier to detonate and transmit detonation to other explosives over greater distances. If they are tamped to a greater density, this effect is increased. Liquid explosives are the next easiest to detonate and transmit explosive force. The colloids are the toughest to detonate and the stiffer the mass, the more difficult it becomes. The solid, larger aggregates can be very hard to initiate.

The formula of the blasting gelatin affects its ability to be detonated.

93% NG and 7% collodion cotton is exploded by a #1 (weakest) cap. It transmits detonation in 25 mm cartridges 10mm away.

91% NG and 9% collodion cotton is exploded by a #4 cap. It will not detonate adjacent cartridges without a #6 cap because of its tougher mass.

Nobel also experimented with making less expensive blasting gelatins to sell by mixing his gelatinized NG with other oxidizer nitrates and chlorates, or with black powder directly. To this he would add cheap combustibles such as coal dust, sawdust, sugar, starch, rosin, and sulfur. This resulted in the first **gelatin dynamites**.

One of his typical low cost gelatin dynamites would consist of

Nitroglycerin	62.5%
Saltpeter	27%
Wood Meal	8%
Collodion Cotton	2.5%

## History, Design, and Manufacture of Explosives

These "plastic" masses would be made using a gelatin with only 2-5.4% collodion cotton instead of the straight NG and could be kneaded and shaped. These gelatin dynamites would be the forerunners of modern plastic explosives. The gel would be made by mixing NG and the collodion cotton and letting it stand at 40-45 C overnight. The remaining materials are then mixed into it. Low freezing nitric ester mixtures would replace the NG by 1915.

Formulas for gelatin dynamites include

	<u>30%</u>	<u>35%</u>	<u>40%</u>	<u>50%</u>	<u>55%</u>	<u>60%</u>	<u>70%</u>	<u>75%</u>	<u>80%</u>	<u>81%</u>
Nitroglycerin	23	28	33	42	46	50	60	70.4	75	75.8
Sodium Nitrate	62.3	58.1	52	45.5	42.3	38.1	29.6			
Potassium Nitrate								19.3	15	15.2
Collodion Cotton	.7	.9	1	1.5	1.7	1.9	2.4	4.6	5	5.2
Combustible*	13	12	13	10	9	9	7	4.7	4	2.8
Antacid	1	1	1	1	1	1	1	1	1	1

\* The combustibles usually consisted of 60-70% wood pulp, flour, rosin, sulfur, and grain meals. The antacids varied from chalk (calcium carbonate), magnesium carbonate, and other alkali powders (but not baking soda which attacks the explosives).

Most of these blasting explosives were developed to assist in the mining of coal and other valuable minerals. The blasting would often stir up so much coal dust that the combustible clouds of coal and oxygen would explode from the next blast. In addition, methane gases would often in the deeper mines and the explosive gas mixtures would detonate from the blast. After many serious mine explosions in the late 1800's and early 1900's, governments began to regulate the use of "permissible" explosives in mining. The science of developing new low temperature, non-flammable explosives had begun.

When methane is mixed with air in ratios of 5-14%, the amount of oxygen is in chemical balance with the fuel so that it can burn continuously and explode. At the 9.5% ratio, the balance converts to the greatest amount of hot gas and produces the most powerful (and hottest) explosions. This mixture would be ignited at 650-700 C and since all explosives generate temperatures higher than this, it was first believed that explosives could not be used at all. Then, in 1887, a scientist named Le Chatelier found that the methane mixtures would delay in the exposure to the higher temperatures before actually exploding.

At 650 C - 10 seconds to detonate  
 At 1,000 C - 1 second  
 At 2,200 C - Instantaneous

## History, Design, and Manufacture of Explosives

Only the 2,200 C temperature would always ignite the methane gases. Later, they found that they could go as high as 1,500 C in coal seams and 1,900 in bordering rock without igniting the gas mixtures. The reason that these temperature explosives could be used is that the flame produced at the center of the explosion lasts only a fraction of a second at its highest temperatures. The expanding gases quickly cool off and lower the temperature below the ignition point of the gas.

Black powder burns hot and slow and will always ignite dangerous methane gas mixtures. The search was now on for materials that produce cool gases and that could be added to explosives to make them safe in dangerous, combustible atmospheres. Also, by detonating the explosives in confined bore holes, the expanding gases would do more work by cracking rock and would substantially cool before escaping into the mine shafts where the combustible-air mixtures were located.

The first, and obvious way to produce a low temperature explosive that would not detonate methane or coal dust mixtures in air was to consider the low temperature gun propellants. Guanidine nitrate and nitroguanidine had already found use as low temperature propellants in artillery formulas. Ammonium nitrate, which burns at 950-1130 C depending on its physical state and initiation was the most economical explosive low temperature explosive but in the first part of the century was hard to formulate and initiate. It also contained an excess of oxygen which meant that it should be mixed with added combustibles to make it explode to its maximum potential.

[ Authors note: While writing this book, I have been asked by the readers if they will need to know chemistry or science to be able to understand it. As a consequence, I have attempted to write it to explain an understanding of the ideas that go along with the lab and manufacturing procedures. I include many formulations in the book where it is practical, because it is necessary for many of the explosive formulas to be in a chemical balance so all the oxygen combines with all the combustibles to produce gas or solids and not leave too much of either leftover. If there is too much combustible, you usually have a fire instead of an explosion. Too much oxygen can yield a fire, or either case in extreme may fail to ignite altogether, or the combustion gases of a started fire may extinguish itself. The point is that explosives are chemicals, and you cannot completely ignore the chemistry when attempting to build reliable explosive materials and devices.]

The second method of producing low temperature explosions involved adding materials that would lower the explosion flame temperature at detonation.

First, it was already known that black powder containing an excess of the carbon material (charcoal), would burn at lower temperatures. This is because more carbon monoxide would be produced than carbon dioxide resulting in more total gas volume for the same energy. This means cooler gases are formed.

## History, Design, and Manufacture of Explosives

Second, it was also known that by adding water physically or chemically to an explosive, that much of the explosive heat would be absorbed by vaporizing the water.

Thirdly, by adding salts or substances that would decompose in an explosion, they would absorb some of the heat into their own decomposition products.

Several early explosives were built around ammonium nitrate. Since the ammonium nitrate has an excess of oxygen and cannot reach its full potential as an explosive, additives were included to provide an ideal balance and still keep the explosive temperature below 1,500 C. Some of these included nitroglycerin, nitrocellulose, other aromatic nitros, as well as combustibles such as sulfur, charcoal, flour, sugar, oil, sawdust, rosin, and paraffin. All these added to the power of the explosive and added to the gas and heat but could still keep the temperature within requirements.

The ammonium nitrate would be mixed and ground together with these ingredients in the wheel mills of the time. The mass would be broken up, screened, and then packed in the paper-paraffin cartridges.

Some of the early formulations of the century included -

Ammonium Nitrate	91.5	86.5	95	90	88	70	65	87.5	82.5
Potassium Nitrate		5		5	5		5		5
Dinitronaphthalene	8.5	8.5							
Trinitronaphthalene			5	5					
Nitroglycerin						29	29	12	12
Nitrocellulose						1	1	.5	.5
Tetryl					7				

Usually, the addition of 10% NG and 10% combustible was common in most formulations

The effect of temperature reduction with the use of ammonium nitrate in was measured as

Guhr dynamite	2,940 C
1/2 Guhr % Ammonium Nitrate	2,090 C
20% Guhr/80% Amm. Nitrate	1,468 C

The coarse grained materials would produce low velocity explosions that produced coal in lumps. The fine grained ammonium nitrate would have a faster velocity and would shatter the coal into finer pieces for use in coking coal.

## History, Design, and Manufacture of Explosives

These explosives could be cooled by adding different salts to the mixes which absorbed flame heat during decomposition. These included sodium and potassium chloride, ammonium chloride, and ammonium sulfate. Several hydrated salts that contained waters of hydration in their chemical crystalline structure were also used. The waters of hydration would absorb considerable heat and convert it to water vapor. These included -

Alum	$Al_2(SO_4)_3 \cdot 2H_2O$	$K_2SO_4 \cdot 24H_2O$
Ammonium Alum	$Al_2(SO_4)_3 \cdot (NH_4)_2SO_4$	$24H_2O$
Chrome Alum	$Cr_2(SO_4)_3 \cdot K_2SO_4$	$24H_2O$
Aluminum Sulfate	$Al_2(SO_4)_3 \cdot 18H_2O$	
Ammonium Oxalate	$(NH_4)_2C_2O_4 \cdot H_2O$	
Copper Sulfate	$CuSO_4 \cdot 5H_2O$	
Borax	$Na_2B_4O_7 \cdot 10H_2O$	
Epsom Salts	$MgSO_4 \cdot 7H_2O$	
Glaubers Salts	$Na_2SO_4 \cdot 10H_2O$	
Gypsum	$CaSO_4 \cdot 2H_2O$	

All of these yield water, and in the case of the ammonium products, some toxic nitrogen compounds. The hydrated sodium carbonates were tried but they attacked the explosive ingredients and caused them to decompose.

The blasting gelatins used in coal mines would often contain up to 10% sodium chloride which would reduce the flame temperature of the decomposition gases. This would usually eliminate the chance of starting underground fires from the blasting.

Examples of the actual formulas include -

Ammonium Nitrate	52	53	60	61	66	73	78	83
Potassium Nitrate	21					2.8	5	7
Sodium Nitrate		12	5	3				
Barium Nitrate								2
Chloride Salt (above)	6		21	20.5	22	15	8	
Ammonium Oxalate	16	19						
Wood meal/grain meal		5	4	7.5	2	1	5	2
Glycerin				3				
Powdered Coal					6			
Nitrotoluene			6	1				
Dinitrotoluene						5		
TNT		6						2
Nitroglycerin	5	5	4	4	4	3.2	4	4

## History, Design, and Manufacture of Explosives

Sometimes it is desired to destroy enemy military targets that include mines, grain elevators, or other enclosed areas that are filled with grain or coal dust or a combustible-air mixture. The following device described by the US Army is suitable for detonating these mixtures.

### Initiator for dust explosions

An initiator which will initiate common material to produce dust explosions can be rapidly and easily constructed. This type of charge is ideal for the destruction of enclosed areas such as rooms or buildings.

#### Materials Required

A flat can, 3" (8 cm) diameter and 1.5" (3-3/4 cm) high  
(A tuna can works well)

Blasting Cap

Explosive

Aluminum (wire, cut sheet, flattened can, or powder)

Large Nail, 4 in. (10 cm) long

Wooden Rod - 1/4" (6 mm) diameter

Flour, gasoline and powder or chipped aluminum

**Note:** Plastic Explosives produce better explosions than cast explosives in dust initiators

#### Procedure

1. Using the nail, press a hole through the side of the tuna can 3/8 to 1/2 in. (1-1.5 cm) from the bottom. Using a rotating and lever action, enlarge the hole until it will accommodate the blasting cap.

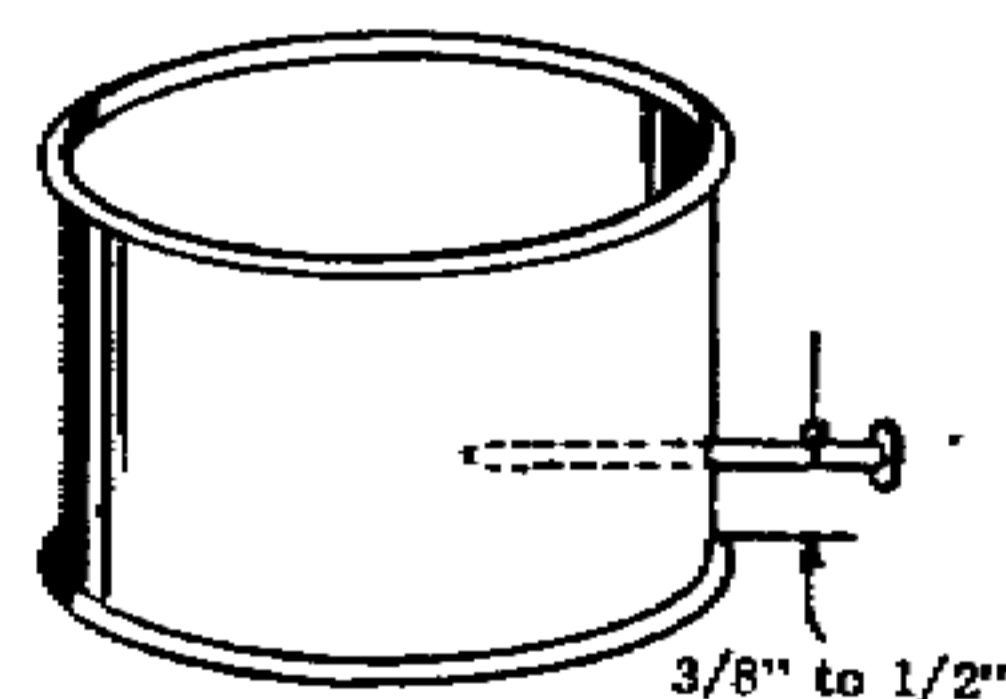

2. Place the wooden rod in the hole and position the end of the rod at the center of the can.

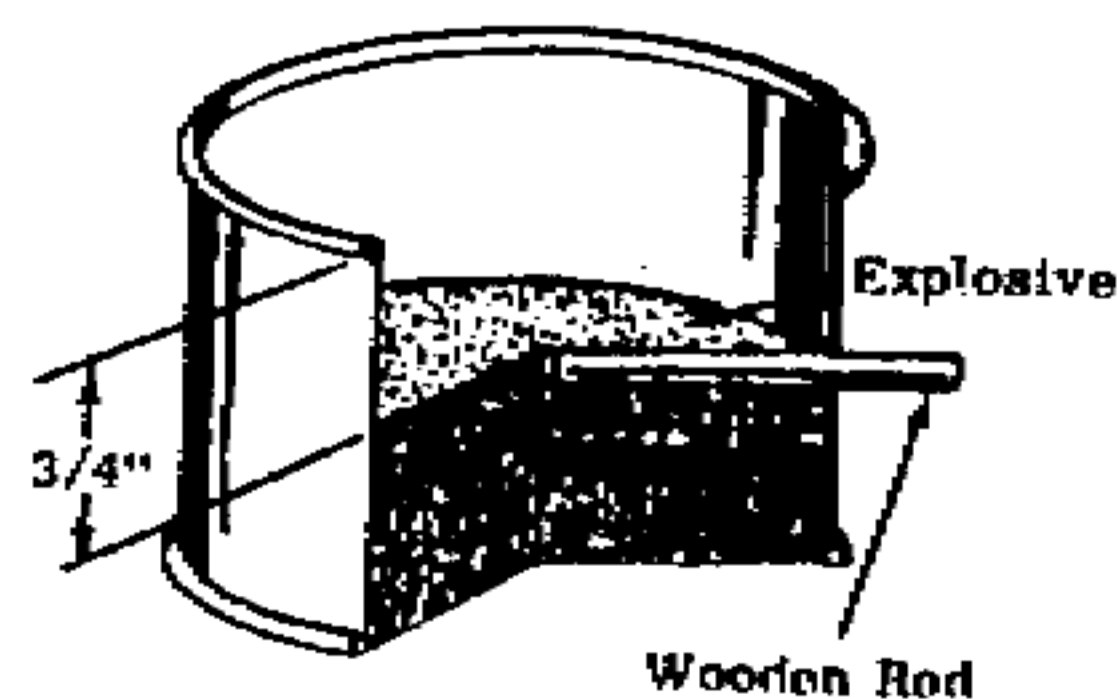



## History, Design, and Manufacture of Explosives

3. Press explosive into the can being sure to surround the rod, until it is 3/4" (2 cm) from top of the can. Carefully remove the wooden rod.

4. Place the aluminum metal on top of the explosive.

5. Just before use, insert the blasting cap into the cavity made by the rod. The initiator is now ready to use.

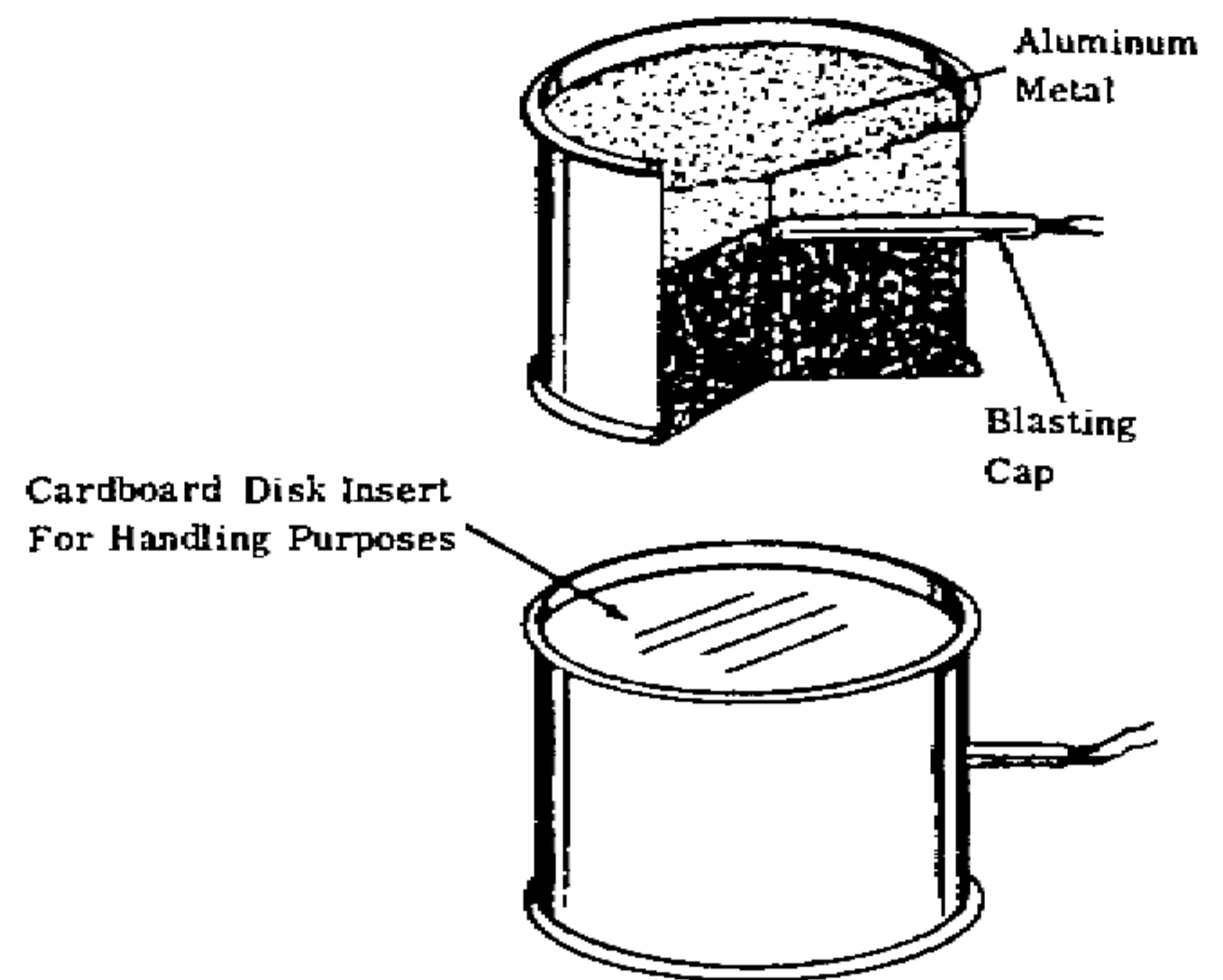

**Note:** If it is desired to carry the initiator some distance, cardboard may be pressed on top of the aluminum to insure against loss of material.

### How to use

This particular unit works quite well to initiate charges of 5 # of flour, 1/2 gallon (1.66 litres) of gasoline or 2 # of flake painters aluminum. The solid materials may merely be contained in sacks or cardboard cartons. The gasoline may be placed in plastic or glass milk bottles. The charges are placed directly on top of the initiator and the blasting cap is actuated electrically or by fuse. This will destroy a 2,000 cubic foot enclosure (10 x 20 x 10 feet) For larger enclosures, use proportionately larger initiators and charges.

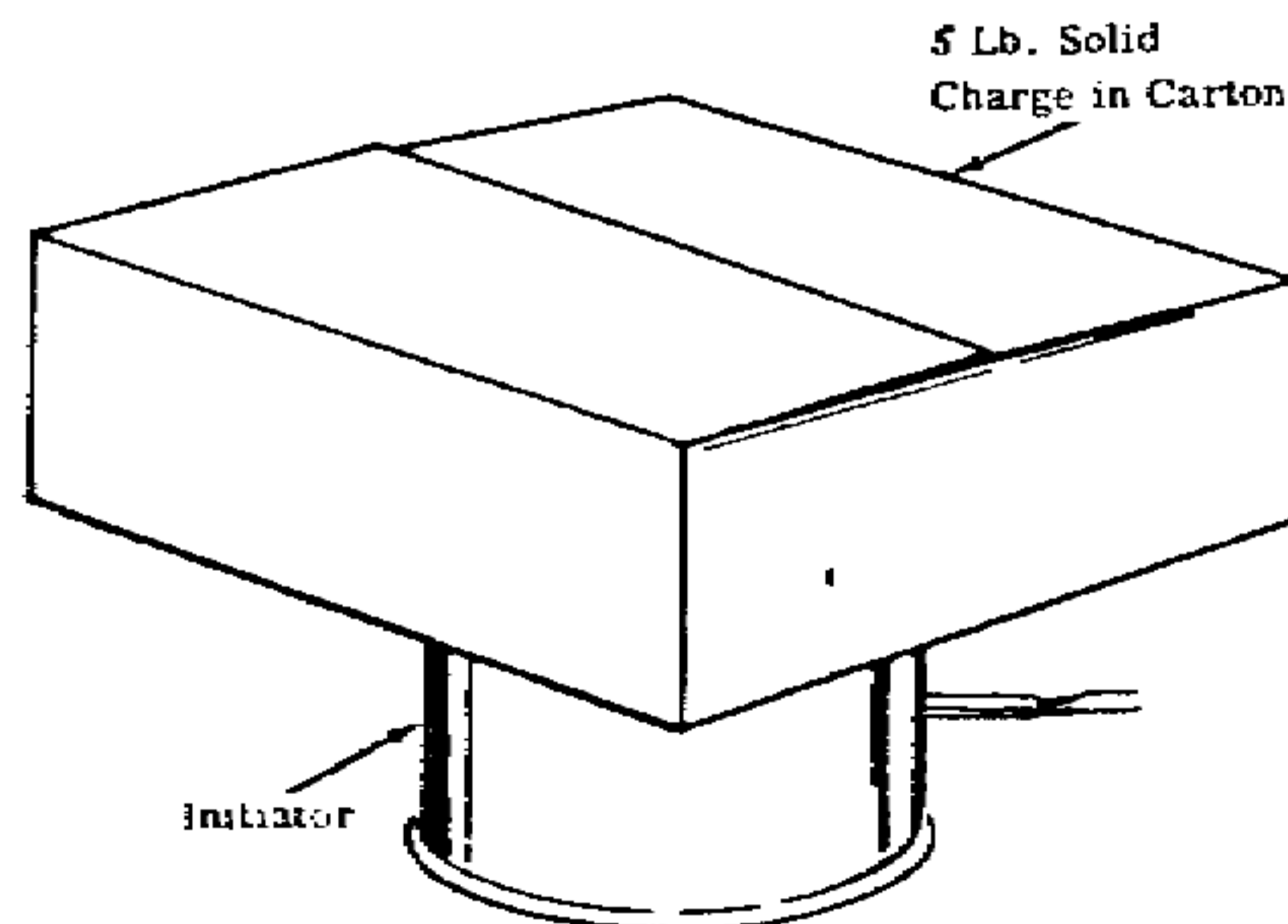

## History, Design, and Manufacture of Explosives

Also included in the US Army's improvised munitions handbook is the following method for improvising a nitric ester dynamite from scratch. This will work with most of the nitric esters using the same basic procedures.

### Methyl Nitrate Dynamite

An moist explosive mixture can be made from sulfuric acid, nitric acid, and methyl alcohol. This explosive can be detonated with a blasting cap.

#### Material Required

Sulfuric Acid

Nitric Acid

Methyl Alcohol

Eyedropper or syringe with glass tube

Large diameter glass jar (2 qt.)

Narrow glass jars (1 qt)

Absorbent - fine sawdust, shredded paper or cloth

Cup

Pan ( 3-5 gallon)

Teaspoon

Wooden Stick

Steel Pipe with end cap

Blasting Cap

Water

Tray

#### Sources

Clear battery acid boiled until white fumes appear

Field grade Nitric Acid 90%

Methanol or wood alcohol

Anti Freeze (non permanent)

#### Procedure

1. Add 24 teaspoons of sulfuric acid to 16.5 teaspoons of nitric acid in the 2 qt. jar.

2. Place the jar in the pan ( 3-5 gallon) filled with cold water or a stream and allow acid to cool.



## History, Design, and Manufacture of Explosives

3. Rapidly swirl the jar to create a whirlpool in the liquid ( without splashing) while keeping the bottom portion of the jar in the water.



4. While continually swirling, add to mixture, 1/2 teaspoon at a time, 13.5 teaspoons of methyl alcohol, allowing mixture to cool at least one minute between additions.

**Danger:** If there is a sudden increase in the amount of fumes produced or if the solution turns much darker or begins to froth, dump solution in the water within 10 seconds. This will halt the reaction and prevent a runaway explosion.

5. After the final addition of methyl alcohol, swirl for another 30-45 seconds.



6. Carefully pour the solution into one of the narrow glass jars. Allow jar to stand in water for app. 5 minutes until 2 layers separate.

7. With an eyedropper or syringe, remove top layer and carefully put into another narrow glass jar. This liquid is the explosive.

**Caution:** Explosive is shock sensitive

8. Add an equal quantity of water to the explosive and swirl. Allow mixture to separate again as in step 6. The explosive is now the bottom layer.



## History, Design, and Manufacture of Explosives

9. Carefully remove the top layer with the eyedropper or syringe and discard.

10. Place one firmly packed cup of absorbent in the tray.

11. While stirring with the wooden stick, slowly add explosive until the mass is very damp but not wet enough to drip. Explosive is ready to use.

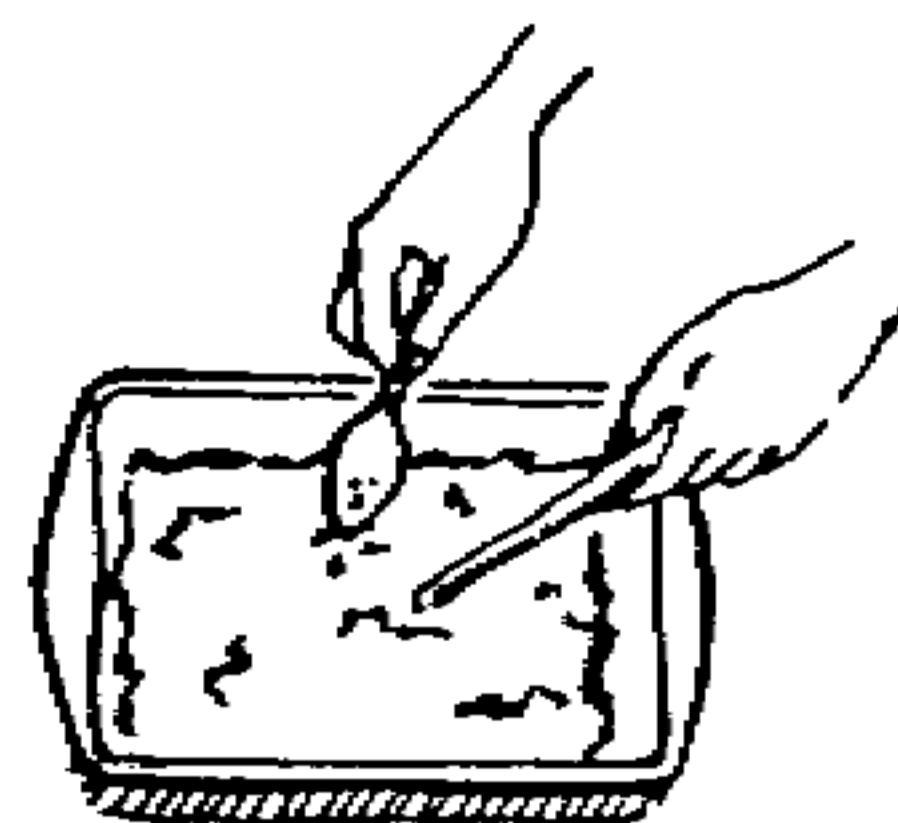

**Note:** If mixture becomes too wet, add more absorbent.

If storage is required, store in a sealed container to prevent evaporation.

Liquid explosive can burn. If it touches skin wash with water.

### How to use

1. Spoon the mixture into an iron or steel pipe which has an end cap threaded on one end. If a pipe is not available, you can use a dry tin can or glass jar.



2. Insert blasting cap just beneath the surface of the explosive mix.

**Note:** Confining the end of the container will increase the power of the explosive.

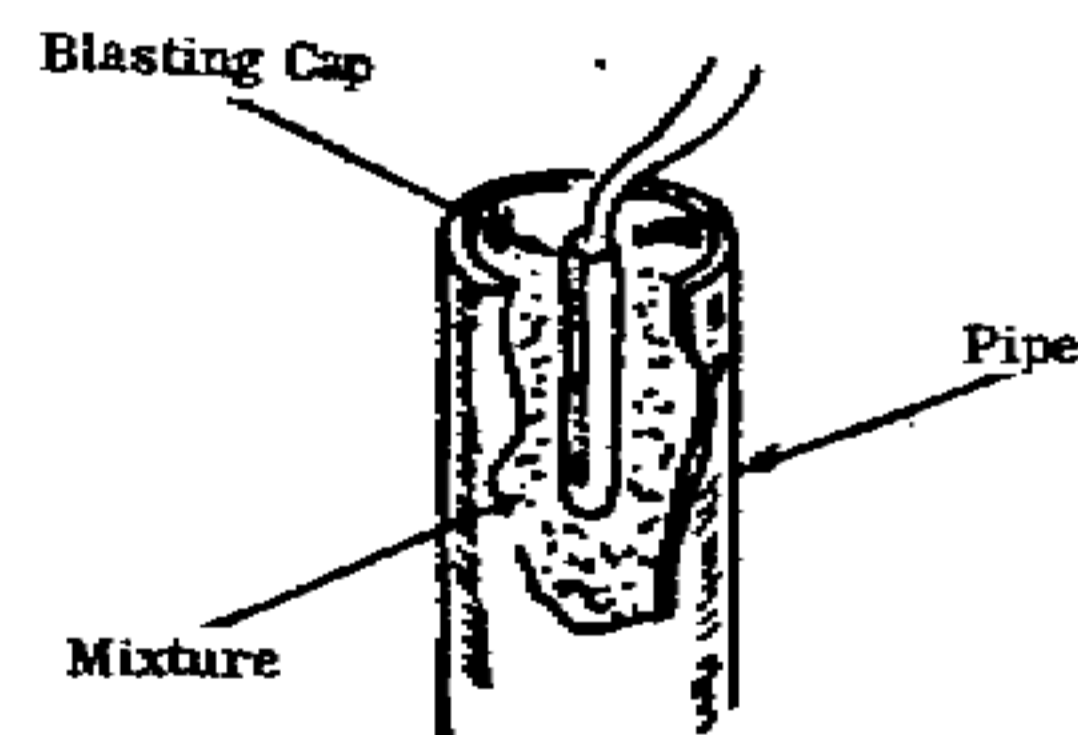

## History, Design, and Manufacture of Explosives

The modern dynamites in use today often use ammonium nitrate as the oxidizer in the formula. These dynamites have been in considerable decline since WW2, and the use of black powders and liquid oxygen in commercial and military explosives has nearly disappeared.

Some of the modern dynamite formulas include -

Nitroglycerin	40	14	92	32	21	9
Sodium Nitrate	44	33		52	49	5
Ammonium Nitrate		36			14	65
Sodium Chloride						10
Nitrocellulose			7	.7	.4	
Combustible Carbon	14	12		11	9	10
Antacid	2	1	1	4	7	1

Most of these are initiated with #3 or #6 blasting caps.

There are hundreds of dynamite formulas in the marketplace, almost all built around the following ingredients -

<u>Oxidizers</u>	<u>Fuels</u>	<u>Sensitizers</u>
Nitroglycerin	Sawdust	Tetryl
Nitrostarch	Wood metal	Dinitrotoluene
Ammonium Nitrate	Flour	Trinitrotoluene
Sodium Nitrate	Wood Pulp	Nitrostarch
Nitrocellulose	Dextrin	PETN
	Starch	Smokeless Powder
	Sulfur	Pentolite
	Ethylene Glycol Dinitrate	
	Other freezing point depressants	
<u>Waterproofing Materials</u>	<u>Coolants</u>	<u>Antacids</u>
Stearates	Ammonium Nitrate	Calcium Carbonate
Silicon Resins	Sodium Chloride	Magnesium Carbonate'
Waxes	Ammonium Chloride	Zinc Oxide
Carboxymethyl cellulose (swelling agents)	Sodium Bicarbonate	Magnesium Oxide
Film forming oils		

Since WW2, the use of industrial explosives has increased from less than 200,000 tons to more than 2 million tons per year. Almost all of this today is in the form of the dry and water based ammonium nitrate explosives.

## History, Design, and Manufacture of Explosives

### Ammonium Nitrate (AN) Explosives

In 1867 in Sweden, the first patent for the mixture of ammonium nitrate alone, and combined with other explosives was granted. The formulas were balanced to convert all the excess oxygen to CO<sub>2</sub> and the hydrogen to water, but these formulas turned out to be hard to detonate. The next batch of patents involved adding ingredients to the ammonium nitrate to make it easier to explode. This was usually accomplished by adding a sensitive explosive to it like nitroglycerin, and adding an initiator like fulminate.

Nobel purchased the rights to the ammonium nitrate inventions in the 1870's and immediately discovered that they had the problem of drawing moisture. He quickly solved this by first incorporating it into the gelatin dynamite, and then by coating it directly with oils, metallic soaps, and other water repelling substances. The gelatin dynamite worked well for small amounts of 20-30% in the formula, but when large amounts were included (50-70%), the gelatin lost its jelly characteristics and would crumble in his fingers with a plastic consistency.

To make it easier to detonate it he began coating the AN with NG, DNT, TNT, and TNX. These could be liquid or solid. These would explode first and carry the shock wave into the AN particles. These would then detonate into nitrogen, water vapor, and oxygen gases. The oxygen would then combine to burn with any other available combustible. In addition to the liquid explosives used to sensitize the AN, a number of solid explosives were used including nitrostarch and nitrocellulose.

In order to detonate straight AN, it usually had to be confined. A detonator of 1 gram of mercury fulminate would be used to detonate a booster explosive made up of a mix of dinitrobenzene and ammonium nitrate (30 grams). This would then detonate a 8cm shell containing 180 grams of confined AN. The fulminate detonator at 3 grams could not completely detonate the AN by itself in the same shell casing.

By 1922, fuses made of TNT were produced and passed completely through the ammonium nitrate cartridges. This would reliably detonate the AN.

During WW1, the French developed several formulas using ammonium nitrate in high explosive 75mm shells. These formulas were mixed together in a wheel mill and then loaded into the shells under compression.

	<u>NX</u>	<u>NT</u>	<u>NTN</u>	<u>NDTN</u>	<u>N2TN</u>
Ammonium Nitrate	77	70	80	85	50
Sodium Nitrate					30
TNT		30		5	
Trinitroxylyene	23				
Dinitronaphthalene				10	
Trinitronaphthalene			20		20

## History, Design, and Manufacture of Explosives

The British developed "Amatol" in the second World War. They melted TNT at 90 C and mixed it into granulated ammonium nitrate. This was then poured into shells where it solidified. The mix ratios of AN to TNT were 50/50, 60/40, and 80/20. The cavity for the detonator is drilled out and installed. Moisture was the only serious drawback to the use of this explosive.

This mix had the interesting property of having less brisance and more heaving power as the AN was increased in the formula. The 80/20 shells would also leave smoke where it exploded from incomplete burning of its ingredients. This enabled artillery spotters to see where the shell landed more easily. Flake aluminum was added to the formulas to increase their power and they would explode with a bright flash. The Germans increased the use of the aluminum in their ammonal shells more and more to replace the TNT which came in short supply near the end of WW2

Ammonium Nitrate today is the cheapest source of available oxygen for explosives, and because it is hard to initiate on its own, it is considered to be the safest explosive that can be used commercially. In fact pure AN is impossible to initiate with blasting caps. The ammonium nitrate can exist in 5 crystal forms and each of these have different volume, structure and heat changes.

AN is used in many water gel and slurry explosives, and are made from thickened suspensions of oxidizers, fuels, and sensitizers that are mixed into saturated salt solutions. The sensitizers used include aluminum, and inert small glass spheres filled with gas (gas bubbles or microspheres), and other powdery porous solids which aid in detonating the AN. The fuels include coal dust, urea, sulfur, and all kinds of petroleum products. Thickeners such as guar gums, the methylcelluloses, resins and other agents are used to thicken the mix. The slurry explosives add hydrophilic colloids to tie up the water and bond to the solids.

The typical slurry blasting agents or explosives may contain -

Ammonium Nitrate	30-70%
Sodium Nitrate	10-15%
Calcium Nitrate	15-20%
Nitramines	0-40%
Aluminum	15-25%
TNT/Sensitizer	5-15%
Gelling agents	1-2%
Stabilizers	.1-2%
Ethylene Glycol	3-15%
Water	10-20%

Sodium tetraborate and/or Potassium dichromate are added to achieve the desired viscosity.

## History, Design, and Manufacture of Explosives

When the ammonium nitrate is mixed with fuel oil at 5.6-6%, all the oxygen can be consumed in an explosion, and the simple act of adding the fuel oil to the mix increases the explosive force by almost 300%. Once mixed in this form, the AN becomes what is now called an ammonium nitrate-fuel oil explosive, or ANFO. It can be initiated in this form by a powerful booster, but only if it is confined with a charge diameter of more than 4 cm. If it is unconfined, and the charge diameter is less than 7.5-13cm, it will not explode. Rifle bullets will not detonate ANFO which makes it desirable in dangerous blasting situations.

The ANFO's are usually initiated with a blasting cap detonating a booster such as Pentolite 50/50 or composition B. The ANFO's can be made more sensitive to initiation by

1. Fine grinding to produce smaller particle sizes
2. Decreasing the loading density
3. Increasing the porosity (the microsphere gas bubbles mentioned earlier)
4. Adding the oil at only 2-4%. Beyond 4% sensitivity is drastically reduced
5. Keeping it dry. Water decreases sensitivity
6. Strongly confining the AN

Detonation velocity increases with charge diameter and peaks at a fuel oil mix of 5.5%. Strong confinement also increases detonation velocities. Adding Aluminum or Ferrosilicon increases the power of the explosion and the temperatures.

A comparison of ANFO, AN slurries, and TNT explosions show the amount of earth excavated in cratering as compared to TNT (TNT=1)

	<u>Detonation Pressure</u> GPa	<u>Detonation Velocity</u> km/s	<u>Heat of Detonation</u> kJ/g	<u>Excavated Volume</u>
ANFO	6.0	4.56	3.76	1.1
AN slurry	10.4	6.05	3.05	1.2
AN slurry (2%Al)	6.0	4.3	3.14	1.2
AN slurry (8%Al)	6.6	4.5	4.64	1.4
AN slurry (20%Al)	8.5	5.7	6.07	1.7
AN slurry (35%Al)	8.1	5.0	8.16	1.8
TNT	18.7	6.93	4.61	1.0

The ammonium nitrate is manufactured by bubbling anhydrous ammonia through nitric acid while cooling. The industrial explosives prills are made by spraying a hot 96% liquid solution down a cooling tower into cool air. The outsize material is remelted and recycled.



## History, Design, and Manufacture of Explosives

The ANFO is usually mixed on site in trucks by simply adding the oil to the prills. The ANFO is then usually blown by air into the boreholes.

The slurries are usually bulk mixed at the plant, transported to site, thickened with an agent, and poured into the hole. The slurries can also be poured hot into sausage shaped polyethylene bags and cooled. The bags can then be hand carried into the sites for detonating.

The following improvised munitions can be prepared from AN.

### AN Aluminum explosive

A dry explosive mixture can be made from ammonium nitrate fertilizer combined with fine aluminum powder. This explosive can be detonated with a blasting cap.

#### Material Required

Ammonium Nitrate fertilizer (min 32% Nitrogen)  
Fine Aluminum Bronzing Powder  
Measuring container  
Mixing container  
Two flat boards ( 2 x 4 and 36 x 36 Inches)  
Storage Container ( Jar, can, etc.)  
Wooden Rod - 1/4 in. diameter  
Pipe, can, or jar

#### Procedure

##### Method 1 - to obtain a low velocity explosive

- a. Measure 4 parts fertilizer to 1 part aluminum bronzing powder and pour into the mixing container.
  
- b. Mix ingredients with the wooden rod

## History, Design, and Manufacture of Explosives

### Method 2 - To obtain a high velocity explosive

- a. Spread a handful of the fertilizer on the large flat board and rub vigorously with the other board until the large particles are crushed to a very fine powder that looks like flour ( app 10 min.)

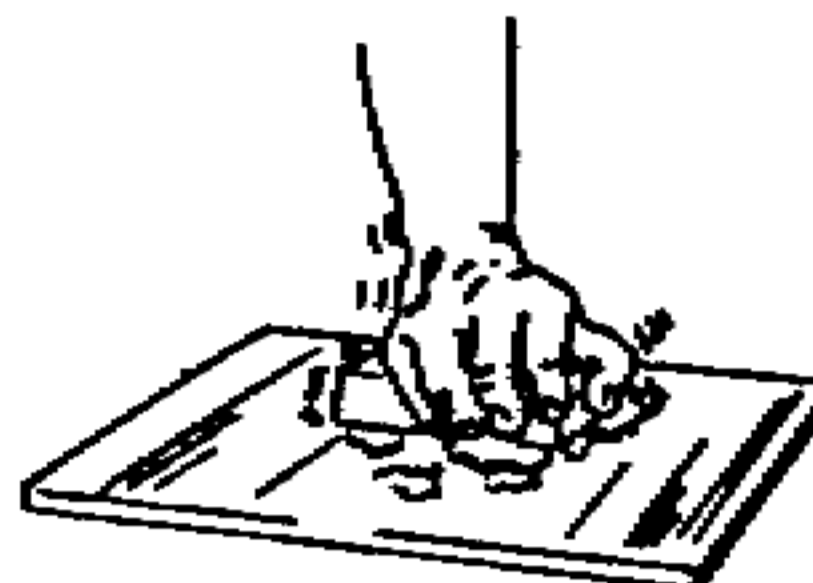

- b. Follow a and b above

then store the mixture of methods 1 or 2 in waterproof container such as a glass jar, steel pipe, etc. and seal until ready to use.

When ready to use prepare as fertilizer explosive with blasting cap.

### Fertilizer Explosives

An explosive munitions can be made from fertilizer grade ammonium nitrate and either fuel oil or a mixture of equal parts of motor oil and gasoline. When properly prepared, this explosive munition can be detonated with a blasting cap.

#### Material Required

- Ammonium Nitrate (not less than 32% Nitrogen)
- Fuel oil or gasoline and motor oil (1:1 ratio)
- Two flat boards. ( 2 x 4 and 36 x 36 inches)
- Bucket or container for mixing ingredients
- Iron or steel pipe or bottle, tin can or heavy walled cardboard tube
- Blasting cap
- Wooden rod - 1/4 in. diameter
- Spoon or other measuring container

## History, Design, and Manufacture of Explosives

### Procedure

1. Spread a handful of the ammonium nitrate on the large flat board and rub vigorously with the other board until the large particles are crushed into a very fine powder that looks like flour. (app. 10 min.)

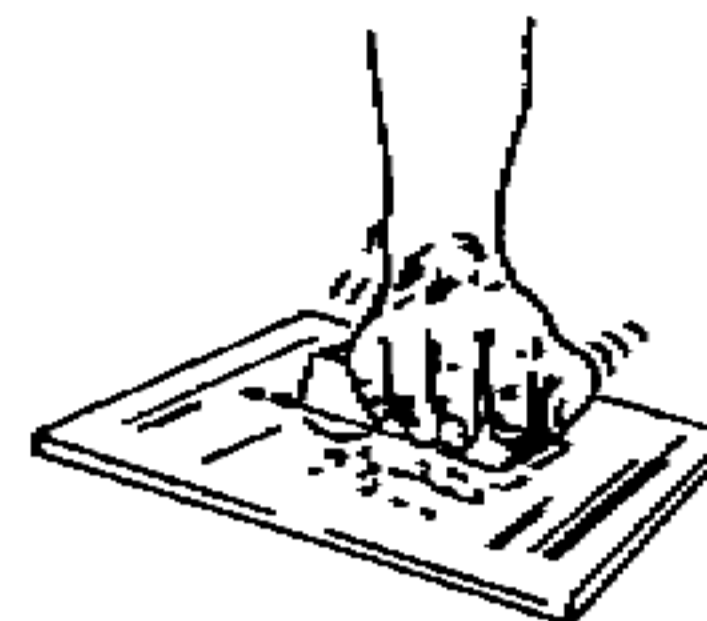

**Note:** Proceed with step 2 as soon as possible since the powder may take moisture from the air and become spoiled.

2. Mix one measure of fuel oil with 16 measures of the finely ground ammonium nitrate in a dry bucket or other suitable container and stir with the wooden rod.



If fuel oil is not available, use 1/2 measure of gasoline, and 1/2 of motor oil. Store in a waterproof container until ready to use.

3. Spoon this mixture into an iron or steel pipe which has an end cap threaded on one end. If a pipe is not available, you may use a dry tin can, a glass jar, or a heavy walled cardboard tube.

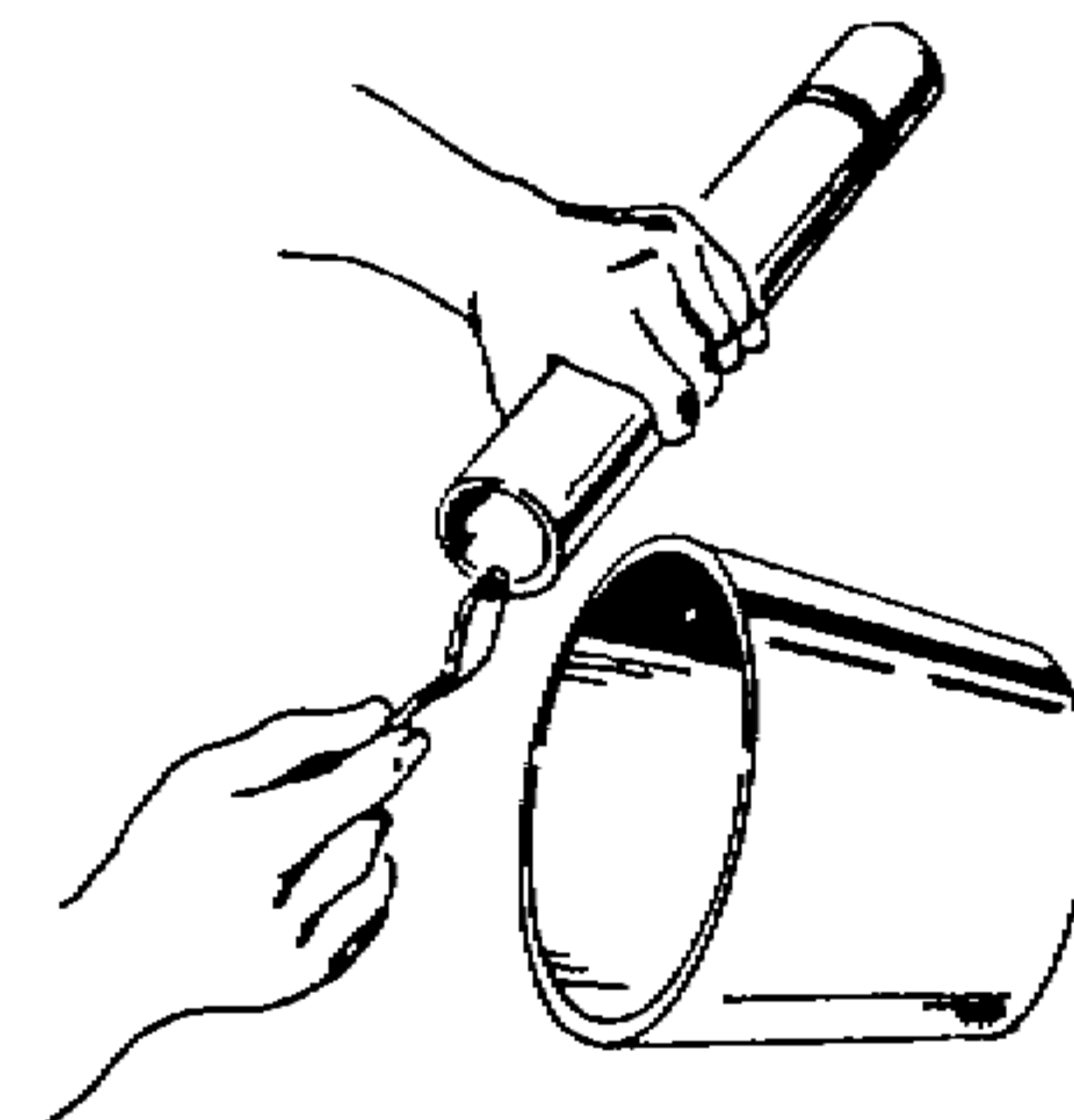

**Note:** Take care not to tamp or shake the mixture in the pipe. If mixture becomes tightly packed, one cap will not be sufficient to initiate the explosive.

## History, Design, and Manufacture of Explosives

4. Insert blasting cap just below the surface of the explosive mix.

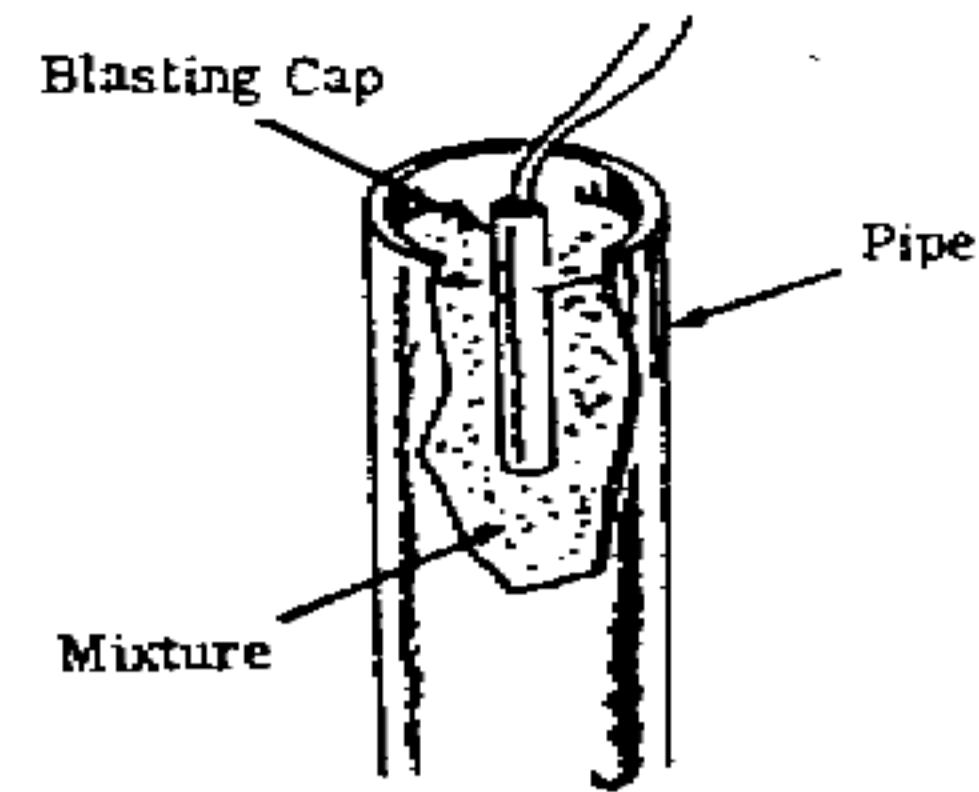

**Note:** Confining the end of the explosive will add to the effectiveness of the explosive.

### Non-Nitrate Explosives

Most the explosives described thus far have been derived from nitric acid. This can be easily derived from ammonia and oxygen, or from sulfuric acid and potassium nitrate as previously described. Their are conditions where access to nitrogen based explosive materials and essential acids is restricted. Accordingly, there is a need for knowledge on alternative explosive sources and formulas. I will describe these sources in the rest of this chapter and the next.

In 1871, a new class of explosives were invented by Hermann Sprengel. The series of patents he was granted came to be known as "Sprengel" explosives. His novel concept was to mix the explosives just prior to actual use. This meant that they would not have to maintain shelf life and deterioration would not be a problem. They were usually mixed and poured into the target hole or cavity and then detonated with a blasting cap.

#### Oxidizers

Potassium Chlorate  
Concentrated Nitric Acid  
Liquid Nitrogen Dioxide

#### Combustibles

Nitrobenzene  
Nitronaphthalene  
Carbon Disulfide  
Gasoline or other Petroleum  
Picric Acid

The strong Nitric Acid was corrosive and would eat through many storing materials including the copper in blasting caps which would predetonate the fulminate. The mixtures of it would also be very sensitive to shock and blows and would often be absorbed onto fullers earth to form plastic masses. These would still be very corrosive, and would have about 70% of the strength of dynamite.

## History, Design, and Manufacture of Explosives

Some of the early formulas sold were -

<u>Hellhoffite</u>		<u>Oxinite</u>	
Nitrobenzene	28%	Picric Acid	58%
Fuming Nitric Acid	72%	Fuming Nitric Acid	42%

They were not allowed in England because the law they required a licensed manufacturing plant, and there was no mechanism for permitting on-site explosive preparations.

100 tons of Sprengel explosives were detonated on October 10, 1885 with 21 tons of dynamite to blast out the Hells Gate Channel in New York City's harbor. The on-site mix was 79% Potassium Chlorate mixed with 21% Nitrobenzene. It was the largest single blast in history to that point.

The French prepared Sprengel explosives by first mixing 80-95% Potassium Chlorate with 5-20% Magnesium Dioxide and compressing it into cartridges. This was then dipped into a mix of

Nitrobenzene	50	60
Turpentine	20	15
Naphtha	30	25

The cartridges would not evenly absorb the same amount of liquid mix. The amounts varied from 8-13% and this sometimes caused incomplete and uneven detonation.

Similar combination dipping mixes included

Turpentine	90	with	Potassium or Sodium Chlorate	80
Phenol	10		Magnesium Dioxide	20

Nitrobenzene	80	with	Potassium Chlorate	70
Turpentine	20		Potassium Permanganate	30

Liquid Nitrogen Dioxide with	Carbon Disulfide
	Nitrobenzene
	Nitrotoluene
	Gasoline

All of this last group were liquid-liquid mixes and were very sensitive to shock. These were put into binary bomb compartments by the French in WW1 under the name "Anilites". When the bomb was released, a propeller on the tip opened a valve and mixed the two parts while the bomb was on its way down. Once mixed, the now explosive mix was so sensitive it did not need a fuse or initiator to detonate. On impact it produced a powerful anti-personnel explosion.

## History, Design, and Manufacture of Explosives

### Oxygen based explosives

By 1895, the process for liquefaction of air would yield large quantities of Oxygen, Nitrogen, some Argon, and solid water-CO<sub>2</sub> mixtures. Modern production proceeds as follows -

1. Air is filtered and then compressed to 77 PSI.
2. It passes to an oxidation chamber which converts any hydrocarbon gas into CO<sub>2</sub> and water.
3. The air goes to a water separator which removes most of the water.
4. It passes to a heat exchanger which rapidly cools the air to -168 C. This causes solid water and CO<sub>2</sub> to separate out.
5. The pure oxygen-nitrogen mixture, now at -168 C and 72 PSI enters a fractionating column. An expansion valve at this point opens and causes further cooling to -190 C. [When gases are expanded, they cool]
6. Nitrogen rises to the top of the column because it boils at -196 C. The oxygen boils at -183 C. The oxygen stays at the bottom of the column as a liquid because it is less volatile than the liquid nitrogen.

The now 90-95% oxygen contains some argon and other impurities. These are separated out by additional fractionating.

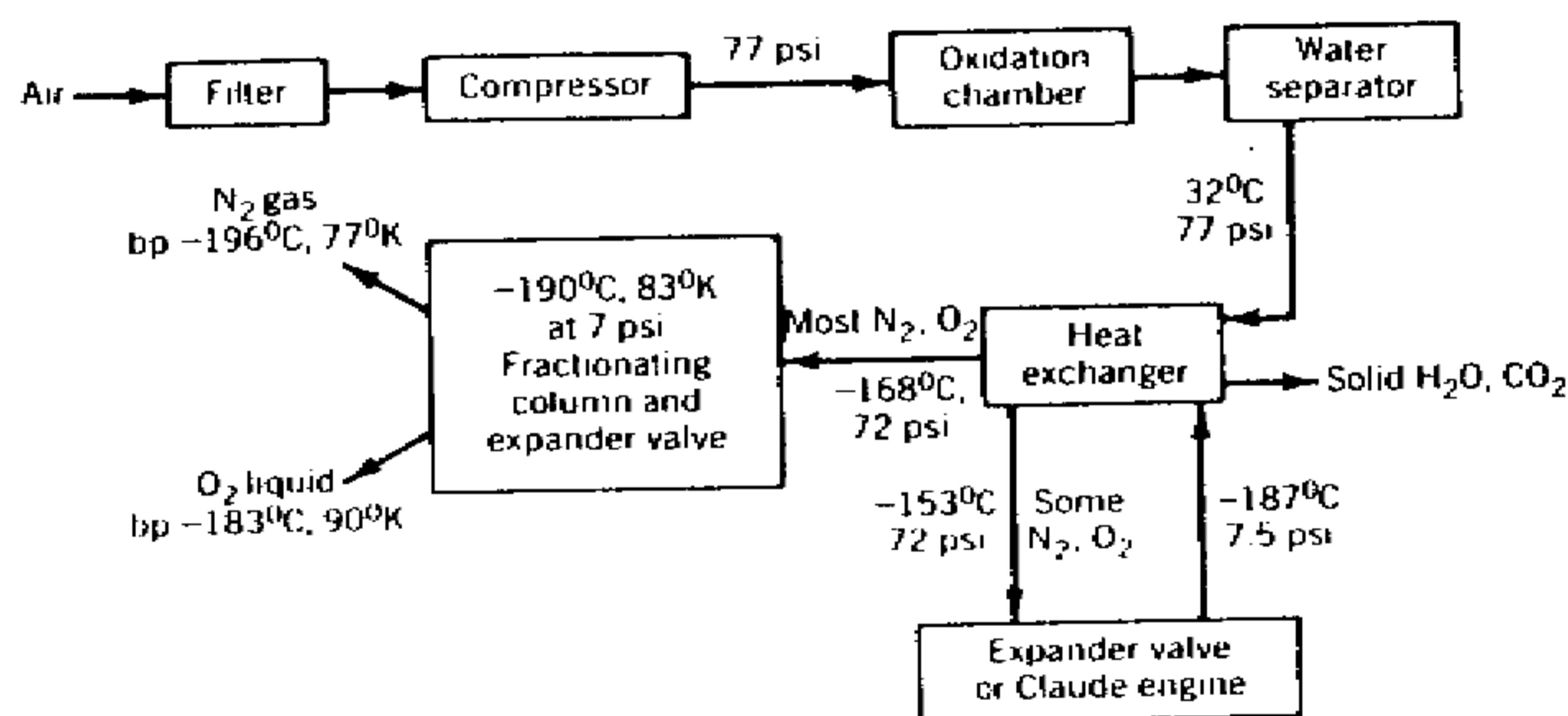

This is where the manufactured oxygen used to make the huge volumes of nitric acid comes from. Since oxygen is the main source of explosive power it was natural that explosives would be directly produced with it.

## History, Design, and Manufacture of Explosives

The first attempts to do so involved the pumping of liquid oxygen into cartridges of porous combustible materials. This method had the advantage of being safe. If the explosive, which was mixed on site, failed to explode, it would take an hour or so to evaporate out of the cartridges and would then be safe for workers to reenter the mine. They did not have to worry about chipping into an explosive that might kill them.

Liquid oxygen catches fire easily and becomes a severe uncontrolled self detonation risk because of the incredibly fast rate of burning. It also burns hotter in the explosive reactions than other oxidizers and were not allowed in underground mining.

In actual manufacture, cartridges of a combustible mix would be prepared. These would consist of -

- Gasoline absorbed into Fullers Earth
- Carbonized cork
- Spongy metallic aluminum
- Fullers Earth, Lampblack (soot), and wood pulp

The cartridges would soak in the liquid Oxygen for at least 30 minutes and until ready to use. The aluminum mix would yield gas from the reaction, but the incredibly high heat of explosion would instantly expand excess oxygen and the surrounding air to produce the explosive shock wave. The soaking would take place in enclosed, insulated pasteboard containers.

The use of 98% oxygen produced the best results. Drop in purity results in drastic drop of explosive strengths. By the start of WW2, new ideas had been tested and it was found that by mixing the absorbent with phosphoric acid, monocalcium phosphate, diammonium phosphate, and ammonium chloride would render the final mix with the liquid oxygen nearly fireproof. In fact, it was impossible in many circumstances to even ignite it with a lit cigarette. It made it possible to handle and transport mixed oxygen based explosives safely.

The use of liquid oxygen in explosives has nearly ceased since WW2 mainly due to its flammability, and the fact that it can be much more safely incorporated into explosives by mixing with ammonia for nitric acid and its oxidizer derivatives.

Up to this point, virtually all explosives we have covered require access to basic chemical industries to produce in quantity. In many situations and many countries, even the most basic access to combustibles and oxidizers is strictly controlled and limited. Several other sources of explosive materials can be obtained from local gas stations, salt and electricity, and even human body waste. We will cover these here.

## History, Design, and Manufacture of Explosives

### Chlorate based explosives

All chlorate based explosives are ultimately derived from ordinary table salt. In early times, salt could be heated to drive off the chlorine as a gas leaving caustic soda behind. The chlorine gas could be distilled and used to "chlorinate" solutions of calcium and sodium to produce calcium and sodium "Hypochlorites". These would be chlorinated again to produce the first chlorates. These chlorates would find uses in the early explosives, pyrotechnics, and rocket industries. In 1866, the electrolysis of salt water (brine) was discovered, and it was used to mass produce both sodium hydroxide and chlorine.

The science of producing chlorate explosive oxidizers from electricity is simple. You only need a power supply and an electrolysis cell. The simplest design I have seen, is for making an improvised cell using the power of an auto battery and vehicle alternator. The alternator and battery provides 12 volts of electricity to a feedstock solution of salt water.

Although the chemistry is very, very complex, the chemical results are not. The salt water solution has a current passed through it using conducting rods called anodes and cathodes which break apart water into free hydrogen and oxygen. The hydrogen comes off as a gas at the cathode which causes agitation and mixing of the solution. The oxygen stays in the water solution and reacts with whatever materials are added to the water. In this case, it is our added salt. When salt has oxygen added to it, it becomes Sodium Chlorate. The chemical results are

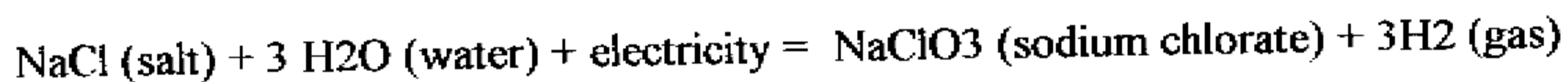

The US Army improvised munitions handbook provides the instructions for the manufacture of chlorates in the field.



## History, Design, and Manufacture of Explosives

### Sodium Chlorate

Sodium Chlorate is a strong oxidizer used in the manufacture of explosives. It can be used in place of Potassium Chlorate or other nitrate salts.

#### Material Required

2 carbon or lead rods  
(1 in. dia. x 5 in. long)  
Salt or ocean water  
Sulfuric Acid, diluted  
Motor vehicle  
Water  
2 wires, 16 gauge (3/64" dia.) x 6' long insulated  
Gasoline  
1 gallon glass jar, wide mouth (5" x 6" high)  
Sticks and String  
Teaspoon and Knife  
Trays and Large flat pan  
Cup  
Heavy cloth

#### Procedure

1. Mix 1/2 cup of salt into the one gallon glass jar with 3 liters or quarts of water.
2. Add 2 teaspoons of battery acid to the solution and stir vigorously for 5 minutes.
3. Strip about 4 inches of insulation from both ends of the 2 wires.

#### Sources

Dry cell batteries (2.5 x 7 in.)  
or plumbing supply store  
Grocery store or ocean  
Auto battery

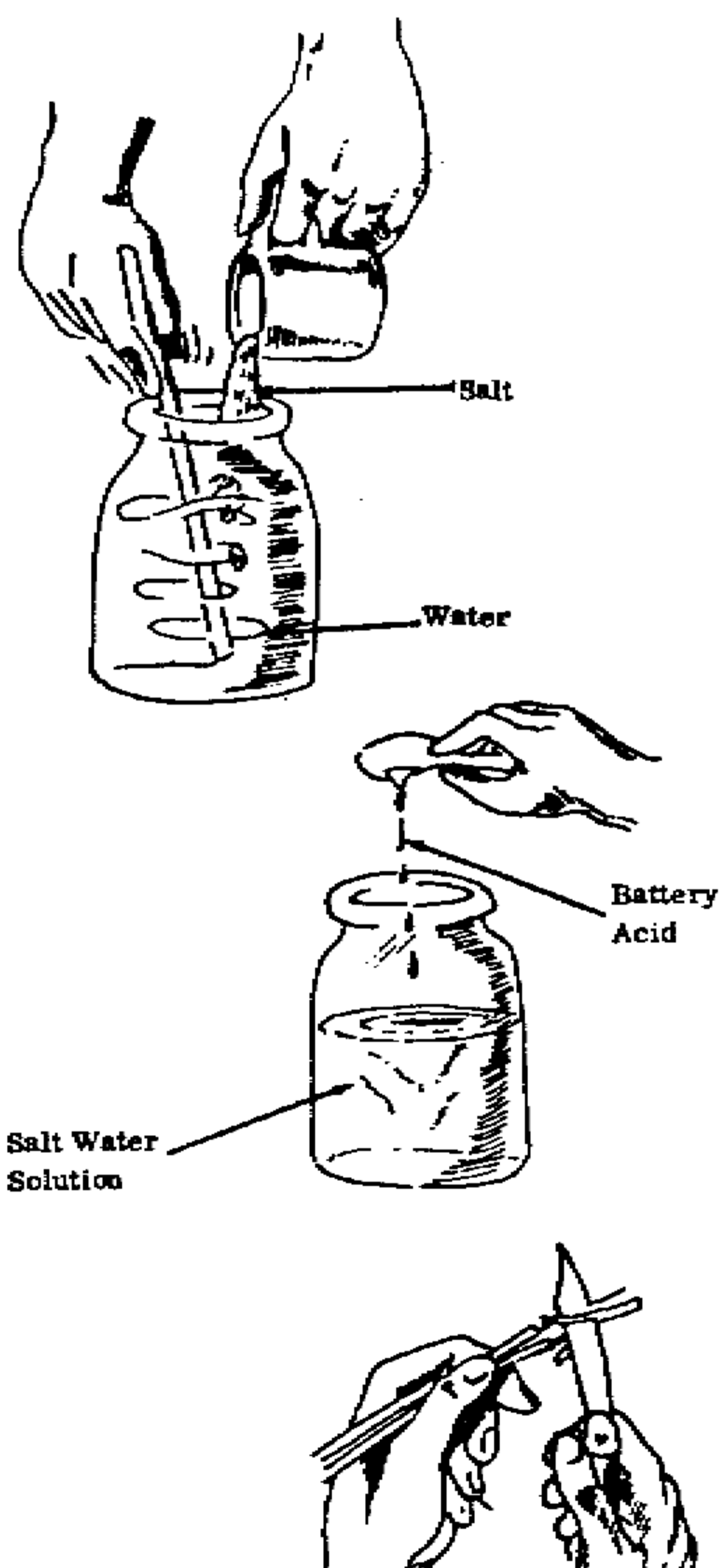

## History, Design, and Manufacture of Explosives

4. With knife and sticks shape 2 strips of wood 1 x 1/8 x 1-1/2". Tie the wood strips with string to the lead or carbon rods so that they are 1-1/2" apart.

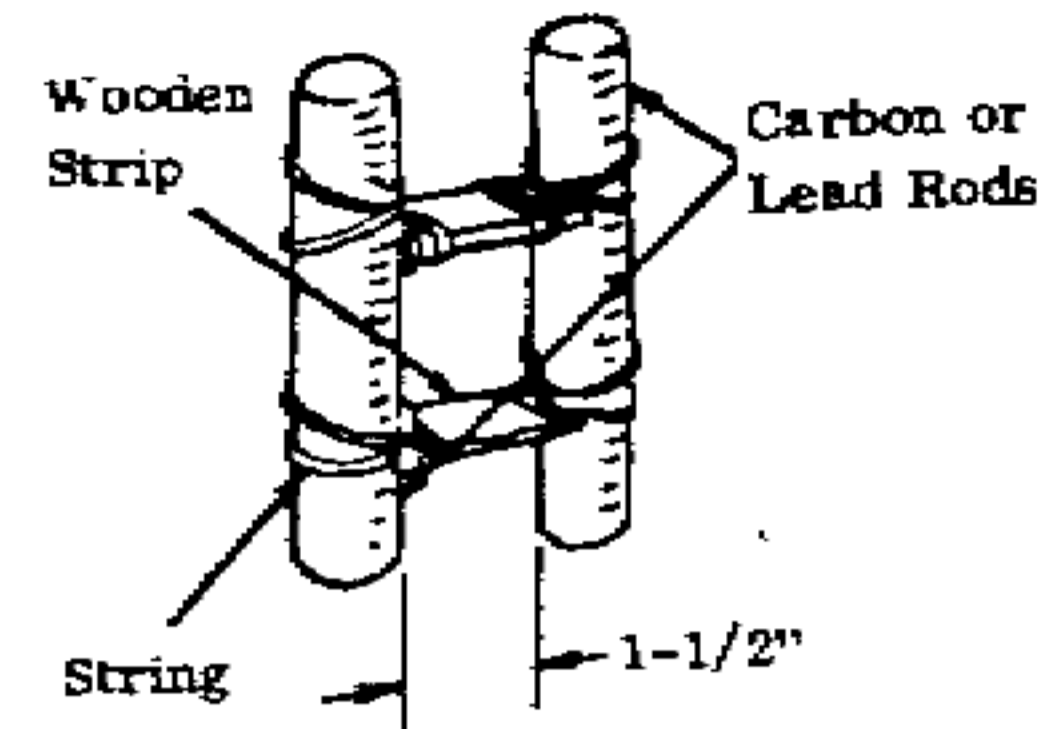

5. Connect the rods to a battery in a motor vehicle with the insulated wire.

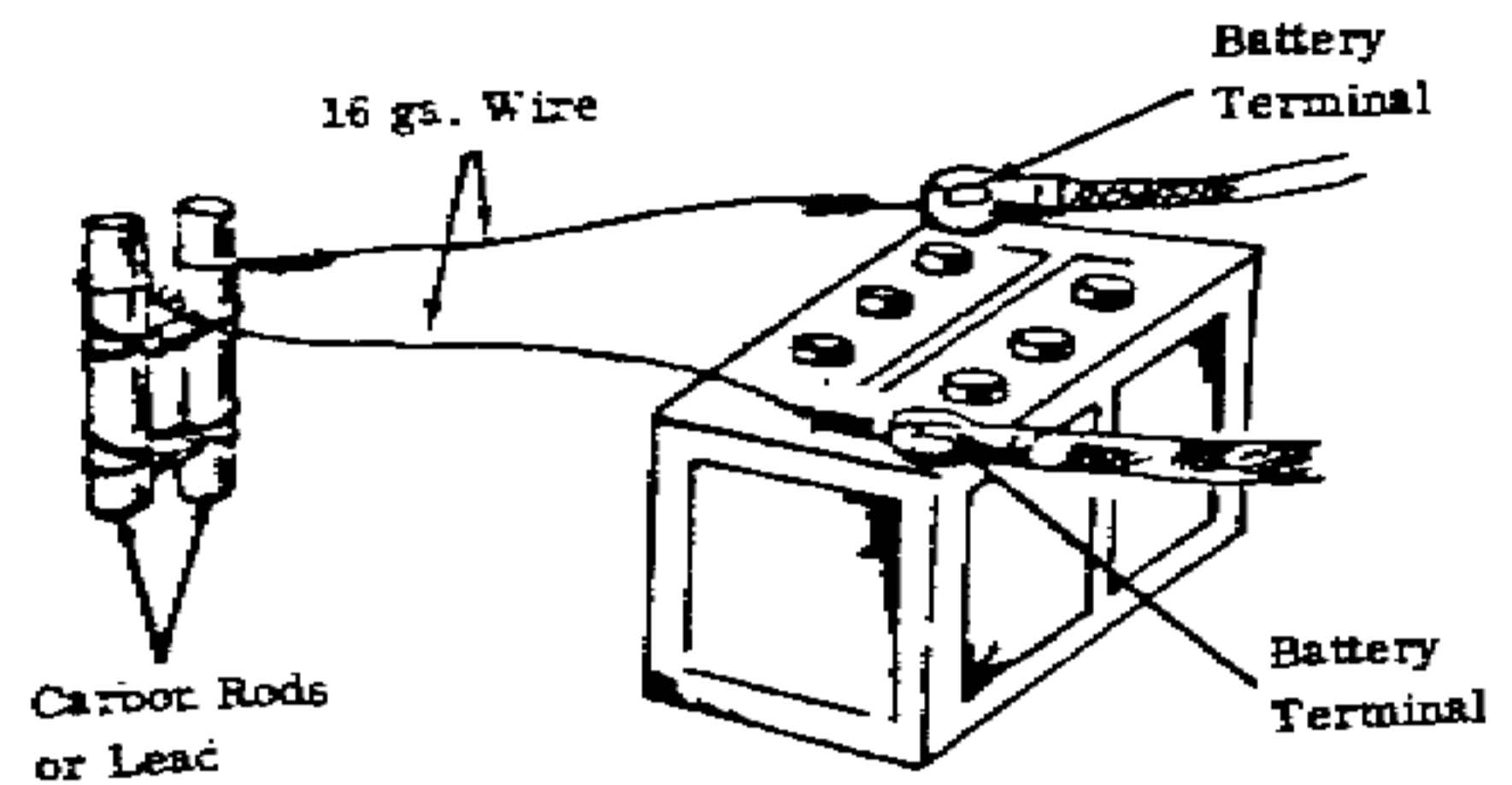

6. Submerge 4.5 in. of the rods into the salt water solution.

7. With gear in neutral position, start the vehicle engine. Depress the accelerator 1/5 of the distance to the floorboard.

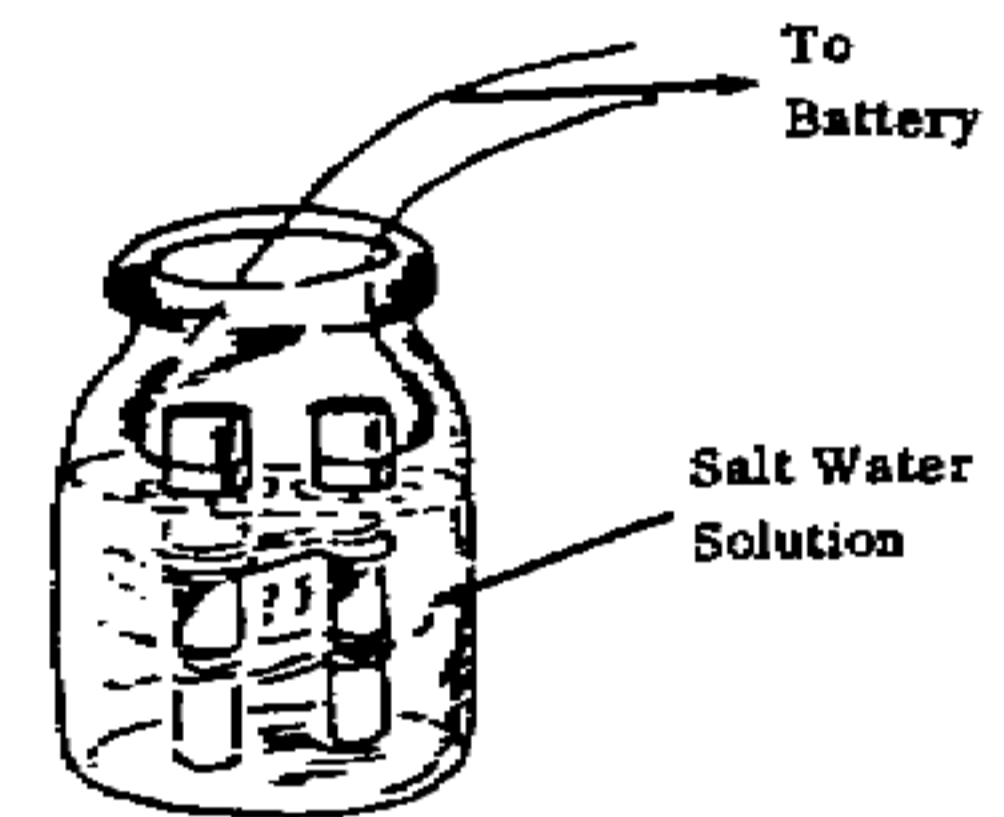

8. Run the engine with the accelerator in this position for 2 hours, then shut it down for 2 hours.

9. Repeat this cycle for a total of 64 hours while maintaining the level of the acid salt water solution in the glass jar.

Caution: Do not touch bare wire leads to avoid dangerous shock.

10. Shut off the engine. Remove the rods from the glass jar and disconnect wire leads from the battery.

11. Filter the solution through the heavy cloth into a flat pan or tray, leaving the sediment at the bottom of the glass jar.

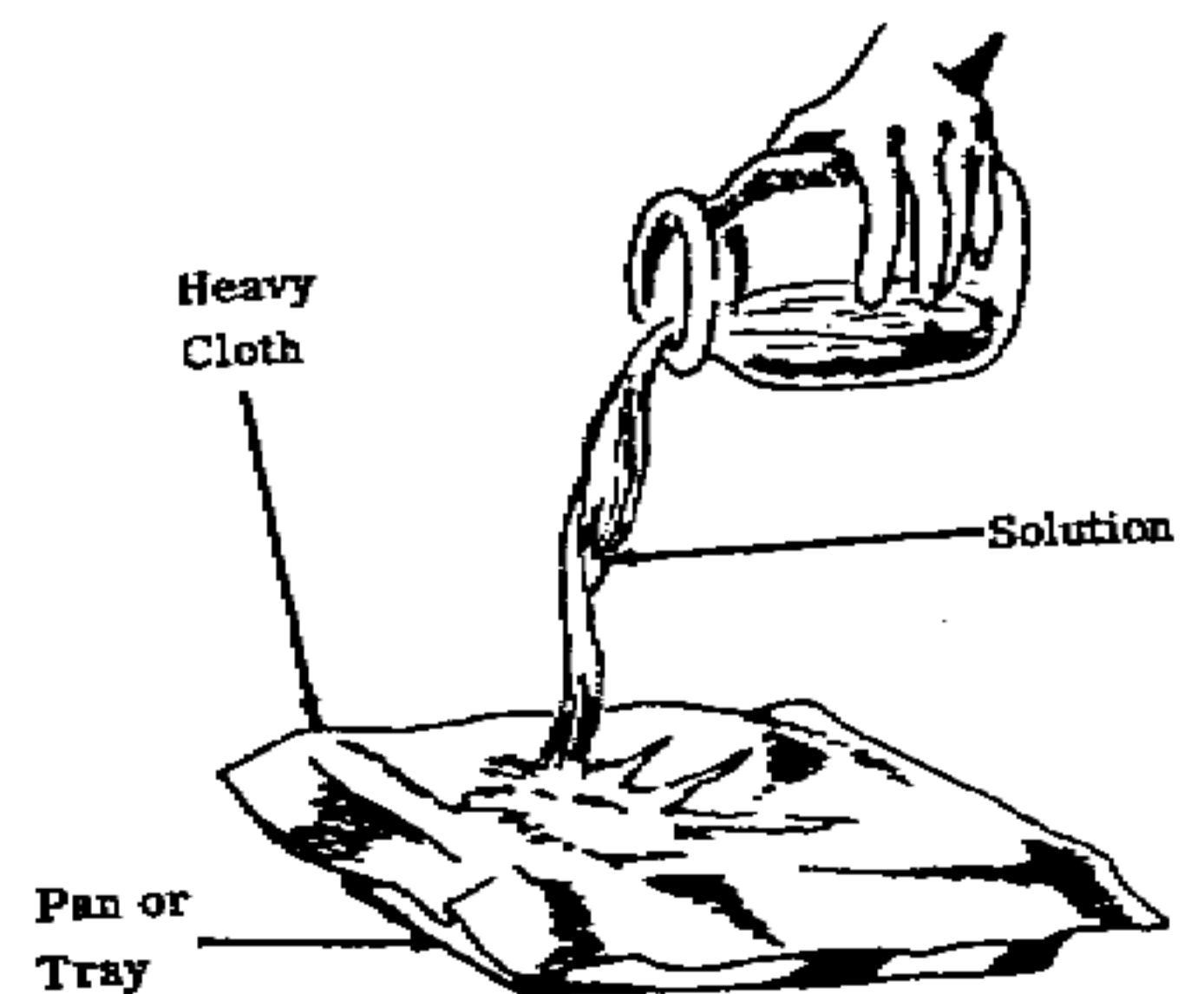

12. Allow the water in the filtered solution to evaporate at room temp. (app 16 hrs.). The residue is app. 60% or more Sodium Chlorate which is pure enough to be used as an explosive ingredient.

## History, Design, and Manufacture of Explosives

The commercial production of Sodium Chlorate uses a number of refinements. These include-

1. Using graphite anodes while operating at  $>40\text{ C}$  ( $60-75\text{ C}$  is best).
2. Using titanium anodes coated with one of the "noble" metals at  $80\text{ C}$
3. Making large cells with spacings of .3-.6cm between anodes-cathodes..
4. Using salt concentrations of 100-110 g/liter.
5. Using mild steel cathodes.
6. Use a recovery system for the hydrogen gas.
7. Optimum pH is 6.9
8. Adding 2-3 grams of sodium chromate per liter to reduce loss of cathode material.

[Part of the chemistry is production of acid and alkali which eats the metals]

The end result is the conversion of 1300# of salt, and about 800# of water using about 6,000 kW-h to produce one ton of sodium chlorate. In improvised production, 12 volt systems are used for safety reasons. These can easily be set up at home using step down transformers to convert house 110 volt to 12 volt systems. This is done for many portable electrical devices.

The solids that form come from impurities in the salt, water, and breakdown of the rods. These are filtered off. Rods are consumed at a rate of 25-60# per ton of chlorate produced.

When the cell material is converted (at app 30 hours) to a mix of app 60% sodium chlorate and 40% salt and hypochlorite, it is passed to a holding cell where 1 gram of urea or formate is added per liter to destroy residual hypochlorite. The leftover chromate remains and provides protection for metal parts. The liquid is filtered, and heated and allowed to concentrate by evaporation. This precipitates a crop of sodium chloride (salt) crystals leaving behind a hot solution of very concentrated sodium chlorate. This solution is cooled and the sodium chlorate crystals precipitate out. The leftover solution is recycled back to the electrochemical cells or the cell feed.

## History, Design, and Manufacture of Explosives

It is also possible to skip the concentration step, let the water cool, recover a crop of sodium chlorate crystals, and then resaturate the liquid with salt and recycle it to the cells.

The sodium chlorate can be recrystallized in alcohol which precipitates the salt first. This is filtered off and distilled leaving behind purified sodium chlorate.

To make sodium perchlorate, the high concentration of sodium chlorate crystals are mixed into water in the same way as the starting salt solution was, and this is fed into the cell. The process is repeated with additional oxygen going into the water and forming the perchlorate salts.

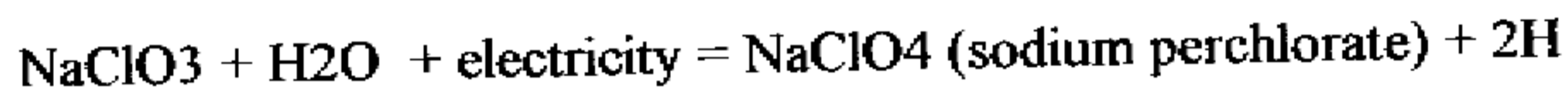

To produce Potassium Chlorate, a hot solution of Potassium Chloride is prepared and sodium chlorate added to it. The reaction yields sodium chloride salt and potassium chlorate crystals which can be precipitate from the cold water in the same way as the sodium chlorate. Potassium chlorate can also be produced by processing potassium chloride in the electrochemical cells in the same fashion.

The following chart shows the solubility's of both chlorates.

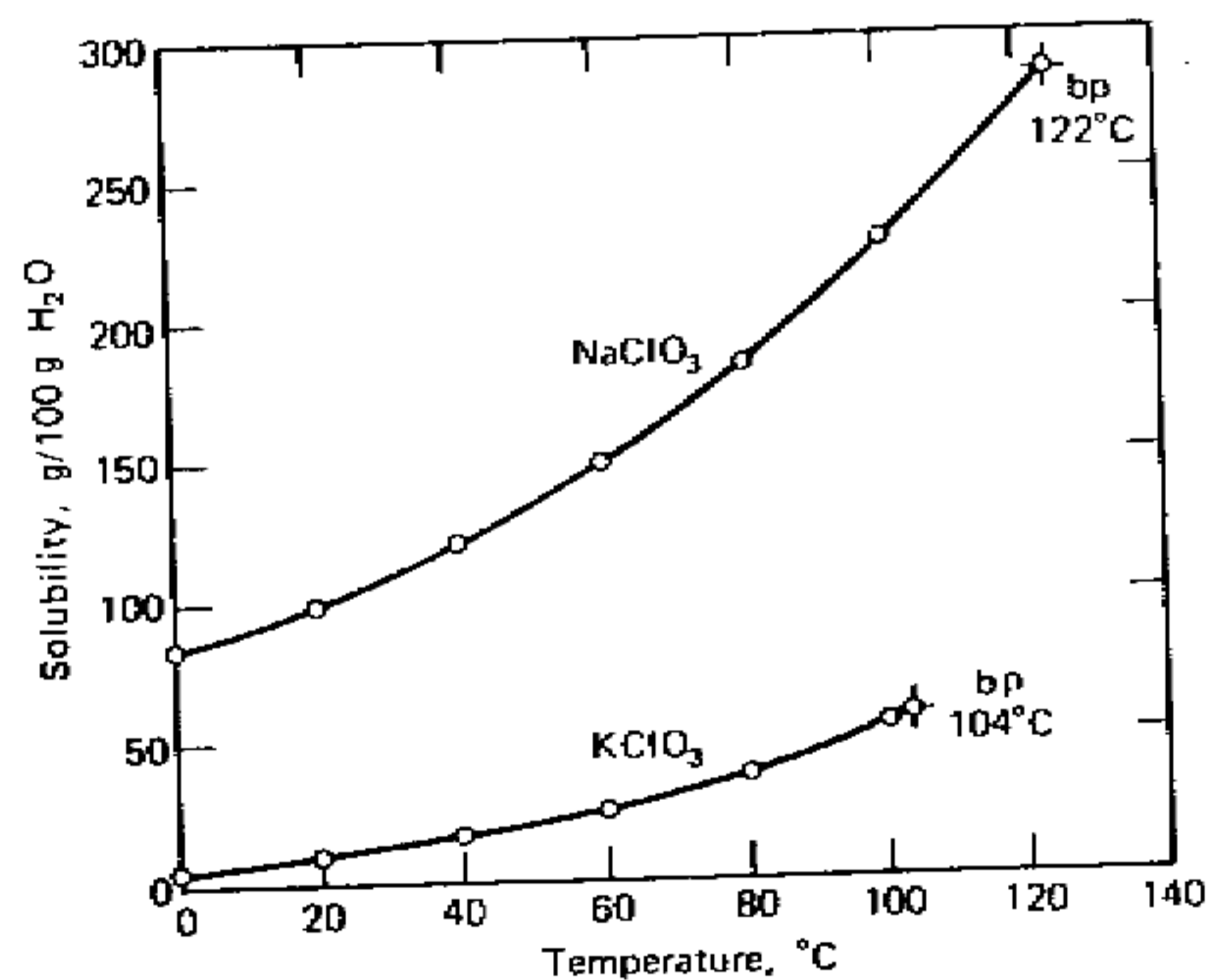

Solubility of NaClO<sub>3</sub> and KClO<sub>3</sub> in water at various temperatures.

## History, Design, and Manufacture of Explosives

The following are the diagrams of two commercially available sodium chlorate electrochemical cells capable of producing 25-100 tons/year.

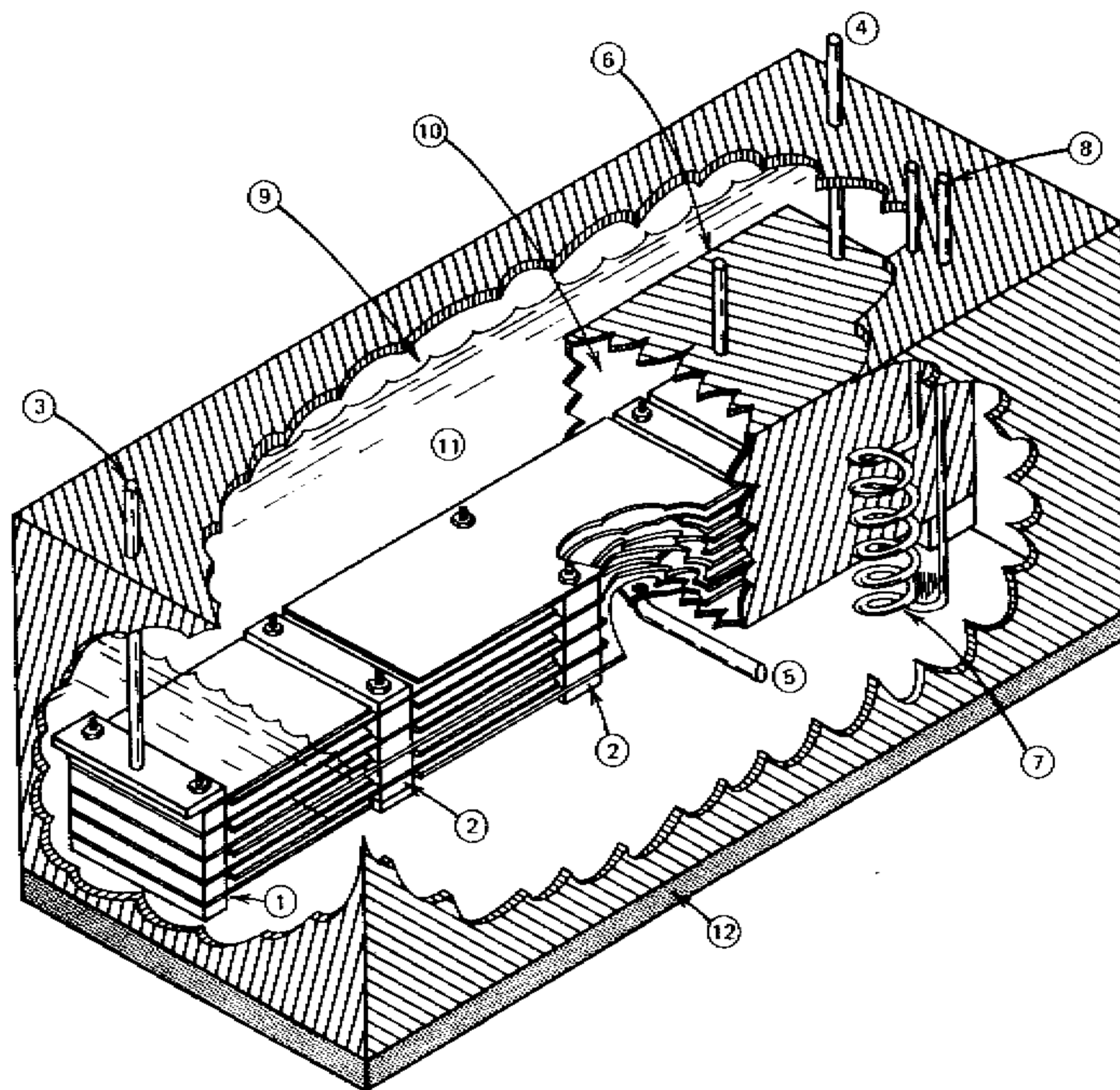

Diamond Shamrock/Huron Chemicals cell for the production of chlorates. 1, cathode feeder electrodes; 2, bipolar electrode units; 3, cathode current feeder; 4, anode current feeder; 5, electrolyte input to electrolysis chamber; 6, electrolyte exit from electrolysis chamber; 7, cooling coil; 8, cooling water connections; 9, electrolyte level; 10, electrolysis chamber; 11, chemical reaction chamber.

## History, Design, and Manufacture of Explosives

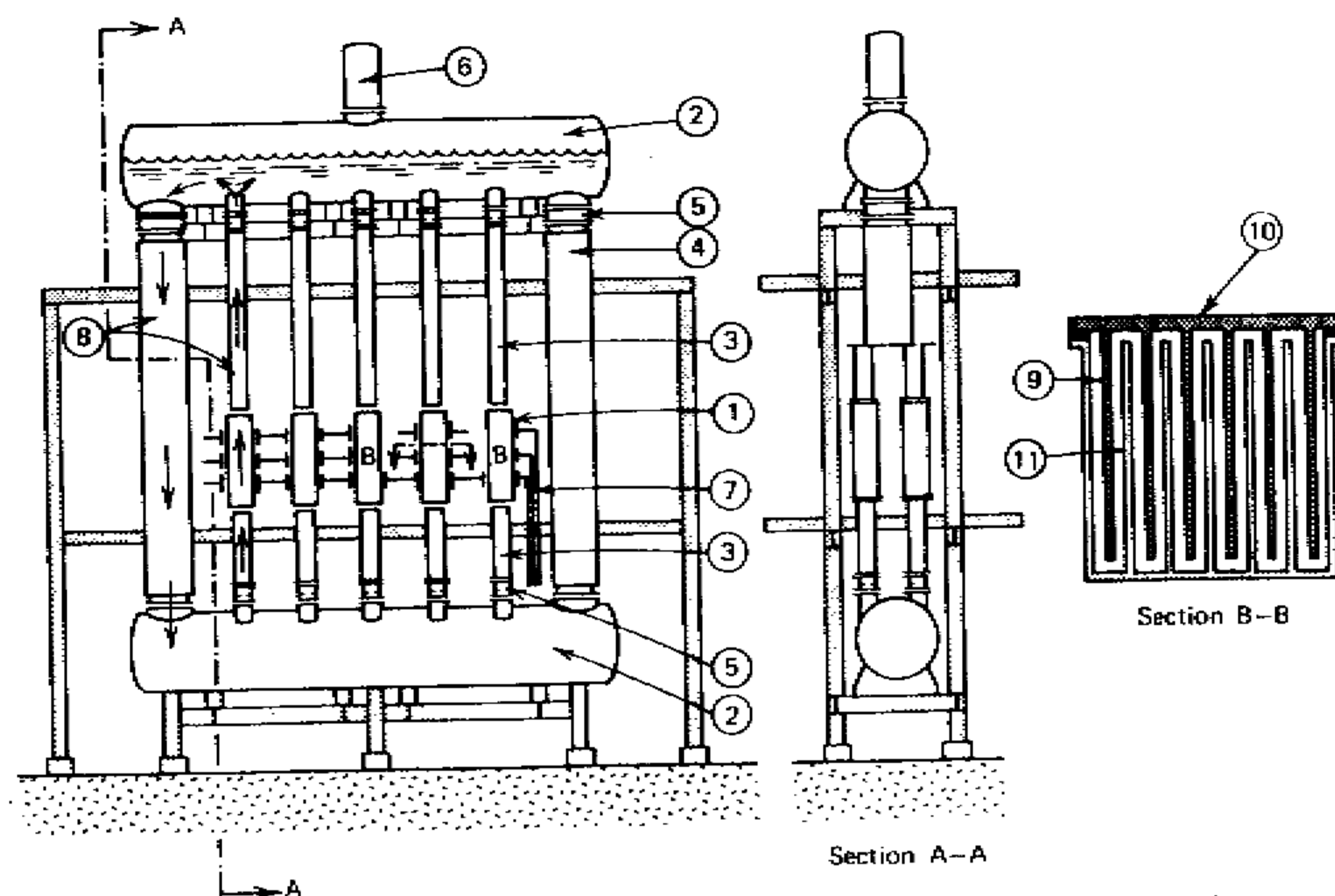

Krebs (Zürich) cell for the production of chlorate; tank and pipes are titanium or steel polytetrafluorethylene. 1, electrolysis cells; 2, reaction tanks; 3, risers; 4, downcomers with cooling jacket; 5, expansion joints; 6, hydrogen demister; 7, bus bars; 8, circulation of electrolyte through gas evolution at the counter electrode; 9, anodes (activated titanium); 10, titanium flange onto which the anodes are bolted; 11, steel cathodes welded directly onto the cell housing.

The first attempted use of potassium chlorate occurred in 1788, when Berthollet attempted to replace the potassium nitrate in a black powder stamp mill with the chlorate salt. He mixed it in at 6 parts chlorate to one part each of sulfur and charcoal. In about an hour, the mill exploded killing workers, observers, and destroying the mill.

In 1849, an attempt was made to make chlorate gunpowder again. The mix this time was

Potassium Chlorate	4 parts
Cane sugar	1 Part
Potassium ferrocyanide	1 part

It was a poor propellant powder, but made a sharp explosion with a lot of noise. Because of this it found use as a pyrotechnic powder for entertainment.

The chlorates would also soon find uses in primers and Sprengel high explosives. The chlorates were found to be very sensitive to blows and friction when mixed with sulfur, sulfides, and picric acid.

## History, Design, and Manufacture of Explosives

A series of blasting formulas called the "Cheddites" were developed in France in the early 1900's. They were made by melting a nitro compound in castor oil at 80 C and slowly adding powdered chlorate a little at a time. The mix is poured onto a table where it was rolled into a thin layer and cooled. It would harden and could be broken up into pieces by a roller and then screened for use.

	<u>Formula 41</u>	<u>Formula 60 bis</u>	<u>M Cheddite #4</u>	<u>Cheddite #1</u>
Potassium Chlorate	80	80	79	
Sodium Chlorate				79
Nitronaphthalene	12	13	1	
Dinitrotoluene		2	15	16
Castor Oil	8	5	5	5

The sodium chlorate is very hygroscopic and because of this presents storage problems. It contains more available oxygen than potassium chlorate and can yield more powerful explosions per pound. Neither of these should be mixed with ammonium nitrate or ammonium perchlorate, (or any other ammonium salt) because of the reaction to produce unstable ammonium chlorate which may explode on its own.

Potassium Chlorate and its perchlorate salt are the most popular to use in explosives and propellants because they have among the lowest solubility's in water, are less reactive, and do not draw moisture like the other salts do. The perchlorates require higher temperatures to decompose than their equivalent chlorate salt, and provide more oxygen to an explosive formula per pound.

The chlorates should be coated or mixed with a phlegmatizing material like castor oil, or animal, vegetable, or petroleum oils before mixing with aromatic nitro compounds. If this is not done, the explosive may be too sensitive to safely handle. Rosin (A resin from the sap of pine trees), has been mixed into chlorate explosives at 8-20% and made them safe to handle.

Some of the explosive formulas from WW1 for mines, grenades, and mortars include -

Potassium Chlorate	90		90	90	89
Sodium Chlorate		89			
Heavy Petrol Oil			3		
Vaseline				3	4
Paraffin	10	11	7	7	5
Pitch					2

By adding aromatic Nitros to the formulas in place of carbon combustibles, more powerful and brisant explosives can be made. NG added as a coating adds to this effect and had a plasticizing effect on the mass making it less sensitive to shock and friction.

## History, Design, and Manufacture of Explosives

Some of the German and French formulas included -

Sodium Chlorate	72	75				
Potassium Perchlorate			58	59		
Ammonium Perchlorate					82	50
DNT and/or TNT	20	20	28	29	13	15
Vegetable Meal	2	2	2	2		
Paraffin	4	4				
Ammonium Nitrate			8	10		
Sodium Nitrate						30
Nitroglycerin	4		4			
Castor Oil					5	5

Ammonium Perchlorate found use by the French in WW1 in 75mm artillery shells and 58mm trench mortar shells. Its temperature of explosion is only 1,084 C and has about the same shock sensitivity as picric acid.

	<u>75mm</u>	<u>58mm</u>
Ammonium Perchlorate	86	61.5
Sodium Nitrate		30
Paraffin	14	8.5

Guanidine Perchlorate is sensitive to small amounts of initiators and is a very powerful explosive.

The chlorates and perchlorates are used today mostly in rocket and missile propellant formulations and pyrotechnics.



## History, Design, and Manufacture of Explosives

### Other Explosives

Other possible sources of explosives include

1. The use of **gasoline** and other volatile **hydrocarbons**.

The refining and distillation of crude oil produces a number of combustible materials.

<u>Boiling Points</u>	<u>Name</u>	<u>Use</u>
< 20 C	Gases	Similar to natural gas. Flared (burned) because of cost of recovery. May be used as fuel.
20-150 C	Gasoline (Light Naphtha)	Used as fuel and chemicals, contains some aromatics
150-200 C	Heavy Naphtha	Same as light naphtha
175-275 C	Kerosene	Jet, tractor, and heating fuel
200-400 C	Gas Oil	Diesel and heating fuels
>350 C	Lubricating Oil	Lubrication and cracking for lighter fuels
>350 C	Heavy Fuel Oil	Boiler Fuel, may be cracked for lighter fuels
>350 C	Asphalt	Paving, coating, and structural uses

All of the above have been used in explosive formulas with oxidizers. The heavier materials burn slowly and have found use in rocket and missile propellants. Any of them may be suitable for use with the oxidizers already described for explosives. The author would recommend their use as binary explosives to be mixed as used because many form sensitive or self igniting mixtures.

Those mixtures that are volatile (the lighter fuels) can explode when mixed into air at 5-15% concentrations. Many of them boil at 30 C or below and easily and quickly form gas-air mixtures that can be detonated. By preheating above 30 C and then distributing the gas by pumping through garden hoses and out of fine nozzle lawn sprinklers, explosive mixtures can be quickly produced that detonate from spark and can be used against underground bunkers, trenches, or placed in the path of advancing enemy forces.

## History, Design, and Manufacture of Explosives

US military fuel air explosives use 72# bomblets containing liquid ethylene oxide. At atmospheric pressures its boiling point is app 10 C which means that once the casing bursts in ordinary temperatures, the liquid instantly disperses and boils off as a gas. The liquid forms a cloud of vapor about 50' across and 8' high in less than a second. This is then ignited at 429 C (805 F). The bomblets are dropped in groups to provide thorough area coverage. The explosive shock wave has app. 5 times the briscance or blast effect of TNT. They are very effective at clearing minefields because of the overpressure they produce.

2. Prisoners of war, and of conscience often find themselves incarcerated under harsh and unjust conditions. Many would fight back if given the tools to do so. One of the interesting possibilities, depicted at the start of the movie "blown away" by an IRA member imprisoned in a British jail, is the ability to produce explosives from human waste. The body consumes food as a fuel. It produces urine, that once dried yields urea salts (a combustibile) which we already described, and the solid wastes, or ground up vegetable waste from the food, can be spread out or mixed into the soil to yield potassium nitrate salts (the oxidizer) by bacterial action on the nitrogen and potassium in the solids.

Although it may seem repugnant, given time, patience, and the know how, the salts can be produced and slowly dehydrated in small amounts for use later. The urea - potassium nitrate explosive would have a low velocity of detonation, but would be a useful weapon in many circumstances. It would only lack a suitable initiator which we will cover in the next chapter.

## Chapter 7

### Primary Explosives and Fuses

Many explosives require a special material to cause their detonation. These are called

**Fuses:** which are lengths of easily burned material that transmit fire to primers or detonators to cause explosive detonation.

**Primers:** are initiating materials that usually use shock or friction to produce fire to ignite the explosive.

**Detonators:** are materials that produce a shock wave to initiate high explosives.

These are the primary explosives which explode from shock, heat, friction, electrical charge, or chemical reaction. They can be used in many ways and in combinations. A fuse can provide a delay to allow the user to reach safety. Once it burns down, it may ignite a primer which then generates more heat, which may ignite a booster charge or detonator, which then produces a shock wave to detonate the main charge.

The method and kind of initiator you choose often depends on what kind of main explosive you are trying to detonate. Usually it means taking a tiny amount of primary explosive that is dense and sensitive, and "fire" it to initiate a much larger, less dense, and less sensitive, main charge. The energy intensification can be increased as much as a million times. Here, we will describe the science of making primary explosives and how to apply them.

There are many characteristics that are common to making primary explosives. These are-

1. They must usually be able to be "pressed" into very small metal capsules called blasting caps.
2. They must be able to convert a mechanical action such as a stab or other friction, or the heat of a fuse entering one end of the cap, into a shock wave inside the small diameter of the cap. This shock wave then must be able to detonate the next charge.
3. They usually have less detonation velocity and less energy than the secondary explosives.
4. They must be powders that flow well and can be pressed into the caps at production line rates.
5. Many safety precautions must be observed by the operators and the transporters.
6. Initiators that are not already loaded into detonators must be shipped in water and be very well cushioned to avoid detonation.
7. Once the material has been pressed into the detonator, it is protected from electricity, the internal movement creating friction is no longer possible, and the container provides some physical protection against heat, moisture, and shock.

## History, Design, and Manufacture of Explosives

### Mercury Fulminate

The sciences of fulminating (to make exploding) metals began with attempts to precipitate ammoniated solutions of gold, silver, and platinum. All these produced incredibly sensitive and dangerous salts that could detonate from sunlight, or even by touch alone. They found some on the spot mix, uses as colorful and noisy fireworks at fairs.

The earliest times mercury was successfully fulminated (and recorded) occurred with the red and yellow mercuric oxides. The red mercuric oxide was prepared by simply heating mercurous nitrate until it decomposed to the red precipitate. In contact with organic material, it could burst into flame. This substance was digested into a solution of ammonia water and formed a white scale on the containers side over 8-10 days. When scraped off, it would explode violently on contact with any flame and self decomposed on standing.

The yellow mercuric oxide was made by mixing caustic soda with mercuric chloride. The salt water was separated from the mercuric oxide and dried. It was then mixed at 30 parts to 4-5 parts sulfur. The resulting mixture would explode when heated on a plate, or hit with a hammer.

In 1779, methods were described for making detonating materials by mixing -

Sodium or Potassium alkali metal (NaO or KO)  
with  
Silver chloride or oxide / Mercuric chloride or oxide  
or  
Carbon Tetrachloride / Chloroform

In fact, the chloroform explodes instantly on contact with the alkali metal with a bright flash.

The first time a modern mercury fulminate was prepared by laboratory procedure appears to be 1716 by Johann Kunckel von Lowenstern who also discovered the element phosphorus. He first dissolved mercury in nitric acid and evaporated it to dryness. He then added alcohol and heated it slightly so it started to dissolve. It began to boil vigorously on its own and he observed that if it was confined in a glass beaker with the stopper on it, it would explode.

By 1800, the chemical process for preparing it was refined further. 100 grains of mercury was added to 1.5 drams of nitric acid and heated to dissolve it. The solution was cooled and poured into 2 ounces of alcohol in a glass beaker. The mixture was warmed until effervescence began and the reaction then proceeded and finished on its own. The precipitate was collected on a filter, washed with water, and dried at low temperature in a water bath.

## History, Design, and Manufacture of Explosives

The resulting fulminate could be detonated by contact with concentrated sulfuric acid (used in modern chemical delay fuses) or by electric spark. They observed it could be detonated by striking with a hammer and the force of a few grains exploding would indent both the hammer and the anvil. Floated in tinfoil on hot oil, it exploded at 186.7 C (308 F). It was also covered with loose black powder and would detonate without detonating the powder. This method was also used to make the first modern silver fulminate as well.

The silver fulminate was prepared by pouring an ounce of alcohol onto 100 grains of powdered silver nitrate, followed by an ounce of nitric acid. After the fulminate precipitate formed it was diluted in water to keep it from re-dissolving and was immediately filtered. This fulminate produced more spectacular explosions than the mercury and was more sensitive to heat and friction. It was often used in demonstrations at local fairs and exhibits as "magic". A young boy named Liebig saw a fair demonstration of it in about 1815, recognized and remembered the odor of the alcohol, and went home to prepare it himself. He would produce several research papers on the fulminates in his own laboratories in a few years.

The modern method used to make it is essentially the same laboratory method.

1. 5 grams of mercury is added to 35cc of nitric acid in a 100cc flask. Do not shake. The mercury is allowed to stand until it dissolves.
2. This is then poured into 50cc of 90% alcohol in a 500cc beaker which is either under a hood to easily exhaust the fumes, or attached to a tube and condenser to recapture the fumes and recycle them to the alcohol for the next batch.
3. The reaction becomes vigorous and hot. White fumes appear and the fulminate precipitates. Then red fumes appear and more fulminate precipitates. Then white fumes again as the reaction winds down. This takes about 20 minutes to complete.
4. Water is added, and the crystals are washed and the water decanted continuously until the water is pH neutral (no more acid). This produces grayish-yellow crystals.
5. Pure white crystals can be obtained by purifying in strong ammonia water, filtering, and adding 30% acetic acid which reprecipitates it. It is filtered, washed, and stored under water until ready to use or press into detonators.

The fulminate can also be prepared using the following substitutes for alcohol -

- Acetaldehyde
- Paraldehyde
- Metaldehyde
- Dimethyl and diethyl acetal
- Sodium nitromethane (+warm dilute hydrochloric acid)

## History, Design, and Manufacture of Explosives

Modern Fulminate manufacture involves scaled up batches of one part mercury into 11 parts of 57% nitric acid. This is then poured into 10 parts of 95% ethyl alcohol.

When fulminate crystals are shaken into a cap, they have a density of about 1.75. In detonators they are usually pressed to 2.5. When compressed to 3,000 psi, they have a velocity of detonation of 4,000 m/s, and when compressed under 25,000 psi (dead pressed) they no longer explode, but will burn from fire. It can still be exploded by loose fulminate however. The velocity of detonation at the higher densities reaches 6,000 m/s.

The fulminate crystals from alcohol precipitation are anhydrous. The crystals from water contain 1/2 molecule of water of hydration. Both explode in similar fashion. Fulminate stored under water is not exploded by ordinary shock or spark. However, a tiny amount of dry fulminate can detonate the wet material. If there is a chance of freezing, alcohol should be added to the water.

In 1907, "Wohler and Matter" conducted tests by heating primary explosives in a bath at temperatures for 20 seconds and raised in 10 degree increments. The explosion temperatures were

Benzenediazonium Nitrate	90 C
Chloratotrimercuraldehyde	130 C
Sodium Fulminate	150 C
Mercury Nitromethane	160 C
Mercury Fulminate	190 C
Nitrogen Sulfide	190 C
Silver Azide	290 C

Ten years later they repeated the experiment using compressed pellets of .02 grams at five second intervals.

Cobalt Azide	148 C	Thallium Fulminate	120 C
Barium Azide	152 C	Silver Fulminate	170 C
Calcium Azide	158 C	Copper Fulminate	205 C
Strontium Azide	169 C	Mercury Fulminate	215 C
Cuprous Azide	174 C	Cadmium Fulminate	215 C
Nickel Azide	200 C	Sodium Fulminate	215 C
Manganous Azide	203 C	Potassium Fulminate	225 C
Lithium Azide	245 C		
Mercurous Azide	281 C		
Zinc Azide	289 C		
Cadmium Azide	291 C		
Silver Azide	297 C		
Lead Azide	327 C		

## History, Design, and Manufacture of Explosives

The amount of fulminate or azide detonator needed to initiate an explosion is very small. The smallest amount necessary to detonate different high explosives is listed in the following table.

	<u>Tetryl</u>	<u>Picric Acid</u>	<u>TNT</u>	<u>Trinitroanisol</u>	<u>Trinitroxylyene</u>
Cadmium Azide	.01	.02	.04	.01	
Silver Azide	.02	.035	.07	.26	.25
Lead Azide	.025	.025	.09	.28	
Cuprous Azide	.025	.045	.095	.375	.4
Mercurous Azide	.045	.075	.145	.55	.5
Thallium Azide	.07	.115	.335		
Silver Fulminate	.02	.05	.095	.23	.3
Cadmium Fulminate	.008	.05	.11	.26	.35
Copper Fulminate	.025	.08	.15	.32	.43
Mercury Fulminate	.29	.3	.36	.37	.4
Thallium Fulminate	.3	.43			

Only a thin layer of crystals in confinement are required to transform any flame into a powerful detonation. Mercury Fulminate is no longer used in the US as a detonator because it decomposes in storage at high temperatures and loses its ability to reliably detonate.

The US Army provides the following instructions for field improvisation of mercury fulminate.

# History, Design, and Manufacture of Explosives

## Mercury Fulminate

Mercury Fulminate is used as a primary explosive in the fabrication of detonators. It is to be used with a booster explosive such as picric acid or RDX.

### Material Required

Nitric Acid 90%  
Mercury  
Ethyl (grain) alcohol  
Filtering material  
Teaspoon measures ( 1/4, 1/2, and 1 teaspoon capacity)  
aluminum, stainless steel, or wax coated  
Heat source  
Clean wooden stick  
Clean water  
Glass containers  
Tape  
Syringe

### Source

Field Grade or chem. supplier  
Thermometer or mercury switches

Paper towels

### Procedure

1. Dilute 5 teaspoons of Nitric Acid with 2.5 teaspoons of clean water in a glass container by adding acid to the water.

2. Dissolve 1/8 teaspoon of mercury in the diluted nitric acid. This will yield dark red fumes.

**Note:** It may be necessary to add water, one drop at a time, to the mercury-acid solution in order to start reaction.

3. Warm 10 teaspoons of the alcohol in a container until the alcohol feels warm to the inside of the wrist.

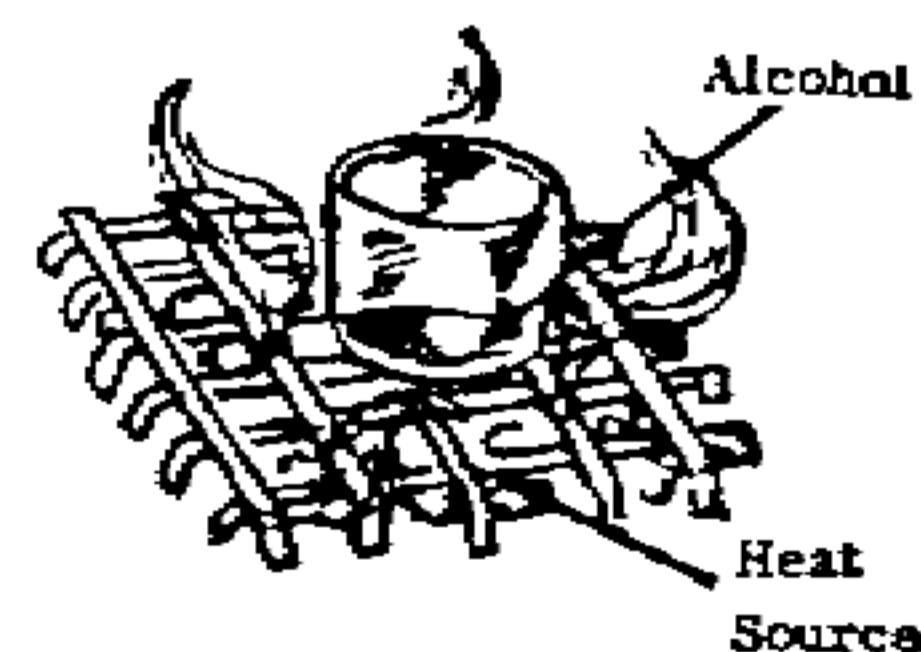
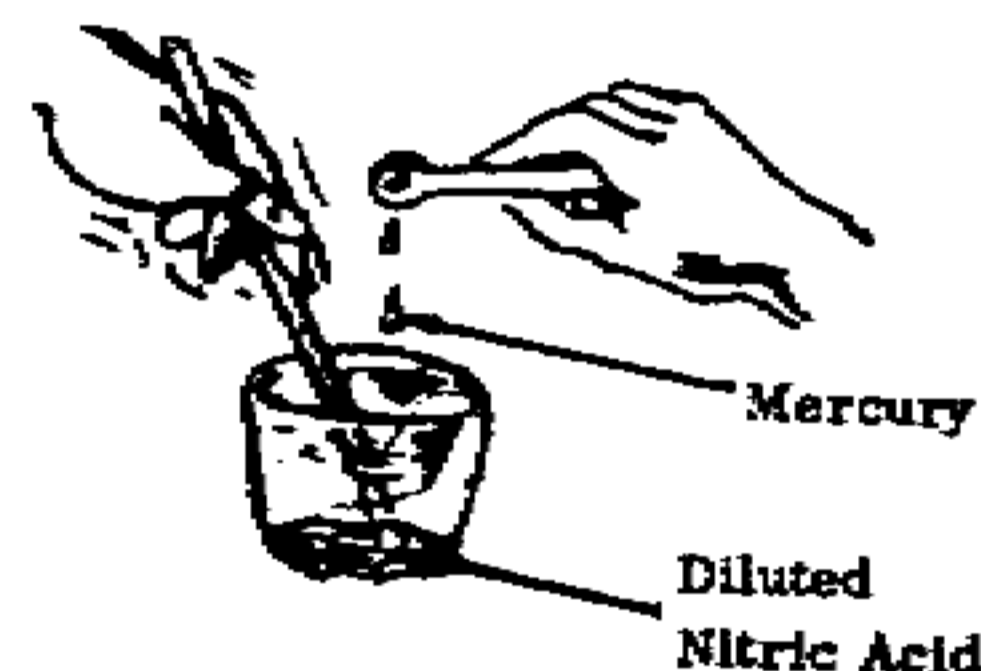



## History, Design, and Manufacture of Explosives

4. Pour the metal-acid solution into the warm alcohol. Reaction should start in less than 5 minutes. Dense white fumes will be given off during reaction. As time passes, the fumes will become less dense. Allow 10 to 15 minutes to complete reaction. Fulminate will settle to bottom.

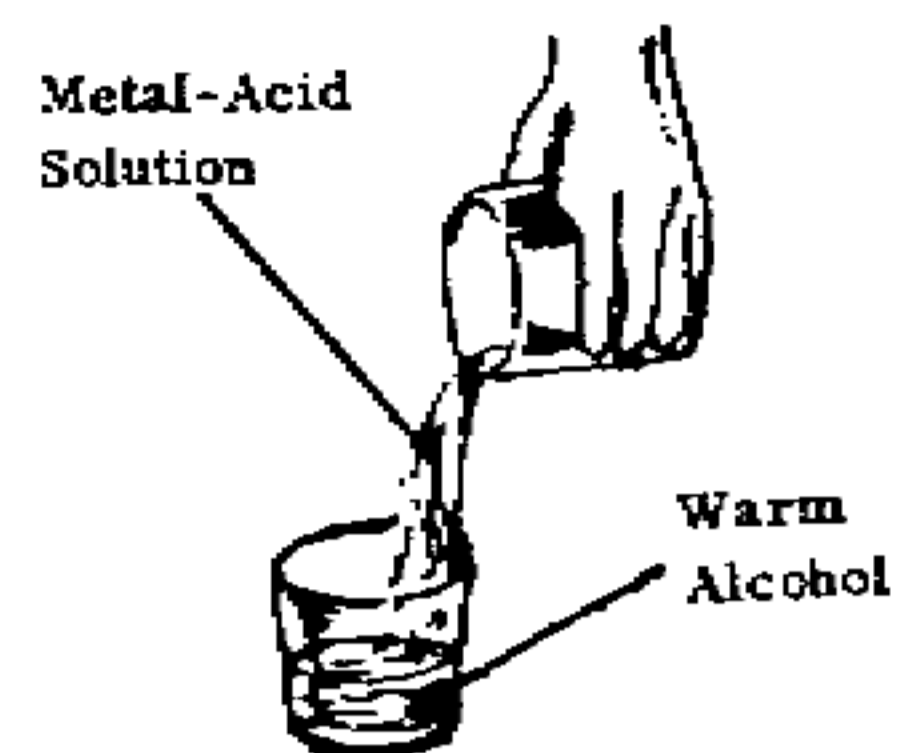

**Caution:** This reaction generates large quantities of toxic, flammable fumes. The process must be conducted outdoors or in a well ventilated area away from sparks and open flames.

5. Filter the solution through a paper towel into a container. Crystals may stick to the side of the container. If so, tilt and squirt water down the sides of the container until all the material collects on the filter paper.

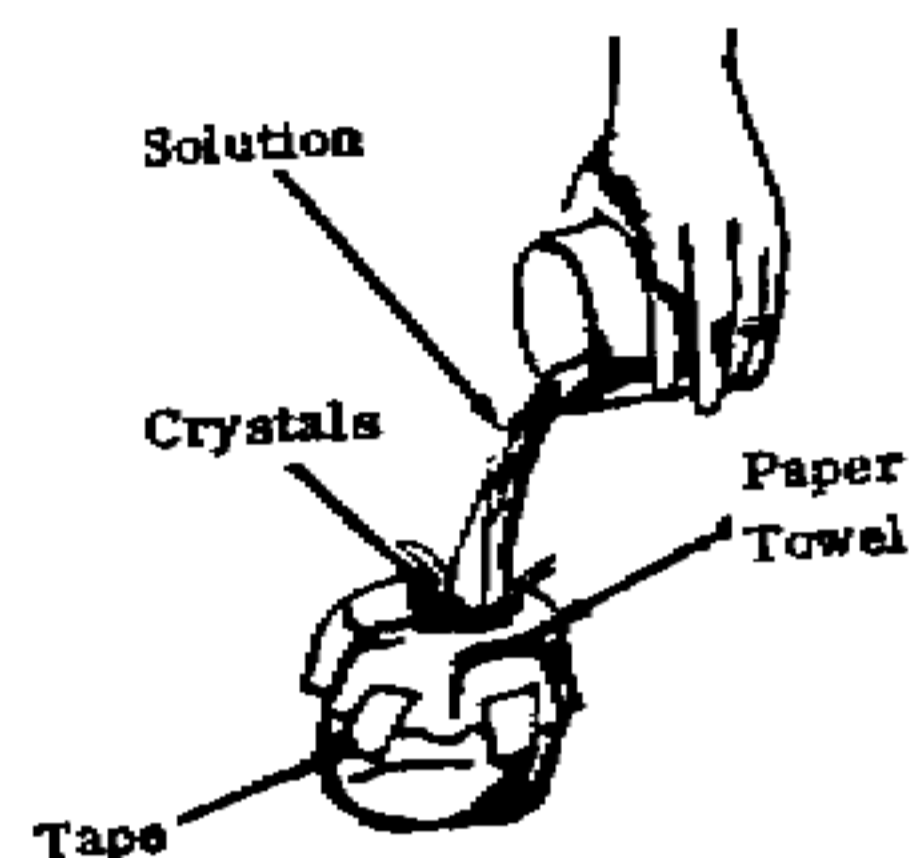

6. Wash the crystals with 6 teaspoons of ethyl alcohol.

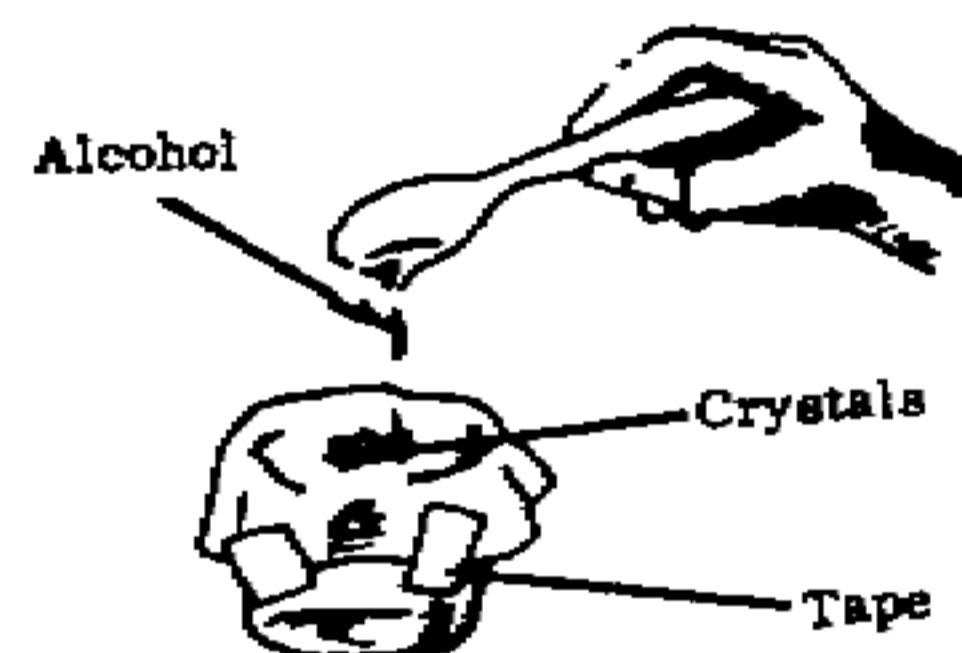

7. Allow these mercury fulminate crystals to air dry.

Handle with care!

## History, Design, and Manufacture of Explosives

### Lead Azide

Lead Azide has become one of the most popular detonator materials because it ignites at 112 degrees higher temperature than mercury fulminate making it safer to use, and it does not decompose under hot storage conditions. When lead azide is pressed into a detonator, it becomes harder to ignite with a spark or fire. For many years a coating of lead styphnate was added as a coating to sensitize it and make it explode more easily. Modern blasting caps use mixtures of detonating materials to make them reliably explode under varying conditions. A typical example would be

#### NOL 130

Lead Azide	20%
Antimony Sulfide	15%
Lead Styphnate	40%
Barium Nitrate	20%
Tetrazene	5%

Lead Azide does not produce fire from impact. It is often combined with other primers as in the above formula for blasting caps and artillery fuses to better communicate fire and explosion.

It was often thought that the larger lead azide crystals were more sensitive to shock and friction and many efforts have been historically made to reduce crystal size including the use of nucleating agents such as dextrin, polyvinyl alcohol (PVA), and carboxymethylcellulose. By adding these to the dissolved mix, they would cause far more smaller crystals to nucleate and form without making the larger sizes.

The sensitivity issue has been disputed between manufacturers, and the use of methods to make finer particle sizes continues in many countries. There are material handling advantages with some of the nucleating systems that improve loading into detonators and mixing characteristics. They also provide coatings that alter the igniting properties somewhat and make the crystals free flowing.

Lead Azide is made by mixing lead acetate or lead nitrate in solution with sodium azide. Sodium azide is very toxic and it must not come into contact with acids or allowed to sit in solutions or it will form dangerous hydrazoic acid.

## History, Design, and Manufacture of Explosives

The sodium azide is prepared by mixing caustic soda and ethyl nitrite into alcohol solution, and then adding hydrazine. The sodium azide precipitates out, is filtered, washed with alcohol, and dried. It has also been made by melting metal sodium (Na) and bubbling ammonia (NH<sub>3</sub>) through it. This yields the sodamide  $2\text{NaNH}_2 + \text{H}_2$ . This molten sodamide then is autoclaved in an ammonia atmosphere at 230 C and nitrous oxide is mixed into the melt. Half of the sodamide reacts as  $\text{NaNH}_2 + \text{N}_2\text{O} = \text{NaN}_3 + \text{water (H}_2\text{O)}$ . The other half reacts to form caustic soda and ammonia. The reaction is finished when no more ammonia comes off. It is purified by fractional crystallization, or reacting the caustic soda in the batch carefully with nitric acid.

The commercial manufacture of lead azide is done by remote control in stainless steel vessels using filtered and distilled water. In the manufacture of lead azide with a nucleating agent such as dextrin, the procedures are -

1. Lead Nitrate, Dextrin, and Sodium Hydroxide are mixed into water solution at a pH of 4.6-4.8 and reacted.
2. This solution is cooled, filtered, pumped to storage, and allowed to settle for 8 hours.
3. A solution of sodium azide is similarly prepared.
4. The lead solution (at 60 C) is added to a special made stainless steel tilting pot equipped with an agitator, feed tubes, water jacket, and water spray ring.
5. The sodium azide solution is added at 2 L/minute while keeping at 60 C. The lead azide precipitates as free flowing, fine, white agglomerates.
6. After settling, the solution is decanted onto a filter, collected, and then neutralized with 30% sodium nitrite and then 30% nitric acid to decompose leftover azide ion. The acid is neutralized with soda ash which precipitates leftover lead as lead carbonate.
7. The solid lead azide from the filter is washed repeatedly with water, vacuum filtered, and dried.

The final mix is app. 92% lead azide. Without the dextrin, the yield is 99%. It is desired that there are no needle shaped crystals longer than .1mm. The dextrinated lead azide is less sensitive than the pure material. The material cannot be dead pressed (pressed to where it cannot be initiated any longer). It is a nonconductor, and flaked graphite is added to form a conducive mix when used in electric detonators. Production of lead azide is considered very hazardous and should be undertaken carefully.

## History, Design, and Manufacture of Explosives

### Silver Azide

Silver Azide has received considerable attention recently because it requires only tiny amounts to initiate main charges. This allows the miniaturization of fuse components in many modern explosive designs. It requires a little less time than the lead azide to initiate, as well as less flame energy (it's more heat sensitive). It decomposes on contact with sulfur compounds, tetrazene, and some metals including copper.

Silver Azide is manufactured using the same methods as lead azide, only silver nitrate is used in place of lead nitrate.

In comparison to mercury fulminate -

1. Silver Azide .05 grams will detonate .4 grams TNT, with or without confinement in a #6 cap.
2. Mercury Fulminate required .24 gram to detonate the .4 gm. of TNT and only when confined.

The "sand crushing" power of both was about the same. It can be inferred that chemical or mechanical properties other than sheer force enhance silver azides detonating abilities.

### Lead Styphnate

also known as lead 2,4,6-trinitroresorcinate, it is considered the most sensitive to stab, flame, heat, and impact. Using it insures the ability to ignite a primary explosive. It is stable and non-corrosive and is used as the top contact charge in stab detonators, as a spot charge in electric detonators, or as part of the contact mixtures. Graphite is added to improve its ability to be ignited electrically. It is very sensitive when dry to electrostatic discharge, but loses much of this sensitivity after being pressed into detonator caps.

Its lab production has already been described in chapter 4. In modern production, the lead styphnate is precipitated from a mixture of magnesium styphnate (made by mixing magnesium oxide and styphnic acid) and lead acetate, followed by acidifying with dilute nitric acid to the trinitro form.

The styphnic acid is made by simply nitrating the combustible aromatic "resorcinol".

## History, Design, and Manufacture of Explosives

### Diazonium salts and Diazodinitrophenol

represent a group of chemical salts that explode easily when in their dry crystalline form. The members of this group are usually formed by "diazotization, or reacting an aromatic with nitrous acid or gas in the presence of excess mineral acid.

One of the earliest known of this group is diazobenzene nitrate, first prepared by bubbling nitrous gas into a cooled aqueous solution of aniline nitrate, and adding an equal volume of alcohol which precipitated the white crystals on addition of ether. This was washed with ether, gently pressed between two pieces of filter paper and dried under vacuum. Sunlight and moisture causes it to rapidly decompose. It detonates very easily from blow or friction, or when heated to 90 C.

Also exhibiting the same sensitivity is m-Nitrobenzenediazonium perchlorate, patented in 1911 and used in compound detonators for high explosive nitric esters. It is also unstable in moisture and sunlight. It is prepared by -

1. Add .5 gram of m-nitroaniline to 5cc of water in a wide test tube and stir to suspension.
2. Add .5cc of concentrated hydrochloric acid and 2.2cc of 20% perchloric acid and stir.
3. After the solids are dissolved, add 15cc of water and keep cool by immersing the test tube in cracked ice.
4. Dissolve 1/4 gram of sodium nitrite in 1 or 2 cc of water and add in 4 doses while stirring with a glass rod with the end covered with rubber tubing.
5. After standing in the ice for 5 minutes, filter, wash the pale yellow needles with cold water, then with alcohol, and then with ether.
6. Dry in several small portions separately on filter paper.

Diazodinitrophenol (DDNP), was originally produced by bubbling nitrous gas into an alcoholic solution of picramic acid (dinitroaminophenol, which is **not** picric acid).

## History, Design, and Manufacture of Explosives

It has since been made by -

1. Suspending 10 grams of picramic acid in 120cc of 5% hydrochloric acid in a beaker standing in a cooling bath of ice water and stirred rapidly.
2. Sodium nitrite (3.6 grams) is dissolved in 10cc of water and added all together and then stirred for 20 minutes.
3. The precipitate is filtered (slowly and gently) or preferably collected, and washed thoroughly with water.
4. The dark brown crystals may be used "as is" or purified by dissolving in hot acetone and agitating while adding a lot of ice water to precipitate the now yellow crystals.

The DDNP is nearly non-hygroscopic, a little less stable than lead azide, and sensitive to friction and impact. Its brisance is similar to TNT and it is incorporated in many blasting cap formulations. It cannot be dead pressed, and does not always detonate from fire if unconfined, but will burn with a quick flash like nitrocellulose. It is soluble in nitrobenzene, acetone, strong hydrochloric acid and nitroglycerin. It is insoluble in cold water. It decomposes in sunlight and with exposure to moisture.

Various tests show that DDNP is much more powerful than mercury fulminate or lead azide. Because it will not always ignite easily from fire it is safer in some circumstances than these other primary explosives. It reliably detonates at 180 C from hot metal when confined.

**Trinitroazidobenzene** is made by

1. Chlorinating aniline to form trichloroaniline
2. Diazotizing as already described to form sym-trichlorobenzene and then nitrating it.
3. Nitration is accomplished by dissolving the material first in 32% oleum, adding strong nitric acid, and heating at 140-150 C until the precipitation stops.
4. This resulting trinitrochlorobenzene is added to an actively stirred solution of sodium azide in water wet alcohol.
5. The precipitate is filtered, washed with alcohol, and then water, and is air dried.
6. It can be purified by dissolving in chloroform and allowing to cool where the greenish yellow crystals form.

## History, Design, and Manufacture of Explosives

It is readily soluble in chloroform, slightly in alcohol, and insoluble in water. It is not hygroscopic, and does not attack the metals in the presence of moisture. It is volatile at elevated temperatures and decomposes rapidly in hot storage. This decomposition yields hexanitrosobenzene which is an explosive comparable to tetryl and is stable and nonhygroscopic.

This explosive burns when ignited in the open, but explodes with great force when confined in detonators. It is less sensitive to shock and friction than mercury fulminate but is made more sensitive by mixing in finely ground glass to it. It can also be dead pressed to where it only burns when ignited. It is best used by mixing moist material with nitrocellulose and a small amount of amyl acetate, hand screening, and allowing it to dry to granules.

### Tetracene and its related explosive salts

Tetracene exists as pale yellow crystals and is made in modern production by adding sodium nitrite to a solution of 1-aminoguanidine hydrogen carbonate in dilute acetic acid at 30 C. The precipitated crystals are filtered, water washed, dried at room temperature, and are stable up to 75 C. It is insoluble in water, alcohol, ether, and benzene.

**Tetracene** (short for 1-guanyl-4-nitrosoaminoguanyltetrazene) forms many explosive salts with useful properties, some of which we will describe here.

It is soluble in hydrochloric acid and forms tetracene hydrochloride that is precipitated by adding ether. By treating it with alkali like ammonia or sodium acetate, it yields the tetracene again.

In a solution of excess silver nitrate, it yields tetracene silver nitrate.

When left in solution with caustic soda, it produces several compounds including triazonitrosoaminoguanidine which reacts with copper oxide or acetate to yield a blue copper explosive precipitate. This can be mixed with acid to further yield the explosive tetrazolyl azide.

Sodium Nitrite, in the presence of mineral acids, reacts with the aminoguanidine to form **guanyl azide**. This forms salts with acids such as guanyl azide nitrate which does not explode, but produces considerable light during rapid decomposition.

When reacted to form picrate and perchlorate salts, powerful explosives sensitive to heat and shock are formed.

## History, Design, and Manufacture of Explosives

If hydrolyzed with strong alkali, it forms the alkali metal salt of hydrazoic acid. It is hydrolyzed by ammoniacal silver nitrate in cold water to form soluble silver azide and yellow silver cyanamide precipitate. This can be treated with acids or weak base to convert it to 5-aminotetrazole.

When aminoguanidine and sodium nitrite are reacted in an excess of acetic acid, they form 1,3-ditetrazolyltriazine.

When tetracene explodes, it produces a lot of black smoke, but very little noise. As it is pressed it begins to rapidly lose its power and is dead pressed easily. It has the unusual property of increasing its power beyond its own brisance when used in combination with other primary explosives. This synergistic effect has led to its being incorporated into many combination and compound detonators. It is also a very powerful booster because of this effect. It has been used in primer, detonator, compound, and other detonators including explosive bolts and rivets.

**Cyanuric Triazide** is made by adding pure powdered cyanuric chloride to a water solution of an excess of silver azide while cooling and agitating. It is insoluble in water and readily soluble in acetone, benzene, and ether. It melts at 94 C and decomposes at 100C. The melted material dissolves TNT and the other aromatic nitros. It is so sensitive that the crystals should be dried gently under vacuum.

The tiny crystals are more sensitive than the fulminates and have exploded while loading into detonators, and the large crystals are very sensitive and explode with very little pressure of any kind. It is one of the more powerful of the primary explosives as the following comparison demonstrates.

<u>Explosive</u>	<u>Velocity of detonation m/s</u>
Cyanuric Triazide	5,545
Lead Styphnate	4,900
Lead Azide	4,500
Mercury Fulminate	4,490

It usually requires only 1/3 to 1/4 as much cyanuric triazide to detonate other high explosives than mercury fulminate often only a few hundredths of a gram being used. It is much more sensitive to shock than mercury fulminate

This material is hygroscopic and slightly volatile and must be used only in detonators that are completely sealed.



## History, Design, and Manufacture of Explosives

**PETN** has already been described in chapter two under formaldehyde based explosives. It is used as a pressed base charge, in detonators and blasting caps. It is also used as the core of commercial detonating cord and in sheet explosives. It is very easily and reliably initiated.

In the expansion tests the comparative results of detonators were

PETN	100%
Trinitrotriazidobenzene	90%
Tetryl	70%
TNT	60%
Mercury Fulminate	23%
Lead Azide	16%

**Nitrogen Sulfide** melts at 178 C and explodes at higher temperatures. It detonates violently with shock or blow and is less sensitive than the fulminates but has a lower velocity of detonation. It has found occasional use in fuses, primers, and blasting caps in the first half of this century by itself and with other oxidizers.

It is made by

1. Dissolving 1 parts sulfur chloride in 10 parts carbon disulfide and cooling.
2. Anhydrous ammonia is bubbled in until the first dark brown precipitate has redissolved and an orange yellow solution forms.
3. This solution contains solid ammonium chloride and it is filtered off and rinsed with carbon disulfide.
4. The solution is evaporated and the residue is boiled in carbon disulfide to remove sulfur.
5. The undissolved material is crude carbon disulfide which is added to by the cooling precipitates from the liquid.
6. The entire mass is recrystallized in carbon disulfide to purify.

**Nitrogen Selenide** is produced by bubbling anhydrous ammonia into a solution of selenium chloride which yields an orange-red precipitate. It detonates on contact with sulfuric acid and is used best with acid delay detonators. It explodes violently with heated and is considered dangerous to handle because it ignites from friction, heating to 230 C, and very mild blows.

# History, Design, and Manufacture of Explosives

## Chapter 8

### Pyrotechnics

The art and science of chemically generating light, heat, and sound, is closely related to the pure science of explosives which chemically generates the same effects. These effects, when used to entertain, for convenience, or for war, are called "pyrotechnics".

The categories of uses include

- Fireworks
- Theatrical Effects
- Model Rockets
- Utility Flares
- Photography
- Smoke
- Tracer munitions
- Incendiaries
- Time Delay Initiators

The pyrotechnics use the same basic chemistry as explosives. They do not depend on oxygen from the air to generate the combustion reactions, but have their own oxidizer to supply the necessary oxygen, and their own fuel to support combustion. When ignited together, they perform the work required by their design and chemistry.

### Fireworks

The first fireworks were basically the black powder used in the early weapons, combined with an additional combustible, to produce noises and propel "fire" compositions into the air. These first combustible additions included -

Iron and steel filings	Obtained from steel mills and screened for fine and coarse sizes, they produce white and red sparks.
Ground cast iron	Filings ground in mortars and used to make "Chinese fires"
Copper filings	Produced green sparks
Zinc filings	Yields blue flame
Antimony Sulfide	Fine powder produced blue flame
Yellow Amber	Produces yellow flame

## History, Design, and Manufacture of Explosives

Lampblack	Soot, adds deep red color to fire
Yellow sand	Produces golden yellow rays

All of these were combined to the standard black powder formulas in the earliest fireworks to provide entertaining colors. Soon, the early pyrotechnists would experiment with various chemical salts to find out what new colors and effects could be created. The earliest combinations include -

Copper sulfate and ammonium chloride	For green fire. The chloride combines to volatilize the copper and produce brighter colors.
Potassium chlorate and perchlorate	Added to provide oxygen in the reaction with salts which would add new and much brighter colors to the flames that burned.
Copper acetate and copper sulfate	Added to ammonium chloride to produce brilliant "Russian fire"
Strontium Nitrate or chlorate	To yield various red colors to flame
Calcium chloride	with alcohol to produce orange flame
Copper nitrate	for emerald flame
Sodium chloride, niter, and alcohol	for yellow flame

These early formulas would be mixed, often with alcohol, and then loaded into paper cartridges with a cotton wick running out from the mixture. These were sealed with wax or clay and then the wick would be lit when ready to use to ignite the mixtures. Chlorate mixtures had to be handled carefully since they would easily ignite during loading from friction (potassium chlorate is the material on the end of matches). Adding sulfur to the mixtures usually added considerably to the brightness of the mixtures, but was often hazardous. The addition of extra nitrates to add both color and oxygen to the reaction was also a popular trend.

The first use of magnesium as a fuel in fireworks occurred in 1865, and aluminum in 1894. Both are still used as the most common fuel source in pyrotechnic formulations today. Both produce the dazzling white lights we see as the foundation in most fireworks mixtures. The magnesium works better in acid mixtures with such oxidizers as alkali metal salts or barium and potassium nitrates that include a few percent organic binder to stabilize the mix. These mixes are used in tracer bullets and flares.

## History, Design, and Manufacture of Explosives

Aluminum powder is more energetic in alkaline mixes such as when mixed with potassium perchlorate for photoflash compositions. Sulfur should not be added to magnesium mixtures, but in other formulas it improves the ignitability and retards the reaction rate for longer burns.

The formula materials have to be carefully considered when designed. Adding ammonia salts to the mixes can lead to the formation of ammonium chloride salts which may ignite on standing. The chlorates can react and spontaneously ignite sulfur or red phosphorus during mixing.

Ammonium picrate soon became part of formulas where colored fires were desired without the production of smoke and offensive odors (such as in indoor theaters). It could detonate on contact with potassium chlorate or lead nitrate and would detonate from shock or fire. Hydrated lead picrate (1 H<sub>2</sub>O) was used in caps and primers because it detonates easily from fire and shock. Potassium and sodium picrate deflagrate from flame in mixtures adding to the show. Other picrate salts were found unsuitable for use in fireworks.

Metal oxides (such as iron oxide) and the metal fuels magnesium and aluminum or barium peroxide have found use in incendiary pyrotechnics called "thermites" which require special igniters to use.

There are many older formulations that were prepared around the following materials and ranges.

Potassium Nitrate	50-80%	used in white colors, and to make pink with strontium salts
Sulfur	10-25%	adds intensity and slower burning to formula
Strontium Nitrate	50-70%	Makes red with no potassium nitrate, pink with it
Barium Nitrate	25-70%	Makes yellow with no potassium nitrate, blue with Potassium chlorate
Charcoal	5-10%	Slows down burning rate
Potassium chlorate	15-40%	Used in combinations with or without potassium nitrate
Sugar, sawdust	5-20%	added combustible in slower burning mixes
Cryolite	5-20%	Aluminum sodium fluoride, adds yellow to flame
Picric acid	10-30%	Deepens colors and adds brilliancy, explosion from shock risk
Potassium picrate	10-30%	replaces part of potassium nitrate to make "whistle" sounds
Aluminum	10-30%	adds dazzling brilliance to light
Perchlorate salts	10-40%	Used in aerial compositions without sulfur, sulfides, or picric acid (for safety)

## History, Design, and Manufacture of Explosives

The strontium and barium salts would provide oxygen for the combustion as well as coloring the flames, and were usually combined with sulfur and/or charcoal as the combustible.

The propellant for the early fireworks consisted of black powder mixtures that were diluted with added combustible of sulfur and charcoal to slow down the production of gases as the rockets became larger. This was done for safety and show as the paper and cardboard tubes could not withstand artillery formulations even in small amounts.

Modern safety regulations and technology has led to the use of other "salts" in fireworks formulas. These are mixed to produce shadings from the primary colors.

Red	Strontium carbonate or oxalate
Yellow	Sodium oxalate or Cryolite (aluminum sodium fluoride)
Blue	Cupric carbonate with ammonium perchlorate or Potassium chlorate with Polyvinyl chloride (PVC) or hexachlorobenzene [Do not mix chlorate and ammonium]
Green	Barium Chlorate
Silver	Aluminum with ammonium perchlorate (choice of aluminum powder or flake is critical)
White	Black powder and Antimony or, Strontium and barium nitrates with magnesium in PVC
White Glitter	Aluminum, antimony, and black powder
Gold glitter	Above with sodium oxalate
Gold streamers	Charcoal or lampblack (soot)

These formulas would be propelled with black powder or the modern rocket propellants described in chapter 3. Additives are included for producing other properties that the final device requires.

The actual design and manufacture of the fireworks devices has been an art form. The ideas that led to the wide range of entertaining actions were often ingenious. The main forms of the devices will be described here.

**Whistle** devices are fireworks made with materials that produce different pitch sounds when burned inside a tube and the air is discharged through a narrow throat similar to band instruments. The pitch is varied by the size and shape of the hole and by the size or diameter of the charge. The larger the charge, generally producing the deepest pitch and greatest volume because of the larger amount of gas produced. These devices were often built into multiple charges that produced changes in pitch with changes in the visual burning display.

## History, Design, and Manufacture of Explosives

The earliest whistle makers used 60% potassium picrate and 40% potassium nitrate rammed into bamboo tubes 1/4" to 3/4" in diameter. This mix could be exploded from shock and was not used in aerial fireworks for fear of premature detonation from the shock of the "rocket" propellant. Sometimes, they were attached to the side of rockets to make whistle noises during the rockets flight. Safer whistles soon emerged using 75% potassium chlorate, and 25% gallic acid and were often used in whizzers that would scoot along the ground "whistling" and then explode at the end of the movement.

Modern whistles use the chlorates, perchlorates, or nitrates, mixed with an aromatic compound like trihydroxybenzoic acid, or potassium benzoate, or sodium silicylate.

**Roman candles** are basically mortars that fire out a succession of displays called stars, or showers of glowing sparks, or other projectiles. They are constructed of cardboard tubes that have the stars, a delay mixture, and black powder propellant in alternating layers. The delay mixture is a special mix of black powder with a large excess of larger granule charcoal mixed in. This causes it to burn much more slowly while sending out a lot of sparks. The earliest delay mixture was called "candle comp" and was formulated as -

Potassium Nitrate	34 parts	200# (mesh size)
Sulfur	7 parts	200#
Charcoal #4	15 parts	24#
Charcoal #3	3 parts	16#
Charcoal #2	3 parts	12#
Dextrin	1 part	

The bottom of the tube was sealed with clay.

The bottom layer would be standard black powder pressed into place.

The next layer would be the star, projectile, or other device.

The third layer would be the candle comp.

The stars or projectiles were smaller than the diameter of the tube and would leave air space around their bodies. These would be filled with candle comp and all three layers would be rammed tightly into place.

These layers would be repeated until the tube was full and a fuse was attached to the final layer on top. Once the fuse was lit, the candle comp would burn slowly around the star and when it would reach the black powder layer, the instant burning would propel the star or other entertainment out the end of the tube which would ignite and present its visual show. The candle comp would continue to burn in the next layer underneath repeating the show until all the layers were finished.

## History, Design, and Manufacture of Explosives

The stars used in the roman candles are pellets of burning mixtures that yield a variety of light and sparks when ignited. The stars are prepared by thoroughly mixing a damp mixture of the mass and then cutting or extruding the mix into the desired size and star shape. This shape is preferred because the corners catch fire from the candle comp easily while permitting the burning around the cuts.

Examples of early formulas include -

	<u>Red</u>	<u>Blue</u>	<u>Green</u>	<u>Yellow</u>	<u>Rose</u>	<u>Amber</u>	<u>Green</u>	<u>Violet</u>
Potassium Chlorate	48	48	12	32				
Potassium Perchlorate					12	10	44	12
Potassium Nitrate					6			
Barium Perchlorate							90	
Strontium Carbonate	8							
Strontium Oxalate					1			9
Barium Nitrate		16	12	12				
Paris Green		18						
Copper Oxalate								5
Sodium Oxalate				2		4		
Fine Charcoal	8		4	8				
Lampblack					1			
Dextrin	3	3	1	3	1		6	
Shellac	6	10	2	6		2	15	3

The **willow tree shower** effect in roman candles used a formula of

Meal Powder	32 parts
Lampblack	24
Antimony sulfide	4
Shellac in alcohol	2

**Twinklers** which produce showers of alternating brightness while falling were made using

Meal Powder	24 parts
Sodium oxalate	4
Antimony sulfide	3
Powdered aluminum	3
Dextrin	1

## History, Design, and Manufacture of Explosives

**Spreader stars** use about 2/3rds powdered zinc which yield a green-white flame

**Fountains**, are also known in various forms as **gerbs, wheels, pinwheels, saxons, and flower pots**. They produce jets of brilliant sparks that are the result of the combustion of pyroaluminum, cast iron turnings, or coarse titanium. Black powder diluted with an extra ingredient, so it slows down the overall reaction, is used for the combustion. During loading into heavy cardboard tubes, a mix of 50% alcohol and water is used. It is ignited by fuse strands passed from top to bottom. When ignited, the contents spews out under great pressure without exploding. The wheels are driven by tubes attached to the sides or edges of round or curved device that rotates around its center. The tubes shoot out jets of fire and operate in a prearranged sequence.

**Serpents** are mixtures that burn progressively and form large amounts of black ash as they burn. They use a mild oxidizer like picric acid and which is mixed with nitrated naphthol pitch. A mix of roofing pitch 40% and syrian asphalt 60% has also been used in place of the naphthol pitch.

**Torpedoes** are small primary explosives (such as silver fulminate) that are enclosed in small bags and mixed with gravel. They explode on impact when thrown against solid surfaces.

**Firecrackers** have been produced using many formulations. The formulas are usually coarse grained powder in tubes of cheap paper. They would use fuses of tissue paper twisted around the powder and wrapped together in "Chinese firecrackers". Powdered aluminum, potassium chlorate and potassium perchlorate have also been incorporated into the many variations of firecracker compositions.

**Sparklers** are currently made by dipping wires into a thick liquid mix containing dextrin or shellac, an oxidizer, steel filings, and pyroaluminum. The older formulas were usually black powder with barium nitrate, antimony sulfide, aluminum powder, dextrin, and lampblack mixed together as very fine powders. These were mixed with small amounts of water until a "molasses" consistency was achieved. The wires would be dipped into the mix and allowed to dry. Then they would be re-dipped until the desired thickness is achieved.



## History, Design, and Manufacture of Explosives

### Theatrical Effects

Many effects like smoke, fog, lightning, and flame, are usually produced from the use of oil dispersions, dry ice, and arc lamps. Bullet fire as well as artillery or cannon fire is accomplished by using blank cartridges with small amounts of black powder that discharge gray solids only from the blast. They provide better visual effects than the commercially produced blank shells. The bullet hits are usually small holes that resemble exit craters. These are filled with a small explosive, red liquid, and then covered to conceal their presence. They are ignited in the desired sequence electrically producing an outward burst. In reality, a bullet that strikes an individual only leaves a small hole going in and as it pushes against body tissues it forms craters at its exit point. The actual bullet exit more closely resembles the "Hollywood" bullet entrance hits.

Other effects such as erupting volcanoes and certain other science fiction scenes use pyrotechnic reactions that are violent and are filmed with high speed equipment and then slowed for use in movies. Reaction substances include dropping glycerin on potassium permanganate, a mix of potassium chlorate and powdered sugar detonated with a drop of sulfuric acid, or by mixing potassium nitrate, ammonium dichromate, and dextrin and igniting by flame or electricity.

### Rockets

Rockets used in fireworks and model rockets are entertaining forms of pyrotechnics which propel themselves skyward by their own power. The older rockets used paper and cardboard casings, while some modern versions use plastic and composite materials. The bottom of the rocket tube is usually sealed with clay and then filled with either a pressed black powder charge or a casted solid propellant similar to those described in chapter 3. The black powder produces only about 20-30% of the specific impulse of the solid propellants because of the large volume of solids produced in its combustion. Most use a clay nozzle to produce the high pressure discharge of the gases. The rockets are usually ignited by a fuse cord or electric match. The burn time lasts less than a second so the combustible container usually does not catch fire.

When adding pressed black powder to the rockets, the formulas are adjusted and diluted down for the larger diameter tubes. The reason for this is that the amount of powder burned at the same time in the larger tubes is much greater and yields hot gas much faster than cardboard tubes and the nozzle can take. Typical formulas for the different sizes include -

## History, Design, and Manufacture of Explosives

<u>Diameter</u>	3"	4.25"	13"
<u>Weight</u>	<u>1 ounce</u>	<u>3 ounce</u>	<u>6 pound</u>
Potassium nitrate	36	36	30
Sulfur	6	5	5
Charcoal #3		5	12
Charcoal #6	12		
Charcoal dust	7	17	12

When the propellant runs out in some rockets, the head (as opposed to warhead) contains a parachute, firecrackers, stars, or other entertaining payload which is deployed by a separate charge of gunpowder.

### Utility Flares

are used by railroads and highway crews as well as stranded motorists. They were generally used to warn people in case of coming upon an accident or signal a train crossing or stranded vehicle. One of the early formulas for producing a slow burning red flare was made by first preparing a mix of -

10# of maple sawdust  
1 oz. of miners wax

in a steam jacketed kettle and cooked to a dry powder. The oils were retained which aided in moderating the burning rate. This was mixed as follows -

Strontium Nitrate	100#(mesh)	132 parts
Sulfur	200#	25
Prepared sawdust	20#	20
Potassium perchlorate	200#	15
Wood flour	200#	1

This mix filled into a paper tube would burn at about 1 inch per minute. The top is usually charged with a primer of potassium chlorate, charcoal, red gum, and barium nitrate moistened with alcohol and sealed. It is lit by a scratch device similar to matches. It usually is designed to burn with a distinctive red flame for about 30 minutes.

## History, Design, and Manufacture of Explosives

The color of a flare or other light source becomes important in bad weather conditions. The amount of relative intensity required from a particular color of light to be visible at 5,000 meters (nearly 3 miles) is

<u>Night</u>	<u>Red</u>	<u>Amber</u>	<u>White</u>	<u>Green</u>
Clear	1.0	2.0	2.5	2.8
Light Rain	1.2	2.1	3.0	3.2
Overcast and haze	3.2	4.1	3.1	5.9
Heavy Rain	8.9	33.5	132	567
 <u>Day</u>				
Clear	2,000	2,111	3,222	4,000
Overcast and haze	4,778	7,556	11,111	10,000

A number of chemical light generating substances have been developed for use as emergency lighting. These are usually based on mixing hydrogen peroxide with a fluorescing substance such as bisphenylethynylanthracene and a cyclic compound such as trichlorocarbonyloxyphenyl oxalate.

Flares are used by the military for a variety of uses. These include -

Infra Red flares used to locate downed aircrew and behind the lines personnel.

Decoy flares to draw enemy forces to wrong locations

Ground illumination for parachuting

Signal flares

The infra red flares take advantage of the fact that the natural terrain usually reflects long wavelengths. The use of infra red image intensifiers make it very easy to pick out IR signals from the background. Formulas to emit specific wavelengths include -

	<u>.76um</u>	<u>.79um</u>	<u>.8-.9um</u>
Silicon	10	10	16.3
Potassium Nitrate	70		
Cesium Nitrate			78.7
Rubidium Nitrate		60.8	
Hexamethylenetetramine	16	23.2	
Epoxy Resin	4	6	5

## **History, Design, and Manufacture of Explosives**

Directional flares used to signal from concealed locations usually consist of long tubes inside a air cooled tubing that burns deep inside and emits light only where it is pointed. The air cooled second tube yields no detectable signal to other observers. These often use magnesium-flouorocarbon reactions that are lower in heat production.

In the visible light spectrum, magnesium is reacted with alkali nitrates to produce the greatest brightness and intensity for the longest duration (1-5 minutes). This is the usual duration of a parachute drop. Flares must usually generate combustion temperatures of more than 3,000 C to be visible to the human eye. This can be achieved with zirconium and titanium, but the best results are usually achieved with aluminum and magnesium. Illuminating shells and flares usually use 53-58% magnesium powder, 36-40% sodium nitrate, and 4-8% alkyd resin.

### **Photography**

Night photography flashbulb light is basically the use of explosives to generate light.

Commercial flash bulbs use zirconium metal in a glass bulb which is ignited by an electric wire which is coated with a friction sensitive chlorate composition. Once the camera shutter is actuated, the wire is pushed into the bulb and rubs against an activating surface which ignites the bulb and burns the oxygen instantly producing the bright light for the photograph.

Military flash systems use mixtures of loosely packed aluminum powder, potassium perchlorate, and barium nitrate. These are initiated by explosive charge and are used in large scale night aerial and ground photography. These mixtures can generate massive amounts of visible light when used in volume. They are also used to simulate projectile ground bursts.

### **Smoke**

Smoke is used by the military to obscure vision, signaling, daytime fireworks, and to locate artillery fire. Obscuring methods usually use fog-oil atomizers, dispersal's of titanium tetrachloride (FM smoke), or burning sulfur trioxide. HC smoke is the result of the combustion of aluminum with hexacloroethane and zinc oxide which produces a cloud of finely divided zinc.

Signal smoke is usually colored or white. Black is difficult to distinguish against the background and is usually not used. The visibility of the smoke depends on its particles abilities to scatter light, how large the particles are, how hot the cloud is or if it is illuminated by another source, and its contrast to the background colors. Under hazy conditions for example, yellow and orange are easier seen than blue or green.

## History, Design, and Manufacture of Explosives

Formulas use organic dyes that have a low combustion temperature, so they easily volatilize, evaporate, and then recondense in the cool air. Modern formulas add sodium bicarbonate to inhibit the chlorate and often have added sugar or sulfur. The modern dyes are "substituted anthraquinones" which are also carcinogenic and pose health and disposal problems.

The following formulas have been used in previous wars.

	<u>Red</u>	<u>Yellow</u>	<u>Green</u>	<u>Blue</u>
Potassium Chlorate	1	33	33	7
Lactose	1	24	26	5
Paranitraline Red	3			
Auramine		34	15	
Chrysoidine		9		
Indigo			26	8

Rhodamine red, malachite green, and methylene blue have been used in more modern dye formulas as the pigmentation agent.

White smoke has been made by burning a mix of 60% potassium chlorate, and 20% each of lactose and powdered aluminum chloride which produces a cloud of finely divided white particulates.

Shell marker "smoke boxes" used for artillery sighting have historically used arsenous oxide and red phosphorus mixed with small amounts of paraffin or stearine. When the shell exploded, a colored cloud would form marking the location of the hit. This was done when smokeless explosive shell formulations came into use.

### Tracer Munitions

Tracer bullets have been used to

- Mark target impacts
- Identify nighttime combat participants
- Estimate range
- Guide the direction of fire
- Act as incendiaries

Tracer bullets are designed to leave a clearly visible trail, usually red for the best visibility in bad weather. Green tracer formulations are made by using barium salts in the formula. Daylight tracers include using dry powders, sublimed organic dyes, and the combustion of phosphorus, or cadmium and sulfur (yellow smoke). Adding magnesium to the tracer increases visibility.

## History, Design, and Manufacture of Explosives

	Delay igniter	Dim Igniter	Bright Day Igniter	Red Tracer
Strontium Peroxide	90			
Magnesium		6	15	28
Delay action igniter		94		
Calcium Resinate	10			4
Barium Peroxide			83	
Zinc Stearate			1	
Strontium Nitrate				40
Strontium Oxalate				8
Potassium Perchlorate				20
Toluidine Red Identifier			1	

### Incendiaries

Most "pyro" incendiaries are based on the use of metal fuels such as aluminum and magnesium with an oxidizer and a small amount of barium nitrate to make the mix easy to ignite. They are also a group of metals that can be made to burn as the oxides flake from their surface during combustion. These metals have been incorporated in incendiary rounds and include zirconium, titanium, depleted uranium, and misch metal. [Misch metal is a mix of fused rare earth chlorides treated by electrolysis].

The idea behind using the above formulations in bullet and artillery rounds, and in air dropped bombs is that they easily start destructive and dangerous fires. They are usually used against flammable targets such as fuel depots and aircraft fuel tanks. The larger rounds carry fuses and are used to spray the incendiary metal fragments inside enemy tanks to ignite fuel tanks and munitions.

Against other targets that do not ignite easily, the military uses napalm and thermite mixtures that adhere to the target and burn at length, forcing an ignition. The thermites use coarse iron oxide scale and granular aluminum that are made easy to ignite by adding a small amount of barium nitrate.

### Time Delay Initiators

are used in grenades, bombs used against bunkers, aircraft ejection systems, missile separation and so on. Black powder fuse cord has been used for centuries to provide a reliable delay. Once lit, it can be depended on to continue to burn at predicted rates because of the presence of hot solid by products (its hard to put out the fuse). Operating conditions in the high atmosphere, under water, or in other difficult conditions brought about new fuse delay formulations. These include -

## History, Design, and Manufacture of Explosives

			<u>Burn time s/cm</u>
Manganese delay	Mn	29%	.8-5.4
	PbCrO4	26%	
	BaCrO4	45%	
"T-10"	B	3-15%	.23-.32
	BaCrO4	97-85%	
Zirconium-Nickel	Ni-Zr	26%	.8 for 70%Zr-30%Ni
	BaCrO4	60%	4.6 for 70%Ni-30%Zr
	KClO4	14%	
	CeO2	up to 10%	
Tungsten-Viton	W	30%	.8-6.2
	BaCrO4	55%	
	KClO4	10%	
	Fullers Earth	4%	
	Viton	1%	
Tungsten delay	W	30%	.04-16 / up to 24 with CaF2
	BaCrO4	55%	
	KClO4	10%	
	Fullers Earth	5%	
Mn	=	Manganese	
PbCrO4	=	Lead Chromate (Yellow chrome)	
BaCrO4	=	Barium Chromate (Lemon chrome)	
B	=	Boron	
Ni	=	Nickel	
Zr	=	Zirconium	
KClO4	=	Potassium Chlorate	
CeO2	=	Cerium Dioxide	
W	=	Tungsten	
Fullers Earth	=	Diatomaceous earth	

# History, Design, and Manufacture of Explosives

## Chapter 9

### Explosive Devices

The devices used to hold, move, and initiate explosives fall into the following main categories.

1. Friction, Percussion, Primer and Bullet Design
2. Thrown Explosives
3. Artillery propellant and shell design
4. Rocket, Missile and Warhead design
5. Land Mines
6. Booby Traps, blasting caps, and positioned explosives
7. Air dropped bombs
8. Naval torpedoes, mines, and depth charges
9. Shaped, plastic, and slurry explosives

Many other categories of uses of explosives exist, but are not weapon related.

#### 1) Friction, Percussion, Primer and Bullet design

Friction primers are devices used to start a fire from the force of a motion. This motion can be the pulling of a grenade pin, ejecting a flare from a plane or holding cartridge by means of a spring, certain artillery shells that do not use percussion primers, and a wide range of other explosive machines.

The friction primer uses a formula like that seen on the end of a match to initiate a fire. The motion causes this formula to rub against a striker panel like that on a matchbox which ignites the primer. The fire then initiates the next material such as a delay fuse or primary explosive.

Typical formulas include

Potassium Chlorate	2	56.2	44.6	14
Antimony Sulfide	1	24.6	44.6	
Sulfur		9	3.6	
Meal Powder			3.6	
Ground Glass		10.2	3.6	
Charcoal				1.6
Calcium carbonate	.02	2	2	
Dextrin				.3



## History, Design, and Manufacture of Explosives

An example of a friction primer is in the checkoslovakian RG34 Grenade. When the safety pin (2) is pulled out, the striker moves to a central point directly over the friction formulation (3). When the grenade is jarred by the striking of an object, the striker (1) stabs into the primer which ignites the primary explosive (4). This detonates the main charge of high explosive filling (5). The grenade casing which acts as a strong confinement and aids in initiation, shatters into small fragments when detonated. It explodes on impact once the pin is pulled.

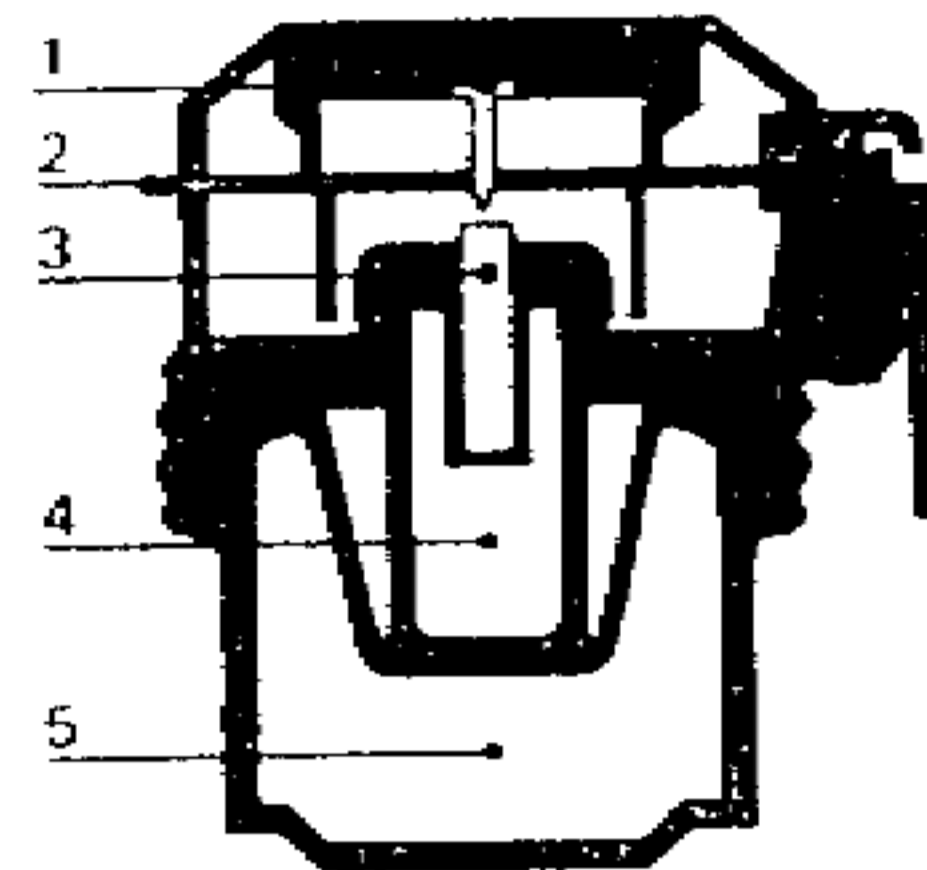

Percussion primers are designed to also produce fire when struck by the firing pin of a pistol, rifle, or cannon. It may also be used in the nose of a bullet or shell to initiate a fire on impact with a target. The early formulas used -

Mercury Fulminate	To produce the first explosion with heat and flame
Antimony Sulfide	To keep the flame burning longer
Potassium Chlorate	Provides oxygen for the combustion

TNT, Tetryl, PETN, or other high explosives may be added to make them burn hotter. Ground glass is sometimes added to make them more sensitive to the percussion by throwing hot particles of glass into the black powder charge. The hotter explosives are used for smokeless propellants. The formulas were usually mixed wet with a gum arabic solution. They were loaded into the caps like blasting caps are loaded, and then are pressed into place with the anvil inserted and pressed in over it.

Mercury Fulminate	10	28	48.8	4	5	2	
Potassium Chlorate	37	35.5	24.4	2	9	3	50
Antimony Sulfide	40	28	26.2	3	3	3	20
Ground Glass	13	8.5		5			
Ground Coke					1		
Tetryl					2		
TNT							5
Lead Peroxide							25

The last formula uses no fulminate and relies on the reaction of well mixed particles.

## History, Design, and Manufacture of Explosives

The following is an improvised field formula for gun cartridges as described by the US Army.

### 1) Reusable Improvised Primer and Rifle Cartridge

#### Materials Required

Used Cartridge (Make sure it fits the gun you are using)

2 Long Nails with the same diameter as the inside of the primer pocket

Safety or Striking matches App. 2 or 3 for primer/ 50 or 60 for cartridge

Vise

Hammer

Knife

Saw

Threaded Bolt that fits the neck of the cartridge

File

Rag Wad

Bolt (small enough to fit in cartridge case)

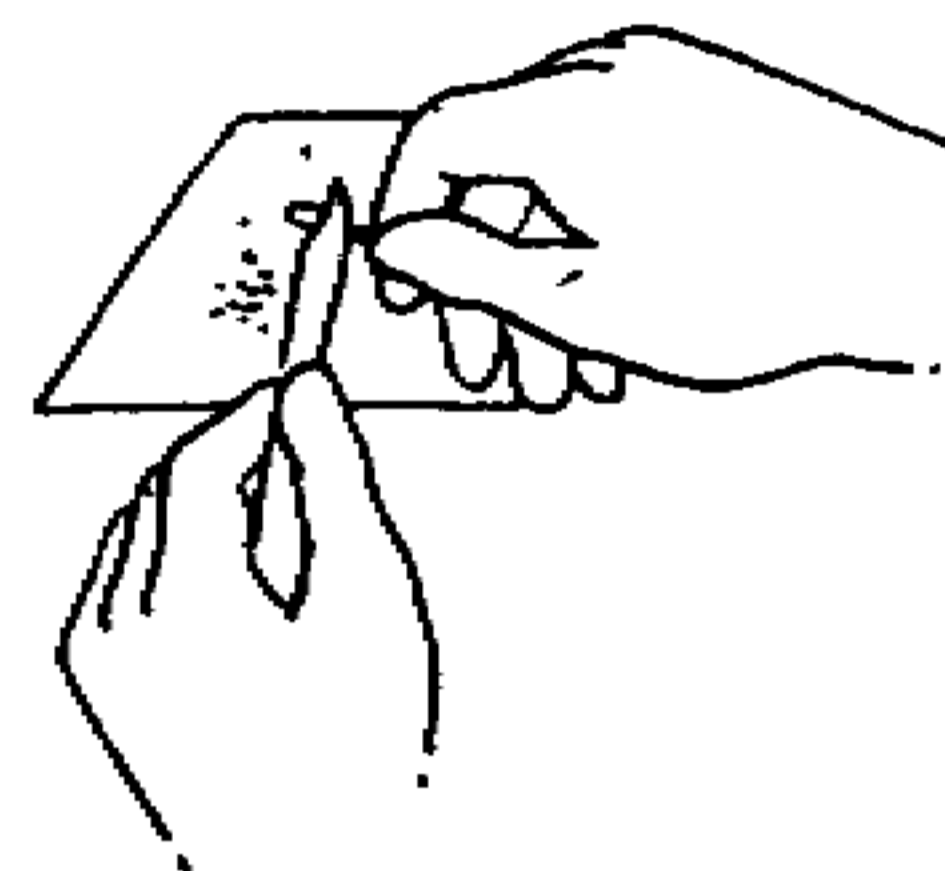

#### Procedure

- 1) File one nail to a needle point so that it is small enough to fit through hole in primer pocket.

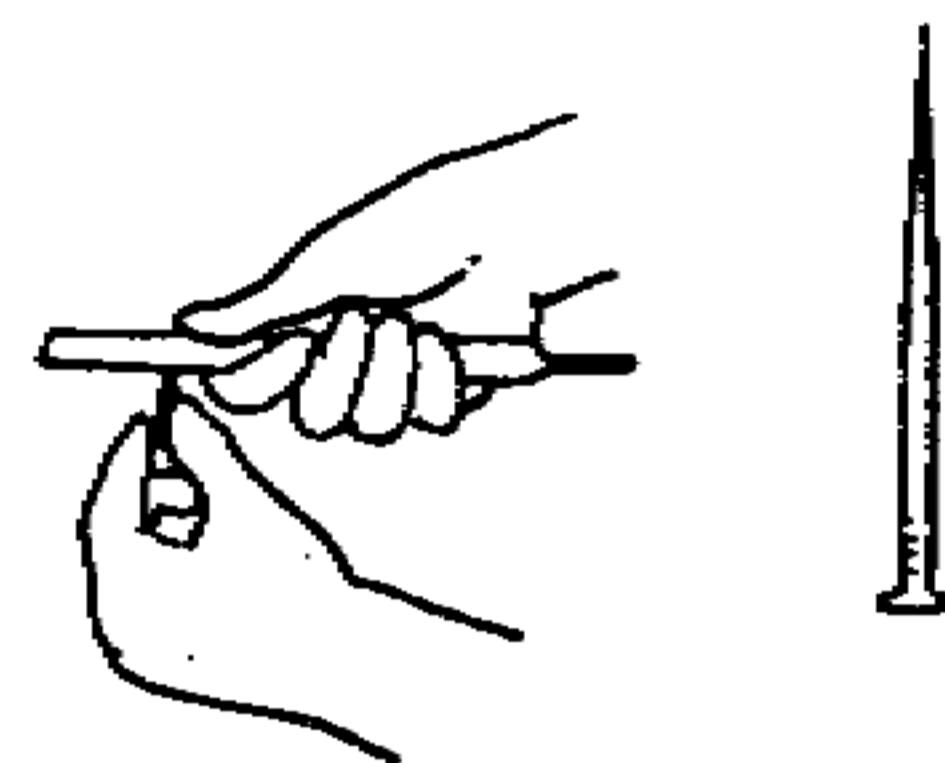

- 2) Place cartridge case and nail between jaws of vise. Force out fired primer with nail as shown.

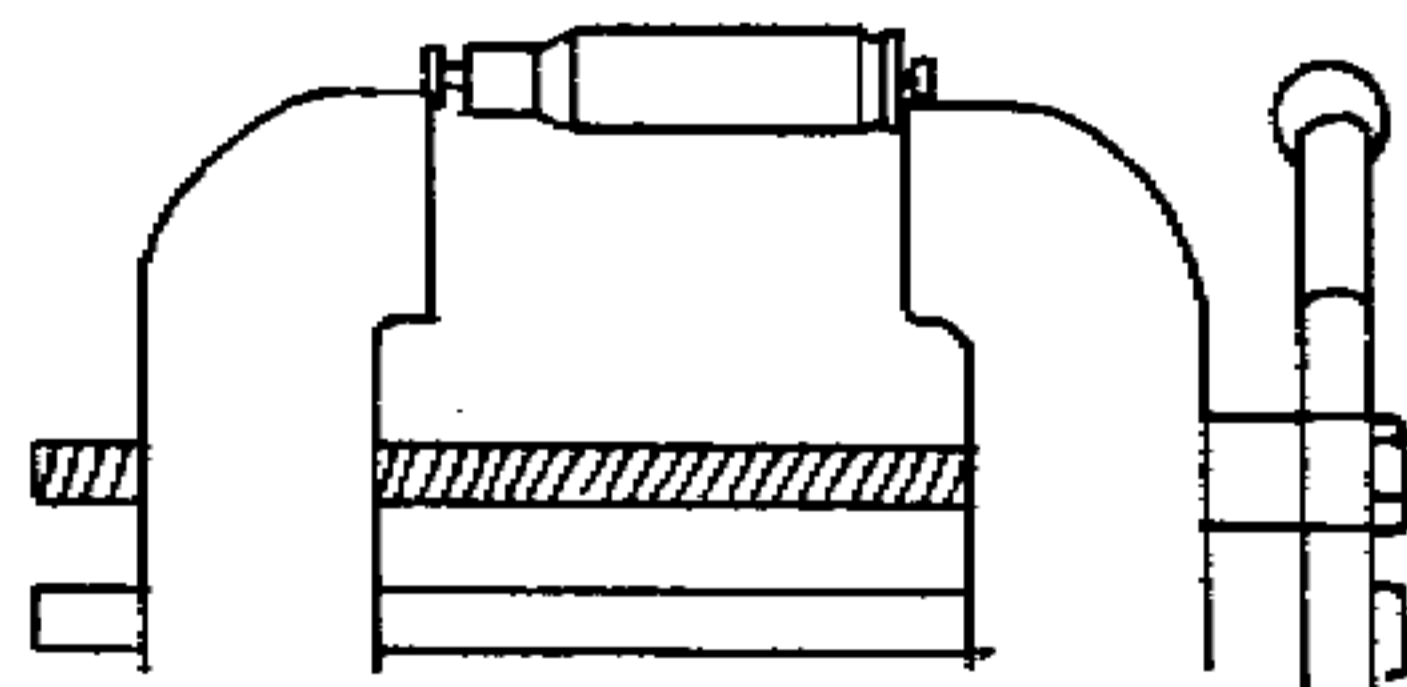

- 3) Remove anvil from primer cup



ANVIL

- 4) File down point of second nail until it is flat.

## History, Design, and Manufacture of Explosives

- 5) Remove indentations from face of primer cup with hammer and flattened nail.

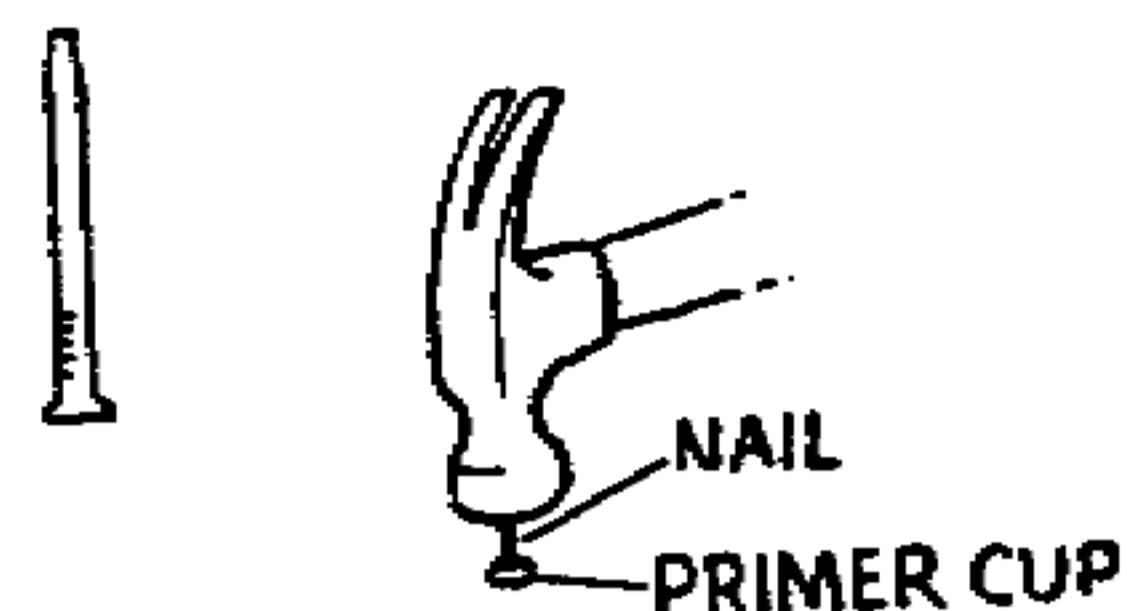

- 6) Cut the tips off the heads of the matches using knife. Carefully crush the match tips on dry surface with the wooden match stick until the mixture is the consistency of sugar.

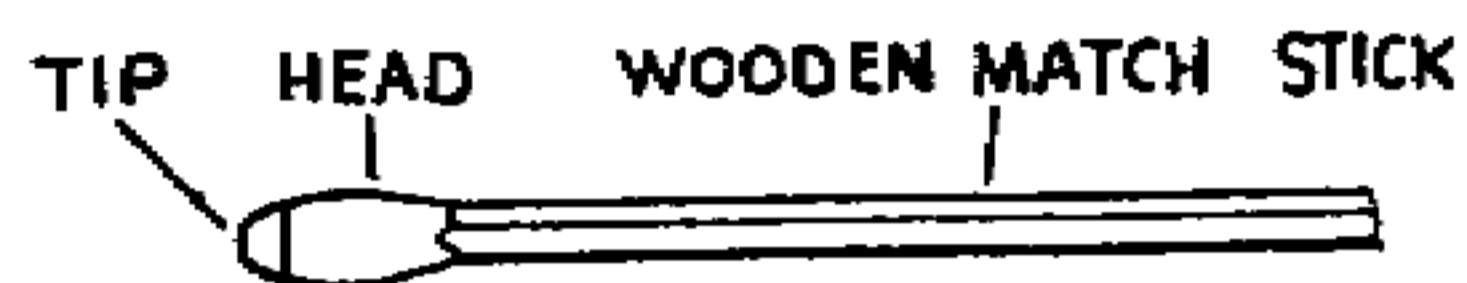

**Danger: Do not crush more than 3 match tips at one time or the mixture may explode**

- 7) Pour mixture into primer cup. Compress mixture with wooden match stick until primer cup is fully packed.

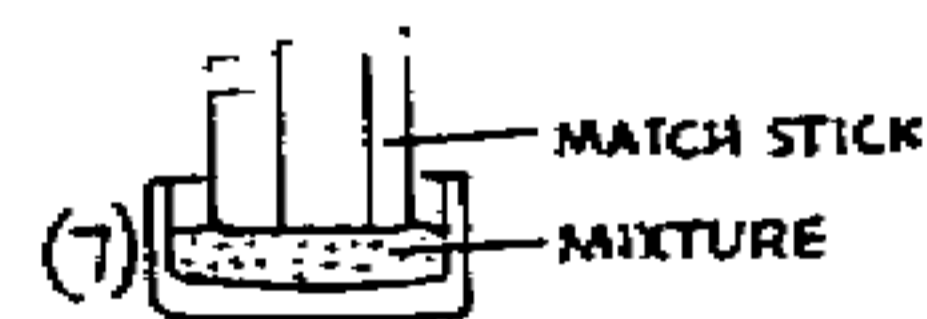

- 8) Place anvil in primer pocket with legs down.



- 9) Place cup in pocket with mixture facing downward.

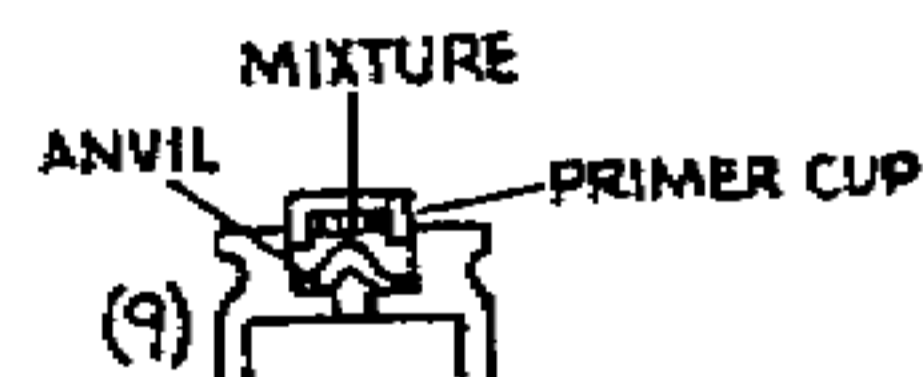

- 10) Place cartridge case and primer cup between vise jaws, and press slowly until primer is seated into bottom of pocket. The primer is now ready to use.

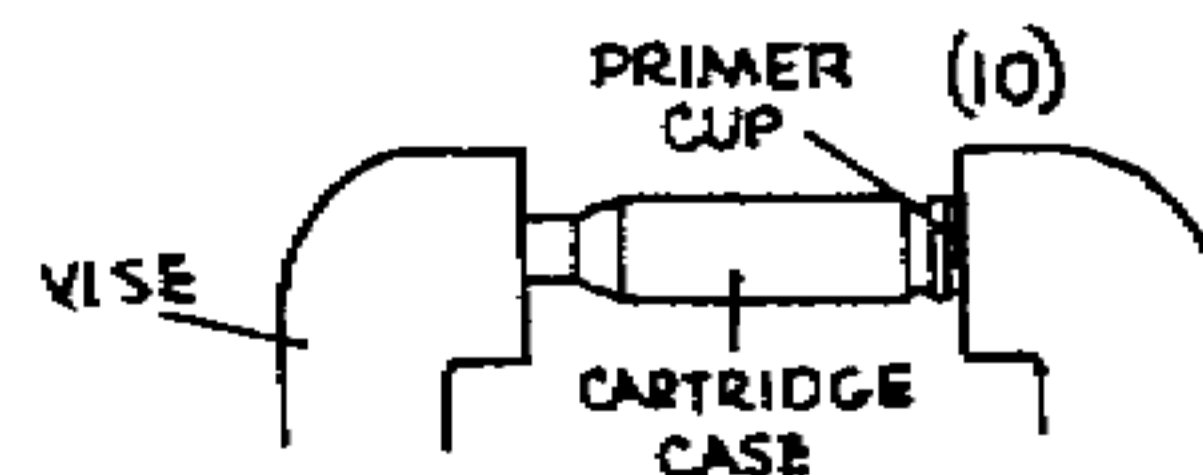

## History, Design, and Manufacture of Explosives

### Procedure for Cartridge

- 1) Remove coating on heads of matches by scraping match sticks with a sharp edge.

**Caution: If wooden striking matches are used, cut off tips first and use for reusable primer.**

- 2) Fill previously primed cartridge case with matchhead coatings up to its neck. Pack evenly and tightly with match stick. Remove head of match stick before packing so it does not explode. Stand to the side and pack gently. **Do not hammer.**



- 3) Place rag wad in neck of case. Pack with match stick from which head was removed.

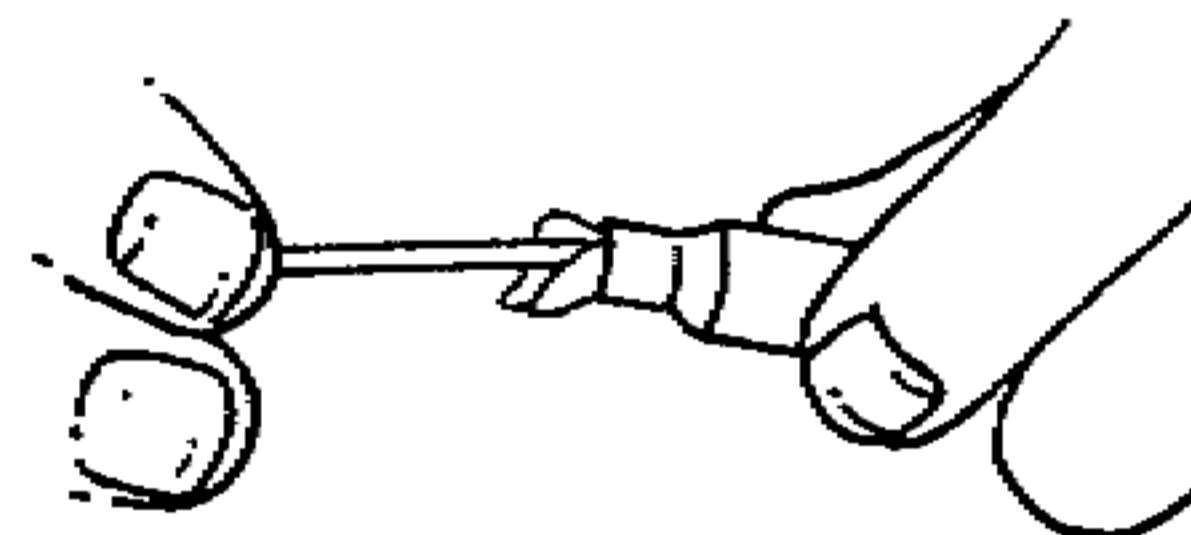

- 4) Saw off head end of bolt so remainder is app. the length of the standard bullet.

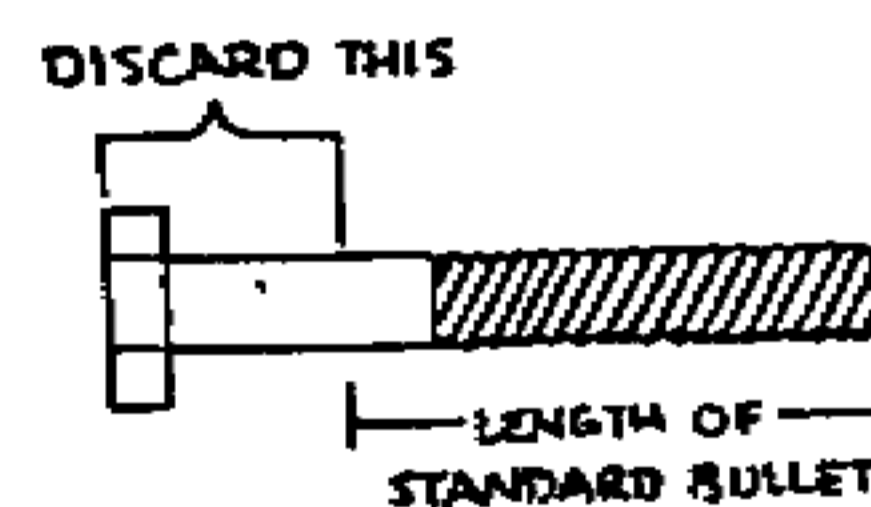

- 5) Place bolt in cartridge so that it sticks out about the same length as the original bullet.

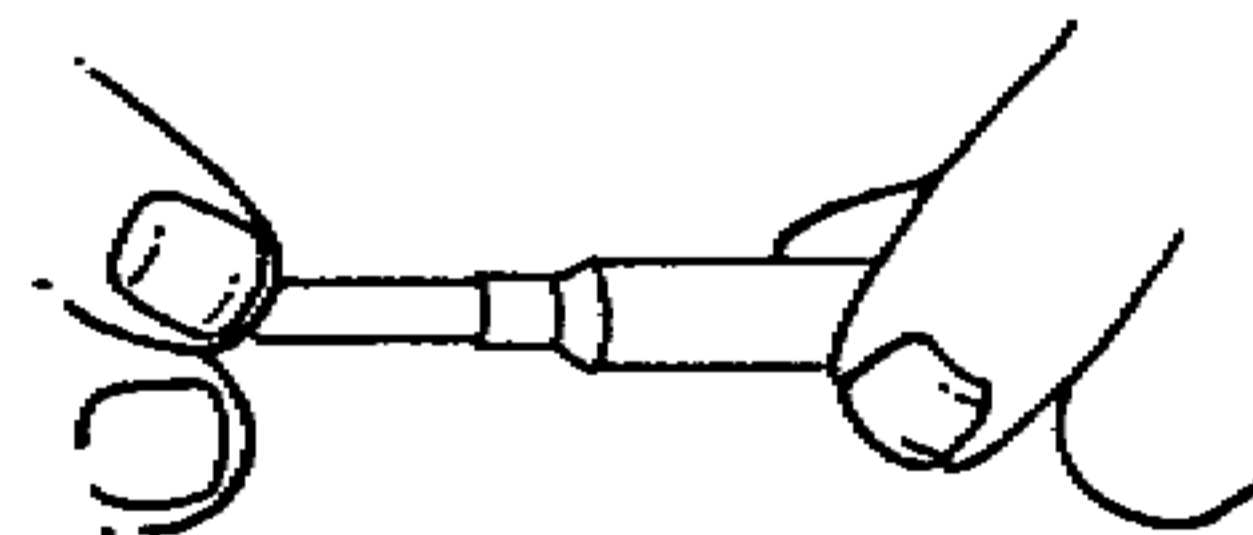

**If bullet does not fit snugly, force paper or match sticks between bolt and case, or wrap tape around bolt before inserting in case.**

## History, Design, and Manufacture of Explosives

Modern primer compositions use different materials. These include lead salts that communicate "hot" lead combustion products into the main propellant charge and thiocyanate that acts as an antacid. The PA-101 is non-corrosive and uses lead styphnate as the main explosive. The FA-70 uses the chlorate combustion to form the combustion reaction. The final formula G-11 was developed for use in aircraft guns used at high altitudes where the bullets reached temperatures of more than 200 C without misfiring.

	<u>FA-70</u>	<u>PA-101</u>	<u>G-11</u>
Lead Styphnate		53	
Barium Nitrate		22	
Potassium Chlorate	53		51
Antimony Sulfide	17	10	26
Calcium Silicide			13
Tacot*			10
Lead Thiocyanate	25		
TNT	5		
Aluminum Powder		10	
Tetracene		5	

\* Tetranitro benzotriazolo benzotriazol - Tacot is the trade name (Du Pont)

When a .30" rifle cartridge is fired (the firing pin is struck), the following actions occur.

- 1) The firing pin dents the cap
- 2) The cap in the cartridge case crushes a detonating compound against a brass anvil
- 3) The flash of the small primer ignites the main charge
- 4) The main charge explodes, burning rapidly. The temperature reaches 2700 degrees C and after .0005 seconds from ignition the propellant expands to 14,000 times its own volume in gas. The chamber pressure reaches 51,000 ft lbs. per sq.in.
- 5) The expanding gases force the sides of the cartridge case to seal so tightly against the walls of the chamber that no gas leaks to the rear
- 6) The pressure forces the bullet up the bore and out of the muzzle at very high velocities

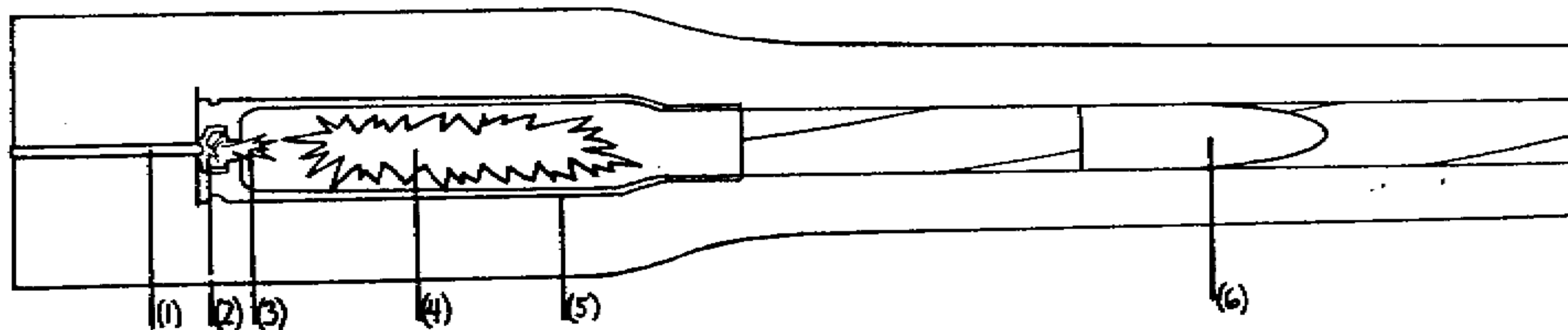

# History, Design, and Manufacture of Explosives

## 2) Thrown Explosives

Nearly all hand propelled explosive devices are called "grenades". Their large scale use began in the trenches of WW1 where the soldiers quickly learned that they could throw explosives into the enemys hidden or enclosed positions without exposing themselves to direct enemy gun fire. This worked well in attacking trenches, bunkers, street fighting around corners and obstacles, and inside of buildings.

The grenades usually came in two types. The first was a blast grenade which exploded, wounding and killing those nearby. This could be thrown at a far enough distance that the thrower was usually safe from the local blast. The second type, was often the same blast grenade design surrounded by a "fragmenting" material such as nails or special made fragmenting cases that would be propelled by the detonation over large distances. These would throw fragments back into the thrower as well over distances further than could be thrown which required the thrower to be behind protective cover.

The earliest improvised grenades were simply sticks of explosives with fuses attached. The fuses would be lit before throwing. Explosives were tied to sticks so that they could be thrown further and would allow the use of larger charges. Tobacco tins and other commercial containers were often used to hold the explosive.

Nails were soon taped around the explosive package to add the fragmentation effect.

- The **modern grenade** is designed with
- a. a filler plug
  - b. High Explosive filling
  - c. Striker and spring
  - d. Initiating cap
  - e. Base plug
  - f. Safety pin on a metal ring
  - g. Initiating lever
  - h. Detonator
  - i. Time Fuse

Once the ring is pulled out, the hand holds the lever against the grenade until he throws it. The lever held the spring in place. It now pushes a striking pin into the cap and starts a delay fuse which burns for 4-8 seconds. This then fires the detonator which ignites the main charge.

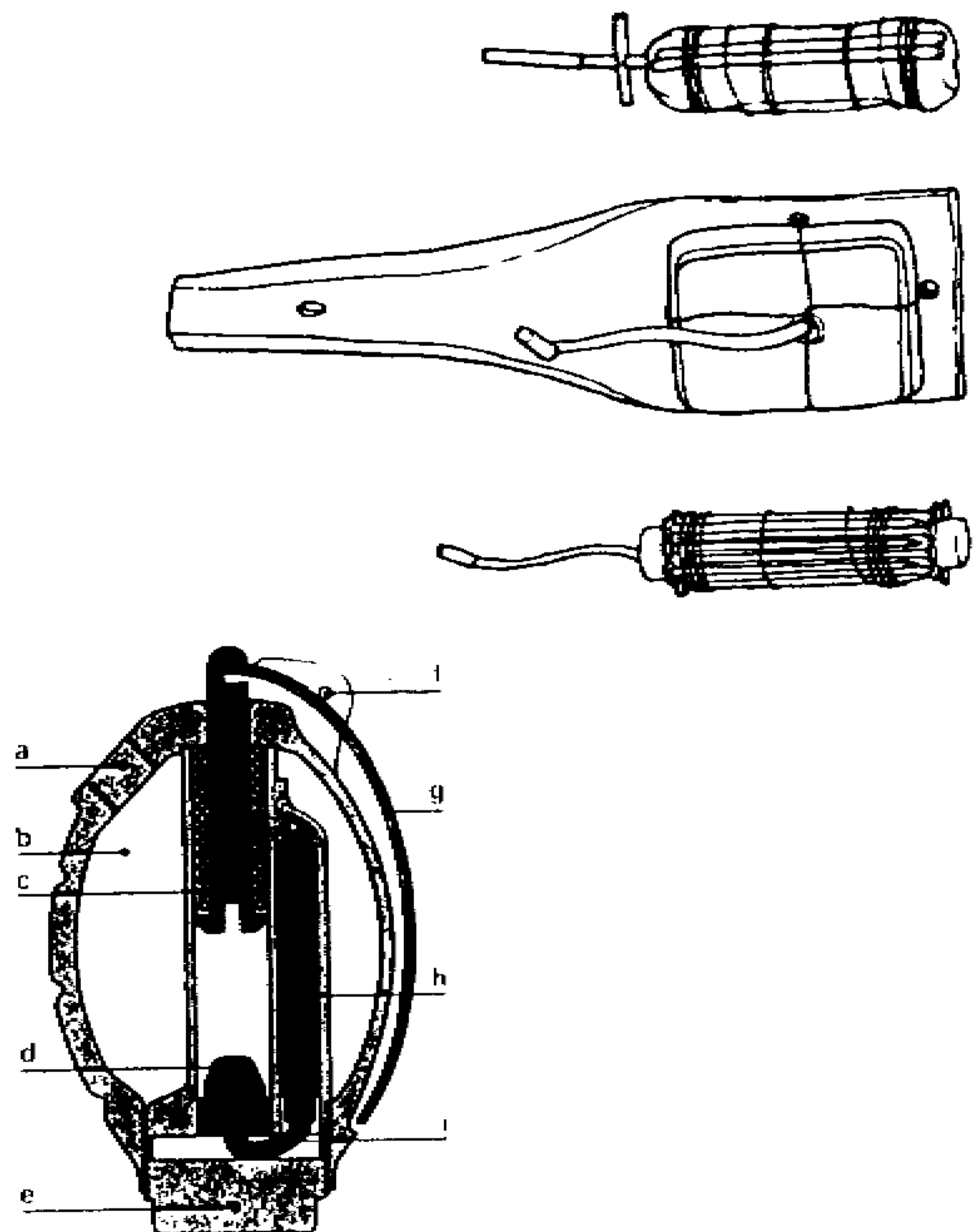

## History, Design, and Manufacture of Explosives

Field improvised hand grenades can be made as described by the US Army as follows -

### Pipe Hand Grenade

Hand grenades can be made from a piece of iron pipe. The filler can be plastic or granular military explosive, improvised explosive, or propellant from shotgun or small arms ammunition.

#### Material Required

Iron pipe, threaded ends, 1 1/2" to 3" dia. to 8" long  
Two (2) iron pipe caps  
Explosive or propellant  
Nonelectric blasting cap  
Fuse cord  
Hand drill  
Pliers

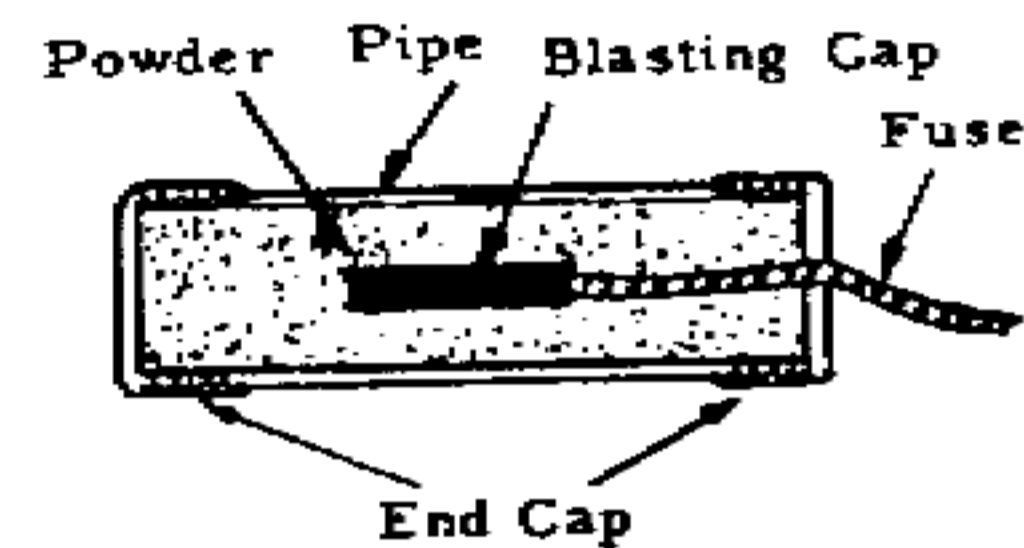

#### Procedure

1. Place blasting cap on one end of fuse cord and crimp with pliers.

**Note:** To find out how long the fuse cord should be, check the time it takes to burn a known length. If 12 inches burn in 30 seconds, a 6 in. cord will ignite a grenade in 15 seconds.

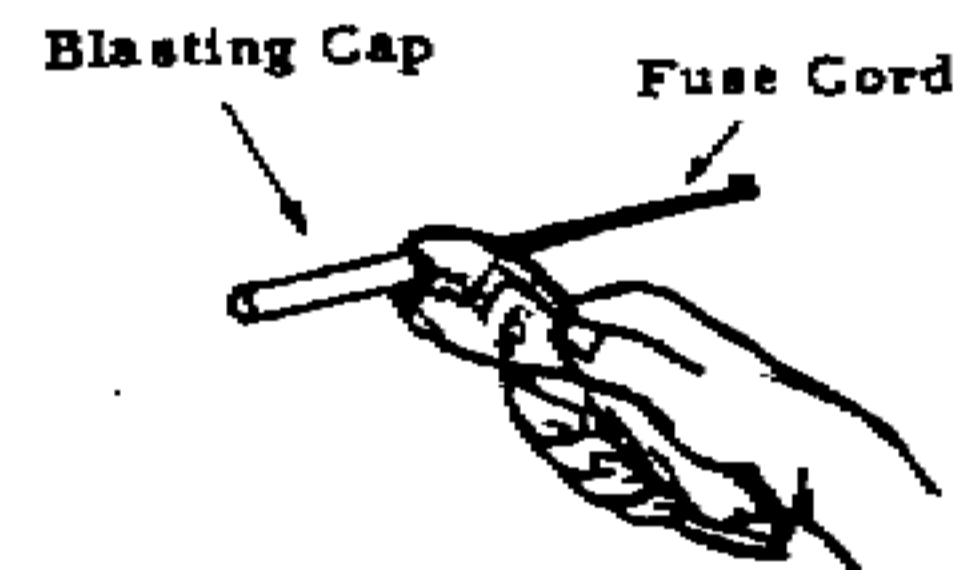

2. Screw pipe cap to one end of pipe. Place fuse cord with blasting cap into the opposite end so that the blasting cap is near the center of the pipe.

**Note:** If plastic explosive is to be used, fill pipe before inserting blasting cap. Push a round stick into the center of the explosive to make a hole and then insert the blasting cap.

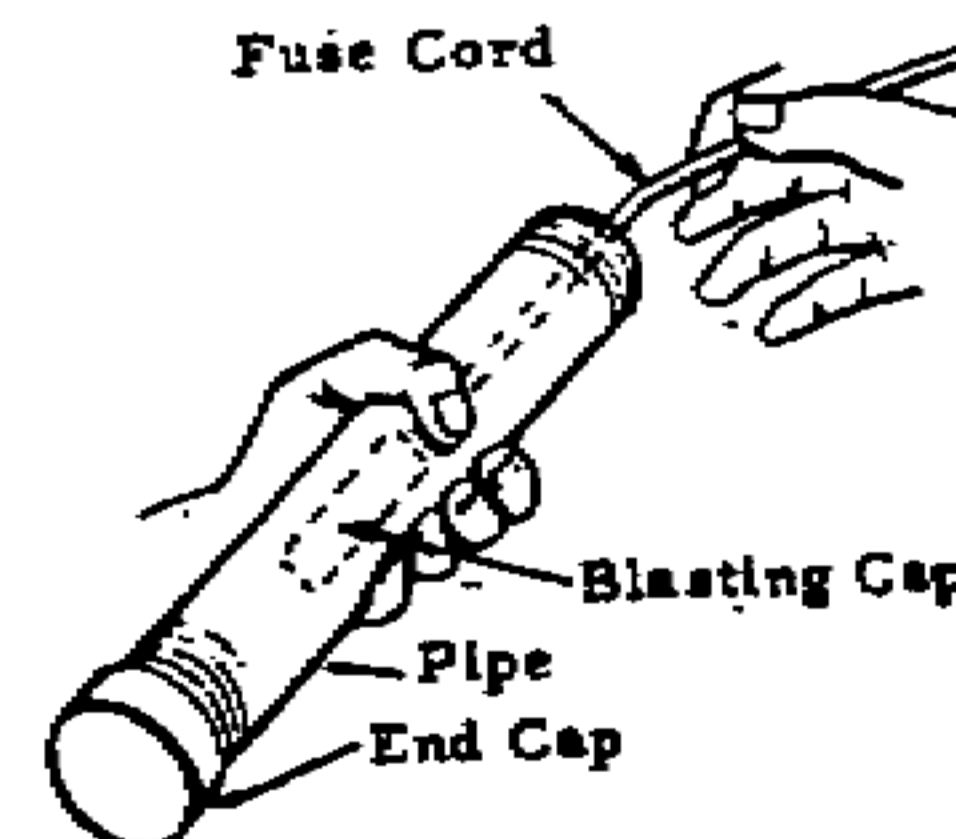

## History, Design, and Manufacture of Explosives

3. Pour explosive or propellant into pipe a little bit at a time. Tap the base of the pipe frequently to settle filler.

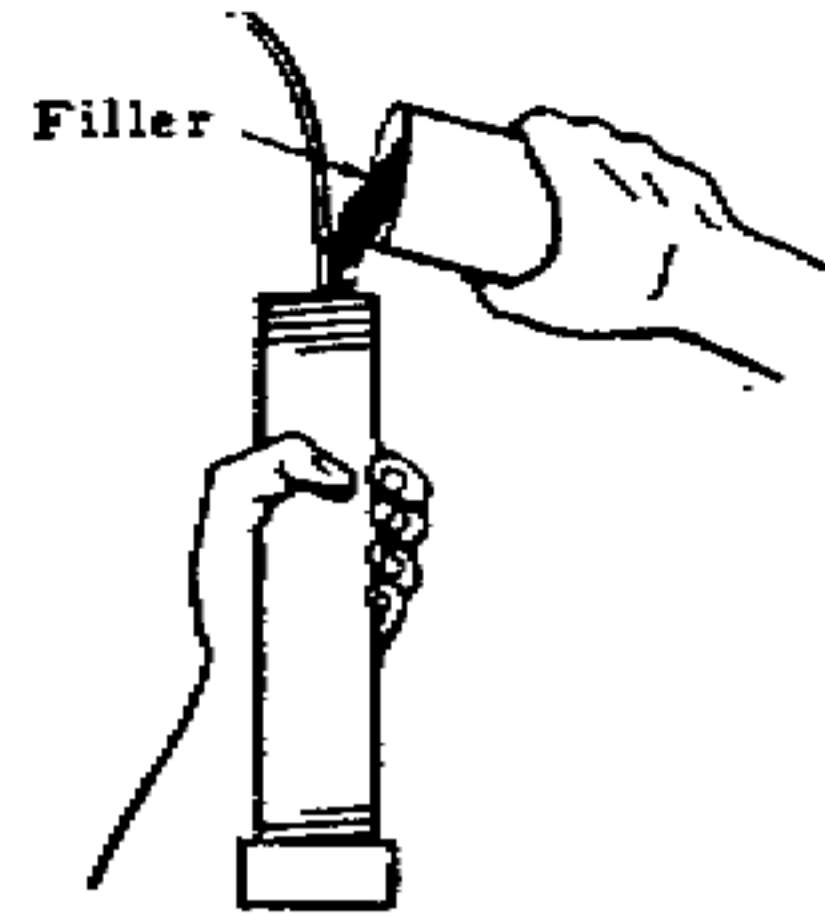

4. Drill a hole in the center of the unassembled pipe cap large enough for the fuse cord to pass through.

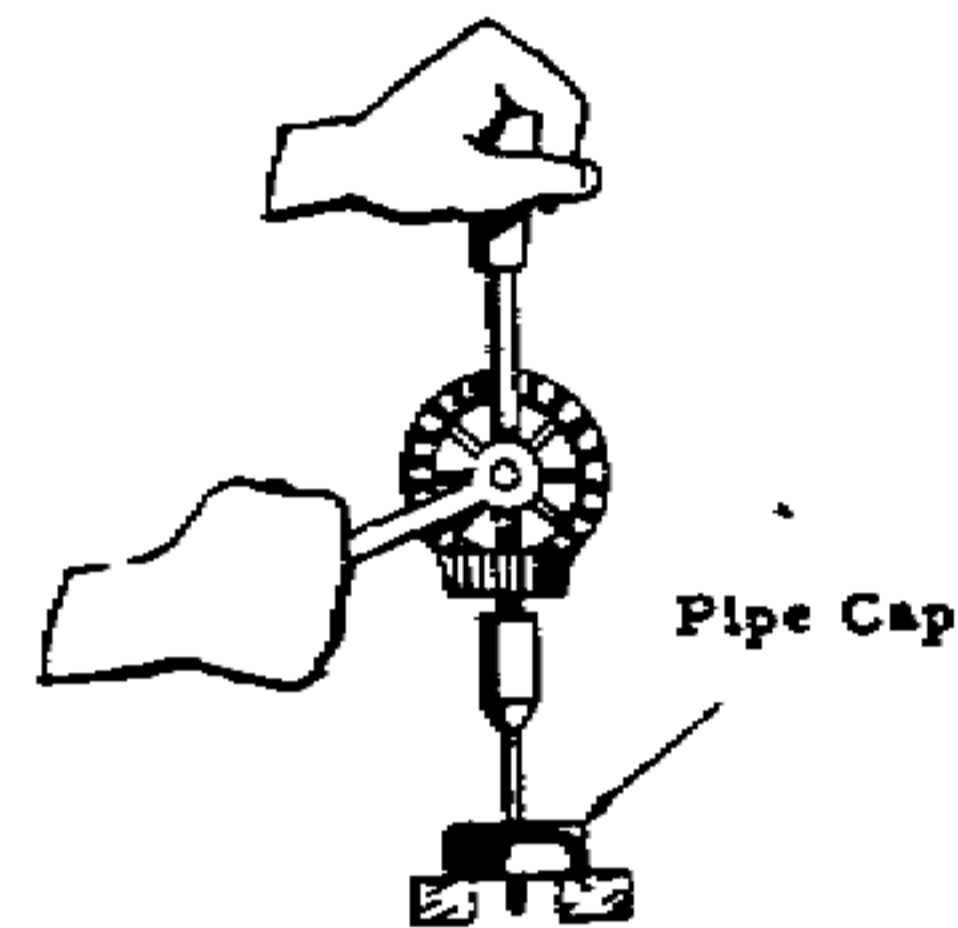

5. Wipe pipe threads to remove any filler material.

Slide drilled pipe cap over the fuse and screw handtight onto the pipe.

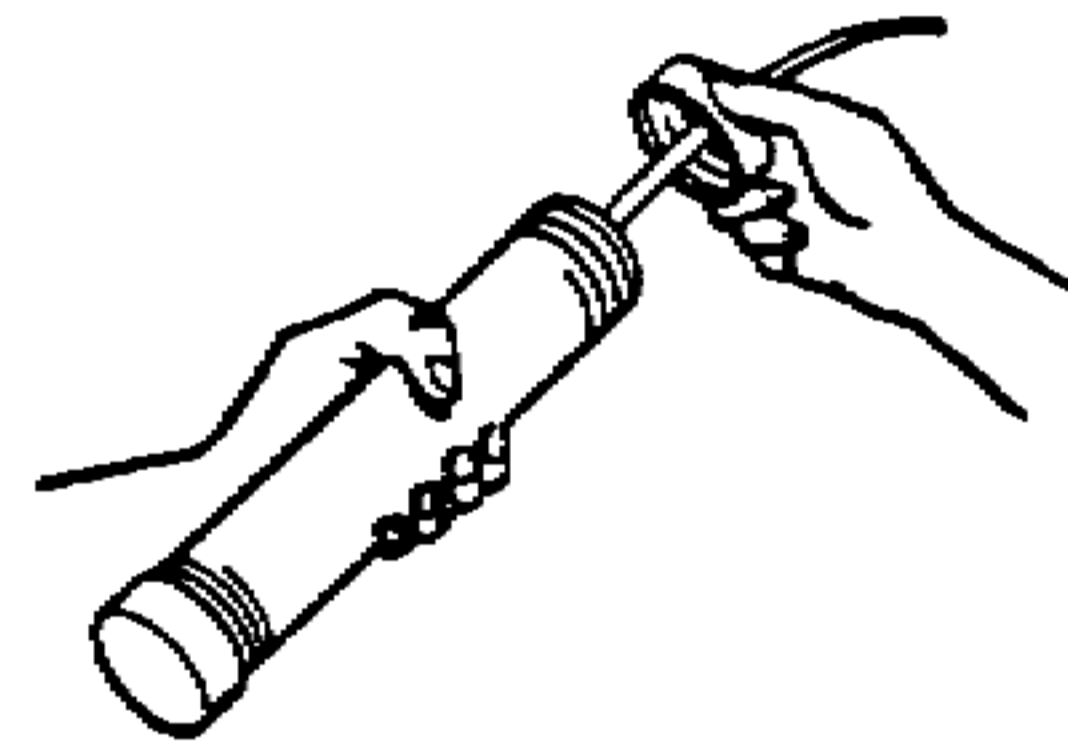



## History, Design, and Manufacture of Explosives

### Nail (shrapnel) Grenade

Effective fragmentation grenade can be made from a block of TNT or other blasting explosive and nails.

#### Material Required

Block of TNT or other blasting explosive

Nails

Non electric blasting cap

Fuse cord

Tape, string, wire, or glue

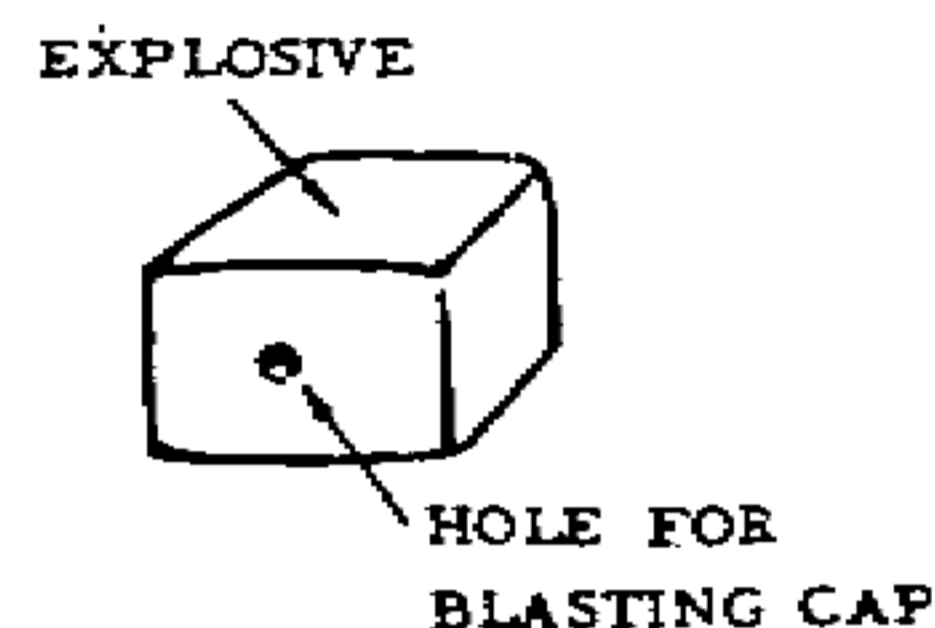
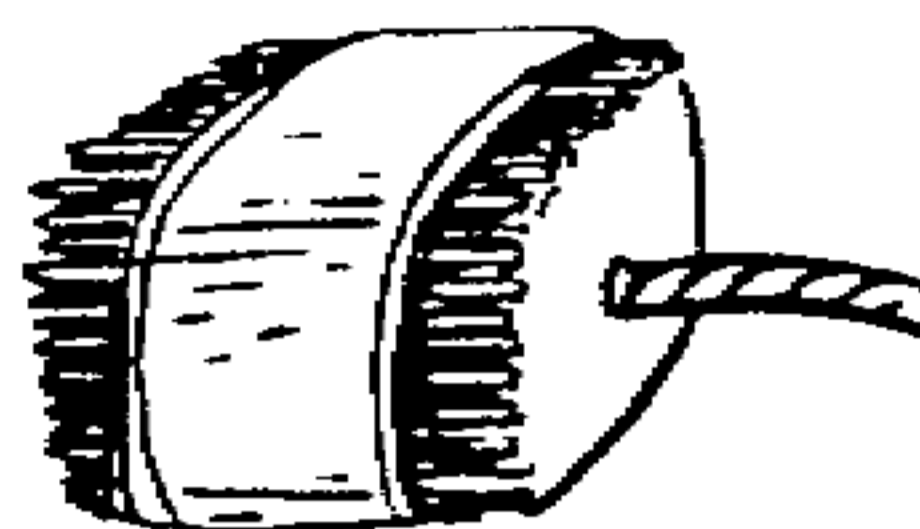

#### Procedure

1. If an explosive charge other than a standard TNT block is used, make a hole in the center of the charge for inserting the blasting cap. TNT can be drilled with relative safety. With plastic explosives, a hole can be made by pressing a round stick into the center of the charge. The hole should be deep enough that the blasting cap is totally within the explosive.

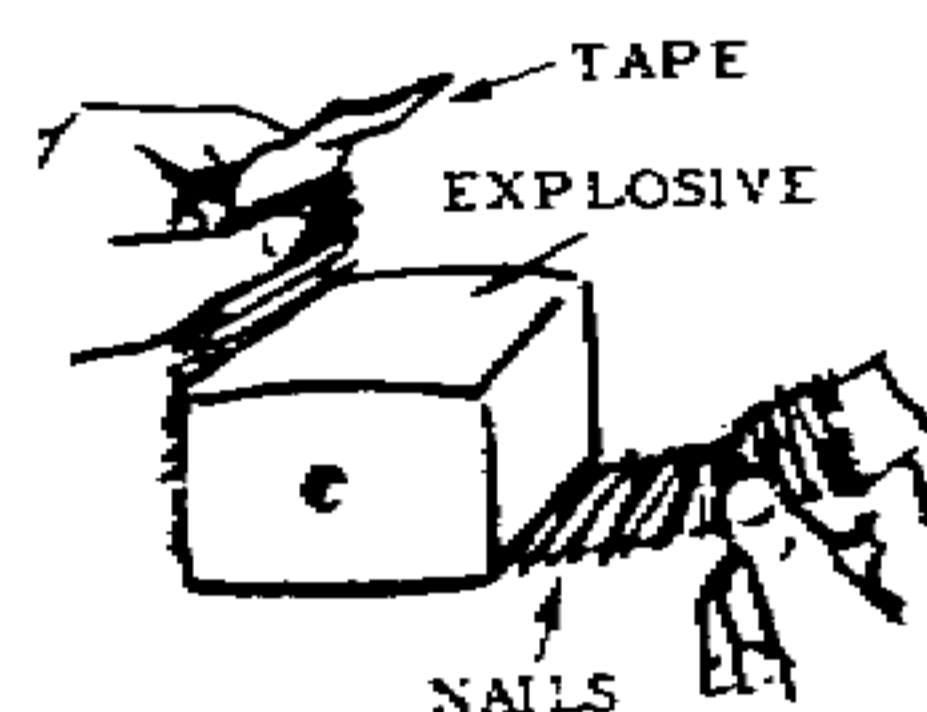

2. Tape, tie, or glue one or two rows of closely packed nails to sides of explosive block. Nails should completely cover the four surfaces of the block.

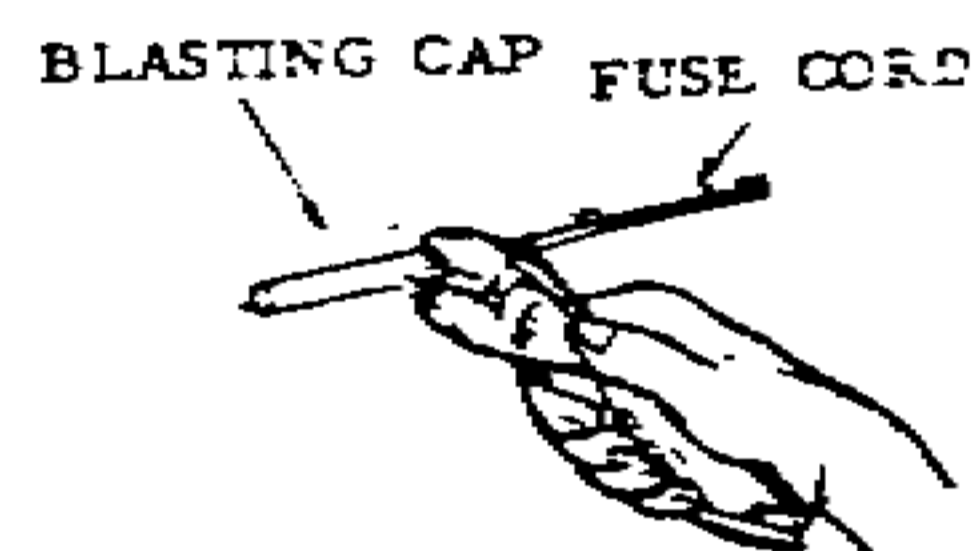

3. Place blasting cap on one end of the fuse cord and crimp with pliers.

Note: To find out how long the fuse cord should be, check the time it takes to burn 12 inches. If it takes 30 seconds, then a 15 second delay requires 6 inches, and a 10 second delay, 4 inches of fuse.

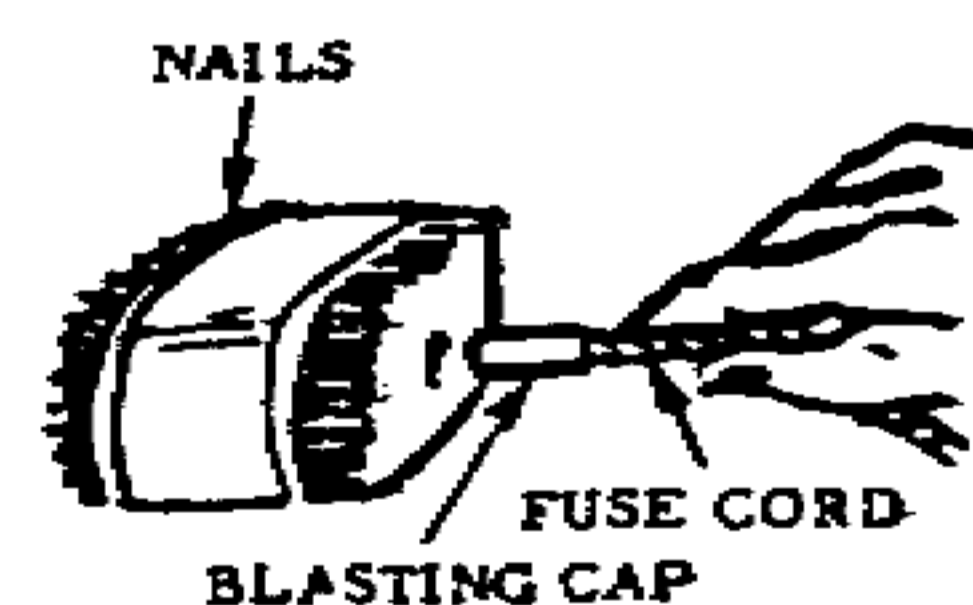

4. Insert the blasting cap in the hole in the block of explosive. Tape or tie fuse cord securely in place so that it will not fall out when the grenade is thrown.

#### Alternate use

An effective directional anti-personnel mine can be made by placing nails on only one side of the explosive block. In this case an electric blasting cap can be used.

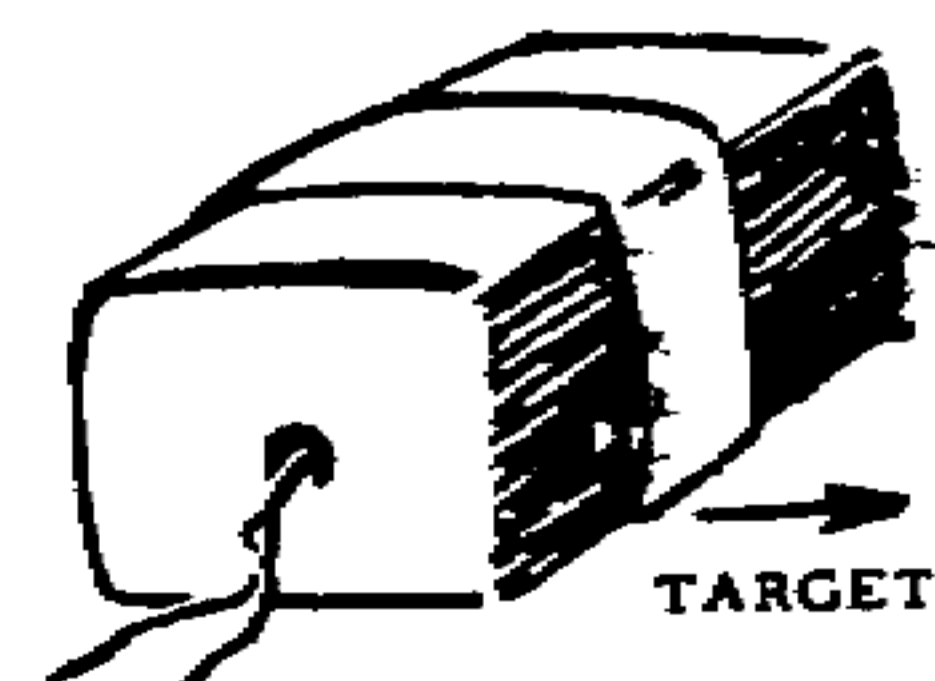

# History, Design, and Manufacture of Explosives

## 3) Artillery Propellant and Shell Design

Artillery ammunition loads come in 3 main types

a. Fixed: loaded as a cartridge which contains both the shell and the primer.

b. Semi fixed: Shell is loaded first and the primer and main charge are loaded as a metal case afterwards.

c. Separate loading: where a separate spot in the breech allows the shell and the charge to be loaded simultaneously and the charge can be adjusted for trajectory and range. The projectiles have different fusing and shell filling for the different jobs they are required to do.

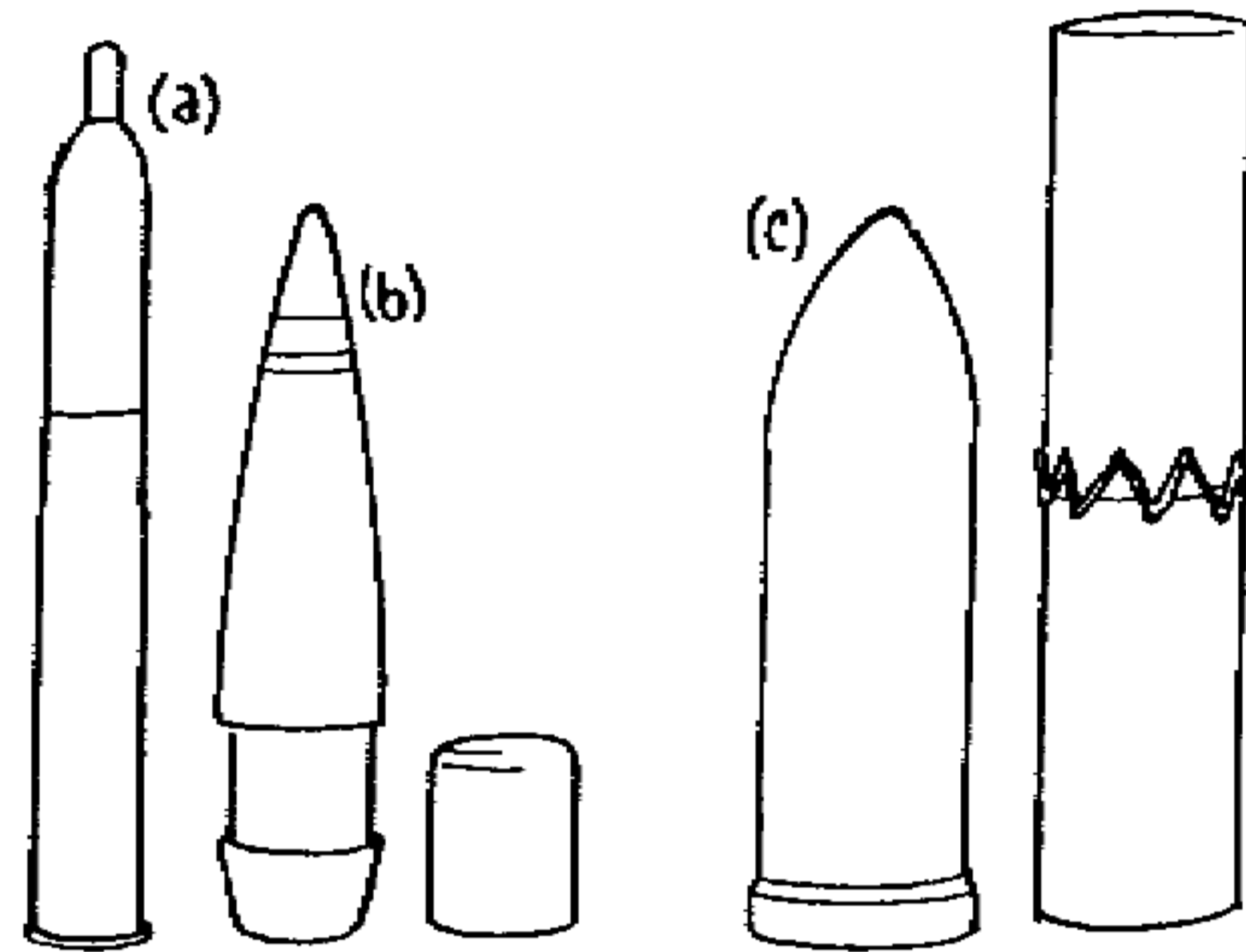

### Shrapnel shell design

- a. bursting charge
- b. bullets
- c. flash tube from fuse
- d. fuse

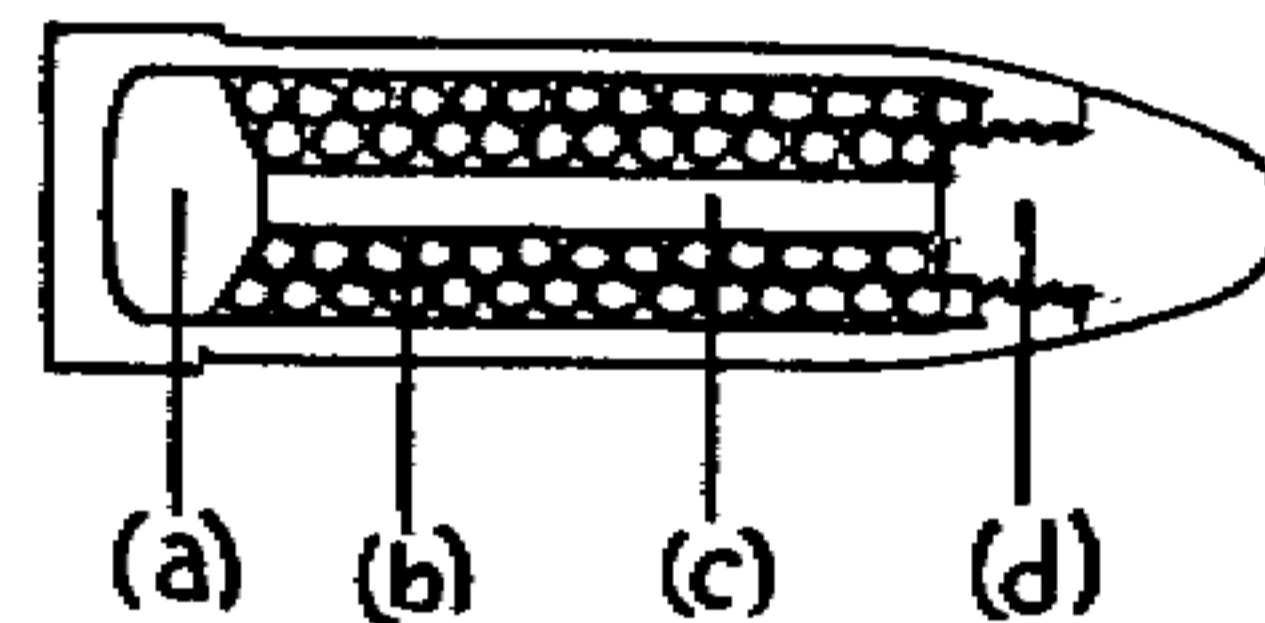

### High Explosive shell design

- a. high explosive filling
- b. fragmenting walls
- c. amplifying charge
- d. fuse

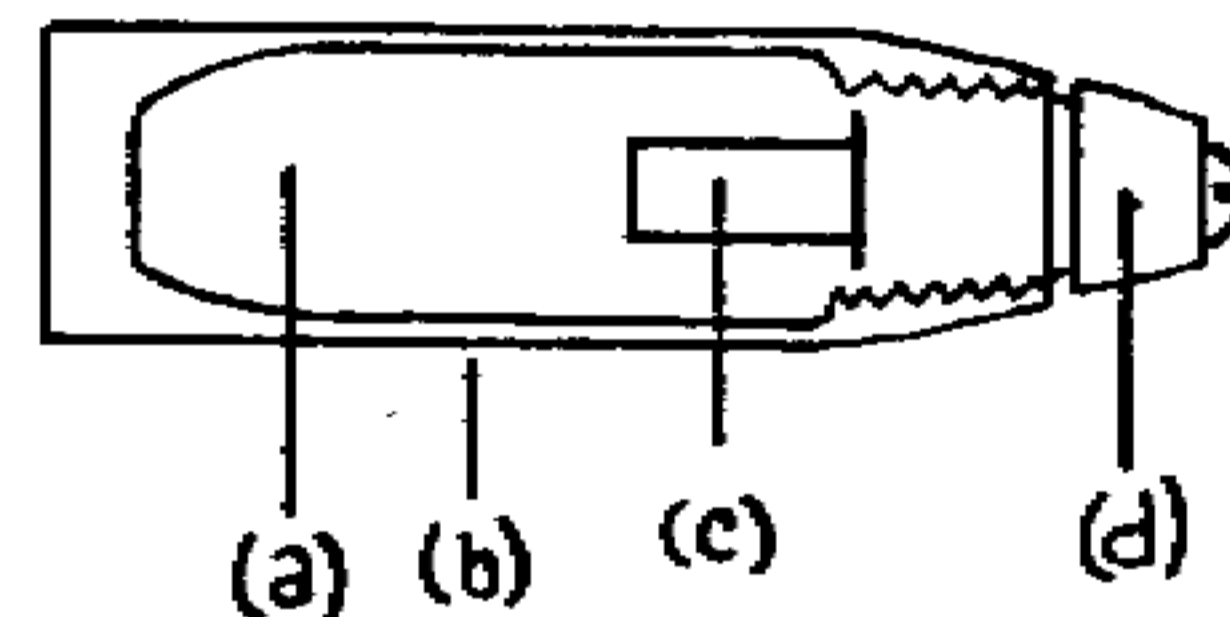

### Poison Gas or Phosphorus shell design

- a. chemical agent
- b. bursting charge
- c. fuse

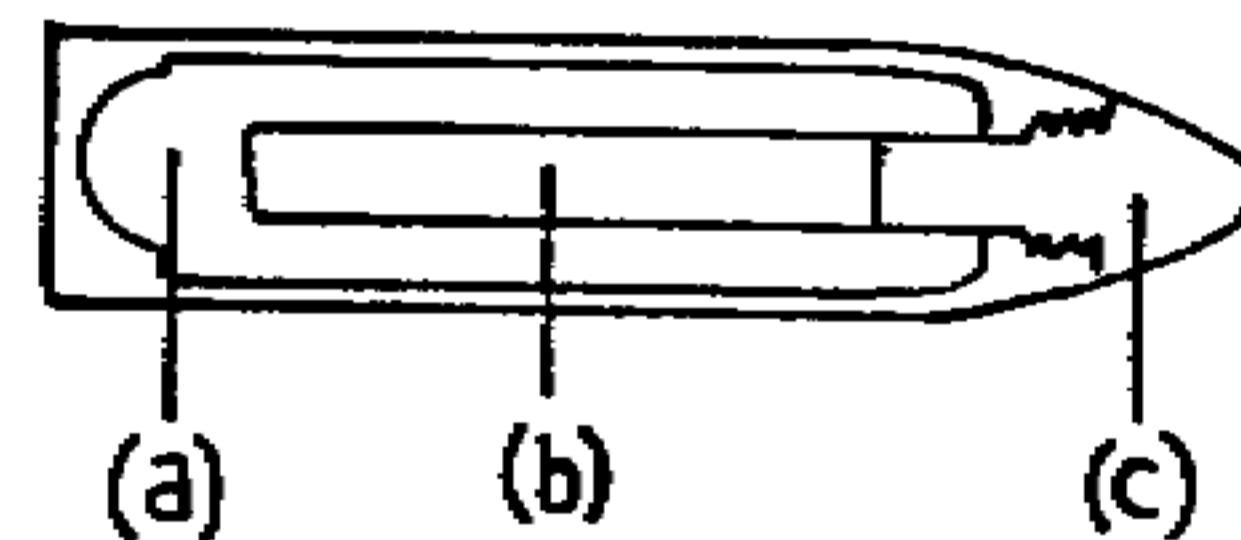

An 11" naval shell fired at 45 degrees at 3,000' per second would have a range of about 50 miles if it traveled in a vacuum. Since air, wind direction, and velocity affect it, the range is usually about half that distance.

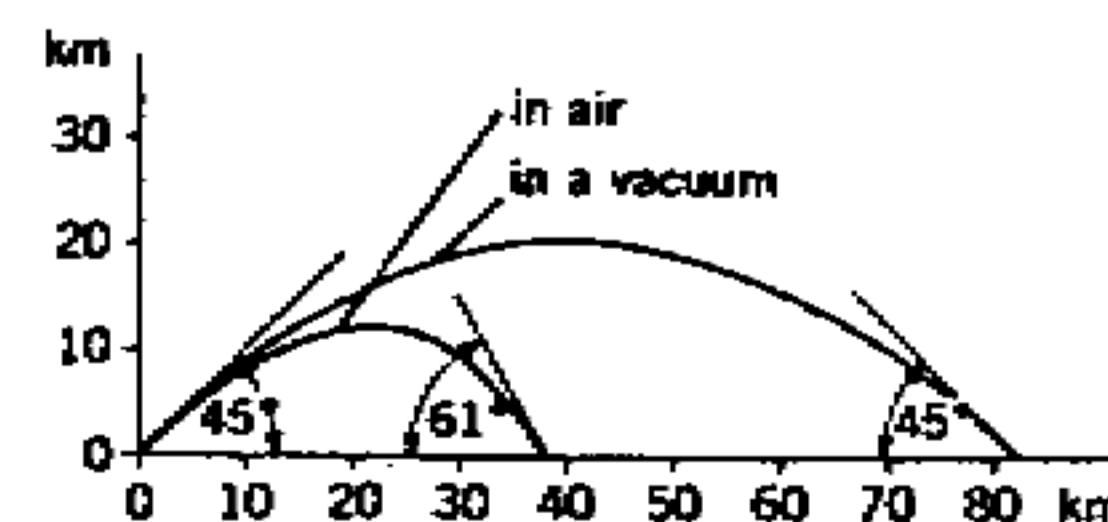

## History, Design, and Manufacture of Explosives

Anti armor ammunition designs include:

a. Armor Piercing solid shot with a soft metal cap to support the point during penetration.

b. Armor Piercing shell which contains a high explosive and a base fuse which explode after penetration.

c Composite Rigid shot which has a hard core surrounded by a soft hollow casing.

d and e. Armor piercing sabots with a tapered skirt squeezed during firing or discarded after firing.

f. HEAT which explodes a shaped charge a few inches from the target concentrating great force on a small spot and injecting blast and hot metal through this spot into the tank.

g. HESH-High Explosive Squash Head which spreads against armor on impact, and then detonates with the shock wave breaking and fragmenting tank lining into the tank interior.

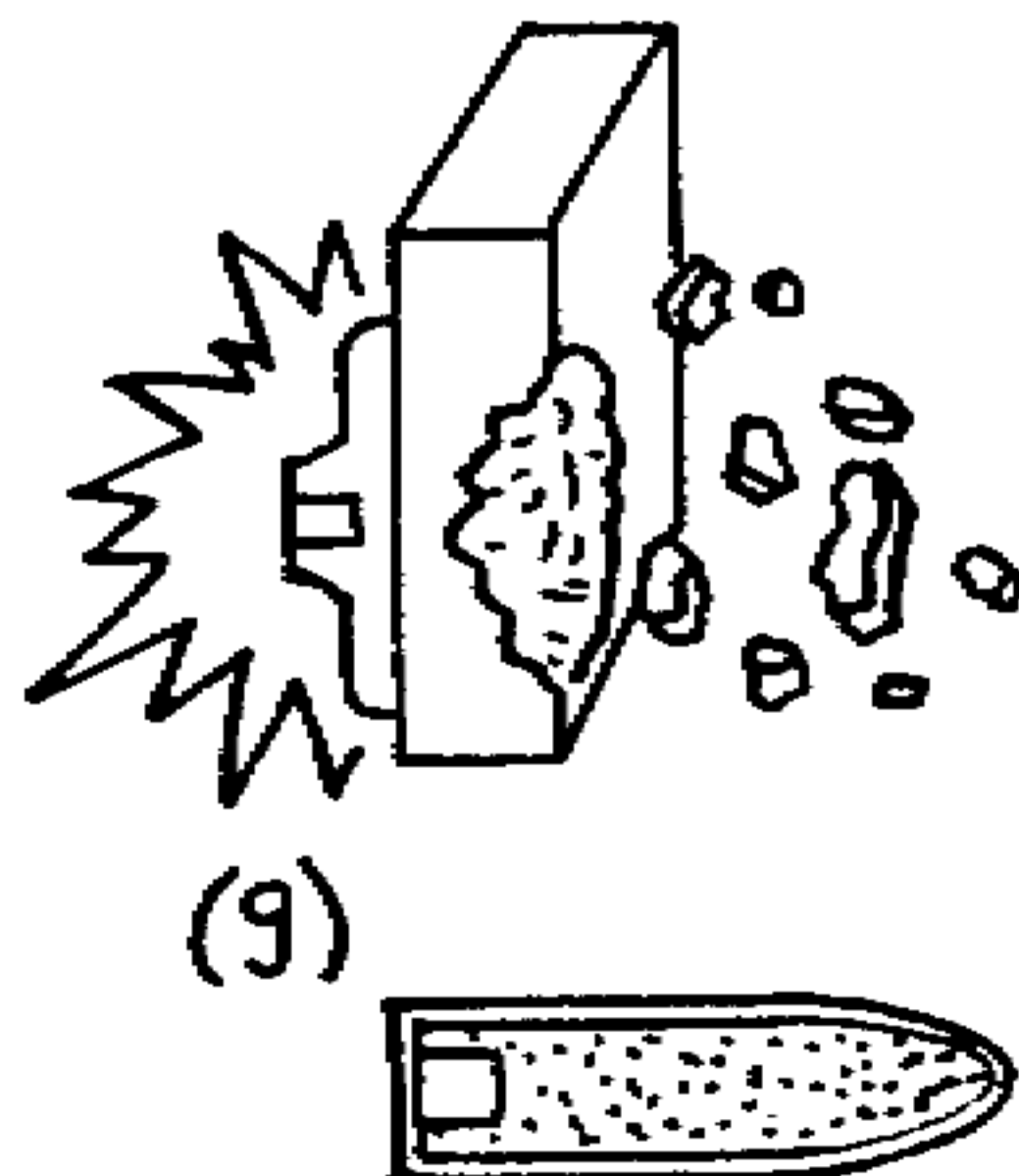
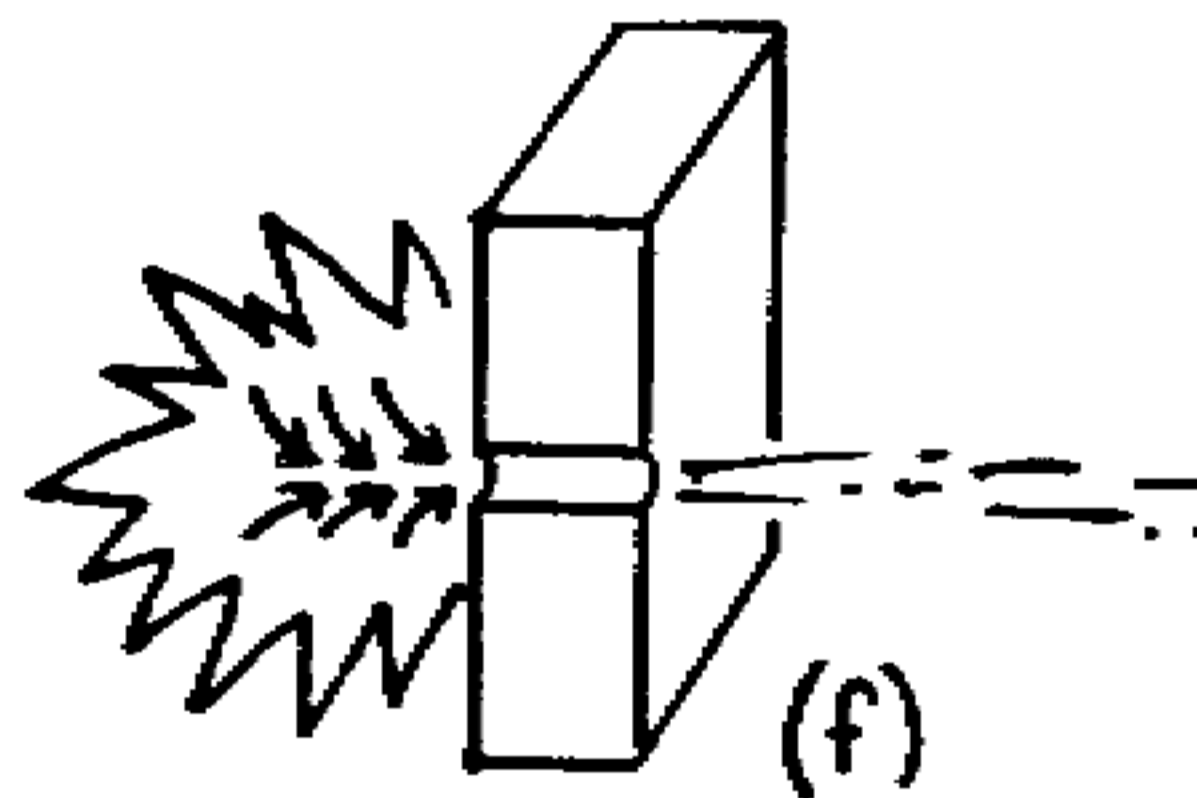
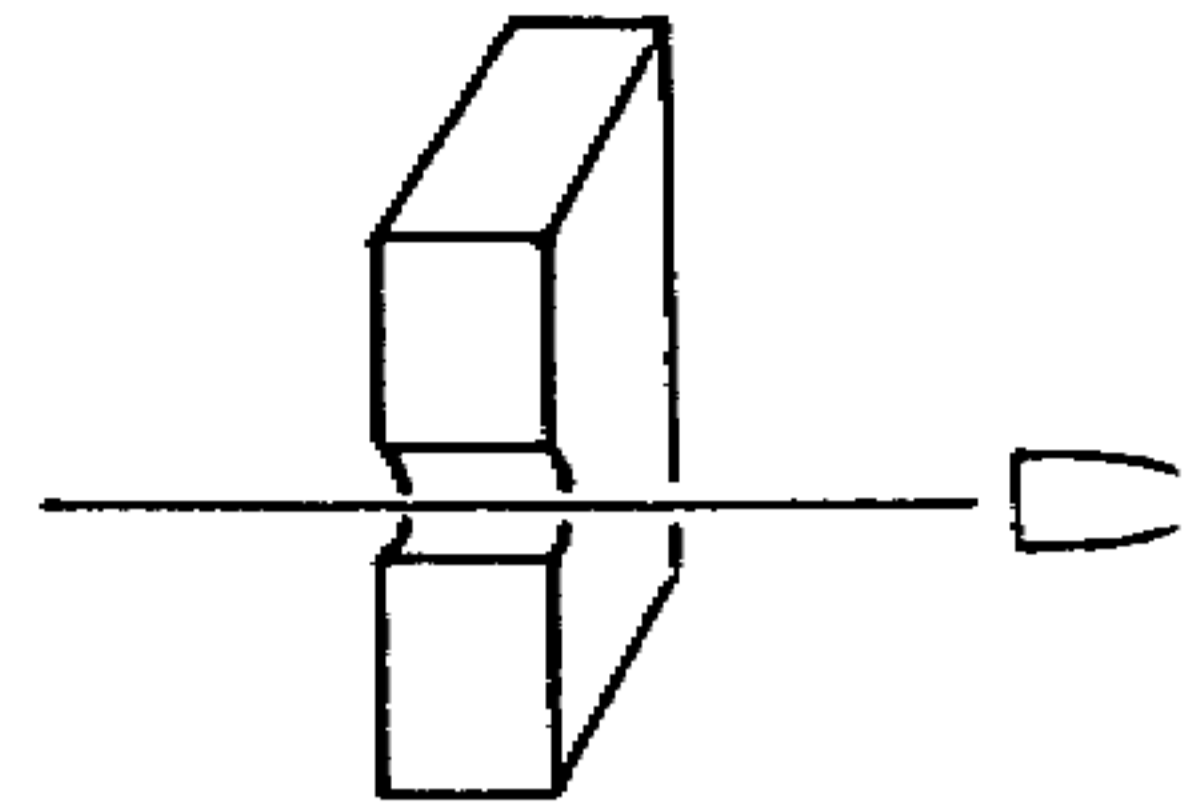

Illuminating shells have their descent arrested by parachute when the charge is ignited

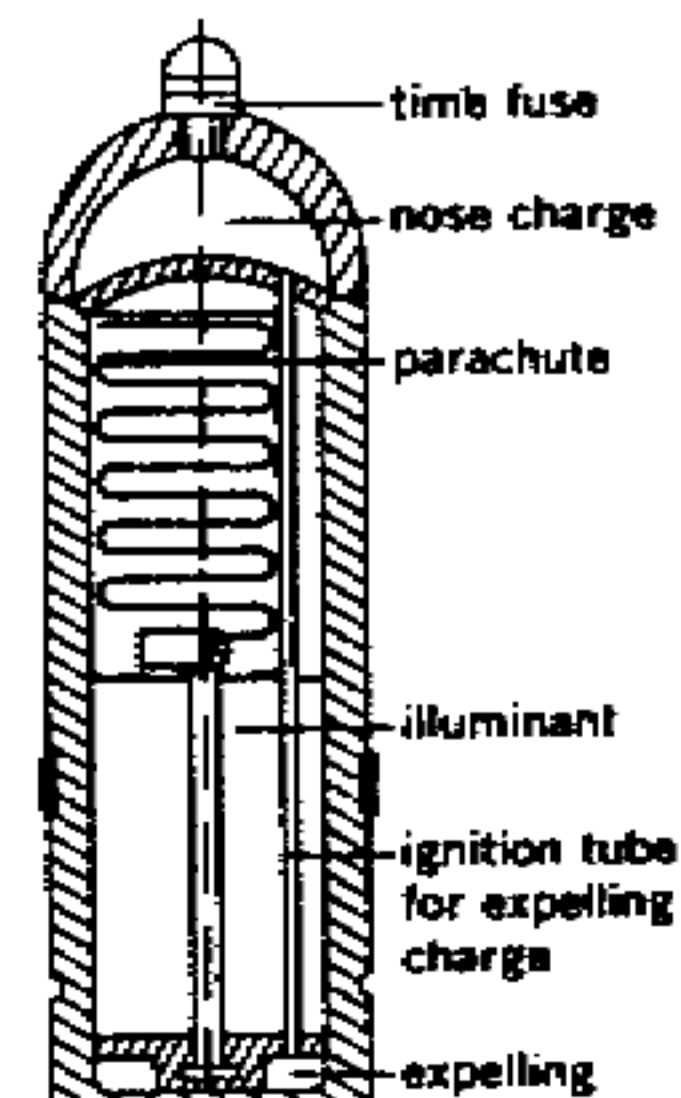

## History, Design, and Manufacture of Explosives

The "fuse" used to initiate the explosive is usually located in the nose or the base of the projectile. It can be an impact fuse with or without a delay action, or a proximity fuse initiated by radar or other electronic input. The figure shows a typical impact fuse design.

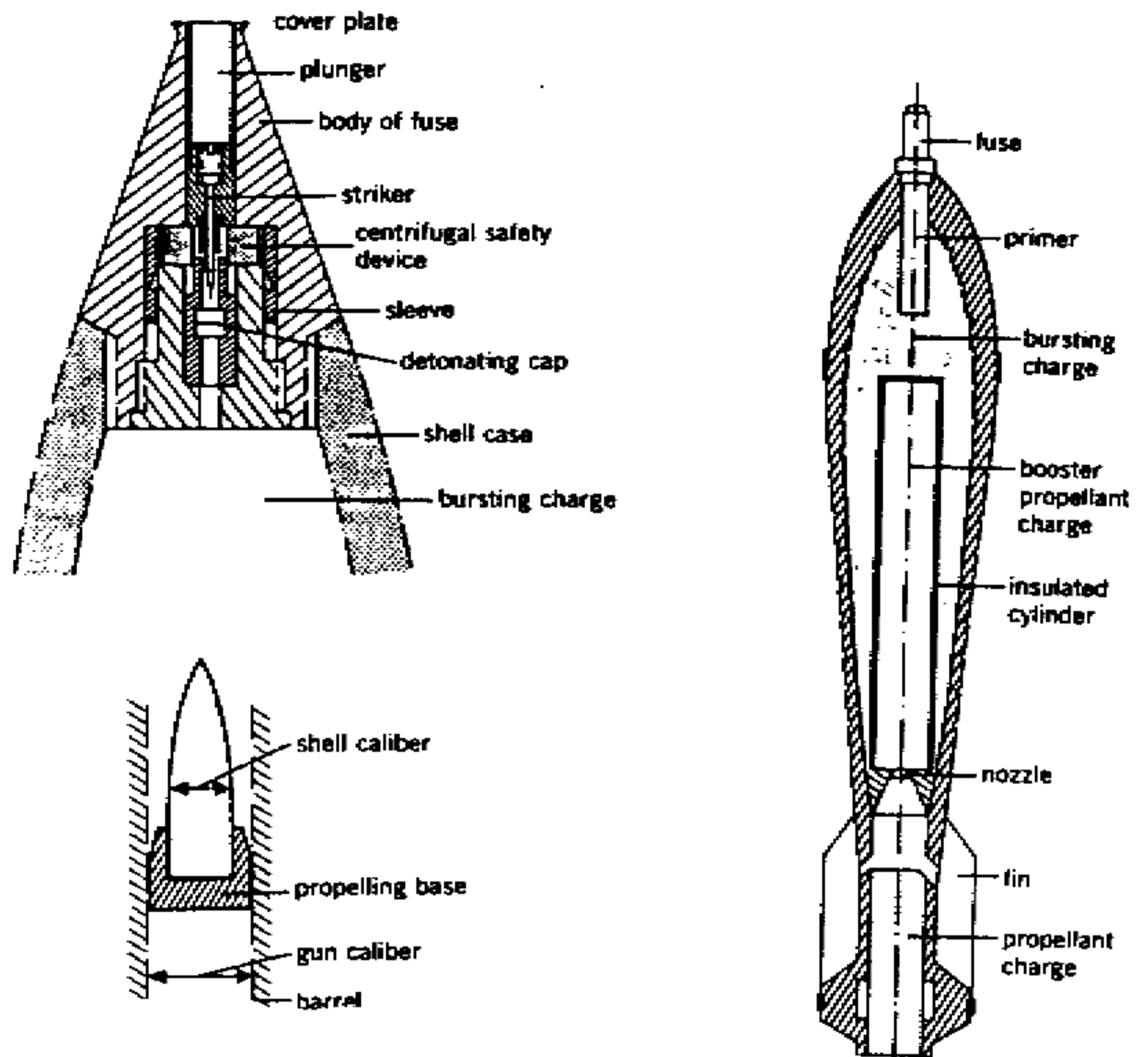

To obtain extremely high muzzle velocities, the projectile is made smaller in diameter and much lighter than its propelling base which drops off after firing. The gas pressure designed for the much larger shell accelerates the shell at much greater velocities. Normal muzzle velocity is 1,200 m/s. Smaller shells reach 1,600 m/s.

Mortar shells use rear fin stabilization and a typical teardrop shape. When dropped tail first in the mortar tube, the ignition charge strikes the firing pin igniting the propellant. A booster charge in the tail adds range to the mortar which flies point first.

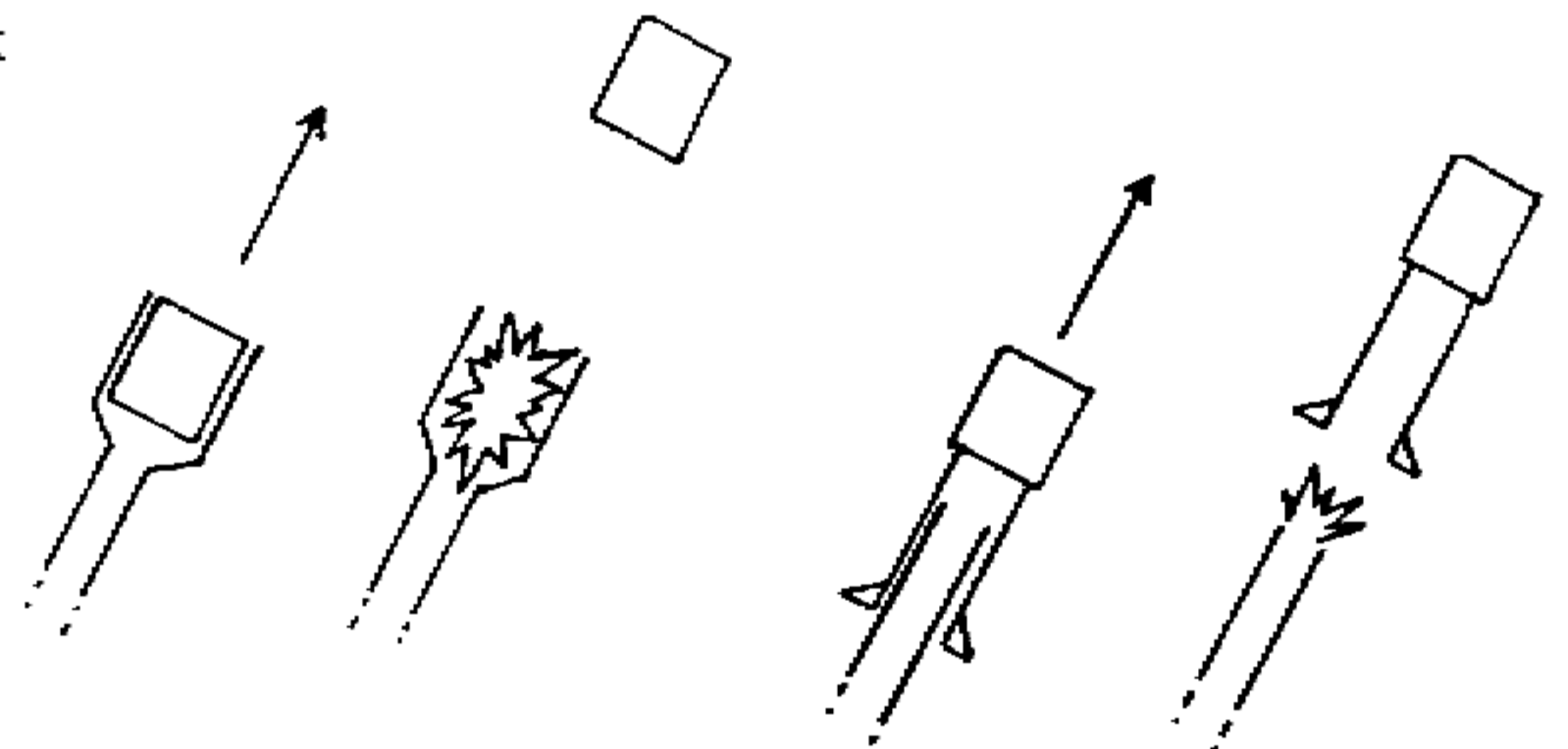

Grenades may also be launched mortar style by using a cup extension on the end of a rifle. Special propellant rifle cartridges are used.

Grenades with stabilizing fins fly point first and are useful and accurate in anti-tank battles.



Recoilless launchers fire projectiles from a shoulder supported tube. The shell either forces a counterweight out the rear, or sends a mass of high velocity gas out the back to propel a shell forward to its target.

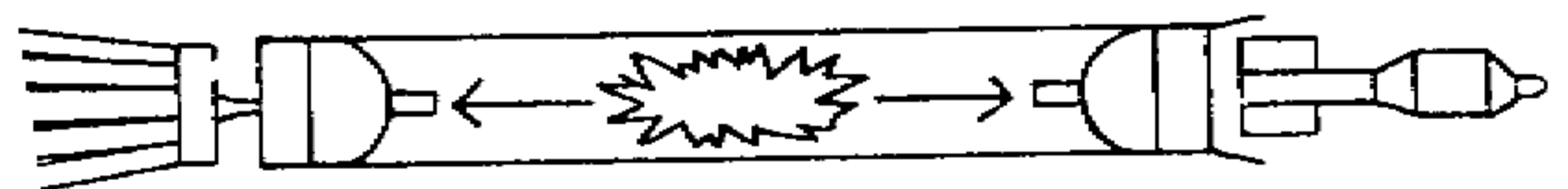

## History, Design, and Manufacture of Explosives

### 60 mm Mortar Launcher

A device to launch 60 mm mortar rounds using a metal pipe 2.5 " in diameter and 4' long as the launching tube.

#### Materials Required

Mortar projectile (60mm) and charge increments  
Metal Pipe 2.5" in diameter and 4' long, threaded on one end  
Threaded end cap to fit pipe  
Bolt, 1/8" in diameter and at least 1" long  
Two nuts to fit bolt  
File  
Drill

#### Procedure

1. Drill hole 1/8" in diameter through center of end cap.



2. Round off end of bolt with file.

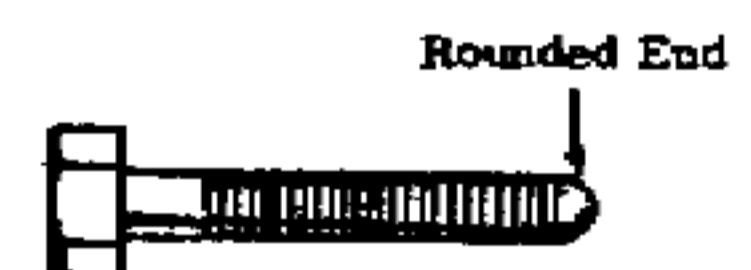

3. Place bolt through hole in end cap. Secure in place with nuts as illustrated.

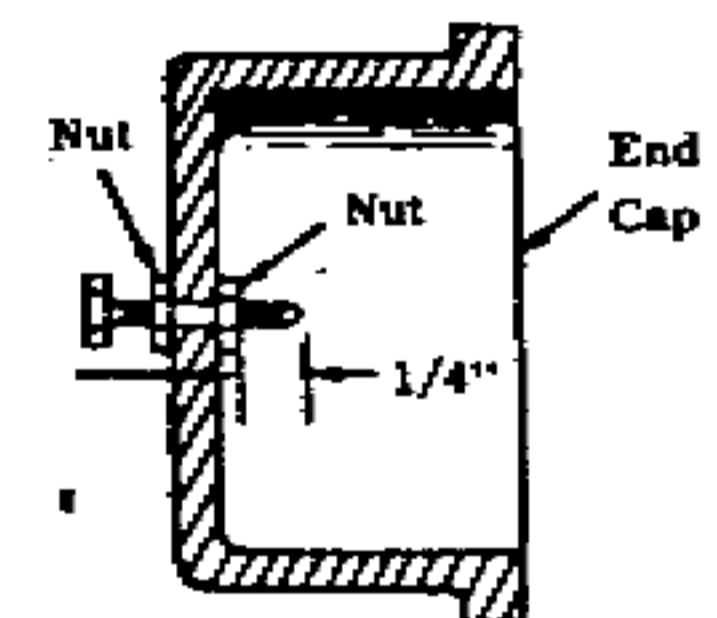

4. Screw end cap onto pipe tightly. Tube is now ready for use.

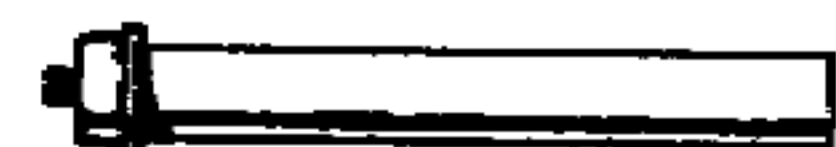

## History, Design, and Manufacture of Explosives

### How to use

1. Bury launching tube in ground at desired angle so that bottom of tube is at least 2 ft. underground. Adjust the number of increments in rear finned end of mortar projectile.

2. When ready to fire, withdraw safety wire from mortar projectile. Drop projectile into launching tube, FINNED END FIRST.

Caution: Be sure bore riding pin is in place in fuse when mortar projectile is dropped in tube. A live mortar round could explode in the tube if the fit is loose enough to permit the bore riding pin to come out partway.

Caution: The round will fire as soon as the projectile is dropped into tube. Keep all parts of body behind the open end of the tube.

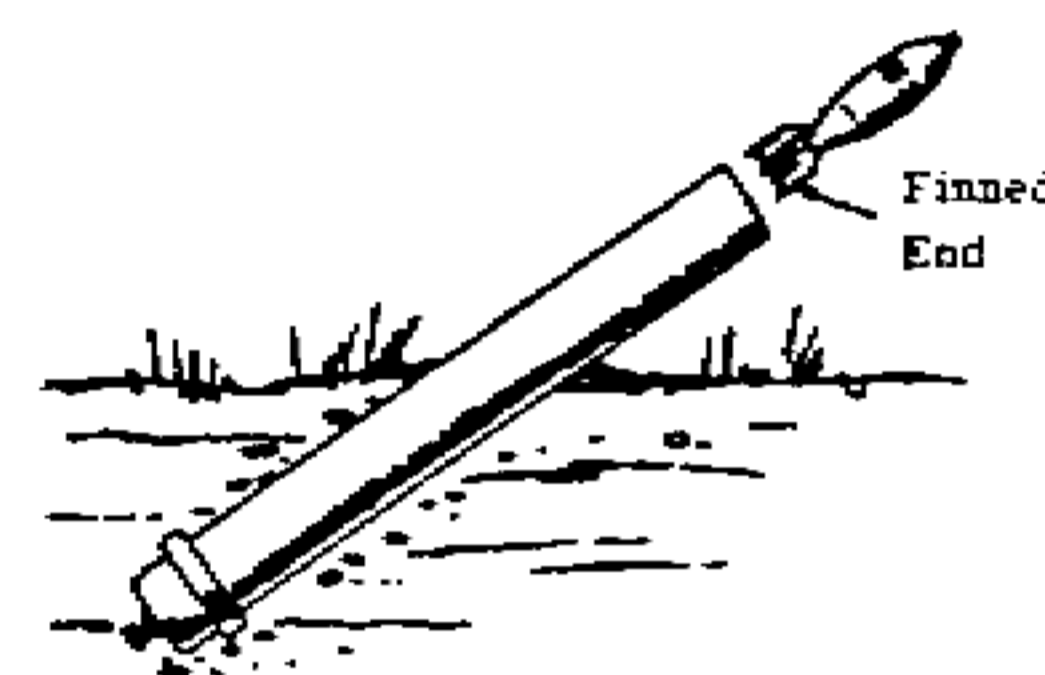
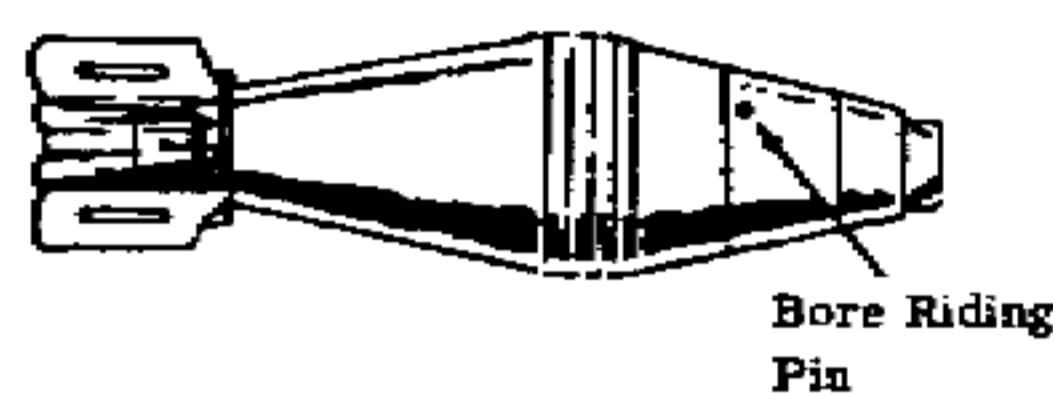
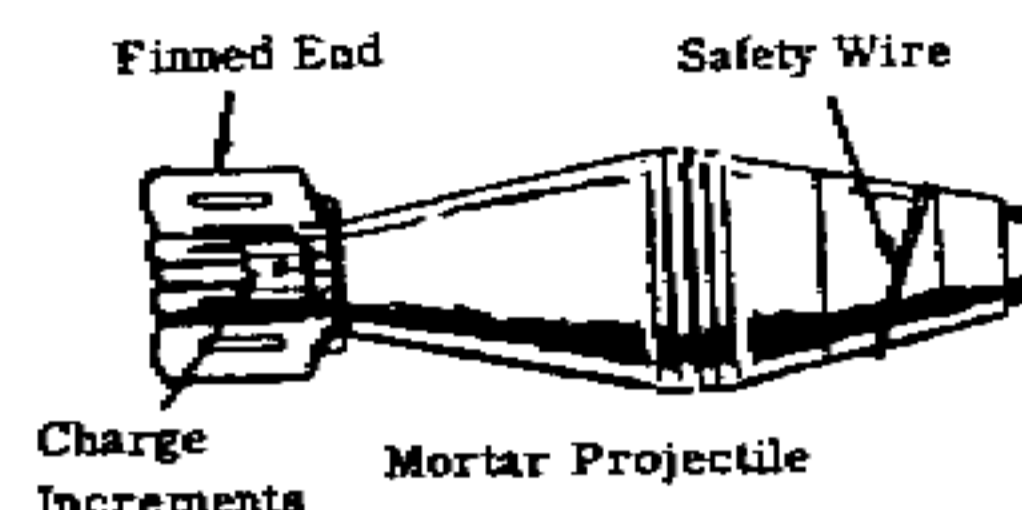
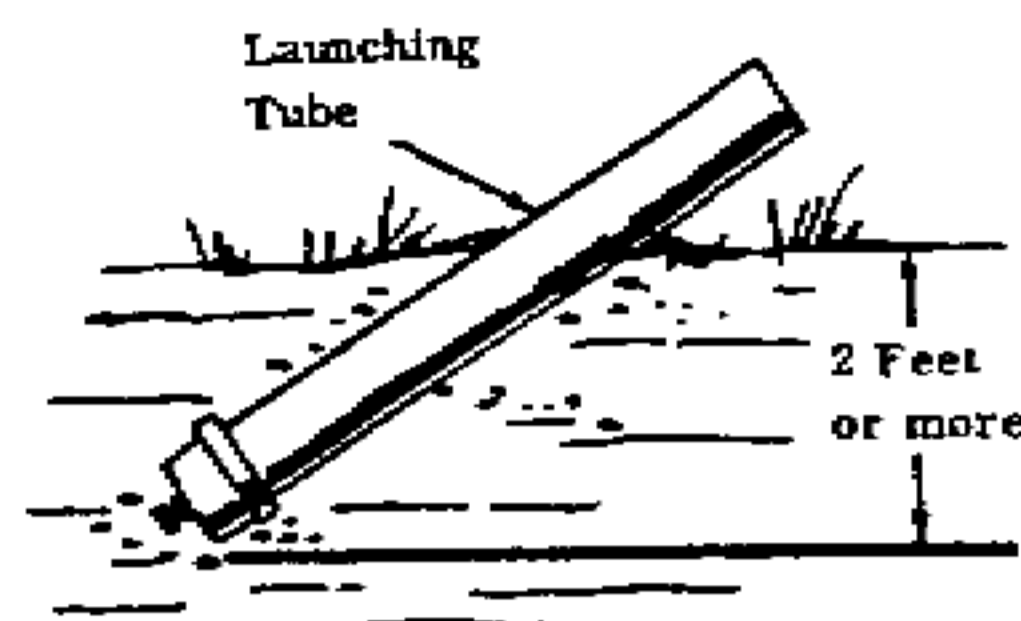

Desired Range	Maximum height mortar will reach (yards)	Required angle of elevation of tube (horizontal degrees)	Charge - number of increments
150	25	40	0
300	50	40	1
700	150	40	2
1000	225	40	3
1500	300	40	4
125	75	60	0
300	125	60	1
550	250	60	2
1000	375	60	3
1440	600	60	4
75	100	80	0
150	200	80	1
300	350	80	2
400	600	80	3
550	750	80	4

# History, Design, and Manufacture of Explosives

## 4) Rocket, Missile, and Warhead Design

Self propelled rockets and missiles provide their own propulsion as a means of delivering a projectile (warhead) as accurately as possible to an enemy target.

All methods of propelling missiles and rockets are based on Newton's third law of motion "for every action there is an equal and opposite reaction. Every method either pushes air, water, or hot gases backward which thrusts whatever it is attached to forward.

This principle can easily be demonstrated with an elastic balloon. The air inside a blown up balloon exerts equal pressure in all directions. When the balloon is released (a) the pressurized air rushes out producing an equal reaction of driving the light balloon in the opposite direction (b).

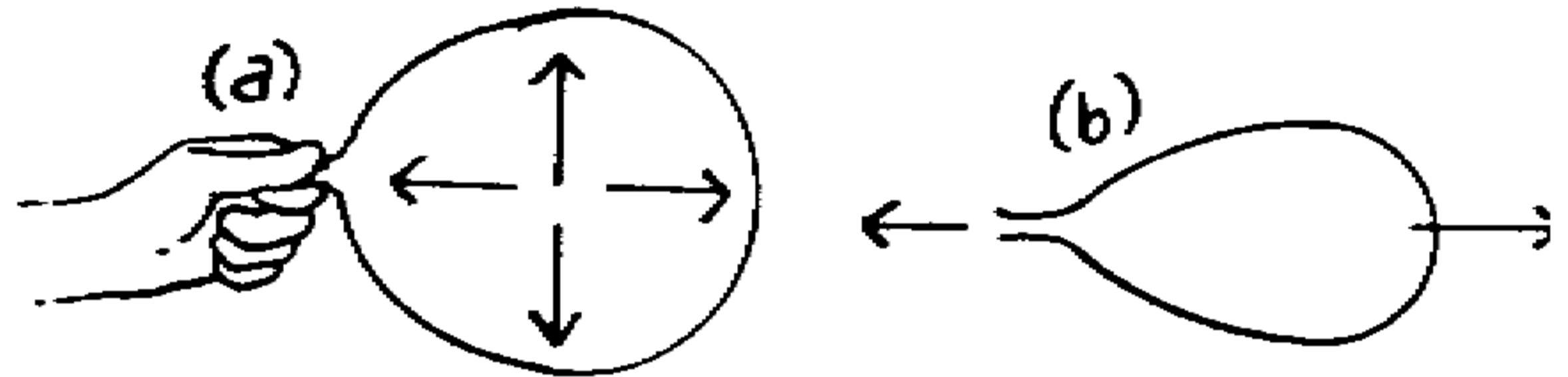

A rotating propeller on a torpedo ( or ship) pushes a large mass of water ( or air when on an aircraft) backward and creates a reaction (1) that thrusts the propeller and everything attached to it forward (2).

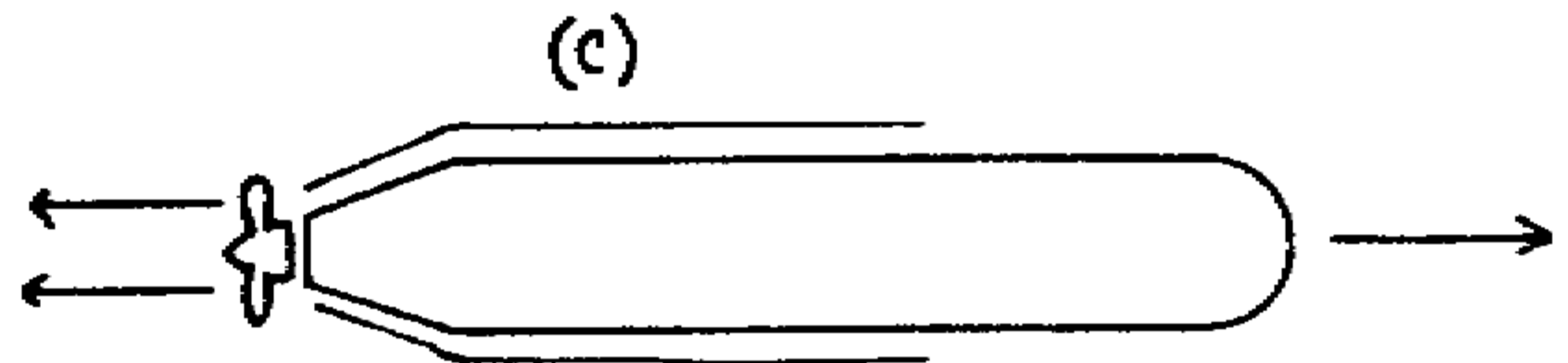

Jet or rocket engines work by generating a backward stream of accelerated gasses which push the device forward.

Jet engines accelerate air it takes in the front by mixing it with fuel (1). The fuel is burned (2) and the hot expanding gases flow out the rear at great speed (3).

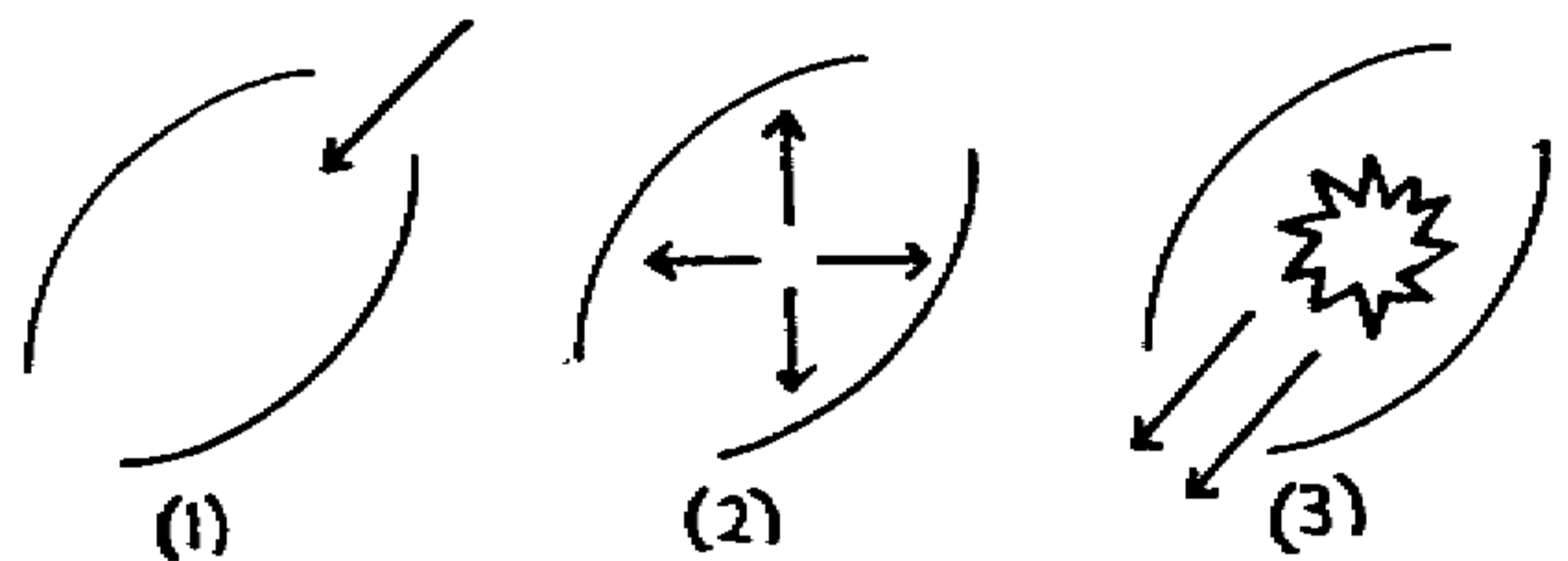

Rocket motors burn fuel in a combustion chamber (a) creating high pressure which push through a tapered opening (nozzle) and the rocket is thrust forward.

The rocket nozzle design is crucial. The throat is the narrow opening where the gases exit the combustion chamber and must be narrow to maintain the high pressure in the chamber while still venting the gases at a continuous rate.

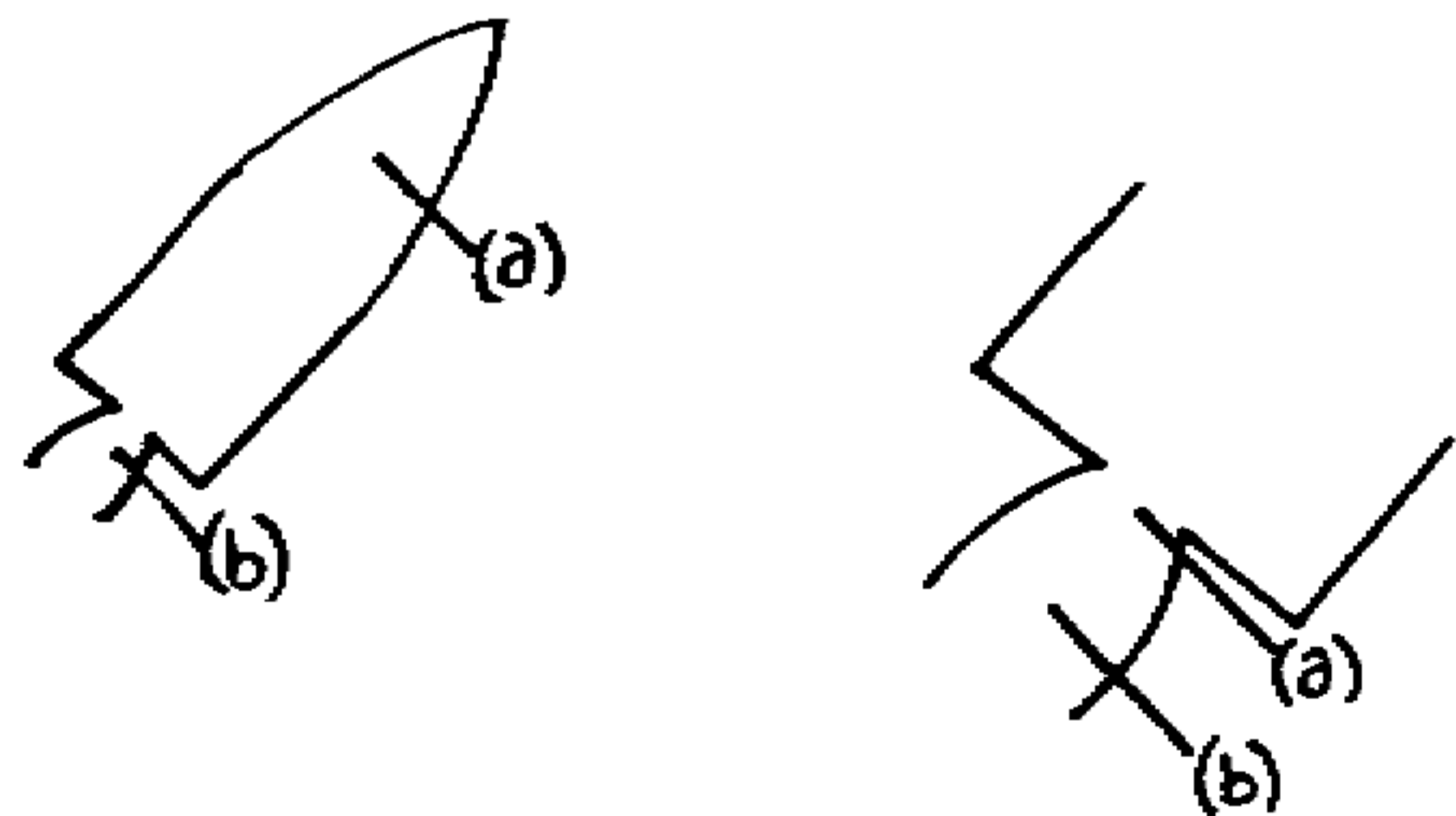

## History, Design, and Manufacture of Explosives

The cone shaped expansion chamber decreases turbulence and maintains a steady stream of directed gases. The nozzle requires special inserts of heat resistant material (b) to protect it from the hot gases (a). Cool burning propellant may be cast in a ring shape adjacent to the nozzle (c) which provides a protective layer of cool gas (d).

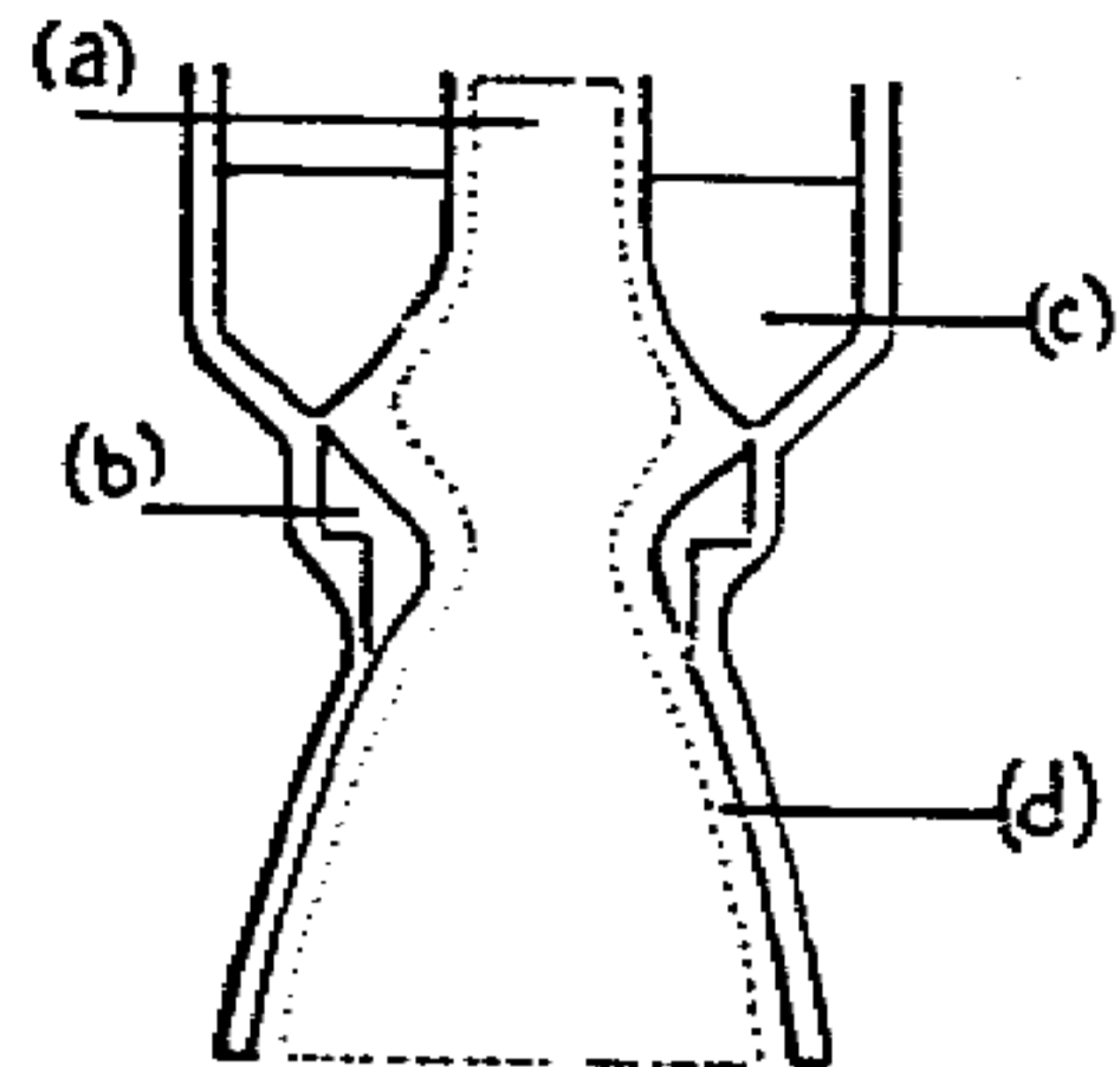

Improvised rockets may be produced using these diagrams as a general guide.

The rocket case should be large diameter iron or steel pipe with the explosive payload and fuse mounted in a separate chamber on the front of the rocket.

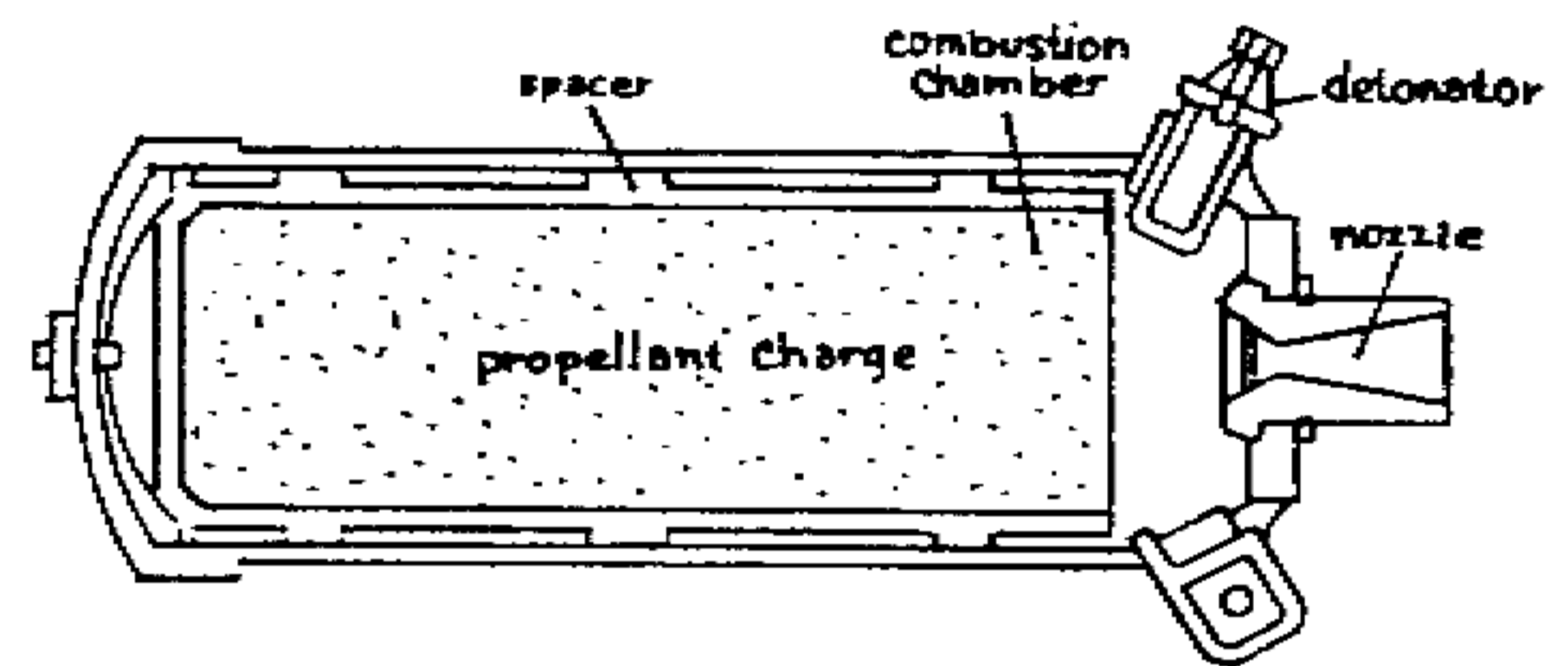

The main body of the pipe is provided with a rubber lining. A star shaped mold is then placed inside and the sides are filled in with a castable propellant explosive. After the propellant has set the mold is removed leaving a shaped cavity. This is so that the burning surface is kept constant.



This is used in fast burning formulas which produce high thrust over short periods of time. Long range surface to air missiles use end burning designs for slower initial thrust and longer burn periods.

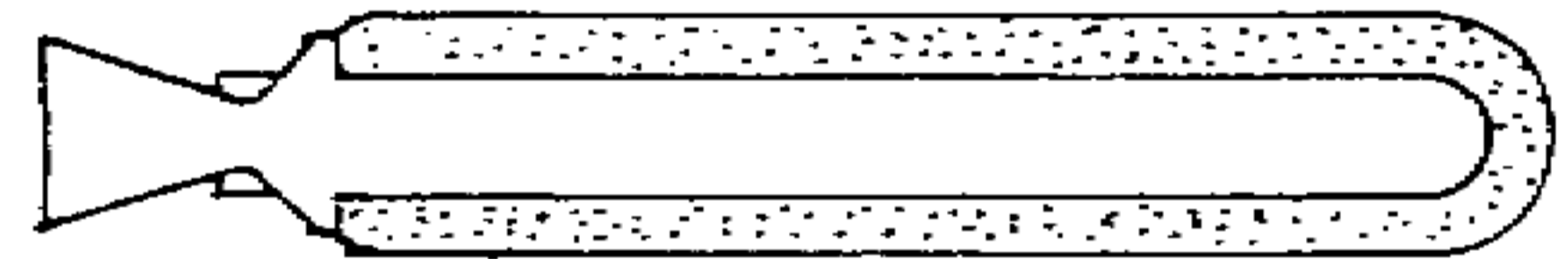

Unless you plan on using direct fire (like kids do with pop bottle rockets) every design should be field tested and charted for angle of fire, design of fuel burning system and amount of propellant.

- A. End burning grain burns only the small surface area at the end for limited and constant thrust.
- B. End burning with fast burning grain initially for a fast launch and a slower burning formula for sustained flight.
- C. Circular center cavity (tubular) which allows progressive acceleration.
- D. Tubular star which has a large boost at takeoff and sustained flight.

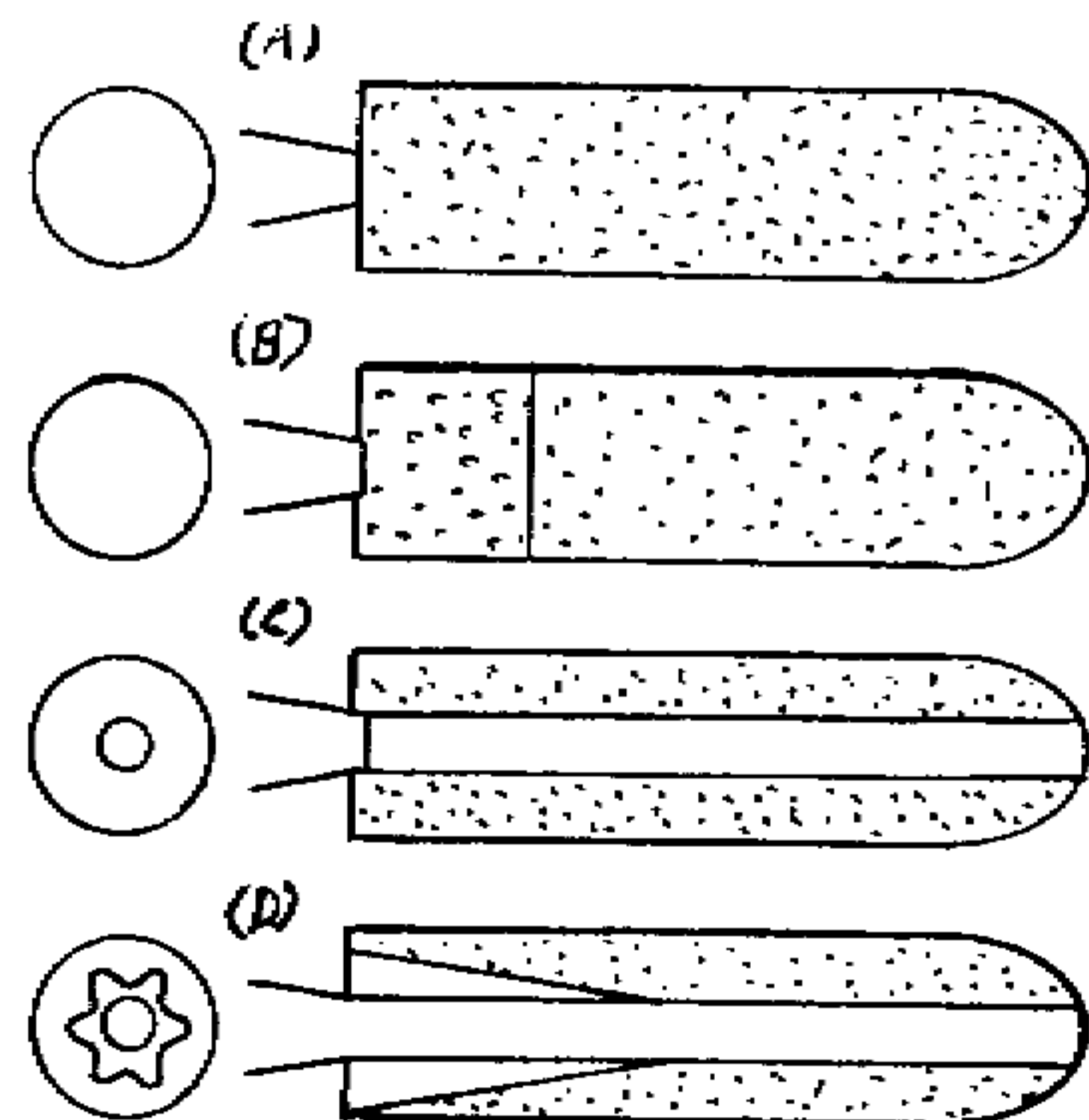



## History, Design, and Manufacture of Explosives

Rocket stability in flight may be achieved by the addition of fixed stabilizing fins or having the exhaust propellant act on spinning vanes as it exits the nozzle.

Rockets and missiles may be guided by adding control surfaces as adjustable vanes fitted on the wings or in the nozzle (or radio guided model aircraft wings for subsonic designs), a swiveling exhaust nozzle, or fuel injection into the sides of the nozzle deflecting the exhaust.

Guidance systems can be simple, such as mounting a radio controlled vane system on the rocket or missile and mounting a mini camcorder near the nose. The target area and end target are kept centered in the viewing area by a hand held remote control until it reaches the target. By using a VCR and recording the flight video, excellent airborne surveillance can be obtained. Adding commercial infra red and low light systems enhance this ability.

Military systems include homing on communications, radar, heat, laser illuminated, video designated, and geographically designated targets. Each of these involve onboard computers to calculate course changes and direct adjustments in control surfaces.

Other methods of propelling and guiding missiles require scientific and industrial support beyond the ordinary scope of improvisation.

Rockets and missiles can be launched from

1. Hillsides
2. Platforms
3. Ramps and rails
4. Tubes (manmade and held)
5. Silos

Improvised mountings for almost any weapon can be made with a welder and anything that moves on wheels. Examples include

- |                                  |                                    |
|----------------------------------|------------------------------------|
| Motor Vehicles and Trucks        | Livestock, Car, or U-Haul trailers |
| Wheeled log splitters            | Cement Mixers                      |
| Engine hoists                    | Hand dollies                       |
| Drum trucks and carriers         | Elevating platforms and lifts      |
| Self dumping and tilting hoppers | Jib Cranes                         |

An example of a warhead design is the missile launched US M815 Heat Projectile -

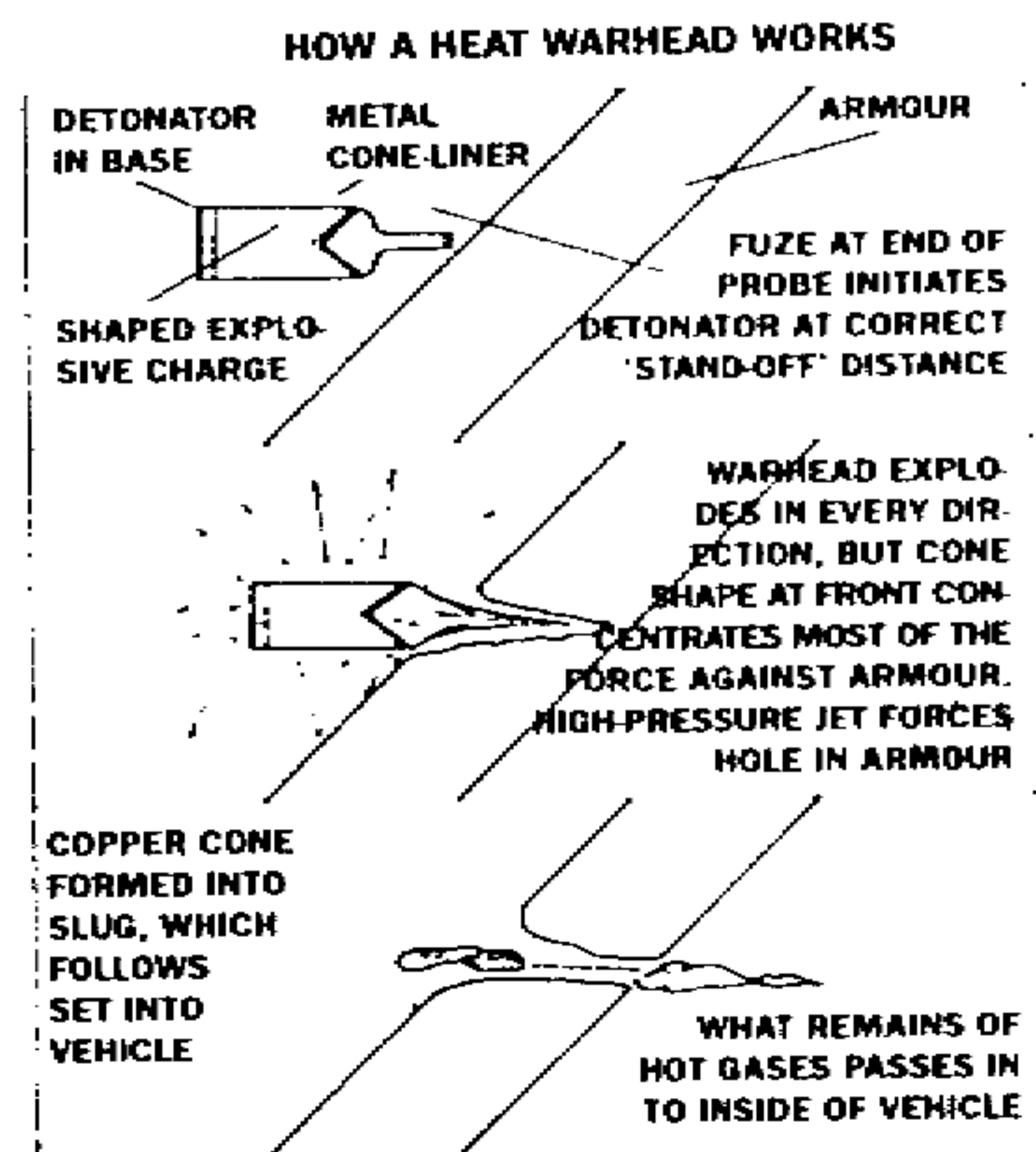
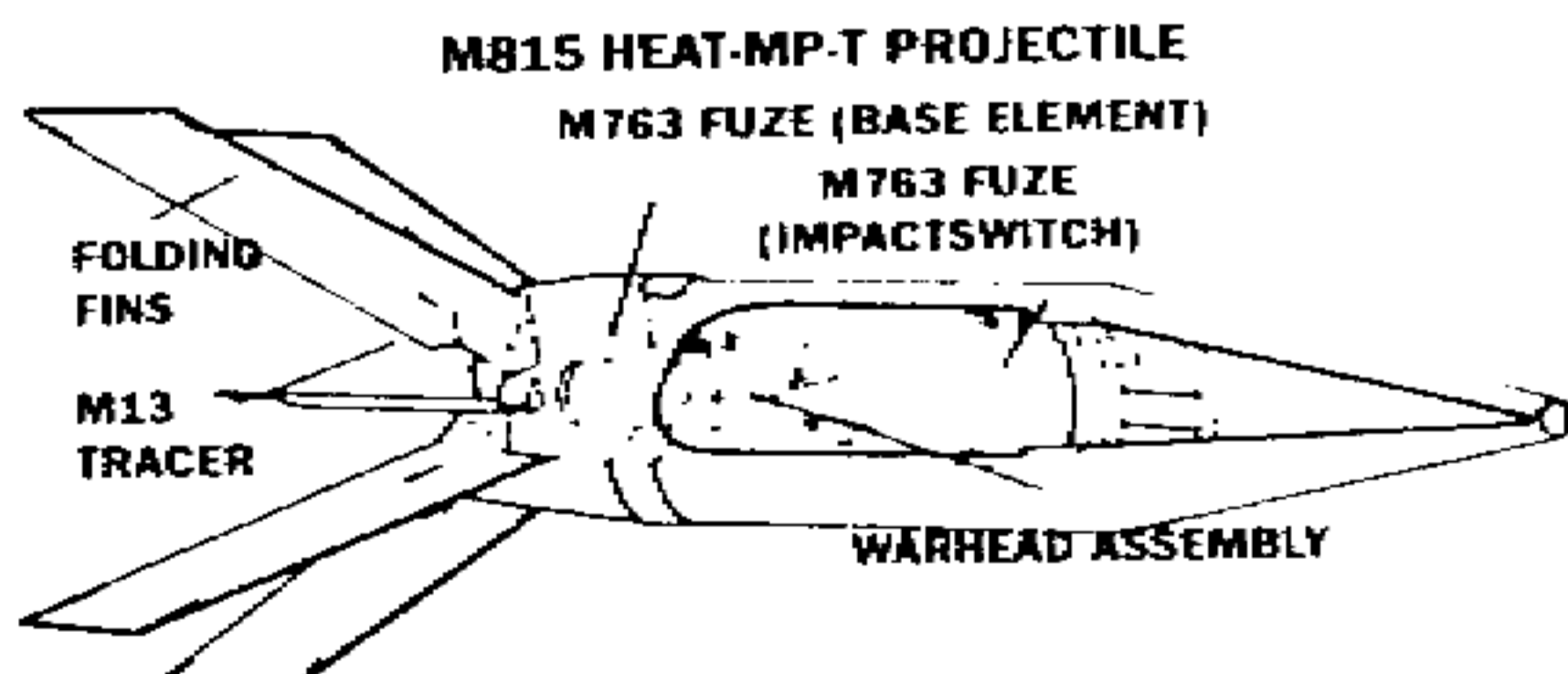

# History, Design, and Manufacture of Explosives

## 5) Land Mines

Mines are mass produced booby traps manufactured for the armed forces of the world. They are generally of two types, anti-personnel and anti-tank, and are much more sophisticated than common traps. Modern designs allow some mines to be dug up and reused when they are needed elsewhere. This is because the supply of mines has historically run out before all the areas they can, or should be used in were covered. In order to stop German armor in WW2, the Soviet army laid over 220 million mines which caused over 22% of all tank casualties. In Vietnam, they accounted for 73% of all tank casualties. A single platoon can lay 500-1,000 mines per night which can make their protected positions very difficult to penetrate.

The simplest and slowest way of laying mines is by digging a spot in the ground and placing them in by hand. This individual attention makes them easy to conceal.

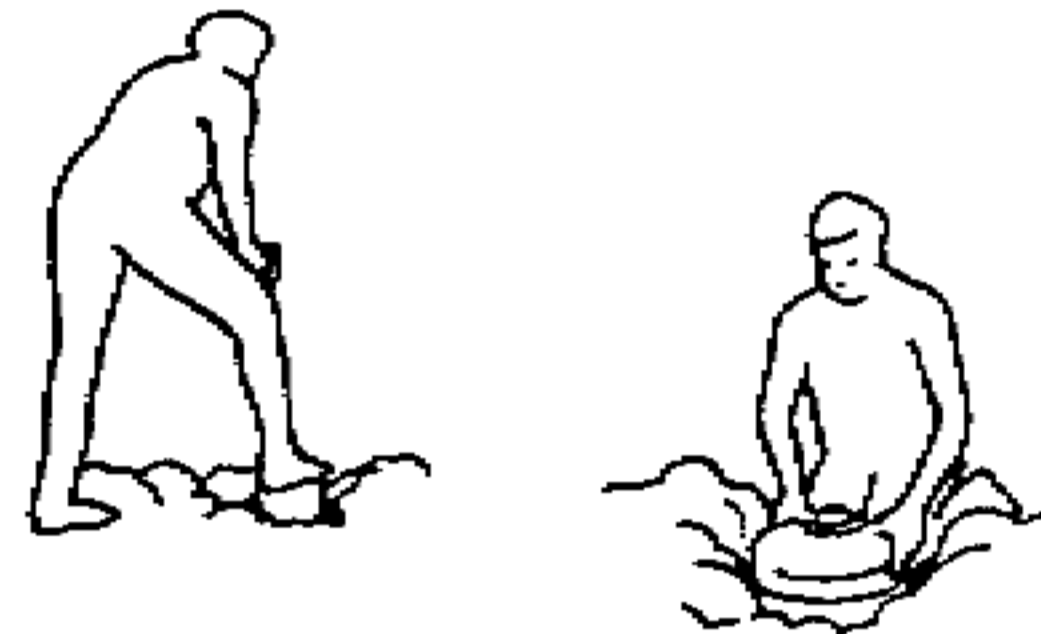

Many armies use mine plows to sow strips of anti-tank mines. The plow is usually towed behind an APC. The mine passes down a conveyor (1) where it is fused (2), and placed in a furrow (3) dug by the plow. A pair of discs at the rear (4) covers the furrow concealing the row of mines.

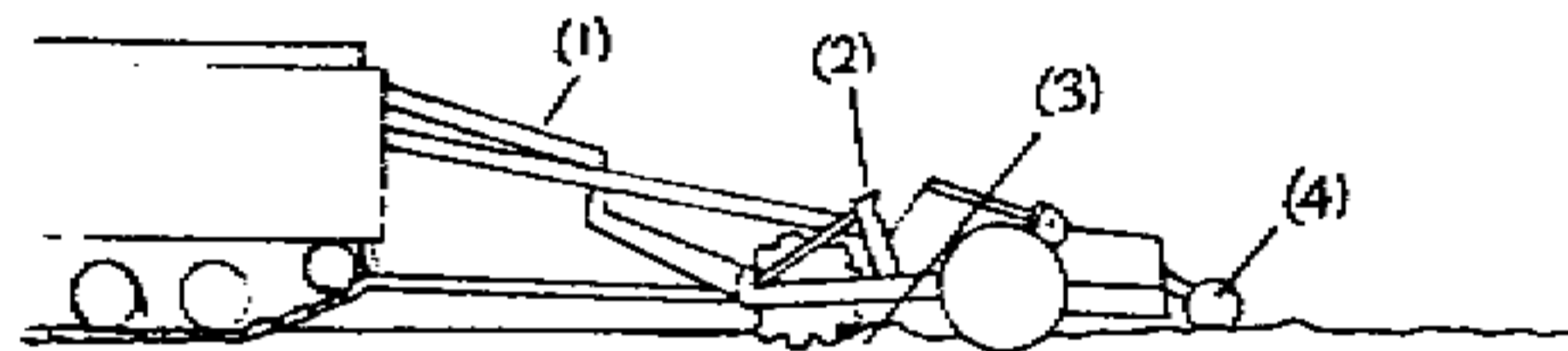

Rocket artillery can be used to deliver instant minefields up to thirty miles behind enemy lines. These are usually small mines called RDM's for "remote deployed mines". They are about the size of a grenade and generally cannot destroy a tank. They are able to knock the tracks off or damage the suspension. In addition they are capable of inflicting huge numbers of human casualties.

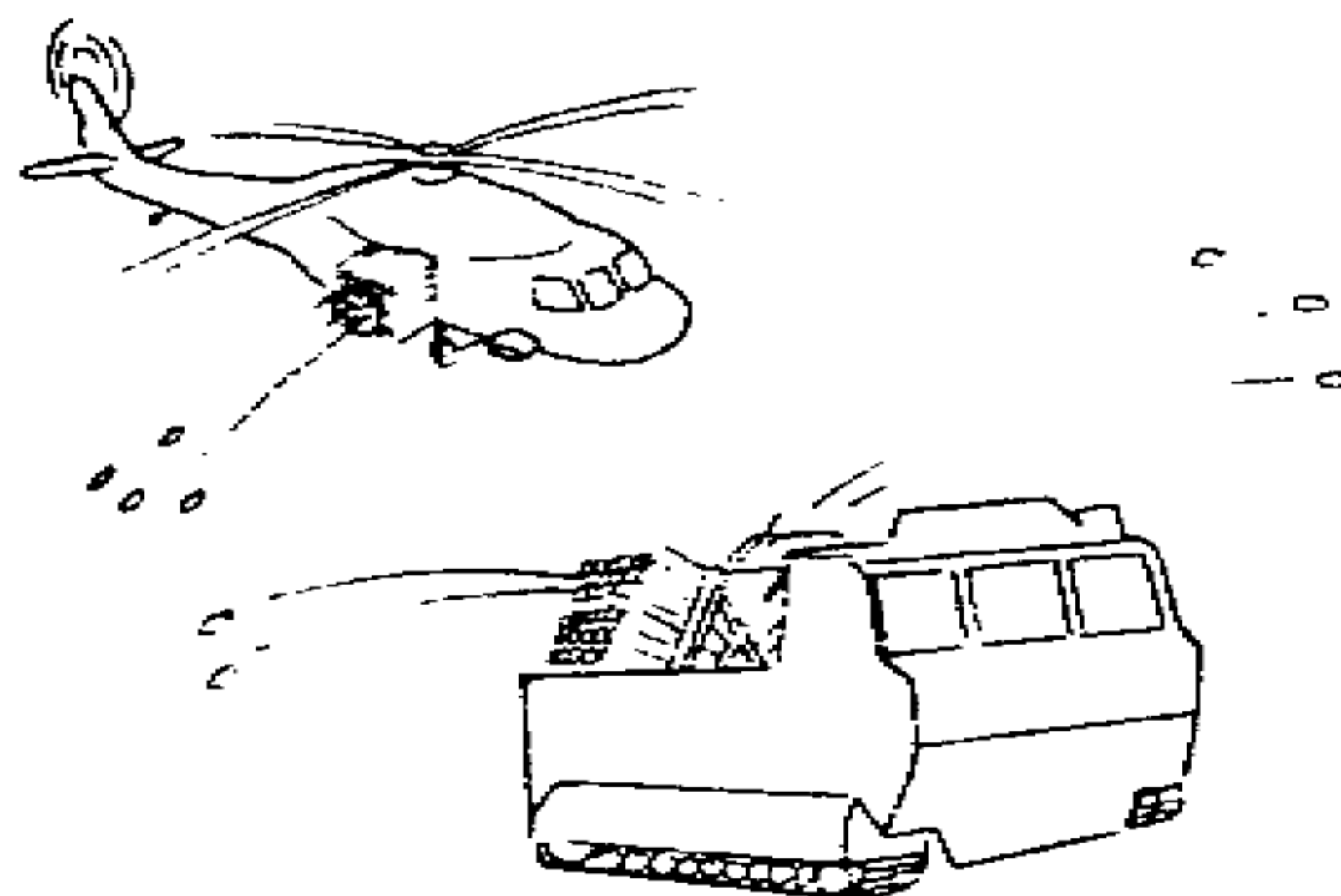
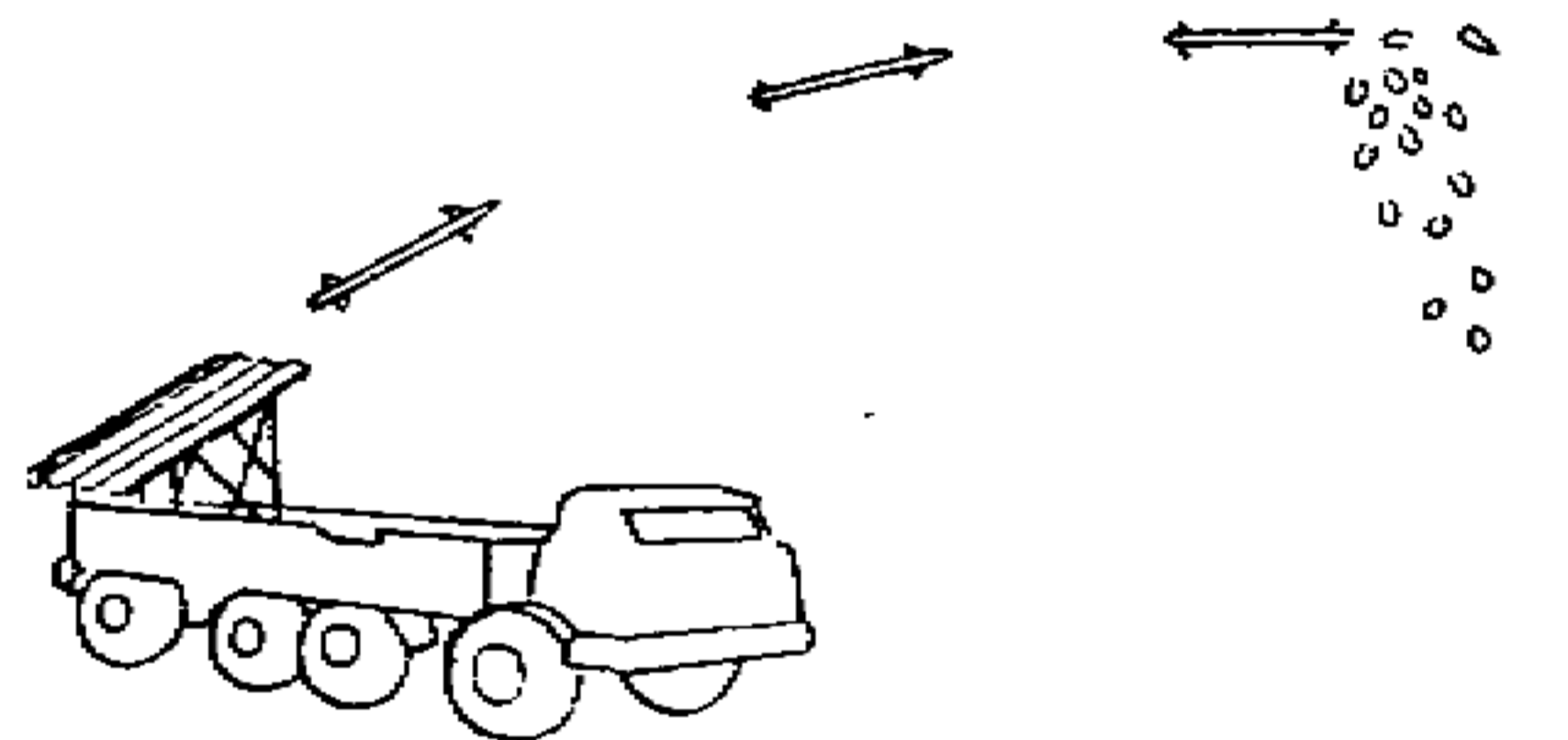

Helicopters and APC's can also lay large minefields quickly when these smaller types are used.

## History, Design, and Manufacture of Explosives

Anti helicopter mines were used in Vietnam with a fan blade on the top. When the fan is spun by the air wash of a helicopter, the mine is propelled upwards towards the copter and explodes about waist height. Electronics emissions and Infra Red can also be used for detonating mines.

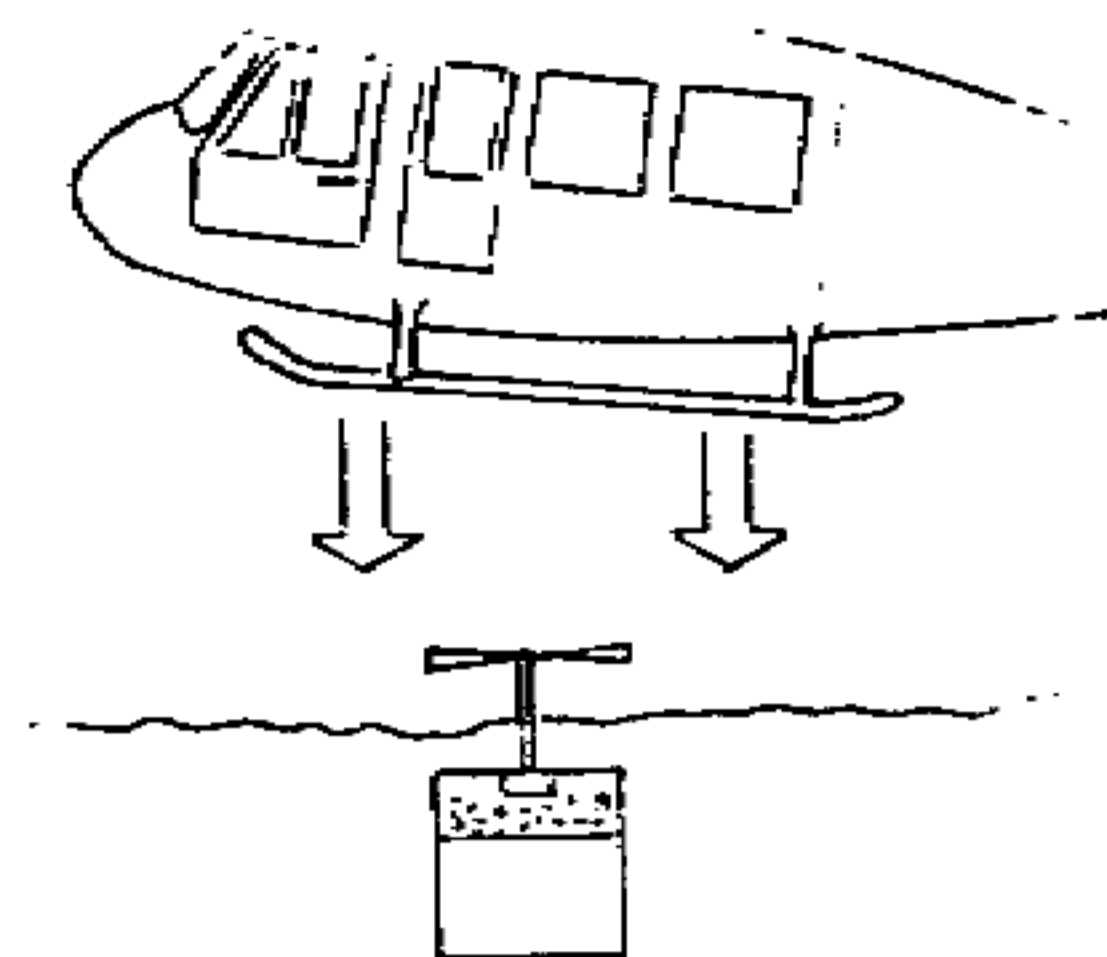

Mines are located by probing the ground with a knife or using a metal detector. Modern mines are often made of nonmetallic materials to prevent magnetic detection.

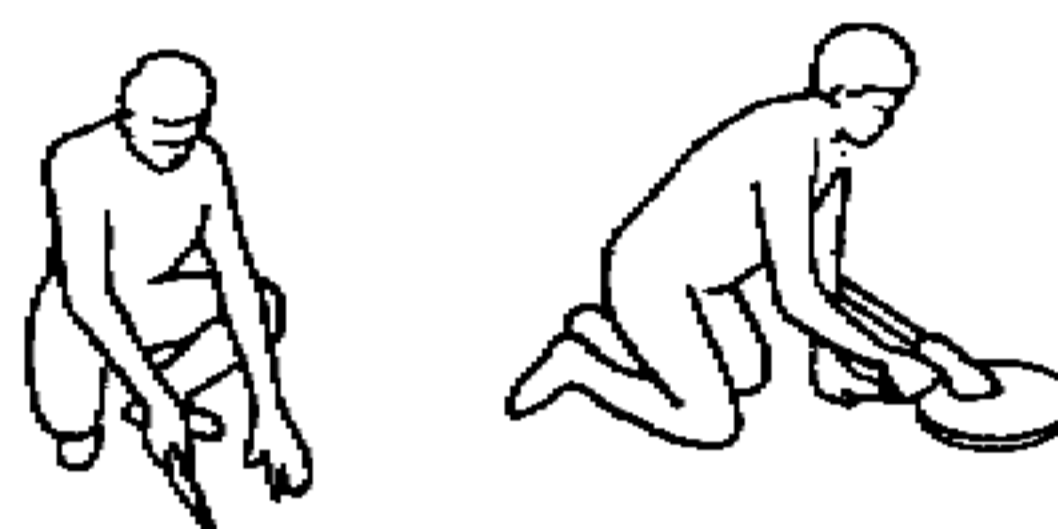

Mine clearing tanks have been designed to a. flail the ground with chains to cause pressure to detonate the mines. b. Using rollers to simulate the magnetic field of an armored vehicle. Newer mines are designed to be tripped twice to defeat these strategies. Newer ways of clearing a path includes using a plow (c) to push the ground and mines out of the way. The plow also deflects the blast of exploding mines. During Desert Storm, the US Marines used rockets to lay hoses filled with fuel air explosives to set off all the mines in a selected path with its massive overpressure.

Sophisticated electronic mines can detect and measure the differences in the magnetic fields of different vehicles. When the desired vehicle hull is recognized, a clearance charge blows the ground overhead out of the way. The main charge is then launched towards the belly of the vehicle.

Methods of detecting targets and initiating mines include contact (top row) and influence (bottom row).

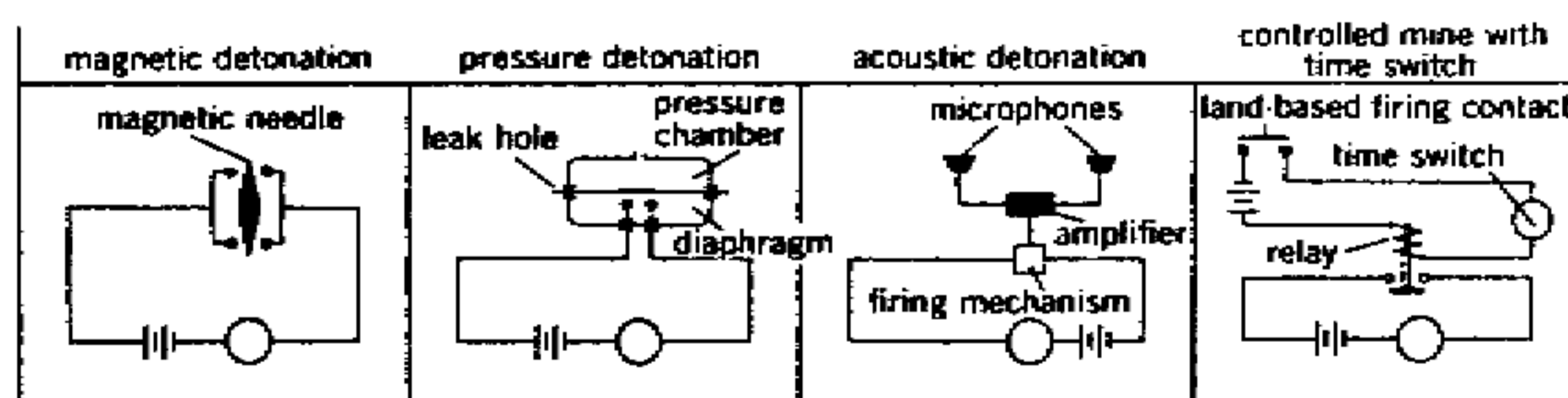
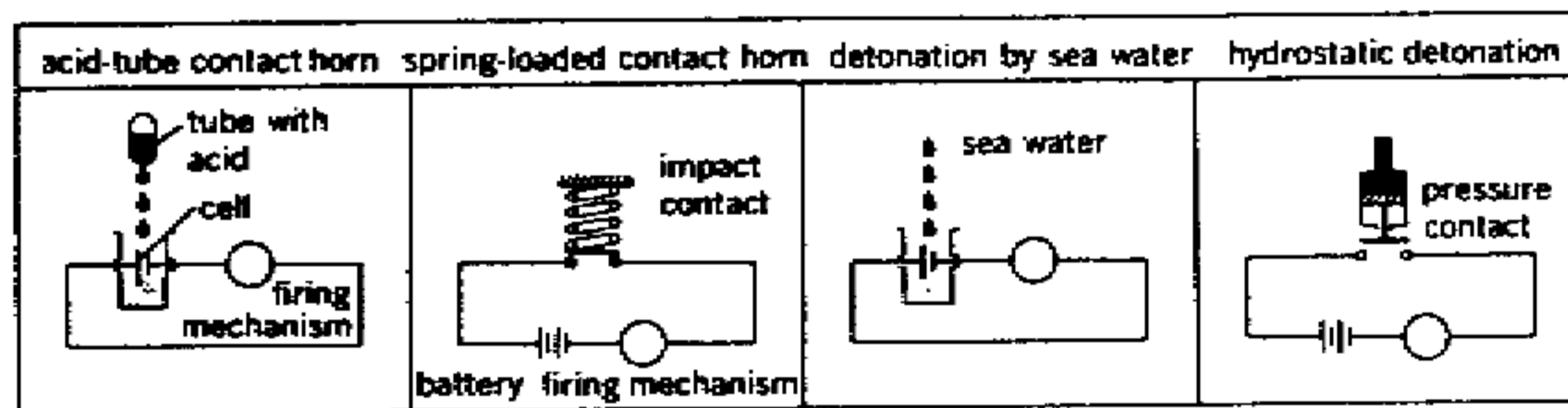

## History, Design, and Manufacture of Explosives

The German "Tellermine" used in WW2 had a steel container holding 12# of TNT. It was buried 3-6" below the surface and would only be detonated by pressures of 250# or more (vehicles). A second ignite (g and h) was added to insure detonation if the enemy tried to dig it up (tilting it).

- a Main charge of TNT
- b Pressure-plate
- c Pressure-plate spring
- d Striker and spring
- e Detonator
- f Main booster
- g Bottom fuze well
- h Booster

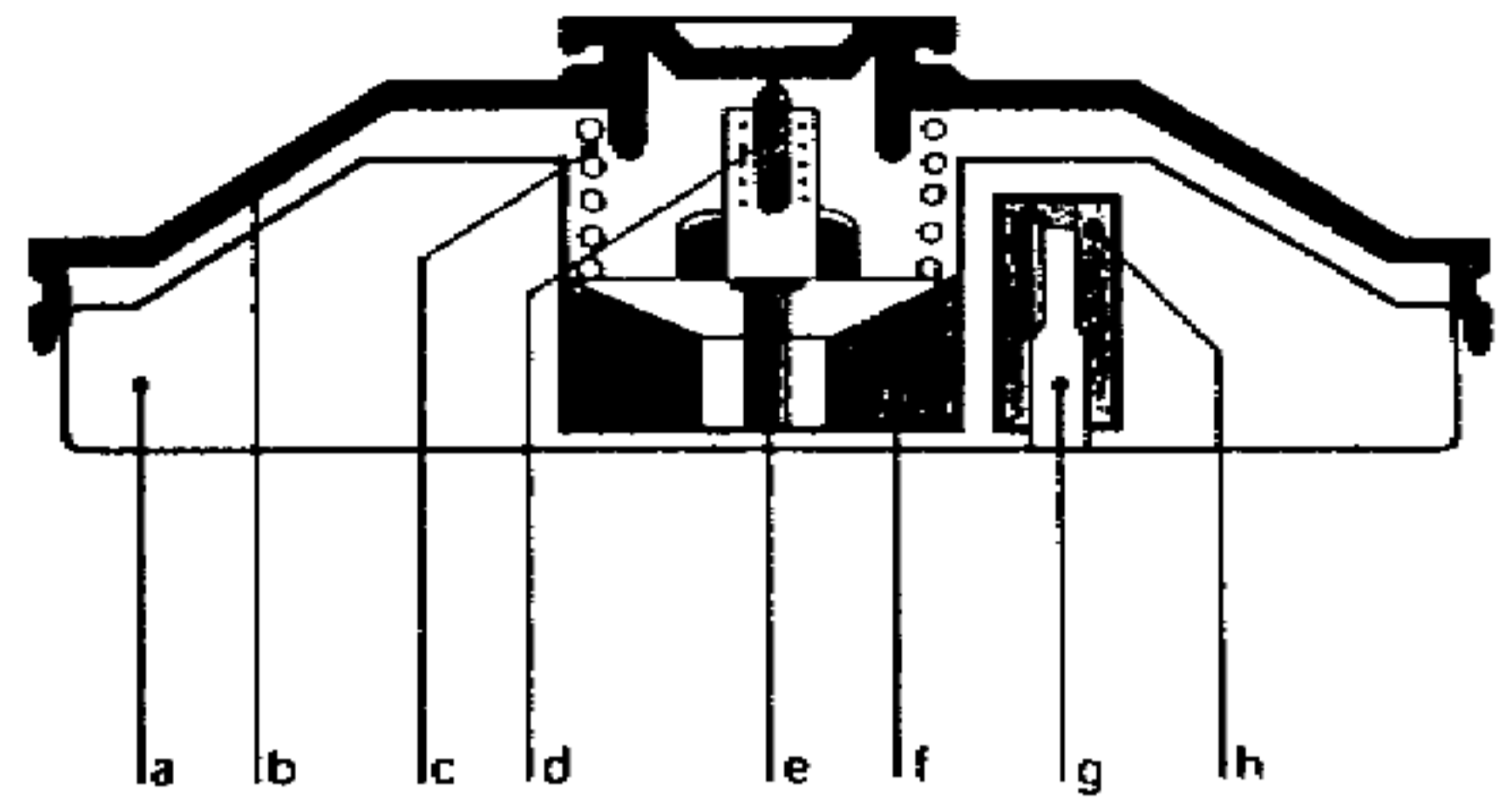

A deadly anti-personnel mine used by the Germans in WW2 was the "Sprengmine". A trip wire was attached to the igniter extension (a). When the wire was moved, the propellant charge (b) propelled the mine into the air. At 3' high, the anchor wire pulls the fuse igniting the main charge (c) which fires steel balls over a large area.

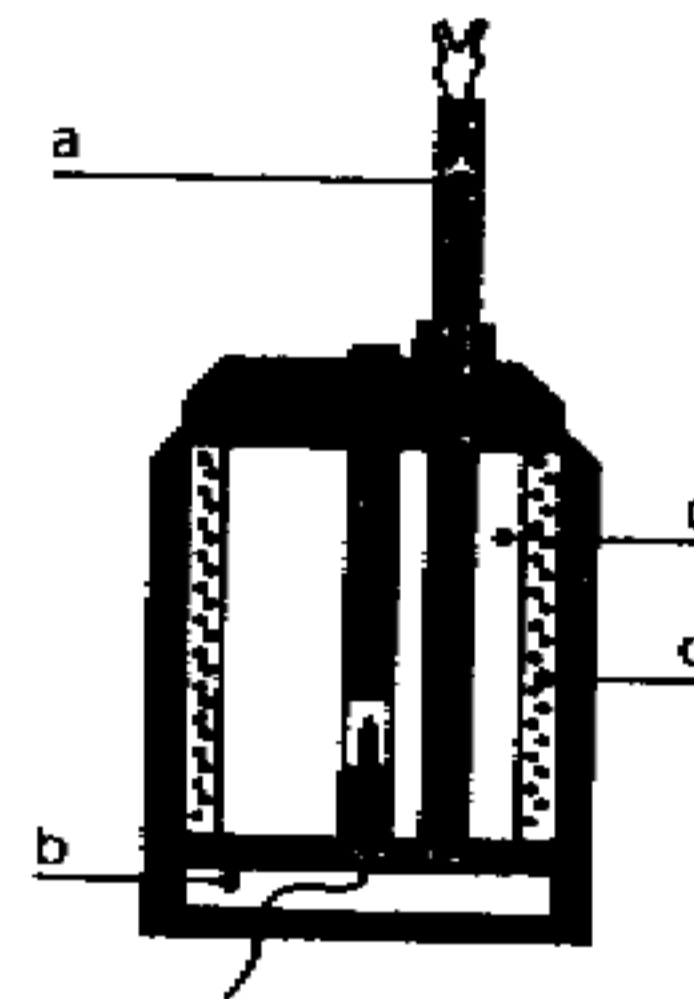

The US M14 used in the 1950's used a plastic case which housed the explosive. It was set by rotating the pressure plate that was then set off by a man's weight.

- a Pressure-plate
- b Belleville spring
- c Striker
- d Main charge
- e Detonator

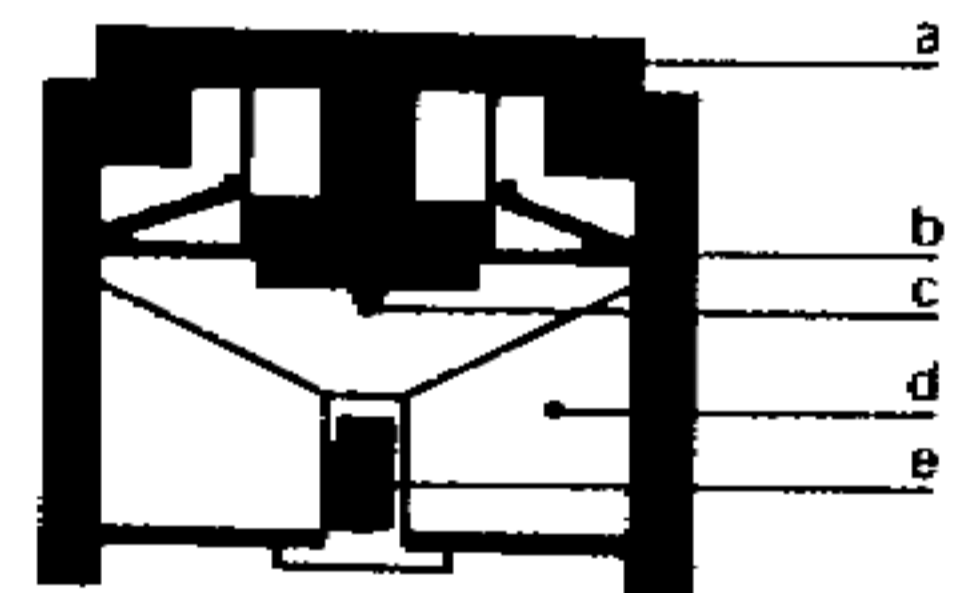

The claymore mine used in Vietnam had a plastic case housing a curved explosive that fired a large number of steel balls over a football field sized area. It was comparable to firing 30-40 shotguns simultaneously over this same field.

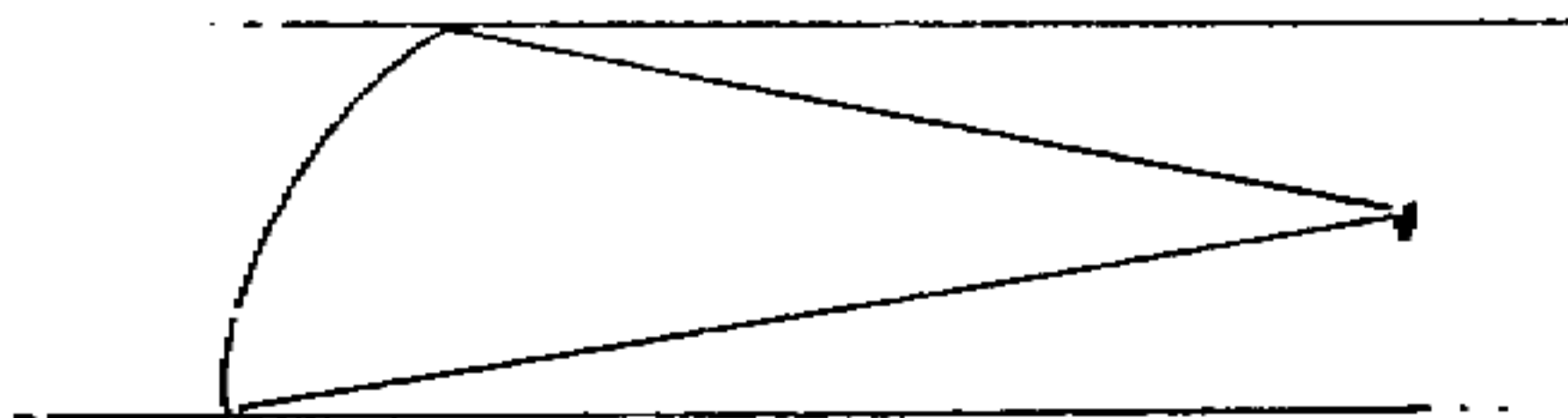

## History, Design, and Manufacture of Explosives

Improvised mines can be field prepared as follows

### Grenade Tin Can Land Mine

This device can be used as a land mine that will explode when the trip wire is pulled

#### Material Required

Hand grenade with side safety lever

Sturdy container, open at one end, that is just large enough to fit over grenade and its safety lever (tin can of proper size is suitable)

Strong string or wire

**NOTE:** The container must be small enough to prevent the safety lever from springing open. One end must be completely open.

#### Procedure

1. Fasten one piece of string to the closed end of the container, making a strong connection. This can be done by punching 2 holes in the can, looping the string through them, and tying a knot.

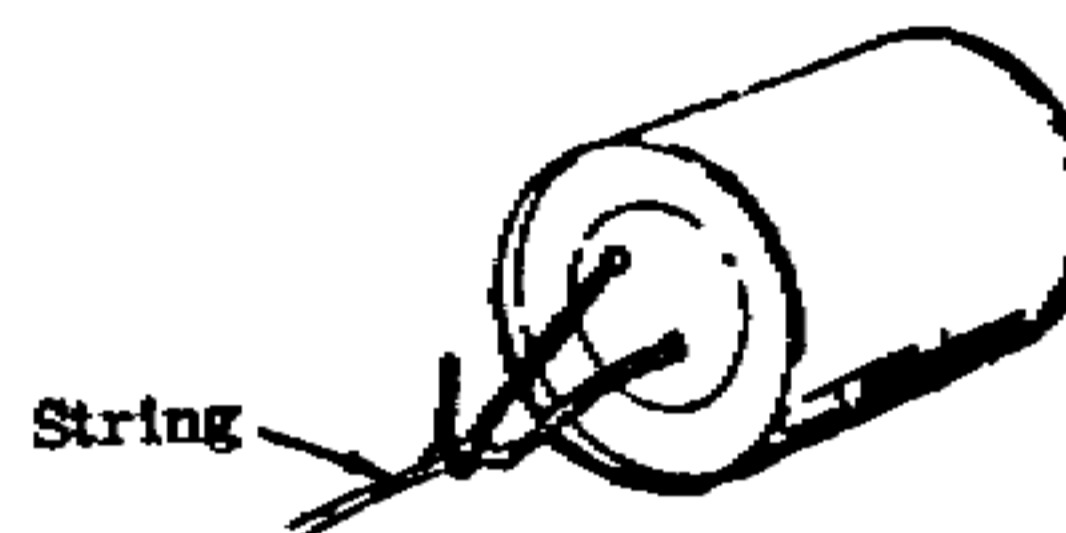

2. Tie free end of this string to a bush, stake, fencepost, etc.

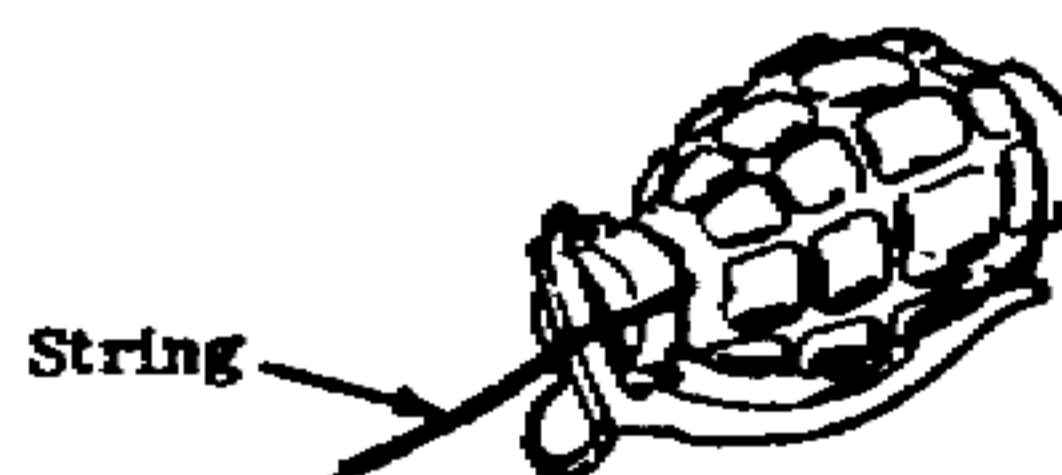

3. Fasten another length of string to the grenade so that it cannot interfere with the functioning of the ignition mechanism of the grenade.

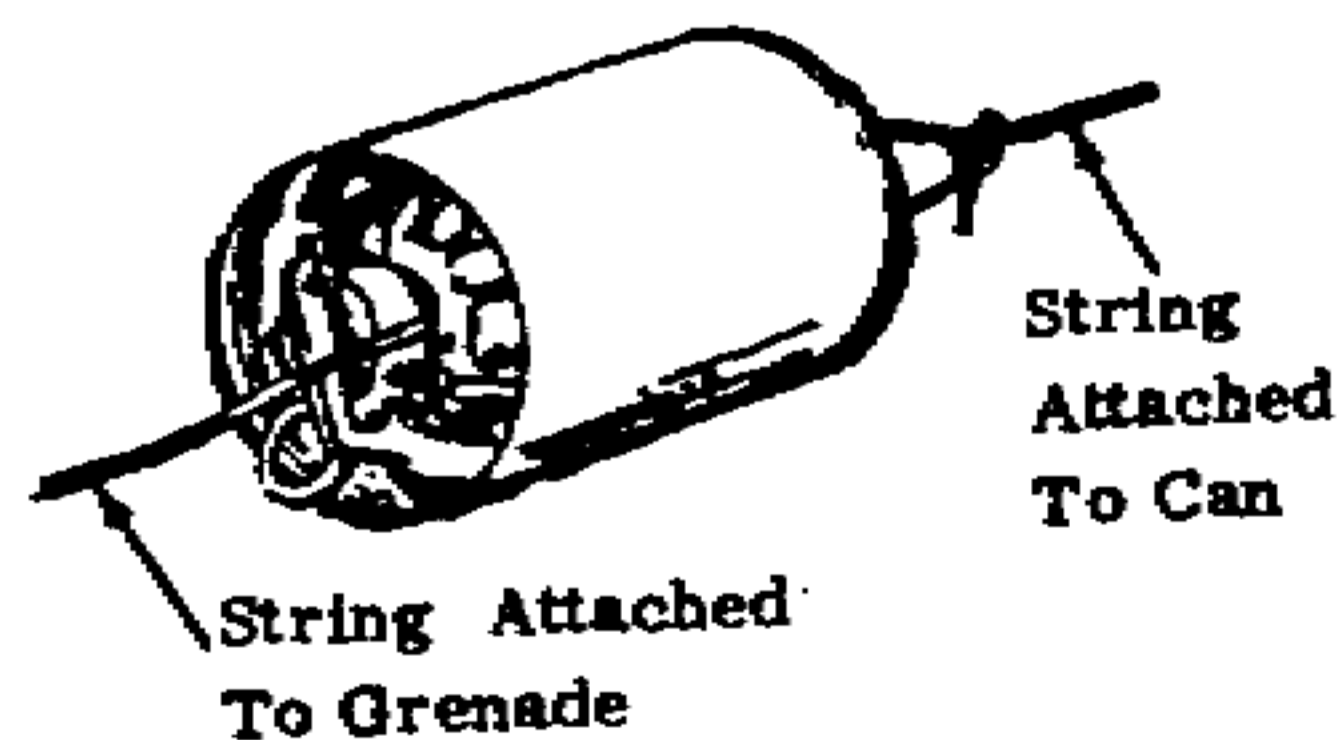

4. Insert grenade into container.

## History, Design, and Manufacture of Explosives

5. Lay free length of string across path and fasten to stake, bush, etc. The string should remain taut.

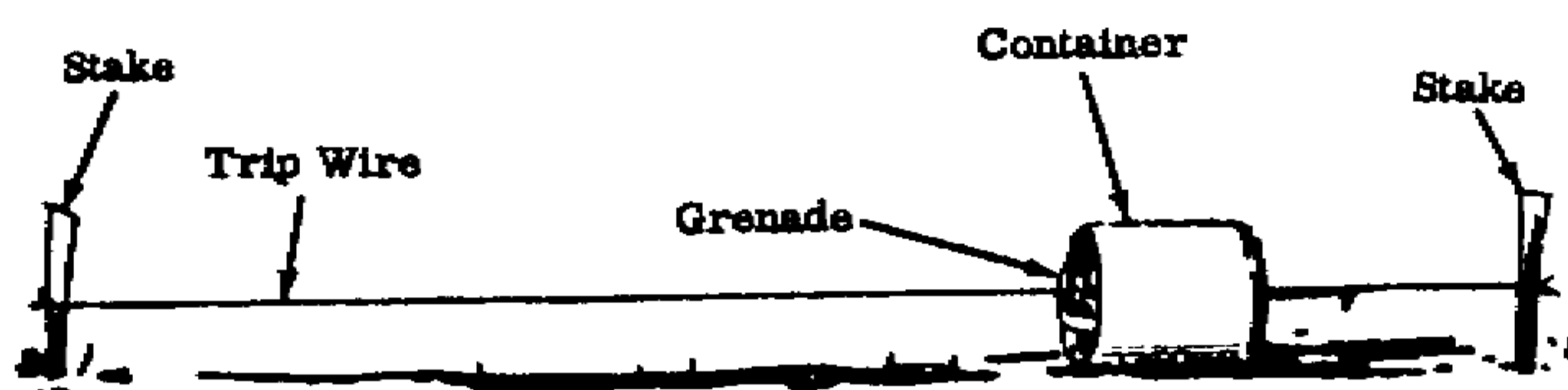

### How to use

1. Carefully withdraw safety pin by pulling on ring. Be sure safety lever is restrained during this operation. Grenade will function in normal manner when trip wire is pulled.

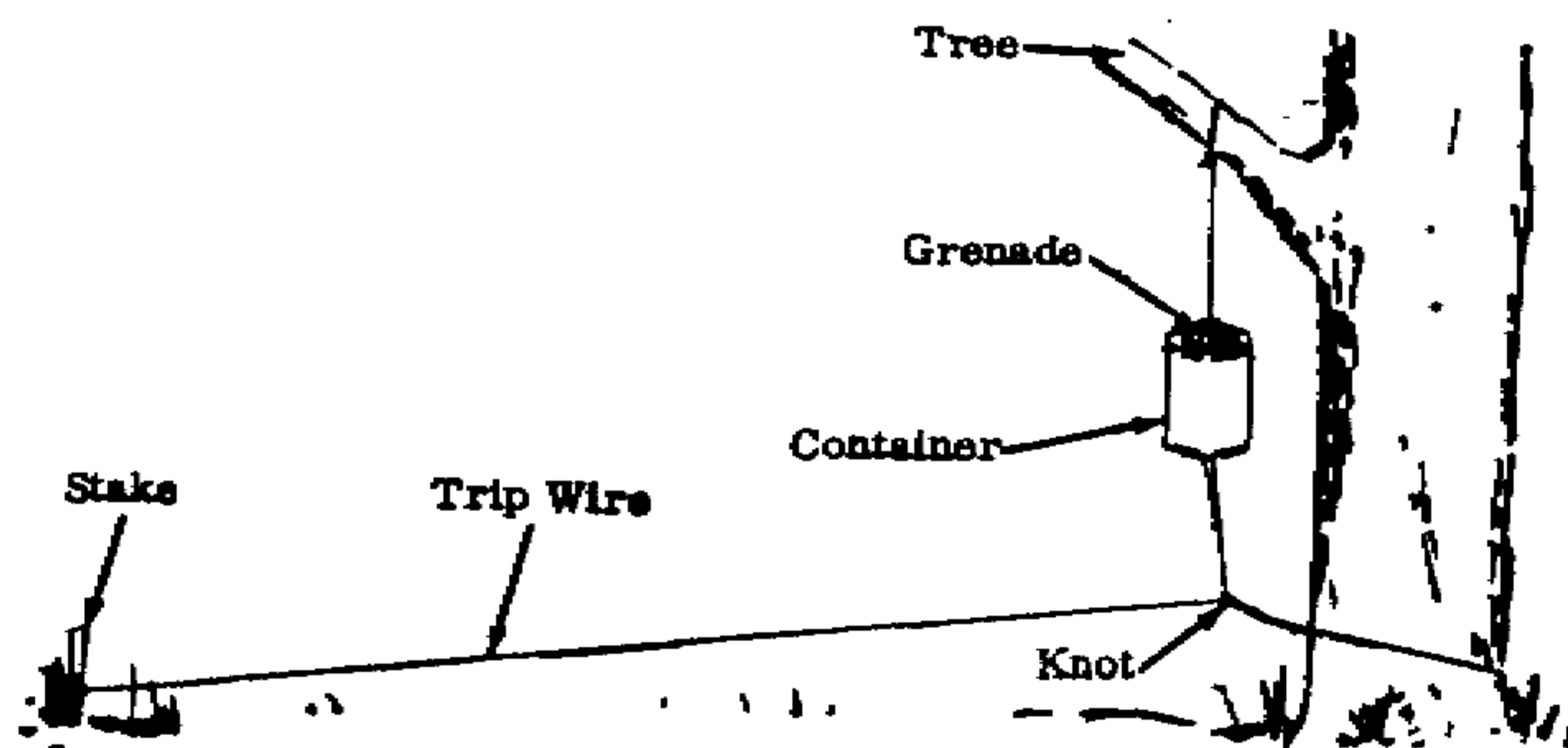

# History, Design, and Manufacture of Explosives

## Mortar Scrap Mine

A directional shrapnel launcher that can be placed in the path of advancing troops

### Material Required

Iron pipe app. 3 ft. long and 2-4" in diameter and threaded on at least one end. Salvaged artillery cartridge case may be used.

Threaded cap to fit pipe.

Black powder or salvaged artillery propellant about 1/2 pound total.

Electrical igniter. Safety or improvised fuse may also be used.

Small stones about 1" in diameter or small size scrap; about one pound total.

Bags for wadding, each about 20"x20".

Paper or bag

Battery and wire

Stick (non metallic)

**NOTE:** Be sure pipe has no cracks or flaws

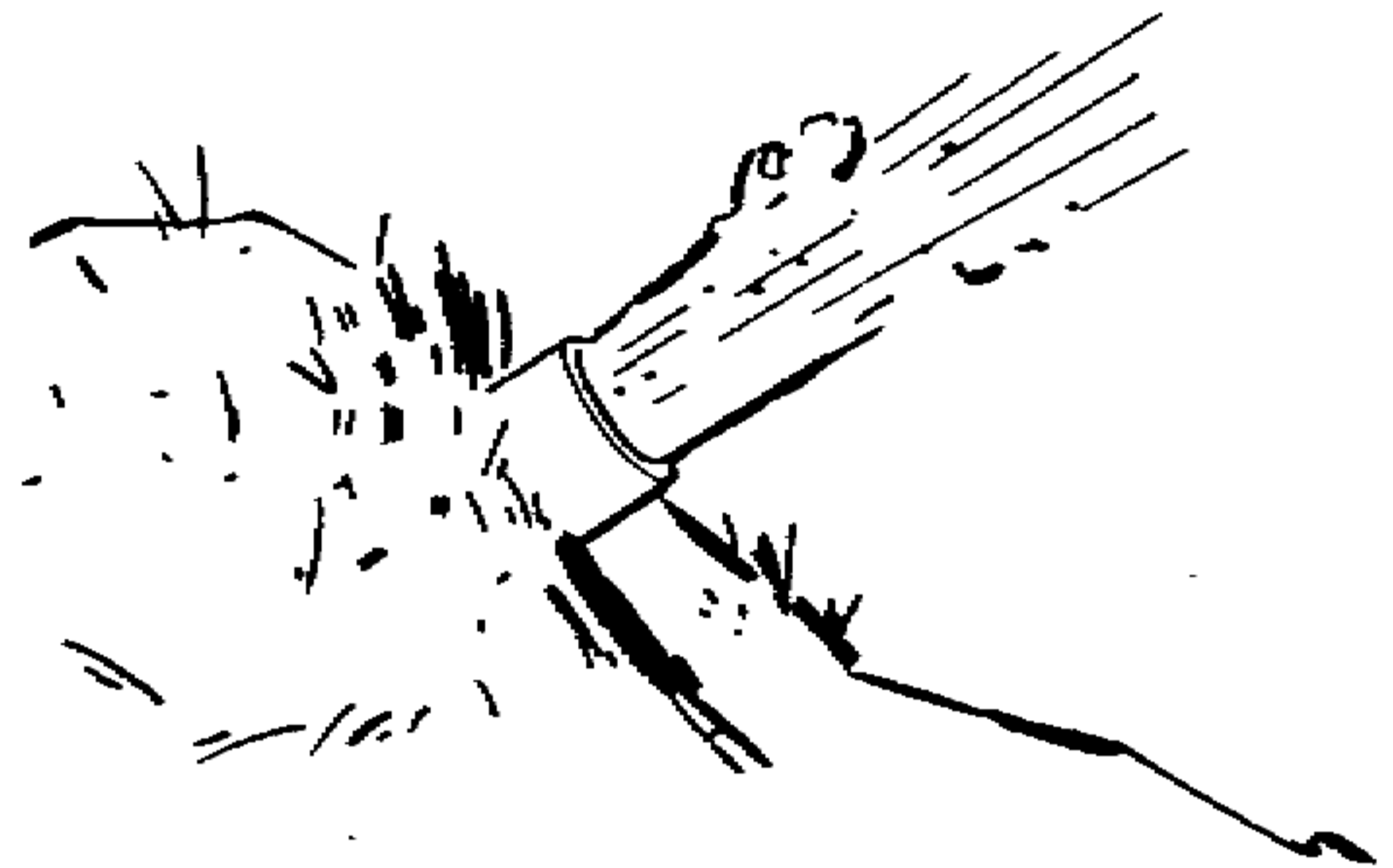

### Procedure

1. Screw threaded cap onto pipe.
2. Place propellant and igniter in paper or rag and tie package with string so contents will not fall out.
3. Insert packaged propellant and igniter into pipe until package rests against threaded cap leaving firing leads extending from open end of pipe.
4. Roll rag till it is about 6" long and the same diameter as pipe. Insert rag wadding against packaged propellant igniter. With caution, pack tightly using stick.
5. Insert stones and/or scrap metal into pipe.
6. Insert second piece of rag wadding against stones and/or metal scrap. Pack tightly as before.

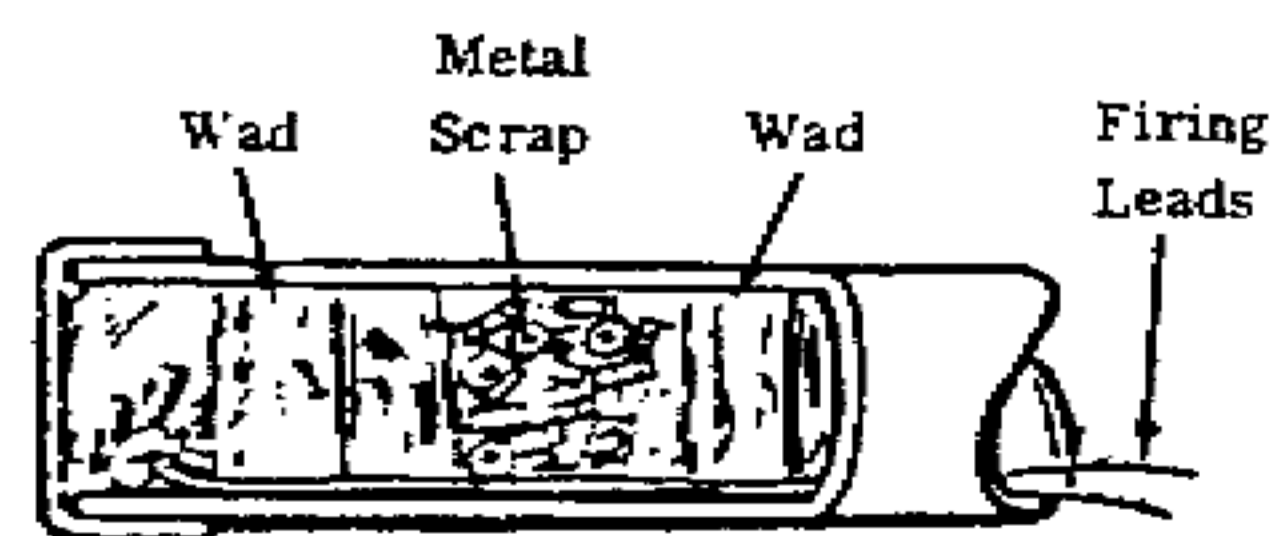
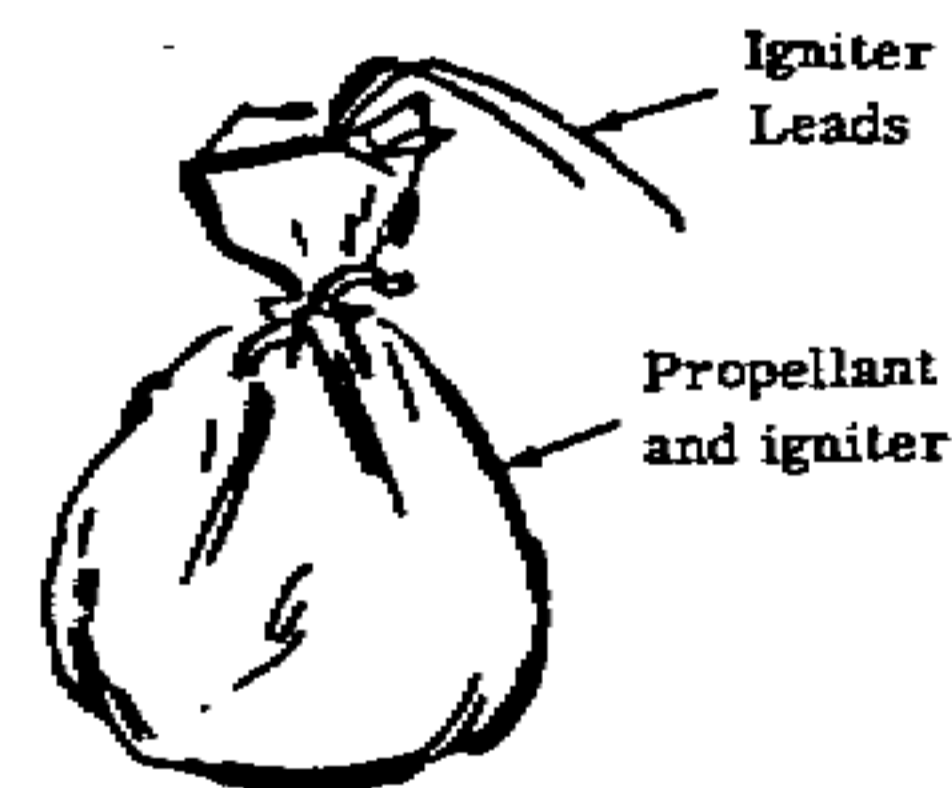

## History, Design, and Manufacture of Explosives

### How to use

1. Bury pipe in ground with open end facing the expected path of the enemy. The open end may be covered with cardboard and a thin layer of dirt or leaves as camouflage.

2. Connect firing leads to battery and switch. Mine can be remotely fired when needed or attached to trip device placed in path of advancing troops.

**NOTE:** A non electrical ignition system may be substituted for the electrical ignition system as follows.

1. Follow above procedure, substituting safety fuse for igniter.

2. Light safety fuse when ready to fire.

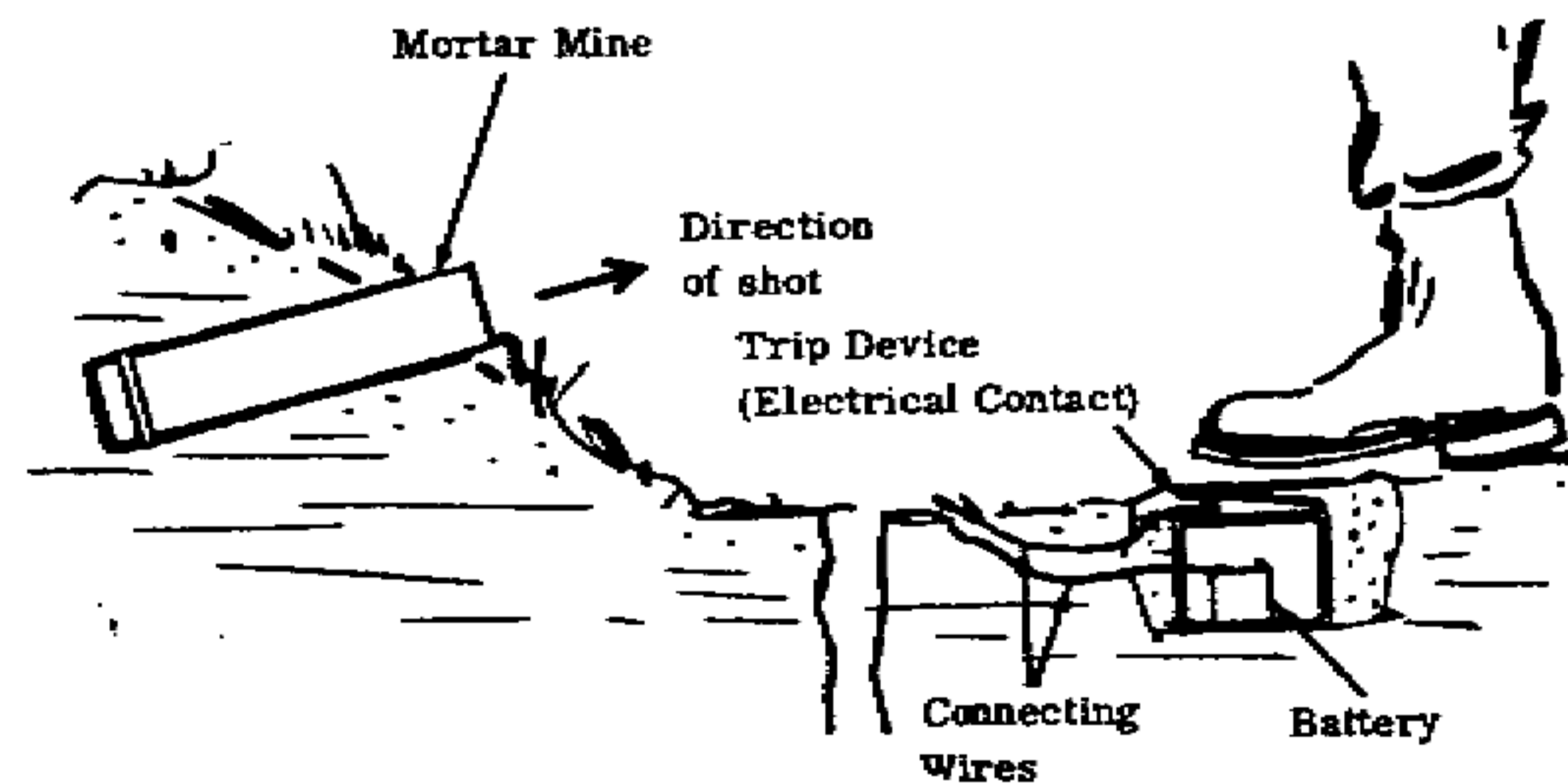



# History, Design, and Manufacture of Explosives

## 5) Booby Traps, Blasting Caps, and Positioned Explosives

While obstacles are designed to deter or stop the physical movement of the enemy these devices are designed to kill or wound an enemy without personnel being present. They are usually concealed and have their own source of stored energy to cause physical injuries. These weapons have three great advantages.

First, they are very cheap to build.

Second, they are easy to train troops to construct and set.

Thirdly, your troops don't have to be there and get shot at by an enemy while they are being attacked.

Since these weapons are machines, they do not run from battle or freeze in the heat of combat. They are reliable and can be set by ill trained troops or civilians in short notice. They are effective against the enemy's most dangerous weapons (tanks and artillery) and can give a defending force a considerable advantage.

The first part of being able to use a positioned explosive and/or device is to be able to reliably detonate it. A detonator or blasting cap is built using a metal case filled with primary explosive as already described. It is then attached to or placed inside of the main charge as shown.

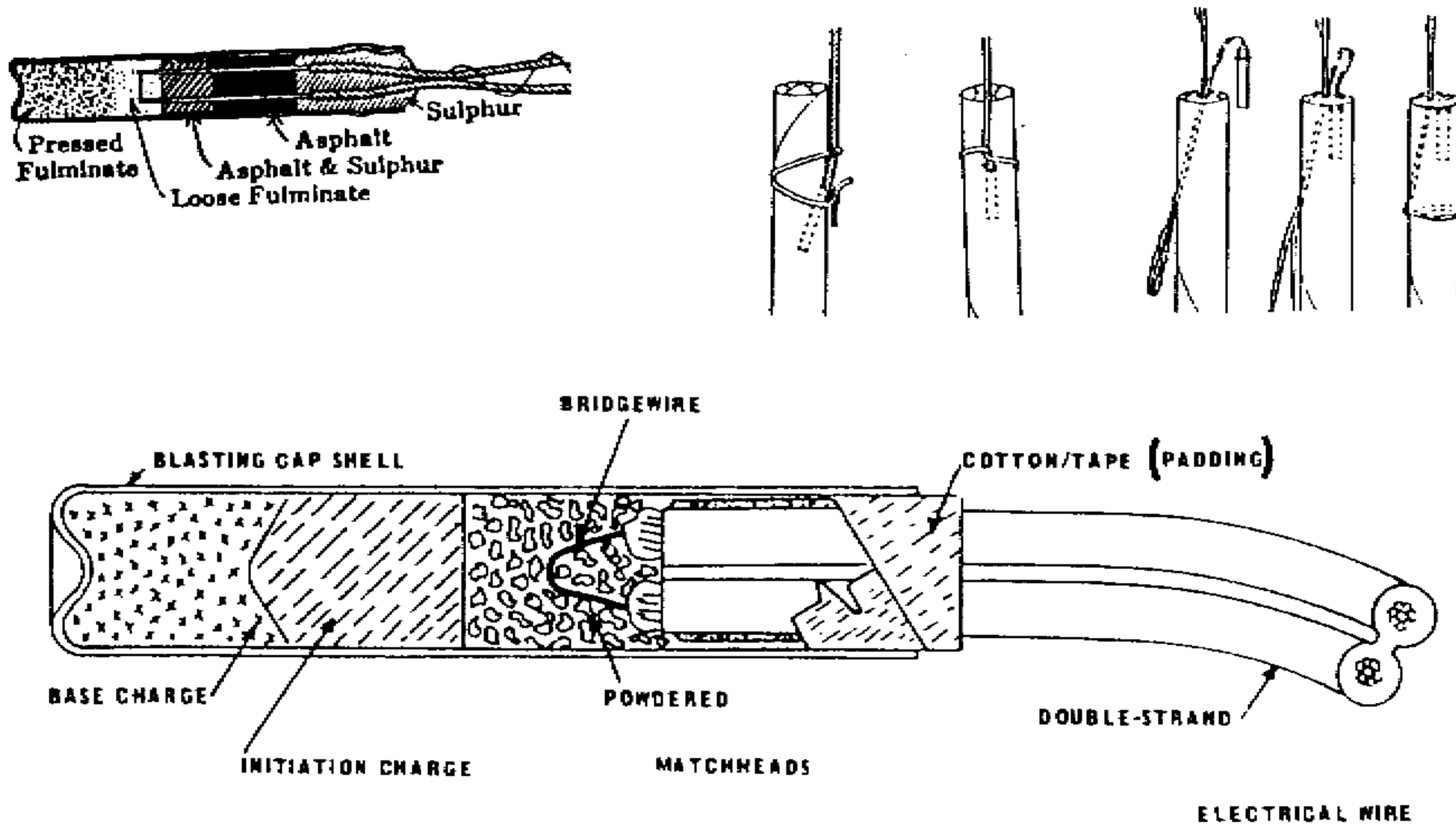

## History, Design, and Manufacture of Explosives

### A Field Improvised Detonator

Detonators (blasting caps) can be made from a used small arms cartridge case and field manufactured explosives. Detonators are used to initiate secondary high explosives.

#### Material Required

Primary explosive

Booster explosive

Improvised scale

Used cartridge case

Fuse, 12" long

Round wooden stick (small enough to just fit in the neck of the cartridge case)

Drill or knife

Long nail with sharpened end

Vise

Improvised loading fixture

#### Procedure

1. Remove fired primer from a used cartridge case using a sharpened nail.

2. If necessary, open the flash hole in the primer pocket using a drill or knife. Make it large enough to receive fuse.

3. Place one end of the fuse in the flash hole and extend it through the case until it becomes exposed at the open end. Knot this end and then pull fuse in cartridge case thus preventing fuse from falling out.

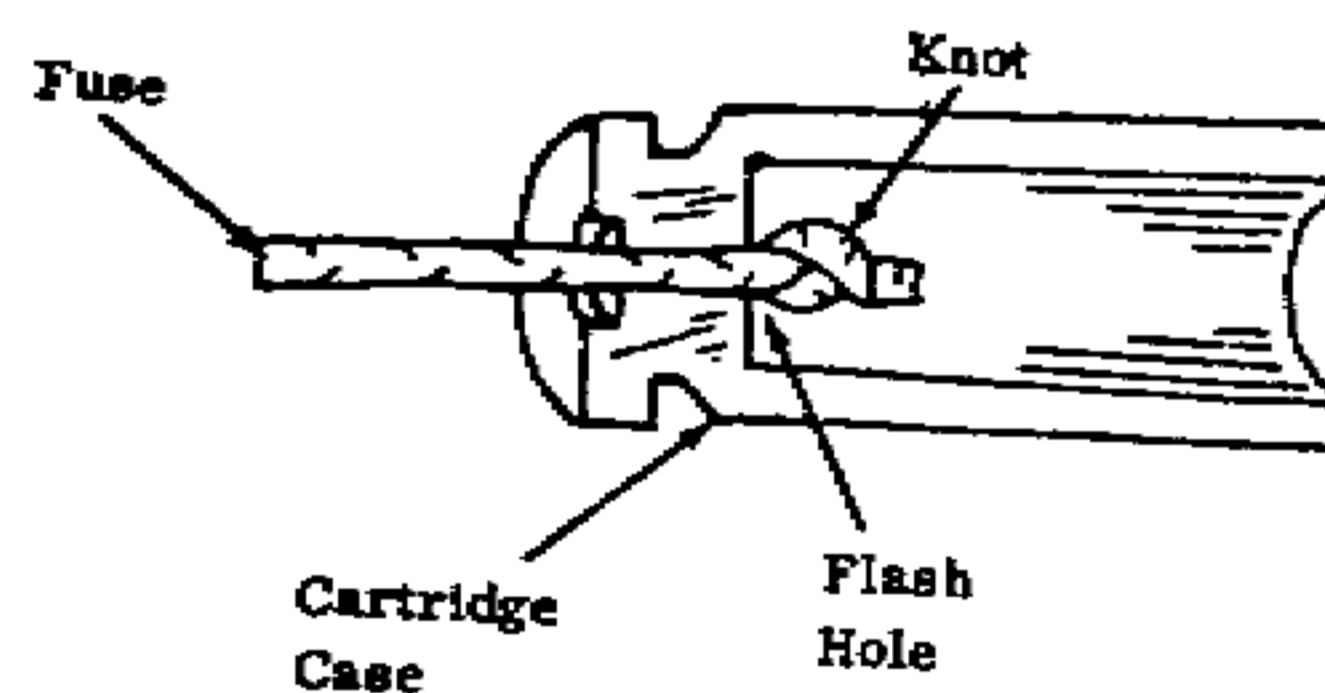
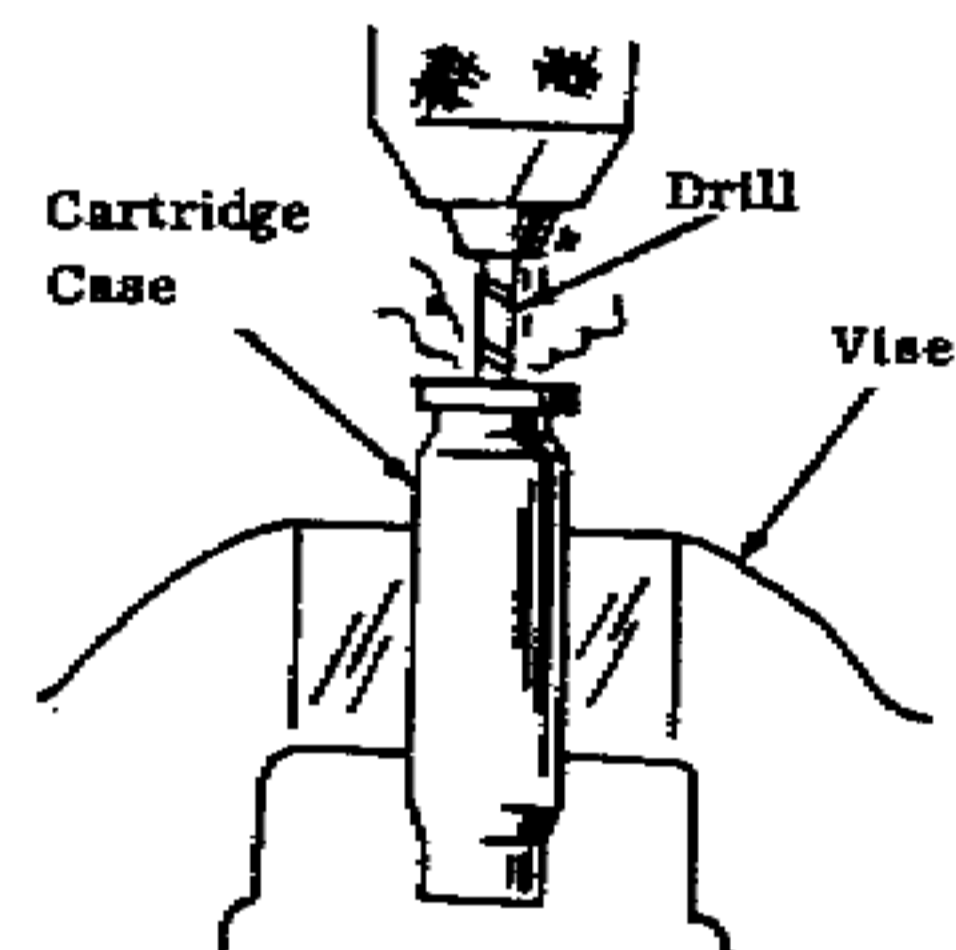

## History, Design, and Manufacture of Explosives

4. Load the primary explosive in the cartridge case as follows

Lead Picrate	3 grams
TACC (Tetramminecopper Chlorate)	1 gram
DDNP	.5 gram
Mercury Fulminate	.75 gram
HMTD	.75 gram
Double Salts	.75 gram

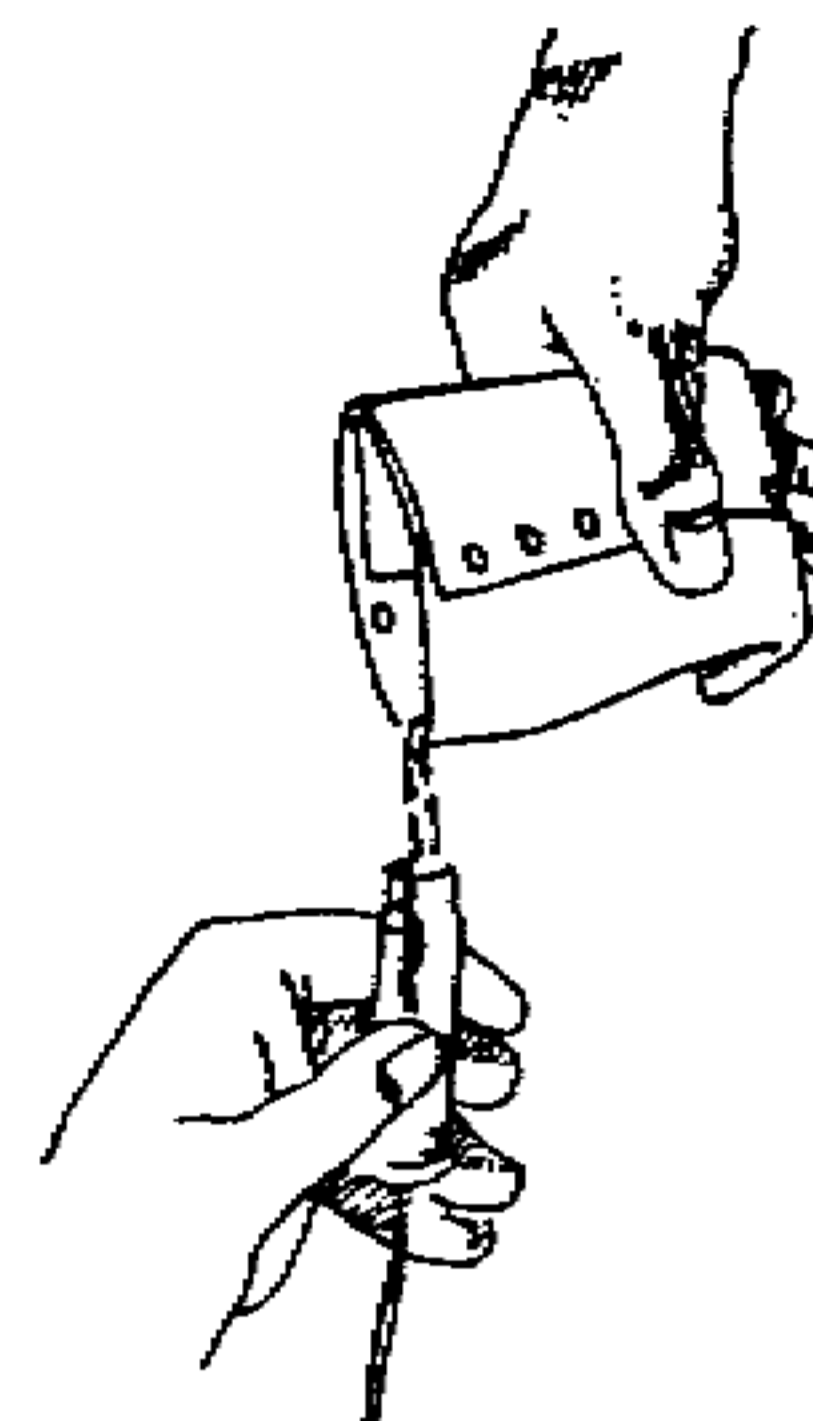

5. Compress the primary explosive into the cartridge case with the wooden stick and the following improvised loading fixture.

**CAUTION:** The primary explosive is shock and flame sensitive.

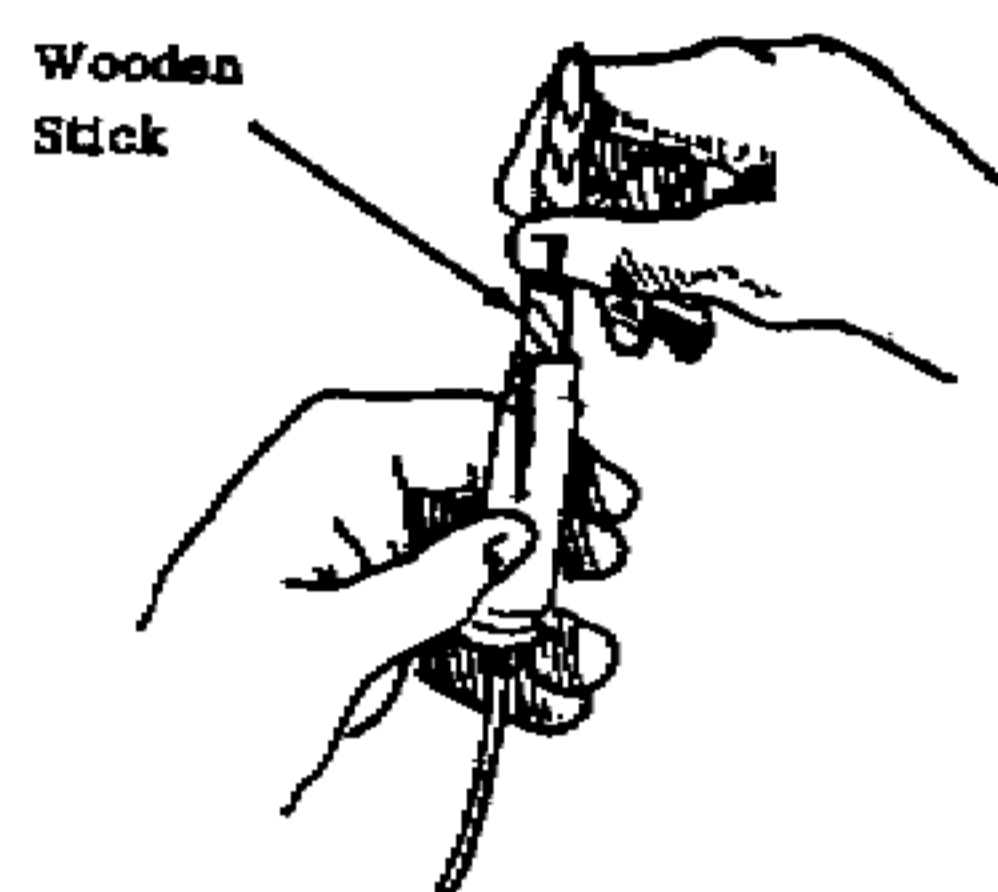
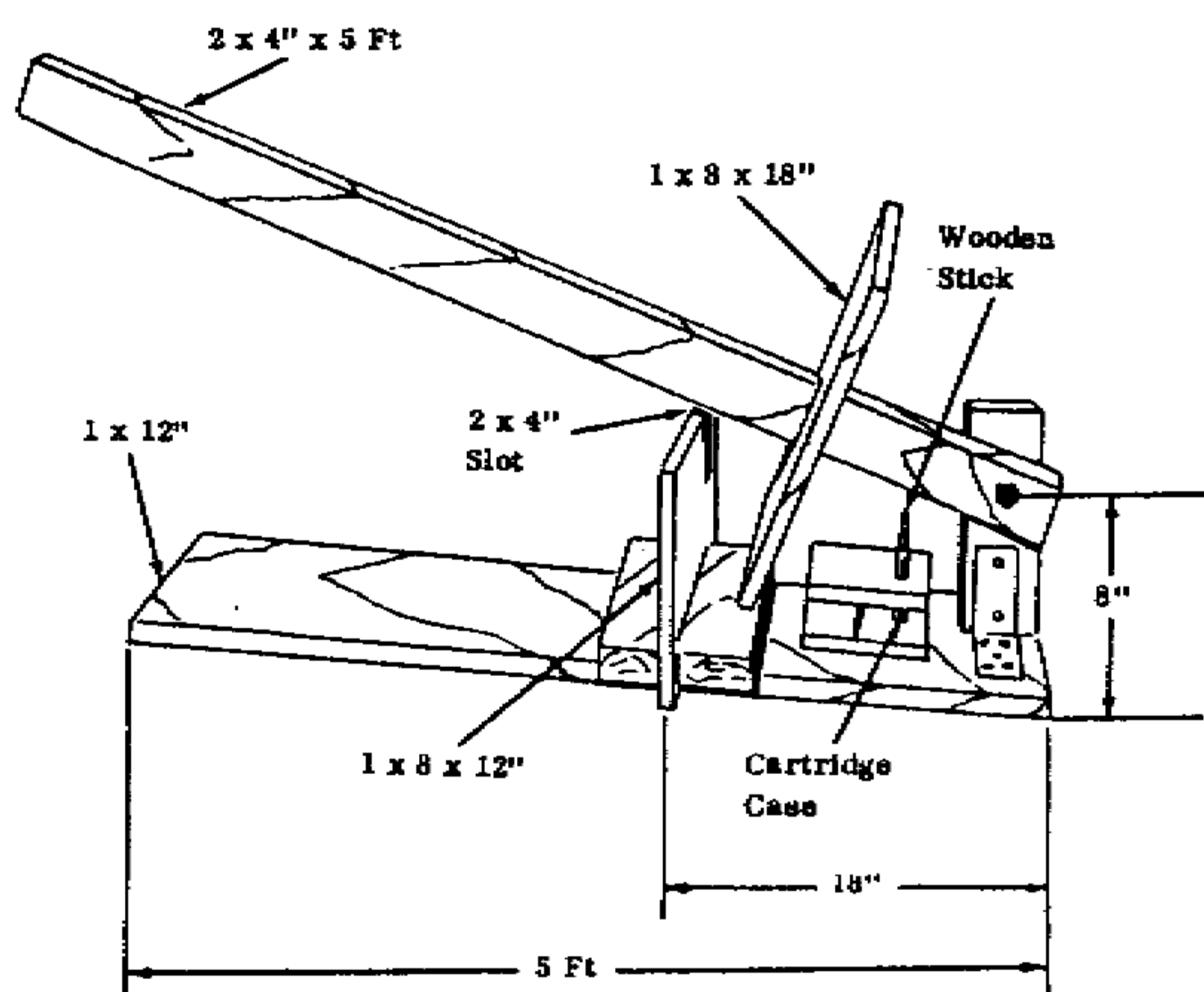

6. Add one gram of booster explosive. The booster can be RDX.

7. Compress the booster explosive into the cartridge case with wooden stick and the loading fixture.

8. If the case is not full, fill the remainder with the secondary explosive to be detonated.

**CAUTION:** Detonator has considerably more power than a military blasting cap and should be handled carefully.

## History, Design, and Manufacture of Explosives

A wide range of methods are used to activate booby traps.

**Pressure:** where the weight of the foot stepping on an object causing it to move and pull a wire setting off an explosive.

This is usually initiated by stepping on a thin board which gives enough to trigger the firing device.

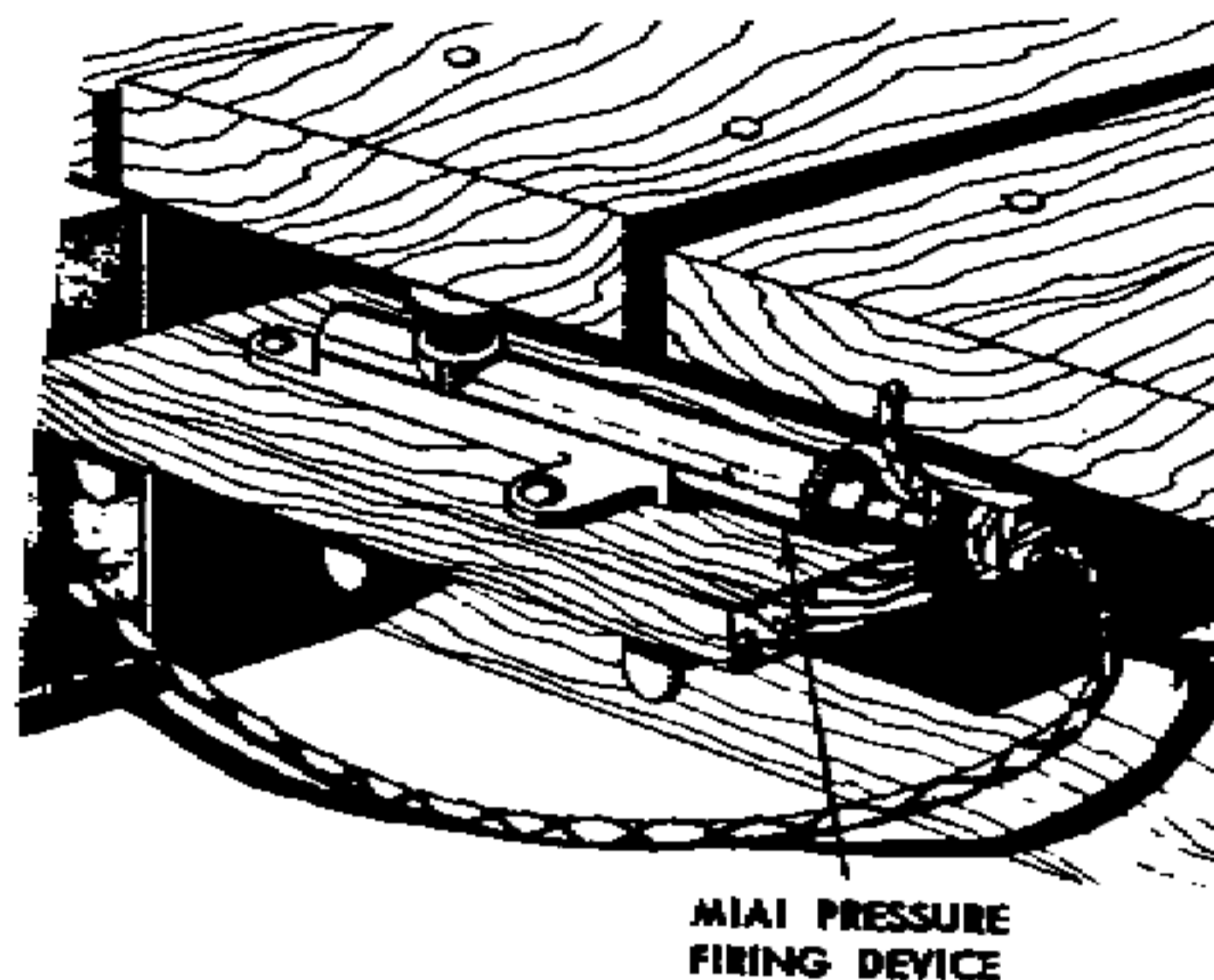

A tilting box buried in the ground and stepped on or driven over can collapse moving a trip wire and firing the trap.

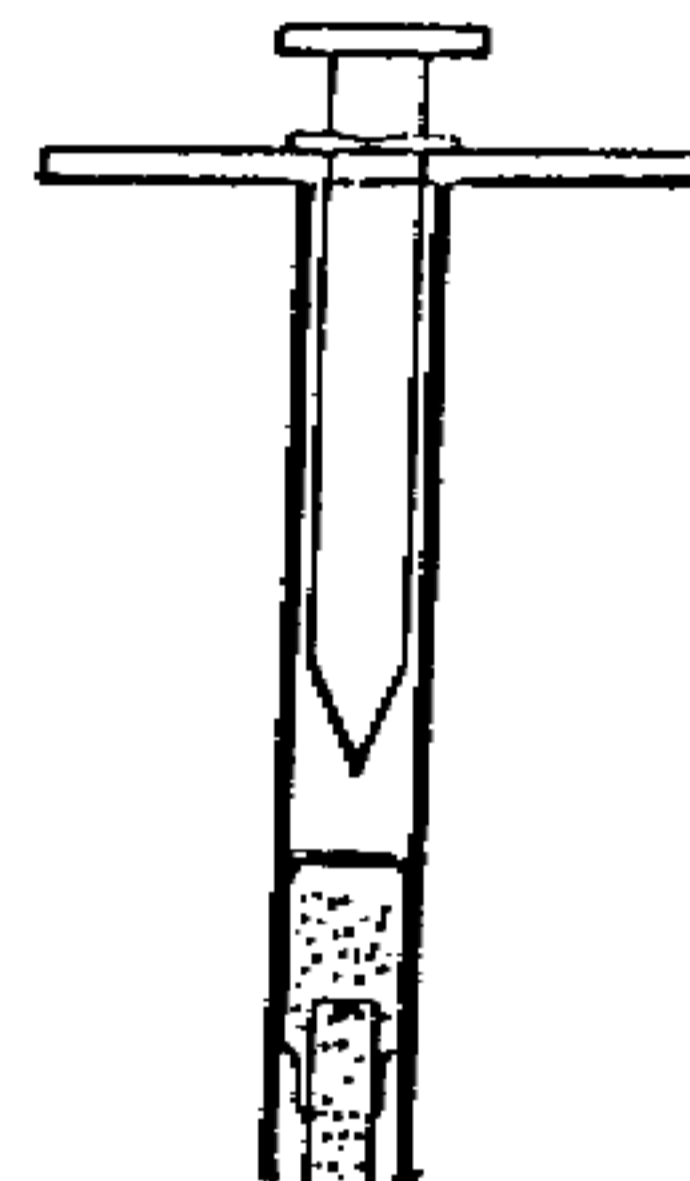
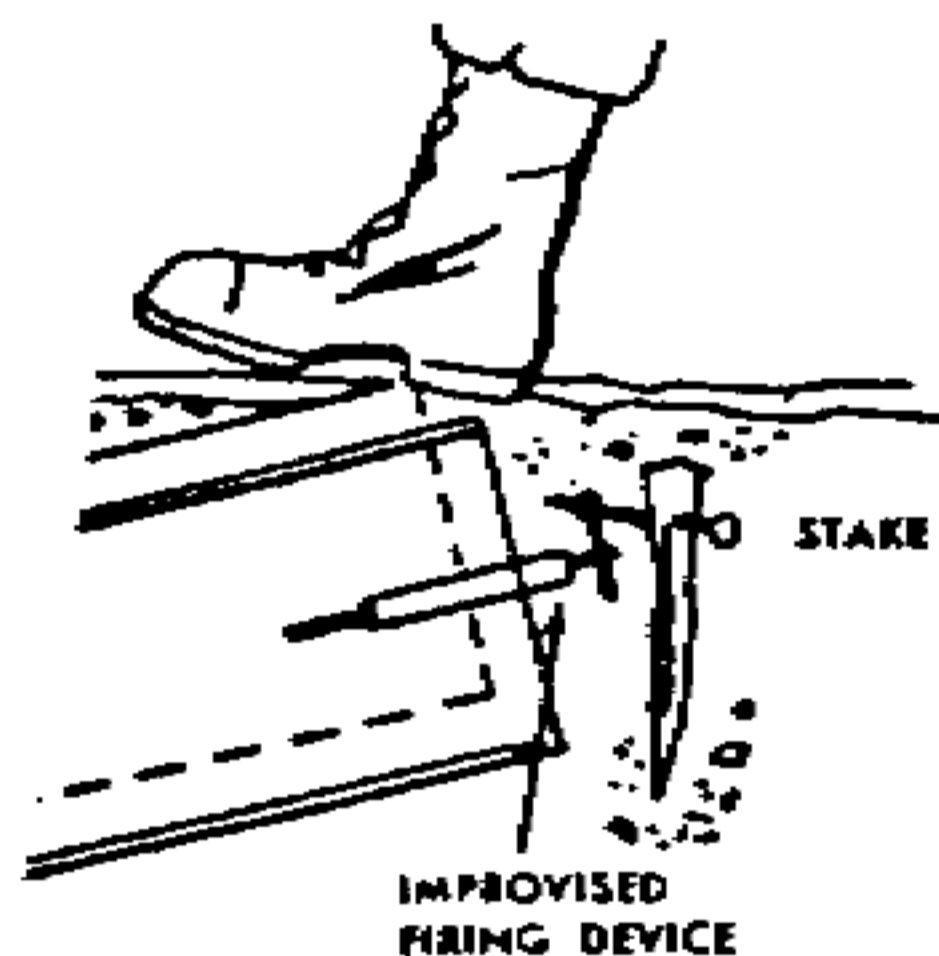

A striking pin (stab detonator) can be used in the same manner as conventional ammunition. When the striker is pressed, it sets off the explosive.

**Spring pressure boards** and electrical contact plates can also be used as explosive initiators as shown.

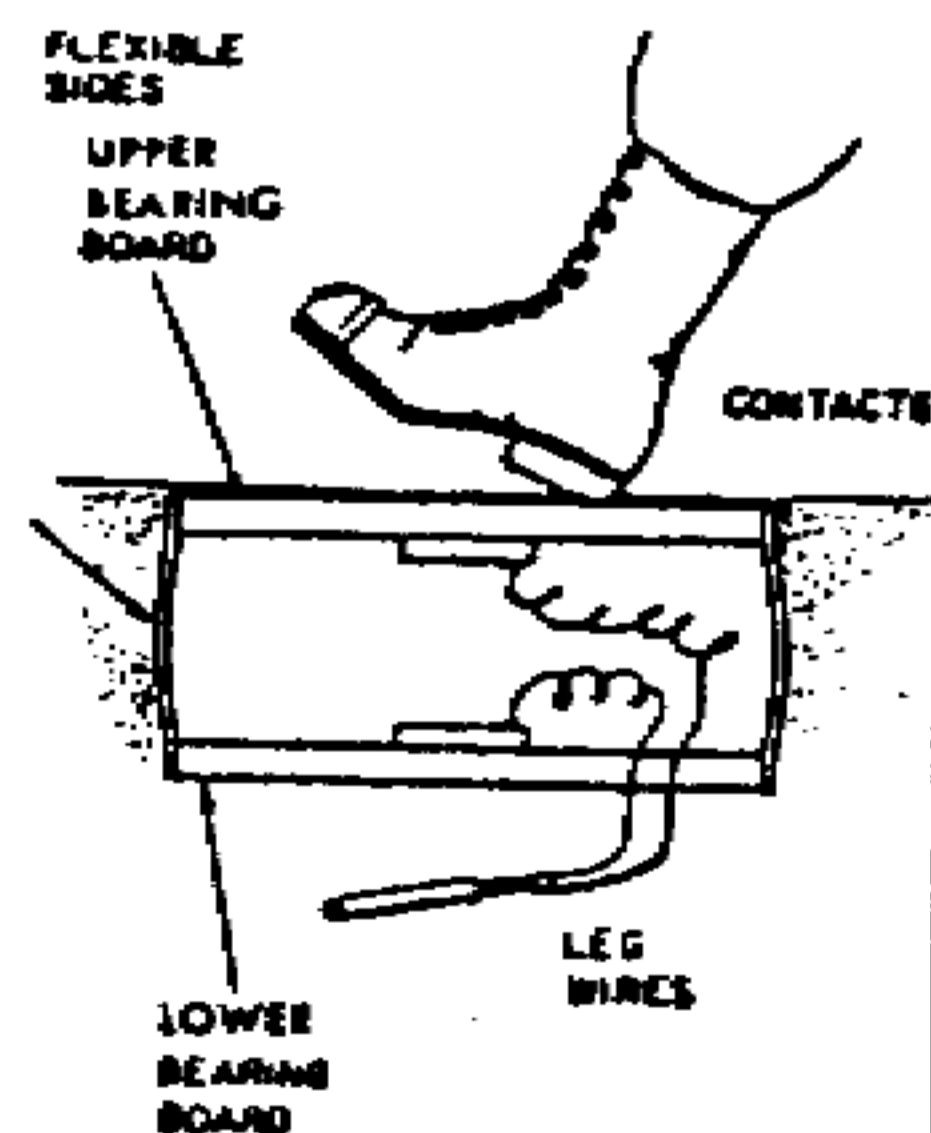
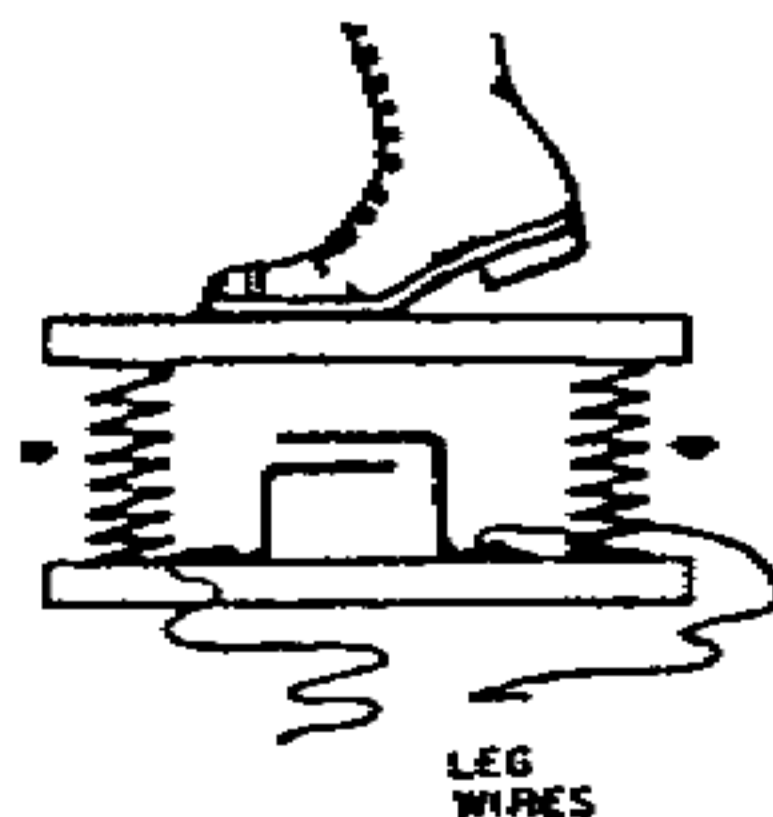
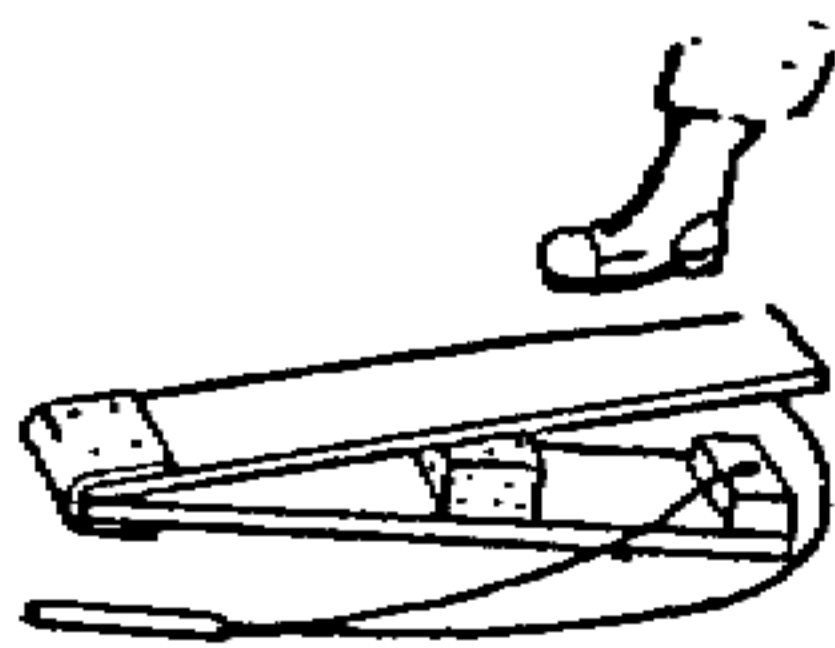

## History, Design, and Manufacture of Explosives

**Pulling:** where the act of moving an object such as an abandoned rifle will pull a trip wire and set off the device.

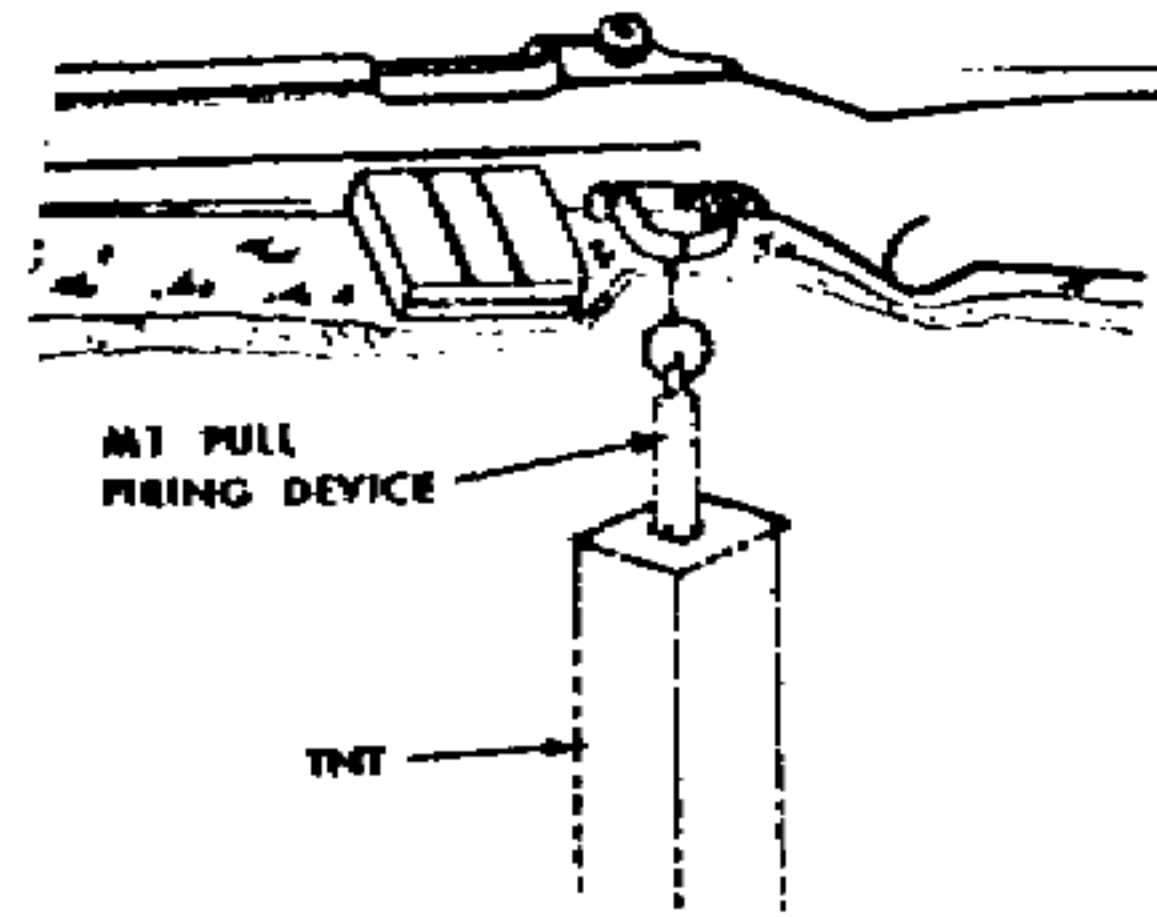

A clothespin can be fitted with electrical contacts. When the pin is pulled off a nonconducting barrier, an electric circuit is completed and detonates the charge.

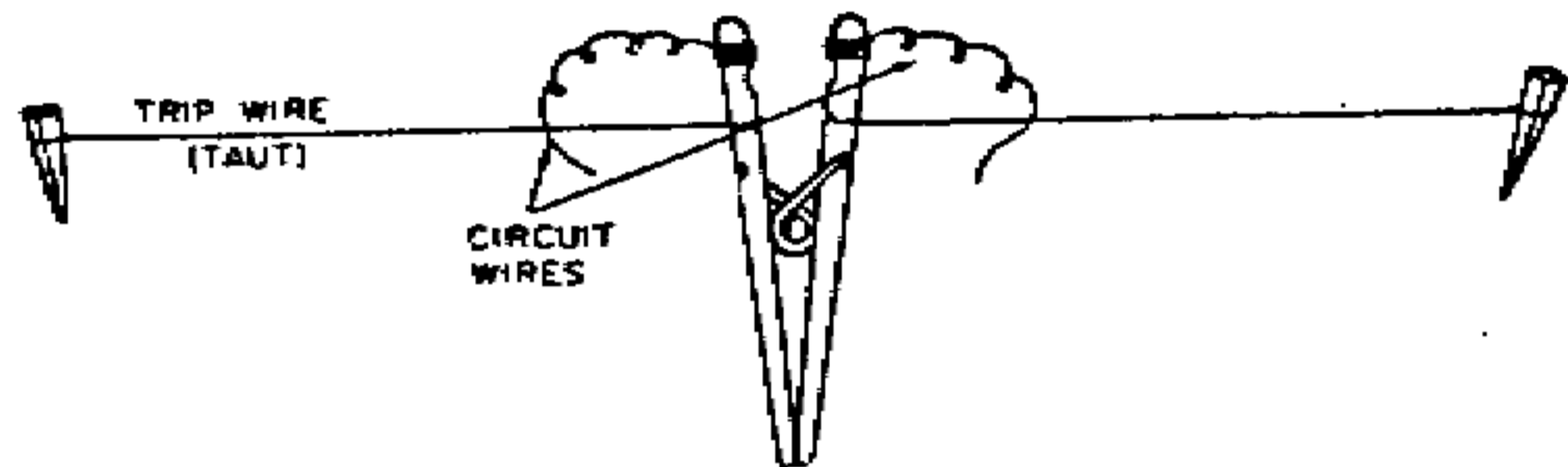

Examples of pulling a door open

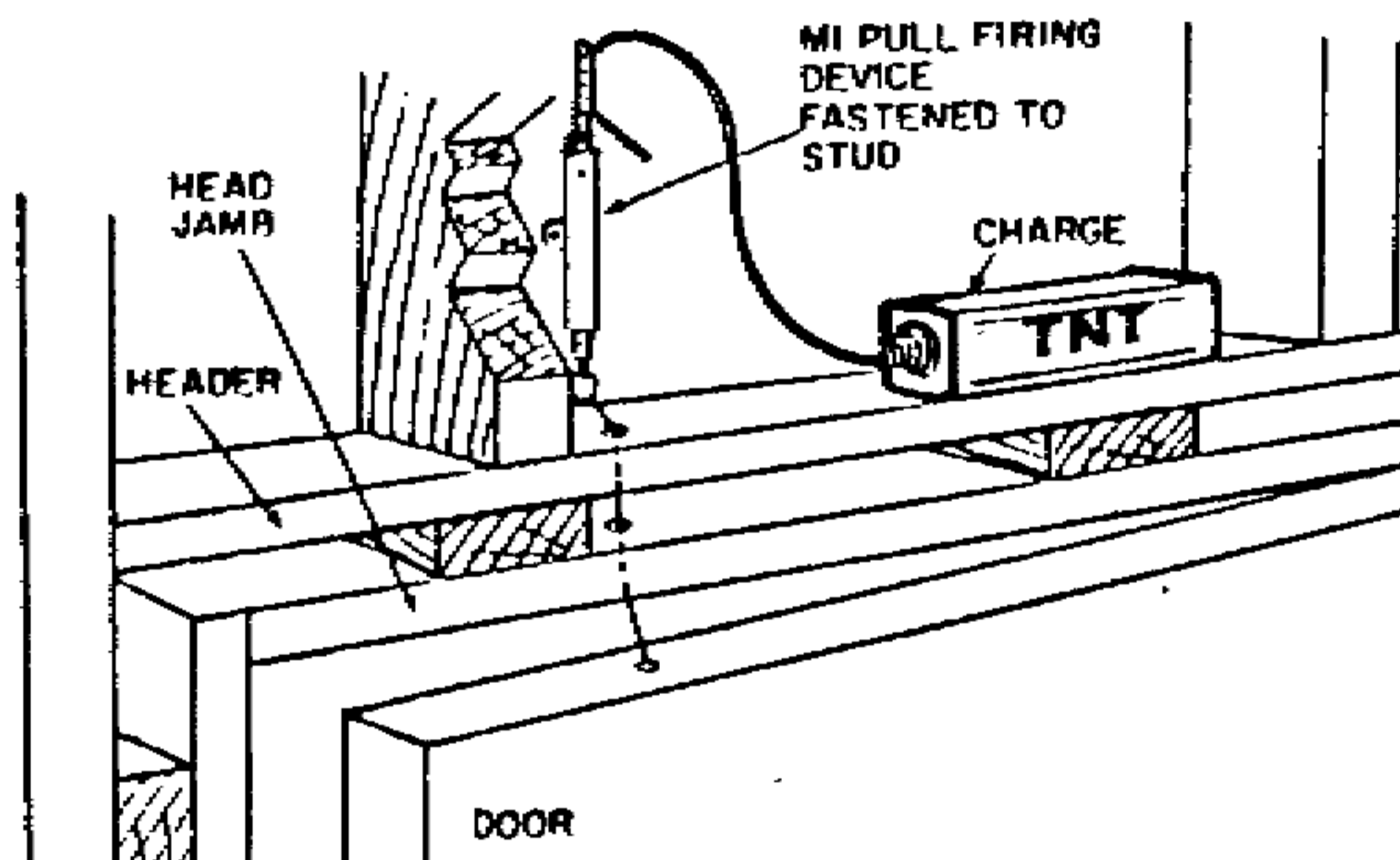

or opening a drawer to initiate explosives is shown.

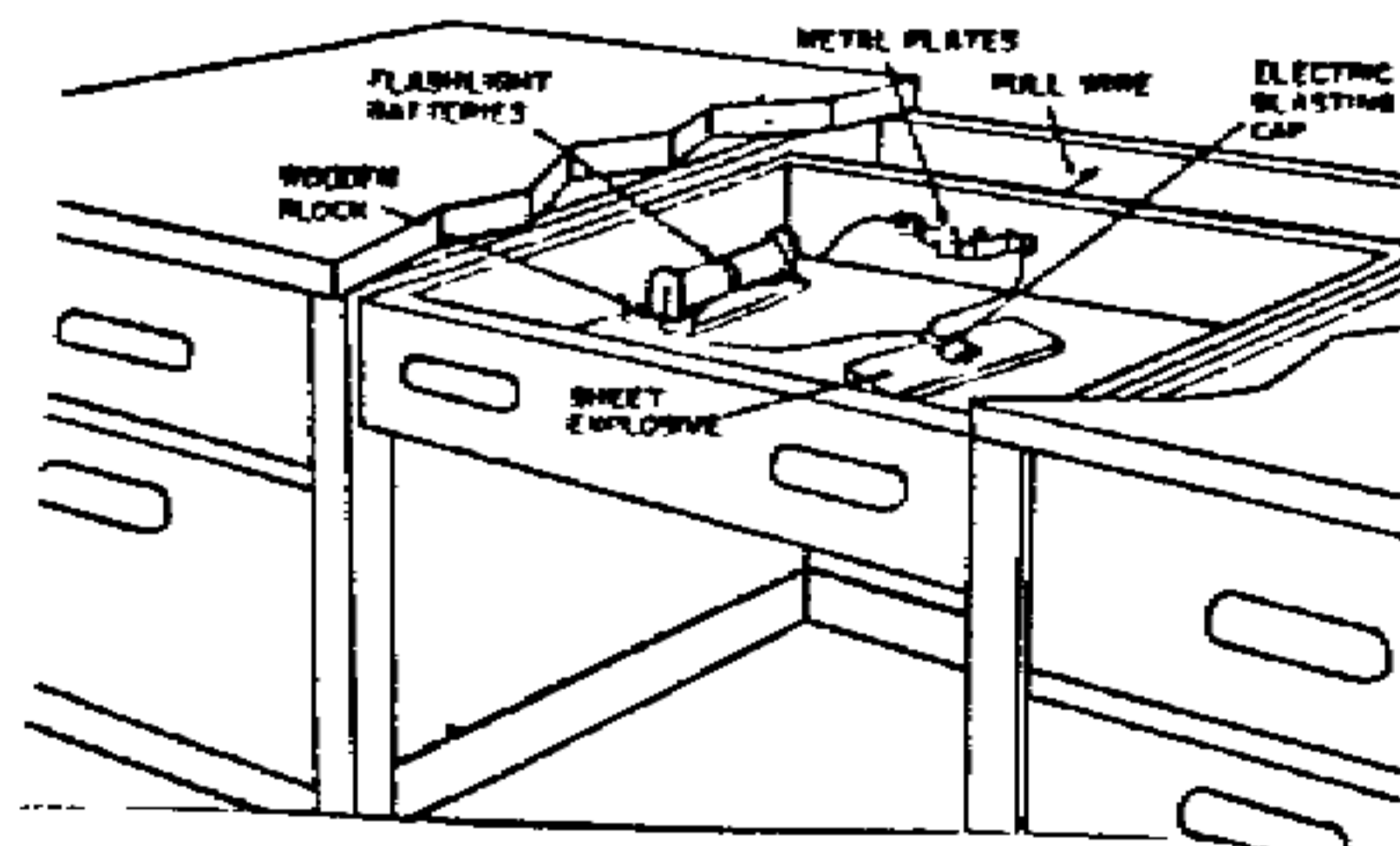

**Pressure release:** is similar to the previous methods, however, an initiator is left in a state of tension. When the lure or object is moved, the firing mechanism is tripped setting off the explosive.

## History, Design, and Manufacture of Explosives

The obvious example is a **grenade with the pin removed** and set to initiate when a rock it is set under is disturbed. These can be placed under debris or obstacles that an enemy must disturb to pass over.

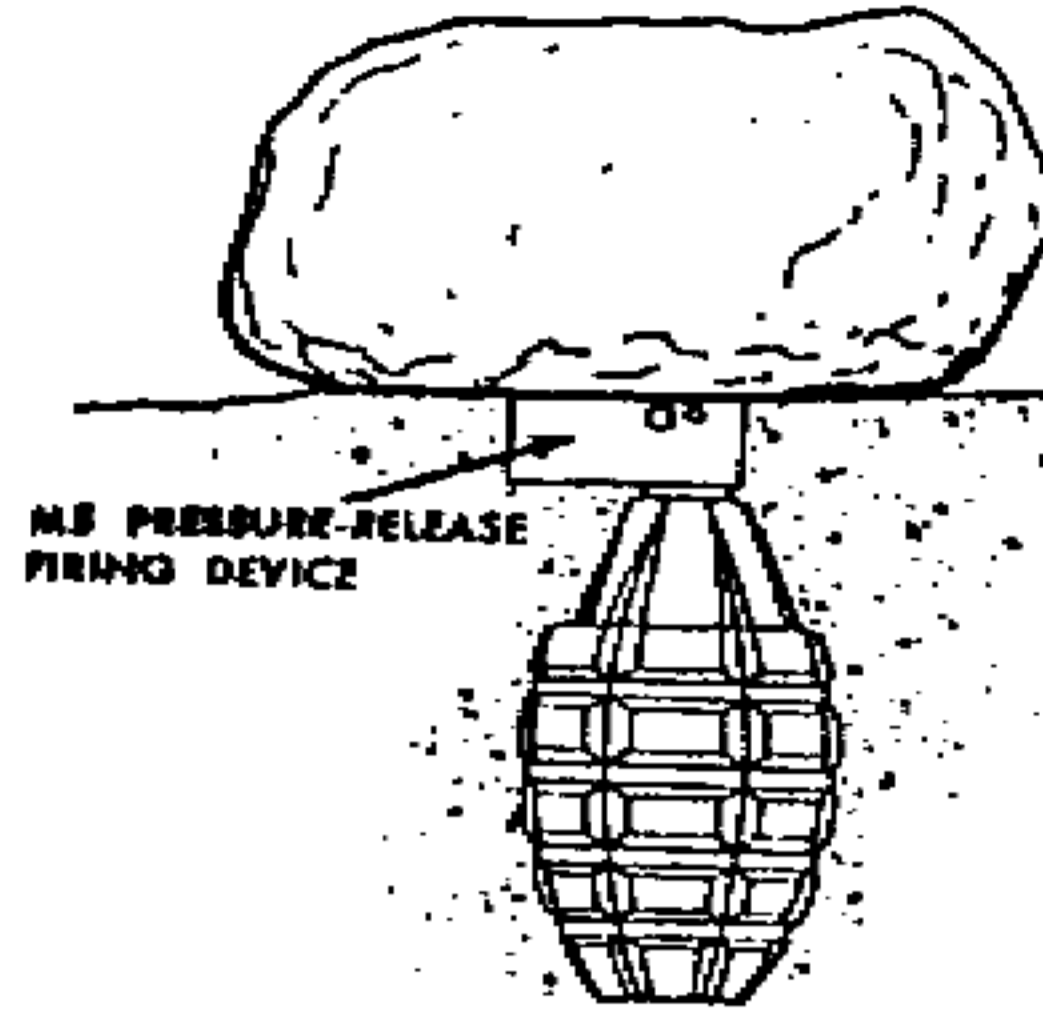

The firing devices can be initiated internally by

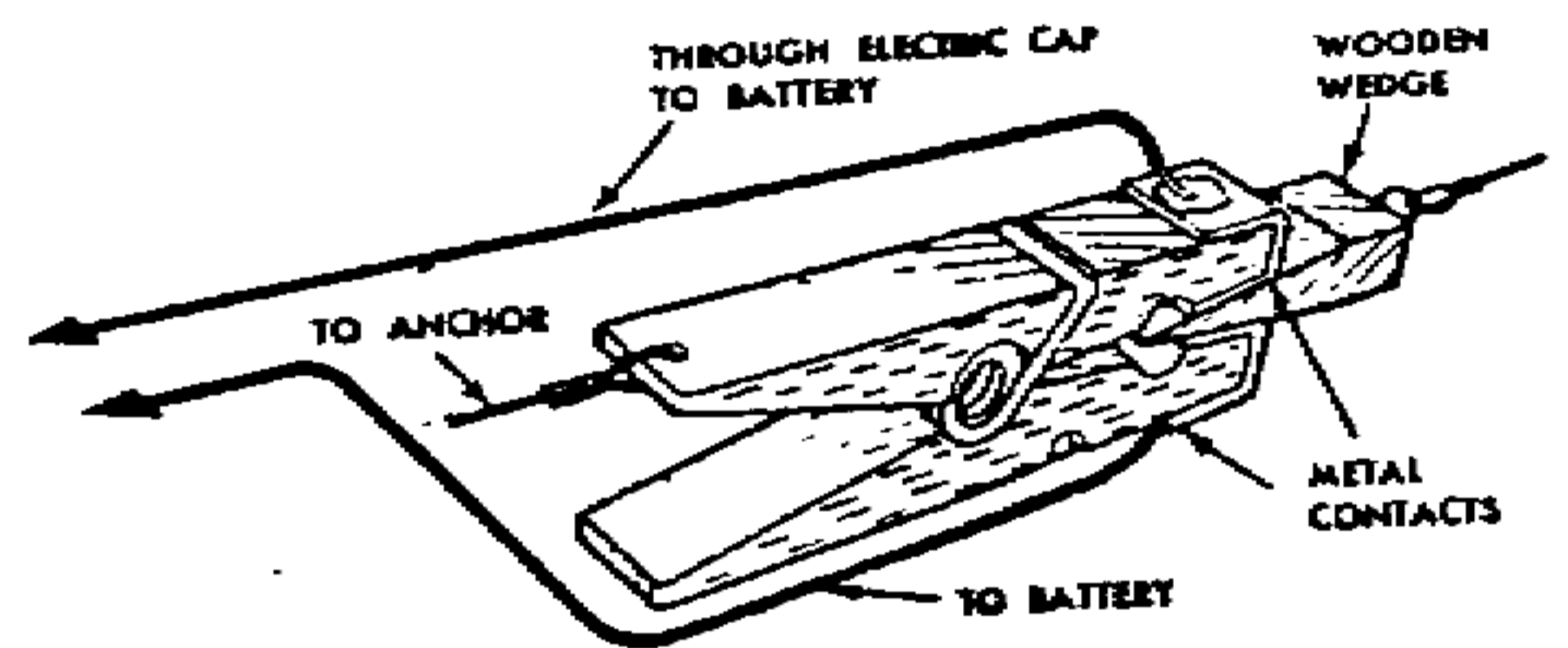

**Mechanical** means where a released striker, driven by a spring, fires a percussion cap.

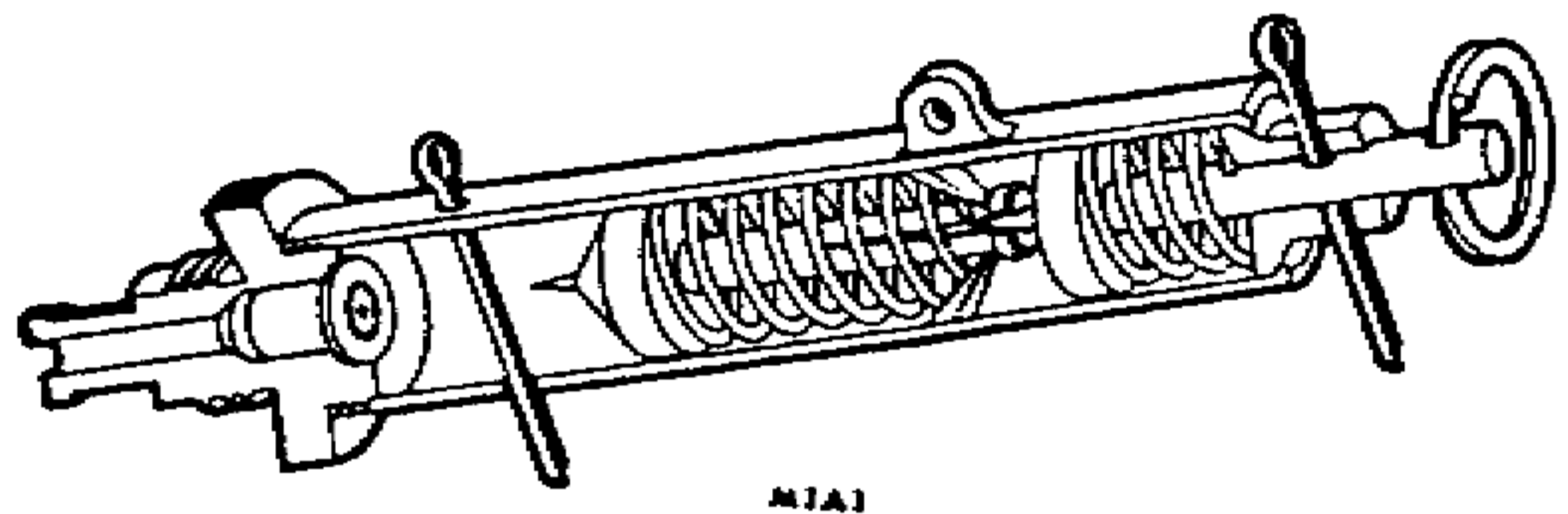

**Pull friction:** where a chemical pellet causes a flash when pulled setting off the charge.

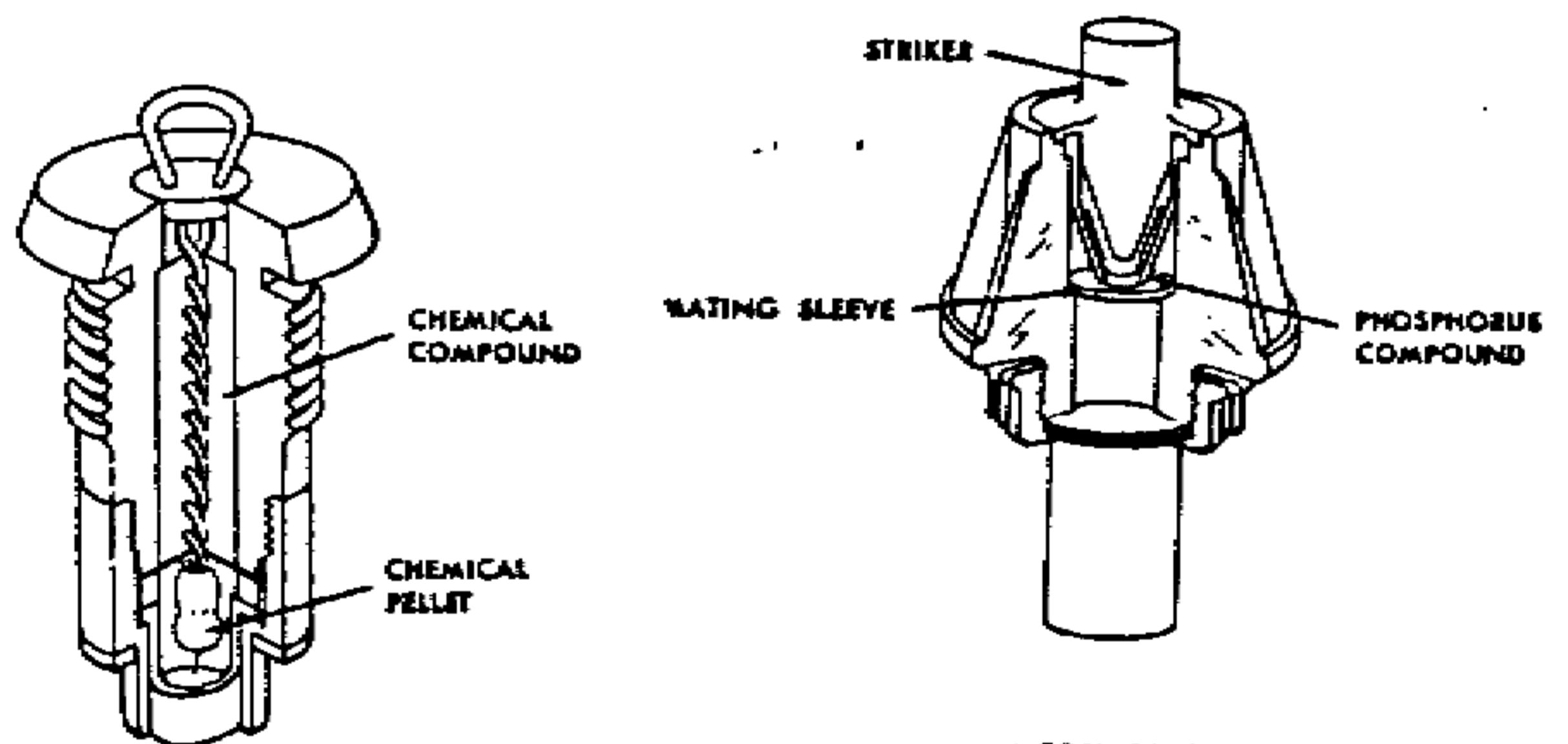

**Pressure friction:** where the pressure forces a cone shaped end into a phosphorus mixture setting off a flash to ignite the device.

## History, Design, and Manufacture of Explosives

Chemicals are used for longer delay devices.

A quick detonation can be produced using sulfuric acid in a glass vial. When the pressure is applied, the acid mixes with the powder and causes a flame that ignites the charge.

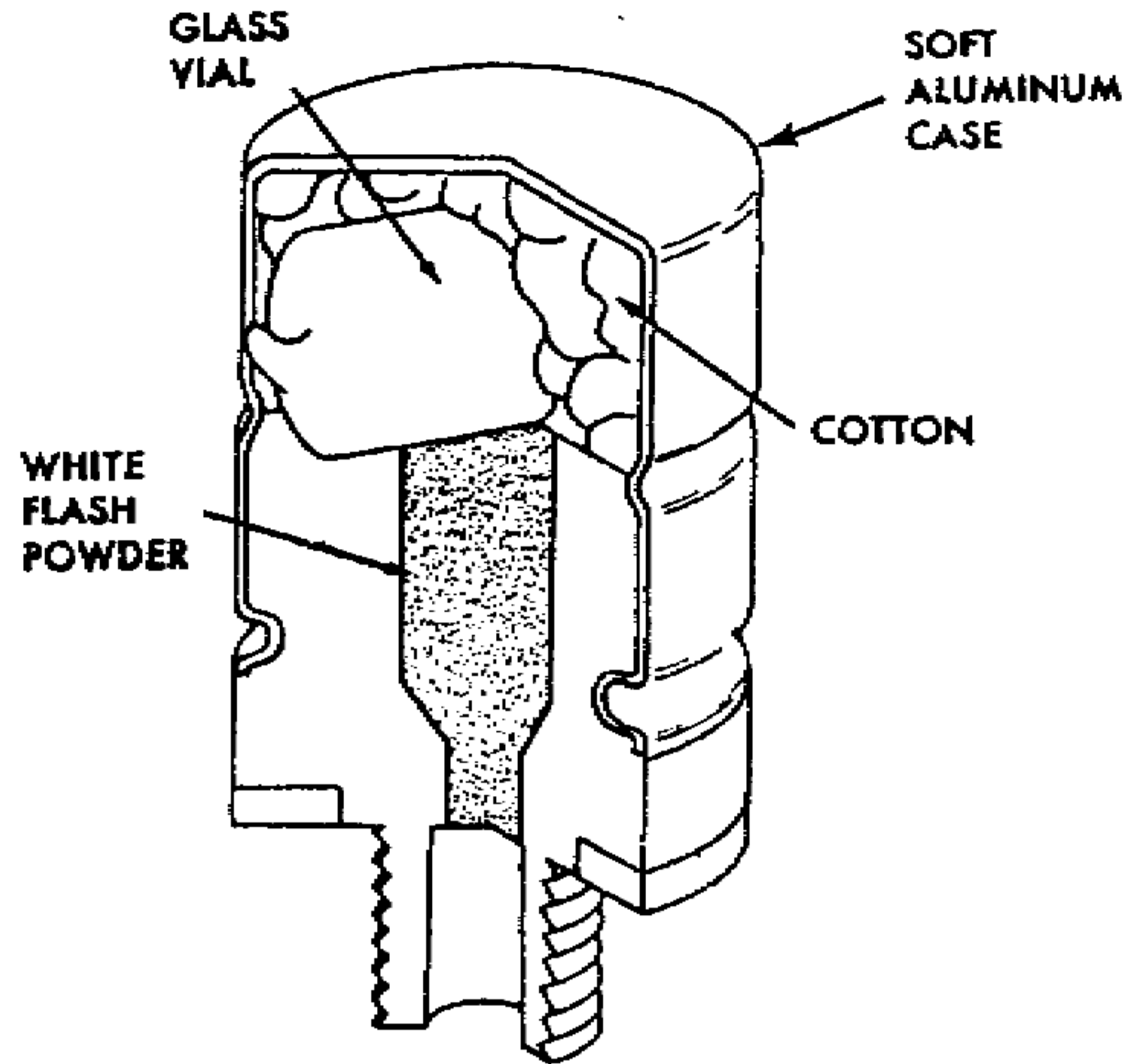

WW II GERMANY  
BUCK CHEMICAL  
FUZE

Acids in a vial can be used to delay explosions by using a retaining wire of fabric (short fuse) or metal (long fuse). When the glass is broken and releases the acid, a wire is corroded or eaten away which releases a spring detonating the trap.

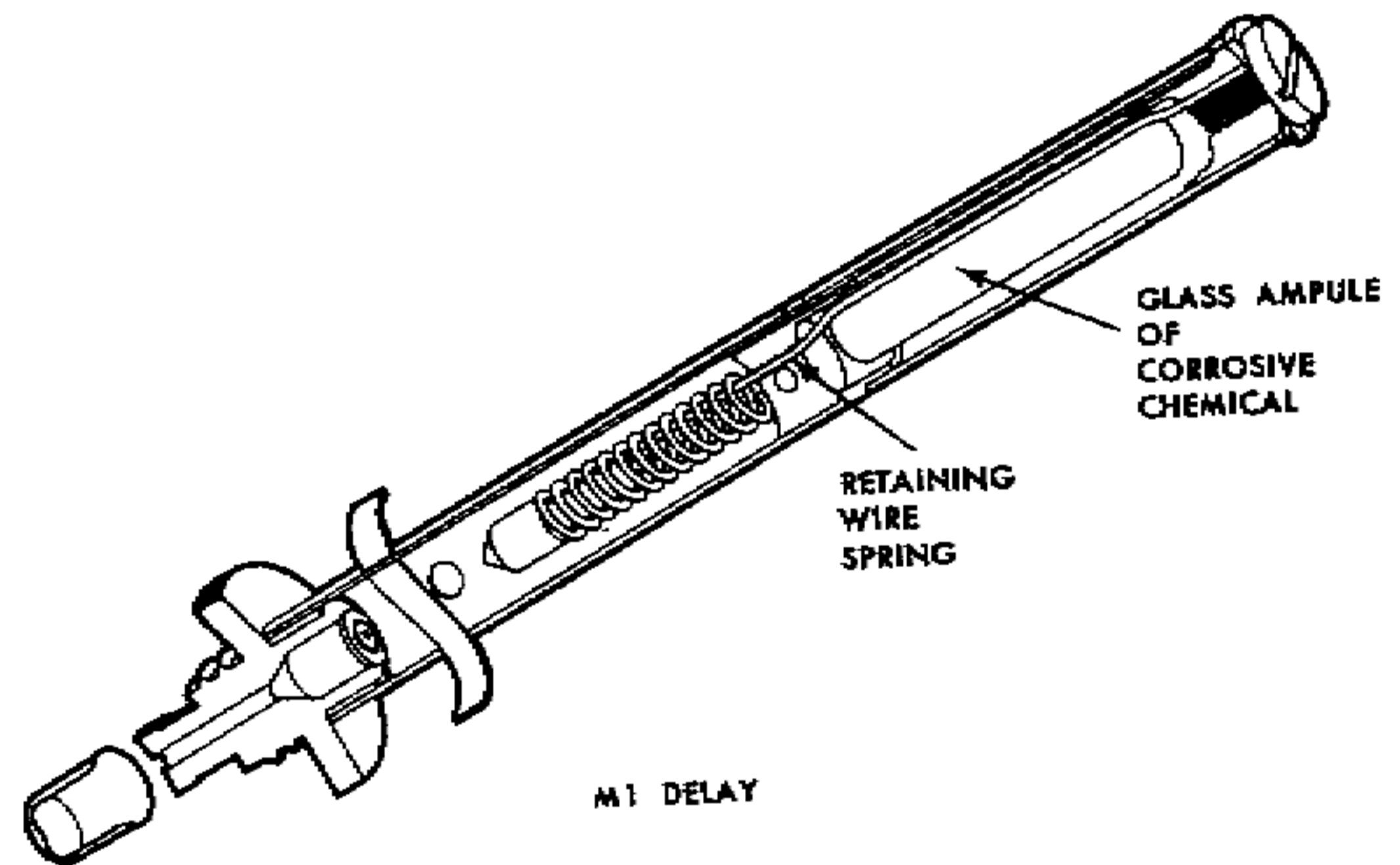

Doors, windows, and walkways are the ideal locations to set traps for specific targets.

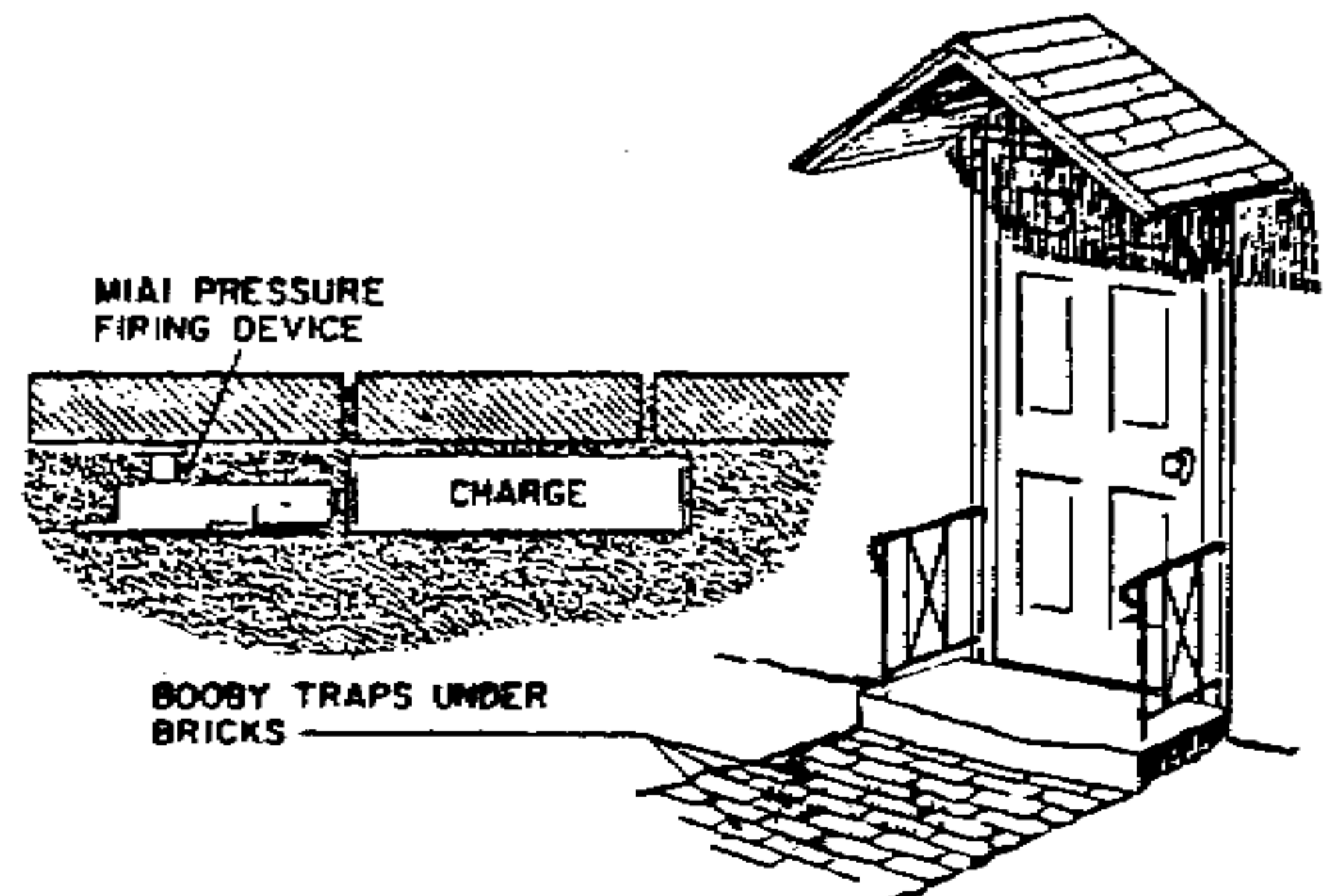

## History, Design, and Manufacture of Explosives

Lures, such as coating the device in chocolate and packaging it as candy has been used in the past. Terror weapons against civilians include trapping toys, beverages, books, and any other household materials that can camouflage the trap.

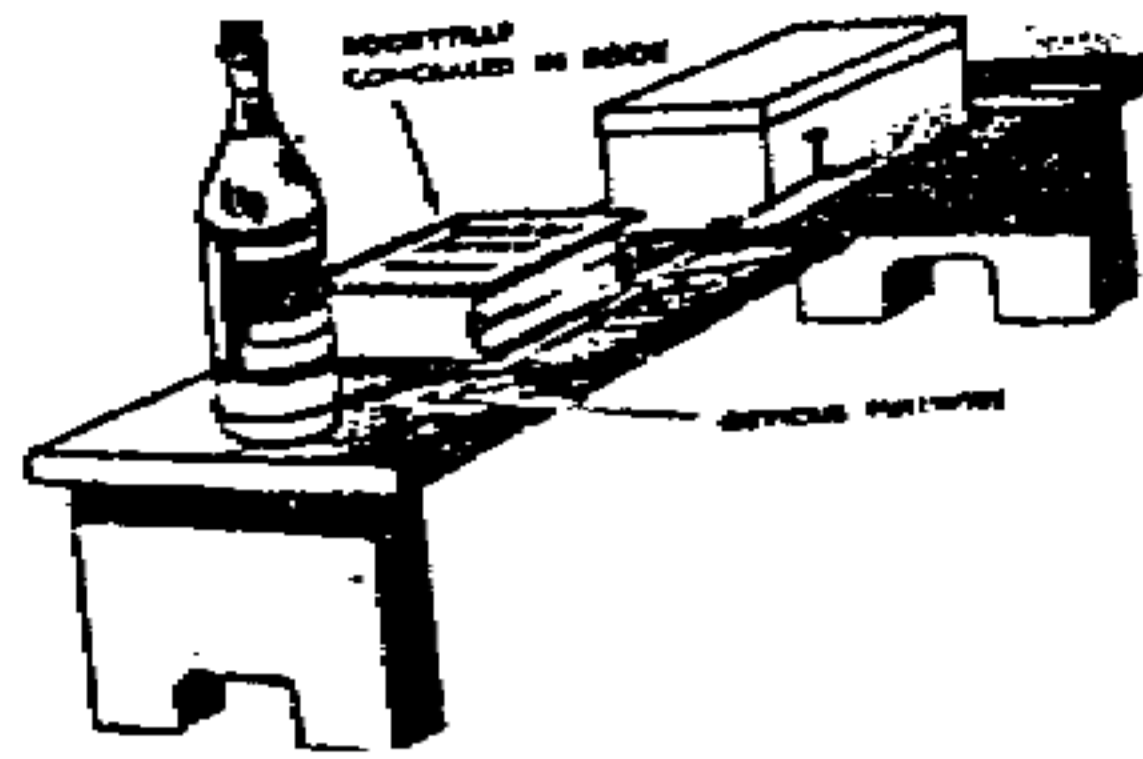

Deliverable explosive weapons include anything that can be delivered by third parties such as postal workers or commercial delivery services. These include letter and package bombs.



The types of bombs use a variety of initiators and configurations. Thin cardboard insulators can be used to keep metal contacts from touching until the letter is opened and the cardboard pulled out with the decoy letter. The contact plate, wires, and explosive are taped into place so they do not pull out with the letter. The battery is a miniaturized type such as a digital watch battery. The detonator can be a drop of fulminate or other sensitive formula. The explosive can be a thin casted or molded sheet of plastic explosive. Larger packages can hold more sophisticated and powerful devices.

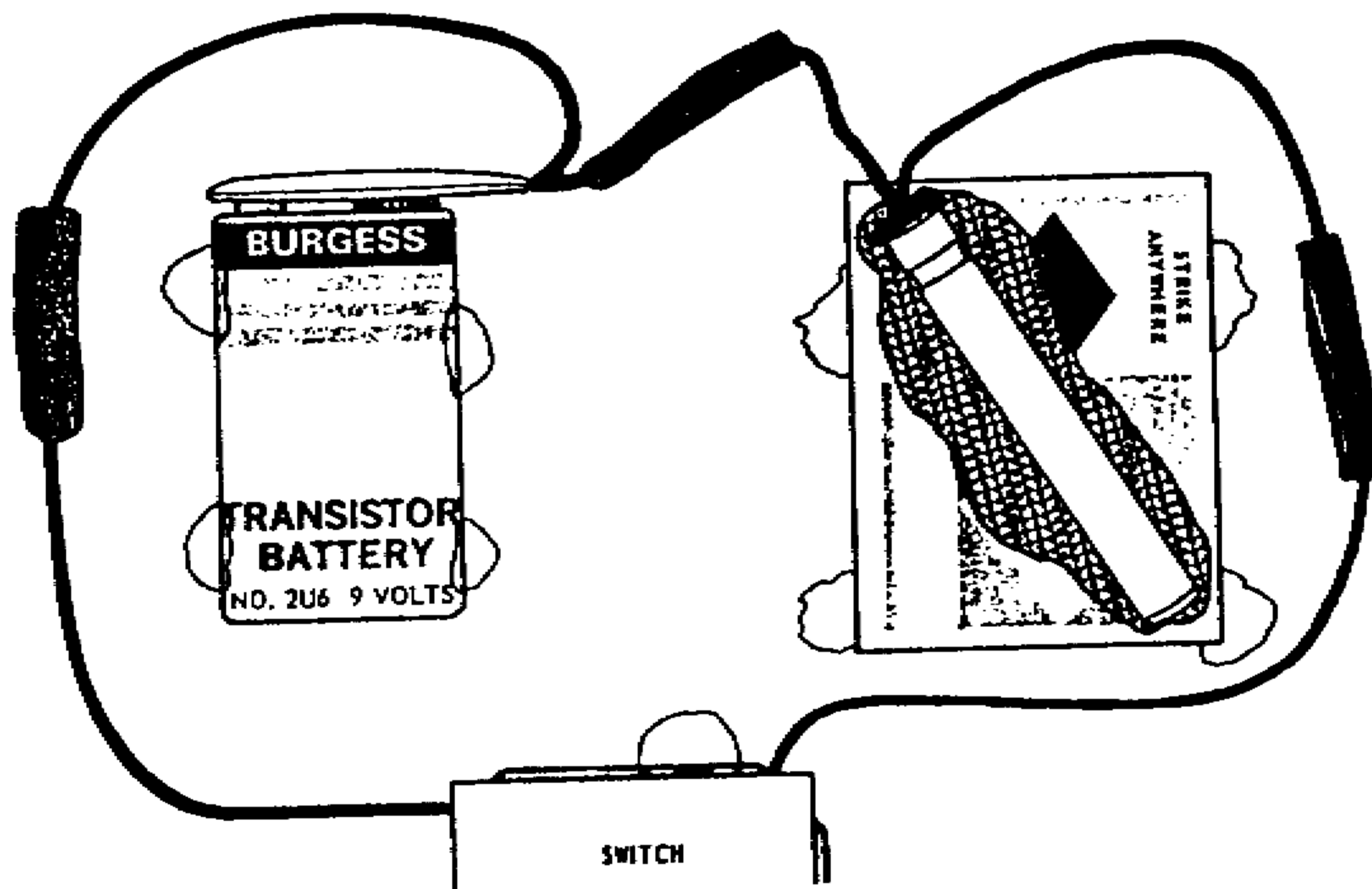



## History, Design, and Manufacture of Explosives

Large package bombs can be constructed using larger explosives and improvised timers as shown.

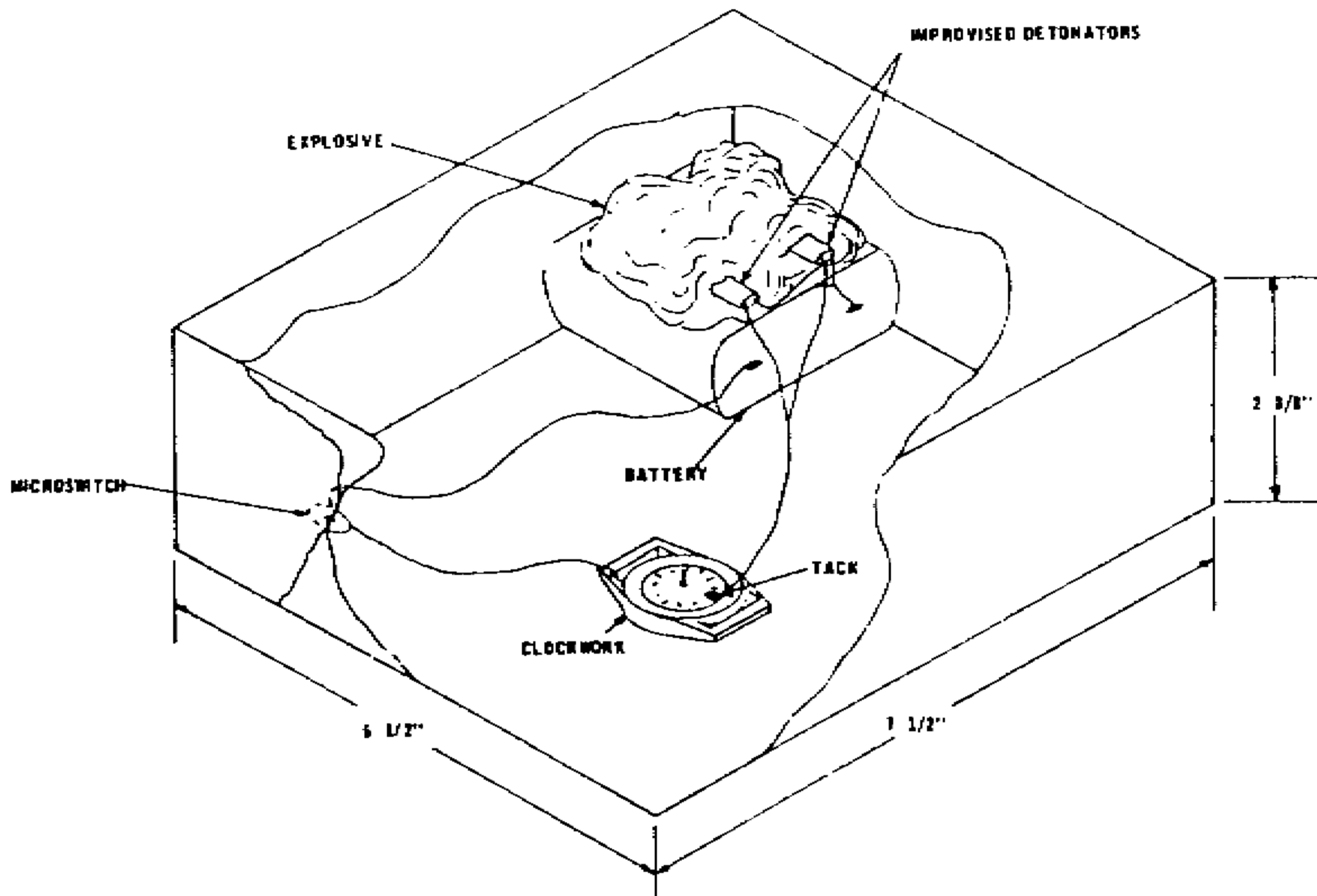

Flashbulbs can be used directly to detonate explosives or incendiaries.

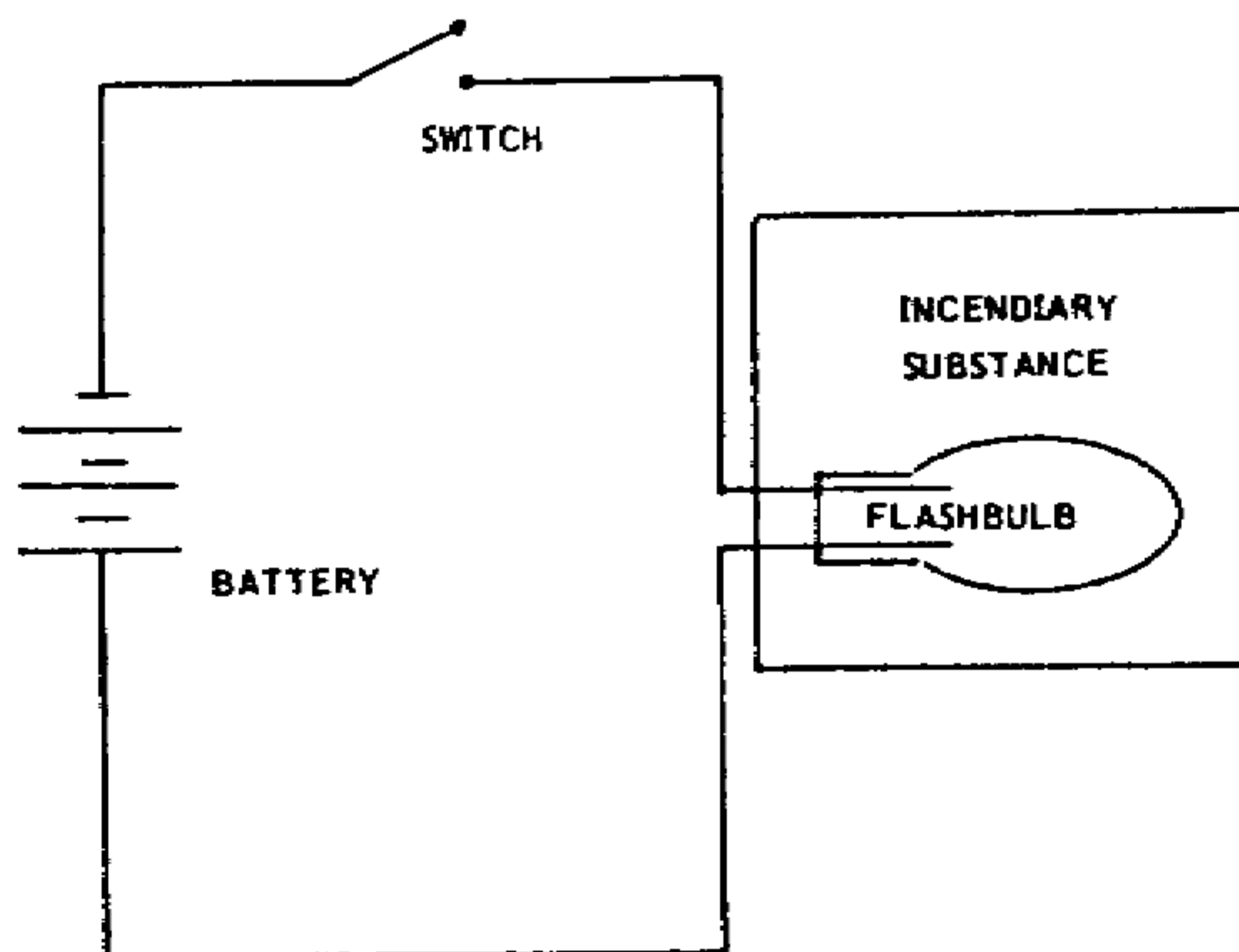

## History, Design, and Manufacture of Explosives

Since flashbulbs are a small explosive in their own right, they are ideal for initiating other explosives.

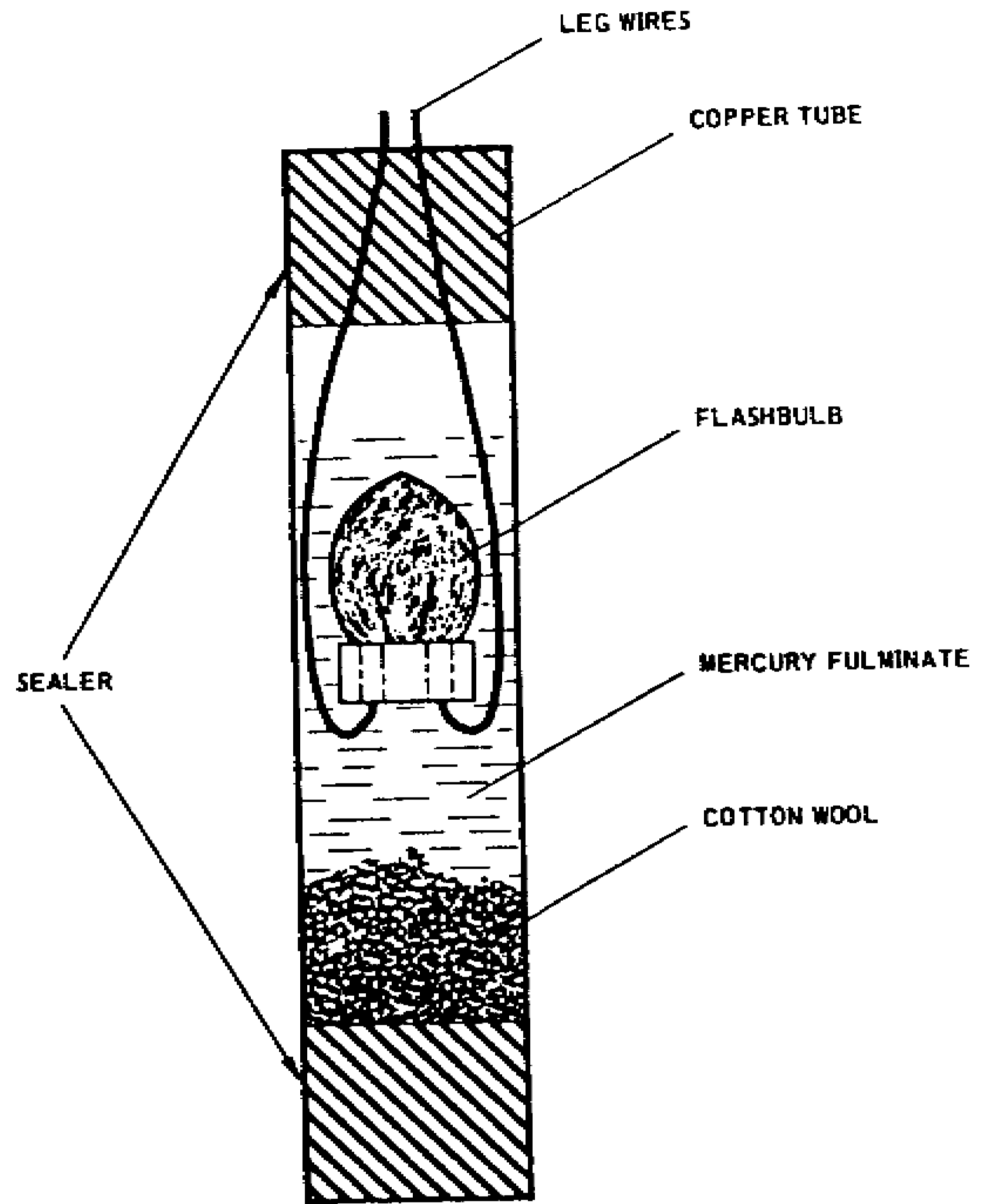

Electric bulbs can also be used to initiate explosives by breaking the glass of a small bulb, inserting it into a tube, and filling the tube with ignitable mixtures. When the bulb is turned on by a completed electrical circuit, it detonates the charge.

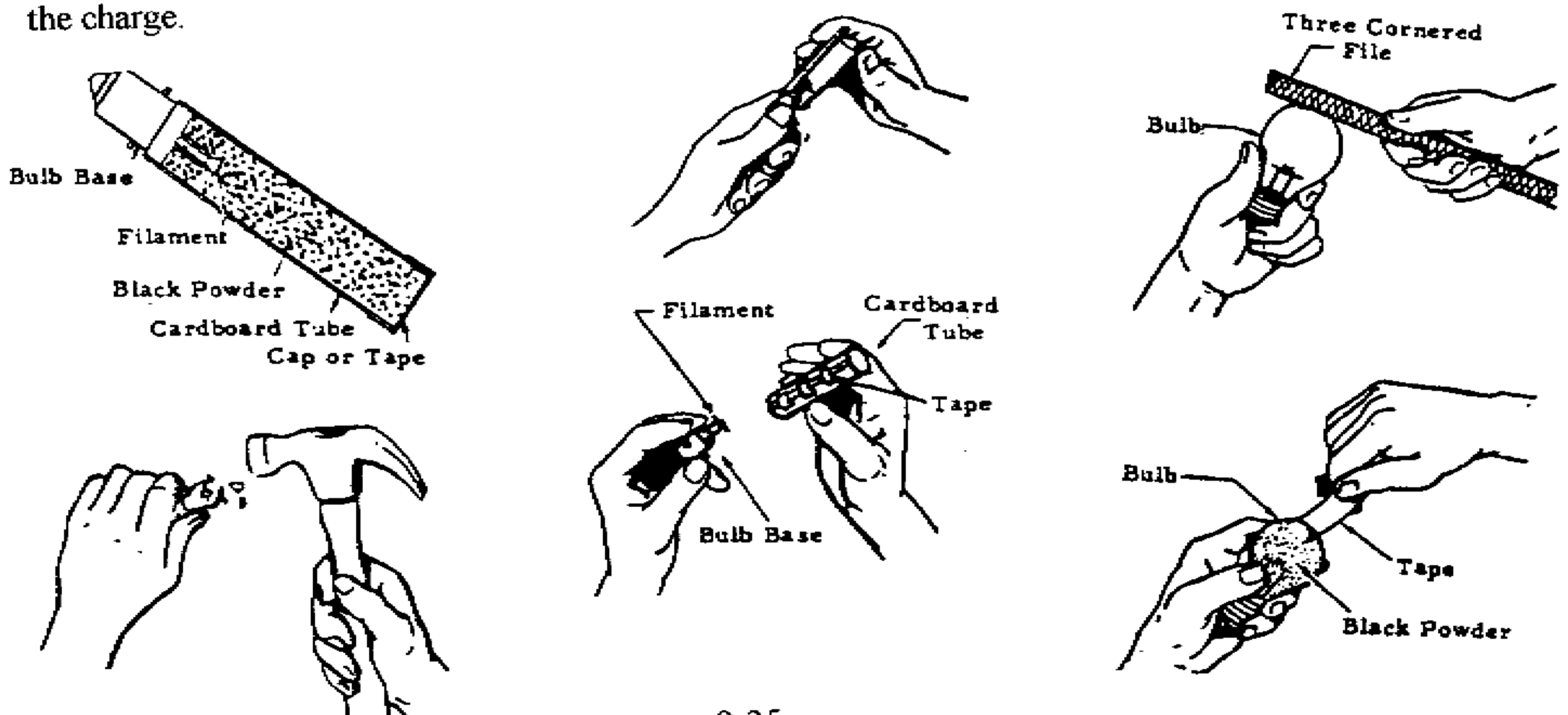

## History, Design, and Manufacture of Explosives

### Fuse Cords are essential in creating delay before initiation

These fuse cords are used for igniting propellants and incendiaries or, with a non-electric blasting cap, to detonate explosives.

### FAST BURNING FUSE

The burning rate of this fuse is app. 40" per minute

#### Material Required

Soft cotton string		(Potassium Nitrate	25 parts
Fine Black Powder	or	(Charcoal	3 parts
Piece of round stick		(Sulfur	
Two pans or dishes			

#### Procedure

1. Moisten fine black powder to form a paste or prepare a substitute as follows:

- Dissolve Potassium Nitrate in an equal amount of water.
- Pulverize charcoal by spreading thinly on a hard surface and rolling the round stick over it to crush to a fine powder.
- Pulverize sulfur in the same manner.
- Dry mix Sulfur and Charcoal
- Add Potassium Nitrate solution to the dry mix to obtain a thoroughly wet paste

2. Twist or braid three strands of cotton string together.

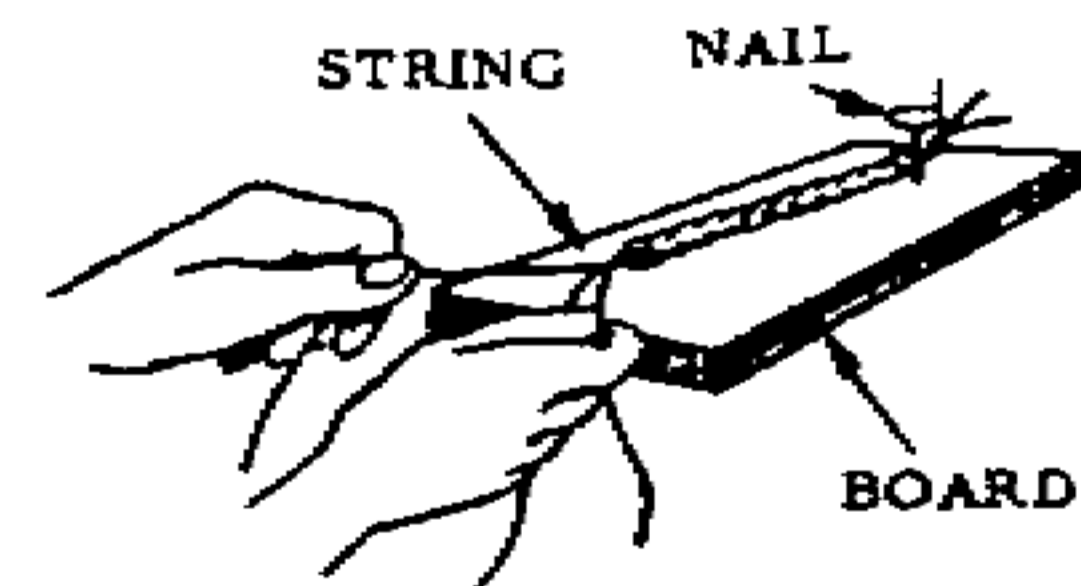

3. Rub paste mixture into twisted string with fingers and allow to dry.

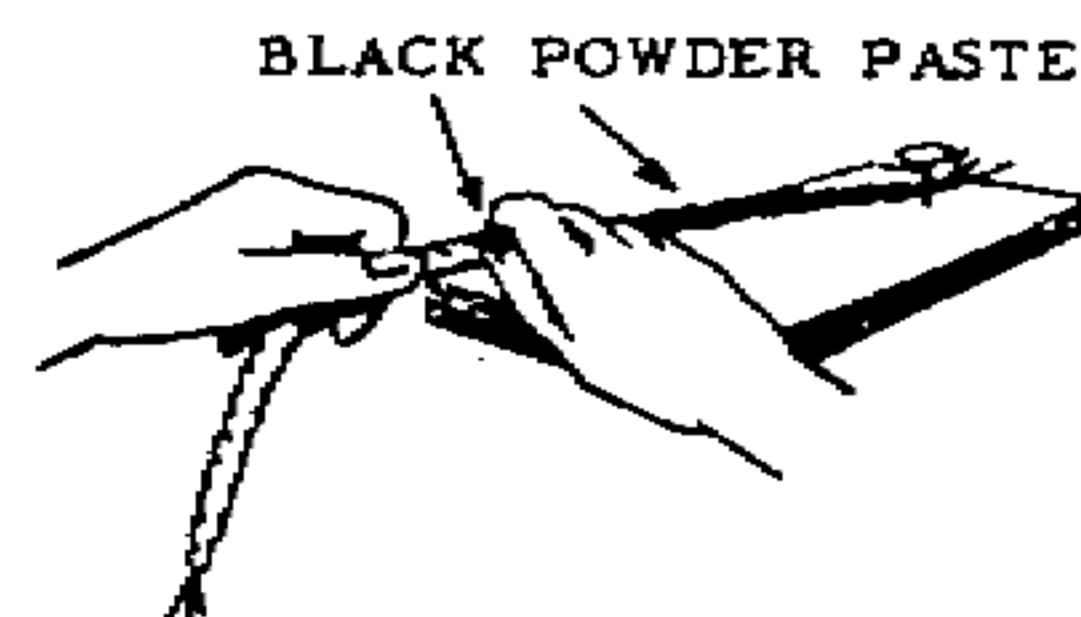

## History, Design, and Manufacture of Explosives

4. Check actual burning rate of fuse by measuring the time it takes for a known length to burn. This is used to determine the length needed for a desired delay time. If 5" burns for 6 seconds, 50 inches of fuse cord will be needed to obtain a one minute (60 second) delay time.

### SLOW BURNING FUSE

The burning rate of this fuse is app. 2" per minute

#### Material Required

Cotton string or 3 shoelaces  
Potassium Nitrate or Potassium Chlorate  
Granulated Sugar

#### Procedure

1. Wash cotton string or shoelaces in hot soapy water; rinse in fresh water.
2. Dissolve 1 part Potassium Nitrate or Potassium Chlorate and 1 part granulated sugar in 2 parts of hot water.
3. Soak string or shoelaces in solution.
4. Twist or braid three strands of string together and allow to dry.
5. Check actual burning rate of the fuse by measuring the time it takes for a known length to burn. This is used to determine the length needed for the desired delay time. If 2" burns for 1 minute, 10" will be needed to obtain a 5 minute delay.

**NOTE:** The last few inches of this cord (the end inserted in the material to be ignited) should be coated with the fast burning black powder paste if possible. This **MUST BE DONE** when the fuse is used to ignite a blasting cap.

**REMEMBER:** The burning rate of either of these fuses can vary greatly. **DO NOT USE** for ignition until you have checked their burning rate.

## History, Design, and Manufacture of Explosives

Other delay devices include using

A burning cigarette to provide fire to a fuse cord. The delay being equal to the time it takes a cigarette to burn down. 1" for 7-8 minutes in still air is normal.

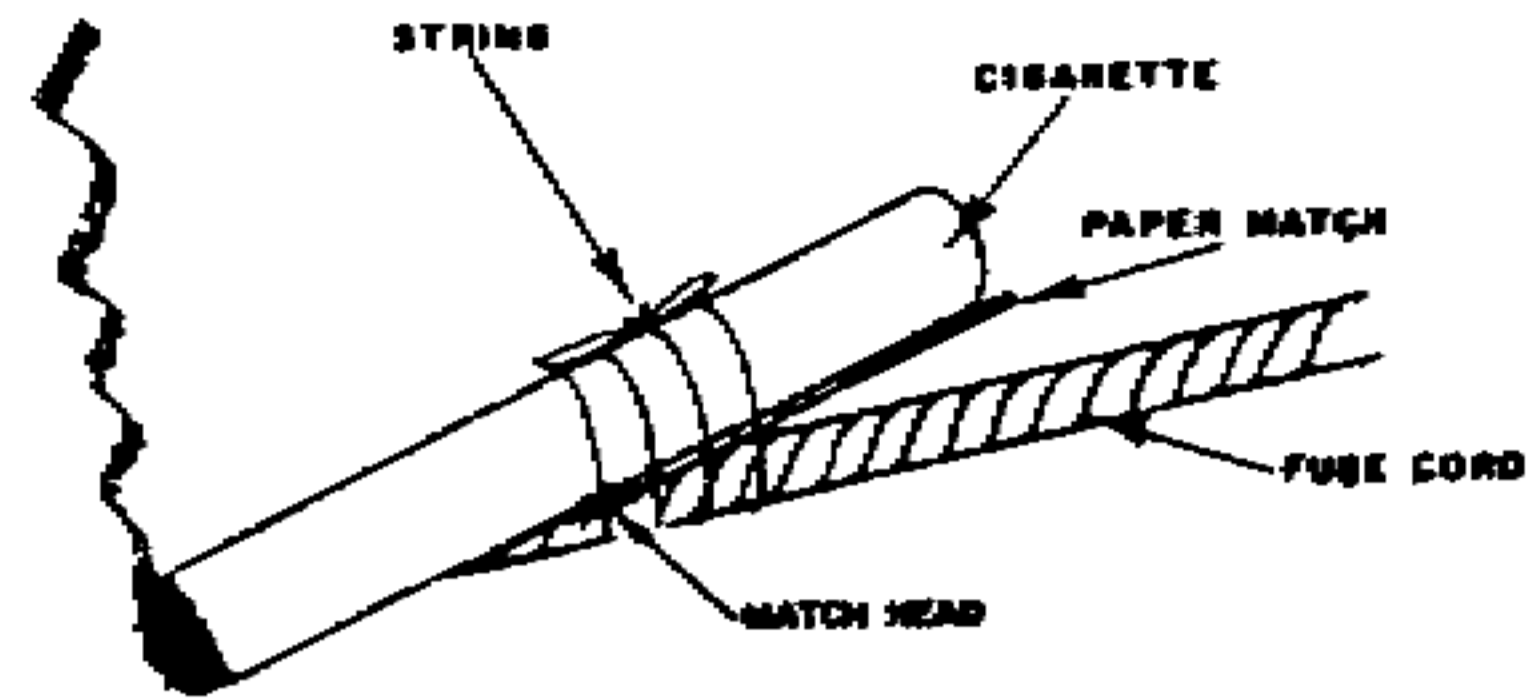

CUT SO INNER CORE IS EXPOSED



Using the expansion of dry seeds. The seeds expand when soaked in water and force a metal plate up to complete a circuit. This can be several hours.

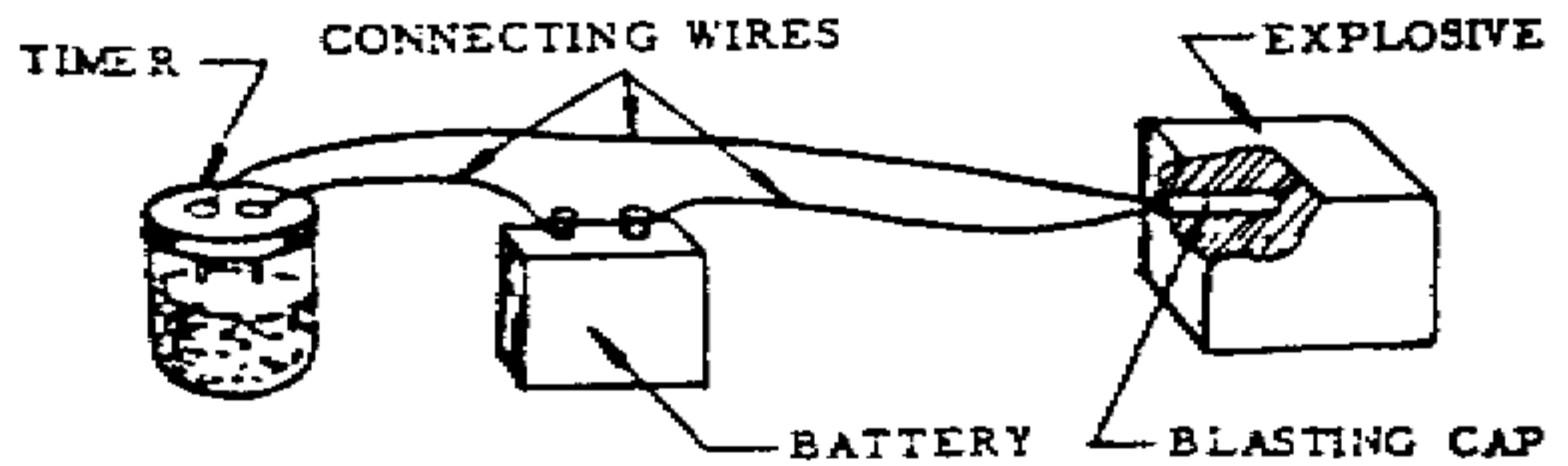
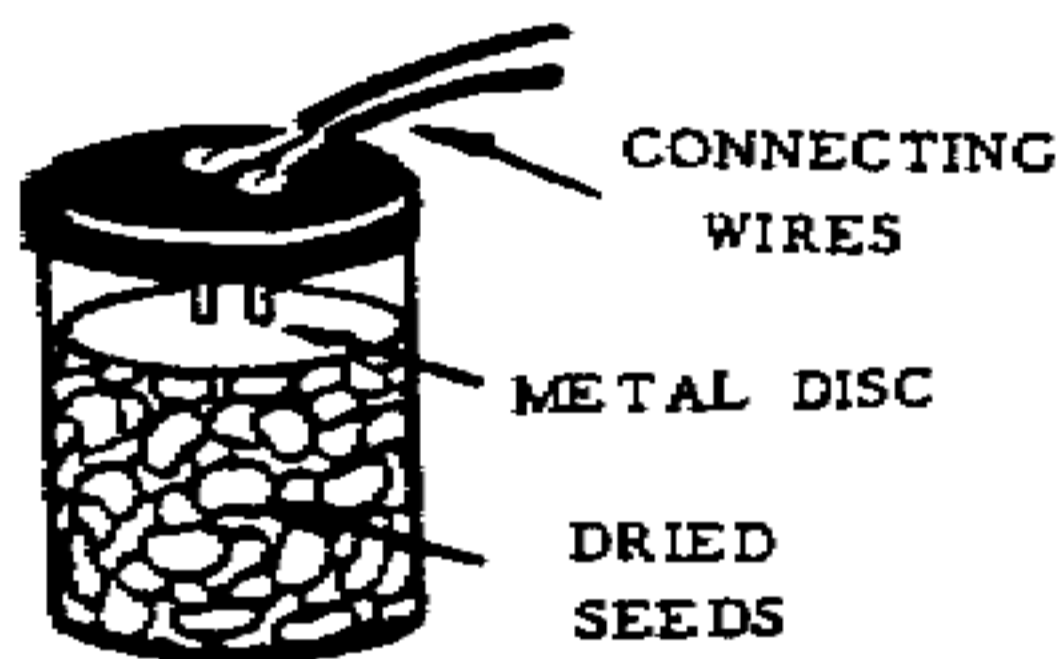

Liquids can be used to complete circuits for delay explosives.

Water can be placed in a container and drained slowly by a pin hole. The size of the container, drain rate of the hole, and amount of water determine the delay. When the water nears the bottom, a float holding an extension wire completes a circuit at the top of the container.

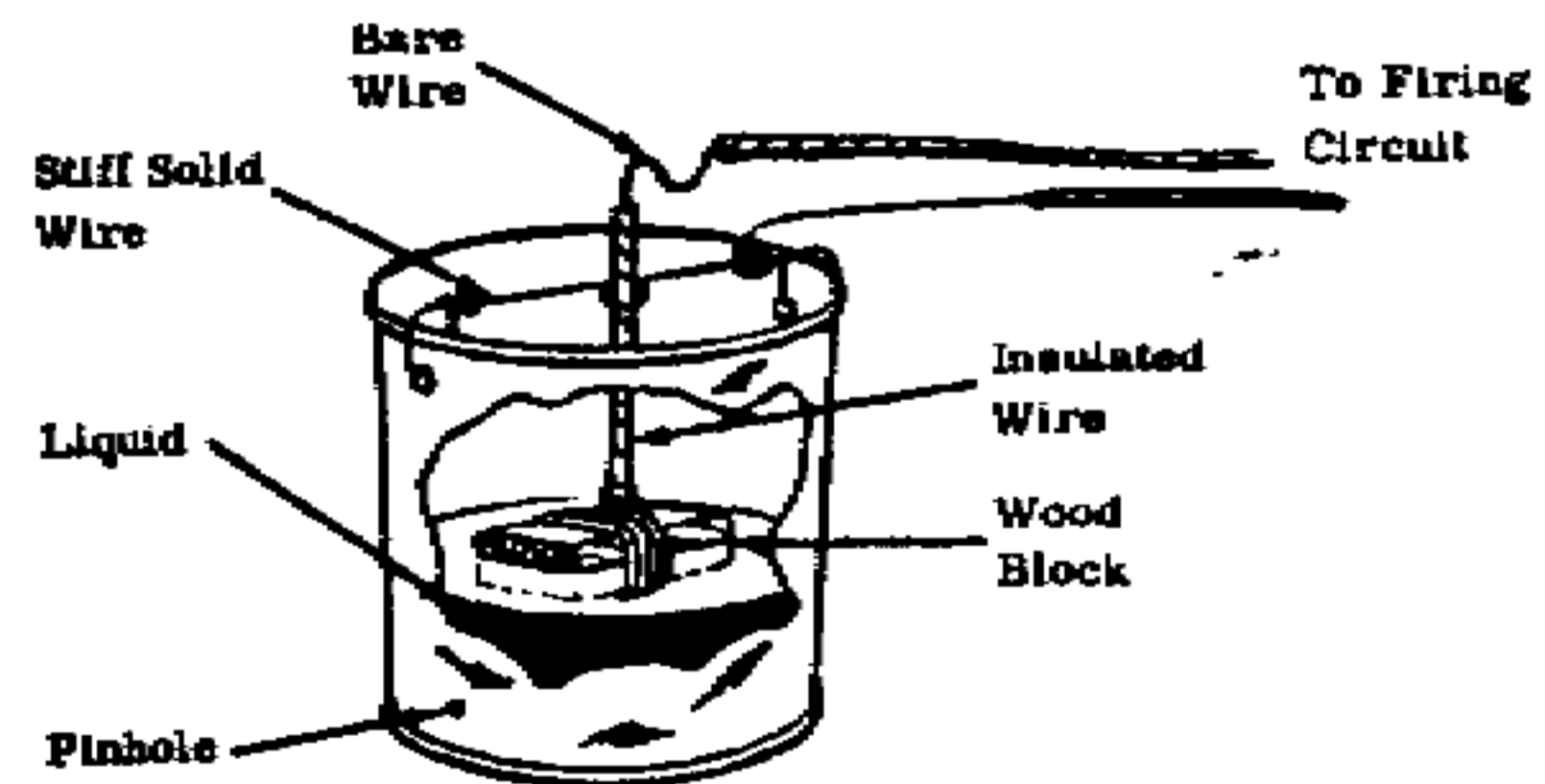

A volatile liquid such as gasoline can also be used with its vapors adding to the detonation.

## History, Design, and Manufacture of Explosives

Large explosive packages have often been used in tunnels dug enemy fortifications. They have been delivered by vehicles in the form of truck and car bombs that can be filled to the carrying capacity of the vehicle. In war they are used against infrastructure targets such as key bridges, tunnels, utilities, and political centers. In acts of terrorism, small packages have been used on commercial aircraft, and against public assemblies, and against buildings such as the world trade center and the federal building in Oklahoma City.

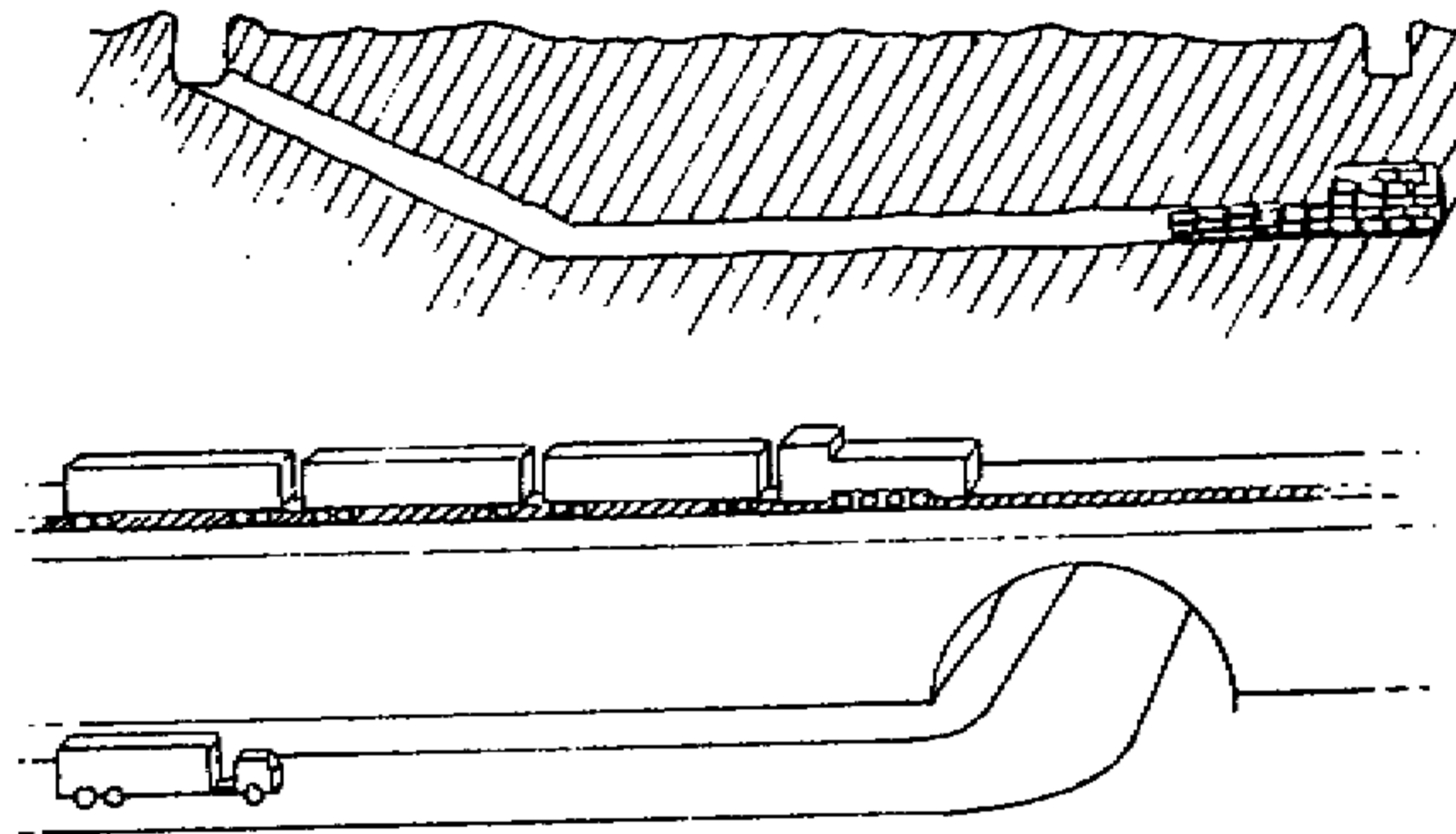

In war, large explosives have been prepositioned to detonate in the midst of the enemy passing by and to hurl large amounts of debris or fragments into approaching soldiers by filling sloping pits with explosives and covering it with the fragment material.

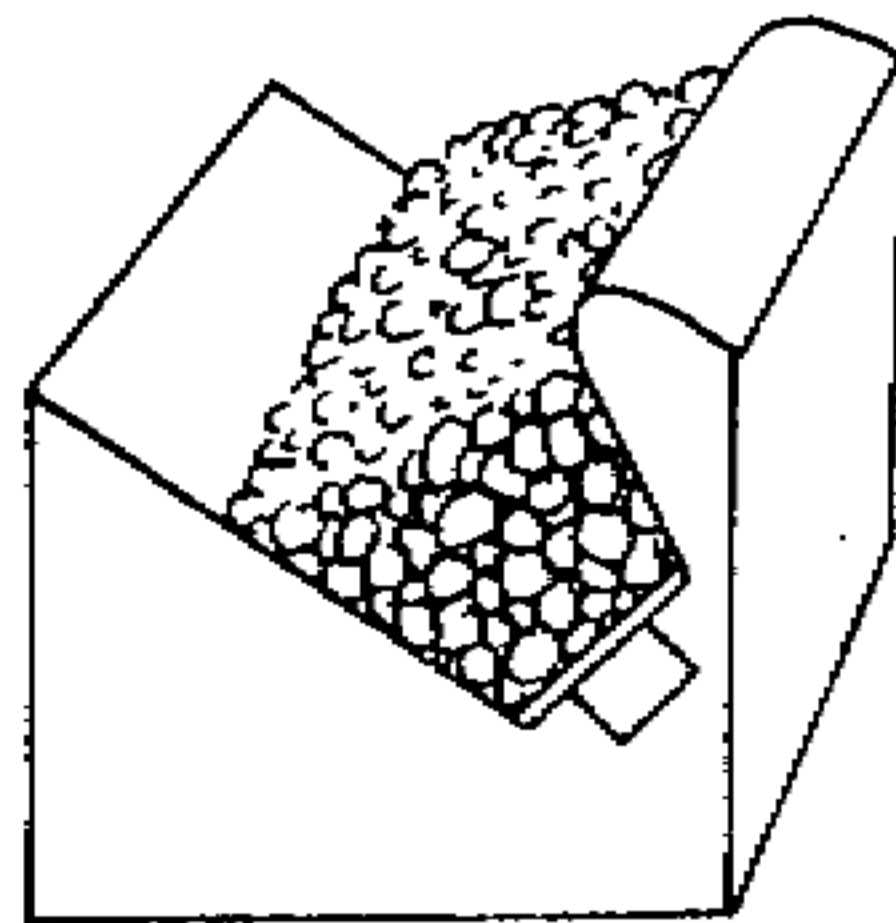

# History, Design, and Manufacture of Explosives

## 7) Air Dropped Bombs

Aerial bombs are simply large explosive or other packages inside a metal casing and dropped from an aircraft.

Parts of an aerial bomb include

1. Casing: which houses the explosive and provides confinement to aid in detonation. Modern designs include streamlining to smooth descent and improve aim, and placing hundreds of "cluster" bomblets inside the casings for use against groups of targets.
2. Suspending lug used to hold the bomb onto the plane until it is ready to be dropped.
3. Anti-ricochet collar designed to keep the bomb from bouncing off in a glancing blow. The collar digs into the target.
4. Tail fins usually designed to create drag at the tail so the bomb descends point first. It often contains a fan that turns from the airflow and arms the bomb.
5. Side pockets for special fuses.
6. Equipment for the nose fuse. This may include special armor and bunker penetrating metals that can go through walls before igniting the explosive.

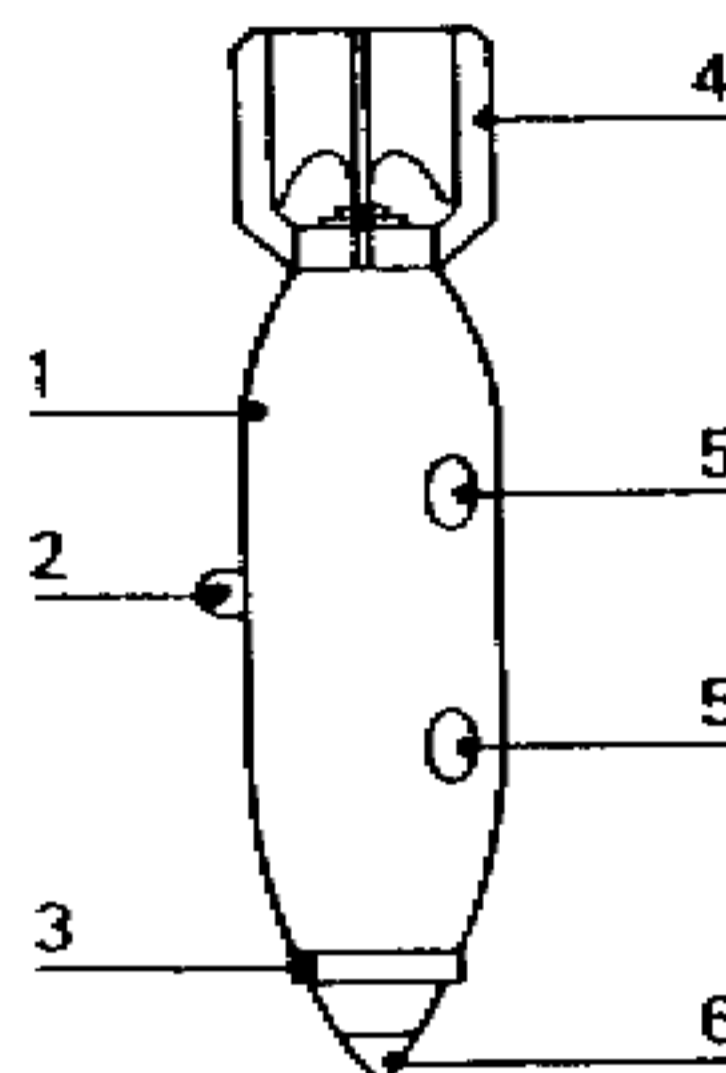

Bomb designs include packages for

<u>Explosives</u>	<u>Chemical</u>	<u>Pyrotechnic</u>	<u>Biological</u>	<u>Nuclear</u>
All purpose	Gas	Photoflash	Biotoxins	Fissionable
Fragmentation	Smoke	Target ID	Pathogens	Fusion
Demolition	Incendiary		Vectors	
Anti-armor				
Fuel-air				

## History, Design, and Manufacture of Explosives

### 8) Naval Torpedoes, Mines, and Depth Charges

Naval torpedoes are self propelled, underwater, guided missiles used to home in on an enemy ship or submarine and deliver an explosive package.

The typical torpedo used against surface ships is 23' long and 21" in diameter. It contains a 600# explosive warhead in its nose along with a guidance package.

The next section is a compressed air, water, and fuel reserve.

Batteries are used to drive the torpedo forward in electric propulsion systems.

The propulsion equipment and regulating systems guide the torpedo in its search and homing path. The fuel and air mixture are burned in a turbine which turns the propeller and drives the torpedo forward. The regulating equipment include sonar, lofar, gyroscopes, and depth control equipment. Modern designs include using rocket propulsion (ASROC) for long range attacks against ships and submarines.

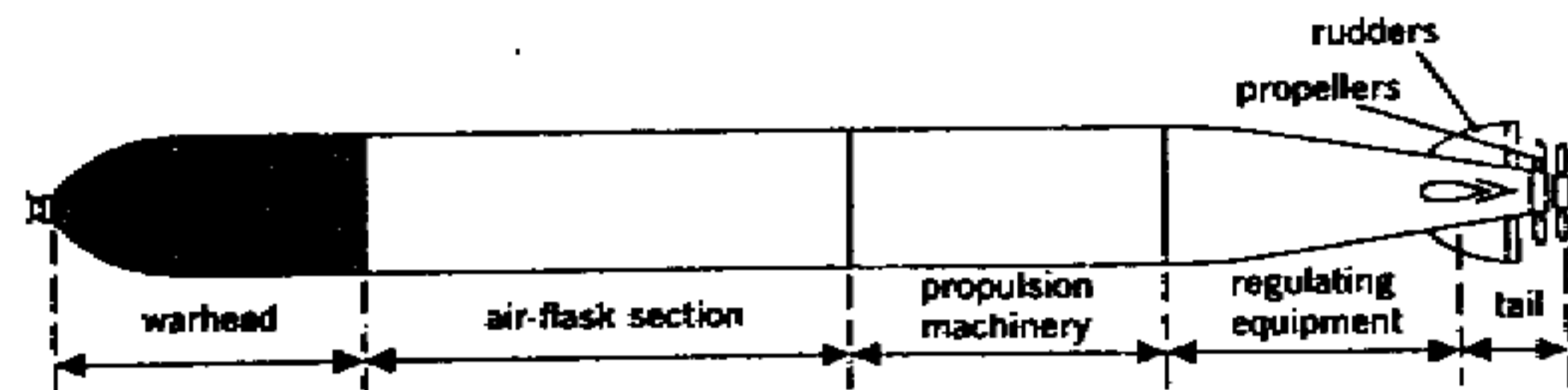

Detonator mechanisms for the warhead include physical impact, lofar sound proximity, sonar proximity, magnetic proximity, and wire guidance and ignition.

Naval mines have been mostly of the moored type. The mine, attached to an anchor, is thrown into the ocean. A separate weight, also attached, descends to the desired depth of the mine. Once it reaches this depth, the hollow anchor is flooded with water so it sinks to the bottom pulling the mine down with it. The cable connecting the mine to the anchor unravels from the desired depth. This positions the mine at the correct depth and it is held in place by the anchor.

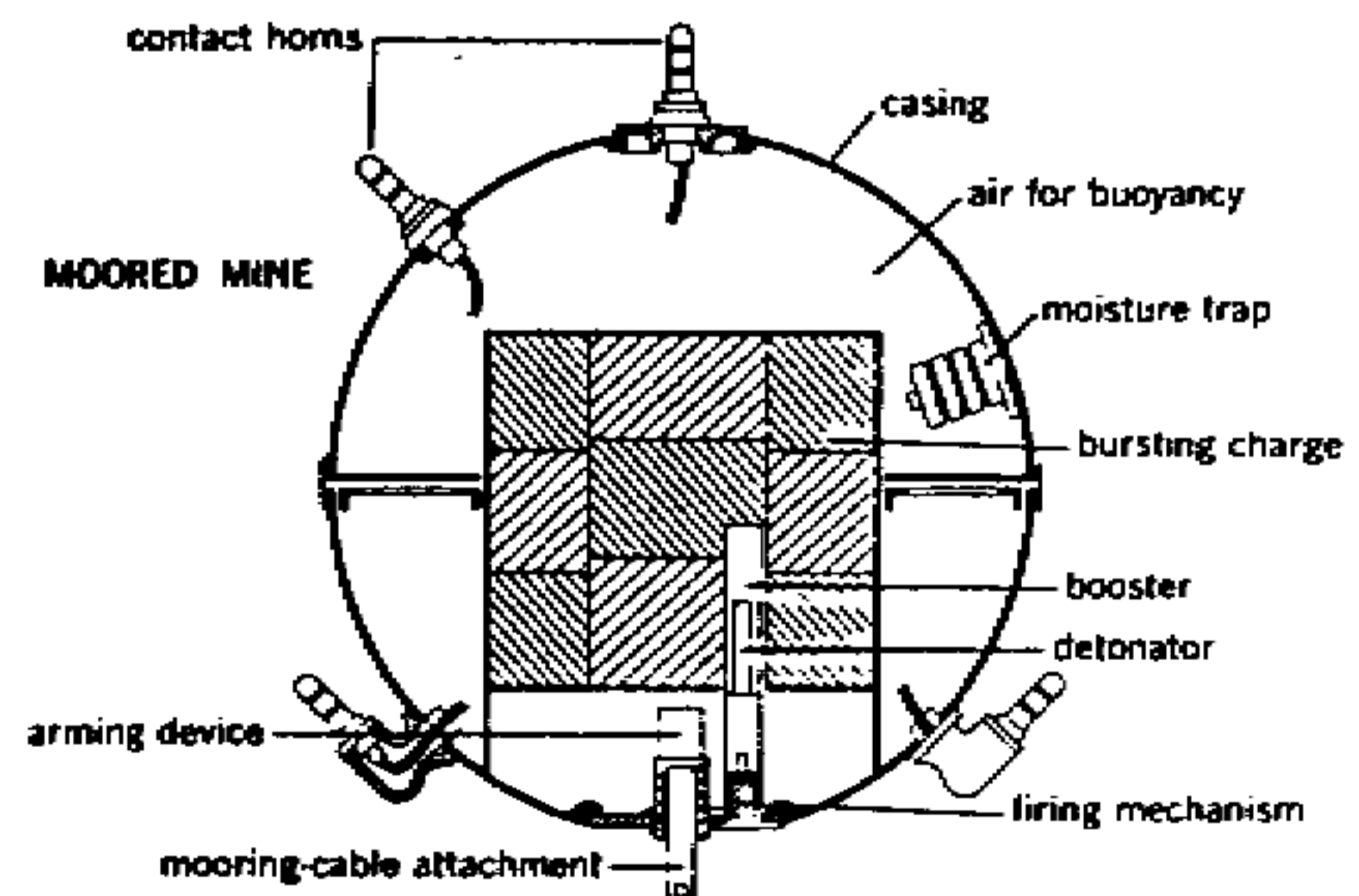



## History, Design, and Manufacture of Explosives

The mines are detonated by "horns" which can be activated by impact with the target, by the increase in hydrostatic pressure created by a passing ship, by the magnetic field, and by the noise. The horns contain a spring or an acid vial which act to complete electric circuits to detonate the main charge. The size of the explosive package depended on how close the fusing mechanism is set. It could be as little as 10# for direct contact to as much as a ton or more for proximity. Mines can be dropped by parachute from airplanes or laid by surface ships or sub's. They can be floating, moored from the bottom, or lay on the seabed and "rise" into the passing target.

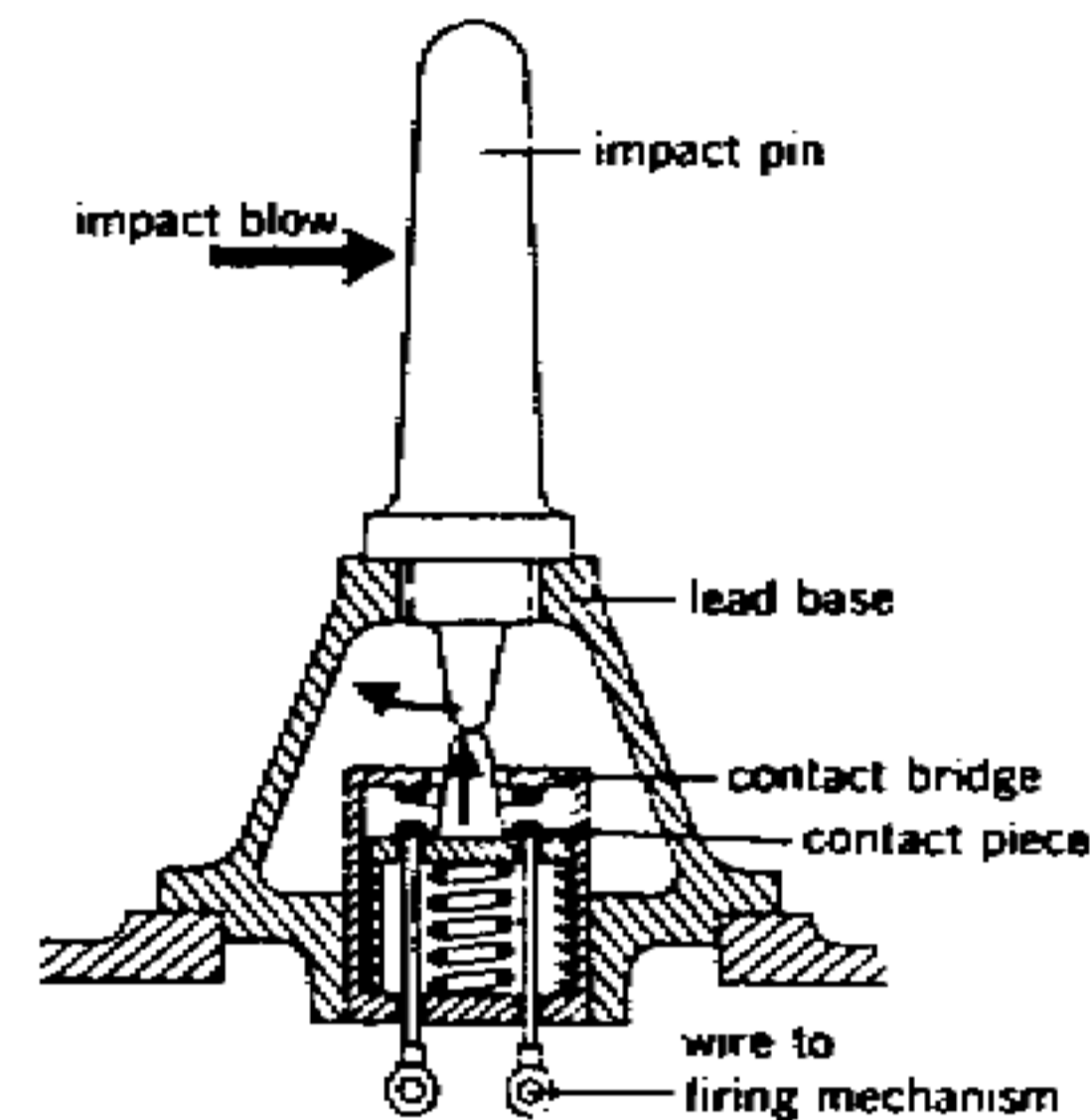
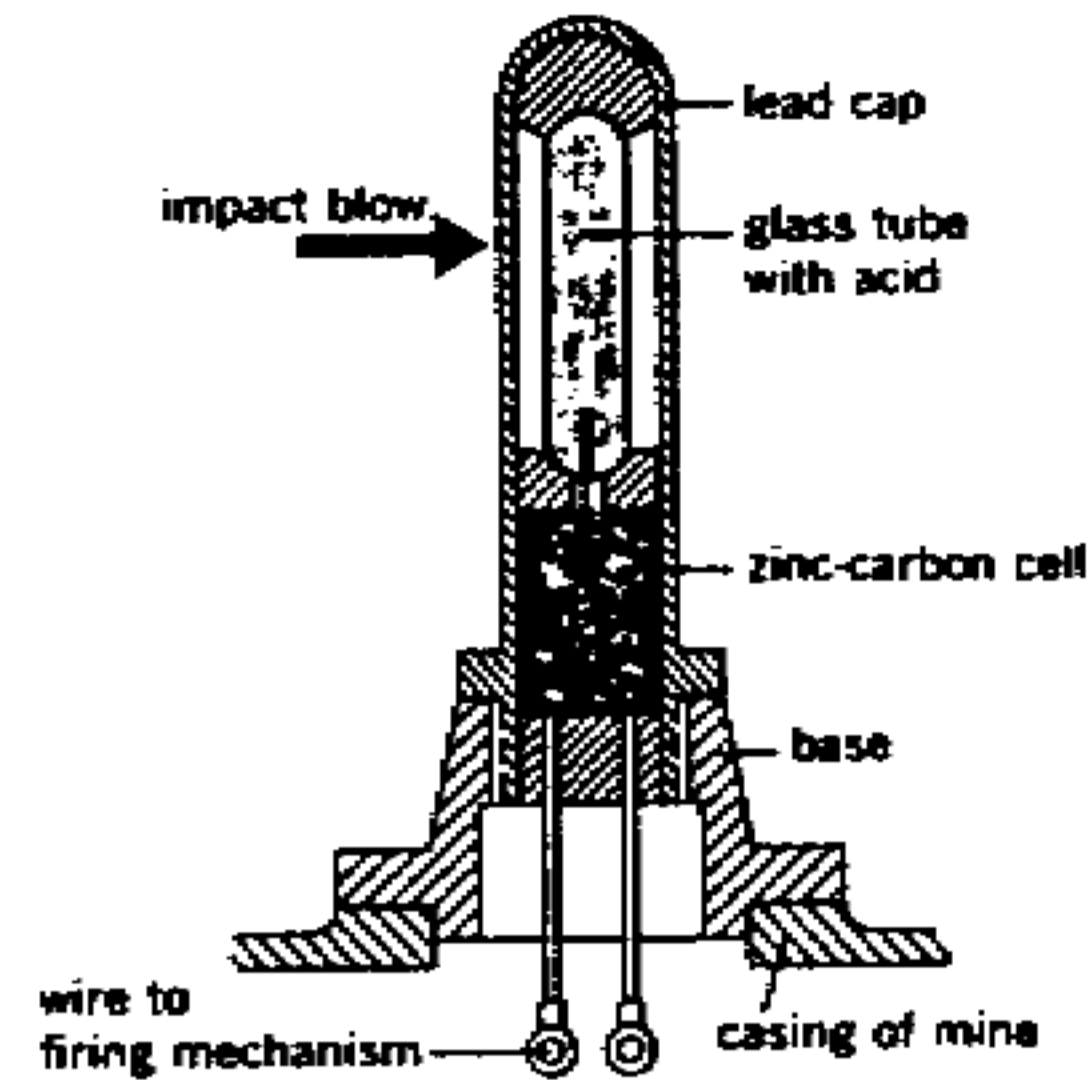

**Depth Charges** are bombs containing a high explosive and designed to be dropped or propelled into the sea by catapults or propelled launching systems. They are of the small "hedgehog" type where salvo's of small 31# bomblets are launched into the target area, or of the larger depth bombs which carry 200-3,000# warheads. They were set to explode at the estimated depth of the submarine.

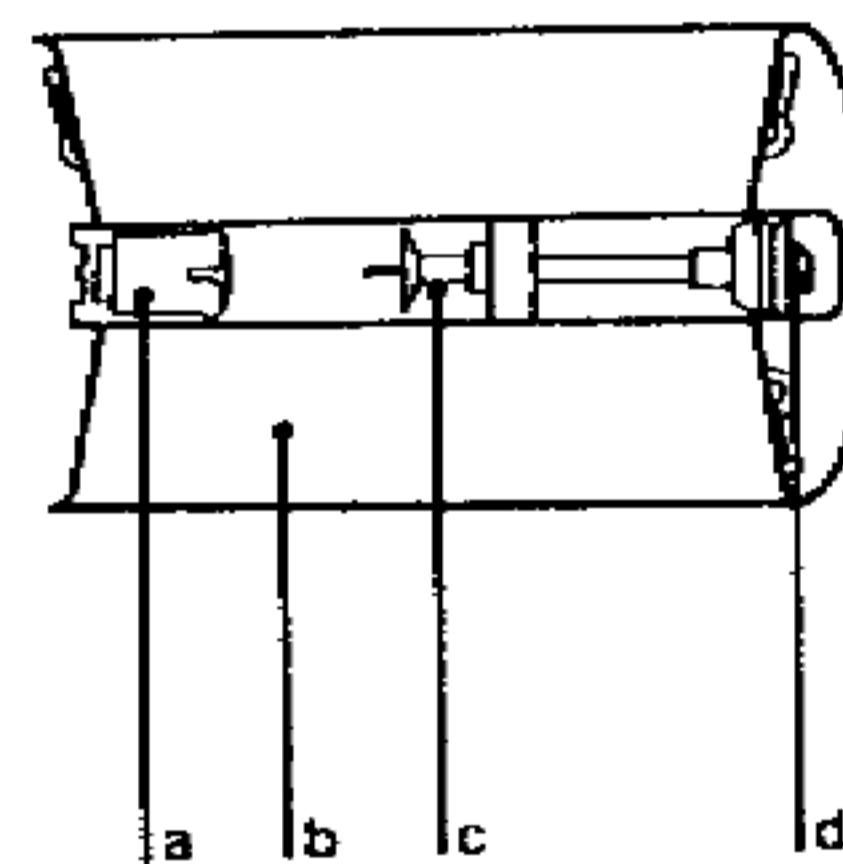

- The charge consisted of -
- a. A detonator
  - b. The explosive charge
  - c. A Pistol
  - d. Depth setting key

Once the depth key is set to the targets depth, it drives the pistol into the detonator setting off the explosive charge.

## History, Design, and Manufacture of Explosives

### 9) Shaped, Plastic, and Slurry Explosives

Often, regular explosive packages cannot be used in many military and civilian uses. The explosive may be too sensitive in its crystalline form to be handled safely, it may not have the right mechanical properties in its pressed or casted form, or it may simply not fit in the location or use desired.

A new science of **Plastic Bonded Explosives (PBX)** was developed to create new explosives that could be handled safely, be mechanically pressed, be extruded into desired shapes, be cast in desired shapes, or be shaped on location in a putty like mass. These would be known in the trade as plastic explosives.

The first step to making the PBX's is

1. To prepare a lacquer of organic polymer. This is dissolved in a solvent such as ethyl acetate.
2. The lacquer is then mixed into a water slurry of the explosive of choice.
3. The mix is distilled under vacuum while it is agitated to recover the solvent. The polymer is precipitated on the explosive particles coating the explosives.
4. The coated explosives form small agglomerates as the distilling is finished.
5. The explosive is vacuum filtered, washed, and vacuum dried to form a dustless, free flowing, high density powder.

An alternative method of preparing a coated PBX is to add a low temperature melt of wax to a hot water slurry of explosive. The slurry is kept hot enough to keep the wax melted. The mix is agitated to distribute the melted wax onto all the powdered particles. The temperature is lowered to allow the wax to solidify and the water is decanted (poured off). The remaining mass is filtered and dried.

Polymers that can be used for PBX's number in the thousands and include -

#### Natural

Polysaccharides  
Starch  
Cellulose  
Seaweed Gums (agar)  
Vegetable Gums (arabic)  
Polypeptides  
Hydrocarbons-Rubber  
Gutta Percha (polyisoprene)

#### Synthetic

Thermoplastic isomers  
Nylon  
PVC  
Polyethylene  
Polystyrene  
Polypropylene  
Polyurethane  
Acrylate Resins

#### Semi-synthetic

Rayon  
Methylcellulose  
Cellulose acetate  
Starch Acetate

## History, Design, and Manufacture of Explosives

The now coated explosive powders can be mechanically pressed by melting, vacuum pressing, hydrostatic pressing through a membrane, and so on into many shapes that could not be produced beforehand. The finished shapes can also be machined safely to the final form desired. The final form can also be baked forming a cast of considerable mechanical strength. The PBX's also formed excellent water based slurries that could be poured into a cavity and detonated.

Most of the PBX's are made using 90-95% RDX for C-4 plastic explosives, or a combination of 40-45% RDX, and 40-45% HMX for Semtex. These are much less sensitive to impact, friction, heat, and shock than the original explosives. PBX explosives are also made in extruded strips that can be formed from the original putty, or they can be formed in the field "to fit" and baked to form a rigid mass.

Several commercial PBX's have the following properties -

<u>Name</u>	<u>Detonation Velocity Km/s</u>	<u>Explosion Temperature C</u>	<u>Fragmentation Velocity as % TNT</u>
A3	8.1	280	125
C4	8.04	263	125
HMX-KEL-F 95/5	8.89		140
LX-04-1	8.48	337	130
PBXN 3	8.45	337	125
PBX 9404	8.37	309	140

Many explosives are produced in shapes that focus most of the energy into a single point or a thin line to dent or penetrate armor. This is called the "Munroe effect" after Charles Edward Munroe discovered that by making guncotton with letters countersunk into the mass, he could detonate the mass on steel plate and produce indentations of the letters in the steel. He discovered that the greatest effects on the steel plate was at the points where the explosive stands away from it. These are the points where the explosive waves from different directions meet and reinforce each other. As he increased the depth of the concavity of the explosive, he produced greater and greater effects on the steel. Solid blocks of explosive would only dent or bend the steel. The shaped explosives would blow holes through it at the point of focus of the blast wave. The earliest use of these types of explosives was in submarine torpedoes using charges hollowed in the forward end.

It was also found that the same effect could be produced by placing two or more blasting caps in the same charge at different positions. These produced reinforcing shock waves that were used in mining and oil well drilling.

Examples of field improvised plastic explosives using mineral jelly (vaseline) in place of polymeric or wax material is described as well as several examples of shaped explosives.

## History, Design, and Manufacture of Explosives

### Plastic Explosive Filler

A plastic explosive filler can be made from potassium chlorate and petroleum jelly.

#### Materials Required

Potassium Chlorate  
Petroleum Jelly (Vaseline)  
Piece of round stick  
Wide mixing bowl or container

#### Procedure

1. Spread potassium chlorate crystals thinly on a hard surface. Roll the round stick over crystals to crush into a very fine powder until it looks like face powder or wheat flour.
2. Place 9 parts powdered potassium chlorate and one part petroleum jelly in a wide bowl or similar container. Mix ingredients with hands (knead) until a uniform paste is obtained.

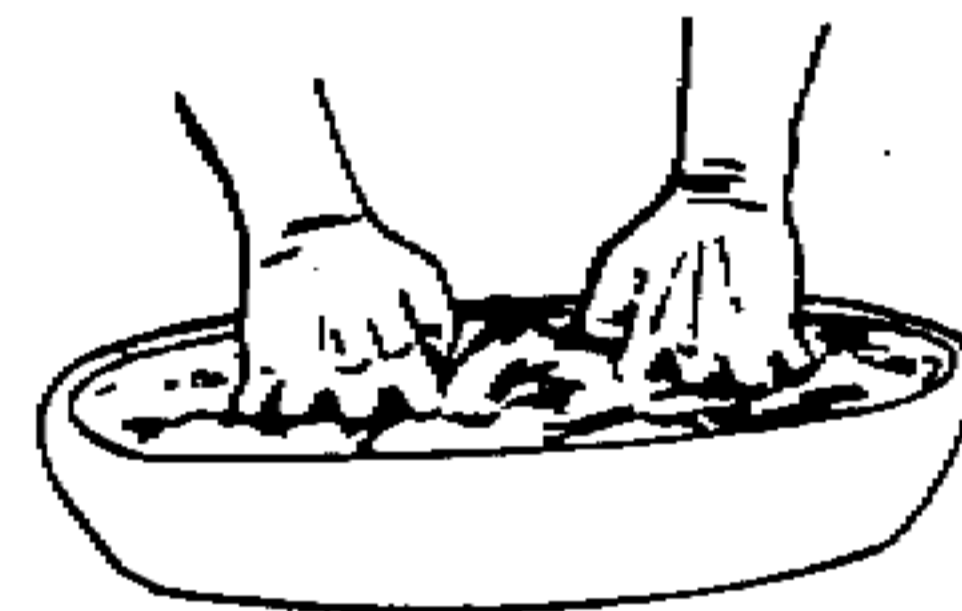

**Note:** Store explosive in a waterproof container until ready to use.

# History, Design, and Manufacture of Explosives

## Wine Bottle Cone Charge

This cone charge will penetrate 3-4" of armor. Placed on an engine, engine compartment, fuel storage, or magazine, it will disable a tank or other vehicle.

### Material Required

Glass wine bottle with false bottom ( cone shaped )  
Plastic or castable explosive  
Blasting Cap  
Gasoline or kerosene ( small amount )  
String  
Adhesive Tape



### Procedure

1. Soak a piece of string in gasoline or kerosene. Double wrap this string around the wine bottle app 3 in. above the top of the cone in the wine bottle bottom.

**Note:** A small amount of motor oil added to the gasoline or kerosene improves results.

2. Ignite the string and allow to burn for 1-2 minutes. Then plunge the bottle into cold water to crack the bottle. The top half can now be easily removed and discarded.

3. If plastic explosives are used: (a) pack explosives into the bottle a little at a time compressing with a wooden rod. Fill the bottle to the top. (b) press a 1/4" wooden dowel 1/2" into the middle of the top of the explosive charge to form a hole for the blasting cap.

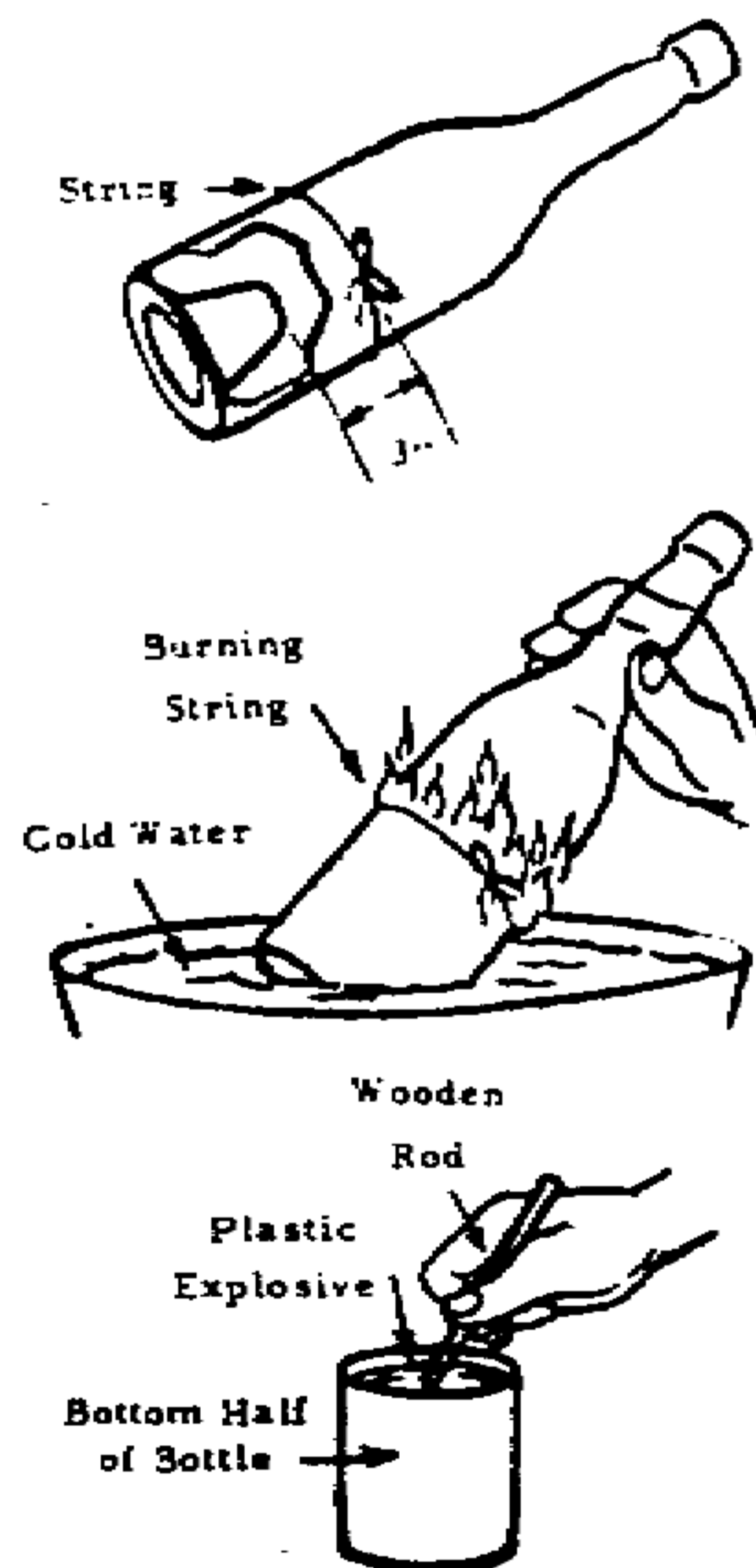

## History, Design, and Manufacture of Explosives

4. If TNT or other castable explosive is used:

(a) break explosive into small pieces using a wooden mallet or non sparking metal tools. Place pieces in a tin can.

(b) Suspend this can in a larger container which is partly filled with water. A stiff wire or stick pushed through the smaller can will accomplish this.

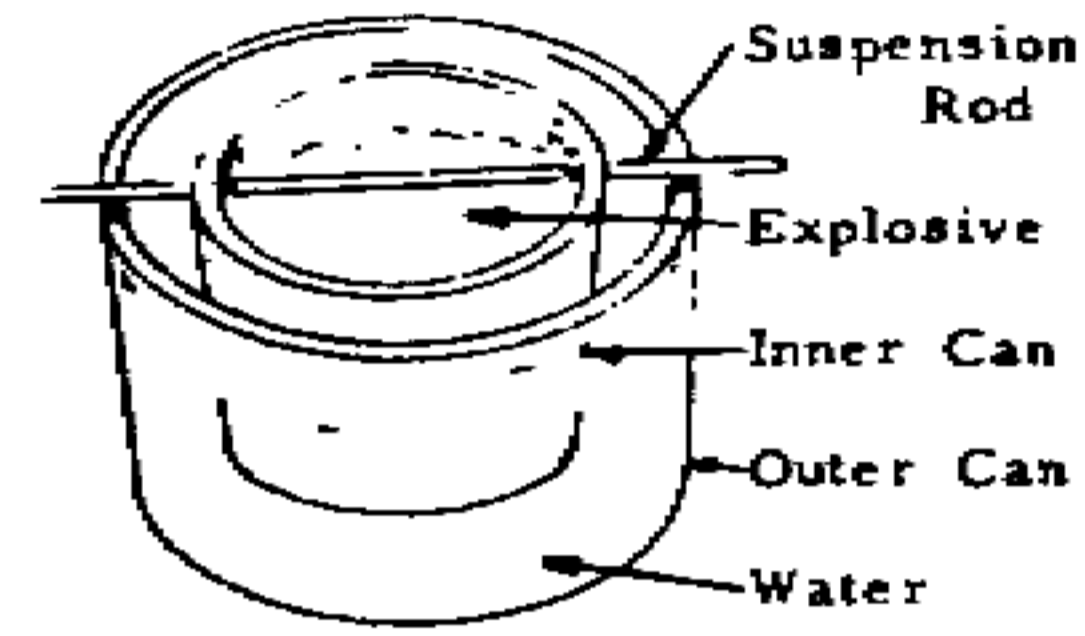

**Caution:** The inner can must not rest on the bottom of the outer container.

(c) Heat the container on an electric hot plate or other heat source. Stir the explosive frequently with a wooden stick while it is melting.

**Caution:** Keep area well ventilated while melting explosive. Fumes may be poisonous.

(d) When all the explosive has melted, remove the inner container and stir the molten explosive until it begins to thicken. During this time the bottom half of the wine bottle should be placed in the container of hot water. This will preheat the bottle so that it will not crack when the explosive is poured.

(e) Remove the bottle from hot water and dry thoroughly. Pour molten explosive into the bottle and allow to cool. The crust which forms on top of the charge during cooling should be broken with a wooden stick and more explosive added. Do this as often as necessary until the bottle is filled to the top.

(f) When explosive has completely hardened, bore a hole for the blasting cap in the middle of the top of the charge about 1/2" deep.

## History, Design, and Manufacture of Explosives

### How to use

1. Place blasting cap in the hole in the top of the charge. If non-electric cap is used be sure cap is crimped around fuse and fuse is long enough to provide safe delay.
2. Place the charge so that the bottom is 3-4" from the target. This can be done by taping legs to the charge or any other convenient means as long as there is nothing between the base of the charge and the target.
3. If electric cap is used, connect blasting cap wires to firing circuit.

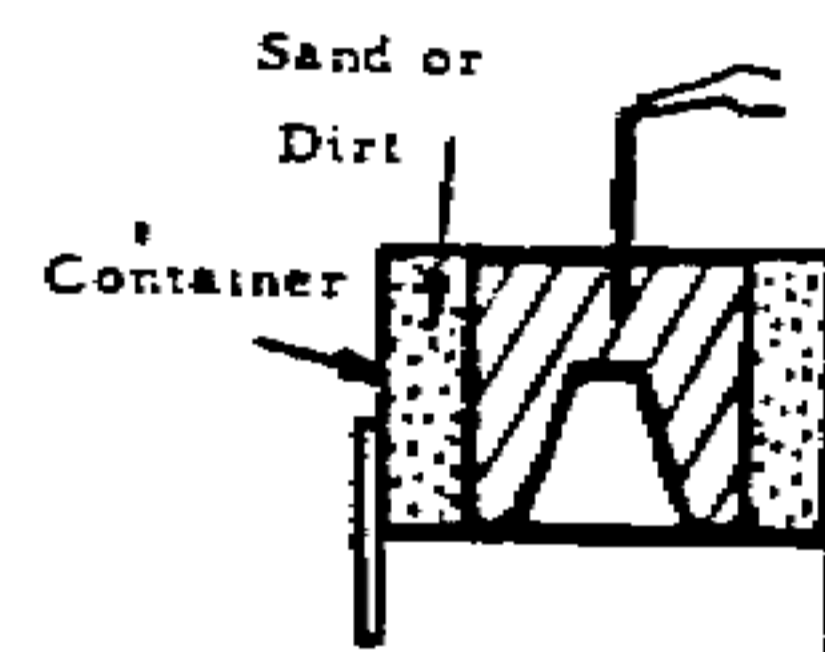
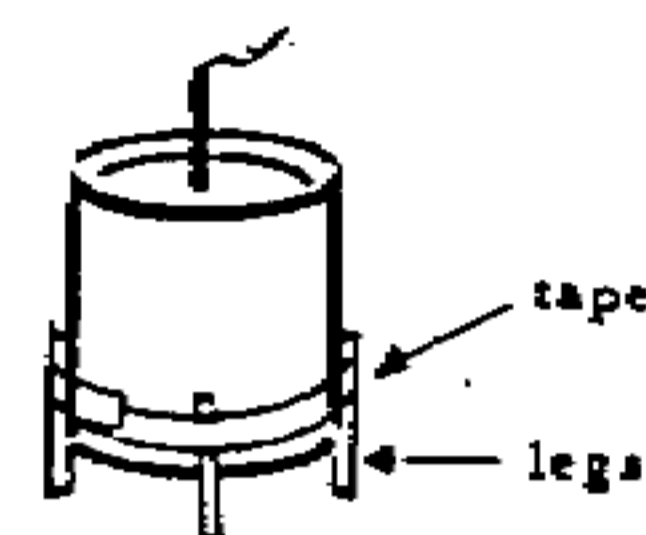

**Note:** The effectiveness of this charge can be increased by placing it inside a can, box, or similar container and packing sand or dirt between the charge and the container.

## History, Design, and Manufacture of Explosives

### Coke Bottle Shaped Charge

This shaped charge will penetrate 3" of armor. It will disable a vehicle if placed on the engine, engine compartment, magazine or fuel storage.

#### Material Required

Glass coke bottle 6.5 oz. in size

Plastic or castable explosive, about 1#

Blasting Cap

Metal cylinder, open at both ends, about 6" long and 2" inside dia.

Cylinder should be heavy walled for best results

Plug to fit mouth of coke bottle ( rags, metal, wood, paper, etc.)

Non metal rod about 1/4" in dia. and 8" long

Tape or string

2 tin cans if castable explosive is used



**Note:** Cylinder may be cardboard, plastic, etc. If castable explosive is used.

#### Procedure

1. Place plug in mouth of bottle



2. Place cylinder over top of bottle until bottom of cylinder rests on widest part of bottle. Tape cylinder to bottle. Container should be straight on top of bottle.

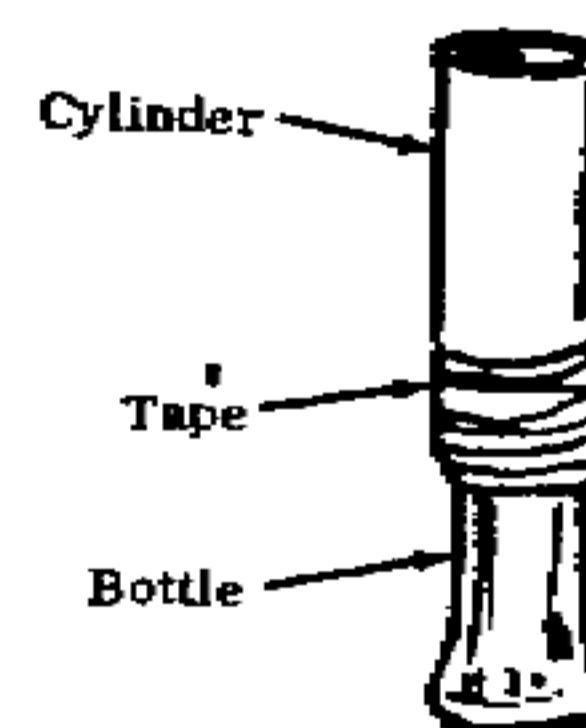

3. If plastic explosive is used

(a) Place explosive in cylinder a little at a time tamping with rod until cylinder is full.





## History, Design, and Manufacture of Explosives

(b) Press the rod about 1/2" into the middle of the top of the explosive charge to form a hole for the blasting cap.



4. If castable explosive is used, follow procedure of wine bottle cone charge.

### How to use

#### Method 1 - For electrical blasting cap

1. Place blasting cap in hole in top of explosive.

**Caution:** Do not insert blasting cap until charge is ready to be detonated.

2. Place bottom of coke bottle flush against the target. If target is not flat and horizontal, fasten bottle to target by any convenient means, such as by placing tape or string around target and top of bottle. Bottom of bottle acts as stand off.

**Caution:** Be sure that base of bottle is flush against target and that there is nothing between the target and the base of the bottle.

3. Connect leads from blasting cap to firing circuit.

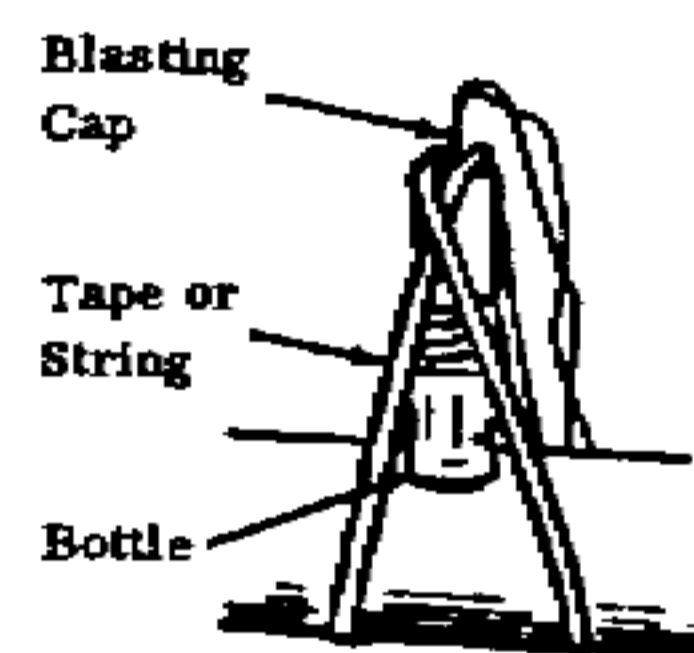
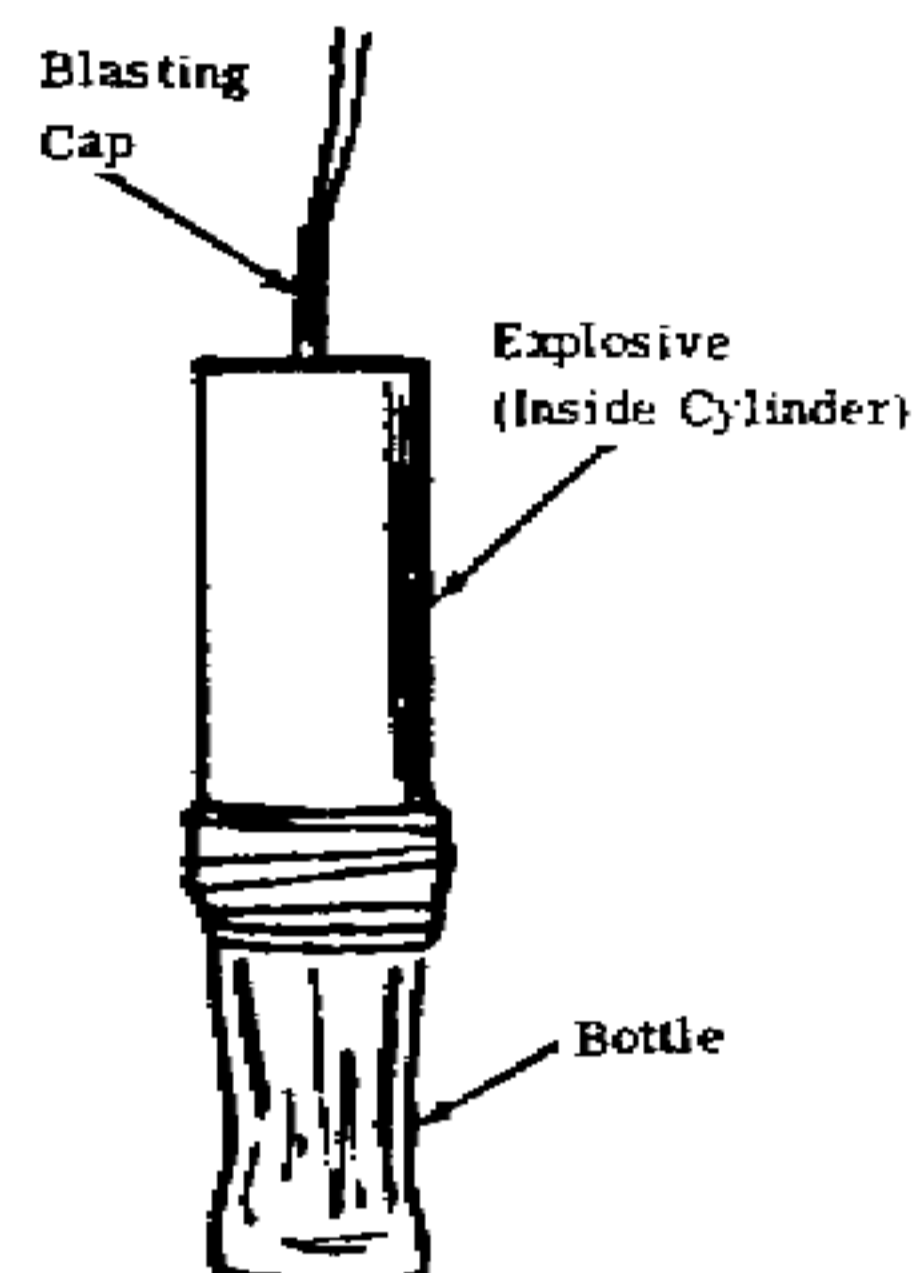

#### Method 2 - for non electrical blasting cap

1. Crimp cap around fuse

**Caution:** Be sure fuse is long enough to provide a safe delay.

2. Follow 1,2, and cautions of method 1.

3. Light fuse when ready to fire.

# History, Design, and Manufacture of Explosives

## Cylindrical Cavity Shaped Charge

A shaped charge can be made from common pipe. It will penetrate 1.5" of steel producing a hole 1.5" in diameter.

### Material Required

Iron or steel pipe, 2-2.5" in dia. and 3-4" long

Metal pipe 1/2-3/4" in dia. and 1.5 in. long, open at both ends. The wall of this pipe should be as thin as possible

Blasting Cap

Non-Metallic Rod, 1/4" in dia.

Plastic or castable explosive

2 metal cans of different sizes (If castable explosive is used)

Stick or wire

Heat source

### Procedure

1. If plastic explosive is used

a. Place larger pipe on flat surface. Hand pack explosive into pipe. Leave app. 1/4" space at top.

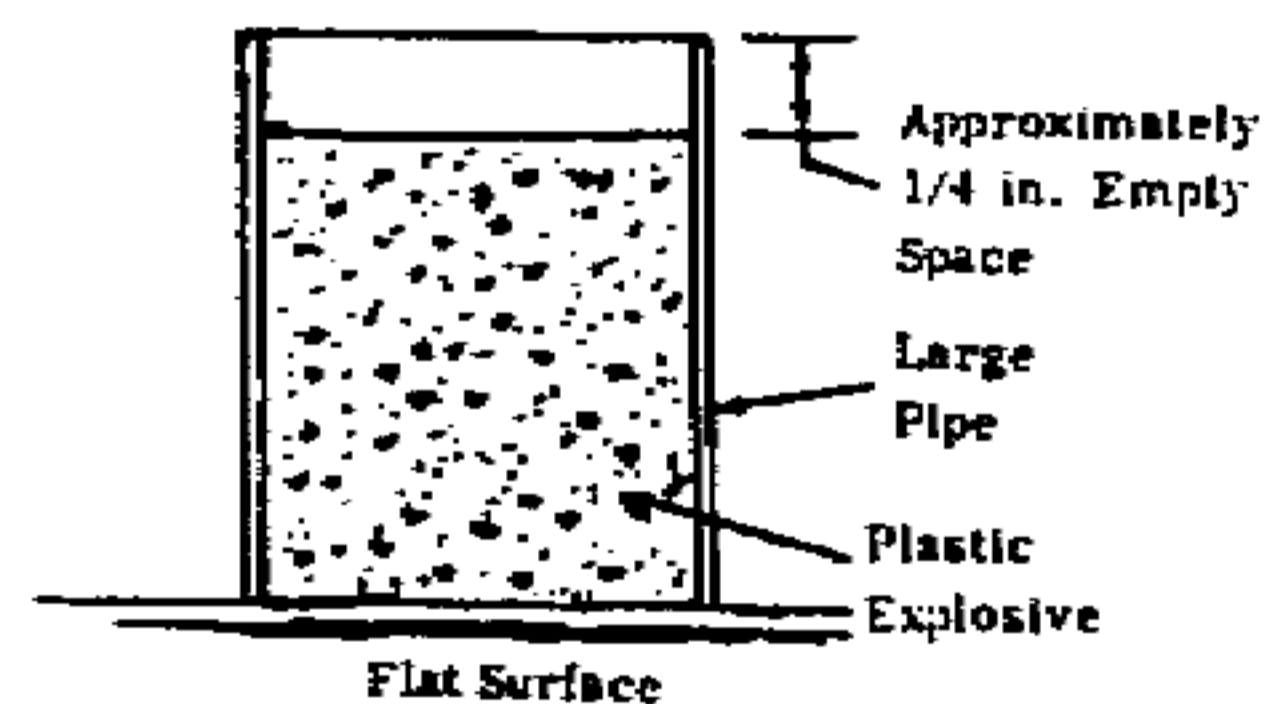

b. Push rod into center of explosive. Enlarge hole in explosive to diameter and shape of small pipe.

c. Insert small pipe into hole.

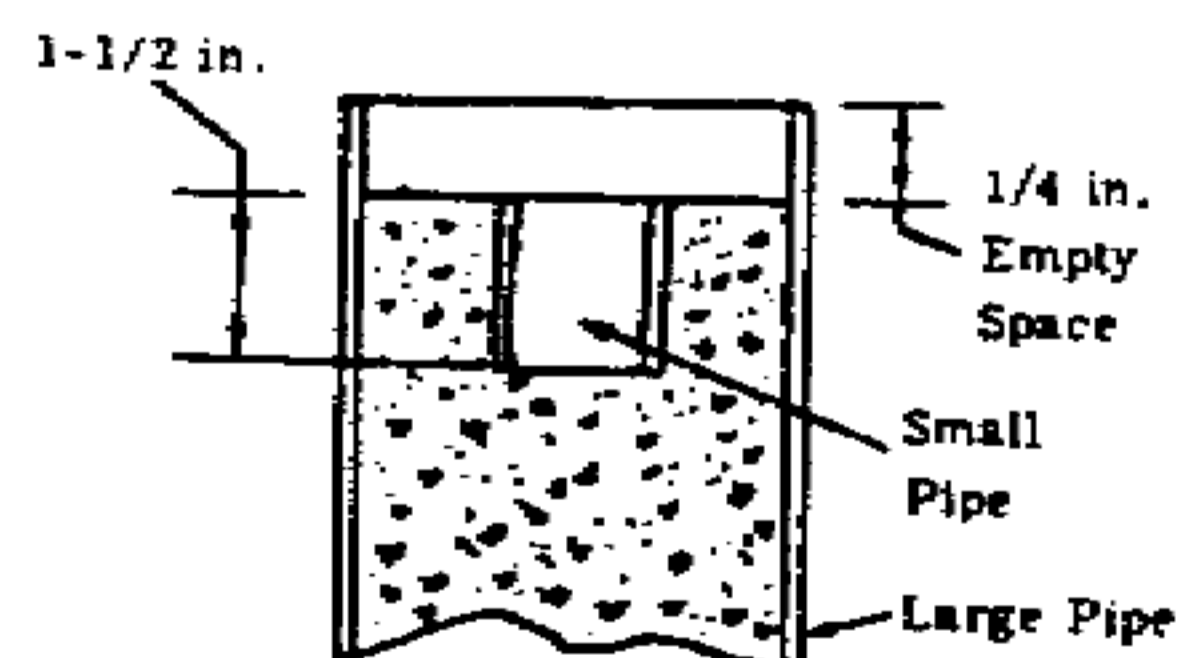

## History, Design, and Manufacture of Explosives

**Important:** Be sure direct contact is made between explosive and small pipe. Tamp explosive around pipe by hand if necessary.

d. Make sure that there is 1/4" empty space above small pipe. Remove explosive if necessary.

e. Turn pipe upside down and push rod 1/2" into center of opposite end of explosive to form a hole for the blasting cap.

**Caution:** Do not insert blasting cap in hole until ready to fire shaped charge.

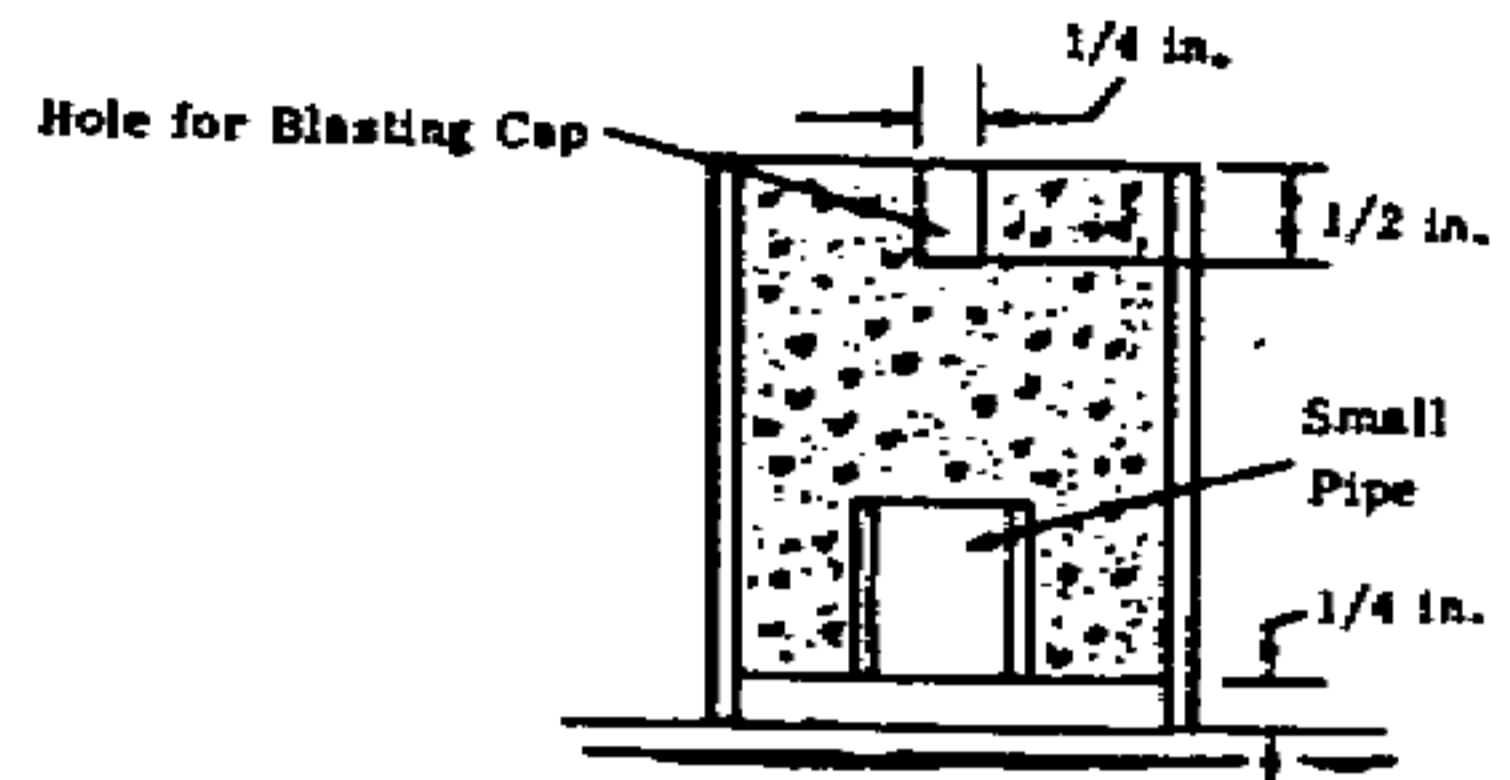

2. If TNT or other castable explosive is used

a. Follow step 4, parts a, b, and c of wine bottle cone charge

b. When all the explosive has melted, remove the inner container and stir the molten explosive until it begins to thicken.

c. Place large pipe on flat surface. Pour explosive into pipe until it is 1-3/4" from the top.

d. Place small pipe in center of large pipe so that it rests on top of explosive. Holding small pipe in place, pour explosive around small pipe until explosive is 1/4" from top of large pipe.

e. Allow explosive to cool. Break crust that forms on top of the charge during cooling with a wooden stick and add more explosive. Do this as often as necessary until explosive is 1/4" from the top.

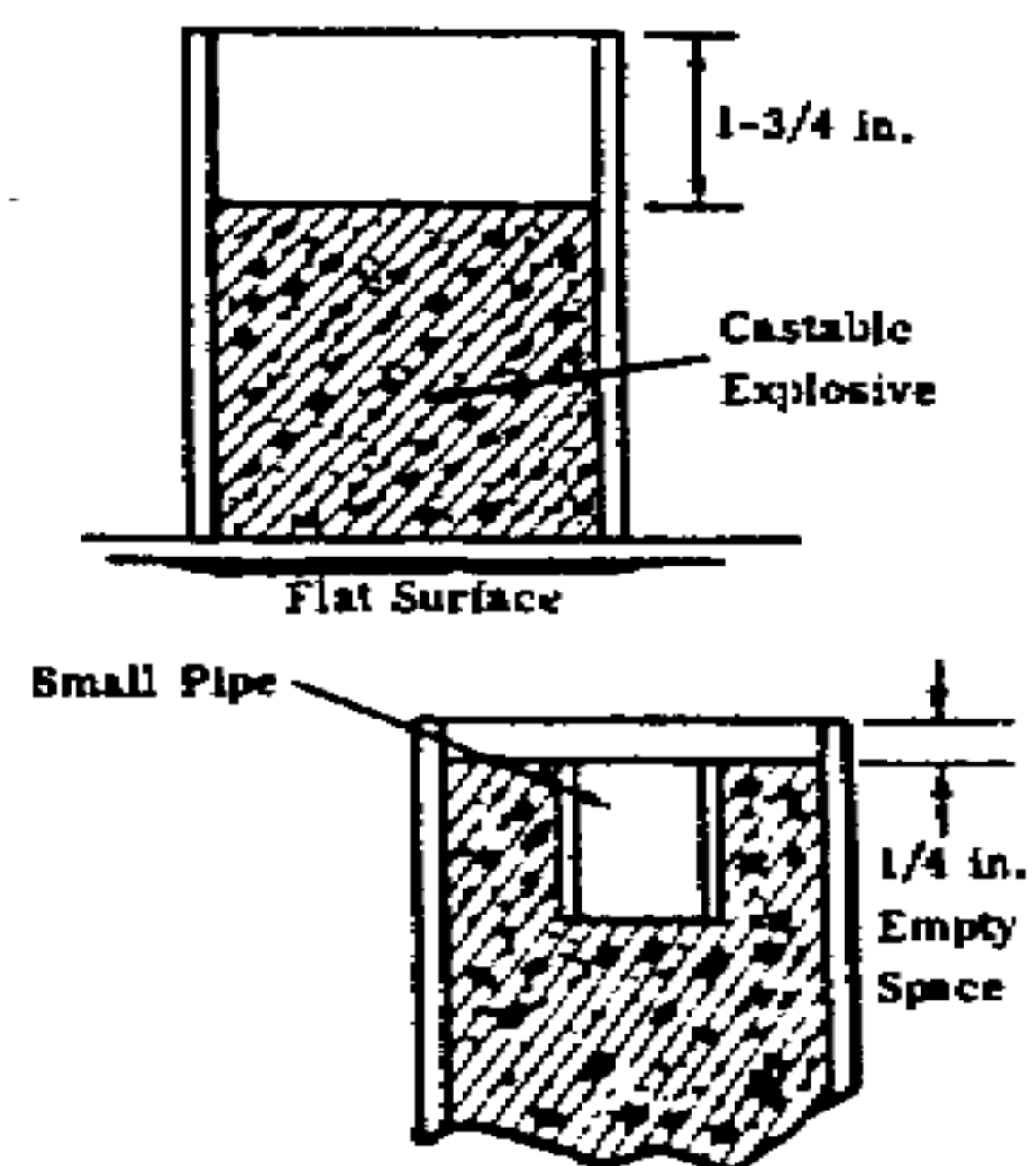

## History, Design, and Manufacture of Explosives

f. When explosive has completely hardened, turn pipe upside down and bore a hole for the blasting cap in the middle of the top of the charge about 1/2" deep.

### How to use

#### Method 1 - if electrical blasting cap is used

1. Place blasting cap in hole made for it.

**Caution:** Do not insert blasting cap until charge is ready to be fired.

2. Place other end of pipe flush against the target. Fasten pipe to target by any convenient means, such as by placing tape or string around target and top of pipe, if target is not flat and horizontal.

**Caution:** Be sure the base of the pipe is flush against target and there is nothing between the target and the base of the pipe.

3. Connect leads from blasting cap to firing circuit.

#### Method 2 - for non electrical blasting cap

1. Crimp cap around fuse.
2. Be sure fuse is long enough for a safe delay.
3. Follow steps 1 and 2 of method 1.
4. Light fuse when ready.

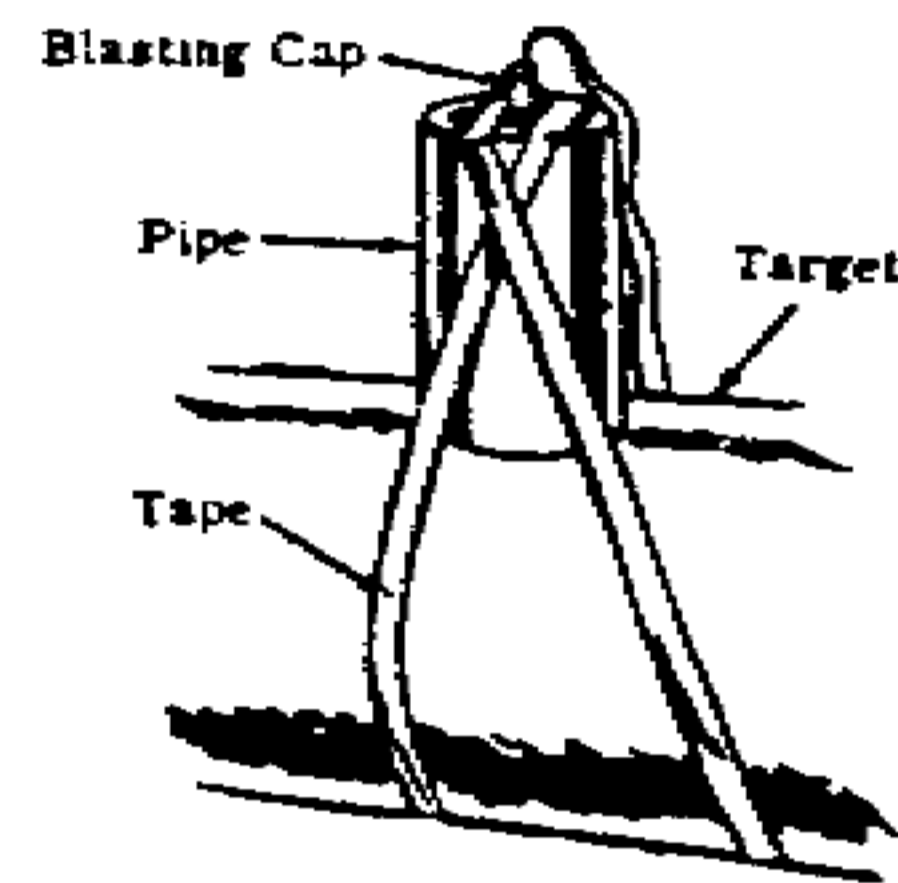
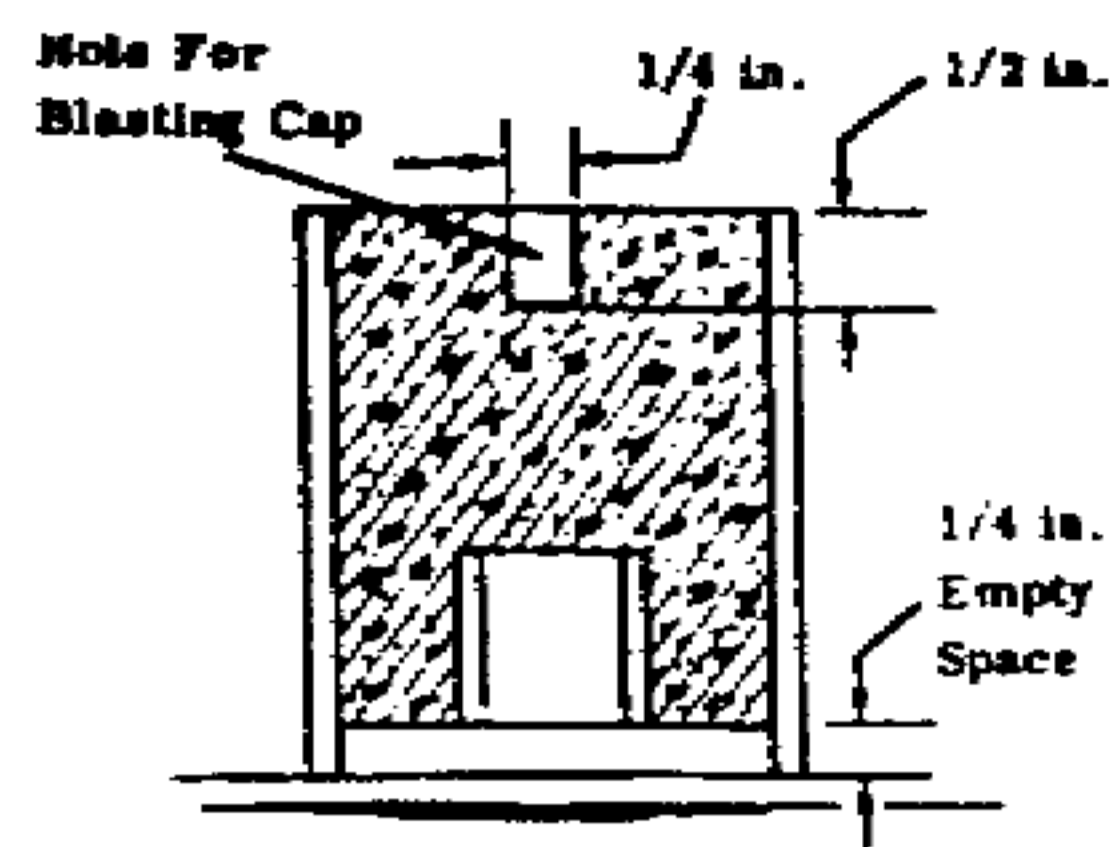

## History, Design, and Manufacture of Explosives

### Funnel Shaped Charge

An effective shaped charge can be made using various types of commercial funnels. See table for penetrating capabilities.

#### Material Required

Container (soda or beer can) app 2.5" in dia. x 5" long

Funnel(s) 2.5" in dia. at top

Wooden rod or stick, 1/4" in dia.

Tape

Blasting Cap

Sharp cutting edge

Explosive

#### Procedure

1. Remove the top and bottom of can and discard.

2. Cut off and throw away the spout of the funnels.

**Note:** When using 3 funnels (see table), place the funnels together as tight as straight as possible. Tape the funnels together at the outer ridges.

3. Place the funnels in the modified can. Tape on outer ridges to hold funnels to can.

4. If plastic explosive is used, fill the can with the explosive using small quantities, and tamp with wooden rod or stick.

**Note:** If castable explosive is used, follow step 4 of wine bottle cone charge.

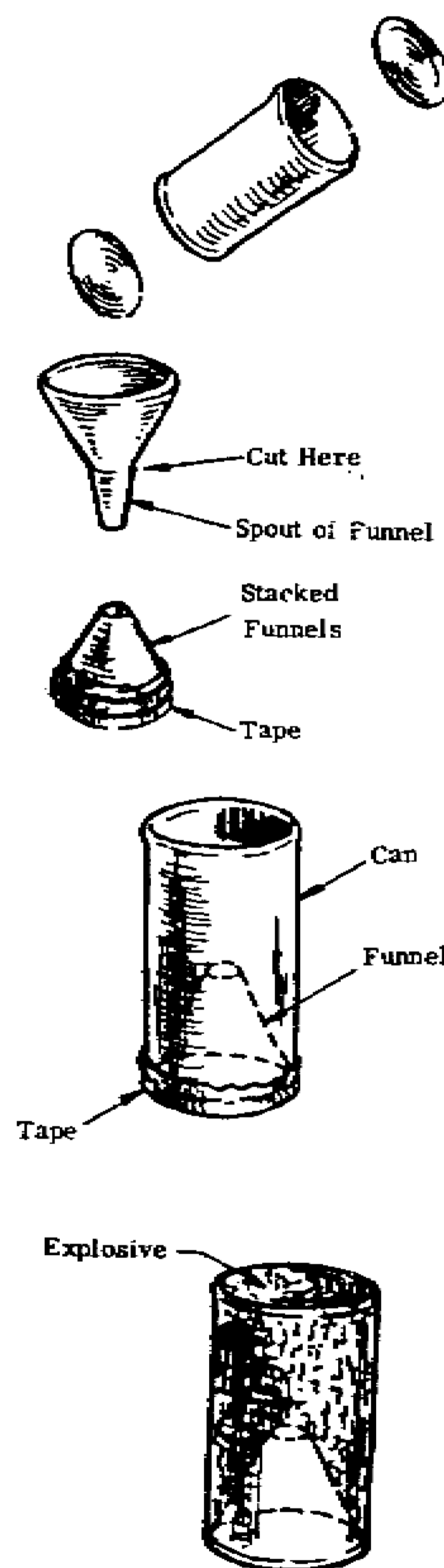

## History, Design, and Manufacture of Explosives

5. Cut wooden rod to lengths 3" longer than the standoff length (see table). Position 3 of these rods around the explosive filled can and hold in place with tape.

**Note:** The position of the rods on the container must conform to standoff dimensions to obtain the penetrations given in the table.

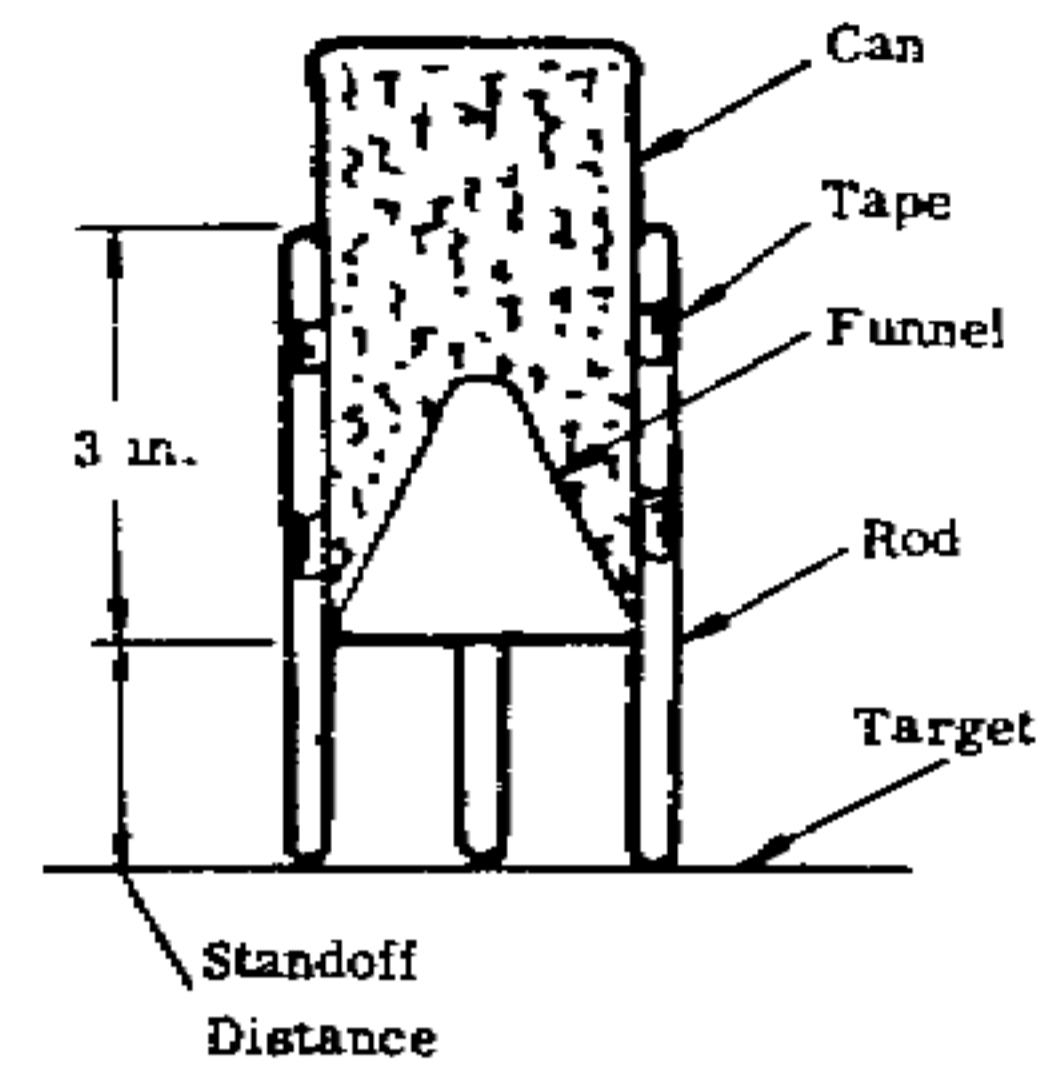

<u>Funnel Material</u>	<u># of funnels</u>	<u>Standoff</u>	<u>Penetration of steel armor</u>
Glass	1	3.5"	4"
Steel	3	1"	2.5"
Aluminum	3	3.5"	2.5"
Steel	1	1"	1.5"
Aluminum	1	1"	1.5"

(if only one steel or aluminum funnel are available, the standoff distance must be shorter and a loss of penetrating ability occurs)

6. Make a hole for blasting cap in the center of the explosive with rod or stick.

**Caution:** Do not place blasting cap in place until the funnel shape charge is ready to use.

### How to use

1. Place blasting cap in the hole in top of the charge. If non electric cap is used, be sure cap is crimped around fuse and fuse is long enough to provide safe delay.
2. Place (tape if necessary) the funnel shaped charge on the target so that nothing is between the base of charge and target.
3. If electric cap is used, connect blasting cap wires to firing circuit.

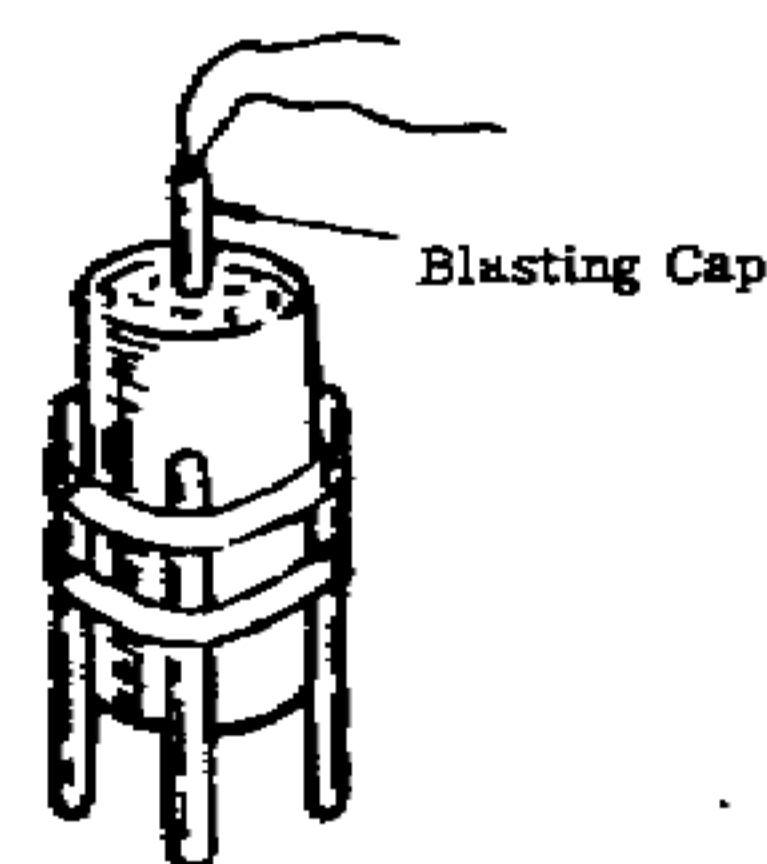
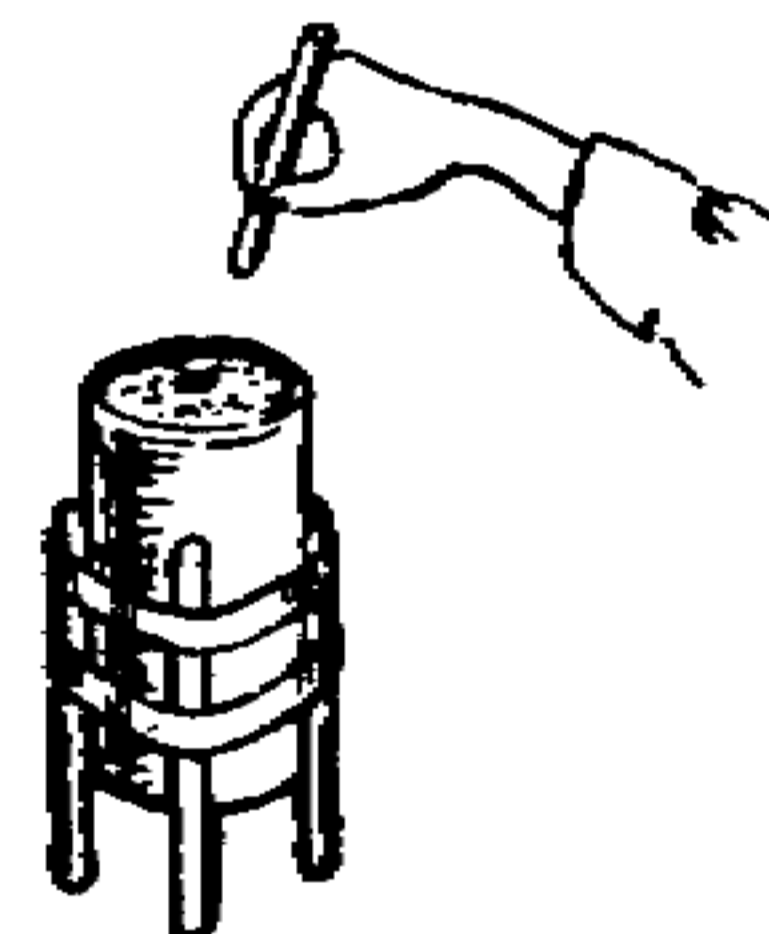

## History, Design, and Manufacture of Explosives

### Linear Shaped Charge

This shaped charge made from construction materials will cut through up to nearly 3 inches of armor depending on the liner used. (see table)

#### Material Required

Standard structural angle or pipe (see table)  
 Wood or cardboard container  
 Hacksaw (If pipe is used)  
 Vice  
 Wooden rod, 1/4" dia.  
 Explosive  
 Blasting Cap  
 Tape

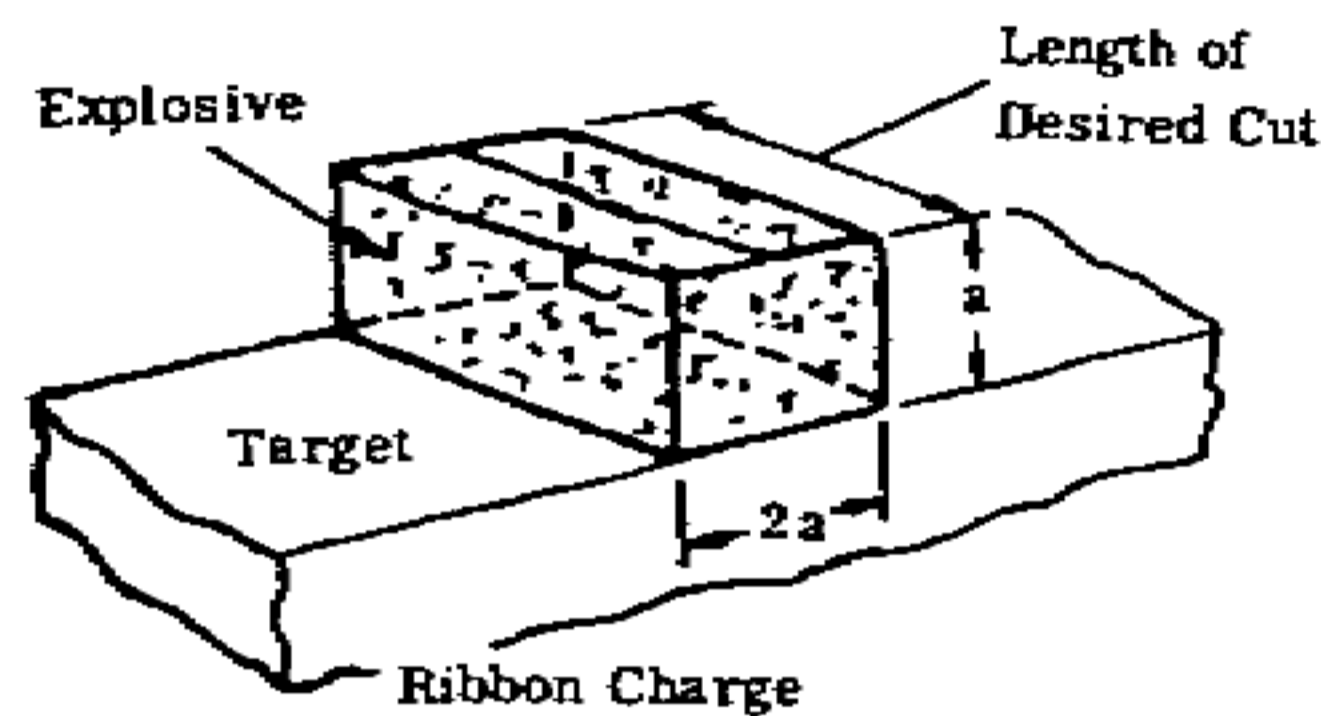

Table

<u>Type</u>	<u>Material</u>	<u>Liner Size</u>	<u>Standoff</u>	<u>Penetration</u>
angle	steel	3 x 3 legs x 1/4 web	2"	2-3/4"
angle	aluminum	2 x 2 legs x 3/16 web	5-1/2"	2.5"
pipe 1/2 section	aluminum	2 diameter	2"	2"
pipe 1/2 section	copper	2 diameter	1"	1-3/4"

If a flat ribbon shaped charge is used, no standoff is required  
 The above shapes were found to be more efficient than the ribbon shape

#### Procedure

1. If pipe is used

## History, Design, and Manufacture of Explosives

a. Place the pipe in the vise and cut pipe in half lengthwise. Remove the pipe half section from vise.

b. Discard one of the pipe half sections, or save for another charge.

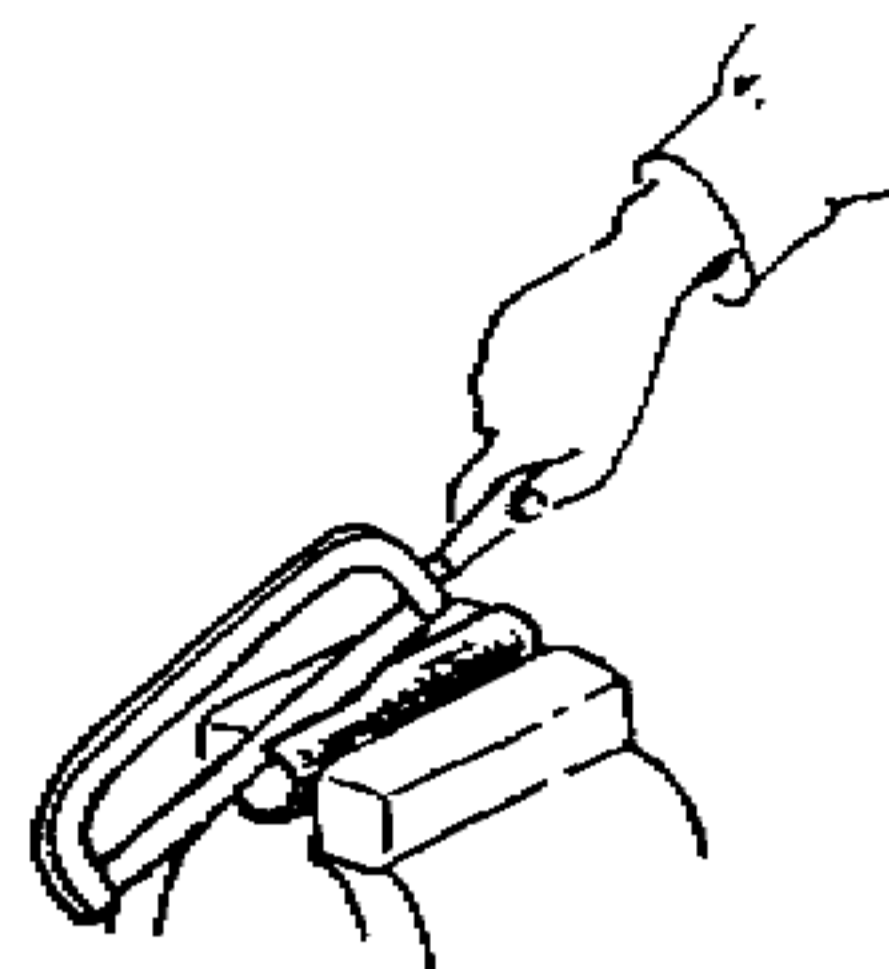

2. Place angle or pipe half section with open end face down on a flat surface.

3. Make container from any material available. The container must be as wide as the angle or pipe half section, twice as high, and as long as the desired cut to be made with the charge.

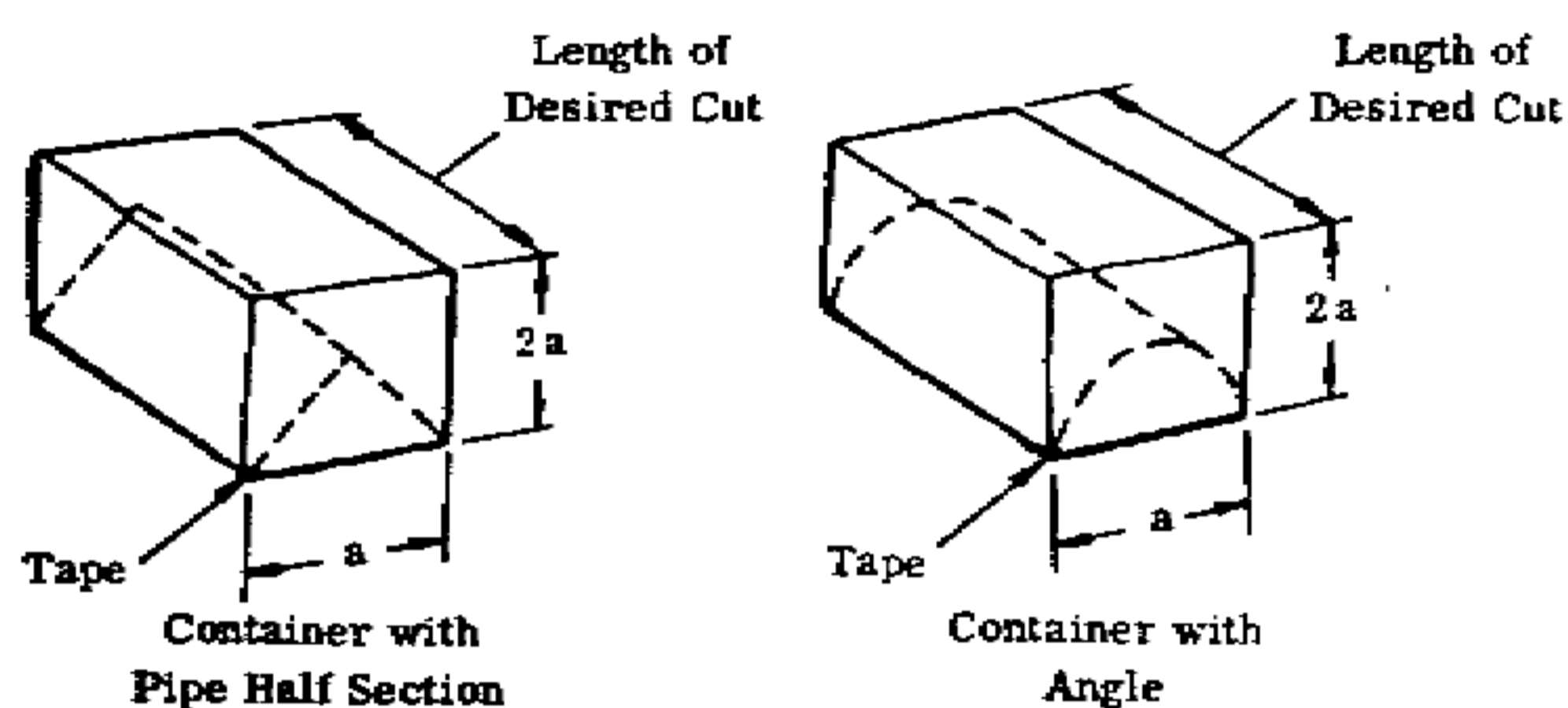

4. Place container over the liner (angle or pipe half section) and tape liner to container.

5. If plastic explosives are used, fill the container with the explosive using small quantities, and tamp with wooden rod or stick.

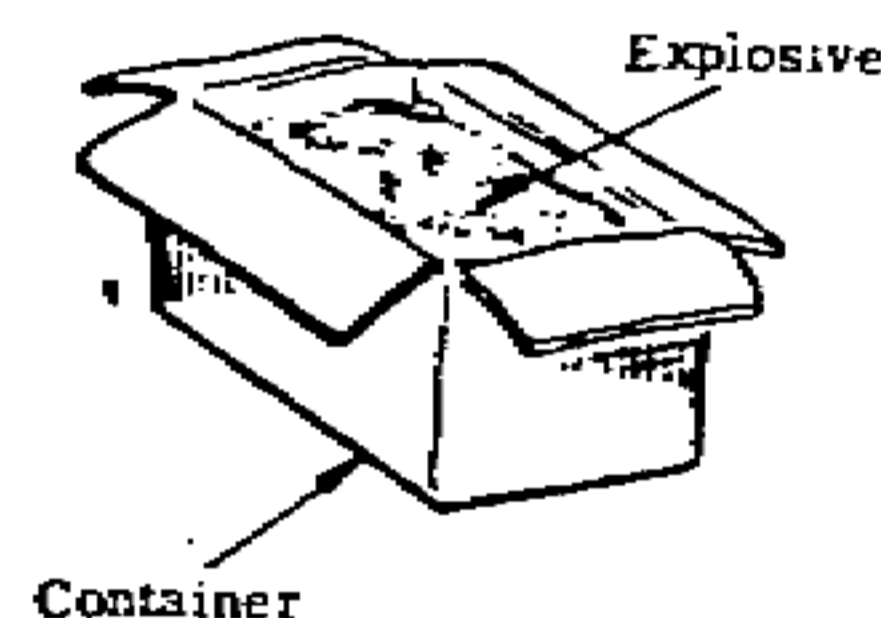

**Note:** If castable explosive is used, follow step 4 of wine bottle cone charge.

6. Cut wooden rod to lengths 2" longer than the standoff length (see table). Position the rods at the corners of the explosive filled container and hold in place with tape.

**Note:** The position of the rods on the container must conform to standoff and penetration dimensions given in the table.

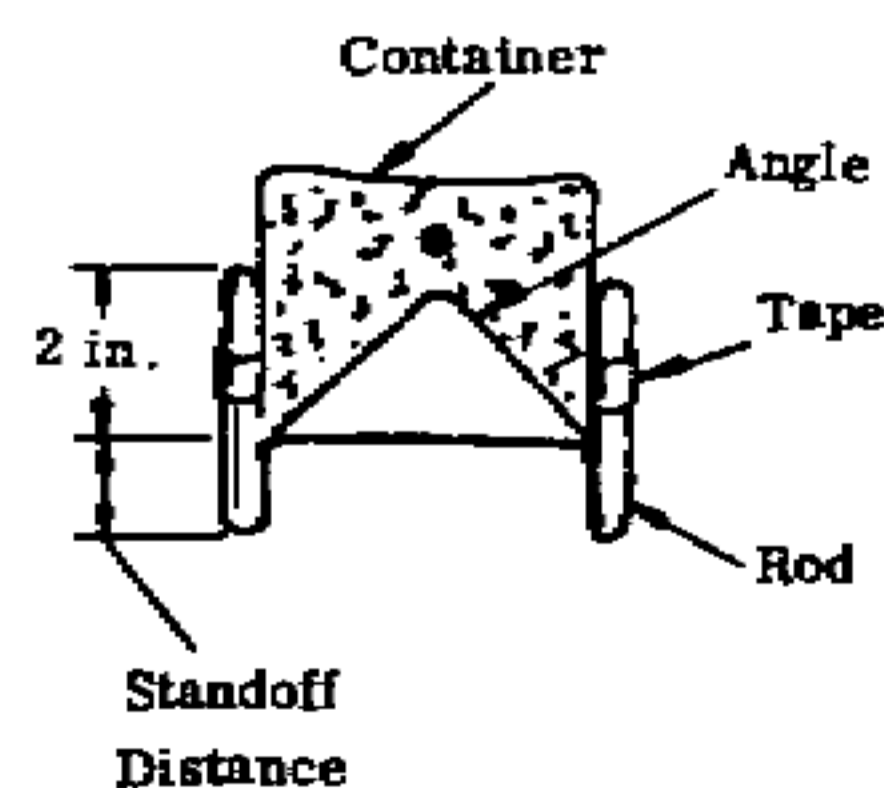



## History, Design, and Manufacture of Explosives

7. Make a hole for blasting cap in the side of the container 1/2" above the liner and centered with the wooden rod.

**Caution:** Do not place blasting cap in place until linear shaped charge is ready to use.

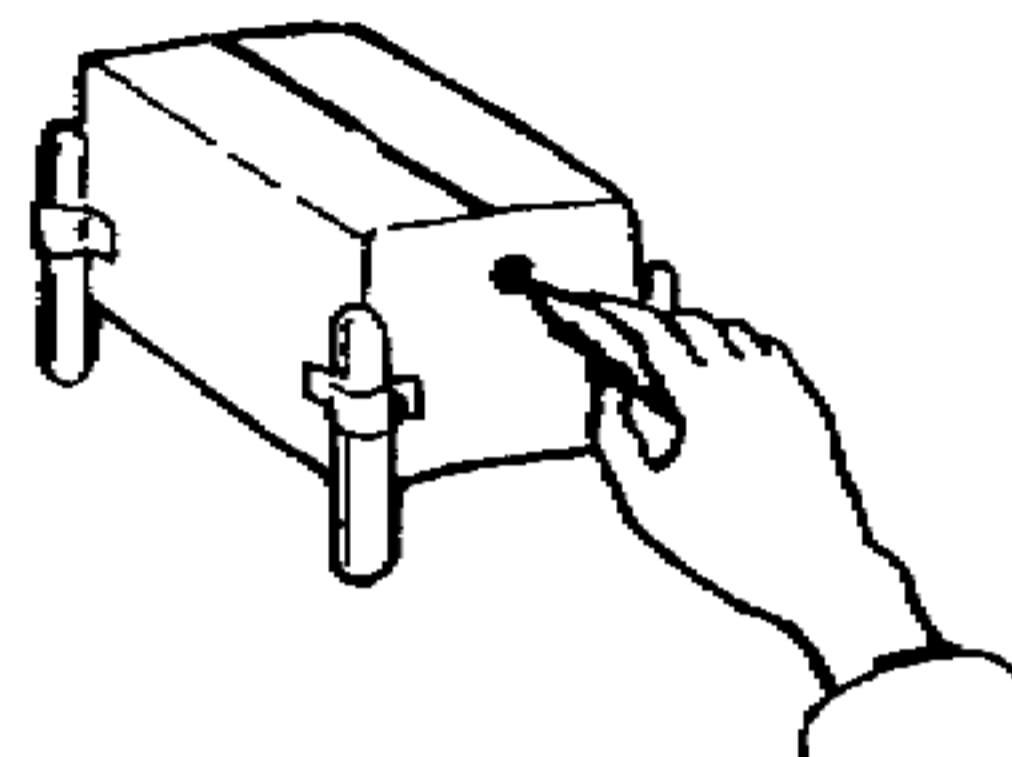

### How to Use

1. Place blasting cap into hole on the side of the container. If non electric cap is used, be sure cap is crimped around fuse and fuse is long enough to provide safe delay.
2. Place (tape if necessary) the linear shape charge on the target so that nothing is between the base of charge and target.
3. If electric blasting cap is used, connect blasting cap wires to firing circuit.

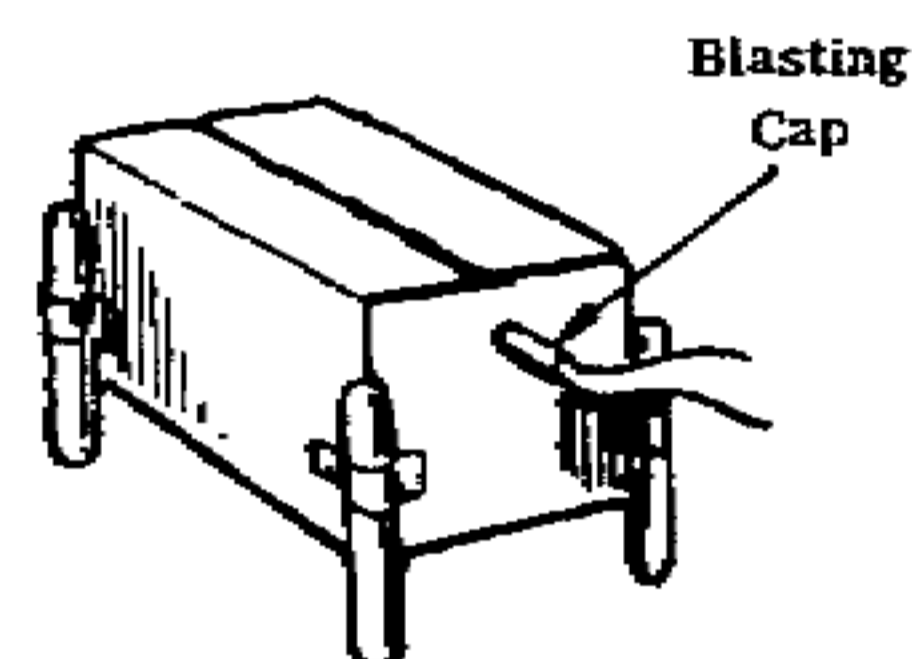

## History, Design, and Manufacture of Explosives

The HESH warhead on the nose of anti-armor missiles uses plastic explosives to defeat enemy armor.

### HOW A HESH WARHEAD WORKS

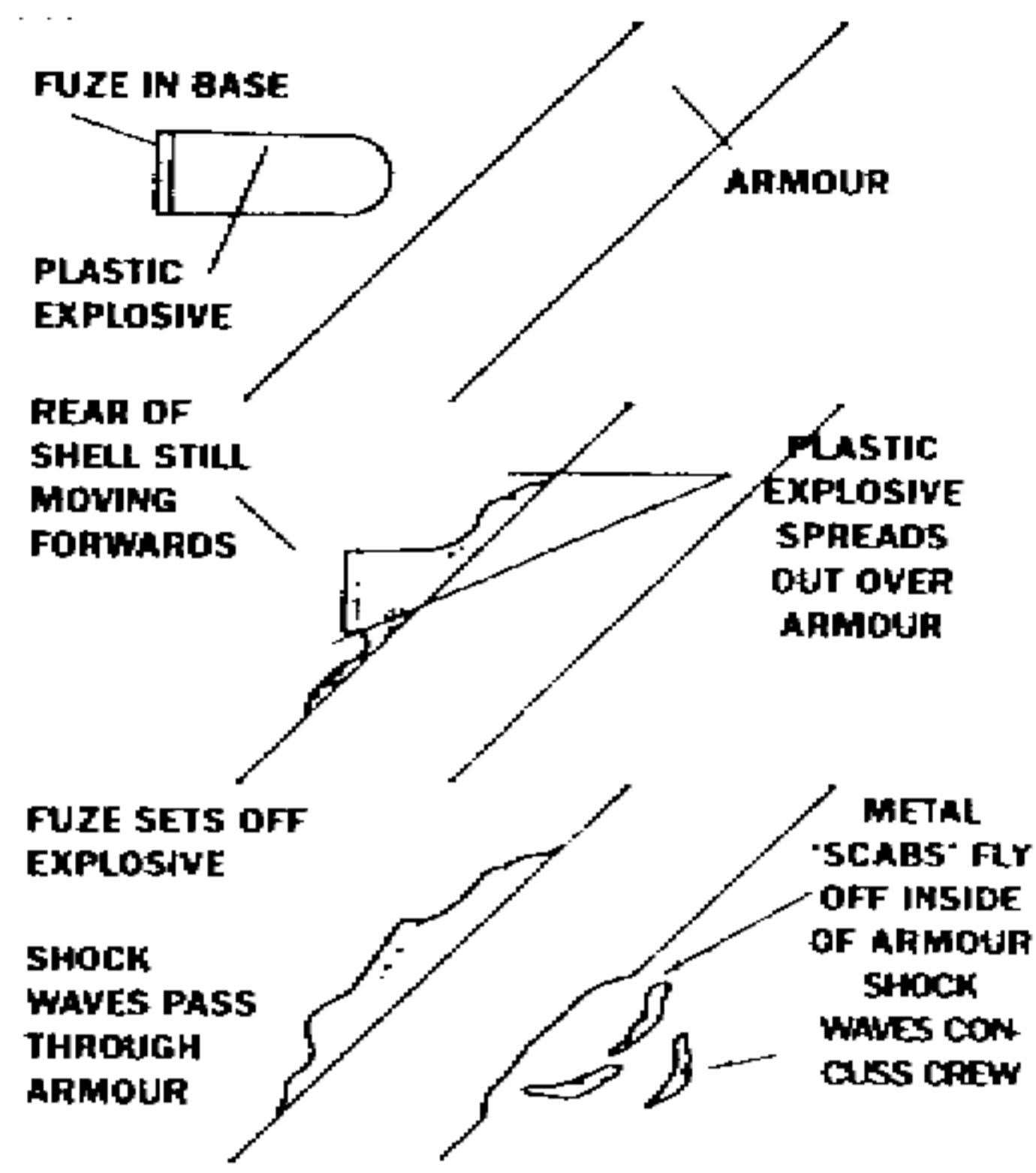

Explosives are also shaped and used to counter enemy weapons.

Explosive reactive armor is manufactured and used in sheets on top of tank armor to add extra protection to the tank.

When the HEAT warhead strikes the reactive armor, the armor moves to provide maximum protection and explodes outward to "counter" the shockwave from the enemy warhead.

By the time the HEAT warhead reaches the main armor, its focused wave is disrupted and its power is drastically reduced.

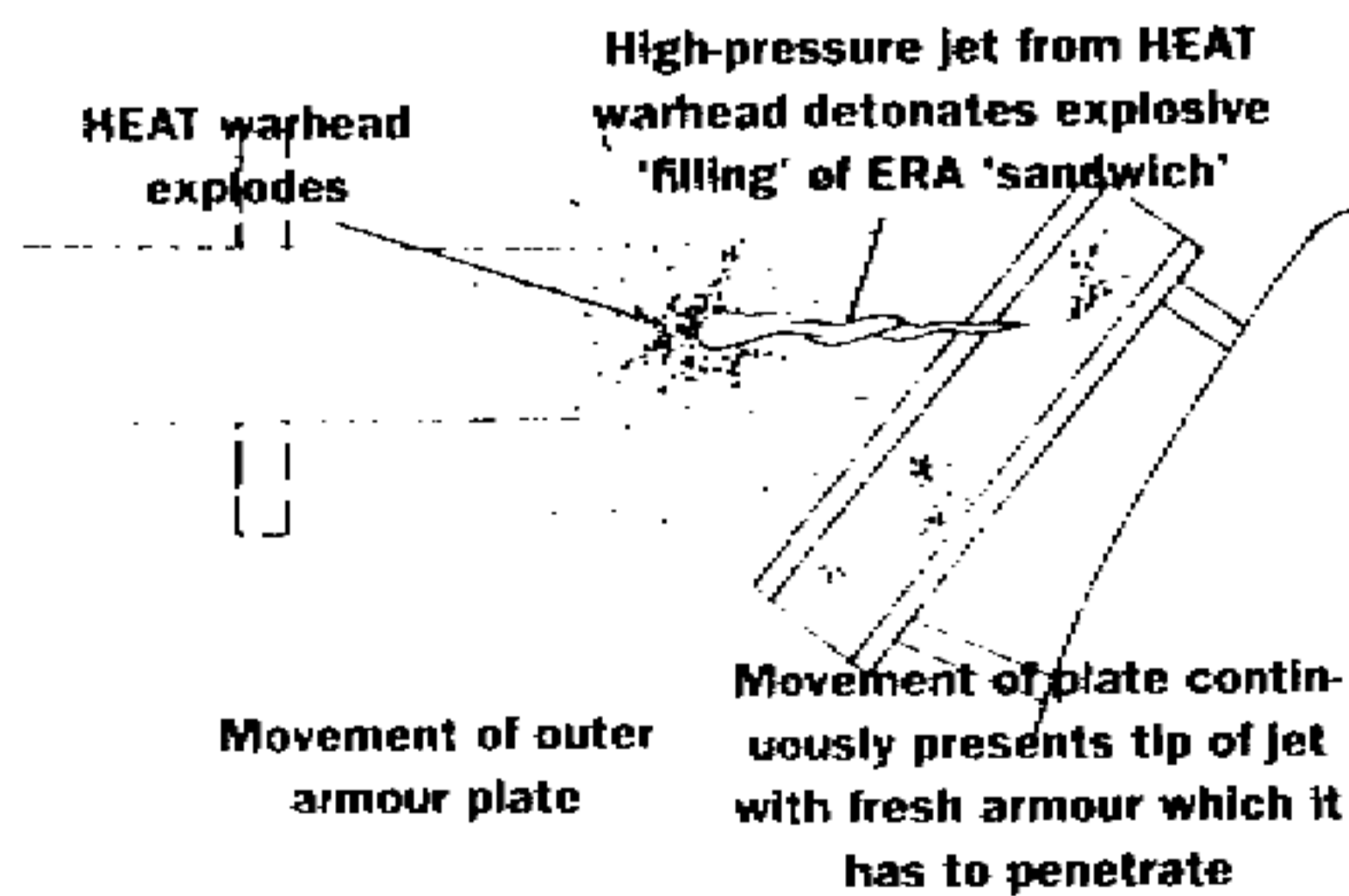
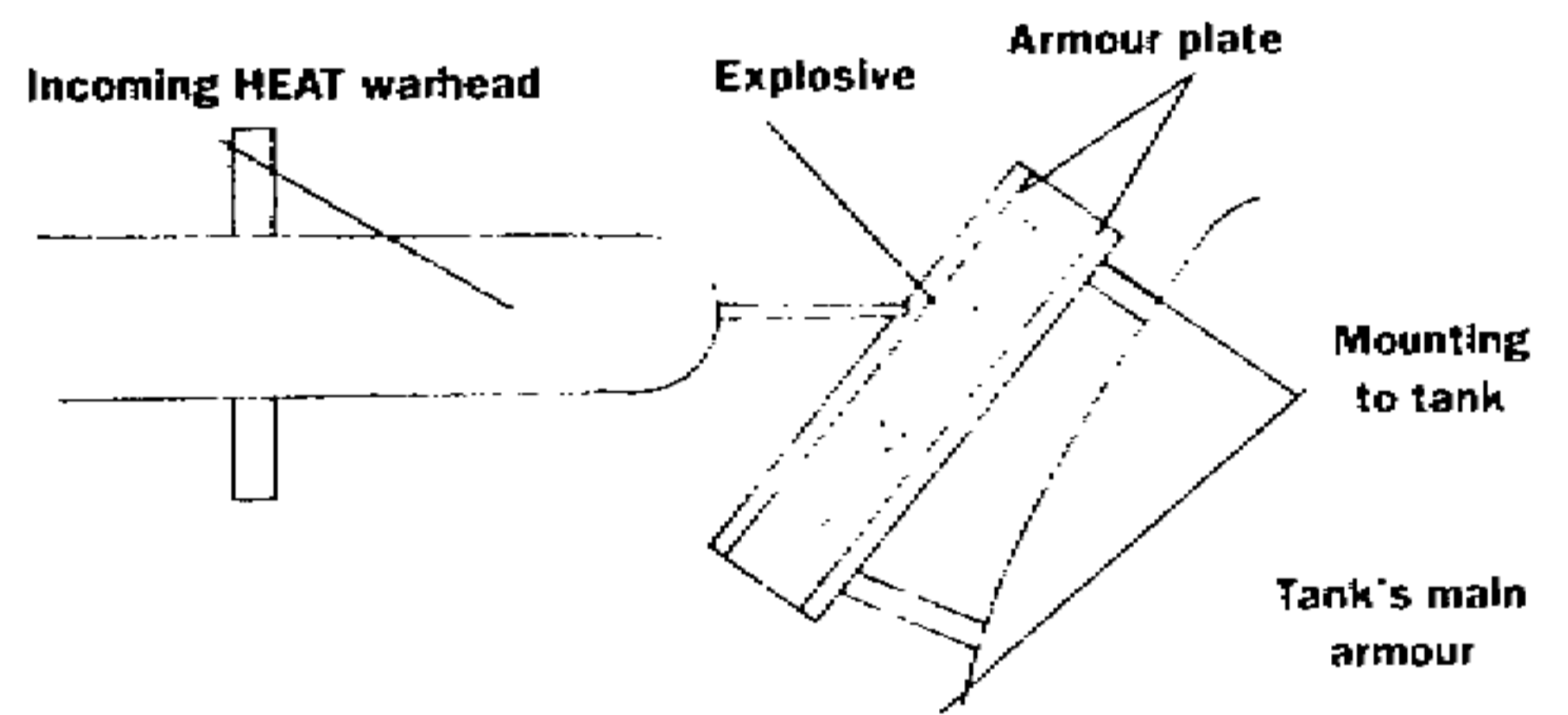

# History, Design, and Manufacture of Explosives

## Chapter 10

### Safety and Material Handling

#### Safety Rules for storing and handling Explosives

Do not store sensitive primers and detonators in the same location as primary explosives.

Do not throw, drag, push or roll explosives when handling. They must be carefully lifted, moved and placed.

Do not make up primers in the storage area.

Do not smoke, have matches, any burning item such as a candle or lamp, firearms or cartridges, in or near the storage area.

Black Powders may cake over time and should be broken up gently before use.

Do not use metallic tools, welding equipment, or allow firearms practice anywhere near the storage facility.

If explosives freeze or get wet allow to air dry or warm. Do not try to apply artificial heat.

Use artificial light such as flashlights in storage areas.

Keep the doors locked, and unauthorized personnel away from storage areas.

Maintain good ventilation in the storage area.

Store all primary explosives in a separate magazine.

Do not store any main explosives in the primary explosive magazine or try to transport them together.

Do not remove explosives from packages until ready to use.

Open boxes with a screw driver and rubber mallets.

Don't try to tap on, open, or remove wires from blasting caps.

Do not place primer into main explosive charges until the charge is located in its firing position on-site.

# History, Design, and Manufacture of Explosives

## American Table of Distances for Storage of Explosives

Distances in feet\*

EXPLOSIVES <sup>(1,2,3,4)</sup>		Inhabited Buildings <sup>(8)</sup>		Public Highways <sup>(11)</sup> Class A to D		Passenger Railways— Public Highways with Traffic Volume of more than 3,000 Vehicles/ Day <sup>(10,11)</sup>		Separation of Magazines <sup>(5,12)</sup>	
						Barri- caded (6,7,9)	Unbarri- caded	Barri- caded (6,7,9)	Unbarri- caded
Pounds† Over	Pounds† Not Over								
2	5	70	140	30	60	51	102	6	12
5	10	90	180	35	70	64	128	8	16
10	20	110	220	45	90	81	162	10	20
20	30	125	250	50	100	93	186	11	22
30	40	140	280	55	110	103	206	12	24
40	50	150	300	60	120	110	220	14	28
50	75	170	340	70	140	127	254	15	30
75	100	190	380	75	150	139	278	16	32
100	125	200	400	80	160	150	300	18	36
125	150	215	430	85	170	159	318	19	38
150	200	235	470	95	190	175	350	21	42
200	250	255	510	105	210	189	378	23	46
250	300	270	540	110	220	201	402	24	48
300	400	295	590	120	240	221	442	27	54
400	500	320	640	130	260	238	476	29	58
500	600	340	680	135	270	253	506	31	62
600	700	355	710	145	290	266	532	32	64
700	800	375	750	150	300	278	556	33	66
800	900	390	780	155	310	289	578	35	70
900	1,000	400	800	160	320	300	600	36	72
1,000	1,200	425	850	165	330	318	636	39	78
1,200	1,400	450	900	170	340	336	672	41	82
1,400	1,600	470	940	175	350	351	702	43	86
1,600	1,800	490	980	180	360	366	732	44	88
1,800	2,000	505	1,010	185	370	378	756	45	90
2,000	2,500	545	1,090	190	380	408	816	49	98
2,500	3,000	580	1,160	195	390	432	864	52	104
3,000	4,000	635	1,270	210	420	474	948	58	116
4,000	5,000	685	1,370	225	450	513	1,026	61	122
5,000	6,000	730	1,460	235	470	546	1,092	65	130
6,000	7,000	770	1,540	245	490	573	1,146	68	136
7,000	8,000	800	1,600	250	500	600	1,200	72	144
8,000	9,000	835	1,670	255	510	624	1,248	75	150
9,000	10,000	865	1,730	260	520	645	1,290	78	156
10,000	12,000	875	1,750	270	540	687	1,374	82	164
12,000	14,000	885	1,770	275	550	723	1,446	87	174
14,000	16,000	900	1,800	280	560	756	1,512	90	180
16,000	18,000	940	1,880	285	570	786	1,572	94	188
18,000	20,000	975	1,950	290	580	813	1,626	98	196
20,000	25,000	1,055	2,000	315	630	876	1,752	105	210
25,000	30,000	1,130	2,000	340	680	933	1,866	112	224
30,000	35,000	1,205	2,000	360	720	981	1,962	119	238
35,000	40,000	1,275	2,000	380	760	1,026	2,000	124	248
40,000	45,000	1,340	2,000	400	800	1,068	2,000	129	258
45,000	50,000	1,400	2,000	420	840	1,104	2,000	135	270
50,000	55,000	1,460	2,000	440	880	1,140	2,000	140	280
55,000	60,000	1,515	2,000	455	910	1,173	2,000	145	290
60,000	65,000	1,565	2,000	470	940	1,206	2,000	150	300
65,000	70,000	1,610	2,000	485	970	1,236	2,000	155	310
70,000	75,000	1,655	2,000	500	1,000	1,263	2,000	160	320

# History, Design, and Manufacture of Explosives

## American Table of Distances for Storage of Explosives

Distances in feet.

EXPLOSIVES <sup>(1,2,3,4)</sup>		Inhabited Buildings <sup>(9)</sup>		Public Highways <sup>(11)</sup> Class A to D		Passenger Railways— Public Highways with Traffic Volume of more than 3,000 Vehicles/ Day <sup>(10,11)</sup>		Separation of Magazines <sup>(5,12)</sup>	
Pounds† Over	Pounds† Not Over	Barri- caded (6,7,8)	Unbarri- caded	Barri- caded (6,7,8)	Unbarri- caded	Barri- caded (6,7,8)	Unbarri- caded	Barri- caded (6,7,8)	Unbarri- caded
75,000	80,000	1,695	2,000	510	1,020	1,293	2,000	165	330
80,000	85,000	1,730	2,000	520	1,040	1,317	2,000	170	340
85,000	90,000	1,760	2,000	530	1,060	1,344	2,000	175	350
90,000	95,000	1,790	2,000	540	1,080	1,368	2,000	180	360
95,000	100,000	1,815	2,000	545	1,090	1,392	2,000	185	370
100,000	110,000	1,835	2,000	550	1,100	1,437	2,000	195	390
110,000	120,000	1,855	2,000	555	1,110	1,479	2,000	205	410
120,000	130,000	1,875	2,000	560	1,120	1,521	2,000	215	430
130,000	140,000	1,890	2,000	565	1,130	1,557	2,000	225	450
140,000	150,000	1,900	2,000	570	1,140	1,593	2,000	235	470
150,000	160,000	1,935	2,000	580	1,160	1,629	2,000	245	490
160,000	170,000	1,965	2,000	590	1,180	1,662	2,000	255	510
170,000	180,000	1,990	2,000	600	1,200	1,695	2,000	265	530
180,000	190,000	2,010	2,010	605	1,210	1,725	2,000	275	550
190,000	200,000	2,030	2,030	610	1,220	1,755	2,000	285	570
200,000	210,000	2,055	2,055	620	1,240	1,782	2,000	295	590
210,000	230,000	2,100	2,100	635	1,270	1,836	2,000	315	630
230,000	250,000	2,155	2,155	650	1,300	1,890	2,000	335	670
250,000	275,000	2,215	2,215	670	1,340	1,950	2,000	360	720
275,000	300,000	2,275	2,275	690	1,380	2,000	2,000	385	770

Numbers in ( ) refer to explanatory notes.

Note 1: "Explosive materials" means explosives, blasting agents, and detonators.

Note 2: "Explosives" means any chemical compound, mixture or device, the primary or common purpose of which is to function by explosion. A list of explosives determined to be within the coverage of "18 U.S.C. Chapter 40, Importation, Manufacture, Distribution and Storage of Explosive Materials" is issued at least annually by the Director, Bureau of Alcohol, Tobacco, and Firearms, Department of U.S. Treasury. For quantity and distance purposes, detonating cord of 50 grains per foot should be calculated as equivalent to 8 lbs (3.7 kg) of high explosives per 1,000 feet (305 m). Heavier or lighter core loads should be rated proportionately.

Note 3: "Blasting Agents" means any material or mixture, consisting of fuel and oxidizer, intended for blasting, not otherwise defined as an explosive: provided that the finished product, as mixed for use or shipment, cannot be detonated by means of a number 8 test blasting cap when unconfined.

Note 4: "Detonator" means any device containing any initiating or primary explosive that is used for initiating detonation. A detonator may not contain more than 10 g of total explosives by weight, excluding ignition or delay charges. The term includes, but is not limited to, electric blasting caps of instantaneous and delay types, blasting caps for use with safety fuses, detonating cord delay connectors, and nonelectric instantaneous and delay blasting caps that use detonating cord, shock tube, or any other replacement for electric leg wires. All types of detonators in strengths through No. 8 cap should be rated at 1½ lb (0.7 kg) of explosives per 1,000 caps. For strengths higher than No. 8 cap, consult the manufacturer.

Note 5: "Magazine" means any building, structure, or container, other than an explosives manufacturing building, approved for the storage of explosive materials.

Note 6: "Natural Barricade" means natural features of the ground, such as hills, or timber of sufficient density that the surrounding exposures which require protection cannot be seen from the magazine when the trees are bare of leaves.

Note 7: "Artificial Barricade" means an artificial mound or revetted wall of earth of a minimum thickness of three feet (0.9 m).

Note 8: "Barricaded" means that a building containing explosives is effectually screened from a magazine, building, railway, or highway, either by a natural barricade, or by an artificial barricade of such height that a straight line from the top of any sidewall of the building containing explosives to the eave line of any magazine, or building, or to a point twelve feet (3.7 m) above the center of a railway or highway, will pass through such intervening natural or artificial barricade.

Note 9: "Inhabited Building" means a building regularly occupied in whole or in part as a habitation for human beings, or any church, schoolhouse, railroad station, store, or other structure where people are accustomed to assemble, except any building or structure occupied in connection with the manufacture, transportation, storage or use of explosive materials.

Note 10: "Railway" means any steam, electric, or other railroad or railway which carries passengers for hire.

Note 11: "Highway" means any public street, public alley or public road. "Public Highways Class A to D" are highways with average traffic volume of 3,000 or less vehicles per day as specified in "American Civil Engineering Practice" (Abbott, Vol. 1, Table 46, Sec. 3-74, 1956 Edition, John Wiley and Sons).

Note 12: When two or more storage magazines are located on the same property, each magazine must comply with the minimum distances specified from inhabited buildings, railways, and highways, and, in addition, they should be separated from each other by not less than the distances shown for "Separation of Magazines," except that the quantity of explosive materials contained in detonator magazines shall govern in regard to the spacing of said detonator magazines from magazines containing other explosive materials. If any two or more magazines are separated from each other by less than the specified "Separation of Magazines" distances, then such two or more magazines, as a group, must be considered as one magazine, and the total quantity of explosive materials stored in such group must be treated as if stored in a single magazine located on the site of any magazine of the group, and must comply with the minimum of distances specified from other magazines, inhabited buildings, railways, and highways.

Note 13: Storage in excess of 300,000 lbs. (136,200 kg) of explosive materials in one magazine is generally not required for commercial enterprises.

Note 14: This Table applies only to the manufacture and permanent storage of commercial explosive materials. It is not applicable to transportation of explosives or any handling or temporary storage necessary or incident thereto. It is not intended to apply to bombs, projectiles, or other heavily encased explosives.

\* one foot equals 0.3048 m

† one pound equals 0.4536 kg

# History, Design, and Manufacture of Explosives

## American Table of Distances for Storage of Explosives

Donor Weight		Minimum Separation Distance of Receptor when Barricaded <sup>2</sup> (ft§)		Minimum Thickness of Artificial Barricades <sup>5</sup> (in.)#
Pounds‡ Over	Pounds‡ Not Over	Ammonium Nitrate <sup>3</sup>	Blasting Agent <sup>4</sup>	
	100	3	11	12
100	300	4	14	12
300	600	5	18	12
600	1,000	6	22	12
1,000	1,600	7	25	12
1,600	2,000	8	29	12
2,000	3,000	9	32	15
3,000	4,000	10	36	15
4,000	6,000	11	40	15
6,000	8,000	12	43	20
8,000	10,000	13	47	20
10,000	12,000	14	50	20
12,000	16,000	15	54	25
16,000	20,000	16	58	25
20,000	25,000	18	65	25
25,000	30,000	19	68	30
30,000	35,000	20	72	30
35,000	40,000	21	76	30
40,000	45,000	22	79	35
45,000	50,000	23	83	35
50,000	55,000	24	86	36
55,000	60,000	25	90	35
60,000	70,000	26	94	40
70,000	80,000	28	101	40
80,000	90,000	30	108	40
90,000	100,000	32	115	40
100,000	120,000	34	122	50
120,000	140,000	37	133	50
140,000	160,000	40	144	50
160,000	180,000	44	158	50
180,000	200,000	48	173	50
200,000	220,000	52	187	60
220,000	250,000	56	202	60
250,000	275,000	60	216	60
275,000	300,000	64	230	60

Note 1: Recommended separation distances to prevent explosion of ammonium nitrate and ammonium nitrate-based blasting agents by propagation from nearby stores of high explosives or blasting agents referred to in the Table as the "donor." Ammonium nitrate, by itself, is not considered to be a donor when applying this Table. Ammonium nitrate, ammonium nitrate-fuel oil or combinations thereof are acceptors. If stores of ammonium nitrate are located within the sympathetic detonation distance of explosives or blasting agents, one-half the mass of the ammonium nitrate should be included in the mass of the donor.

These distances apply to the separation of stores only.

Note 2: When the ammonium nitrate and/or blasting agent is not barricaded, the distances shown in the Table shall be multiplied by six. These distances allow for the possibility of high velocity metal fragments from mixers, hoppers, truck bodies, sheet metal structures, metal containers, and the like which may enclose the "donor." Where storage is in bullet-resistant magazines\* recommended for explosives or where the storage is protected by a bullet-resistant wall, distances and barricade thicknesses in excess of those prescribed in the American Table of Distances are not required.

Note 3: The distances in the Table apply to ammonium nitrate that passes the insensitivity test prescribed in the definition of ammonium nitrate fertilizer promulgated by the National Plant Food Institute;† and ammonium nitrate failing to pass said test shall be stored at separation distances determined by competent persons and approved by the authority having jurisdiction.

Note 4: These distances apply to nitrocarbonitrates and blasting agents which pass the insensitivity test prescribed in the U.S. Department of Transportation (DOT) and the U.S. Department of the Treasury, Bureau of Alcohol, Tobacco, and Firearms.

Note 5: Earth, or sand dikes, or enclosures filled with the prescribed minimum thickness of earth or sand are acceptable artificial barricades. Natural barricades, such as hills or timber of sufficient density that the surrounding exposures which require protection cannot be seen from the "donor" when the trees are bare of leaves, are also acceptable.

Note 6: For determining the distances to be maintained from inhabited buildings, passenger railways, and public highways, use the Table of Distances for Storage of Explosives in Appendix A of NFPA, 1973, Code for the Manufacture, Transportation, Storage, and Use of Explosive Materials.

\* For construction of bullet-resistant magazines see Chapter 6 of NFPA No. 495, Explosives Materials Code.

† Definition and Test Procedures for Ammonium Nitrate Fertilizer, National Plant Food Institute, November 1964.

‡ one pound equals 0.4536 kg

§ one ft equals 0.3048 m

# one in equals 25.4 mm

When you need to know absolutely, positively, how to destroy it by tomorrow- Call STIP!

Published By STIP  
PO Box 59  
Silver Creek, Nebr. 68663

**Scientific Principles of Improvised Warfare and Home Defense \$30/Volume**

**Volume 1 Basic Training**

Hand Held Weapons

Chemistry, Manufacture and Use of Explosives

Mounted Weapons

Properties and Improvisation of Firearms

Hand Held Firearms and Explosives

Non Explosive Chemical Weapons and Incendiaries

**Volume 2 Basic Training**

Bio Toxic Weapons

Armor, Personal Protection, and Material Handling

Combat Support, Skills, and Equipment

Defensive Obstacle Construction and Countermeasure

Booby Traps, Mines and Positioned Weapons

Strategies, Tactics, Resistance, and Countermeasures

**Volume 3 History, Design, and Manufacture of Explosives**

**Volume 4 Incendiaries: The Science of Using Fire as a Weapon**

**Volume 5 Advanced Chemical Weapon Design and Manufacture**

**Volume 6-1 Advanced Biological Weapons Design and Manufacture**

Biological Entry

Bacteria Based Weapons

## **Lab Supplement**

The material in this laboratory supplement is designed to provide the readers of our encyclopedia series a visual reference for lab procedures and general operations that we describe but sometimes do not picture in our textbooks. There are thousands of pieces of equipment and supplies that are used in laboratories today. Many of these are common instruments like thermometers and drying ovens, or simple crucibles or cups.

Some of the procedures we describe in our books dealing with chemical instructions for explosives, incendiaries, and various biologicals were not well understood by our readers. I have selected a number of lab materials to illustrate and describe here so that you, the reader will better understand what we are talking about and we will include this with the first order of our books for free. This is not a comprehensive supplement. It is intended to fill in at least some of the blanks that the readers encounter if they don't understand a procedure we describe.

### **Safety in the Laboratory**

1. Wear eye protection when working around all chemicals and biologicals.
2. Wear dust masks or gas masks if the material you are working with represents an inhalation hazard.
3. Do not taste chemicals or other materials
4. Do not eat, drink, or smoke in the lab. This is because of the chance of contamination of consumables by dangerous effluents and dusts.
5. Wear shoes at all times.
6. Never work alone.
7. Use exhaust equipment or fume hoods for any material that produces vapors.
8. If you need to smell a substance, never directly smell it. Place the source a few inches away and fan the fumes towards you with your hand.
9. Wear gloves to handle any glassware or other heated materials.
10. When mixing acids, always add the acid to the water, never add the water to the acid.
11. Keep all volatile liquids away from flame or ignition sources.



## Scientific Principles of Improvised Warfare - Lab Supplement

12. Discard all solid waste in a waste basket, or not pour down the sink. This is to avoid dangerous combinations.
13. If you have skin contact with dangerous materials, always wash immediately with soap and water for 15 minutes. Use disinfectant if working with biologicals.
14. Accurately label all materials and mixes at all times.

### DO NOT CONTACT

**Alkali metals**, such as calcium, potassium and sodium with water, carbon dioxide, carbon tetrachloride, and other chlorinated hydrocarbons.

**Acetic Acid** with chromic acid, nitric acid, hydroxyl-containing compounds, ethylene glycol, perchloric acid, peroxides and permanganates.

**Acetone** with concentrated sulphuric and nitric acid mixtures.

**Acetylene** with copper (tubing), fluorine, bromine, chlorine, iodine, silver, mercury or their compounds.

**Ammonia, Anhydrous** with mercury, halogens, calcium hypochlorite or hydrogen fluoride.

**Ammonium Nitrate** with acids, metal powders, flammable fluids, chlorates, nitrates, sulphur and finely divided organics or other combustibles.

**Aniline** with nitric acid, hydrogen peroxide or other strong oxidizing agents.

**Bromine** with ammonia, acetylene, butadiene, butane, hydrogen, sodium carbide, turpentine, or finely divided metals.

**Chlorates** with ammonium salts, acids, metal powders, sulfur, carbon, finely divided organics or other combustibles.

**Chromic Acid** with acetic acid, naphthalene, camphor, alcohol, glycerine, turpentine and other flammable liquids.

**Chlorine** with ammonia, acetylene, butadiene, benzene and other petroleum fractions, hydrogen, sodium carbides, turpentine and finely divided powdered metals.

**Cyanides** with acids.

**Hydrogen Peroxide** with copper, chromium, iron, most metals or their respective salts, flammable fluids and other combustible materials, aniline and nitro-methane.

**Hydrogen Sulfide** with nitric acid, oxidizing gases.

**Hydrocarbons, generally**, with fluorine, chlorine, bromine, chromic acid or sodium peroxide.

**Iodine** with acetylene or ammonia.

**Mercury** with acetylene, fulminic acid.

**Nitric Acid** with acetic, chromic and hydrocyanic acids, aniline, carbon, hydrogen sulfide, flammable fluids or gases and substances which are readily nitrated.

**Oxygen** with oils, grease, hydrogen, flammable liquids, solids and gases.

**Oxalic Acid** with silver or mercury.

**Perchloric Acid** with acetic anhydride, bismuth and its alloys, alcohol, paper, wood and other organic materials.

**Phosphorous Pentoxide** with water.

**Potassium Permanganate** with glycerine, ethylene glycol, benzaldehyde, sulfuric acid.

**Sodium Peroxide** with any oxidizable substances, for instance: methanol, glacial acetic acid, acetic anhydride, benzaldehyde, carbon disulfide, glycerine, ethylene glycol, ethyl acetate, furfural, etc.

**Sulfuric Acid** with chlorates, perchlorates, permanganates and water.

## Scientific Principles of Improvised Warfare - Lab Supplement

### CONVERSION FACTORS

To Convert From	To	Multiply By	To Convert From	To	Multiply By
Centimeters	Feet (U.S.)	0.0328	Cubic Inches	Cubic Centimeters	16.3872
	Inches (U.S.)	0.3937		Square Inches	Square Centimeters
Cubic Centimeters	Cubic Inches (U.S.)	0.0610	Kilogram	Pounds (Avoirdupois)	2.2046
	Gallons (U.S.)	$2.6417 \times 10^{-4}$		Ounces (Avoirdupois)	35.27
	Milliliters	0.9999	Liter	Quarts	1.0570
	Ounces (U.S., Fluid)	0.0338		Cubic Centimeters	1000.0280
	Pints (U.S., Liquid)	0.0021		Gallons (U.S.)	0.2642
Quarts (U.S., Liquid)	0.0011	Ounces (U.S., Fluid)	33.8143		
			Pints (U.S., Liquid)	2.1134	
Square Centimeters	Square Inches	0.1550	Meters	Feet (U.S.)	3.2808
Drams (Avoirdupois)	Ounces (Avoirdupois)	0.0625		Inches (U.S.)	39.37
	Pounds	0.0039	Cubic Meters	Cubic Feet (U.S.)	35.3144
	Dram (Apothecaries)	0.4557		Cubic Inches (U.S.)	61023.38
Drams (U.S. Fluid)	Cubic Centimeters	3.6967	Square Meters	Square Inches	1550
	Gallons (U.S.)	$9.7656 \times 10^{-4}$		Square Feet	10.76
	Ounces (Fluid)	0.1250	Microns	Centimeters	$1 \times 10^{-4}$
		Inches		$3.937 \times 10^{-5}$	
Feet (U.S.)	Centimeters	30.4801	Pints	Cubic Centimeters	473.179
				Cubic Inches	28.875
Cubic Feet (U.S.)	Cubic Centimeters	28317.016		Liters	0.4732
	Liters	28.31625	Pounds (Avoirdupois)	Grains	7000
	Quarts (U.S., Liquid)	29.922		Grams	453.5924
		Pounds (Troy)		1.2153	
Square Feet (U.S.)	Square Meters	0.0929	Milliliters	Cubic Centimeters	1.000028
				Ounces (U.S., Fluid)	0.0338
				Pints (U.S., Liquid)	0.00211
				Dram (Apothecaries)	0.2705
Gallons (U.S.)	Cubic Centimeters	3785.434	Ounces	Gallons (U.S.)	1/128
	Cubic Feet	0.1337		Liters	0.0296
	Gallons (British)	0.8327		Milliliters	29.5729
	Liters	3.7853			
	Ounces (U.S., Fluid)	128			
Grams	Grains	15.4324			
	Drams	0.5643			
	Ounces (Avoirdupois)	0.0353			
	Pounds (Avoirdupois)	0.0022			
Inches (U.S.)	Centimeters	2.5400			
	Millimeters	25.4001			

# Scientific Principles of Improvised Warfare - Lab Supplement

The most common laboratory equipment includes -

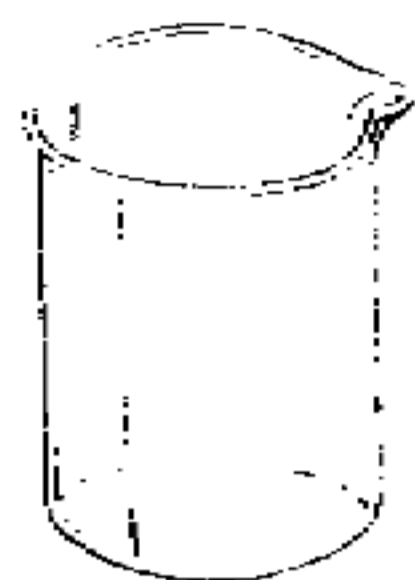

Beaker



Erlenmeyer flask



Suction flask



Graduated cylinder



Thermometer



Test tube

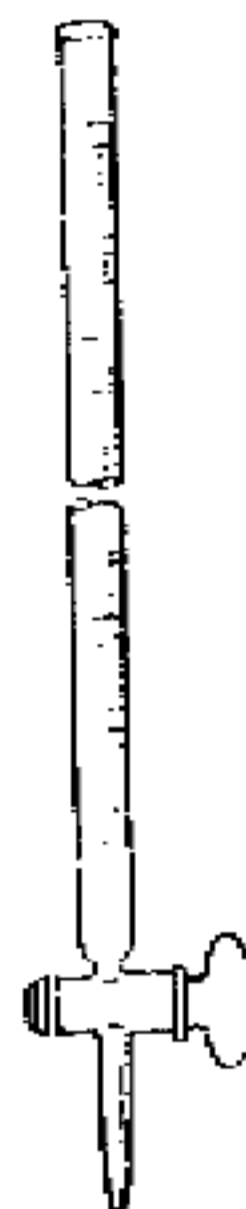

Buret



Pipet



Funnel

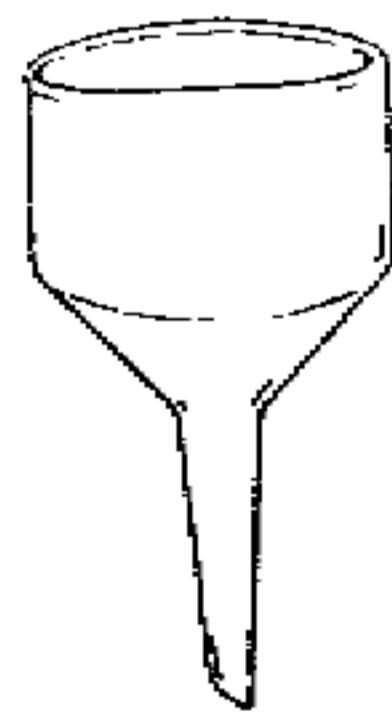

Büchner funnel



Test tube brush



Crucible and cover

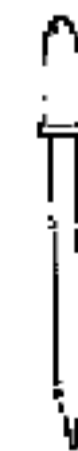

Eye dropper

# Scientific Principles of Improvised Warfare - Lab Supplement



Crucible tongs



Test tube holder

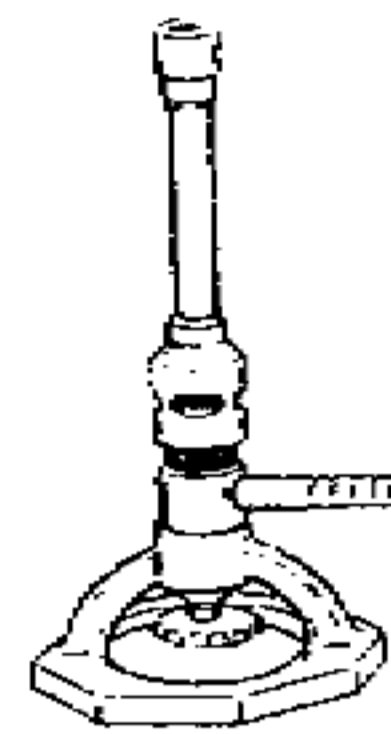

Bunsen burner  
(Tirrill type)

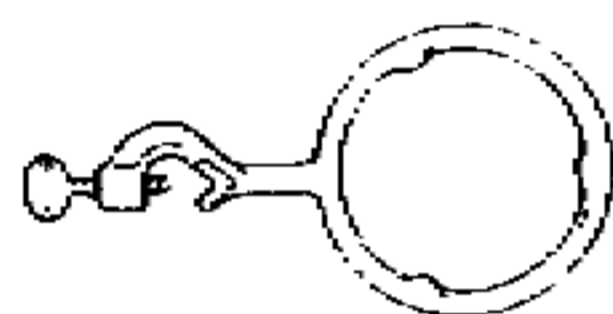

Ring support



Utility clamp

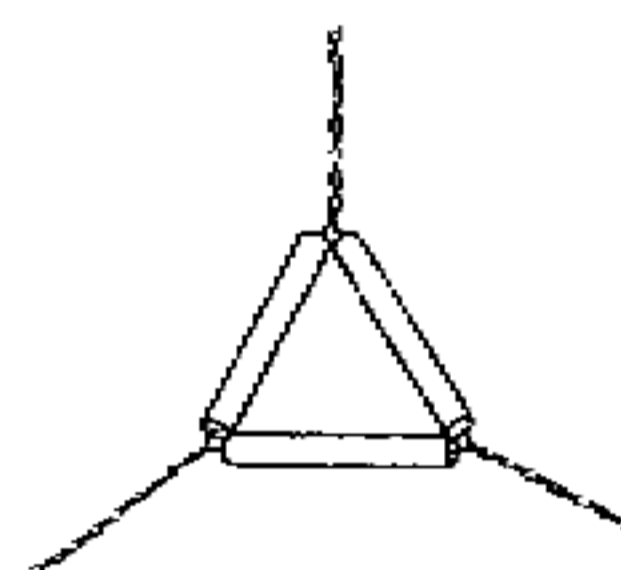

Clay triangle

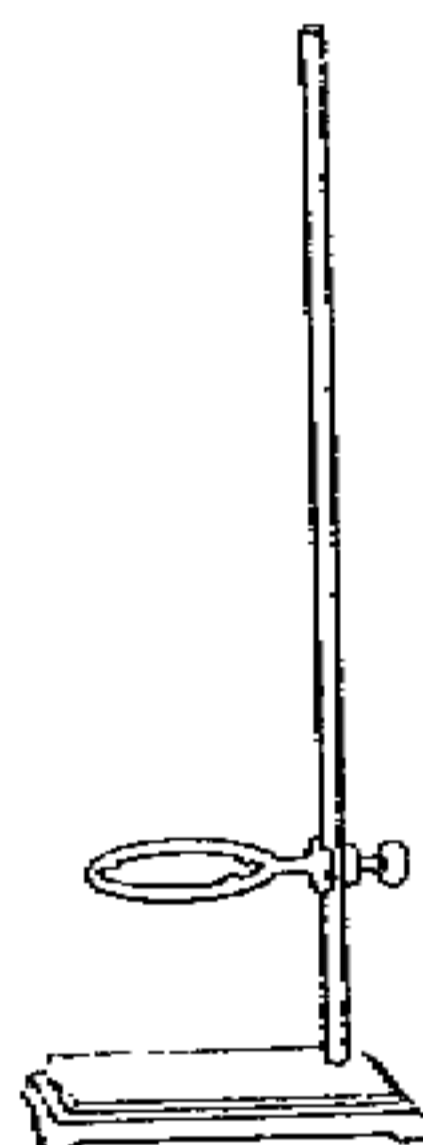

Ring stand with support

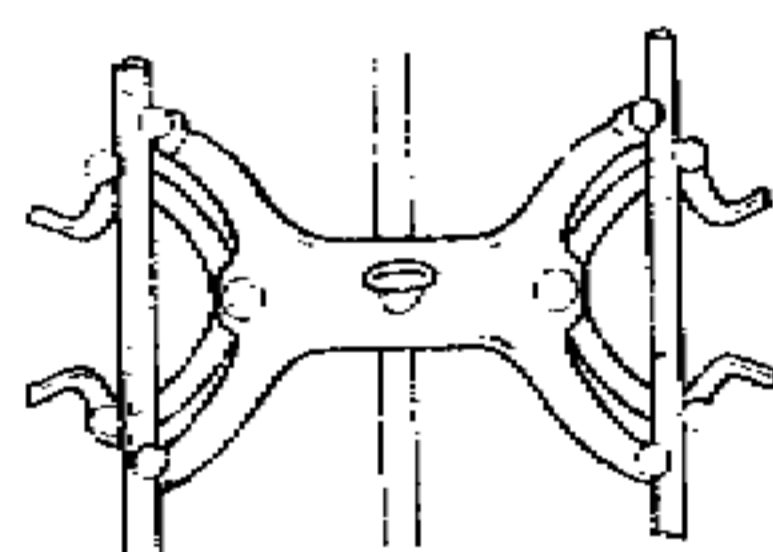

Buret clamp



Wire gauze



Evaporating dish



Watch glass

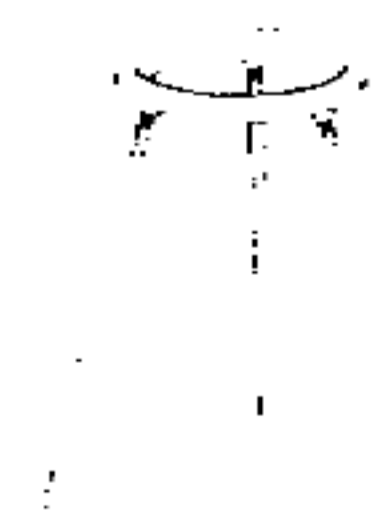

Tripod

## Scientific Principles of Improvised Warfare - Lab Supplement

The lab burner, often called a bunsen burner in chemistry classes provides heat for many chemical procedures.

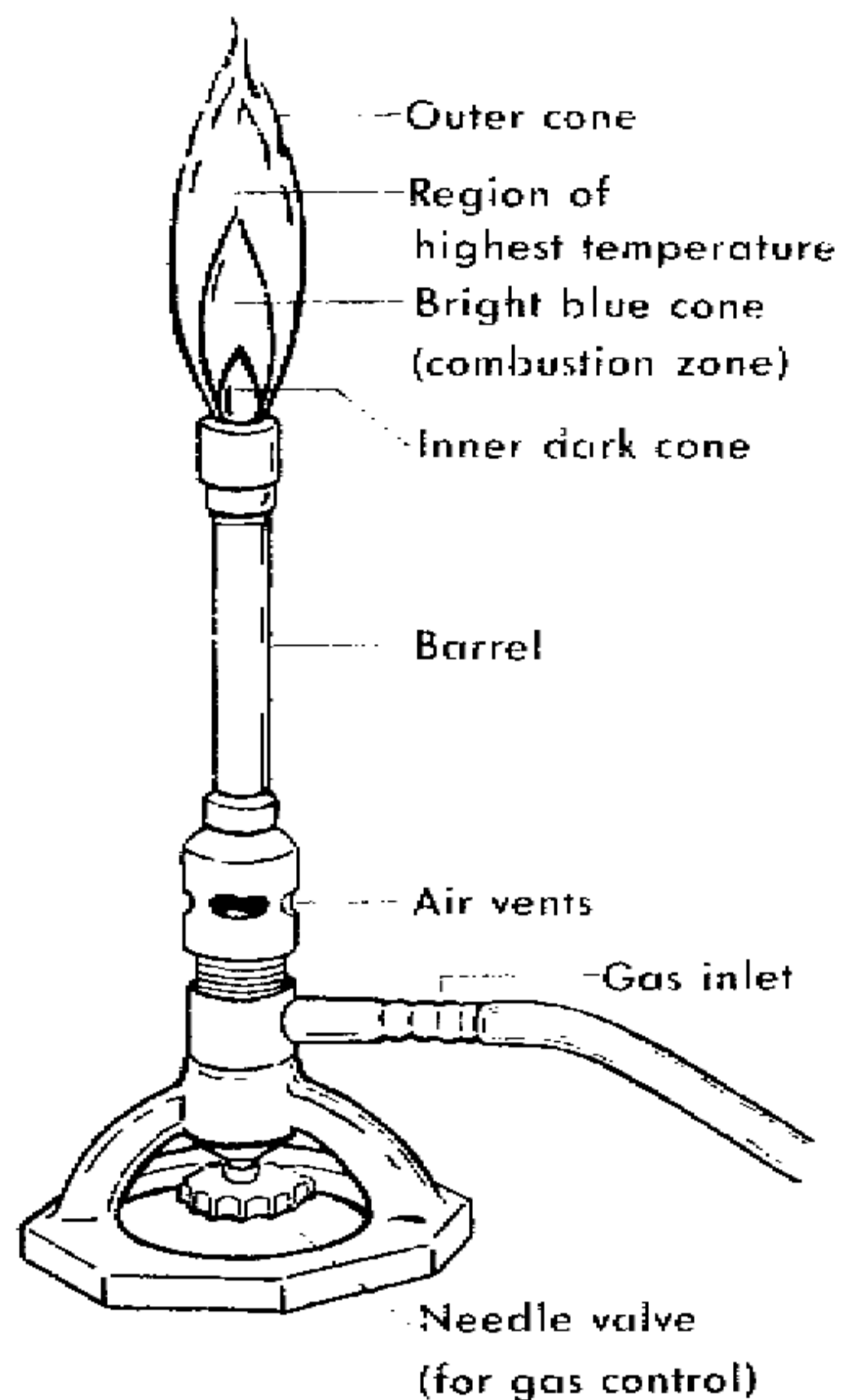

Pour liquid from a bottle to a container by running the stream down a glass rod.

Pouring from a beaker using a rod.

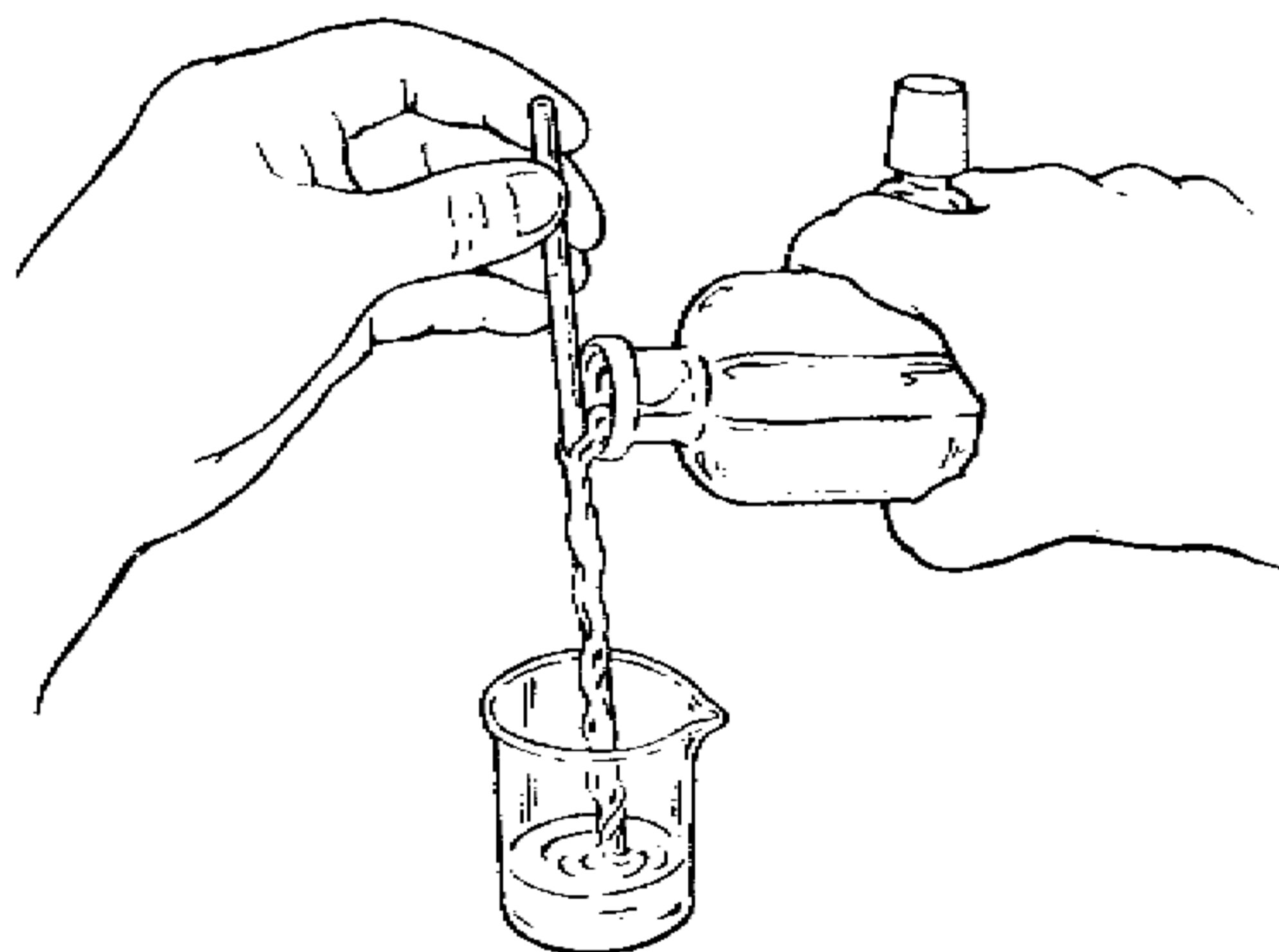

## Scientific Principles of Improvised Warfare - Lab Supplement

Measuring and moving solid chemicals. Tap your finger to disperse small amounts of the solids into the weigh or holding container.

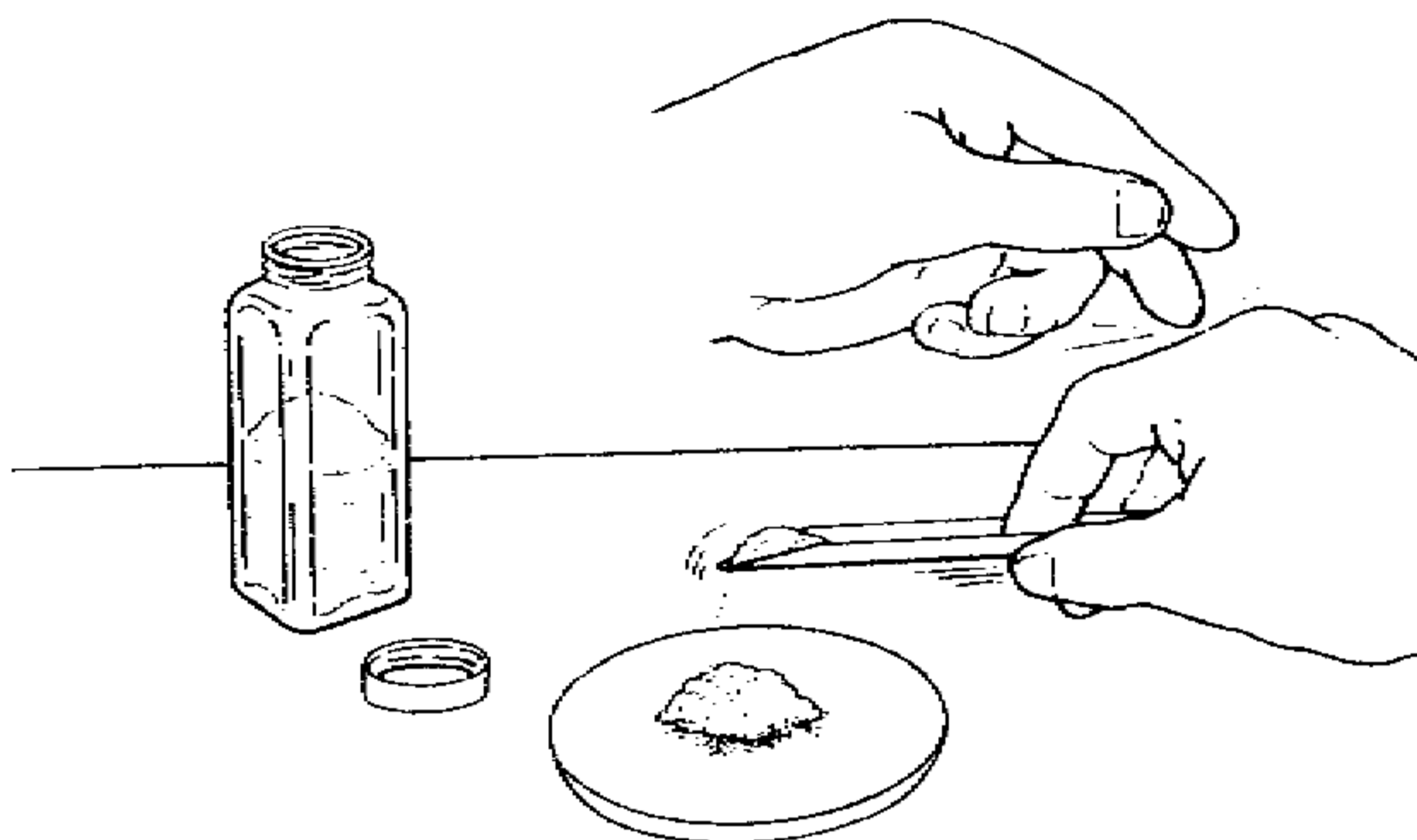

In biological testing of toxic materials on animals, a variety of procedures are used to identify dermal, eye, inhalation, and digestion effects. The animals must be autopsied in order to determine the internal effects. A decapitator is used to quickly kill lab animals. Generally, two sizes are available, the smaller one for rats and mice, while the larger one is used for rabbits, monkeys, and guinea pigs.

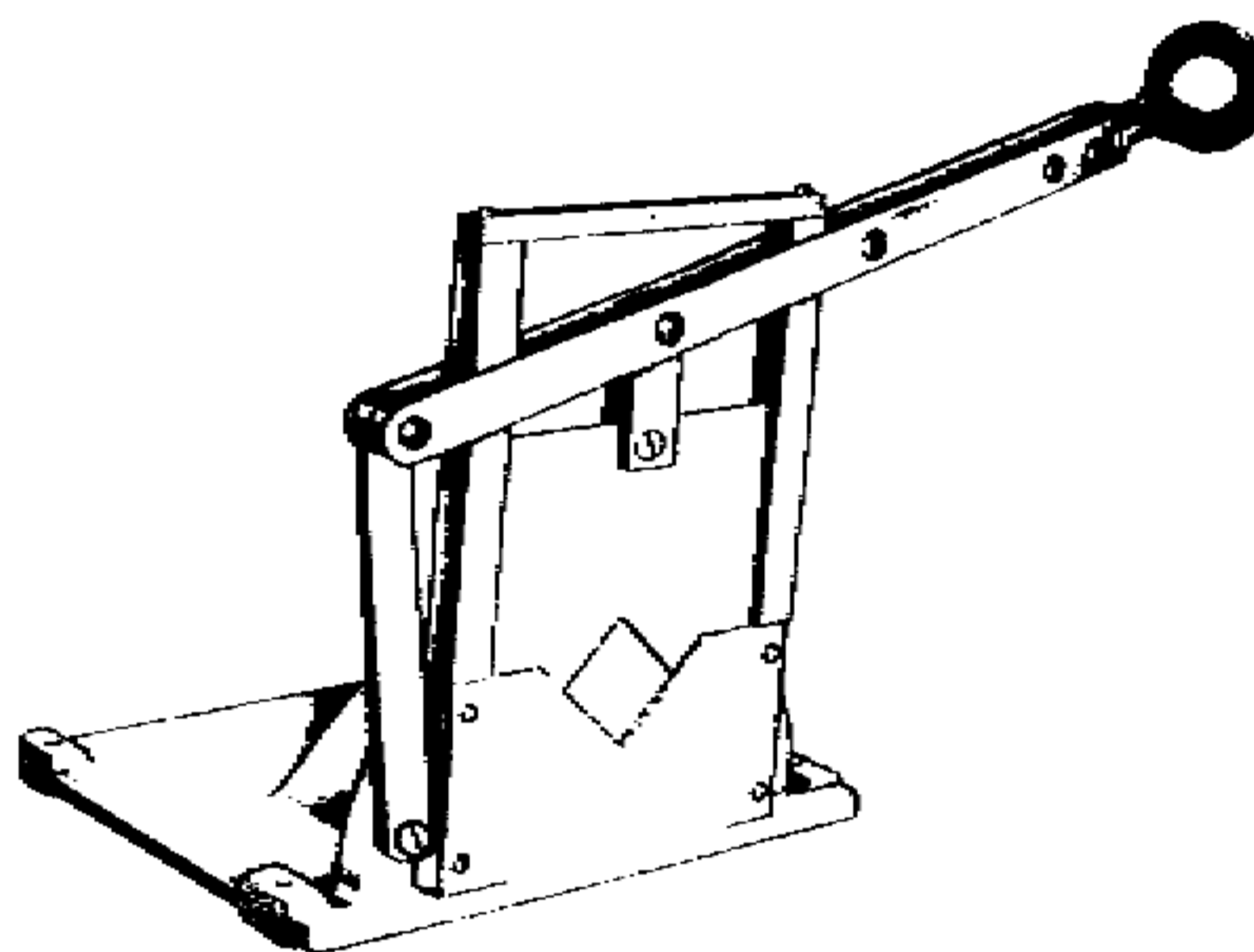

Animal restrainers are used to apply or tape on materials for dermal studies and to administer (gavage) internal doses. See Volume 2, end of chapter 7 on toxicology examinations.

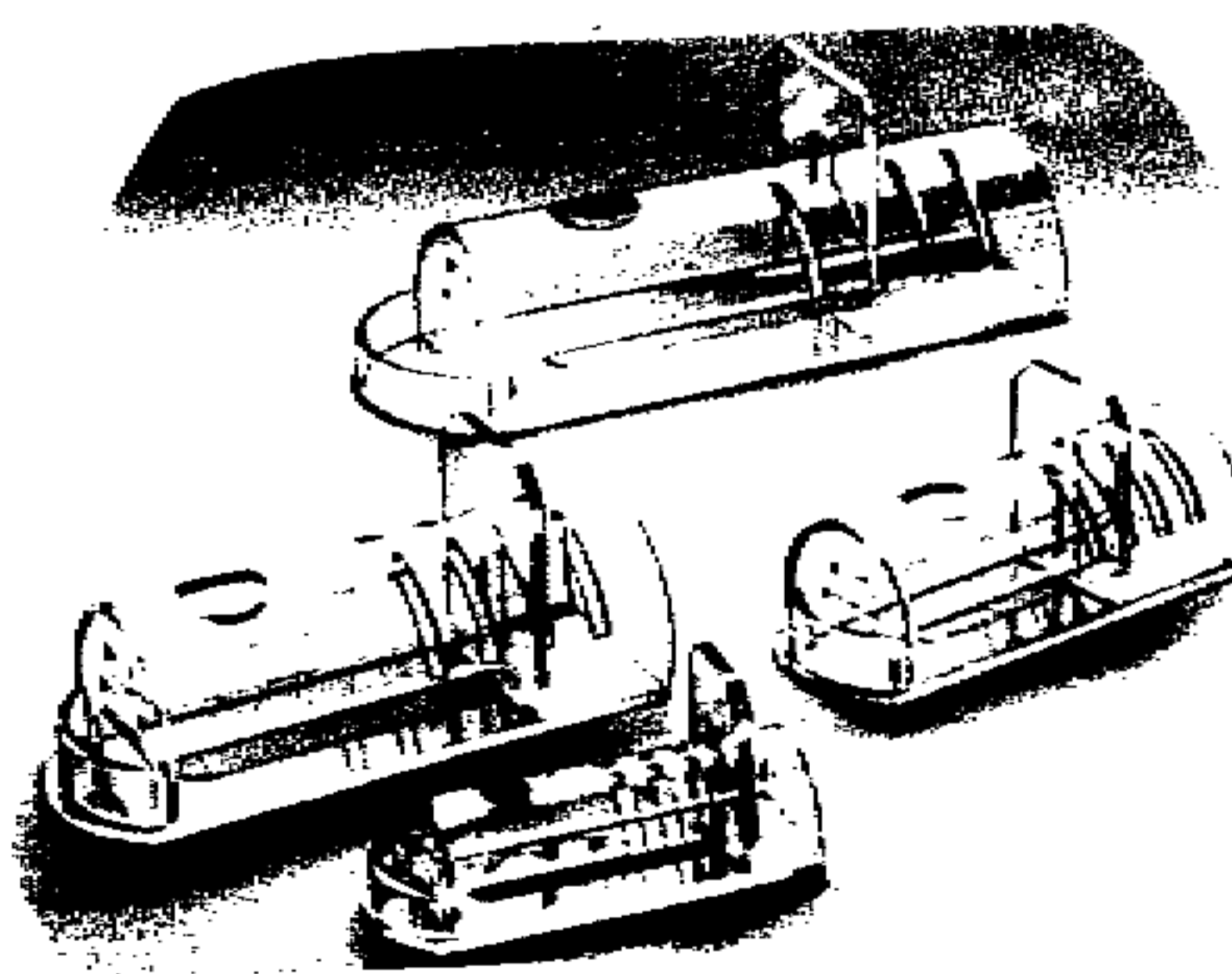

## Scientific Principles of Improvised Warfare - Lab Supplement

Balance beams are used to weigh test animals and materials.

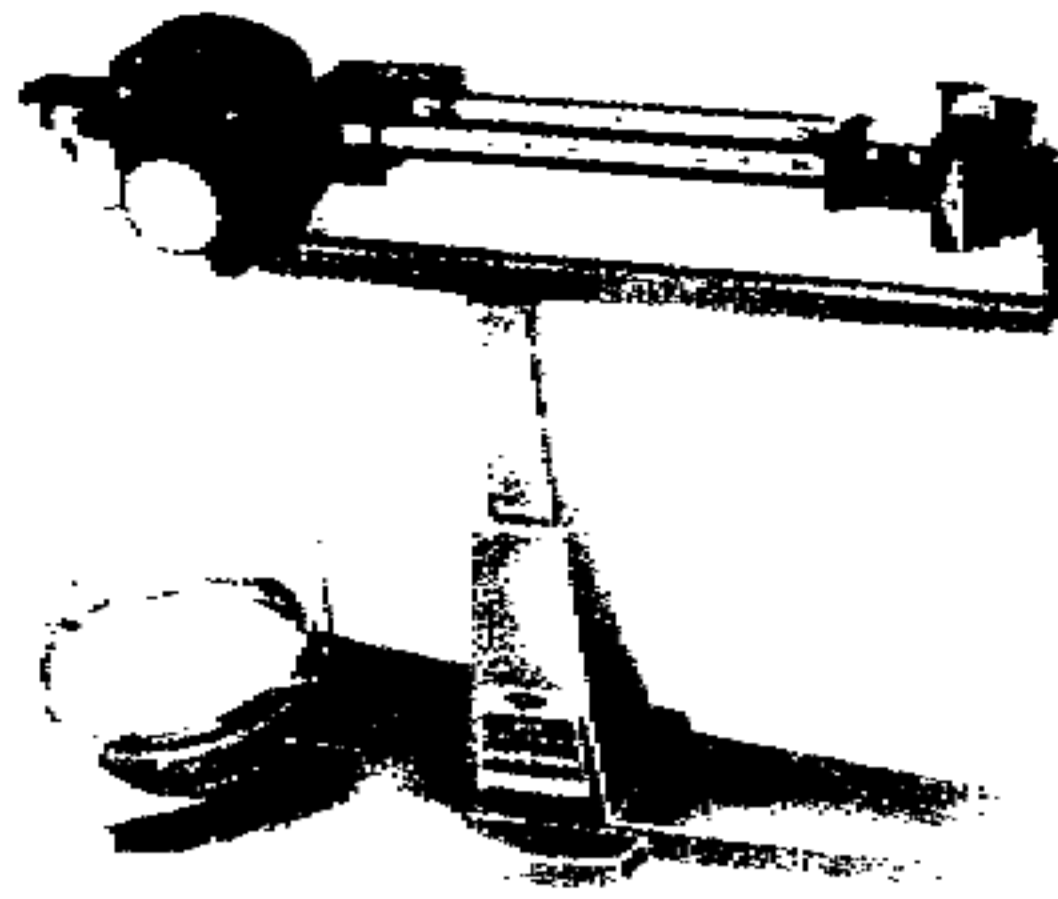

Plastic air tight containers, commonly called "gas paks" are used to culture and collect biologicals, especially anaerobic bacteria.

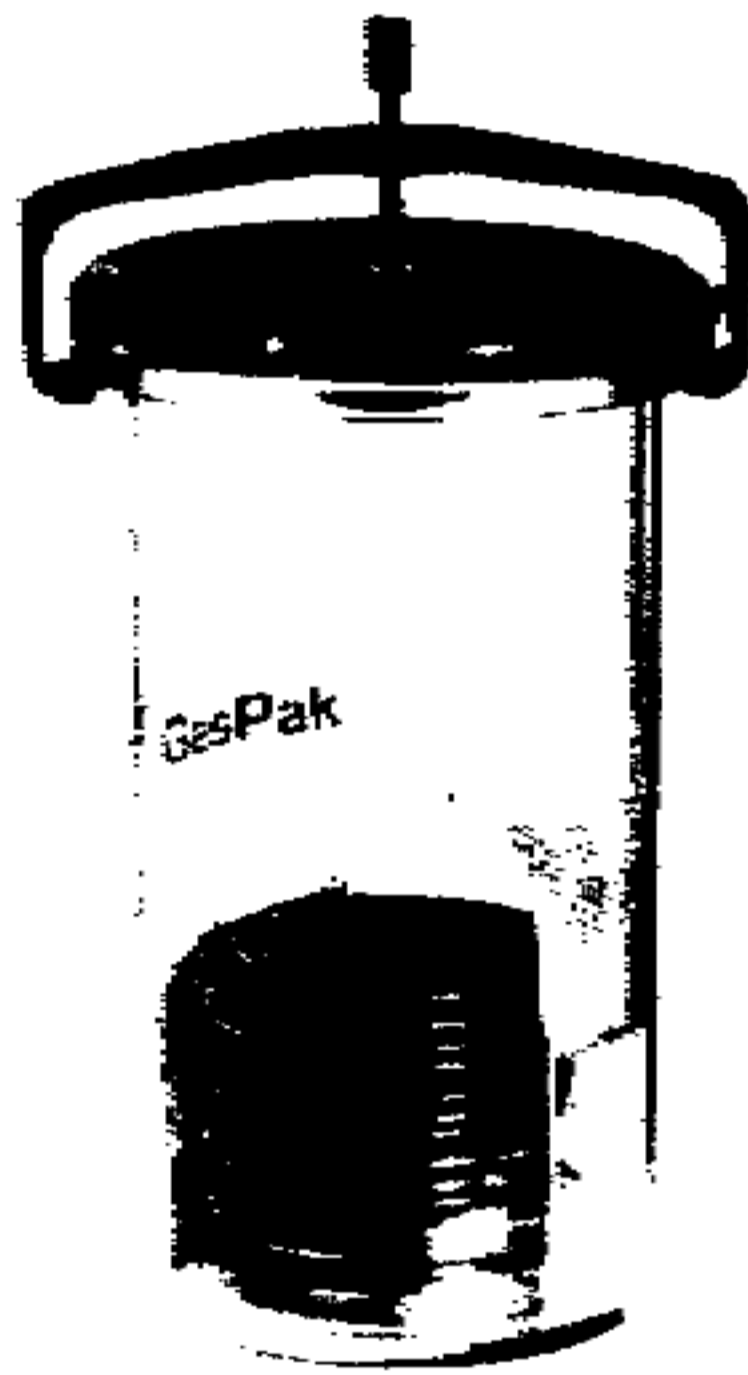

Wash bottles are used to administer streams of water, usually for cleaning surfaces and tissues.

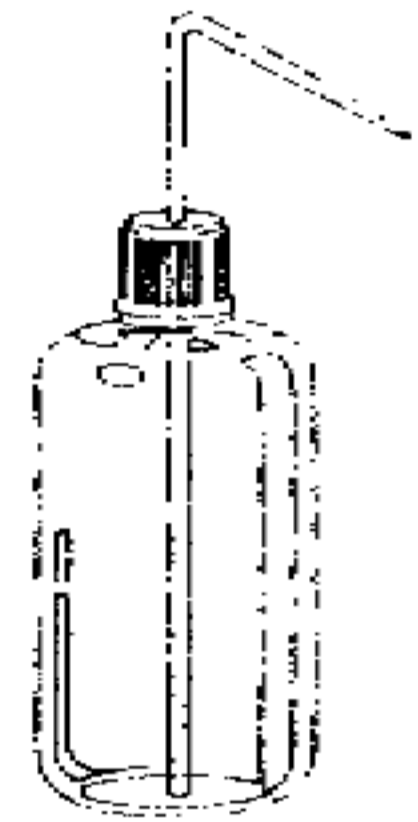

A wide range of burets are used to measure and add small amounts of liquids.

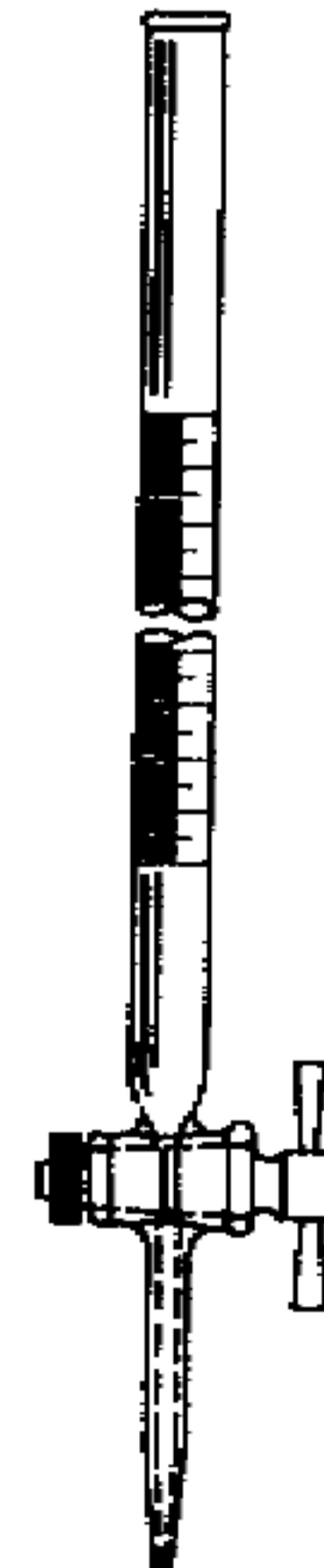
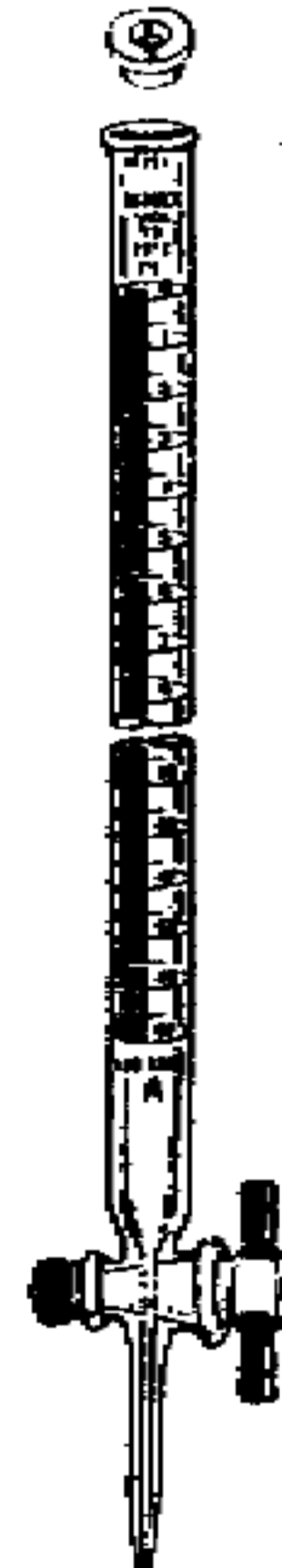

## Scientific Principles of Improvised Warfare - Lab Supplement

A true bunsen burner nozzle on a portable fuel supply, and a multi flame "blast" burner.

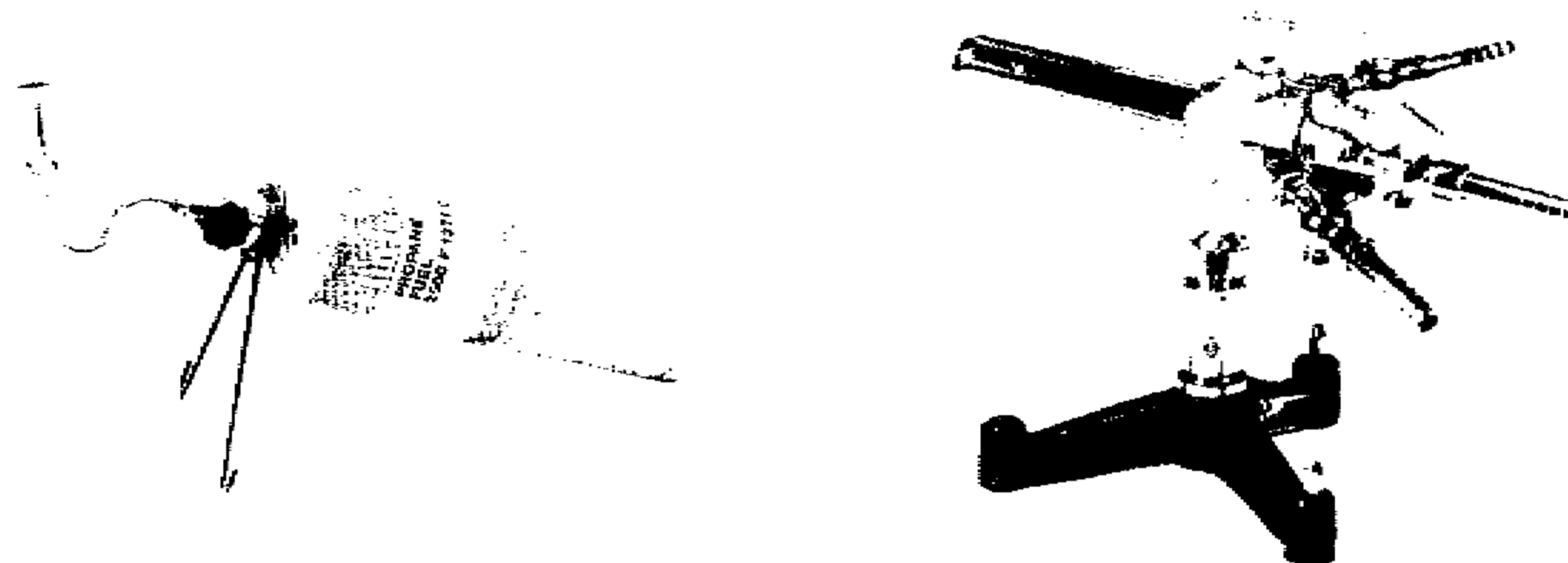

Various condensers used in distilling procedures. The hot gases coming off of the distilling materials flow into the glass (pyrex) condensers where the coils or other cool surfaces cause the gases to condense back to liquids.

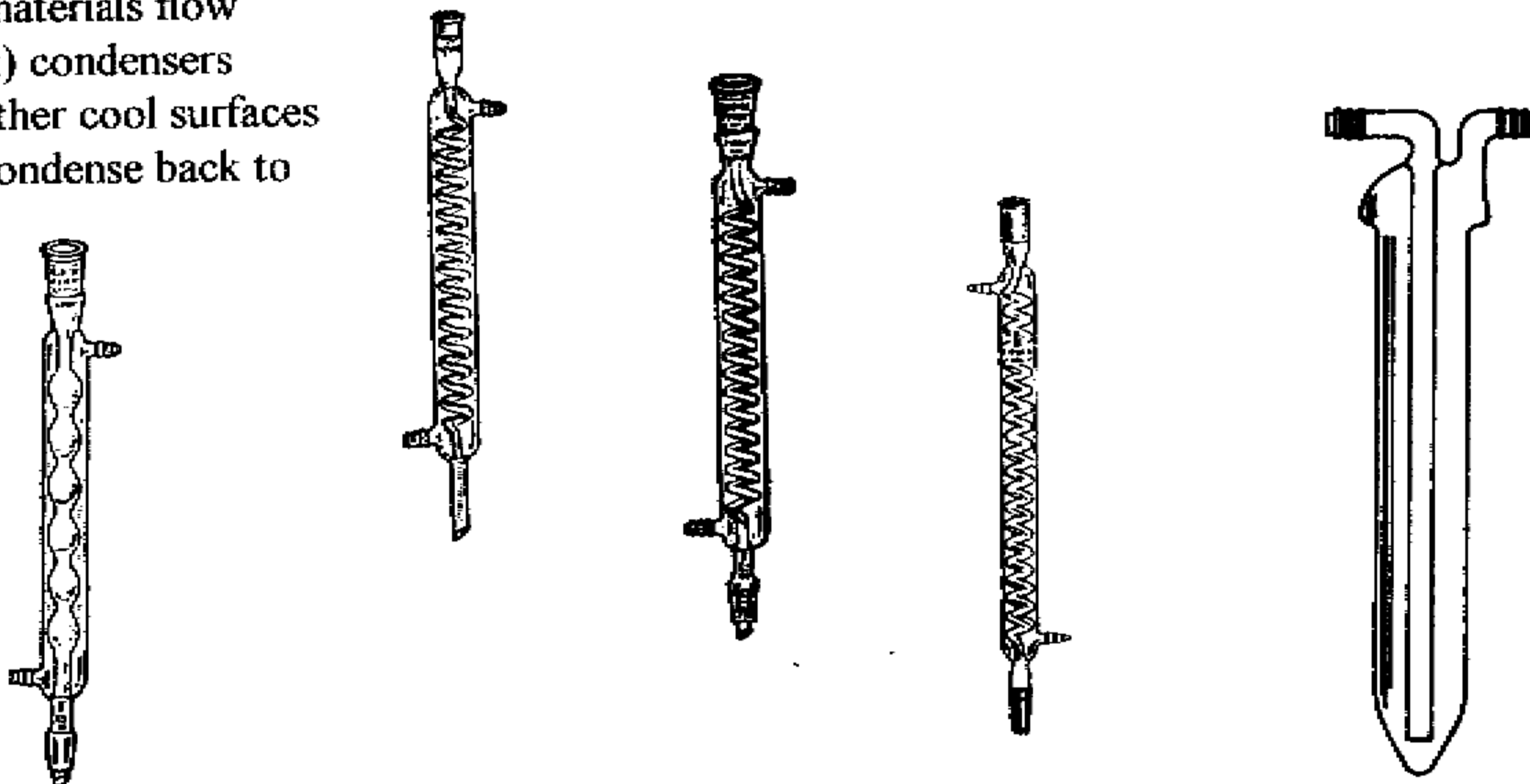

Reflux condensers are used in many nitration procedures in explosives preparations. The ideas are to return a portion of the gas or liquid to the distilling material to provide seeding, or act as a catalyst for the further production of the distillate.

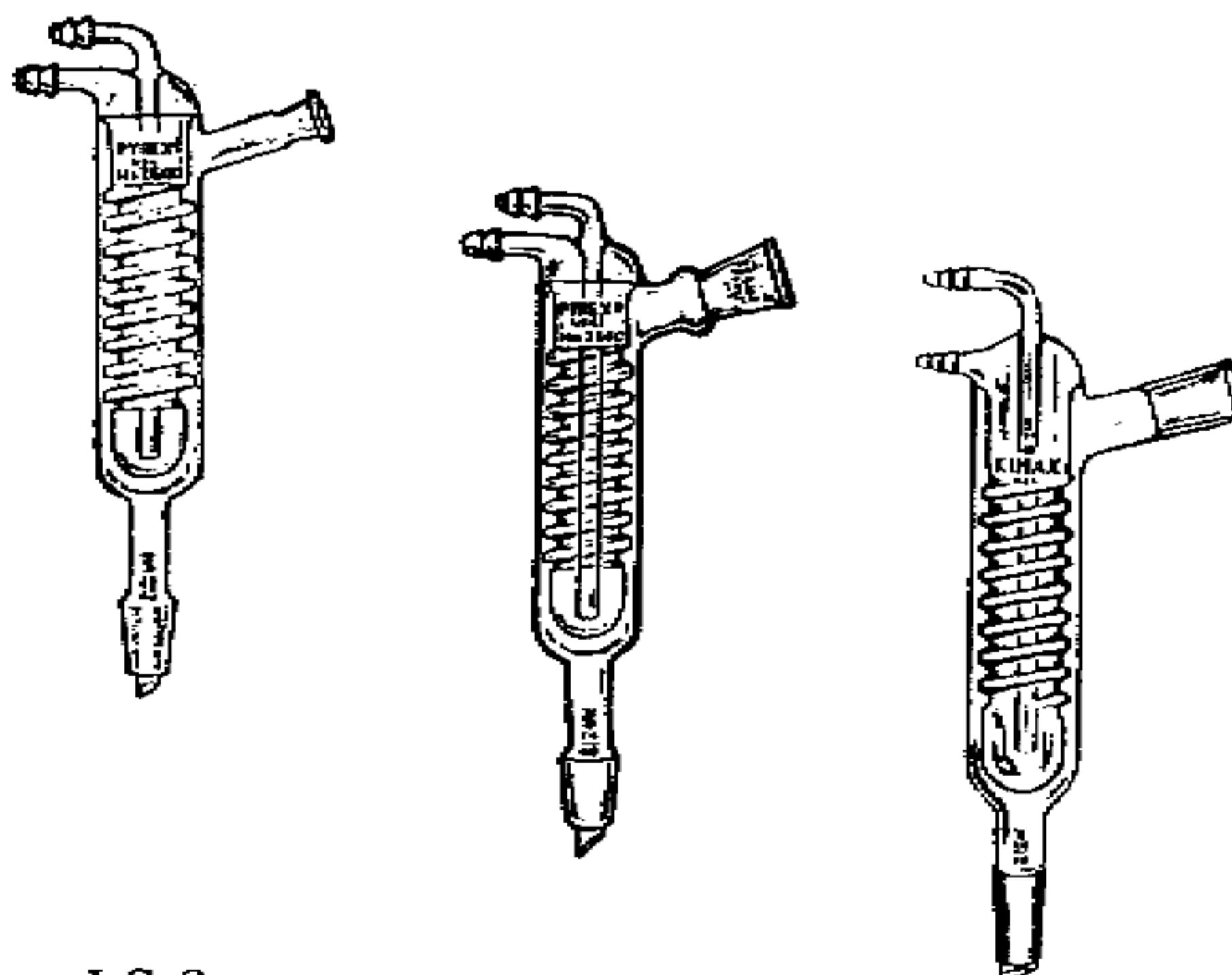



## Scientific Principles of Improvised Warfare - Lab Supplement

Vacuum dessicators are used to both heat and vacuum out air (lowering the air pressure) to speed drying or distilling. They are ovens with vacuum systems attached and are usually made of stainless steel.

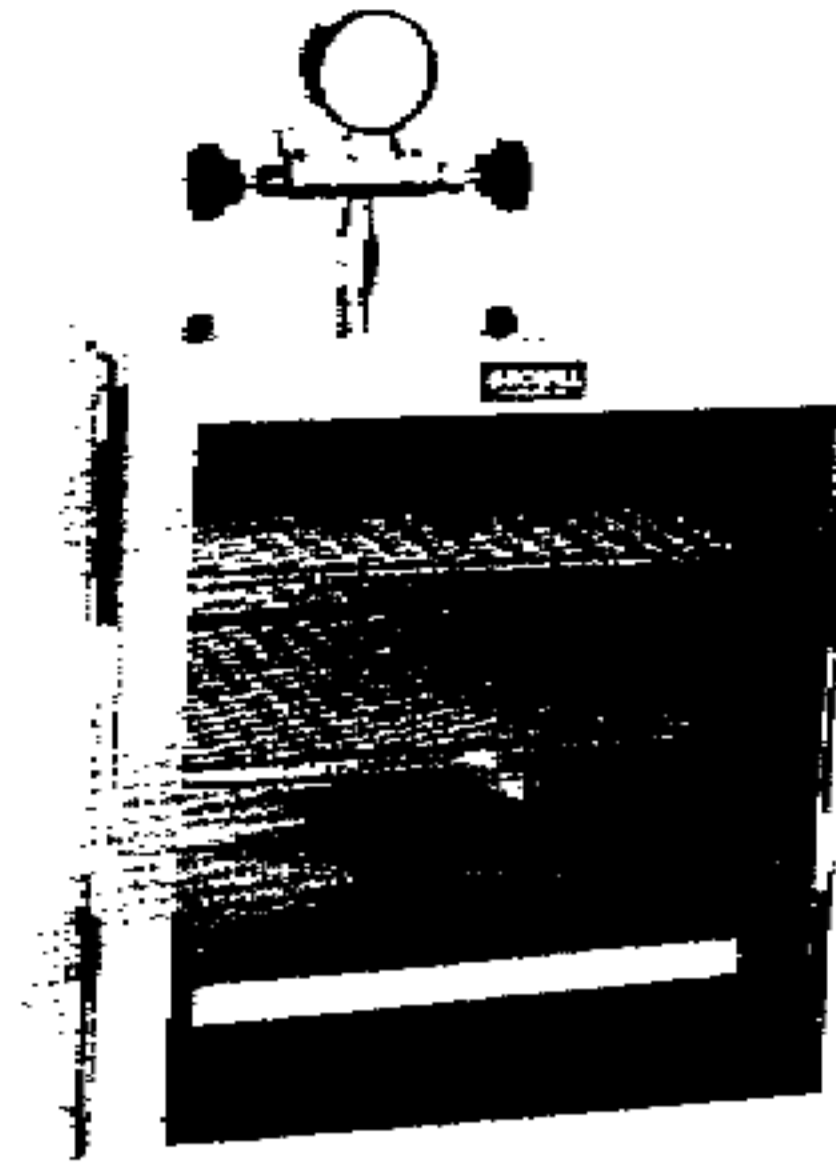

A wide range of petri dishes are used for collection and culturing (growing) of biological organisms. The petri dishes are made of plastic or glass and contain a gelled growth medium that is designed for specific types of biologicals.

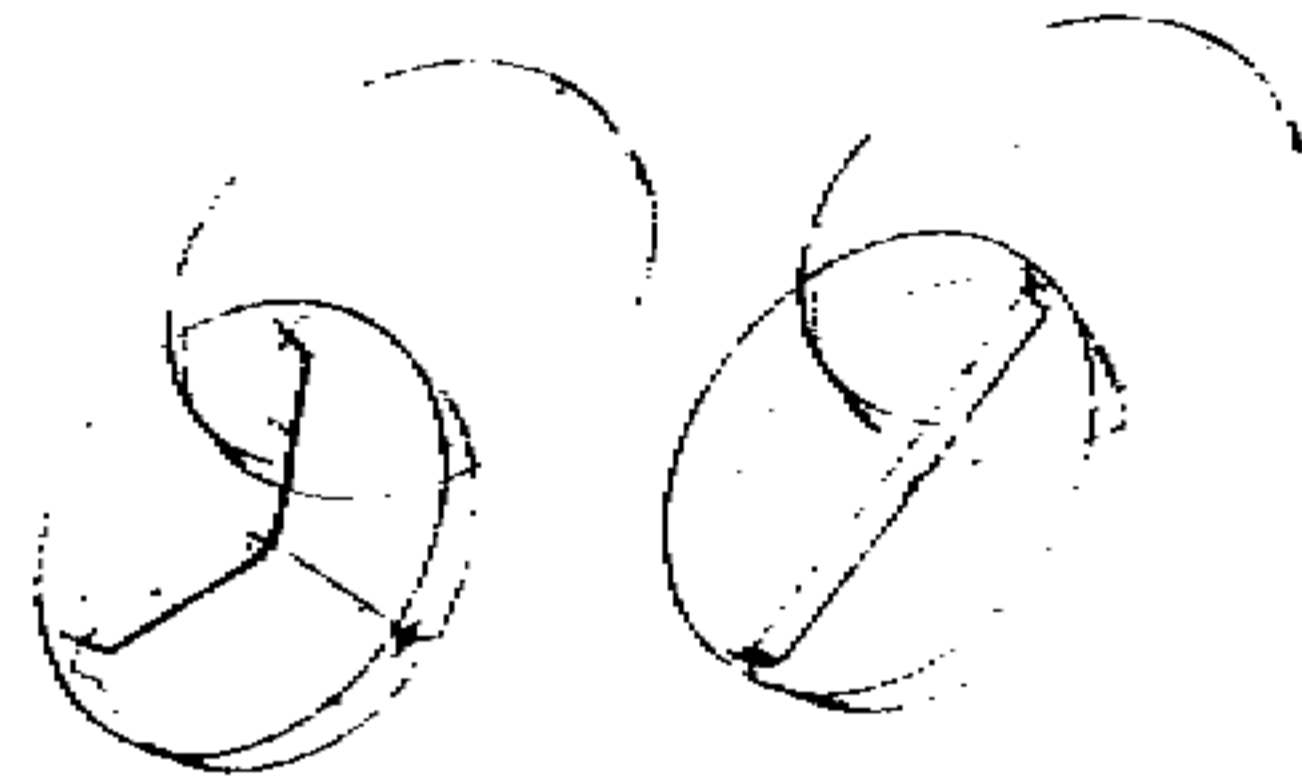
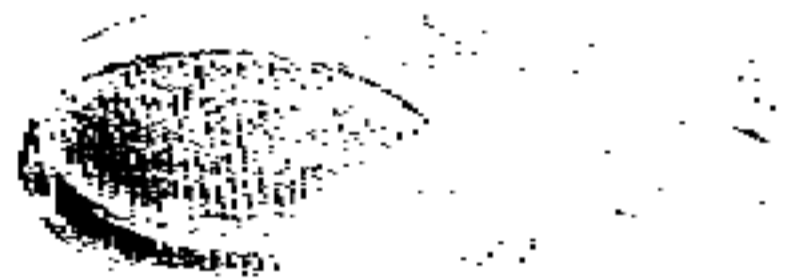

Dissecting and examining animal tissues requires special tools. These are sold in kits called dissecting kits and usually contain scalpels, scissors, knives, needles, a ruler, and forceps.

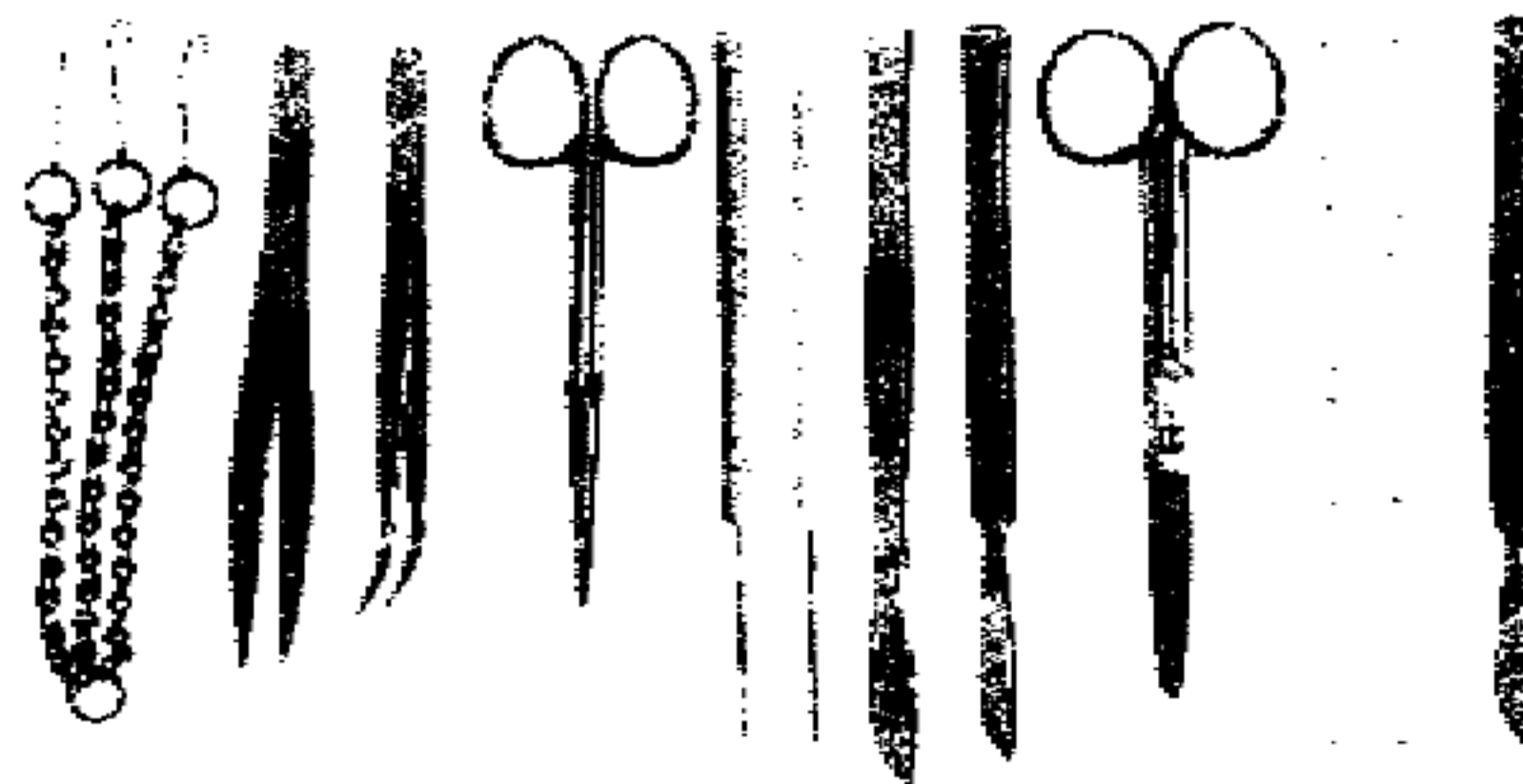

## Scientific Principles of Improvised Warfare - Lab Supplement

Various distilling apparatus shown with the condenser, connecting glassware, and flasks.

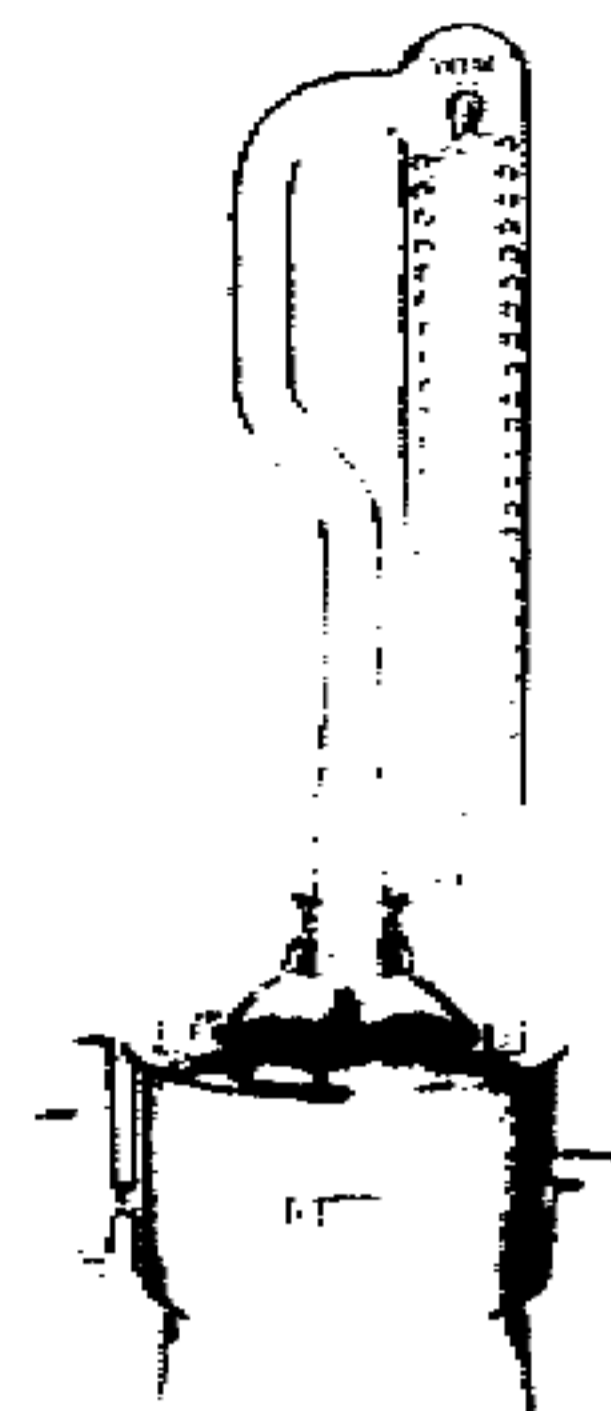
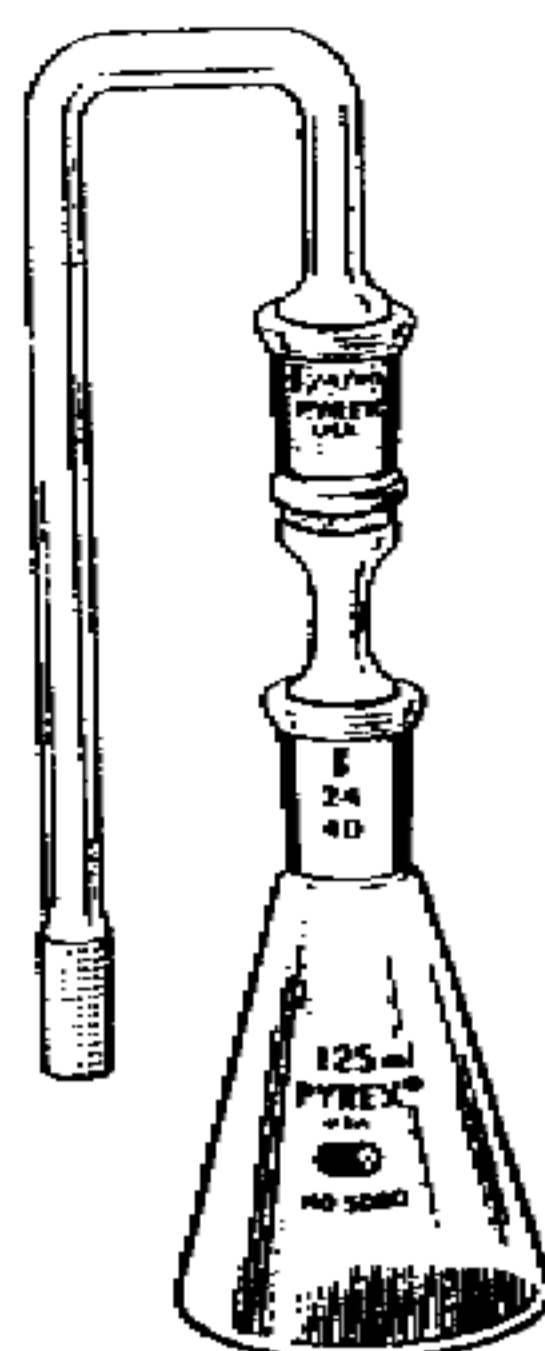
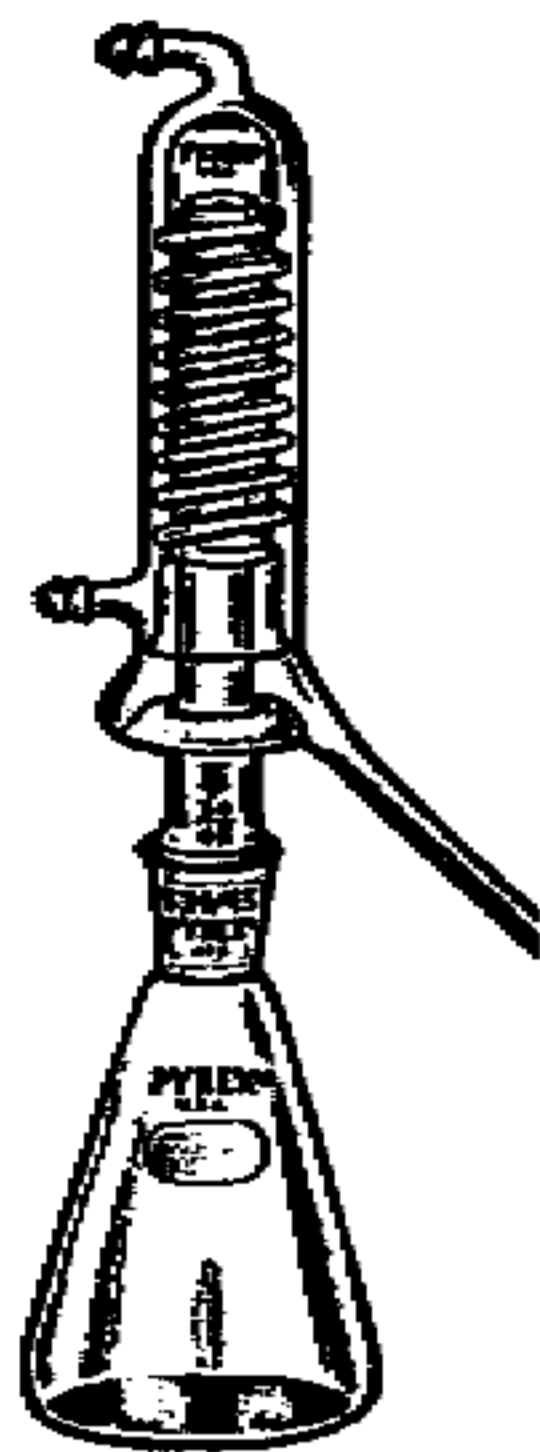
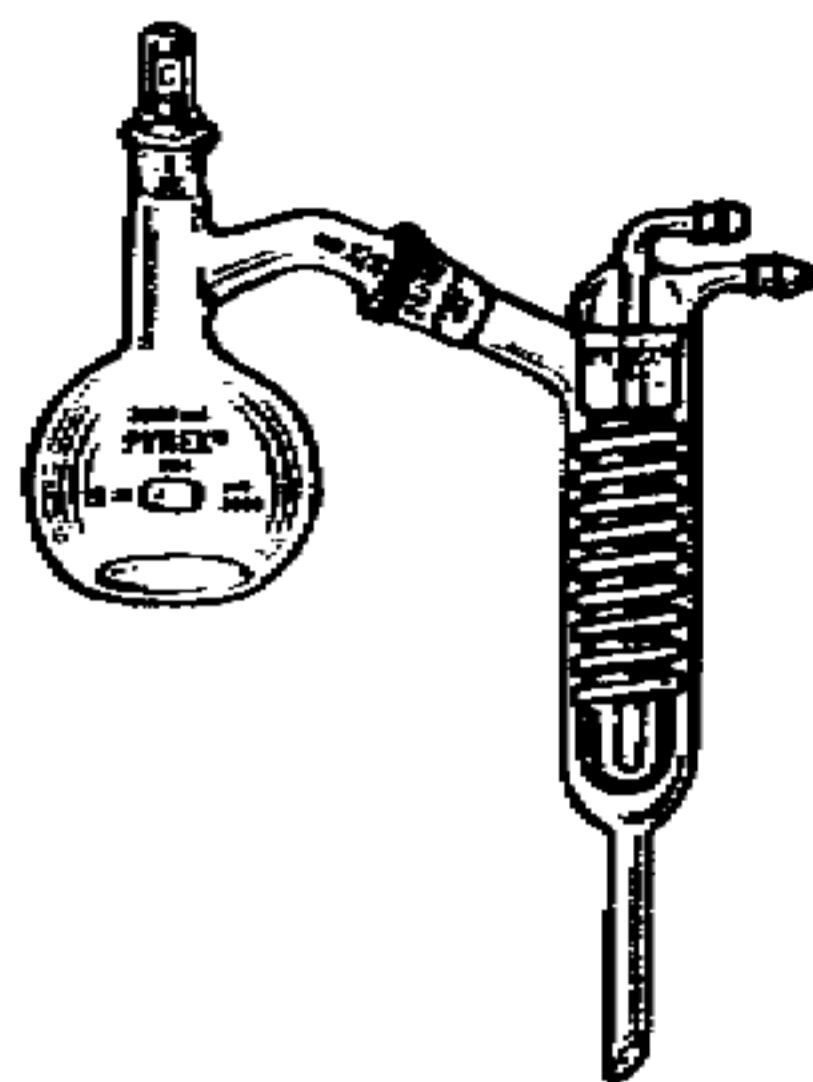

Filters are used to separate or remove solids from liquids. This is usually done on the inside surfaces of a funnel.

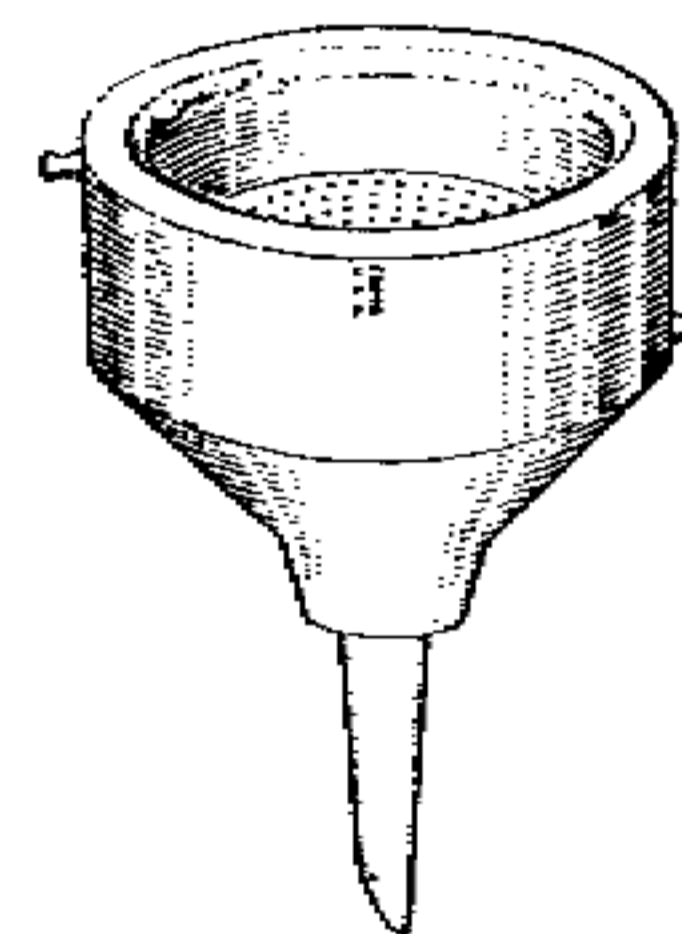
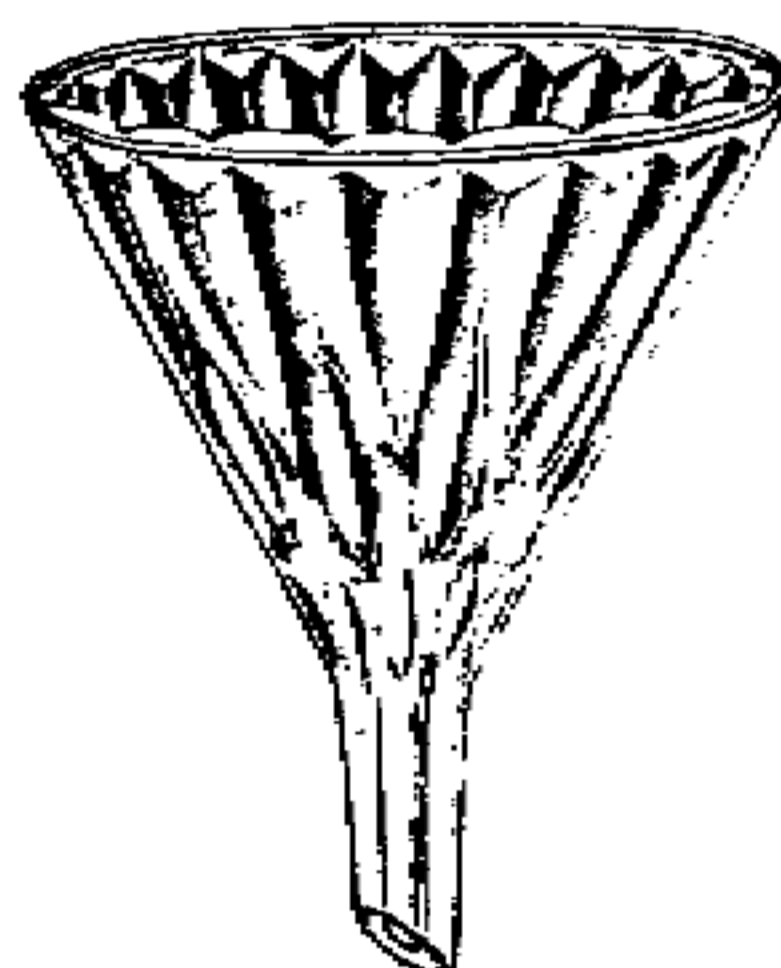

Separatory funnels are used to separate two liquids that do not mix together.

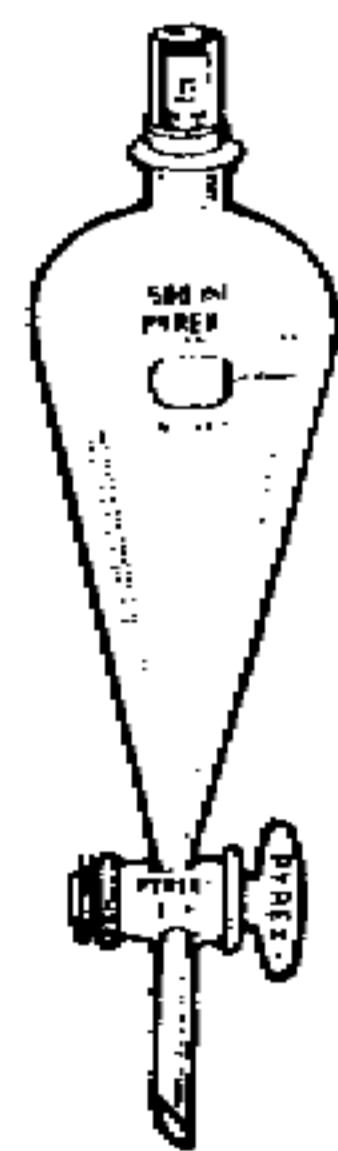

## Scientific Principles of Improvised Warfare - Lab Supplement

Electric Furnaces which can be set up for inert atmospheres and distilling apparatus can be used to prepare white phosphorus used in incendiaries and nerve gas production. Temperatures easily reach 1593 C (app 2900 F).

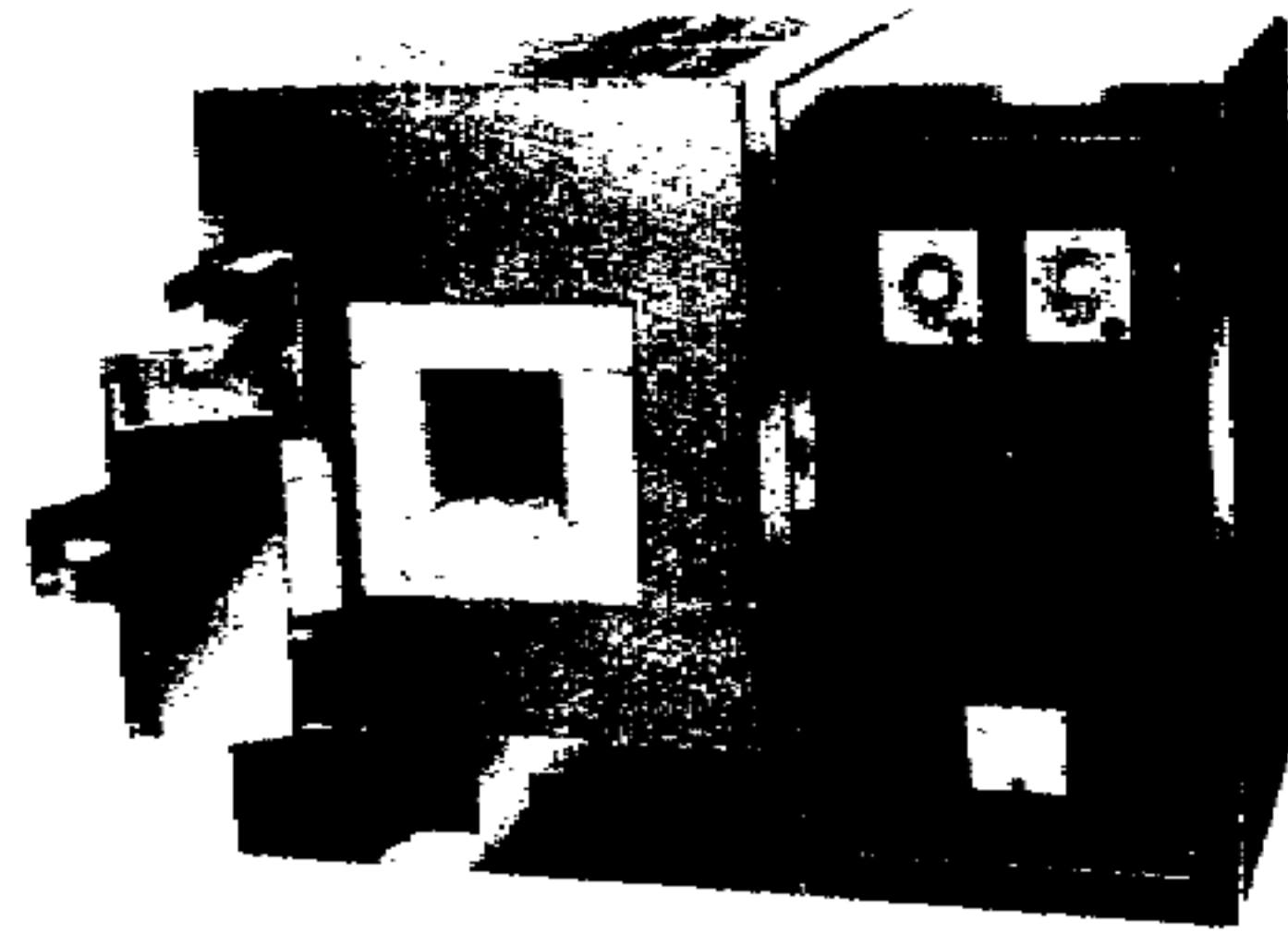

Special controlled environments called "glove boxes" use neoprene or special rubber gloves called "Bellows" gloves to handle dangerous materials and test organisms inside sealed mini-rooms.

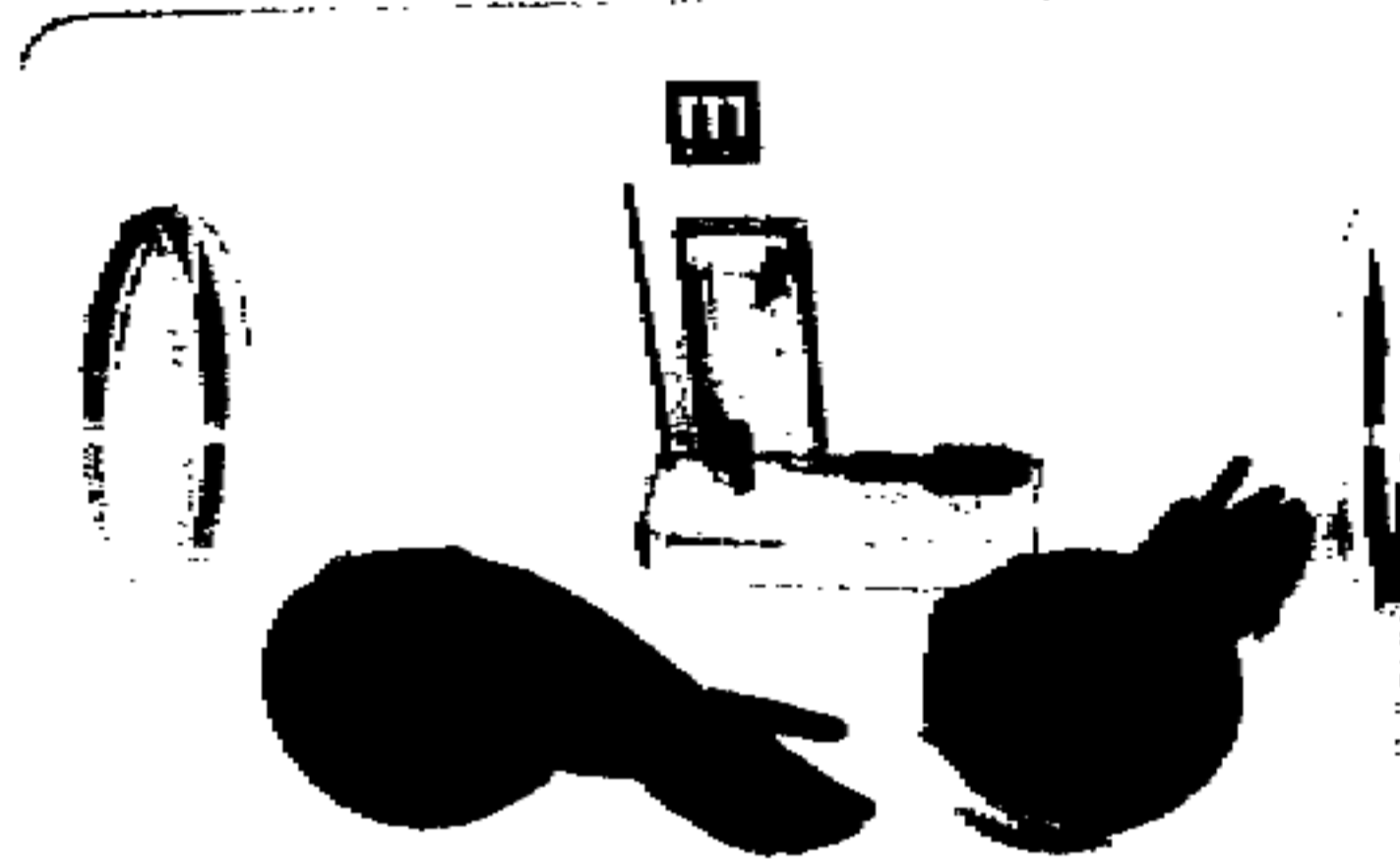

These rooms are used for controlled atmospheres, bacteriologicals, chemicals, animals, and radioisotopes.

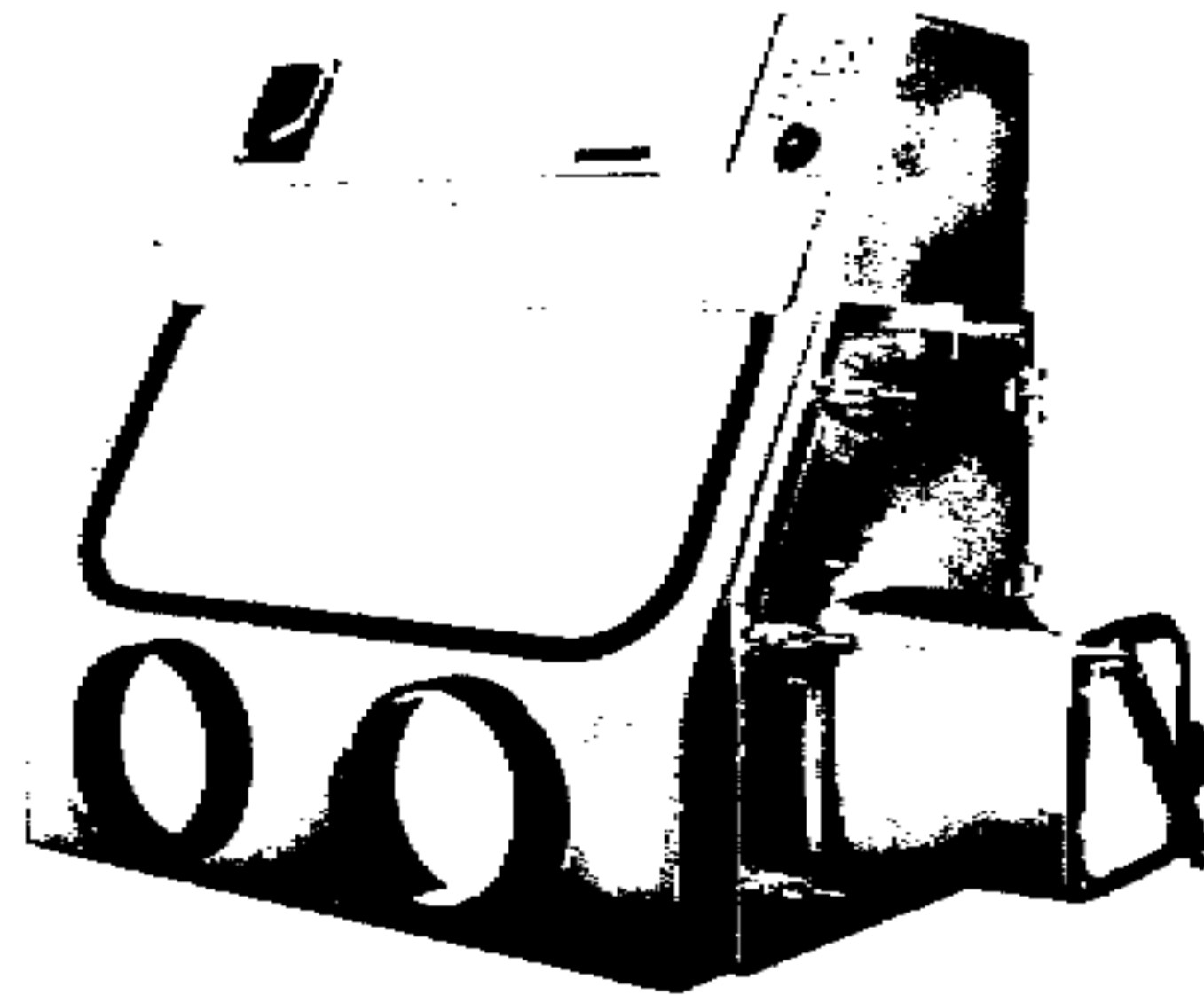
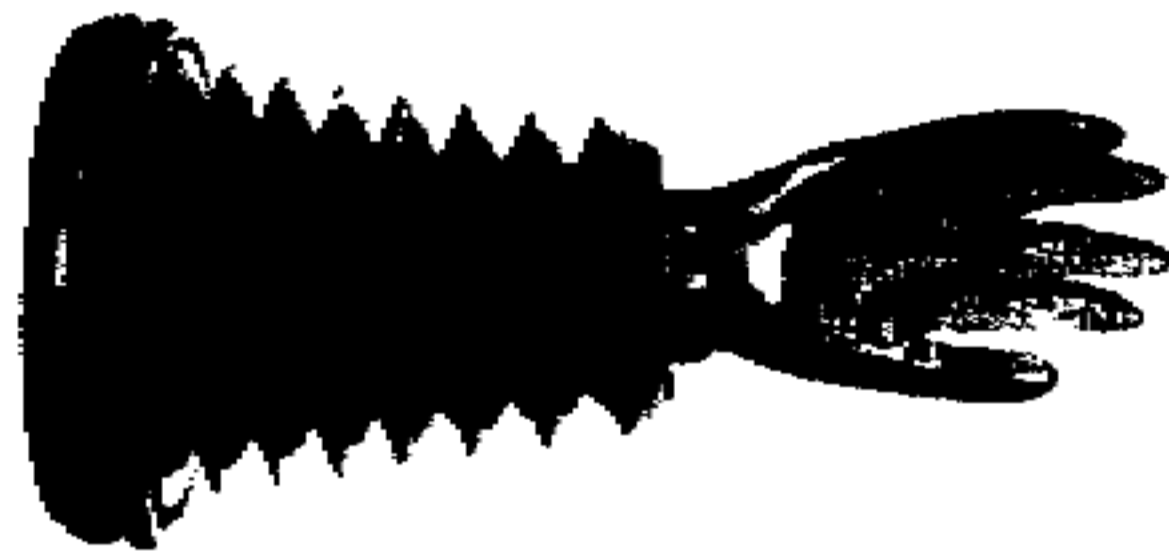

pH meters used to measure acidity and alkalinity are common to most lab's and are used in reactions where neutralization (to a pH of app 7) of an acid is required.



## Scientific Principles of Improvised Warfare - Lab Supplement

Incubators are low temperature ovens used to grow organisms at close to body temperature (app 98 F).

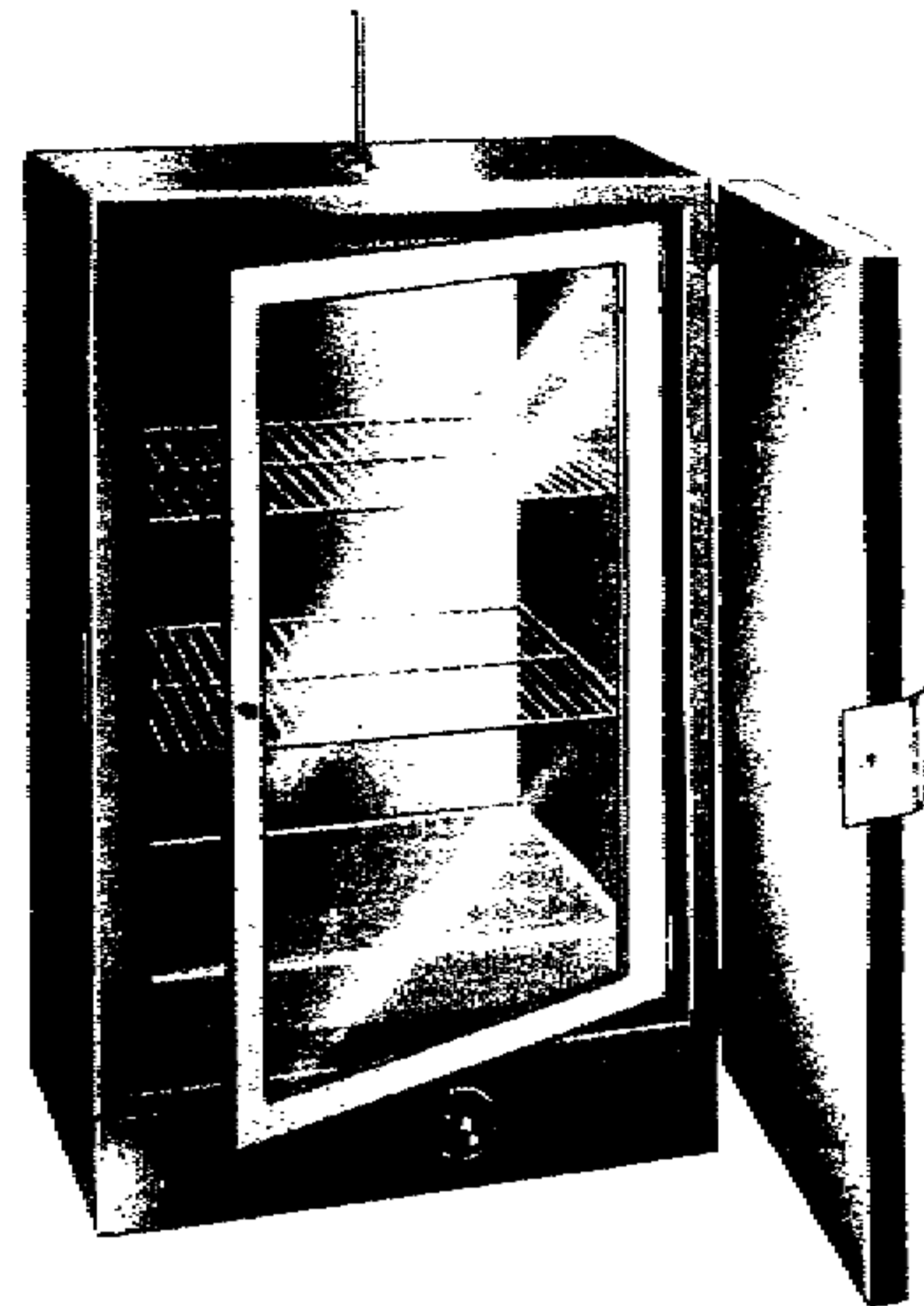

Carbon Dioxide (CO<sub>2</sub>) analyzers are used to measure atmospheres and insure that there is excess CO<sub>2</sub> in anaerobic cultures.

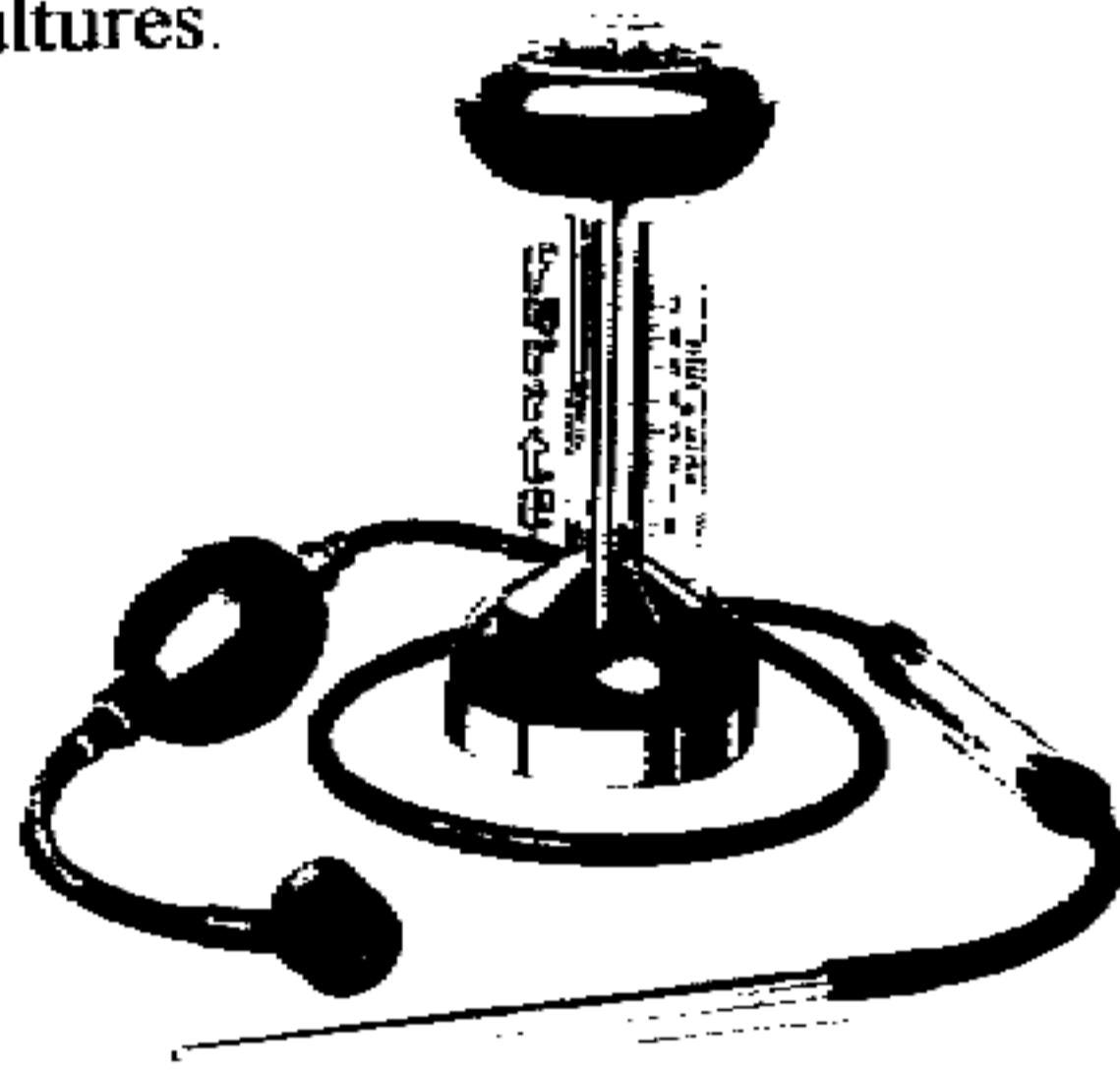

A variety of chemistry glassware sets are available at low cost \$200-400.

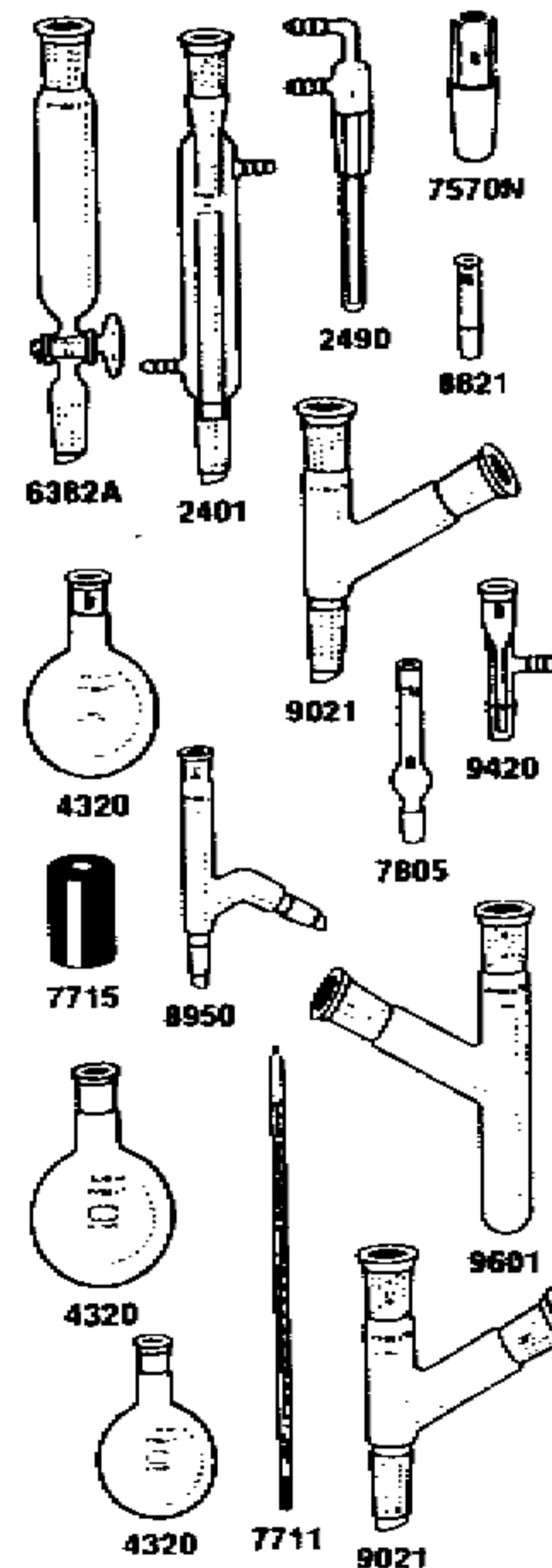
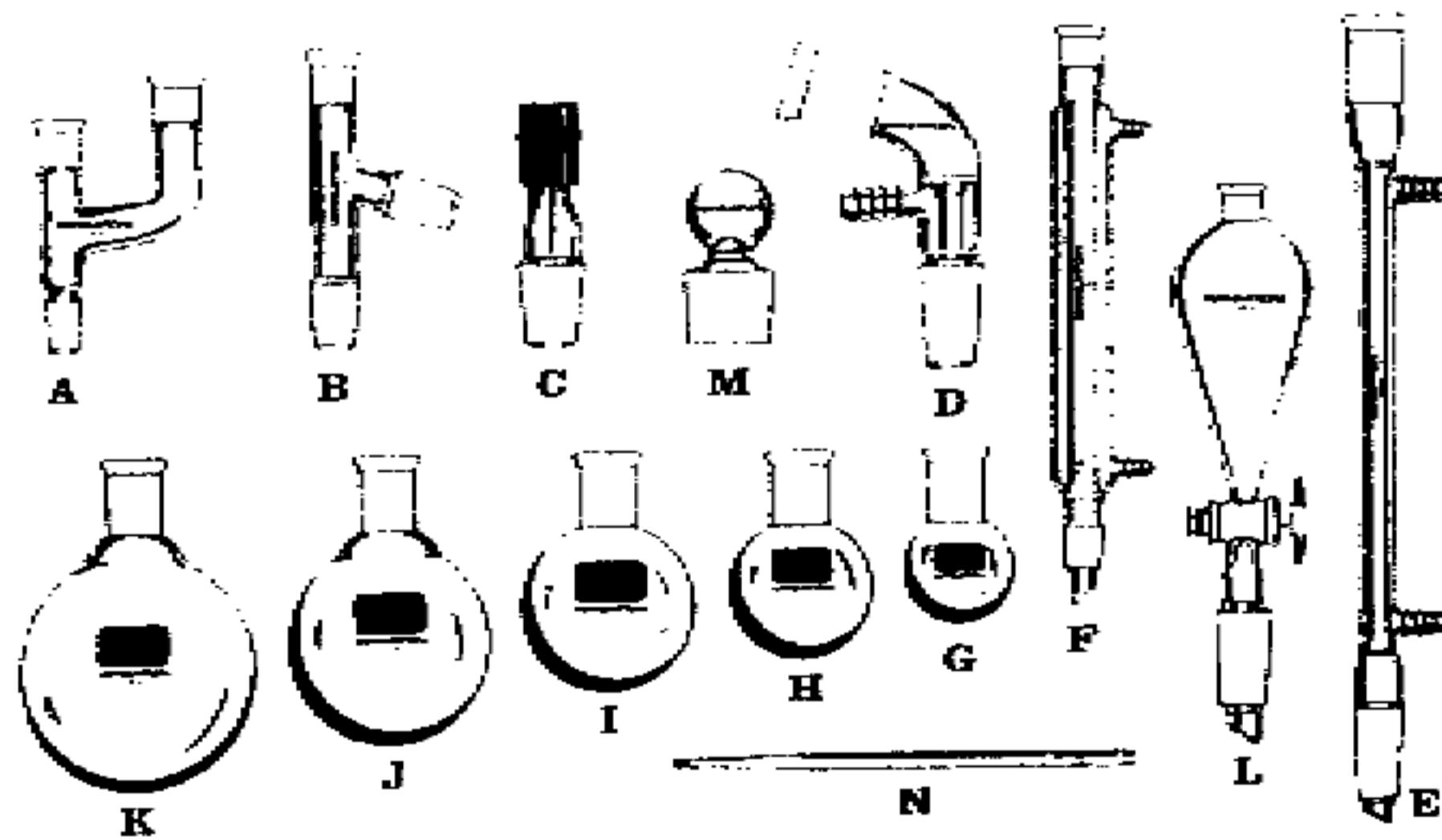

Lamp magnifiers are very useful for low power examination of many materials and organisms.

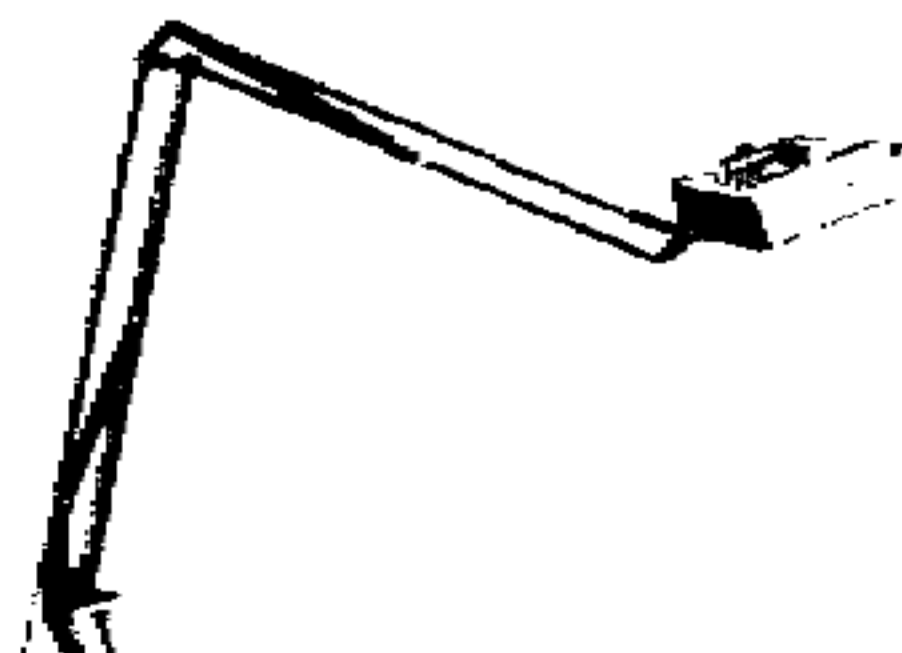

## Scientific Principles of Improvised Warfare - Lab Supplement

Longwave and short wavelength ultraviolet lights, hand-held, are useful in seeing body fluids and biologicals such as toxic fungi that are invisible in normal light.

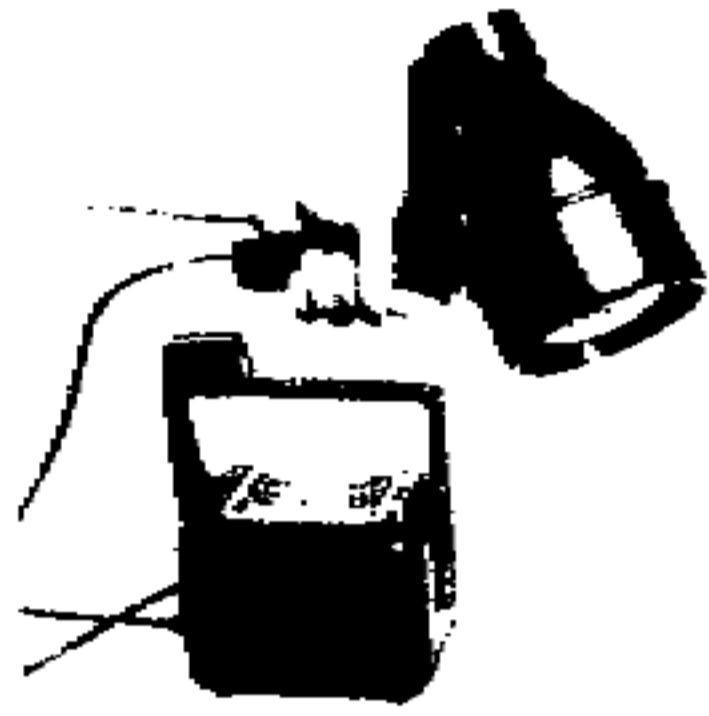

Professional microscopes are very useful in identifying biologicals and in seeing the forms of crystals such as those formed by solid explosives.

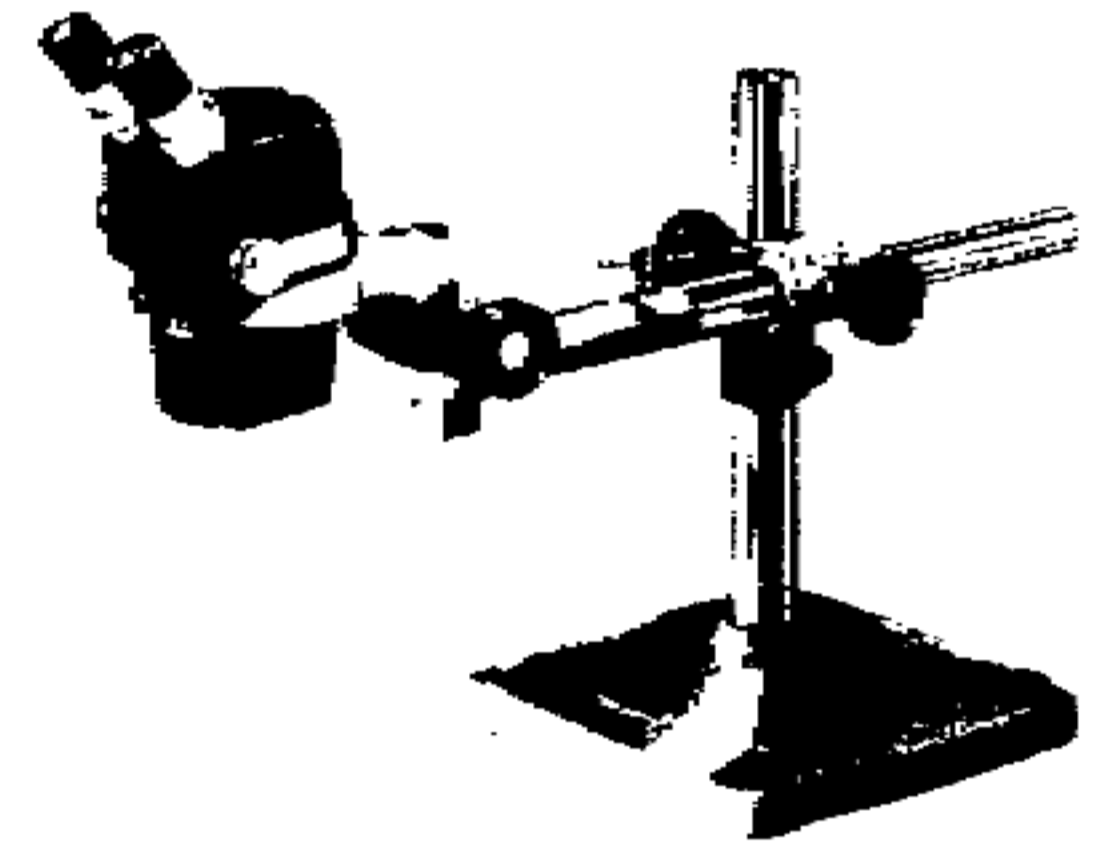
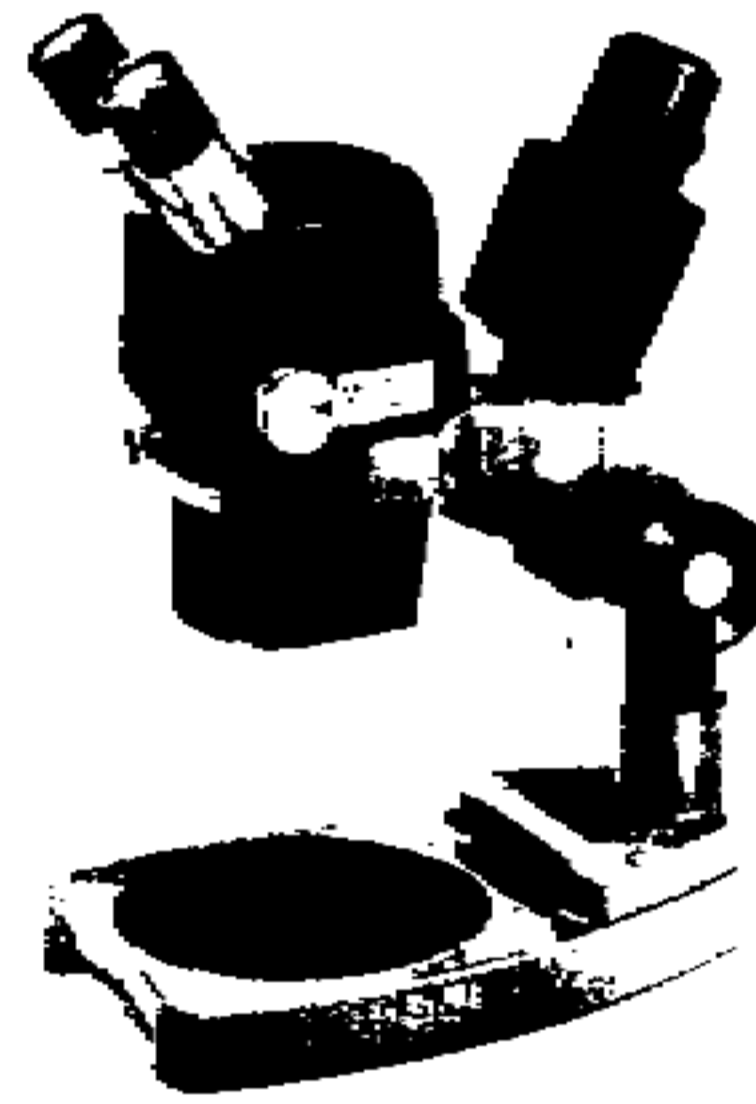
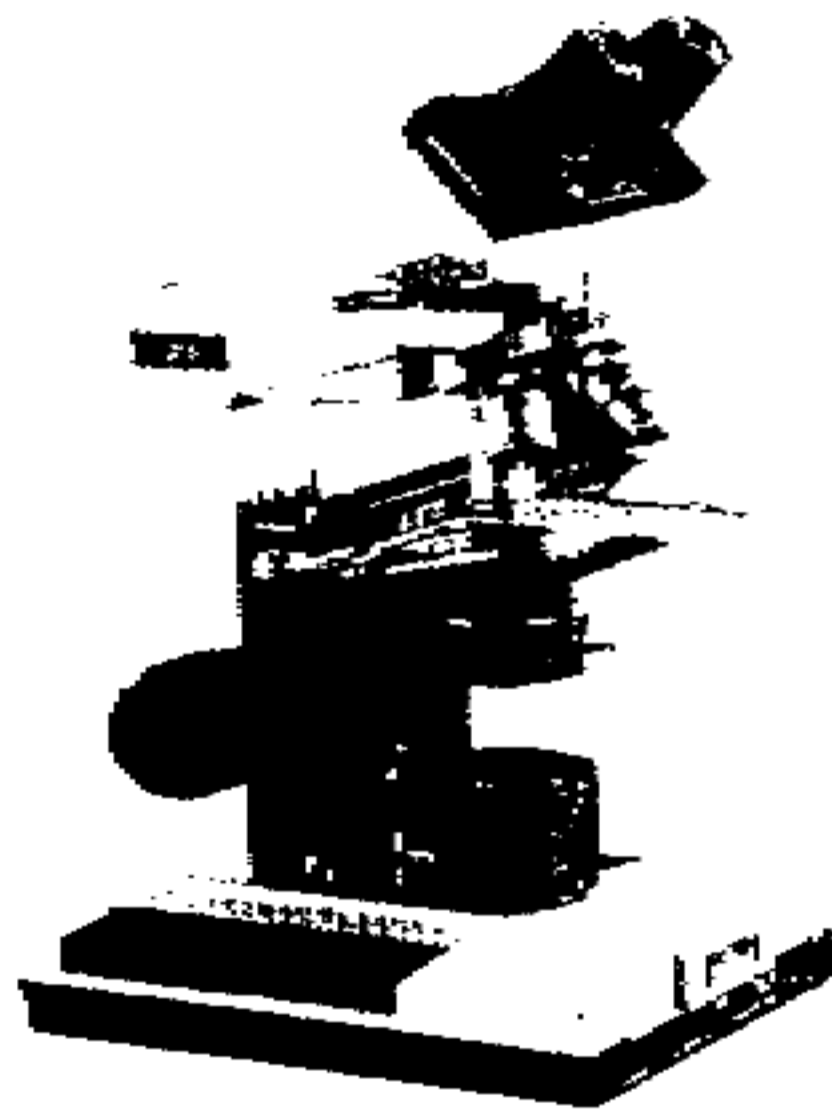

Various types of grinders are used to produce fine materials. From standard hammermills to pulverizers to ball mills, they are essential in preparing ordnance and important chemicals in all stages of processing. Ball mills use tiny balls or pebbles in a rotating cylinder to grind down the solids. Improvised grinders are improvised in the field by adding tiny ball bearings to a cement mixer.

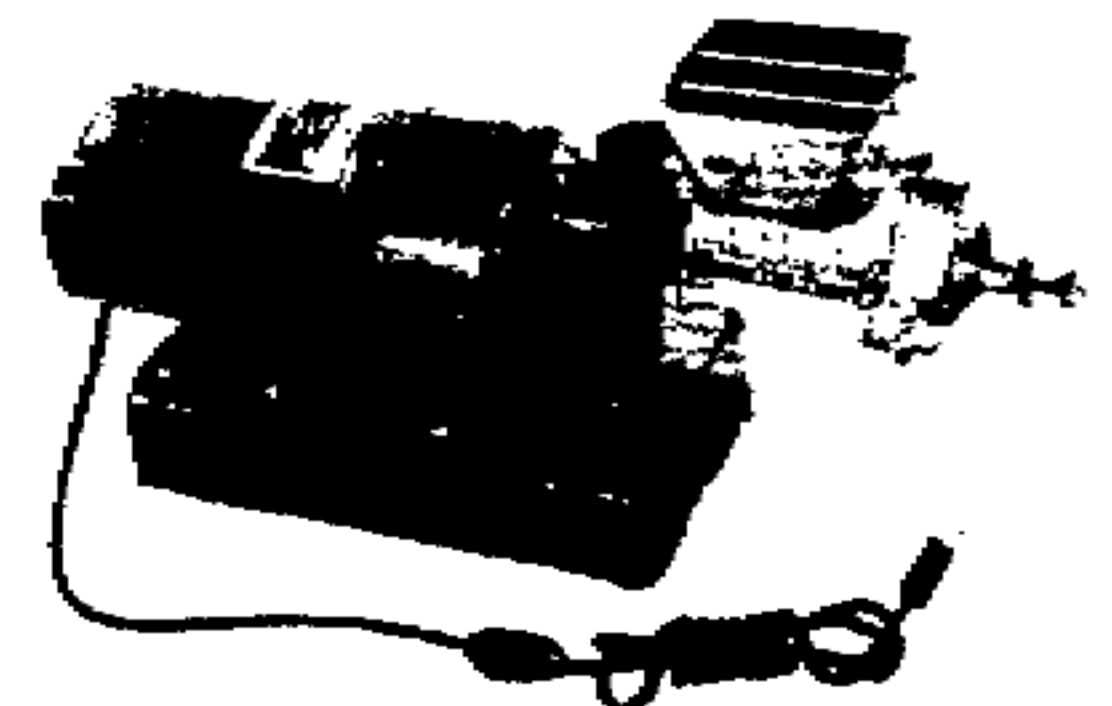
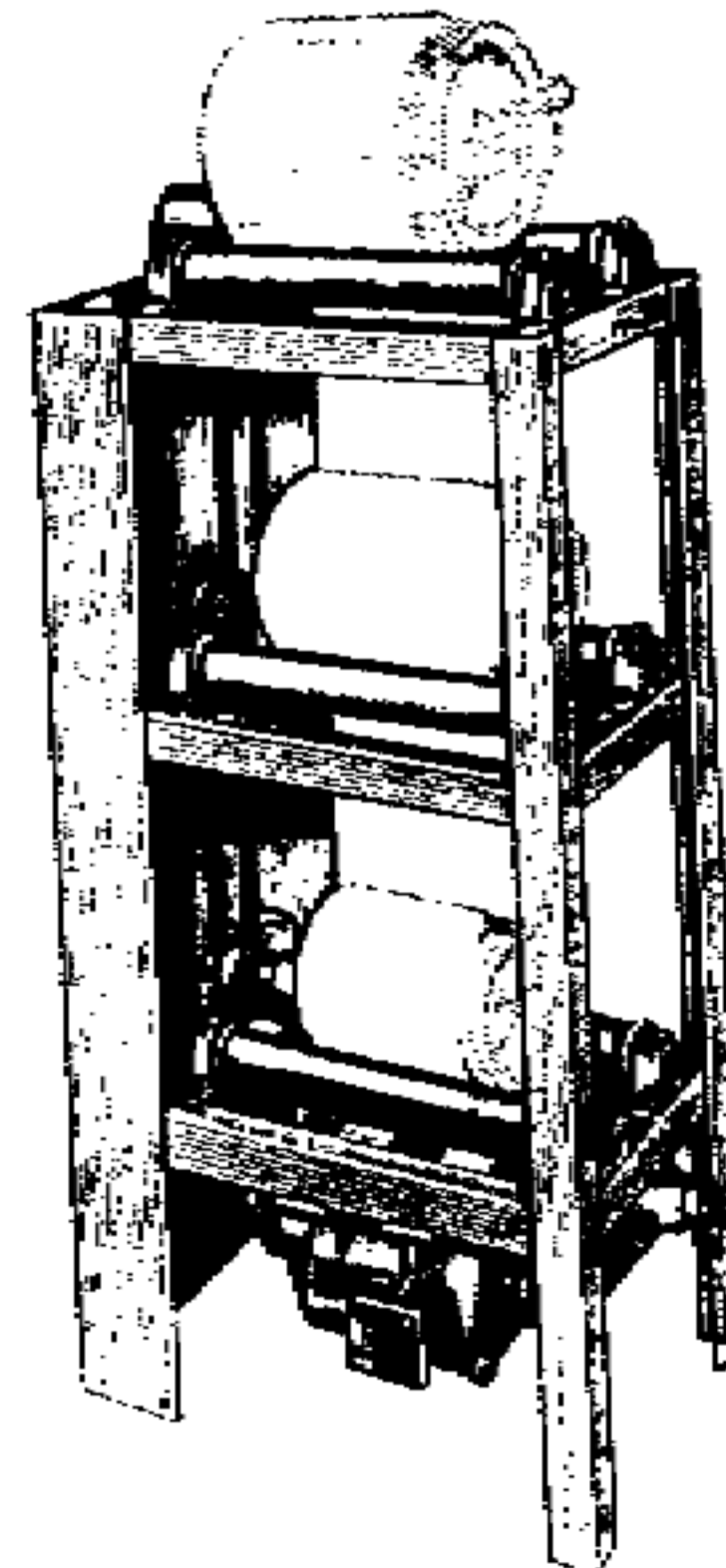

## Scientific Principles of Improvised Warfare - Lab Supplement

A mortar and pestle are used to grind materials by hand.

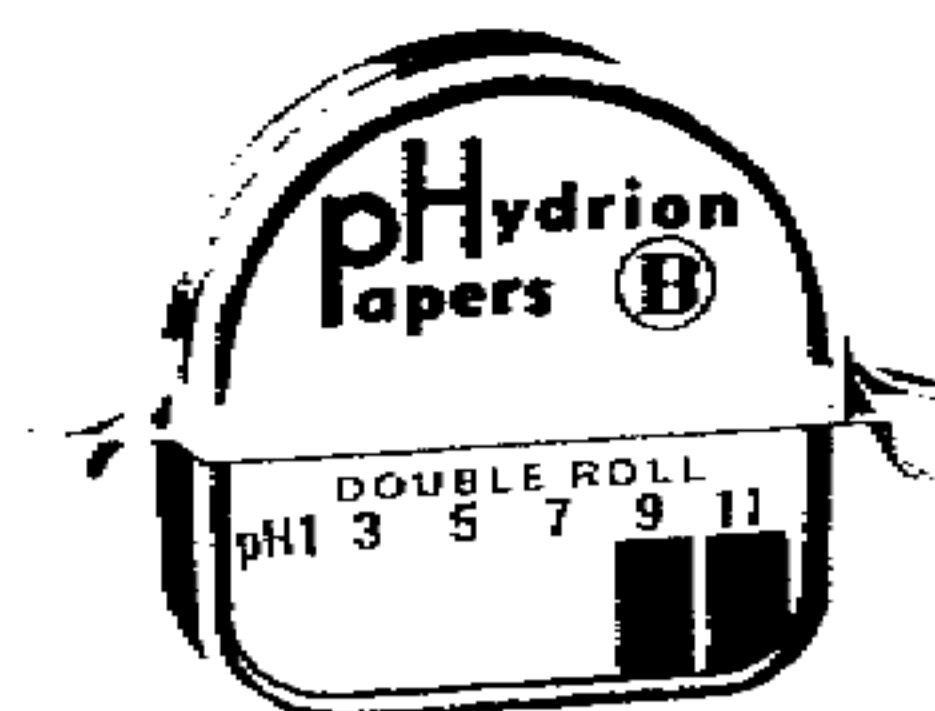

pH paper is used to measure acidity and alkalinity by color changes of the paper when it is immersed in the liquid being measured.

Tag Open Cup Flash Point tester is used to measure the flash points of liquids. It is useful in testing incendiary materials, especially volatile hydrocarbons.

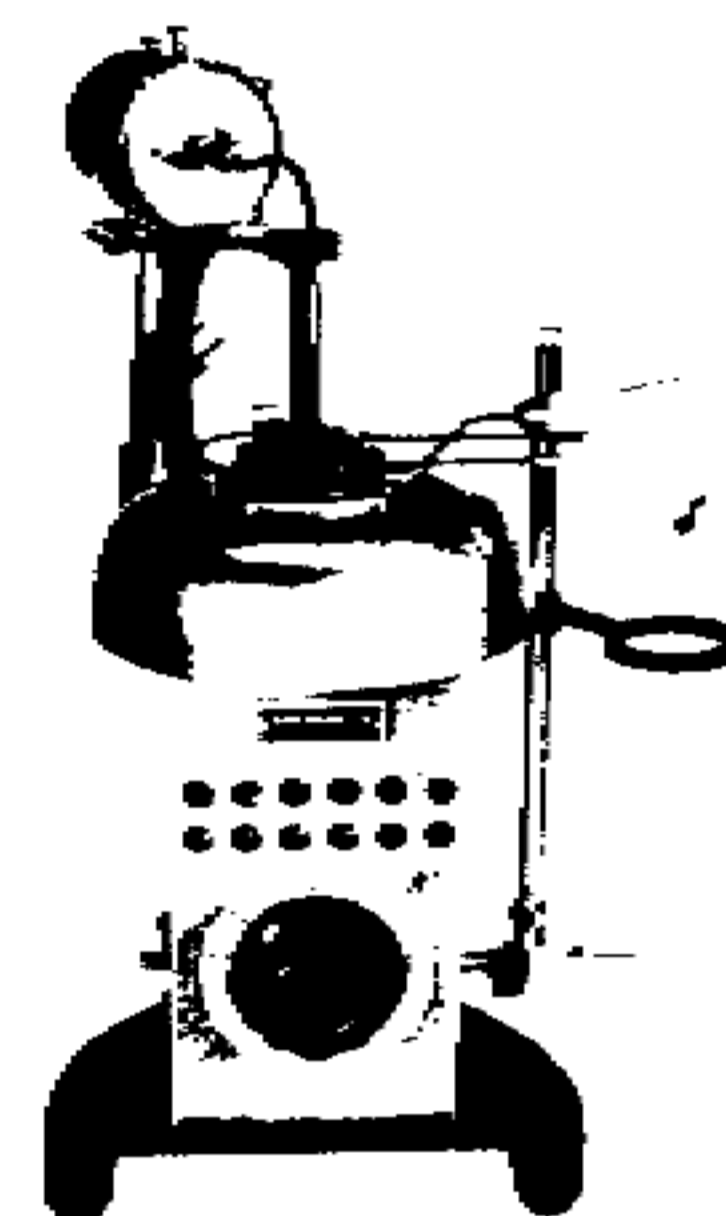
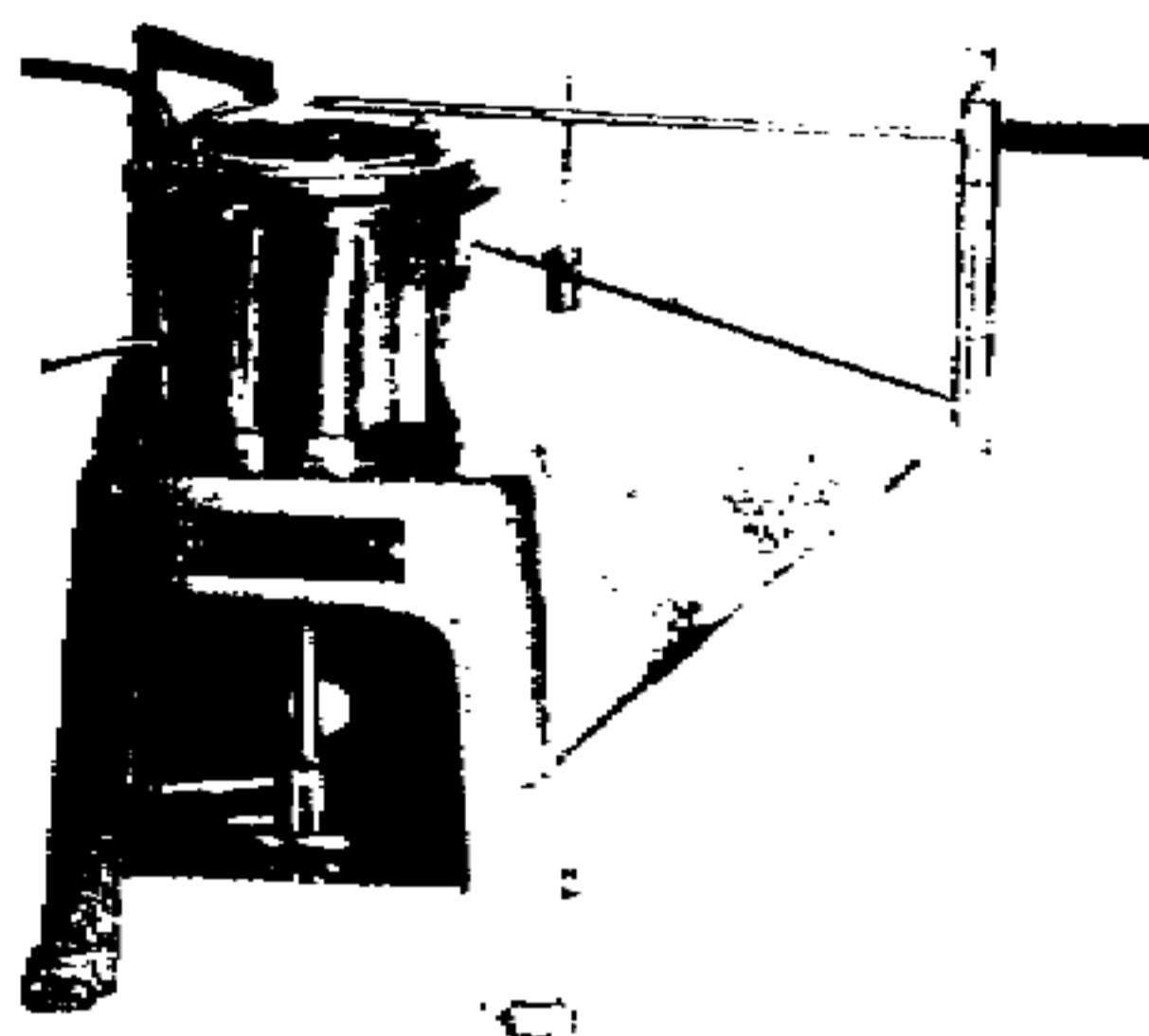

Closed Cup uses a water bath for indirect heat.

Vapor pressure guage used to measure pressure generated by liquids contained under pressure above their boiling points. Such liquids are useful as fuel-air explosives.

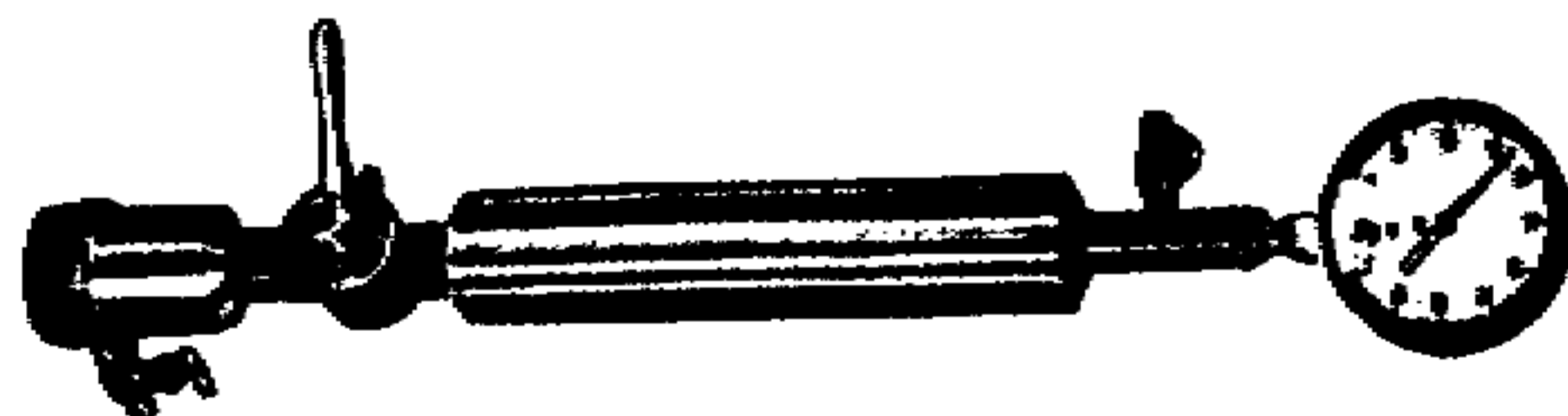
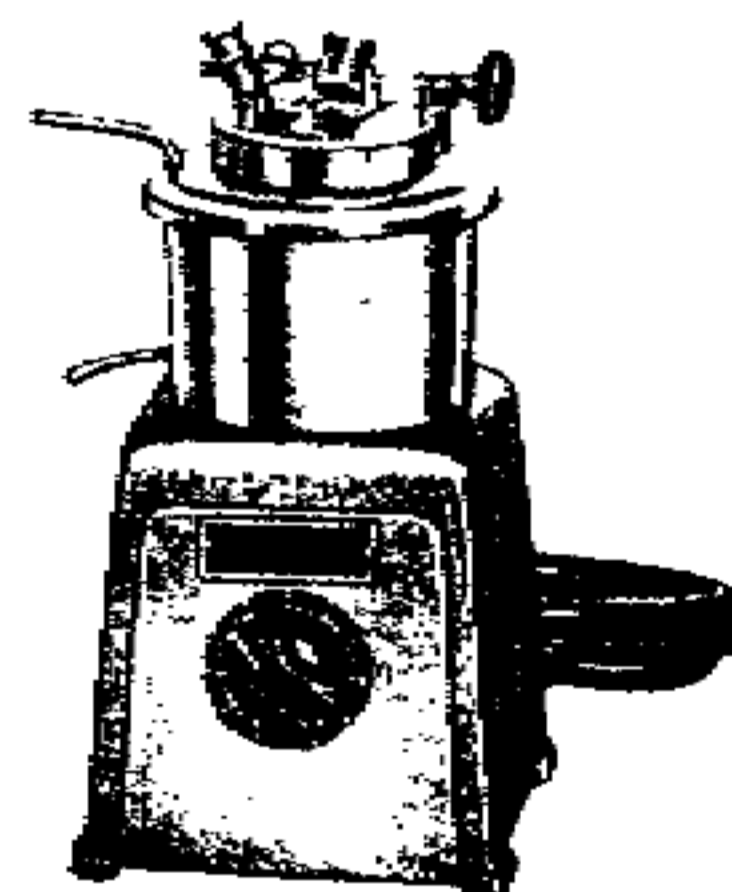

## Scientific Principles of Improvised Warfare - Lab Supplement

Sieves are containers with different size screens that allow small particles to pass and retaining particles larger than the screen size. When stacked on top of each other they allow all the particles to be grouped according to sizes. Oversize particles are usually reground while undersize are often recycled.

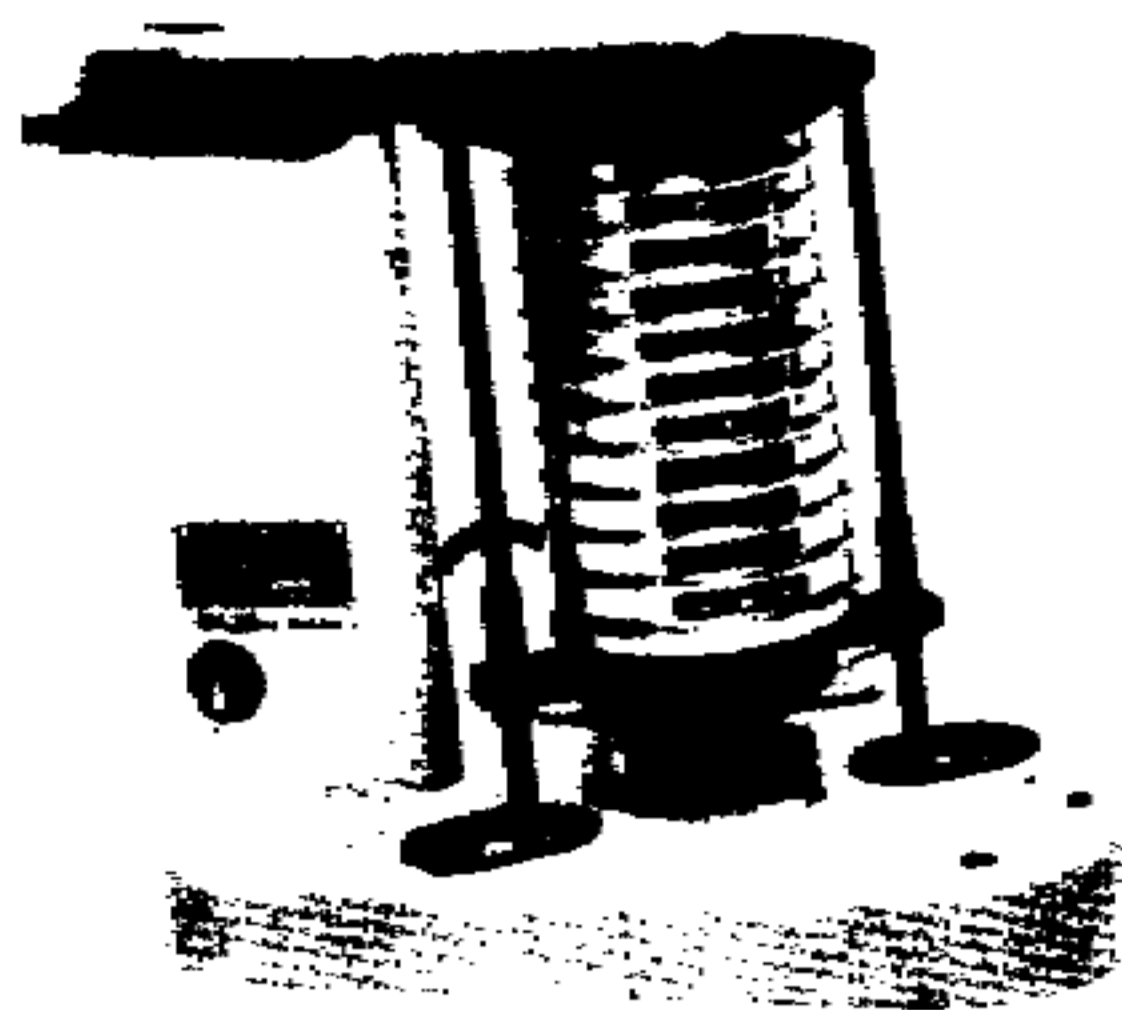

Automated stirrers are used to mix reacting materials. They can be mechanical, magnetic, or use a variety of methods. The magnetic stirrers use a magnet in the solution which is made to spin by a rotating motor under the container.

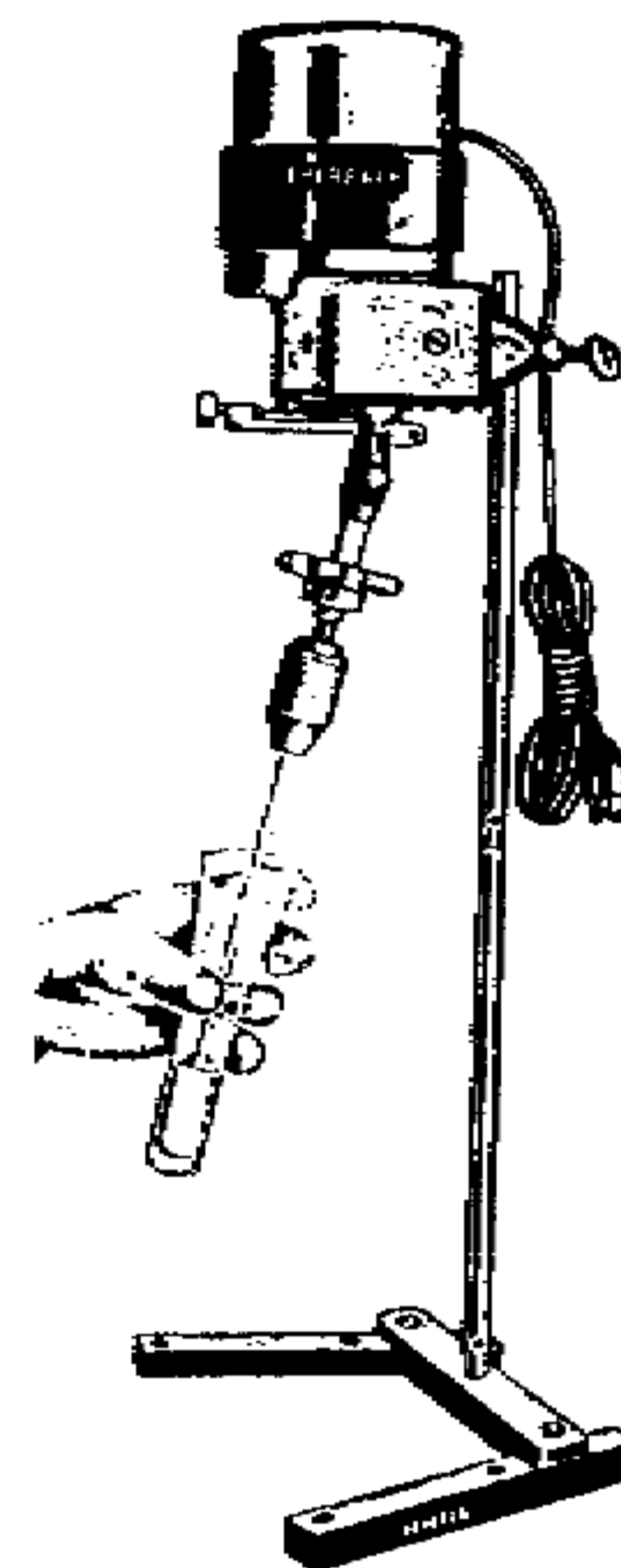

Water baths are used to keep materials at desired temperatures. Making many chemicals require outside heat. Many explosives use ice or refrigerated baths to prevent runaway explosive reactions.

