

SCIENTIFIC PRINCIPLES OF IMPROVISED WARFARE AND HOME DEFENSE Volume 2

The Basics

- Bio Toxic Weapons
- Defensive Obstacle Construction and Countermeasures
 - Armor Personal Protection and Material Handling
 - Booby Traps Mines and Positioned Weapons
 - Combat Support Skills and Equipment
- Strategies Tactics Resistance and Countermeasures

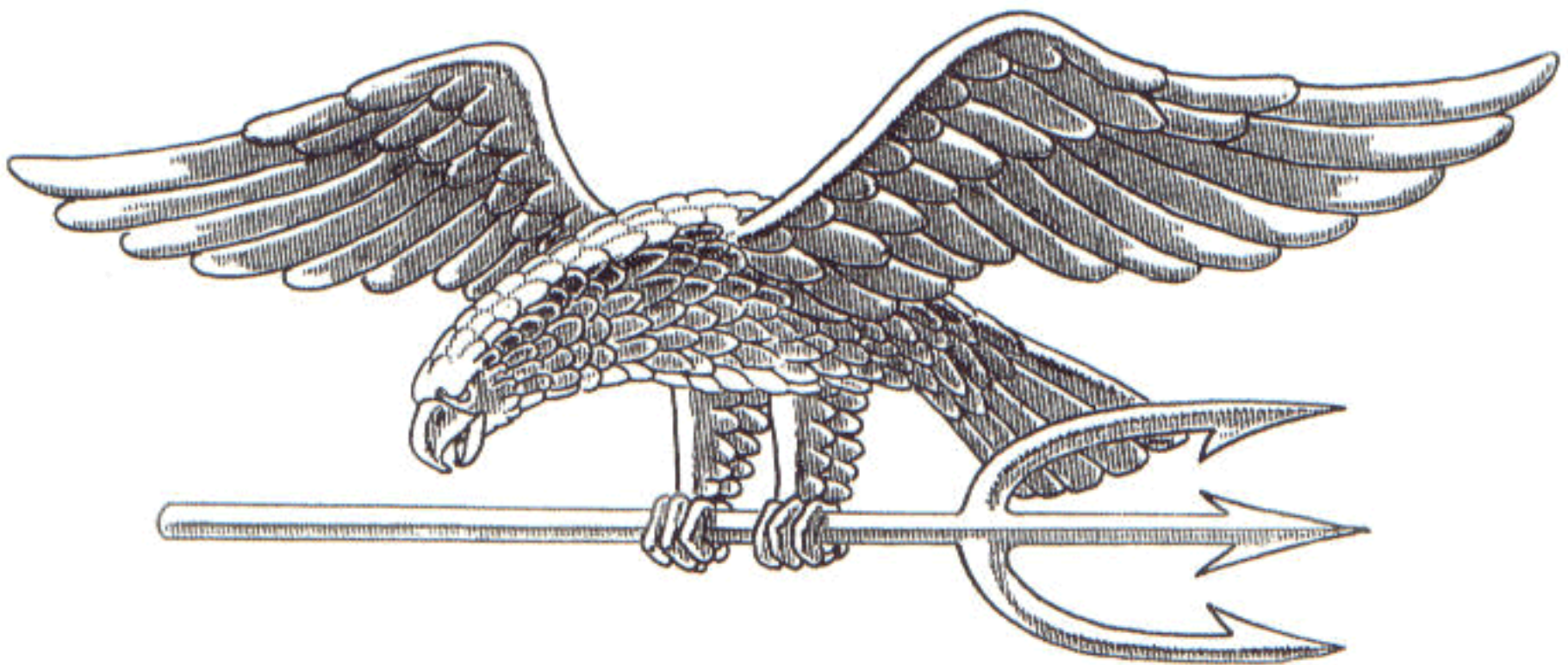

Scientists right to bear arms: I will give up my right to know how to construct a long metal tube, enclosed on one end, and capable of propelling projectiles at high velocity, when they pry the know-how from my cold dead brain!

SCIENTIFIC AND TECHNICAL INTELLIGENCE PRESS ©
1996 BY TIMOTHY W TOBIASON

For Academic Purposes Only

Scientific Principles of Improvised
Warfare and Home Defense

Copyright 1996 ISBN #
by Scientific and Technical Intelligence Press
and Timothy W. Tobiason

Printed in the United States of America

Published by
Scientific and Technical Intelligence Press
P.O. Box 59
Silver Creek Nebraska 68663

All rights reserved.

Except for use in a review, no portion
of this book may be reproduced in any
form without the express written permission
of the publisher.

This book is intended for academic use only.
Neither the publisher or the author assumes
any responsibility for the use or misuse
of information contained in this book.

Scientific Principles of Improvised Warfare and Home Defense

Table of Contents

7. BioToxic Weapons	7-1
Introduction and History	7-1
Natural Sources	7-6
-Animals	7-6
-Plants	7-14
-Insects	7-20
-Fungi and Mushrooms	7-23
-Bacteria, Viruses, and Internal Parasites	7-27
Manufacturing and Harvesting Systems	7-37
Direct Delivery Systems and Vectors	7-43
Indirect Delivery Systems and Countermeasures to Germ Warfare	7-45
Improvised Methods of Determining Toxicity	7-48
8. Defensive Obstacle Construction and Countermeasures	8-1
Earthworks and Waterworks	8-2
Stone and Concrete	8-6
Wood, Brush, Glass, and misc. materials	8-8
Chemicals and living organisms	8-10
Countermeasures to obstacles	8-11
9. Armor, Personal Protection, and Material Handling	9-1
History	9-2
Importance of Protective Defence	9-8
Modern Material Science	9-9
Applied Armor Science and Material Handling	9-14
10. Booby Traps, Mines, and Positioned Weapons	10-1
Mechanical Traps	10-2
Explosives or firing positioned weapons	10-5
Booby trap activating systems	10-7
Mines	10-13
Improvised Position Weapons	10-16
-Grenade Tin Can Land Mine	10-17
- Mortar Scrap Mine	10-19
-Fire Bottle Launcher	10-21
-Electric Bulb Initiator	10-25
-Delay Igniter from Cigarette	10-27
-Watch Delay Timer	10-29
-No Flash Fuse Igniter	10-31

Scientific Principles of Improvised Warfare and Home Defense

-Dried Seed Timer	10-33
-Fuse Cords	10-35
-Clothespin Time Delay Switch	10-37
-Time Delay Grenade	10-39
-Detonator	10-40
-Can Liquid Time Delay	10-42
11. Combat Support, Skills, and Equipment	11-1
Organization	11-1
Industry	11-4
Intelligence	11-6
Communications and Electronic Warfare	11-9
Survival and Evasion	11-12
Leadership	11-32
12. Strategies, Tactics, Resistance, and Countermeasures	12-1
Attacking Pilosophies and Ideas	12-1
Defending Strategies and Tactics	12-6
Modern Military Concepts for the Next Century	12-7
What if	
Kurds	12-10
Kuwait	12-11
Bosnia	12-13
Waco	12-14
U.S. Courts, Crime, Congress, and Change	12-18

Scientific Principles of Improvised Warfare and Home Defense

Chapter 7 Bio Toxic Weapons

Toxic weapons of biological origin can be obtained and improvised as weapons from a variety of natural sources. Because nature provides organisms with ways to effectively protect themselves and kill prey by self produced chemical toxins, these materials can be economically mass produced and/or harvested for humans to use as well.

Areas covered in this chapter

1. Introduction and brief history
2. Natural sources
 - a. Animals-alive and dead
 - b. Plants
 - c. Insects
 - d. Fungi and mushrooms
 - e. Bacteria, Viruses, and internal parasites
3. Manufacturing and harvesting systems
4. Direct delivery systems and vectors
5. Indirect delivery systems and countermeasures to "germ warfare".
6. Improvised methods of determining toxicity

1) Introduction and brief history

Biological weapons exploit mans susceptibility to disease and to disease causing toxins.

Biowarfare agents enter the body by

- a. The digestive system, usually by food or water, making food and water supplies high priority targets of biological weapon systems.
- b. Through the skin by cuts, scratches, insect bites and overall dermal exposure.
- c. By inhaling microorganisms and their products into the respiratory tract.
- d. By absorption through the eyes

Scientific Principles of Improvised Warfare and Home Defense

In ancient times biological agents used in war often consisted of putting dead animals (and sometimes humans) into enemy water supplies or catapulting them over the wall of besieged cities to spread disease.

Since man began to hunt for his own food, in every part of the world, he discovered and devised new ways of applying nature's weapons to his own weapons.

He learned that snake venom and the juices of plants could be applied to hand held weapons making them much more effective. He observed that animals died after eating certain types of plants and that he could use these plants to poison selected water holes and thereby insure a supply of dead or weakened animals that stopped to drink at the water holes.

Possessors of such secret knowledge could feed an entire tribe in this manner. This is how the early medicine man came about to wield such influence and power in early civilizations. Early man also learned that when an arrow tip was soaked in the blood of his killed enemies and used again in battle that the targets would die from normally minor wounds. Man had learned the cause and effect of septic (blood poisoning) wounds. He also found that he could, with the possession of this knowledge, rid himself of competing and enemy tribes, and objects of his jealousy, hatred, and revenge. He also learned how to mix the blood serum with snake venom to make combination poisons which killed much more quickly and could often incapacitate in a few moments.

Examples of ancient bioweapons and their use include

- * The leaf beetle (*Diamphidia Simplex*) used by bushmen of Central Africa who smear its crushed body fluids onto arrow and spear heads with depressions worked onto the surfaces for holding these fluids. When the arrows cause even a slight wound the target dies slowly in a violent delirium. It is now known that it is the larva (caterpillar) stage that produces a toxalbumin that causes paralysis and agonizing death. When the larvae are squeezed, a colorless fluid exudes from the body which is smeared onto the arrowhead. Its properties resemble some snake venom's and has the ability to be stored almost indefinitely.
- * The Ovambos of Southwest Africa use the fluids of *Adenum* plant as arrow poisons while tribes near Congo and Zambezi use the seeds of the *Strophanthus*.
- * The pygmies of Central Africa mix red ants as a main ingredient in an arrow mixture that is so deadly that a single arrow has killed adult elephants.

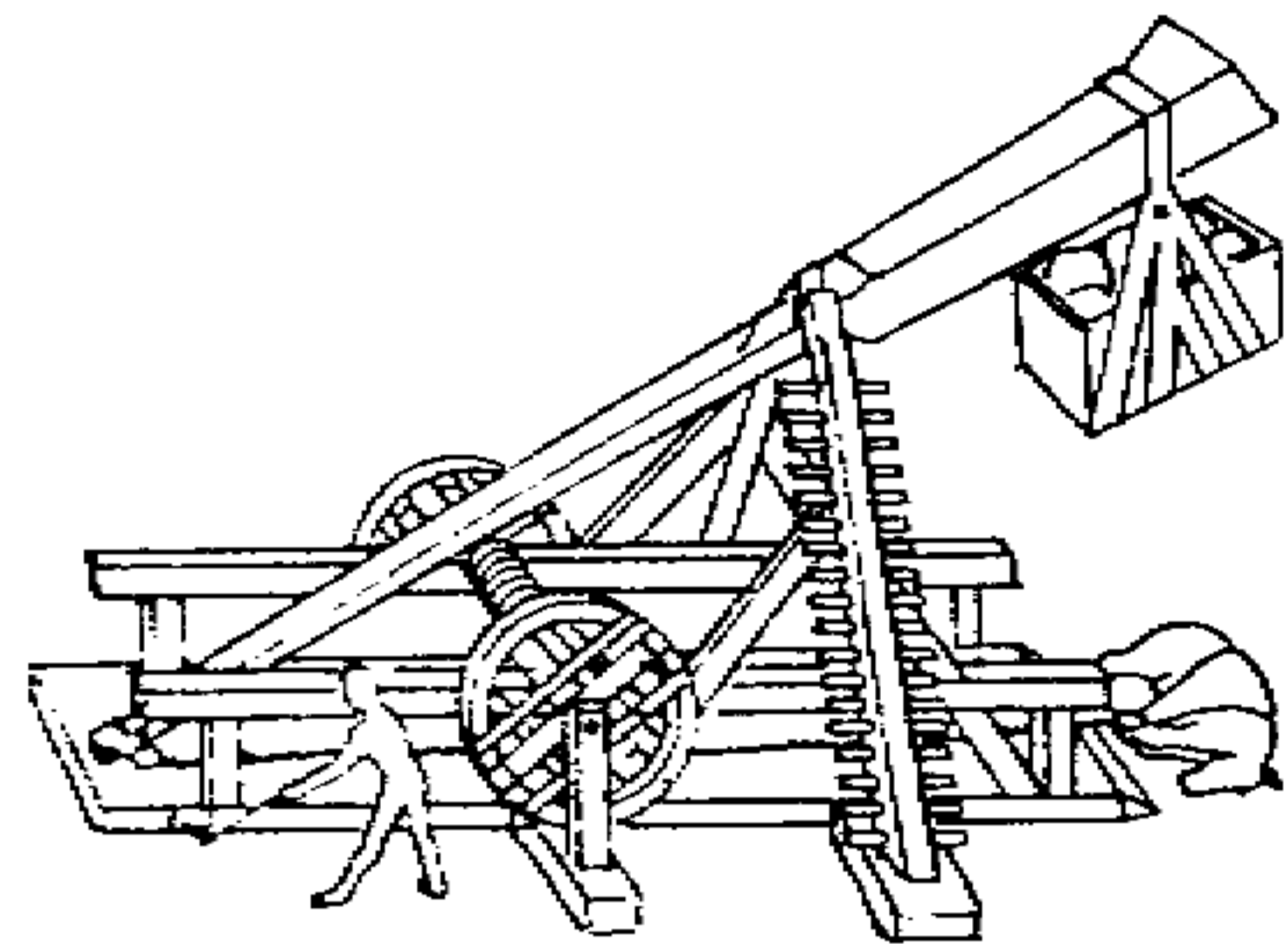

Scientific Principles of Improvised Warfare and Home Defense

- * Malaysians who use narcotic preparations in their piercing weapons to make it is easy to rob their targets without killing them. Natives would even combine poison and honey on one side of a knife blade and would subsequently find a way to share a meal with their enemy target. They would slice the food and he would provide the pieces bearing the poison to the target while eating the harmless portions himself.
- * Natives in Java and Borneo use the sap of the upas tree, often mixed with snake, scorpion, or centipede venom and sometimes arsenic to poison their darts which often kill in 30 minutes or less. The sap is prepared by boiling to remove non toxic liquids and concentrate the poisons. The mixture is stirred until thick and then is allowed to cool and harden. It is stored until ready to use. It is ground to a flour and mixed with a small amount of water to make a paste for the darts when needed.
- * The Choco Indians of Columbia, South America extract poison from tree frogs (also works with Newts) by holding the animal on a stick over a fire. Heat causes the glands of the skin to excrete the poisons which are collected in containers and are usually used in a few days.
- * California Indian tribes used soap root (*Chlorogalum Pomeridianum*). Besides acting as a soap, the crushed pulp would be dropped into the water of a stream or small pool and stirred. The area fish are stunned by the poison (not killed) and float to the surface where they are captured for food. Vinegar weed (*Trichostemma lancerlatum*) has a similar effect.
- * West African Tribes harvested the Calabar (ordeal) bean which contained physostigmine, a powerful poison of which exposure to a few grams could kill. It has been harvested and used in minute quantities by ophthalmic surgeons for medical purposes in this century.
- * The Hottentots kill snakes by extracting nicotine and oil nicotianin which are both soluble in water and extracted from tobacco leaves. A single drop of the pure oil kills snakes instantly and small animals in a few minutes. [Pure Nicotine has been used in deliberate human poisonings in this century]
- * Many cultures used Opium and other narcotics to effect enemies and provided large quantities to their own troops prior to battle to render them insensible to the dangers they faced.

Scientific Principles of Improvised Warfare and Home Defense

The first modern organized warfare in which the science of growing identified disease cultures and delivering them against an enemy occurred from 1914-1918 where a variety of methods were used by Germans against the Allied civilian populations.

Tiny darts placed in shells with bursting charges and candies with wrappers were saturated with cholera bacilli and typhoid and dropped by air over France, Romania, and in May 1917, near Rome Italy. These produced a number of individual casualties.

On July 29, 1917 the US attorney general announced the presence of Tetanus and anthrax in court plaster used for treating livestock cuts and other injuries. The poisoning and resulting outbreaks were attributed to German spies who contaminated the plaster at the source of packaging or manufacture.

On July 9th, 1917 while preparing to evacuate territory west of St. Quentin, France the Germans inoculated all French men, women, and children with the tuberculosis bacilli under the pretense of vaccinating for smallpox that they claimed was sweeping the country. Only those individuals vaccinated developed tuberculosis.

On March 30th, 1917, a German plan to infect the horse food supply and to use commandos to scratch the insides of allied horse nostrils with contaminated wires was intercepted by military police.

The world is aware of the research conducted by the nazi's during WW2 and even today it is suspected that chemical or Bio weapons may be the cause of Gulf War Syndrome among US troops who fought in the Persian Gulf war.

Many countries still quietly conduct both offensive and defensive Bio warfare research today. The principle means of planned delivery systems include missiles or shells with bursting charges of solid or liquid aerosols. Insects or vermin may also be infected and distributed to spread disease.

Scientific Principles of Improvised Warfare and Home Defense

The candidate agents considered for use today fall into the following categories.

<u>Category/Agent</u>	<u>Infectivity</u>	<u>Transmissibility</u>	<u>Incubation</u>	<u>Mortality</u>
Bacteria				
Anthrax	Moderate	None	1-5 days	100%
Brucellosis	High	None	7-21	2-10%
Cholera	Low	High	1-5	5-75%
Dysentery	High	High	1-3	2%
Pneumonic Plague	High	High	2-5	100%
Typhoid Fever	Moderate	Moderate	7-21	10%
Rickettsiae				
Epidemic Typhus	High	None	6-15	10-40%
Viruses				
Encephalitis	High	None	5-15	1-80%
Influenza	High	High	1-3	1%
Smallpox	High	High	7-16	5-60%
Yellow Fever	High	None	3-6	5-40%

Many other diseases have been evaluated as military weapons.

We will now cover a variety of biologically produced poisons and their source species.

Scientific Principles of Improvised Warfare and Home Defense

2) Natural Sources

A) Animals

In general, some large animals can provide substantial and deadly Bio toxins. Large animals often have the disadvantage of being hard to locate, are generally few in numbers, and can use their poison against you. If you are located on a coast, the ocean can provide a good selection of toxin producing animals. These include Eels, Jellyfish, Pufferfish, Stingrays, Scorpion Fish, and Sea Snakes.

In some cases the poison can be milked or harvested in an aquarium. In other cases the individuals must be killed and the venom "sacs" cut out and burst. If you are unfamiliar with the biology and architecture of your choice, there is a procedure that can be followed to recover the poison.

1. The area of the animal believed to contain the poisonous reservoir is cut out. In the case of a poisonous snake, the head can be cut off.
2. The tissues are ground to a fine meal. A coffee grinder can be used, however, it might generally be safer to use a pestle and mortar to hand grind or a ball mill (small ball bearings rolling around in a cement mixer with the animal tissues) to grind to a powder without making an aerosol. Do not use a hammermill.
3. The fine powder is mixed with water, alcohol, or a mild solution of acid or alkali to solubulize and leach out the poison.
4. The solids are separated from the liquid by leaching through a cloth into a bucket. This process can be drastically speeded up by creating an improvised vacuum filter.

[An improvised vacuum filter can be made by taking a 5 gallon round top, metal can with a lip at the top to contain the mix. Punch numerous fine holes through the top with a hammer and nail and then fit a round male pipe fitting to the side of the can which exactly holds a vacuum cleaner hose end. The idea is to place the mix on a cloth on the top of the can and attach the vacuum hose to the can to create a suction which rapidly pulls the liquid through. This is much faster than gravity leaching.]

5. The poisonous solution is poured out of the container (the solids discarded) and then allowed to evaporate to a paste. Do not try to boil dry and do not dry to a powder.

This general method of extraction can be used on all living animal, plants, insects, fungi, and microorganisms that produce toxins, and can be scaled up to factory levels in wartime. The poisons go into solution with all the other soluble components (mostly water in the tissues) and the liquid is separated and evaporated to concentrate the poisonous substance. Knowledge of the specific poison and the laboratory method of purifying to near 100% can be found in the medical, chemical, and biology journals of most Universities.

Scientific Principles of Improvised Warfare and Home Defense

Animals that can be obtained in larger numbers and are widespread are found among the reptiles and amphibians. Several will be provided as examples here.

Eastern Newt: Found in North America from Nova Scotia to Texas, it is widely distributed, and found in lakes, ponds, and backwaters with dense aquatic vegetation and damp woodlands. Adults are found in stagnant water and eat invertebrates and amphibian eggs and larva. They breed in winter and early spring when females lay 200-400 eggs. Newts secrete a poison, coating their skin to protect them from fish and other predators. The secretions are water insoluble and are removed by heating the newt so that the glands excrete the poison and its viscosity is lowered allowing it to drip into a pan. This Newt is greenish in color with a yellowish area around the shoulders and legs.



Chinese Warty Newt: Found along the northeast coast of China and Ningpo island. Uniformly dark green in color.

Spanish Ribbed Newt: Southwest Iberian Peninsula and Northwest Morocco. Mix of light blue and white with black dots make it easy to identify.

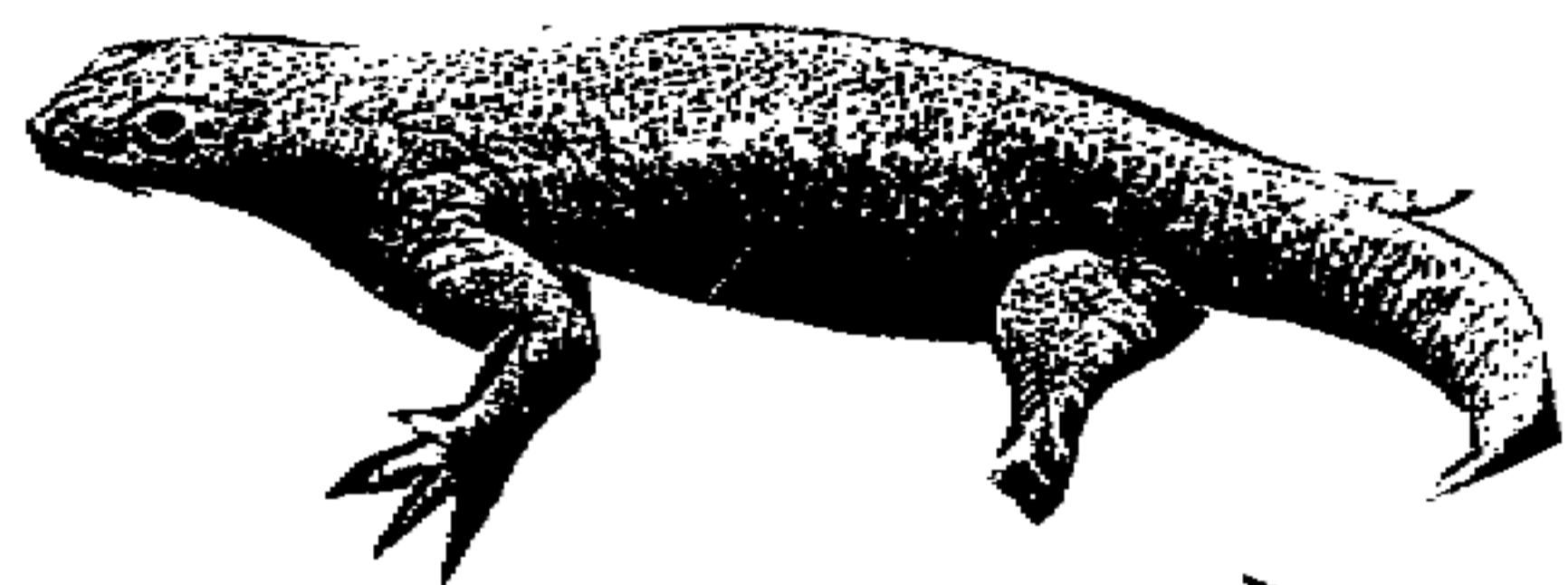

California Newt: Coastal and Sierra Nevada ranges of California. Dark green with brown banded legs.

Scientific Principles of Improvised Warfare and Home Defense

Alpine Newt: Western central and Southeastern Europe. Blue with black and white leopard spots on its underside

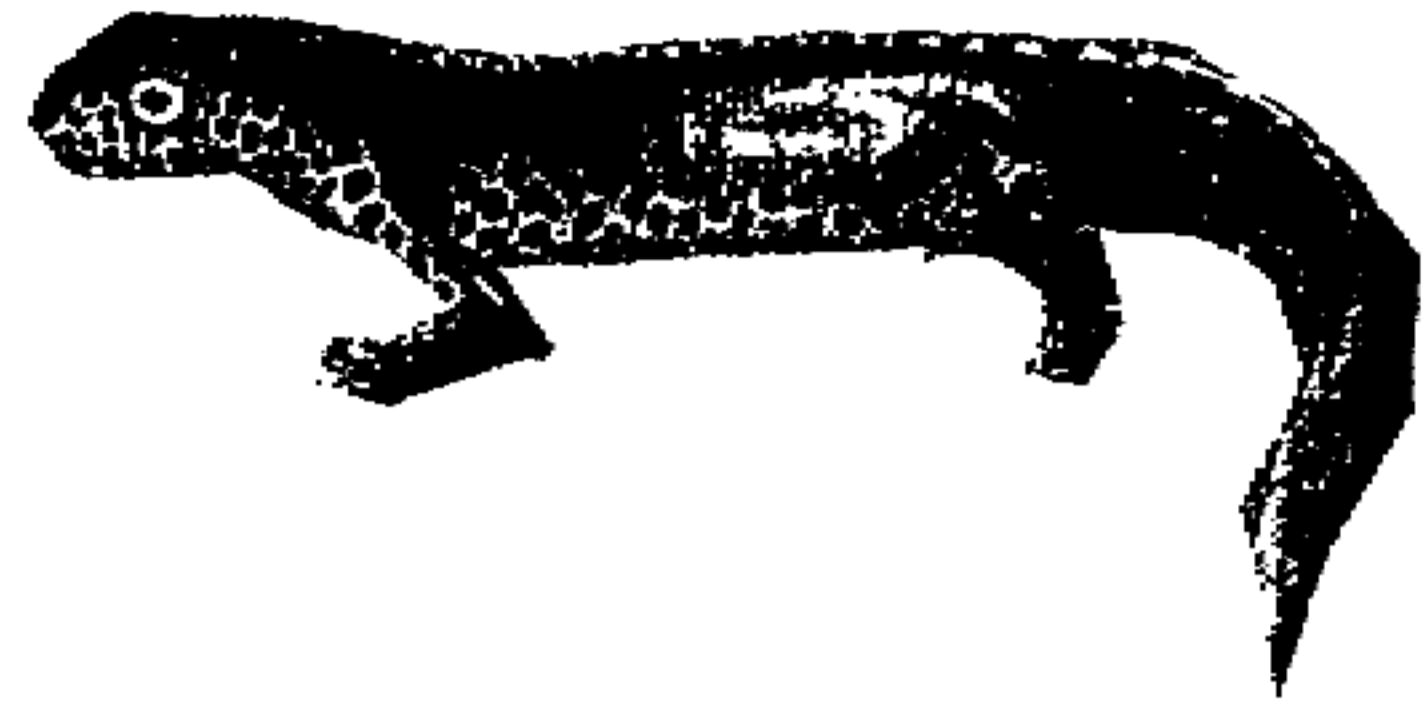

Crested Newt, Warty Newt: Europe to Central Asia. Yellowish with dark green spots and background

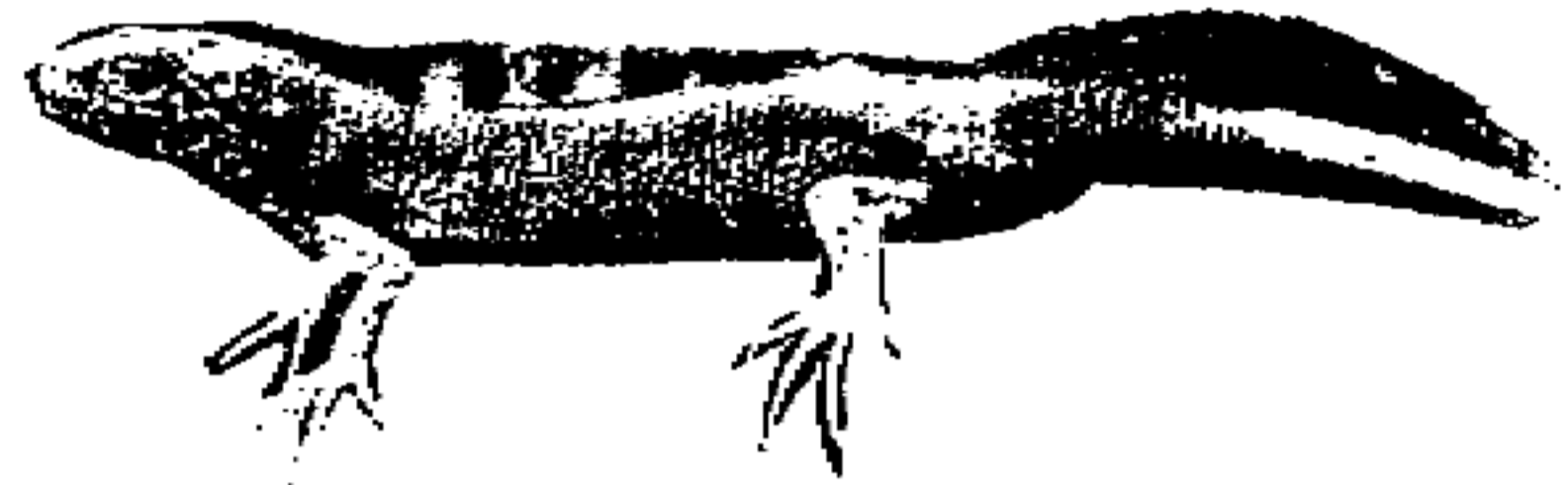

Marbled Newt: South and West France and Iberia. Light brown with small black dots



Smooth Newt: Europe to West Asia. Light green with tiny black spots and black bands



Emperor Newt, Crocodile Newt: China and southeast Asia, Northern Thailand. Bright yellow and orange legs dots and stripes



Scientific Principles of Improvised Warfare and Home Defense

Marine Toad: Widely found in all the Americas and introduced to many other countries. Active at night and covered with dark brown warts. This species has been widely distributed as an insect control agent. Milky secretions from its Paratoid glands will kill any predator that tries to eat this toad. Light brown in color.

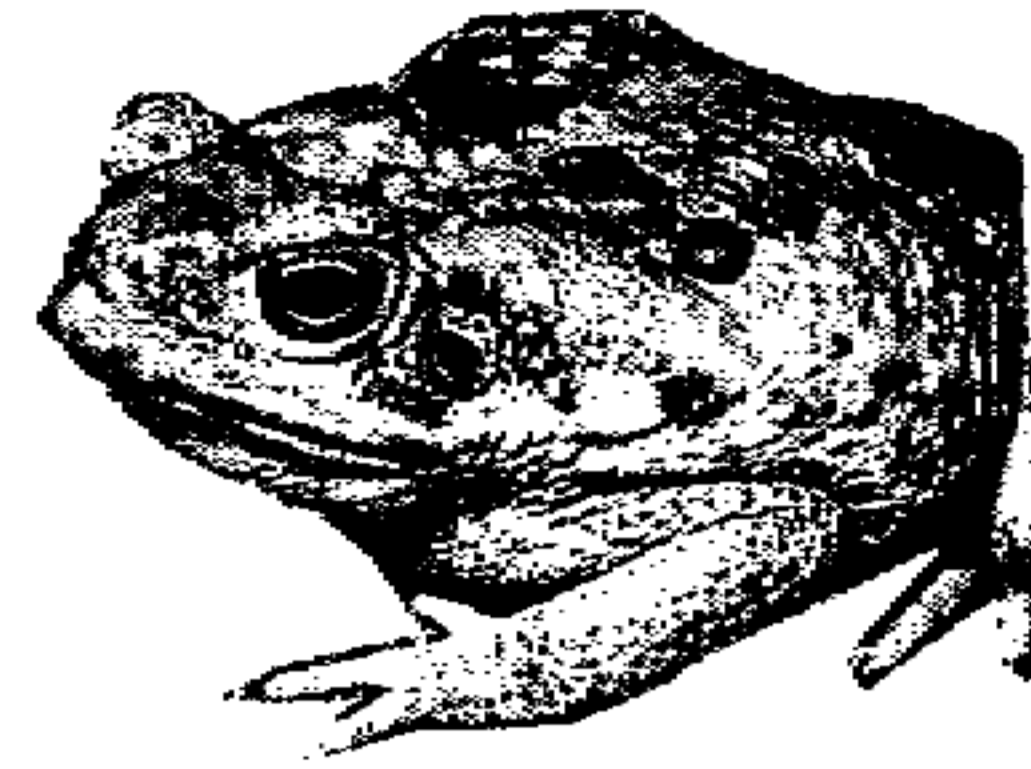

Strawberry Poison Dart Frog: Found in Central American Rain forest, almost always in leaf litter and decomposing vegetation. Its skin contains many glands which secrete poison. Red to yellow body with blue spotted legs on a black background.

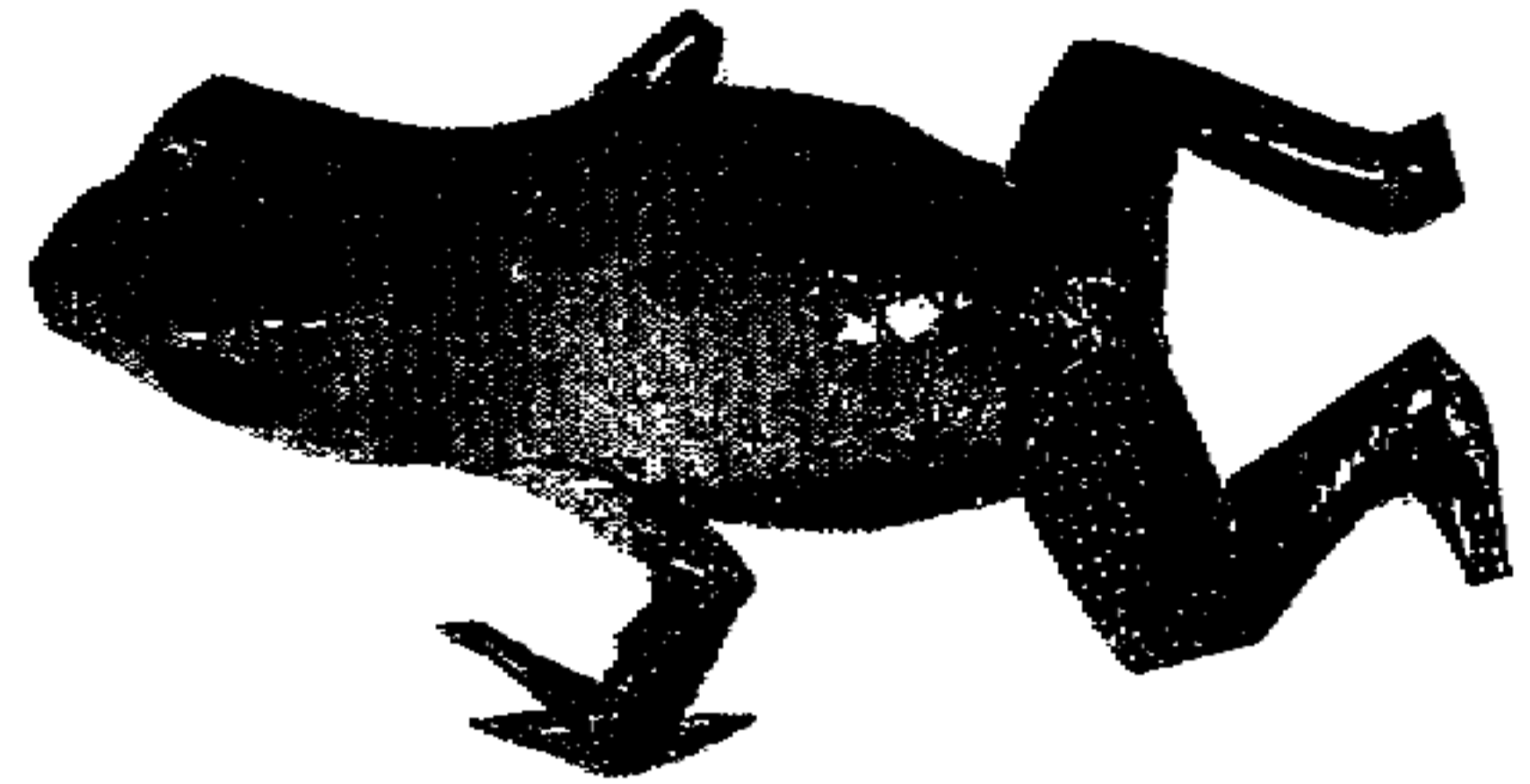

Red Banded Crevice Creeper: Found in South Africa. When disturbed, it emits a foul smelling, irritant toxic substance from its skin. Has orange spots and stripes over a greenish-black background.

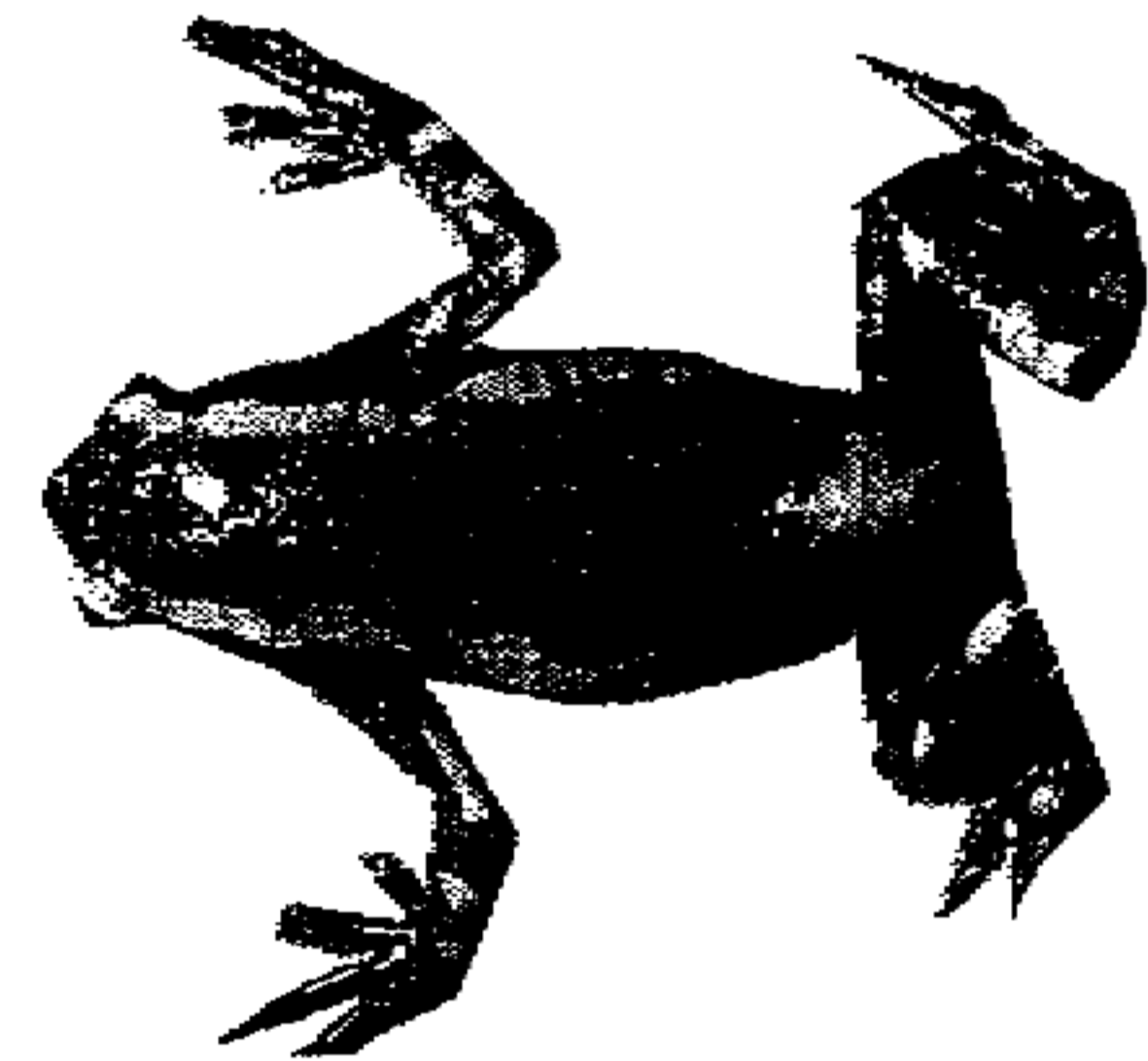

Gila Monster: The only poisonous lizard, it uses its venom to immobilize prey and is very dangerous to humans. Found in Southwest USA and northern Mexico. Black with yellowish-white banding



Mangrove Snake: Southeast Asia to the Philippines. Mildly venomous, rear fanged, lives in trees overhanging rivers and streams. Prey are immobilized by venom injected with grooved teeth in the rear of the upper jaw. Bites are painful but not lethal to humans. Black with yellow stripes.



Scientific Principles of Improvised Warfare and Home Defense

Boomslang: found in Sub Saharan Africa. It injects very poisonous venom in small amounts which attacks blood cells and prevents clotting and are very dangerous to humans. Green with a tan-white belly.

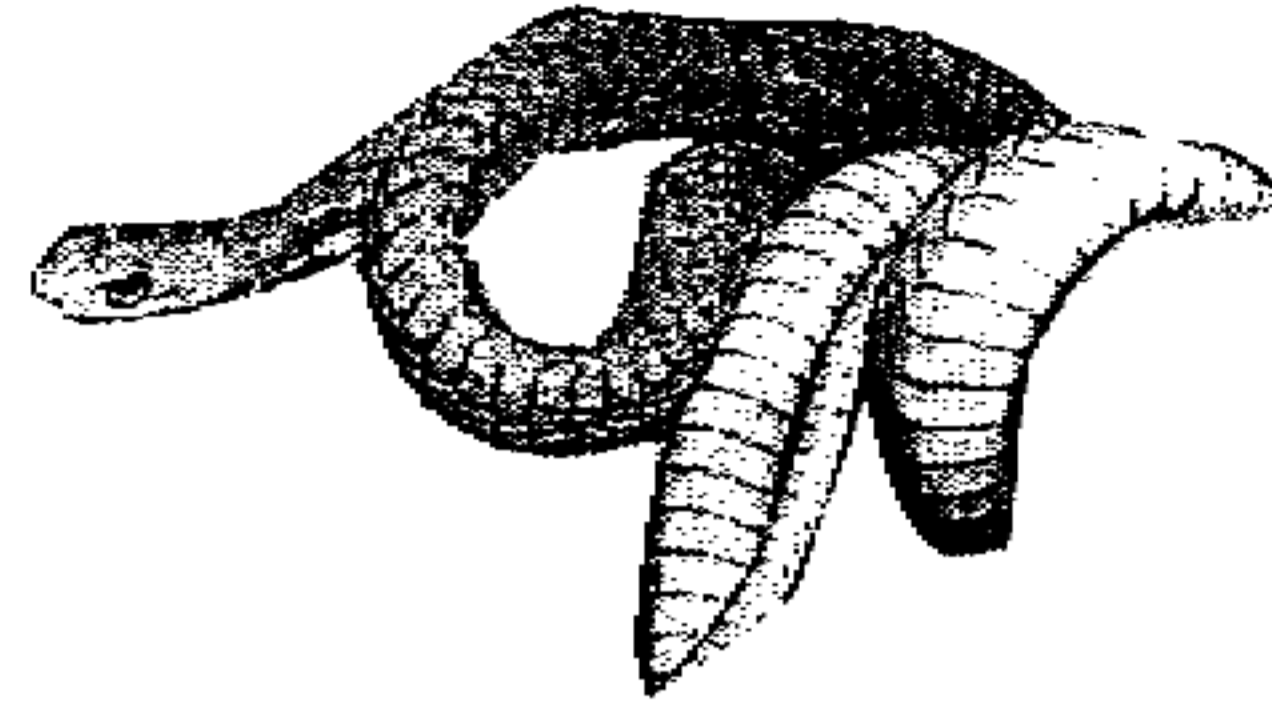

Montpelier Snake: Mediterranean countries, Balkans, and Southwestern Asia. Injects venom which quickly immobilizes its prey. Single bites will not kill humans. Color from green to brown to black depending on orientation observed.

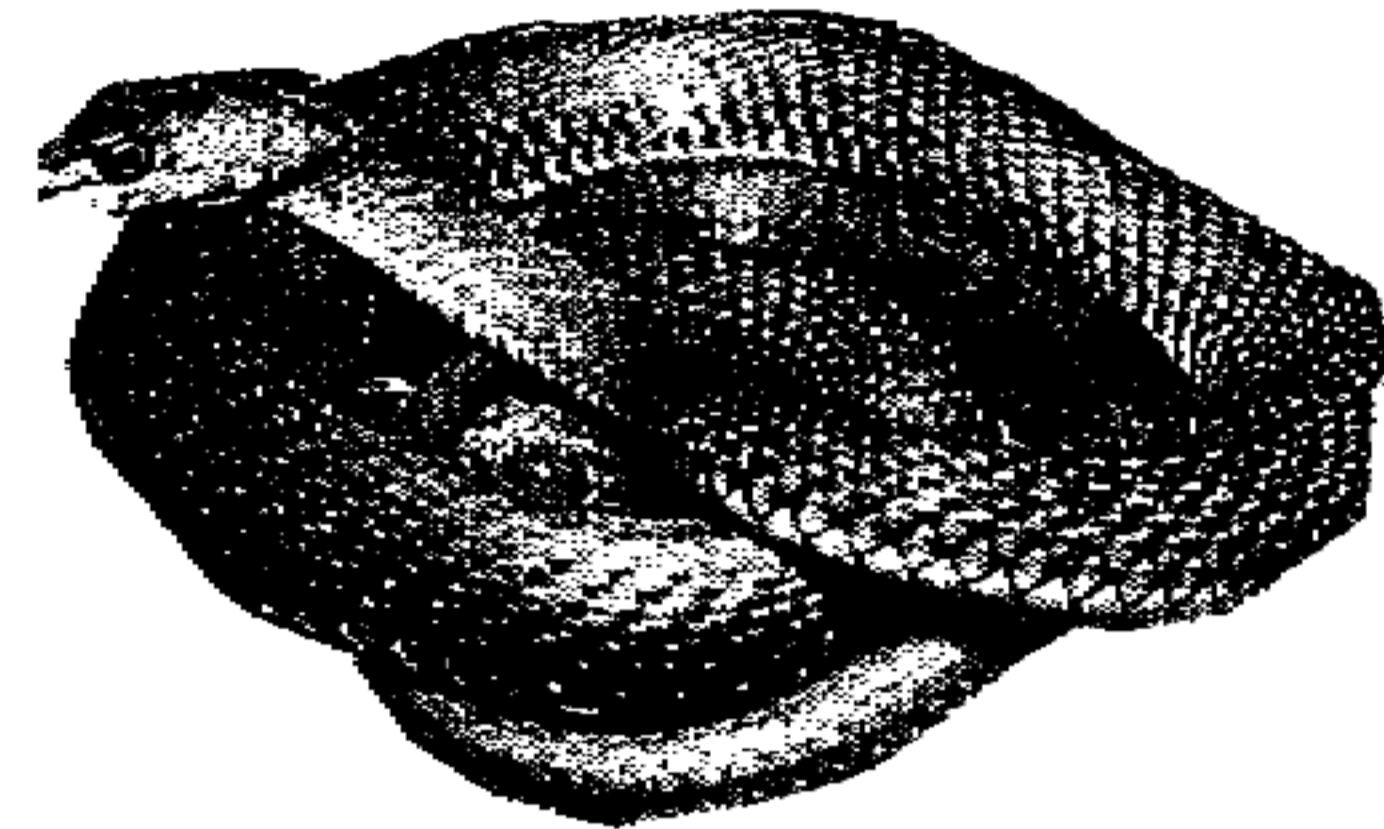

African Twig Snake: Central and West Africa. Powerful venom similar to boomslang but rarely bites people.



Death Adder: Australia. Venom is extremely toxic. One of the worlds deadliest snakes. Found in forests, open woodlands, and semiarid scrubland. Lures prey by twitching tail. Black with thin white bands.



Banded Krait: India, Southeast Asia, and Malay. Found in grassy fields close to streams. Hides under stones and logs. Rarely bites humans even when harassed. Has a highly toxic venom. Yellow with black bands.

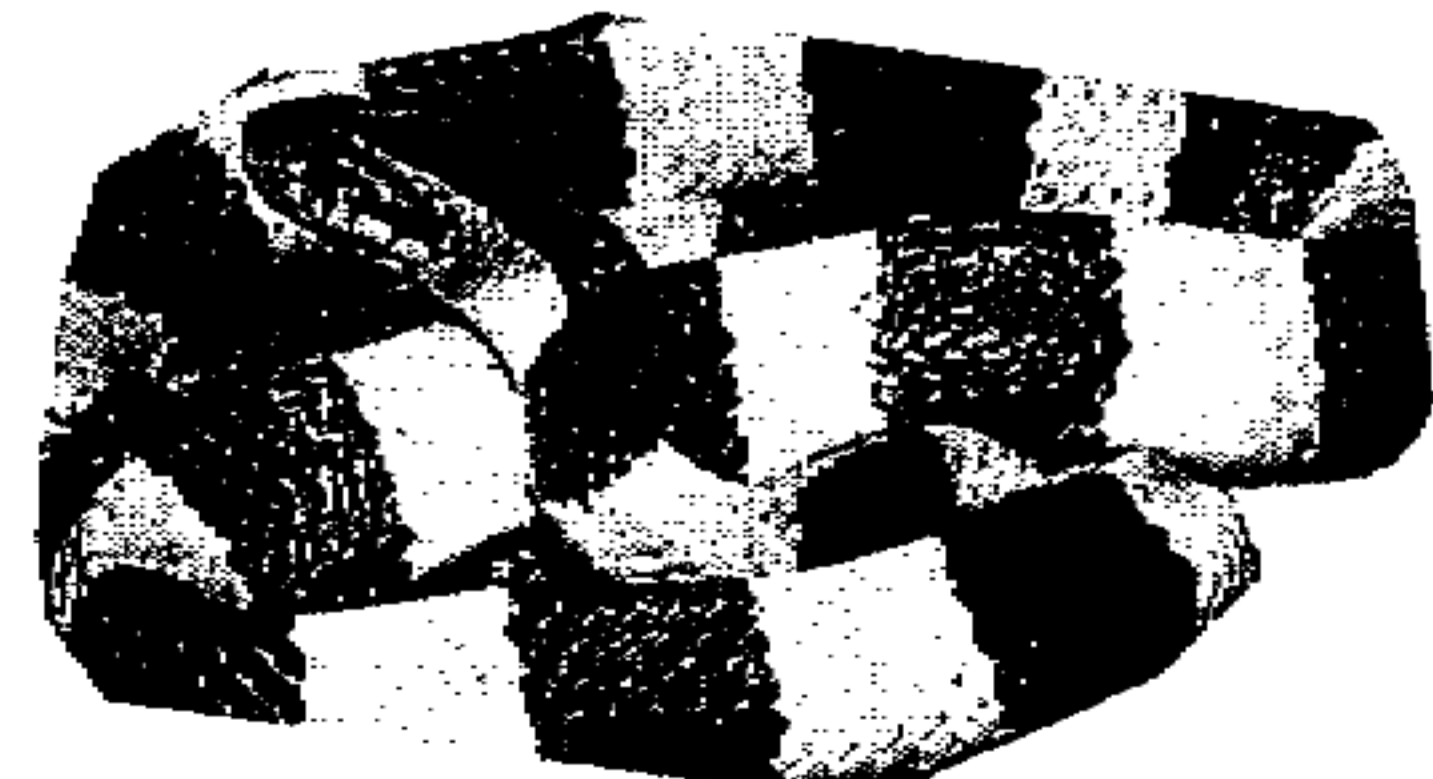

Scientific Principles of Improvised Warfare and Home Defense

Black Mamba: East, Central, and South Africa. Very aggressive and venomous. Dual toxins, both neurological and cardiotoxic make it very potent. Whitish-tan in color



Yellow Tipped Sea Brait: Venomous sea snakes found in coasts of West Pacific and East Indian Oceans. Found on land and sea. Bite may be lethal but withstands rough handling without biting. Yellow and black bands.

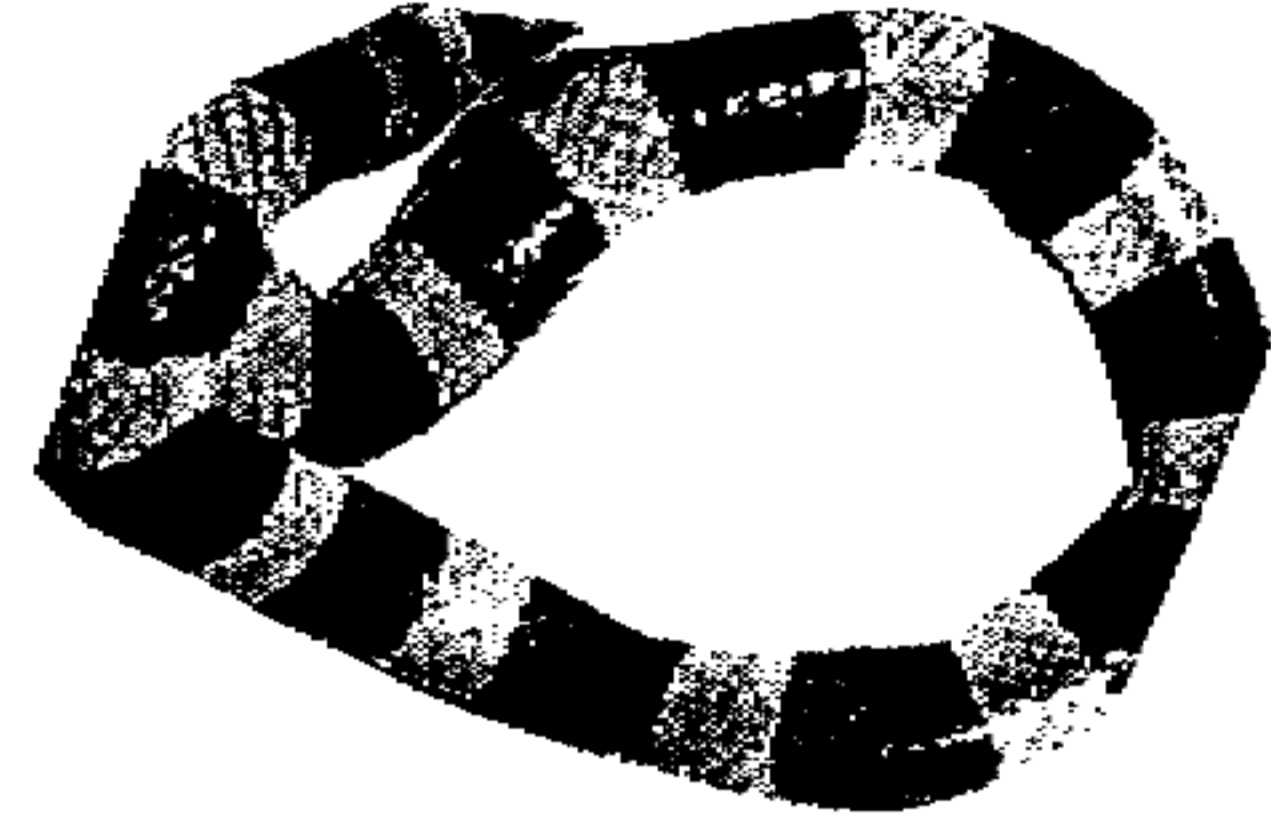

Eastern Coral Snake: Southeast USA and Northeast Mexico. Bite is life threatening and this snake bites. Larger snakes are lethal with a single bite. Red with narrow yellow bands on each side of a black band.

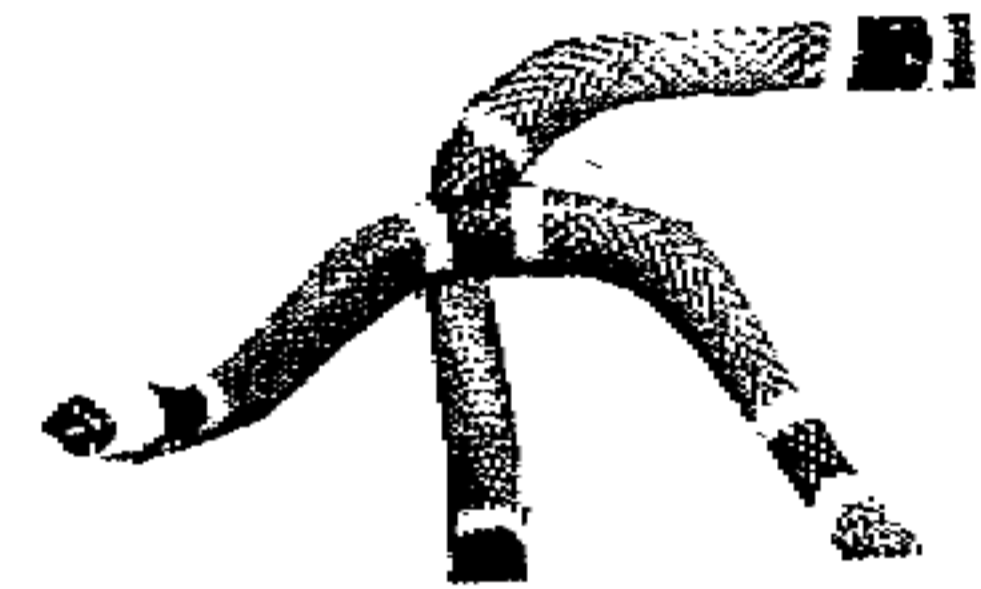

Cobras: Found in Africa, Asia, Pacific, Indian Ocean islands. Easily identified because its neck spreads to a hood when disturbed. All species venom are neurotoxic and account for thousands of deaths each year.

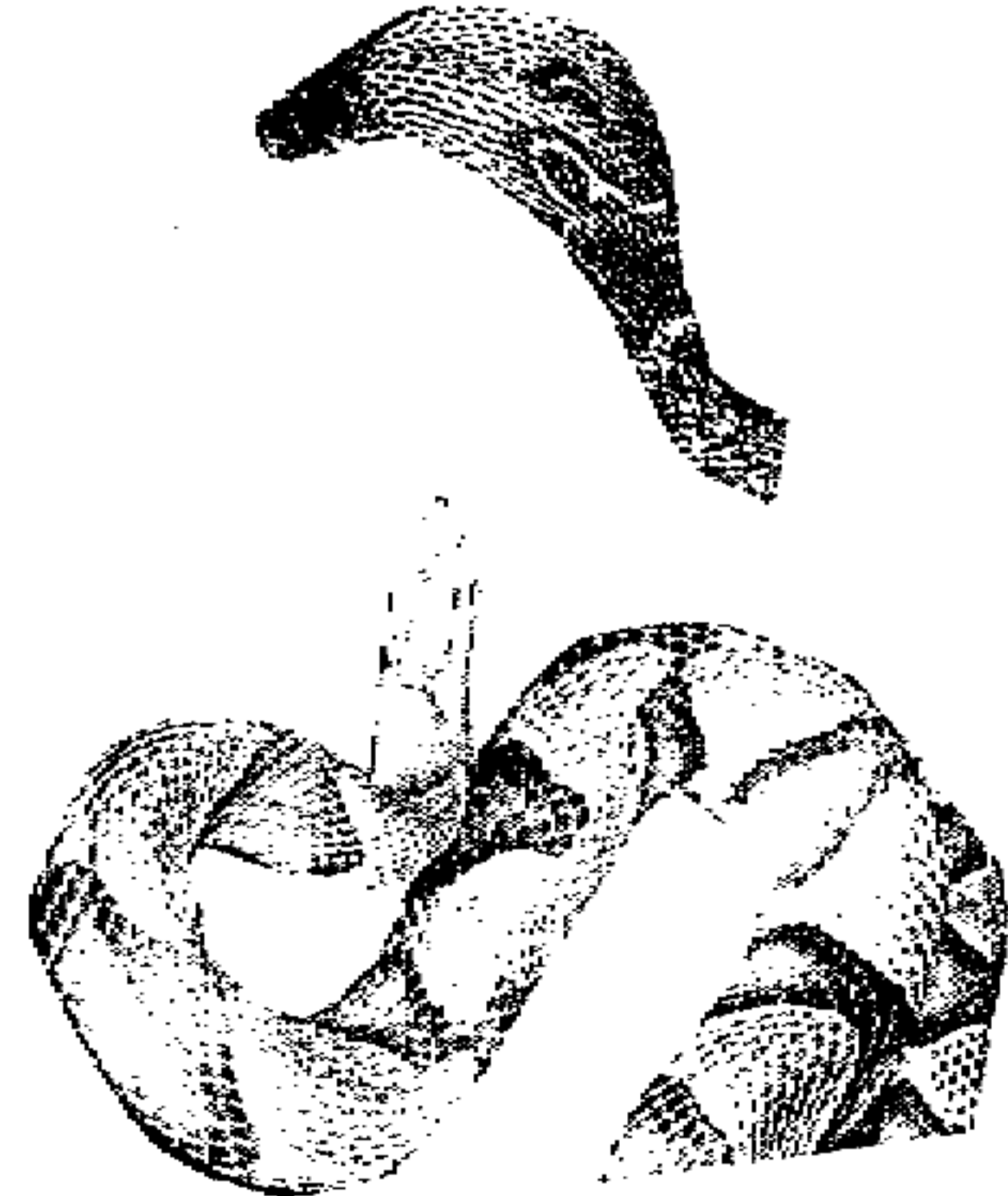

Copperhead and related Vipers: Eastern 2/3rds of the US. Bites are painful but only moderately venomous. Copper colored with dark brown bands.

Scientific Principles of Improvised Warfare and Home Defense

Puff Adder: Africa, bites are very serious.

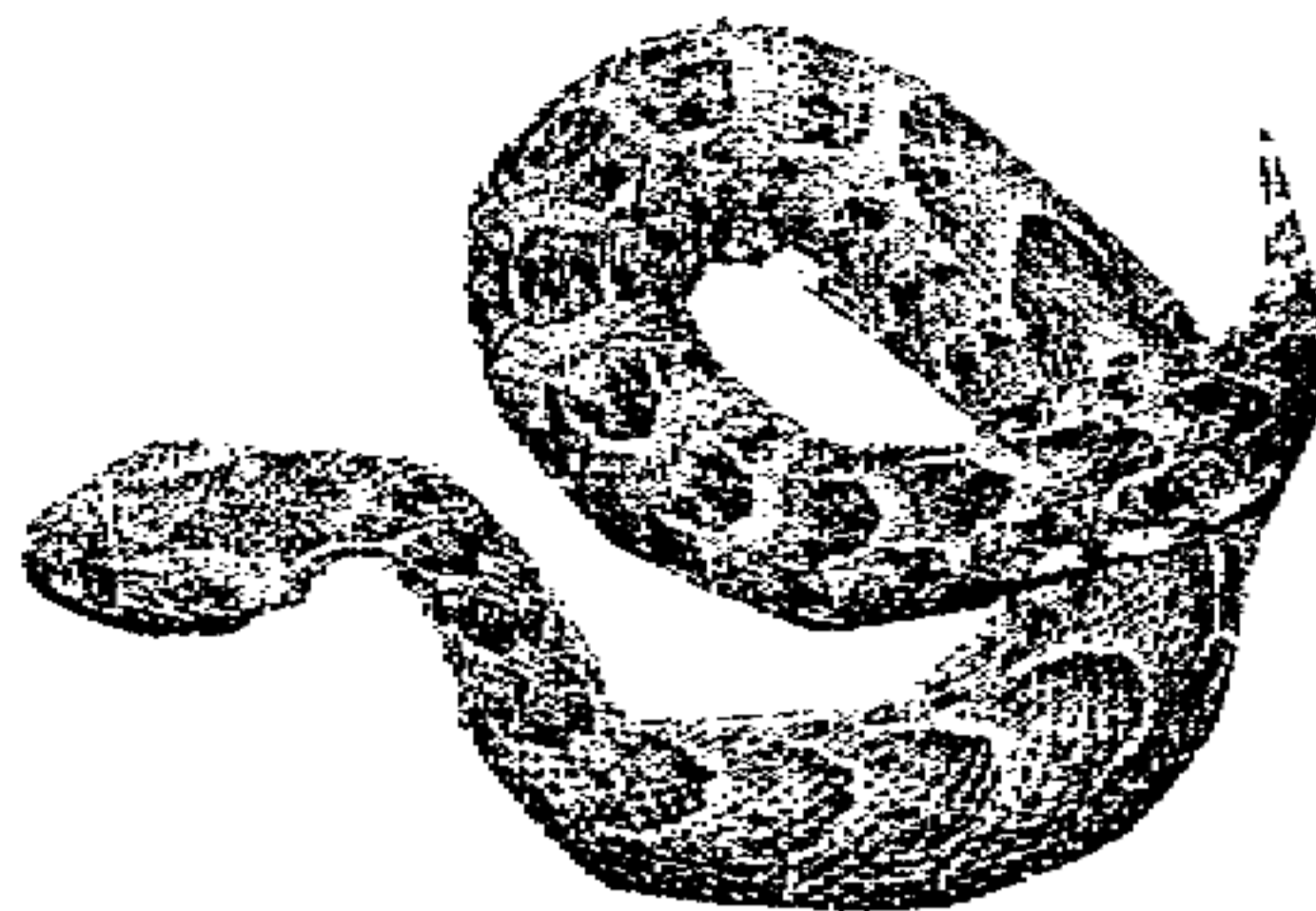

Desert Horned Viper: North Africa and Southwest Asia. Powerful Venom.



Rattlesnakes: US, Mexico. Identified by distinct rattle on tail. Deadly venom acts quickly requiring antivenin ASAP.

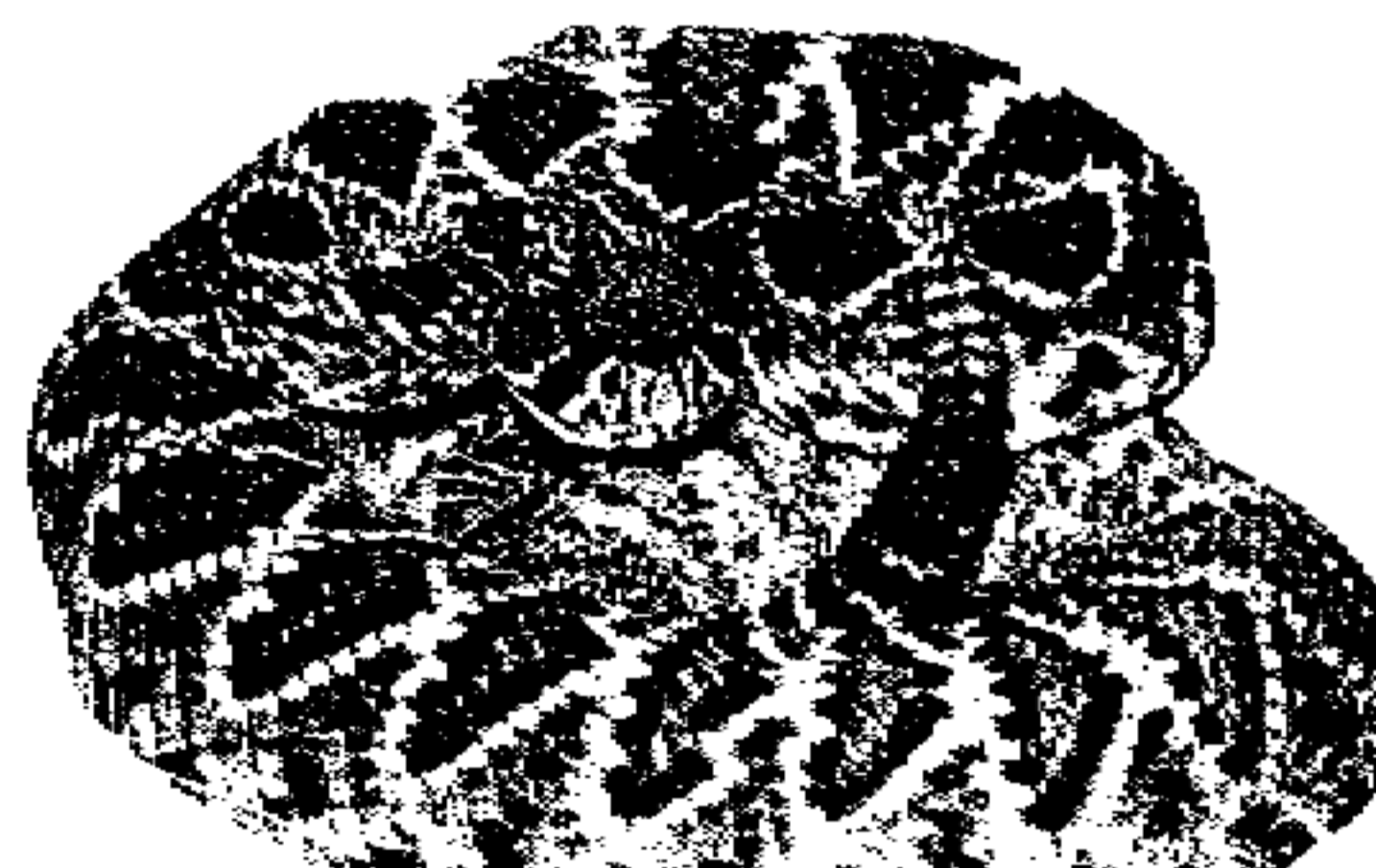

Saw Scaled Viper: North 1/2 of Africa and Southern Asia. Very potent haemotoxic makes it very deadly.

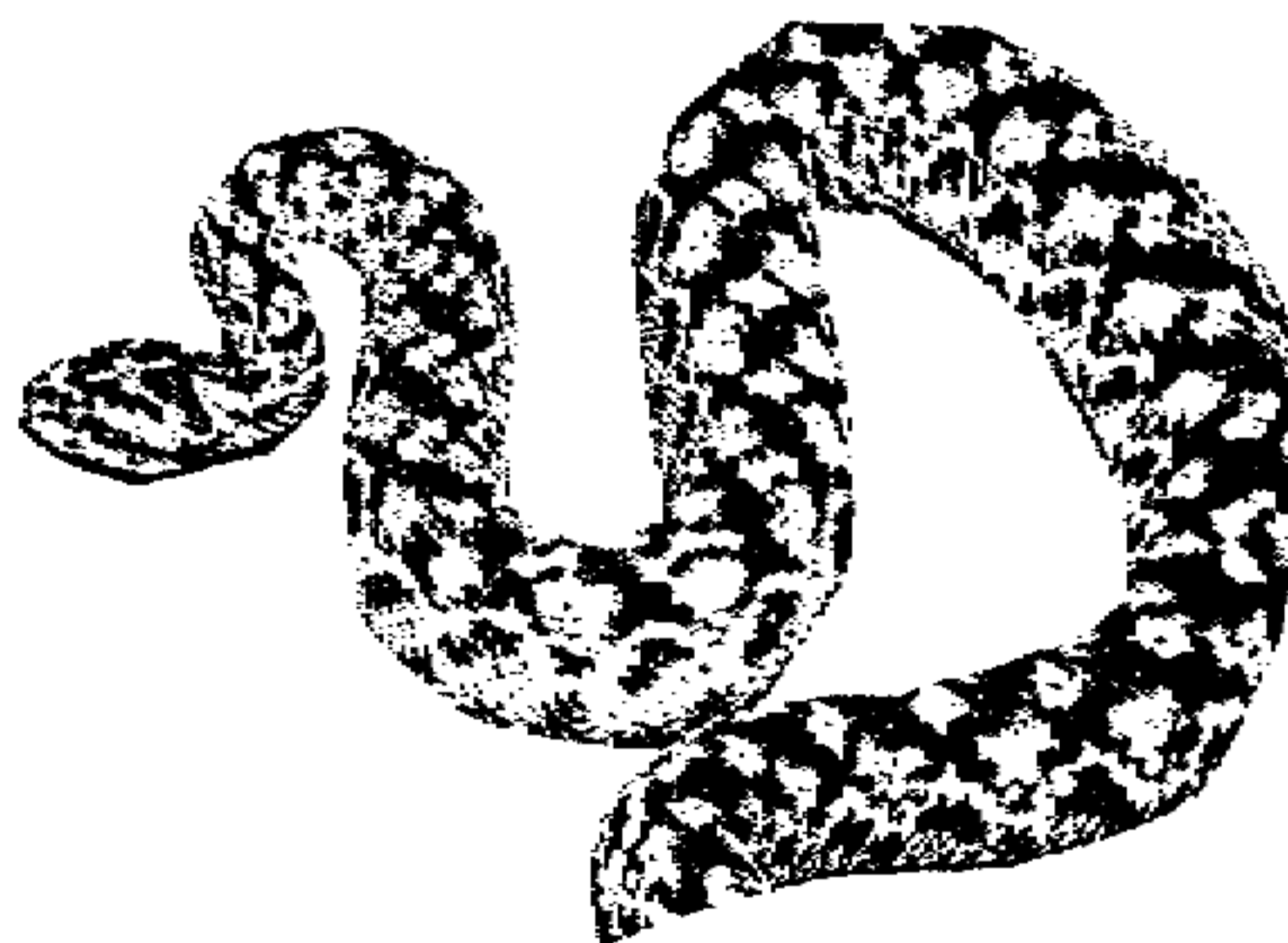

Russell's Viper: South Asia and China, Taiwan, and Indonesia. Untreated bites have high mortality and this snake is aggressive.



Scientific Principles of Improvised Warfare and Home Defense

These and their related subspecies can be found nearly anywhere on earth. Since their toxins can be harvested, a large supply can be accumulated over time. As with any field of endeavor, special skills and experience need to be acquired.

There have been numerous examples, both ancient and modern, of using deadly snakes directly as a weapon or booby trap. These have had only limited success.

Animals and humans that have been wounded or killed, or are ill are sources of infectious agents that can be collected, cultured, mass produced, and delivered against enemy forces. Most of these consist of Bacteria, Viruses, or Parasites which will be covered in detail later in the chapter. Carriers and reservoirs of disease include individuals and animals who have been infected but recovered and still carry the suppressed infectious agent, animal products and foods not sterilized or properly preserved, and the soil which acts as an enormous source of potential spores or dormant infectious organisms.

Most organisms deadly to humans reproduce in injured tissues or dead and decomposing animal tissues, or are found growing in large numbers in raw sewage where these large numbers of tiny, invisible organisms can rapidly spread to the general living populations. This method of disease spread is usually accomplished by a 3rd party or vector such as rats or insects (on rats) which carry infected manure or tissue on their legs and deposits them on human foods, clothing, into water supplies, and directly into human tissue by direct contact or biting.

Scientific Principles of Improvised Warfare and Home Defense

B) Plants

In the book "Poisonous Plants in the United States and Canada" author John M. Kingsbury identifies and describes over 700 plants known to be poisonous to man or animals. One of the rules of thumb in survival is to avoid eating unknown white fruits plant foliage without checking for poisonous symptoms by feeding to lower animals first. Dangerous plants can be found in woods, gardens, as house plants, and along public highways. Poison can be isolated from roots, fruit, or foliage by the extraction method described for animals or following the appropriate lab procedure.

We will describe some of these plants and provide an additional list as an introduction to this source of biotoxins.

Star of Bethlehem (Ornithogalum umbellatum or O. Nutans)

Small herb growing 14 inches high with an egg shaped bulb 1-1.5" long. Bulbs contain poisonous alkaloids that kill grazing animals and a lesser degree in the foliage. Long stalked white flowers with 6 petals with green strip on the lower side. 3 lobed fruits contain black seeds. Grows wild throughout east 2/3rds USA.



Death Camass (Zigadenus venenosus) and all 12 related species:

Perennial Herb producing an egg shaped bulb. All plant parts, especially the bulbs, contain the violently poisonous alkaloid "zygadenine" which causes GI distress, weakness, loss of motor function and death. With 6 petal whitish flowers with small egg shaped fruit which splits open at maturity releasing tiny brown seeds. Found in the Northwest USA.



Scientific Principles of Improvised Warfare and Home Defense

Atamasco Lilly (*Zephyranthes atamasco*) and all 11 related species.

Extremely poisonous bulbs produce staggering, collapse, and death. Found in wet areas of the Southeast USA with long funnel shaped 6 lobed flowers- one flower for each stem. Papery, leathery, 3 lobed fruits mature and split open to release shiny black seeds.



Yellow Flag (*Iris pseudoacorus*) and all Iris species

The leaves and roots of all Iris species are poisonous. The roots are emetic and cathartic containing the poison Irisin and are lethal. Large perennial herb with long narrow sword shaped leaves and large bright yellow showy flowers, 3 petals spreading, each crested with brownish irregular spots and 3 narrower upright petals. Produces elongated fruits. Iris's are widely distributed around wet areas and gardens throughout the US.



Common Buttercup (*Ranunculus acris*) and all buttercup species

Oil in the leaves and stem contains bitter tasting poisons that cause diarrhea and blindness. Several flowers in a branched, open, spreading cluster, with 5 bright glossy yellow to whitish petals 1/2" long, broadest at the tip. Buttercup species are found in yards, fields, and clearings throughout the US.

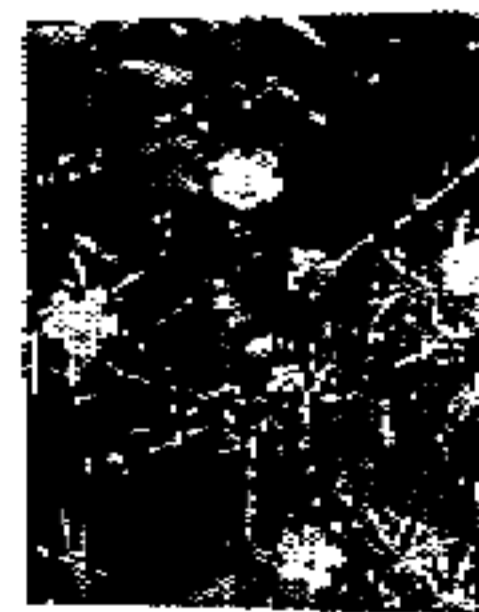

Scientific Principles of Improvised Warfare and Home Defense

Jimson Weed (Datura Stramonium) all Datura species

All plant parts including seeds contain the alkaloids atropin and hyoscyamin which are violently poisonous and cause impaired vision, thirst, delirium, coma, and death. Its flowers suggest wild petunias and are responsible for many child poisonings. Its trumpet shaped flowers attract children who pick and suck on them. The plant rarely produces vomiting resulting in absorption of large amounts before symptoms set in. A coarse annual herb, its flowers are long, showy, white to light purple with a heavy fragrance. Found throughout the USA in barnyards, fields, roadsides, and disturbed sites.



Yellow and White Sweetclover (Melilotus officinalis)

Harvested sweetclover dampened, will easily mold producing "coumarin", an anticoagulant that causes severe internal bleeding and death. Moldy sweetclover in hay has killed large numbers of cattle. Leaves are composed of 3 leaflets Numerous elongated clusters of bright yellow or white flowers resembling tiny pea blossoms. Introduced from Europe and Asia it is found growing wild in all North America along fencerows, roadsides, and old fields.



Pokeweed (Phytolacca Americana)

Mature leaves, stems, and roots* contain more toxins than young growth and berries. These produce diarrhea, vomiting, cramps, sweating, reduced breathing and death. Cooking water that has even been boiled with this plant is dangerous. Found in eastern 1/2 of USA along roadsides and woodland margins. It produces a 10 seeded juicy berry that is safe to eat when cooked. The poison goes with the water. Dangerous when eaten raw. * This root is deadly and the plant is found as a weed in many gardens.



Scientific Principles of Improvised Warfare and Home Defense

Dogbane (*Apocynum androsaemifolium*) and all other *Apocynum* species

Found in open woodlands, roadsides, and fields in dryer areas. Produces several bell shaped, white to pink, spreading flowers in branched clusters. All plant parts contain poisonous resins and glycosides in milky sap that affect the cardiovascular system of all mammals.



Butterfly Weed (*Asclepias tuberosa*) and all 30 native *asclepias* species

All plant parts contain glycosides, alkaloids, and resinoids that cause weakness, staggering and seizures. Responsible for many livestock deaths. Found in most of US east of Colorado, in fields, prairies, and woodlands. Showy, branched, flat topped clusters of flowers in orange to red to yellow 5 part deeply lobed petals.



Poison Ivy (*Toxicodendron radicans*) and Poison Oaks

Found in woodland, pastures, and wet areas across USA. Low shrub or climbing vine with hairy, light brown twigs with coarse teeth along margin of leaves, immature are bronze in color with tiny male flowers in branched clusters. Fruits are rounded, creamy white, and produced in clusters like grapes. All plant parts have the oily resin "urushiol" which causes rashes and blisters on the skin, in the nose, mouth, throat, and nasal passages from eating the berries or breathing smoke from burning plants.



Scientific Principles of Improvised Warfare and Home Defense

Other toxic plant species include:

White baneberry	Poisonous berries
February Daphne	" "
Spindle Tree	Poisonous Red Fruit Capsules in fall
Common Moonseed	Very Poisonous Black Berries
May Apple Mandrake	Root is very poisonous and berries cause diarrhea
Castor Oil Plant	Tree like plant up to 40' tall produces seed (castor bean) which contains Ricin, a deadly blood poison. 3 seeds alone can kill a 200# man. Plant is the source of castor oil.
Black Locust	Poisonous seeds and inner bark, fatal to children.
Deadly Nightshade	Bright red fruits killed many livestock and humans.
Yews	Extremely poisonous seeds and toxic foliage (Green parts)
Wisteria	Twining vines with poisonous seeds
Aconite	Poisonous foliage
Water Hemlock	Roots and seeds are poisonous causing livestock losses
Poison Hemlock	Foliage mistaken for parsley and seeds for anise-in intentional poisonings
Larkspur	Foliage responsible for many cattle poisoning in western US
Foxglove	Leaves are source of heart stimulants and digitalis. Fatal if ingested in large amounts.
Cypress Spurge	Foliage is fatal to cattle
Rhubarb	Contains oxalic acid in leaf stalks and kills livestock
Skunk cabbage	Acrid tasting raw leaves with poison destroyed by cooking or drying.
Dumb Cane	One bite of stalk causes temporary loss of speech and potentially fatal swelling of the tongue and throat.
Poinsettias	Milky sap is skin irritant and leaves are poisonous
Common Lantana	Foliage poisons livestock, some human poisonings from fruit.
Oleander	Poisonous flowers and leaves used deliberately in ancient times.
American Mistletoe	Poisonous Fruits
Fly Poison	Toxic alkaloid and foliage is deadly to flies and humans in small amounts
Bloodroot	Rootstock is bitter and acrid-contains stimulant to gastric secretions and aids digestion in small amounts, causes vomiting, dizziness and paralysis in large amounts.
Horsetail	New shoots and foliage contains aconitic acid and poisons grazing animals
Velvet Grass	Leaves contain hydrocyanic acid (deadly poison) used by KGB

Scientific Principles of Improvised Warfare and Home Defense

Indian Poke or white Hellebore	Violently narcotic and contains poisonous alkaloids which are spontaneously vomited.
Marsh-Marigold	Uncooked stems, leaves, and flowers contain the deadly glucoside, "helleborin" which goes to water solution when boiled.
Celandine	A member of the poppy family, with both narcotic and toxic properties.
Cherry, Plum, and Peach	Trees with leaves that when wilted develop hydrocyanic acid and kill browsing animals
Wild Indigo Jewel Weed Arrow Grass	Leaves contain toxins and poison browsing cattle. Young stems and leaves are emetic and poisonous Fresh plant contains hydrocyanic acid . Seeds are used for coffee.
Hoary Pea	Plant juice is used as fish poison and roots are lethal to small mammals.
Horse Chestnut	Fresh seeds have leachable notorious toxin that causes vertigo, coma, and death.
Apple of Peru Henbane	Foliage is deadly poisonous, used as fly poison. Contains hypnotic poison hyoscyanin, actions resemble atropin
Ground Hemlock Mahogoney Daphne	Stone of the red fruit contains very toxic alkaloid "taxine" Large, thin fleshed drupes are bitter and poisonous Dense masses of red berries are highly poisonous (as few as 12 recorded to kill children) Flower fragrance can induce headaches
Privets	Poisonous blackish berries

A special comment will be made here about Nicotine, the chief alkaloid of Tobacco. A thin, oily liquid with an acrid odor, a single drop kills small animals by ingestion in a few minutes. Both nicotine and oil nicotianin are soluble in water and readily absorbed by the skin. Even the tobacco leaf can produce poisonous symptoms when applied to cuts. Pure nicotine has been used in deliberate poisonings. Much of the exposure to nicotine is reduced by its 90%+ combustion and decomposition prior to inhalation as smoke.

Scientific Principles of Improvised Warfare and Home Defense

C) Insects and other toxic Arthropods

The Arthropods include scorpions, spiders, ticks, myriapods, and insects. Venom and numerous disease vectors are found among this group and all have found their way into ancient or modern warfare.

Scorpions: contain a poison gland located in the last segment of the tail in an enlarged pouch attached to a tapered stinger. The venom's are almost always neurotoxic and cause death by respiratory paralysis. Many scorpions are not toxic and the poisonous ones are found only in a few countries.

Spiders: About 100 of the 20,000 species of spiders contain venom. The Black Widow is considered one of the most dangerous. Its sting causes muscle contractions, sweating, bronchial congestion, and severe weakness. It is seldom fatal because of the small size of the spider (1/2" diameter) and its resulting low dose of venom. All spider venom's are neurotoxic and intended to paralyze prey.

Ticks: Only one species found in Eastern Australia is deadly, however ticks are considered an important transmitter of disease and will be discussed in detail later.

Myriapods: (Centipedes) are made up of segments, each with pairs of legs. Some of the tropical species are considered deadly. Many grow to a foot long, have sharp claws and a nasty sting.

Insects: can cause a wide variety of biological harm. Blood sucking mosquito's transmit malaria, yellow fever, and a variety of viruses. Bees can swarm and cause sting related fatalities. Fire ants can cause terrible grief with numerous painful bites. Flies can spread sleeping sickness, typhoid, cholera and dysentery. Lice can transmit Typhus. Fleas can transmit plague.

The following species cause the following injury or disease

Cockroaches	Mechanically transport pathogens on body parts
Bed Bugs	Loss of blood from bites
Kissing Bugs	Painful bites, vector of Chagas in tropics
Chewing Lice	Ectoparasites of birds and mammals: cause secondary infections
Sucking Lice	Ectoparasite of man and mammals: vector of disease, causes dermatosis
Mosquitoes	Irritating bites, disease vector including malaria and yellow fever
Black Flies	Irritating bites, vectors of disease
Deer Flies	Vector of serious eye disease
Tsetse Flies	Vector of African sleeping sickness
Sand Flies	Vectors of several tropical diseases
House Fly	Vector of amoebic dysentery, typhoid, and cholera
Horse Flies	Anthrax vector
Blow Flies	Typhoid and Cholera vector
Fleas	Vector of epidemic typhus and plague

Scientific Principles of Improvised Warfare and Home Defense

Bees, Ants, and Wasps Inflict painful stings, allergic reactions to venom can be fatal
[When bees sting, they leave behind a stinger, venom sac, and various other body parts. Injury is directly related to the volume of venom which is usually lethal in swarming attacks]

Usually the diseases are carried on the insect legs or mouthparts used and classified as
piercing-sucking
lacerating-sucking
sponging lapping

These species buzz around humans and animals tracking fecal material across food, and by biting and transferring organisms from one to another or causing severe blood loss. Insect larvae feed on dead or dying (injuries) animal and human tissues so their excrement often contains large reserves of infectious bacteria.

Insects that can damage crops and be distributed to enemy cropland can cause enormous financial losses and starvation in poor countries. These insects include

Grasshoppers, Crickets, Katydid	Nymphs and adults feed on leaves
Plant Bugs, Seed Bugs	Damage stems, leaves, flowers, and seeds
Aphids, Cicadas, Scale Insects	
Whiteflies, Treehoppers, and Leafhoppers	Piercing sucking mouthparts damage all parts of the plants and are vectors of plant disease
Thrips	Mechanical damage to leaves and flowers, disease vector
Beetles and Weevils	Grubs cause root damage, adults and larvae attack all parts of plants and infest seeds.
Flies	Leaf Miners and gall formation
Sawflies, Gallmakers, Webspinners	Larvae may leaf feed and all may damage leaves
Moth and butterfly larvae	Caterpillar damage to all plant parts

Bacteria, fungi and viruses that attack plants are transmitted mechanically and directly by insects, and they rarely spread without insects to move them. This is why vectors are important in all forms of biological warfare and greatly increase rate of disease spread. The correct insect vector is necessary and must be properly matched to the disease.

Termites cause mechanical damage to buildings, but this process is more of a long term nuisance rather than an aid in war and will not be considered as a potential weapon here.

[Authors Note: During the early 1990's I researched the production of intestinal bacteria of termites for use in a commercial leaf and grass decomposer]

Scientific Principles of Improvised Warfare and Home Defense

Flesh Fly feeds on dead animal tissue and larvae on decaying plant vegetation. May breed in human digestive tract and excrement. They do not bite. They transmit disease.



Deer Fly larvae are found in wet soil and prefer very alkaline soil. They administer painful bites and transmit disease.

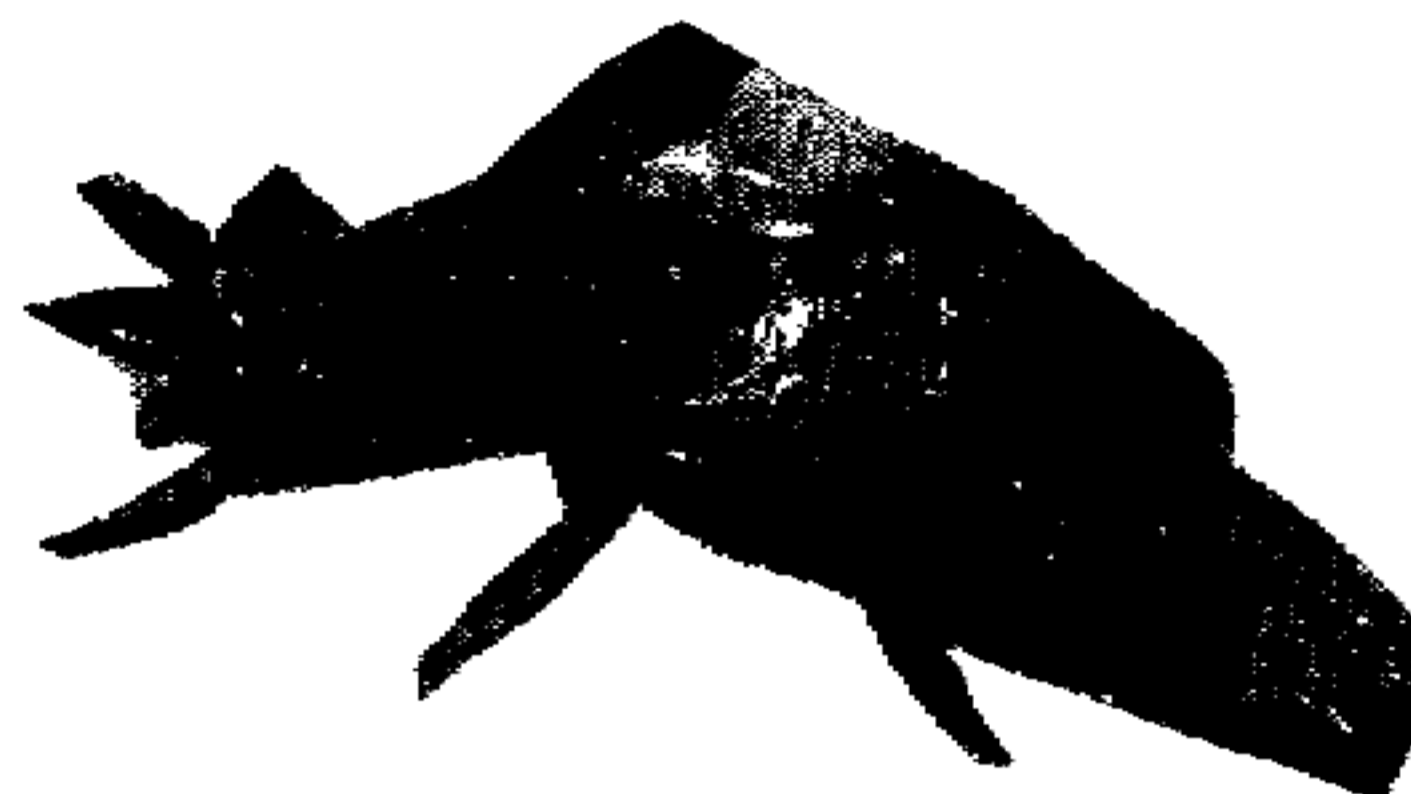

Malaria Mosquito larvae prefer clean, still water in shaded areas. Adults prefer cattle barns. This species is the principal malaria vector and caused great loss of life during the building of the Erie Canal in New York during the early 1900's.

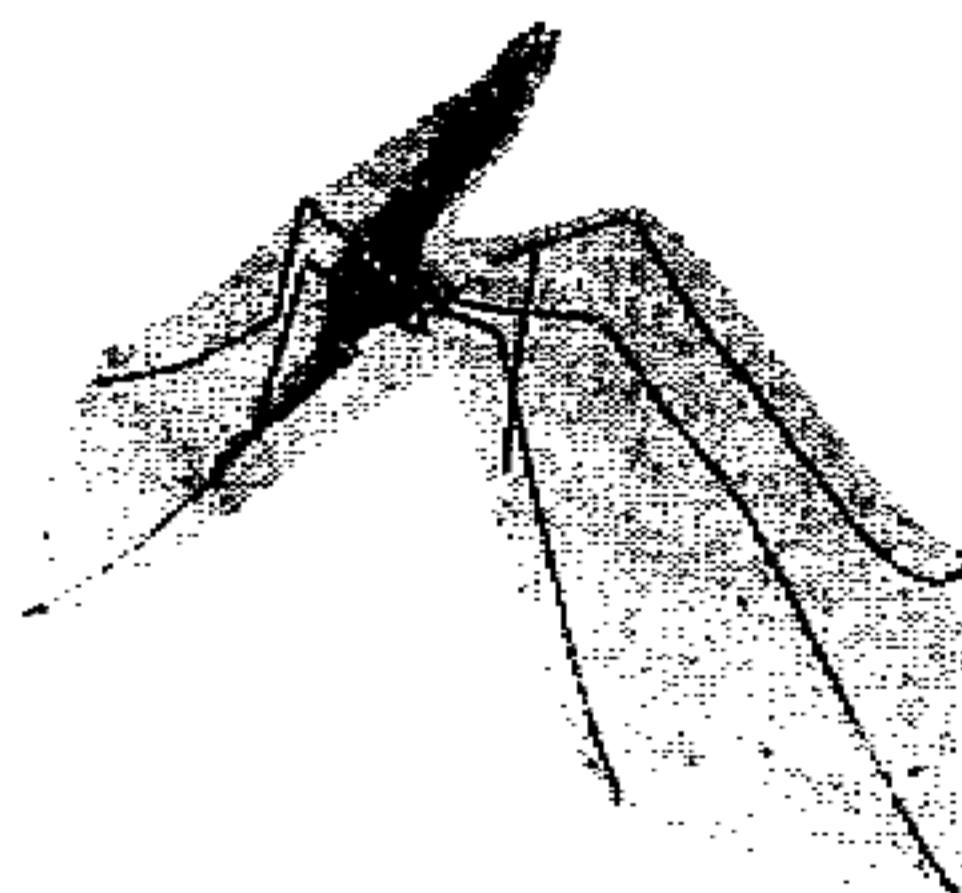

Salt Marsh Mosquito larvae prefer plant material and decaying vegetation while adults congregate around salt marshes. The female sucks blood and is a considerable pest. They are carried by the wind from marshes to cities over great distances. They are the vectors for many serious diseases.

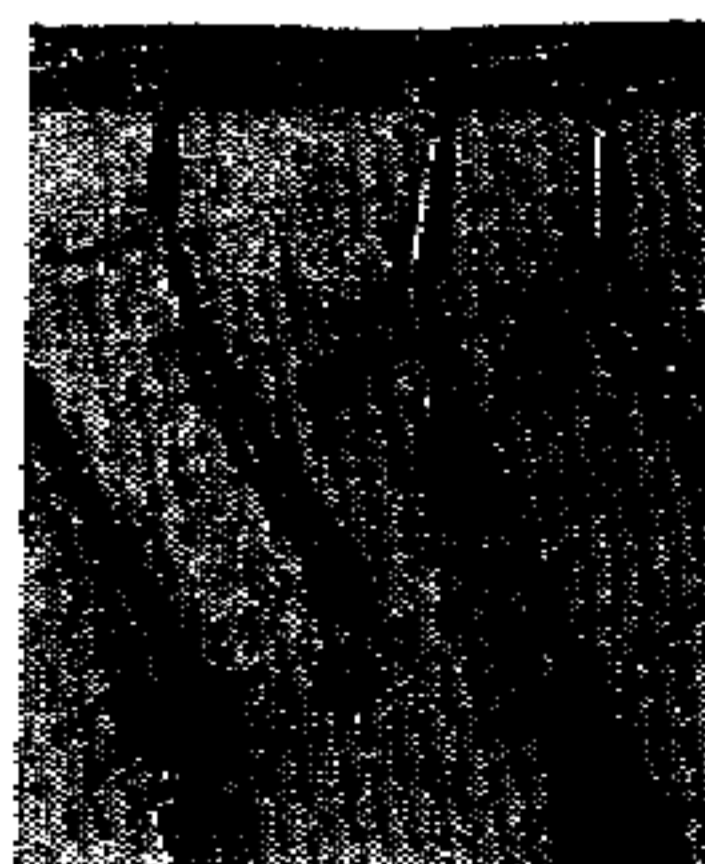

Body and Head Louse live on hairy parts of the body and cling to clothing. Eggs are glued to hairs and clothing. The life cycle lasts about one month and are spread by close contact. They are vectors of deadly disease and cause skin lesions.

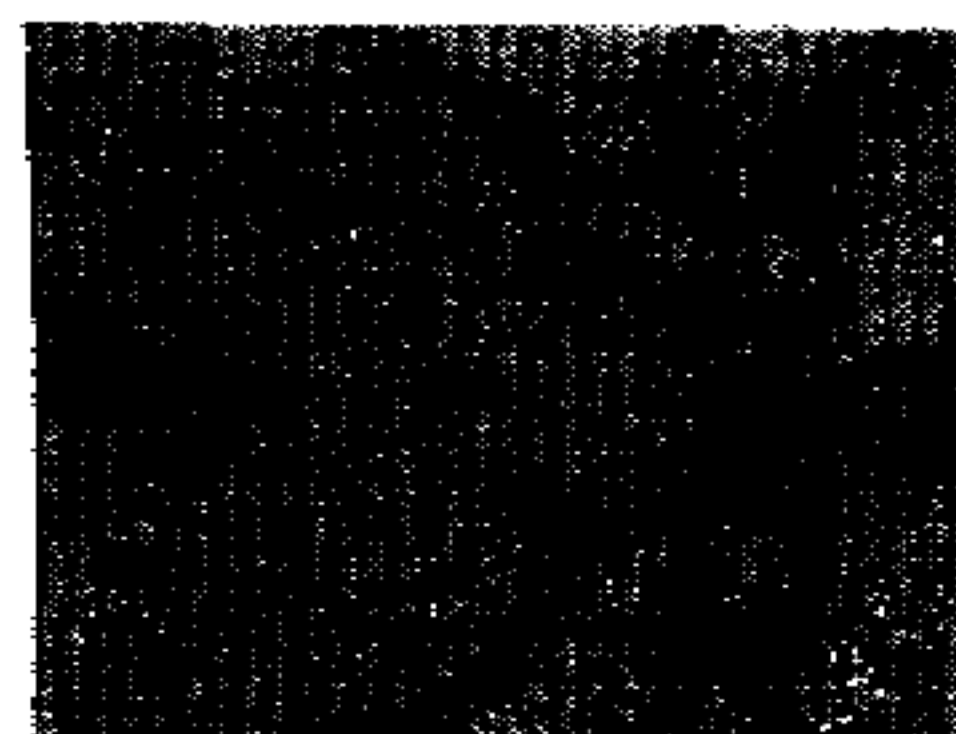

Scientific Principles of Improvised Warfare and Home Defense

D) Fungi and Mushrooms

[Authors Note: In the early 1990's, during our leaf decomposition project, we cultured several species of decay fungi in a series of experiments. When we ordered the fungi from the American Tissue Culture Collection (ATCC) they didn't arrive for several weeks. They had trouble getting the original strains to start growing. On arrival we could not get any of the strains to grow on conventional media and this created a near panic since parts of leaves and grass could only be decomposed by certain ligninase and hemicellulase enzymes that these fungi produced. Not only that, if a successful product formula were devised, it would have to be mass produced in a package for resale and be reproducible in large amounts once applied to the lawn waste. In about three days I devised the following method of mass producing the fungal strains and found it to work on all species tested for producing large volumes. We dry baked feed (or store bakers) yeast in an oven at 300 degrees until we would smell a burnt odor. We continued baking for about 5 more minutes, then removed the yeast, added water to form a pasty consistency and found that we could grow the fungi directly on the paste or on commercial agar when it was coated with the paste. This method would be effective in aiding the mass production of poisonous species of fungi as well.]

Fungi are simple parasitic life-forms that include molds, mildew, yeast's, mushrooms, and toadstools. Some form colonies of individual cells (the yeast's), while others form chains of tubular hairlike filaments called hyphae. These are part of a large network of filaments called mycelium. Some of the fungi that live in soil form fruiting bodies which we see as mushrooms or toadstools. Many form spores which act as seeds and are carried on the wind to settle and grow in new locations.

Fungi cause illness and disease in several ways that make them candidates for improvised weapons.

1. The fruiting bodies of some fungi contain toxins that can be used directly as a poison.
2. Some fungi infect food crops that leave dangerous toxins, thereby causing food poisoning.
3. Inhaled spores of certain fungi cause lung allergies and life threatening infections.
4. Some invade moist areas of the body and cause a variety of irritations and infections.

Scientific Principles of Improvised Warfare and Home Defense

Examples of these include mushroom poisoning, aflatoxin and ergot, moldy hay, and jock itch.

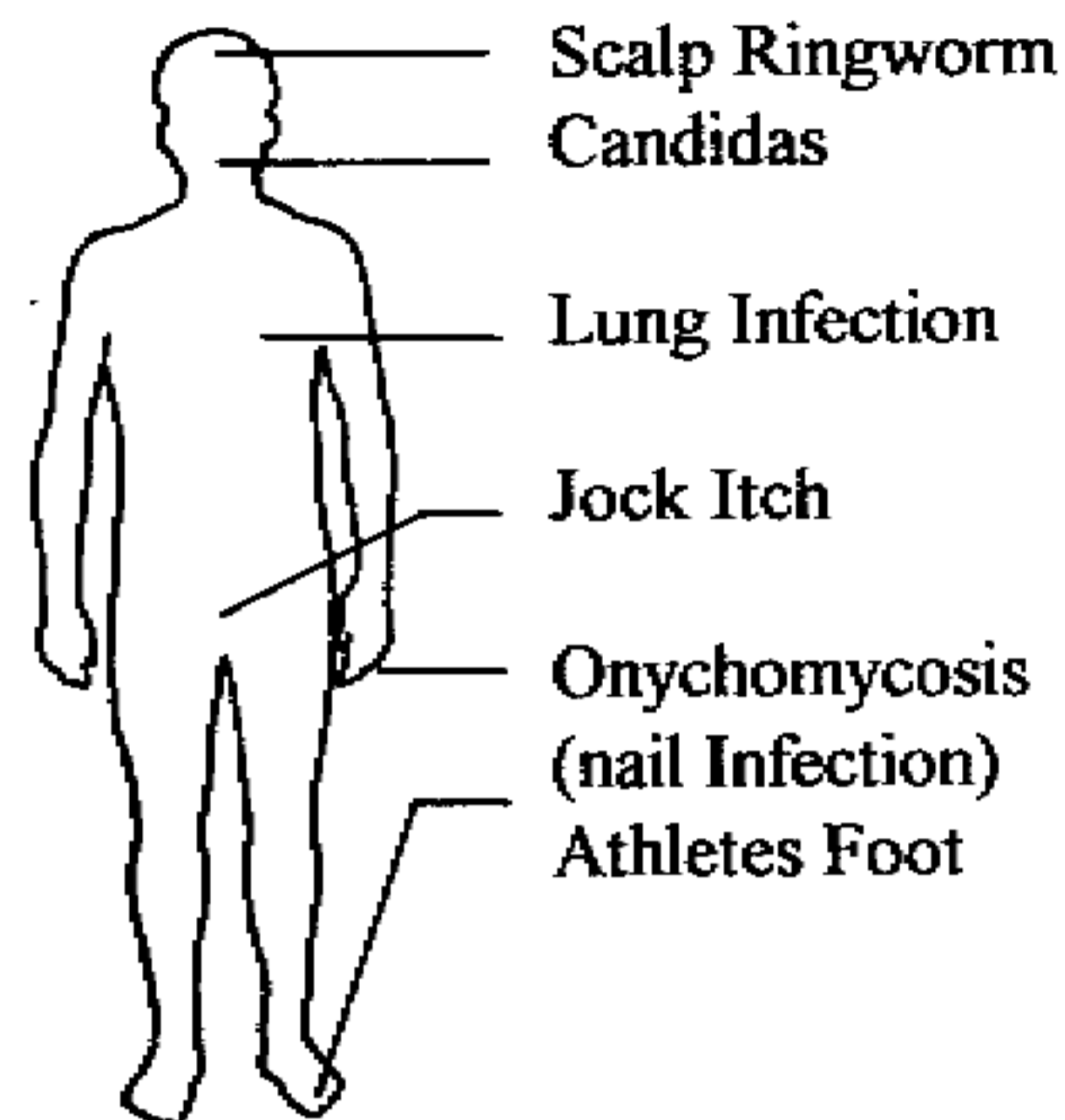

Most plant diseases are caused by fungi. Bread mold, powdery mildew on fruit, rot, warts, rusts, scabs and wilts are the commonly observed conditions on infected plant tissue. Most of these fungi only grow in moist and warm conditions and depend on high humidity to produce spores.

Serious fungal diseases of humans include

Histoplasma capsulatum which enters the lungs by inhalation. The spores grow in the lungs and may spread to other tissues proving fatal. It is found in soils contaminated with bird droppings in the Ohio and Mississippi river valleys of the United States and carried by dust particles from abandoned bird roosts.

Blastomyces dermatidis occurs in soils in the Southeastern United States and causes skin and lung infections which may be serious.

Aspergillus Species growing on peanuts and grain produce aflatoxins which are deadly poisons and cause cancer in small amounts. Aflatoxin is easy to produce from moldy corn which can be ground, moistened, and mixed to spread the growth.

Claviceps purpurea produce "ergot" alkaloids that cause degeneration of the capillary blood vessels with symptoms of vomiting, diarrhea, thirst, hallucinations, convulsions, and lesions of the extremities. Outbreaks of mass hallucinations have been traced to contamination of food with ergot.

Amanita phalloides produces toxic mushrooms containing amatoxins and phallotoxins. Vomiting and diarrhea occur 8-24 hours after and kidney and liver damage occurs resulting in near 100% fatality rates after ingesting only 5-10 mg. of toxin.

Scientific Principles of Improvised Warfare and Home Defense

There are many books on mushrooms- locating, cultivating, and harvesting which provides a basis for production of necessary toxins for use as chemical poisons. Horse manure and straw are mixed and fortified with nitrogenous sugars and vitamins, and grown in high humidity at 75-77 degrees. To mass produce edible mushrooms the temperature is lowered to 16 degrees and fruiting bodies appear in about 10 days. This can also be used for production of toxin producing species. The toxins are extracted by leaching in solution in the same manner described for plant extraction. Mushrooms containing ammatoxins cannot be made safe by drying or boiling because of the delay of the onset of symptoms which ensures that this poison is 100% effective if ingested or absorbed in cuts or scratches, even in small amounts. There is no treatment or antidote for a fatal dosage.

Ammanita Phalloides also known as the "death cap" prefers to grow under broadleaf trees, especially oak. It is deadly poisonous and a single cap can kill a 200# adult male.



Amanita Verna and Amanita Virosa

Both are deadly poisonous and known as fools mushroom and destroying angel respectively. While many mushrooms with poisons taste bitter, these may taste good

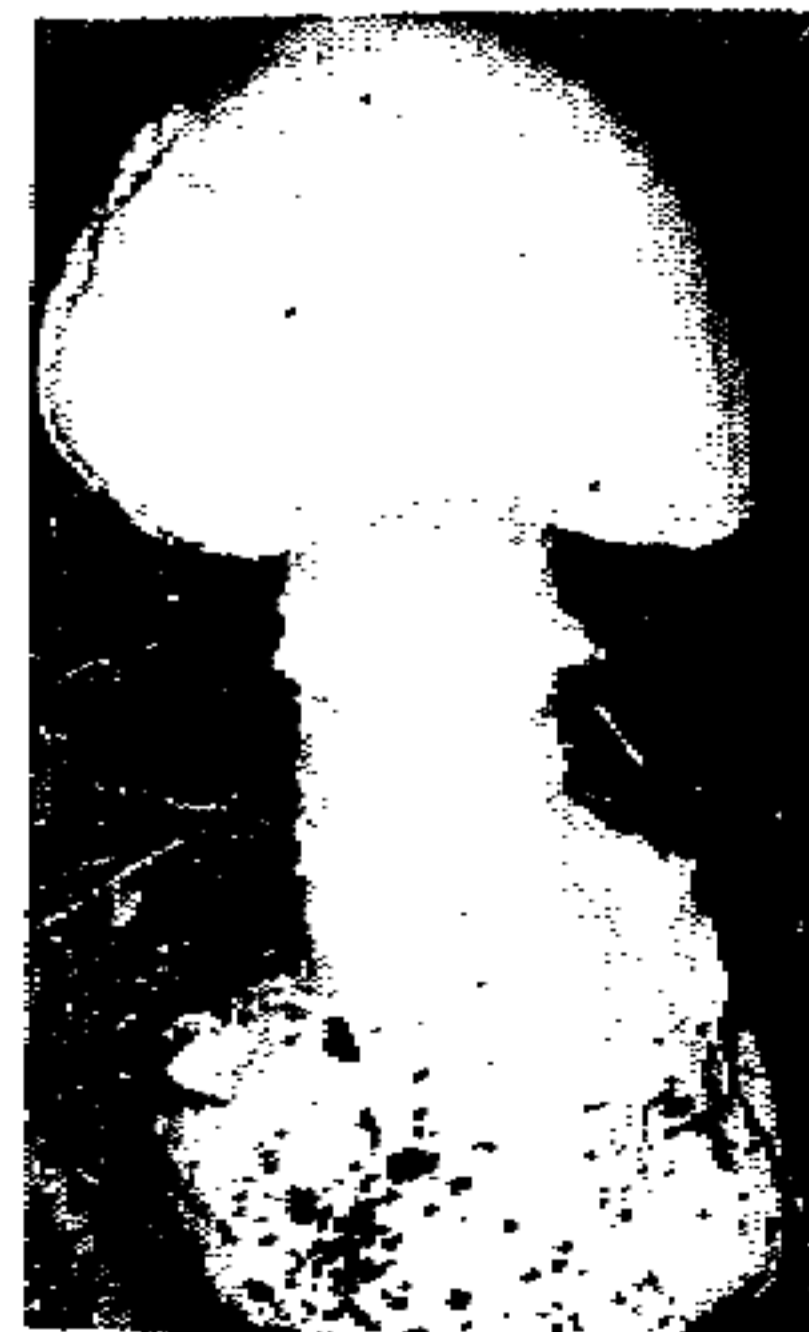

Scientific Principles of Improvised Warfare and Home Defense

Cortinarius Speciosissimus

A common and lethal fungus that prefers coniferous trees, especially Norway Spruce, in moss, and bilberries.



Cortinarius Orellanus found widely in Europe under broadleaf woods. It is deadly poisonous.



Scientific Principles of Improvised Warfare and Home Defense

E) Bacteria, Viruses, and Internal Parasites

All previously described living organisms produce chemicals that cause injury and disease. Microorganisms described here are complex and cause disease. In order to best understand their role in causing disease and how to use these as a weapon of war, you must understand what disease is. Here is a short course on the language and comprehension of this field.

Disease is caused by damaging changes to a persons structure or function of their different body tissues. When these tissues are no longer working properly, we see the effects as symptoms such as fever, coughing, headache, rash, paralysis, vomiting, diarrhea, death, and so on. The body can repair some temporary types of injury. Other types of disease that cause permanent damage cannot be repaired and are often fatal.

Inflammations: are the bodies responses to an irritant. A simple example is a sliver that pierces the skin and results in a boil. First, the body tries to remove the sliver by physical means (if you can't do it by using a tweezers) through bleeding to carry it away, or by tissue contraction. Next, cells called phagocytes and leukocytes try to destroy or consume the foreign invaders such as bacteria. Some bacteria produce capsules protecting them from attack while others produce enzymes or toxins that destroy these cells and surrounding tissue causing Necrosis. Deadlier invaders cause more serious damage and discomfort. If the sliver is removed mechanically, a remaining clean cut will heal by itself. If invaders must be attacked, a local swelling and some redness occurs and if serious, it results in a boil. Gradually, dead local tissue and cells decompose into "pus", the boil breaks, and the pus is released, often leaving scars. If boils burst internally, they can spread infection throughout the body with serious effects.

You can see why the North Vietnamese were so effective dipping a punji stick in ox manure and using them as booby traps. The resulting deep wounds were automatically infected, the slivers could not be removed easily, and the deep wounds could spread lethal infectious agents if not treated with antibiotics. This is a low tech example of the modern practice of biological warfare.

Infections: occur when microorganisms invade the body and causes harm to tissues. To do this they must

1. Be able to invade the body and reach a location where they can do some harm. This is accomplished through mechanical piercing of the skin, inhalation, or ingestion to deliver the organism. Piercing is accomplished by booby traps, shrapnel from explosives, or using a vector such as a chewing or biting insect. Inhalation or ingestion are accomplished by delivery of aerosols to the target area and ingestion by directly (or indirectly) contaminating the food and water supplies.
2. Cause harm by producing a toxin or interfering with life processes. The ability of the target to ward off these harmful effects is called "resistance to infection".

Scientific Principles of Improvised Warfare and Home Defense

In order to be effective, Bio weapons must be supplied in large numbers or be combined through combination or shotgun approaches to overcome enemy (host) resistance and relief efforts of antibiotics and field health care.

Most disease produce similar patterns or symptoms. The names of the most general disease patterns are:

Abscess: is a severe local infection with pus forming bacteria. If it ruptures internally, it can spread infection throughout the body and prove fatal.

Necrosis: occurs when cells are damaged beyond repair. This condition results in tissues being cut off and suffocated, dissolved directly (pus), and cells destroyed leaving masses of fat and protein. When bacteria grow at these sites, they produce blackening of the tissue and putrid odors. This condition is called gangrene and requires amputation.

Toxicity: Bacteria produce two types of toxins that can spread through the bodies blood and lymph systems.

1. Exotoxins which the bacteria excrete and spread quickly. These can usually be destroyed by boiling or heating (60 degrees C for 30 minutes). Tetanus and diphtheria are Exotoxins. The host usually produces antibodies to these types of toxins.

2. Endotoxins are released from inside the bacteria when it dies and its cell wall breaks down. When antibiotics kill large numbers of these types of infectious bacteria, they often release vast amounts of endotoxin and may kill the patient. Endotoxins are heat resistant, usually less toxic than Exotoxins and are poor antigens (the host can't produce antibodies to fight them). These are effective toxins against enemy food and water supplies because instructions for boiling to make these supplies safe do not work. This produces enormous economic hardship on enemy populations.

Respiratory: Bronchitis, Pneumonia, and Emphysema are names to describe infective conditions in different parts of the respiratory system. These occur from dust and smoke irritation, colds or the flu, aspirating foods, vomit, or air pathogens, and from the direct action of a variety of bacteria and viral infections.

Gastrointestinal: are diseases caused by toxins that are ingested. These include appendicitis, peritonitis (infection of the abdomen), cholecystitis (infection of the gall bladder), enteritis (inflammation of the small intestine), and colitis (inflammation of the rectum).

Genitourinary: infection of the kidneys resulting in blood in the urine, retained nitrogen in the body with fever, chills, weakness and loss of appetite.

Scientific Principles of Improvised Warfare and Home Defense

Circulatory: which usually result from local infections that were allowed to spread. These include pericarditis- infection of the membrane around the heart, rheumatic fever- causing direct damage to the heart, arthritis- causing painful joints and bones, and osteomyelitis- infection of the bone.

Now that you understand some of the basic language of disease we will cover the individual diseases by their method of entry into the body.

Airborne Diseases: are diseases that travel and enter the body by air and can be delivered as aerosols on fine water droplets or dust. These types of infections are usually spread by coughing, and breathing on uninfected individuals.

Individuals generally inhale 10,000 to 1,000,000 microorganisms daily. Some of these are able to multiply in the tissues of the respiratory tract causing localized infections and may spread via the bloodstream throughout the body.

Viruses

Common cold: are rhinoviruses which infect the cell linings of the nasal passages and pharynx producing an inflammation and may lead to secondary infections and symptoms.

Influenza: is an often serious and temporarily debilitating virus that can that can cause tissue damage resulting in secondary infections and viral pneumonia. High fever, muscle and headache, and malaise occur. Death rates from flu epidemics can be very high and unvaccinated armies under war conditions can suffer severe losses from these outbreaks alone.

Measles and Mumps: produce various infectious symptoms which usually are not serious and these are common childhood diseases.

Bacteria

Pneumonia: is caused by a variety of bacterial and viral agents that have overcome the individuals defense mechanisms. The most common infective agent is *pneumococcus* which is often present in the throat and recovered in large amounts in patient sputum. Sore throat, congestion, and high fever are common symptoms. These bacteria reproduce and spread in the lung tissue forming lesions. The cell response produces an inflammation and exudate which inhibits gas exchange in the lungs. Without treatment, this infection produces 30% fatalities.

Mycoplasma produce hydrogen peroxide that cause serious cell damage in the lungs and became known as walking pneumonia during WW2.

Psittacosis: known as parrot fever, it is caused by inhaling *Chlamydia Psittaci* on dust from domestic and pet bird droppings. Symptoms are usually mild but can lead to fatal pneumonia if untreated.

Scientific Principles of Improvised Warfare and Home Defense

Diphtheria: is caused by the bacteria *Corynebacterium diphtheria* which infects the upper respiratory tract. Diphtheria toxin is a potent protein that kills almost all cell types resulting in localized necrosis. This makes separate culture and production of this toxin a potent chemical weapon by itself. The bacteria generally don't invade the tissues. It is the spread of the toxin from small localized infections on surface linings of the upper respiratory tract that causes the disease symptoms.

If enough lung tissue is damaged by the toxin, death results from suffocation. If this is to be used as a weapon it is important to vaccinate troops for diphtheria bacteria and obtain antitoxin to counter the effects of the toxin should your own troops become exposed.

Whooping Cough: Infection of the bronchi and trachea is caused by *Bordetella pertussis* which produce toxins that cause local necrosis, inflammation, and fever. Severe coughing, cyanosis, vomiting, and convulsions can occur with serious infections.

Tuberculosis: is transmitted by air droplets and contaminated foods. The bacteria inflame and produce lesions in lower lung tissue and spread through the lymph and blood systems to other parts of the body. Phagocytes are ineffective and this becomes a slow and progressive infection that is often fatal without treatment. Once tubercles are formed from unhealed lesions in the lung the host has the disease for life.

Meningitis: an inflammation of the membrane surrounding the brain and spinal cord which can be caused by a variety of bacteria and viruses. Any injury that exposes the central nervous system to bacteria can result in this disease. The release of toxins in these areas can result in life threatening inflammations and death.

Anthrax: is a deadly disease of cattle, horses, and sheep. The *Bacillus anthracis* secrete a powerful exotoxin that accumulates and causes localized necrosis. The infection can spread to the blood and lymph systems causing systemic infection and death. Its toxin may also interact with the central nervous system causing acute respiratory failure. It is usually transmitted by skin contact with animal hair, wool, and hides, containing the spores of *B. anthracis* and has been known as wool's sorters disease. Once a spore is deposited on the skin it germinates and begins to produce toxins. Untreated skin lesions have a mortality rate of 10-20%. When deliberately cultured and mass produced its spores can be delivered as an aerosol or on food or in water resulting in serious infections. Inhaled spores in large numbers may produce 100% fatalities and are delivered in aerosol canisters usually air dropped with bursting charges. The toxin alone is an effective chemical poison.

Scientific Principles of Improvised Warfare and Home Defense

Ingested Diseases: are absorbed with food or water. Two separate disease processes may occur. First, microorganisms growing in food or water can produce toxins and when these contaminated materials are ingested they start a disease process called food poisoning or intoxication. The causative organism does not need to be present so there is no infectious process. Absorbed toxins can cause all symptoms previously described and are fatal if the dosage is large enough (effectiveness is directly dose related). The second type is where the invasive pathogens cause a localized infection and spread. This usually requires a very large dose of organisms because the body has a range of effective defense mechanisms such as acids that kill most invaders.

Gastroenteritis: is an inflammation of the lining of the GI tract caused by a group of several different viruses and often called a 24 hour flu. Large numbers of the virus are reproduced in human fecal matter and subsequent contamination of food or water by any means of transmission or vector results in this disease. Symptoms include stomach pain, vomiting, diarrhea, and if there is a large loss of body fluids, this can be fatal (especially among infants).

Hepatitis: is a systemic virus that affects the liver and may spread. It may enter the skin through punctures or is often spread by fecal contamination of food or drink and is widespread in areas with inadequate sewage treatment. Several outbreaks have been associated with consumed contaminated shellfish that had concentrated virus from sewage effluents. Initial symptoms include fever, abdominal pain, and nausea followed by jaundice due to liver damage.

Polioviruses: are a serious danger to areas without vaccination programs. It is transmitted by ingestion of contaminated food and water or on airborne dust particles. The virus multiplies in the tonsils and intestines. Once they pass into the bloodstream, they infect lymphatic tissues and eventually cross the blood-brain barrier where they cause nervous system damage. Symptoms start as vomiting, constipation and sore throat and eventually may lead to paralysis.

Botulism: is the most serious form of food poisoning. Neurotoxins produced by *Clostridium botulinum* are absorbed from the intestinal tract and transported by the bloodstream to motor nerve synapses where their action blocks normal neural transmissions by preventing the release of acetylcholine. Of seven known botulism toxins only three cause human disease. These are type E associated with fish and fish products and outbreaks occur with some frequency in Japan. Type B is prevalent in Europe while Type A is the cause of most cases in North America. Over 90% of the cases of food poisoning of this type are caused by improperly home-canned foods. Between 1899 and 1974, 57% of the outbreaks were caused by contaminated vegetables, 15% from fish, and 12% from fruit.

Scientific Principles of Improvised Warfare and Home Defense

The *C. botulinum* endospores are widespread in nature, are heat resistant and survive prolonged exposure at 100 degrees C. Canned foods provide an ideal "anaerobic" environment for growth and toxin production, however, it cannot grow and produce toxin at low pH and is stopped by pickling or by acidic food products. Anaerobic means that it can only grow in solutions of foods (or injured body tissues) without oxygen (inside the liquid areas). Bulging or off smelling cans of food are warning signs of this toxin. Symptoms include difficulty swallowing and speaking, nausea, vomiting, and double vision. Untreated cases have a 70% mortality rate while treated cases (with antitoxin) still suffer 25% losses. This is usually due to suffocation from paralysis of the respiratory muscles. The botulinum toxin A is so deadly that it has been mass produced and incorporated into weapons of mass destruction. In toxicity studies it has been determined that a single milligram of pure toxin A can kill more than 10 million mice, or the equivalent body weight of 10,000 adult human beings. About 5000 grams uniformly delivered to all humans on earth may be enough to depopulate the entire planet (this is about the weight of a single bag of grass seed). The manufacture of this toxin will be described in detail under "manufacturing systems".

Normally *C. botulinum* cannot establish direct infection of humans because of the low pH of the stomach and the presence of air (oxygen) in the lungs. It has been implicated in cases of sudden infant death syndrome where babies were fed honey containing the endospores and *Lactobacillus* species which normally colonize the intestines and lower the intestinal pH with Lactic Acid had not yet established themselves.

Perfringens: food poisoning is caused by another related species "*Clostridium perfringens*". When ingested on contaminated food, the toxin produces abdominal pain and diarrhea within 10-24 hours. It is most often associated with gravy that is prepared with cooked meats. It is usually not lethal.

Staphylococcus aureus: food poisoning occurs due to production of an exotoxin that is also an enterotoxin. Once absorbed it produces disease symptoms. It grows in unrefrigerated protein rich foods such as custard, meat, cream, salad dressing, and deviled eggs, especially when left out in the open sun to be contaminated (inoculated) and incubated. The exotoxin is heat stable and generally produces cramps, nausea, vomiting and diarrhea. Recovery is normal in 1-2 days and is dose related. *Stretococcal* food poisoning is rarer because it is caused by fecal contamination and usually requires a vector to inoculate human foods such as unrefrigerated cheeses, evaporated milk, turkey dressing, barbecued beef, turkey a la king, and similar foods. Symptoms are similar to the Staph poisoning.

Salmonellosis: is caused by a number of *Salmonella* species that have pili which allow them to attach to the intestinal wall. These are normally transmitted by ingestion of contaminated food. Inadequately cooked birds and domestic fowl and raw eggs are the primary source. During acute salmonellosis the feces may contain 1 billion salmonella per gram and tiny amounts can be widely spread to animal parts in meat packing plants, and other food and water supplies. Cramps, fever, and diarrhea last for 3-5 days after eating contaminated food and the feces may contain mucus and blood. Full recovery is normal unless untreated or complicated with other infections.

Scientific Principles of Improvised Warfare and Home Defense

Shigellosis: caused by *Shigella* species occurs by direct fecal to oral transmission, through vectors and occasionally through food and water contamination resulting in bacterial dysentery. *Shigella* penetrate the lining, multiply, form bleeding ulceration's and spread through the intestines. Cramps, fever, diarrhea, and mucus and blood in the feces occur with recovery in 2-7 days unless severe dehydration is untreated. This can be fatal.

Typhoid Fever: is caused by *Salmonella typhi* from contaminated water supplies and contact with infected carriers. This strain of *Salmonella* is unusual in that it does not cause infection in the GI tract, but enters the body by ingestion and migrates to other sites to cause infection. A very low dose is required to establish an infectious site. The infecting bacteria rapidly enter the lymphatic system and are disseminated by the circulatory system. This bacteria even multiplies in phagocytic blood cells. The spreading infection causes damage to many organs over 3-4 weeks producing high fever, headache, apathy, weakness, abdominal pain, and a rash with rose colored spots. Mortality reaches 10% in untreated cases.

Cholera: is caused by the enterotoxin produced by *Vibrio cholerae*. It is epidemic annually in India and Bangladesh where rain waters regularly wash raw sewage into drinking water supplies. Mortality is normally 5-15% but occasionally rises to 75%. The *V. cholerae* multiply in the small intestine, mass producing the toxin which binds irreversibly to epithelial cells of the small intestine. The result is an initiation of secretion of water and electrolytes causing rapid loss of fluids from affected cells producing dehydration, shock and high mortality from diarrhea and fluid loss if untreated.

Diseases from animal and insect bites: use the animals or insects as reservoirs for the infective pathogen or as a vector. The primary means of protecting civilian populations is to control these reservoir populations. Used in war, efforts are made to propagate these sources.

Rabies: originates in the infected saliva of wild infected animals such as foxes, skunks, squirrels, raccoons, badgers, and vampire bats. Animal bites with associated excretions from the saliva allow the virus to penetrate under the skin. Transmission from bats can occur by inhalation of aerosols in the atmosphere around dense populations of infected bats. The virus rapidly multiplies in muscle tissue around bites and reach nerve endings and migrates to the central nervous system. There, it causes abnormalities resulting in anxiety, irritability, depression, and sensitivity to light and sound followed by a fear of water due to difficulty in swallowing. Paralysis, coma, and death soon follow. Rapid identification from the infected animal and vaccination is the only cure. Untreated, death is 100% certain.

Yellow Fever: is caused by a small virus carried by mosquito vectors in tropical regions of the world. The onset is marked by anorexia, nausea, vomiting, and fever. In about 1 week either death or recovery occurs. Mortality is usually 5%. Insect control is effective for prevention in urban areas but a huge primate reservoir exists in jungle populations.

Scientific Principles of Improvised Warfare and Home Defense

Dengue Fever: also transmitted by mosquito's, the virus multiplies within cells of the circulatory system causing vascular damage. Mortality can reach 8%. Outbreaks occur in the Caribbean, South pacific, and Southeast Asia.

Encephalitis: is an inflammation of the brain caused by various viruses present in reserves of birds, rodents, and arthropods. Mosquito's and arthropods transmit the viruses by biting and saliva transmission as in rabies. The infection moves to the central nervous system where lesions develop. Fever, headache, and vomiting are followed by stiffness, paralysis, convulsions, psychosis, and coma. Depending on the strain of virus and its virulence, mortality varies from 15 to 80%. There is no cure but there are vaccines to control outbreaks of the individual strains.

Plague: The bacteria *Yersinia pestis* multiplies in the gut of fleas who transfer the disease between rodents and ultimately to humans. When the flea becomes infected, normal digestion is blocked causing the flea to increase feedings and frequency of biting which increases the spread of the disease. *Y. pestis* is firmly established in rodent populations worldwide including from the Rockies to the west coast in the United States. There are many other alternative small animal hosts making it impossible to eliminate plague in humans. The incidence is small due to sanitation and rodent control programs. Once plague is introduced into humans it begins a progressive infection that can involve any tissue or organ in the body.

In *Bubonic Plague* *Y. pestis* inflames the regional lymph nodes producing malaise, fever, and pain in the area. Severe tissue necrosis develops and the skin blackens. This is where the name "black death" came from. Without treatment, the mortality rate reaches 60-100%.

In *Pneumonic Plague* the disease progresses to the respiratory tract where it is spread by airborne droplets. Once the bacteria invades the lungs it progresses very rapidly causing severe prostration, respiratory difficulties, and death within a few hours of the start of symptoms. This pneumonic form has been a major cause of historical epidemics.

Typhus Fever: consists of several strains of rickettsias transmitted to humans by biting arthropod vectors. Lice are the primary source passing the disease on from human to human. The main strain is *R. prowazekii* which multiplies in the gut of the louse. When the lice bites a human, it defecates at the same time depositing contaminated feces that enter the bite wound. Lice infestations are responsible for the epidemic forms of this disease. Symptoms include rash, fever, and headache. The heart and kidneys are frequently the site of vascular lesions. Outbreaks in WW1 and WW2 produced 50% mortality among once healthy untreated soldiers. Relapses can occur later in life and there is no way to prevent this.

Endemic typhus is spread by rat fleas to humans and the symptoms are the same, only milder and the mortality is low.

Scientific Principles of Improvised Warfare and Home Defense

Malaria: is one of the most common infectious diseases in the world with about 150 million cases annually. Sanitation and public health practices have nearly eliminated it from North America and Europe. It is caused by 4 species of Plasmodium which are transmitted by mosquito vectors. After inoculation, the sporozoites of the Plasmodium reproduce in the liver cells and growth is explosive through several stages causing anemia, fever, chills, headache, and muscle aches. These last about 6 hours and return every 48-72 hours depending on the strain. These infections persist for long periods and only the strain *P. falciparum* produces large mortality.

Disease from wounds and burns: occur because the injuries provide portals of entry for microorganism from the air and on the skin to enter the openings. A simple band aid or gauze is often sufficient to prevent opportunistic infection from normal skin bacteria. Shallow wounds are often staph and strep infections that are localized. Deep wounds usually allow the entry and growth of anaerobic bacteria which can be far more deadly.

Gas Gangrene: is a serious infection that depends on endospores of Clostridium species such as Clostridium perfringens to be deposited in the wound tissue. At the same time, the tissue damage must shut off circulation to a small area to allow the bacteria to grow without the presence of oxygen. Once the Clostridium germinate and multiply, they produce Exotoxins that cause tissue necrosis which extends the area of dead and anaerobic tissue. These toxins include a lecithinase that attacks cell membranes, hyaluronidase, collagenase, proteinase, and deoxyribonuclease. The "ase" at the end of these words means that these are enzymes which break down the substance that is named in the rest of the word. This allows the infection to rapidly spread. The growing bacteria produce CO₂, hydrogen gases, and nasty smelling low molecular weight metabolic products which create painful pressure at the wound site. This condition becomes noticeable within 72 hours of the wound and if untreated or in major organs is 100% fatal. Even with antibiotics and amputation, the mortality rate is high. To survive, all foreign material and dead tissue must be removed. If treated in time, local tissues can be amputated and antibiotic therapy can prevent the spread of infection.

Tetanus: (lockjaw) is caused by Clostridium tetani which produces a neurotoxin that can cause muscle spasms and convulsions. It is widely distributed in the soil and in the manure of herbivore species (remember the punji sticks dipped in ox manure in Vietnam) and disease normally occurs from a puncture wound inoculated with *C. tetani* spores. If circulation is cut off around the wound, the spores germinate and colonize the site but does not spread. The neurotoxin spreads systematically causing the disease. Rusty nails resting in soil containing the spores has been responsible for infection. If untreated, tetanus is frequently fatal. If recovery occurs, the dose of neurotoxin was sublethal and there are no lasting effects. Antitoxin and vaccines are available for treatment.

Scientific Principles of Improvised Warfare and Home Defense

Colonies of *Clostridium Perfringens* growing on blood agar in an anaerobic container. Note the black areas around the colonies.

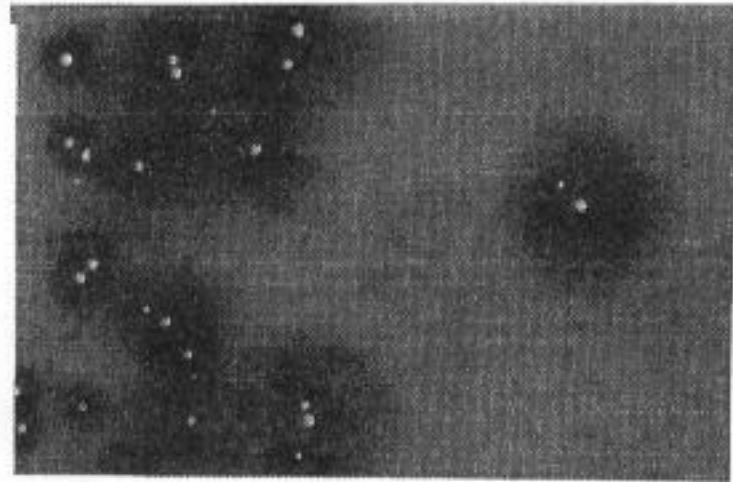

Staphylococcus aureus growing on blood agar.

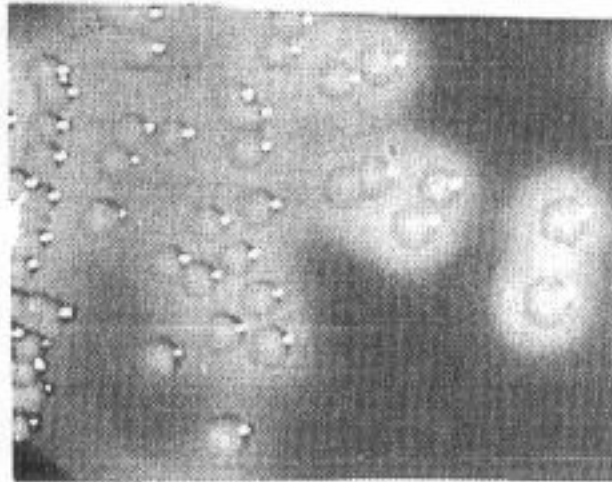

A number of internal parasites infect about 20% of the population of the planet in one form or another. Protozoa found in cat feces, sandboxes, flower beds, and soil and any other place where feces and soil mix can be transmitted through cockroaches and flies to small animal reservoirs and humans.

Helminths (worms) eggs and larvae are ingested in contaminated food and water and begin various grand tours through the body tissues and organs that are too complicated to describe here. Generally the worms produce large numbers of eggs in the feces and reinforce the cycle where sewage is improperly disposed of.

These tend to be more of a nuisance rather than an effective weapon. The allies during the Persian gulf war conducted indirect Bio warfare against Iraq by destroying the sewage treatment plants which assisted the propagation of many disease processes and infections.

Scientific Principles of Improvised Warfare and Home Defense

3) Manufacturing Systems

Manufacturing of improvised biological weapons for use in war involve

1. Collection of
 - a. Disease specimens
 - b. Vector specimens
 - c. Growth media, material, and equipment for organisms and vector species.
 - d. Poison and toxin producing specimens
2. Construction of mass culturing and production of specimens
3. Extraction systems for separating and concentrating toxins, and/or microorganisms

1. Collection of

- a. Disease causing organisms is accomplished by obtaining samples of
 - Blood of infected animals or humans
 - Urine
 - Throat Swabs
 - Wound Swabs
 - Rectal Swabs
 - Feces or animal manure
 - Sputum
 - Uncovered food samples left in open air
 - Home canned foods left open, then sealed- those with bad odors or bulging
 - Mixtures of soil and human manure or animal manure
 - Mixtures of soil and animal tissues
 - Animal tissues with deep stabs from soil and manure candidate samples
 - Deliberate wounds in large animals with confirmed symptoms of Clostridium

The collection of these organisms must be done with great care and accomplished with good vector control to prevent infection of your personnel. Use of sterile swabs and culture tubes or sealed plastic bags is important. **Do not leave samples lying around in the open.**

Scientific Principles of Improvised Warfare and Home Defense

b. Vector specimens

Mosquito larvae and eggs can be obtained by removing them from the surface of still water by skimming with a dipper or spoon and placing in a container. Fine mesh nets are used to collect adults.

Mites, Lice, and other Arthropods are collected from small animals by using tweezers, jars, and other household tools. Experienced entomologists from Universities can be a good source of assistance and information on insects.

Worm eggs are recovered by straining candidate animal and human waste through a fine wire mesh screen used on screen doors.

Rodents are easily obtained by commercial purchase from pet stores or can be trapped alive with commercial store traps (A small box with food and a one way door).

c. Growth media, material, and equipment for organisms and vector species

A growth media will serve one of two purposes. First it may be used to provide nutrients for the mass production of organisms. Secondly, if your force has the adequate medical laboratory skills, enriched media can be made that will only allow the growth of your desired organisms or a group or class of organisms. This aids in identifying and obtaining pure cultures which can be used to inoculate mass production cultures and vectors.

One simple example is a media for growing lactic acid bacteria selectively. In a one quart jar you add 1 oz. of sugar, 1 oz. of yeast extract (or baked-killed yeast) to provide a fermentable sugar and yeast growth nutrients. Raw milk, sewage, and rotting vegetables are used to fill the jar with inocula. At the start, many species are growing in the bottle which is anaerobic because there is little oxygen available under the liquid surface. As the lactic acid bacteria begin to grow, they produce lactic acid which effectively pickles the solution in a few hours. Almost all other organisms cannot survive the concentrated lactic acid and die off. The lactobacillus are the only remaining species in a few hours as the pH drops.

In order to identify what is growing in the culture and how to separate them from other organisms, a system of making an agar or semi-solid gel is used. This gel is mixed with a special cocktail of growth nutrients to supply food for the desired organisms and is sometimes mixed with certain chemicals or salts to inhibit most or all undesired organisms.

Scientific Principles of Improvised Warfare and Home Defense

You have already learned in the explosives chapter how to make a gel. The principal here is the same only the mixture is based on water and nutrient mixtures. Solidifying water is accomplished by mixing agar, methylcellulose, serum or egg albumin and in some cases heating or simply mixing and allowing to set on its own. These are added at 3-30% of the water and 1-5% of growth materials are added to the mix. The egg albumin mix can be prepared by gently heating the mix until it forms a semi-solid surface gel. Overheating will destroy important proteins necessary to grow the organisms so do not fry it like an egg.

Once you have the mixture completed, it is poured into a petri dish and covered. The disease specimens you have collected are streaked across the surface of the medium. The lids are placed back on the dish and in 12-24 hours, colonies, each containing millions of organisms appear on the surface. By using selective mixtures or media and looking at differences in the colony characteristics you can determine if you are growing the disease causing organism you want. Sometimes, there will be several different types of colonies on the plate and further culturing must be done to separate and identify the strains.

Formulas for culture plates:

Organisms that prefer blood require a mixture of

90-95% Boiled Water to kill all organisms

3-5% Jelling mix

2-7% Defibrinated sterile blood (no contaminants)

or live animal or outdated human blood from hospital inventories may be used in the field

1/2-1% crystal violet can be added to inhibit growth of almost all gram positive bacteria

1/2-1% bile salts which inhibit almost all non enteric gram negative bacteria

[Bile salts come from the liver and assist in breakdown of foods-It is stored in the gall bladder until after a meal it when it is discharged through the bile duct and is excreted with the feces which it gives a dark brown color.]

Hospital supply companies provide a wide range of specialized growth media and these are scientifically prepared and reliable. Sheep's, horse, and rabbits blood free of antibiotics, human antigens, and other undesirable factors are used. Professional culture media may not be available in many field situations and hence the need to improvise. Microbiology and medical laboratory textbooks provide a great deal of information in this area that is useful in this area.

Scientific Principles of Improvised Warfare and Home Defense

As you have already seen, the Clostridium species produce some of the most serious disease and deadly toxins known to man. All these species will grow on blood agar or meat mixed into the agars. A preboiled mixture of water and meat (to sterilize) will support the anaerobic growth of Clostridium.

To isolate and identify the desired strains, the inoculated culture plates must be grown without oxygen. This is accomplished by placing them in a sealed jar. One gram of pyrogallic acid is placed in the jar with a small cup of salt water. The jar is tipped to one side to spill the water and cause it to mix with the acid. The chemical reaction produces enough hydrogen to consume all the oxygen in the jar and allows the anaerobic growth to proceed. Commercial gas-pak jars are available to accomplish this. Dangerous Clostridium species produce the enzyme (toxin) lecithinase. A commercial media called LEY agar will produce a lecithin precipitate with a zone of opalescence around a colony of deadly Clostridium allowing certain identification of a pure colony. Because of spore production, Clostridium may be stored on cooked meat broth for months or years and remain viable.

Most household pots, pans and utensils can be used to sterilize, grow and store the media and organism growth. Vector growth supplies can be purchased as commercial small pet foods, or in the case of insects, small mice may be used. It is very important to use completely enclosed cages to prevent escape of vermin and insects, especially if they harbor the diseases.

d. Poison and toxin producing specimens

Are collected by growing and or harvesting the appropriate plant, animal, insect, or microbe. Once you decide on the particular specimen, it is helpful to consult a local library or take the appropriate college class since the huge number of possible specimens makes it impossible to cover here. These specimens are usually physically separated from the poison or toxic chemical before incorporation into a weapon. There are laboratory procedures for the specific isolation, production, separation, and concentration for every species and toxin in the various biology, microbiology, and chemical trade journals at almost every university.

Scientific Principles of Improvised Warfare and Home Defense

2. Construction of mass culturing and production of specimens

Once you have recovered a candidate specimen, you can test it for toxicity (section 6). If it is suitable for weapons use, you must decide how much you will need to use to accomplish the tactical and strategic goals of the operation. Often, in time of war this can be a considerable undertaking, especially if the targets are widespread and involve large enemy armies and population centers. A plan needs to be devised for each particular disease, vector, and toxin. One example would be for a plan to drop large numbers of bubonic plague carrying rats, mice and insects into a target area. This requires feeding and propagating large numbers of insects and vermin in sealed and contained environments, and creating the means to deliver them clandestinely and safely to the enemy targeted area. You could simply accumulate infected blood and distribute it across fields, parks and streams. Anywhere that local insects would come into contact and consume the blood and become the local vectors.

There are many means of mass producing potential weapons. The best example I can give here will be the production of a Clostridium cocktail. Once a certain specimen has been secured from a blackened wound (gangrene) and cultured it can be mass produced by inoculating a boiled meat broth and mixing it in a large pot at room temperature (boiling sterilizes the soup, eliminates dissolved oxygen and allows better anaerobic growth). The pot must have a lid on it at all times and be stirred every hour to distribute the nutrients and maximize production. You use the same procedure for botulism using a contaminated canned food jar. When mixed together and applied to any piercing vector, booby trap, conventional weapon, or aerosol it makes a deadly 1-2 punch.

To mass produce an intestinal infection, you can inoculate culture plates with raw sewage and grow the organisms as needed in large numbers. Likewise, you can use enriched media in large pots and bubble air from an air compressor into the liquid to maintain high levels of dissolved oxygen to support culture growth E Coli, Salmonella, Shigella and other enteric organisms.

To mass produce Botulinum toxin for use as a weapon of mass destruction (to destroy cities) requires a considerable investment in production equipment and feedstock. It takes about 1 ton of raw soup material (on a dry basis) to produce only a few grams of purified Botulinum toxin. Theoretically, it is possible to kill thousands with this amount. The problem is that if it is delivered as an aerosol or used against a water supply, it becomes diluted by many millions to one and becomes nearly ineffective. It is necessary to produce the toxin by the pounds or even the ton. A plant designed to process, separate, concentrate, and package a ton per year of Botulinum Toxin A would cost \$2-3 million and require 100,000 tons of feedstock growth medium. At about \$100 per ton, this would add about \$10,000,000 in raw materials cost, not to mention the labor expense, safety systems, security, and so on. A plant built on this scale would yield ton amounts of Botulinum Toxin and the C2 and C3 toxins and would not go unnoticed and would represent a very real military threat to any nation that the toxin could be delivered against. This concentration, used against several cities water supplies at the entry points (from rivers) would produce massive casualties.

Scientific Principles of Improvised Warfare and Home Defense

Mass production techniques may also be applied to the recovery of hydrocyanic acid from arrow or velvet grass, or from the wilted leaves of peach, cherry, and plum trees. The hydrocyanic acid kills by reacting with and turning body tissues into poisonous cyanides. Tiny amounts of this material have been used by the KGB to assassinate individuals. Small doses of liquid acid sprayed on the skin or inhaled as tiny droplets by aerosols killed in a matter of seconds in many well documented cases. One of the most famous involved using an umbrella with a needle filled with hydrocyanic acid (also known as prussic acid) in the tip and using it to inject a tiny amount at a public function by "accidentally" poking the victim.

3. Extraction systems for separating and concentrating toxins and microorganisms

Once a volume of toxin or microorganisms is obtained, they must be concentrated so that they can be efficiently or clandestinely transported and delivered to the enemy. In the case of growth on culture plates, the colonies are already as concentrated as it is possible and the surface material only needs to be scraped off, and mixed in solution for immediate application as an aerosol or infective agent for water and food supplies.

To concentrate toxins and spores you need to vacuum filter off the solids through coarse filter cloth allowing the water, toxin, and spores to be pulled into the container. The remaining solids on the cloth should be disposed of by burning or burying. You slowly evaporate the toxin containing liquid by air drying on trays or in pans. As the consistency reaches a paste it is ready for incorporation as a weapon. Do not completely dry because an invisible amount of botulinum toxin A will kill you. Do not be concerned if the amounts recovered appear small. They are effective and may be tested on live animals to confirm toxicity.

If you remember the toxicity chart at the start of chapter 6, the dermal exposure to kill via a wound (LD50) for the major weapons were

Botulinum "A"	.00007 mg per man	Botulinum is more toxic by
"VX"	15 mg	200,000 times
Sarin "GB"	1700 mg	20 million times
Distilled Mustard	4500 mg	60 million times

Scientific Principles of Improvised Warfare and Home Defense

4) Direct Delivery Systems and Vectors

Direct delivery systems usually mean preparation of a bomb, artillery shell, bullet, airborne canister (aerosol), or hand delivered to enemy targets in special packages.

Ordnance: Toxins and organisms may be delivered to enemies on any ordnance or on the tips of piercing weapons and booby traps. The gangrene bacteria or toxin can be incorporated with a bursting charge into any explosive ordnance large or small. The resulting shrapnel wounds start multiple infections which are nearly impossible to contain ensuring certain death. They can be added to hollowpoint bullets or mixed as a paste in shotgun pellets to enhance their effectiveness and turn wounds into kills. Piercing devices in booby traps dipped in concentrated toxins are capable of very quick kills over the slow infections of ordinary punji sticks. With Botulinum toxin or hydrocyanic acid even a tiny cut or scratch caused by treated vegetation will kill.

Special Packages: These are weapons designed to cause serious and large scale harm to enemy armies and populations.

Major targets for attack include

- Enemy troops directly
 - Enemy city water supplies (ingestion)
 - Enemy food supplies (ingestion)
 - Public places such as swimming pools, theaters, shopping areas, etc.
- Generally, the water supplies of enemy troops may originate close to home and it is not good strategy to pose infective and toxic risks to your own populations and armies.

Enemy populations obtain their water supplies from rivers and underground wells and springs.

The easiest means to cause widespread infection and loss of life is to contaminate the water supplies. The most effective means of doing this is with direct toxins that resist chemicals and boiling and are unaffected by antimicrobials. The next is mass produced enteric and other infective organisms to overload the systems protective measures. Contaminating the supply can be as simple as throwing a dead, rotting carcass into the water supply inflow or well casing, weighting it down so it sinks out of sight.

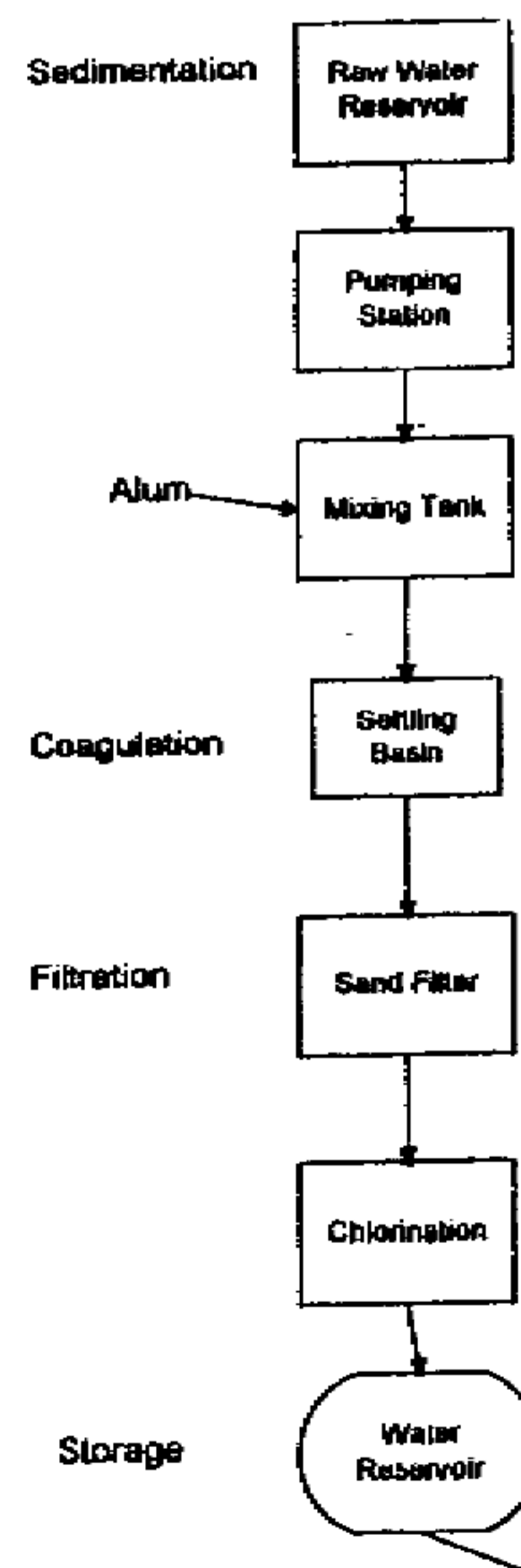

Scientific Principles of Improvised Warfare and Home Defense

Cities manage water supplies by

1. Pumping water in
2. Sedimentation to let solids settle out. Sometimes alum and coagulants are used to assist in this clearing of the water.
3. Water is then passed through sand filter beds which remove about 99% of the bacteria in the water supply.
4. The water is then disinfected to kill any remaining organisms.

To effectively penetrate an enemy's water supply, you must

1. Locate the enemy water sources and treatment facilities.
2. Deliver the toxins or organisms package to the water reservoirs after processing
3. Toxins may be delivered at inflow locations

If the enemy warns people to boil the water, this may not be sufficient to stop toxins and heat resistant bacteria. Also, they will contaminate eating utensils and washcloths during washing of the utensils if they attempt to use the same water sources, not to mention bathing. The ingestion hazard remains as long as packages can be delivered to the inflow sources and can effectively destroy enemy morale and life.

[Authors Note: In war an entire enemy population is organized to build weapons, ordnance, food, and supply soldiers to kill you. In the recent case of Bosnia, where surrender meant annihilation anyway, the massive use of biological weapons to destroy Serb population centers is easily justifiable.]

Vectors of infected mosquito's, rodents, and other arthropods and vermin can be delivered by commandos or other "mailmen" into the target areas. Infected blood from outdated hospital supplies can be used as direct food for the organisms while being delivered. Spreading infected blood throughout a target city is an effective means of spreading disease.

[Even POW's are not helpless. They can use their teeth to bite and pierce their skin to provide blood. Mixing this with solid excrement or in decomposing rodent or insect remains will create the base for a biotoxic weapon which, when place on the point of any piercing instrument can cause potentially fatal blood poisoning with even a small scratch. A torsion skeen can be made to provide the energy for an innocent looking scratch trap.]

Scientific Principles of Improvised Warfare and Home Defense

5) Indirect delivery systems and countermeasures to "germ warfare"

Indirect delivery systems to cause infection in enemy armies and populations involve the destruction of public health systems and the use of remote hit or miss infective agents.

Strategies falling in this category include

- Delivering insects to damage enemy crops by contaminating railroad cars, ships, trucks
- Delivering infectious agents by these same routes or invisibly by the mail.
- Infecting POWs and returning them to their country
- Destroying enemy sewage treatment plants to force discharge or accumulation of untreated waste.

This last category combined with direct delivery of vectors can be especially effective.

Sewage treatment involves three stages

1. Primary: to remove suspended solids by sedimentation. These solids account for enormous numbers of potentially infectious coliforms.
2. Secondary: Where microbials are used to mineralize dissolved organic matter so it can be removed as solids. This part is very sensitive to poisonous chemicals that kill the plant bacteria and can result in large discharges of untreated sewage. Organic chemicals octachlorocyclopentene and hexachlorocyclopentadiene can easily kill all treatment plant bacteria by simply flushing a couple hundred pounds down the toilet or into the sewer lines. It is possible for added hexane to combine with bacteria produced methane forming explosive air mixtures which can destroy this part of treatment plants.
3. Chemicals are added to precipitate and remove dissolved minerals that may be harmful to life at the discharge point, to kill certain organisms left over from the treatment and/or using filters such as activated carbon to finish cleaning the system.

Destruction of sewage plants can have considerable effect on an enemies public health.

Scientific Principles of Improvised Warfare and Home Defense

Countermeasures to protect yourself from any widespread use of your own weapons or an enemies use against you include

1. Teaching the proper boiling of water, clothes, and eating utensils.
2. Collecting and using rainwater as the only source of fresh usable drinking water
3. Boiling or completely cooking all foods sufficiently to kill spores
4. Disposing of all sewage by burning with fuel or burying the solids far away from water sources. [or delivering to the enemy water supplies, or use in soils for production of saltpeter]
5. Controlling insect, arthropod, and small animal populations by the use of pesticides or spraying of light fuels into water, and eliminating standing water areas for mosquito's.
6. Prepare to use immunizations and antitoxins where possible.

Various exposure sites must be protected from infectious agents

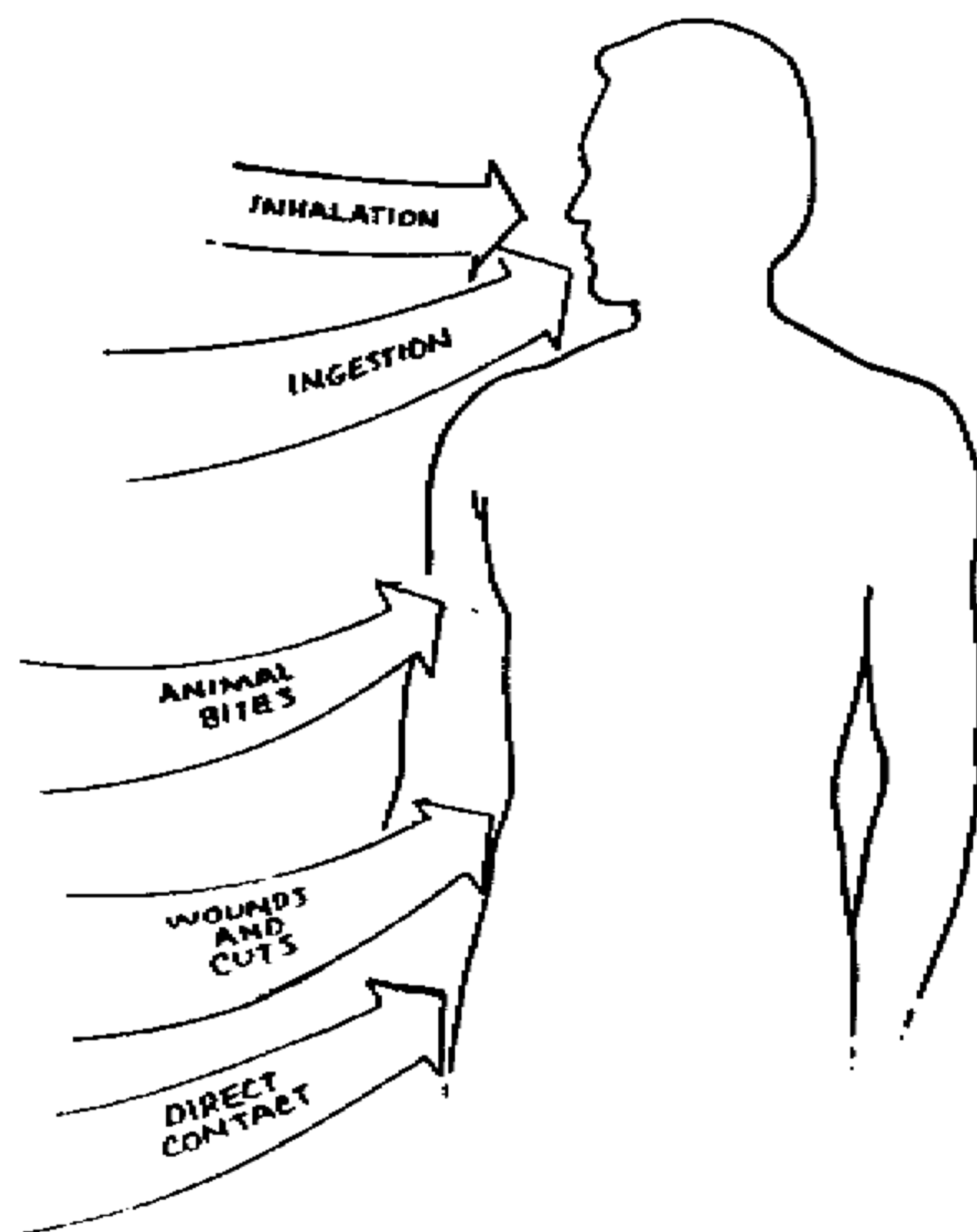

Scientific Principles of Improvised Warfare and Home Defense

Chemicals and Antibiotics may be helpful in preventing infection

Phenolics	Disinfectant/Antiseptic	Phenylphenol, hexylresorcinal, hexachlorophene
Halogens	Disinfectant/Antiseptic	Chlorine, Iodine, Iodophers, and treated soaps
Alcohols	Bactericidal/Fungicidal	Ethanol, Isopropanol
Heavy Metals	Antimicrobials	Silver, Copper, Mercury, and Zinc (Topical only)
Dyes	Antiseptics-minor wounds	Gentian Violet
Surface active agents	Mechanically removes microbes Antimicrobial	Soaps and detergents Quaternary compounds (ammonium)
Acids and Alkalis	Preservatives/Fungicides	Sorbic, Benzoic, Lactic, Propionic, Salicylic, Undecylenic

Antibiotics effective against

Gram Positive Microbials

Bacitracin
Cloxacillin
Erythromycin
Lincomycin
Methicillin
Oleandomycin
Penicillin G
Vancomycin

Gram + and - Microbials

Ampicillin
Cephalosporin
Chlortetracycline
Kanamycin
Neomycin
Nitrofurantoin
Oxytetracycline
Streptomycin
Sulfonamides
Tetracycline

Gram Negative Microbials

Carbenicillin
Colistin
Gentamicin
Novobiocin
Polymixin B

Fungi - Amphotocerin

Mycobacterium
Tuberculosis - Isoniazid
-Para-aminosalicylic acid

Antibiotics may be obtained from animal health and feed stores, or be improvised by culturing on media (usually blood) from the original bacteria that produce it. Topical preparations can be made by mixing the antibiotic producing microbials with egg albumin.

Scientific Principles of Improvised Warfare and Home Defense

6) Methods of determining toxicity

The US EPA established guidelines used in evaluating herbicides in which a battery of acute toxicology tests are run to determine how dangerous a substance is by the exposure routes. Herbicides are materials that have label claims of killing living things. It is important to know how they effect human beings and our life processes. These procedures can be field improvised to reliably test chemicals and poisons for lethal effect.

Ingestion: There are two methods used to evaluate oral toxicity. The first is a single oral dose given to rats. This is usually given by mixing the chemical or poison in a given amount of water. The chemical is measured in grams or milligrams and weighed out as a percentage of weight of the animal tested. An initial dose is selected and is administered by gavage (Pouring down the throat with a tube). The rats are observed for 14 days. Usually there are 5 female and 5 male rats. If more than half live the dose is doubled. If less than half live it is cut in half. Adjustments are made until the amount that kills half the animals is known.

The second method is to incorporate (mix) the poison into the normal ground rat food and feed at adjusted doses until a 50% death rate is reached.

An improvised method of doing this would be to mix a small % in the feed (.5# in a 50# bag) and free feed and observe store bought or trapped mice for 24 hours, using 3 per test. The dose is doubled or halved with a new set of rodents each day until it kills all specimens in 24 hours. The test criteria here is to determine the amount necessary to kill 100% of a target population in 24 hours. This method gives you a rule of thumb for evaluating toxicity of various oral poisons without great difficulty.

Eye Toxicity: A potential poison intended to cause blindness or kill through eye exposure can be evaluated by a shortcut method of the EPA protocols. Normally a group of 6 rabbits have a measured dose of the poison dosed on the anterior surface of one eye and over 21 days the eyes are examined by an ophthalmologist who records the eye irritation (reversible changes) and the corrosion (irreversible tissue damage). The untreated eye is observed as a control. At the test protocol doses, any acids or alkalis would cause permanent damage and are no longer tested. To determine toxicity in the field, a tiny dose (1 mg) can be administered to the eyes of mice or rabbits to see if complete blindness or death occurs. The dose is doubled or halved each day with a new animal until total blindness or death occurs depending on desired criteria.

Scientific Principles of Improvised Warfare and Home Defense

Dermal Toxicity: 5 male and 5 female rabbits have fur clipped from 10% of their body surface, off the dorsal and ventral areas where a dose of the poison is applied. If the poison is intended to cause injury or death by dermal routes it should be applied in the solid or liquid or gas form that it would be used in the field. A thin and uniform film is applied to the entire 10% of the surface area and the effects are observed and recorded. For purposes of evaluation as a weapon, serious injuries, nervous system damage, and any other debilitating effects should be evaluated. The dose size can be reduced if 100% mortality is observed, until a survival dose is reached.

This is a very complicated testing area and the many options and considerations that would come into play in serious commercial weapons evaluations are far beyond the scope of this book. Irritation, sensitivity, and toxicity can all be evaluated with all having some importance, especially when cocktail mixtures such as Sarin nerve gas and Sulfuric Acid are combined. The acid provides a skin injury which greatly increases the absorption potential and lowers the dose requirements for injury and death. Under this heading a puncture toxicity can also be observed in which a poison is dosed on a piercing instrument and is applied as shallow or deep wounds in different parts of the animals and the effects recorded and applied to human body weights.

Inhalation: Involves the application of an aerosol poison to 5 female and 5 male rats at a specified concentration for 4 hours. For the purposes of determining toxicity, an enclosed chamber or jar can be dosed with a given amount of aerosol in the form that it is used in the field. Two or three animals are observed for 1 hour. The dosage is increased with fresh mice or rats until a 100% mortality is reached. It is preferred for effective inhalation weapons to cause death at some concentration in air in a few minutes and ideally in a few seconds. The dose as a % concentration in air is measured and recorded.

In all testing, autopsies of dead and injured animals (living animals can be killed with car exhaust so that their tissues remain mostly unchanged) can be conducted to determine what sites are affected with inflammations, necrosis, and so on.

Scientific Principles of Improvised Warfare and Home Defense

Chapter 8 Defensive Obstacle Construction and Countermeasures

Constructing fortifications for military purposes is the specialized job of Engineers. This is not intended to be a work on military construction. It is intended to provide the sound principles of creating physical obstacles to hinder a potential enemy and how to overcome obstacles the enemy may present.

The purposes of obstacles are to

- Entangle or Immobilize which provides an easy target
- Trap the Enemy
- Camouflage intentions and objects
- Slow Down the Enemy
- Provide Warning
- Stop Enemy Movements
- Funnel an Enemy into Fire Zones, Booby Traps, Minefields, or advantageous terrain

The ability to Improvise obstacles depends on the available materials and the circumstances the defender finds himself in. These will be classed as

- 1. Earthworks and Waterworks**
- 2. Metalwork's**
- 3. Stone and Concrete**
- 4. Wood, Brush, Glass and Misc. materials**
- 5. Chemicals and Living organisms**

Scientific Principles of Improvised Warfare and Home Defense

1) Earthworks and Waterworks

Earth and water have been used since the dawn of man to provide defense against enemies. These commonly took the form of

Earthen Hills and Walls: which provided the advantage of gravity, forcing an enemy to expose his upper body and head as the closest points while surmounting the defense. The added work and effort makes assault against hills and walls or other elevated positions physically demanding (it is easier to run and fight downhill) and usually exposes the attackers movements and bodies to observation, aiming, and fire from protected positions.

Ditches: Provide trenches for soldiers to conceal themselves from fire and observation, house passive weapons such as spikes, entanglements, and a variety of traps. They are used to physically stop enemy movements and require a direct effort to overcome. Carefully placed ditches are placed in fields of fire which force enemies to expose troops to direct fire from hidden positions. Whenever troops stop near front lines they dig in. This even includes digging in the vehicles to present a minimal profile.

Moats: are water filled ditches used to conceal the nature of the ditch and prevent its use as a trench by the enemy. Water has presented enormous obstacles from ancient to modern times. Castle moats, the English Channel, and the Suez Canal have changed the course of history many times by hindering the armies trying to pass over them.

Ditches can be filled with spikes in the form of sharpened spears or pikes and can be combined with entangling brush or barbed wire.

The ditches can be continuous and interlocking. They can be shallow or deep, and combined in many fashions to confuse and frustrate the enemy.

Ditches are most effective when concealed by brush or other camouflaged so an enemy can be trapped or taken by surprise.

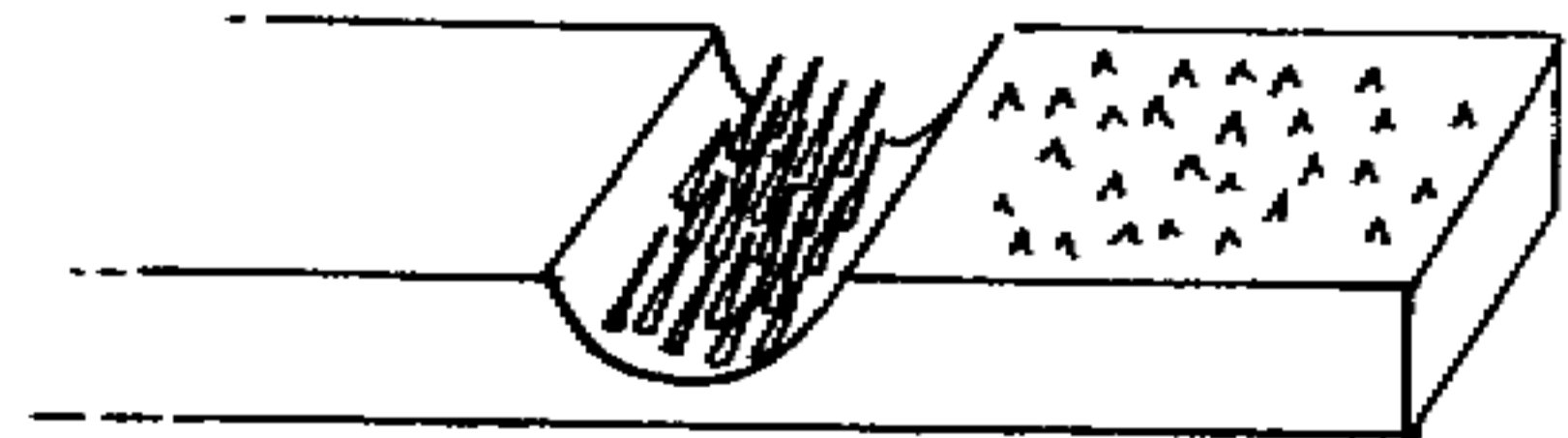

Scientific Principles of Improvised Warfare and Home Defense

Ditches are also used to conceal troops from observation by air, infra red sensors, and electronic surveillance.

The defender that is dug in has the advantage of not having to move and reveal his position. This, combined with the low physical exposure makes it unlikely for the defender to lose his life. The attacker has to move across terrain with considerable exposure to unseen enemy fire. Risk of loss of life is high. When the attacker suffers losses and injuries, both sides observe this and the attacker has to attend to wounded while under fire. The defender suffers fewer casualties and these are unseen by most of the participants on both sides. This has serious morale effects on the attacker and encourages the defender.

There is safety at the bottom of his ditch. You can shoot out of a concealed ditch without being detected which adds to the safety and effectiveness. This is why entrenching tools are standard issue to troops and are an essential tool of improvised warfare.

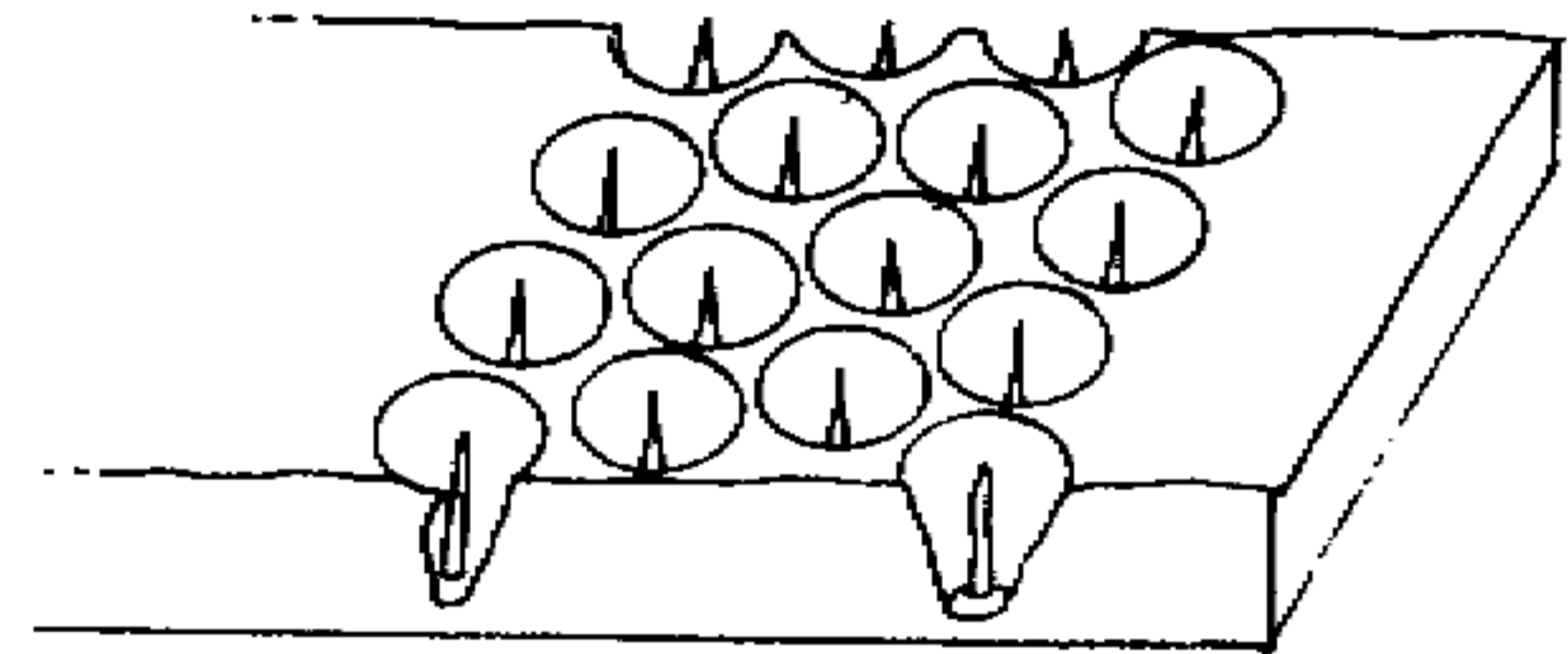
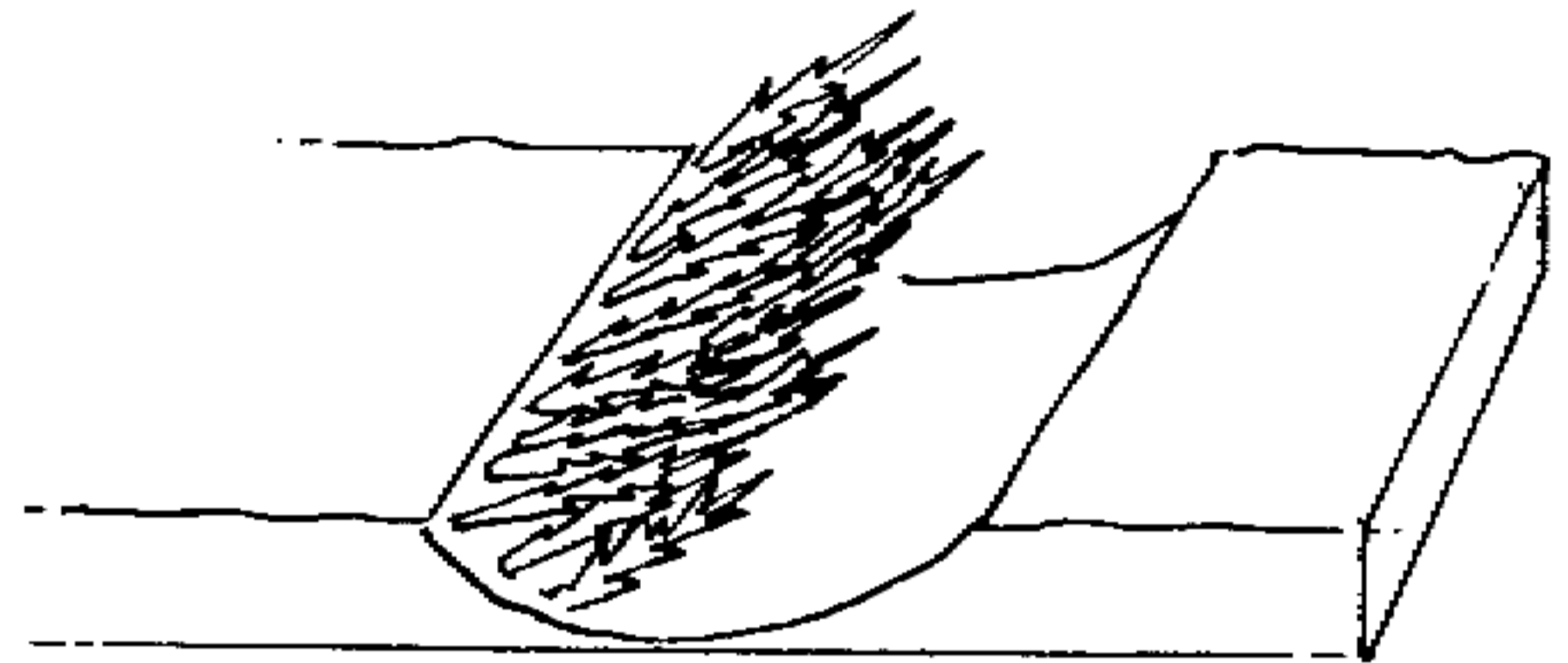

Terrain broken up by ditches prevent enemy vehicles and armor from maneuvering. When the enemy is slowed down, immobilized, or forced to "funnel" to a single crossing area they become exposed to the defenders advantageous fire.

Ditches also protect and conceal supplies, and ammunition. They can be reinforced with other materials of construction and become fortifications. Digging trenches may seem like wasted effort but when civilians are called on to assist in resisting an enemy, the effort alone can raise morale while giving a population something to focus on and do rather than just give up.

Ditches were used in ancient time to resist siege engines and keep them at a distance from city walls. Ancient Romans designed their city defenses with walls 30' high and 15' thick. Spaces were cleared out to 200 yards to make all approaches visible. Three sets of ditches were then dug 35 yards wide and as deep as the soil allowed. The earth from the ditches was piled up in between and tree branches stuck in the ground at an angle and resembled deer antlers. Cords were strung with bells attached to warn of approaching enemies (especially at night).

Scientific Principles of Improvised Warfare and Home Defense

The earliest tank trap was devised at this time. Many empty jugs would be buried, filling up a ditch and were covered with dirt. Soldiers could walk over the trap without noticing. Once a heavy siege engine was brought forward, the weight caused the jugs to break and the wheels to sink in shallow traps, or with the entire engine falling into a deeper hole. Similar modern designs have been used to trap troops, light vehicles, and tanks. Any collapsible material that can support a few inches of soil is sufficient.

Ditches were often dug to below the water line to form the earliest moats. Additional waterworks were devised to maintain full moats when necessary.

Any time ditches or moats were encountered, the only means of logically overcoming them (before aircraft) was to fill them up with earth, brush and trees, or "bridge" them with special equipment. To make these efforts difficult, by WW1 the opposing sides built trenchworks 10-20 miles deep across hundreds of miles of front. A virtual sea of craters and mud in between the trenches made advances nearly impossible. Entrenchment's, and waterworks allowed the modern defenses of Casino, Leningrad, Kursk Tobruk, and Berlin during WW2 costing enormous losses on the attacking side. Korea from 1950-1953, and the Iran-Iraq (1981-1988) war turned into entrenched line warfare in more modern times.

Earthworks constructed as tunnels have also been very hard to overcome as evidenced by the Japanese defense of Pacific islands during WW2 with trenches and caves costing great loss of American life, and the tunnels of Cu Chi in Vietnam in 1967 which required special types of warmaking skills to deal with. Tunnels have been used to undermine castle walls and dig into forts to support surprise attacks and gain entry against hard to overcome obstacles. They can be used in this manner offensively, or can be used to evacuate wounded, resupply troops, and deploy troops without being observed.

Most earthworks have been dug by hand throughout history. In this century, the advent of explosives to rapidly do the work of digging holes, ditches, caves, create a cratered landscape, and demolish concrete hiways and bridges allows the rapid preparation of defensive layers of anti anything ditches, fire positions, and strongpoints. The ability to requisition backhoes, graders, motor shovels, diggers and bulldozers, (or put dozer blades on tanks and trucks) allows a defender to create seas of earthwork obstacles that can bog down or paralyze any attacker.

Dramatic historical examples of the use of these ideas include the massive tunnel and explosives placement built by General Grant against Lee's fortifications near the end of the US Civil War. During the Arab-Israeli war in 1973, the Israeli anti-tank ditches stopped the Syrian armored assault. When the Syrians brought forward scissors bridging equipment and finally crossed the gap, they brought their tanks to the location to force a crossing, channeling them into a prepared Israeli killing zone.

Scientific Principles of Improvised Warfare and Home Defense

One future plan for the defense of Europe included the laying of underground pipe over hundreds of miles of front areas. Once an enemy attack began, the pipes would be filled with liquid explosives and detonated to create a maze of anti tank ditches quickly and at the desired time so it would only hinder the enemy and not friendly forces.

Modern warfare also provides prefabricated buildings and reinforced roofs that can be dropped into ditches for command bunkers and troop trenches. These can be quickly covered with dirt for camaflouge and defense (with openings for gun barrels and sighting or troops can use 2 way mirror periscopes in camaflouge to observe enemy approaches).

Many modern examples of motorized earth moving equipment include

One man Portable Trencher

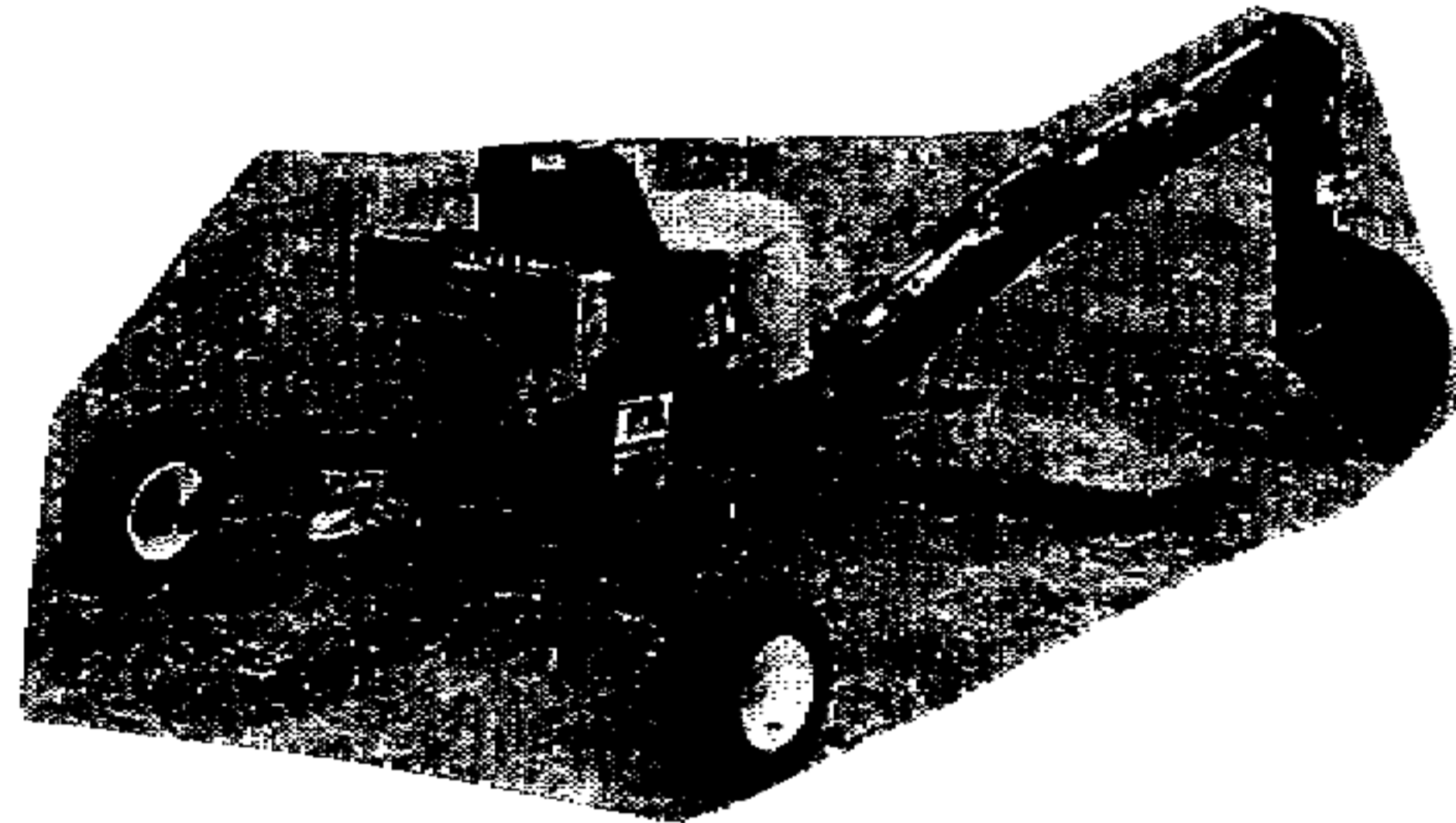

Portable Backhoe

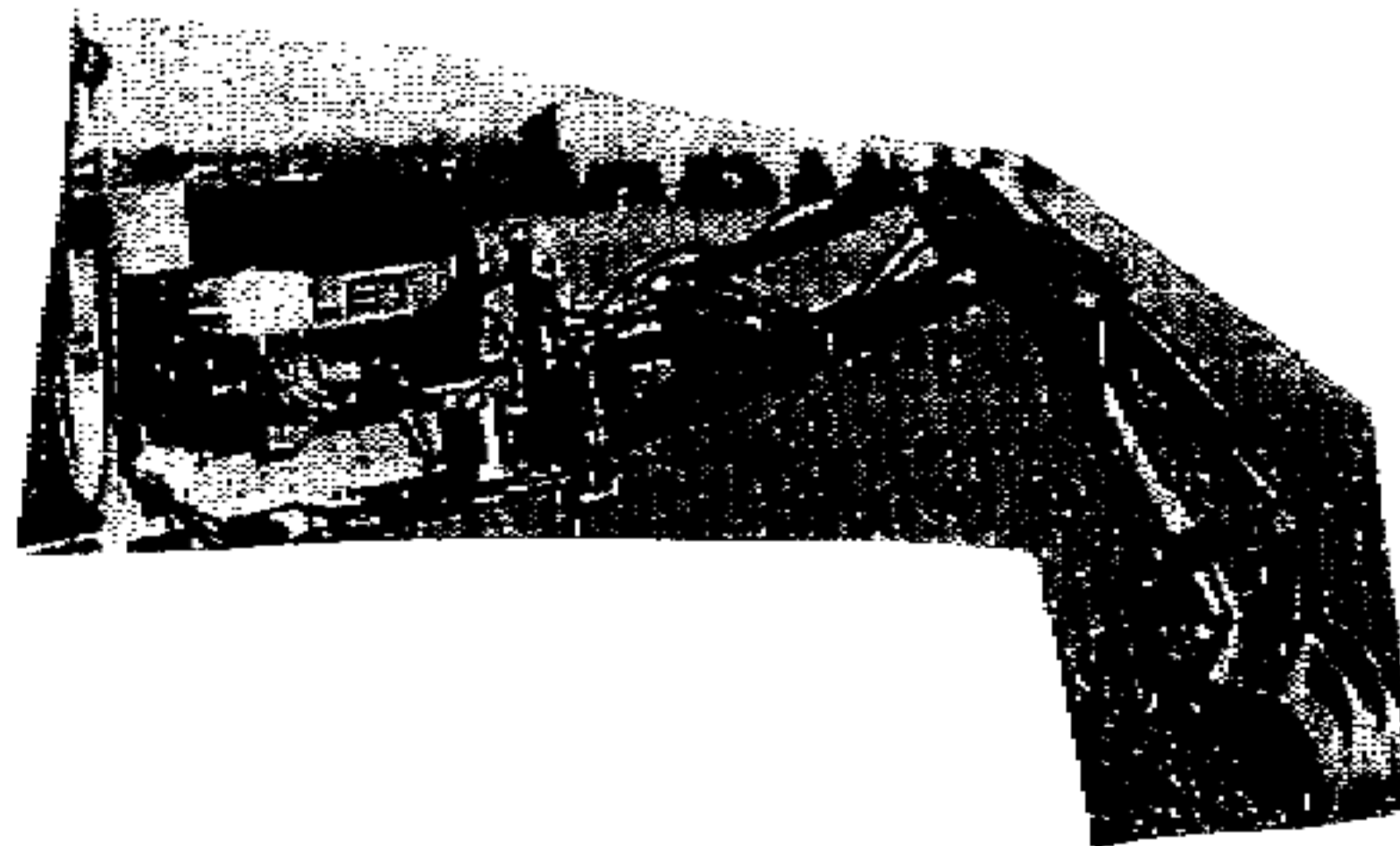

Scientific Principles of Improvised Warfare and Home Defense

2) Metalwork's

The ability to prefabricate metal by hammering, heating and bending, and casting has allowed the creation of many prepared obstacles. The most obvious of these include piercing instruments such as nails, spikes, barbs, teeth or poles.

These can be imbedded in

Wooden logs and branches

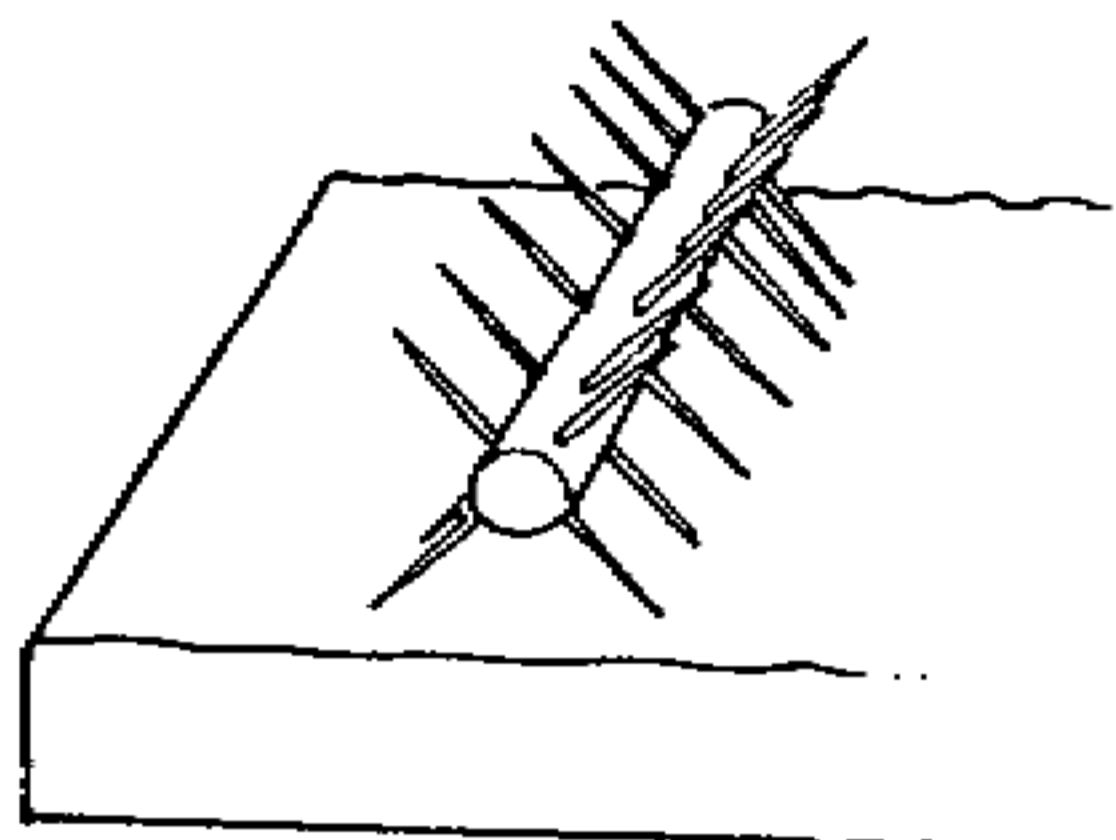

In stakes buried in the ground or ditches

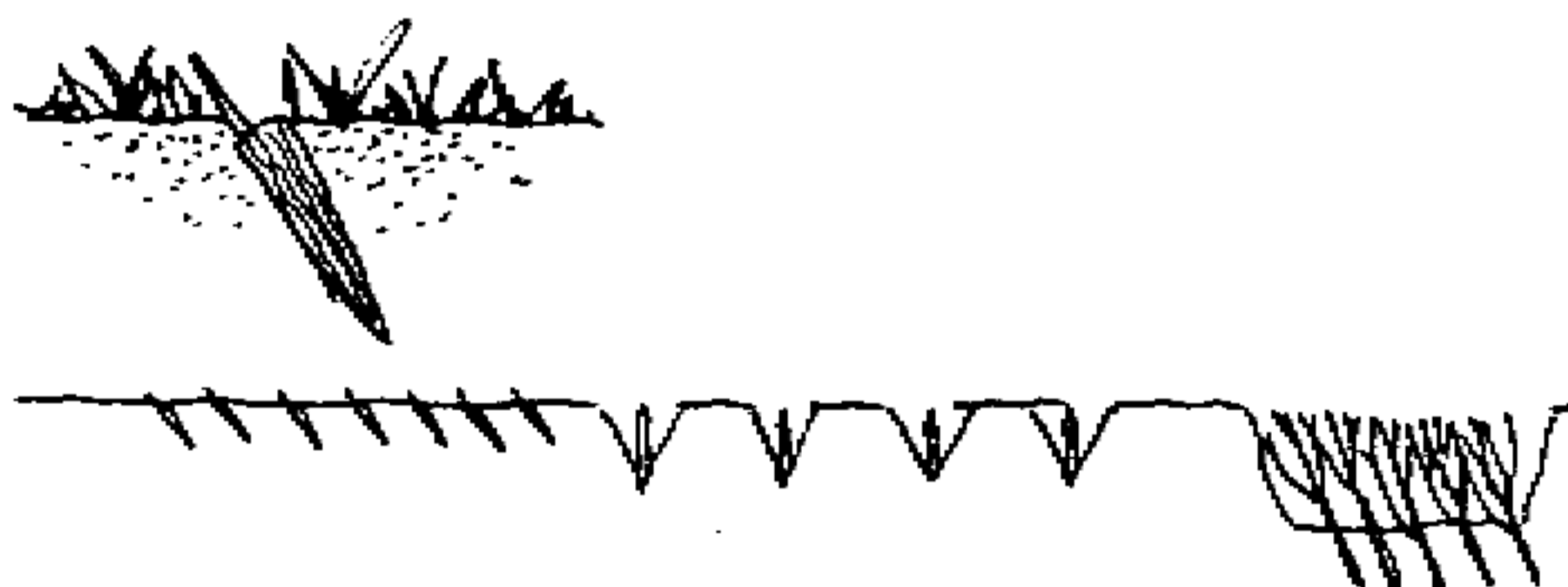

Attached to wire or rope as barbed and razor wire

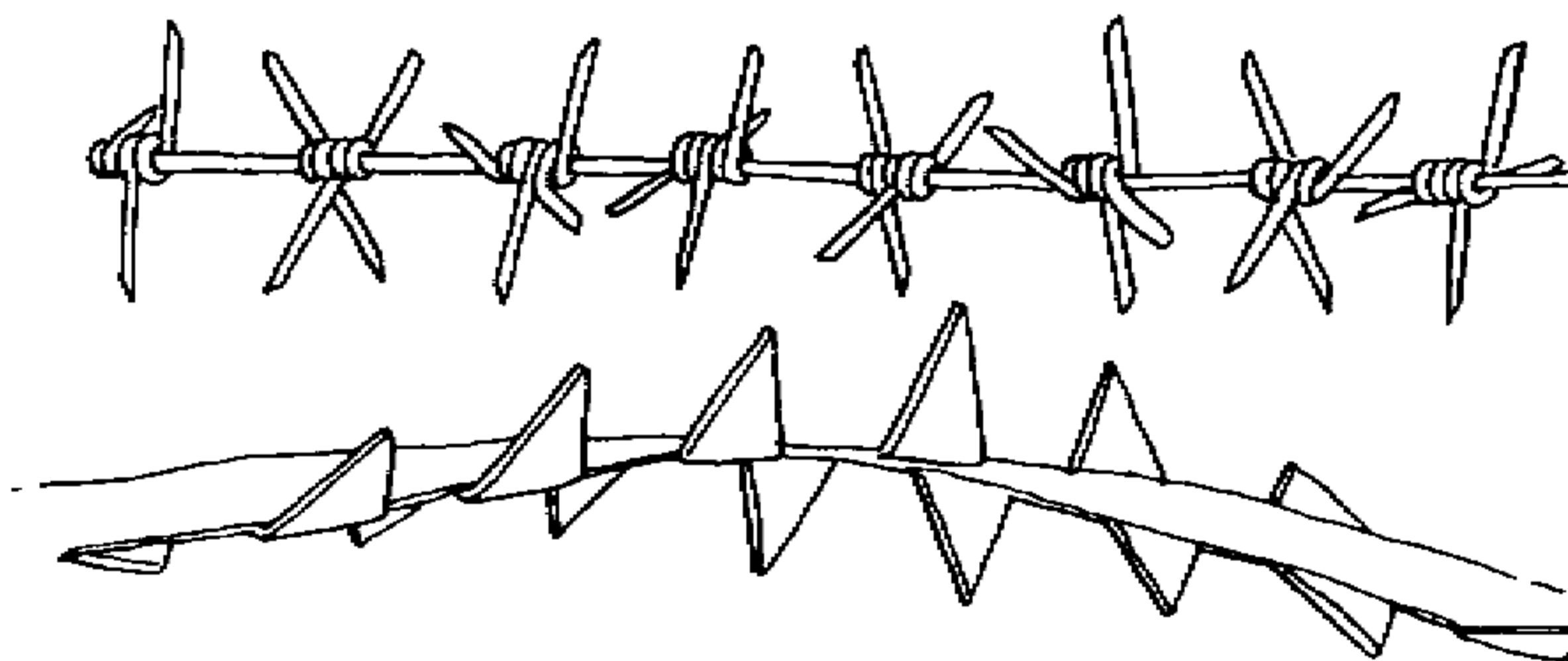

Scientific Principles of Improvised Warfare and Home Defense

These types of wire can be laid down between pickets as entanglements

as coiled wire

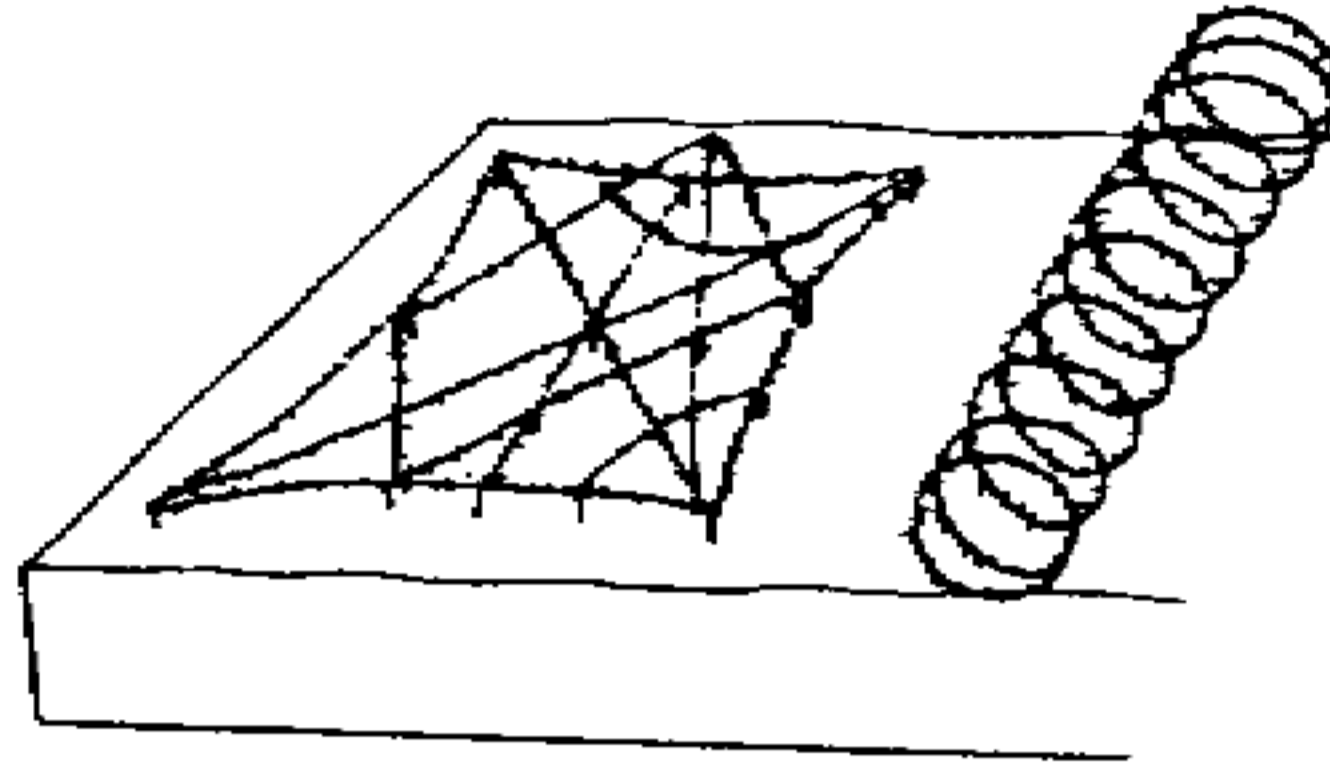

as fences of coiled wire

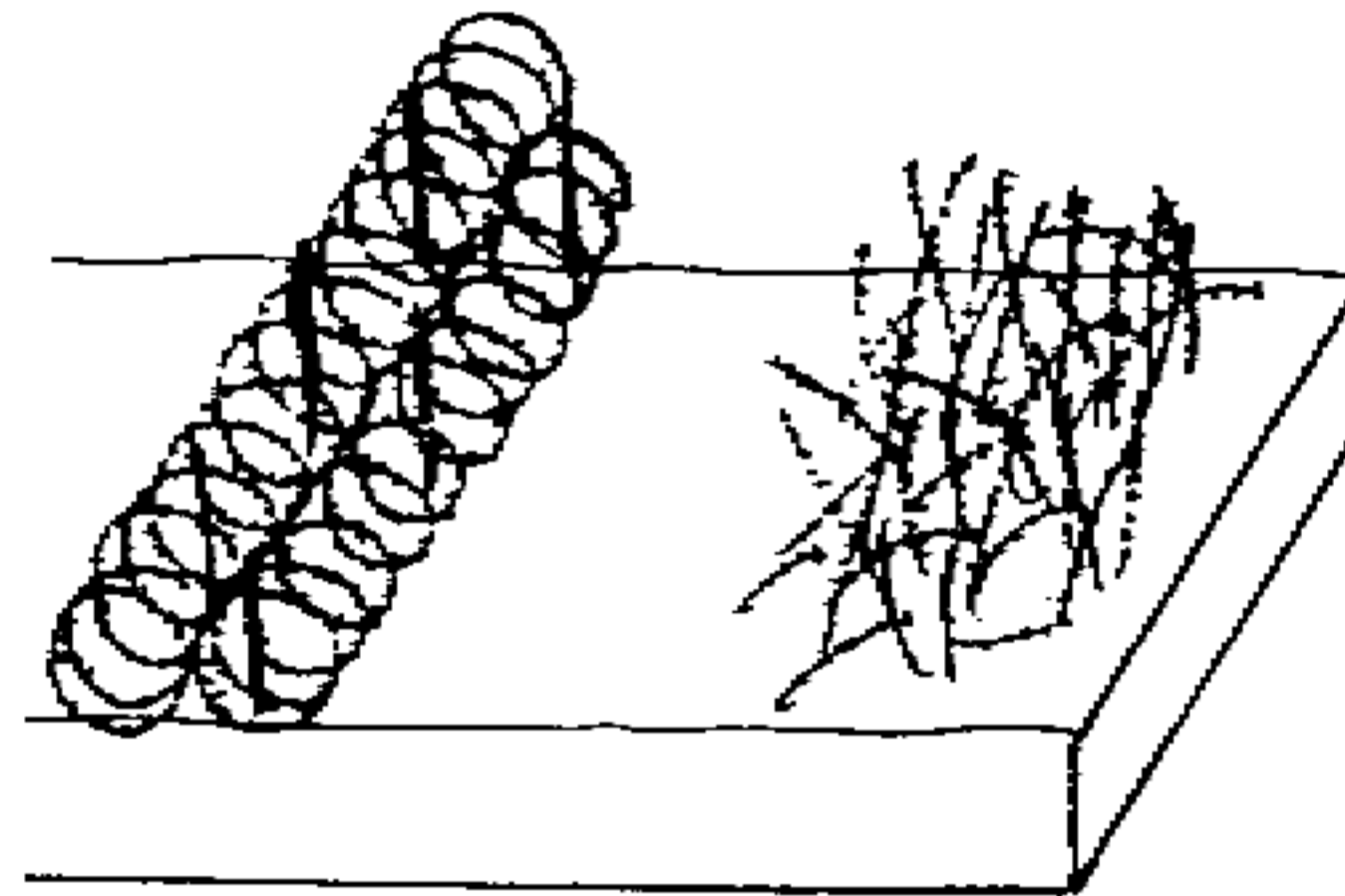

or as wire thickets to hinder clearance

Poles or pikes (or even railroad tracks) can be buried in the ground with concrete or dirt foundations. These can be used to stop or puncture tanks or landing craft.

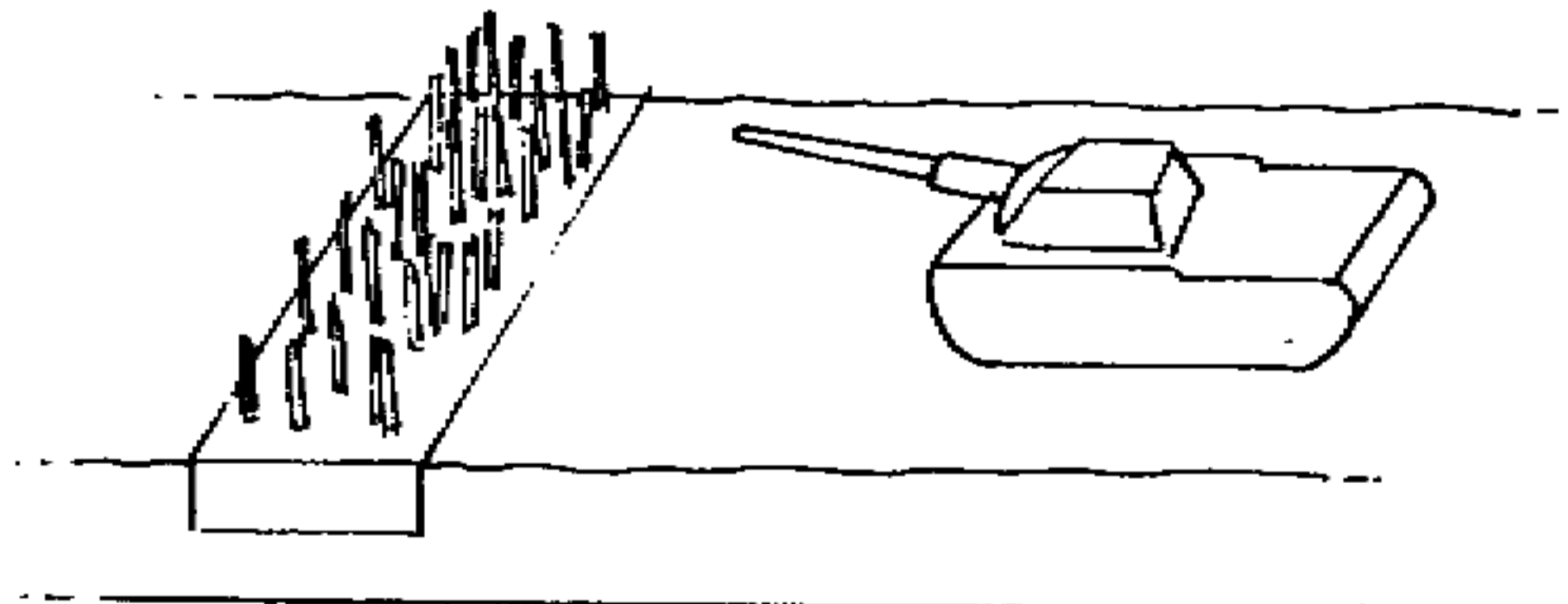

Scientific Principles of Improvised Warfare and Home Defense

Heavy metal barricades are erected along vehicle routes to prevent free movement of the enemy. These can be as simple as 55 gallon drums filled with sand

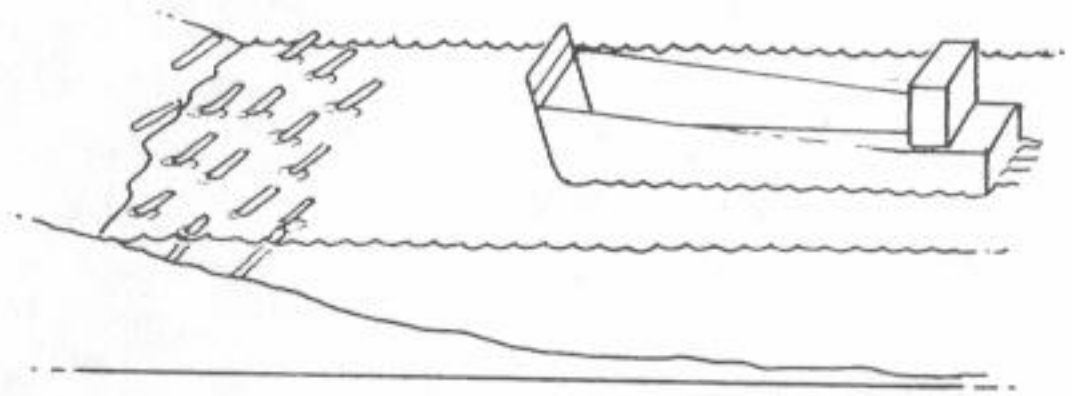

Barbed wire and even **grapnels** hung from trees can be used to hinder the enemy. Pitchforks can be buried forks up to intimidate and slow an enemy. Ordinary log chains can be thrown across roads, moats and rivers to slow progress of vehicles and boats

3) Stone and Concrete

Masonry materials have been used since the dawn of man to build **walls** to protect himself, buildings to live in and shelter him from the elements, animals, and insects, and roads to travel on.

The ideas of wall design included using bricks and heavy stone that could not be broken through easily. They would be filled in with concrete to anchor in place. Walls would be 10-30' thick to discourage attempts to batter them down. Ledges and watchtowers allowed the safe observation of the approach of enemies. The walls were designed to funnel attackers towards gates where they could be attacked from above on three sides. Bastions flanking gateways were extremely effective in aiding defense.

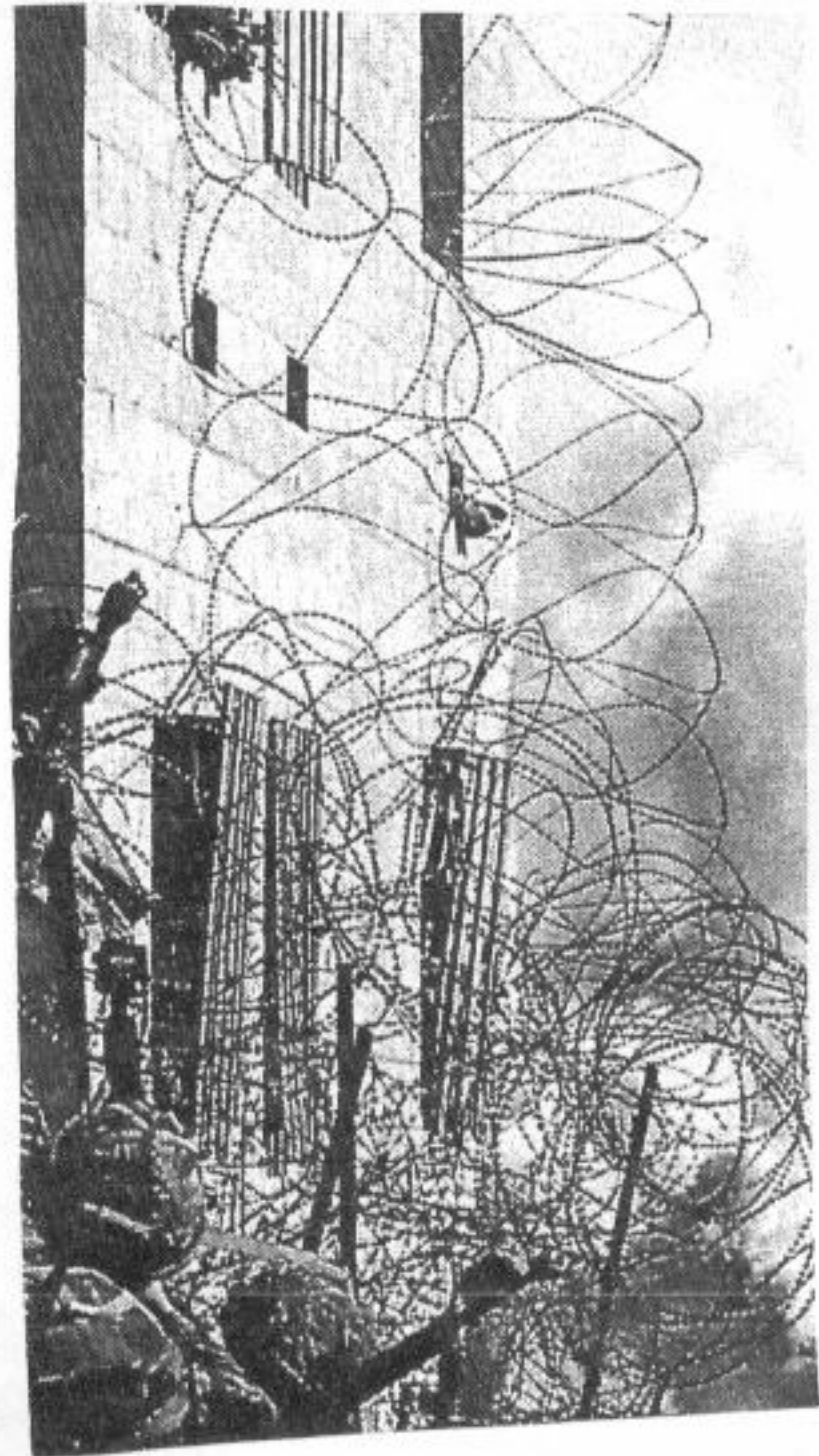

Scientific Principles of Improvised Warfare and Home Defense

The **parapet** was developed as an overhanging extension which had openings in trapdoors. This allowed the door to be opened so he could shoot or drop arrows, stones, boiling oil, molten lead or red hot sand onto the attackers head without being exposed to return fire.

Walls had to be 30' high to prevent attackers from quickly scaling them with ladders and 15' thick to prevent battering rams from breaching them.

Cranes were used to swing heavy weights against siege machinery and enemy troops, much like wrecking balls of today. The crane cable and ball could have a variety of piercing and entangling devices attached to add to its effectiveness as an anti-personnel weapon.

Castles were built with larger and thicker walls and placed on hill and mountain peaks. The Chateau Coucy reached 180' in height and 18' thick. Many of these were impossible to breach and siege, and it became a matter of starvation to overcome them until the advent of gunpowder. Cannon could then provide sufficient explosive force to knock the walls down.

Concrete is essential in reinforcing and anchoring many obstacles and fortifications.

Most city dwellings contain substantial concrete and many commercial structures are built with thick concrete walls. Even in the event of an enemy destroying buildings and structures, the rubble can still be piled up and used as obstacles and camouflaged for tank nests or snipers.

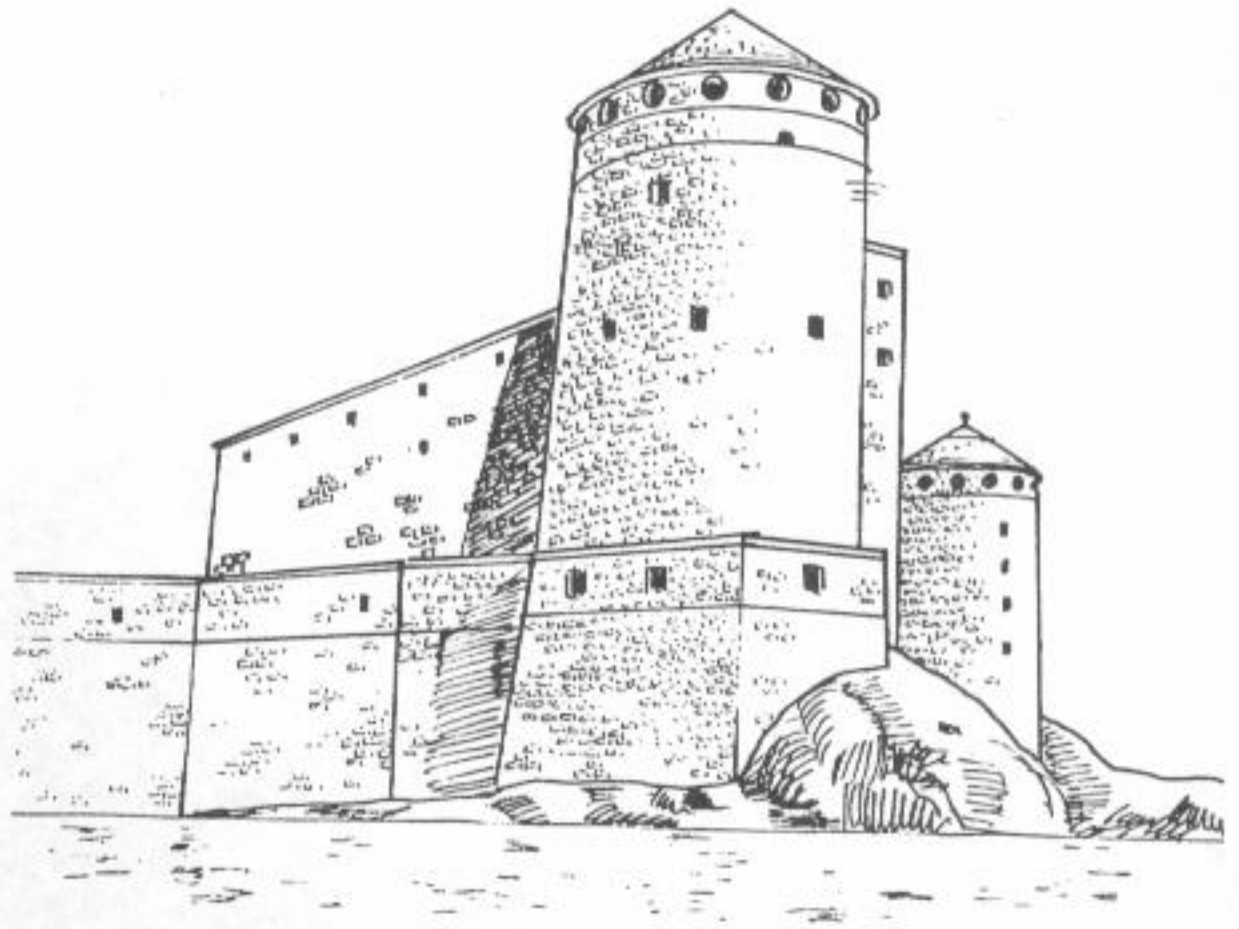

Scientific Principles of Improvised Warfare and Home Defense

4) Wood, Brush, Glass, and Misc. materials

Wood is an abundant material available almost anywhere on earth. It can be carved into many types of piercing devices, it can burn and be used to deliver fire as a weapon, it can store energy by being bent like a bow string for booby traps and it can be put to many uses as an obstacle.

Wood can be combined with nails or barbed wire to anchor spikes and entanglements. Branches can be carved into spikes. Small demolition charges or a chain saw can rapidly produce large volumes of major obstructions very quickly by dropping trees from forests and bocage countryside. A jungle or dense forest can be a major obstacle all by itself.

Brush is useful for camouflage and entanglement. Broken glass can flatten tires and cause foot soldiers to not examine the path or road for mines or traps. Any rubble or solid physical material that can be moved and piled or placed in an obstructive manner is suitable for use.

5) Chemicals and Living Organism

Chemicals already listed as weapons can be passively placed and combined or incorporated into obstacles. Fire is a considerable obstacle to free movement and can be lethal if entangled troops are caught in incendiary traps and ignited (see the movie Braveheart). Smoke is an obstacle because it blinds enemy vision (and your own), it clogs lungs, and it conceals movements and traps.

Smoke is easily created by spraying diesel fuel on engine exhaust pipes or from thrown smoke grenades. Chemicals can fill the jugs of modern tank traps so that once a vehicle has fallen in they cannot be simply pulled out, if the chemicals produce nerve gas or acid/blister agents are used. These would kill vehicle crews and adjacent infantry. The psychological effect would be considerable. They would also damage moving parts rendering the vehicles unusable even if they are recovered.

Living organisms were first used as obstacles when man chained Bears or Lions to his castle gates and he now uses modern dogs for guard duty. Any living thing that can slow down an enemy with fear or nuisance effect may be used. Bee nests in traps, rodents, bats or other animal the enemy is not accustomed to can be used for shock effect. Any biological toxin or organism can be incorporated into any piercing or entanglement obstacle. Even dead animal or human body parts can strike fear into an enemy force unaccustomed to the sight.

Scientific Principles of Improvised Warfare and Home Defense

The Khmer Rouge left skeletal remains to intimidate horror stricken civilians. Genghis Khan ordered the beheading of all inhabitants of cities that did not surrender to him. This was to insure that no one faked death. The skulls would be piled up in huge pyramids to terrorize travelers and spread the word. Northern Iran was almost completely depopulated by this method. Those accustomed to slaughtering their own animals for food are less intimidated by this (so were the horsemen assigned to the gruesome task).

Obstacles are an effective means of resisting enemies. The best obstacles are not just wire, ditches, water, trees, or traps. They are combinations of all these and more, combined in the same location creating a maze of problems for the attacker.

In order to overcome the obstacles enemy Engineers must bring up specialized equipment, often under direct fire, and always in the right order to clear the path. Each obstacle must be correctly identified, the right solution devised, and the correct equipment and qualified people used in the right order.

When laying obstacles, it is important to use good siting. The sharp profile of earth banks on both sides of a road will prevent the enemy from simply going around. Blocking key streets, bridges, and intersections with craters and trees doubles the problems of those who have to overcome them.

The modern availability of earthmoving equipment and vehicles makes the job of creating and positioning obstacles much easier and modern societies that build over vast areas provide enormous source material for cover and obstructions.

Countermeasures to obstacles

Mans ingenuity to overcome all odds, (and obstacles) can best be summed up by a piece of history that didn't make it into the movie. When the ancient Roman leader Marcus Licinius Crassus campaigned against the revolting slaves and gladiators led by Spartacus, he dug a 15' wide by 15' deep ditch for 30 miles across the entire toe of the Italian boot and backed it with a wall. Spartacus's army filled in the ditch on a snowy night and crossed it in one of the most remarkable escapes from encirclement in history. His revolting army actually lost because his men became overconfident and coaxed him into a direct battle against his better judgment.

Grenades, explosives, remote mechanical probes and grappling hooks are used to expose potential traps or remove obstacles from pathways. In ancient times, battering rams were used to knock down doors and walls. In modern times, explosives do this work. Ditches are filled in with dirt and aggregate. Walls and fortifications are sometimes countered with tunnels to undermine them.

Scientific Principles of Improvised Warfare and Home Defense

In ancient times, overcoming both ditches, moats, and walls is achieved by earthworks. Workers were protected by siege towers.

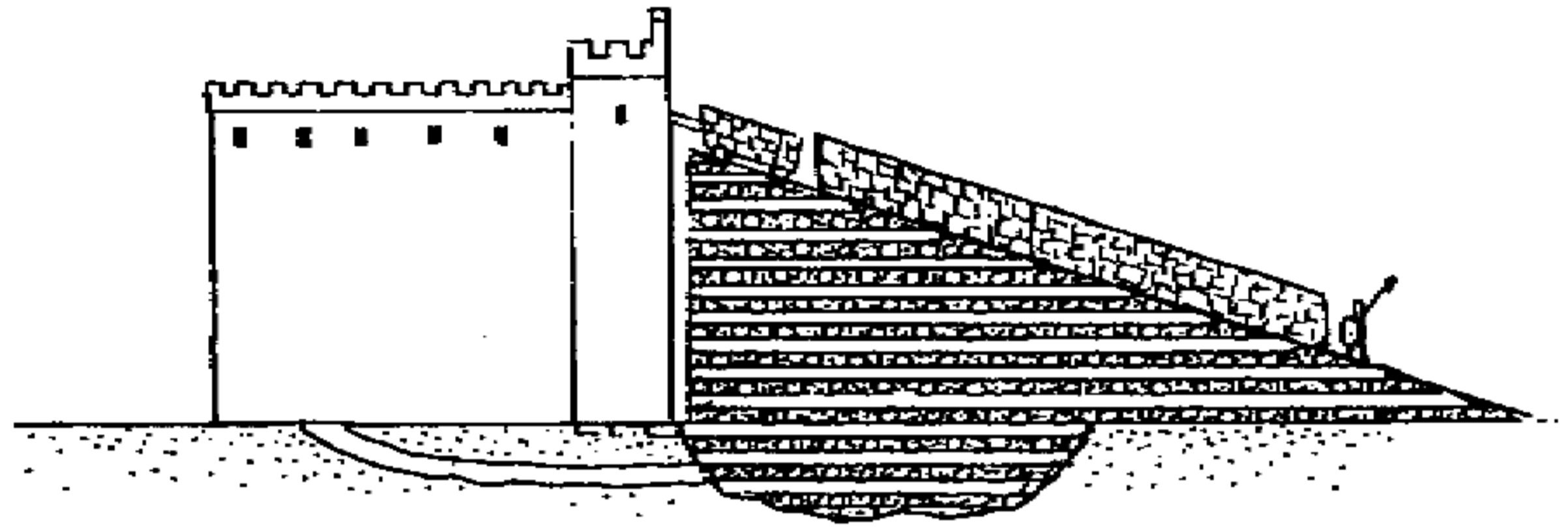

Siege towers provided a protected ladder with missile firing and usually a drawbridge to directly cross to the castle walls

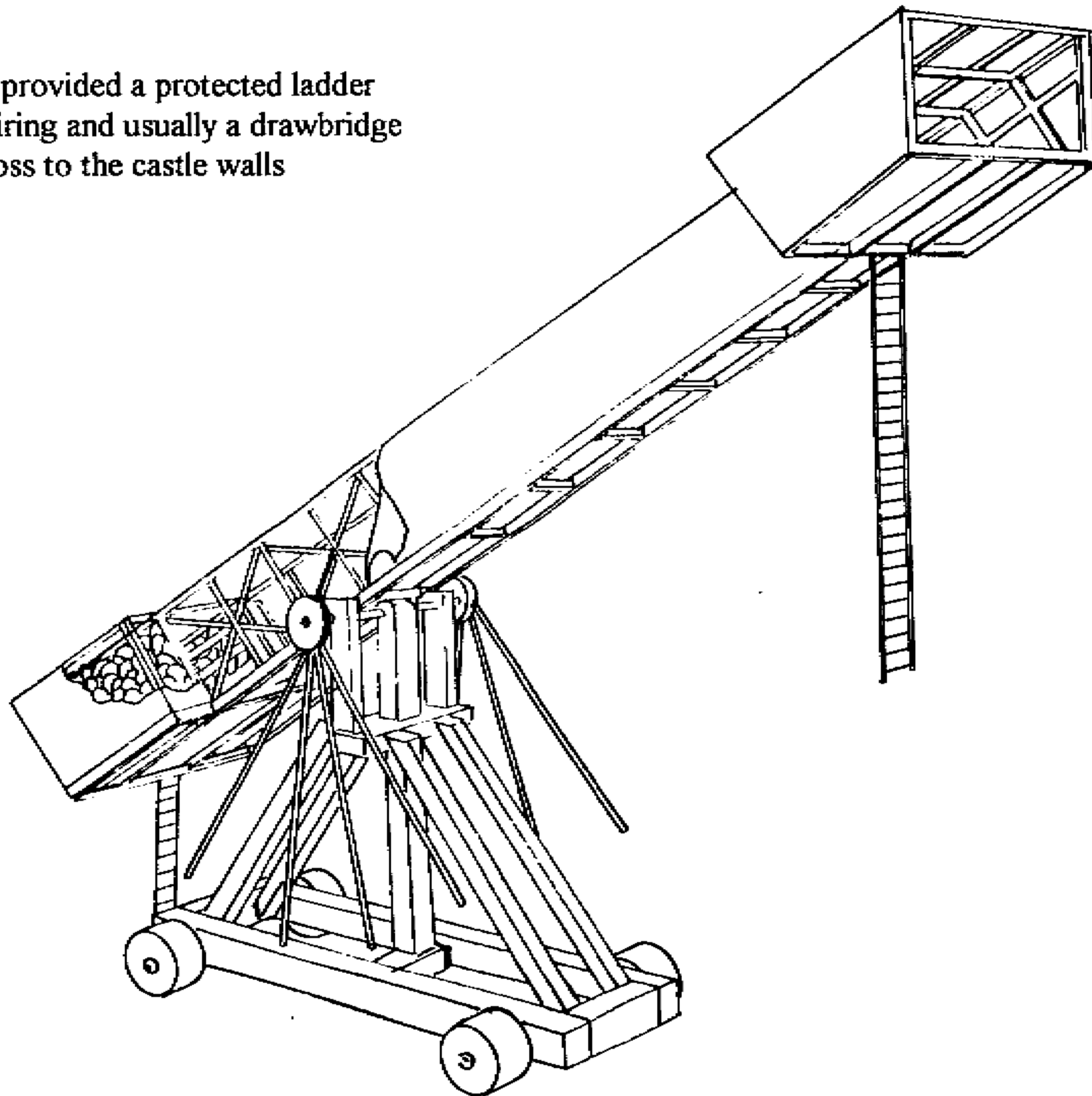

Scientific Principles of Improvised Warfare and Home Defense

Modern engineers use specially designed bridging equipment, bulldozing equipment, and munitions to deal with most obstacles encountered. Traps are dealt with by going around them or filling them in. Some obstacles may require cutting tools, fire, or other specialized equipment to remove.

Modern crossover ladders can be used to overcome smaller obstacles

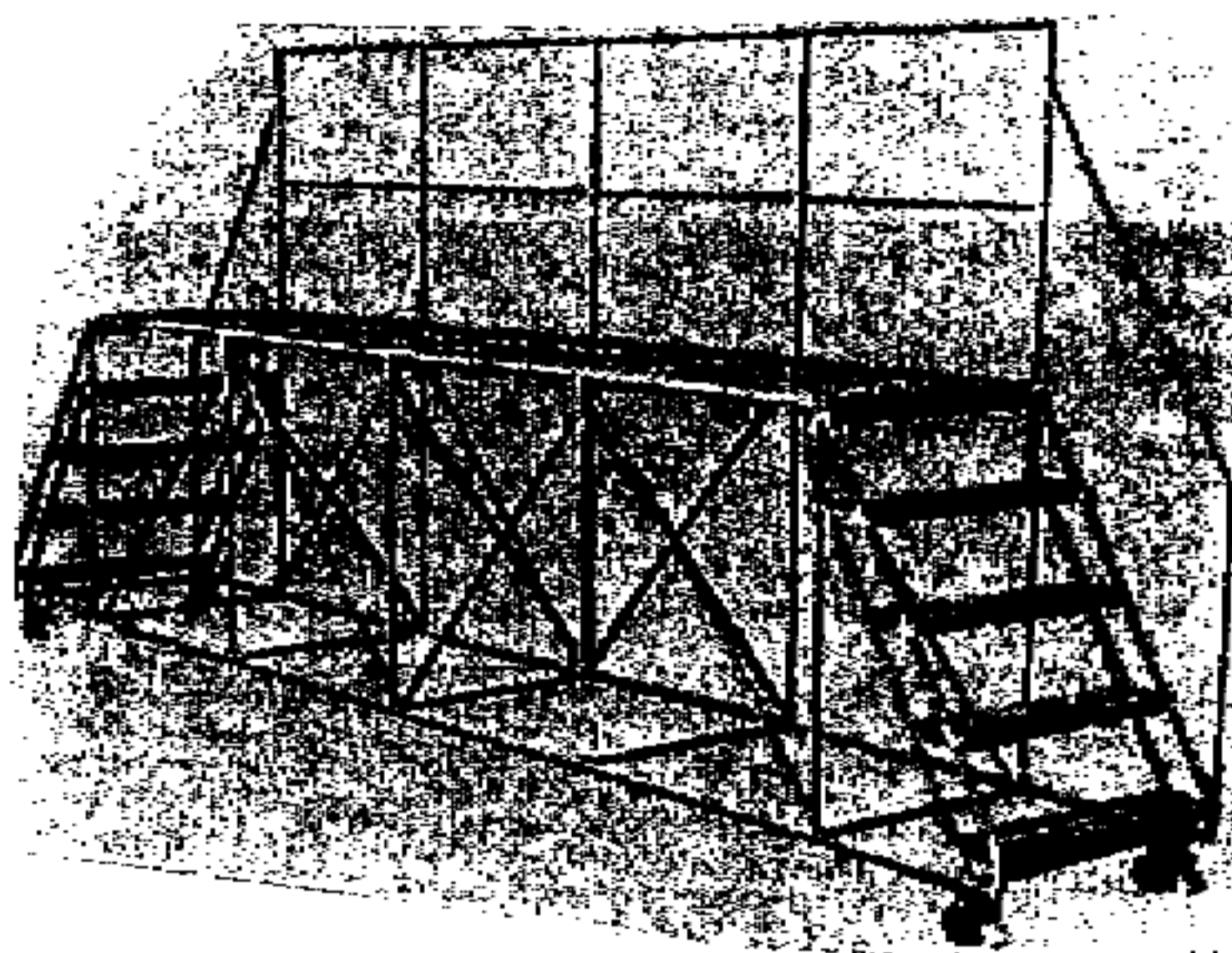
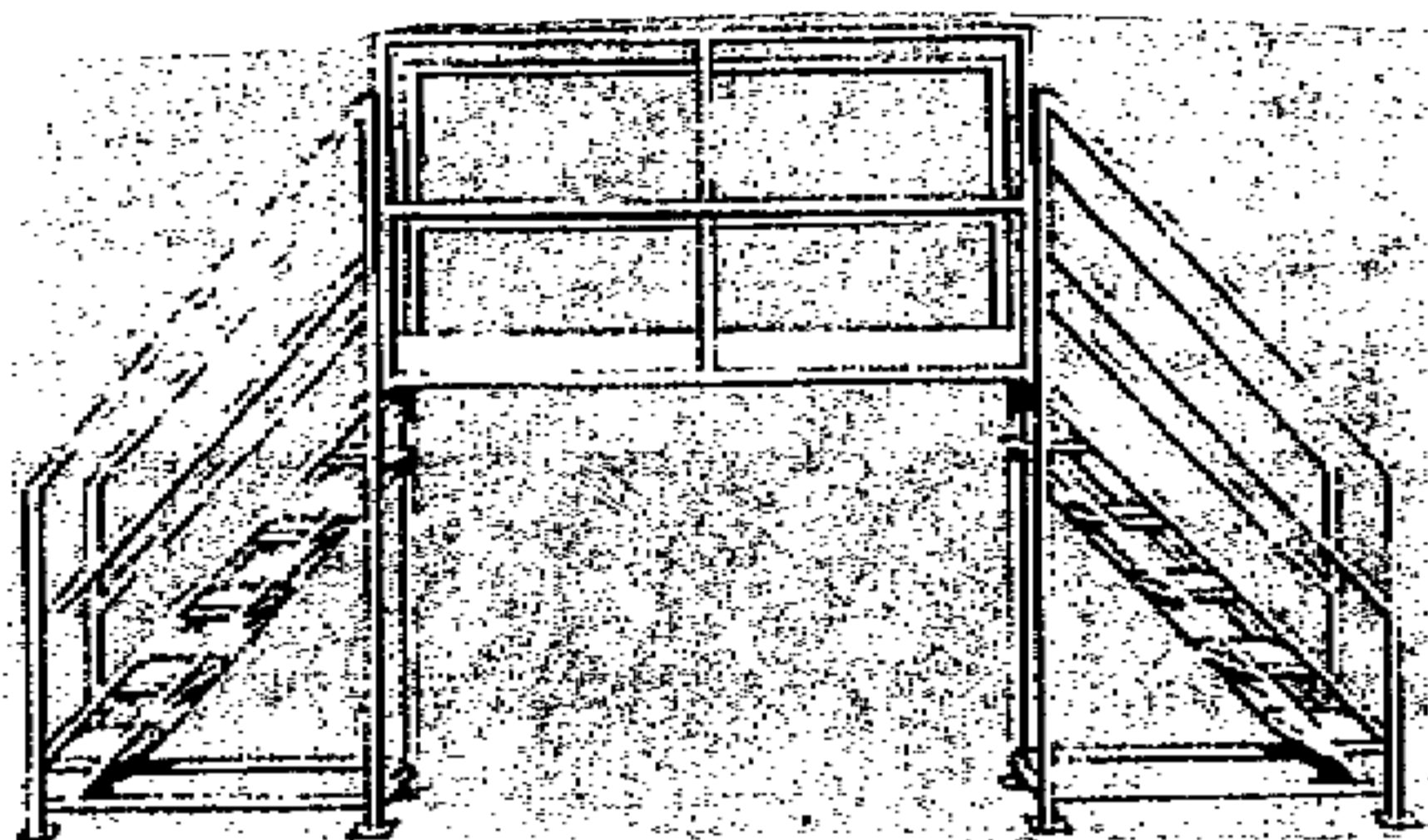

Lifts can be used to scale or reach over walls and into multi story buildings

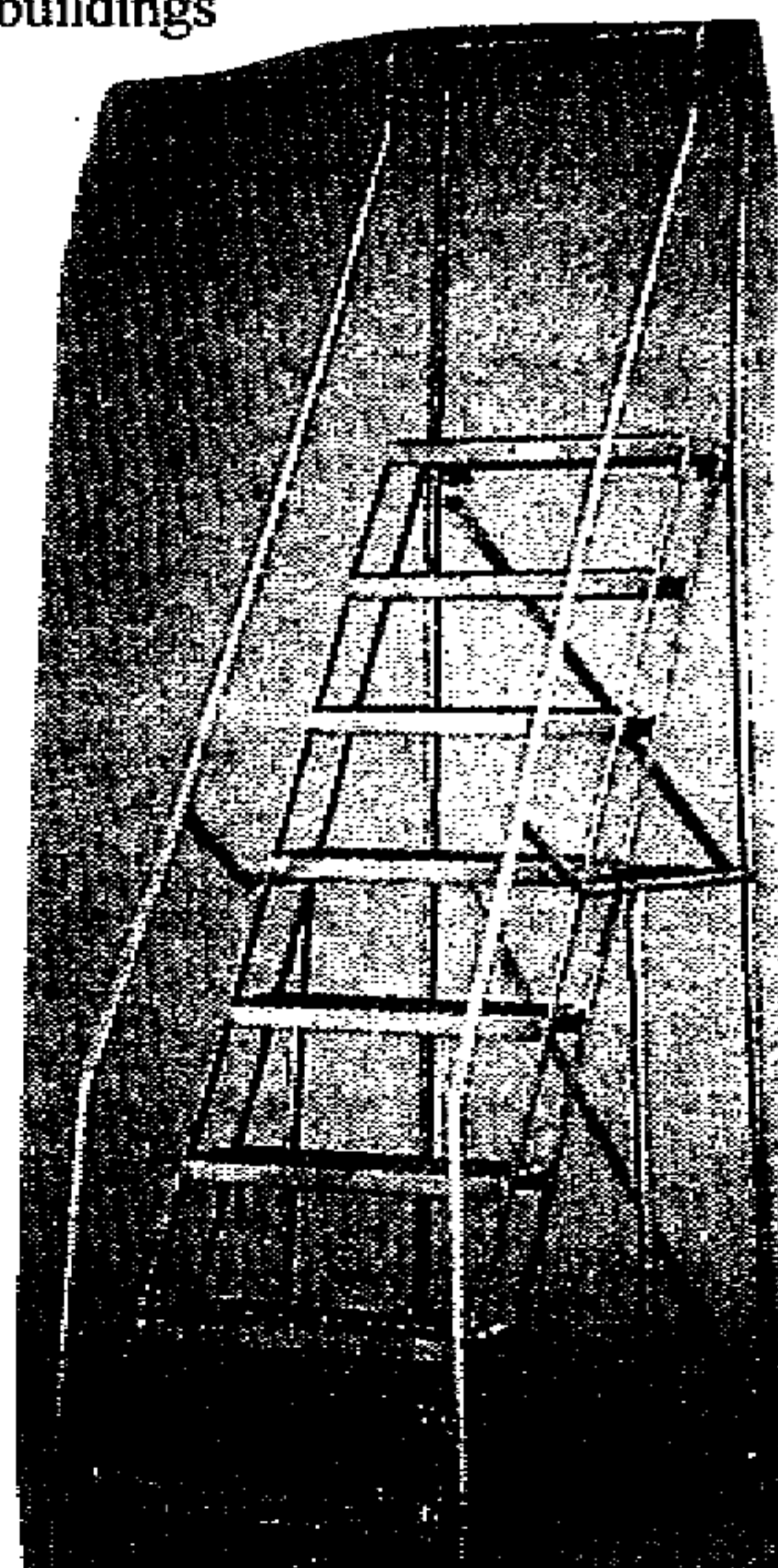
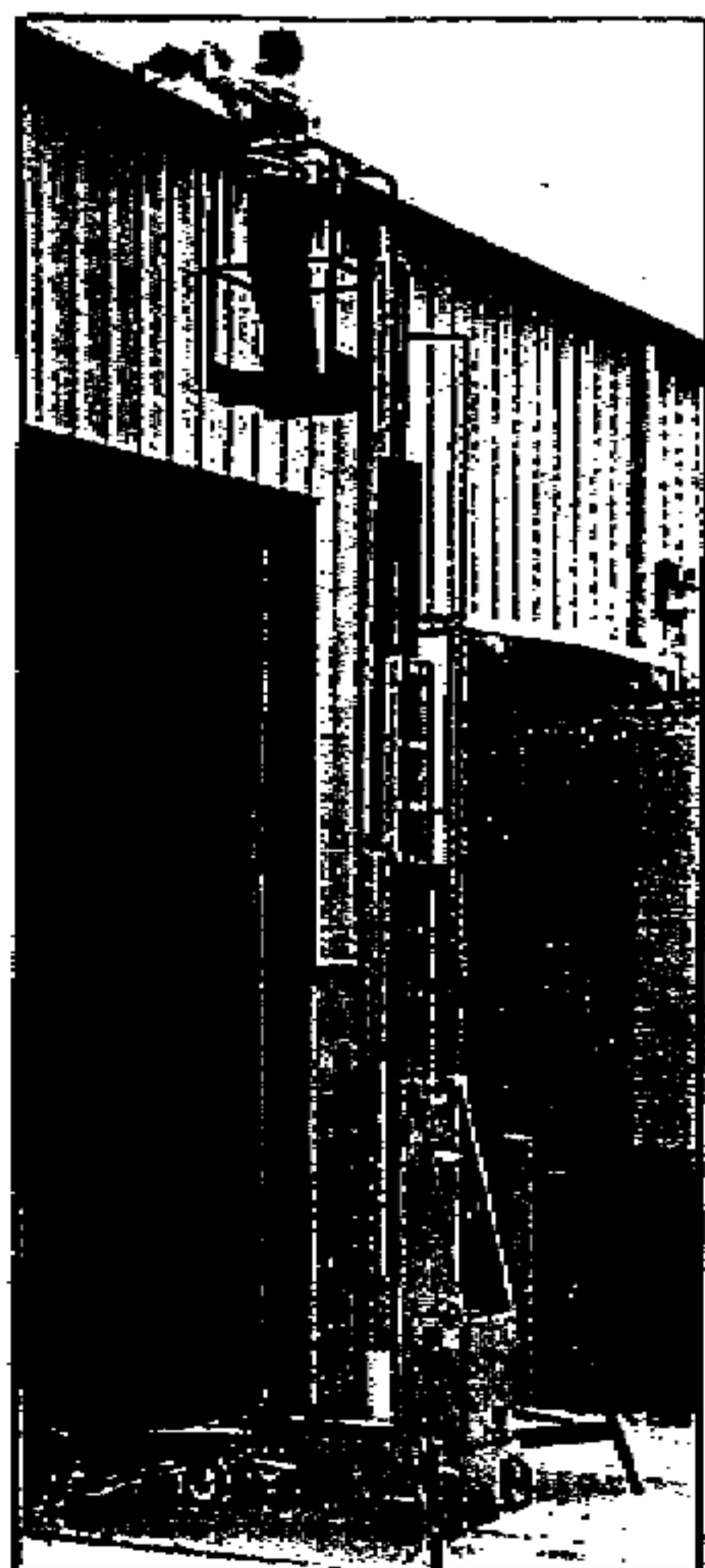

Scientific Principles of Improvised Warfare and Home Defense

Chapter 9 Armor, Personal Protection, and Material Handling

In the course of history, man found himself in conflict with nature, neighbors, thieves, and organized armies. He developed means of protecting himself in areas by building obstacles such as wall and ditches. He soon learned how to apply these same materials to his own personal protection. As armies organized and evolved, they quickly learned that the better protected army enjoyed much greater confidence and morale and would win almost all battles against less protected adversaries.

The sciences of personal protection evolved and by modern times has become quite complex. The same dangers and conflicts that afflicted ancient man still exist today. The potential adversary is much better equipped, from the common thief who may carry a variety of hand weapons and firearms which can launch dense metal projectiles into unprotected skin, to tornadoes and hurricanes which turn ordinary debris into shrapnel resembling an artillery barrage, to modern armies which throw real artillery, chemicals, bombs, and other engineered devices to kill and wound.

Personal protection takes on a very high priority in conflicts and does not have to be pre-engineered. There is rarely time to properly equip yourself unless you are part of an organized military unit and you will likely need to improvise when faced with a threat. This chapter will provide a basic understanding of material sciences that have been applied to protecting armed forces and how these same ideas can be field improvised.

In addition, the science of moving men and materials has been integrated with protection sciences since most losses occur while moving and all offensive combat, or even retreat, requires that the vehicles and personnel being shot at have a chance to survive. Armored vehicles and body armor are the two main means of accomplishing this through all of history.

I have presented this chapter in four parts.

1. Historical to modern applications of materials for personal protection and defense
2. Importance of armor and protective defense.
3. Modern material sciences useful for protection
4. Applied armor science and material handling

Scientific Principles of Improvised Warfare and Home Defense

1) Historical to modern applications of materials for personal protection and defense

Man first defended himself with the only materials he could lift, carry, and fabricate. These consisted of thick clothing, usually leather, and constructing a shield made of wood bound by string and having a handle to allow tactical maneuvering. Clothing was improved and Genghis Khan equipped his army with silk shirts whose fibers would entangle arrowheads that penetrated a riders defenses allowing him to pull the arrow out of the wound with minimal injury. When man invented methods of producing and fabricating metals, shields were made of bronze, then Iron and later, different types of steel. These allowed individuals considerable protection against most hand held weapons.

As man progressed, he applied armor to all parts of his body. Chain mail consisted of tiny chain links formed together in the pattern of protective clothing. This offered great protection against most hand held piercing instruments and is still used today in animal slaughterhouses. Thicker body armor was devised and added to reinforce the flexible chain mail and led to many designs of helmets and plating fully formed and fitted for medieval knights on horseback. While providing great protection this had its drawbacks as well. The armor was heavy and hot in the summers. It took great effort to move and maneuver. Many knights died of heart failure before ever reaching combat due to the stresses and strain of simply moving around. The final blow to ancient body armor came with the advent of firearms which made the user able to penetrate and kill armored individuals at great distances. Armor was also very costly while bullets were cheap.

Wheeled vehicles to carry weapons and soldiers were used in sieges and were armored to protect its contents from missiles, fire, and other objects. This often consisted of wood covered by ox hide and seaweed and was upgraded by the various metals available in each time period.

To protect against modern firearm projectiles a variety of armor materials have been used and tested. It is necessary in modern material science to know the relative weight, cost, and effectiveness of the candidate materials when deciding how to best protect yourself. Standard construction materials can be used and stop ball type projectiles fired at 10' in accordance with the chart. The thickness listed in inches is the minimum required to stop the listed projectiles.

INDIGENOUS MATERIAL	THICKNESS OF MATERIALS					
	Inches			Centimeters		
	5.56 mm	.30 cal 7.62 mm	.50 cal 12.70 mm	5.56 mm	.30 cal 7.62 mm	.50 cal 12.70 mm
Mild steel (structural)	$\frac{1}{2}$	$\frac{1}{2}$	$\frac{3}{4}$	$1\frac{1}{4}$	$1\frac{1}{4}$	2
Mild aluminum (structural)	1	1	2	$2\frac{1}{2}$	$2\frac{1}{2}$	5
Pine wood (soft)	14	22	32	36	56	82
Broken stones (cobble gravel)	3	4	11	8	11	28
Dry sand	4	5	14	11	13	36
Wet sand or earth	6	13	21	16	33	54

NOTE: After many projectiles are fired into the armor, the armor will break down. More material must be added.

Scientific Principles of Improvised Warfare and Home Defense

Ancient chain mail and shields designed to protect the full body from hand held weapons.



These gave way to the modern "flak" jacket or lightweight **bulletproof vest**. The first flak jackets from WWI consisted of steel plates sewn into shirts. By the 1960's, soft armor made of fiberglass or soft plastic were developed. These would spread and absorb the momentum of impact over many layers of fabric. The invention of Aramid "**Kevlar**" fibers which were lightweight and of very high tensile strength are now widely used in body armor designs.

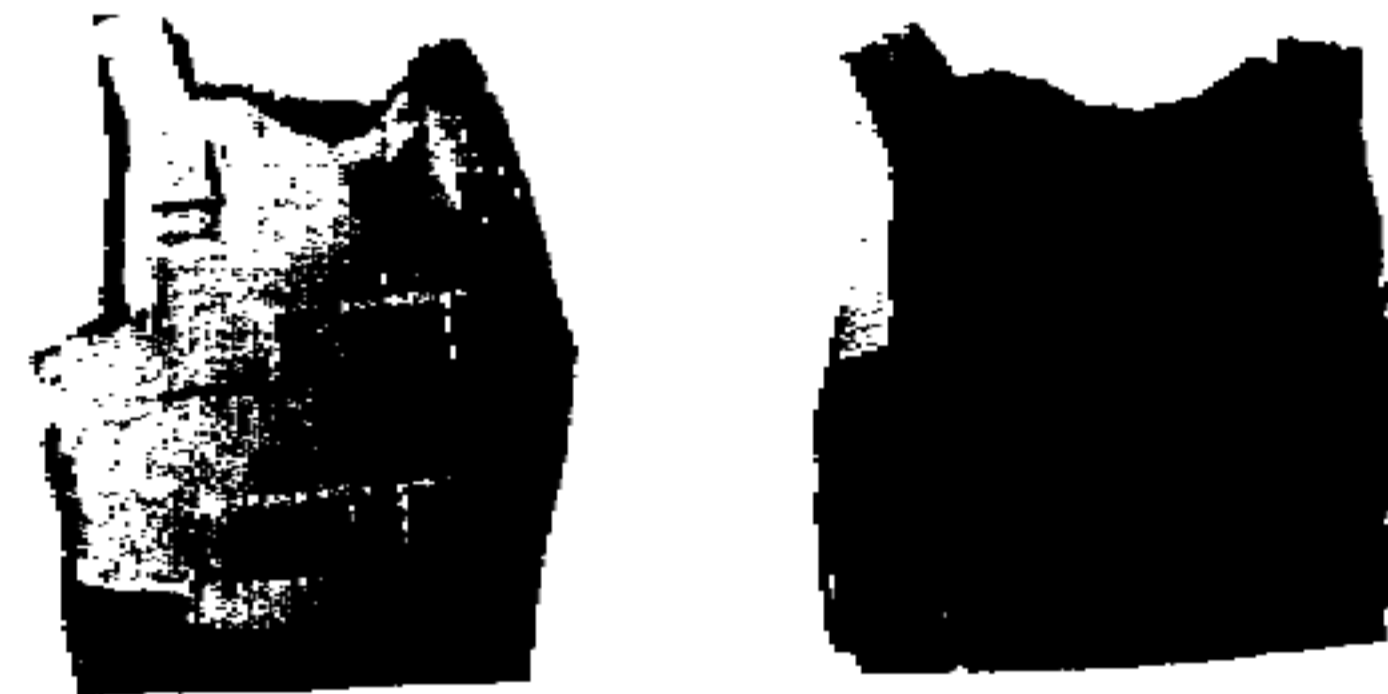

These same materials are also used as helmet material to protect the head.

Hardened steels were used in the earliest armor vehicles. Their weight and the increase of the penetrating ability of new ordnance led to the widespread use of thick, rolled or cast homogenous steel plate. Where weight was a problem, aluminum alloys were used (in aircraft). Aluminum armor would not burn and provides greater protection than steel on a same weight basis. In modern warfare, lightweight titanium steels and "**CHOBHAM**" for composite armor have become the accepted practice. Steel and ceramic are imbedded in layers that prevent debonding. This spreads the kinetic energy of anti tank projectiles over large areas reducing the penetrating ability of shells, and shaped charges.

Spaced armor uses thin metal plates or wire mesh to disrupt the spin of projectiles and predetonate charges before they reach the main armor. This is effective for bullets at a few inches displacement but requires about 3 feet for anti tank guided missiles.

Scientific Principles of Improvised Warfare and Home Defense

West Germany invented **reactive armor** which is made up of boxes of explosives that detonate outward when hit by a shaped charge or projectile. This disrupts the penetrating jet with its countering shockwave and has been very successful in war.

New **soft armors** are used to stop projectiles. These consist of ultrahigh molecular weight polyethylene fibers used in a thermosetting polymer matrix. These cast armors are twice as effective as steel at stopping bullets and shrapnel and weigh about the same. They stop the bullet by flattening it as it strikes the first layer of material. Once the bullet tip is deformed, its energy is spread over many individual fibers that cannot be pushed aside because of the strength of the matrix.

Today, body armor weighs about 10 pounds, is comfortable, and protects the critical parts of the body reliably. In combat, it reduces casualties by 25%. They are expensive, but a \$1,000 investment is a bargain when faced with losing a \$50,000 /year investment in trained soldiers.

Additional and important protective gear include

Gas Masks: to protect the soldier from the effects of poison gas, fumes and dust. These masks are widely available and used in Industry and mining. Different canisters are used for the different chemicals that may be encountered.

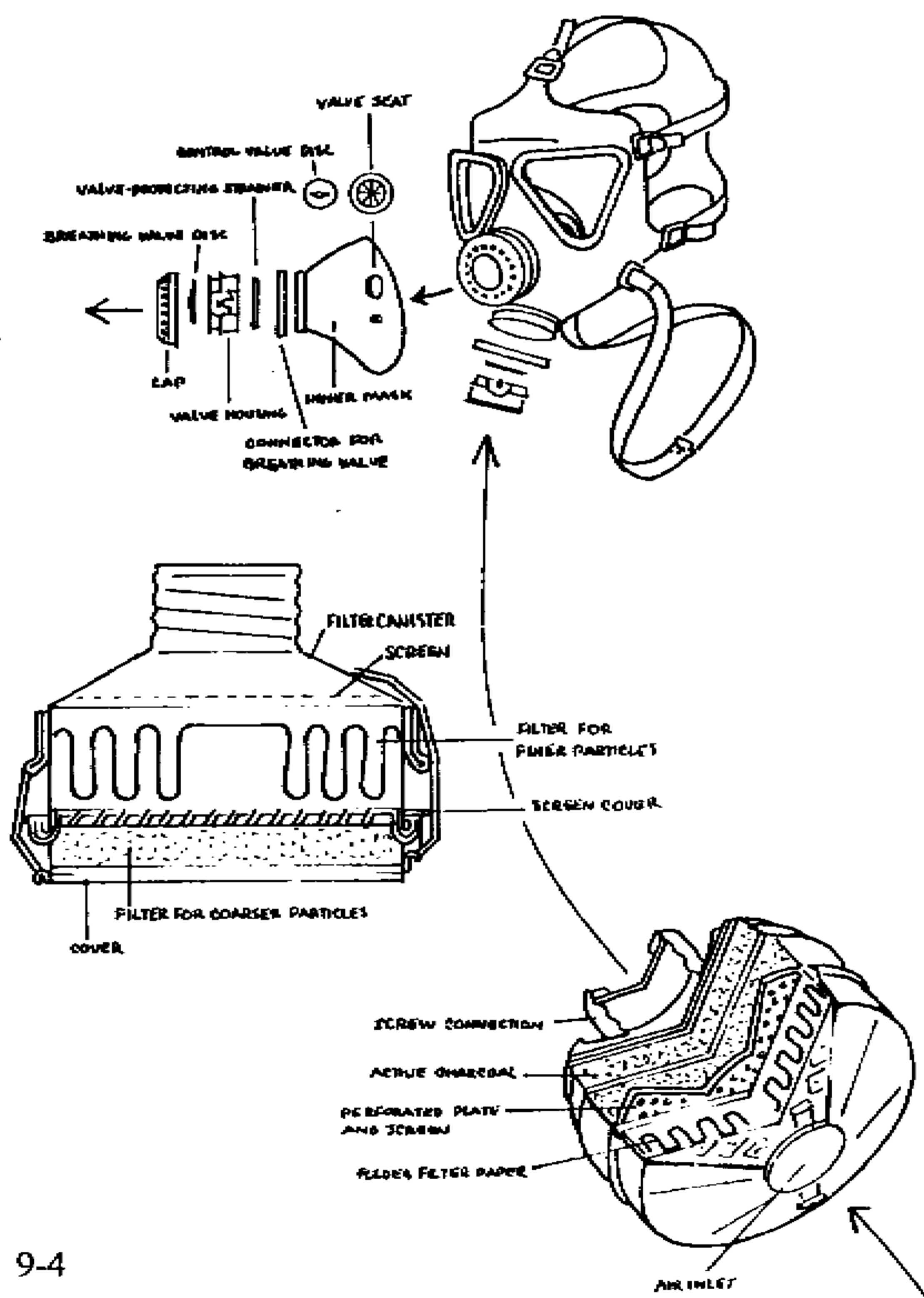
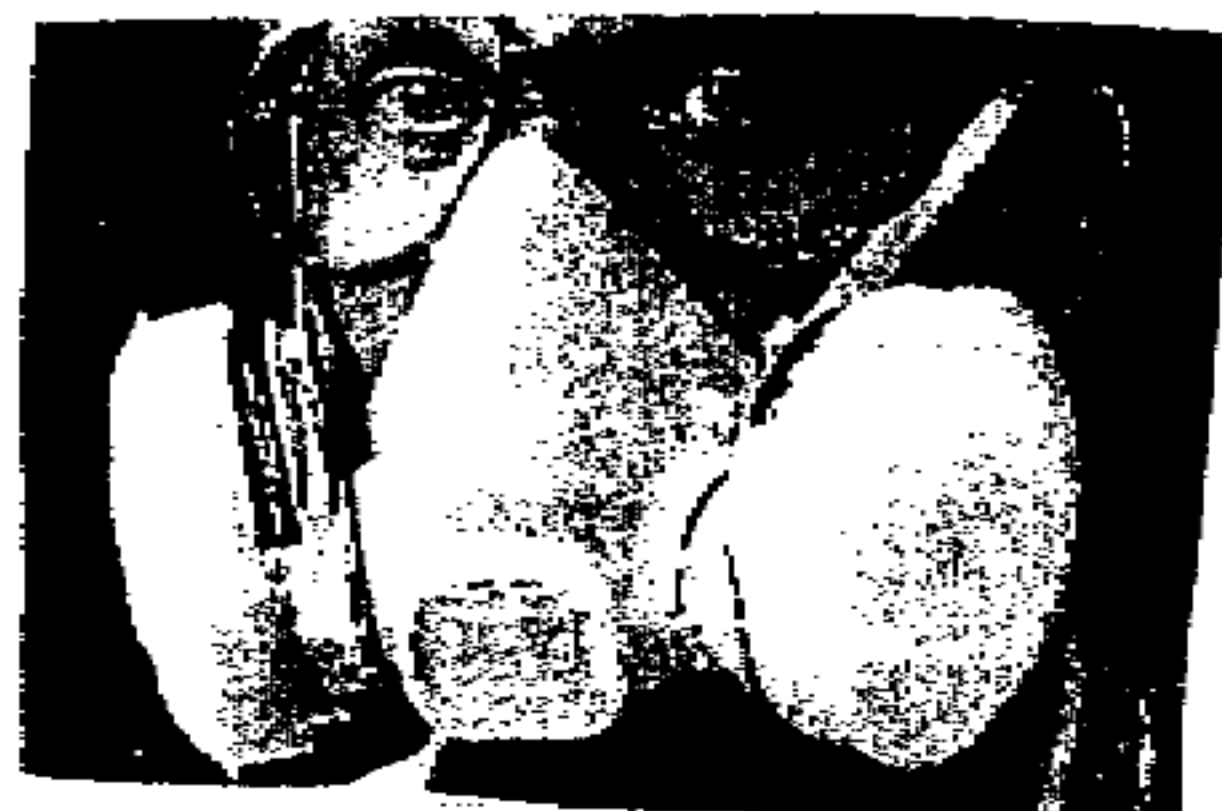

Scientific Principles of Improvised Warfare and Home Defense

Full body protection is also available from safety supply companies in the form of plastic and disposable coveralls, gloves, jackets, boots, etc.



When vehicles are used, it is sensible to maintain a small (50 gallon) water tank fitted overhead. This provides extra drinking water and can be attached to a portable drench shower that can be used to quickly wash chemicals out of eyes and off of an individual. These are common in many modern plants.

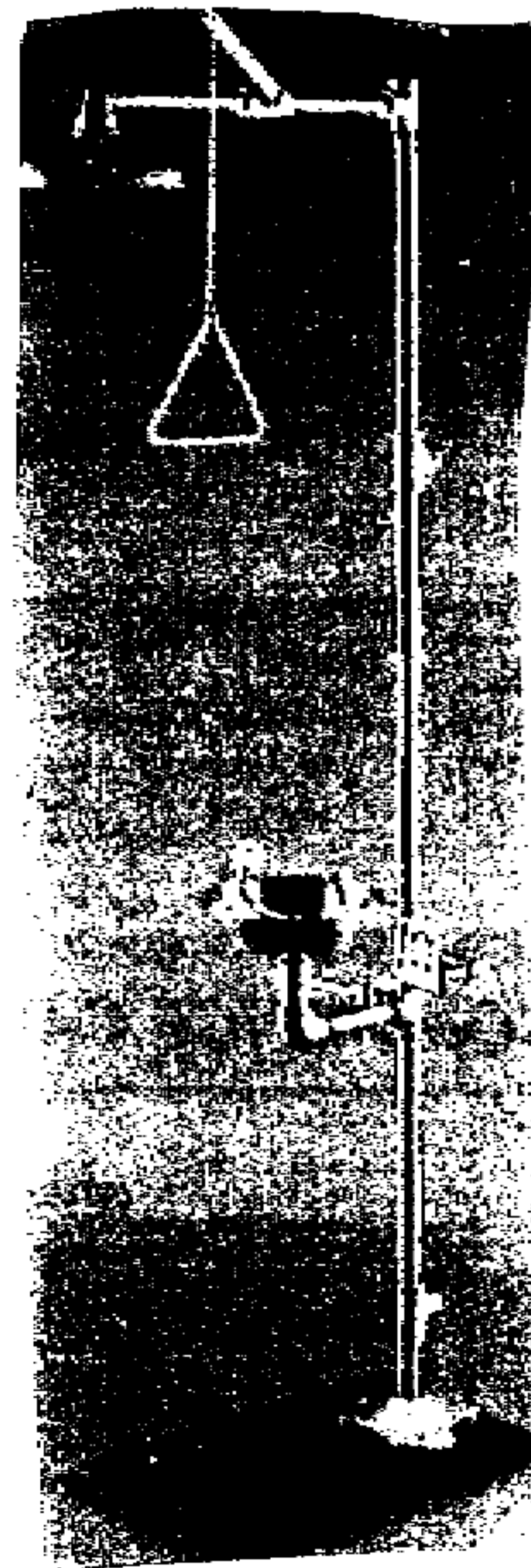
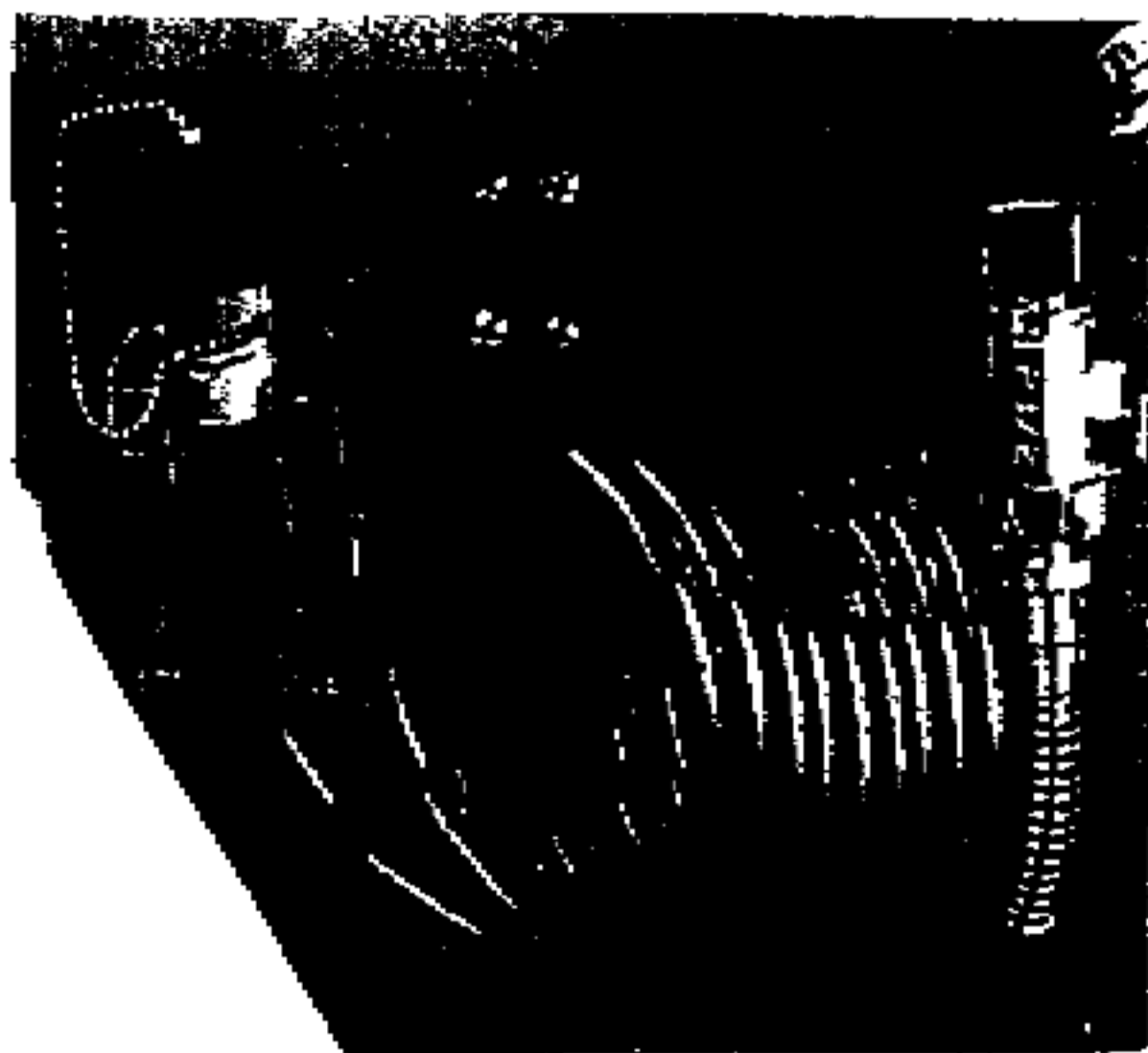

Scientific Principles of Improvised Warfare and Home Defense

To protect a vehicle interior, a simple filtered air system is set up to maintain a positive air flow in the vehicle. The filtered air pushes outward at all air leak areas preventing the inflow of chemical and biological agents. To clear an area an industrial fume exhauster can be used.

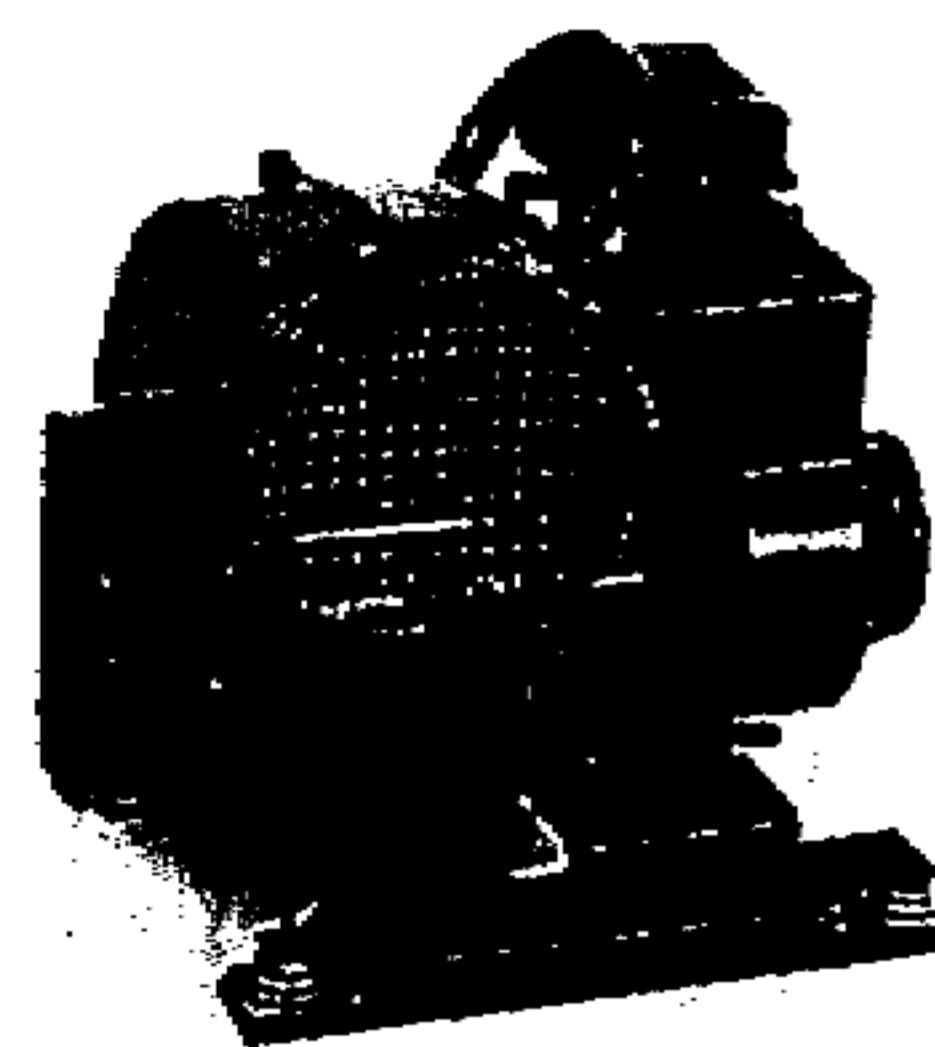
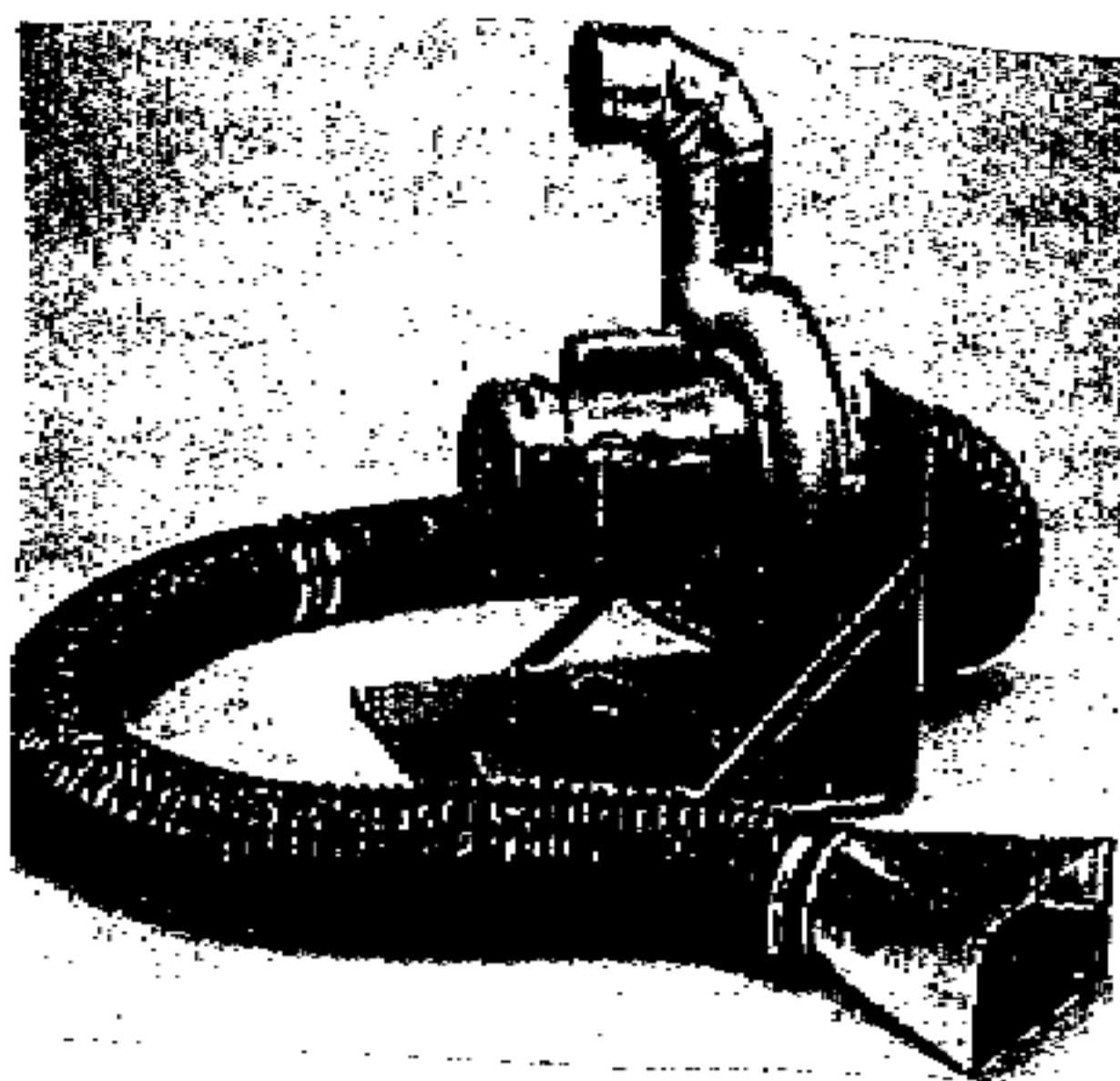

The use of chemical weapons forces the participants to go to extremes to protect their troops. The NBC suit has many drawbacks.

1. Ears are covered making hearing difficult
2. Respirators goggles limit width of vision
3. Special radio needed to communicate, and speech is still hard to understand
4. Hard work makes breathing labored and wearer can suffocate while sleeping if he rolls over and covers the filter
5. Suit is very hot to wear
6. Opening suit to urinate and defecate is time consuming and dangerous in contaminated areas
7. Heavy layers of gloves limit feeling and makes precision work nearly impossible



8. Suit must be changed monthly, or daily in serious contamination
9. Boots make running hard and driving dangerous

Scientific Principles of Improvised Warfare and Home Defense

Since a defender can sit still in his foxhole and doesn't need to physically exert himself, he is able to much more easily accomplish the work of defending himself. The attacker who has to wear all this heavy gear and haul his fighting equipment with him finds himself experiencing exhaustion trauma. This effect is easily illustrated using

- a. a soldier at 100% carrying only his fighting equipment
- b. in full protective gear doing light work, he operates at 40% work (fighting) capacity
- c. high temperatures reduces this to 36%
- d. hard work drops him to 30%
- e. high temperature and hard work equals 27% efficiency

In the Middle East heat the figures are

- f. 20% while at rest
- g. 15% at light work
- h. 10% while digging, running, or carrying

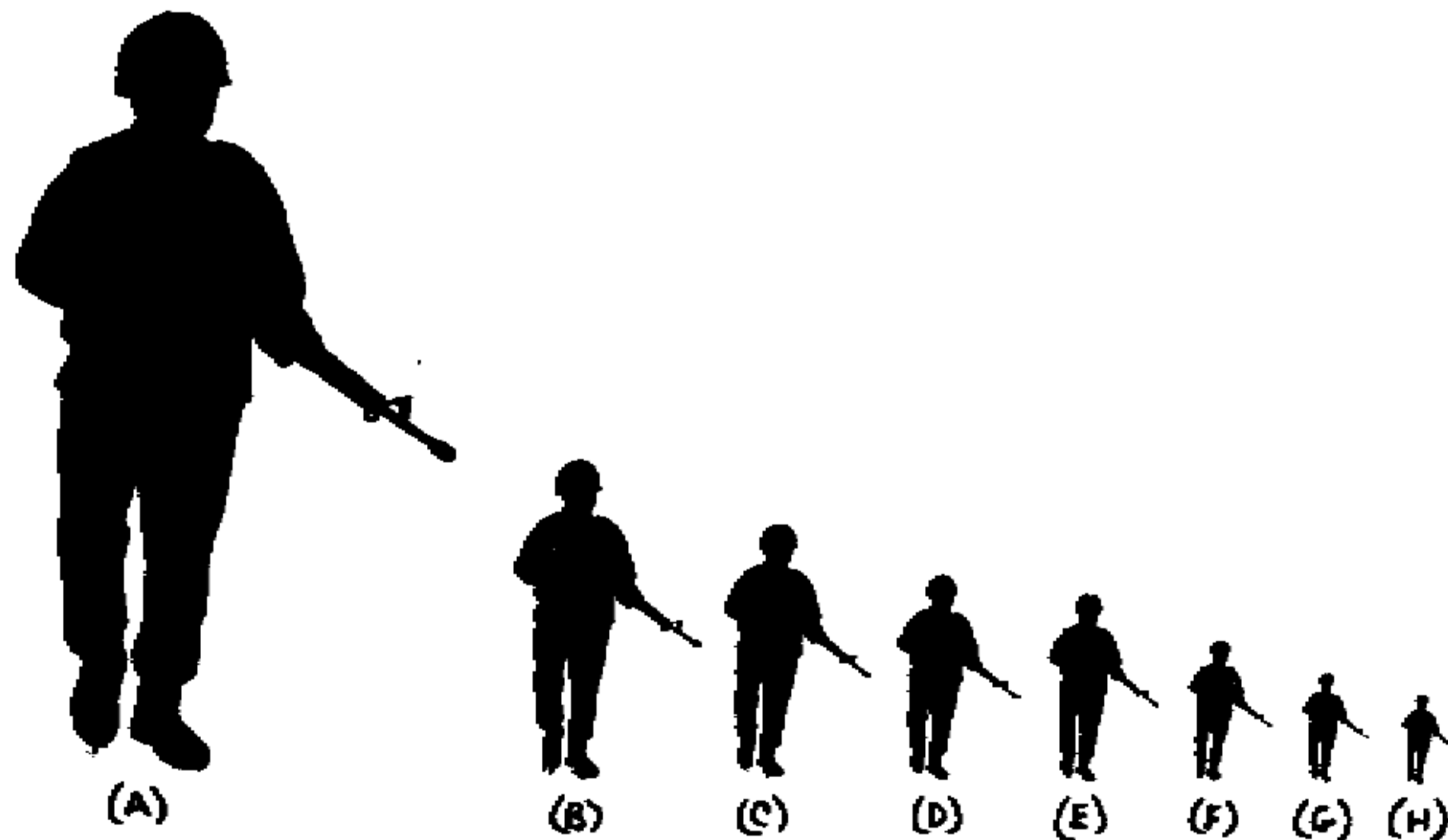

These effects give the defender in chemical battles a considerable advantage over the attacker.

Scientific Principles of Improvised Warfare and Home Defense

2) The importance of armor and protective defense

Men are lost to disease, injury, and fatigue in combat. Protection is important not just because of the moral politicians philosophy and rhetoric that every one of our soldiers life is important, but that it is difficult and expensive to replace soldiers at the point of battle, on the battlefield, at the exact time you need him (right now on the battlefield where he became a casualty).

Historical war figures indicate that when someone is shooting at you and trying to kill you

1. There is one fatality for every three injured

2. About 80% of these losses are due to fragments from grenades, artillery, mines, and bombs

3. 12% are head wounds 43% immediately fatal
 16% are chest wounds 25% fatal
 11% abdomen wounds 17% fatal
 22% arm and leg wounds 5% fatal

4. 20% of all wounds are multiple and these are 50% fatal

On the battlefield a dead soldier is not considered a great loss. A wounded or ill soldier requires the attention of those around him. The physical efforts to move the wounded, stop bleeding, call for help and evacuation, and feeding and aiding them are compounded by the psychological effects of painful screaming and crying, asking to contact loved ones, and the helpless feelings accompanying the caregivers on the battlefield. A policy of killing the badly wounded has been adopted by many armies in history to avoid these problems and has been generally bad for morale and occasionally resulted in violent resistance of the troops themselves. Each wounded man can tie up 2-3 soldiers during critical combat and requires at least one full time medical attendant in the hospital services until he can be returned to combat.

To avoid these costs, the US has recently spent considerable resources on flak jackets for all, special designed helmets, armored boots, and anti shrapnel Kevlar curtains inside vehicles. In addition to the morale boost and increased confidence, the army will survive and fight better and at closer to its full manpower during actual combat.

Scientific Principles of Improvised Warfare and Home Defense

Many wars in history have been won by the side that was better able to keep its troops healthy and protected from General Winter, Colonel Mud, disease, thirst, and starvation. This is why the use of biological weapons is so feared. An entire army can be annihilated without even seeing combat. Protecting and maintaining clean food and water supplies, separating the ill, practicing good sanitation, and insect and vermin control is critical to maintaining an army.

In Afghanistan, Soviet APC's were equipped so that troops could fire their guns from inside their vehicles through holes and not have to get out. The problem with this built in vehicle combat strategy, was that the troops would not leave the security of the APC. Obstacles were placed to prevent their retreat and when their ammo ran out, the Afghan soldiers would appear from their protected positions and kill them.

The rule is that infantry must always dismount and work their way into the obstacles and fortifications or buildings and root out the enemy or they will not be able to accomplish their objectives and will likely lose the battle and their lives. You can't leave the enemy out there shooting at you from behind protection when you are the attacker. If you do , you lose. This means you have to get out of the armored vehicle and face the enemy with only your helmet, a flak jacket, clothes, and a layer of skin to protect you. Motivating men to advance against enemies firing at you from concealed and armored positions of their own is a feat of training, discipline, and courage.

Knowing and understanding these concepts is helpful when having to improvise your own protection and personal defense.

3) Modern material sciences useful for protection

When faced with the prospect of being shot at, anyone with any sense will look for the best way of protecting themselves. Even soldiers who have been issued body armor and ride around in armored tanks look for an edge to take into combat. The purpose of this section is to provide at least some knowledge of materials with properties suitable for stopping high velocity flying objects. Many new materials exist and can be improvised today to protect people in combat.

Polymethyl methacrylate: is used to make the clear sheet material in unbreakable windows and low cost lenses in cameras, flashlights, and safety glasses. It is known by its more common name of "**Plexiglas**". Related high strength polymers are called **acrylics**. Acrylics are esters made by reacting an acid like methacrylic acid with an alcohol. The result is a rigid and clear plastic used as a glass substitute, clear lacquers and coatings. Plexiglas is commonly used in convenience stores to protect employees from robbers. They are usually 1-2" thick and can stop most low velocity rounds. They will not stop high velocity, larger projectiles at close range.

Scientific Principles of Improvised Warfare and Home Defense

One effective method that works for all materials is to have an exterior shield in place several inches from the primary plate. This shield can deflect the high speed projectile so it partially flattens, slows down, and does not travel point first which drastically reduces its penetrating power. This shield is considered disposable and only needs to be a thin piece of metal mesh or fiber composite.

Polyamides: are commonly known as the family of **Nylons**. The names of Nylon such as Nylon 6,6 or nylon 12, refer to the number of Carbon atoms in each of the reacting parts that are brought together to make it. Nylon was the first engineering plastic. It is used in structural parts and can handle temperatures as high as 260 degrees F. The drawback of nylon materials is that they draw moisture which causes a lowering of tensile strength. This is the main strength measuring component for projectile stopping ability. Nylon 6 and 6,6 are very prone to moisture absorption. Nylon 11 and 12 are the most resistant. Nylons are used for shoe soles, awnings, rope, clothing textiles, and many coating applications.

New grades of Nylon have been developed to overcome the material limitations. One of these new Nylons is the group of Aramid fibers commonly known as **Nomex** or **Kevlar**. These have the same structure as other nylons with an extra aromatic functional in their chemical structure. They are commonly sold as sheets or fibers with very high tensile strength and can handle temperatures of 500 degrees F. continuously. Chopped Nomex fibers are used in clutch and brake friction reinforcement. The fibers can be formed and set into any desired shape. Nomex sheet is useful for high temperatures. The Nylon 6 and 6,6 have about the same structural (bullet stopping) strength as soft aluminum alloys. Absorbed moisture in these Nylons act as plasticizers which adds to their impact strength.

Polycarbonates: are a form of Polyester that have high impact strength, temperature resistance, and transparency. It is used in safety helmets and face shields and is similar to the Nylons in tensile properties but can have 10 times the impact strength. This is most useful when impact is spread out such as shrapnel or catching high velocity bullets on a slope. It is used to replace other plastics as moving parts in automobiles and safety glass. The clear sheets are used to make the GE product "**Lexan**" which has 16 times the impact strength of acrylics. Sheets of 1/4" Lexan are bonded together in laminates and have increased abilities to stop high velocity projectiles.

Polyimides and related structures: have instability in sunlight and in contact with acids but can have incredibly high unreinforced strength (up to 23,000 PSI). They are not transparent and cost over \$20-\$500/# as a raw powder, but where money is no object, these can be very useful in armor composites.

Scientific Principles of Improvised Warfare and Home Defense

Polyphenylene Sulfide is a rigid thermoplastic that can be reinforced with mineral, glass and carbon fibers and run from \$5-30 per pound. With this reinforcement, they are being used to replace metals and are superior to nylons at elevated temperatures.

Polyetheretherketone: or **PEEK** is a new class of polymers with mechanical properties equal or greater than the Nylons and a tensile modulus of elasticity of 18 million PSI making it as stiff as Titanium alloys. These properties make it useful as a substitute for aerospace metals where weight reduction is critical and price is no object.

Butyl Rubber: is widely used for inner plies in puncture proof tires and inner tubes. Used as a filler in combination with other materials replacing the air in tires, it can make the vehicles tires invulnerable to small arms fire.

Composites: are mixtures of materials, usually a material of continuous matrix (resin or metal) combined with fibers to give it unusual strength and properties.

Common matrixes

Fibers

Aluminum Magnesium Lead Copper	Graphite	Used in space and electrical applications
Aluminum Magnesium Titanium	Boron	Jet Engine and compressor fan blades Antenna
Aluminum Lead Magnesium	Alumina	Electrical and helicopter transmission structures
Aluminum, Titanium Cobalt Superalloy	Silicon Carbide	High temp. structures and engine parts
Superalloy	Molybdenum Tungsten	High temp. engine components

Scientific Principles of Improvised Warfare and Home Defense

Glass fibers: are the cheapest fiber used to commonly reinforce plastics and concrete.

Graphite: are lower density higher strength, and high stiffness fibers often called carbon fibers.

Aramid: fibers used to make **Kevlar**, can suffer deformation before fracture and give higher toughness than other more brittle fibers.

Boron: add high strength and stiffness in tension and compression.

Whiskers: or spectra fiber is ultra high molecular weight and offers superior armor characteristics over Aramid fibers.

These and other fibers are used to reinforce metals, thermoplastics, thermosets, and ceramics. New combinations and products are being continuously developed and many can be bought in cloth or standard 4'x8' sheets and used to armor vehicles, structures, and clothing.

Common forms of fibers for reinforcement appear as:

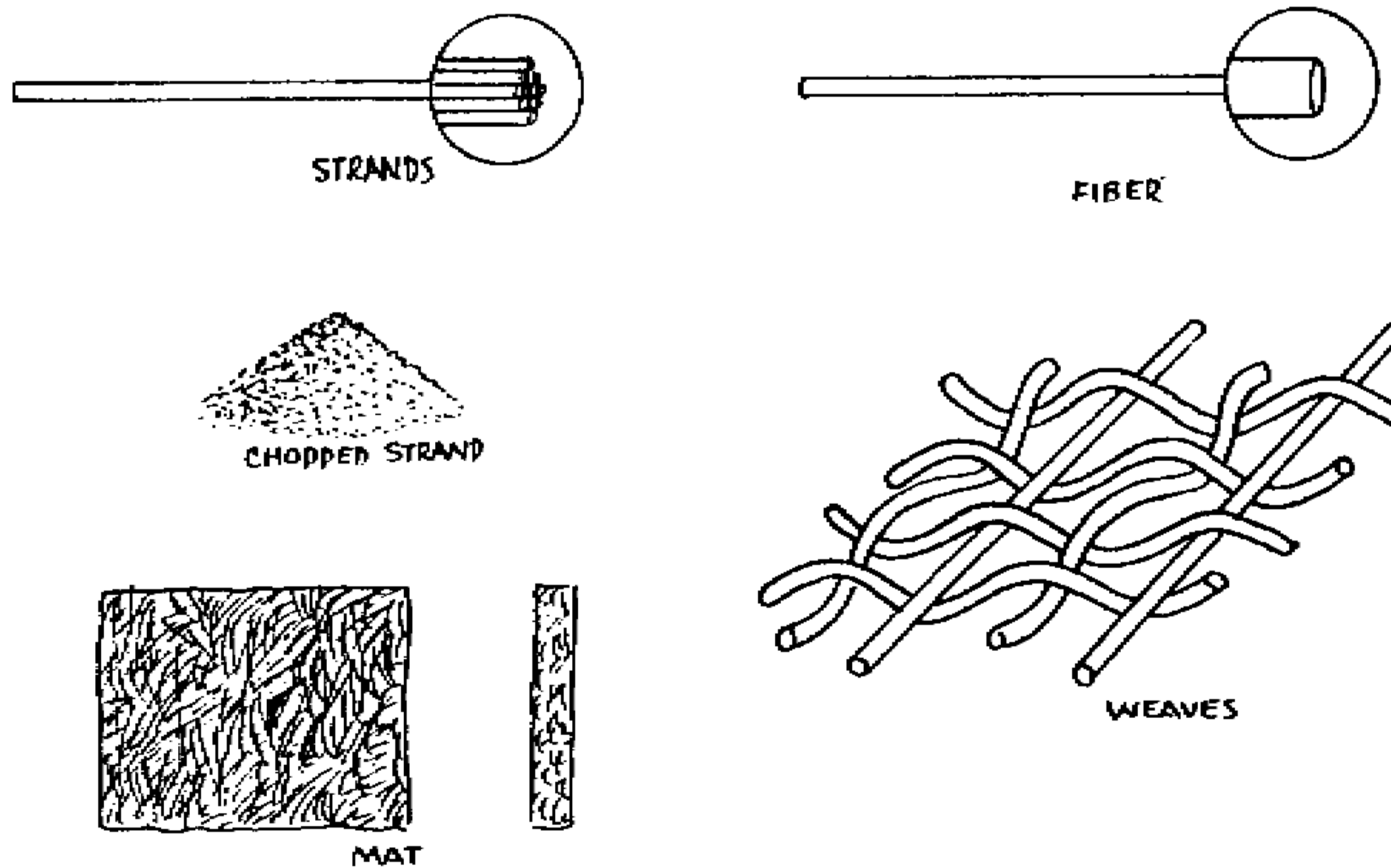

Scientific Principles of Improvised Warfare and Home Defense

A fiberglass reinforced polyester laminate called **Lumagard** is available from American Acrylics and has exceptional bullet stopping/weight characteristics. Available in 4'x8' sheets it is the most cost effective for improvised defense in the authors opinion. I have included the following ballistic chart to give you an idea of its stopping power on 12" x 12" panels at point blank range. Its disadvantage is that it is not transparent and requires a Lexgard or similar window built in if sighting through it is necessary. (S means the bullet was stopped, the - means it penetrated the panel)

<u>Bullet</u>	<u>Velocity(ft/sec)</u>	<u>AG-1</u>	<u>AG-2</u>	<u>AG-3</u>	<u>AG-4</u>	<u>AG-5</u>
22 cal. 40gr LR	1050	S	S	S	S	S
45 cal. Auto 230 gr.	850	S	S	S	S	S
38 cal. Auto 88 gr.	990	S	S	S	S	S
12 guage #4 Lead	1268	S	S	S	S	S
9mm 115 gr JHP	1160	-	S	S	S	S
9mm 124 gr FMJ	1175	-	S	S	S	S
38 cal. super 130 gr.	1280	-	S	S	S	S
357 Mag. 158 gr JSP	1250	-	S	S	S	S
9mm 100gr JHP	1250	-	S	S	S	S
9mm 124 gr. FMJ	1400	-	-	S	S	S
357 mag. 158 gr.	1450	-	-	S	S	S
44 mag 240 gr.	1350	-	-	S	S	S
12 ga. 1 oz. rifled slug	1500	-	-	-	S	S
30 cal carbine 110 gr.	1800	-	-	-	S	S
30.06 rifle 220 gr SP	2410	-	-	-	-	S
.223 55 gr. FMC	3080	-	-	-	-	S
7.62 (AK47) 39 Ball	2400	-	-	-	-	S
" (308 Win) 150 gr.	2750	-	-	-	-	S
30.06 150 gr. M2 Ball	2800	-	-	-	-	S

Scientific Principles of Improvised Warfare and Home Defense

Various metals have been used as shields and armor. There are thousands of combinations of alloys and strengthening techniques to make strong, moldable materials that last under stressful conditions. Many composites and fiber products do not resist the high temperature of certain anti armor ordnance. New tank armor design often include mixed layers of composites, fiber reinforced plastics, ceramics, and metals to make combination plates that are very hard to pierce without nuclear explosives or high weight explosive warheads.

Metals used in combinations for steels include:

Carbon Steels
Manganese Alloys
Nickel Alloys
Nickel-Chromium
Molybdenum
Chromium
Chromium-Vanadium
and various multiples

Titanium is used as an alternative engineering metal with superior properties to steels including weight savings and higher temperature resistance. It is used in aircraft armor and space flight applications. Titanium and its alloys come in a variety of shapes and sizes.

4) Applied armor science and material handling

The application of armor protection is simple. You find the lightest suitable material you can, find a way to cut or mold it into a shape to fit the area to be protected, and mount it there.

For structures that don't move, the cheapest and easiest way to protect yourself is to dig a hole, pour reinforced concrete into forms for the structure around the hole and cover it with a couple of feet of dirt.

Improvised vehicle protection requires fabrication tool such as saws, cutting instruments, and drills. Usually a 4'x8' sheet of armor is cut, sized, and mounted to protect the engine compartment and vehicle interior. Windows are replaced with Lumagard with smaller Lexgard windows and floorboards are armored for protection against mines. Curtains of cloth armor can be hung inside to catch any deflected shrapnel.

Personal protection is improvised by obtaining commercial flak jackets or buying the cloth and fabricating the clothing with it around pieces of solid armor. If this is unavailable, cutting holes in armor sheets that are trimmed to fit the torso, and threading rope to support them off the shoulder will provide a modern shield.

Scientific Principles of Improvised Warfare and Home Defense

The author has invented and designed a mobile combat system which offers a different concept for protecting troops in the field or under fire which I will describe here.

I call this invention the "Rambo Rickshaw".

It is constructed or improvised by taking a hand or appliance truck with the wheels designed to balance the end load. Any of the dollies shown will work. Larger wheels work better in sand and rough terrain.

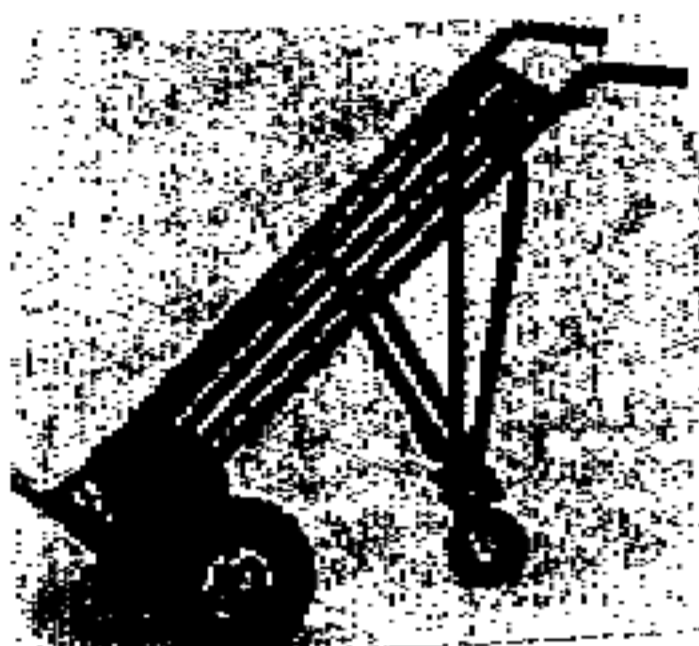
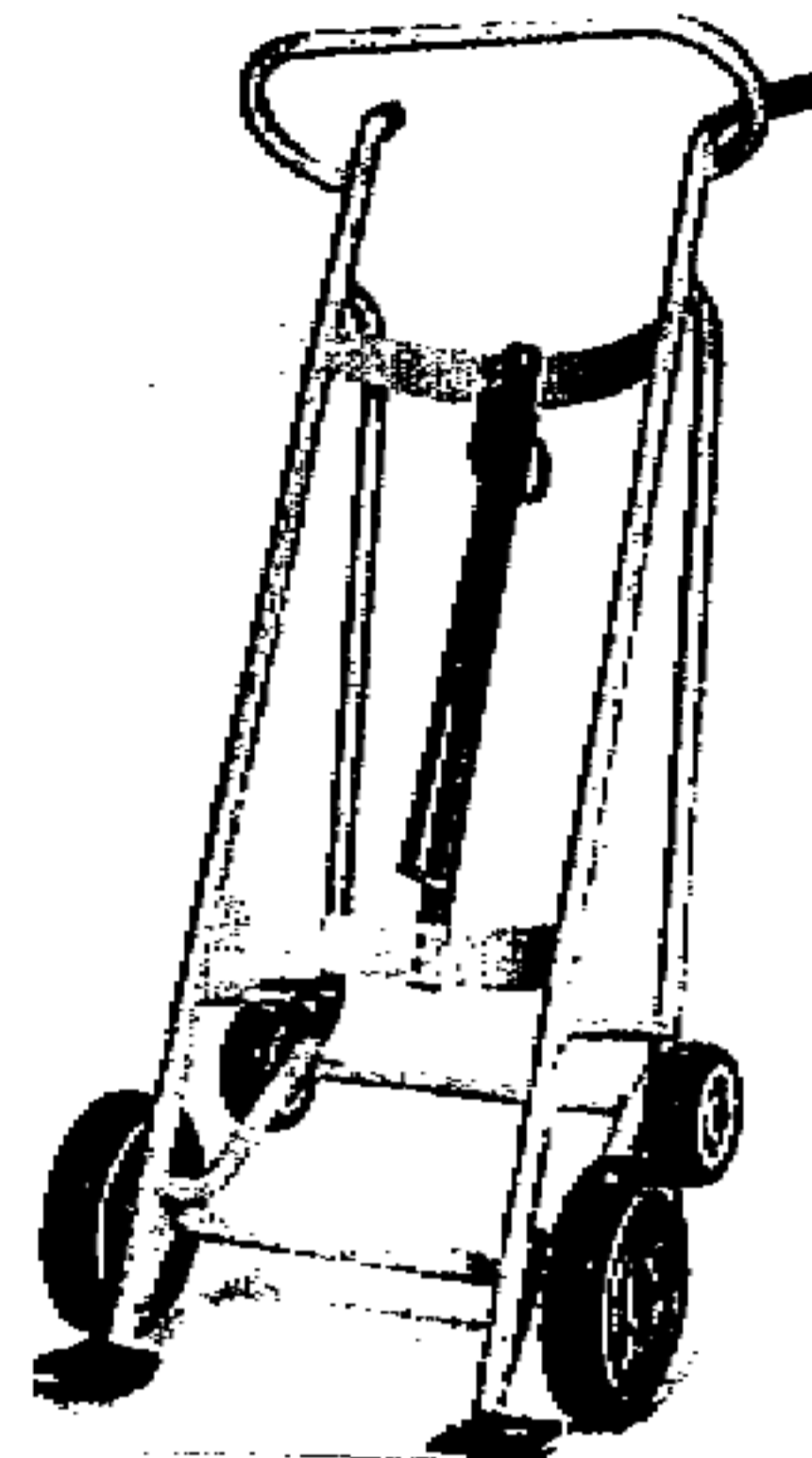
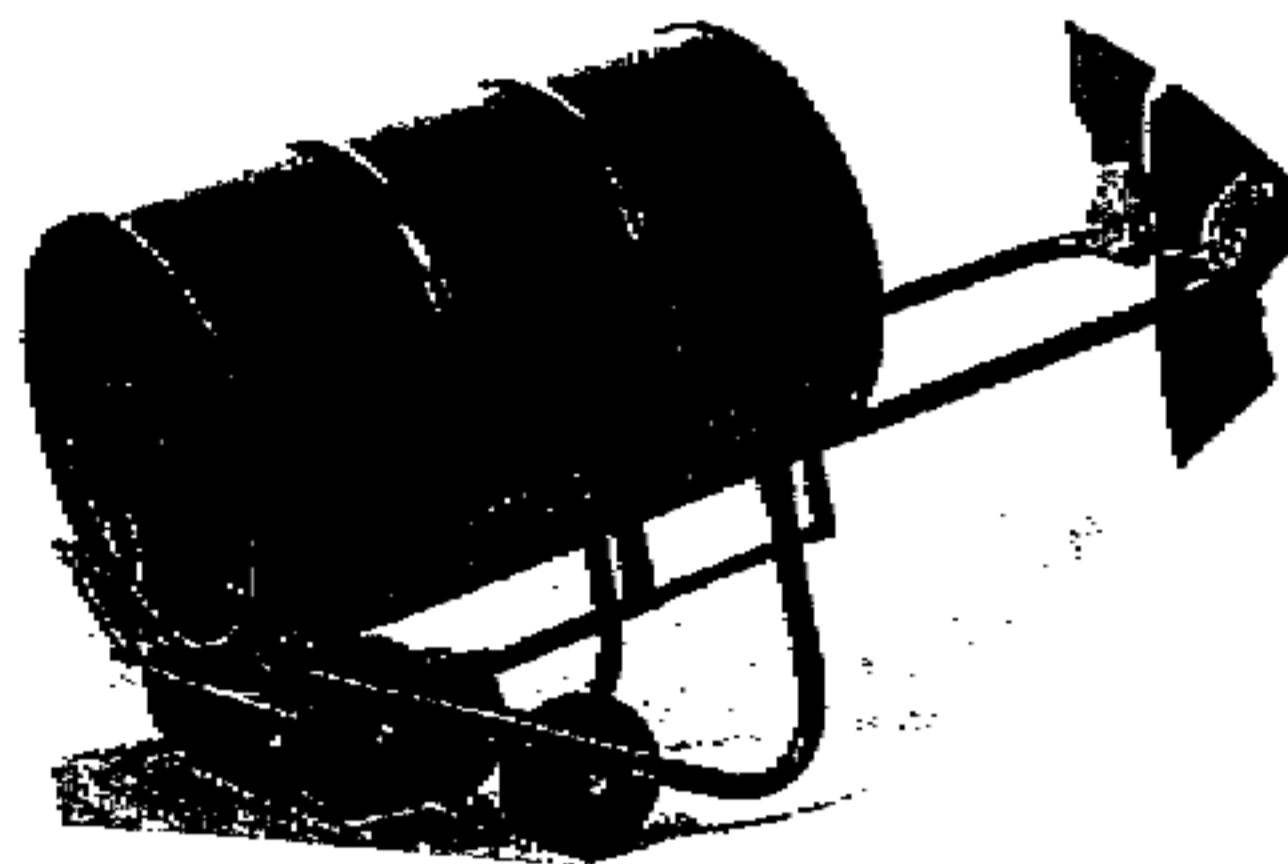

The bottom plate is replaced by a cut section of Plexiglas, Lexgard, or Lumagard with a clear Lexgard window in it.

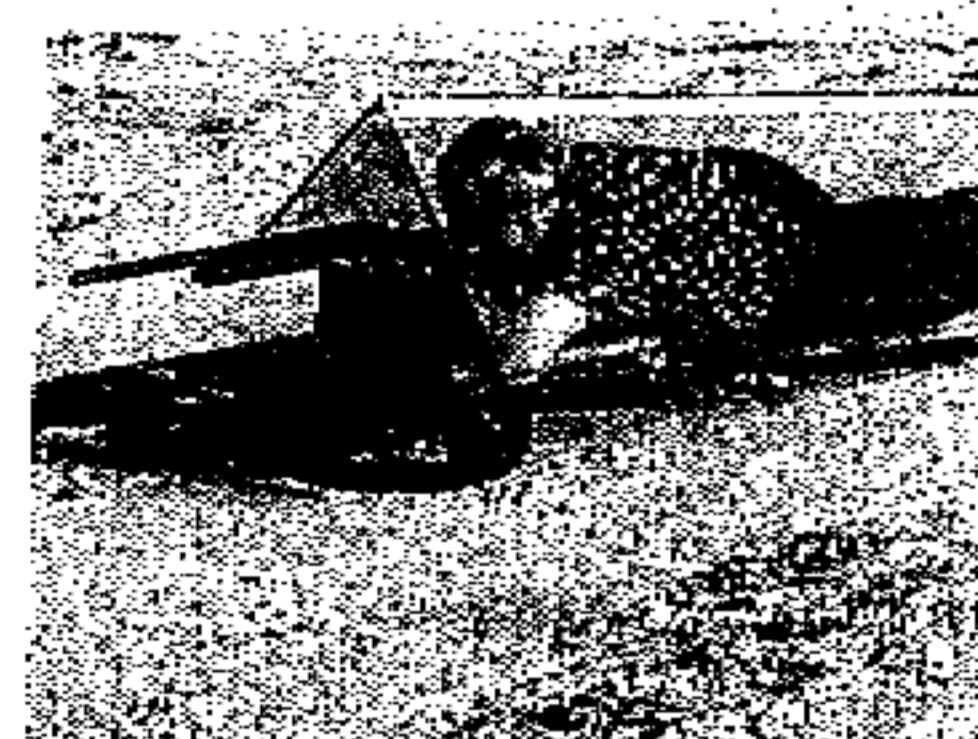
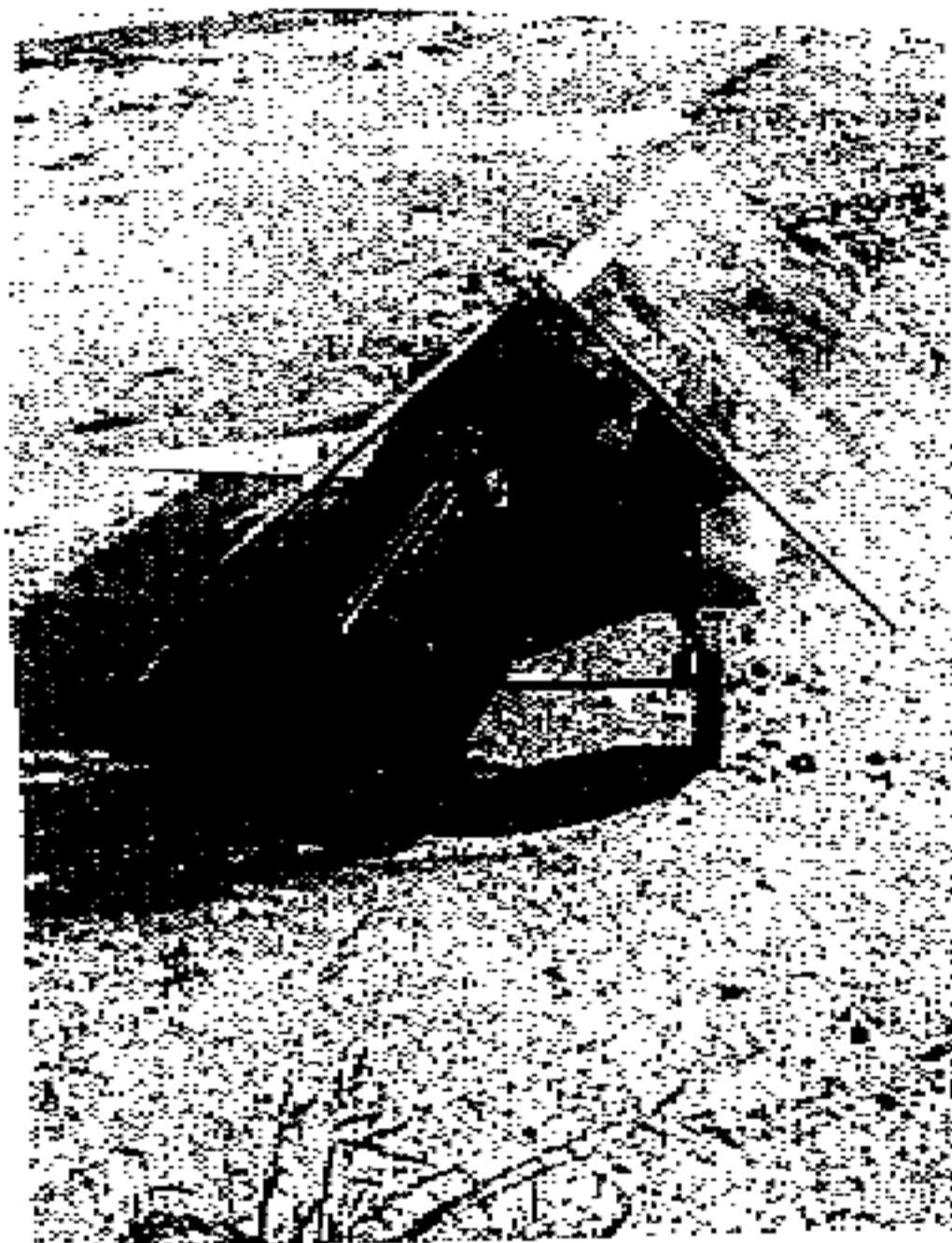

When the shooting starts, the cart is laid down so that the operator can lie behind it, shoot from behind the shield and scoot himself forward while protected to advance on the enemy. It provides a mobile source of cover or a new self powered armored vehicle



Scientific Principles of Improvised Warfare and Home Defense

A hole is cut in the sheet of armor to allow aiming while protected. A handle is bolted to the main shield to allow steering and handling of the device.



The remainder of a 4'x8' sheet of Lexgard is cut and bolted together in a V shape as shown and added to the truck to offer protection while standing, providing cover during artillery strikes, or protection from grenades while advancing on the ground. The sloping sides are more effective at deflecting projectiles.

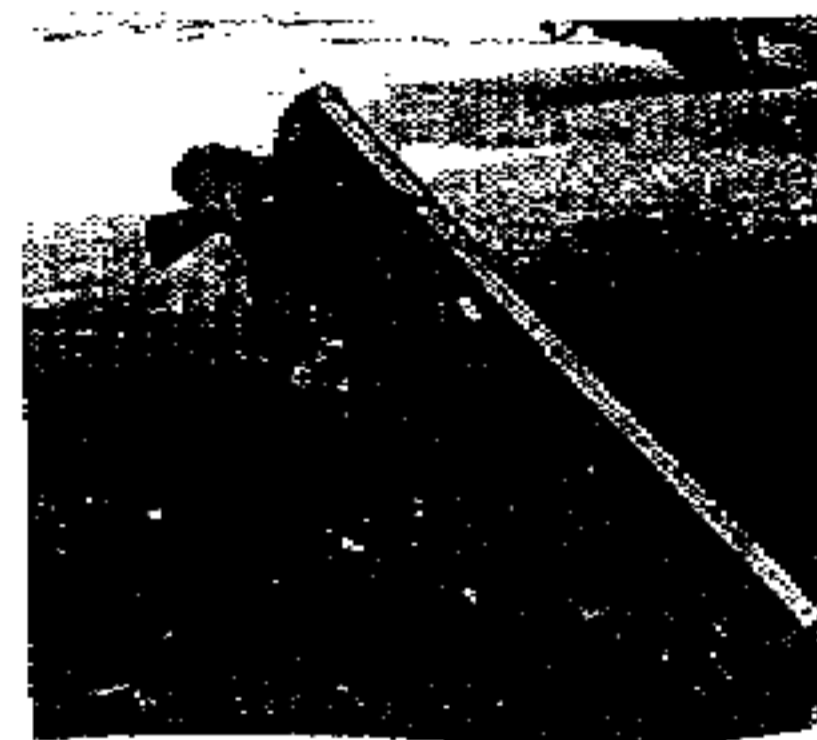

[In testing this concept, the best design appears to be tricycle arrangement for the wheels. It is important that the dolly supports and balances 100% of the weight on its own. It should be steerable, with the shield supported away from the wheels at the bottom, and tapered so the bottom edges do not touch the ground during movement. The top portion protecting the torso should have 3-5 layers of laminated Lexgard to stop the high velocity 1/2" rounds, with only 1 or 2 laminates for the bottom area to keep the weight down.]

Every Army soldier is supposed to be able to lift and carry 80# loads (duffel bags) in combat. These loads consist of ammunition, food, clothes, personal effects, first aid kits, water, and any special weapons such as mortars or HMG's they are assigned. Portable anti-tank missiles and the ammunition constitute additional heavy loads.

The average soldier consumes 6 # of food and 20# of water daily. Ammo consumption can be considerable if in combat. Most of this is carried by vehicles, but the troops still have to get out of the vehicles and fight. They are required to physically advance on an enemy on foot with the helmet, flak jacket, clothes and skin as the only protection from enemy bullets, grenades, artillery shrapnel, and mines. When the heavy stuff comes in they have to dive or run for cover or risk losing their life. At the same time they have to drag their weapons and ammo with them and find ways of aiding and evacuating the injured. This is where my Rambo Rickshaw comes in.

Scientific Principles of Improvised Warfare and Home Defense

The science of lifting and carrying compared to pulling on wheels is simple. A man or woman required to lift and then support an 80 # load during all foot travel consumes a great deal of energy. By placing the same load on wheels and simply leaning over or pulling that same weight consumes only a fraction of the energy. That is why mankind first invented carts and used animals or even themselves to pull loads or plow fields. This use is still in wide practice in the orient where many men make their living as Rickshaw drivers. Grapnels and pulleys can be used in hills or mountain terrain to assist moving the supplies.

Normally, a helicopter or APC will deliver troops to the combat area and drop them off. It makes sense to be able to provide a Rambo Rickshaw for these operations. The advantages are clear.

1. It provides a way of expending a lot less energy to move supplies and weapons.
2. It provides immediate cover for the full body saving having to look for something to hide under
3. It allows the troops to advance low to the ground while deflecting bullets and shrapnel
4. It allows protected evacuation of wounded by one man instead of 2 or 3
5. It drastically decreases field injuries from fragments which increases battlefield manpower
6. It can be used to pass over minefields
7. Allows the hauling of 200-300# per man with less expended energy
8. Allows the mounting, moving, and firing of heavy weapons from a covered position.
9. Can be used while standing or advancing upright.
10. Can be used in buildings
11. Allows close to the ground covered movement
- 12 It is easy to camouflage

The V can be taken off and used as a full body shield. This can be especially useful in civilian law enforcement in dealing with armed individuals or bombs.

Scientific Principles of Improvised Warfare and Home Defense

The physical benefits of full body protection, improved supply and using less work to haul it around, and the ability to carry ready to operate heavy weapons on foot are obvious.

The psychological benefits can be enormous as well. Knowing that you can advance under cover while carrying your cover with you makes it easier to get the troops moving while under fire. The shielding from grenade and artillery fragments and protection from mines that the other side does not have can give an army confidence that it would not otherwise have. The drastically reduced casualties prevents the unnerving and demoralizing effects of watching buddies die or scream in pain.

[Authors Editorial: Since this is my book and I can write what I want about it I have decided to interject an unrelated discussion here. The above system and general design is a new concept and invention. I have not seen it in use or practice anywhere in the world. Knowing this my first inclination would have been to file for a patent to practice the supposedly exclusive right to make and sell it. The reasons I have not are these-

The patent office has institutionalized first filing rejection by arguing that your invention is obvious. The actual argument to reject above concept would go something like this.

" Since the knowledge of hauling things around on a cart has been around for a long time and the knowledge of putting armor around vehicles has likewise been practiced for ages, your invention cannot be considered new. It would be obvious to any soldier skilled in the trade that putting a piece of transparent armor in front of him or over him to deflect fragments might save his life as you claim in your patent filing. Further, it would be obvious to anyone in the business of trucking, or hauling heavy loads around that the use of these hand trucks would save on effort, and free a soldier to move forward under fire with a load. Because your invention is obvious, you don't get a patent."

It doesn't matter that it wasn't obvious enough by anyone worldwide in either of these fields to combine them in a new and unique way before this. It doesn't matter that the invention consists of parts that have never before been combined in this fashion and used commercially or militarily. It doesn't matter that the very practice of doing this in an army would create an entirely new art. The patent office would still reject it anyway. This is how they treat all, and try to weed out all first round patent filers. It doesn't even matter that you are the true and honest inventor of something new. It doesn't matter that by this reasoning, every invention on earth has to be based on some accumulated human knowledge that they use to "steal" from an inventor what is supposedly a temporary right from you to practice the invention. These arbitrary, dishonest, and exclusionary methods of the patent office effectively make the patenting of new inventions the sole domain of rich individuals and big wealthy corporations. There is no real "equal opportunity" to create and patent ideas in this country. It is only pretend equal opportunity in this country because a lazy or indifferent patent examiner won't take the time to learn and understand the subject matter and provide a sensible and honest evaluation of the persons filing.

Scientific Principles of Improvised Warfare and Home Defense

'When patent examiners act in this fashion, they don't just steal from a few disappointed individuals. They steal from the entire country. You should, as a nation, want all of your people who are the honest and legitimate creators of new ideas, products, and services to be able to own and sell the inventions of their own making, and not trying to screw the vast majority of the American people out of their property rights (or privilege) if they aren't backed by big corporations or a large bank account. Using an obviousness argument can be applied to every invention in the history of man. Every invention is built upon mans accumulated knowledge. The obviousness argument is no more than a crutch for the patent office employees who can't take the time to study and know the subject matter and use arguments that actually make sense in their rejections of the new ideas.

My final response to the patent office has evolved to this. If the patent office doesn't want to grant me the exclusive right to my honest and merited new inventions, then I don't need to own the intellectual property that I create through a patent. All I need to do is write about them in a book and sell the book. Now, instead of inventing new ways or new products for helping the lives of my fellow man which is what I had really wanted to do a few years ago, (and struggle on my own to patent them and fight to make and market it) I can now invent new ways for my fellow man to kill each other and make my living off of teaching my fellow man how to practice this knowledge through writing books like this one (to those skilled in the art, this book is only a beginners manual in each of the subject areas). In this case the readers don't need my approval to practice the new inventions and ideas because I never filed for patent protection.]

And now, back to the main text of the book. [Letting off steam like this is good therapy]

Scientific Principles of Improvised Warfare and Home Defense

Chapter 10 Booby Traps, Mines, and Positioned Weapons

While obstacles are designed to deter or stop the physical movement of the enemy these devices are designed to kill or wound an enemy without personnel being present. They are usually concealed and have their own source of stored energy to cause physical injuries which obstacles do not have as a rule. These weapons have three great advantages.

First, they are very cheap to build.

Second, they are easy to train troops to construct and set.

Thirdly, your troops don't have to be there and get shot at by an enemy while they are being attacked.

Since these weapons are machines, they do not run from battle or freeze in the heat of combat. They are reliable and can be set by ill trained troops or civilians in short notice. They are effective against the enemy's most dangerous weapons (tanks and artillery) and can give a defending force a considerable advantage.

The different types of weapons covered here are

1. Mechanical Traps
2. Explosive or firing positioned weapons
3. Booby trap activating systems
4. Mines
5. Improvised positioned weapons

Scientific Principles of Improvised Warfare and Home Defense

1. Mechanical Traps

The simplest traps are mechanical in nature and use the motion energy of the enemy to cause injury.

Pungi (or punji or panji) sticks are spikes made from bamboo which naturally cuts to a point. They are placed in the path of the enemy to pierce boots and cause injury. The spikes are dipped in ox dung to insure serious infection in the wound.

A **trip wire** is often placed so that the forward motion of the soldier changes his center of gravity when he snags the wire.

He falls forward onto an area of spikes causing many full body injuries.

The spikes can be improvised from tree branches or nails pounded into wood and camouflage.

Pits or ditches are often filled with spikes and covered with camouflage to conceal the openings. These use the energy generated by gravity to increase the piercing ability of the spikes. All of the victims own forward momentum and weight is accelerated by falling onto fine points.

Examples from the Vietnam war include

a. Pit covered with leaves or a thin layer of soil.

b. Covered with a platform balanced by a rod which rotates and can cover the trapped individual.

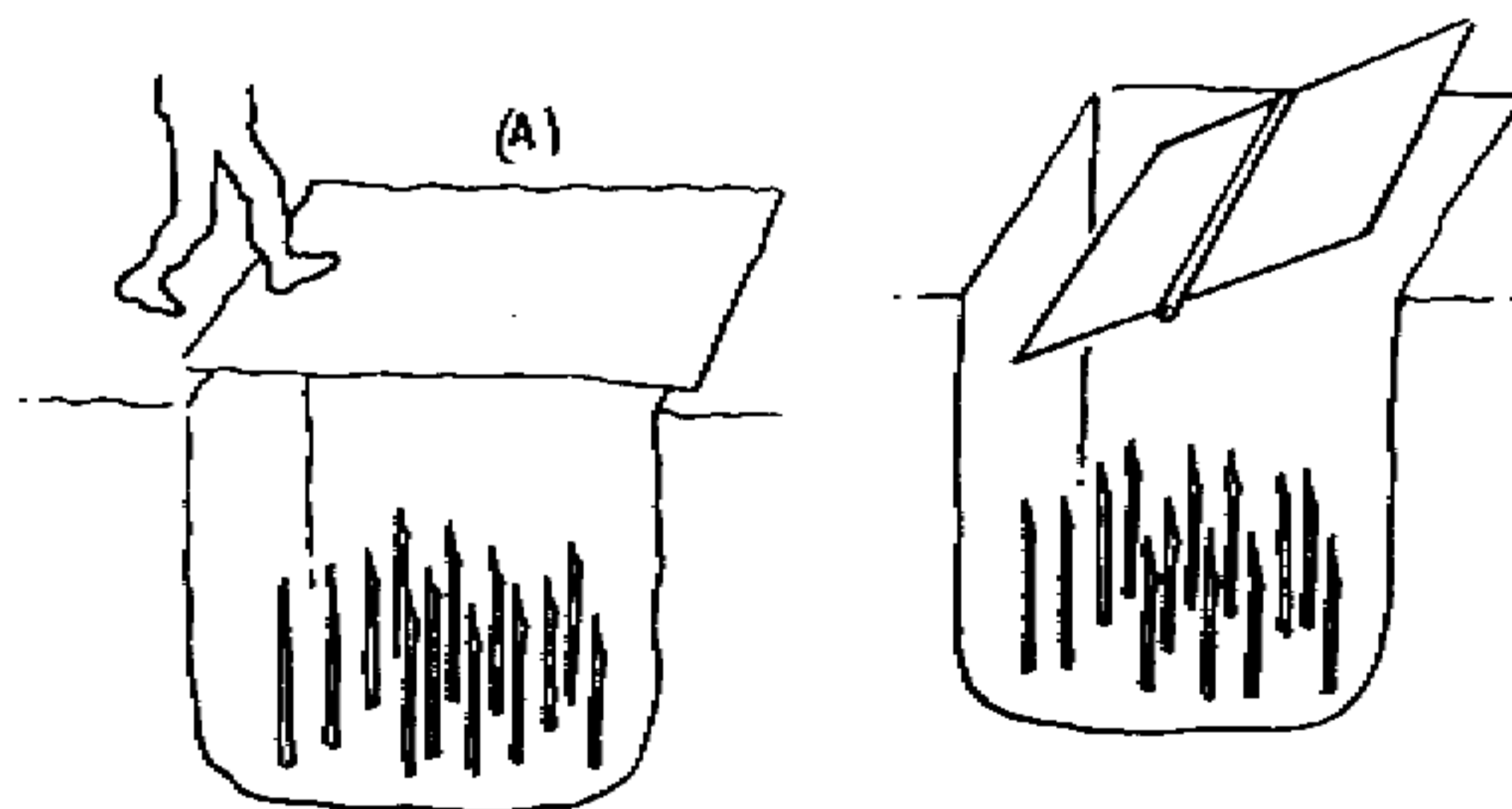
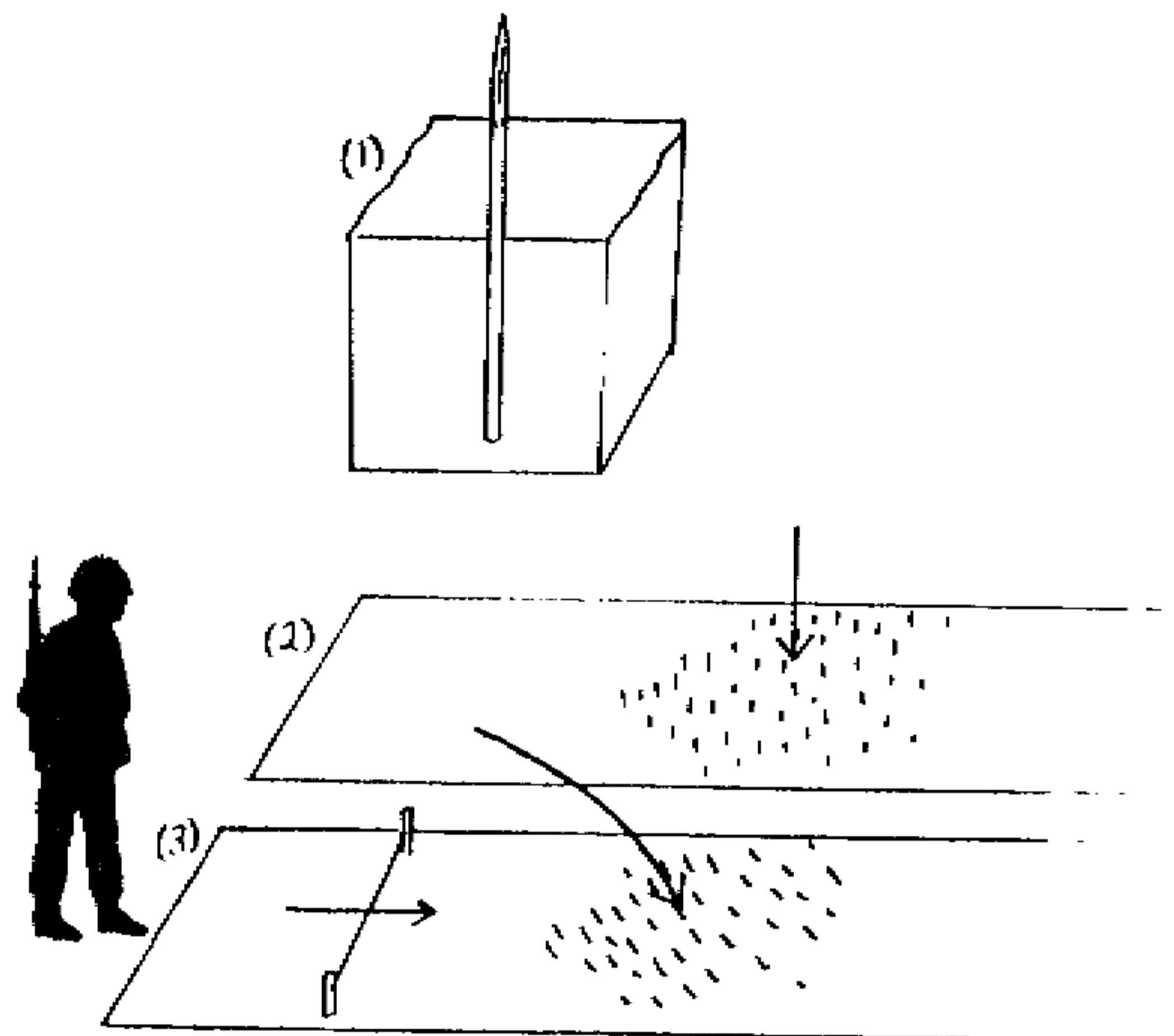

Scientific Principles of Improvised Warfare and Home Defense

c. Covered with flexible metal spokes across the top to trap a leg or torso making it impossible for the victim to pull himself back up.

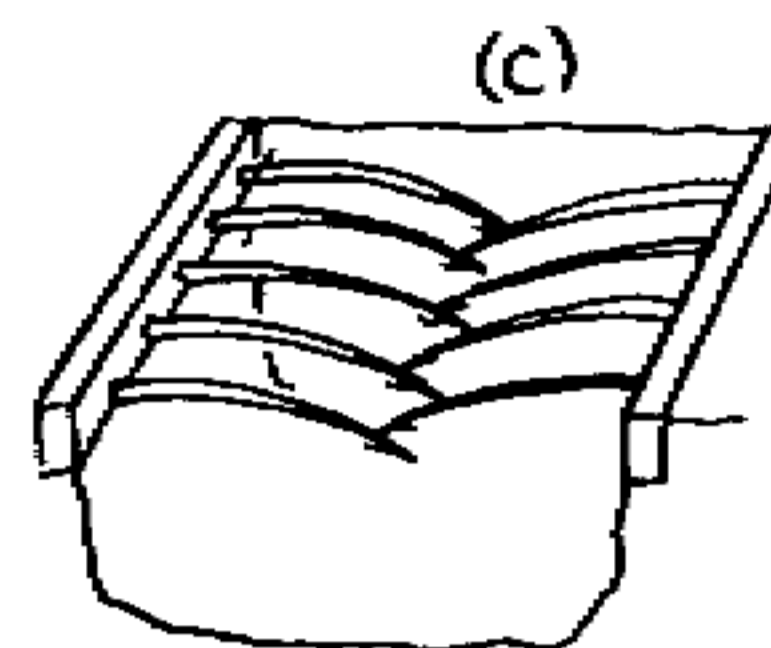

d. A premade spike frame for use in covering pits and traps and operates on the same principle. The frame was wooden and the spikes made of steel.

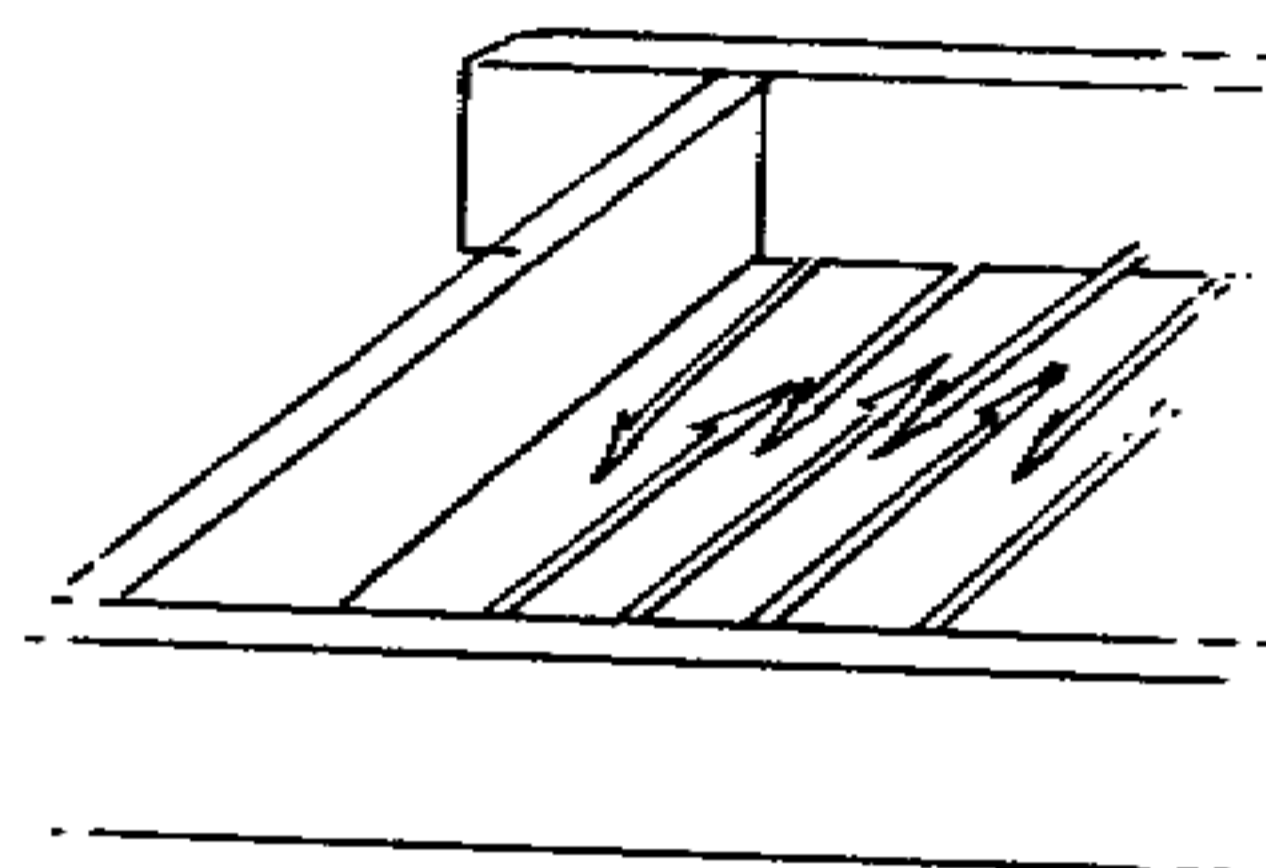

The falling energy of gravity can also be exploited by making the Pungi spikes fall. This is accomplished by "spiking" a heavy object such as a log or plywood panel. The trap is suspended overhead and dropped when the victim trips an actuating device such as a wire. Added energy can be provided by using a the torsion skeen described in an earlier chapter. It is similar to what was used in ancient catapults and can be lethal.

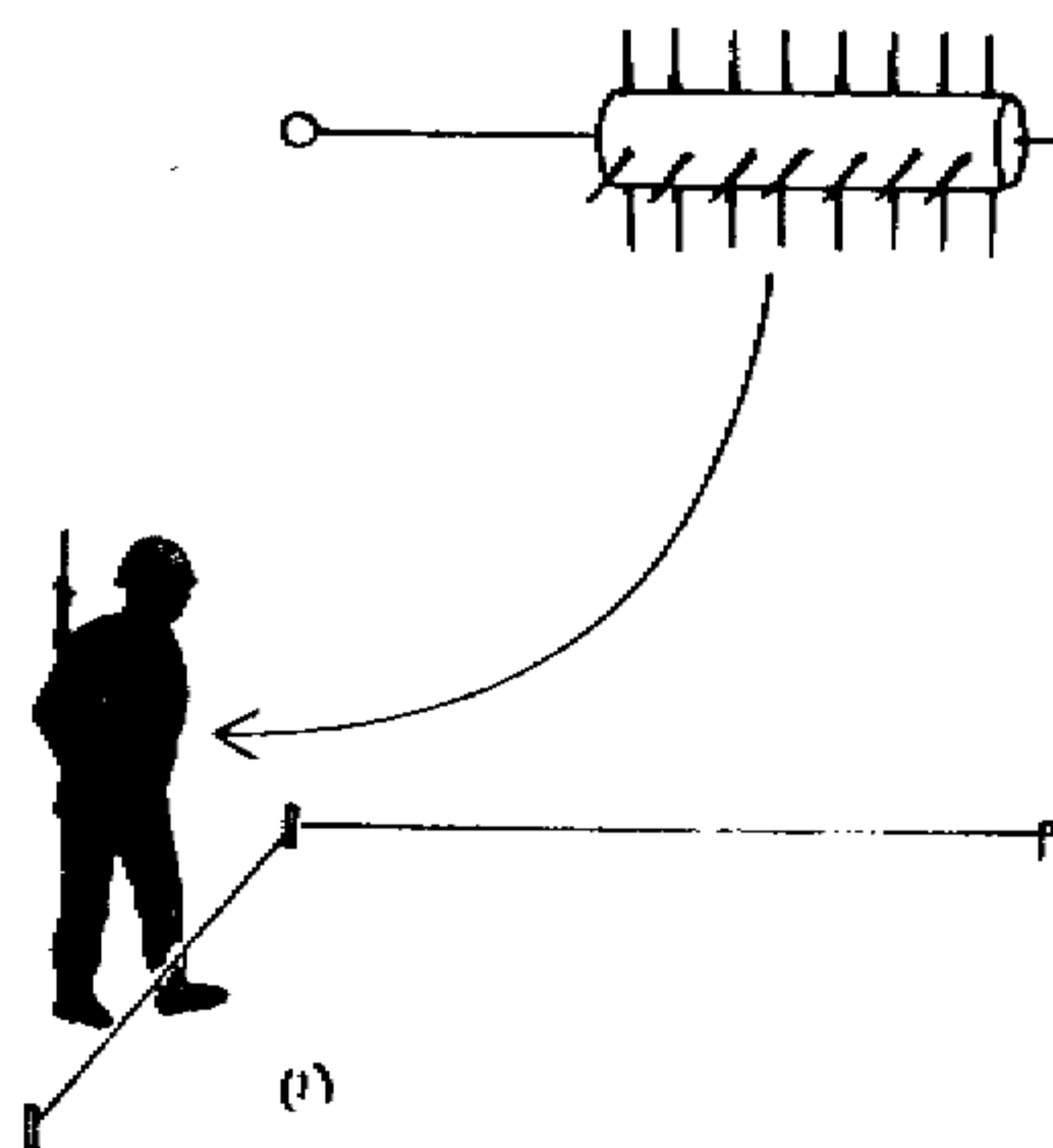

Scientific Principles of Improvised Warfare and Home Defense

Spiked weapons can be dropped from directly overhead.

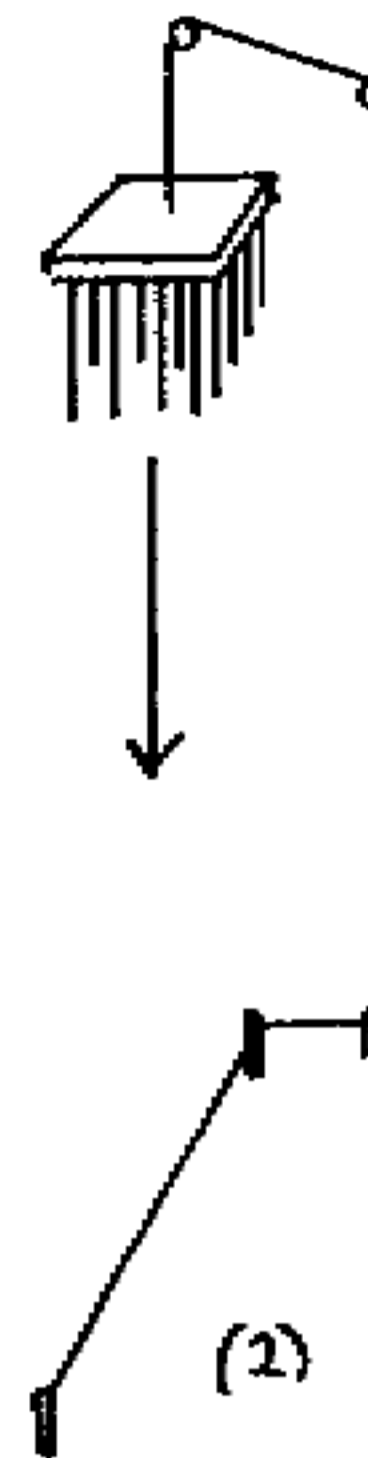

Spike boards can also be driven by the victim who steps on a lever which drives the opposite spiked end onto him.

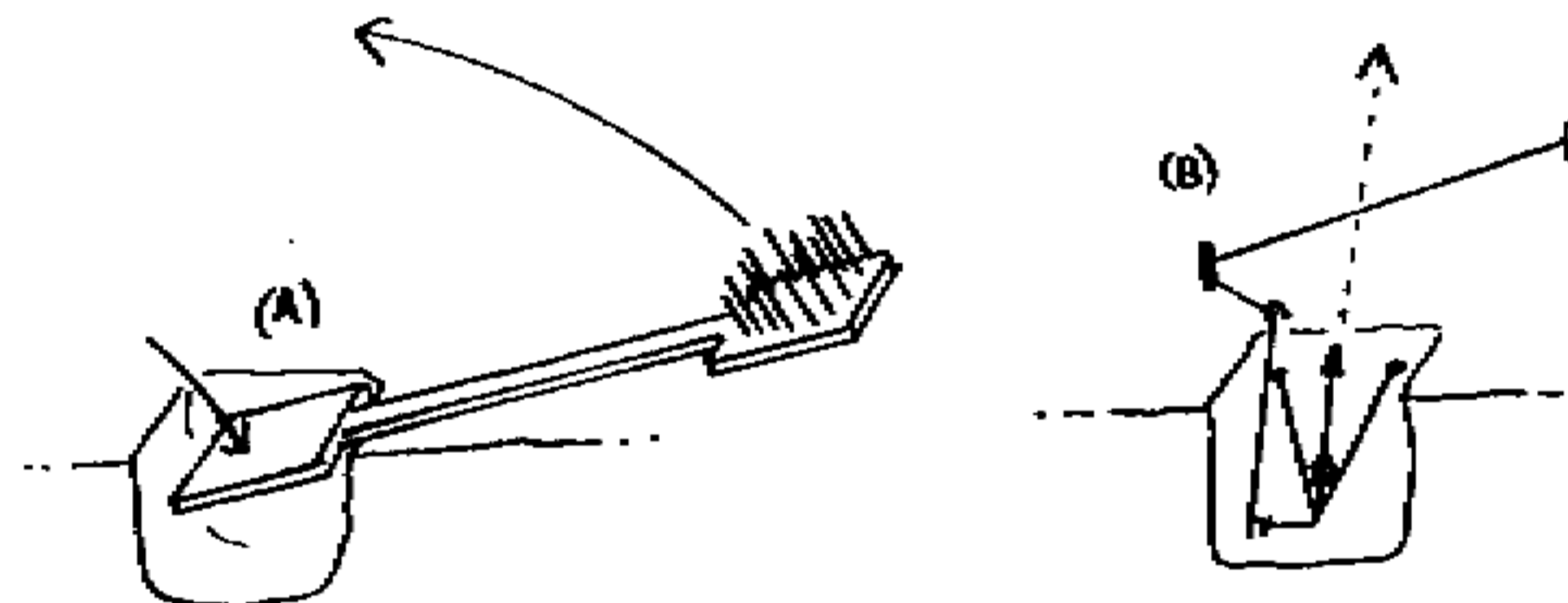

Most hand or other non firearm weapons can be placed in pits and provided with propelling energy such as a bow and arrow set off by trip wire.

Small animal traps can also be used for anti-personnel purposes. The jaw trap is sprung when the victim steps onto a tilting plate. Two jaws powered by a spring snap shut trapping the target. The jaws often contain spikes or are sawtoothed. A powerful spring can prevent easy removal.

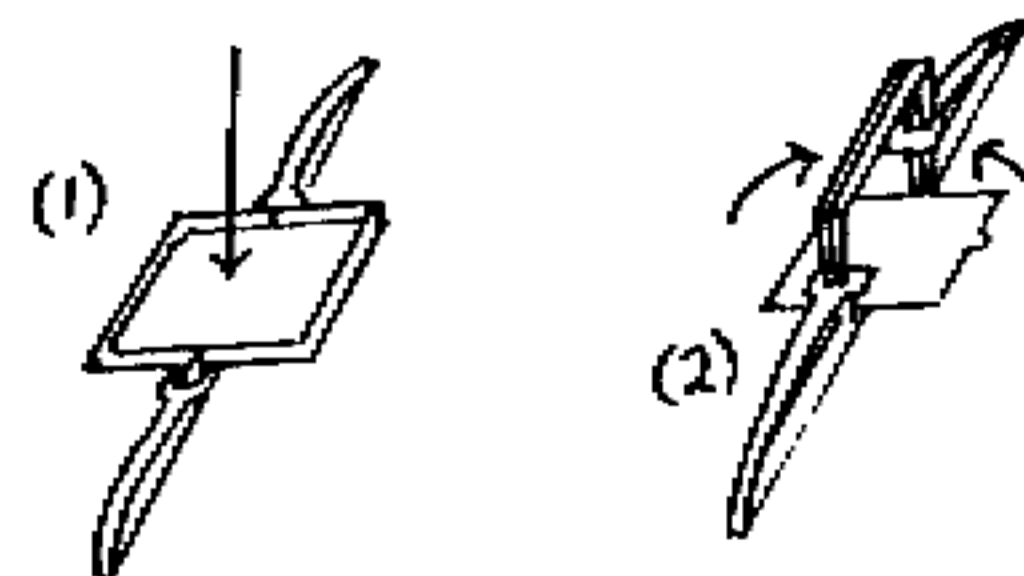

Scientific Principles of Improvised Warfare and Home Defense

2. Explosive or Firing Positioned Weapons

Known as booby traps or bombs, these weapons use the power generated by explosives to cause injury. The injury can be caused by using a firearm as the weapon, but more often a high explosive which injures by blast or fragments is employed. This is because of the unidirectional nature of an explosion where a firearm only aims for one spot. It is possible to injure many enemy forces with an explosive trap.

Common ways of setting off booby traps include

- a. Tripping a wire
- b. Applying pressure to a plate
- c. Releasing pressure
- d. Causing vibration
- e. Turning on a light

Triggering traps can be accomplished by a distant observer by pulling a cord, sending a current through a cable, or using a radio beam as a detonator.

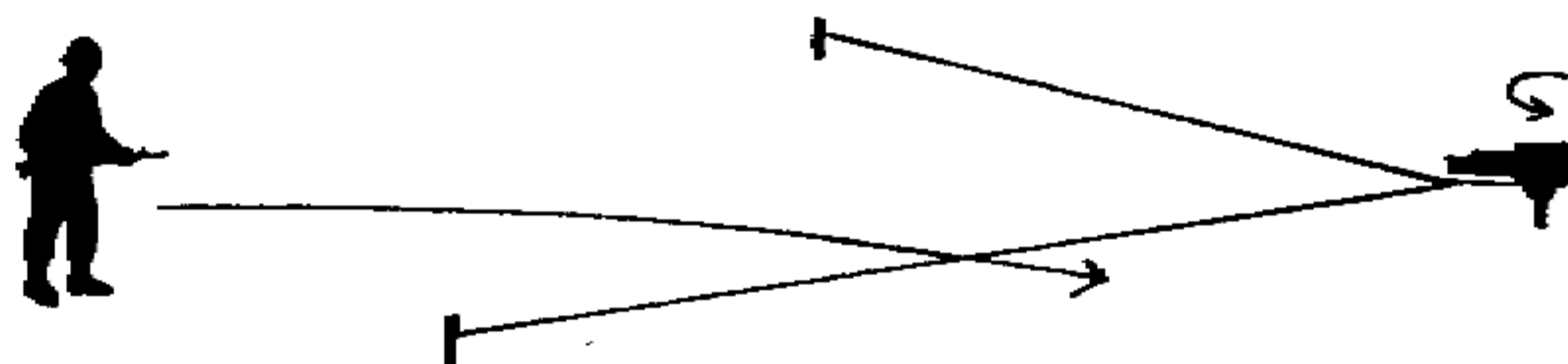

Robot guns can be placed in positions to cover an enemy's advance. They can be tripped by any of the activating devices described. A shotgun type of effect is desired to cover as large an area as possible.

Sloping pits have been used in the last four centuries for launching debris. The pit is loaded with a layer of explosives in the bottom. A pile of fragments such as nails, gravel or other projectiles fills the pit which is covered and camouflaged.

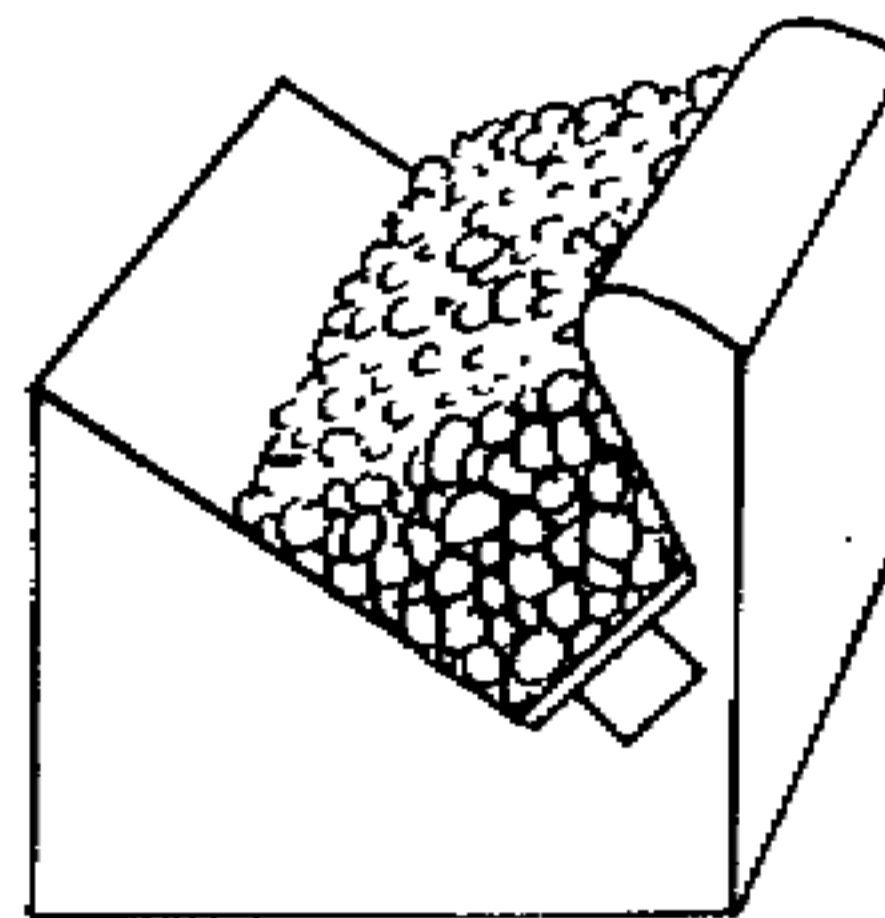

Scientific Principles of Improvised Warfare and Home Defense

When the enemy attacks and reaches a position in front of the ditch, the explosives are detonated showering the enemy with missiles. A charge of 80# of explosives and 5 tons of projectiles will shower an area of 350' wide by 450' deep.

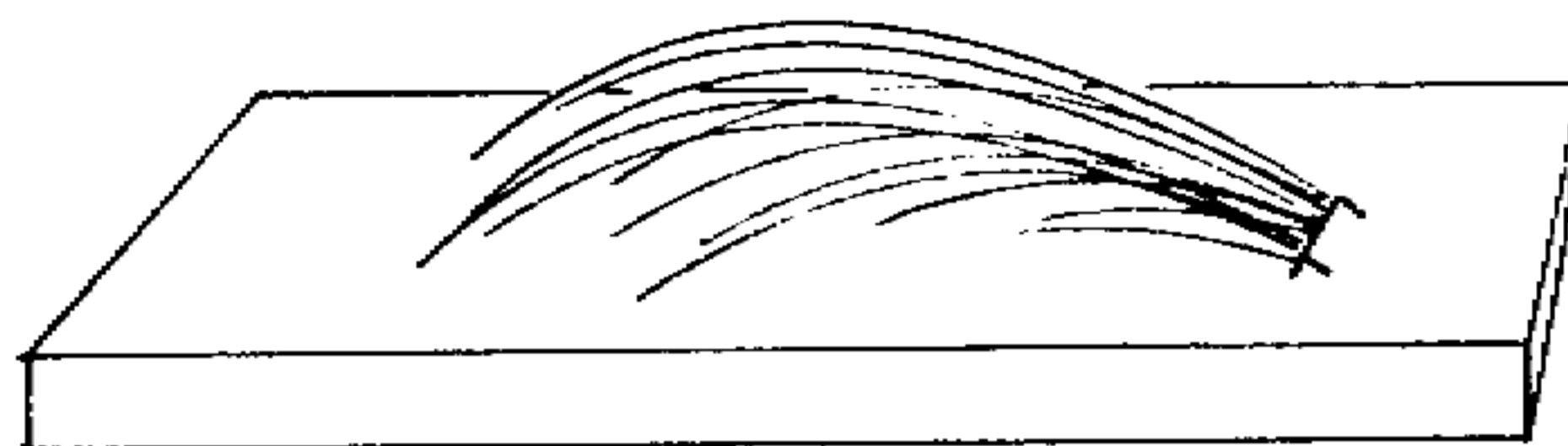

The modern "claymore" mine uses the same principle. When detonated, it sends a hail of steel balls out up to 270 yards in a 60 degree arc.



It is designed as a plastic case holding a curved shaped explosive and loaded with hundreds of small ball bearings.

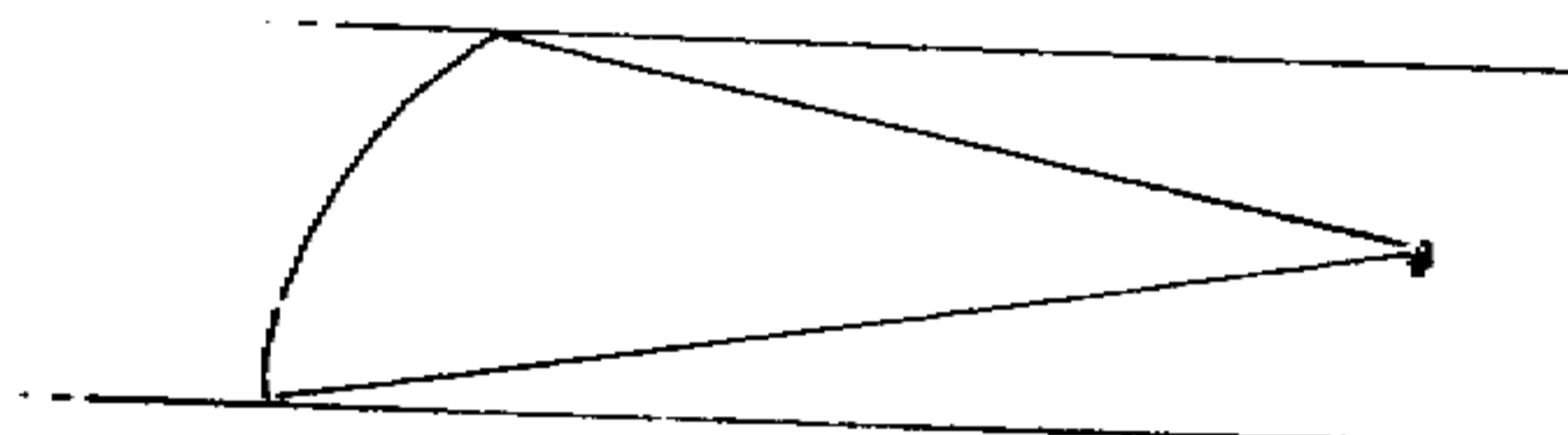

In the siege warfare of the Civil War and WW2, mines were often dug under enemy positions and large amounts of explosives placed inside. The resulting explosion usually left a crater where the enemy position used to be.

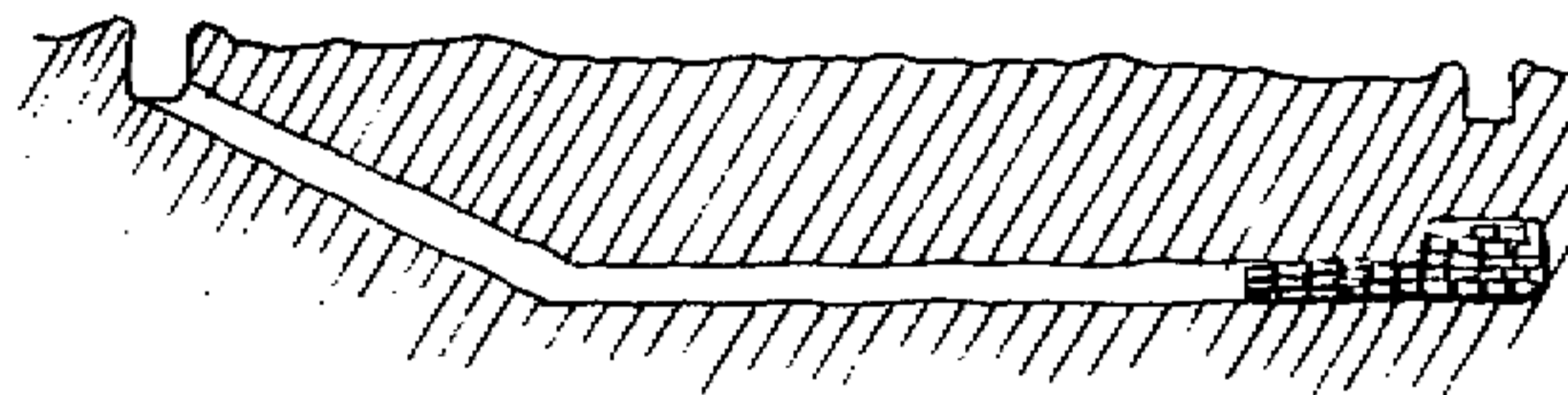

Sabotage explosives are used against structures such as bridges, power stations, communications centers, and vehicles. They are frequently also used as weapons against civilian populations by guerrillas and terrorists. These targets include anyplace where people meet or travel in public. The explosive devices are concealed to look like luggage, mail, clothing, or practically anything imaginable.

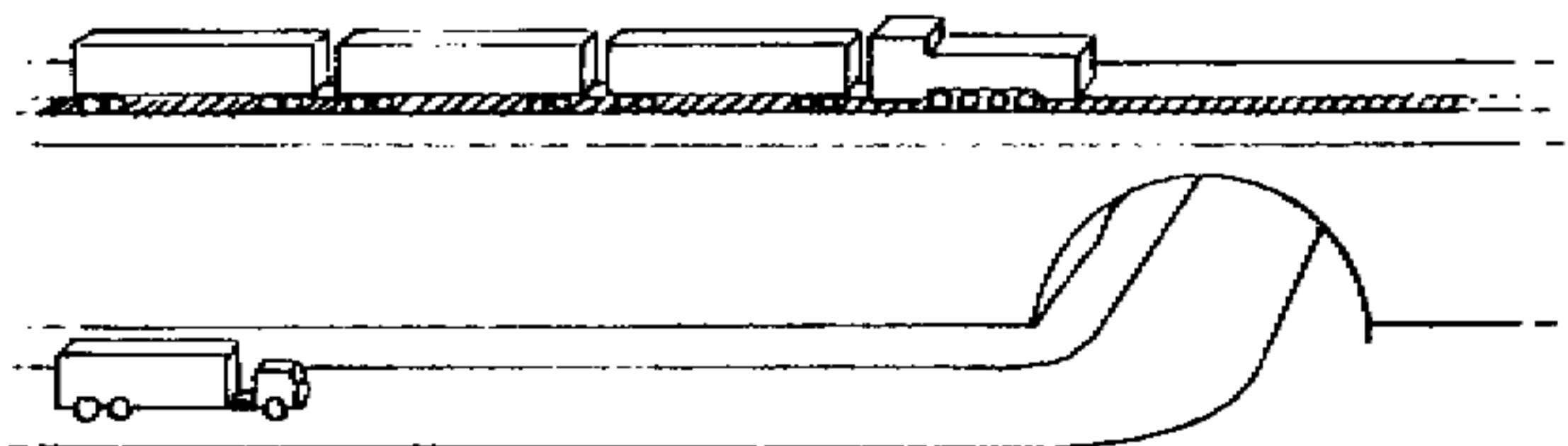

Scientific Principles of Improvised Warfare and Home Defense

3. Booby Trap activating systems

Pressure: where the weight of the foot stepping on an object causing it to move and pull a wire setting off an explosive.

This is usually initiated by stepping on a thin board which gives enough to trigger the firing device.

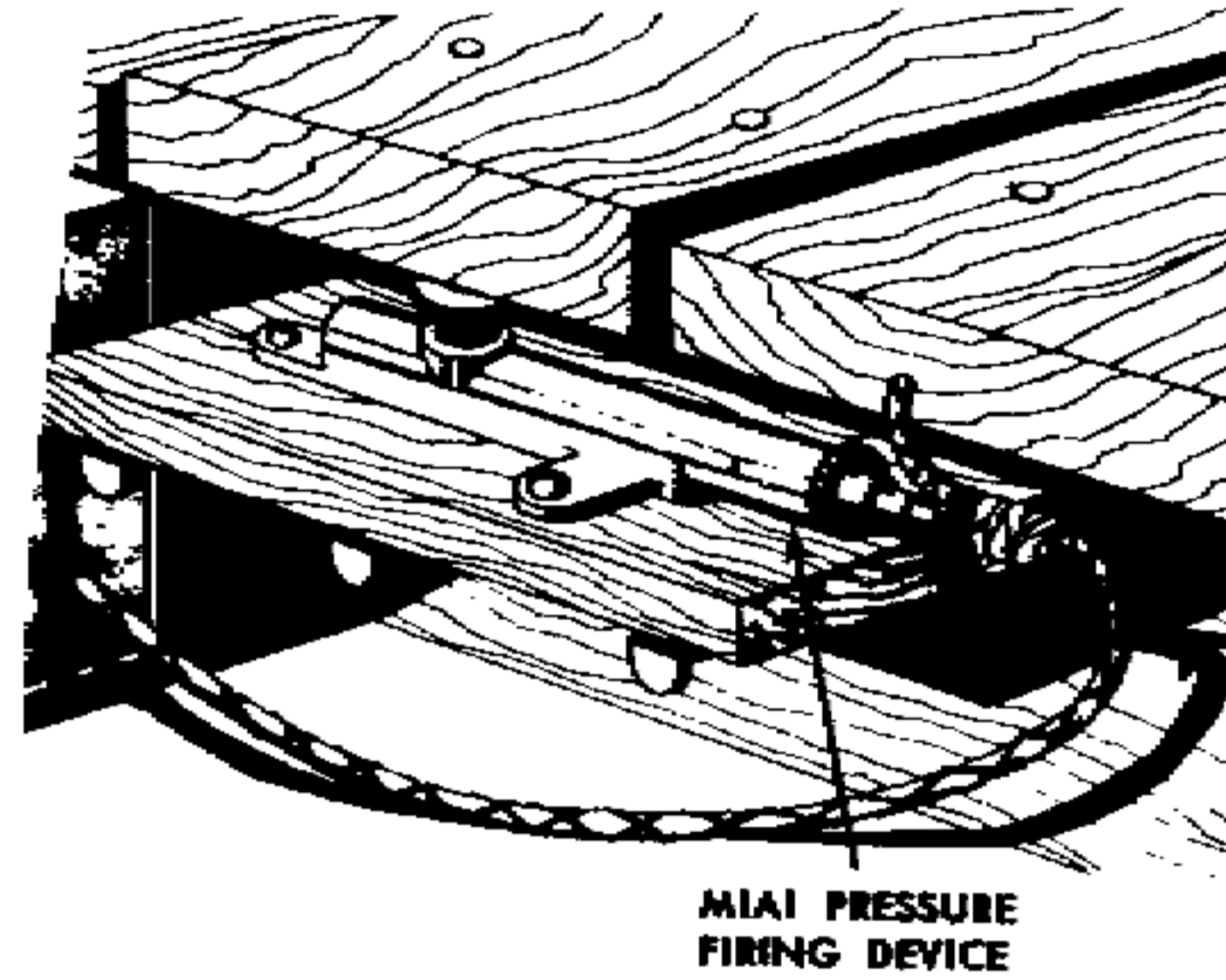

A tilting box buried in the ground and stepped on or driven over can collapse moving a trip wire and firing the trap.

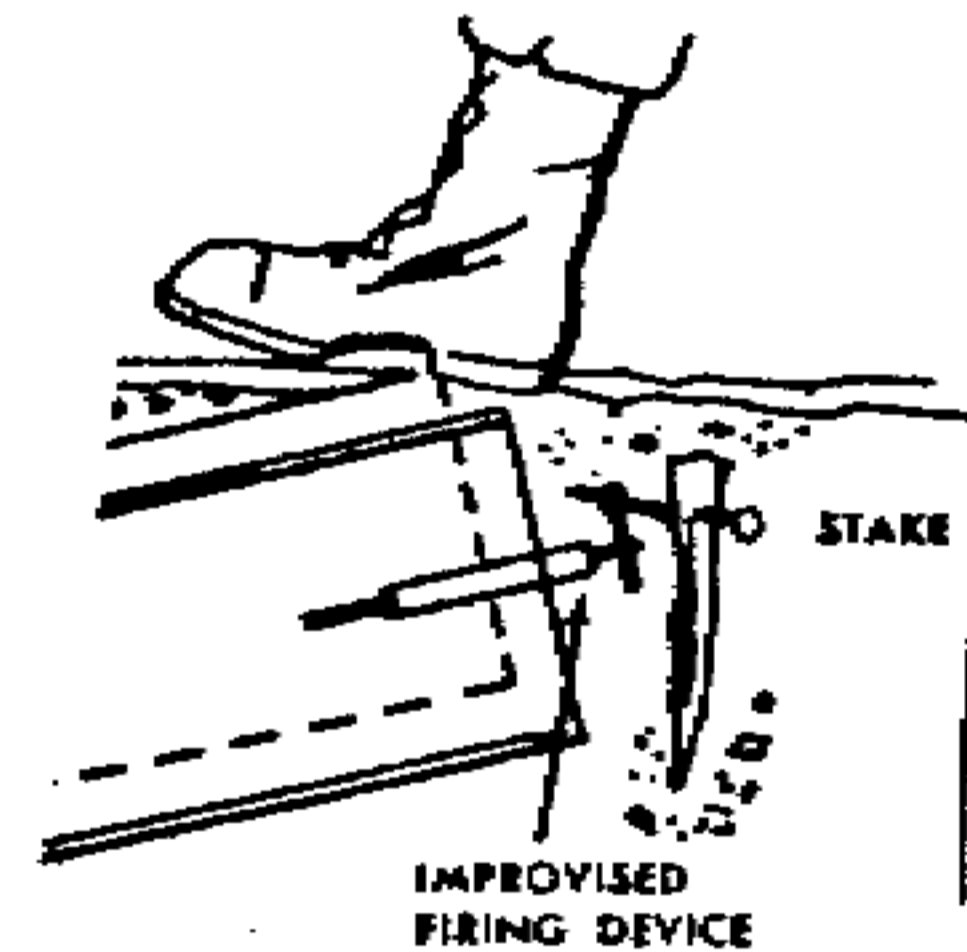

A striking pin can be used in the same manner as conventional ammunition. When the striker is pressed, it sets off the explosive.

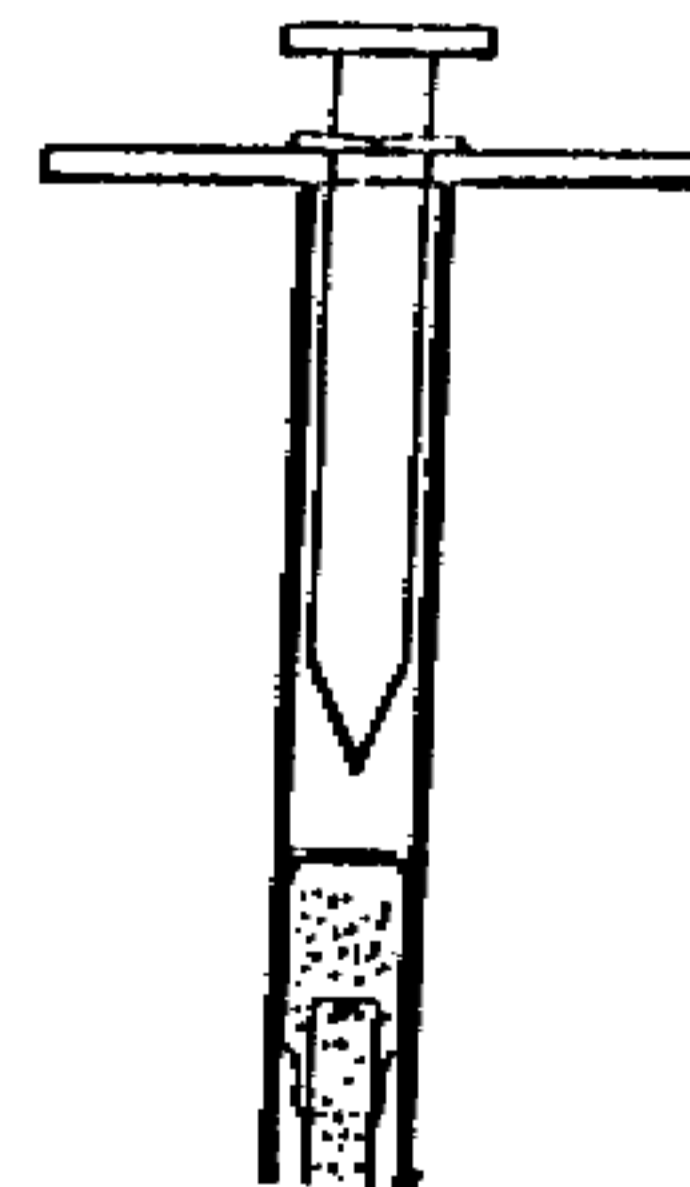

Scientific Principles of Improvised Warfare and Home Defense

Spring pressure boards and electrical contact plates can also be used as explosive initiators as shown.

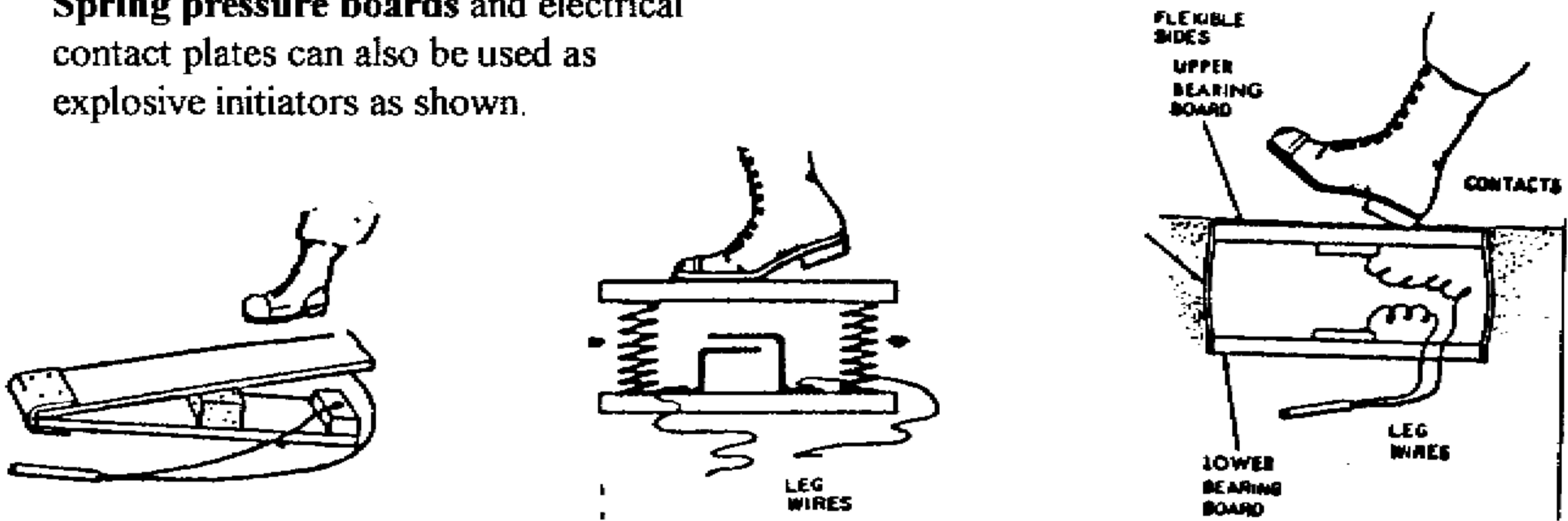

Pulling: where the act of moving an object such as an abandoned rifle will pull a trip wire and set off the device.

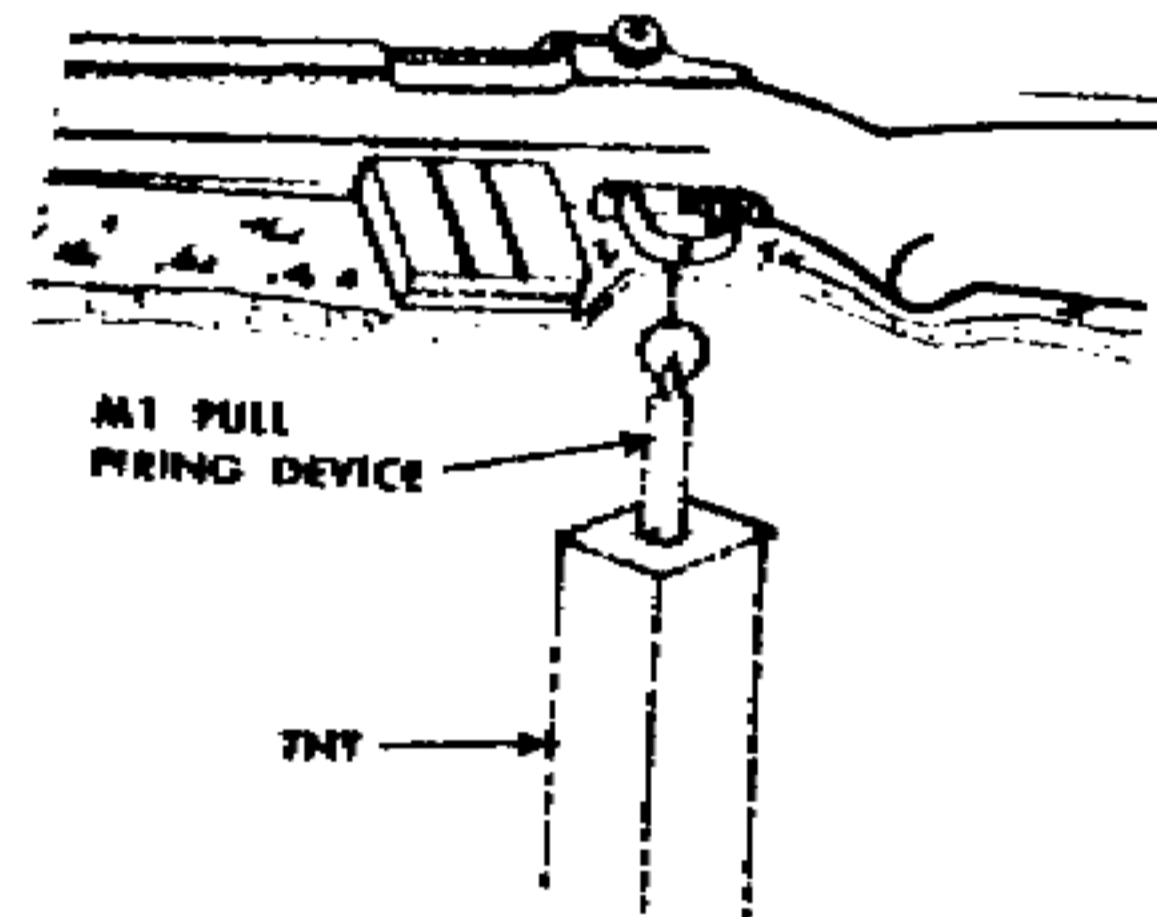

A clothespin can be fitted with electrical contacts. When the pin is pulled off a nonconducting barrier, an electric circuit is completed and detonates the charge.

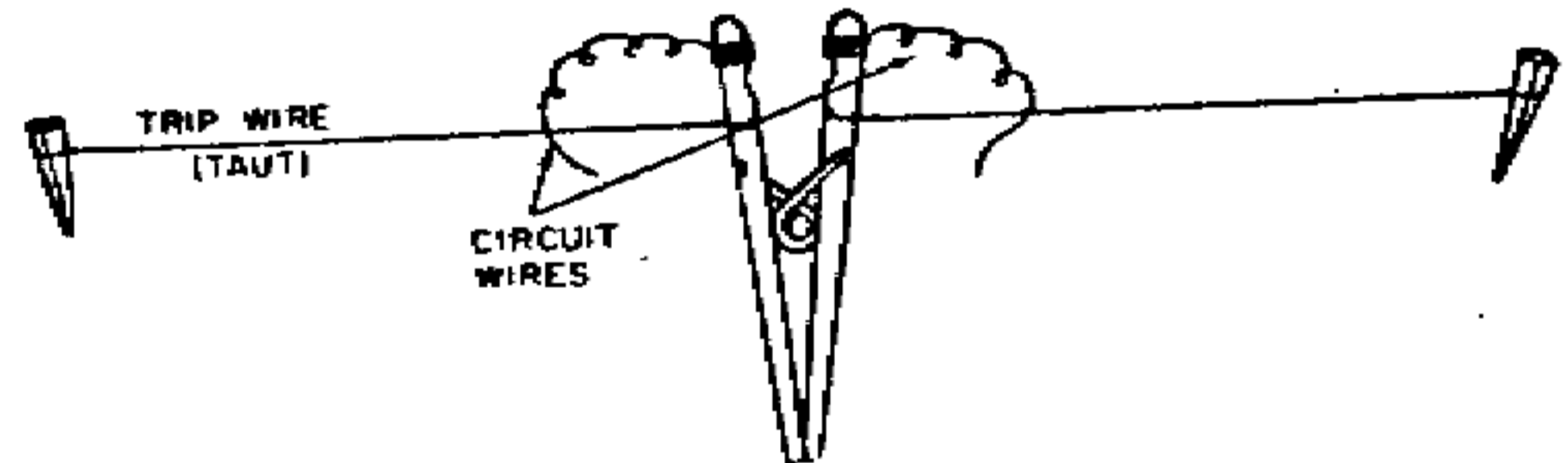

Examples of pulling a door open

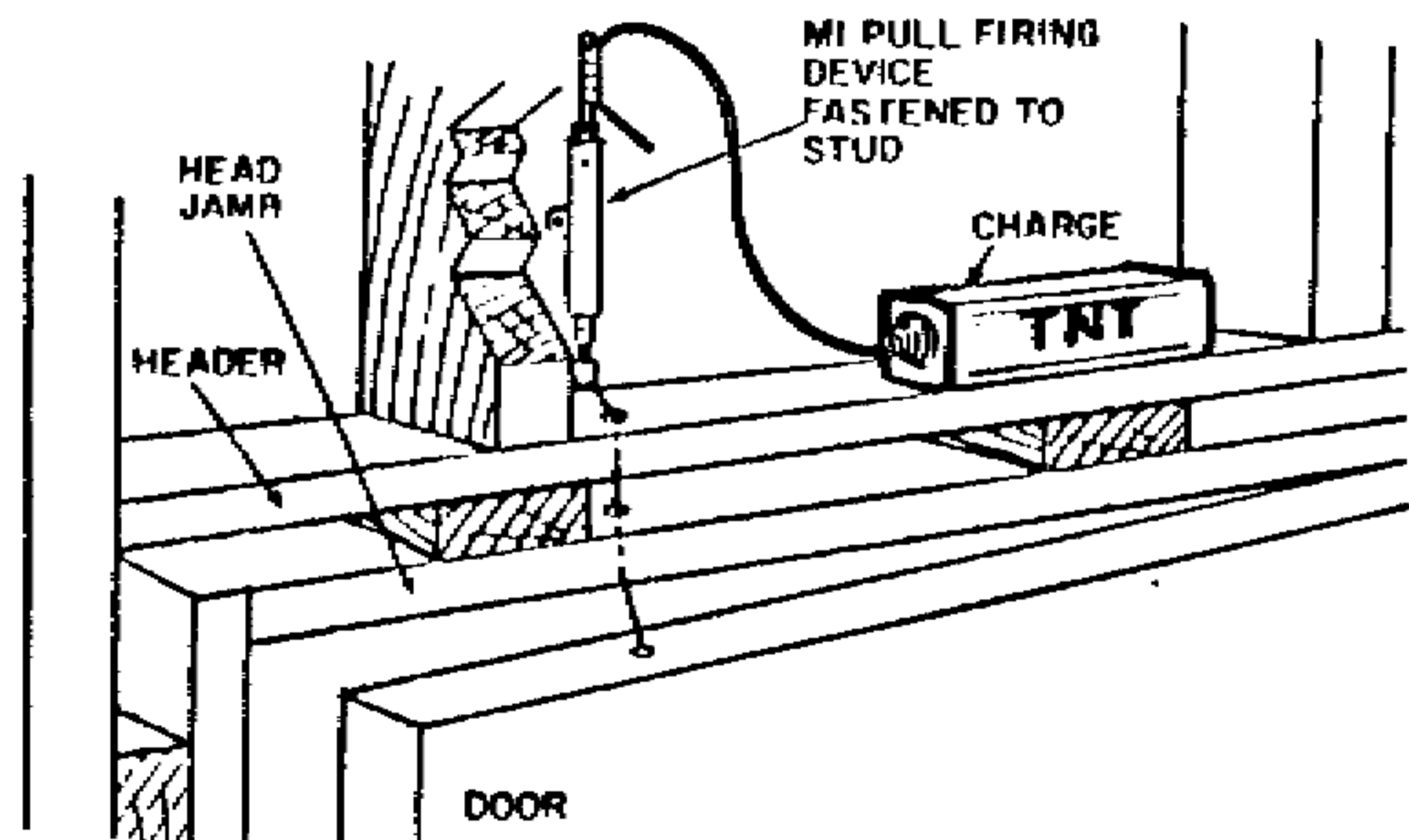

Scientific Principles of Improvised Warfare and Home Defense

or **opening a drawer** to initiate explosives is shown.

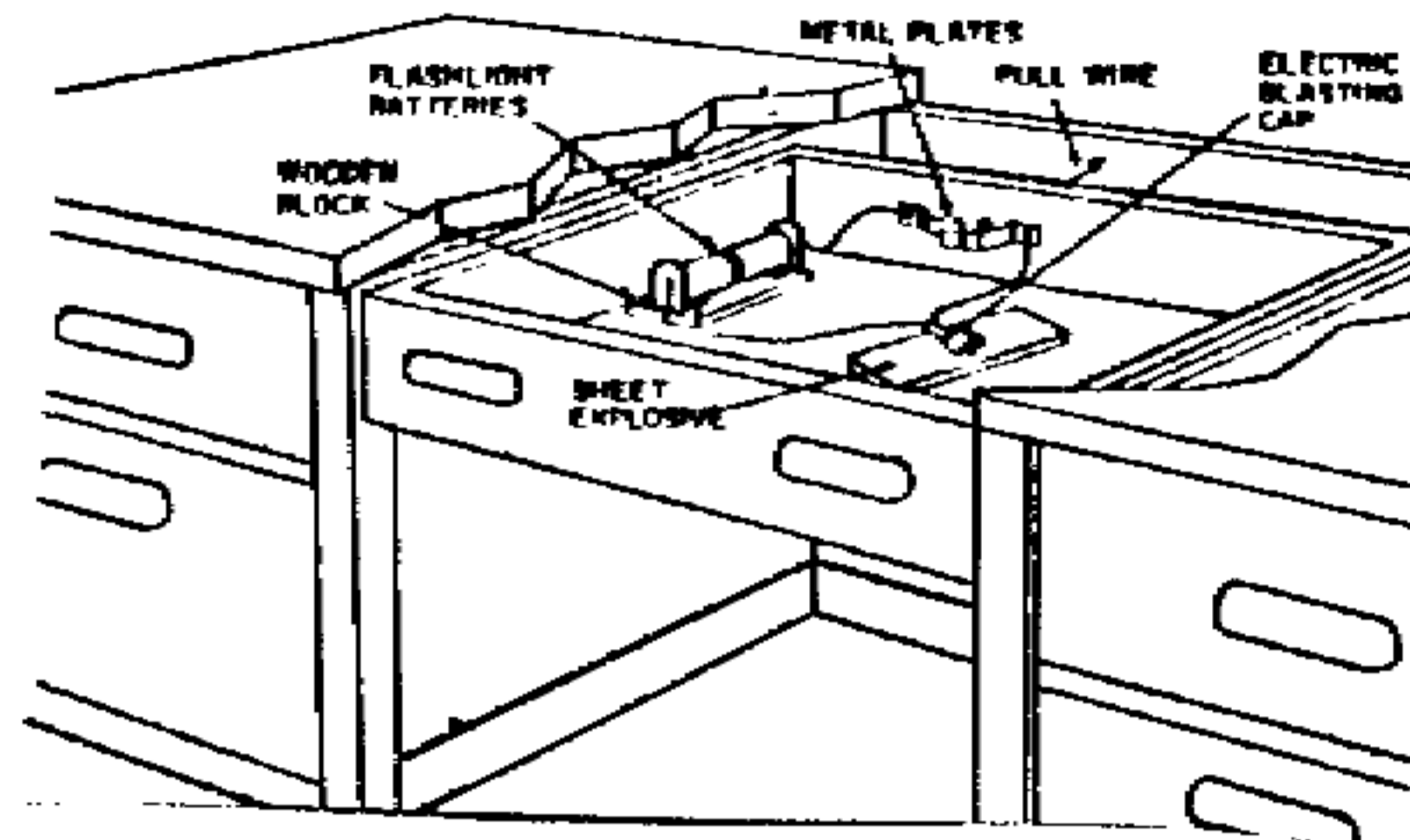

Pressure release: is similar to the previous methods, however, an initiator is left in a state of tension. When the lure or object is moved, the firing mechanism is tripped setting off the explosive.

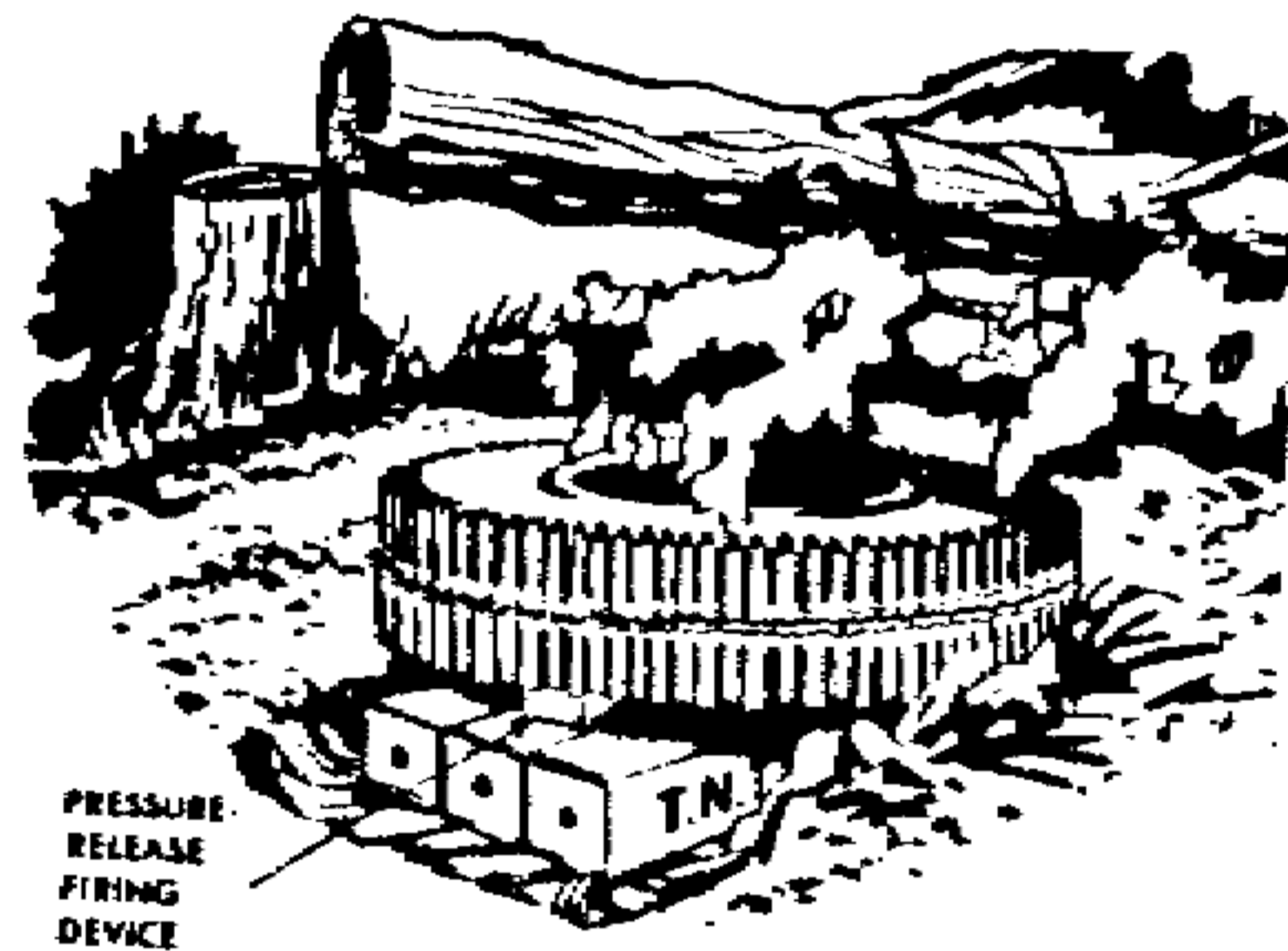

The obvious example is a **grenade with the pin removed** and set to initiate when a rock it is set under is disturbed. These can be placed under debris or obstacles that an enemy must disturb to pass over.

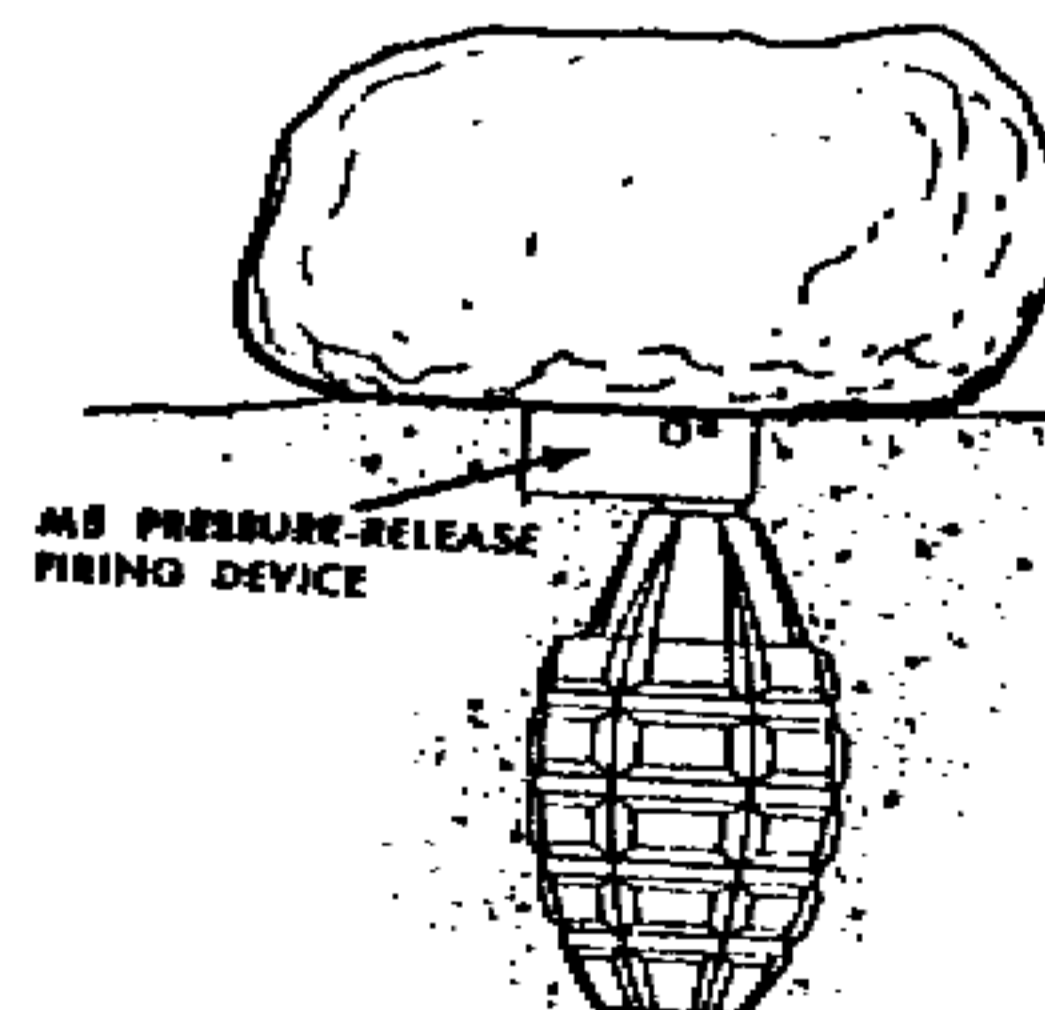

Scientific Principles of Improvised Warfare and Home Defense

The firing devices can be initiated internally by

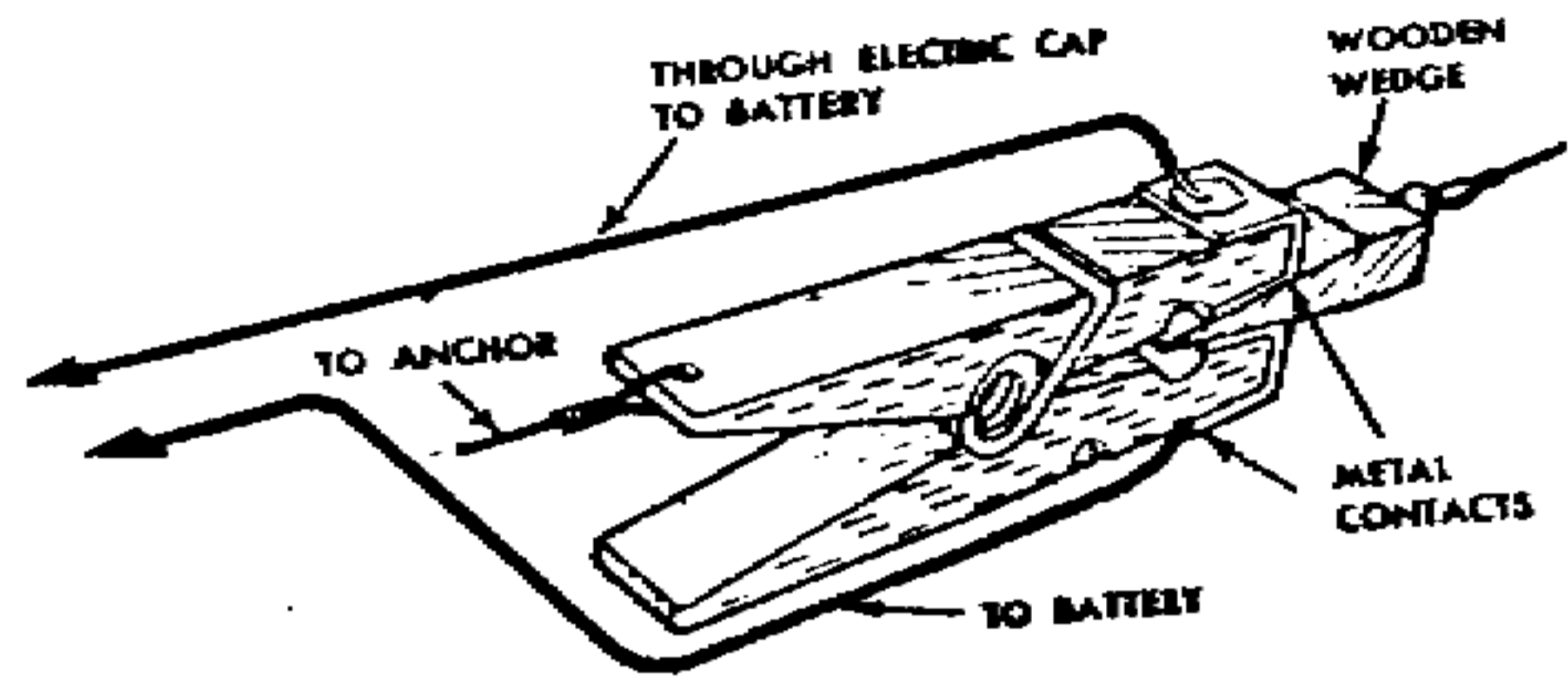

Mechanical means where a released striker, driven by a spring, fires a percussion cap.

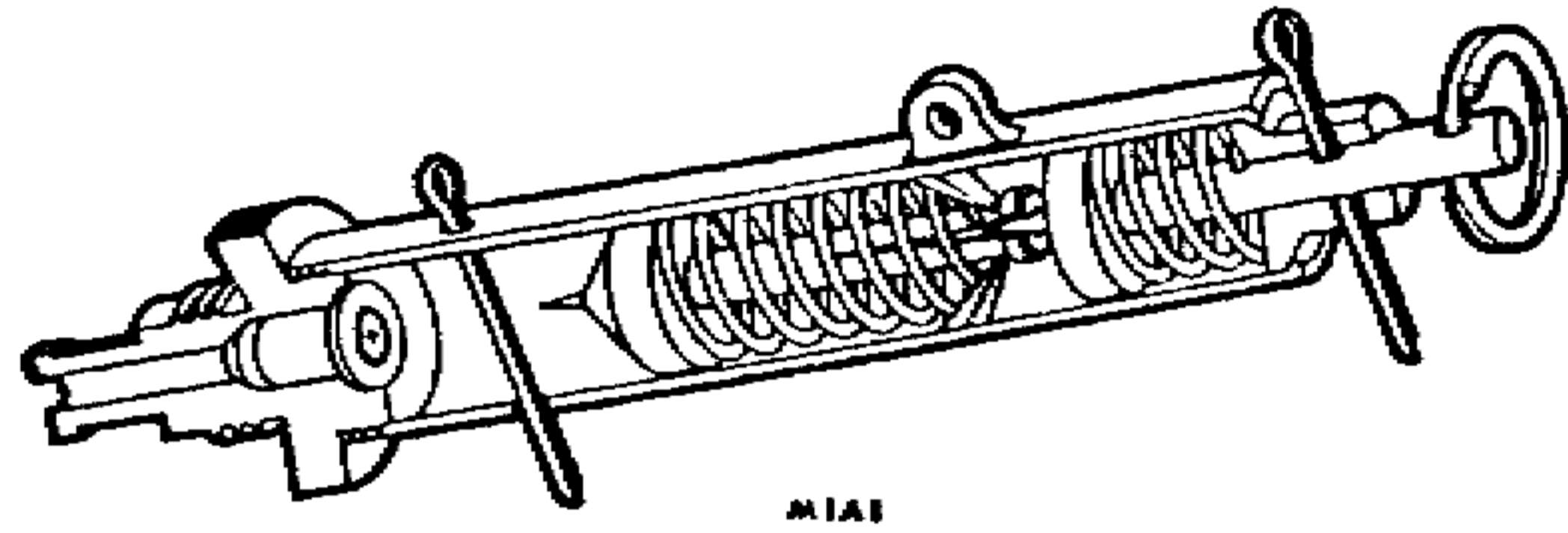

Pull friction: where a chemical pellet causes a flash when pulled setting off the charge.

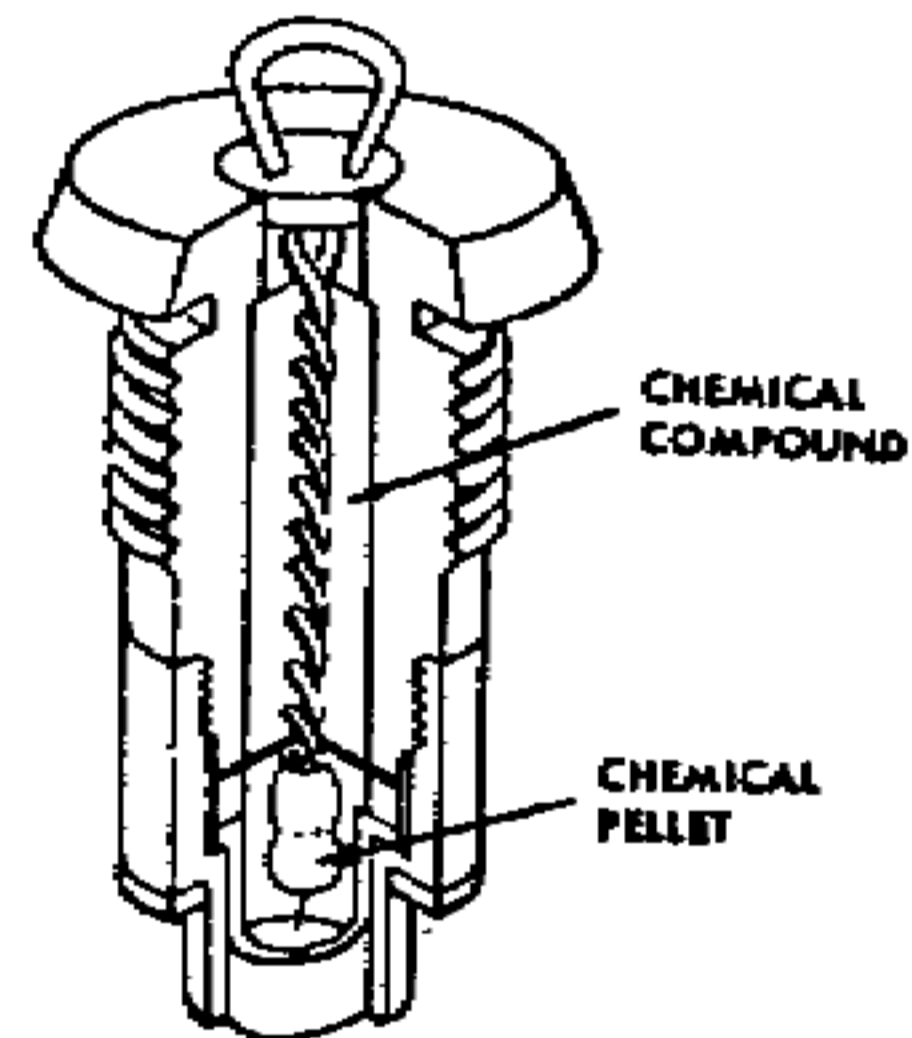

PULL-FRICTION FUZE, WEST WW II GERMANY

Pressure friction: where the pressure forces a cone shaped end into a phosphorus mixture setting off a flash to ignite the device.

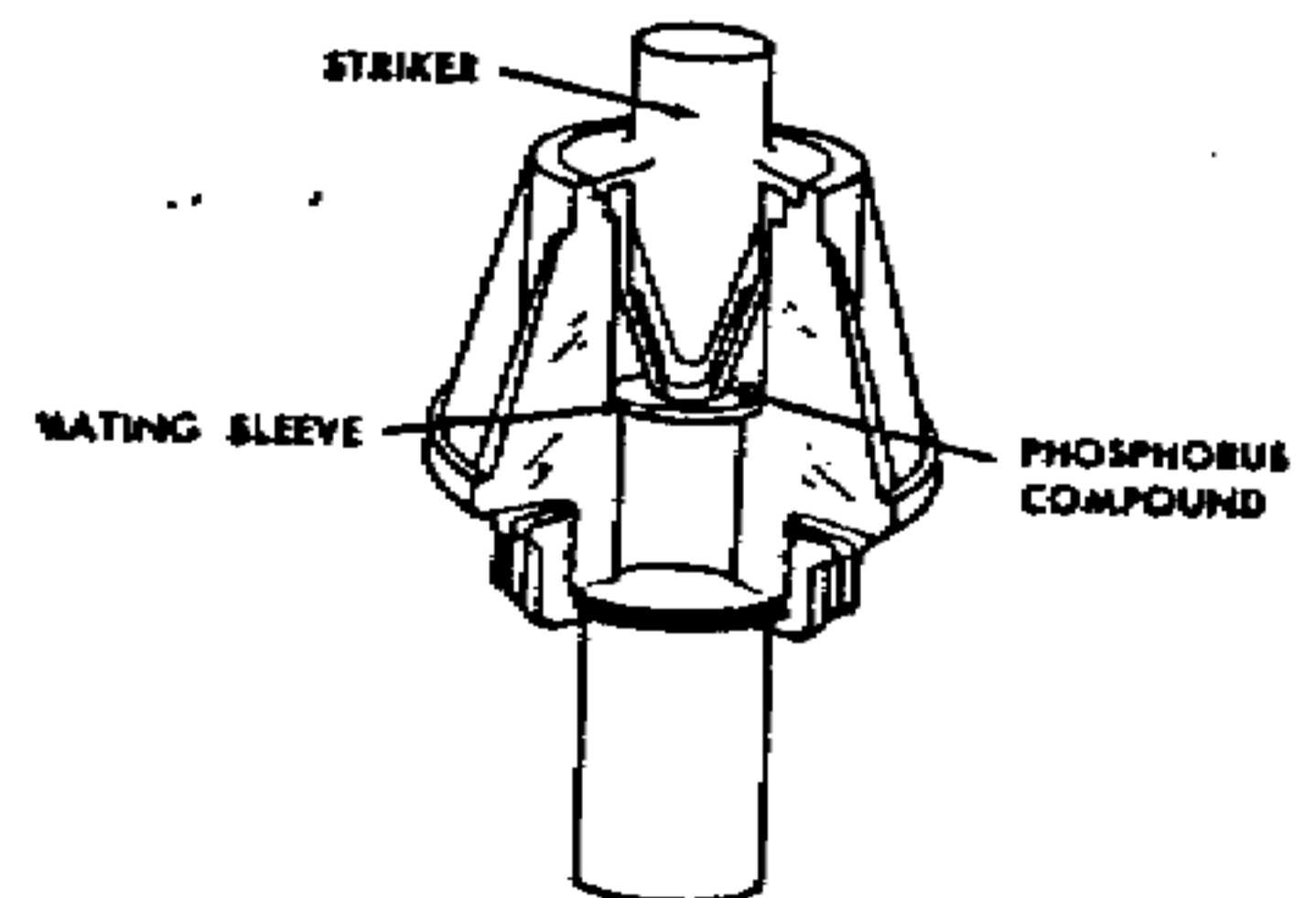

MODEL 1952 FRANCE

Scientific Principles of Improvised Warfare and Home Defense

Chemicals are used for longer delay devices.

A quick detonation can be produced using sulfuric acid in a glass vial. When the pressure is applied, the acid mixes with the powder and causes a flame that ignites the charge.

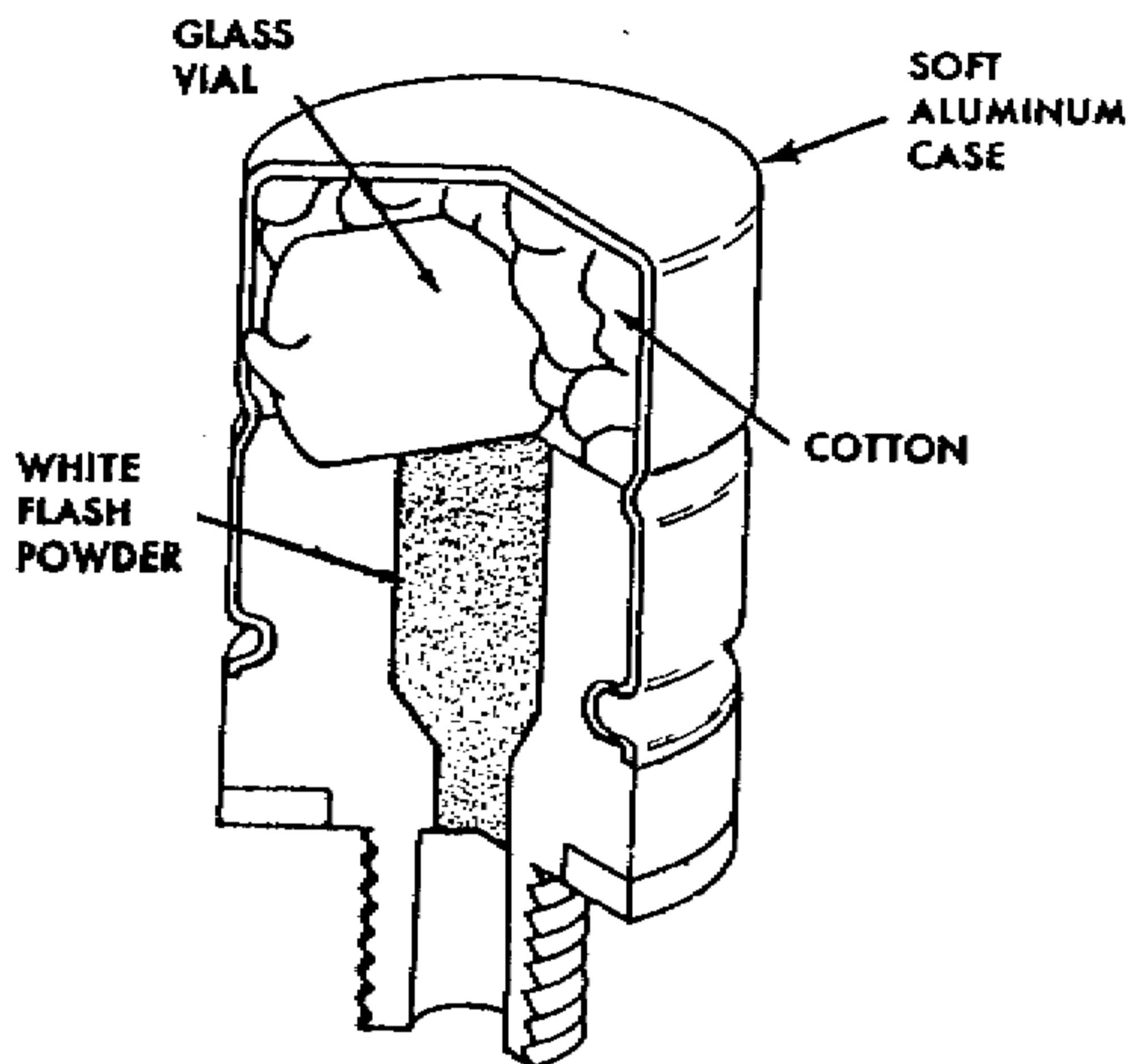

WW II GERMANY
BUCK CHEMICAL
FUZE

Acids in a vial can be used to delay explosions by using a retaining wire of fabric (short fuse) or metal (long fuse). When the glass is broken and releases the acid, a wire is corroded or eaten away which releases a spring detonating the trap.

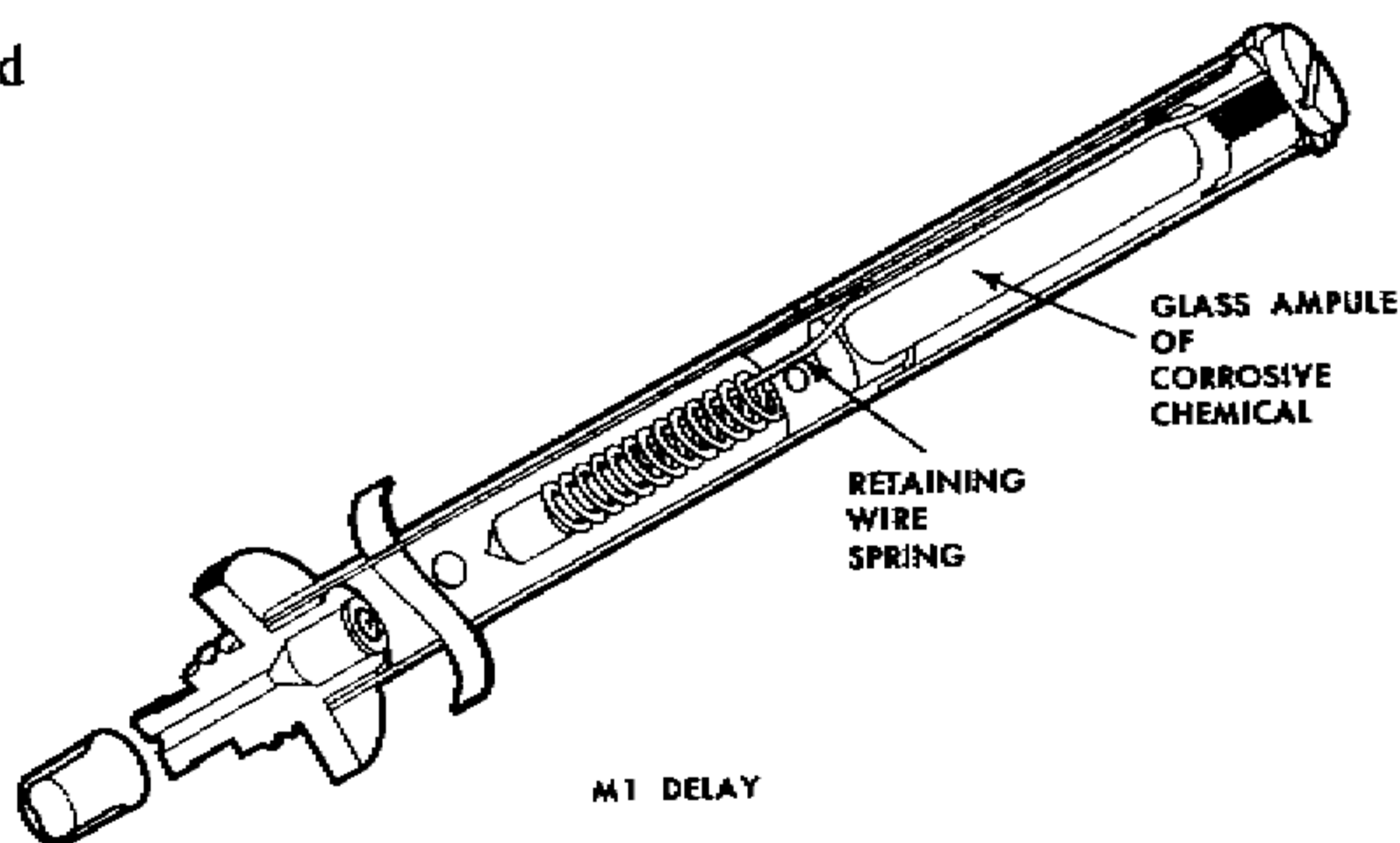

Scientific Principles of Improvised Warfare and Home Defense

Doors, windows, and walkways are the ideal locations to set traps for specific targets.

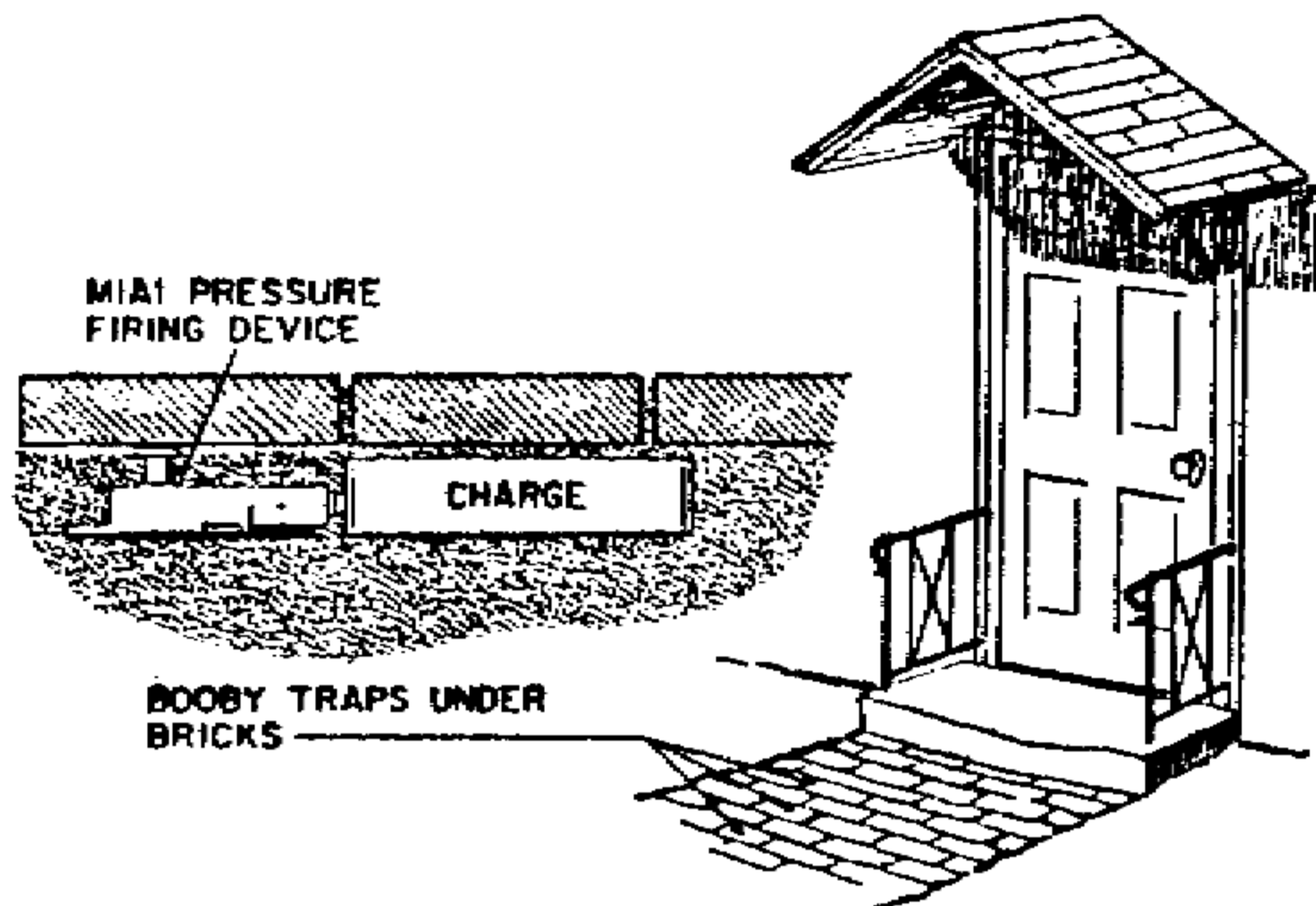

Lures, such as coating the device in chocolate and packaging it as candy has been used in the past. Terror weapons against civilians include trapping toys, beverages, books, and any other household materials that can camouflage the trap.

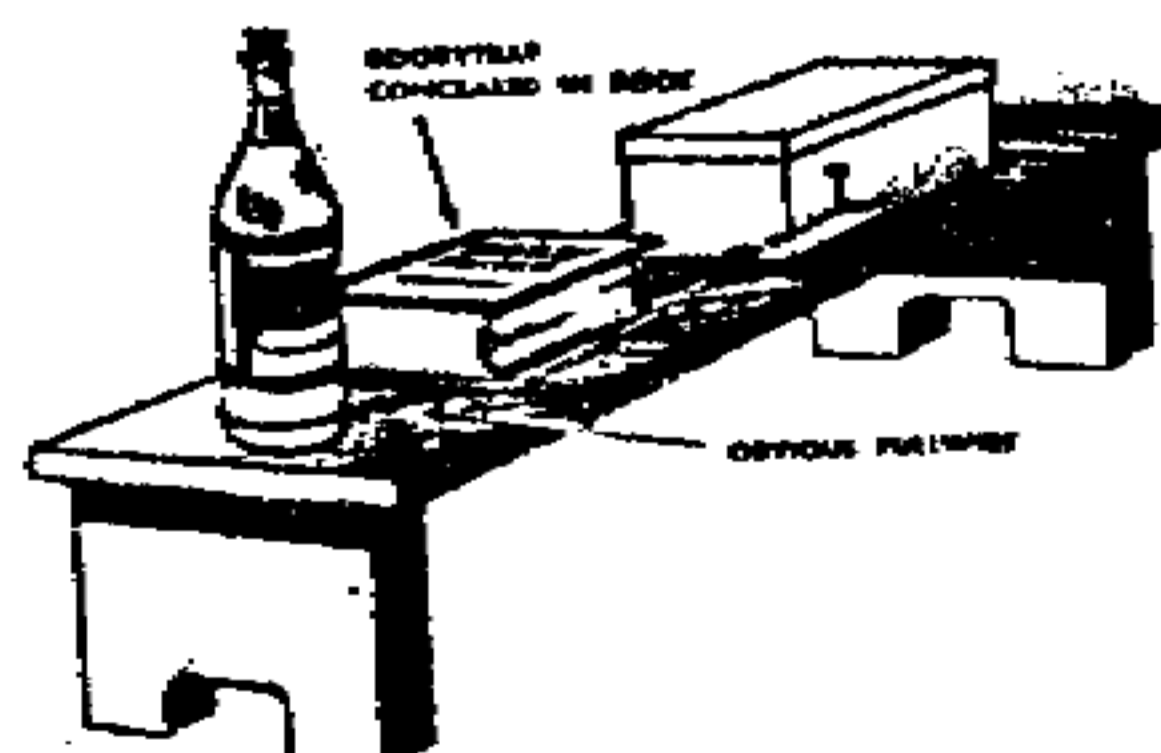
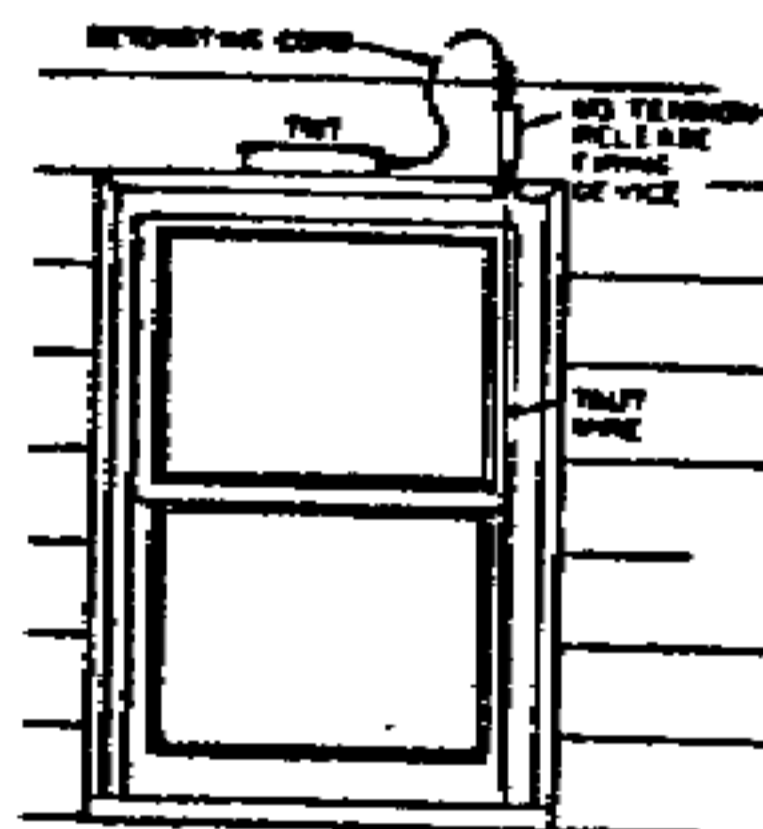

Scientific Principles of Improvised Warfare and Home Defense

4. Mines

Mines are mass produced booby traps manufactured for the armed forces of the world. They are generally of two types, anti-personnel and anti-tank, and are much more sophisticated than common traps. Modern designs allow some mines to be dug up and reused when they are needed elsewhere. This is because the supply of mines has historically run out before all the areas they can, or should be used in were covered. In order to stop German armor in WW2, the Soviet army laid over 220 million mines which caused over 22% of all tank casualties. In Vietnam, they accounted for 73% of all tank casualties. A single platoon can lay 500-1,000 mines per night which can make their protected positions very difficult to penetrate.

The simplest and slowest way of laying mines is by digging a spot in the ground and placing them in by hand. This individual attention makes them easy to conceal.

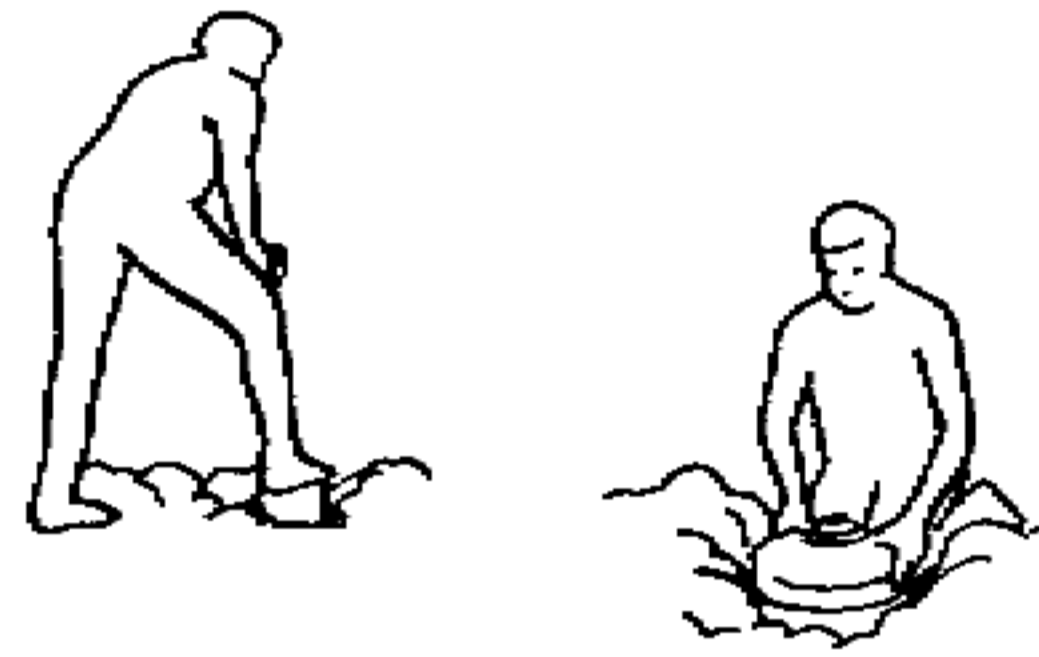

Many armies use mine plows to sow strips of anti-tank mines. The plow is usually towed behind an APC. The mine passes down a conveyor (1) where it is fused (2), and placed in a furrow (3) dug by the plow. A pair of discs at the rear (4) covers the furrow concealing the row of mines.

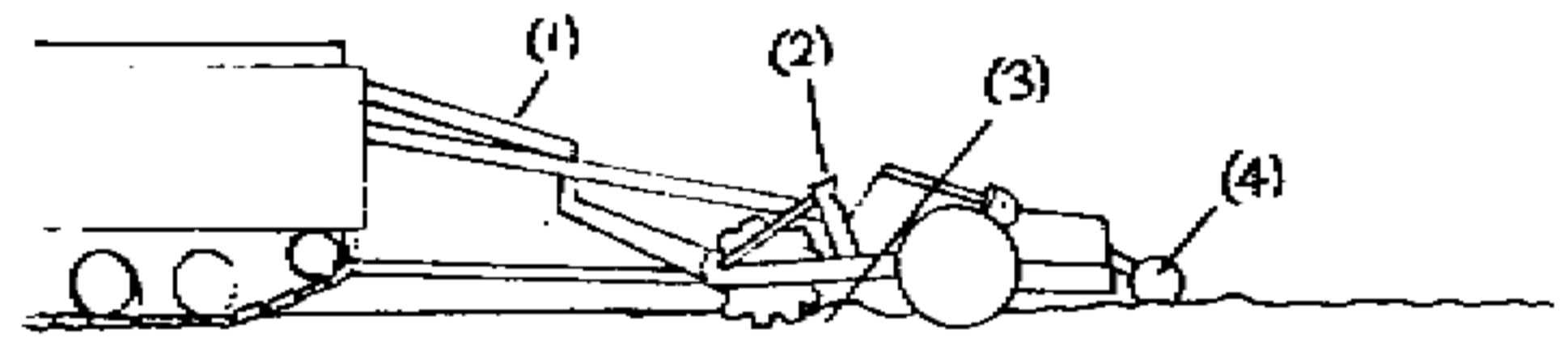

Rocket artillery can be used to deliver instant minefields up to thirty miles behind enemy lines. These are usually small mines called RDM's for "remote deployed mines". They are about the size of a grenade and generally cannot destroy a tank. They are able to knock the tracks off or damage the suspension. In addition they are capable of inflicting huge numbers of human casualties.

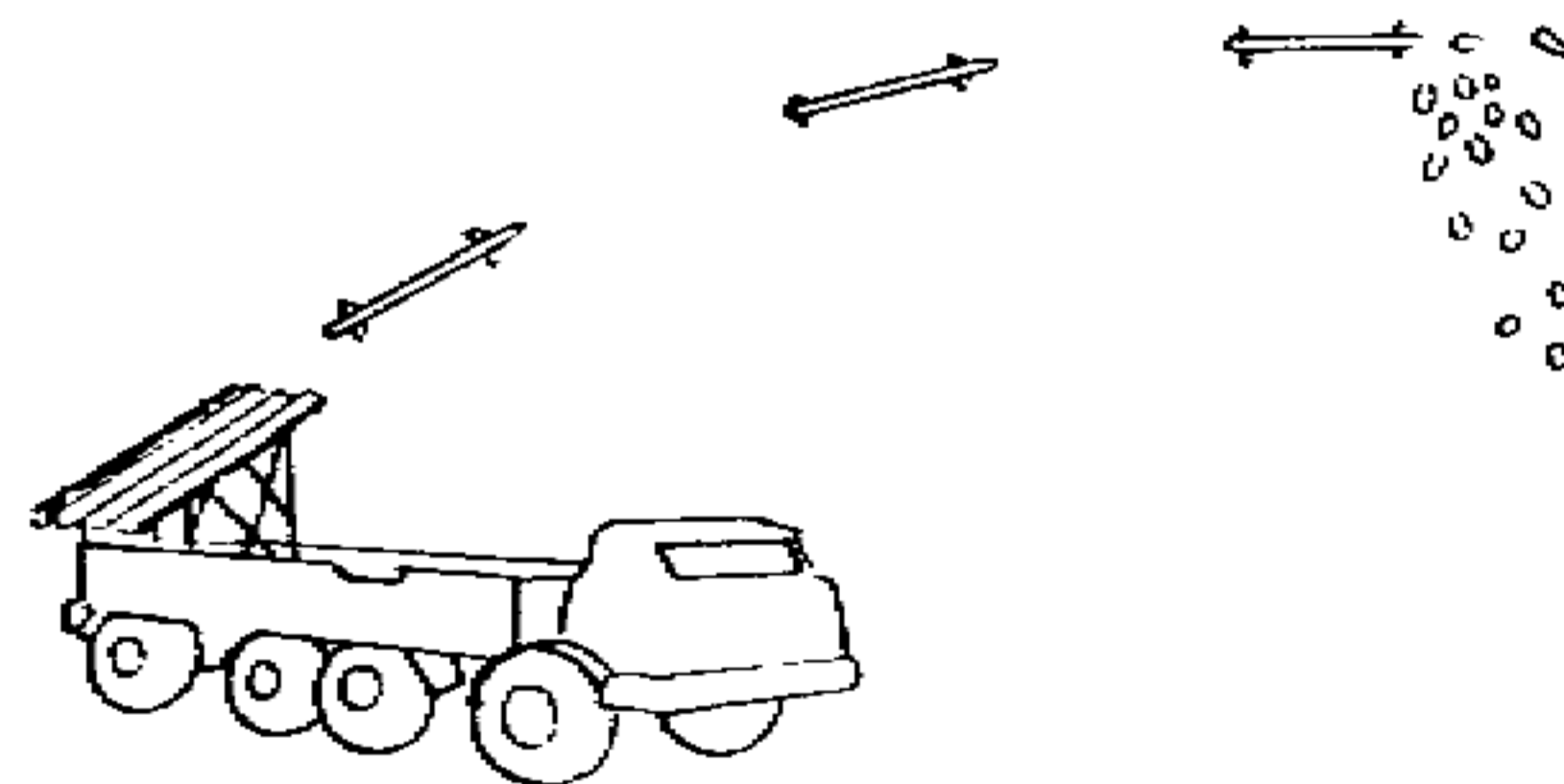

Scientific Principles of Improvised Warfare and Home Defense

Helicopters and APC's can also lay large minefields quickly when these smaller types are used.

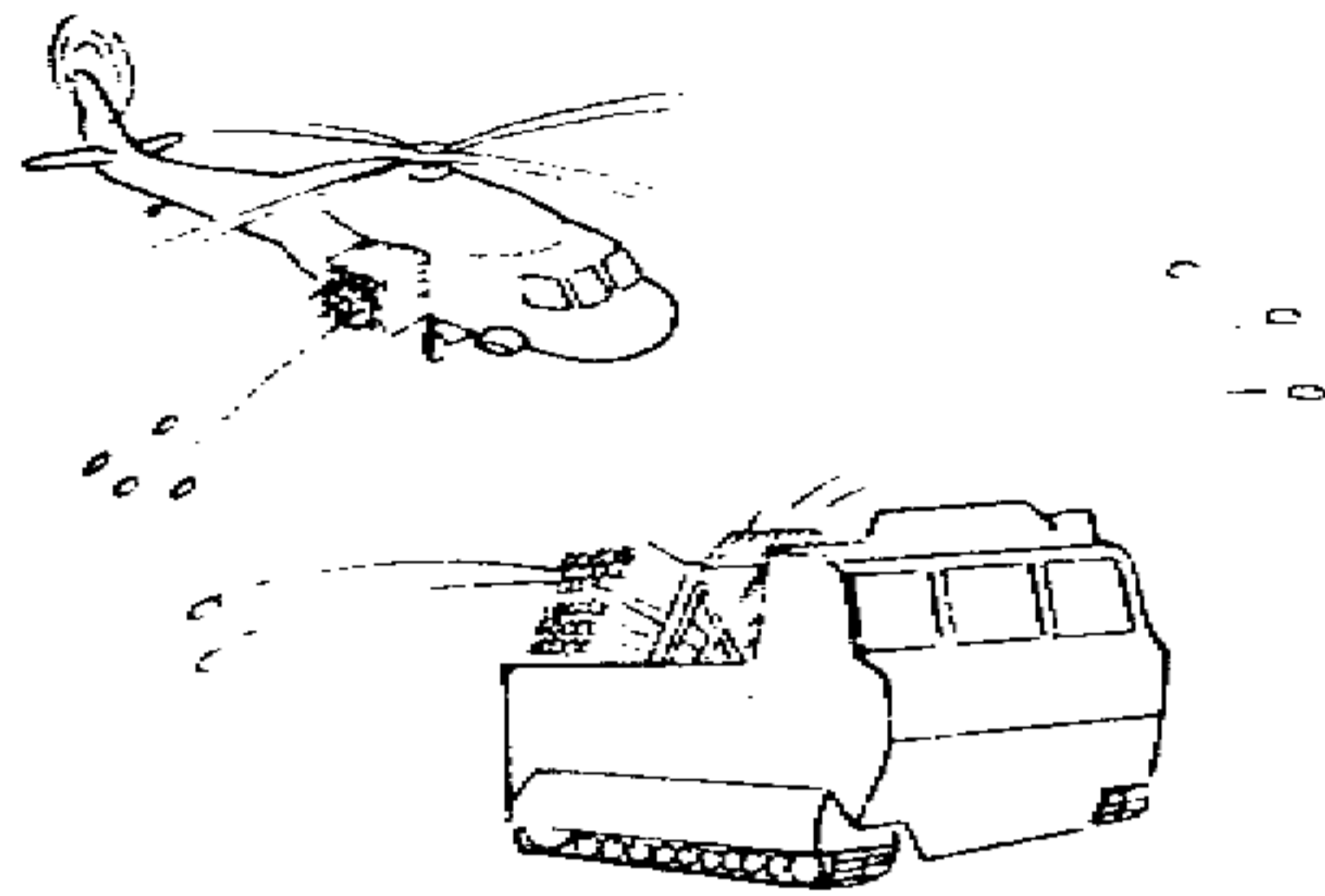

Anti helicopter mines were used in Vietnam with a fan blade on the top. When the fan is spun by the air wash of a helicopter, the mine is propelled upwards towards the copter and explodes about waist height. Electronics emissions and Infra Red can also be used for detonating mines.

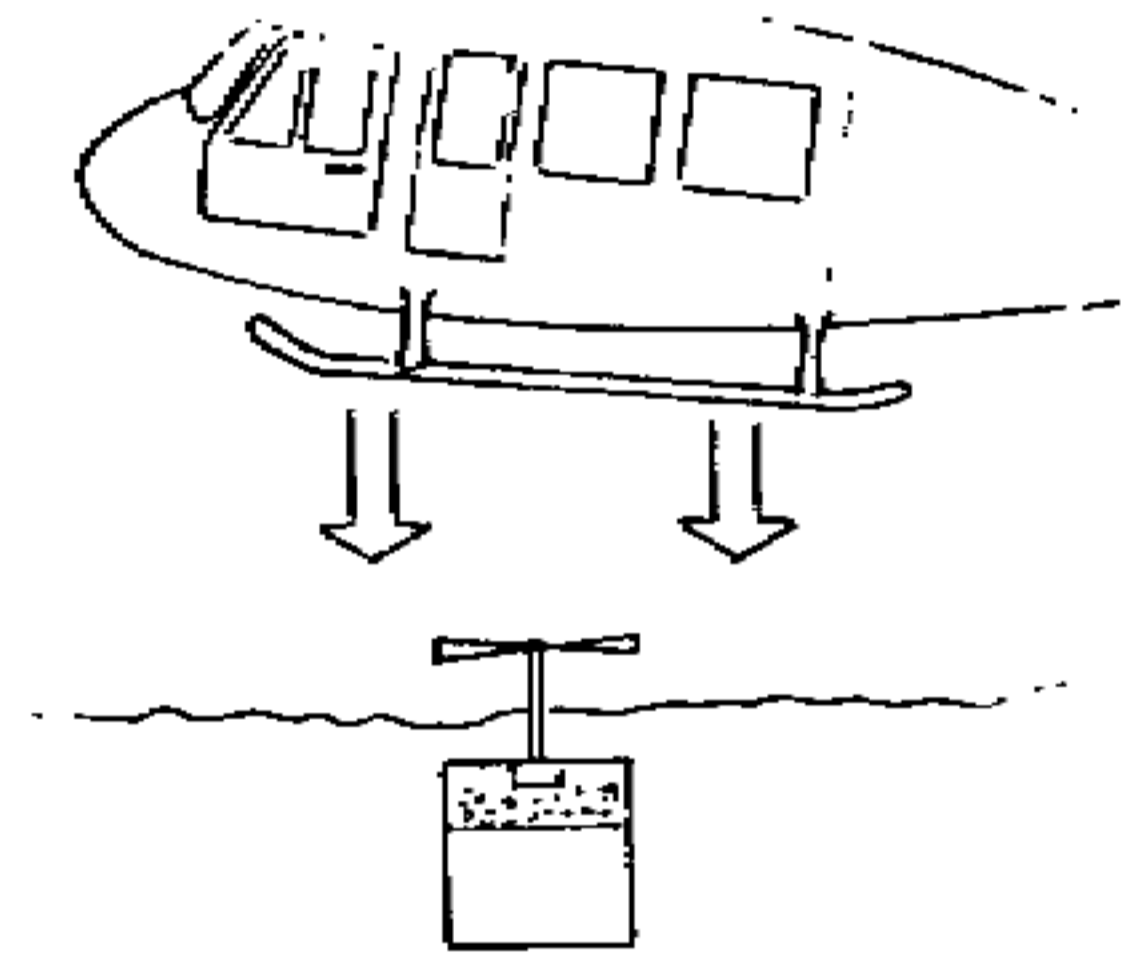

Mines are located by probing the ground with a knife or using a metal detector. Modern mines are often made of nonmetallic materials to prevent magnetic detection.

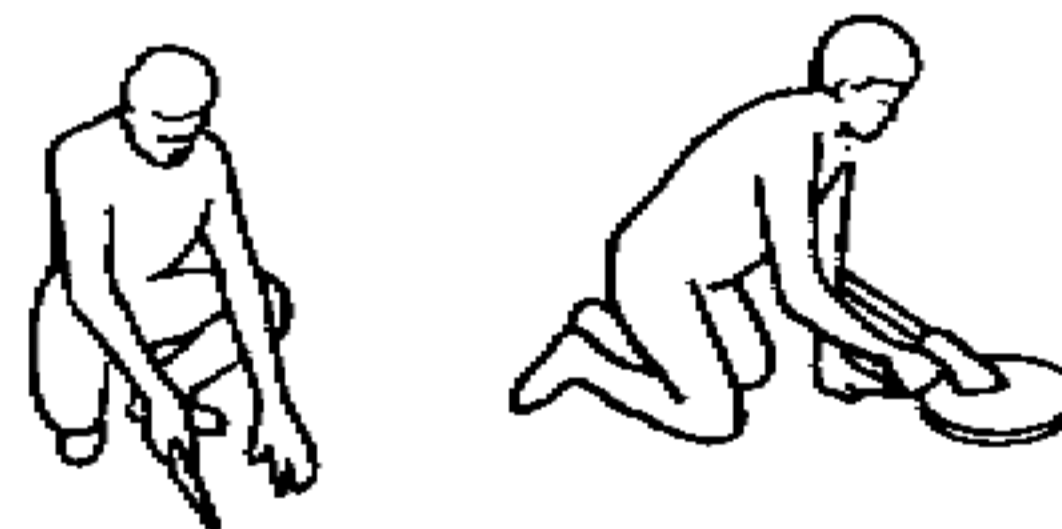

Scientific Principles of Improvised Warfare and Home Defense

Mine clearing tanks have been designed to

a. flail the ground with chains to cause pressure to detonate the mines

b. Using rollers to simulate the magnetic field of an armored vehicle

Newer mines are designed to be tripped twice to defeat these strategies. Newer ways of clearing a path includes using a plow (c) to push the ground and mines out of the way. The plow also deflects the blast of exploding mines.

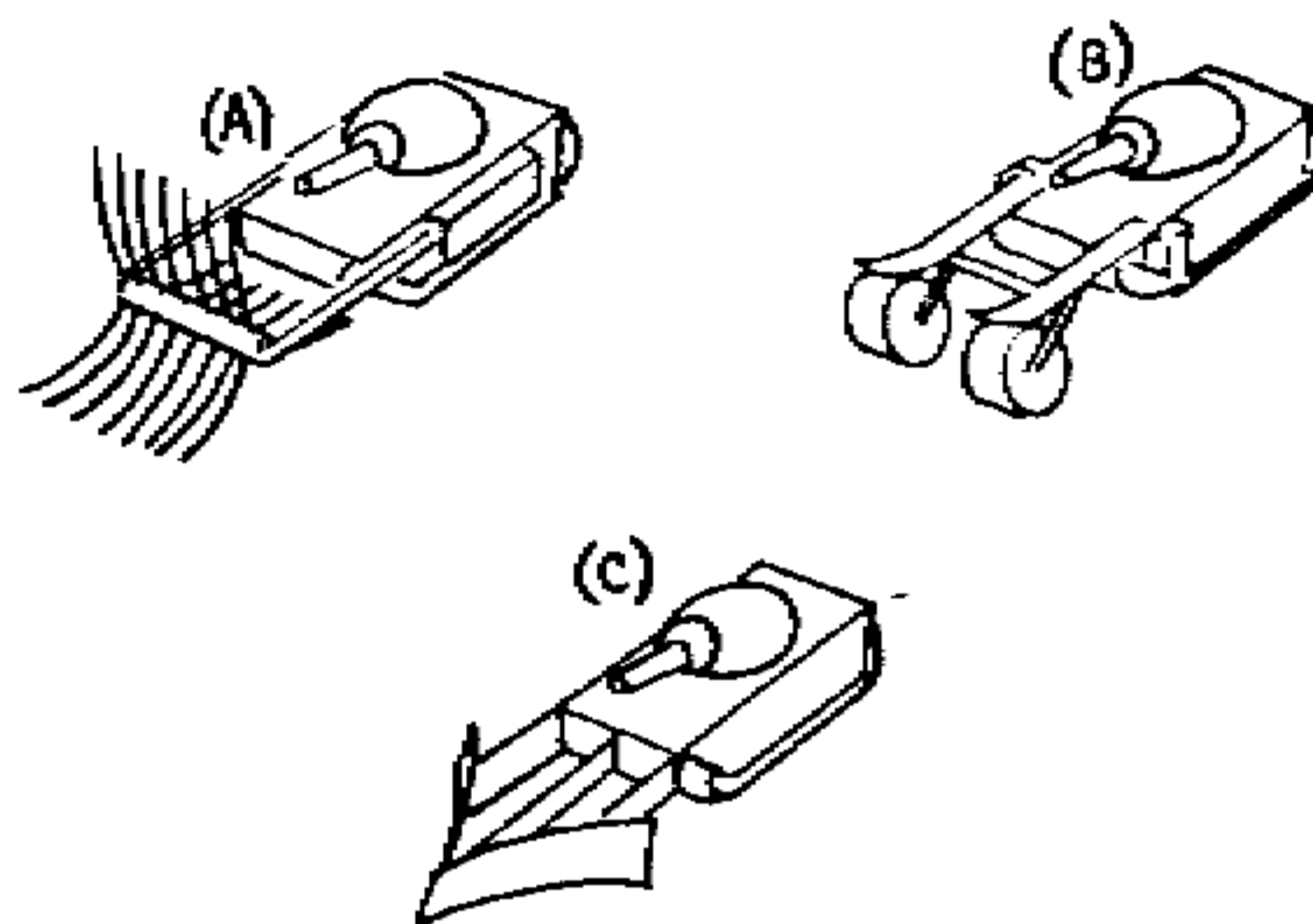

During Desert Storm, the US Marines used rockets to lay hoses filled with fuel air explosives to set off all the mines in a selected path with its massive overpressure.

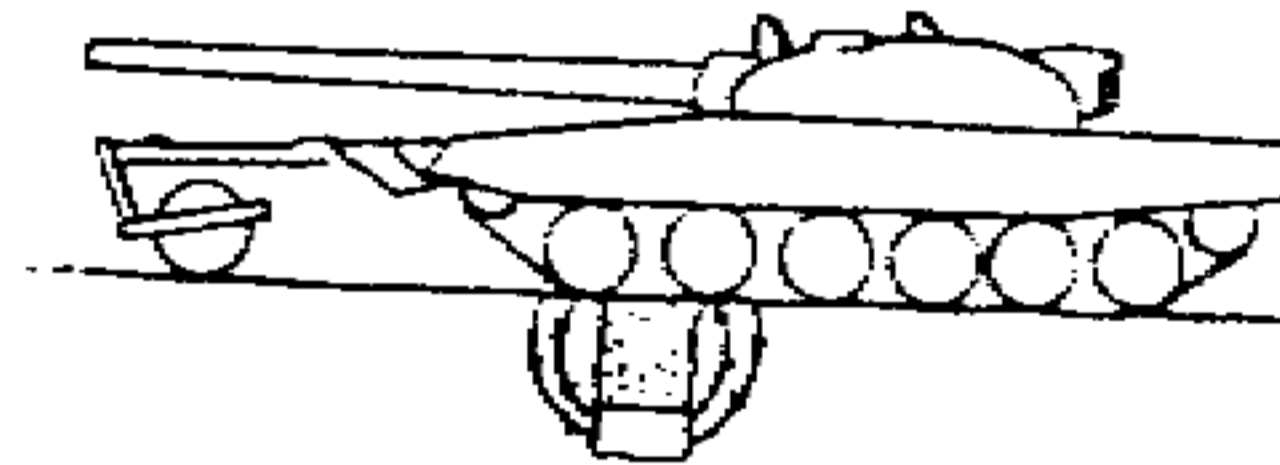

Sophisticated electronic mines can detect and measure the differences in the magnetic fields of different vehicles. When the desired vehicle hull is recognized, a clearance charge blows the ground overhead out of the way. The main charge is then launched towards the belly of the vehicle.

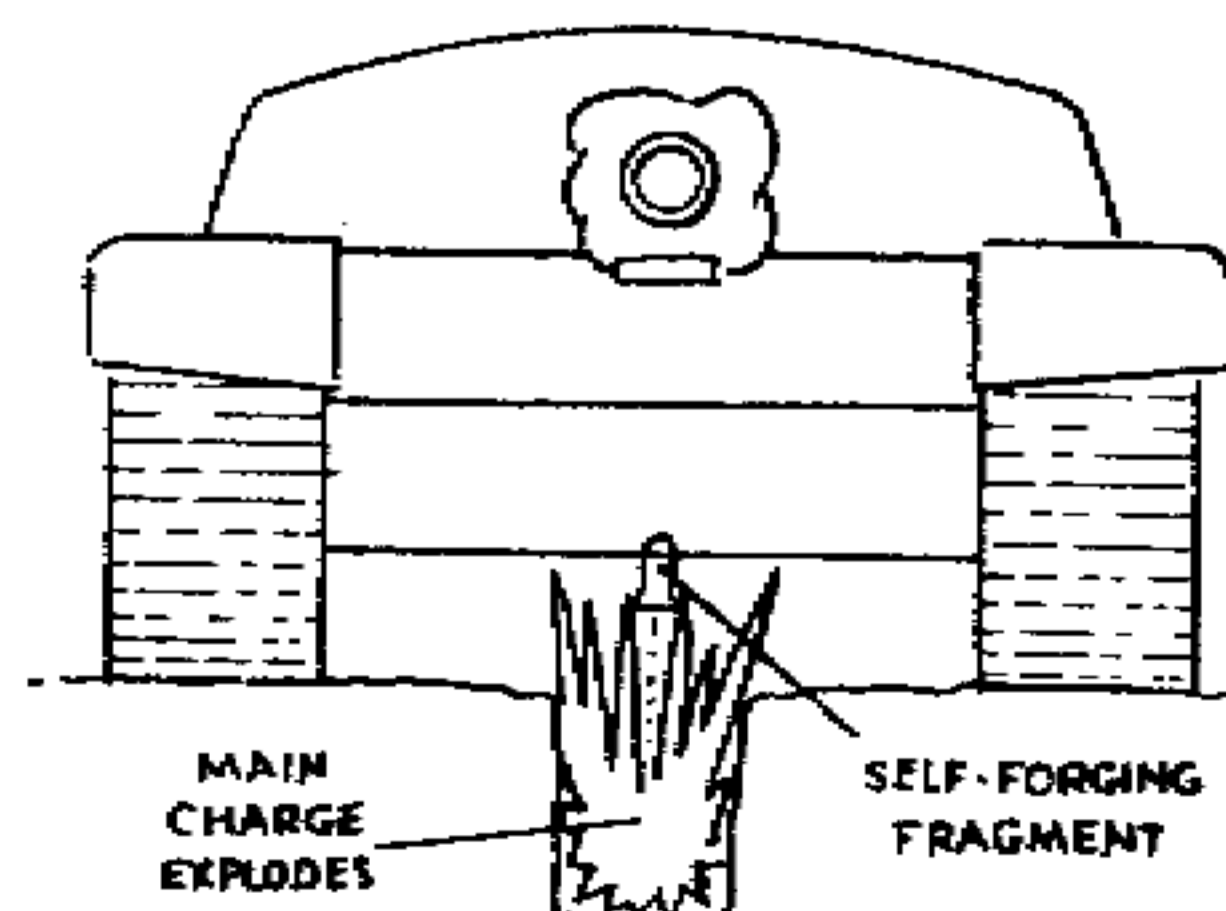
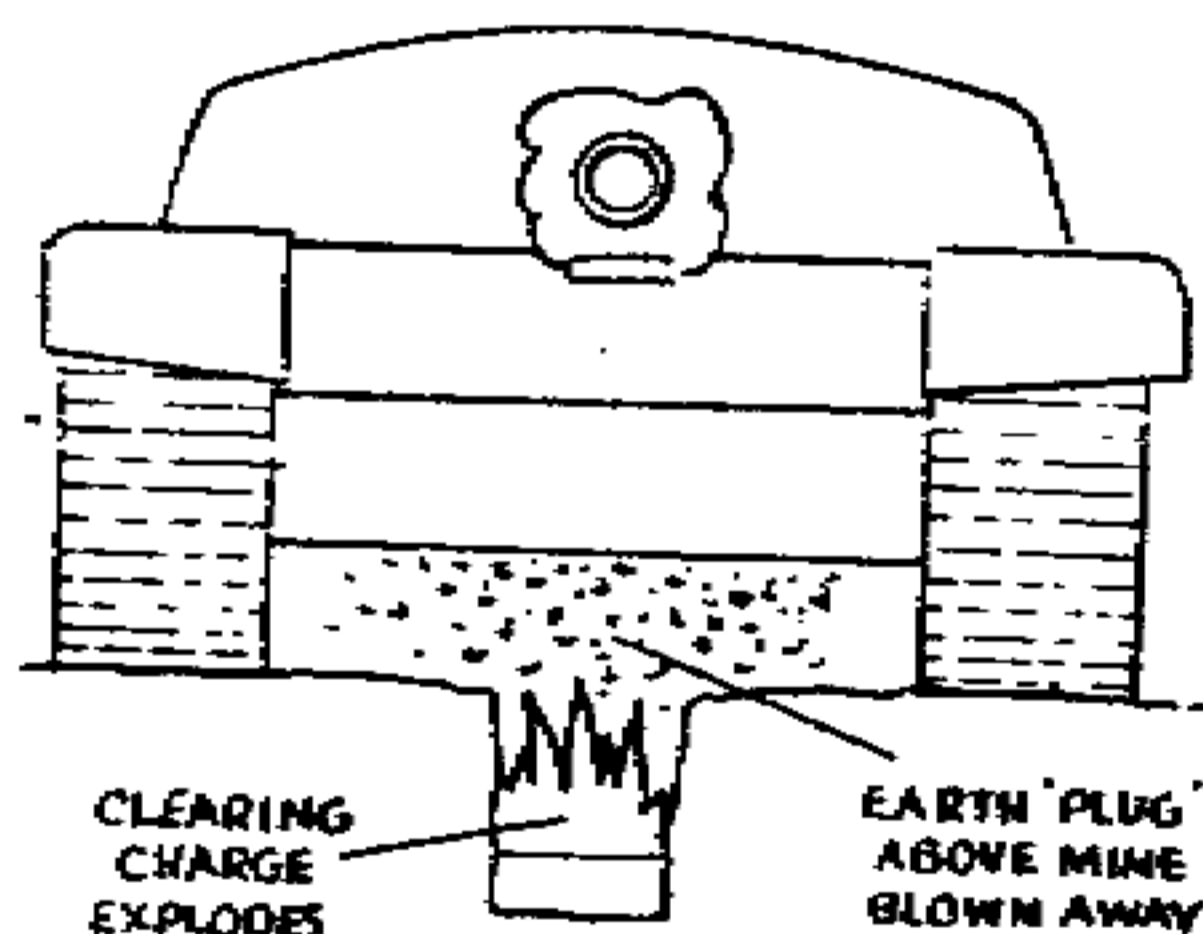

Scientific Principles of Improvised Warfare and Home Defense

5. Improvised positioned weapons

From the US Army Improvised Munitions Manual

a. Grenade Tin Can Land Mine

b. Mortar Scrap Mine

c. Fire Bottle Launcher

d. Electric Bulb Initiator

e. Delay Igniter from Cigarette

f. Watch Delay Timer

g. No Flash Fuse Igniter

h. Dried Seed Timer

j. Fuse Cords

k. Clothespin Time Delay Switch

l. Time Delay Grenade

m. Detonator

n. Can Liquid Time Delay

Scientific Principles of Improvised Warfare and Home Defense

a. Grenade Tin Can Land Mine

This device can be used as a land mine that will explode when the trip wire is pulled

Material Required

Hand grenade with side safety lever

Sturdy container, open at one end, that is just large enough to fit over grenade and its safety lever (tin can of proper size is suitable)

Strong string or wire

NOTE: The container must be small enough to prevent the safety lever from springing open. One end must be completely open.

Procedure

1. Fasten one piece of string to the closed end of the container, making a strong connection. This can be done by punching 2 holes in the can, looping the string through them, and tying a knot.



2. Tie free end of this string to a bush, stake, fencepost, etc.

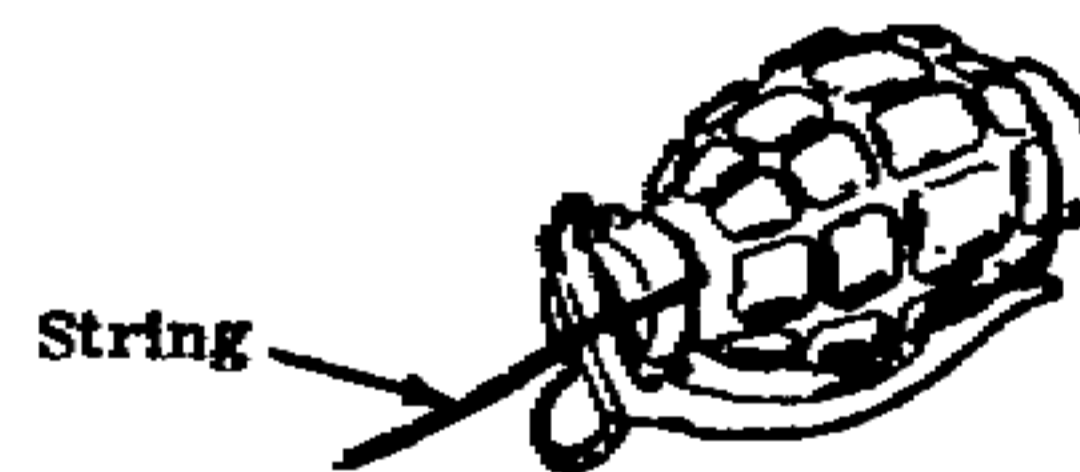

3. Fasten another length of string to the grenade so that it cannot interfere with the functioning of the ignition mechanism of the grenade.



4. Insert grenade into container.

Scientific Principles of Improvised Warfare and Home Defense

5. Lay free length of string across path and fasten to stake, bush, etc. The string should remain taut.

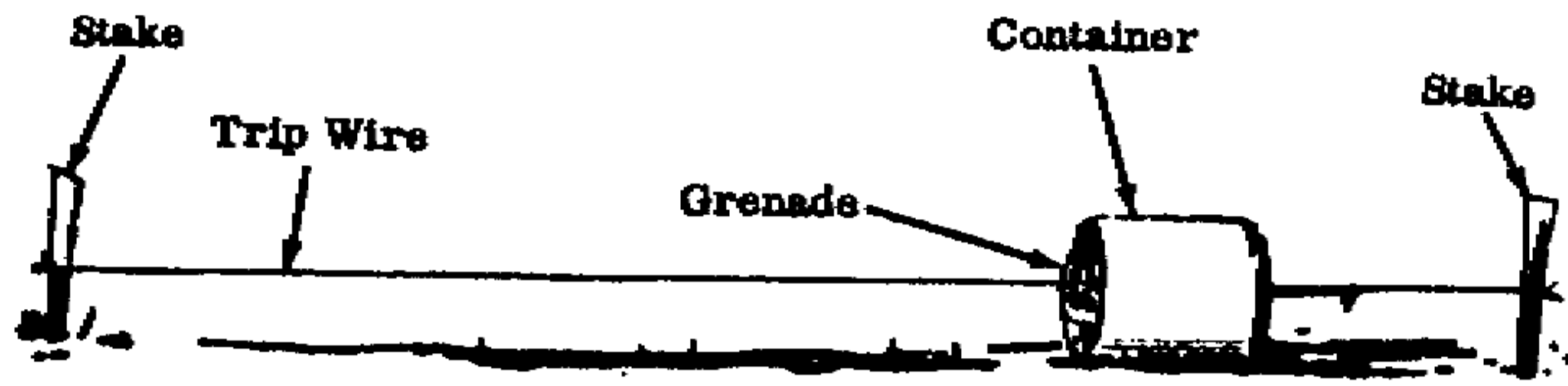

How to use

1. Carefully withdraw safety pin by pulling on ring. Be sure safety lever is restrained during this operation. Grenade will function in normal manner when trip wire is pulled.

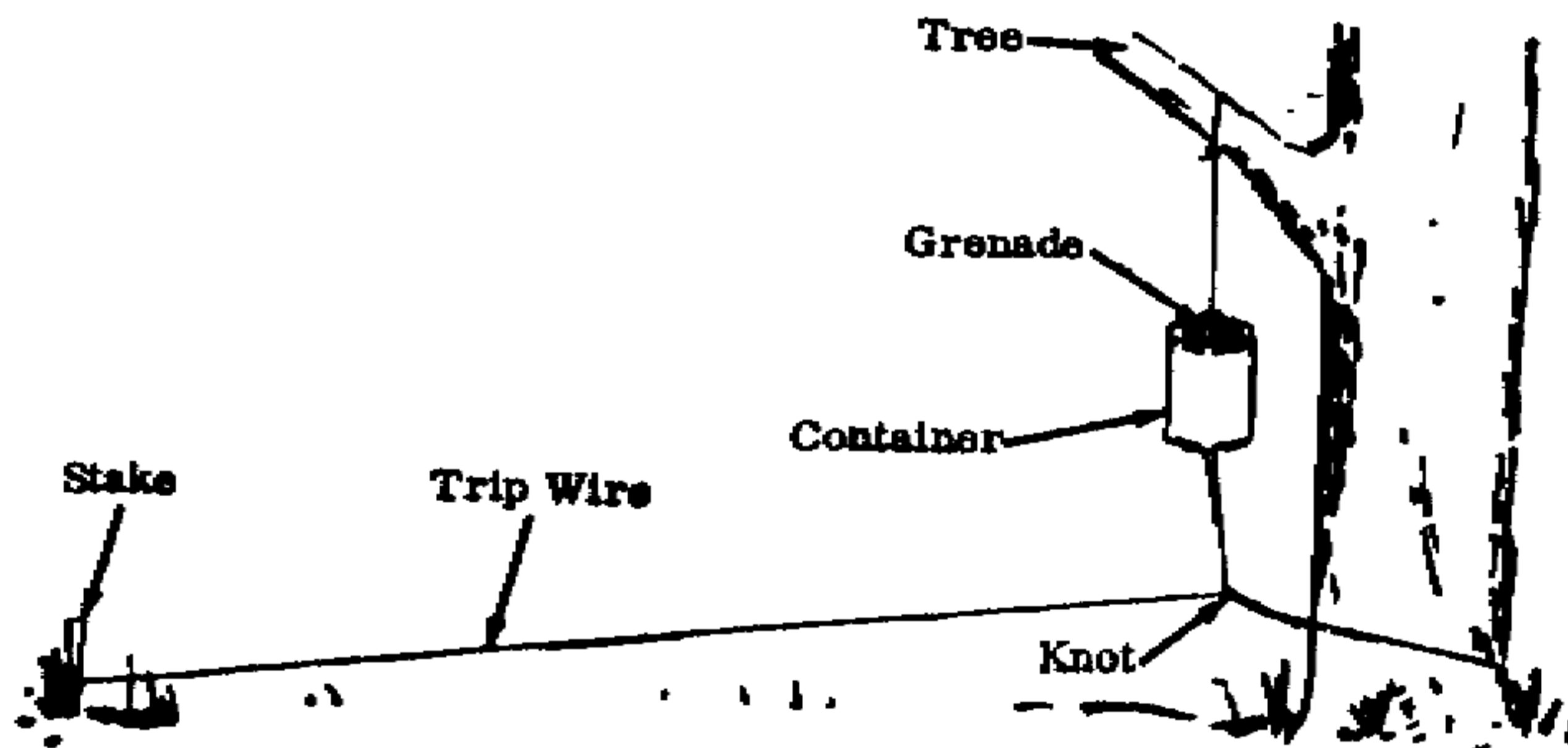

Scientific Principles of Improvised Warfare and Home Defense

b. Mortar Scrap Mine

A directional shrapnel launcher that can be placed in the path of advancing troops

Material Required

Iron pipe app. 3 ft. long and 2-4" in diameter and threaded on at least one end. Salvaged artillery cartridge case may be used.

Threaded cap to fit pipe.

Black powder or salvaged artillery propellant about 1/2 pound total.

Electrical igniter. Safety or improvised fuse may also be used.

Small stones about 1" in diameter or small size scrap; about one pound total.

Bags for wadding, each about 20"x20".

Paper or bag

Battery and wire

Stick (non metallic)

NOTE: Be sure pipe has no cracks or flaws

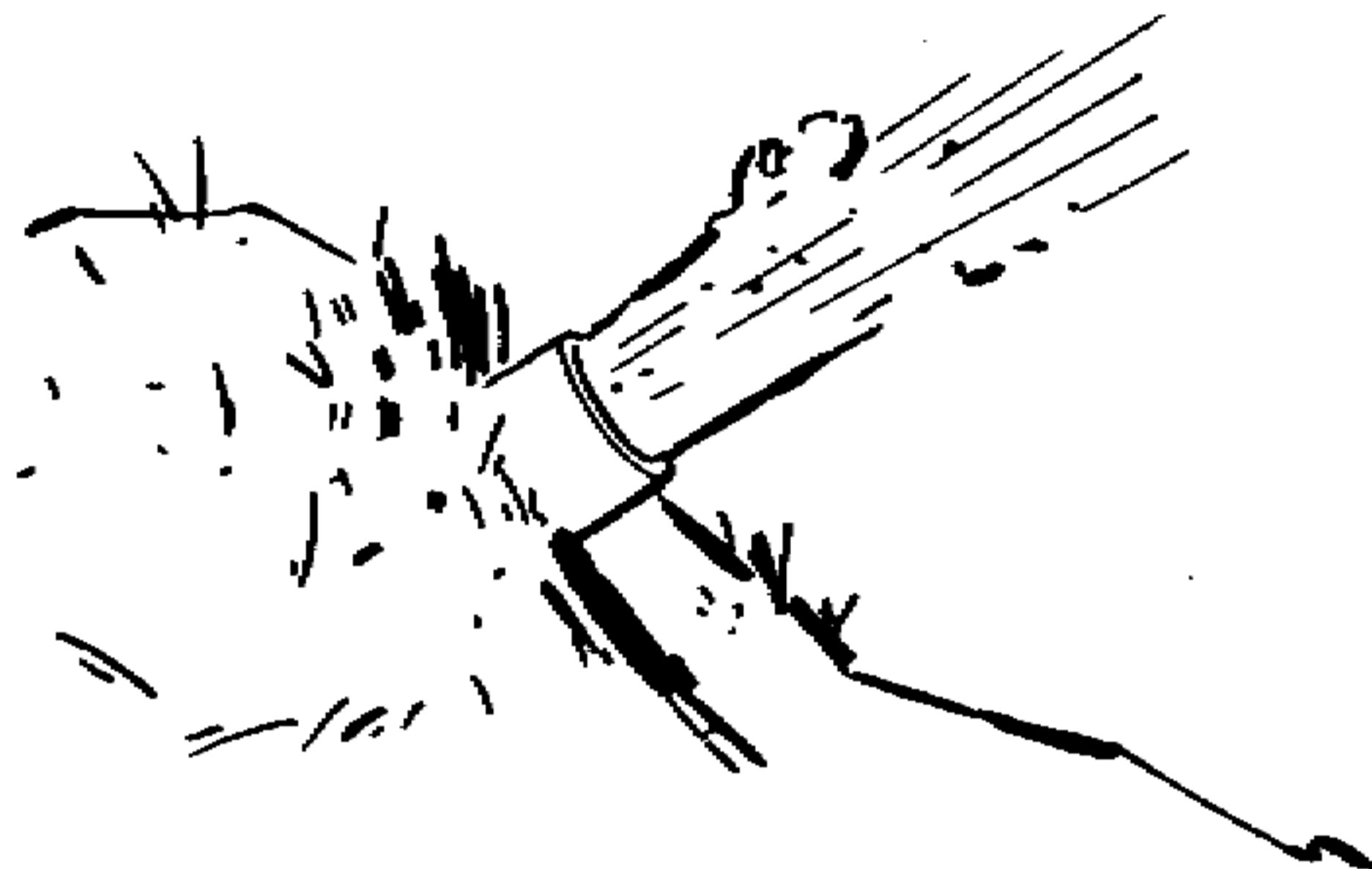

Procedure

1. Screw threaded cap onto pipe.
2. Place propellant and igniter in paper or rag and tie package with string so contents will not fall out.
3. Insert packaged propellant and igniter into pipe until package rests against threaded cap leaving firing leads extending from open end of pipe.
4. Roll rag till it is about 6" long and the same diameter as pipe. Insert rag wadding against packaged propellant igniter. With caution, pack tightly using stick.
5. Insert stones and/or scrap metal into pipe.
6. Insert second piece of rag wadding against stones and/or metal scrap. Pack tightly as before.

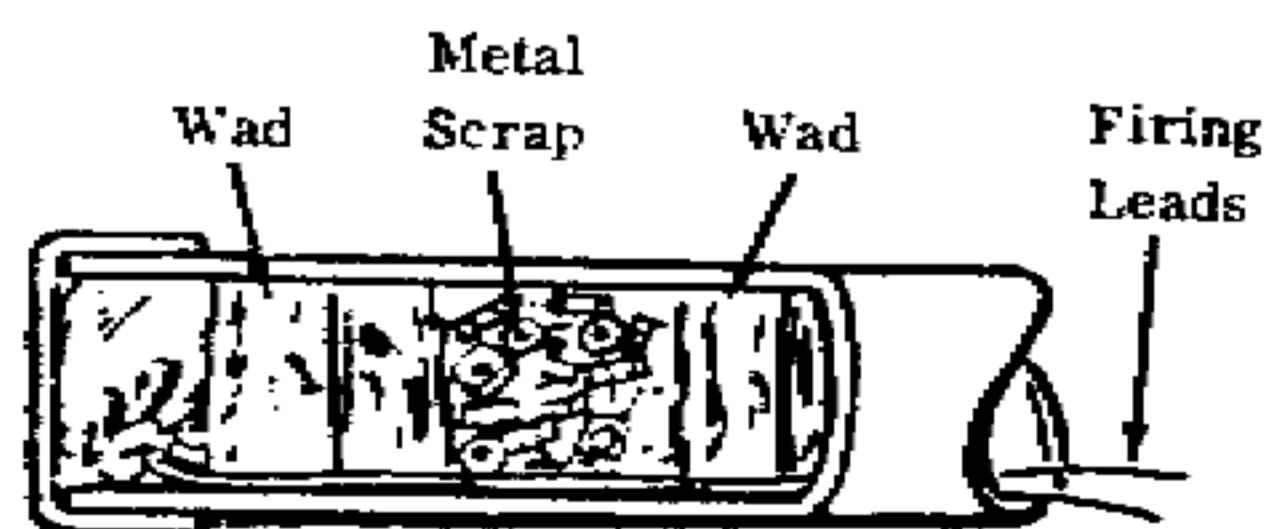
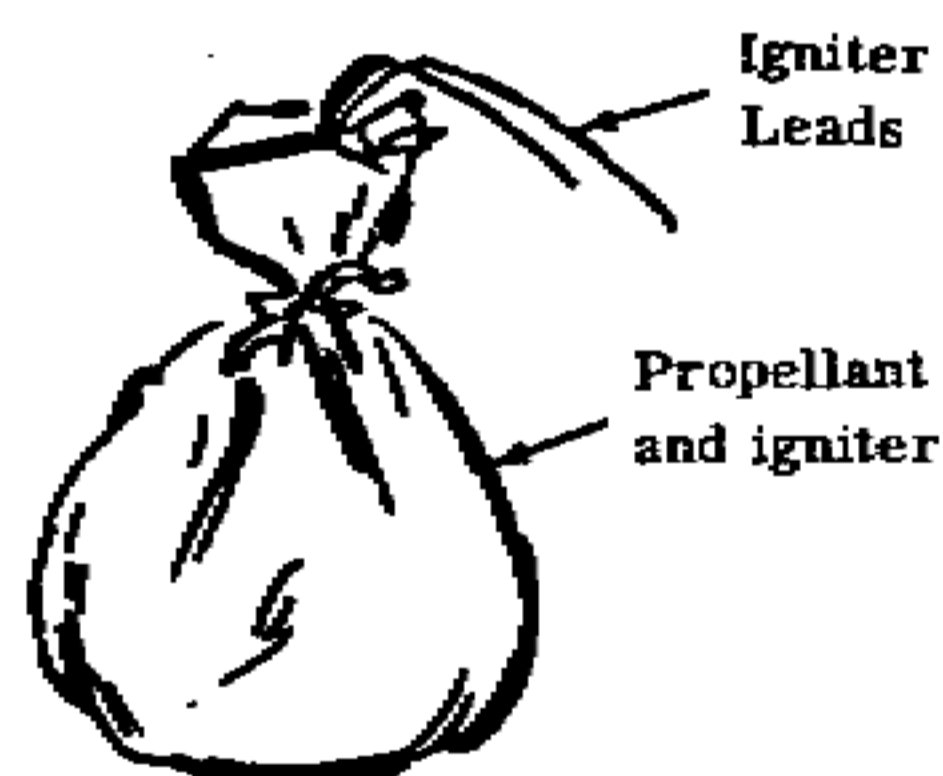

Scientific Principles of Improvised Warfare and Home Defense

How to use

1. Bury pipe in ground with open end facing the expected path of the enemy. The open end may be covered with cardboard and a thin layer of dirt or leaves as camouflage.

2. Connect firing leads to battery and switch. Mine can be remotely fired when needed or attached to trip device placed in path of advancing troops.



NOTE: A non electrical ignition system may be substituted for the electrical ignition system as follows.

1. Follow above procedure, substituting safety fuse for igniter.

2. Light safety fuse when ready to fire.

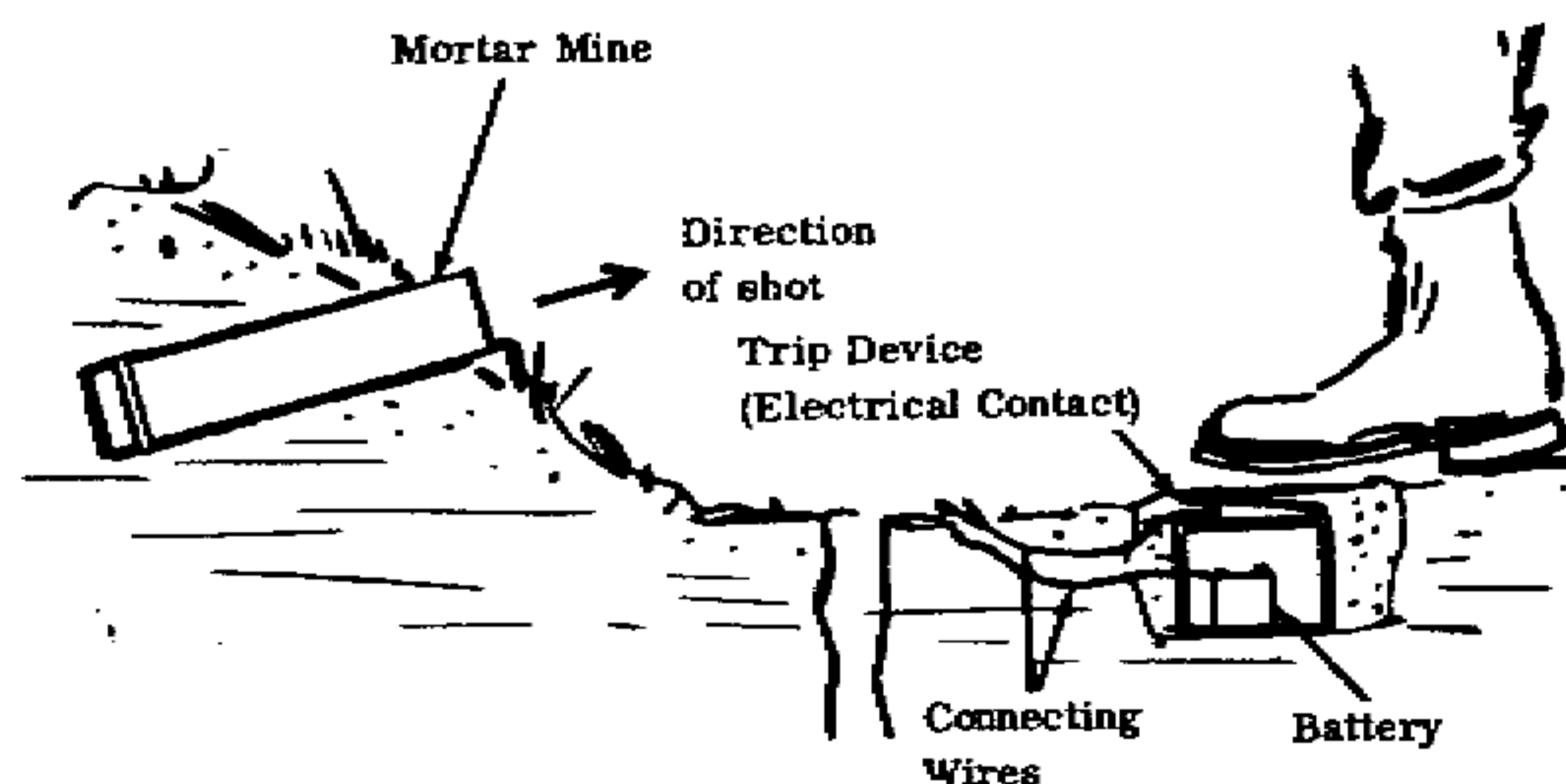

Scientific Principles of Improvised Warfare and Home Defense

C. Fire Bottle Launcher

A device using 2 items (shotgun and chemical fire bottle) that can be used to start or place a fire 80 yards from launcher.

Material required

Standard 12 gauge or improvised shotgun
Improvised fire bottle (Incendiary chapter)
Tin can, about 4" in diameter and 5-1/2" high
Wood, about 3" x 3" x 2"
Nail, at least 3" long
Nuts and bolts, or nails, at least 2-1/2" long
Rag
Paper
Drill

If Standard Shotgun is Used

Hard wood stick, about the same length as shotgun barrel and about 5/8" in diameter. Stick need not be round.
2 washers, having outside diameter of 5/8"
Rubber disk, 3/4" in diameter and 1/4" thick. Leather or cardboard can be used.
12 gauge shotgun ammunition

If Improvised Shotgun is Used

Fuse, safety or improvised fast burning
Hard wood stick, 3/4" in diameter and about same length as the shotgun barrel
Black powder- 9 grams (135 grains)

Scientific Principles of Improvised Warfare and Home Defense

Procedure

Method 1 - If Improvised Shotgun is Used

1. Drill 2 small holes in center of wood block app. 1" deep. Hole should have app. the same diameter as the wooden stick.

2. Drill 2 small holes on opposite sides of the wooden block. Hole should be large enough for bolts to pass through.

3. Fasten can to block with nuts and bolts.

NOTE: Can may also be securely fastened to block by hammering several nails through can and block. Do not drill holes, and be careful not to split wood.

4. Place wooden stick into hole in wooden block. Drill small hole (same diameter as that of the 3" nail) through wooden block and through wooden stick. Insert nail in hole.

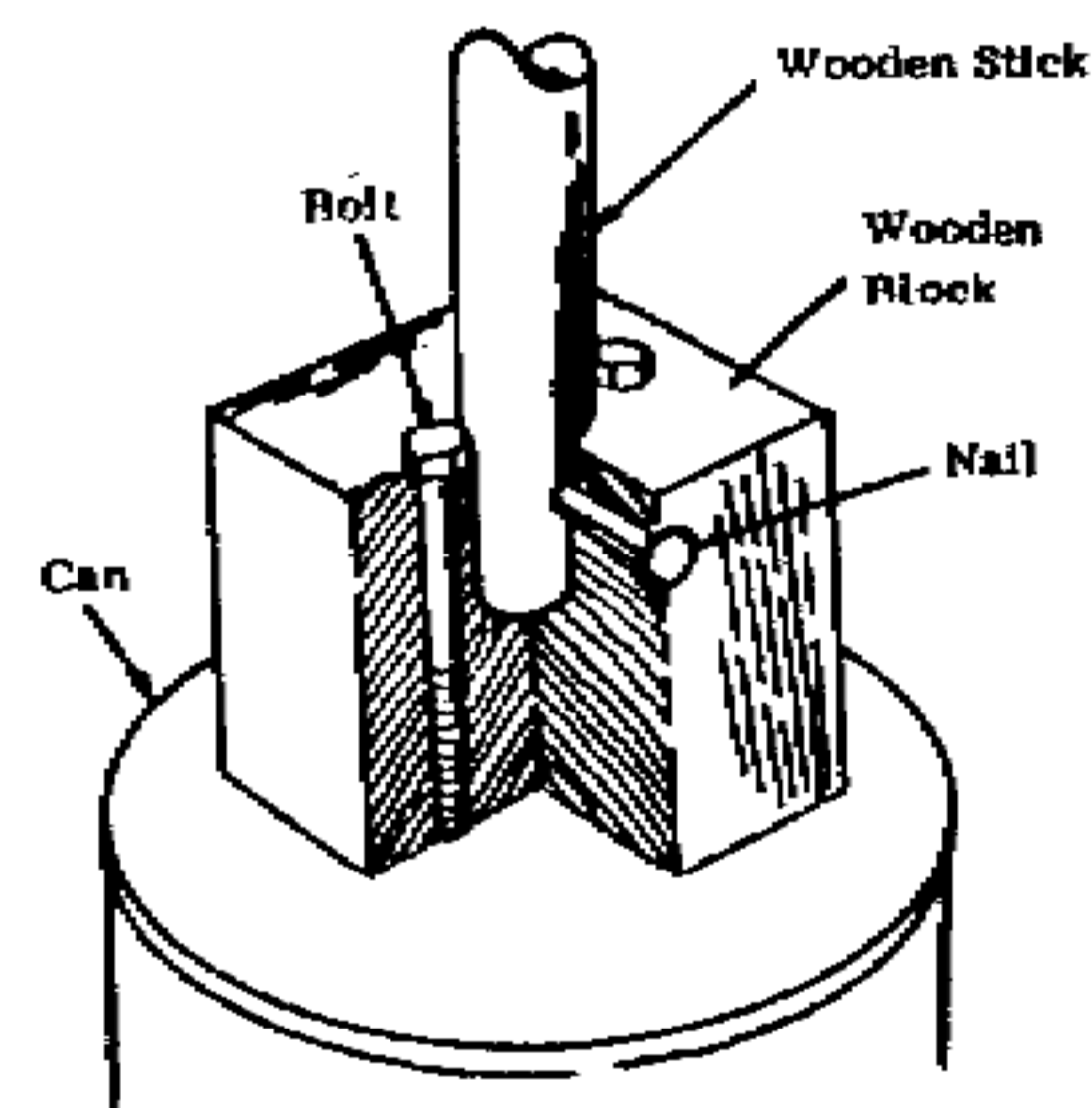
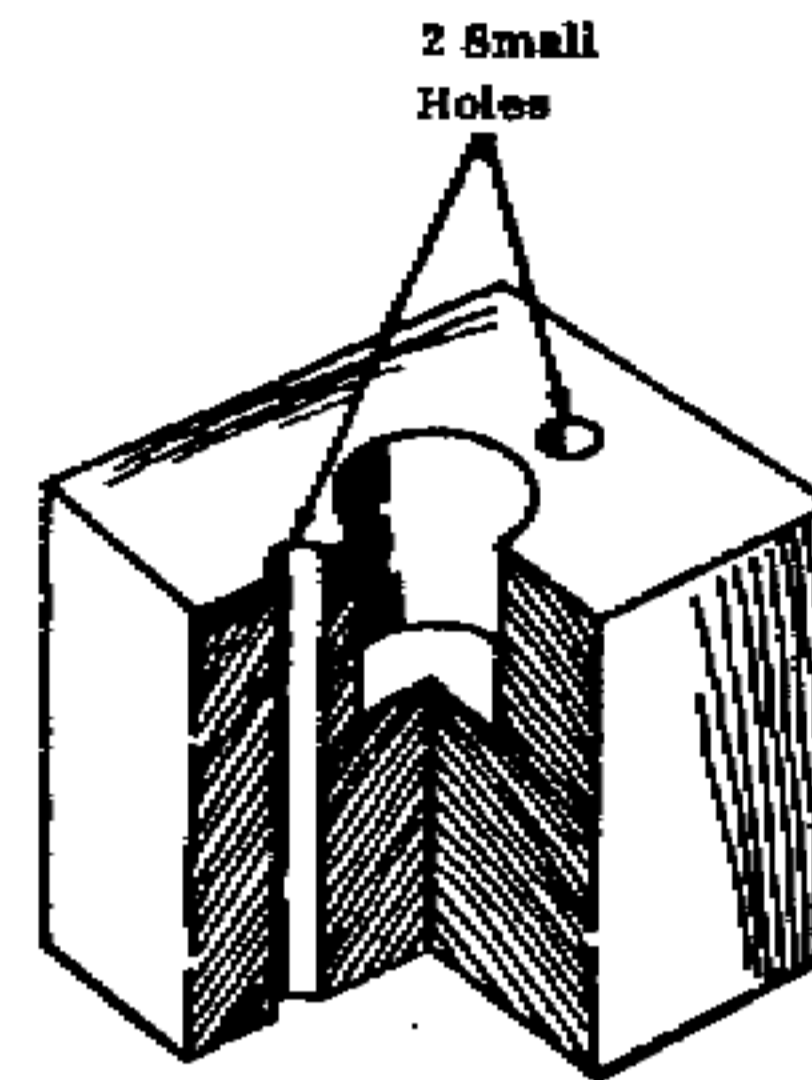

Scientific Principles of Improvised Warfare and Home Defense

5. Crumple paper and place in bottom of can. Place another piece of paper around fire bottle and insert in can. Use enough paper so that bottle will fit snugly.

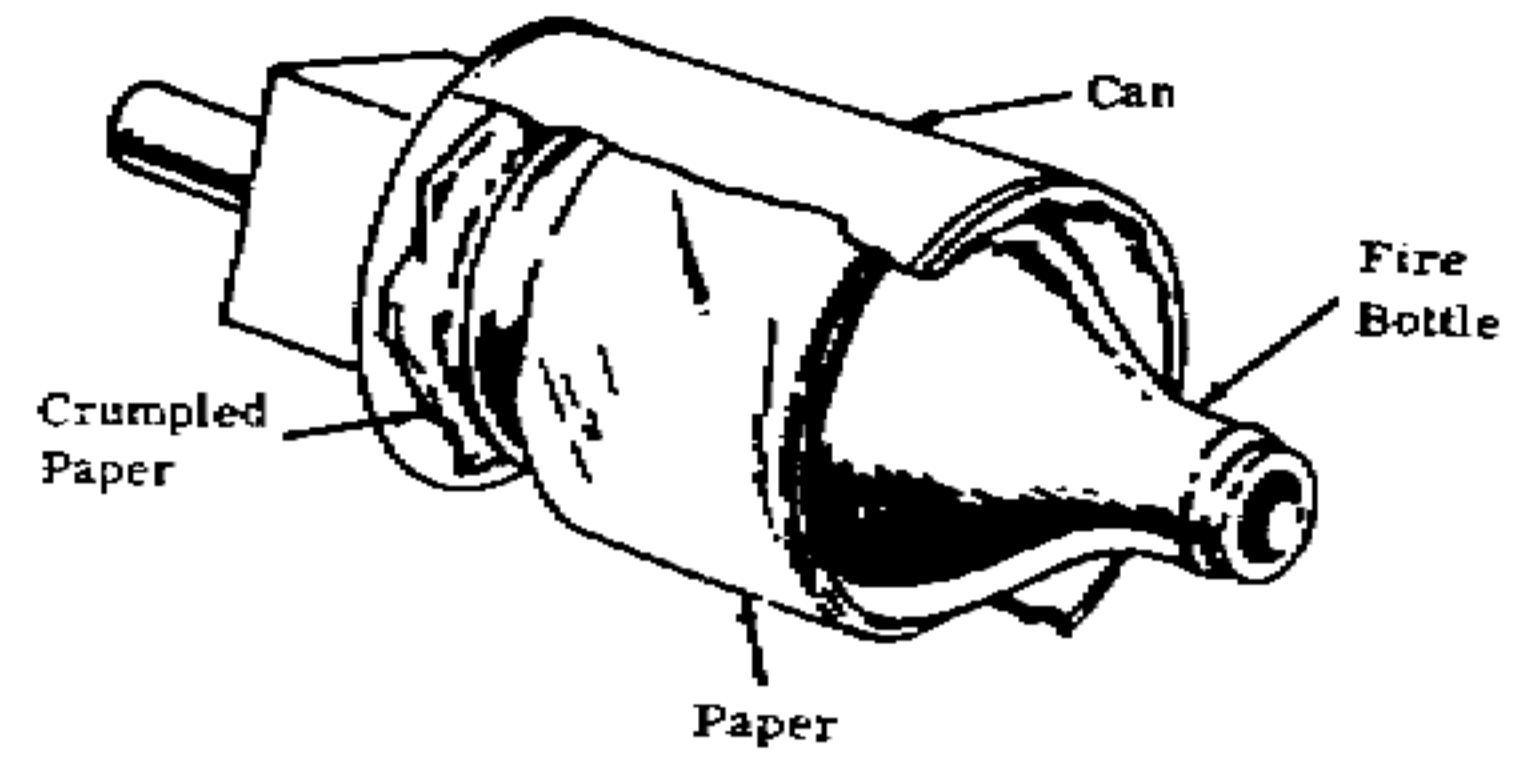

6. Place safety fuse and black powder on paper. Tie each end with string.

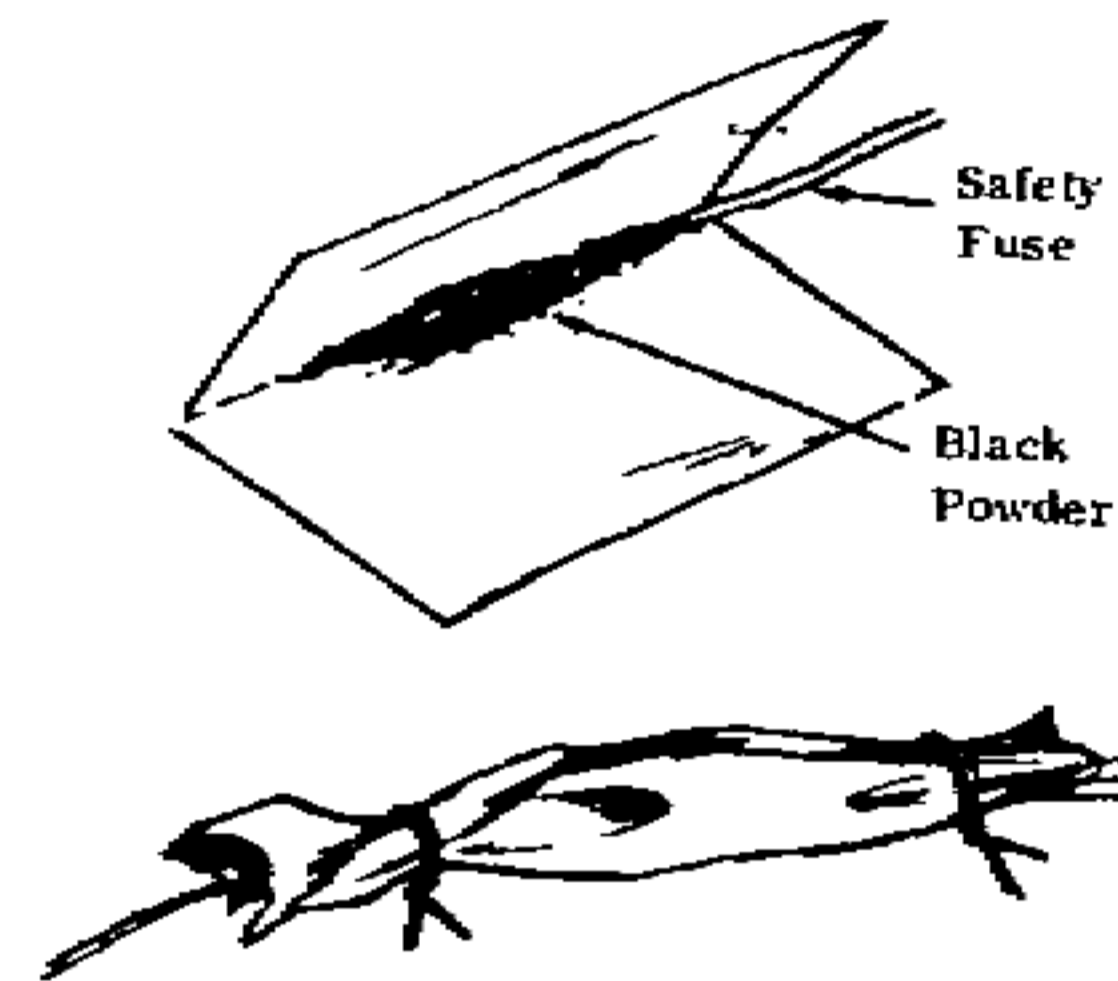

7. Thread fuse through hole in plug. Place powder package in rear of shotgun. Screw plug finger tight into coupling.

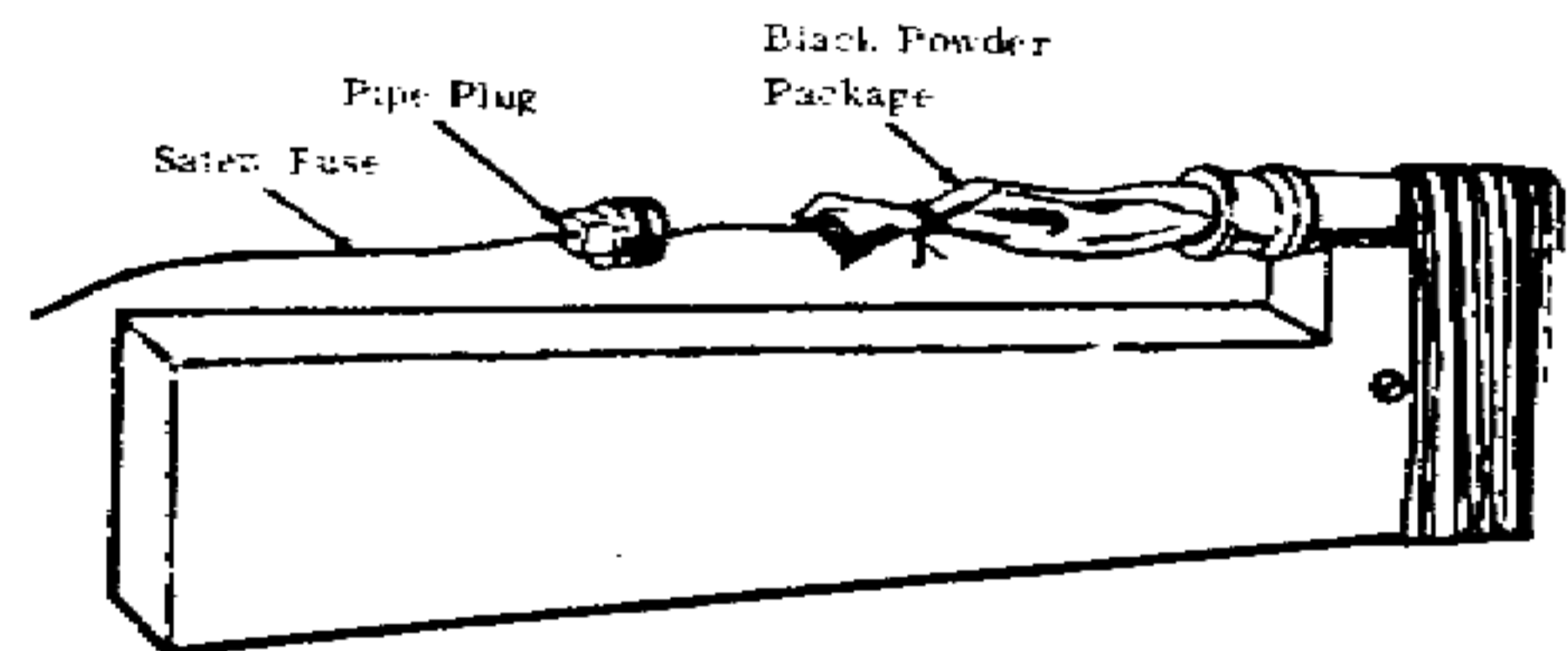

NOTE: Hole in plug may have to be enlarged for fuse.

8. Insert rag into front of shotgun. Pack rag against powder package with stick.
USE CAUTION.

Scientific Principles of Improvised Warfare and Home Defense

Method II - If Standard Shotgun is Used

1. Follow steps 1 and 2 of shotgun grenade launcher
2. Follow procedure of method 1, steps 1-5.
3. Follow steps 9-11 of shotgun grenade launcher (chapter 4) using 1/3 of total propellant instead of 1/2.
4. Load cartridge in gun.

How to use

1. Insert stick and holder containing chemical fire bottle.

Caution: Do Not tilt muzzle downward

2. Hold gun against ground at 45 degree angle and light fuse.

Caution: Severe burns may result if bottle shatters when fired. If possible, obtain a bottle identical to that being used as the fire bottle. Fill about 2/3 full of water and fire as above. If bottle shatters when fired instead of being launched intact, use a different type of bottle.

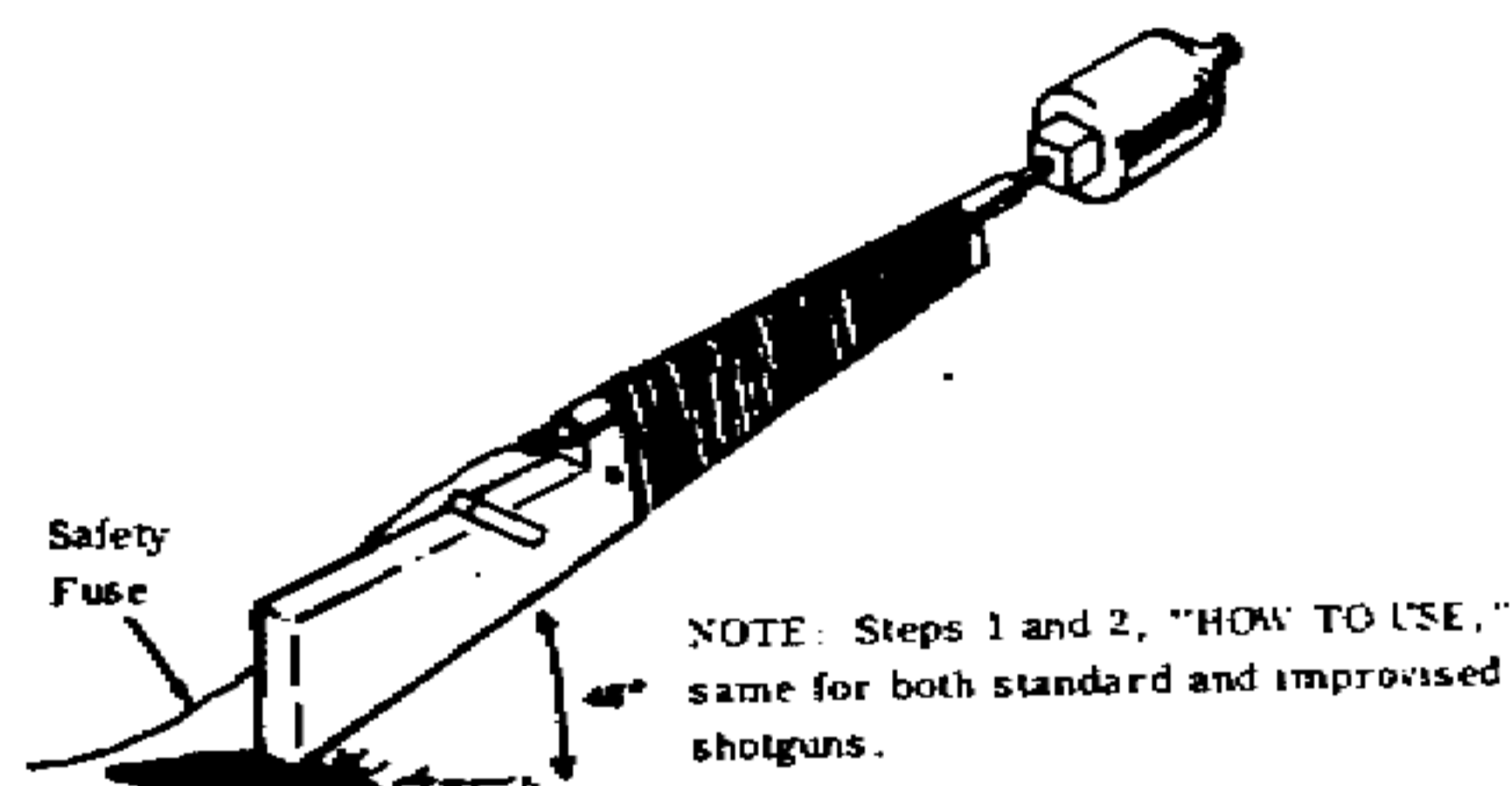
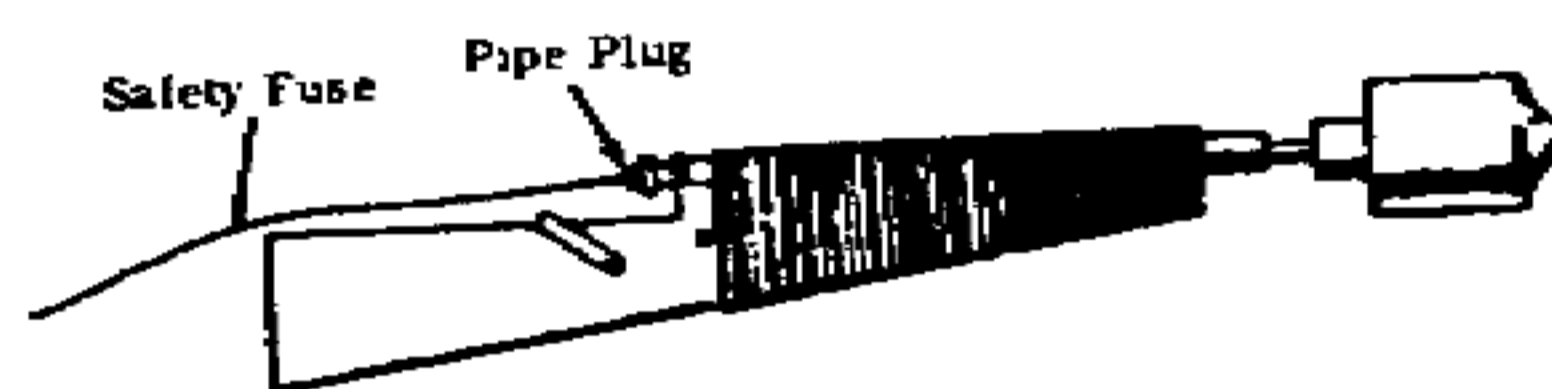

Scientific Principles of Improvised Warfare and Home Defense

d. Electric Bulb Initiator

Mortar, mines and similar weapons often make use of electric initiators. An electric initiator can be made using a flashlight or automobile electric light bulb.

Material Required

Electric light bulb and mating socket
Cardboard or heavy paper
Black Powder
Adhesive tape

Procedure

Method 1

1. Break the glass of the electric light bulb. Take care not to damage the filament. The initiator will not work if the filament is broken. Remove all glass above the base of the bulb.

2. Form a tube 3-4" long from cardboard or heavy paper to fit around the base of the bulb.

3. Fit the tube to the bulb base and tape into place.

Make sure that the tube does not cover that portion of the bulb base that fits into the socket.

4. If no socket is available for connecting the initiator to the firing circuit, solder the connecting wires to the bulb base.

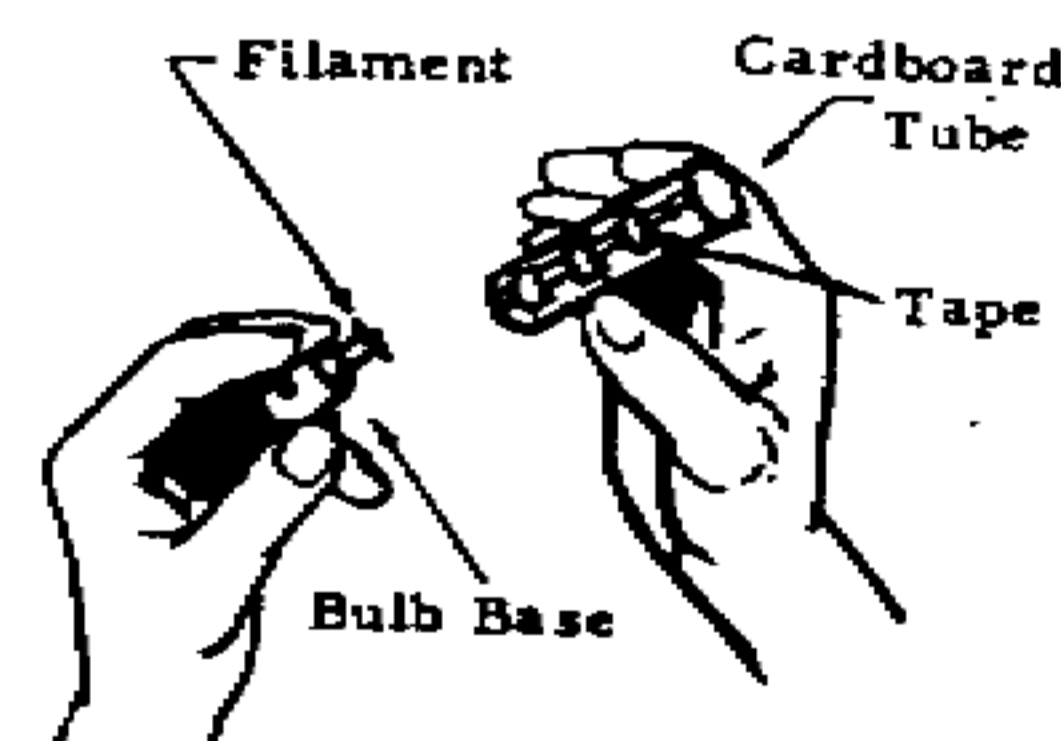
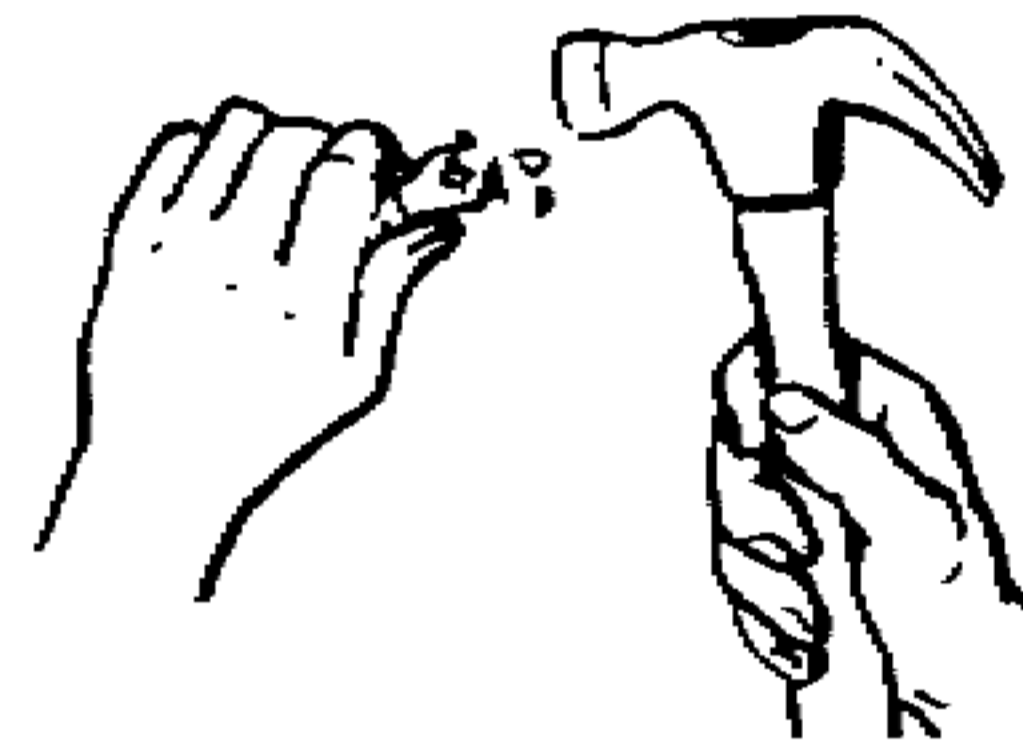
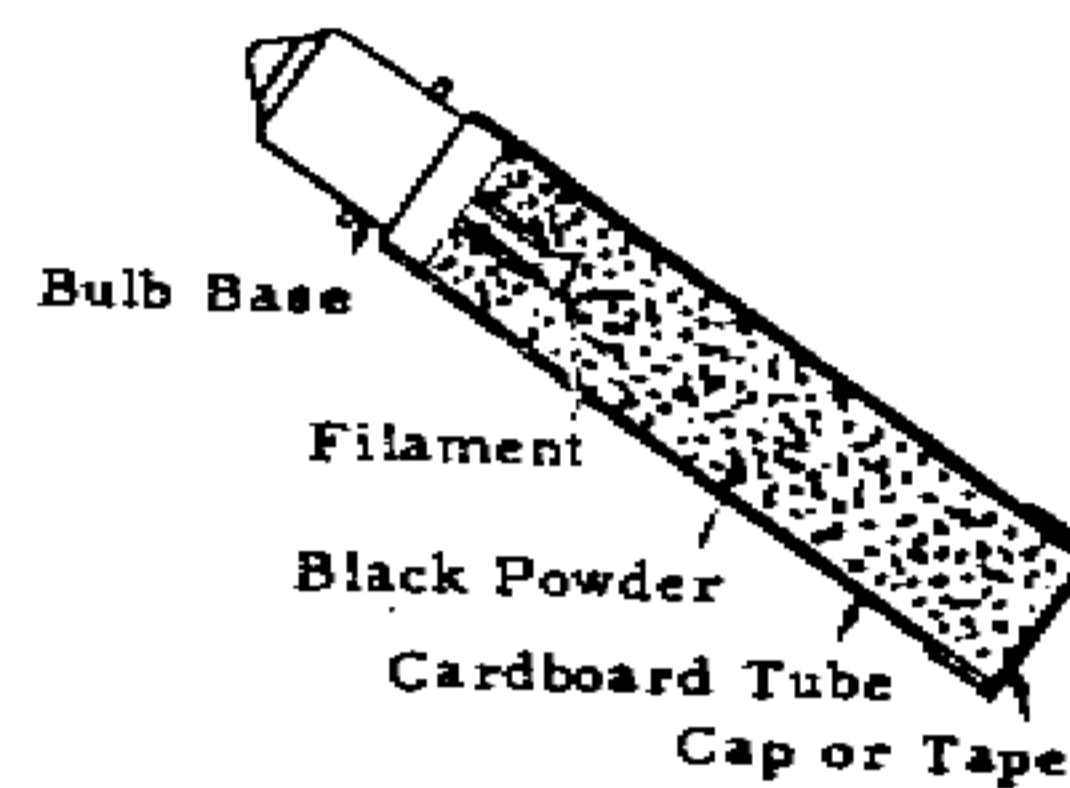

Scientific Principles of Improvised Warfare and Home Defense

CAUTION: Do not use a hot soldering iron on the completed igniter since it may ignite the black powder.

5 Fill the tube with black powder and tape the open end of the tube closed.

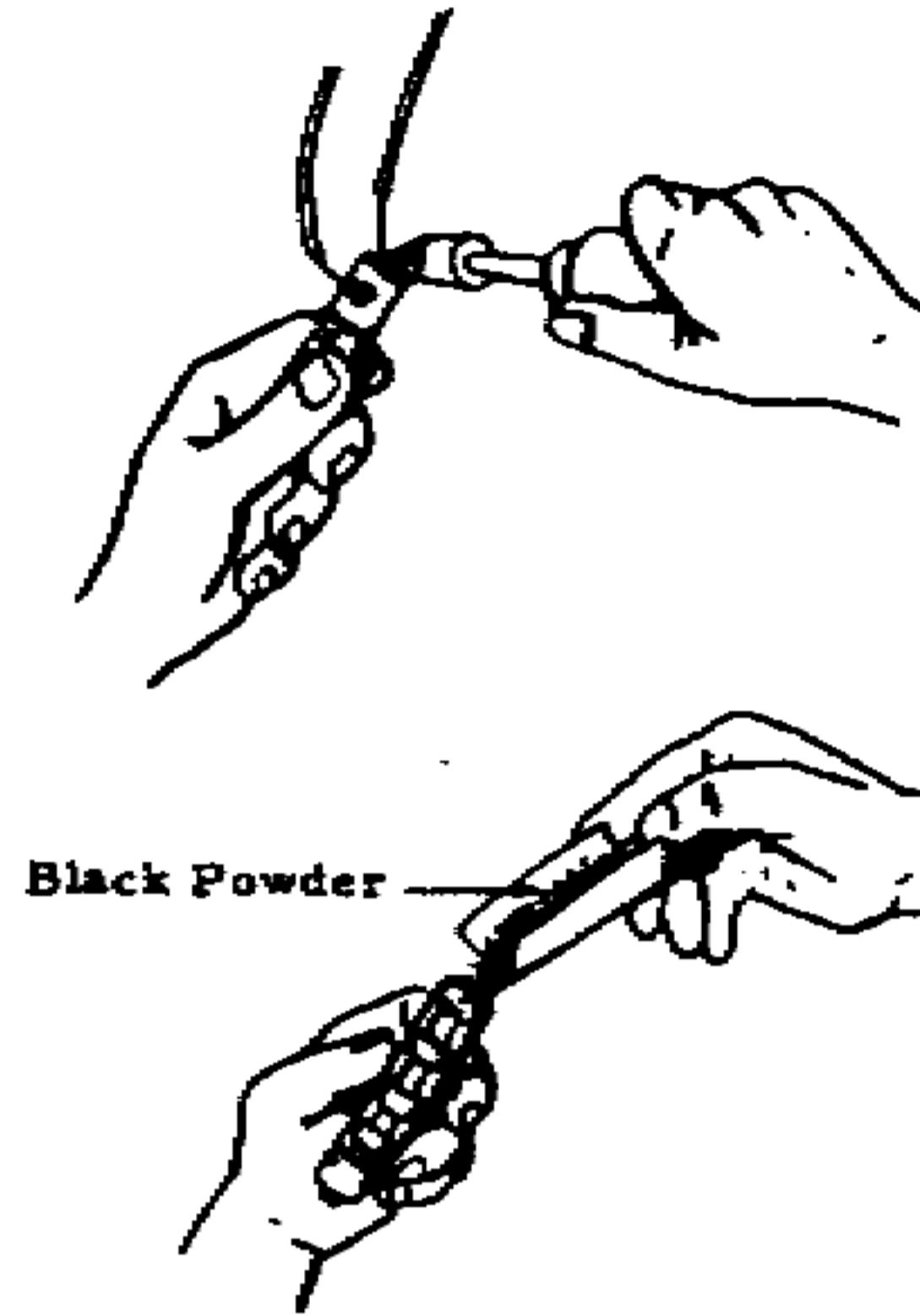

Method II

If the glass bulb is large enough to hold the black powder, it can be used as the container.

Procedure

1. Fill a small hole in the top of the bulb.

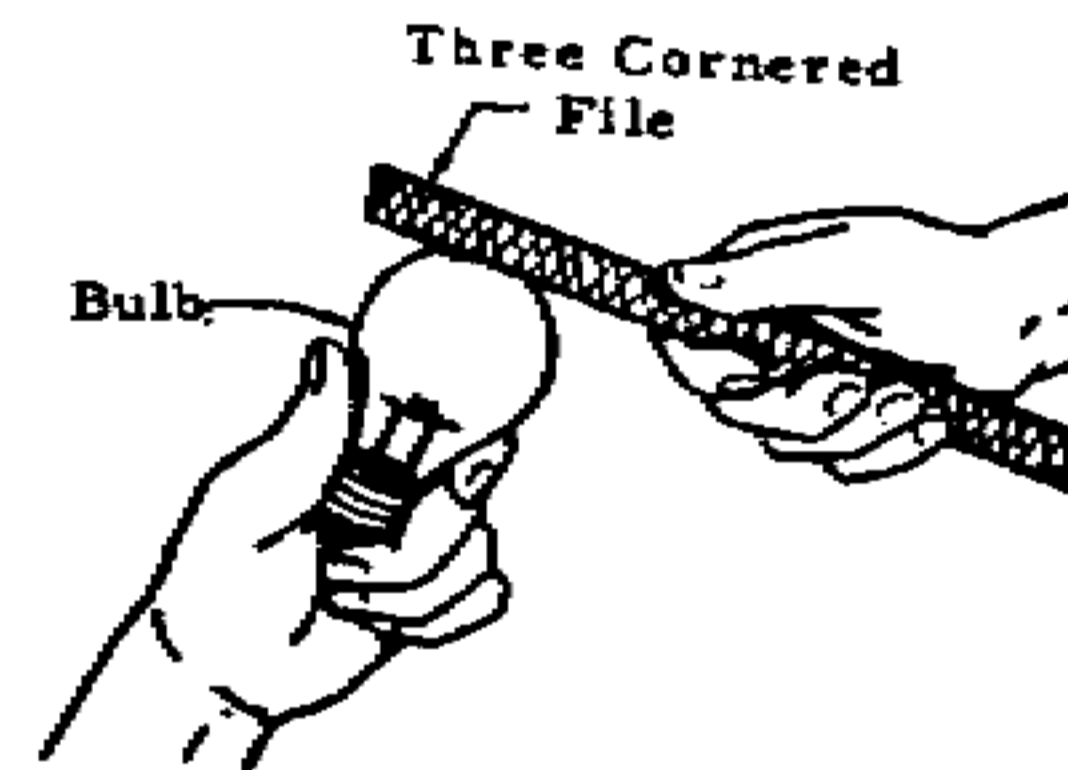

2. Fill the bulb with black powder and tape the hole closed.

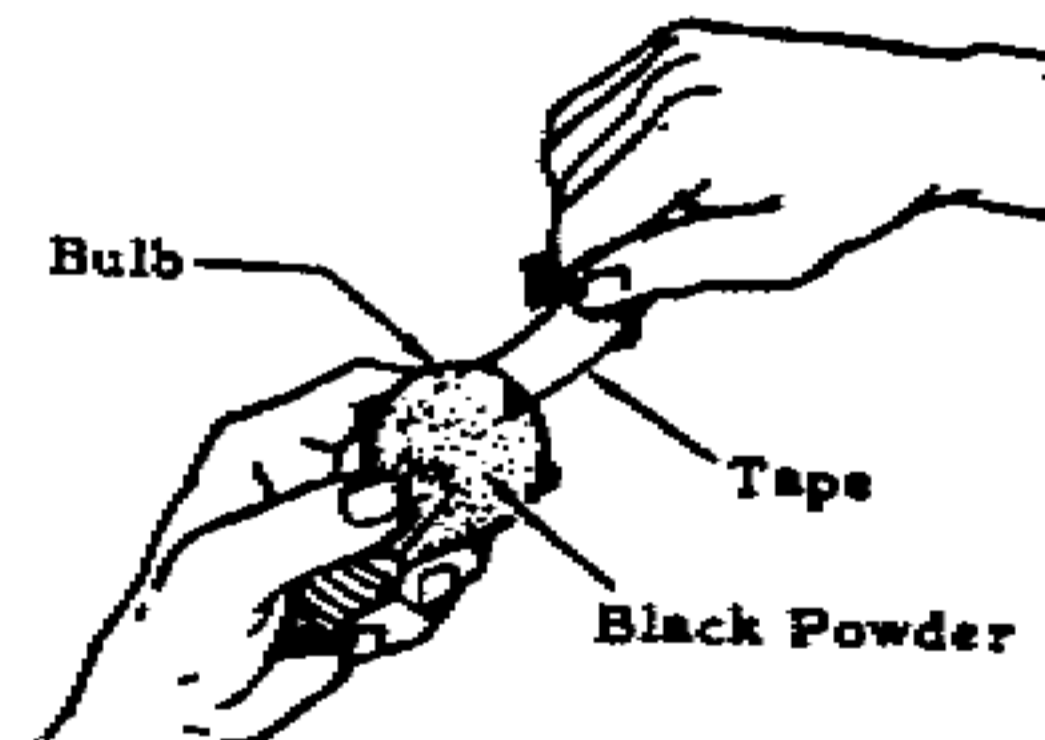

Scientific Principles of Improvised Warfare and Home Defense

e. Delay Igniter From Cigarette

A simple and economical time delay can be made with a common cigarette

Materials Required

- Cigarette
- Paper match
- String (shoelace or similar cord)
- Fuse Cord (improvised or commercial)

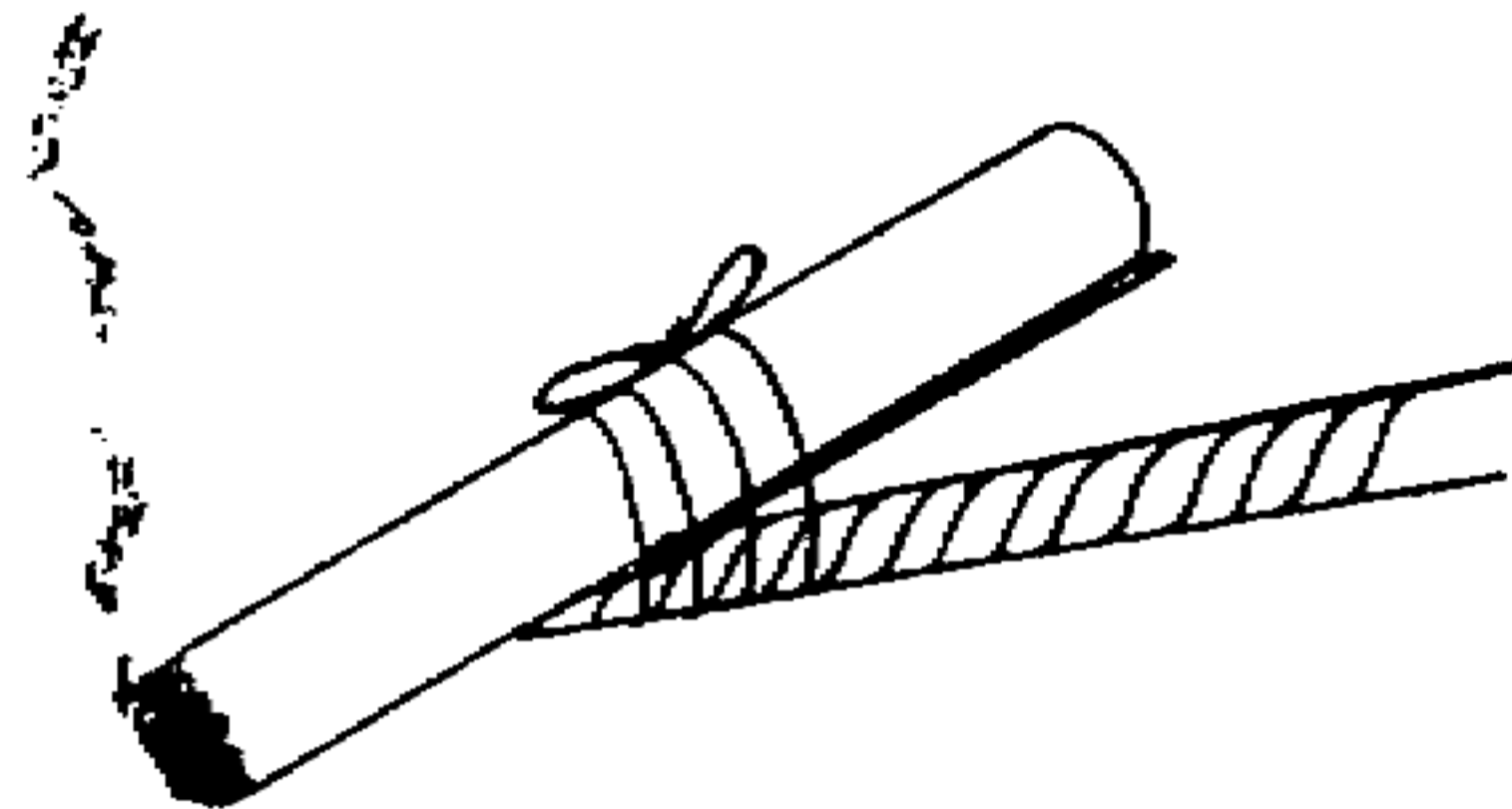

Procedure

1. Cut end of fuse cord to expose inner core.

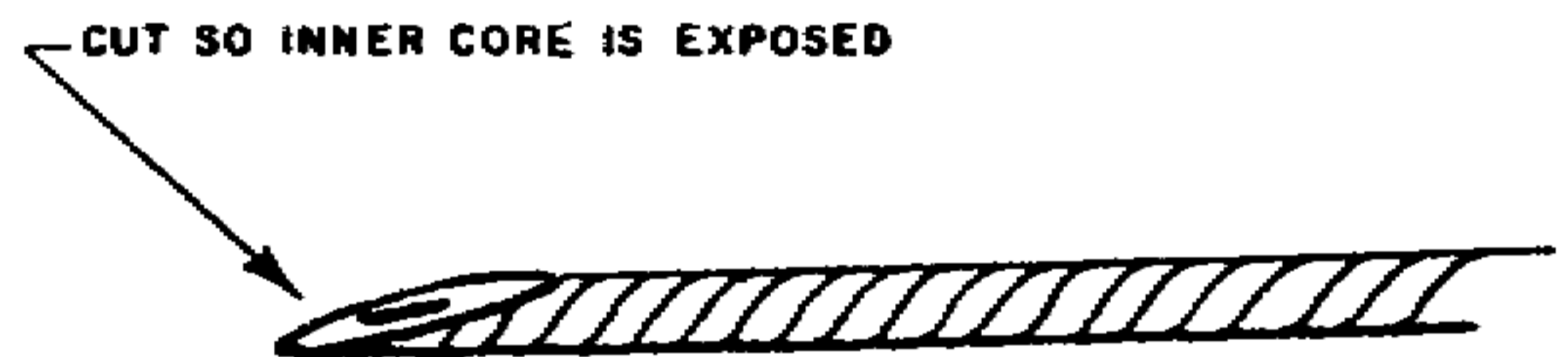

2. Light cigarette in normal fashion. Place a paper match so that the head is over exposed end of fuse cord and tie both to the side of the burning cigarette with string.

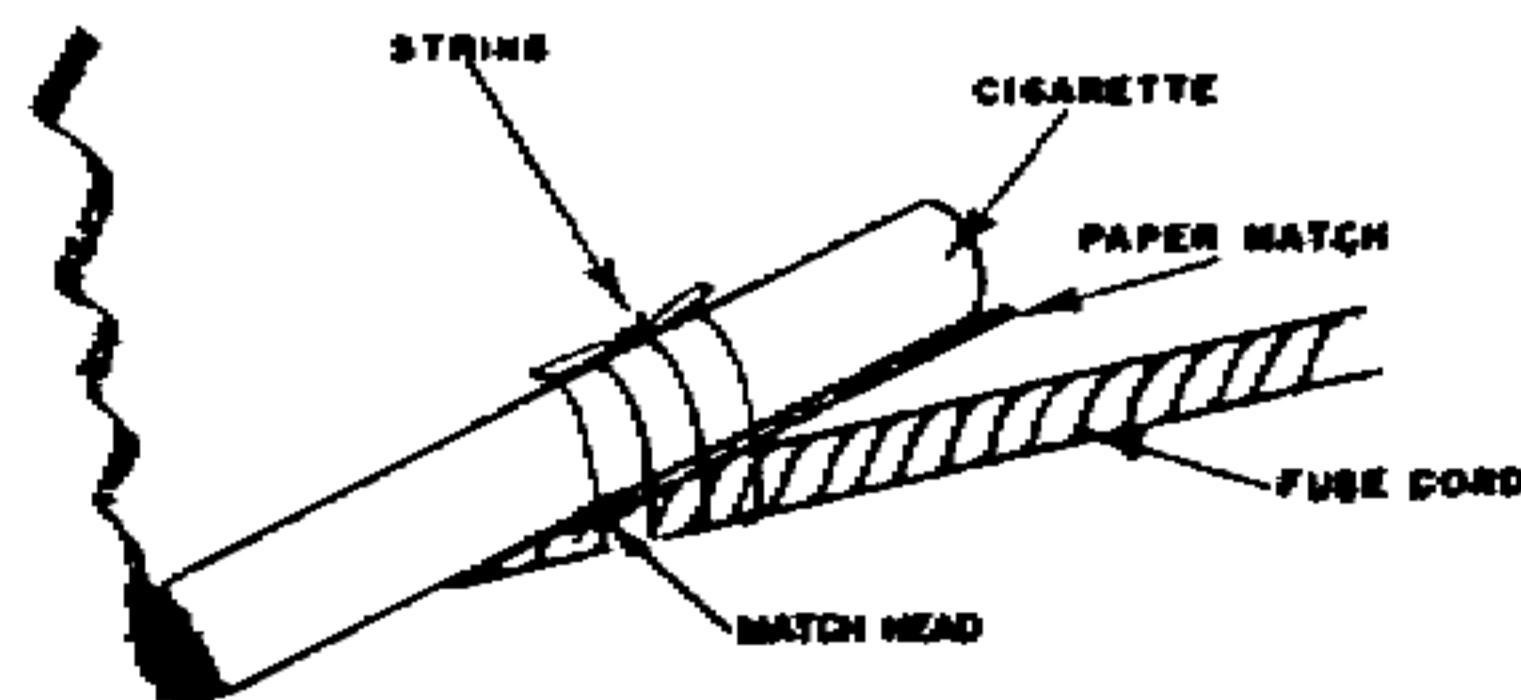

Scientific Principles of Improvised Warfare and Home Defense

3. Position the burning cigarette with fuse so that it burns freely. A suggested method is to hang the delay on a twig.

NOTE: Common dry cigarettes burn about 1" every 7 or 8 minutes in still air. If the fuse cord is placed 1" from the burning end of the cigarette a time delay of 7-8 minutes will result.

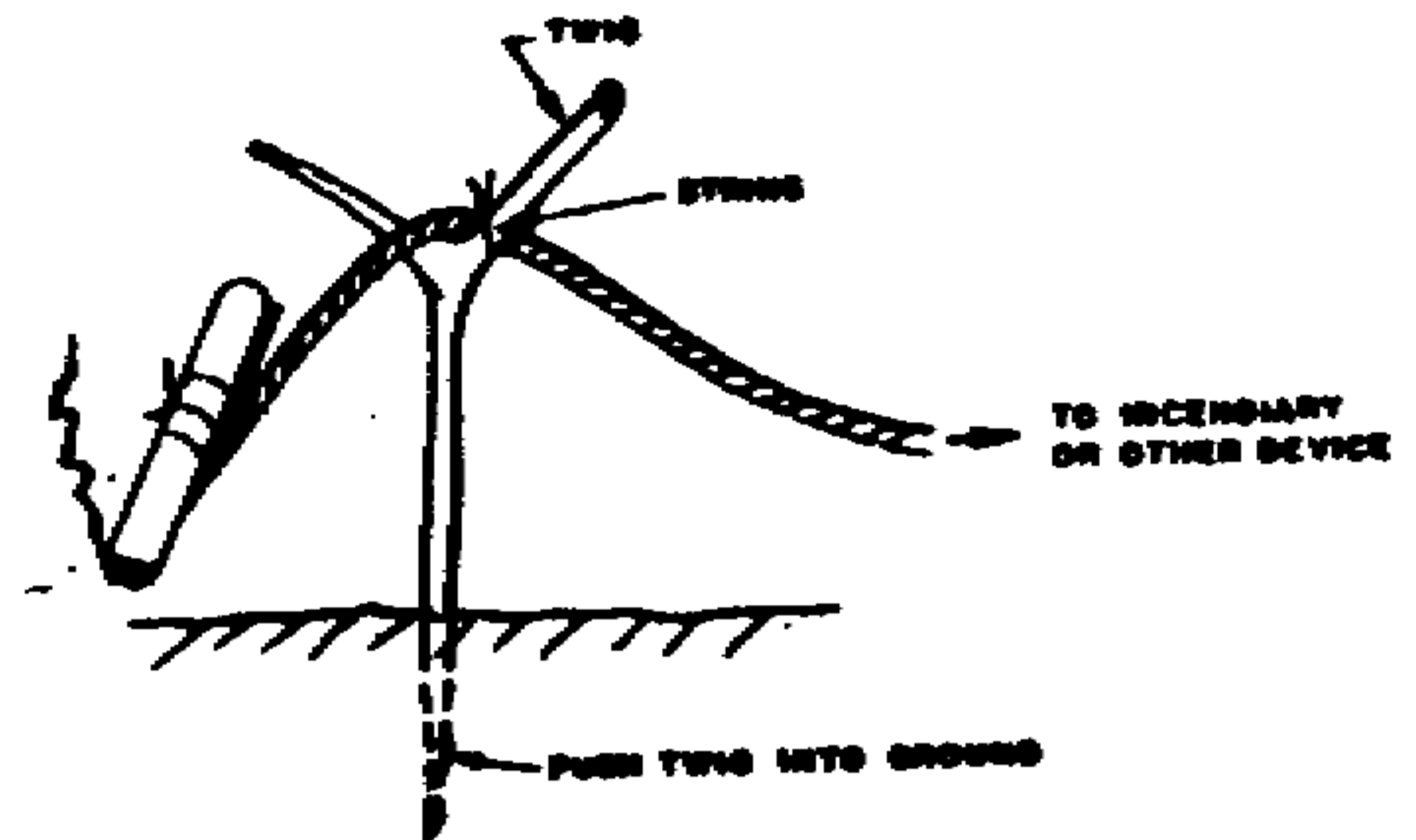

Delay time will vary depending upon type of cigarette, wind, moisture, and other atmospheric conditions.

To obtain accurate delay time, a test run should be made under use conditions.

Scientific Principles of Improvised Warfare and Home Defense

f. Watch Delay Timer

A time delay device for use with electrical firing circuits can be made by using a watch with a plastic crystal.

Material and equipment required

- Watch with plastic crystal
- Small clean metal screw
- Battery
- Connecting wires
- Drill or nail

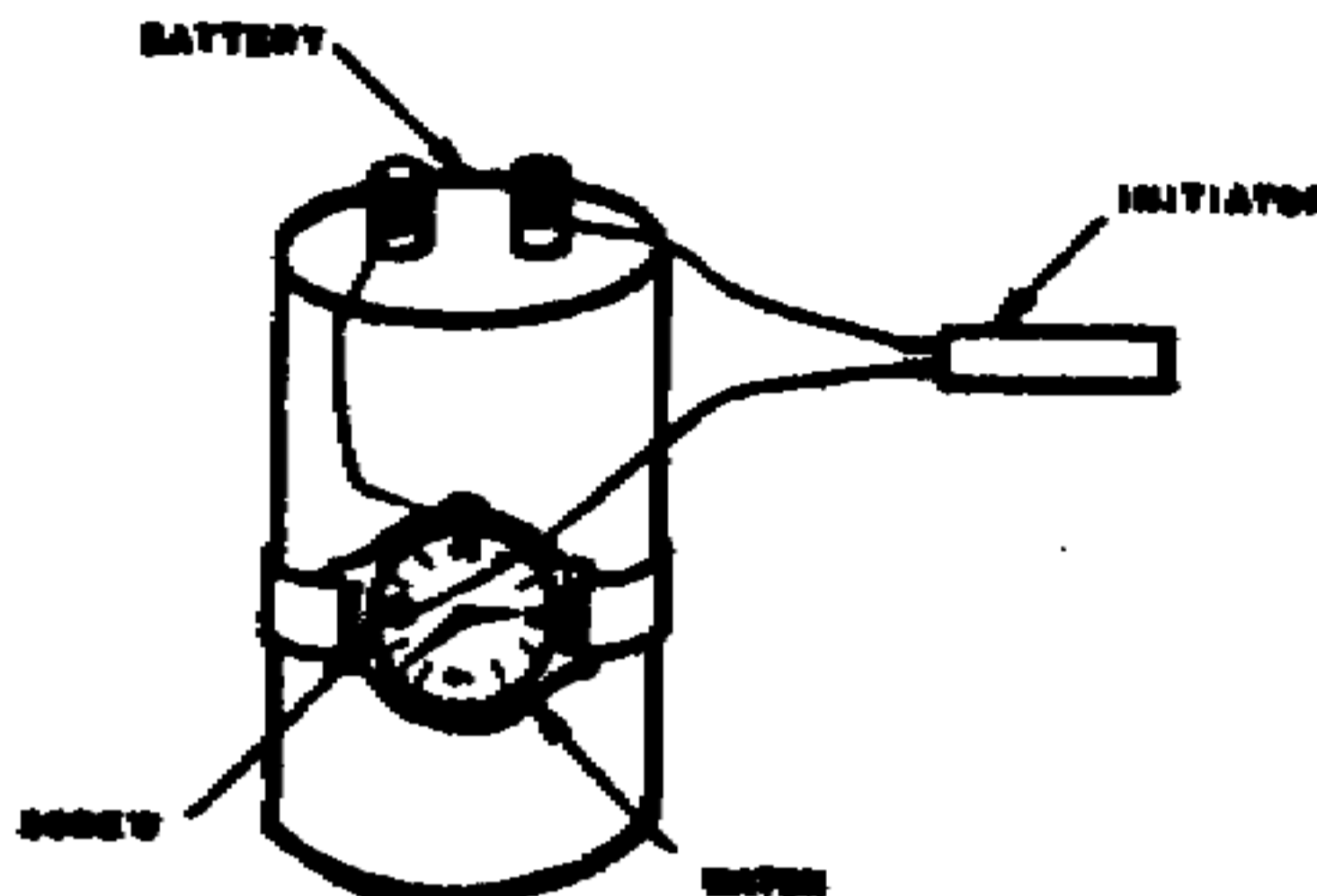

Procedure

1. If watch has a sweep or large second hand, remove it. If delay time of more than hour is required, also remove the minute hand. If hands are painted, carefully scrape paint from contact edge with knife.

2. Drill a hole through the crystal of the watch or pierce the crystal with a heated nail. The hole must be small enough that the screw can be tightly threaded into it.

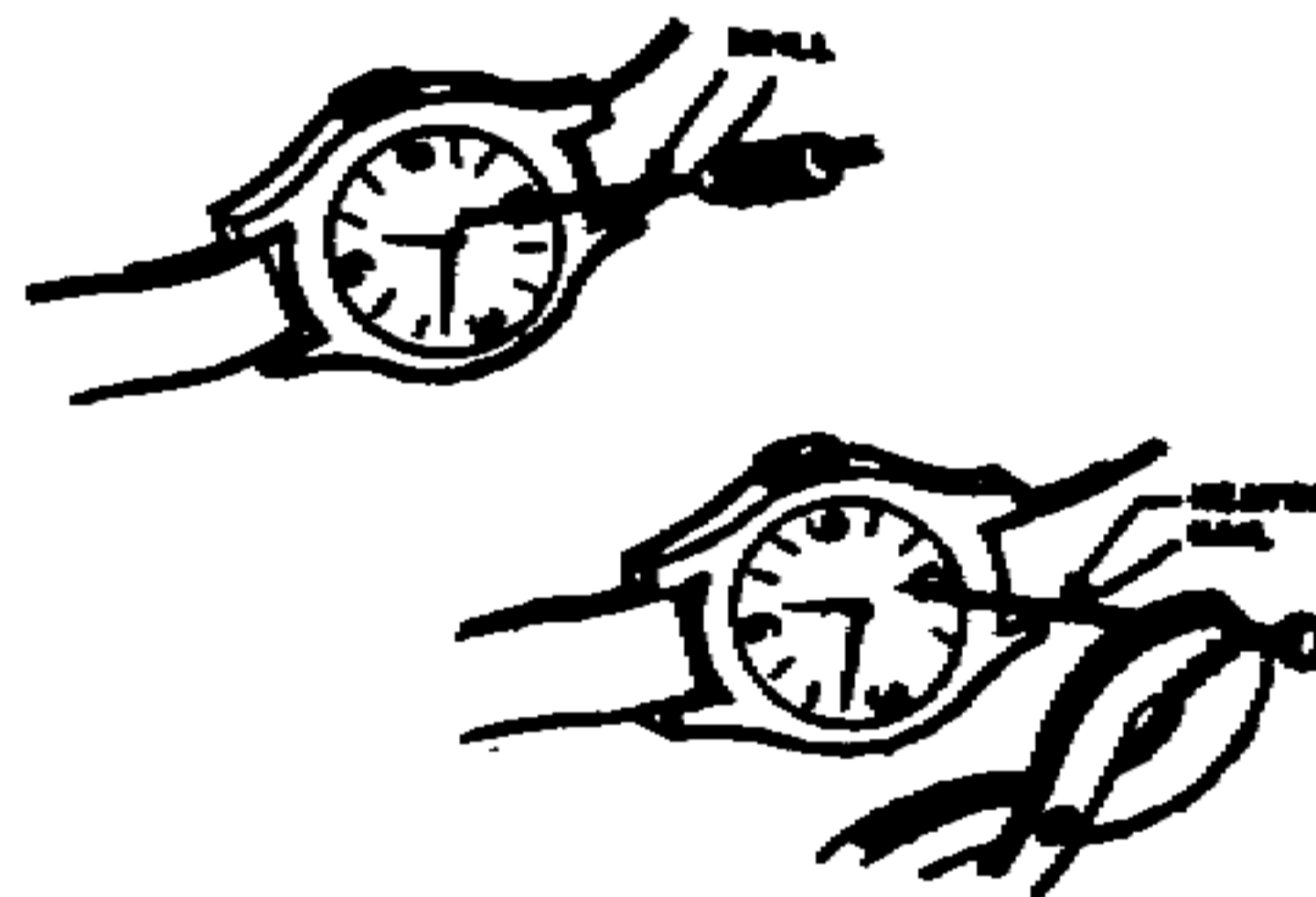

3. Place the screw in the hole and turn down as far as possible without making contact with the face of the watch. If screw has a pointed tip, it may be necessary to grind the tip flat.

If no screw is available, pass a bent stiff wire through the hole and caps to crystal.

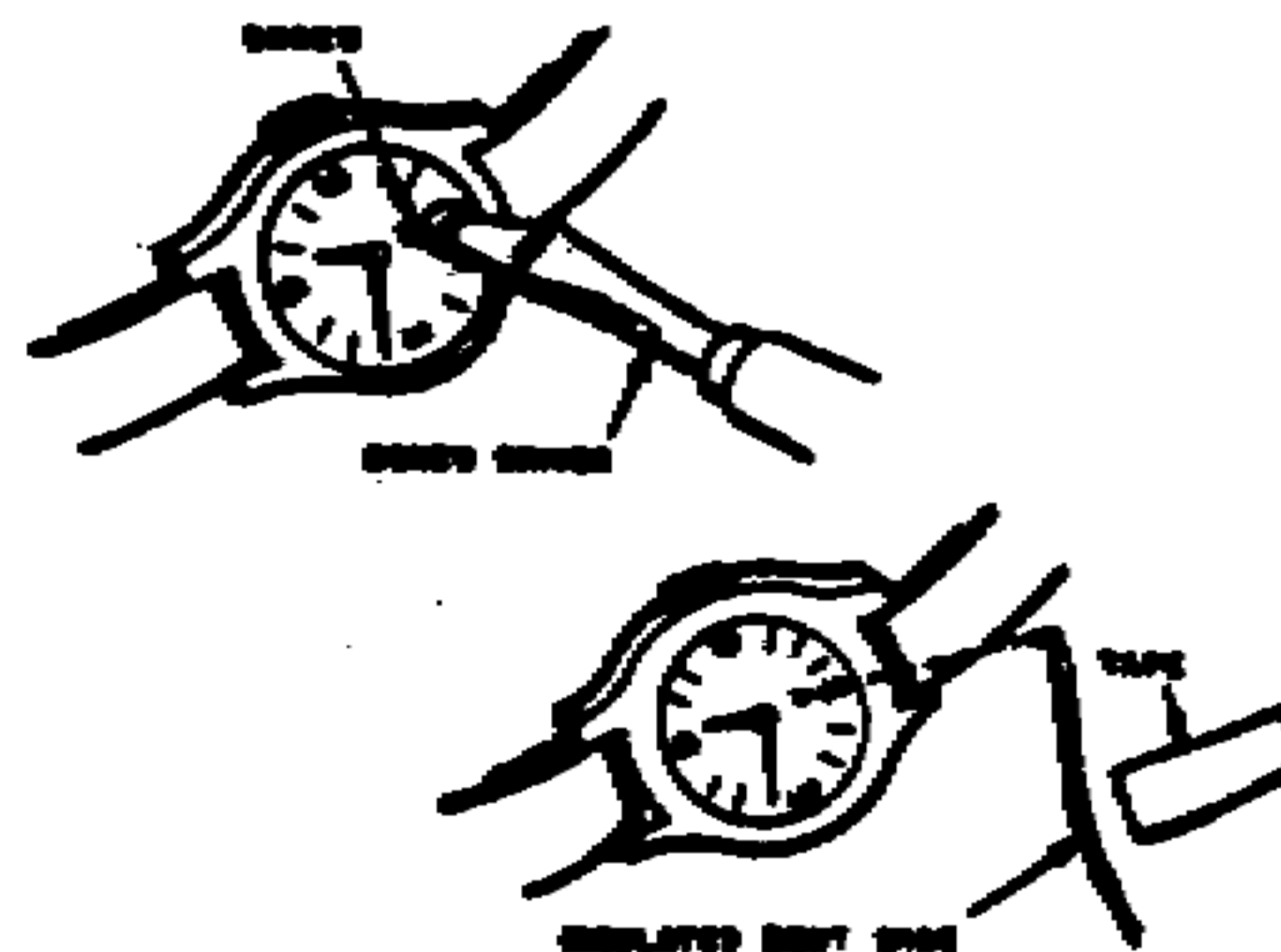

IMPORTANT: Check to make sure hand of watch cannot pass screw or wire without contacting it.

Scientific Principles of Improvised Warfare and Home Defense

How to use

1. Set the watch so that a hand will reach the screw or wire at the time you want the firing circuit completed.
2. Wind the watch
3. Attach a wire from the case of the watch to one terminal of the battery.
4. Attach one wire from an electric initiator (blasting cap, squib or alarm device) to the screw or wire on the face of the watch.
5. After thorough inspection is made to assure that the screw or the wire connected to it is not touching the face or case of the watch, attach the other wire from the initiator to the second terminal of the battery.

CAUTION: Follow step 5 carefully to prevent premature initiation.

Scientific Principles of Improvised Warfare and Home Defense

g. No Fuse Flash Igniter

A simple no-flash fuse igniter can be made from common pipe fittings

Material Required

- 1/4" Pipe cap
- Solid 1/4" Pipe plug
- Flat head nail about 1/16" in diameter
- Hand drill
- Common "strike anywhere" matches
- Adhesive tape



Procedure

1. Screw the pipe plug tightly into the pipe cap.

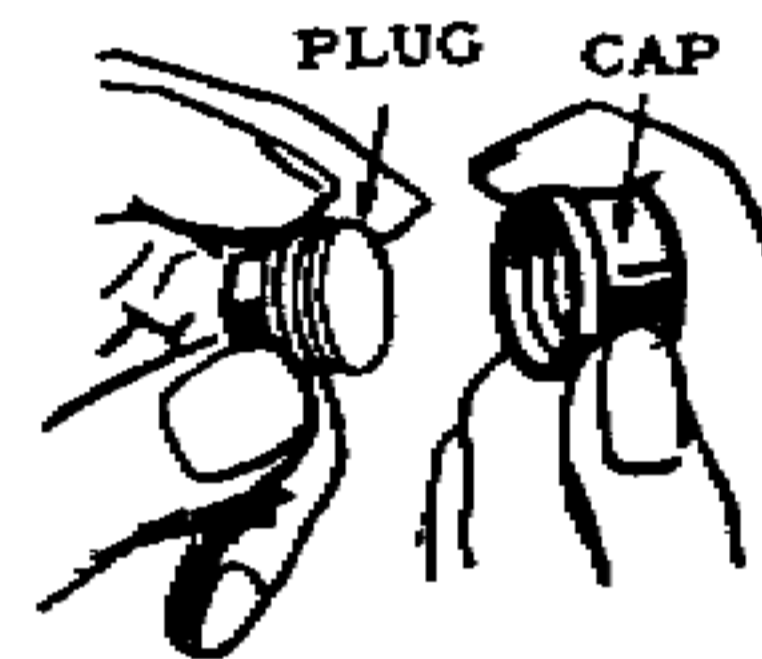

2. Drill hole completely through the center of the plug and cap large enough that the nail fits loosely.

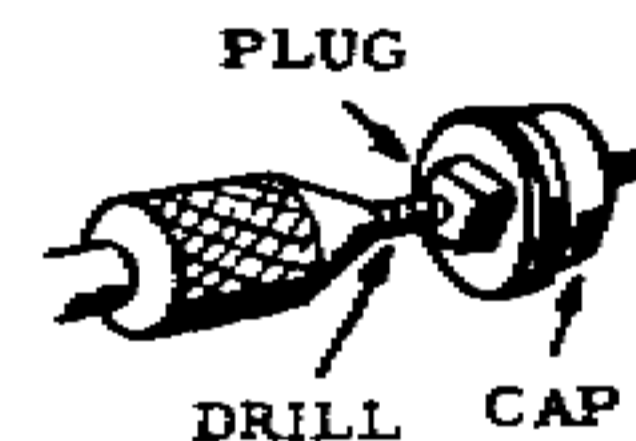

3. Enlarge the hole in the plug except for the last 1/8" so that the fuse cord will just fit.

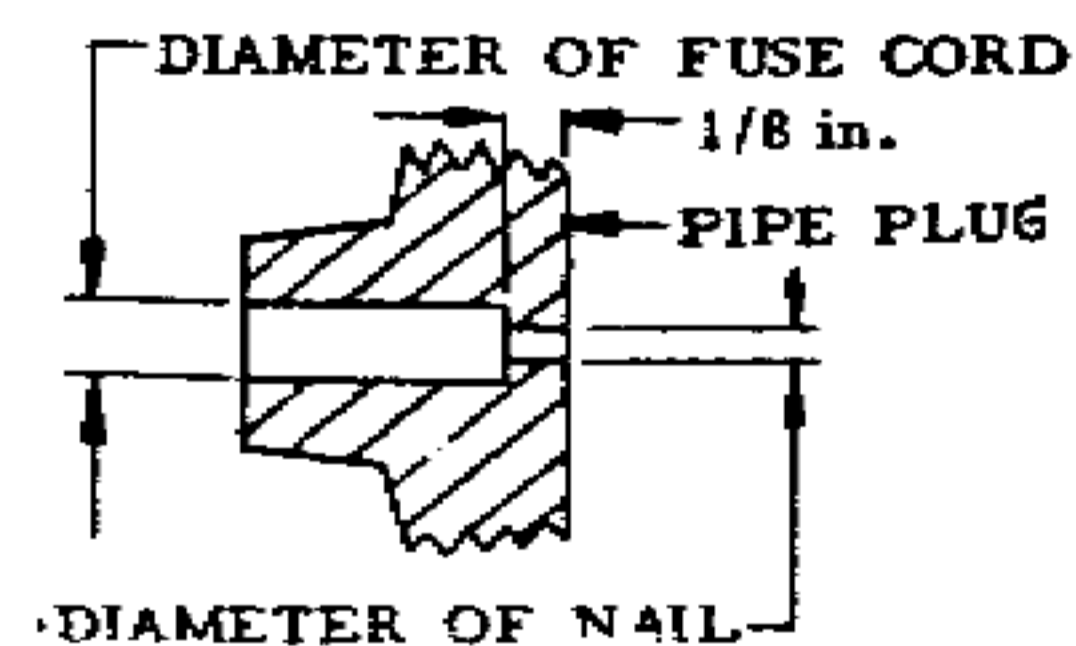

4. Remove the plug from the cap and push the flat head nail through the hole in the cap from the inside.

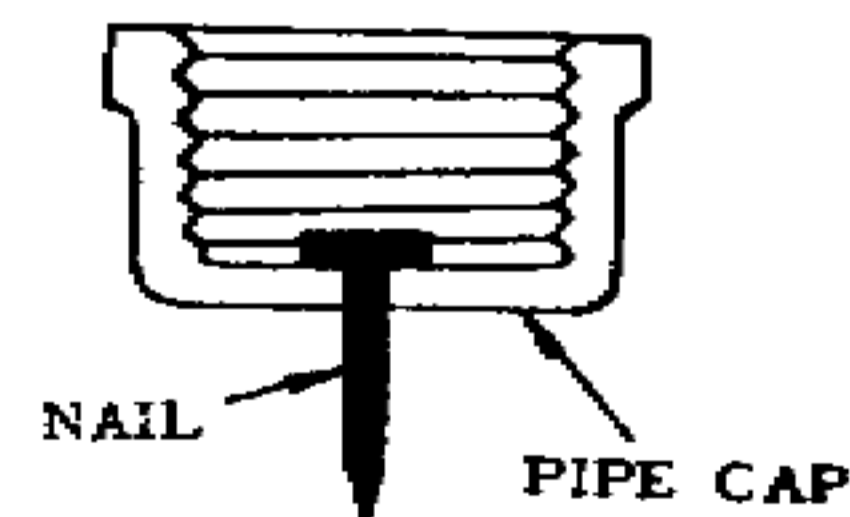

Scientific Principles of Improvised Warfare and Home Defense

5. Cut the striking tips from app. 10 striking matches. Place match tips inside pipe cap and screw plug in finger tight.

How To Use

1. Slide the fuse cord into the hole in the pipe plug.
2. Tape igniter to fuse cord.
3. Tap point of nail on a hard surface to ignite the fuse.

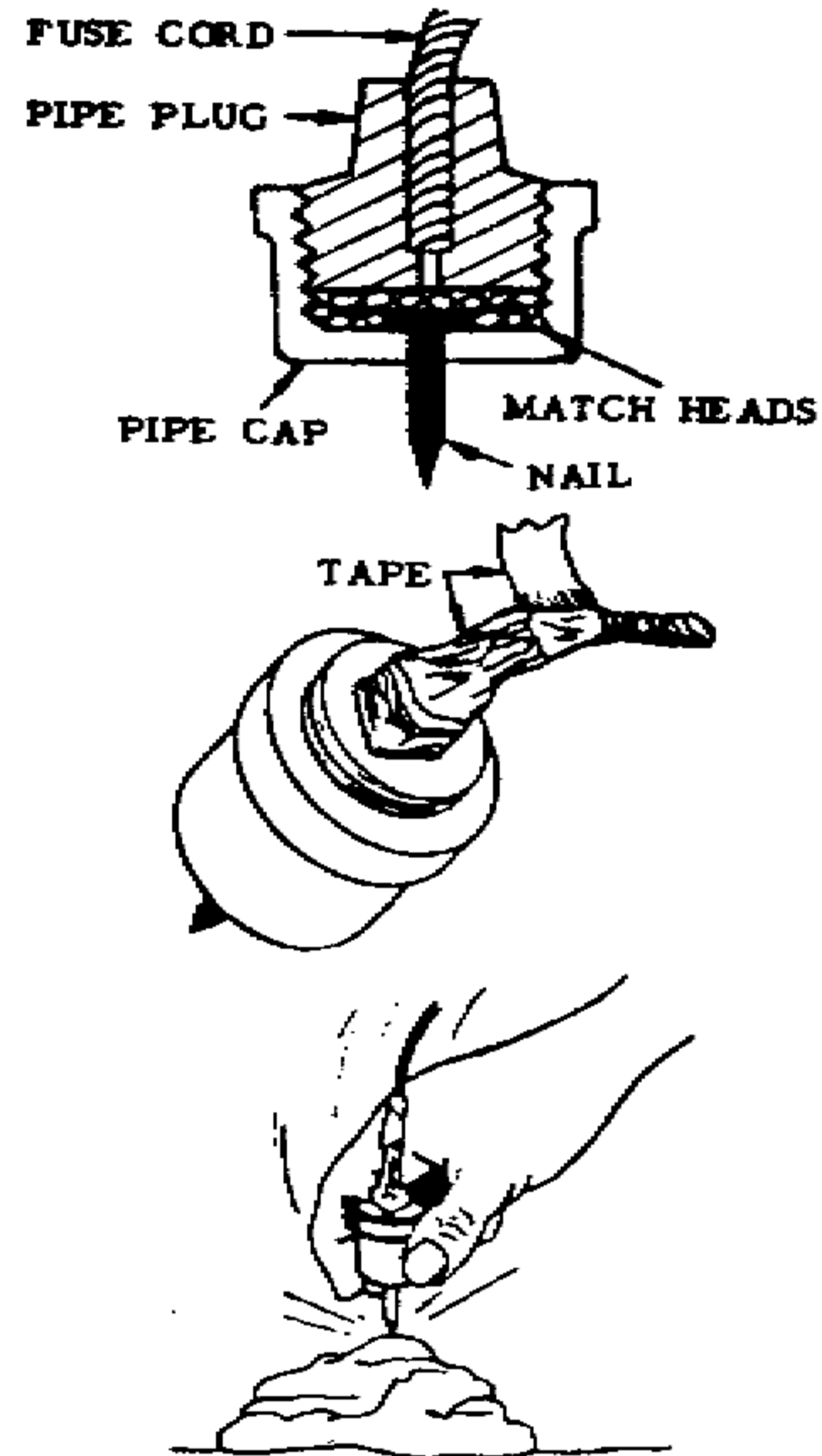

Scientific Principles of Improvised Warfare and Home Defense

h. Dried Seed Timer

A time delay device for electrical firing circuits can be made using the principle of expansion of dried seeds.

Material Required

Dried peas, beans, or other dehydrated seeds
Wide mouth glass jar with non-metal cap
Two screws or bolts
Thin metal plate
Hand drill
Screwdriver



Procedure

1. Determine the rate of rise of the dried beans selected. This is necessary to determine delay time of the timer.
 - a. Place a sample of the dried seeds in the jar and cover with water.
 - b. Measure the time it takes for the seeds to rise a given height. Most dried seeds increase 50% in one to two hours.
2. Cut a disc from thin metal plate. Disc should fit loosely inside the jar.

NOTE: If metal is painted, rusty, or otherwise coated, it must be scraped or sanded to obtain a clean metal surface.

3. Drill two holes in the cap of the jar about 2" apart. Diameter of holes should be such that screw or bolts will thread tightly into them. If the jar has a metal cap or no cap, a piece of wood or plastic (NOT METAL) can be used as a cover.

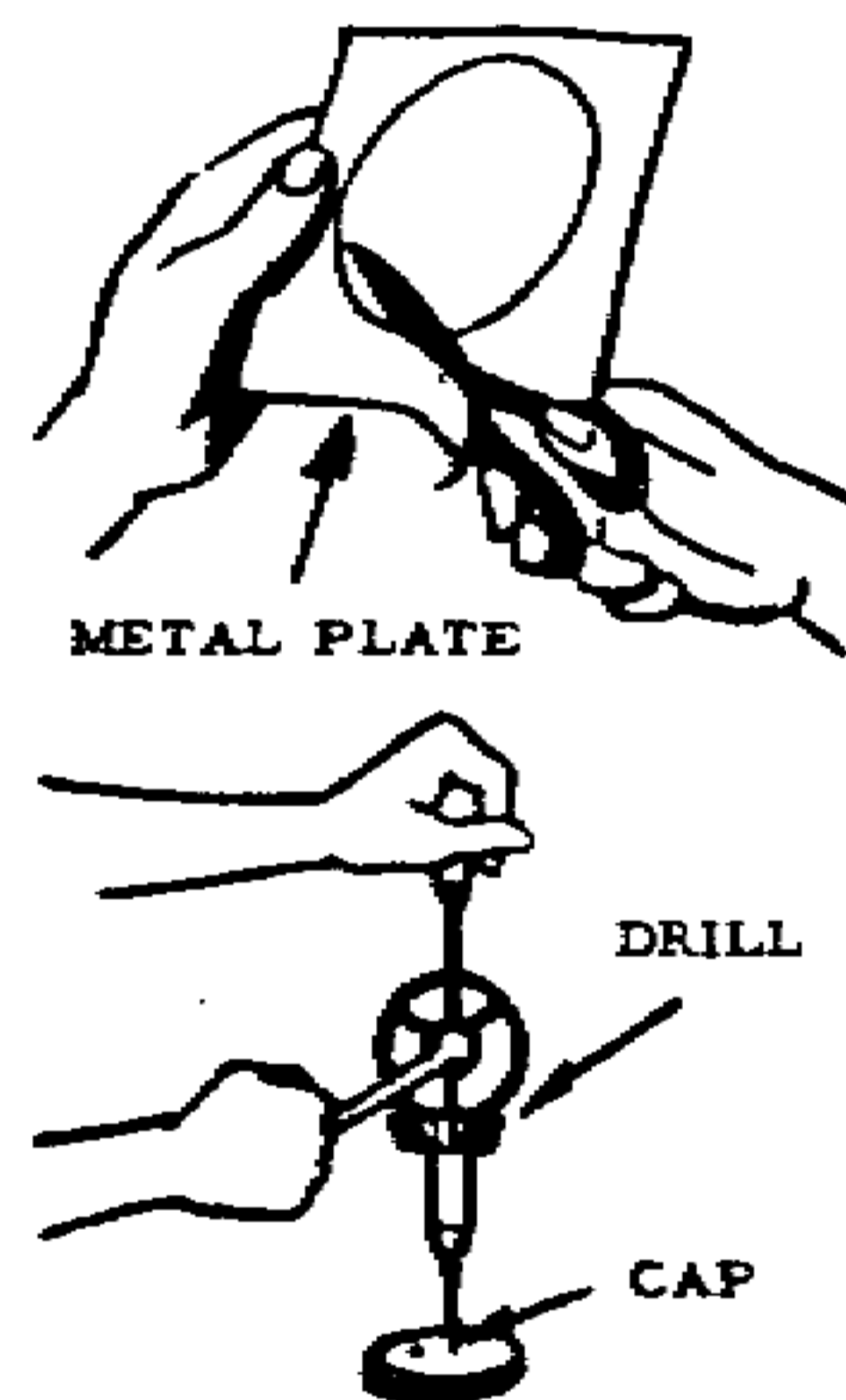

Scientific Principles of Improvised Warfare and Home Defense

4. Turn the two screws or bolts through the holes in the cap. Bolts should extend about 1" into the jar.

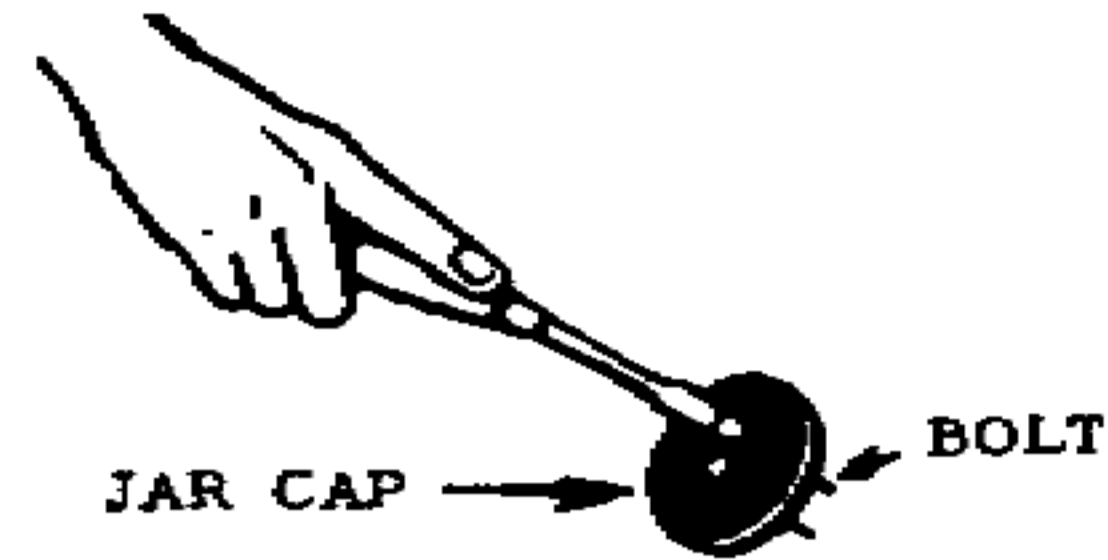

IMPORTANT: Both bolts must extend the same distance below the container cover.

5. Pour dried seeds into the container. The level will depend upon the previously measured rise time and the desired delay.

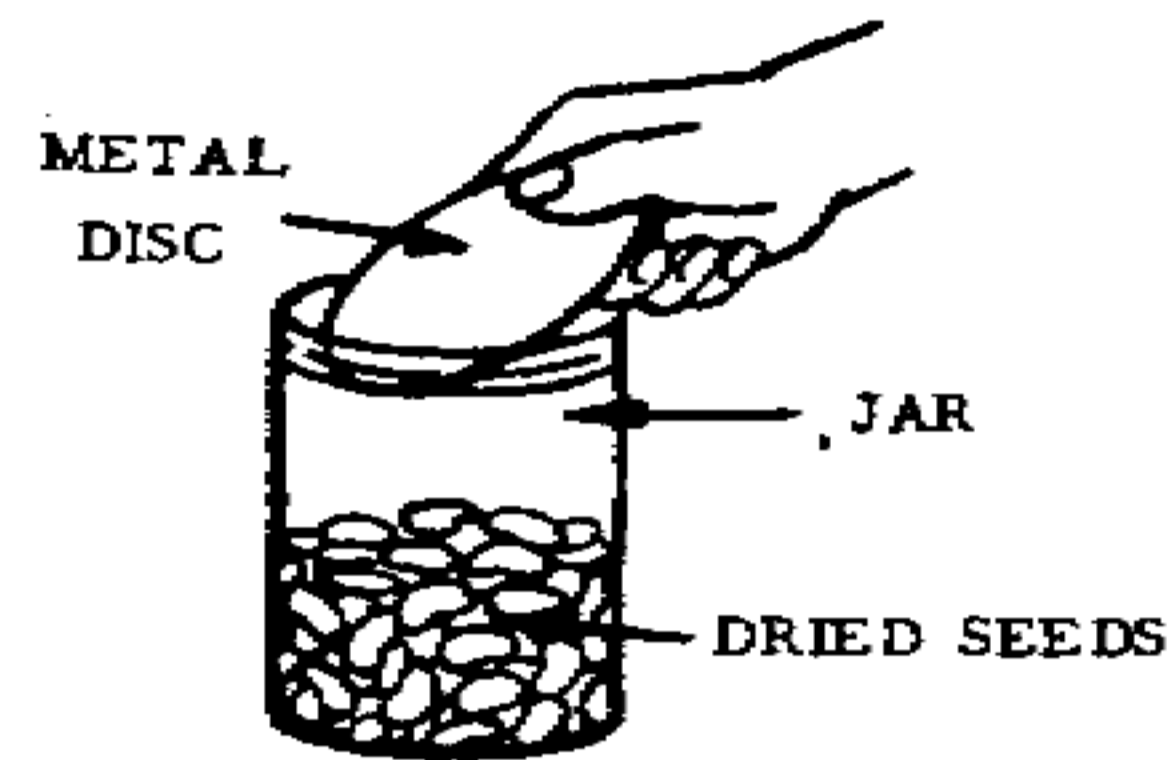

6. Place the metal disc in the jar on top of the seeds.

How to Use

1. Add just enough water to completely cover the seeds and place the cap on the jar.

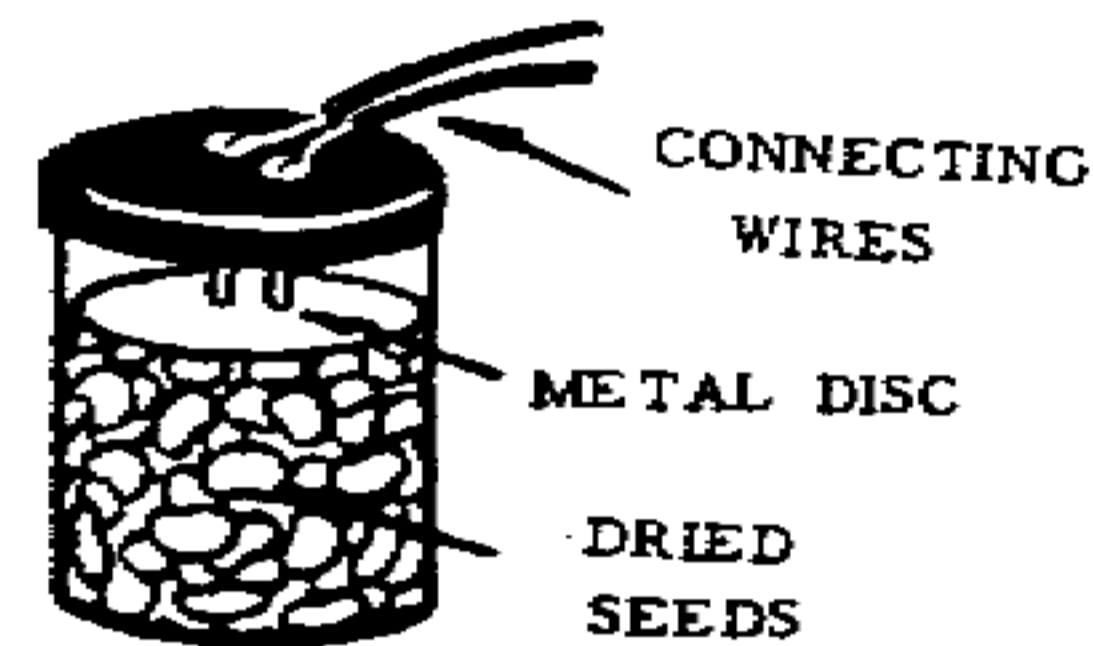

2. Attach connecting wires from the firing circuit to the two screws on the cap.

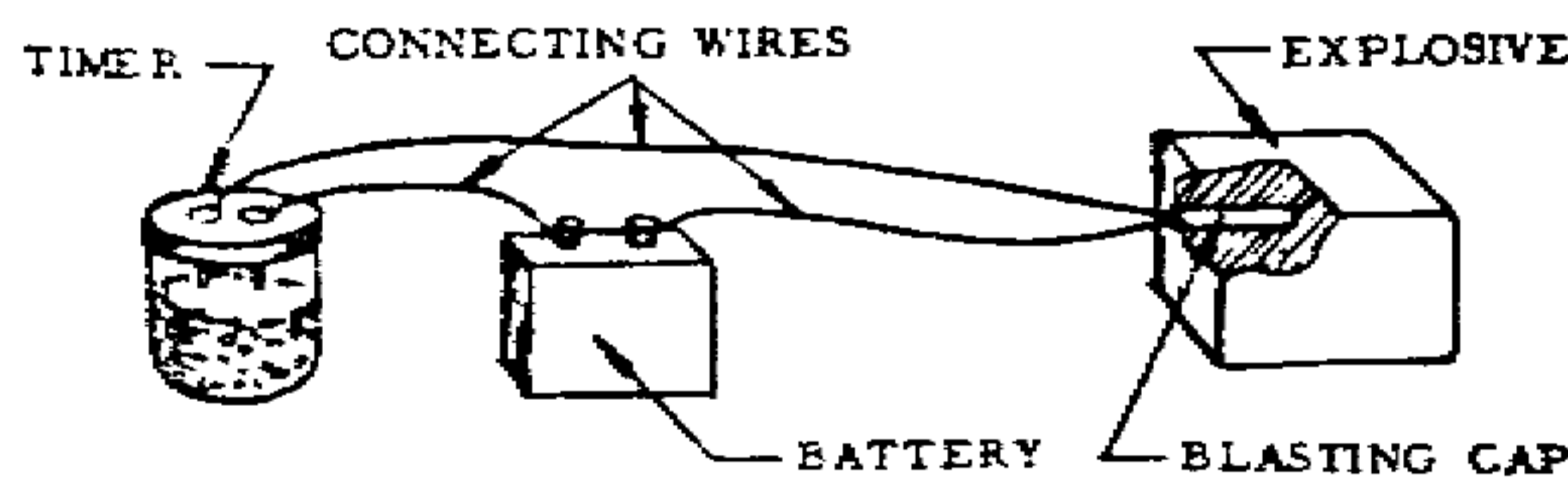

Expansion of the seeds will raise the metal disc until it contacts the screws and closes the circuit.

Scientific Principles of Improvised Warfare and Home Defense

i. Fuse Cords

These fuse cords are used for igniting propellants and incendiaries or, with a non-electric blasting cap, to detonate explosives.

FAST BURNING FUSE

The burning rate of this fuse is app. 40" per minute

Material Required

Soft cotton string		(Potassium Nitrate	25 parts
Fine Black Powder	or	(Charcoal	3 parts
Piece of round stick		(Sulfur	
Two pans or dishes			

Procedure

1. Moisten fine black powder to form a paste or prepare a substitute as follows:

- Dissolve Potassium Nitrate in an equal amount of water.
- Pulverize charcoal by spreading thinly on a hard surface and rolling the round stick over it to crush to a fine powder.
- Pulverize sulfur in the same manner.
- Dry mix Sulfur and Charcoal
- Add Potassium Nitrate solution to the dry mix to obtain a thoroughly wet paste

2. Twist or braid three strands of cotton string together.

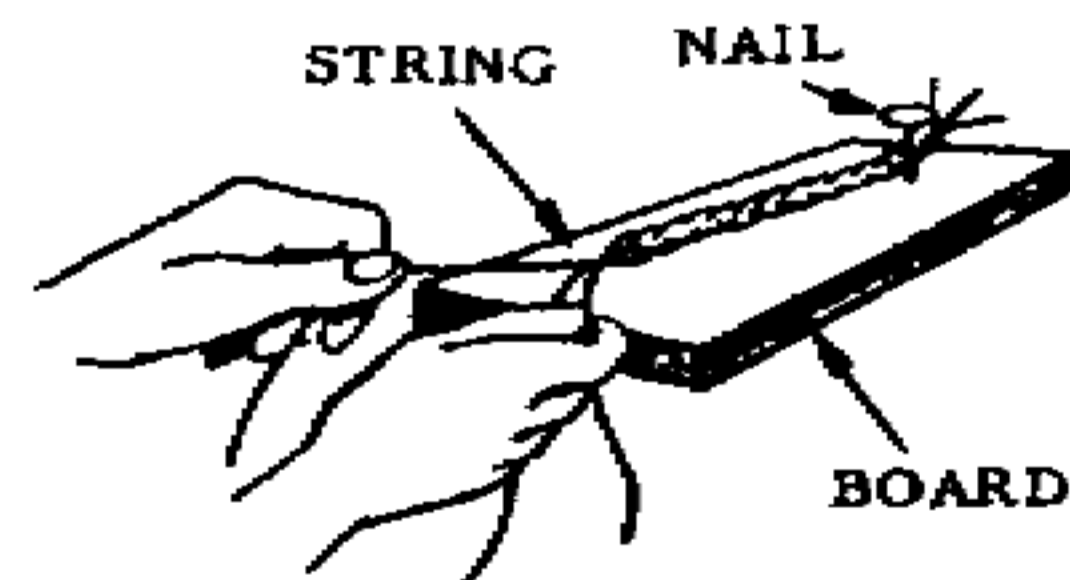

3. Rub paste mixture into twisted string with fingers and allow to dry.

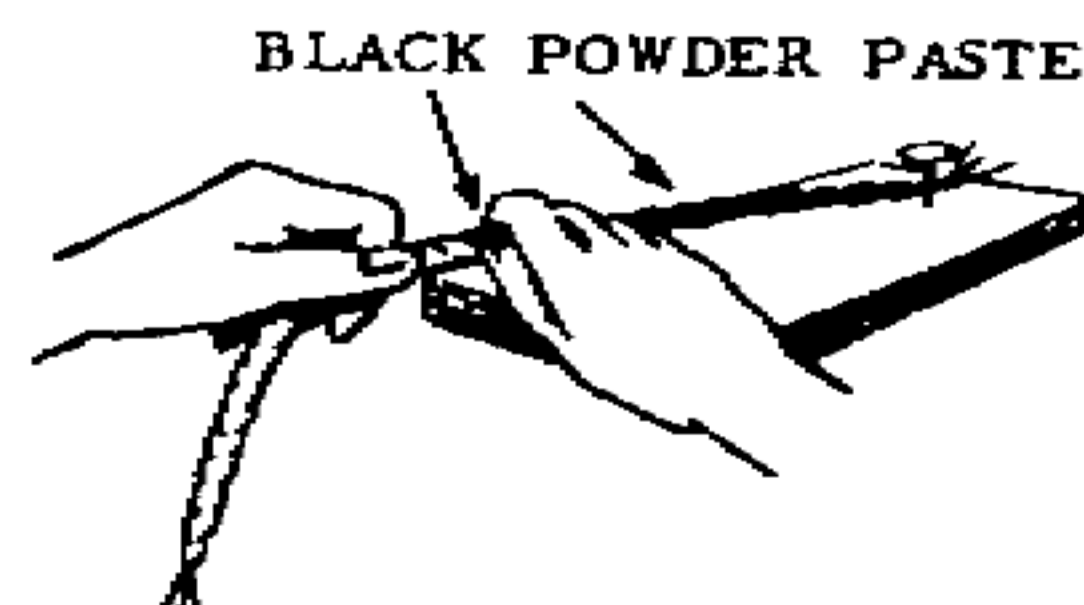

Scientific Principles of Improvised Warfare and Home Defense

4. Check actual burning rate of fuse by measuring the time it takes for a known length to burn. This is used to determine the length needed for a desired delay time. If 5" burns for 6 seconds, 50 inches of fuse cord will be needed to obtain a one minute (60 second) delay time.

SLOW BURNING FUSE

The burning rate of this fuse is app. 2" per minute

Material Required

Cotton string or 3 shoelaces

Potassium Nitrate or Potassium Chlorate

Granulated Sugar

Procedure

1. Wash cotton string or shoelaces in hot soapy water; rinse in fresh water.
2. Dissolve 1 part Potassium Nitrate or Potassium Chlorate and 1 part granulated sugar in 2 parts of hot water.
3. Soak string or shoelaces in solution.
4. Twist or braid three strands of string together and allow to dry.
5. Check actual burning rate of the fuse by measuring the time it takes for a known length to burn. This is used to determine the length needed for the desired delay time. If 2" burns for 1 minute, 10" will be needed to obtain a 5 minute delay.

NOTE: The last few inches of this cord (the end inserted in the material to be ignited) should be coated with the fast burning black powder paste if possible. This **MUST BE DONE** when the fuse is used to ignite a blasting cap.

REMEMBER: The burning rate of either of these fuses can vary greatly. **DO NOT USE** for ignition until you have checked their burning rate.

Scientific Principles of Improvised Warfare and Home Defense

k. Clothespin Time Delay Switch

A 3-5 minute time delay switch can be made from a clothespin switch and a cigarette. The system can be used for initiation of explosive charges, mines and booby traps.

Material Required

Spring type clothespin

Solid or stranded copper wire about 1/16" in diameter (field or bell wire is suitable)

Fine string, about 6" in length

Cigarette

Knife

Procedure

1. Strip about 4" of insulation from the ends of 2 copper wires. Scrape copper wires with pocket knife until metal is shiny.

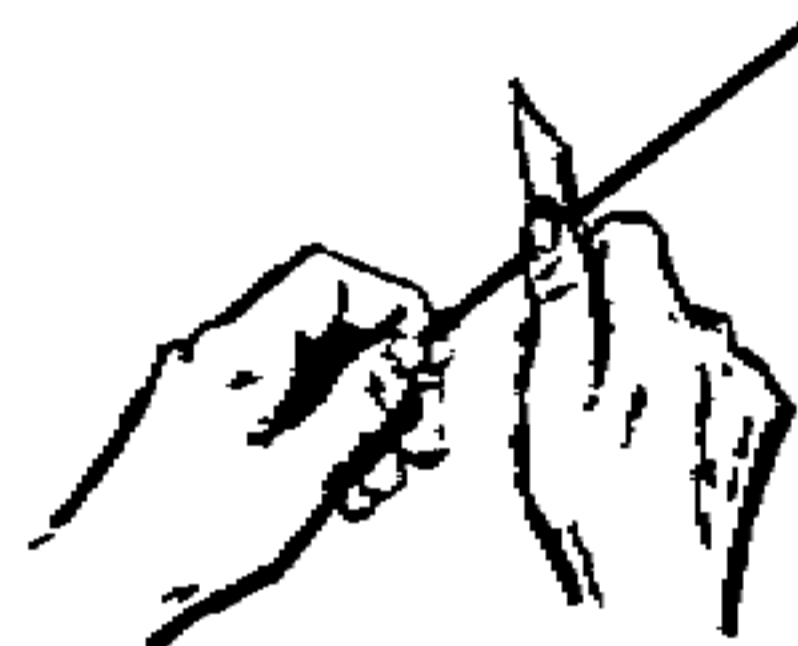

2. Wind one scraped wire tightly on one jaw of the clothespin, and the other wire on the other jaw so that the wires will be in contact with each other when the jaws are closed.

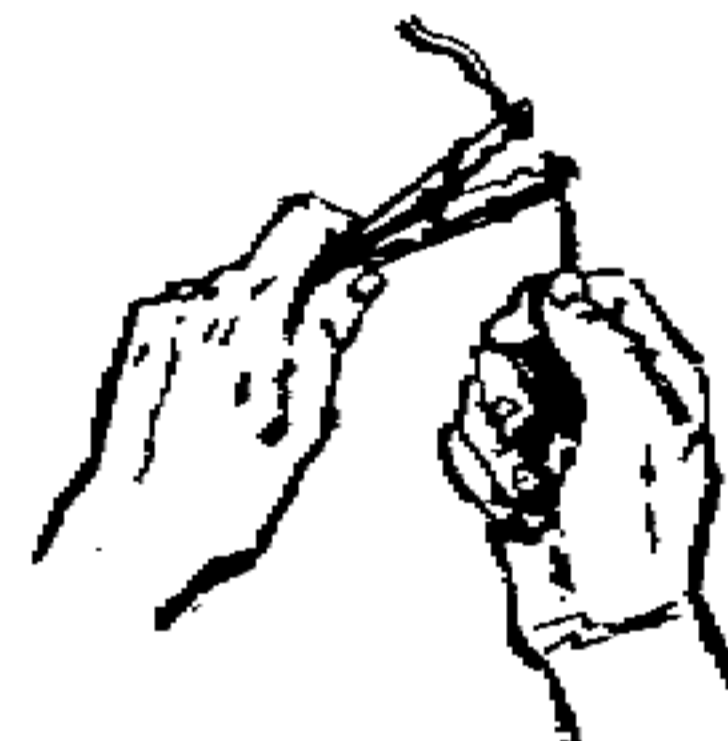

3. Measuring from tip of cigarette, measure a length of cigarette that will correspond to the delay time desired. Make a hole in cigarette at this point, using wire or pin.

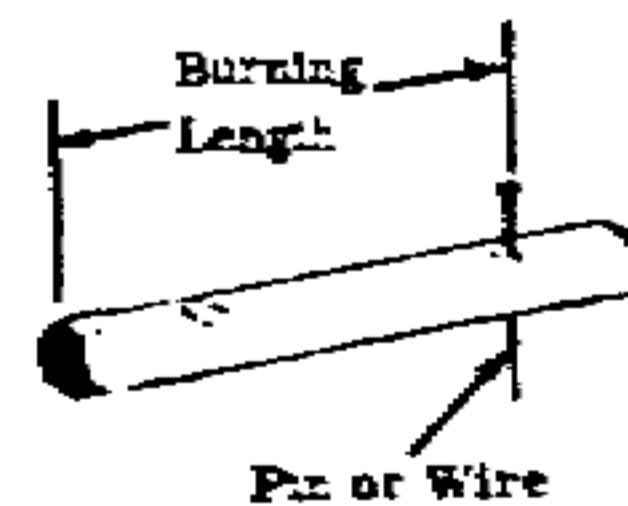

NOTE: Delay time may be adjusted by varying the burning length of the cigarette. Burning rate in still air is app. 7 minutes per inch. Since this rate varies with environment and brand of cigarette it should be tested in each case if accurate delay time is desired.

Scientific Principles of Improvised Warfare and Home Defense

4. Thread string through hole in cigarette.

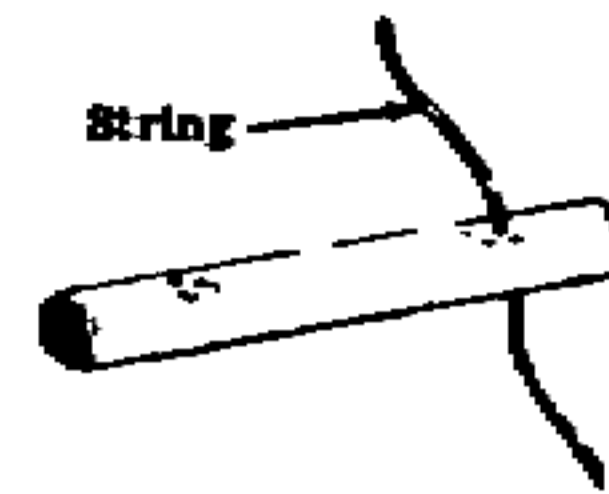

5. Tie string around rear of clothespin, 1/8" or less from end. The clothespin may be notched to hold string in place.

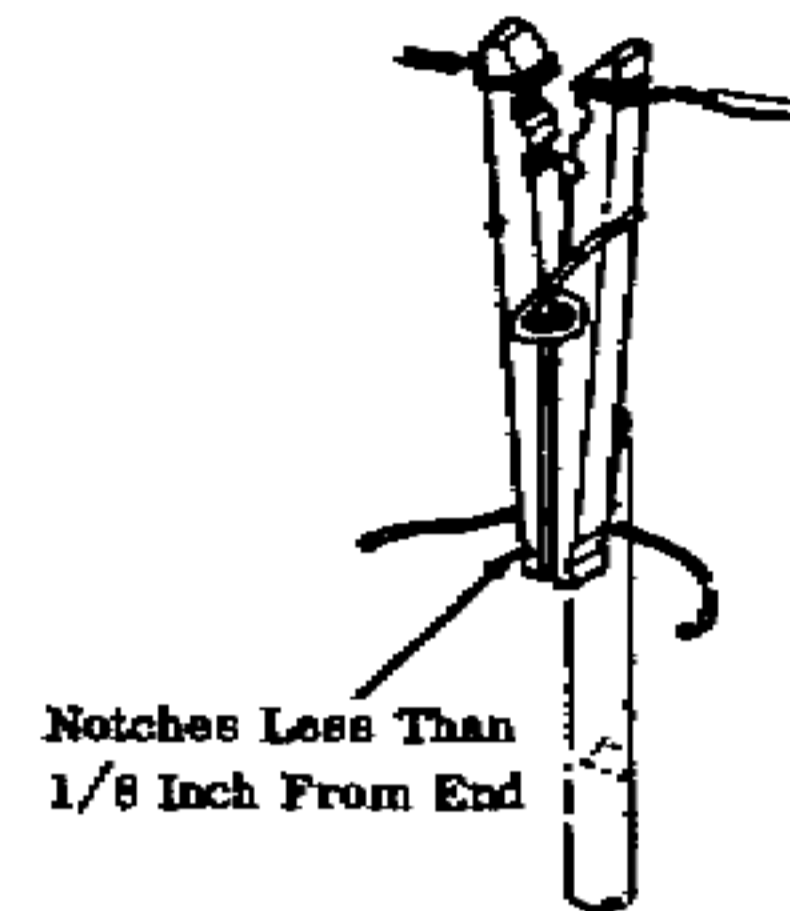

NOTE: The string must keep the rear end of the clothespin closed so that the jaws stay open and no contact is made between the wires.

How to Use

Suspend the entire system vertically with the cigarette tip down. Light tip of cigarette, Switch will close and initiation will occur when the cigarette burns up to and through the string.

NOTE: Wires to the firing circuit must not be pulled taut when the switch is mounted. This could prevent the jaws from closing.

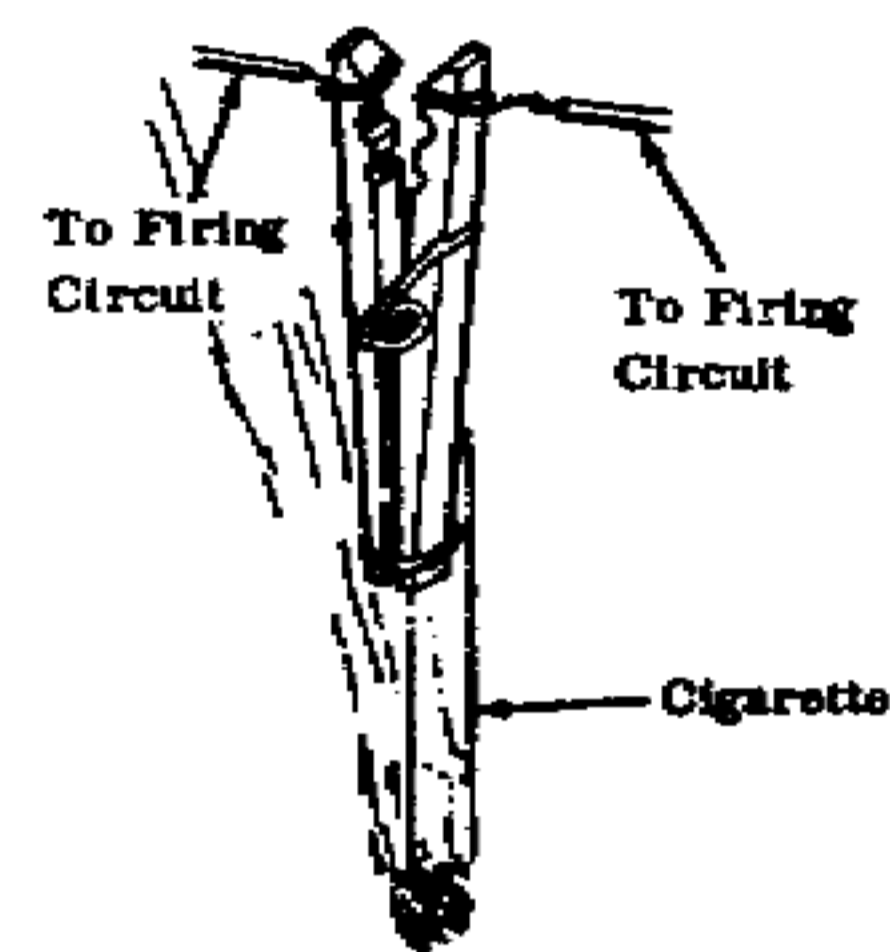

Scientific Principles of Improvised Warfare and Home Defense

1. Time Delay Grenade

This delay mechanism makes it possible to use an ordinary grenade as a time bomb

Material Required

Grenade
Fuse Cord

IMPORTANT: Fuse cord must be the type that burns completely. Slow burning improvised fuse cord is suitable. Safety fuse is NOT satisfactory, since its outer covering does not burn.

Procedure

1. Bend end of safety lever upward to form a hook. Make a single loop of fuse cord around the center of the grenade body and safety lever. Tie a knot of the non-slip variety at the safety lever.

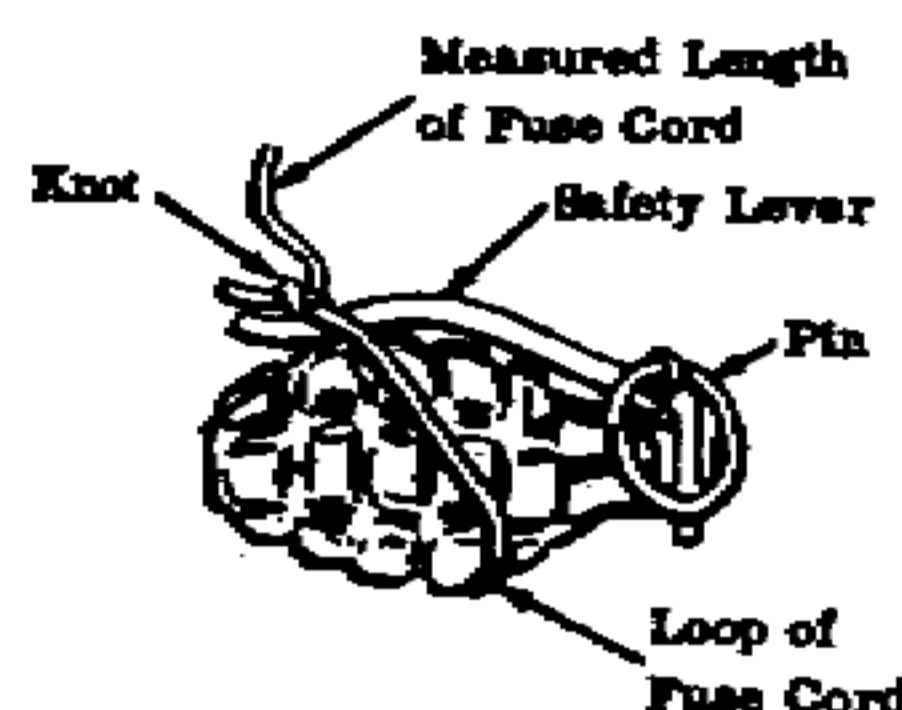

NOTE: The loop must be tight enough to hold the safety lever in position when the pin is removed.

2. Measuring from the knot along the free length of the fuse cord., measure off a length of fuse cord that will give the desired delay time. Cut off the excess fuse cord.

How to Use

1. Place hand around grenade and safety lever as safety lever is held in place. Carefully remove pin.



2. Place grenade in desired location while holding grenade and safety lever.

3. Very carefully remove hand from grenade and safety lever, making sure that the fuse cord holds the safety lever in place.

CAUTION: If loop and knot of fuse cord do not hold for any reason and the safety lever is released, the grenade will explode after the regular time delay.

4. Light free end of fuse cord.

Scientific Principles of Improvised Warfare and Home Defense

m. Detonator

Detonators (blasting caps) can be made from a used small arms cartridge case and field manufactured explosives. Detonators are used to initiate secondary high explosives.

Material Required

Primary explosive

Booster explosive

Improvised scale

Used cartridge case

Fuse, 12" long

Round wooden stick (small enough to just fit in the neck of the cartridge case)

Drill or knife

Long nail with sharpened end

Vise

Improvised loading fixture

Procedure

1. Remove fired primer from a used cartridge case using a sharpened nail.

2. If necessary, open the flash hole in the primer pocket using a drill or knife. Make it large enough to receive fuse.

3. Place one end of the fuse in the flash hole and extend it through the case until it becomes exposed at the open end. Knot this end and then pull fuse in cartridge case thus preventing fuse from falling out.

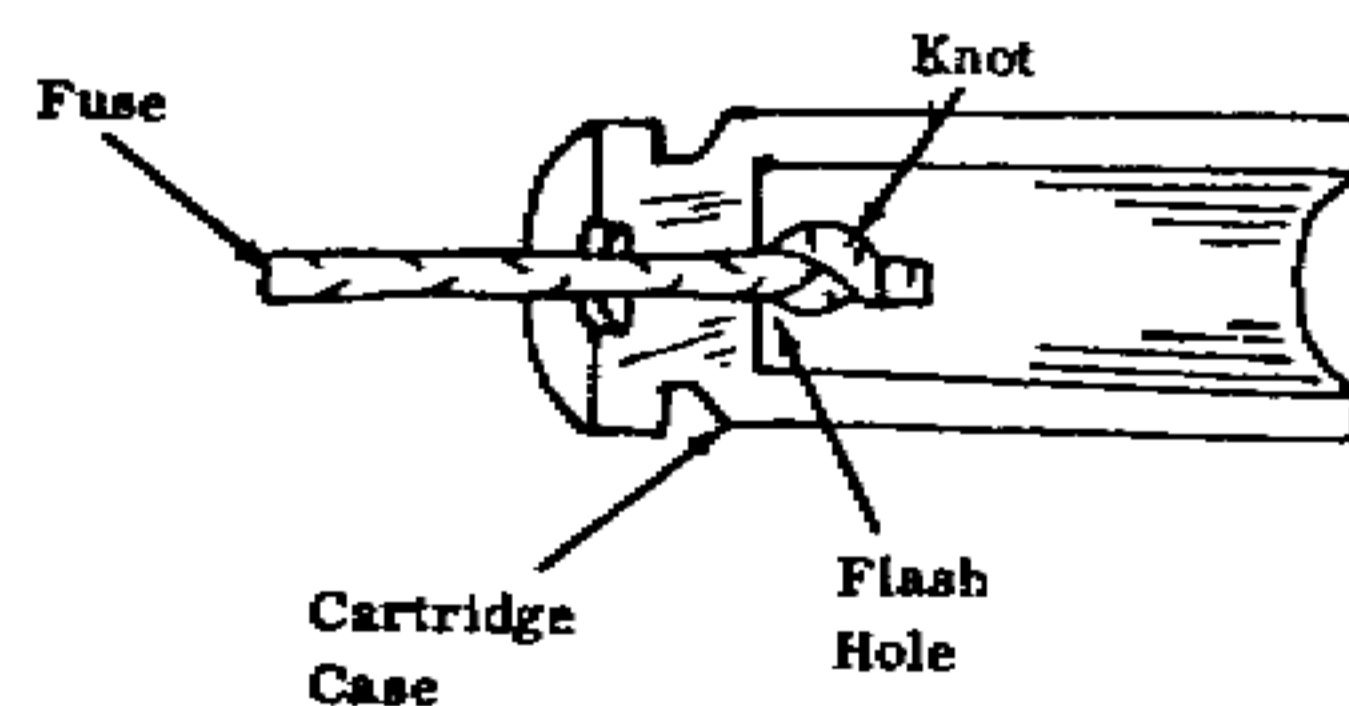
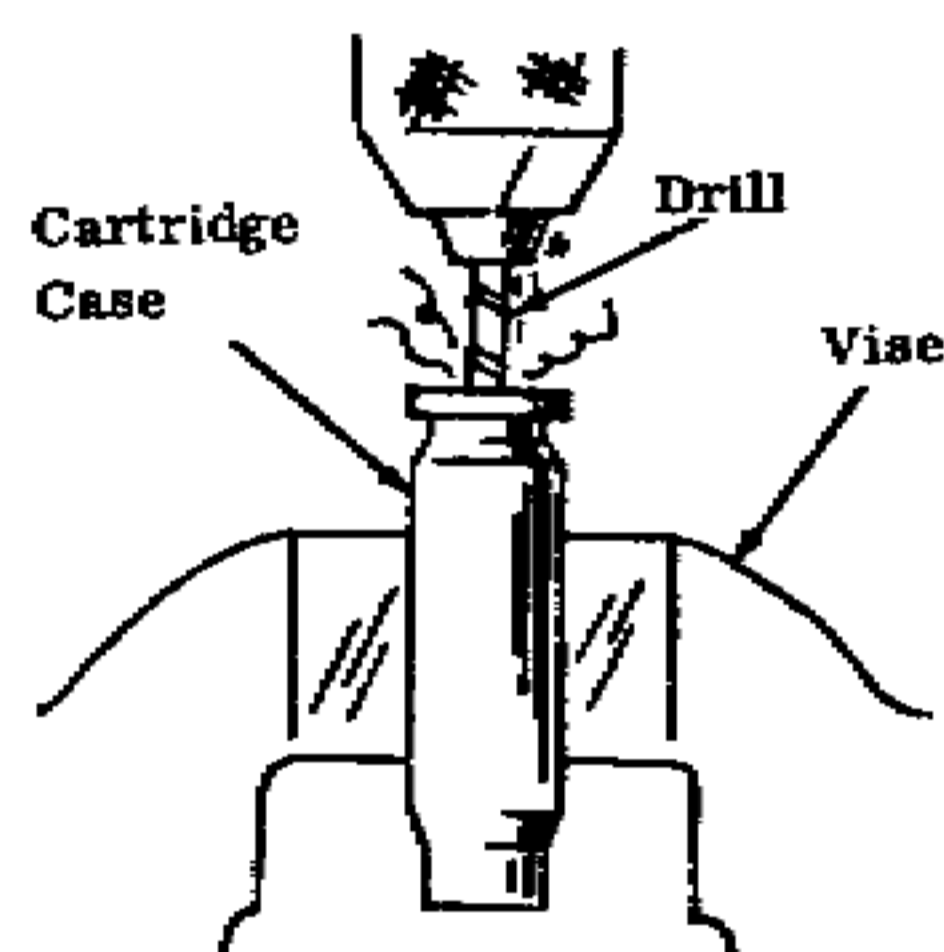

Scientific Principles of Improvised Warfare and Home Defense

4. Load the primary explosive in the cartridge case as follows

Lead Picrate	3 grams
TACC (Tetramminecopper Chlorate)	1 gram
DDNP	.5 gram
Mercury Fulminate	.75 gram
HMTD	.75 gram
Double Salts	.75 gram

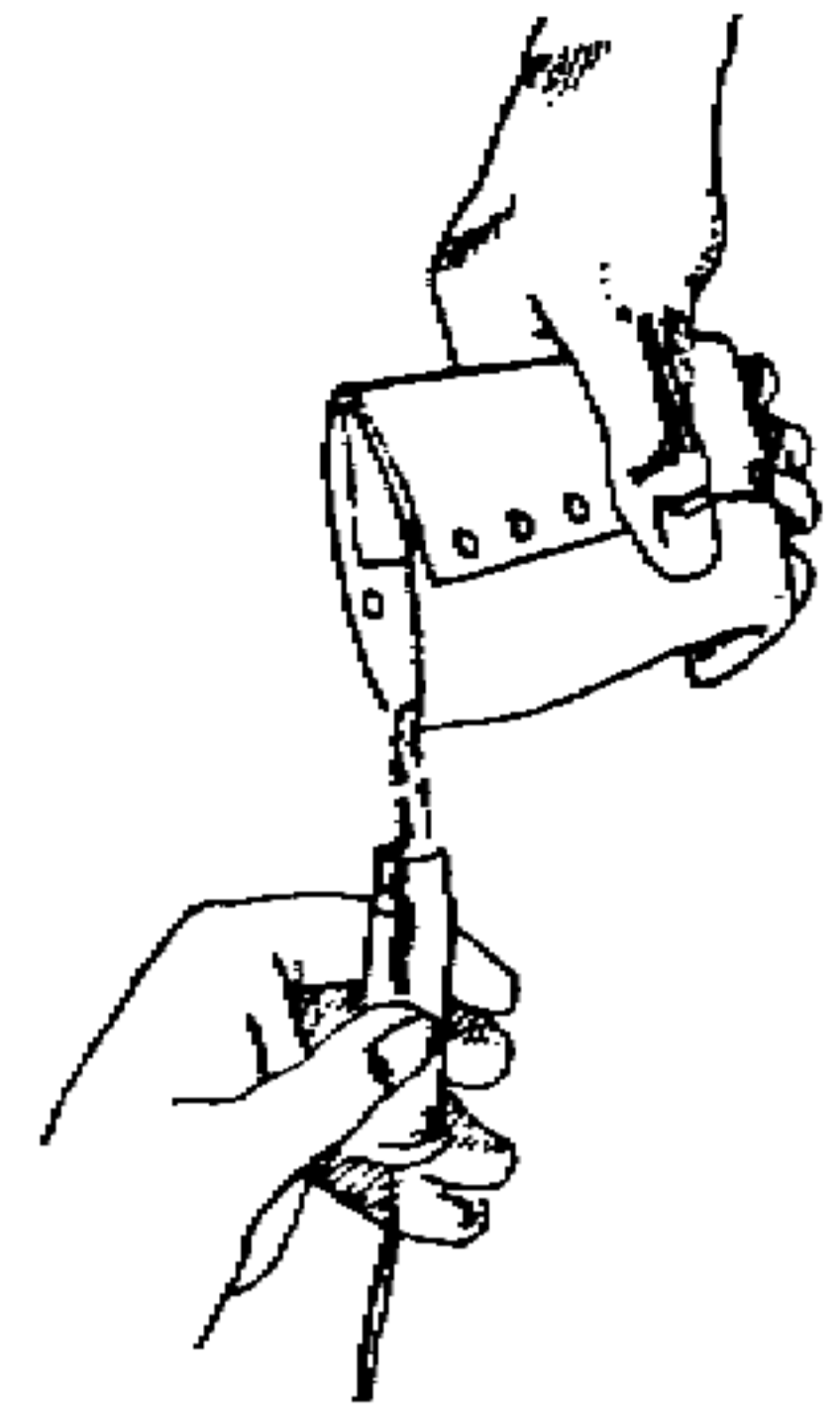

5. Compress the primary explosive into the cartridge case with the wooden stick and the following improvised loading fixture.

CAUTION: The primary explosive is shock and flame sensitive.

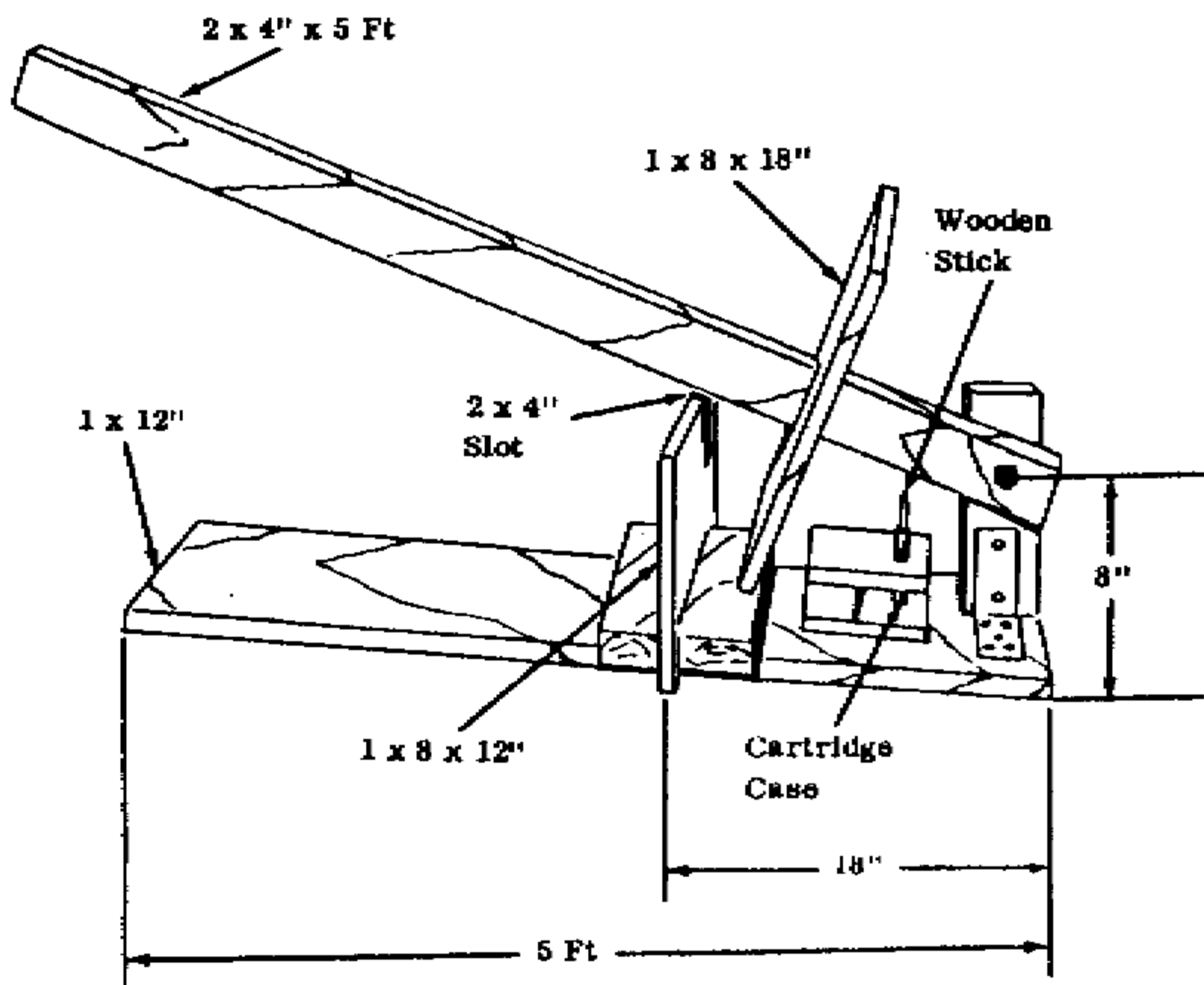
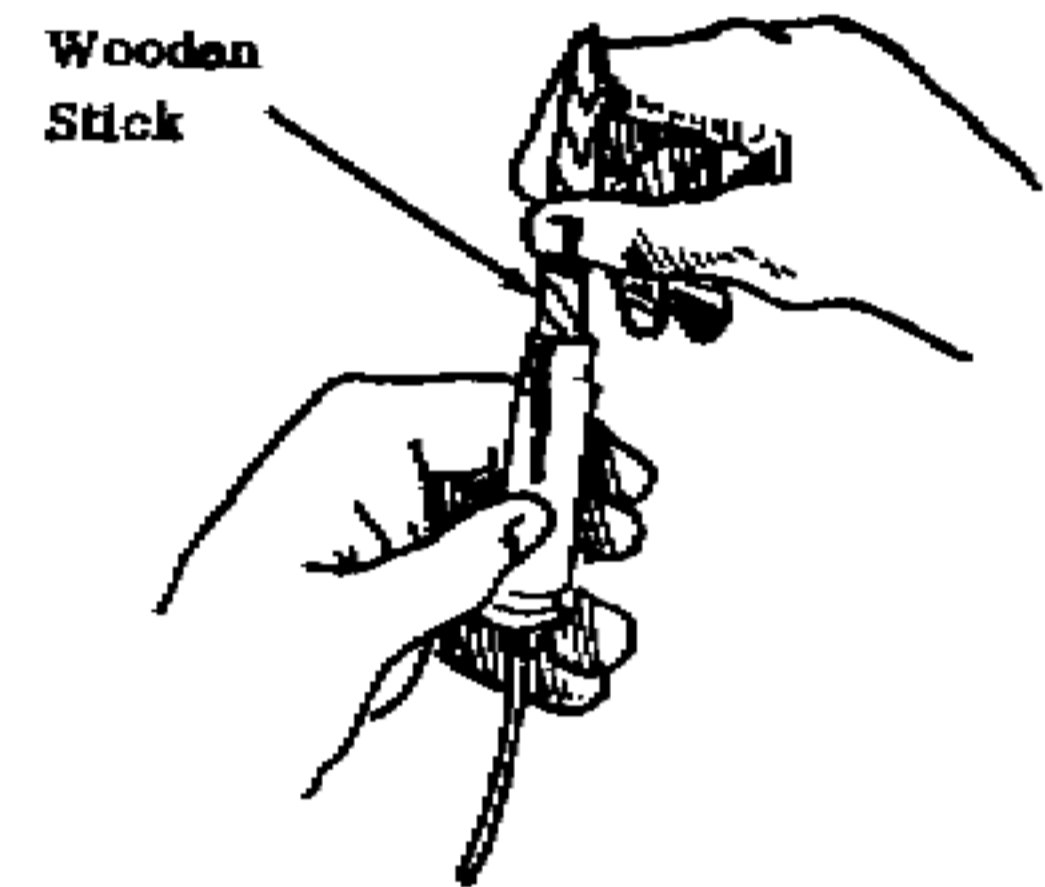

6. Add one gram of booster explosive. The booster can be RDX.

7. Compress the booster explosive into the cartridge case with wooden stick and the loading fixture.

8. If the case is not full, fill the remainder with the secondary explosive to be detonated.

CAUTION: Detonator has considerably more power than a military blasting cap and should be handled carefully.

Scientific Principles of Improvised Warfare and Home Defense

n. Can-Liquid Time Delay

A time delay device for electrical firing circuits can be made using a can and liquid.

Material Required

Can

Liquid (water, gasoline, etc.)

Small block of wood or any material that will float on the liquid

Knife

2 pieces of solid wire, each piece 1 foot or longer

Procedure

1. Make 2 small holes at opposite sides of the can very close to the top.



2. Remove insulation from a long piece of wire for a distance a little greater than the diameter of the can.

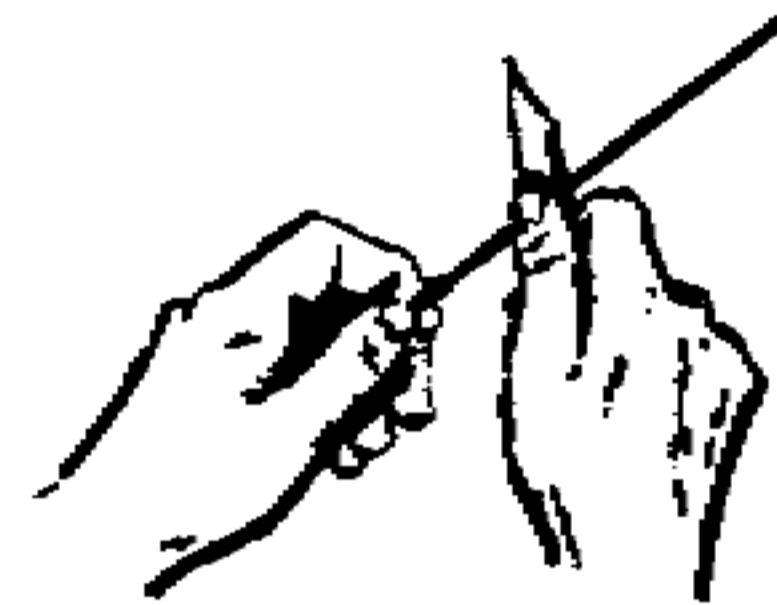

3. Secure the wire in place across the top of the can by threading it through the holes and twisting in place, leaving some slack. Make loop in center of wire. Be sure a long piece of wire extends from the end of the can.



4. Wrap a piece of insulated wire around the block of wood. Scrape insulation from a small section of this wire and bend as shown so that wire contacts loop before wood touches bottom of container. Thread this wire through the loop of bare wire.

Scientific Principles of Improvised Warfare and Home Defense

5. Make a very small pinhole in the side of the container. Fill container with a quantity of liquid corresponding to the desired delay time. Since the rate at which liquid leaves the can depends on weather conditions, liquid used, size of hole, amount of liquid in the container, etc., determine the delay time for each individual case. Delays from a few minutes to many hours are possible. Vary time by adjusting liquid level, type of liquid (water, oil) and hole size.

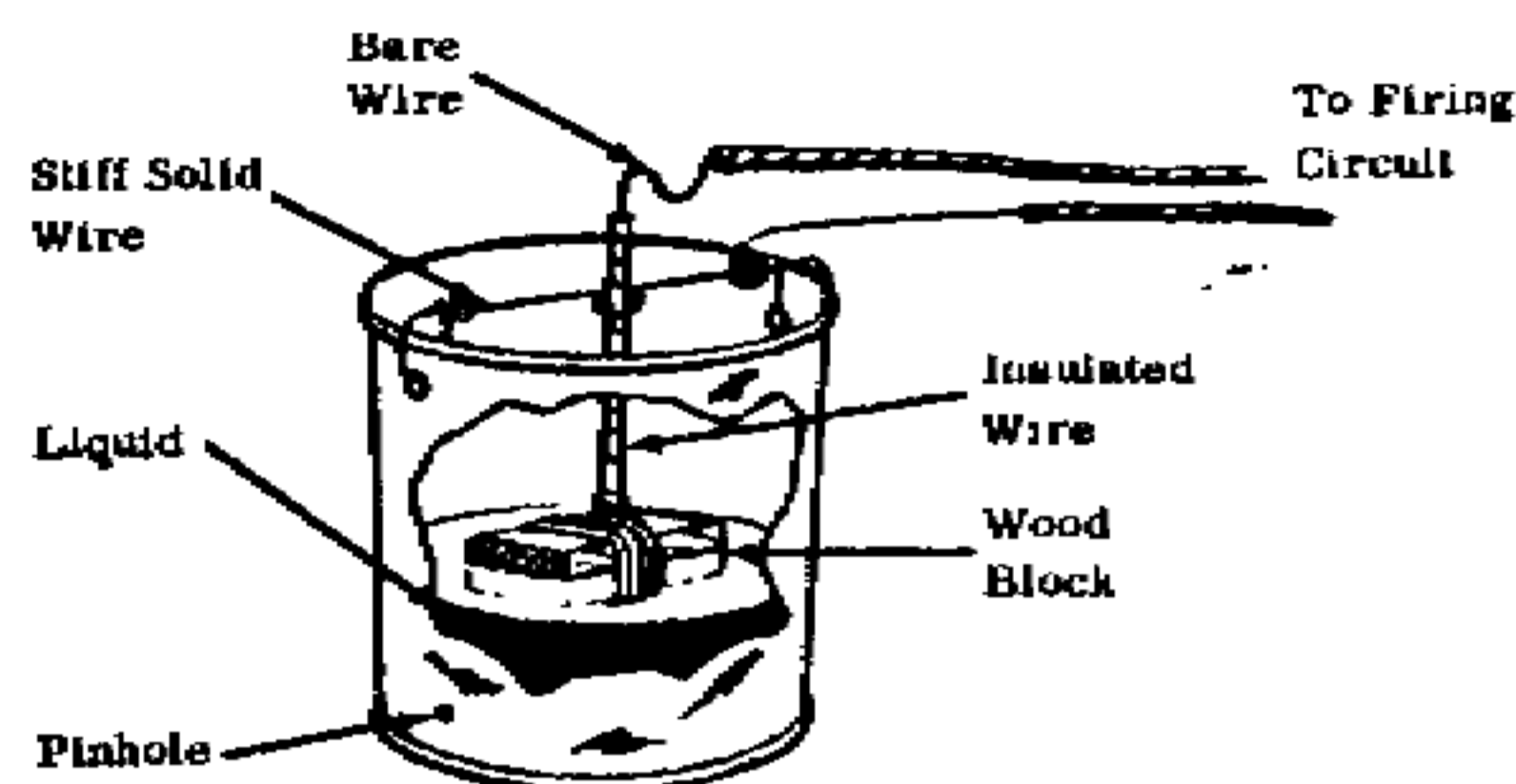

How To Use

1. Fill can with liquid to the same level as during experimental run. Be sure that wooden block floats on liquid and that wire is free to move down as liquid leaves the container.

2. Connect wires to firing circuit.

NOTE: A long term delay can be obtained by placing a volatile liquid (gasoline, ether, etc.) in the can instead of water and relying on evaporation to lower the level. Be sure that the wood will float on the liquid used. **DO NOT MAKE PINHOLE IN SIDE OF CAN.**

Scientific Principles of Improvised Warfare and Home Defense

Chapter 11 Combat Support, Skills, and Equipment

When a decision is made to wage war, soldiers, and the involved civilians need to have certain skills organized toward the work of warmaking and need to be trained to be able to support the warmaking effort. These non combat skills are essential if populations are to survive and resist the disease, injuries, famine, and social upheaval that war brings. Early examples in the 1990's include Bosnia, the Kurds in northern Iraq, the many outbreaks of civil war in the various African nations, and all the other countries where freedoms are only practiced as a pretense.

Essential and basic skills include

1. **Organization:** There must be a clear chain of command to decide what work is to be done and who will do it.
2. **Industry:** It is important that the repetitive work of weapons and ordnance construction and other essential warmaking supplies be efficiently and correctly produced by trained personnel.
3. **Intelligence:** Must be gathered, disseminated, and acted upon.
4. **Communications and Electronic Warfare:** Must be conducted in a secure manner.
5. **Survival and Evasion of troops and civilians:** is essential to maintain power and hope when faced with death or starvation.
6. **Leadership:** must be effective to maintain morale and deal with refugees and the awful living conditions that war often brings to civilians.

1. Organization

When war conditions fall upon a group of people or nation it is critical to put one individual in effective charge of all activities to provide for the war effort. People must be organized to

Create and train an effective fighting force

Support this force through production of key armaments

Supply this force with food, water, transportation, weapons, and ordnance

Give clear direction to civilians who may otherwise waste their efforts in worry and complaining. They can be used to support and aid each other (generating hope)

Establish a police force with a clear purpose of maintaining order and protecting services

Scientific Principles of Improvised Warfare and Home Defense

Much of the work involves organizing and motivating civilians to be able to survive and resist where possible. This may be easy where fear is a strong motivator. The problems come when panic sets in while being attacked and possibly being overrun. If people cannot be orderly evacuated then they must be able to go on living under an enemy while being trained and aided in invisible resistance methods. In order to do this and find the right people, the population must be scoured to find people with:

Military Experience, as leaders or specialists in these essential areas

Industry managers and experts who know how to organize production and supply

Teachers who can teach the essential skills to civilians in resistance and aiding each other

Survival experts, ranging from gardeners who know what plants can be grown or are safe to eat and farmers who may be needed to share their skills to keep the population fed, and others to teach sanitation, personal protection and movement.

Electronics experts for intercepting enemy communications and conducting ECM/ESM

Police and medical experts for crowd and traffic control and teaching the civilians how to aid their wounded and maintain health and sanitation.

Leadership for maintaining hope and clear direction and purpose. This purpose has to be positive and recognized as good for all the people. It cannot be a simple power grab or people will quickly recognize this and rarely support it. Centering efforts on the good things the people can be and what they can do for each other and most importantly, how they can succeed will aid in resisting the enemy.

The work needs to be organized according to the threat. If the threat is armed ground invasion, then the work needs to be organized around stopping the ground assault and evacuation of key equipment and personnel if it becomes necessary. These steps include

Digging ditches and traps and equipping them accordingly. This involves sighting the best locations to stop enemy traffic flow or funneling it to killing zones. The ditches can buy a great deal of time and when combined with obstacles may even deter the enemies approach. All the earth moving equipment must be applied to this effort. Many individuals with shovels can also produce considerable barriers overnight.

Equipping a group to lay mines and other ordnance in the expected path of the enemy is critical in stopping the dangerous armored vehicles and any equipment they would bring forward to fill in or bridge your obstacles and ditches.

Scientific Principles of Improvised Warfare and Home Defense

The military personnel must be organized and focused to produce localized force advantages of 3:1 or greater if it attacks the enemy in meeting engagements or the enemy attempts to attack their own positions. In defense, ditches and camouflaged positions are critical to allow the forces to fire at the enemy from cover without being seen. These positions can be prepared and hardened in advance with steel or concrete covered with dirt.

The civilians can be trained to provide direct military assistance and resistance if they are capable. If the situation is genuinely hopeless, they can be instructed on how to resist with homemade ordnance, video equipment, radios and so on from behind enemy lines.

If evacuation is decided upon, decisions must be made as to who is evacuated, in what order and to where are they going. Masses of civilians cannot be moved easily and risk causing starvation, spreading disease, and hindering any overall resistance effort. Any movement must be protected in order to maintain order and hope of actually reaching a safer location.

If the main threat is air attack or simply being cut off and starved, the work needs to be organized to build the essential rockets, missiles, anti-aircraft guns, protecting civilians from bombing and strafing, and how to produce their own gardens and food to prevent starvation and feed and supply the forces at the front.

Such essentials as burying human waste to provide fertilizer, or using it for ordnance needs to be taught and organized as it is likely that the sanitation facilities will be early targets and the accumulation of garbage and wastes can be a huge health hazard. They don't have to be when they can be turned into fuel for fires, fertilizer, and even ordnance and biological weapons. Untreated wastes should not be discharged directly into streams and rivers unless the enemy is living downstream.

If you are conducting offensive operations from commando raids to actual large scale armed assaults you need essential combat support groups, organized and equipped. These include

Engineers with special training to overcome and bridge the enemies obstacles with bridging equipment and mine clearing abilities. Obstacle and camouflage construction.

Communications specialists to make sure that all forces and command can be coordinated

Transportation troops to keep the supplies and offensive moving at high speed

Military Police to maintain order and protect the government from some of its own people

Intelligence including maps, video, electronic and interrogation information.

Utilities engineers to provide portable electric power, restrooms, baths, decontamination, bakeries and other essential plants.

Scientific Principles of Improvised Warfare and Home Defense

Medical personnel who are trained to give first aid and evacuate troops and conduct preventive medicine to keep the troops in combat shape.

Maintenance experts who can keep utilities and vehicles going. Preventive maintenance is taught by this group.

Headquarters with the communications to all support and combat troops, with intelligence personnel and analysts to support the leaders. The direction and ability to function and coordinate work between all units is critical to success.

2 Industry

Everything combat troops need in the field must be produced or field improvised. Factories can likewise be field improvised. Ammunition can be obtained for guns almost anywhere in the world. As the Bosnian populations quickly discovered, when the rest of the world stops selling the basics you either learn to smuggle what you need, improvise everything, or simply die when the enemy comes for you.

Mini factories can be established for the key components of warmaking in individuals homes. The work can individually be taught and supplies flow worked out as follows.

- | | |
|-------------|--|
| Explosives- | Potassium Nitrate production from mixed waste and dirt sites
Sulfur mining or importing
Charcoal production from wood
Nitric Acid production from the Potassium Nitrate and Sulfuric Acid
All final formula explosives desired from the above raw materials
Chemicals and Biological plants |
| Ordnance- | Mines, grenades, and booby traps
Bullets
Shells
Rockets and Missiles
Demolition
Chemicals and Biologicals |
| Equipment- | Firearms
Rocket and shell launchers
Rocket and missile tube assemblies
Artillery guns (If barrel casting and ammo know how is available)
Mines, grenades, and booby trap parts
Hand held weapons |

Scientific Principles of Improvised Warfare and Home Defense

The information flow needs to be from the raw material supplier to the fabricator of the parts to the final user who must be trained in how to reliably use the weapons. As long as raw materials can be obtained, the entire population could be organized in specialty areas to produce war materials. In addition, each home could effectively be provided with defensive weapons including the mines, booby traps, one shot firearms if regular guns are not available (with a lot of pipe and reloading, every family dwelling and group could put up tremendous resistance even with the simple one shot guns described in this book).

It is important to organize the work into parts where individuals become familiar and eventually expert with what they are making and how to use it. This makes the devices and chemicals reach a high standard of reliability for the troops to have confidence in.

Factories for the specialized production of obstacles such as barbed wire and trenching tools is an important part of a defensive campaign. Having specialists manufacture camouflage and armored bunker sites to shoot from is critical in defense. Where possible, personal armor for the troops must be provided in the form of helmets, flak jackets and body shields.

For unemployed civilians, the accumulation of rubble to cover roads and act as speed bumps against an enemy advance can be an aid and give the feeling of helping the war effort. Offering to feed the laborers as opposed to handing out welfare is suggested.

All of these plans, if carried out can turn an entire civilian population into a trained army of thousands or millions. Instead of having cities of fat sheep or cattle for the simple taking by an enemy, the entire population can be turned into a hornets nest of resistance. If every single approach to a dwelling results in casualties from mines, booby traps, gunfire, incendiaries, and requires the painstaking and time consuming acts of filling in or bridging ditches just to reach the front door, it is likely that the enemy's soldiers will become discouraged. This is especially true if many of their armored vehicles and tanks are lost in the effort.

The recent example of Saddam Hussein invading and retaking the US "protected" areas of northern Iraq provides a good case study. Instead of relying on the "cheap talk" of the allies, the Kurdish population, had they some idea of what to actually do, could have produced their own armaments and obstacles and could have offered tremendous resistance to the 30,000 invading Iraqi army troops. If you arm several hundred thousand civilians with the know how and materials for guns, mines, and the other capabilities described in this book, it would have taken a lot more than two divisions and a couple of days to overrun any of their cities. The same would have been true for the populations in Bosnia and the different African nations where the ethnic differences between the army and civilians resulted in massacres.

Organizing a defense takes time and know how. Common sense is an often used phrase but it is not much help. Common sense only comes from experience obtained on the job or through training. You can have no "common sense" for anything unless you have the know how and experience in the particular field. Without the know how that this book teaches, civilian populations are fat sheep and cattle being led to the slaughter in many parts of the world.

Scientific Principles of Improvised Warfare and Home Defense

When faced with a real shooting war, the know how taught in this book must be translated to a real organization and arming of the civilian population to aid the war effort. The factories must then come on line to supply and support this effort and provide the focus and hope that the population must have in order to keep fighting and eventually win.

One final and important decision in the choice of what factories to build are the political ones. Many leaders might be squeamish about using biological or chemical weapons. The obvious answer is that if this choice is scary to you it will be mortifying to the enemy trying to kill you. When the wolf comes to your door to kill you, you have a right to use **anything** your mind can conceive of to protect yourself. Let the most dangerous chemical and bio weapons you can make be part of the factory plan. Use them defensively in anti tank and personnel mines, booby traps, and ditches. When the enemy forces himself on you and encounters them, its his own fault for trying to invade your homes.

Factories must also be equipped to manufacture the needed items. Using 55 gallon drums in place of pots or pans and cement mixers in place of mixing bowls are obvious. Simple shop tools can be supplied to fabricate components in most cases. The larger scale machines may have to be pooled among the home factories to meet everyone's needs.

3. Intelligence

There are many kinds of intelligence that can be gathered and used. We will cover these one at a time.

Strategic: involves learning everything about the enemy and what they are capable of. This includes collection of maps, home videos, news reports, satellites (including the weather channel), newspapers and other publications of the enemy country, use of spies for obtaining the above and other information and interrogation of POW's. This information must be collected and disseminated to the leaders who must use it.

Tactical: or operational involves details of the areas of concern such as a country or localized front. It is broken down into activities such as troop movements, air operations, naval operations, economic activity, and political activities. These must be studied on an ongoing basis to provide early warning of an enemies approach or intentions. If you know where and about when he is going to strike, you then know where to position defensive ordnance, obstacles and troops.

Scientific Principles of Improvised Warfare and Home Defense

Electronic: may be intercept of communications, satellite transmissions, civilian phone calls, video from airline overflights, and the use of video and infra red sensors mounted on your own drone or regular aircraft and surveillance rockets and missiles. Local electronic sensors can be used for patrolling and providing nearby early warning. These can be mounted and monitored on treetop, building roofs, hilltops, or you can improvise your own hilltop by mounting surveillance equipment on top of cranes and lift equipment (piggyback systems if necessary). The lifts used for portable lights at football stadiums combined with modern optical systems and computers would allow for looking over hills and buildings and would provide a tremendous early warning and targeting system for friendly forces. It should be made a standard part of all military units and makes a good substitute for low flying surveillance helicopters.

Many mounted weapons could be lifted and operated by remote control without exposing troops to direct enemy fire. Entire combat forces could function this way, substituting for guard towers and posting patrols. Mini lift systems could even be used in jungles, forests and difficult to reach urban terrain. Fighting over and around obstacles by remote sensor has to be the way of the future wars. Adapting the wide array of modern material lifting and handling equipment to gather intelligence and aid in this type of fighting is essential.

Even police forces have a need to be able to remotely deliver video and audio systems by crane or lift devices to windows and vents to gather intelligence on hostage and armed hostile situations. The ability to combine this capability with remote delivery of nonlethal ordnance would increase public confidence in the law enforcement profession.

The ability to detect sound, and high resolution video in the visible light, infra red, electromagnetic, and radio spectrums greatly increases the tactical intelligence available to local commanders. These sound and various video and camera systems are readily available and commercially sold throughout the western world. Using all of these systems to gather information on an enemy can give you a quick idea of what he is up to.

Human: sources of intelligence can also be valuable. Finding people who have lived and have home movies and maps of the enemies home areas are of great value. Some of these may be useful as direct spies, double agents, saboteurs, moles, couriers, defector recruiters, assassin's, interrogators, and analysts.

Technical: intelligence is important because capturing or being able study enemy machines of war will tell you how to beat them. How thick the armor is on their vehicles will tell you where to plant demolition of fire ordnance at. The thickness also tells you how large you have to make your own anti-armor explosives and gives you something to test and practice on. Can air filters running the engines be plugged with certain types of smoke. Can the drivers be blinded easily by gas or smoke weapons. Is the enemy using high explosive bullets and shells, or armor piercing ordnance. Can these be defeated easily by different armor systems. What type of camouflage cannot be picked up by their surveillance systems.

Scientific Principles of Improvised Warfare and Home Defense

Once you have gathered the "intelligence", what do you do with it. The obvious first choice is apply it directly to the military operations by establishing effective defense where he is likely to strike and attacking weak areas where you have obvious superiority and can achieve results easily. There are many non combat and indirect uses of intelligence. These include

Camouflage of your troops and setting up falsely camouflaged or fictitious defenses.

Sending false and deceiving communications, radar, and other signal to mislead the enemy

Planting false information in the media or with spies. Inflatable dummy tanks also work.

Planting double agents to pretend to spy for the enemy and lets you know what he knows about you.

Sabotage or destroying key enemy installations. This can even include unlikely or nuisance targets such as water, sewer, television, garbage, mail and other communication and public service facilities, plants and vehicles.

Assassination is useful when the enemy has certain skilled or talented leaders that they cannot easily do without.

Disseminate propaganda behind enemy lines

The gathering of all possible intelligence when faced with a war situation is critical. Building files of information and keeping them will always be useful, especially gathering information during peacetime when it is easiest to collect. Its a little late if you wait until the shooting starts.

Scientific Principles of Improvised Warfare and Home Defense

4. Communications and Electronic Warfare

The importance of secure communications, intercepting and decoding enemy communications, and waging electronic warfare is easily understood when events like Pearl Harbor, the surprise attacks of Germany into Russia in 1941, the Battle of the Bulge, the Chinese intervention in Korea, the TET offensives during Vietnam, the Israel attack in 1967 to seize the Suez canal and Golan heights followed by the Arab riposte in 1973, occur repeatedly in history.

Surprise seems to be the watchword for great military successes and disasters. The element of surprise is achieved by moving men and resources to unexpected positions and sending them on to their objectives without anyone knowing about it until the event takes place. In order to do this the elements of deception and camouflage must be used to their best effect. More than anything else, all communications must be kept secure or the "cat will be let out of the bag" with potentially disastrous consequences.

Being able to intercept the enemies communications have also had great effect on military successes and failures. The more notable examples were the Soviet defense of Kursk after spies intercepted the key German battle plans, the US shooting down of Yamamoto's plane during mid WW2, and many of Rommels North Africa successes.

The use of radio, wire, microwave and satellite transmissions combined with scrambling and encoding devices allow for transmitting and receiving instant messages. Combined with modern computers and fiber optic cables, the ability of someone to pick up the potentially huge flow of information and decoding it in a timely fashion becomes increasingly difficult.

Yet, when war comes, the ability to monitor enemy transmissions and protect your own become life and death matters. To secure your own communications, the use of fiber optic wires reduces the likelihood of interception by wiretap. Adding an encoding system and decoder at the receiving end improves the security. Being able to use computers to compress data thereby reducing the flow of information in one area and broadcasting volumes of gibberish in another area can mislead the enemy as to troop dispositions, concentrations, and intentions.

The other forms of electronic signatures such as radar to provide warning or locking onto of enemy aircraft must be kept to a minimum. The use of passive early warning such as detecting the infra red, video, and electronic emissions of an incoming target can help protect your electromagnetic sources. In today's world, missiles are used to home in on radar, communications, and radio sources and destroy them. The use of cellular phones led to the homing in on and death of the Chechen leader from a homing missile attack in recent years.

Scientific Principles of Improvised Warfare and Home Defense

In improvised warfare it may be hard to accomplish secure communications, much less intercepting an enemies. The effort must be made. Scanning equipment is commercially available in the western nations which can quickly locate active emissions of almost any frequency. Recording equipment can capture the transmission for later decoding by computer assisted analysts. Even information such as the direction and frequency of traffic combined with other intelligence can give an idea of enemy intentions. Using fax and computer equipment to transmit your own messages and doing so remotely or through proxy transmitters can save losses through an enemies use of anti-radiation missiles. Gaining fixes on enemy transmission from two directions can let you counter likewise with emission guided weapons, or direct assault by artillery, rockets or ground forces (commando's).

Techniques such as jamming enemy emissions can be helpful if you can create the powerful signals needed to counter an enemies. Laying down and burying your own secure lines between headquarters is helpful. Setting up satellite communications also makes it hard to be intercepted anywhere in the world. Having access to the weather channel and CNN has even influenced modern wars.

Electricity and electronics can also be used be used as weapons in the form of stun guns, electrocution used in assassinations, and electromagnetic pulses used to damage electronic equipment

An advance inventory of trained personnel and equipment is essential for

- Radios
- Scanners
- Direction Finders
- Computers
- Microwave
- FiberOptic
- Satellite systems
- Encryption and decoding
- Lasers
- Infra-Red and thermal imaging

Scientific Principles of Improvised Warfare and Home Defense

The following chart of frequency band designations can give you an idea of what is needed to cover the potential emissions spectrum.

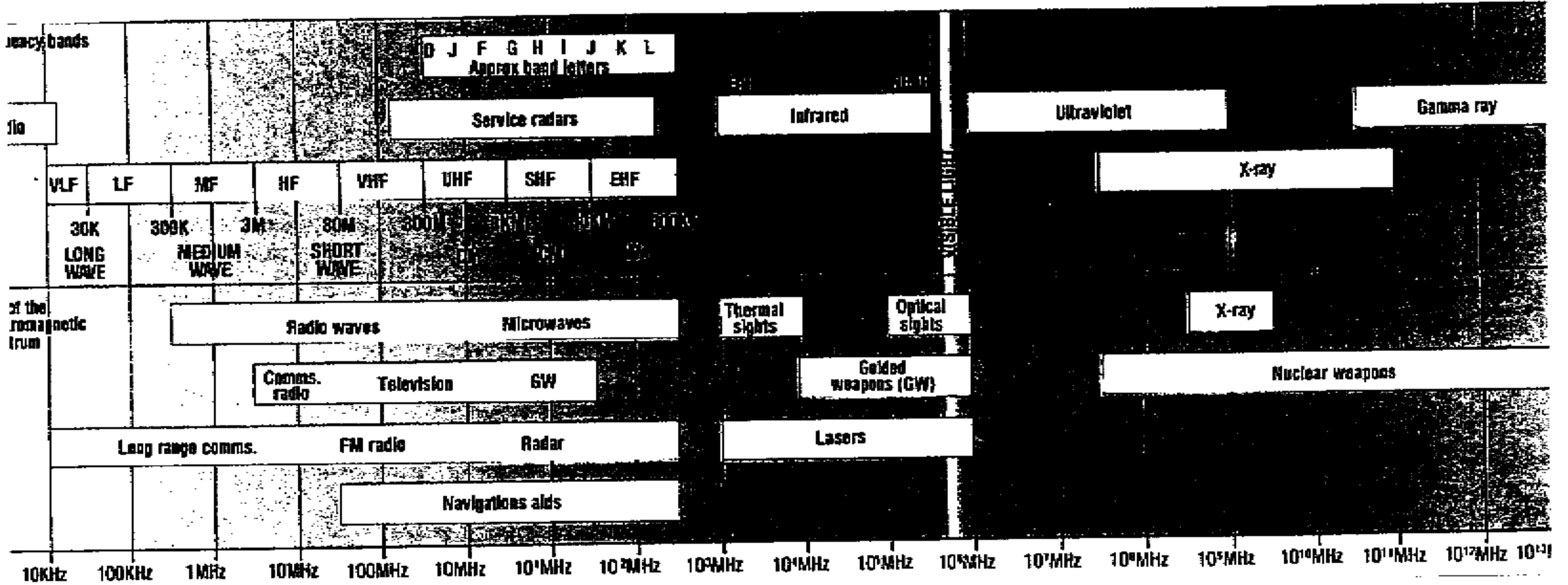

Scientific Principles of Improvised Warfare and Home Defense

5. Survival and Evasion

One of the most important skills that individuals can learn and pass on to others is how to survive. These skills can enable entire populations to survive terrible conditions if the will and know how is there. Countless stories can be repeated from history illustrating survival, from Leningrad during the Nazi invasions, to the recent example of an Air Force pilot shot down over Bosnia. This is not a book about survival, and if an individual believes he may one day be faced with a survival situation, he should equip himself with the tools and a library to help in this regard. I will cover the highlights and some improvisation methods that can help. The most important aspects of surviving and evasion are:

- Attitude
- Terrain and Climate
- Water
- Food
- Oceans
- Shelter
- First Aid
- Group Survival
- Firebuilding

Attitude

In surviving, attitude is everything. The ability to cope with fear, pain, cold, thirst, hunger, fatigue, boredom, and loneliness depends on attitude and know how. Most of mankind had to live every day of his existence with all of this through thousands of years of struggling, before man organized and civilized his activities. Modern tribes all over the world survive every day in jungles, deserts, the arctic, the ocean, and so on, and they think nothing of it. It is part of their everyday existence. The difference is that they learned growing up how to cope with their environment.

This act of learning how to cope and having a "can do" attitude is what allows POW's and crash survivors make it, and allows natives to live comfortably every day in harsh conditions. The difference is that we have become accustomed to comfort. When we are forced in an abrupt way to live without air conditioning or heating, without a meal at the local food outlets, and having to walk any great distance, we become uncomfortable. Combine this with the prospect of an enemy trying to hunt you down and fear begins to set in. How you handle the new combination of stresses determines how you live and if you live.

Scientific Principles of Improvised Warfare and Home Defense

Most of the symptoms described above may come from discomfort rather than any real injury or exposure. Your attitude that recognizes that your current discomfort is only temporary and can get a lot worse if you are captured by the enemy can help you make it. Comfort is not essential, surviving is. Your body and mind can take incredible amounts of mental and physical discomfort for long periods. Anyone who doesn't believe it only has to look at Marine boot camp or the survival schools. The following attitudes will help you make it-

I can make up my mind

I can take it

I am not about to let the other ____ win

I can improvise

I can live on my own (at least for a while-and give the rest of the world some peace)

I keep cool, calm, and in control

I am patient

I can't help the situation I am in, but I can do something about it

I can cope with

Fear: by knowing my equipment, knowing my comrades, knowing my abilities and concentrating on the job at hand

Pain: by being too busy to bother with it. If I am injured I know how to treat it.

Cold: by knowing how to keep warm or building a shelter and fire if it becomes serious

Thirst: by cutting food intake when supplies are low and knowing how to obtain and use water from my surroundings

Hunger: by knowing how to collect edible food and recognizing I can live on very little food

Fatigue: by limiting activity or changing the current activity and having a clear goal and summoning the strength to reach it

Boredom: by getting interested in something and finding something to do-like survive

Loneliness: by knowing how well trained and self sufficient I am and big a party I will have when this is all over

Scientific Principles of Improvised Warfare and Home Defense

Terrain and Climate

Your surroundings determine how you set priorities, with the greatest threat to surviving being dealt with first. The main types of terrain encountered are deserts, jungles, mountains, polar terrain, and areas where survival is easiest- forests and plains.

Deserts: are demanding to physically move through, are difficult to navigate, and are hard to hide in. With high temperatures and hot blowing wind, the first priority is water. Finding shelter (in dry washes with thick vegetation) during the day and traveling by moonlight (with warm clothing) work best. Use cover that reflects sunlight and place them in the shadow of other plants or dune walls. During the likely once a week sandstorms, mark your direction of travel and lie down, cover your mouth and nose with cloth and ride out the storm. Noise and light carry a long way at night and there are no mirages. Avoid traveling without moonlight. Use a compass and select a consistent route. Sweating is the main cause of water loss-avoid activities that cause sweat if water is limited. Let your clothing absorb the sweat and keep it on using it to protect you from the heat. Breathe through your nose to and minimize talking to conserve water internally. If water is short, do not eat. Eating requires water for digestion. Do not ration water, sip small amounts regularly

Obtaining water in the desert can be accomplished by a variety of means

- *Digging in the outside curve or bend of a dry river bed and letting the water collect
- *Sopping up morning dew from rocks and metals with cloth and wringing it out
- *Making a water still by digging a hole in the sand, placing a can or container in the bottom and covering the hole with a sheet of plastic. Push the center of the plastic down to form a cone and use a rock to weight the center down to a point over the can. As the air under the plastic gets hot, ground moisture evaporates and condenses on the underside of the plastic. The drops run down and collect in the container. You can use a tube to draw the water without disturbing the still. Adding vegetation inside the hole will increase the moisture collected. You can also use this method to collect dew by piling rocks on the plastic in the morning.

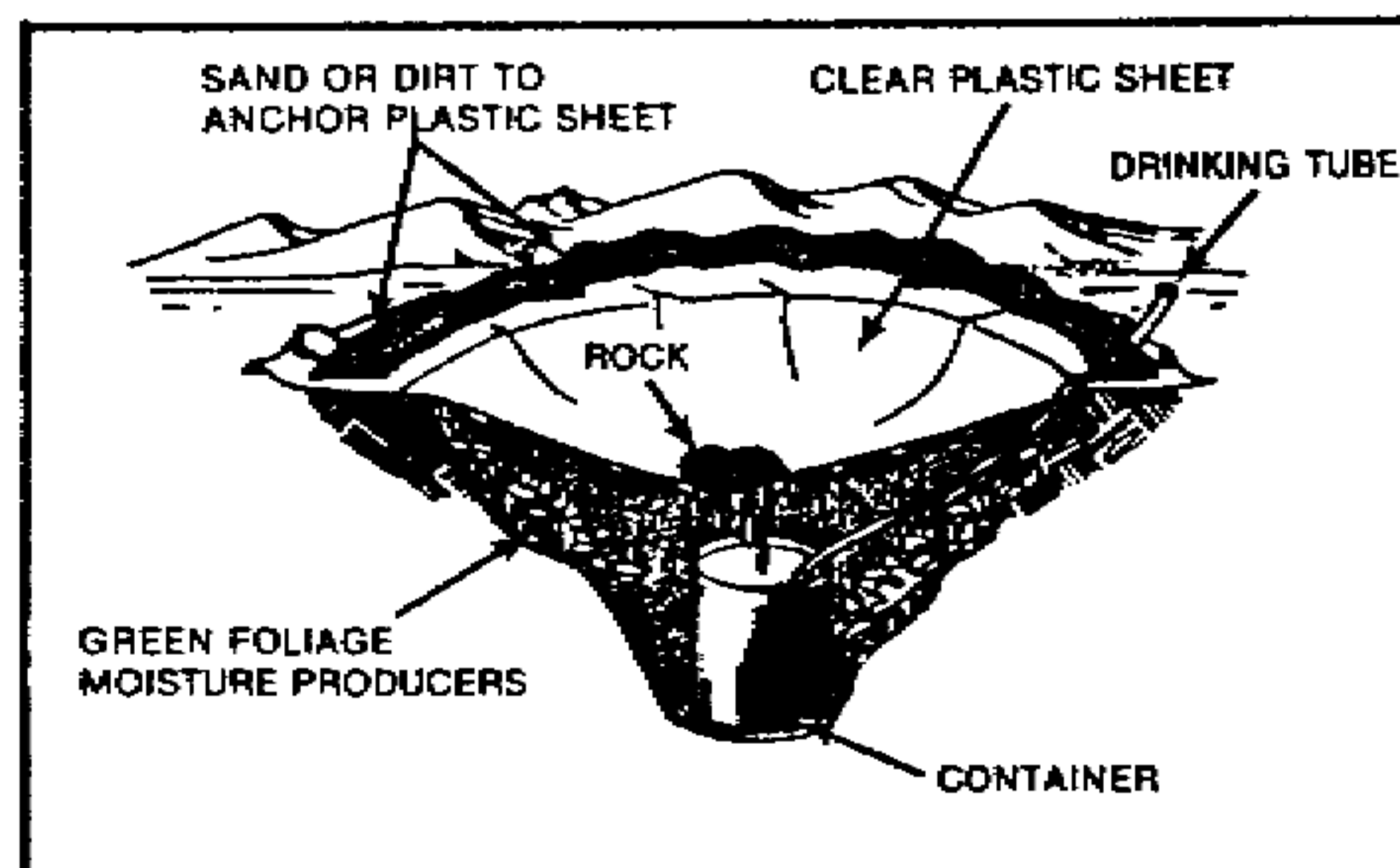

Scientific Principles of Improvised Warfare and Home Defense

There are burrowing animals and snakes that come out at dawn and dusk. These can be snared or trapped for food. Avoid any plants with milky sap.

If equipment is available and shelter is limited, build a tower so that you can get 6-10 feet above the desert floor during the day. The temperatures are significantly cooler there.

Jungles: can provide food, shelter, water, and tools and are easy to survive in and live in if you chose to. Howls, screams and other noises can be frightening but usually represents no real danger.

Build shelter early before nightfall at a high spot or knoll if possible. There will be fewer insects and the ground is dryer. Build a bed or hammock above the ground as far as possible with an A frame covering to keep rain off. Use all materials available for insect netting and protection. Keep pant cuffs tucked in and tied securely, sleeves rolled down and buttoned, and inspect all clothing and body parts daily and rid yourself of attached insects (usually by burning off if they cant be brushed away).

Dry clothes by hanging near fires at night. Make fires each night if possible for cooking, heat, drying off, and smoking out insects. If dry tinder is hard to find, use the inside of tree trunks (Do not use bamboo for fire). Dry out wet wood near your fire. Do not drink water from lakes and streams without purifying or boiling. You can collect fresh rain water by using a tarp or plastic formed as a cone. Banana, bamboo shoots, coconut, and papaya are usually available as food. Anything other mammals (but not birds) eat can be considered safe. Animal trails usually lead to water and all freshwater fish offer a meal. Avoid plants with milky saps. Fish can sometimes be caught by throwing pebbles close to shore in calm areas along rivers. When fish come close to investigate, they can easily be netted.

The most useful tools are

A machete to clear a path, find food, and make a raft

A compass

A first aid kit for fever or infection

A hammock and mosquito netting

Traveling is best along trails (avoiding matted areas which may be trapped. When a river is reached, it can easily be rafted downstream until a larger body of water or a settlement is reached. Only move during the daytime, avoiding night travel.

Learn to look through rather than into the jungle. Frequently look on the ground for game and insects. By developing jungle eyes you avoid many injuries and getting lost.

Do not camp near water, especially during the rainy season (flooding)

Use insect repellent on all clothes and skin. Smear mud on exposed surfaces and face and allow to dry. Buffalo dung mixed with fire ashes also works. Lemonjuice and coconut oil may also help

Scientific Principles of Improvised Warfare and Home Defense

Use tools to push brush aside and avoid anthills

Yellow-green bamboo hanging at 45 degrees often contain fresh, cool water

Cutting the stalk above and below two successive knots provides a portable water bottle

Insects and larvae from rotting stumps can make excellent meals when cooked

Large fruits with agreeable taste are usually safe, spit out any seeds or pips to be safe

Mountains

Food can be obtained from the leaves, roots, and fruits of vegetation without milky sap.

Small animals can be snared near the mouth of burrows. Sucking on ice does not provide enough water. Water must be obtained from streams or melted in quantity.

The main problems in mountains are related to altitude and cold. To combat frostbite, practice muscle contractions to improve circulation. Avoid squatting positions or crouching because it compresses the large arteries of the legs. Keep hands on your stomach or armpits to keep them warmer. Avoid clothing that is tight and may cut down circulation. Avoid contact with metal because it conducts cold.

If you experience "altitude sickness" you should descend in altitude.

Lightning strikes are a particular problem if you are caught in the open in storms

Seeking shelter in a cave
(Large enough with no
water trickling into it)

Sitting at a distance slightly less
than the height of a rock provides
some protection

Not touching a mountainside and
sitting on insulating material with
a rope attached to a foot while on
a cliff.

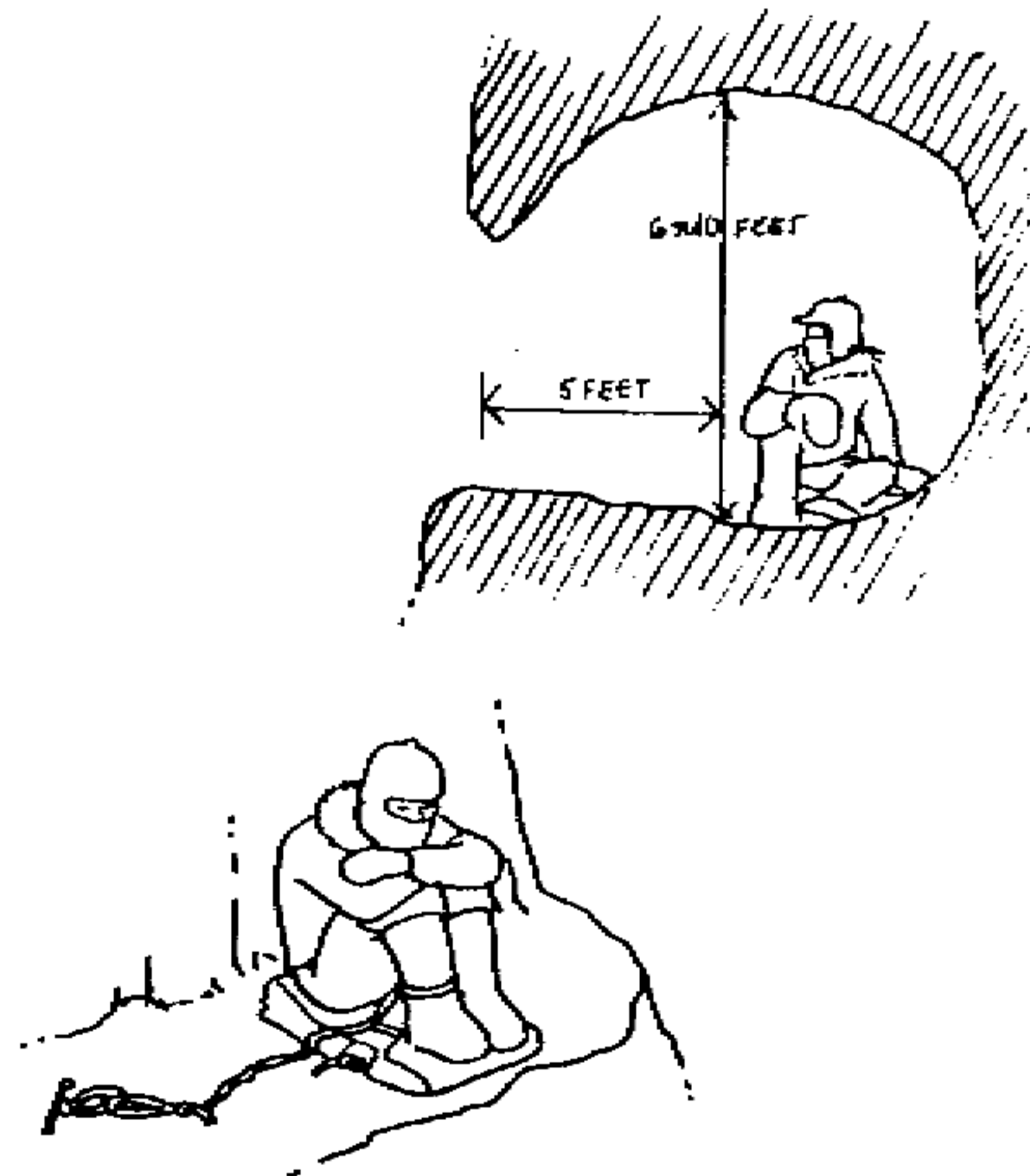

Scientific Principles of Improvised Warfare and Home Defense

When at altitude, a tent is essential to provide protection against wind. It should be pitched behind natural or manmade obstacles to eliminate wind and should be lined to keep the inside temperature above freezing. If this is not available, digging a shelter in snow or ice 6' deep and shaped like a sock will keep radiated body heat inside if the entrance is blocked and covered with a thin layer of snow.

Polar

As in mountain regions, cold and wind are the main enemies. Using snow to build a shelter is best because it is 50-90% air (good insulation), and is easily molded. Piled up snow can serve as a windbreak as well.

A shelter with a sleeping area just big enough for a man and above the tunnel entrance dug out of the snow or fabricated from tent material is best.

An oil lamp or candle will keep the shelter warm.

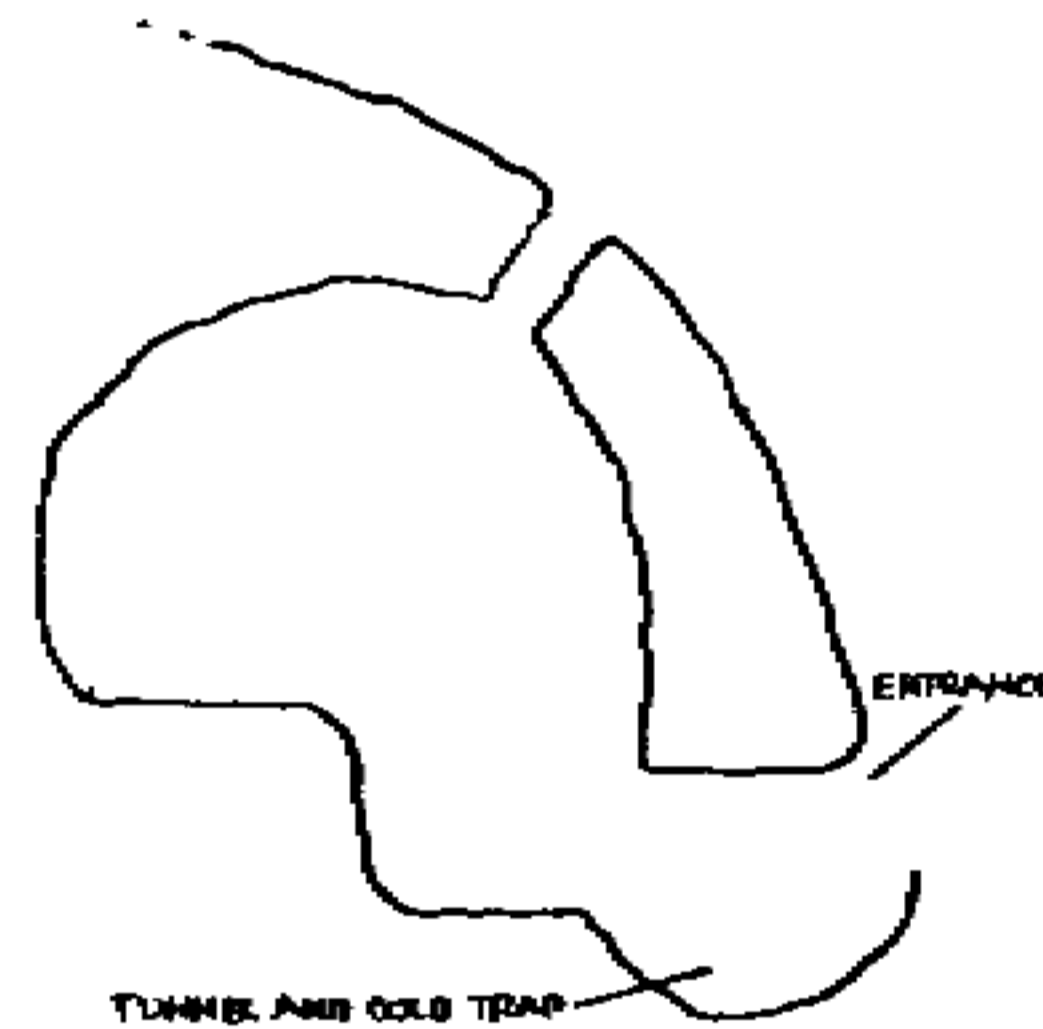

Other shelter designs include

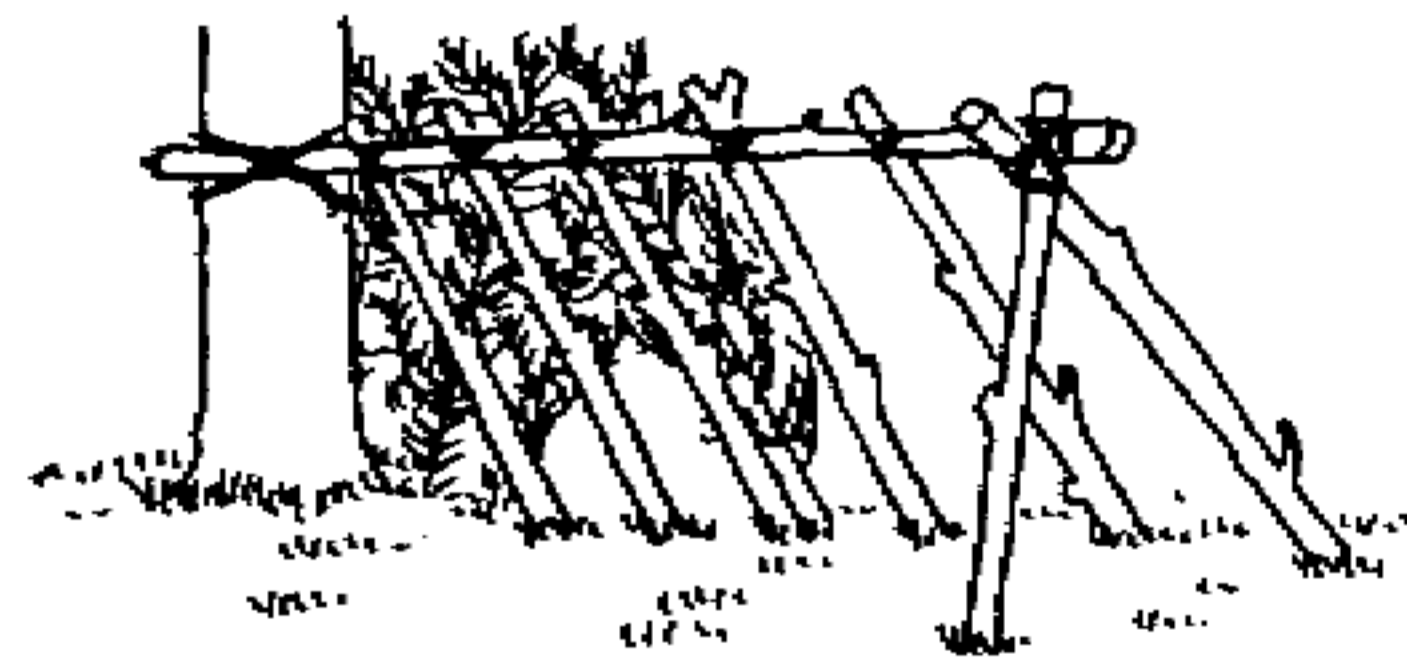

Using a tree or building a lean too.



Scientific Principles of Improvised Warfare and Home Defense

Obtaining food requires being able to hunt animals with guns or fish in deep (650') waters.

Hypothermia is a serious problem in arctic conditions. To avoid this, keep active, wear multiple layers of loose clothing, and keep your clothing dry by air drying or carrying against the body. Hygiene must be continued by taking a snowbath every two days and washing the feet daily and putting on clean socks.

Hills and plains provide plentiful food and water and require only local knowledge of obtaining food and shelter.

Water

Water is the most important survival item. Most of our bodies are made up of water. If a reliable source is not readily available, it must be procured from the environment. Including methods already described, water can be obtained by

- Melting snow and ice
- Desalinating water
- Catching rain in tarps and containers
- Digging near green vegetation and outer bends of river beds
- Morning Dew
- Condensation on metals
- Building water stills
- Plant roots

Large amounts of water can be absorbed by mopping up morning dew in cloth and wringing out. Water can be purified from still ponds by building the still previously described and surrounding the apparatus with a trough for the polluted water. Water can also be purified in most cases by boiling and/or condensing.

Stagnant water can also be cleared by

Placing it in a container and letting it stand for 12 hours and using the top clear layer

Building a natural filtering system as illustrated.

Odor from water can be removed by adding charcoal from your fire for about 45 minutes.

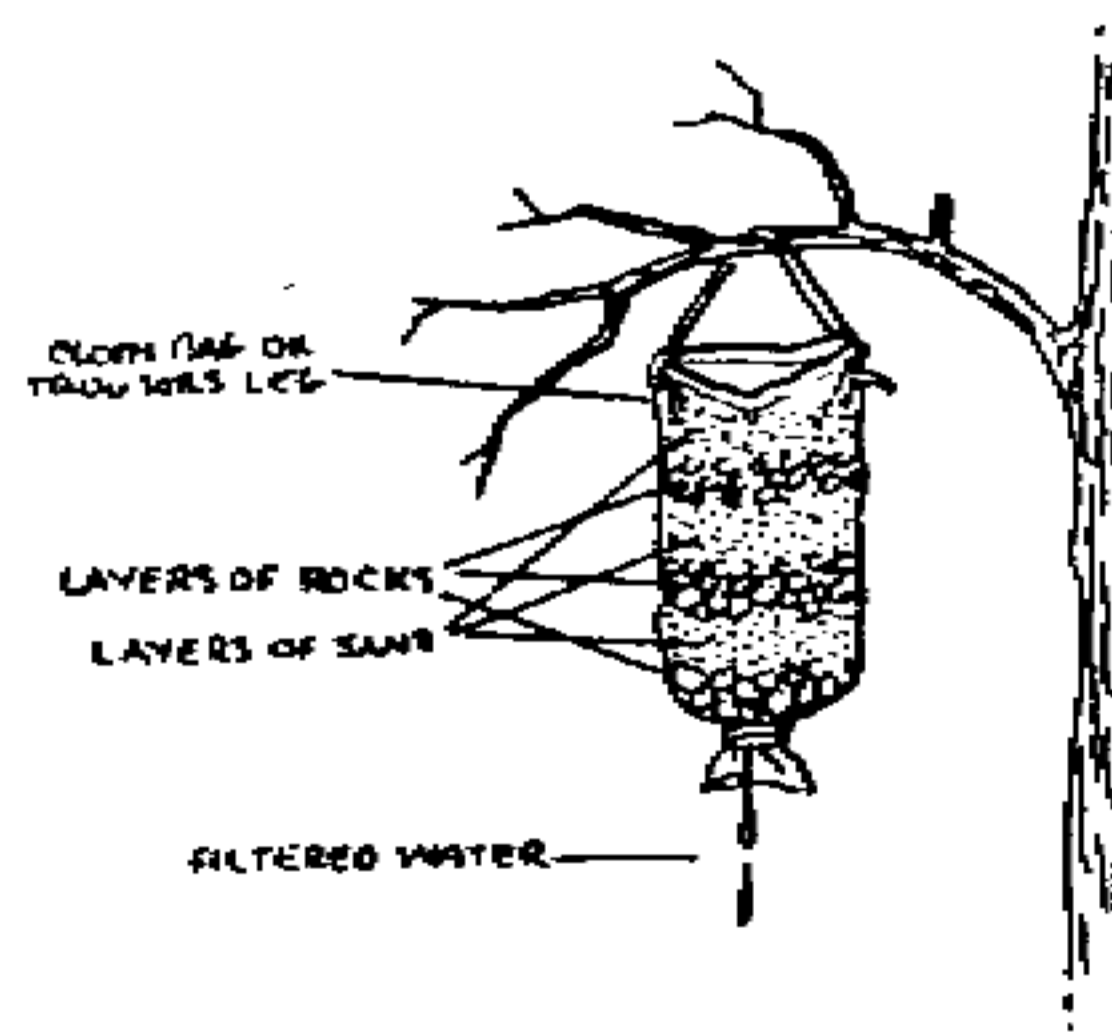

Scientific Principles of Improvised Warfare and Home Defense

Small amounts of seawater can be drunk in amounts that correspond to the required daily salt intake, or about 1 pint daily in 2-3 mouthfuls at a time for a maximum of 5-7 days. Fish and rainwater should be used to supplement water supplies. Use a torsion skein to squeeze out water from small cut cubes of fish tissues. The eyes are about 90% water. Small amounts of urine can also be recycled but only for 2-3 days at one pint limits per day.

Food

Plants, animals, insects, and fish have fed all of the human race through history. Individual survival can be almost assured in most parts of the world by intelligent foraging. Group survival such as large, starving cities require organized farming, foraging, fishing, and bartering efforts to feed.

Most plants and trees have edible parts. If it is unknown what parts are safe to use, the following "Universal Edibility Test" should be followed.

1. Test only one part of a food plant at a time
2. Break the plant into its basic components-leaves, stems, roots, buds, or flowers
3. Smell the food for strong or acid odors
4. Do not eat for 8 hours before starting the test
5. During the 8 hours you are abstaining from eating, test for contact poisoning by placing a piece of the plant part you are testing on the inside of your elbow or wrist. Usually 15 minutes is enough time to allow for a reaction.
6. During the test period, take nothing by mouth except purified water and the plant part tested
7. Select a small portion of a single component and prepare it the way you plan to eat it
8. Before putting the prepared plant part in your mouth, touch a small portion (a pinch) on the outer surface of your lip to test for burning or itching
9. If after 3 minutes there is no reaction on your lip, place the plant part on your tongue, holding it there for 15 minutes
10. If there is no reaction, thoroughly chew a pinch and hold it in your mouth for 15 minutes. **DO NOT SWALLOW**

Scientific Principles of Improvised Warfare and Home Defense

11. If no burning, itching, numbing, stinging, or other irritation occurs during the 15 minutes, swallow the food
12. Wait 8 hours. If any ill effects occur during this period, induce vomiting and drink a lot of water
13. If no ill effects occur, eat 1/8 cup of the same plant part prepared the same way. Wait another 8 hours. If no ill effects occur, the plant part is safe to eat.

Caution: Test all parts, do not assume that if one part is safe that all parts are

Do not eat unknown plants that

1. Have a milky sap or if it turns black when exposed to air
2. Look like mushrooms
3. Resemble onion, garlic, parsley, parsnip, or dill
4. Have carrotlike leaves, roots, or tubers

Parts are prepared for eating by

[Leaves, Stems, Buds, Roots, and Tubers]

Boiling to tenderize and break down toxins, use several changes of water if in doubt

[Nuts]

Leach or soak in water to make palatable

[Grains and Seeds]

Grind to a meal for use as a thickener in soups or for flour for bread

[Sap]

If it contains sugar, boil to remove the water

[Fruit]

Bake, Boil, or Roast

If you do not have a container to cook foods in, large rocks can be placed on your fire and the food and cooking fat placed on the rocks. Boiling is best for most foods because important salts and other nutrients are retained. Various pits can be dug and lined with rocks to create simulated stoves when covered.

Insects such as ants, termites, locusts, and especially large grubs (larvae) found in rotten logs and dead tree bark are excellent food sources and are easily caught by hand. The best way to eat them is to cook them in a soup with other palatable food if you are not used to the idea of eating what much of the rest of the world lives on.

Scientific Principles of Improvised Warfare and Home Defense

Nearly all bodies of water contain fish which can easily be caught by net, hook, or spear.

Snakes, turtles other reptiles can be found in most terrain types around the world.

Birds are found nesting in trees and can supply a steady source of eggs if you leave 2-3 eggs each time and return every week or two. Do not disturb the nest. Birds can be caught to eat by use of a noose on the end of a stick or setting up a net between trees that the birds frequently fly between.

There are many snares and traps that may be used to capture small game.

Reptiles, fish, and game can all be prepared in ways similar to preparing plant foods. Smoking should be used on foods that need to be preserved for later eating by setting up a teepee and set a fire of green broadleaf wood underneath. The smoke will preserve the meat for 2-4 weeks if it is hung 3' above the fire for 1-2 days. A covered pit can also be used. Soaking in saltwater and drying by hanging in the sun or near a fire will also preserve meat.

Game should be skinned and gutted with the blood used in soups and the skin used for leather.

Oceans

Survival at sea depends on your equipment, your knowing how to use it, and your will to make it back to dry land.

If you are down at sea-

Find a raft or debris to cling to or crawl on

Relax, your body's natural buoyancy will keep your head at the surface and only a small effort is needed to put your mouth above water and take the necessary breaths

Floating on your back takes the least energy

Use your pants for flotation by taking them off, tying knots in the legs, and catching air by pulling them overhead.

Once on a raft, salvage all floating equipment and supplies possible

Take seasickness pills if available to avoid vomiting and dehydration it causes

Lash any other rafts to your own to keep everyone close together-its easier to spot

Scientific Principles of Improvised Warfare and Home Defense

Keep dry and use exposure suits, and spray and windshields, or canopy

Ration water and food

Assign duties and keep a log

If in hostile areas, drop anchor during daylight and paddle or sail at night

Use the blue side of the camouflage cloth up

If spotted by an enemy, jump overboard to avoid strafing

Improvise hooks and line to catch fish for food and water

Eat small amounts of seaweed if found

If your raft contains a still, read the instructions and set it up immediately

Make a still using the desert still principles if possible. Clear plastic can be used for a greenhouse effect and the water can be captured in a container or gutter

Use tarps and canopies to catch rainwater

Use the tarps to collect morning dew

Setup a lookout at all times for land, passing ships and aircraft, wreckage, and fish

If you are in the water, throw vomit and feces as far away as possible

Urinate in small spurts allowing it to dissipate

Keep all clothes on including shoes

If your raft is overturned, right it by using a rope as shown

One piece of research indicates that water can be absorbed in the colon by giving seawater enema's without the danger of salt absorption due to its filtering membranes

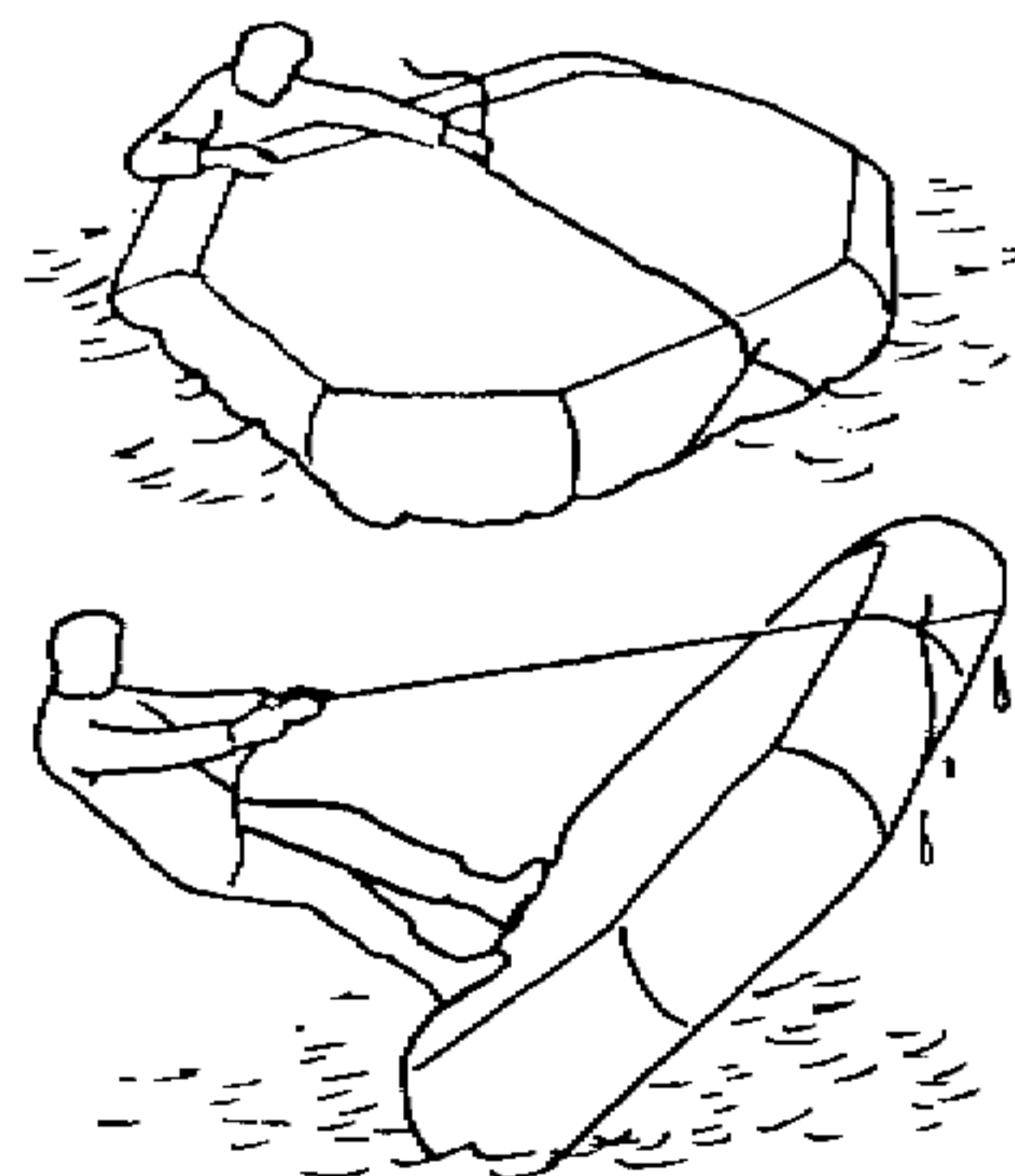

Scientific Principles of Improvised Warfare and Home Defense

Shelter

The kind of shelter you need to build depends on the elements you need to be protected from, the time and effort it takes to build, tools at hand, and the available materials.

A lean-to tent can be made from a poncho as shown

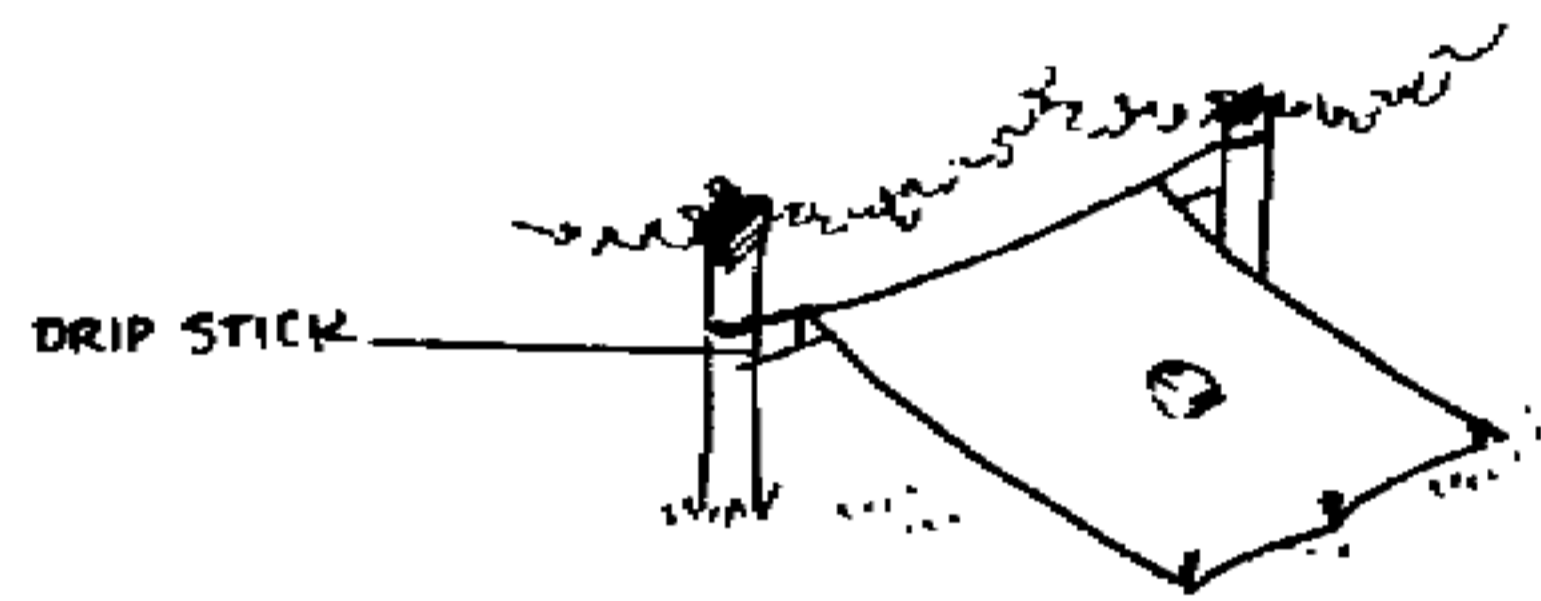

An A frame tent can be assembled using two branches for support

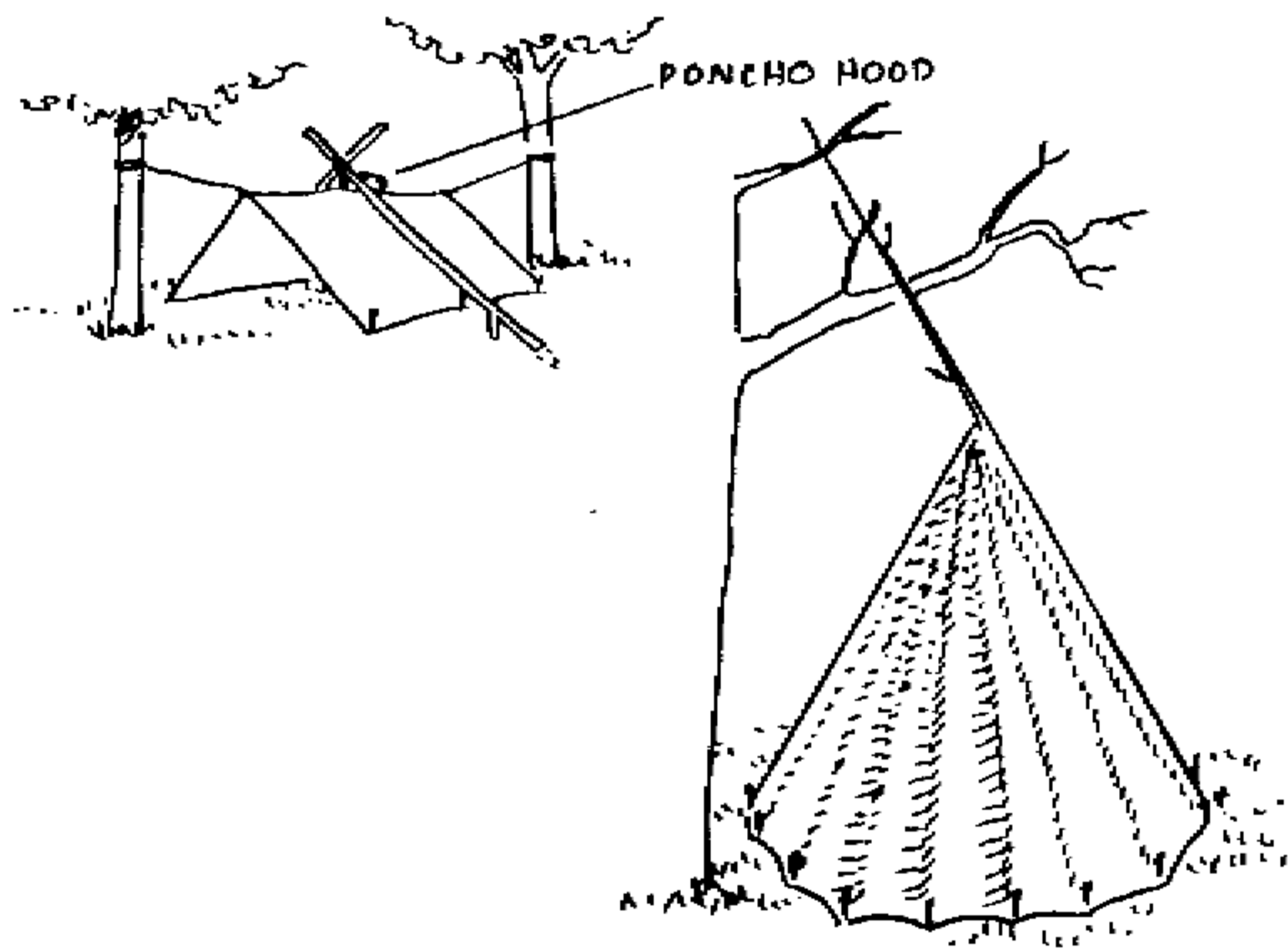

A canopy can be used with cut branches to build a teepee

Scientific Principles of Improvised Warfare and Home Defense

A parachute may also be used by suspending its center from an overhead branch

A one man shelter

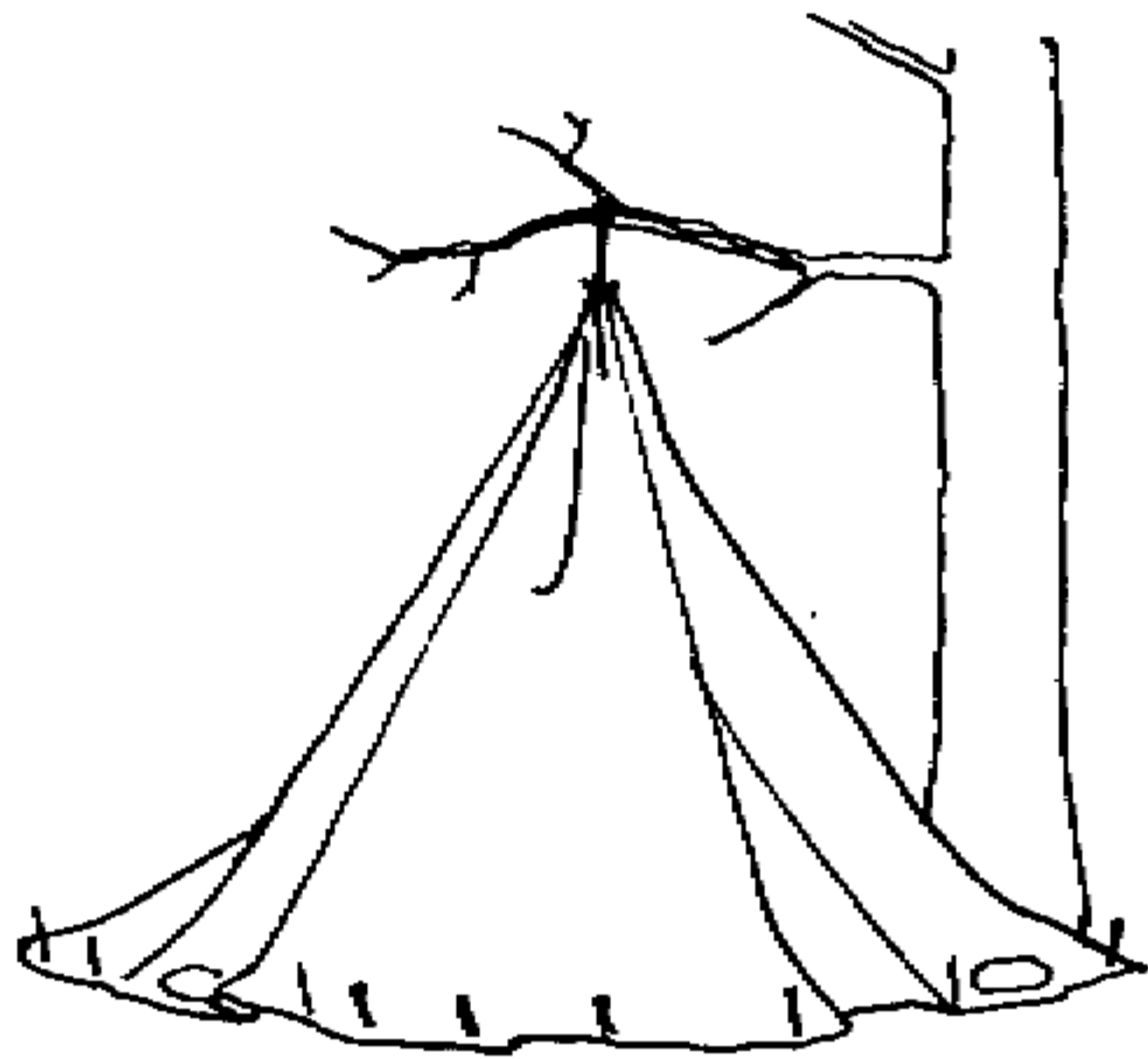

A field lean-to

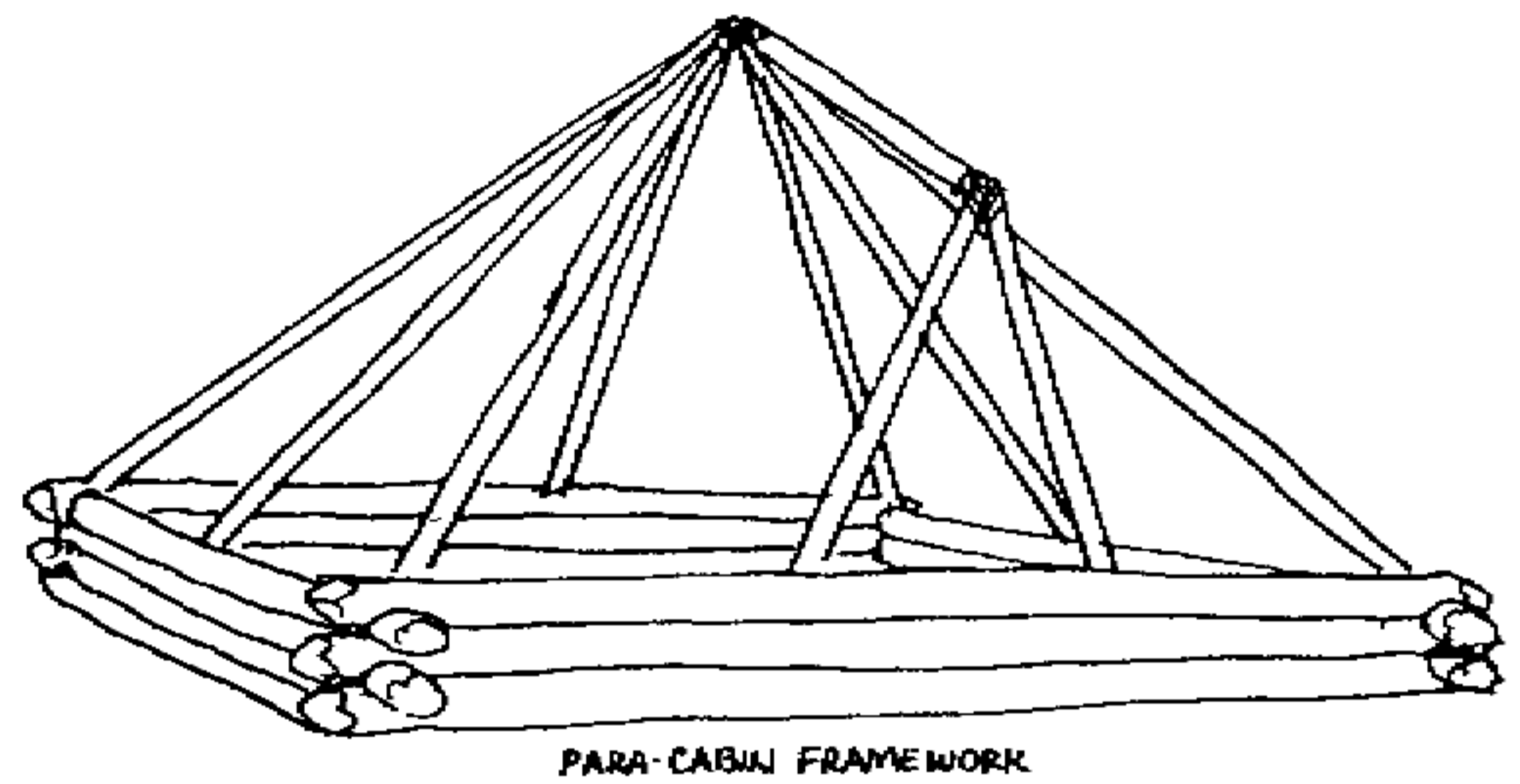
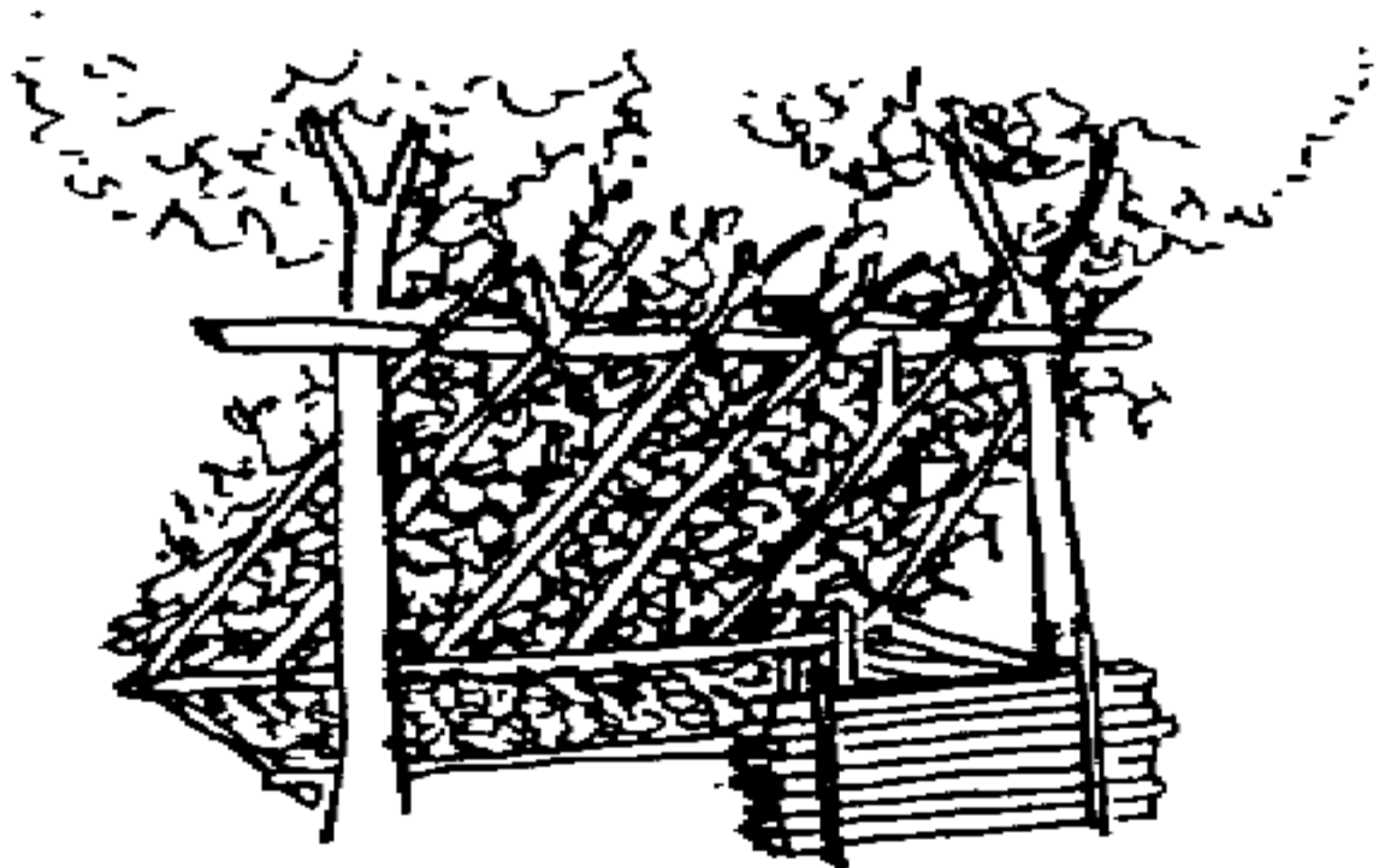

A parachute cabin

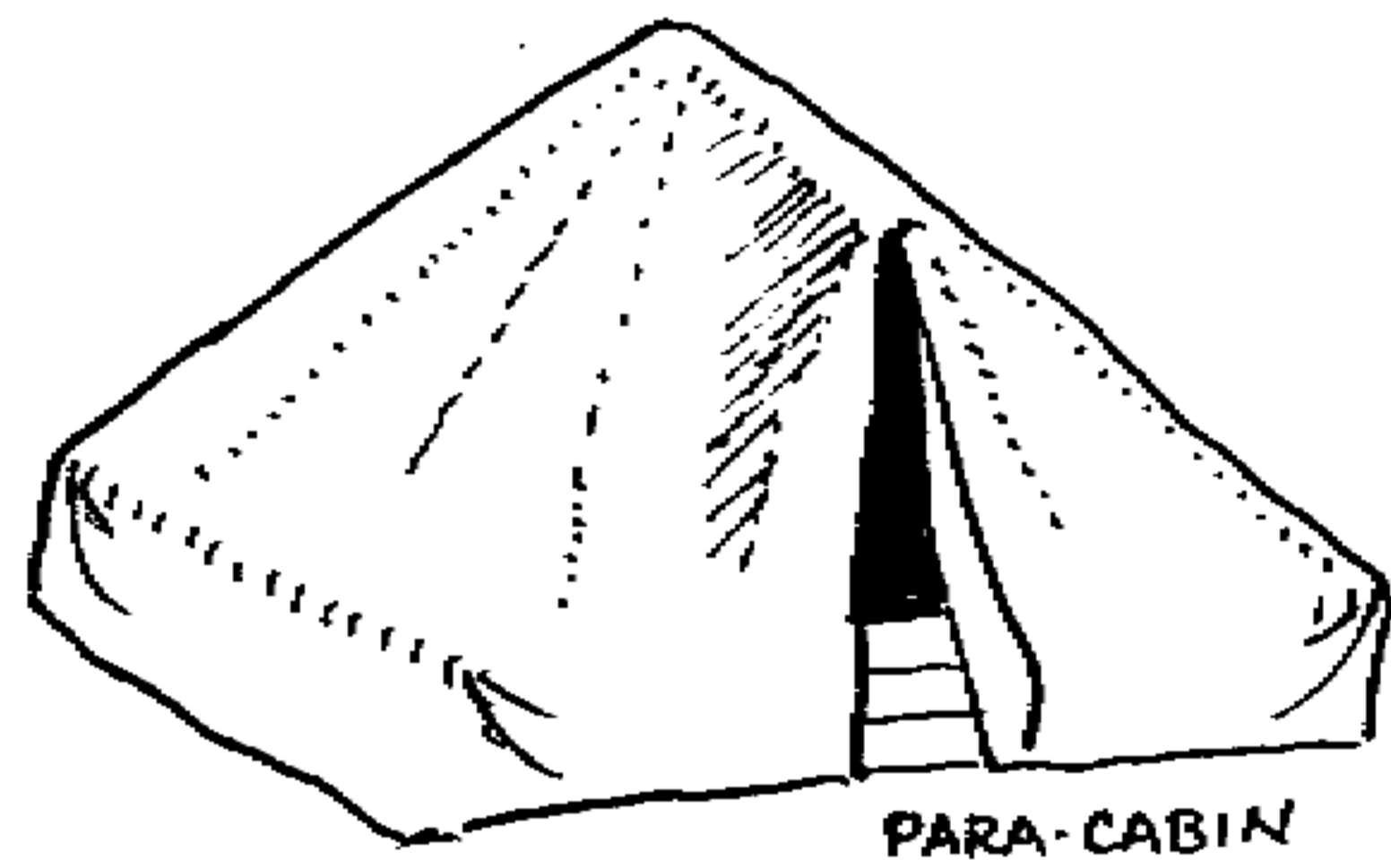

Scientific Principles of Improvised Warfare and Home Defense

A swamp bed to protect you from wet ground

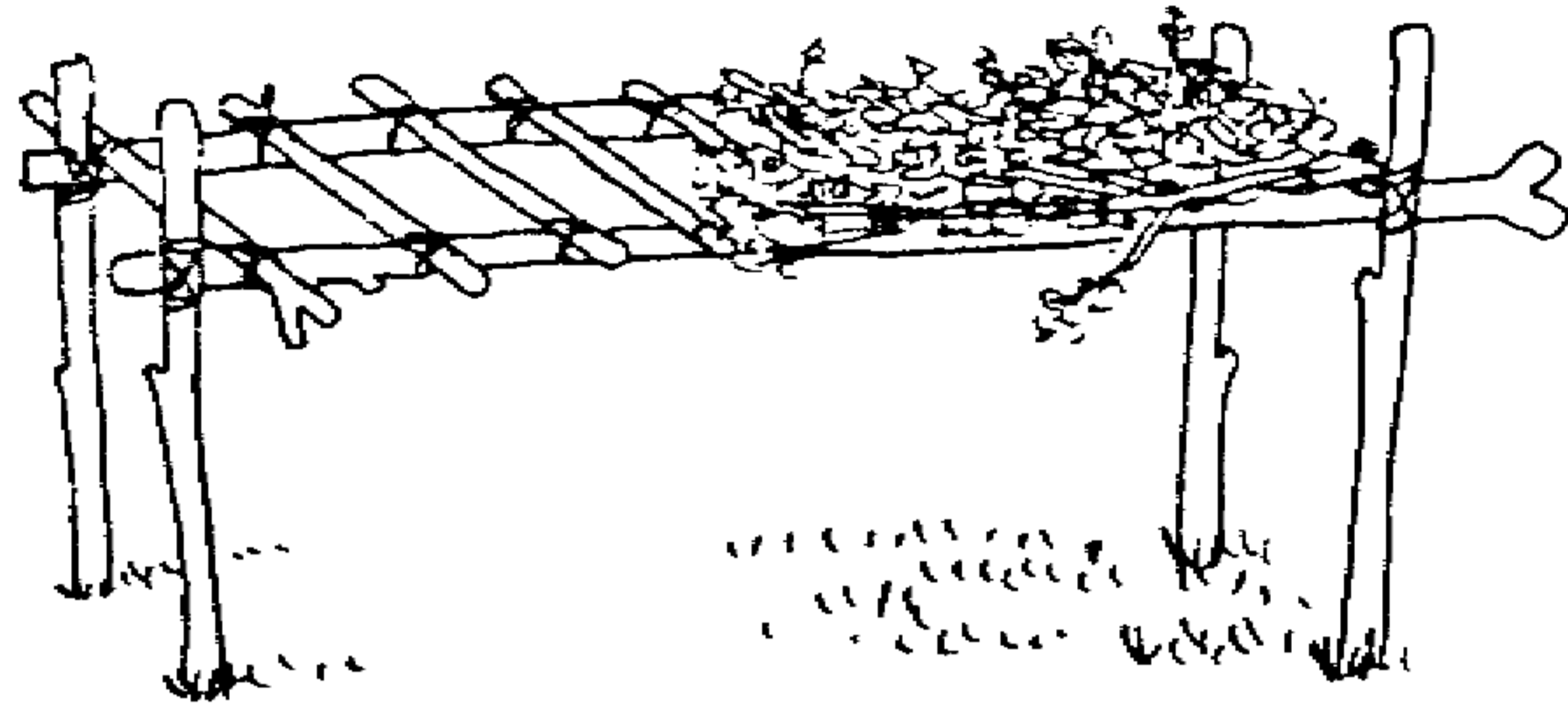

A tree pit snow shelter



A desert shelter

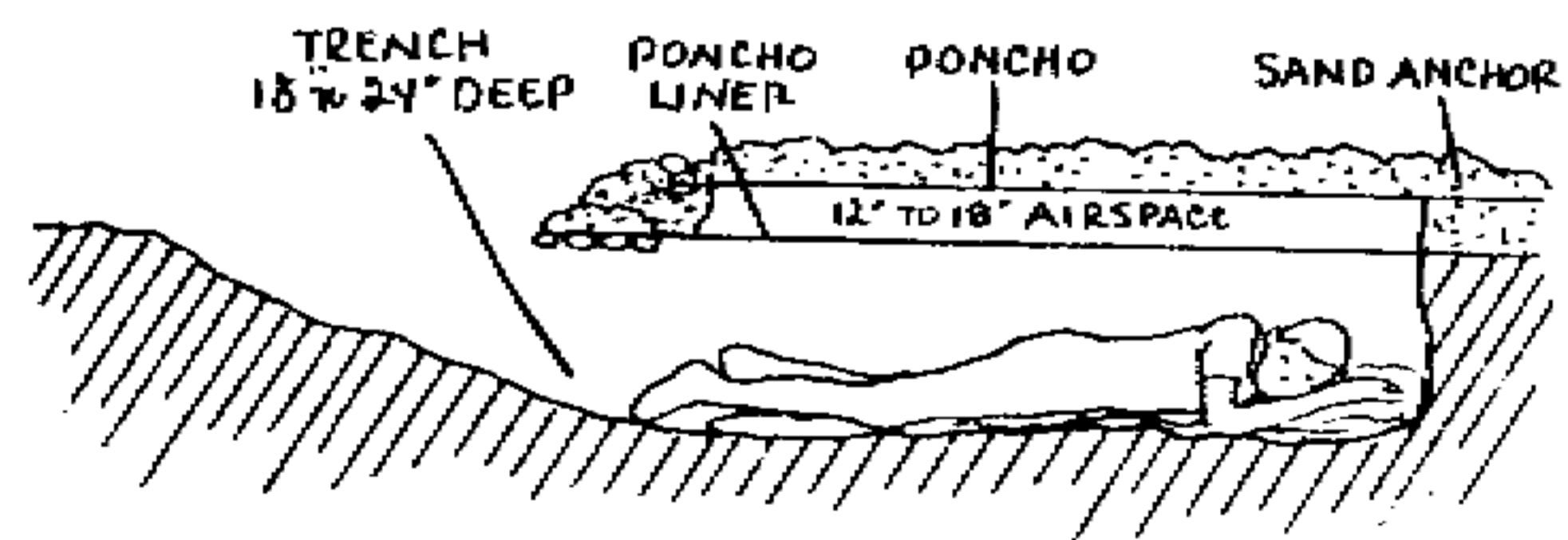

Scientific Principles of Improvised Warfare and Home Defense

First Aid

Getting enough water and food is important in staying healthy and helping the body fight off disease and heal injuries. Cleanliness is also very important in preventing infection and disease. The ability to wash clothes, and yourself daily can prevent many health problems. Sunbathing kills many bacteria on the skin. Washing in ashes or sand can be done in a pinch. Soap can be made by cooking fat to obtain grease and then mixing it with a strained mixture of fire ashes and water. By boiling the mix until it thickens and allowing it to cool you can make bars of soap.

Keeping your hands clean by washing regularly so you don't ingest germs, and keeping hair clean and trimmed to avoid lice and other parasites will help prevent disease. Wash clothes after each wearing or at least air them out in the sun daily if possible. Brush your teeth daily, or use a cloth on your finger to rub all tooth surfaces and use a string to floss.

Stay Rested

Know how to clear airway obstructions and give artificial respiration

Bleeding can be stopped by applying direct pressure with a hand, clothing, or bandages

Elevate the injured extremity

If the bleeding has not stopped, apply a tourniquet above the bleeding area and release every 15 minutes to restore some blood flow

A tourniquet can be improvised by wrapping a handkerchief or other cloth around the limb above the wound and tying it. Pass a stick through the knot and tie it. Then twist the stick so that it tightens around the limb.

If a person goes into shock, have them lie down on a level surface with the legs elevated

If the person is unconscious, lay them on their side so any vomit or blood can drain away from the mouth

Keep them warm with blankets or by adding outside heat if necessary

Outside heat can be improvised by wrapping hot rocks from a fire in clothing, using a prewarmed sleeping bag, hot water in a canteen, or fires on both sides of the injured

Insulate the person from the ground with clothing, or plant and tree material

Improvise a shelter to protect them from the weather

Scientific Principles of Improvised Warfare and Home Defense

Give them warm foods or liquids if they are awake

If insect bites are a problem, do not scratch the bites

Inspect your body daily for attached parasites and burn them off or cover them in

Vaseline, tree sap, or oil to cut off their oxygen and they will release their hold

If you are stung by a bee, immediately remove the stinger and venom sac

Itching from bites may be relieved partially by applying a mix of mud and ashes, dandelion sap, coconut meat or crushed garlic leaves

All bites should be thoroughly cleaned and if they come from poisonous insects, the venom should be sucked out

If a site becomes infected and turns black (necrosis), this tissue must be cut or scrubbed out to prevent the spread of gangrene.

If the infection appears to be spreading, flush the wound daily with water or fresh urine

Drink plenty of fluids

Treat with antibiotics and antiseptics if available

If supplies are not available and you have a necrotic infection-

Consider maggot therapy which involves exposing the wound to flies for one day and then covering it up.

Check daily for maggots

Once they develop, keep the wound covered and check daily until the dead tissue is cleaned out. Then remove all maggots before they start on the healthy tissue. Increased pain and bright red blood at the site indicates they hit healthy tissue

Flush the wound repeatedly with fresh water or urine to remove the maggots

Check every 4 hours to make sure the wound is clear of maggots and detritus

Bandage the wound and treat normally

Infections, rashes, and boils should be kept as clean and dry as possible

Scientific Principles of Improvised Warfare and Home Defense

Internal parasites such as worms can be fought by-

Ingesting 1-and 1/2 cigarettes and repeating 24-48 hours later. The Nicotine will kill most of them

Ingesting a mix of 4 tablespoons of salt with 1 quart of water (do not repeat)

Drinking 2 tablespoons of kerosene and repeat at 24-48 hours.

For diarrhea, improvised solutions can be made of-

Tea containing Tannic Acid made from boiling the inner bark of hardwood trees for several hours (it will have a bad taste)

Mixing a handful of ground chalk, charcoal, or dried bones and treated water till it is the consistency of kaopectate

For burns; soak clean rags for 10 minutes in a boiling tannic acid solution (above) and cool and apply to the wound (Do not use grease or fat)

Broken bones need to be supported with splints tied to the limbs. Serious breaks in the neck and spinal cord require immobilization and great care in moving.

Group Survival

Survival among groups of people depends on leadership and know how. Leadership is the most critical because someone needs to know what to do and be able to teach, organize, and direct the activities needed to save everyone. If people become afraid in the face of common danger, their fear may result in panic rather than concentration on solving the problems.

The leader needs to produce strong group morale by encouraging and reinforcing small group achievements. You can never build morale by external pressure and threats. You must build it by making everybody part of a team that is producing little victories and that can meet failures with persistency rather than giving up.

Moods and attitudes, both good and bad can become contagious and infect everyone involved. Bad attitudes can destroy hope and cause destructive panic, while positive attitudes and constant reinforcement of positive events and achievements will spread confidence and hope.

Scientific Principles of Improvised Warfare and Home Defense

The important factors in group survival are

- Formulating goals to help each other survive and face the future
- Organizing the manpower so that people know what to do and when to do it
- Keeping everyone well briefed and encouraged
- Finding the right people with skills to best do each job
- Make use of everyone's suggestions and criticisms
- Taking action now rather than waiting and wondering about what is the best course
- Check all equipment
- Survey the situation so you know everything about it. That's how you beat fear of the unknown
- Have confidence in your ability to survive. Your knowledge and skills make the difference
- Learn peoples reaction speeds and habits. This avoids shock and panic when surprise strikes against you

On July 2, 1816, the French frigate La Meduse ran aground 62 miles from the African coast. The 6 lifeboats held 250 people and a huge raft was built to hold the remaining 150 and some food. The boats towed the raft for 2 leagues when the tow line breaks and the boats decide to abandon the rafters to their fate. The 146 people remaining on board have only 22 pounds of biscuits, several barrels of water and a few casks of wine. They have no sail, rope, anchor, or map.

Night number one- several men drown, carried away by the waves

Night number two- After drinking a cask of wine, the men mutiny against the few remaining officers in a fit of madness. Sixty six die from being held under water and drowning or being stabbed with swords.

Third day dawn- Only 67 survivors remain and all the food and water are gone
One of the men begins to dismember a corpse and the rest attack him like a pack of wolves. After only three days, the "fear" of starvation rather than any actual starvation has caused uncontrolled panic.

Scientific Principles of Improvised Warfare and Home Defense

Night number four- Hysteria causes 12 more deaths and the following morning, more passengers and crew kill each other. By now there are only 30 left, all of them wounded.

Day number six- After a short discussion, the dying are thrown to the sharks

Day 12- The remaining passengers are found and saved after 12 days of senseless slaughter.

Preparation, know how, skill, and leadership combine to prevent surprise and paralysis in dangerous situations. Developing team spirit and a command structure will allow a positive rather than a dangerous contagious spirit to develop. Do not let weak individuals who panic under stress and danger infect the rest of the group. The result is impaired judgment and people going along with senseless acts. Mobs are impulsive and very aggressive and generally don't solve any of the problems at hand. The individuals in a mob feel anonymous and believe they can be violent without accountability.

Good leaders (especially military ones) know how to use well learned and rehearsed instructions to channel work efforts. The group has to be able to meet aggression or danger as a single man. Everyone must be motivated by a common goal that the entire group wants to accomplish. This unit cohesiveness often takes several months to mold in military units with some members being too individualistic to make it. Installing the ideas of civic responsibility and group values takes cooperation and good leadership to achieve.

The leaders specific job is to provide honest, objective and calming information to the group he is leading. He must be able to delegate authority and responsibility to subordinates and must be able to keep his self control. It must also be understood that the ability to organize for survival, war, or other group activity is not the same as the ability to properly lead that activity.

The leader can also squelch panic by narrowing the alternatives down to zero. Most panic starts when people have a range of choices and everyone picks his own choice usually with his own preferences in mind. When German U-Boats were trapped in WW2 by allies trying to sink them, there were no cases of panic in the presence of great fear. This was due more to the fact that no one had a choice and they were all in it together no matter what happened. The only plan available was to sit out the attack and wait for the destroyers to leave. No other plan could work and everyone knew it.

Scientific Principles of Improvised Warfare and Home Defense

Firebuilding

Look for a dry spot that is protected from the wind (or build one)

Place it near or in your shelter

Find a supply of combustible material including parts of any plants, cardboard, cloth, animal shedding and so on. If the outside is wet, the inside is usually dry enough

Clear an area 3' from the fire in all directions

Build a firewall to act to direct or reflect the heat where you want it and protect the flame

Building an underground fireplace (in a hole) conceals the flame. It needs an air intake and is best near a tree to disperse smoke

To light a fire

Make a tinder bundle and lay it near the firewood

Light your candle or match and light the tinder holding it downward into the flame

A convex lens from binoculars, or a magnifying glass can be used with bright sunlight to ignite tinder

Scraping a knife against metal can produce sparks to ignite tinder

If a battery is available attach wires to both posts and touch the ends in the tinder to produce sparks

Striking steel on flint above the tinder

Scientific Principles of Improvised Warfare and Home Defense

6. Leadership

Leadership requires finding individuals with initiative, resourcefulness, imagination, and an ability to scientifically plan what they are going to do. There are usually only two ways of finding out who can effectively lead. The first is in actual combat. You can observe who successfully fights, wins and has the confidence and respect of their men, or you can setup a system to train, measure and judge men in simulated combat (training).

When the call comes for civilian leadership to step in, the war situation involves and swallows up entire nations. This is when choosing leaders must be improvised. Leaders can still be picked scientifically. Individuals who organize companies in civilian life will likely be good at the military equivalent in such areas as transportation, supply, communications, and most support functions. Finding out who can keep a clear head when the shooting starts and the picture is unclear, is more of a challenge.

Leaders have to be able to organize the work needed to be done to wage a war. They also have to be able to train people to fight this war. Finding and picking the effective teachers is a good place to start. Developing a superior ability to move and conceal men, use weapons, and react faster than an enemy, can be observed, measured, and judged. He must know the total business of fighting and killing and not be squeamish about it.

Modern electronics have turned the ordnance into thinking and remote control killing, which changes the leaders who needs to be at the front lines to inspire the troops. He must still be seen, but much of the modern fighting is done without even seeing the enemy eyeball to eyeball. This means that the better thinking "chess master" is likely to perform well.

Usually, if you find yourself improvising for war, you need to select leaders that know how to teach building improvised weapons and defenses and how to use them. Then you turn them loose with the support resources to do the job. Finding people from the smartest parts of the population to do this works best.

Leaders will be given and giving the jobs of-

Making the machines of war

Teaching how to use the machines of war

Learning how to improve on the use and designs of these weapons in the field

Passing on learned field knowledge to those in the rear to act on

Motivate men to get up and face the enemy while being shot at

Scientific Principles of Improvised Warfare and Home Defense

One final aspect of leadership involves dealing with civilians on both sides of the war. Refugees (your own) get in the way of your troops and create a burden to protect, feed evacuate, and move around. Enemy civilians who are organized by their governments to build weapons and provides men to kill you with are much easier to contend with.

In WW2 the allies did not hesitate to destroy the civilian populations of the axis forces. In modern times with television, most countries seem timid when the subject of targeting civilians comes up. In reality, even though much of the world has recently been revolted by the killing in Bosnia and Africa, those groups doing the killing generally achieved most of the objectives they set out to gain. In addition, the cry for justice over crimes against humanity were pretty much ignored by the participants.

The final lesson seems to be "keep on killing all the enemy until you win or draw" and this includes civilians who cannot really be separated from their own military units when they are the ones who provide support for their side of the war.

In the final chapter, I will examine some of the recent confrontations and apply ideas from this book to these situations.

Scientific Principles of Improvised Warfare and Home Defense

Chapter 12 Strategy, Tactics, Resistance and Countermeasures

This chapter will probably not contain anything that is not already known. Most of what I will cover here falls under the category of common sense. I am also going to use this chapter to play both sides of some "what if" scenarios that concern recent war situations and domestic attempts of "pretend" insurrection. The areas presented here are

1. Attacking philosophies and ideas
2. Defending strategies and tactics
3. Modern military concepts for the next century
4. What if examples
 - a. Kurds
 - b. Kuwait
 - c. Bosnia
 - d. Waco
5. U.S. Courts, Crime, Congress, and Change

1. Attacking philosophies and Ideas

If you take two perfectly matched forces with the same equipment, personnel, and leadership, meeting on open ground head on, you would naturally expect a drawn out evenly fought battle with casualties approaching 100% on both sides before the shooting stops.

Now take one of the forces, put them in rough terrain and let them dig in and stay put while the other side attacks without knowing their exact position. The results are very different. The attacking force will suffer 2-3 times the casualties of the defending force. Why is this?

When the actual actions of combat are analyzed, it is easy to understand why the defender is always better off.

1. The defender can plant machines to kill the enemy as they approach and pass over them. The attacker has to overcome or bypass these mines and traps while watching comrades die and suffer. They have to expend physical energy and emotion just to move through and deal with these conditions.

2. The defender can hide behind or under objects and cannot be seen. The attacker has to actually move physically toward the defensive positions exposing himself to gunfire while not being able to see where the fire is coming from. You can only reliably shoot what you can see.

Scientific Principles of Improvised Warfare and Home Defense

3. The defender can harden his defensive positions, making the only place he is exposed and vulnerable to comparable fire is the small hole where his gun sticks out. This means that the attackers bullets bounce off his shelter while his bullets cause injuries.

4. The defender can create obstacles causing a funneling effect on the attacker. By causing the attacker to be squeezed into a narrow area, they may only have to actually face a small amount of firepower at a time. The defender can concentrate superior firepower on the narrow funnel point, all of it concealed. In addition, by layering this firepower, the defending troops near the front are continually covered around their flanks and blind spots.

5. The attacker usually brings his men in inside of vehicles. A large vehicle is a lot easier to spot from a distance than a man on foot, and it is no contest between hidden men and a big lumbering hunk of metal. The hidden forces always get the first shots off, sometimes for many rounds, and if they are firing lethal ordnance, it is possible for the fight to be over with little or no return fire.

6. The defender knows the terrain because he got there first and had a chance to pick all the good spots and high ground to observe the attackers approach and get better shots off. He can also coordinate his own fire better because he sees what is going on. He knows where the attacker is coming from because he can see him and he knows where all his own forces are. The attacker is on the move and usually doesn't have as good of an idea where all his own forces are and cannot see any of the defenders if they prepared well, although they will see the bullets and shells coming in.

7. The defender can have his front lines withdraw in a prepared and organized fashion under cover if required. The attacker has to simply run for it.

8. The defenders casualties are not seen by the attacker because his wounded are concealed. The attackers men are usually in view when injured. This invigorates the defender and demoralizes the attacker whose men may panic and run. The attack easily breaks down.

9. The defender can draw the attacker into areas where he uses up his precious firepower, ammunition, fuel, and nerve with very few men and resources. By the time the next defensive layers are reached, the attacker may be running out of supplies, energy, and nerve while most of the defenders are at 100%.

10. In virtually all attacks, the attacker is functioning as a patrol that becomes ambushed

11. The defender can cover his mechanical soldiers (the mines and traps) with smoke to add to their concealment and terror effect.

Scientific Principles of Improvised Warfare and Home Defense

12. The defender can retreat to tunnels underground if he had time to build them. This allows him to add to the obstacles, funneling effects, slowing down and overall attrition of the attacker, not to mention the added fear of the unknown. The defender knows what is in there and knows his way around. The attacker feels he is crawling into deep manure.

Given the physical differences of exposure to fire, it would seem to be nearly impossible for the attacker to win battles and wars without incredible material, firepower, and, technology advantages. This has generally been true throughout the history of war. There are a number of strategies and tactics that an attacker can adapt and train and prepare for in advance that will allow him to win these battles. You have to be able to win these battles or you can't win the war.

What can the attacker do to overcome the defenders advantages.

1. Equip and train his men to use remote observation and fighting equipment to detonate or remove mines and traps, and attack the enemies positions without exposing his own men to direct fire. This can include grappling hooks, observation cranes, rooster snakes, etc.

2. Use smoke or fog to blind the enemy and cover most of your approach. This works especially good if the attacker can use polarized light to see through the smoke while the defender can't.

3. Provide personal armor and camouflage beyond the normal issue for the front line troops.

4. Concentrate massive amounts of all his firepower on small areas that can be chipped away at. You don't have to attack in a funnel. You can use your engineers and scouts to find places to attack on the flanks or weakly defended areas.

5. Move offensively into important positions such as hills overlooking the battle zone or encircle and cut off the defender forcing him to come out and attack you, enabling you to shoot from hidden positions. This is called moving offensively and fighting defensively. It works best if you can outmaneuver the enemy and reach a critical spot like a road or rail junction that they need. In this way, you can turn all the defenders advantages into your own.

6. Use the classic historical strategy of starving the defenders out if you have the time. This strategy was regularly used by the Serbs in Bosnia to good effect despite the supply efforts of the UN. The siege actually did not end until the U.S. entered the war with air power and a considerable threat of ground force (taking sides).

Scientific Principles of Improvised Warfare and Home Defense

7. Hit alternate targets such as neighboring cities, or appropriating livestock herds and rural resources forcing them to come out to interdict your efforts. Conducting scorched earth policies in the area may also do the job.

8. Use fire, or chemicals and biologicals on the defenders to eliminate hiding places and drastically increase the misery of holding the fixed positions.

9. Attack at places and times that combines a local superiority in numbers and the element of surprise. This may include night attacks or a paradrop behind lines.

10. Don't attack in muddy or bad weather. This only slows down the pace of attack.

11. Use all firepower to utterly destroy a key enemy strongpoint and bypass and cut off the other interior positions. These cut off groups may surrender without having to root them out.

Caution: Do not use men as cannon fodder. The Japanese Banzai charges looked great in the movies and were heroic. The end result was that they all ended up dead and the Marines still held their positions.

12 If the defender runs, pursue quickly to turn the withdrawal into a rout. This is best done if you can move parallel to the defender so you don't slam into an unexpected rear guard. If you can get ahead of him and set up your own ambush, it is better.

Many other things can be done such as better and more realistic training in the things that actually count on a battlefield. Knowing how to maneuver, how to fight in built up areas, knowing how to overcome obstacles and detonate traps without injury, and how to use all the equipment you have (or improvise) which will make a material difference on the battlefield.

Getting civilians to side with and support your efforts not only are good for morale, it helps to have extra factory production since overcoming an enemy in long wars often requires more of everything (usually 3 times as much) to win.

Knowing what to attack (priorities) can be as important as how, when, and where. Enemy military units are always a priority and are selected according to the threat and circumstances you find yourself in, as well as the resources available to you. You can't attack an enemy air base from a thousand miles away without aircraft, ballistic missiles, or behind the lines forces. You have to chose from what is possible and realistic. After the obvious military threats are dealt with, attacks often involve destroying the enemies will and ability to resist. These targets include

Scientific Principles of Improvised Warfare and Home Defense

Railway Systems: Cars and tracks, bridges, and curves to cause derailments.

Highway Systems: Bridges, demolition of adjacent hills and mountains, mining, etc.

Waterways: Ports, dams, canals, locks, bridges, levees, and ships.

Air Forces Systems: Airfields, parked aircraft, terminals, hangars, radar, radio, lighting, and defenses, as well as aircraft attempting to take off and land.

Communications: Telephone wires, buried cables, microwave towers, terminals and transmitters

Power Grid: Cutting power lines, substations, generating stations and equipment.

Water Supplies: Reservoirs, pipelines, purification plants, towers, and intakes.

Fuel Supplies: Fuel storage- under and on top of the ground, pipelines, depots, truck and rail tankers, and ships.

Industrial: Includes all equipment, supplies, transportation, power, and personnel.

Political: Leaders, gatherings, headquarters, transportation, communications, protection.

Clandestine attacks on individual targets usually require access to the premises they are located at. Ways of gaining access to a target with ordnance may include

Vehicles (drive thru)

Doors

Windows

Chimney

Drilled hole in a wall

Vents

Water Pipes

Sewer

Gas Lines

Electrical Lines

3rd Party- Mailmen, Delivery men, Visitors

Subterranean (tunnels)

Pets, animals, insects, etc.

Scientific Principles of Improvised Warfare and Home Defense

2. Defending Strategies and Tactics

After learning all the advantages of defending, it seems that there isn't a lot left to cover. Many of the tactics described for the attacker can also be applied to the defender, especially if he sees an opportunity to counterattack.

1. Defend in depth using as many nonhuman (traps) troops as possible. Organize direct fire on these traps so it becomes impossible for an attacker to deal with the trap unmolested.
2. Large urban areas can swallow entire armies to cover and attack. By falling back to layer after layer of built up defenses and obstacles, even the best attacks can be chewed up over time. (Stalingrad, Kursk, and Abadan come to mind)
3. Enemy armor, and vehicles are more easily destroyed by foot soldiers in cities and around obstacles because they can be more easily heard and seen and cannot use long range standoff fire in towns.
4. Enemy mobility is quickly arrested and resembles quick sand when mobile vehicles have to enter the close combat battles.
5. Street and house fighting requires training, practice, and organization. Especially withdrawing to new lines. Everyone must know in what order they move, who is to provide cover fire, and who fights the rear guard actions.
6. Civilians can add drastically to the defenders abilities by feeding, supplying, and encouraging the defenders.
7. A continuous front does not require a large concentration of troops to defend.
8. Defenders shoot from the safety of their holes.
9. The only way the attacker can actually win is to hunt down and kill everyone (very difficult without weapons of mass destruction) or get them to surrender. Keeping up morale and making sure everyone believes in what they are fighting for, can win in the end (see Chechnya)
10. Setup continuous ambushes and planned withdrawals to attrit the enemy.
11. Build and prepare obstacles, ditches, and traps everywhere and make sure you know your way around them. The attacker has to get out of their vehicles to enter buildings and tunnels. If these contain numerous traps, the survivors may not want to keep up the offensive.
12. Use tanks and armor to defend with, especially against a larger force which cannot easily damage entrenched and armored vehicles. Tanks are nearly immune to artillery.

Scientific Principles of Improvised Warfare and Home Defense

13. Improvise personal armor everywhere.

14. Withdraw from massed artillery fire causing the attacker to use up precious ammo blowing up rocks. Let the traps fight for you while your men rest up in their deeper positions.

3. Modern Military Concepts for the Next Century

So far in this book I covered a number of ideas including the Rambo Rooter and Rickshaw, and the use of remote video and combat systems mounted on cranes. While these have obvious merit and will likely be used in the future, there are other potential concepts that may see future experience in war.

My short career in the US Navy was like living on a yo-yo with extreme ups and downs and the combination of good memories and common experiences mixed with some really rotten ones.

[During my "A" and advanced schools in sub hunting I would complete and hand in the two hour technical tests in 5-10 minutes with nearly perfect scores each time. This resulted in accusations of cheating and at least one time of being a spy. This was one of the common occasions of wanting to deck a superior officer. The Navy didn't teach pattern recognition of enemy sub signatures on Lofargrams which I recommended to them at the time in the school critiques. They required doing every observed line from rote memory. Aside from this I found the schools to be more effective than college.]

These aside I made several observations which I felt at the time would be likely and sensible future trends. Since no one else has publicly discussed these potential warmaking improvements, I will describe them here.

1. While stationed on board the USS Enterprise I came to the conclusion that the armed forces waste incredible amounts of money on duplication of fighting systems and on tearing apart their ships and upgrading every few years (as if this is something new). The solution I devised for this can be described as follows (I thought this up in 1976)

The entire service should be populated with a single mass produced ship design of about 200-300 multi purpose carriers. These carriers would each be about 50% wider and nearly twice as long as current aircraft carriers and resemble the oil supertankers in size and crew complement. These ships would have the following functions only-

- a. Carry the fighting systems, soldiers, planes, and supplies from here to there.
- b. All fighting systems such as missile batteries, planes, artillery/guns, and so on will be multi service, modular, and drive on, drive off, or fly on, fly off.

Scientific Principles of Improvised Warfare and Home Defense

- c. The extra length and deck area would allow planes to land and take off without a catapult and arresting gear. This saves considerable operating expense and maintenance. It also allows all the service combat (small sized) inventories to fly and fight from the ship.
- d. The crew should number not more than 50, with the fighting arms loaded on board supplying their own maintenance and service personnel.
- e. All electronic equipment for C&C (command and control), ECM, Radar, and so on would be drive on and drive off and modular in nature. This saves having to regularly tear the ship apart to replace the obsolete hardware. Cranes can be used to replace the current tower systems.
- f. The vast size of the ship would allow the outer compartments to actually be filled with a chemical foam that is lighter than water and provides buoyancy should an enemy attempt to make Swiss cheese out of the vessel. This ship could be designed with enough such material to make it unsinkable no matter how many holes were put into it. Even if blown to pieces, all the parts would still float. This would greatly enhance crew confidence and be a discouraging condition for an enemy to face. The chemical foam would also contain a water activated foaming agent similar to the ones I have patented which would be combined with a plasticizer that would fill the holes as they were made. This would allow the ship to heal itself and fill in the damage as it occurred and make damage control easier. Having an unsinkable ship is an advantage in war.
[This will probably work to seal small sized holes or cracks. Huge, gaping holes are always hard to fix and might not be sealable until the inflow water velocity subsides.]
- g. The ship would have a series of portable telescoping decks with leg extensions that would allow a ship to load and unload by drive on and drive off from up to several thousand feet from shore.
This allows fast unloading and loading and is effective against defended shores. The deck and leg assembly would also allow the unloading over and bypassing of beach obstacles and mines.

Given the concepts of directly using all the fighting capabilities of the combined Navy, Army, Marine and Air Force plus the idea of mass producing a single design would greatly lower the ship building cost of the country, lower maintenance through the use of modular systems, and with a fleet of a couple hundred multi purpose carriers, the US could project 10 times the sea based air and ground power that it currently can (at considerably less expense). The use of crew sizes of 1/100th that currently used would result in great cost savings for the country.

Scientific Principles of Improvised Warfare and Home Defense

2. The modern missile designs could be standardized with combined high tech video, thermal, and radar targeting systems and smart warheads that could fuse the explosive in different locations for anti-armor, anti-air, or anti-personnel purposes. These missiles would be used by all services, and could have smart targeting chips that would let you select target type (air, sea, land armor, land infantry, or land bunker). In addition, an Icon of the target type could be presented on a screen asking where you want the target hit, such as on the top of the tank on the turret, or its track, or at a 90 degree angle on its rear armor. These options could be selected by anyone such as a sailor on the deck of a ship firing at incoming aircraft or enemy patrol boat, an infantryman assaulting a building or entrenched position, or a man in the back of a helicopter trying to protect his craft from the enemy gun positions.

The use of a standardized explosive, propellant and targeting package with modern computers which can easily be upgraded would be of great benefit to the services. By using mass production assembly methods and training by all service personnel, the cost of the missiles could be as low as couple thousand dollars. By buying a million missiles a year and using most of them in practice each year, you could keep everyone well trained, while maintaining the factories and inventory turnover that is necessary for effective field weapons and wartime readiness. It would also reduce the costs to the country. By using the electronics to provide the smarts, you can get by with 2 or 3 missile designs rather than the several dozen used by the services now.

My only close up experience dealing with shipboard missiles came when the Enterprise would test its onboard anti-aircraft missile system. We would all go into hiding to the inner compartments on board ship in the hope that if the missile hit the ship or exploded without taking off, we would actually survive the test (this was back when you loaded a computer program by flipping a series of 16 or 32 switches and pressing a load button several times). By contrast, we knew that the Tomcats on boards could shoot down almost anything.

The services need one system that works all the time and can be used by anyone, and they need a lot of them for war purposes without bankrupting the country.

Scientific Principles of Improvised Warfare and Home Defense

4. What If Examples

I decided to apply the ideas I have discussed in this book to several real world examples that we read about in the news. Armchair generals abound, but actually having a plan in which people can be shown what to do is always better than no plan, or having no one in a position of knowing what to do.

Kurds

When the US decided not to go to Baghdad and leave Saddam Hussein in power, it decided to encourage a revolt among the minority populations without actually providing aid or guidance. The US seems to have a need to self inflict failure on its own ideas by not providing the resources necessary to have a snowballs chance in heck of actually succeeding. This seemed to start in a modern sense with the Bay of Pigs and has been regularly repeated since then. The US decided after watching Saddam use force and starvation to exterminate the Kurds, that they would lead an international effort to protect and feed the Kurds. This lasted about 5 years. The CIA evidently provided about \$100 million in aid to support the efforts to be independent. When Saddam was invited to march back in, he overran the Kurd positions in a few days. President Clinton responded by launching 40 some cruise missiles to send a message and then declared a policy victory. Five years earlier, the allies bombed an missiled Saddam by the thousands on a daily basis and couldn't get him to withdraw from Kuwait. To even pretend that a few dozen missiles could actually cause more than an annoyance to him seems absurd. The point of my discussion here will be, what did the CIA spend \$100 million on to help the Kurds defend themselves against Saddam.

Was the money handed out as welfare, or could it have been put to use building defensive obstacles and positioned weapons and defenses (and training and paying the workers). Did the CIA actually want to train them on how to make the necessary explosives and armaments from the local materials, or did they choose to keep them defenseless and dependent so as not to upset Turkey should any of the Kurds use the know how or supplies for insurrection there. My position is that there is much that could have been done to physically separate the Kurds from the Republican Guards rolling Tanks and APC's with the idea of using A-10 strikes to stop a slowed down assault in the future. The \$100 million could have been used to teach essential resistance skills and build the basic armament industries. Precast and premade obstacles could have been constructed and delivered to northern Iraq to at least blockade the main roads. Given the job, here is what I would have done.

The money would have been used to establish a defensive perimeter, army, and munitions factories. If the Iranians could stop Saddam with entrenched positions there is no reason the Kurds couldn't duplicate the trenchworks and build comparable obstacles.

Scientific Principles of Improvised Warfare and Home Defense

Army training would include

- Drilling
- Hand to hand combat and weapons
- Basic Firearms
- Use and manufacture of Mines and Booby Traps
- Survival, Evasion, and Camouflage
- Fighting in built up areas

Basic Munitions would have to center around the extraction of Niter from the soil and the manufacture of munitions from available mined material. The funds would be used to finance the operation of the mines and factories. Once the final explosives were made they would be used to build large numbers of mines and as ammunition for portable weapons. Large numbers of Kurds could be employed, and paid to build layers of ditches and obstacles. This would keep them busy doing something productive and the fact that they are paid for work, would help establish at least a minimal market economy in the area. They would also learn the basic survival and fighting skills needed to protect themselves.

Machine tools and steel would have to be purchased to build the large numbers of arms and ordnance that would be necessary to offer any resistance.

Although it would be a heavily criticized decision, I would also have provided the know how for chemicals and biologicals with the obvious ability to poison the rivers and water supplies of Iraq. The mere threat of giving Saddam a taste of his own medicine would not only be ironic, it would be poetic justice if it were actually used. The threat of retaliation in kind prevented Hitler from using nerve gas during WW2. Since Saddam seems cut from the same mold, the threat, or its actual use would have a strong inhibiting effect on his ambitions.

To help the Kurds be self sufficient in a positive way, the US should probably have supported a few basic mining and farming industries which would have produced a multiplier effect on the local economies and turned the hopelessness and welfare conditions into a self supporting system.

Kuwait

At the other end of the same country is another target of Saddams ambitions. Having looted the country once, it is likely that Saddam will eventually do it again. He has little to lose since he is being choked by UN sanctions anyway and has learned to live with it. Given time and repeatedly "working" the persistence of the US, he will likely wear down the will to jump in with every threatening move he makes and he will probably try to retake Kuwait again.

Scientific Principles of Improvised Warfare and Home Defense

The Kuwaitis have the benefit of their oil wealth, US weapons, training and support, and most importantly, the time to prepare. Given the huge nature of the threat and the reality that they lose by default if the US doesn't fight, it would be expected that they would make considerable preparations for the defense of their country.

The basic strategy should be a series of huge anti-tank ditches in depth (50 or so layers) surrounding the entire country including the Saudi border so that Saddam could not attempt a flanking maneuver. The space between the ditches could be filled with a couple hundred million mines (from the Iraqi inventories would have been nice). The strategy here is obvious, they (Kuwait) have a lot of money and little manpower. The money needs to be converted to as many mechanical and electronic soldiers as possible while they are able. This would leave the air and sea routes as the only quick ways in. Since the Iraqi's don't have any Navy to speak of and most of their air force has been whittled down to Kuwait's size and skill, these do not pose the same threat as they did in 1991.

The highways would then represent the only direct unimpeded traffic means of entry. This could be dealt with by placing pipes under the roads matching the 50 deep ditches dug by earth moving equipment. When an attack is made, the pipes are filled with explosive, detonated, and the roads turn into a massive series of speed bumps. All this is to no avail if there is no army or air force to meet the spearheads. The Iraqi's would simply fill in the ditches, plow the mines and move on. The difference here is that if, while all their equipment is backed up and standing still while filling in the ditches, US or Kuwaiti A-10s and tactical fighter bombers can do a repeat of the highway of death and Saddam could lose his entire force. A stalled armor attack would be in a deadly position in the open desert if it can't move and maneuver.

One other strategy would be to emulate Israel. They have been surrounded by far more numerous enemies and have survived because they could mobilize and enlist the aid of most of their adult population. In this spirit, arming every household with anti-armor recoilless launchers, positioned weapons, and guns would give the population a fighting chance and would seriously bloody any attack that reached Kuwait City (provided the population doesn't want to take over).

If possible, this defense needs to be combined with smart artillery (anti-armor shells) and tank busting aircraft and helicopters. It might even be possible for the Kuwaitis to do so much damage that the attack would fail and western intervention wouldn't be needed. With the amount of money they have to buy the weapons, obstacles, armor, and mines they could practically defend their borders by remote control. Without a large scale ability to fly over or go around the obstacles, the Iraqi army would have to do it the hard way, and they couldn't do it against fewer layers of defense in Iran. Defenses in depth turned back German blitzkriegs at Kursk, Moscow, and Leningrad and have seen success in many wars where maneuver and easy egress are stopped cold. If these types of preparations are not made, both Kuwait and the US may be in for an embarrassing "I told you so".

Scientific Principles of Improvised Warfare and Home Defense

Bosnia

What a mess. When the UN granted Yugoslavia an arms embargo on its former republics in September 1991, it granted a virtual license for the use of its locked in armed superiority to reestablish control over the region. Had there been a sense of any decency and justice when the army and the Serbs armed forces were used, they could have ended any prospect of world outrage and intervention. In the event, news reports acted as a catalyst for domestic and foreign outrage and things got out of hand quickly (is this an understatement?). The Yugoslav and ultimate Serb strategy ended up being a series of encirclements, followed by softening of the surrounded target cities with artillery and starvation. The Moslem and Croat strategy (when they were not fighting each other) seemed to be one of putting out any fire they might be able to reach with their forces and let things run their course elsewhere.

The Bosnia Muslims bore the brunt of ethnic cleansing and had at least some moral support due to the efforts of their enemies to exterminate them. As I have already stated, any population has a right to use any means of survival when the enemy comes to their door to kill them. When surrender only brings death, you don't just surrender. Despite the terrible conditions they faced and the Arms embargo, a ruthless enemy, and lack of organization, there are a number of things that could have been done.

First, after the massacres of captured populations occurred, there was probably a justification for manufacture and use of chemical and biological weapons if for no other reason than to force intervention. For each city "cleansed", a policy of depopulating a Serb city could have followed using nerve gas or Botulinum toxin. This might have also made it easier to bring the overconfident Serbs to the bargaining table in good faith. In the event, the use of chlorine gas was threatened by the Bosnians when they were in danger of being overrun.

Barring a decision to manufacture weapons of mass destruction, the only choice remaining was a mostly defensive battle of attrition (lacking proper arms for an attack). This is what generally occurred until the embargo was bypassed. Several actions could be initiated to cope despite the embargo, and this is where know-how comes in. You can teach the population how to build its own armaments, feed and house itself in the forested areas, and build its own armament industries. Specifically-

1. Building a rocket factory with similar characteristics to the Soviet Kaytushas of WW2. These would have some effect as counterbattery artillery and would provide considerable encouragement to the soldiers and civilian populations they are built to defend.

2. Building at least a few video guided missiles that could reach important targets behind Serb lines. This effect would be more psychological, but anything encouraging would help.

Scientific Principles of Improvised Warfare and Home Defense

3. Teaching the entire population the basics of improvised warfare and survival would have added to the numbers needed to resist Serb aggression and eventually relieve besieged cities. Most cities could survive starvation when surrounded by forests (even without UN supplies) as long as the population has free access to go and collect what they need. When the Serbs surrounded the cities and exterminated those coming and going, it forced the Bosnian Muslims into attacking their now entrenched defensive positions (moving offensively, fighting defensively). Use of nerve gas would have been particularly effective in attacking selected positions, especially if delivered by rocket. If this is not a realistic choice then infantry assaults up the hills becomes the main option.

4. Attacking Serb positions requires infantry assaults on surrounding areas to effectively cut off the artillery and starve them out. (moving offensively, and fighting defensively in reverse). Some of this was done near the end of the war. Large local concentrations to give manpower advantages and especially supported with anti armor munitions would be needed. Mining every approach was also practiced. These types of infantry maneuvers and actions requires intense and specialized training which was apparently provided by retired US military consultants and used to good effect.

5. Attacking Serb cities to draw off troops would also have been effective.

6. Collecting or importing personal armor materials that were not subject to embargo

Survival and improvised warfare training for the general population could have gone a long way to evening up the odds and preventing the easy massacres committed by the Serbs.

Waco

As in all situations, there are two sides to the siege that ended in a massacre at Waco Texas. I do not intend to take a strict position on either side other than to say that David Koresh effectively enslaved a small group of people by using sleep deprivation, dependency, and other subtle and regimented methods to control his flock and make his own life better and didn't really care about improving the life of his followers. He hid behind a mask of religious rights and privilege permitted in this country, (although freedom of religion isn't really free any longer when people aren't allowed to think for themselves or change their minds). My sympathies lie with the innocent followers and children who had to die during the battle fought between Koresh and the government. Neither side was prepared properly for their fight, and neither side had thought through their real goals and plans and how to achieve them. I will offer a devil's advocate view of things that might have been done to change the ultimate outcome without making further comment on the moral issues involved.

1. The defense of the compound: Given David Koresh's state of mind and a clear intent to fight to the death, it seems hard to imagine that any rational plan for the long term defense and eventual survival of the compound and its inhabitants could have ever been implemented.

Scientific Principles of Improvised Warfare and Home Defense

Statements of intending to wage war with the US Government were so preposterous that they only left observers with the impression that the cult leader was demented. If he really did believe and intended to wage war with the government based on the few hundred weapons in his armory and no plan, then he probably was demented. In reality, he was probably too busy with his own control priorities to actually prepare for any assault. The complete lack of a scientifically prepared defense bears this out. Even though he achieved early tactical surprise due to informants, he was clearly strategically surprised and unprepared for a siege. Given the circumstances they were living under, the following actions were called for to improve the ability of the cult to defend itself and improve its position to negotiate a favorable end settlement.

a. A plan needed to be devised to produce such great obstacles to any law enforcement attempt at takeover, that a negotiated settlement would be the only possible outcome. The use of superior firepower from the guns used by the Davidians was only temporary. No matter how big their guns are, US law enforcement are always going to be able to bring more and bigger ones. This was obvious. It is also obvious that the use of artillery, bombs, air strikes, and armored assaults used against American civilians are generally not considered acceptable (see Philadelphia in the early 1980's.) Given this as the only restraint on the government's possible use of force, it should have been possible to construct defenses that were beyond the practical ability of any US law enforcement agency to overcome without military intervention. This would have allowed the Davidians to negotiate a more favorable legal conclusion to the standoff from a position of clear defensive strength. If anyone was to ultimately survive the episode and go on with life, this was the only reasonable plan that could have been pursued.

2. Given a plan to properly defend the compound against a non military assault, the Davidians started with an already impressive arsenal in place including several hundred guns, grenades, and some explosives. Many of the cult members had been well trained in the use of these weapons.

3. The near absence of any defensive personal armor in the form of flak jackets or movable armor (the Rickshaw described earlier) showed up in the casualty count from the first gun battle. An investment in these types of armor would have reduced casualties drastically.

4. The firing positions were not prepared with small observation ports to fire from (resulting in a lot of shooting blindly through walls). In addition, the firing positions needed to be steel reinforced with concrete and soil covering to deflect all incoming munitions.

5. There was no underground facility or bunker to send the kids to when the shooting started. An underground bunker with reinforced concrete covered by a foot of dirt and in the main building would have been sufficient for a command post, shelter, and could have been wired for communications and exterior video surveillance. This would have allowed the proper dispatch of defenders to the key positions as needed.

Scientific Principles of Improvised Warfare and Home Defense

6. A positive flow, filtered air system needed to be installed in the bunker and key defensive positions to prevent the effective use of gas by the attackers. This would have enabled the defenders to remove their gas masks to eat, talk, and perform other essential activities without suffering the effects of the CS.

7. There were no anti vehicle obstacles anywhere. The government drove up and banged on the front door. Any real defensive efforts should have allowed the control of all approaches with an ability to shut them off when the shooting started. How much would it have cost to rent a backhoe for a month and dig 2 or 3 rows of anti whatever ditches. These ditches could have been filled with water with a pipe feed for chemicals in the event of assault. A modern equivalent of a retractable or drawn up bridge would have allowed limited and controlled access to the compound. The dirt could be used for inside fortifications or spread in an uphill fashion towards the buildings. Alternatively, it could be simply piled up in front of the walls allowing some protection against projectiles.

8. The area between the ditches could easily be mined, and barbed wire or steel imbedded in concrete could have posed an intimidating obstacle.

9. Tank reservoirs of several chemicals could be contained and hidden in the buildings. When an assault was attempted over or through the ditches, the chemicals could be discharged by opening valves into the ditches. These could include acid to cause burns on contact with the water. They could include fuel or incendiaries that would float and could be ignited during battle. In addition, combination chemicals that release gas when combined could also be released.

All of these ideas are based on the premise that the army is not used. I know of no law enforcement agency with bridging equipment or trained and equipped engineers. If the President ordered the army in, the battle would be over quickly since the army has personnel and equipment to deal with any obstacle and situation that could be improvised. Conversely, the law enforcement agencies would have strong self interest to conclude the affair without a battle. This would allow a negotiated and potentially favorable conclusion (given the circumstances). An assault against these fortifications combined with the firepower would prove difficult and require large manpower, medical resources, bridging and chemical protection equipment, anti-trap and mine countermeasures, all while advancing under heavy and deadly fire. No matter how embarrassing or pressured they might feel, anyone looking at the reality of breaching that level of defense would look hard at any reasonable alternatives.

2. The government assault of the compound: The same obvious problem of lack of personal protection, even inside of vehicles would result in an embarrassing repulse of the ATF on day one. The first and most obvious question here that needed answers is how to protect the men when faced with any kind of gun battle. The answer is to supplement the flak jackets, with the mobile armor on a dolly that you can see and shoot through. It would have been helpful to have armored plate mounted in the vehicles or on the back of a pickup bed to protect the agents from fire and shrapnel (there was no place to hide). A variety of rolling armored siege engines on wheels could have and should have been in their inventory and used in these types of situations.

Scientific Principles of Improvised Warfare and Home Defense

Armored crane lifts should have been used in the second story assaults rather than ladders. My personal opinion is that the officers that are called on to conduct raids against heavily armed fortifications carrying only clothes, flak jackets, guns, and skin are brave, disciplined, and in some ways completely nuts. Better personal armor that can be carried or rolled into these situations is an absolute must.

The use of remote video surveillance equipment such as that mounted on the ends of cranes, sewer rod, or remote mini truck or tractors would have been helpful in obtaining close up intelligence without risking life and limb. Some effort at gaining remote video nearby or in the compound should have been an early priority.

The use of anesthesia in any assault of this magnitude should have been considered. It is a lot easier to assault a position when most of the defenders are groggy, asleep, or perhaps having a lethal reaction to the gas. This has got to be better than simply choosing bullets and bravery. It could have been delivered by hollow sewer rod, overhead crane, helicopter, grenades, or mortars. The use of armoured vehicles with a narrow pointed battering ram containing video equipment (as opposed to CS gas) could have been sent in on a trial basis to collect interior intelligence, and plant monitoring or time delay equipment to support a later assault. The limited nature of this intrusion would likely have not precipitated the mass suicide/murder by fire that eventually took place. It would have also left the defenders feeling somewhat powerless at the armoured intrusion. The sheer intimidation of this approach could encourage a negotiated capitulation. This device could also carry anesthesia, stun grenades, taser wiring that could be fired in a web to mass stun all the room occupants, and so forth.

The final assault that resulted in fire being used as a weapon against both parties could not have been easily foreseen. The failure to withdraw by the armored vehicles after the application of the gas probably left the Davidians with a feeling of going down fighting rather than be taken alive. The use of nuisance music and other noise to harass and deprive rest probably worked against the ATF. Most people do not think rationally when tired. If the goal is to cause exhaustion to support an assault, then it probably makes sense. If all it does is add to the anger and intensity of the committed defenders, then it is probably not a good choice.

In retrospect, the only thing that can be done now is to have equipment and procedures in place to deal with it. The only ideas I have to offer regarding the use of fire in defense are based on the sciences of firefighting. To have a fire, you need oxygen, fuel, and ignition. Firefighters generally use water to cool ignition temperatures and fire retard combustibles. The use of chemicals to smother a fire are also used. Obviously a fire department presence may become necessary at future siege assaults. I wondered if an inert gas such as neon could be pumped into the buildings to smother the flames while limiting potential losses from fire and the lack of oxygen.

One final idea that I developed for firefighting involved the building of a huge fireproof blanket (100'x100x) made up of weaved carbon, boron and other fibers that could be placed over a building (or in the path of an approaching forest fire) to cut off the oxygen supply. It would also effectively blind the interior occupants of the building reducing the dangers during approach. The blanket could be delivered by helicopter, cranes (the ones used for college football night lights), vehicles, or held up on the ends of poles by the assault force. The effect would be comparable to smoke and would protect the ATF agents from a directly observed approach.

Scientific Principles of Improvised Warfare and Home Defense

5. US Courts, Crime, Congress and Change

It has taken me about 4 months to write this book. During this time I have been given flak from friends and relatives about the lack of merit in writing on this subject. My comeback has usually been that I am doing something positive. I did not give up and go on welfare when the bad breaks got me down. I didn't go out and try to sell securities to finance any new ideas that I may have had. I didn't just gripe about the bad breaks I had in my life. I sat down and did something about it. I wrote a book (and it is possible to write many, much more advanced books on this subject) that will help pay my own way in life. Although the subject is popular among a narrow audience, the niche is there and I have filled it.

Writing about scientific know how is still legal in this country and probably will be as long as we have the first amendment. There is no one that I know of who believes he can decide for the people of the country, what they will be or not be allowed to know. Still, while writing this book, there was a moment that I nearly shelved it to pursue more positive avenues. The same day I considered this, I received a notice from the bankruptcy trustee. I had been in bankruptcy court for 4 years and it was finally coming to a close.

The trustee ruled that because I had an option to buy stock at some future time in the chemical company I worked for, that he would retain a right to go after it in the future if it ever became worth anything. From that moment on I lost any regrets about publishing that I may have had before. Yet, I didn't want to finish the book without offering something positive and some hope or ideas that things can be made better. I have decided to describe my thoughts and ideas for improving "the system" that drives some people to taking extreme measures and here they are-

The Courts

After spending 6 years in 4 different courts over the same subject, I have come to the conclusion that the civil court system has very little to do with justice. The practical effect of a civil suit is that you are guilty until you appear in court to prove yourself innocent of the claims (charges) filed against you. This would be fine except that the boxes they build to fit you into the law has very little to do with innocence, guilt, or responsibility. Because our attorney failed to file a single page of a security filing in Kansas, all the officers and directors were automatically guilty of securities violations. None of them had ever done anything wrong. Many were old men. All risked having their financial lives ruined because of an honest mistake. The suing parties stopped the legal sale of the plant we built and then started competing companies and committed over a hundred acts of financial arson to destroy their own investment and strengthen their lawsuit. Our own attorneys told us that all this did not matter. Financial arson is legal. The only thing that mattered was the failure to file a registration paper in one state and we automatically lose. It is obvious that this case had nothing to do with justice. It only mattered what little legal box you fell into. Well, even this is OK. I could start over again. The problem was that the chase continued with the ability to sue being used as a weapon of revenge and power, to harass and intimidate. Not to see justice done.

Scientific Principles of Improvised Warfare and Home Defense

The solutions are obvious and easily implemented. The civil courts still need to be available to deal with real and honest acts of harm. Some wrongs can be righted (certainly not every one, especially imaginary ones). When somebody makes an accusation, especially a false accusation, there should be a responsibility built in for it. That responsibility would be that if, you are the one filing a claim, you, and your legal counsel will be personally and completely responsible you fail to prove the claims you make. This is not a loser pays. It is a rule that the filer pays if they lose or lie.

In addition, the securities laws and laws in general should be amended to make financial arson a crime. If you commit numerous acts directly or by proxy to harm your own investments, and then sue an insurance company (which they also did unsuccessfully) or others, you should be held responsible both civil and criminally.

The courts were intended to be able to allow people to settle their differences using neutral judges. People would go to court to resolve conflict rather than using fighting and gunplay. Unless this system is changed, I suspect many people will continue to resort to physical methods of dealing with injustice, I have certainly thought about it. This book teaches the skills necessary to do that, in some cases, invisibly

Crime

The bottom line of living in a modern supposedly civilized society, is that you have a known set of rules that everyone agrees to live by. Some of these rules don't work well for some people but everyone compromises so that we can all live together without reverting to "he who has the biggest guns gets his way". Unfortunately, many people will not live within the rules, and this is always going to be the case. Society tries its best to correctly identify, punish, or rehabilitate those it catches breaking the law. The system is imperfect, expensive, and in some cases unjust as well. There are a couple of ways to improve it.

1. Society has already begun to equip its officers with radio monitors so that their conversations and situations can be recorded. They are also using video equipment to record events within the visual sight of the vehicle. This is perhaps the best idea yet to assist law enforcement. The judges and the entire world can see and hear what happened and judge for themselves. When the rare occasion occurs when the officers do something wrong or worse, this too is available for scrutiny. It is hard for either side to lie when what they said and did is recorded. Taking this a step further, I have two ideas to drastically enhance this practice.

- a. Law enforcement generally is unable to buy and obtain the best equipment at the lowest prices because of a lack of a centralized procurement and production plan. The federal government is the only entity capable of organizing something of this magnitude. If federal funding were organized to build a single design, mass produced, video-audio surveillance system for all law enforcement nationwide, a low cost integrated system could be built that would allow for remote audio when officers enter buildings (partial video may also be possible) and video in the car.

Scientific Principles of Improvised Warfare and Home Defense

In dangerous situations, the video could be transmitted back to the station to provide instant intelligence. The cost of such a system when mass produced by the hundreds of thousands could drop to the cost of standardized video systems on the shelf today (Complete under \$1,000 each). The benefits in knowing what happened for sure are considerable.

b. Law enforcement officers cannot be everywhere that a crime is committed. This causes considerable cost to society and leaves doubt during investigation and prosecution. Mistakes do happen. They may not occur often but they do, and it should be the utmost priority to at least have some assurance that you probably are right. For a crime to occur, someone has to be there to commit it. The physical act of being there means you are not somewhere else (an alibi). There is an obvious and easy (and using mass production as above) an inexpensive way of determining with a great degree of physical accuracy, who is at a crime scene and who couldn't be.

A series of high resolution cameras can be installed on utility or other poles every 10 blocks or so on a diagonal pattern 1 block apart (on the diagonal). The cameras would take a high resolution photograph in every direction every 10 seconds or so, day and night. The information could be stored digitally. The equivalent of a meter maid would pick up the photos and deliver them to a central storage daily. Only when a crime occurs, a judge would release the photo library which would allow the people in the crime scene area to be tracked both to and from the scene. Suspects could have alibi's easily checked. This would allow the police to have a much greater likelihood of being right. It would not be in their direct control, which means that if they are involved they can be caught. Evidence used in court is much stronger. Best of all, privacy can still be protected by limiting access to only criminal circumstances. This is already done on a small scale with the video photos used during red light traffic, and in many stores with video interior surveillance.

Putting a video police officer on watch every 10 blocks, 24 hours a day with a photographic (reproducible) and accurate memory would allow watching the criminals leave home, arrive at the crime scene, travel, and return home with a high degree of accuracy. After a while, with a system in place that allows for the quick solving of 99% of the crimes, bad elements in society would begin to curtail criminal behavior or be rapidly incarcerated for it. This will not solve all the problems, but it would get most of them. In the long run, it may actually be cheaper than hiring, training, and equipping more officers. It would also solve such things as car thefts, kidnappings, and perhaps even the O.J. Simpson "mystery".

The alternative is to ask ourselves how much money we want to spend protecting ourselves from each other.

Scientific Principles of Improvised Warfare and Home Defense

Congress and Change

Society needs rules that work for everyone. Most rules do work all right. It would be really nice if those in government would obey their societies rules as well. I have had a number of situations in dealing with government official in recent years in which the rules they are supposed to follow were ignored. These situations affected my life and I will briefly describe a couple of them here.

A few years ago, my company was selling a herbicide when we received a letter from US EPA that effectively put us out of business. The year before, we had submitted toxicology data to support a label change from danger to warning proving our product to be safer than alternatives. Congress had passed a law requiring reviews of submitted data in 90 days. The EPA has never come close to this. To make a long story short, after I wrote a letter for our President, news media and others (I sent it to the EPA first). They expedited the review, changed our label, and effectively "Made it right". This was a rare occurrence and required a PR gun to work. We also threatened a legal gun. Some in America use real guns in dealing with serious situations where government doesn't follow the law and causes them harm.

A State of Nebraska feed official who had a previous disagreement with me decided to not issue a feed license to my employer because I was the company president. This was an automatic license for \$10? that is issued on application to everyone. This was his way to exercise his "power" over me. He didn't have this power under the law and we had to threaten to sue the state over it.

Examples like these were a strong motive to writing this book. Abuse of power by government officials is a very real problem. Laws already in place, passed by congress are supposed to correct these abuses. I guess congress could pass a law requiring officials to obey the laws they already passed, but it seems pointless. Unless there is a real penalty involved, our officials don't seem to care.

When those in government lie and don't obey the law (and the US Supreme Court didn't help when they said it is OK for law enforcement to lie to help get confessions and information) they set a bad example for everyone. How can you expect the citizens of the country to try to live honestly when the law of the land is that it is legal to lie. Institutionalizing lies and ignoring or breaking the law by those in government responsible for it, is the real cancer eating away at the country. When the government doesn't have to tell the truth, why should we. When the government won't obey its own laws, why should we?!

Finally, the US Patent office should be encouraged to practice a little intellectual honesty. I can't sit here and say that they deliberately screwed me over. They are paid to screw everyone out of their rightful patent protection if they don't have the financial and personal stamina to pursue it for years at great expense. No amount of PR can gloss this over. If the Patent office continues to practice intellectual dishonesty to simply weed out applicants, this entire country will lose out in more ways than it will ever know.

Scientific Principles of Improvised Warfare and Home Defense

Inventors deserve the rights to own their honestly created inventions. If that and the application fee is not enough, then the office is dishonest and society will have to live with the consequences. (How much will the Governments have to spend protecting themselves from their own citizens?)

Despite being screwed over several times in my life I learned to live with it. I started over in 1981, building a large and successful feed business. In 1989, I started over again in my garage and in 5 years, my herbicide made it onto thousands of store shelves. Today, after all this, I am starting over again. This book was not my only option, but it was the only reasonable option under the circumstances.

My answer wasn't to go out and blow up a building (although I wrote a book about the science of that). I didn't act to cause personal harm to any government or private individual with the exception of writing letters I felt were appropriate.

Over the years, I could have picked a different attorney to file the securities
I could have used another lab for testing
I could have used other ways to finance my ideas instead of securities
I could have turned down many different paths and avoided all these problems.

I do not intend to live my life in a vacuum. I intend to pull myself back up out of the mud and forge ahead. I don't have to hurt anyone to right the wrongs I see (although it is obvious from the content of this book that I or anyone else could deal with such wrongs). The bad laws will eventually be changed and the world will go on. It may not always be safer, but it will go on. If our leaders show at least some effort to right the wrongs, there will be fewer books like this in the world. If they don't then there may be many new advanced books, as our disaffected and weeded out citizens look for other answers.

When you need to know absolutely, positively, how to destroy it by tomorrow- Call STIP!

Published By STIP
PO Box 59
Silver Creek, Nebr. 68663

Scientific Principles of Improvised Warfare and Home Defense \$30/Volume

Volume 1 Basic Training

Hand Held Weapons

Chemistry, Manufacture and Use of Explosives

Mounted Weapons

Properties and Improvisation of Firearms

Hand Held Firearms and Explosives

Non Explosive Chemical Weapons and Incendiaries

Volume 2 Basic Training

Bio Toxic Weapons

Armor, Personal Protection, and Material Handling

Combat Support, Skills, and Equipment

Defensive Obstacle Construction and Countermeasure

Booby Traps, Mines and Positioned Weapons

Strategies, Tactics, Resistance, and Countermeasures

Volume 3 History, Design, and Manufacture of Explosives

Volume 4 Incendiaries: The Science of Using Fire as a Weapon

Volume 5 Advanced Chemical Weapon Design and Manufacture

Volume 6-1 Advanced Biological Weapons Design and Manufacture

Biological Entry

Bacteria Based Weapons