

# SCIENTIFIC PRINCIPLES OF IMPROVISED WARFARE AND HOME DEFENSE Volume 1

## Basic Training

- Hand Held Weapons
- Properties and Improvisation of Firearms
- Chemistry Manufacture and Use of Explosives
  - Hand Held Firearms and Explosives
  - Mounted Weapons
- NonExplosive Chemical Weapons and Incendiaries

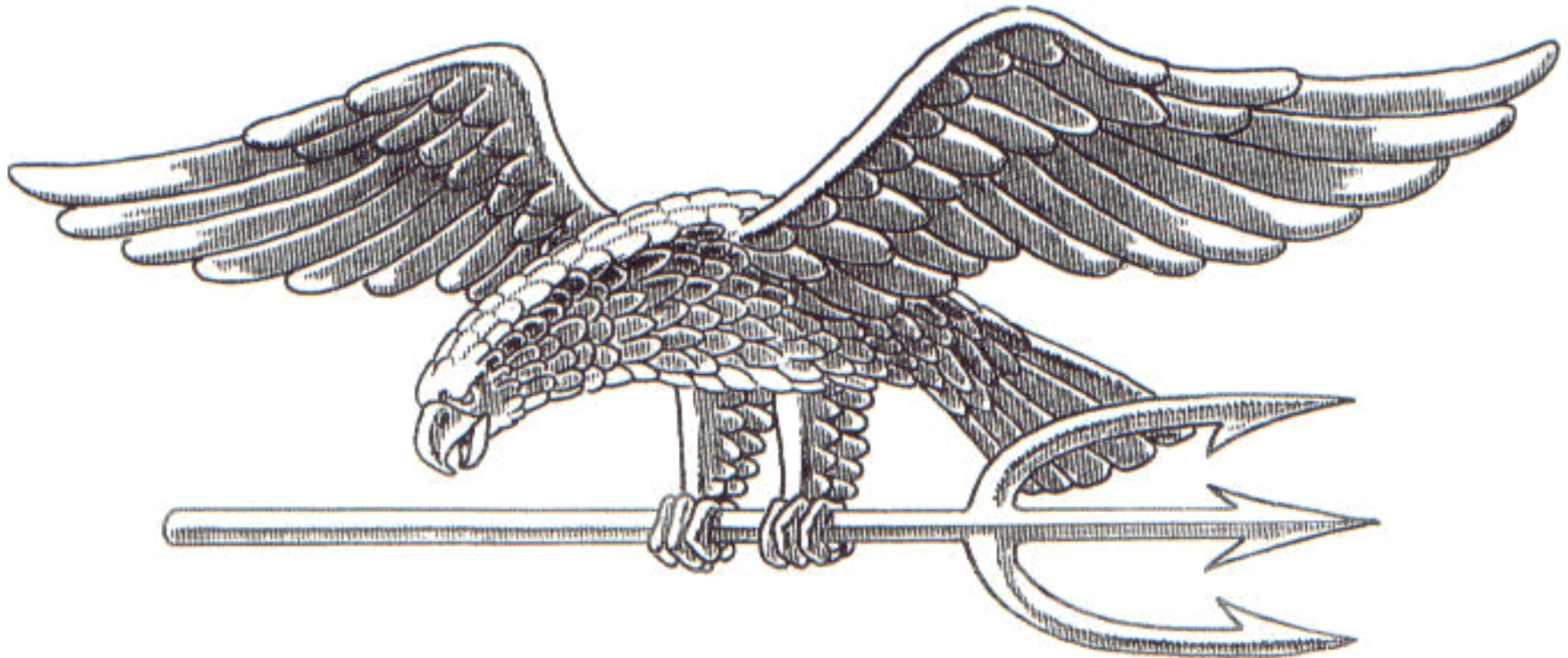

**Scientists right to bear arms: I will give up my right to know how to construct a long metal tube, enclosed on one end, and capable of propelling projectiles at high velocity, when they pry the know-how from my cold dead brain!**

SCIENTIFIC AND TECHNICAL INTELLIGENCE PRESS ©  
1996 BY TIMOTHY W TOBIASON

For Academic Purposes Only

**Scientific Principles of Improvised  
Warfare and Home Defense**

**Copyright 1996 ISBN #**  
by **Scientific and Technical Intelligence Press**  
and **Timothy W. Tobiason**

**Printed in the United States of America**

**Published by**  
**Scientific and Technical Intelligence Press**  
**P.O. Box 59**  
**Silver Creek Nebraska 68663**

**All rights reserved.**  
**Except for use in a review, no portion**  
**of this book may be reproduced in any**  
**form without the express written permission**  
**of the publisher.**

**This book is intended for academic use only.**  
**Niether the publisher or the author assumes**  
**any responsibility for the use or misuse**  
**of information contained in this book.**

# Scientific Principles of Improvised Warfare and Home Defense

## Table of Contents

Introduction	I-1
1. Hand Held Weapons	1-1
Clubs	1-2
Maces	1-5
Picks, Hammers, and Axes	1-6
Daggers	1-7
Swords	1-9
Pole Arms, Spears, and Bayonets	1-11
Fist Weapons, Whips, and Chains	1-14
Slings and Thrown Weapons	1-15
Bows and Arrows	1-17
Blowguns and Airguns	1-19
2. Properties and Improvisation of Firearms	2-1
Barrel and Loading Designs	2-1
Rifling and Ammunition Design	2-3
Improvised Methods for	
-Reusable primer and rifle cartridge	2-9
-Pipe Pistol 22 cal.	2-12
38 cal.	2-14
45 cal.	2-16
9 mm	2-14
-Low Signature System (silencer)	2-21
-Pipe Shotgun	2-24
-Pipe Carbine	2-27
-Match Head Gun	2-30
3. Chemistry, Manufacture, and Use of Explosives	3-1
Basic Chemistry	3-1
Ingredients of Explosives	3-3
-Nitroglycerine	3-5
-Ammonium Nitrate	3-5
-Potassium Chlorate/Perchlorate	3-5
-Liquid Oxygen	3-5
-Potassium and Sodium Nitrate	3-5
-Wood Pulp/Meal	3-6
-Nitrocellulose	3-6
-Picric Acid	3-6
-Ammonium Picrate	3-6
-Trinitrotoluene	3-6
-Amatol	3-6



## Scientific Principles of Improvised Warfare and Home Defense

-Mercury Fulminate	3-6
-Dynamite	3-7
-Gelatin	3-7
-Carbon Sources	3-7
-Flour	3-7
-Sulfur	3-7
-Gasoline	3-7
Safety Guidelines	3-8
Improvised Field Explosives	3-9
-Improvised Electric Detonaters	3-10
-Plastic Explosive Filler	3-11
-Nitric Acid	3-12
-Potassium Nitrate (salt peter, niter)	3-14
-Improvised Black Powder	3-17
-Initiator for Dust Explosions	3-19
-Fertilizer Explosive	3-21
-AN Aluminum Explosive	3-23
-Red/White Powder Propellant	3-24
-Nitric Acid Explosive	3-26
-Nitrocellulose Explosive	3-28
-Methyl Nitrate Dynamite	3-30
-Urea Nitrate Explosive	3-33
-HMTD Primary Explosive	3-35
-Picric Acid Explosive	3-37
-Sodium Chlorate	3-40
-Mercury Fulminate	3-42
-Sugar Aluminum Explosive	3-44
-Fuel Air Explosive	3-45
4. Hand Held Firearms and Explosives	4-1
Firearm Operating Principles and Design	4-1
Grenade Guns	4-8
Hand Held Recoilless Guns and Munitions	4-10
Improvised Field Devices	4-13
-Recoilless Launcher	4-14
-Grenade Launcher	4-16
-60mm Mortar Launcher	4-19
-Pipe Hand Grenade	4-21
-Nail (shrapnel) Grenade	4-23
-Wine Bottle Cone Charge	4-24
-Coke Bottle Shaped Charge	4-27
-Cylindrical Cavity Shaped Charge	4-29
-Funnel Shaped Charge	4-32
-Linear Shaped Charge	4-34



# Scientific Principles of Improvised Warfare and Home Defense

5. Mounted Weapons	5-1
Mechanical Artillery Design	5-1
Explosion Powered Artillery Design	5-3
Projectile Design	5-5
Gun Operation	5-6
Barrel and Shell Design	5-7
Mounted Machine Guns	5-15
Rocket Design	5-15
Missile Design	5-16
6. Non Explosive Chemical Weapons and Incendiaries	6-1
General Use in War	6-1
Use in Guerilla and Civil War	6-4
Routes of Attack	6-5
Methods of Obtaining, Manufacturing and concentration of Primary Chemicals	6-6
1) Acids and Blistering Gases	6-7
Hydrochloric Acid	6-7
Hydroflouric Acid	6-8
Sulfuric Acid	6-8
Oxalic Acid	6-9
Phosgene Gas	6-9
Mustard Gas	6-9
2) Alkalis	6-10
Caustic Soda	6-10
Ammonia	6-10
3) Pesticides	6-11
Aldicarb	6-11
Azinophos-Methyl	6-11
Carbaryl	6-11
Paraquat	6-11
Parathion	6-11
Vapam	6-12
4) Solvents	6-12
Acrolein	6-12
Dioxane	6-12
Ethylene Oxide	6-13
5) Household-Industrial Chemicals	6-13
Acetic Acid	6-13
Arsenic	6-13
Barium	6-13
Carbon Monoxide	6-14
Ethylene Dibromide	6-14
Formaldehyde	6-14

## Scientific Principles of Improvised Warfare and Home Defense

Mercury	6-14
Nitrogen Dioxide	6-15
Selenium	6-15
6) Nerve Agents	6-15
DFP	6-15
Sarin	6-16
Tabun	6-16
Soman	6-16
GB	6-17
VX	6-17
Convulsive Agents	6-18
7) Anesthesia Chemicals	6-18
Diazepam	6-19
Morphine	6-19
Atropine	6-19
Thiopental Sodium	6-19
Nitrous Oxide	6-19
Halothane, Euflothane, Isoflurane	6-19
Incendiary Weapons	6-20
Improvised Incendiaries	6-21
-Chemical Fire Bottle	6-22
-Igniter from Book Matches	6-24
-Mechanically Initiated Fire Bottles	6-26
-Gelled Flame Fuels	6-29
Lye Systems	6-29
Lye Alcohol Systems	6-30
Soap Alcohol Systems	6-31
Egg Systems	6-32
Latex Systems	6-33
Wax Systems	6-34
Animal Blood Systems	6-35
-Acid Delay Incendiary	6-36
Unconventional Delivery Systems	6-38
-Grenades	6-38
-Spray and Air Systems	6-38

# Scientific Principles of Improvised Warfare and Home Defense

## Introduction by Tim Tobiason

This book is a compilation of applied sciences in construction, chemistry, biology, and physics to what is essentially a military undertaking. Urban Warfare and Home Defense can mean many things to many people. If you are in Los Angeles during the riots in the early 90's it means survival against angry mobs. If you're in Afghanistan during the Soviet occupation it means conducting guerrilla warfare operations (Survival, Escape, Evasion, Resistance). If you are part of a militia group in Waco, Texas and an angry and frustrated government launches a heavily armed assault against your home it can mean life itself.

If you are standing on a street corner and are assaulted or robbed, the odds are greater than 95% that a single armed assailant will prevail and very nearly 100% that an armed group will prevail. If you are involved in civil or criminal litigation the likelihood of prevailing in court is skewed almost 50% (odds of 75 to 25) in favor of the deep pockets.

I wrote this book after several experiences in the last 10 years incited me to take action and help empower my fellow man.

Firstly, came a divorce in which custody of the kids to my ex was a foregone conclusion. Child support checks were always paid (no alimony) each month and went to the support of mom and her boyfriends (and drugs) rather than the kids. There is little recourse short of never ending and frustrating legal battles in which the odds of actually winning are about the same as betting on a race horse that has two broken legs (and is dead). Besides, I just wanted all this put behind me.

Secondly, in the mid 1980's a company I had helped to build into a multi million dollar livestock feed business (from nothing in 1982) decided to issue (on my recommendation) securities to finance a feed phosphate plant. We built the plant largely based on faulty lab work which showed Fluorine content to be about 1000% less than it actually was which made the phosphate dangerous to feed. I fixed the problems through a joint research project with TVA and we completed the plant as advertised, were state approved, and then the raw material suppliers (of which there are only about a half dozen in the U.S.) realized we were taking their low cost phosphate rock or phosphoric acid and turning it into high markup feed phosphates in competition with them. This annoyed them so all of them refused to sell the raw materials to us, even for cash in advance. [I should have ignored the buy american promoters and imported the acid]

At the same time this is happening, a group of stockholders who I shall label the Kansas group decided that because the plant was not running as it should have been that I was now a lousy manager. I arranged to have 2 companies with phosphate experience visit the shut down plant and make offers to buy it. The Kansas group, now angry at me insulted the prospects and instigated a civil war to drive me out of the company. I didn't want to work where I wasn't wanted so I left for a more rewarding work environment. The Kansas group blocked a sale offer by one of the companies for \$650,000 which would have gotten all their money back by telling the stockholders that they were being screwed, that I was going to work for the buyer and would make a fortune while they made nothing.



# Scientific Principles of Improvised Warfare and Home Defense

The stockholders voted to sell by a vote of 55% in favor in December 1989. The Kansas group blocked the sale because in Nebraska you need 66.6% to sell a major asset. They then concocted a plan with the other directors to set up competing companies to cripple our feed business and obtain the devalued stock holdings of my family members ( I am not making this up- it gets better-and its all in the court records).

During the next 2 years several things happened.

- 1) It was discovered that the stock issue was registered in Nebraska but not in Kansas. Upon discovering this the Kansas group sued me and my family members and then turned around and sued all the directors who had been working to help them break the feed mill. The failure to register the stock in Kansas had made all the directors and officers liable with no legal defense, even though the company attorney had admitted his mistake to the Banking commission. Because of this, their attorneys took the lawsuit on a commission basis.
- 2) The feed mill meanwhile received a substantial 6 figure settlement from the insurance company of the laboratories which was quickly eaten up in survival and legal expenses.
- 3) I went off to invent a new herbicide (a self foaming root killer for sewer lines) and would go to work for family and friends in a new company to develop this.

The Kansas group received settlements from the attorneys malpractice insurance and all the other directors but not myself. I refused to settle and was eventually forced to bankruptcy court. I refused to settle because I felt it was wrong to pay off "financial arsonists". The failure to register was their insurance policy. To collect, they needed to break the feed mill financially and they committed more than 100 separate acts to cause the loss that they were suing for and each act was legal. (These were no longer innocent shareholders).

By the mid 1990's the Kansas group was still chasing me in Bankruptcy court as well as the company I was working for. (I also learned that my own attorney had some years earlier sued my bankruptcy judge and had settled with his malpractice insurance for a very large sum, and this judge would not let us switch to the other judge). In the meantime the new root killer I invented made it onto about 6,000 store shelves and my employer sold the patent rights for \$650,000 for use in cities and with rooter companies while we kept the store rights.

After four years of chasing and harassing me in the bankruptcy courts, one of my directors negotiated a settlement with the Kansas group directly, over my personal objections and opposition and agreed to pay the settlement himself. [A couple of months before this the main culprit in the Kansas group was supposed to appear in Omaha for my brothers deposition in the case. He never arrived. I was told that his death certificate listed the cause of death as unknown on that same morning.] They tried to argue that because I invented a valuable product and was managing the company that I should have had an ownership interest and they talked a Chapter 13 trustee into agreeing with them (After a previous chapter 7 trustee had told them no).

# Scientific Principles of Improvised Warfare and Home Defense

This taught me that the justice system is really just a roll of the dice after all and that any time a Judge or Jury disagrees with your position you can just spend more money to create new arguments and appeals till you find someone to agree with your side- unless you run out of money first. It also taught me that you cannot simply choose of your own free will to just be an employee working for wages in America. If a trustee or judge doesn't like your attitude they can do whatever they want to you and your employer anyway.

Thirdly, I am generally a creative person and I like to invent new things. Partly out of boredom in the early 1990's I created inventions from several new product ideas (besides the herbicide) out of several thousand ideas I had written down. We attempted to patent several of these ideas and I will briefly recount two of these as examples for you.

1) I developed a new "jelled feed" which contained everything livestock and microbials needed to grow on in a jelled water formula. The ingredients would all be mixed together and the microbials would grow inside the bag which was ready to feed. The patent office rejected our application citing several other similar processes. The problem was that every process they cited used massive amounts of material handling, drying, and sizing equipment to make the final product. The whole point of our patent filing was not a new process to make microbials, it was a new way to make microbials which did not require any of this equipment for making, bagging and storing the feed. Our product would literally grow in the bag. The patent office completely ignored all of our claims and refused to even address our no equipment arguments.

2) I invented a new dry acid. The key word here is dry. Ammonium Bi-Sulfate (ABS) has been around for years as a liquid. Two of its specific properties are that A) if it gets in your eyes it can cause permanent eye damage and B) if you try to dry and store it as a solid, it rapidly absorbs moisture from the air and turns to mush in a few hours. My invention was to precipitate a small amount of Cyanuric Acid with the ABS during processing which resulted in a new ABS with changed properties. First, we had an independent lab run an eye toxicology and determined that the product could not cause permanent eye damage which means that it wouldn't have to carry "danger" as the signal word on the label. It would carry "warning" instead. The second change in properties is that it would now stay dry in the open air. You could now ship it in bags instead of shipping the dangerous liquid in drums.

The patent office rejected our application citing several similar processes to make ABS. All of these processes they cited yielded the unsafe liquid. None were dry and none had our safety properties. They ignored our changed properties argument as if it didn't even exist. We even had mountains of outside lab work supporting this.

These patent filings were "no brainers". Supposedly, in our country, if you invent a genuinely and honestly new material that never existed before you have a "right" to own it and to have patent protection. This is not so. The supposed equal opportunity to file for and own legitimate new inventions does not exist. It is only a pretend equal opportunity in America.

In both cases my employer manufactured and sold small amounts of these products to very happy customers. Without certain patent protection there was no way large amounts of investors money could be risked to build large production lines and support building new markets for the jelled feeds and a sulfuric acid you could hold in your hand without getting hurt.



# Scientific Principles of Improvised Warfare and Home Defense

The Congress of the United States passed laws designed to discourage the pursuit of patentable ideas. They wanted to insure that every Tom, Dick, and Harry with an idea could not flood the patent office with possible inventions that might never be turned into an actual manufactured and sold product. So, to discourage most people from filing for patents they charge large fees, make the legal language so difficult that expensive attorneys are needed to translate every word and concept, and have virtually institutionalized patent rejection for any reason (good or bad) in the first round of filings. The examiner doesn't even have to read or understand your inventions application. They can choose any other patent that looks close and make up vague similarity arguments as their basis for rejection. There is no way that they can even be held accountable. Of course, you can reapply, or appeal, or go to court to argue your case at enormous expense (yours) against all the resources of the federal government (they now get to use your own tax dollars against you in this fight). Your odds of winning here are about the same as the race horse I described earlier only this one has been cremated as well.

I canceled the patent efforts, sent the workers home, and decided that instead of working to develop new product ideas to make my peoples lives better, I would instead write a book to teach my fellow man how to kill each other. This is called empowerment. Do you have the know how, and the power that comes with it to defend yourselves, your homes, and your lives. Do you have the power to right injustices when the courts, justice system, and government bureaucracies ignore or simply run over you.

It appears that I can make a lot more money writing a book that teaches how to wage war than I can by trying to invent and patent a long list of things that might actually help peoples lives instead. It is also strange that the US Government will better protect my right to own and sell the information in this book (you can be sent to prison for photocopying it without permission) than it protects and encourages the people who make lives better through their inventions. In the end , it was the money after all and not a meltdown that motivated this project.

This book is therefore dedicated to

All the abandoned husbands who watch their families taken away by unhappy wives and are made to "pay" for their upkeep by state legislators and the courts.

All the individuals who are beaten up by a court system which favors the deep pockets (If you have money you win or you can buy more chances to find someone in the system to agree with your arguments-lets roll the dice and go to trial-again-and again-and again).

All the would be movers and makers of tomorrow who would like to invent a new portable self appendectomy kit which could be field tested on all U.S. patent examiners. Yes, it might hurt and if they fail they could die, but if they live they could actually claim the experience of knowing what a new invention really is. If it does work, then we get our patent and then have the confidence to go after some of the more vital organs (like their big red pumping thing).



# Scientific Principles of Improvised Warfare and Home Defense

It is also dedicated to a bankruptcy court trustee who certainly has the power to write and tell a judge anything they want. A close friend counseled me that instead of taking justice into my own hands I should do what Abraham Lincoln used to do.

Just sit down and write about what is bothering you and what can be done about it. So, in the spirit of Abe and the trustee, I have decided to do just that. And this book is the product of that decision.

A good college education combined with a little creativity and real intelligence can still be a lot of fun.

# Scientific Principles of Improvised Warfare and Home Defense

## Chapter 1 Hand Held Weapons

Consider for a moment two individuals. First , a mugger who could be an armed robber in New York, a Tiger in Northern India, a Commando team southern Lebanon, or a mad bomber in Oklahoma City. You are the muggee.

It is likely that the mugger has had from a few seconds to weeks or months to observe you in your surroundings. They could be a world class athlete or animal, they could be trained to cause you harm, they could be armed, they could have prepared well in advance.

With these advantages (not to mention surprise), is it any wonder that the average person on the street feels helpless and afraid to leave their own home. Even kids feel compelled to carry weapons to defend themselves in the halls of our schools.

Unless you are a world class athlete, a black belt at some form of martial arts, or a professional boxer, you have little chance of protecting yourself against prepared, determined, and trained assailants.

An animal or headhunter in the jungles of New Guinea may see you as their next lunch. So may the drug addict around the next corner. To protect ourself from being someone else's lunch , man has developed a variety of hand held weapons. (Firearms will be discussed in later chapters).

In real life it is critical (unless your Rambo) to keep an enemy at arms length and strike or shoot him from a distance with whatever tool is available. In this chapter we will describe the following tools and the principles of their use.

- 1) Clubs
- 2) Maces
- 3) Picks, Hammers, and Axes
- 4) Daggers
- 5) Swords
- 6) Pole Arms, Spears, and Bayonets
- 7) Fist Weapons, Whips, and Chains
- 8) Slings and Thrown Weapons
- 9) Bows and Arrows
- 10) Blowguns and Airguns

# Scientific Principles of Improvised Warfare and Home Defense

## 1) Clubs

The idea of a club is simple. A heavy weight is swung at an enemy to create an injury or lethal blow. In martial arts, your hands and feet are rapidly moved to strike blows or deflect enemy blows. This has three disadvantages. First, your own body parts can be injured easily while striking and deflecting. This is because you are made up of skin, bone, tissue, and fluids. Some tissue can be built up with practice and a great deal of force applied to a narrow surface area (such as breaking bricks or boards with karate blows). Second, in order to use your own body parts you have to close on an enemy (or enemies) who may be armed or better skilled than you are and could attack your own vulnerable body areas such as the throat or the groin. Thirdly, hands and feet have low mass and density which makes them poor choices for striking effective blows. Stone, wood or metal are much better to use in striking blows because they are dense and do not transmit damage (injuries) back to your own body.

### Physics of using a club

1) A heavy weight (or stick) held in the hand drastically increases density, adds momentum and mass, and thereby increases total force of the impact.

2) A weight mounted on a stick increases momentum because the end of the stick can be accelerated and this increases the lethal force of the blow.

Because of these advantages, a truncheon or nightstick is still carried by most police forces in western nations.

[ A more effective nightstick can be made by drilling the end, filling it with heavy metal, and sealing it.]

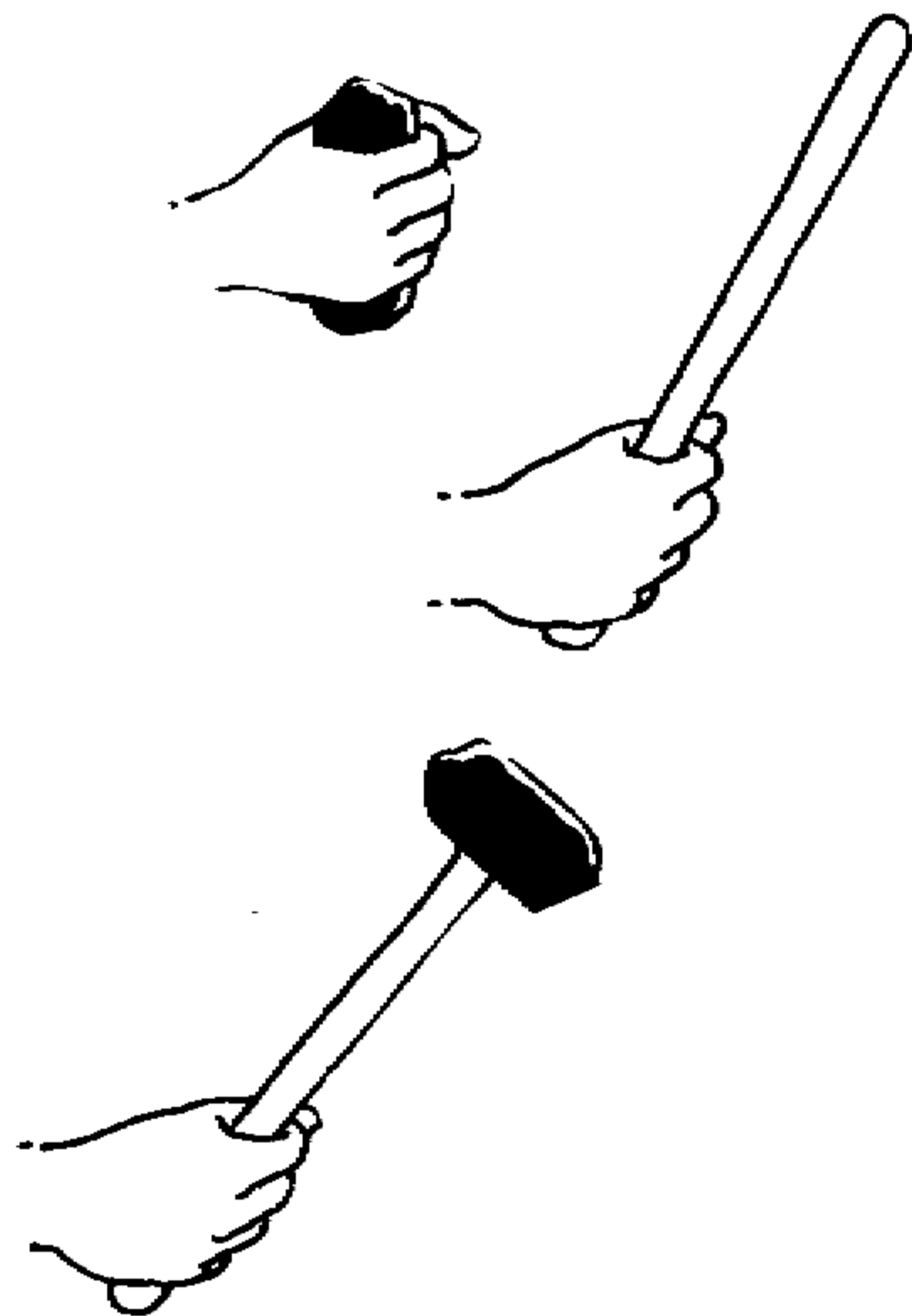

It is these same principles which enable a hammer to drive nails into dense materials such as wood or asphalt shingles. A 2 # metal weight fixed at the end of a stick and accelerated to 30 miles per hour delivers a considerable force onto a small surface area. The shape of the nail focuses this force into an even smaller area ( the point).



# Scientific Principles of Improvised Warfare and Home Defense

A composite club which applies these ideas is made as follows.

A wooden club has wire wound around its end to keep the wood from splitting. Nails are then driven into the wire wound wood and the heads of the nails are clipped off at an angle leaving a sharp point. This improvised club was widely used by troops on the western front in 1914-1918 for silent nighttime commando raids.

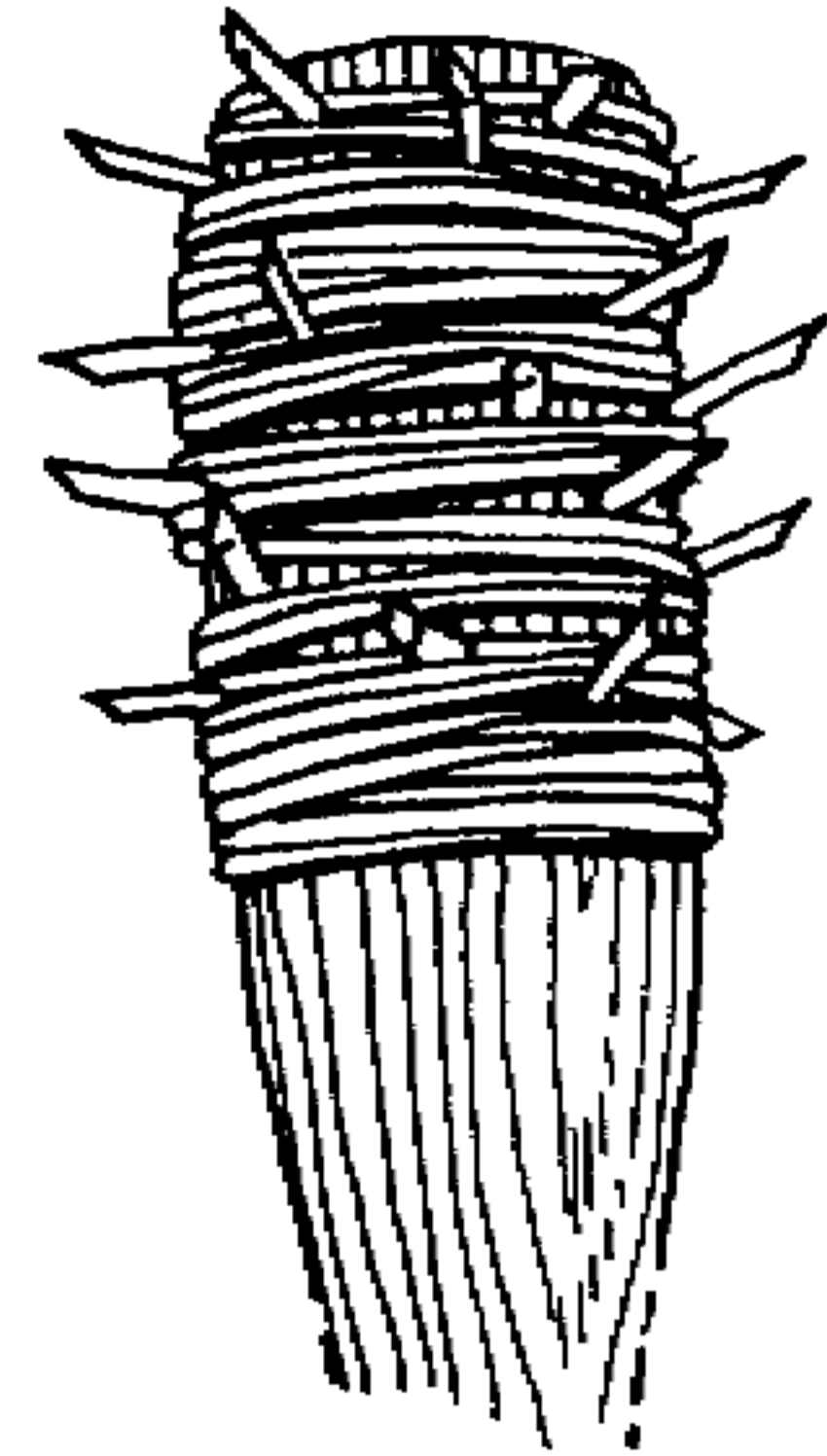

The force and momentum of the blow is imparted over the very small surface area of the nail points and allows a weaker individual to cause serious wounds while requiring only moderate arm strength and swinging ability.

An articulated club (war flail) is made by attaching a weight to the end of a chain attached to the end of a pole or club. The basic principle is that the weight is accelerated much faster than the swing of the free arm or club (to as much as 60-100 mph) drastically increases the power of the blow. By using a chain instead of simply adding a wooden extension it becomes difficult to parry.

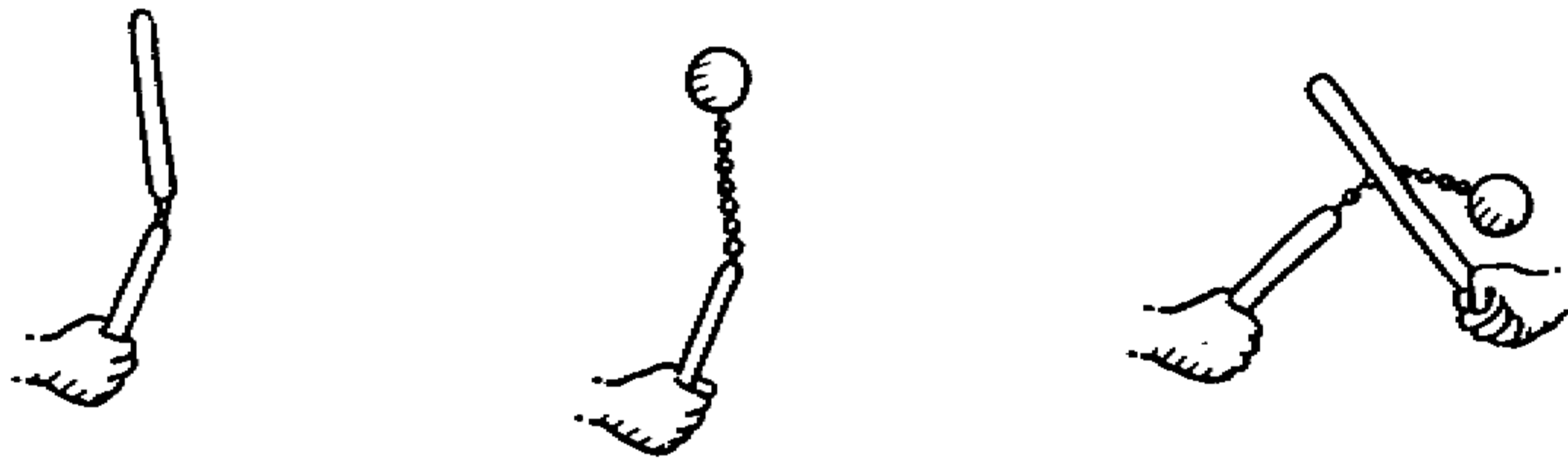

The Chigiriki is a more aggressive articulated club which can entangle an opponent, parry his blows, and keep him at a distance from you.

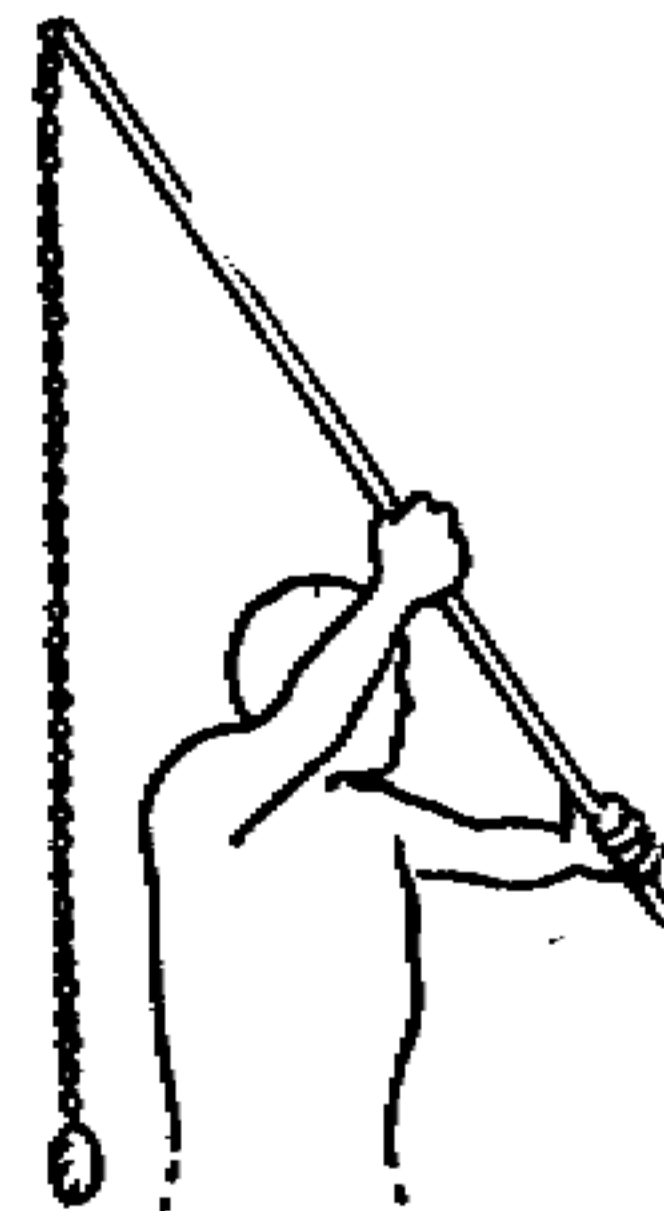

# Scientific Principles of Improvised Warfare and Home Defense

A star mace is made by welding a metal sphere to the end of a chain and welding nails, or razor blades onto its surfaces.

The accelerated force of swinging this device imparts tremendous energy to the small nail or blade ends.

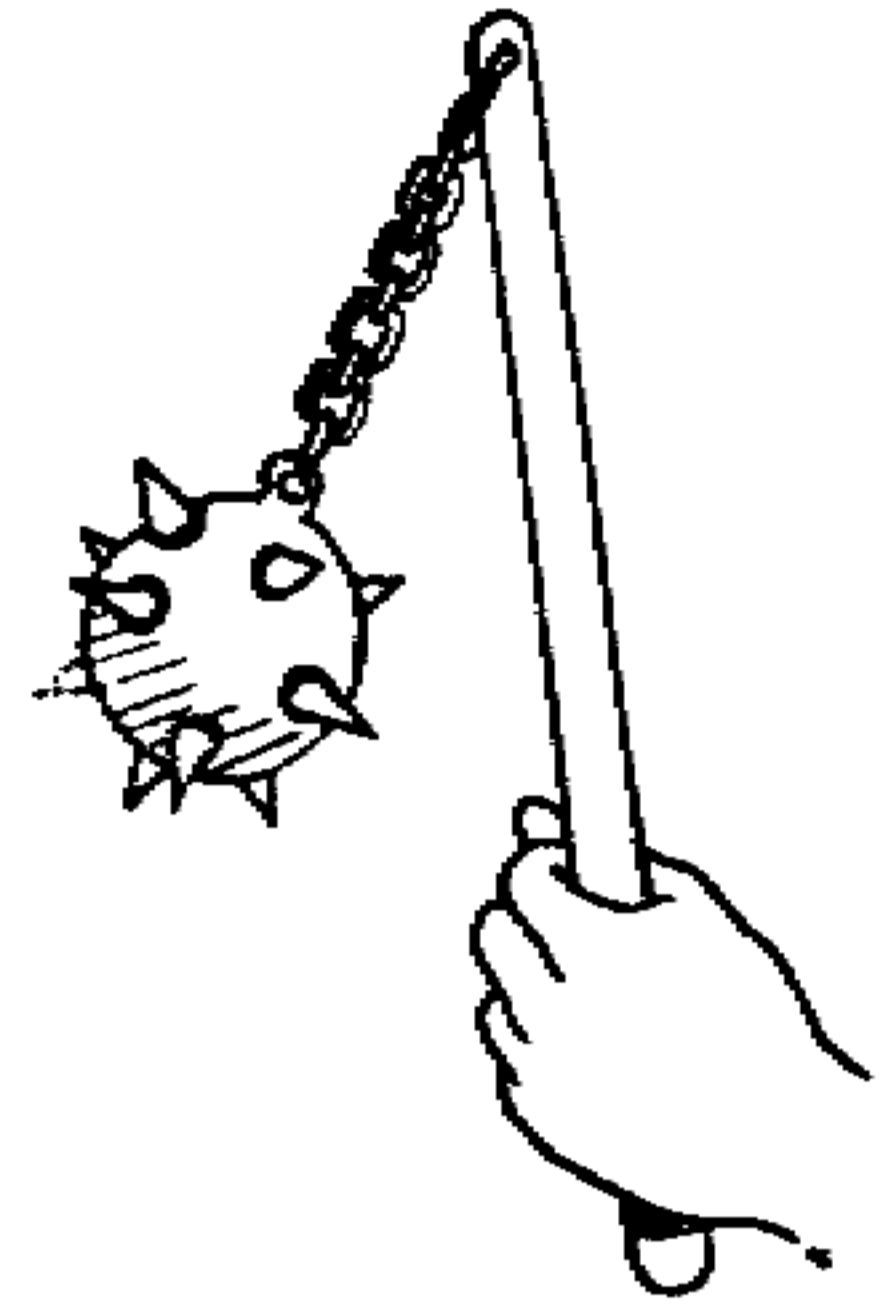

Multiple ball ends can also be used to increase the surface contact covered by the swing. This results in a greater likelihood of hitting your opponent with each swing.

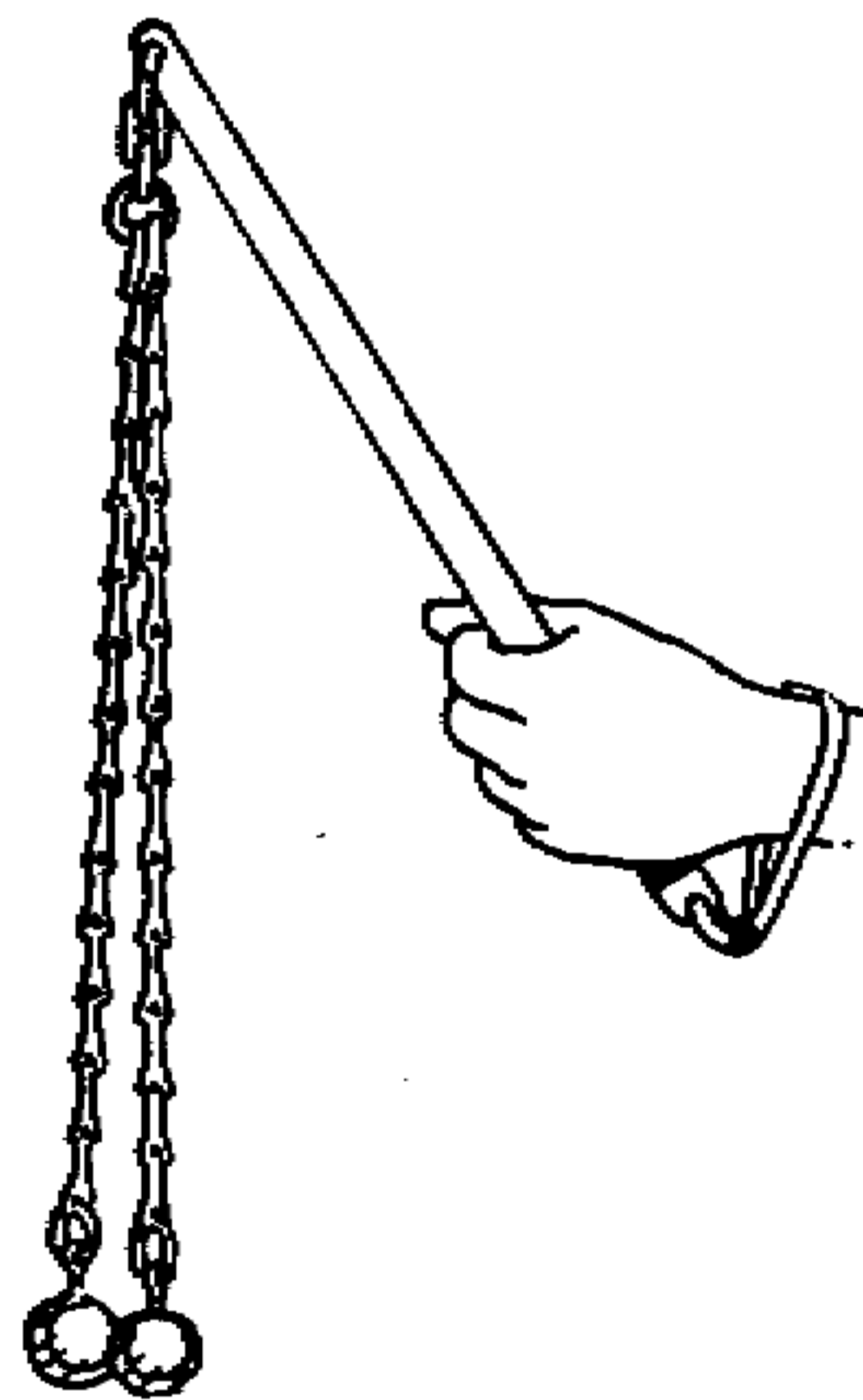

One important addition to a club is a wrist thong or loop made by drilling a hole through the handle, and running rope through it, and tying it in a fashion to fit around your wrist. If this is your only weapon of defense and you drop it, you may not have time to retrieve it.

# Scientific Principles of Improvised Warfare and Home Defense

## 2) Maces

A mace is an all metal club and is used wherever body armor has been used in defense.

A metal rod or pole is fitted with a welded spiked ball, or sharpened and weighted blades, or simply has spikes or points on the end. Historically, it is usually directed against the head although a mace blow on a limb could often break a bone even if the armor is not pierced.

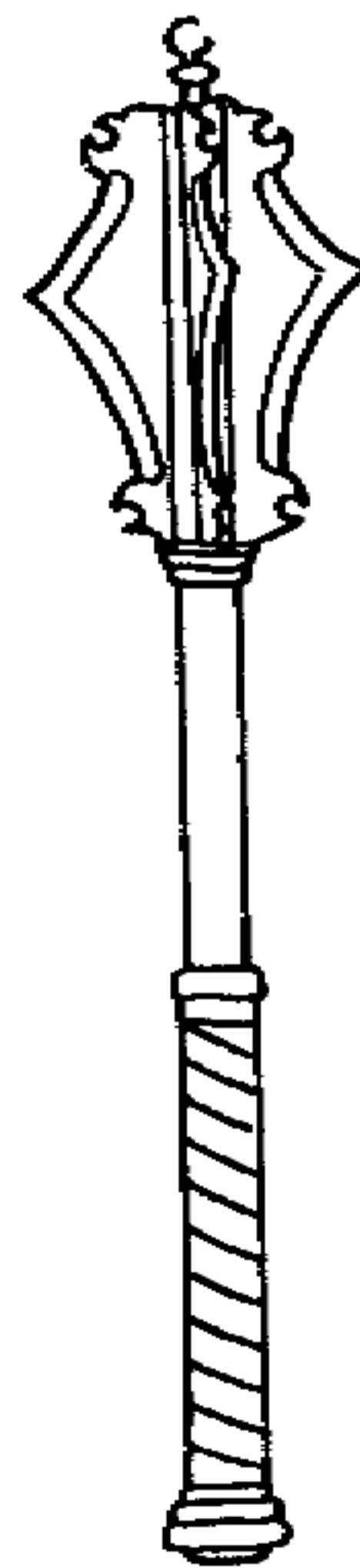
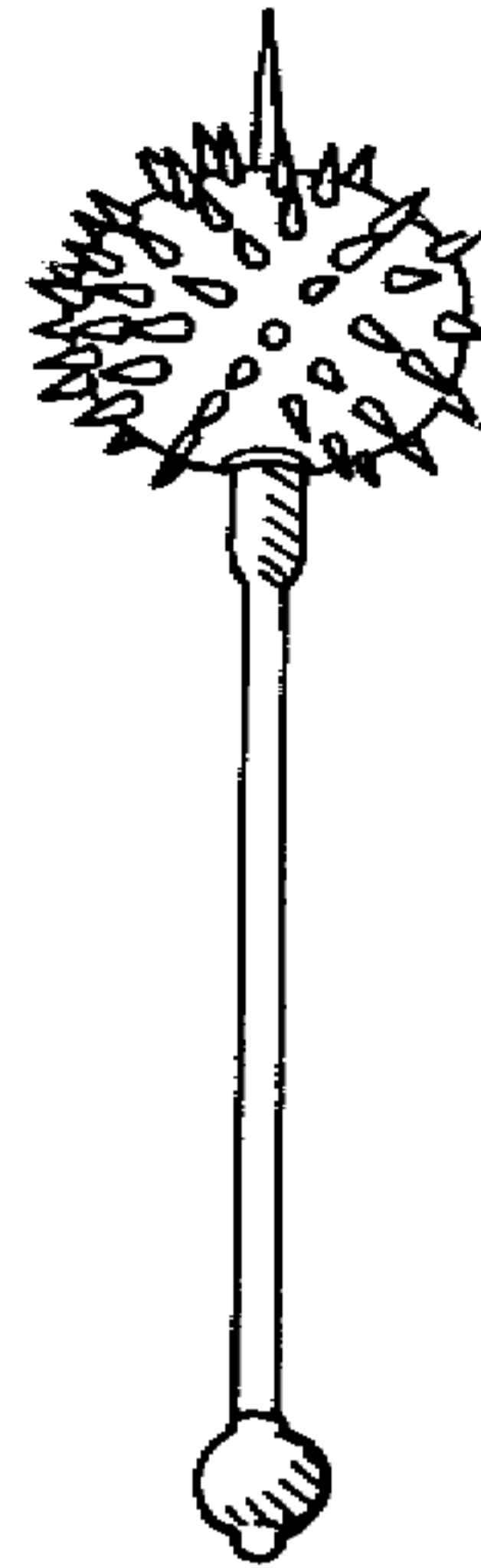



# Scientific Principles of Improvised Warfare and Home Defense

## 3) Picks, Hammers, and Axes

War hammers is the collective term for this group of weapons. A modern tool example would be a hammer with a pick or point on the other side of the haft (club end).

These are intended as piercing weapons with a dagger like blade fitted at right angles to the pole allowing the swing to concentrate all of its force (acceleration x weight or mass) onto a narrow single point on the end. This weapon was commonly used against chain and plate mail armor and helmeted opponents.



Axes have historically served dual roles in armies. First for cutting wood for fortifications, housing, bridges, rafts, and fires, and secondly for striking blows in battle.

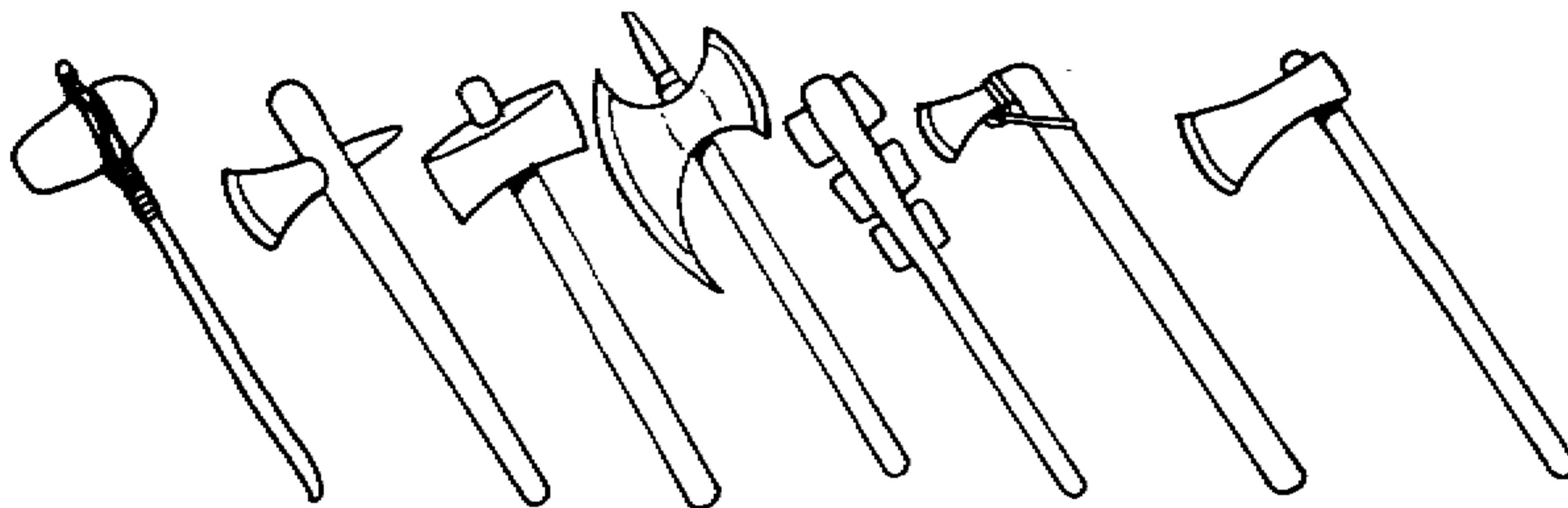

# Scientific Principles of Improvised Warfare and Home Defense

## 4) Daggers

One of the basic ways taught by all armed forces in hand to hand training is the use of daggers to kill or wound by stabbing. Daggers are short bladed, held in one hand, used primarily for thrusting although it may also be used for cutting in the manner of a domestic knife.

The best blade is usually tapered and often double edged. It is critical to have a secure hilt so you can maintain a firm grip and it is preferred to have a wrist thong. Using a store bought knife in thrusting could result in your hand sliding forward during the blade contact causing you to cut yourself or lose grip of your weapon.

The normal grip is with the blade away from the thumb.  
Downward stabbing is the most powerful #1

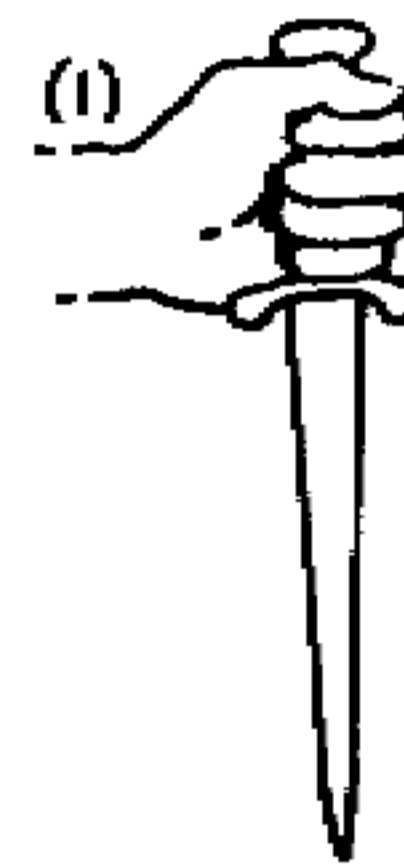

Daggers can also be held and used pointed upwards #2

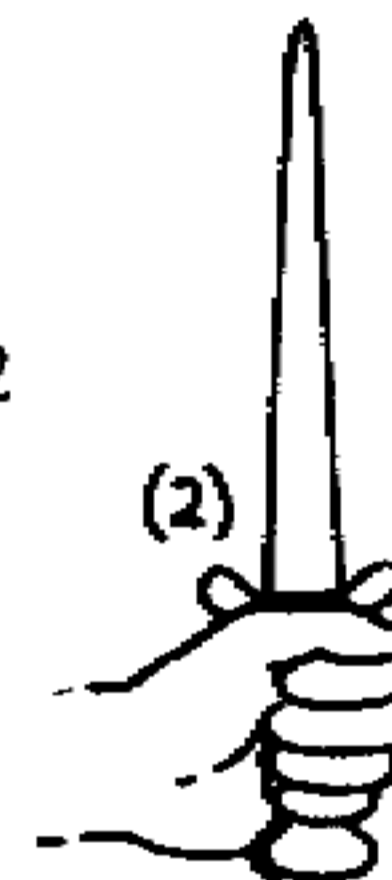

Some daggers combine both methods #3

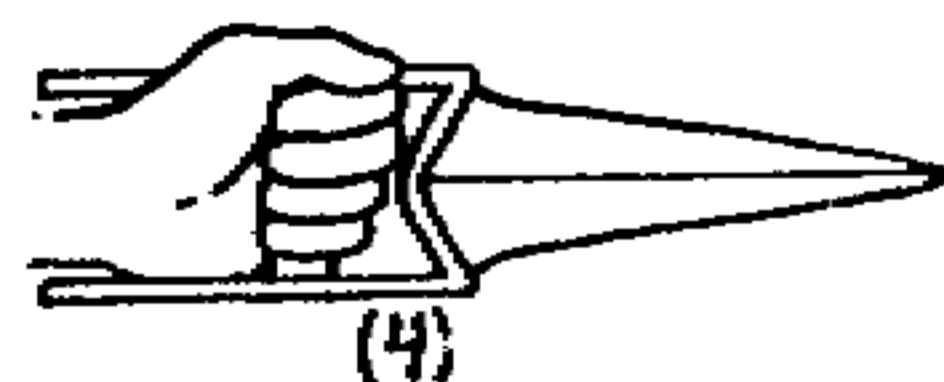
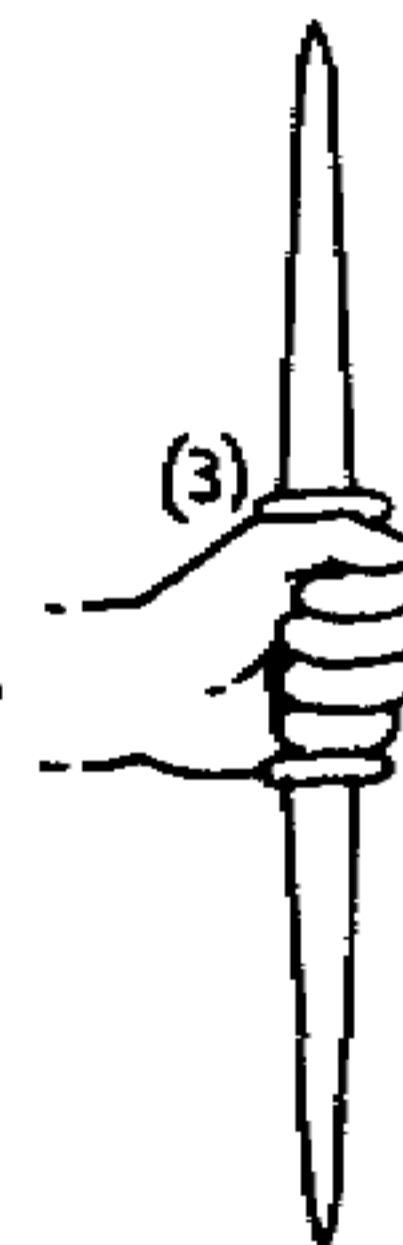

Katars (Indian) can be used to thrust forward #4  
or in all three directions #5

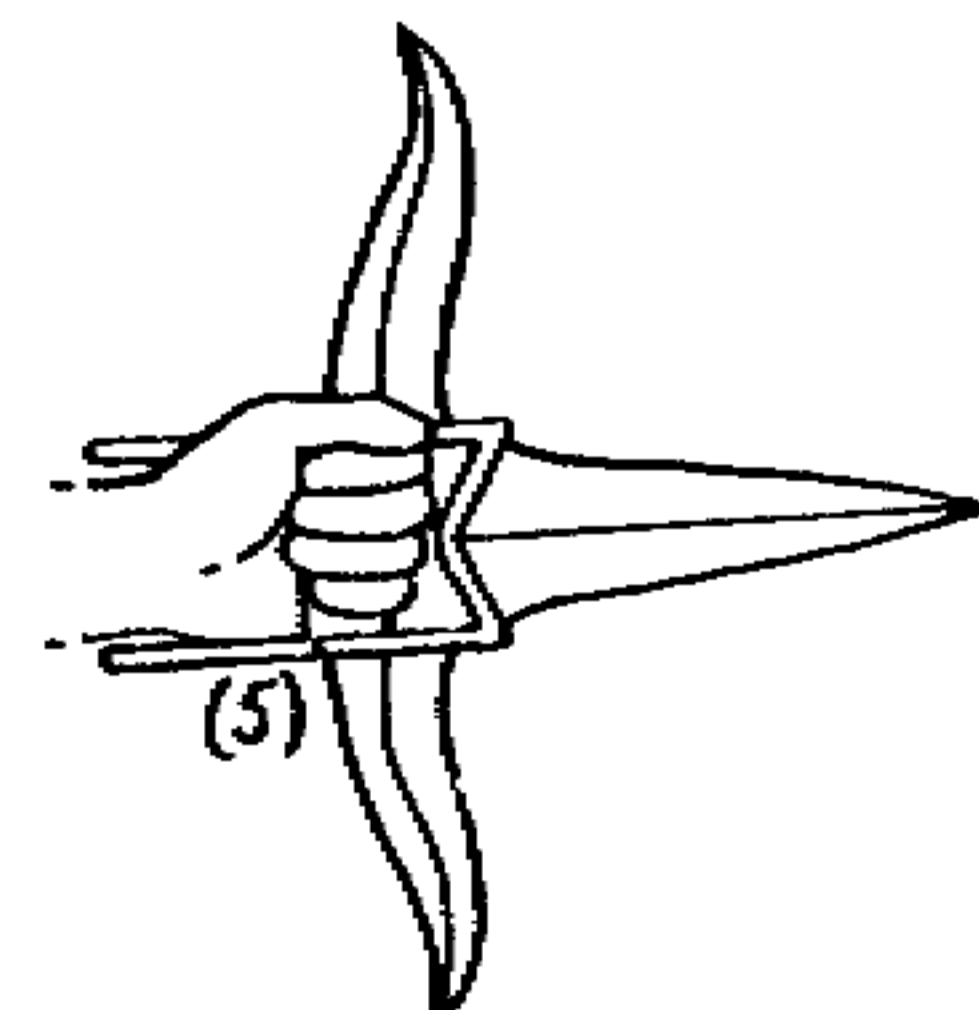

# Scientific Principles of Improvised Warfare and Home Defense

Daggers are easy to conceal, quick to draw, and is often used in clinches where a long blade cannot be drawn back far enough to stab. For these reasons daggers are ideal for self defense and clandestine attack.

Daggers are worn in different places to conceal, draw quickly, or for simple convenience.

- A) Upper Arm
- B) Inner Forearm
- C) Outer Forearm
- D) Left Hip
- E) Right Buttock (Vertical)
- F) Small of Back (Horizontal)
- G) Center Front
- H) Right Hip
- I) Boot Top or Sock

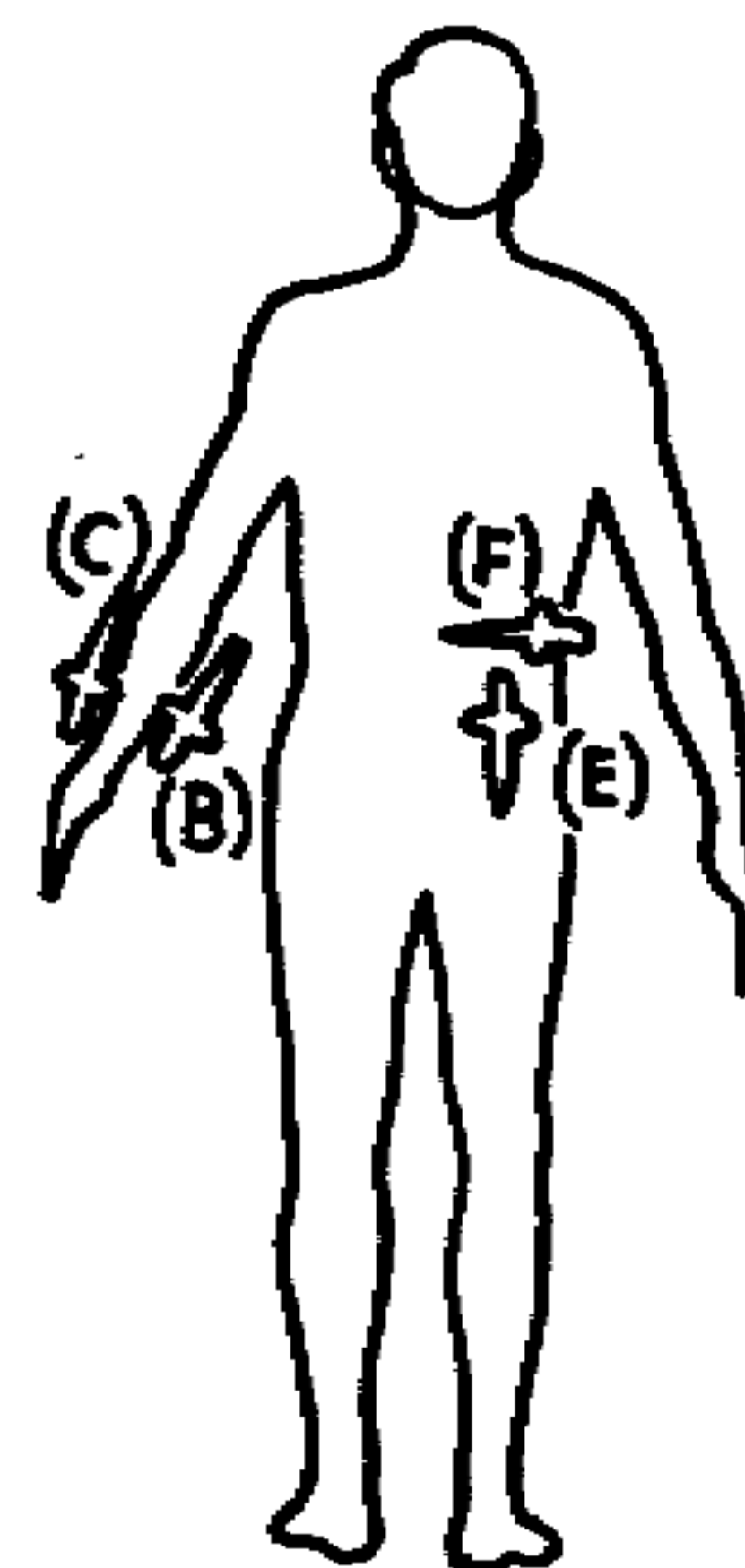
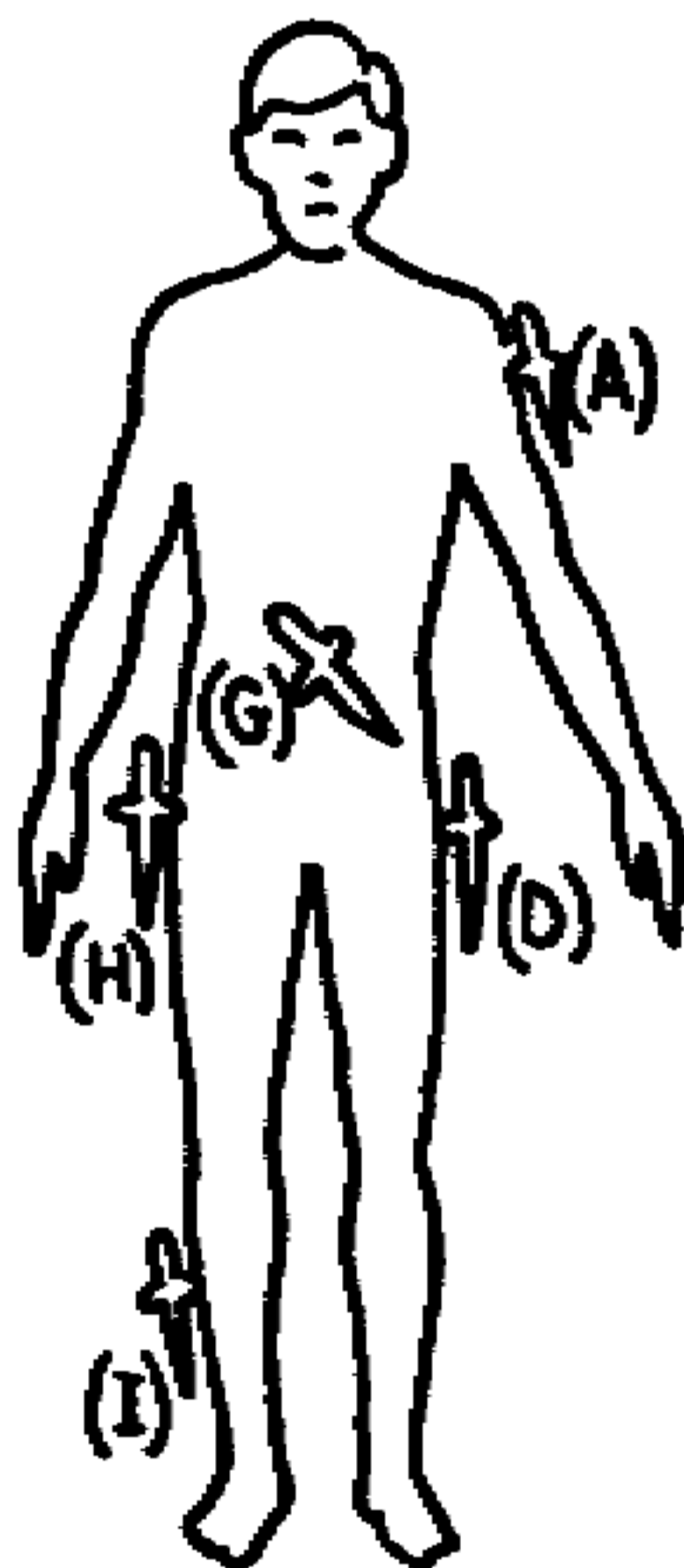

# Scientific Principles of Improvised Warfare and Home Defense

## 5) Swords

A sword is a long blade with a grip on the end. There are countless varieties used for thrusting, parrying, and cutting. It is longer than a dagger and not easily concealed.

### Parts of a sword

- A) Hilt
- B) Blade
- C) Pommel
- D) Grip
- E) Guard
- F) Edge
- G) Point

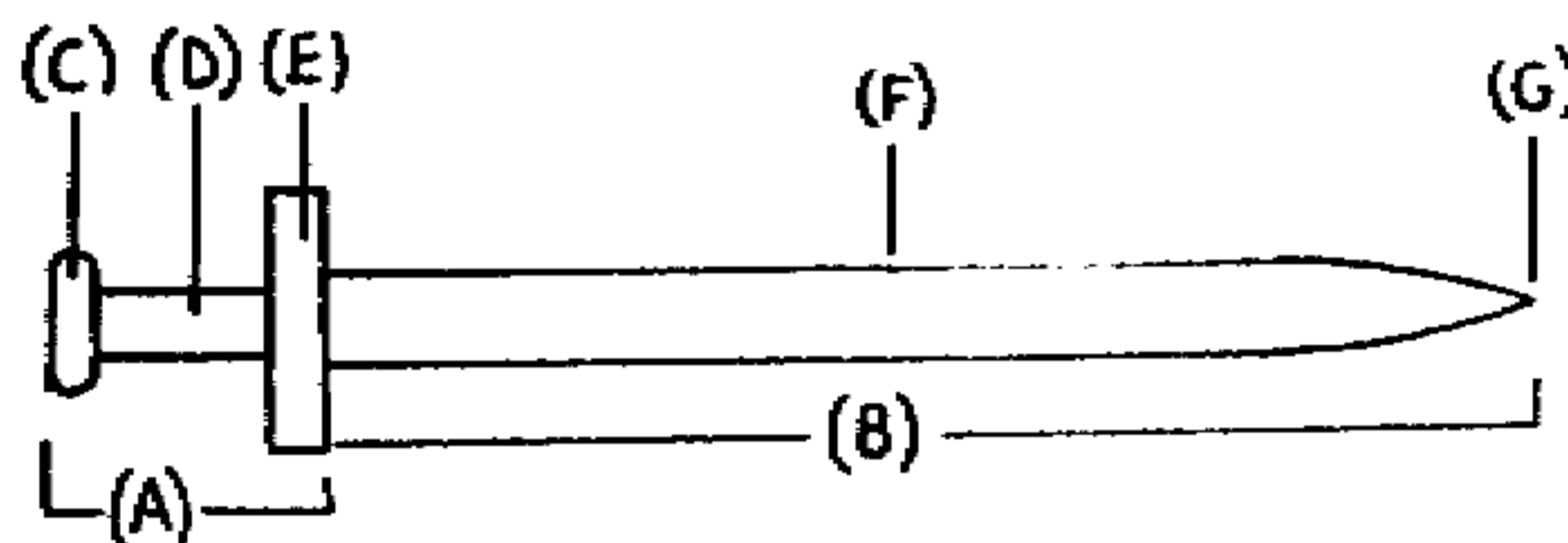

The sword has been developed and used worldwide by all cultures. Its versatility for parrying, thrusting, and cutting has led to the formation of schools to teach the theories and practice of its use.

[Books and schools exist almost everywhere that teach how to become skilled in the use of your own body or hand weapons for survival, street fighting, or military combat. If you decide to become serious in acquiring these skills it is strongly recommended to attend these schools or study books carefully and practice the skills so they become second nature.]

The three main shapes for sword blades are

A) Straight- used for thrusting



B) Backward Curved- for effective slicing cuts



C) Forward Curved- For chopping swings

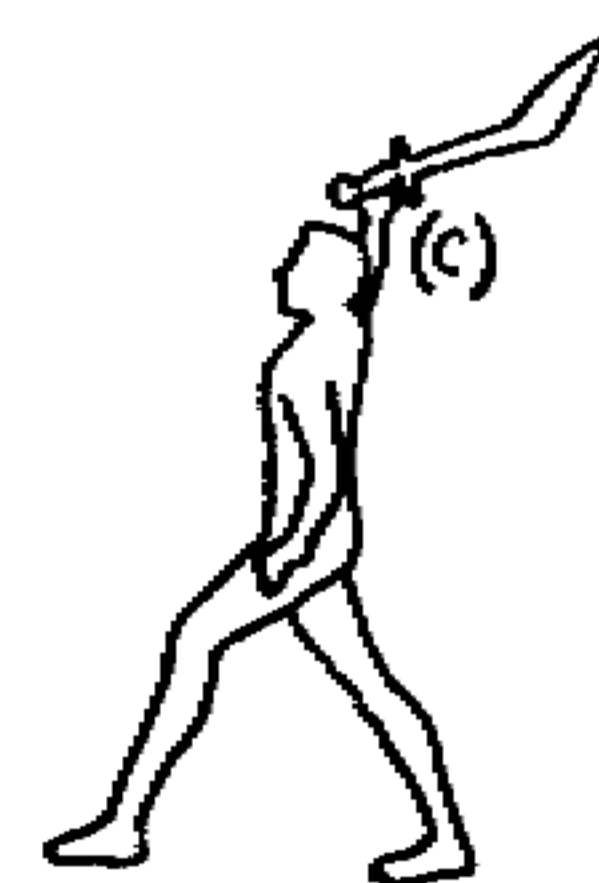



# Scientific Principles of Improvised Warfare and Home Defense

Hilts are added to swords to give a reliable grip in combat, fencing, and dueling.

A) Full Basket Hilt

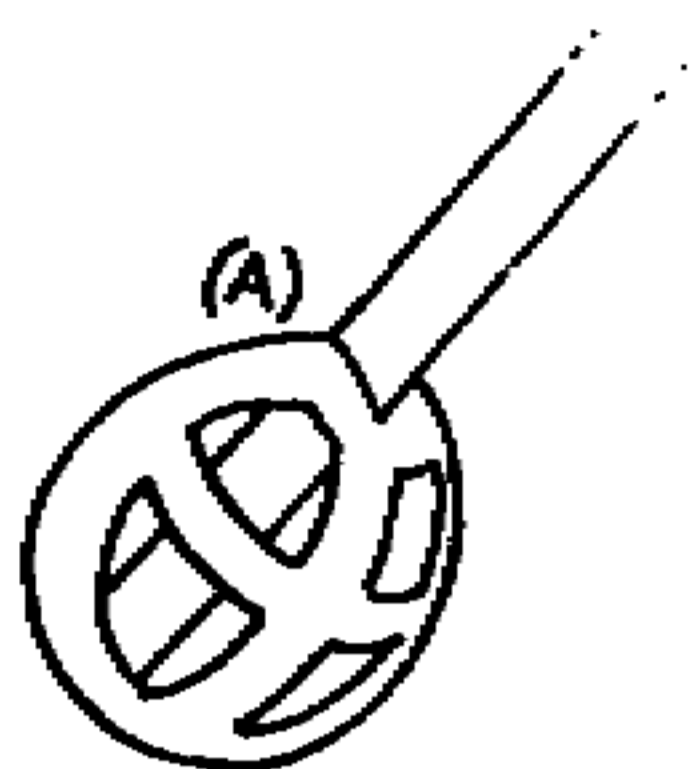

B) Half Basket Hilt

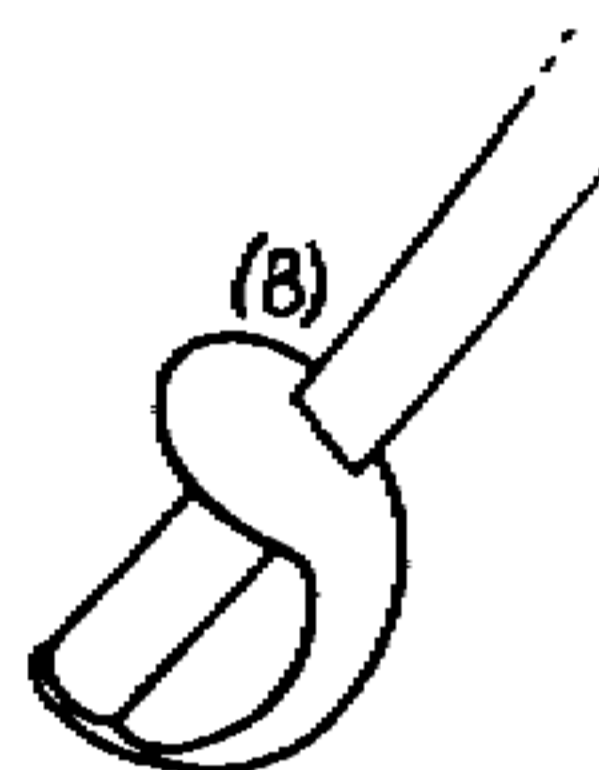

C) Stirrup Hilt

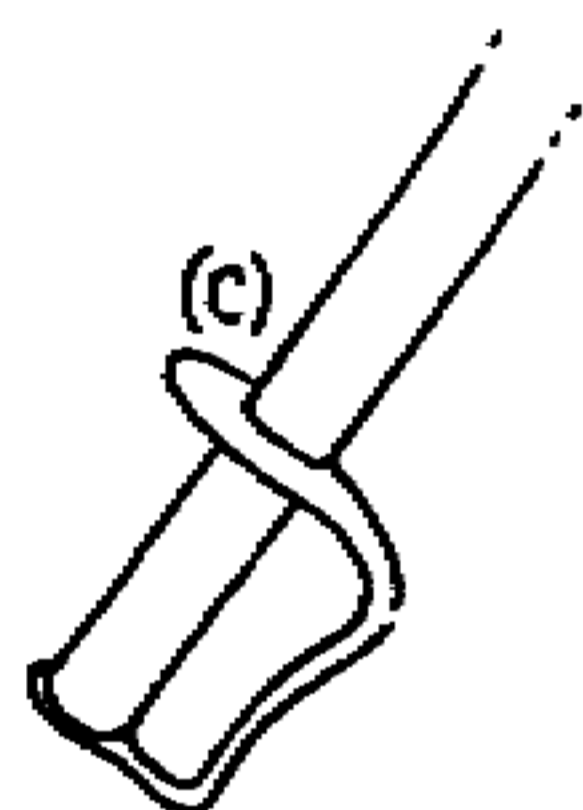

D) Mameluke Hilt



# Scientific Principles of Improvised Warfare and Home Defense

## 6) Polearms, Spears and Bayonets

By adding a long haft (pole) to weapons for cutting, thrusting, or clubbing, you have an advantage of reach over an enemy with a short weapon. It also gives a foot soldier a way of attacking or defending against a mounted horsemen or keep him at a distance. (The movie Braveheart provides an early good example of the use of Pikes in defense.)

A Pitchfork would be an easily obtained example of a polearm that has a civilian use and could be carried in a vehicle.

When combined in a trained military group, polearms can be very effective in both offense and defense.

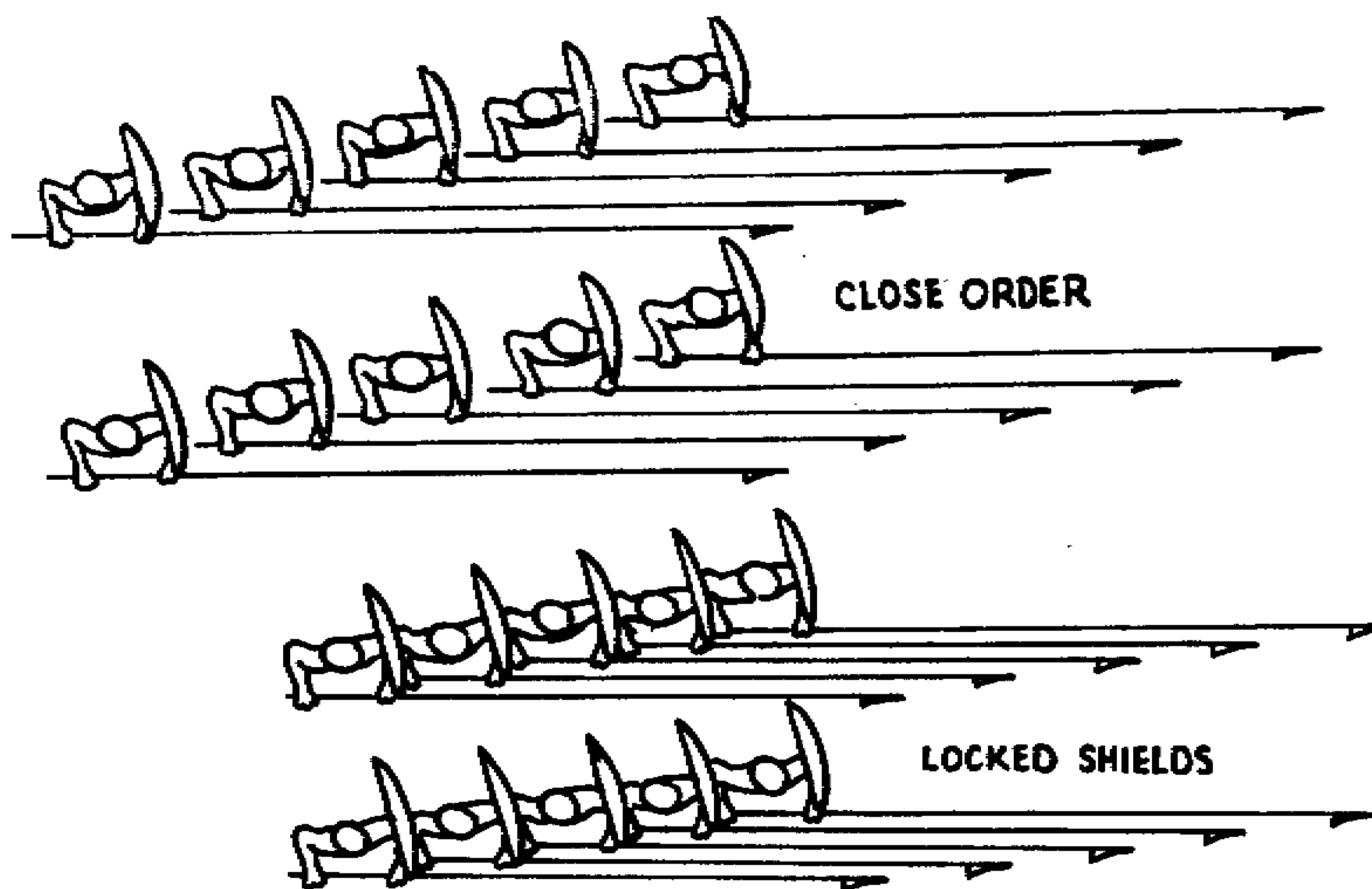

Pikes are long polearms and were used as late as the 17th century to protect squads of musketeers.

# Scientific Principles of Improvised Warfare and Home Defense

Most polearms are categorized as

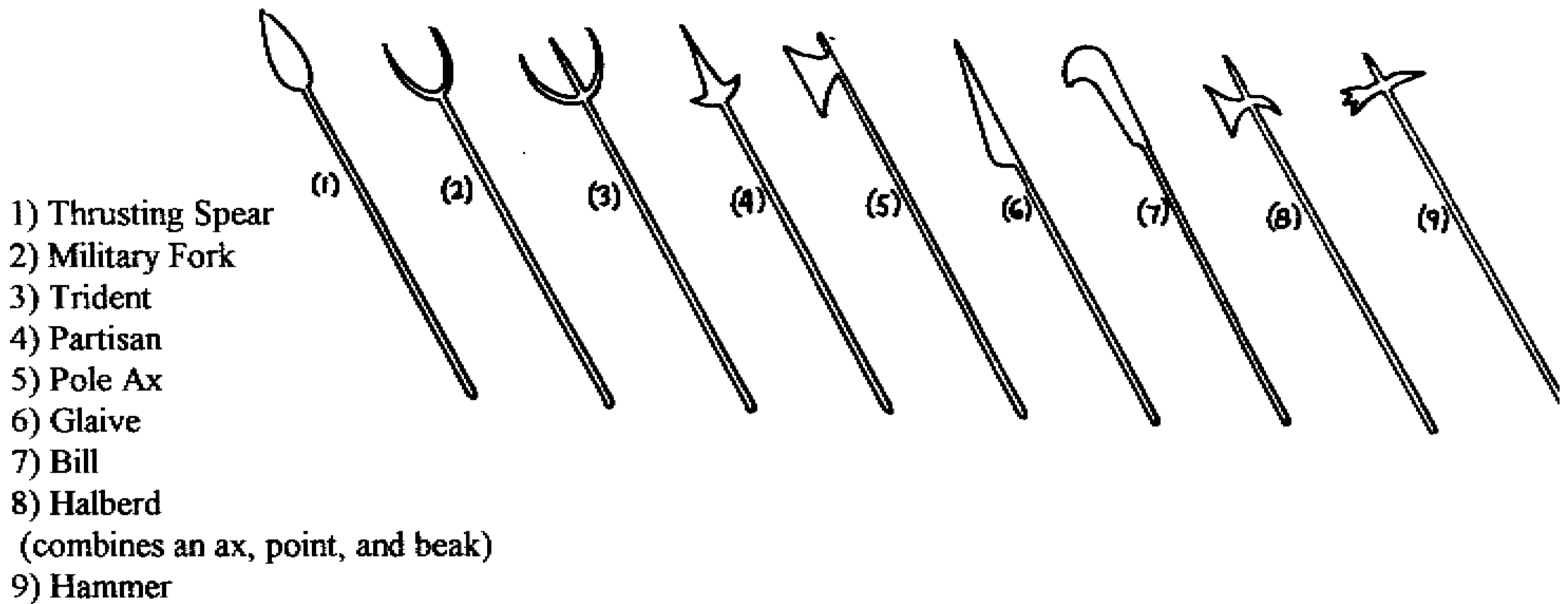

A bayonet is a blade attached to the muzzle of a gun. It converts an infantryman to a pikeman. In the 17th century, pikemen were used to protect the musketeers from cavalry while reloading. The bayonet allowed the musketeer to protect himself. Since World War 1, most armies adopted short bayonets with the blade being used as a general purpose knife when not in combat.

A) Bayonet used in defense versus cavalry



B) Double Rank where one forms a hedge while the other reloads

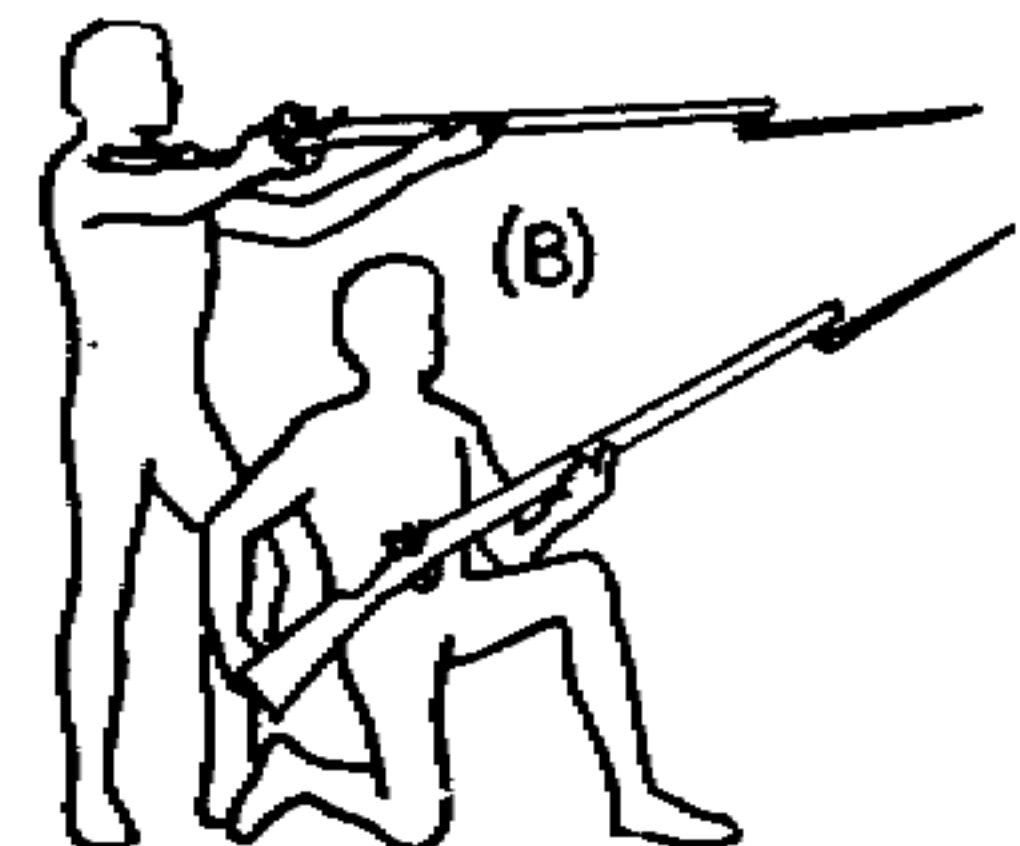



# Scientific Principles of Improvised Warfare and Home Defense

C) Shock attack which required considerable nerve and discipline. Usually, one side would flee prior to actual contact.  
 (A good example is seen in the movie Gettysburg in the defense of little round top)

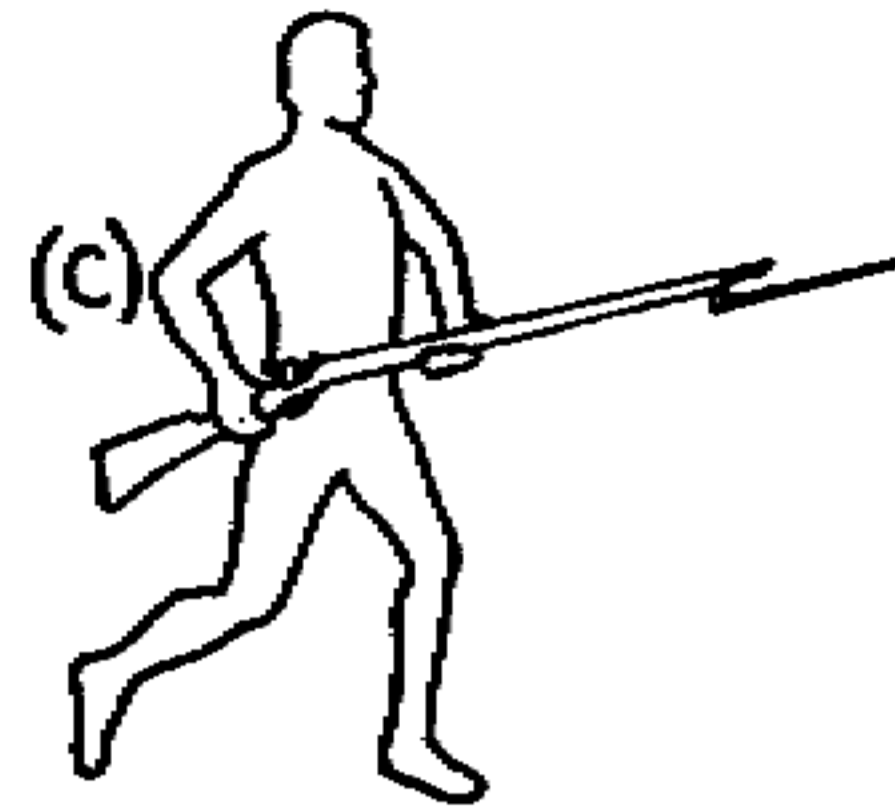

D) Teaching Aggression- used as bayonet practice to develop confidence and hostility towards the enemy. This has undesired carryovers in civilian life.

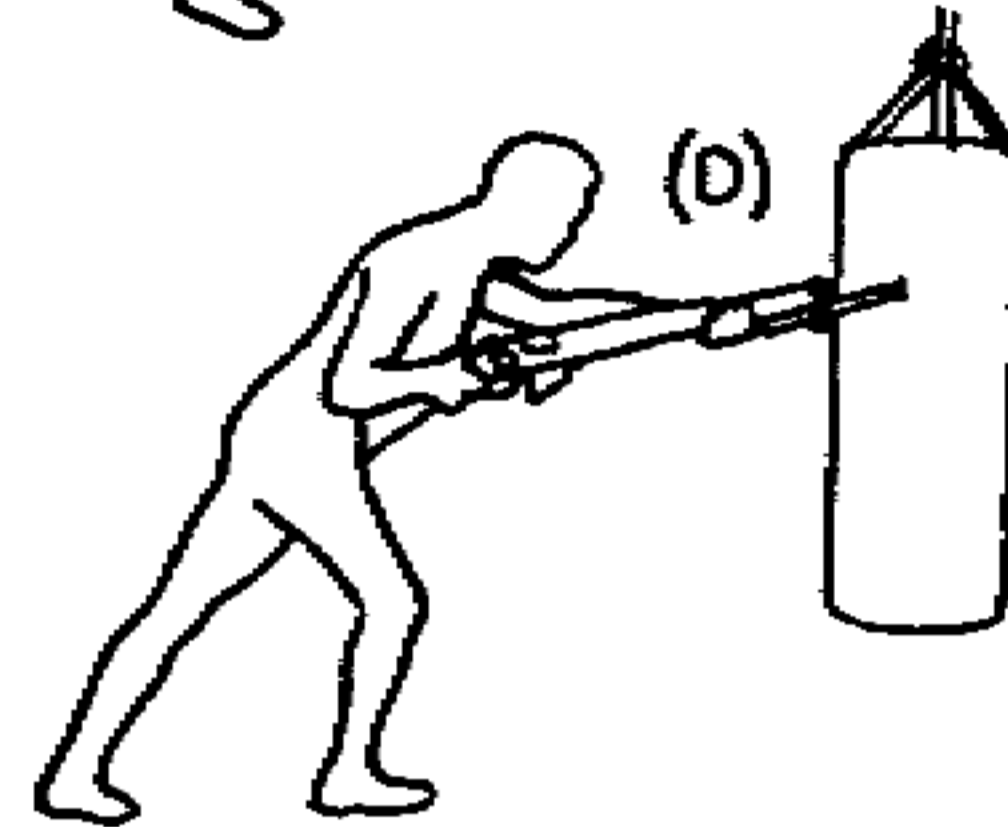

## Types and uses of Bayonets

1) Sword

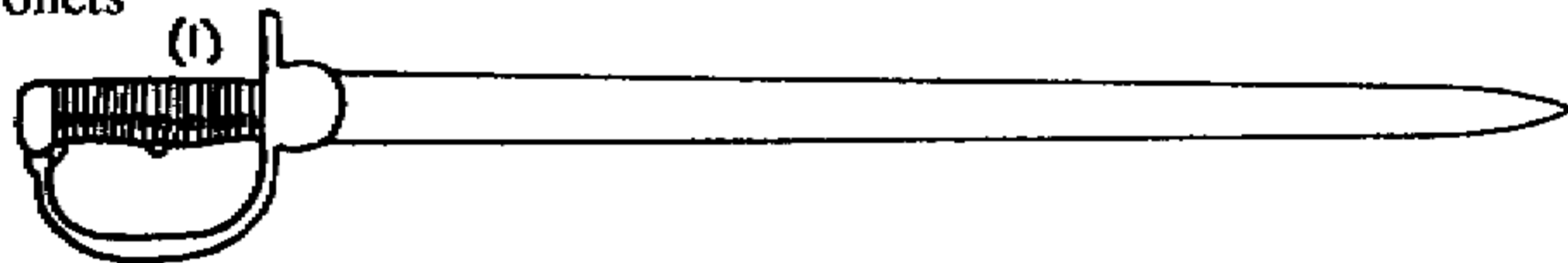

2) Dagger

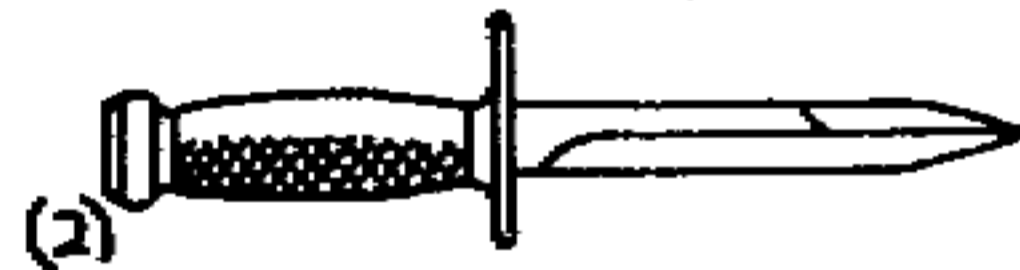

3) Saw (Issued to Engineer, Pioneer or Artillery units to clear obstacles and prepare gun positions)

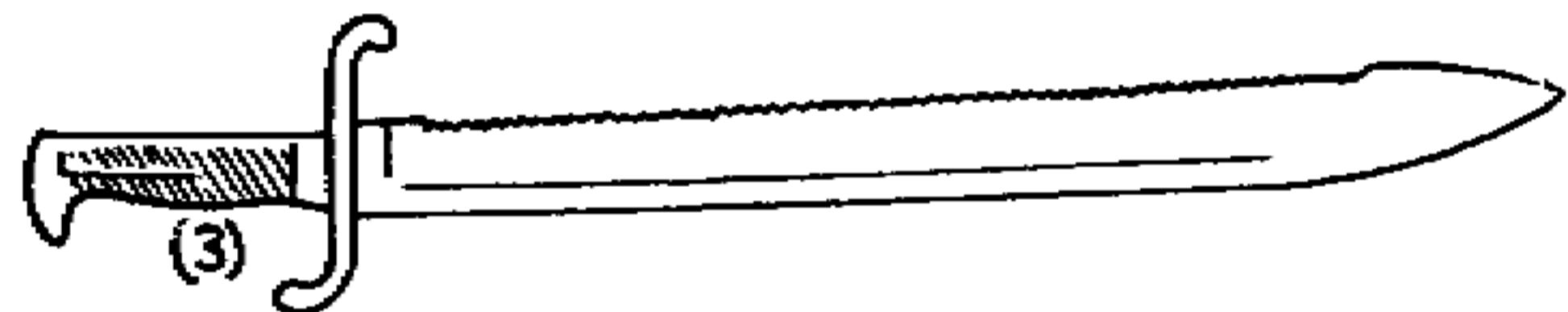

4) Trowel (for entrenching)



5) Mine Probe ( so the troops don't need to stoop)

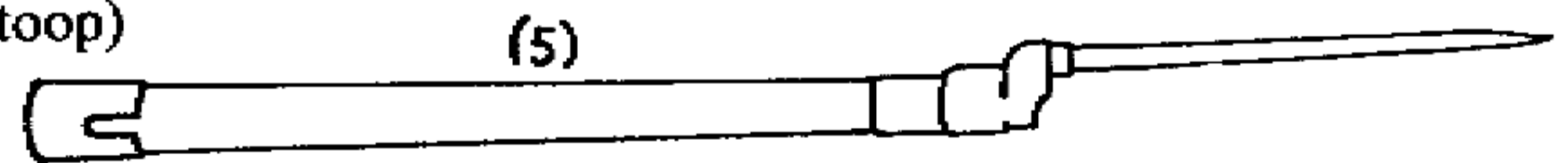

6) Machete (for Jungles)

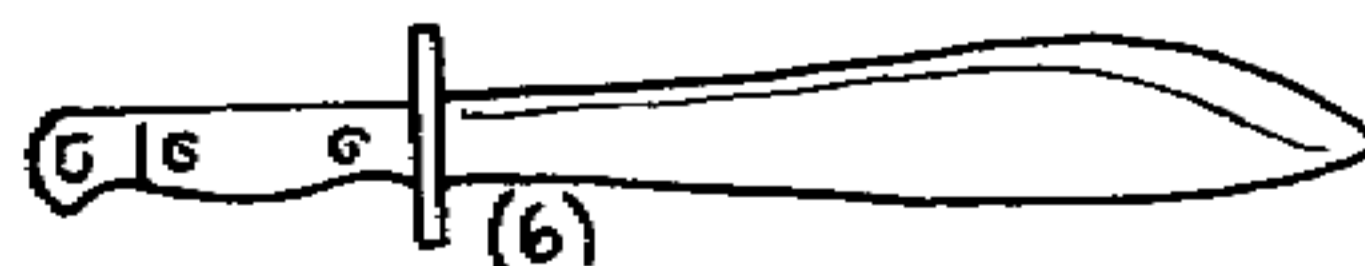

7) Wire Cutters (for sappers)

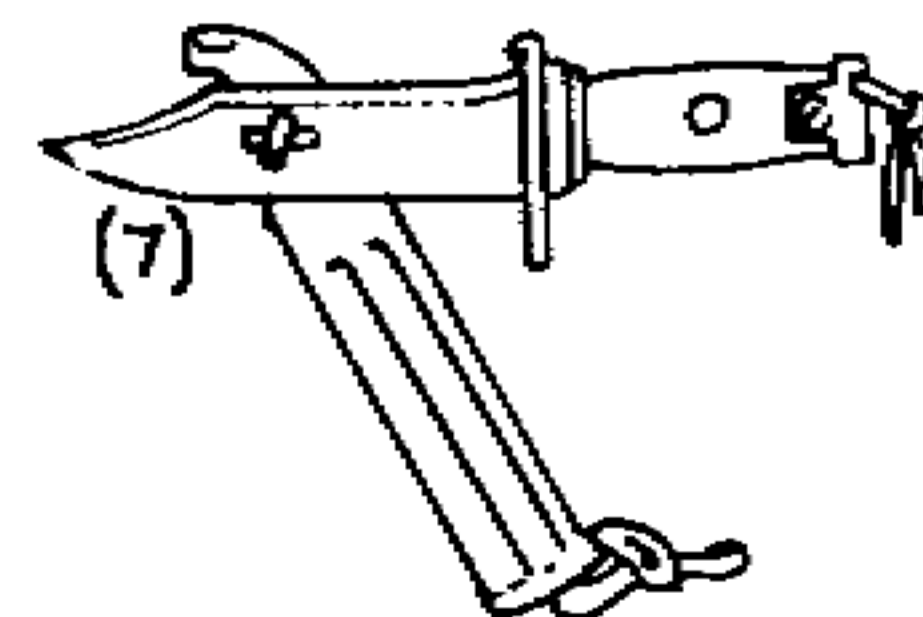

# Scientific Principles of Improvised Warfare and Home Defense

## 7) Fist Weapons, Whips, and Chains

The idea of reinforcing the fist to make a hand blow more effective goes back to ancient Roman times when gladiators fought for sport in the coliseum.

A) Gauntlet with spiked or weighted knuckles

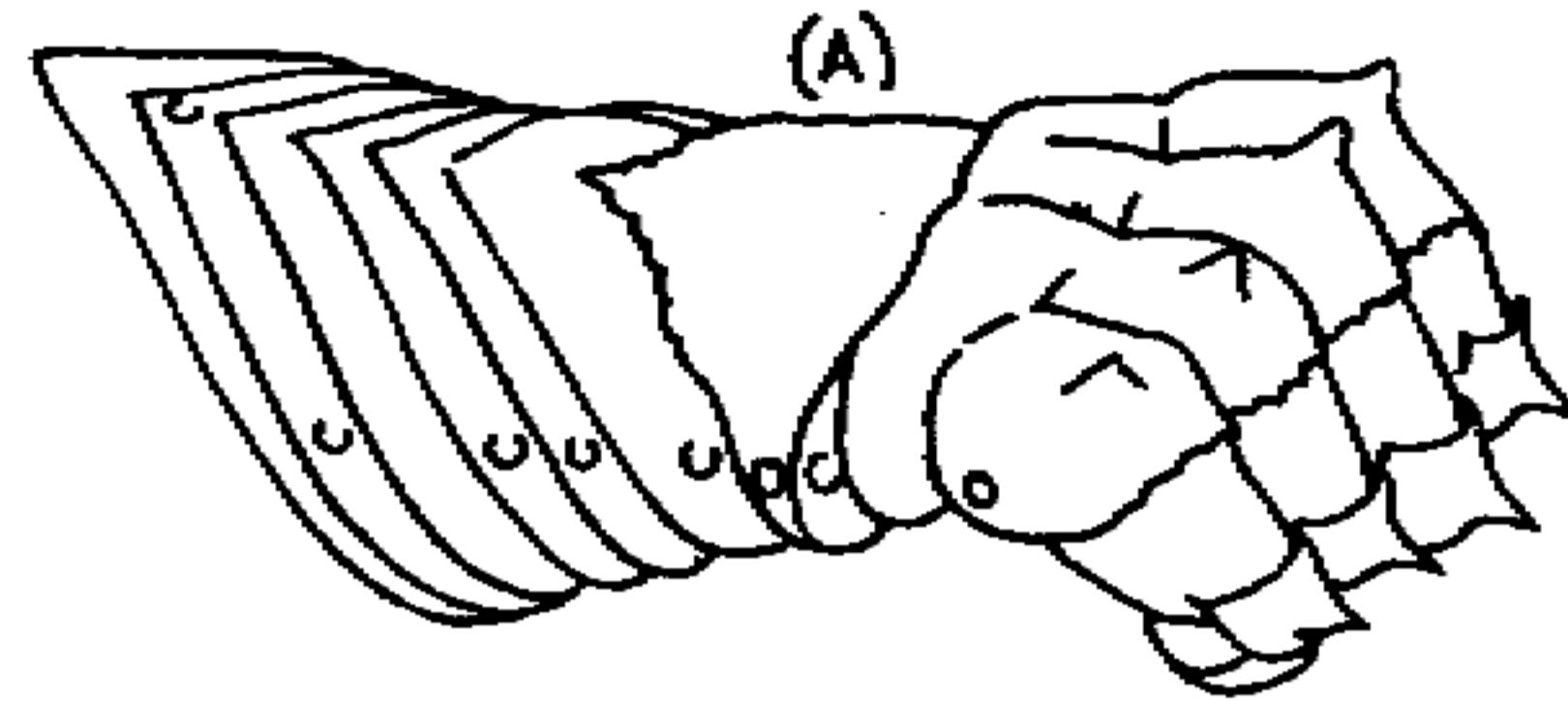

B) Knuckle Duster made of Lead used in the American Civil War



C) Knuckle Duster Dagger- used in trench raids during World War 1 to cut sentries throats after a rear approach.

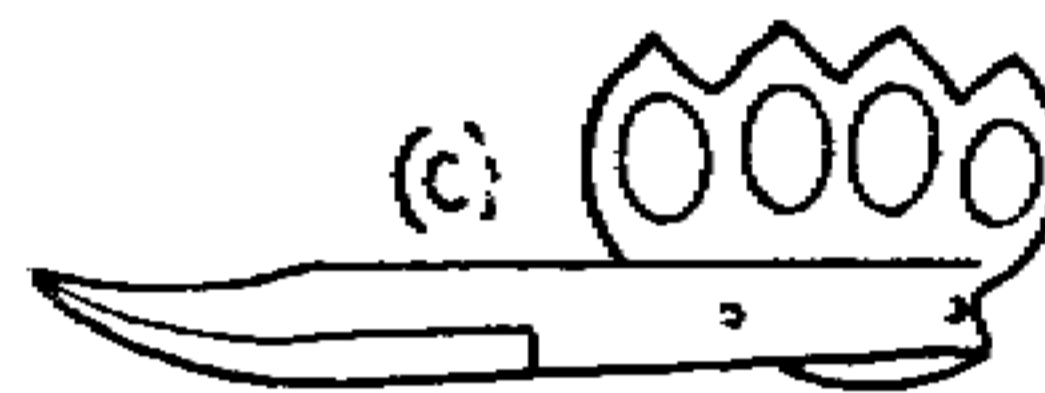

D) Brass Knuckles



E) Bladed Knuckles



F) Tigers Claws to imitate attacks by wild animals



Fist Weapons may be improvised from a metal sheet with the desired shape cut out with welding equipment or a cutting torch and the surfaces sharpened or padded as desired. Wooden or stone pieces may also be cut or carved into the desired shapes.

Whips are used to create slashing wounds and to parry bladed or pole weapons or entangle/trip an enemy. These usually consist of a handle and a braided textile or chained material.

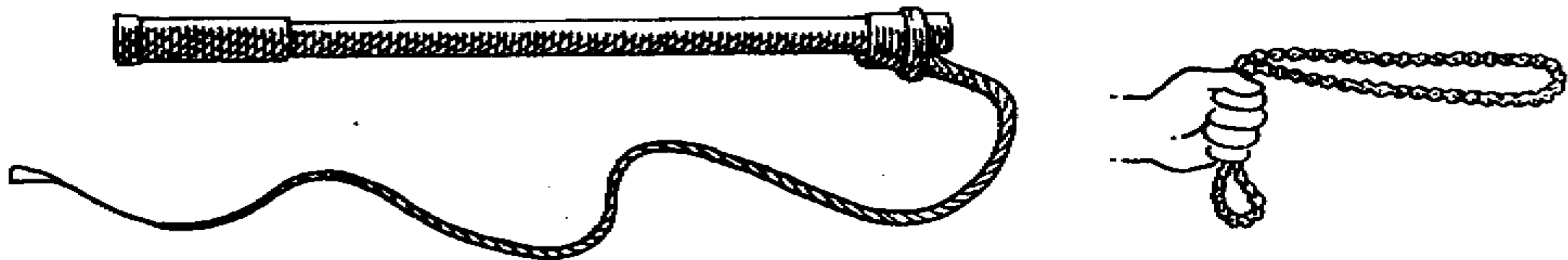

Store bought commercial chains can be effective striking or entanglement weapons. Bicycle chains have often been used in gang fights or as an impromptu weapon.

# Scientific Principles of Improvised Warfare and Home Defense

## 8) Slings and Thrown Weapons

Since ancient times, it has been an advantage to be able to attack a heavily armed force from a distance to avoid direct contact. Spear and rock throwers (slingers) could hit the targets at a distance and run while a heavily armed foot soldier could not chase and run down the lightly clad artillery troops .

- a) Sling- allows a stone to be swung at high speed and released
- b) Staff Sling- adds leverage of a club to release of a sling
- c) Launching Stick- used as a lever to fling a stone with a hole bored in it

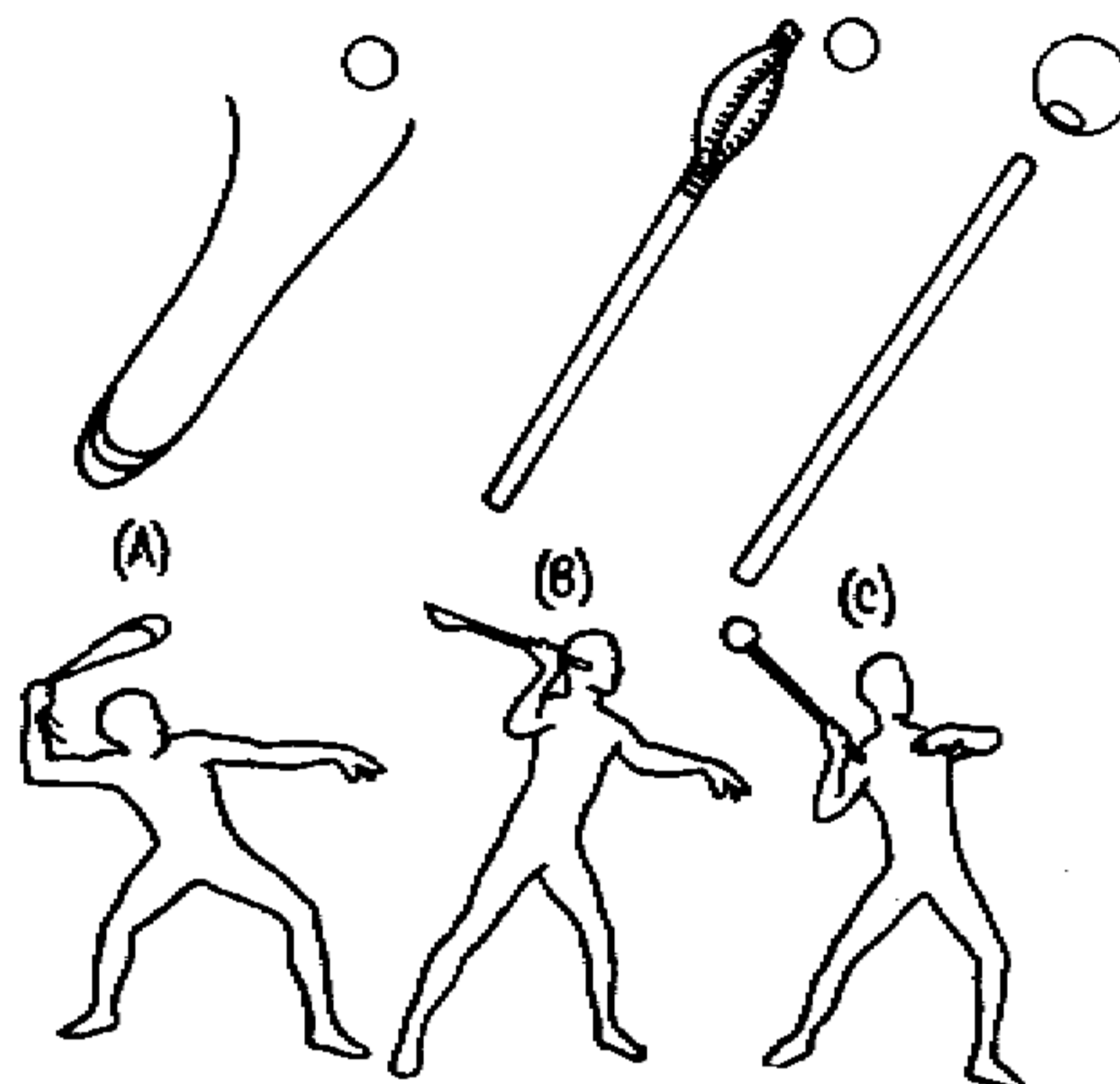

Spears can also be leveraged with similar devices.

An easy means of adding power to a thrown weapon is to be positioned above the target such as on a hill, in a tree, or on a wall. The advantage in height adds the effect of gravity to any thrown object such as a stone.

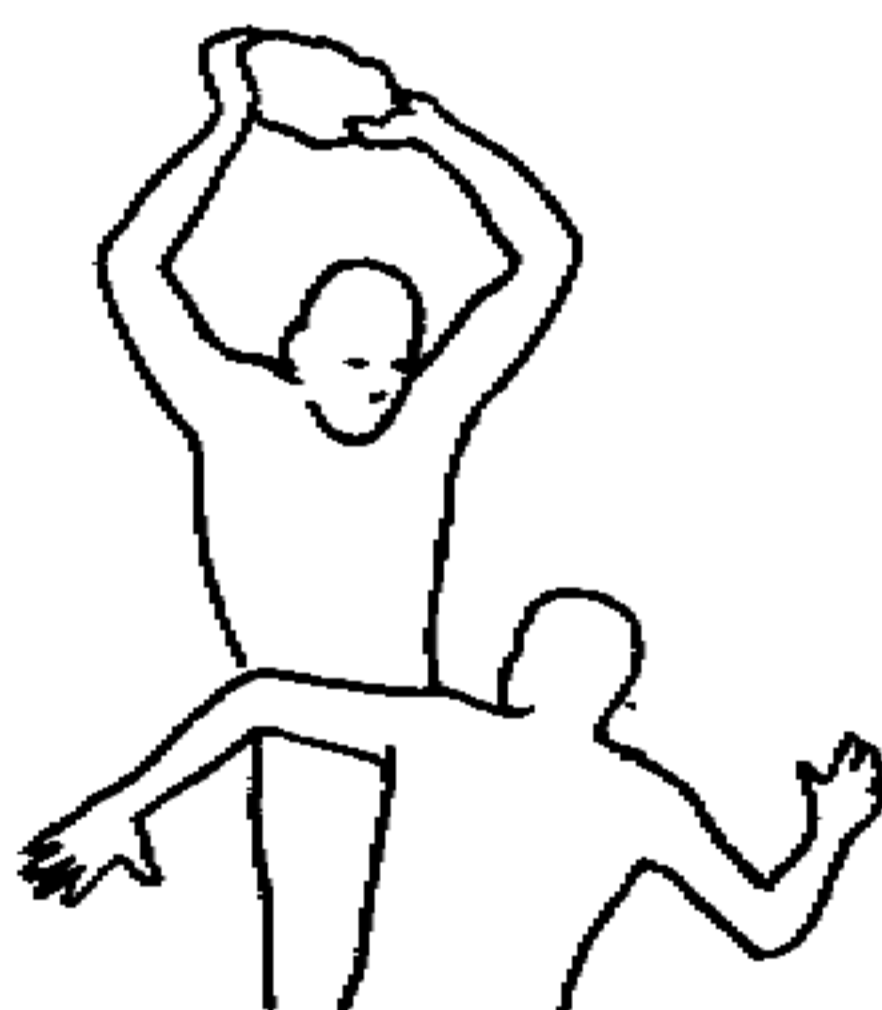

To use a sling, one end of the sling is looped over a finger and the other end is gripped by the thumb. A bullet is put into the pouch which is rapidly spun overhead and released, propelling the bullet by centrifugal force. Bullets or shot of a dense material such as lead (or marbles) was often used with good effect. Modern slingshots provide a simpler mechanical method of effectively launching shot and sound methods of its use can be quickly learned.

# Scientific Principles of Improvised Warfare and Home Defense

Clubs can be thrown with some effect because the addition of a handle to the projectile adds considerable momentum. Once thrown the club is lost and can be thrown back at you which makes it a poor return due to the cost and time spent in its manufacture when compared to lead shot or unworked rock.

The boomerang can be an effective thrown club that uses an aerodynamic shape to extend its flight. They wound by stunning or by cutting with a sharpened edge. Combat boomerangs do not return to the thrower even when the target is missed.

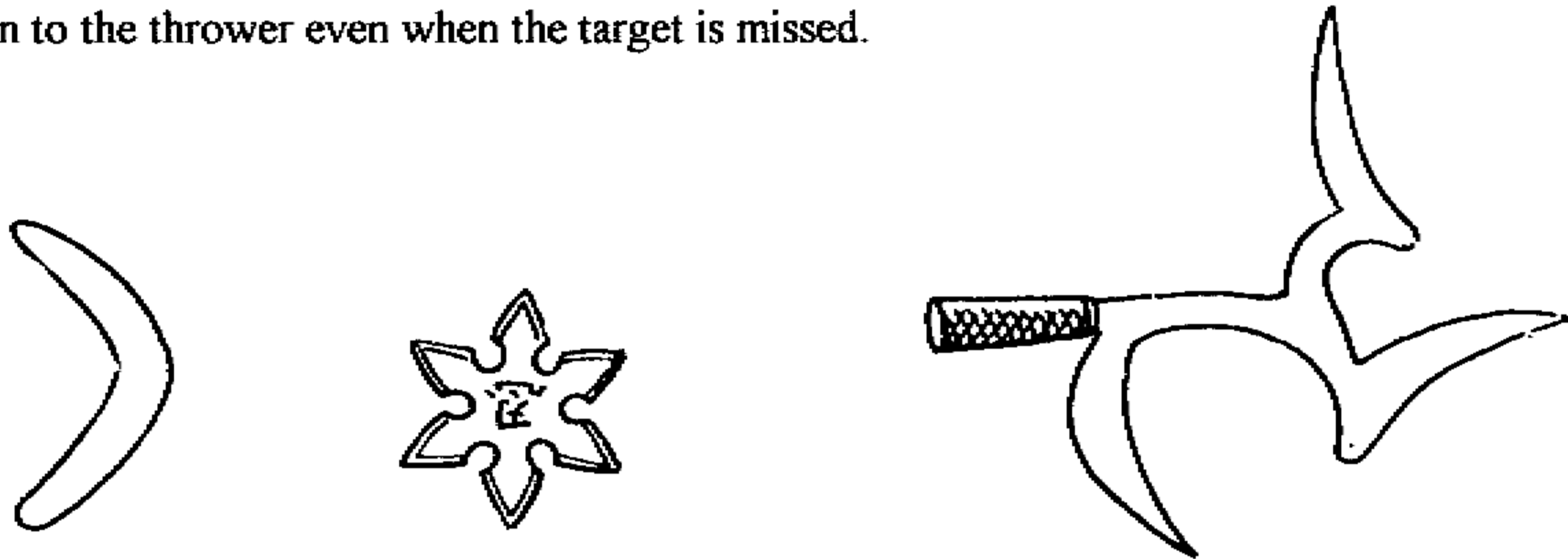

Throwing Knives requires some skill to master because it is required to cut or pierce at different distances from the target which can affect the attitude of the knife itself at the point of impact. Multi bladed throwing knives are more effective because they turn around a common center of gravity and can cut or pierce at almost any attitude of impact.

There are a variety of pointed pole arms which we call spears. Their long shaft enables the sharp tip to be delivered point first and its weight adds to the kinetic energy of the throw. The main problem is that once thrown, the spear is lost. This means he must carry another weapon to continue to fight. Spears are normally longer than the height of the thrower. Short spears are often called javelins or darts. A lever can be used with a spear to add momentum to a throw.



# Scientific Principles of Improvised Warfare and Home Defense

## 9) Bows and Arrows

A bow is a spring that stores and releases energy. By means of a bowstring, the slow pulling strength of an archer as he loads the bow is rapidly transmitted to an arrow or spear (or a stone in a slingshot) propelling it farther and faster than it could be thrown by hand. It has advantages in range and accuracy over all other hand held missiles (excluding firearms).

Common parts and accessories include

The bow and bowcase

A quiver to carry arrows

A pad to protect the forearm from the release of the spring

Bows can be used to propel pellets via a pouch in the bowstring or launch a variety of knives, clubs, and other weapons. Arrows are the usual projectile and many can be carried into battle. The idea is simple, but considerable care is required in manufacturing. Arrows must match the bow in length and weight, be straight, be flexible, and have the correct point for the intended target.

These shapes are common stone and metal designs for arrowheads

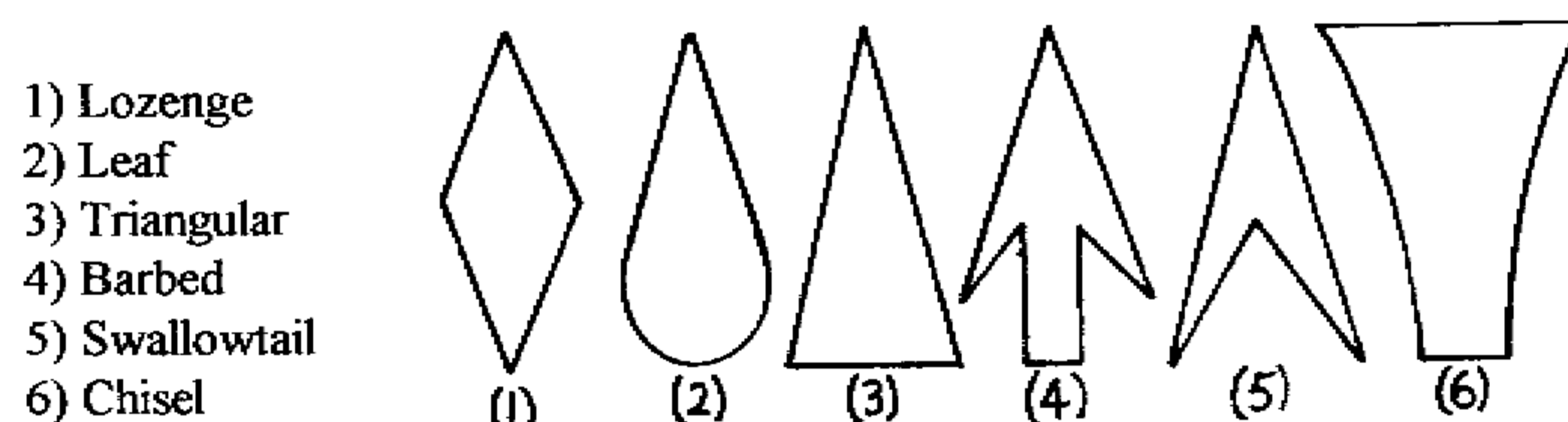

Arrows (and all other weapons contact surfaces) can be made much more deadly by dipping the arrowhead in poison or drilling reservoirs in the arrowhead which can be filled with chemicals or biologicals. This would be comparable to the use by the North Vietnamese of dipping Pungi sticks in Ox dung (manure) to create horribly infected wounds. These are modern examples of the small scale use of chemical and biological weapons which we cover in detail in later chapters.

Any hand held weapon can be used as a delivery vehicle for chemical or biological substances by imbedding its contact points with cloth soaked in the desired material. These can turn ordinary wounds which heal into lethal wounds. An example from South America includes dipping arrowheads in snake or frog poison for use in hunting or tribal wars. The poisonous venom becomes a chemical weapon and the arrow becomes a delivery system.

# Scientific Principles of Improvised Warfare and Home Defense

More effective bows are made by attaching the bow to a stock which allows the bending and release to be mechanically assisted. This increases the power and the accuracy and does not require as skilled or strong an operator to use. Using a crossbow involves

- 1) Spanning - Drawing the string back by hand until it is held by a nut.

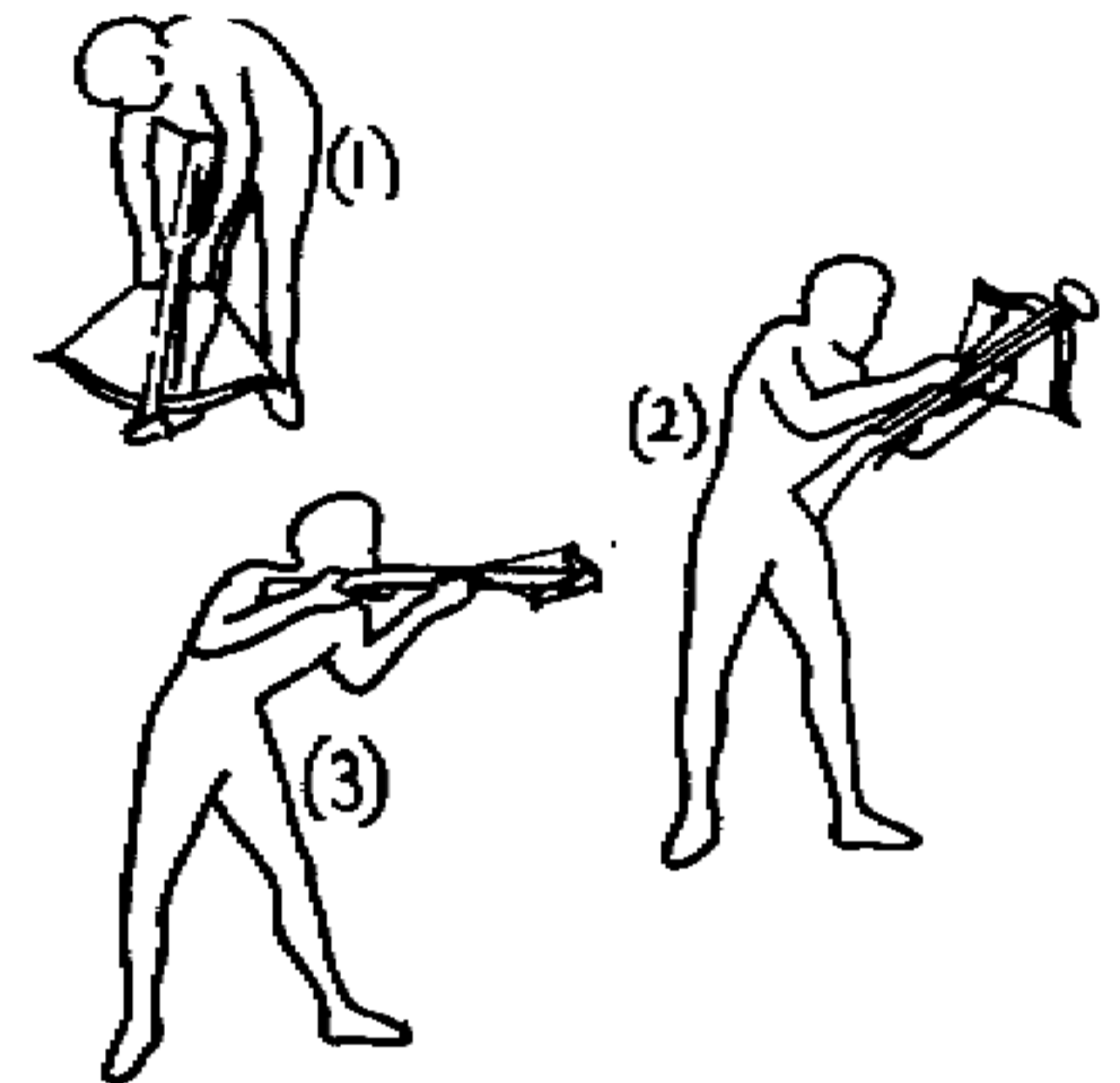

- 2) Fitting the Arrow (Bolt)- Laying the bolt in the groove

- 3) Aiming and Releasing - This allowed the bows to be aimed like a rifle with little disturbance

A handheld bow can be accurately fired about 300 yards at rate of about 6 aimed arrows per minute. A Crossbow can be fired 400 yards at a rate of 1-4 arrows per minute depending on equipment. Both types are capable of penetrating plate armor of the 1600's with a properly tempered arrowhead. Small explosives and incendiaries can also be delivered by arrow (see the movie Rambo 2).

# Scientific Principles of Improvised Warfare and Home Defense

## 10) Blowguns and Airguns

Blowguns are small diameter tubes in which small darts are propelled out of the end by the users breath. Used for hunting and recreation in many parts of the world by aborigines, they have found occasional use in war and assassination.

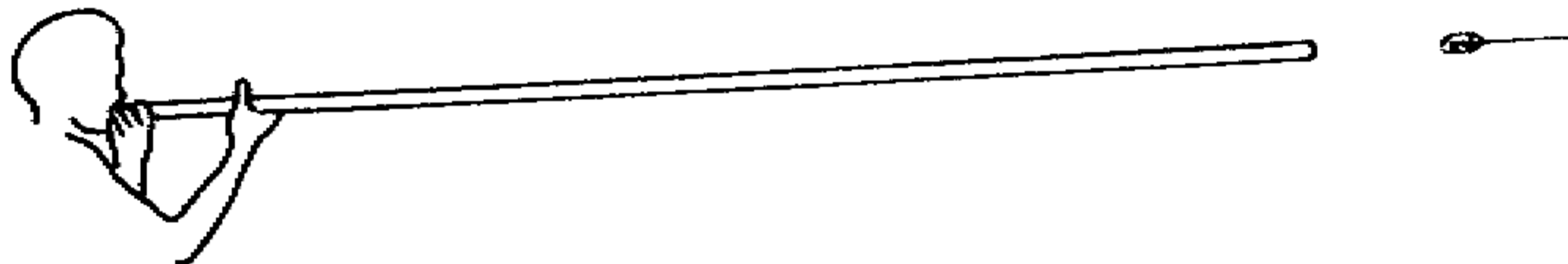

Airguns use a mechanical device to pump up a reservoir of air under pressure or compressed air from other sources. These can rapidly release the pressure into the tube and propel the dart or projectile. A small tank reservoir of compressed air can propel several shots before reloading or repressurizing is necessary.

The Lewis and Clark expedition carried a Jacob-Kuntz air rifle made in Philadelphia. The air is compressed in the hollow metal butt allowed the gun to be fired without the use of flint and powder.

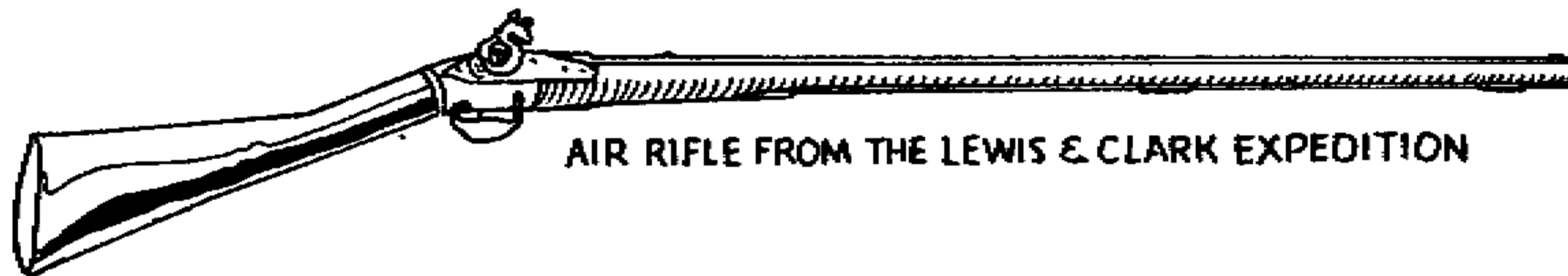

**Chapter 2 Properties and Improvisation of Firearms**

***A scientist's right to bear arms:***

*I will give up my right to know how to construct a long metal tube, closed on one end and capable of propelling projectiles at high speed, when they pry the know how from my cold dead brain.*

Firearms of all kinds, large or small, hand held, mounted, machine reloaded and fired, even those mounted on trucks or Battleships all operate on the same basic principles.

All operate by the principle of an explosion being created in one end of a tube which is closed on the same end. Expanding gases from the explosion force a projectile out of the open end of the tube at high speed.

Early firearms were for many years inferior to bows in range, accuracy, rate of fire, and expense. They succeeded because firearms did not require the weeks of special training, or strong men that armies required for their archer corps. For the first time, the power of the shot was not supplied, even indirectly by the firer's muscle. Gunpowder and other propellants would become the magic of the battlefield.

Firearms are classified by the way they are loaded and also by the way they function.

Early Firearms were **Muzzle Loaded** in which the powder and ball are forced down the barrel with a rod. All firearms loaded from the front of the barrel are muzzle loaded.

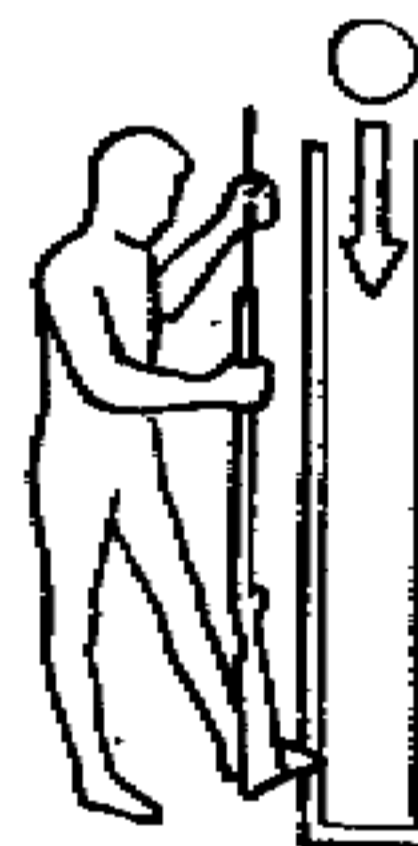

When firearms are loaded from the rear of the barrel they are classified as **Breech Loaded**.

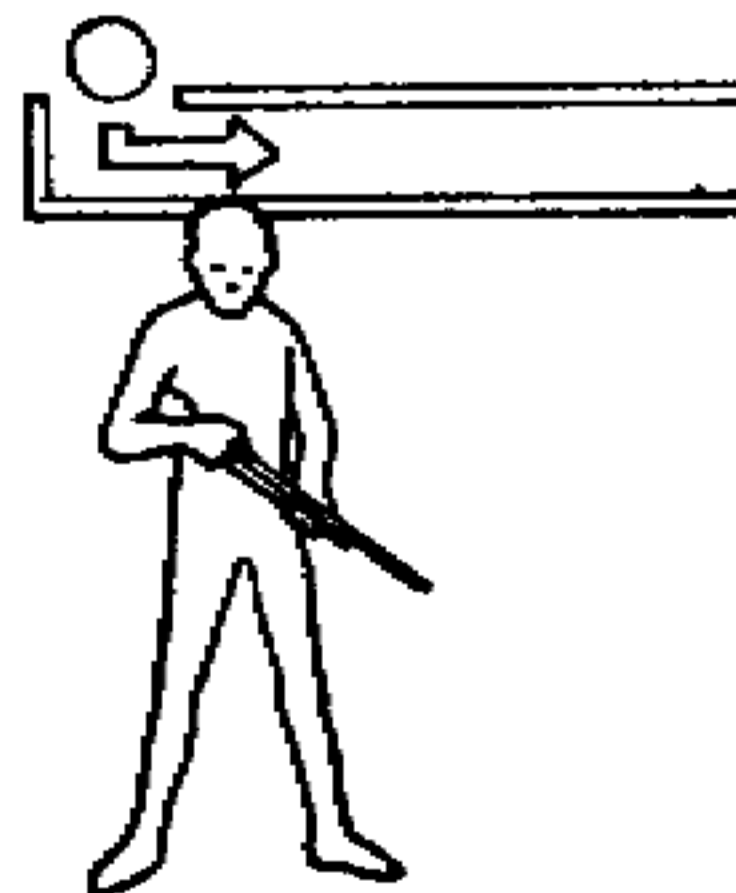



## Scientific Principles of Improvised Warfare and Home Defense

Firearms are classified by the frequency by which they are fired, these functions are described as

**Single shot:** where the firearm must be reloaded after every shot.

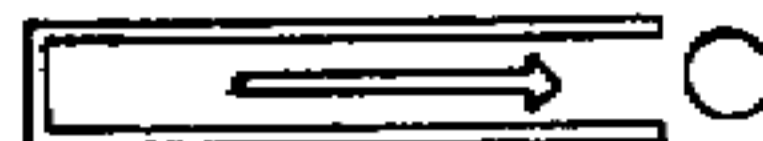

**Multi Barreled:** such as a double barreled shot gun which can fire from each barrel before reloading.

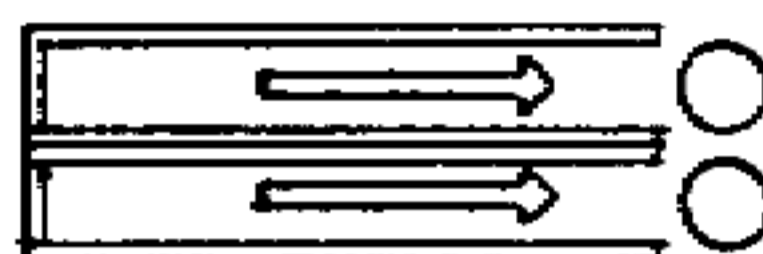

**Repeaters:** which contain a magazine to store ammunition and feed it into the breech by use of a lever. On revolvers the lever is the hammer which is pulled back to rotate the magazine (cartridge) into the breech.



**Semi Automatic:** are designed like repeaters and use the energy of the exploding charge to reload the breech. With each pull of the trigger the next round is fed into the breech and is ready to be fired again. This is also called auto loading.



**Fully Automatic:** fire in continuous spurts as the trigger is pulled.



## Scientific Principles of Improvised Warfare and Home Defense

The basic parts of a rifle are

- a) **Butt** which braces the firearm against the firers shoulder
- b) **Trigger** which fires the gun by a lever action
- c) **Lock** which sets off the charge in the breech
- d) **Barrel**
- e) **Muzzle**
- f) **Stock** protects the hands from the hot barrel

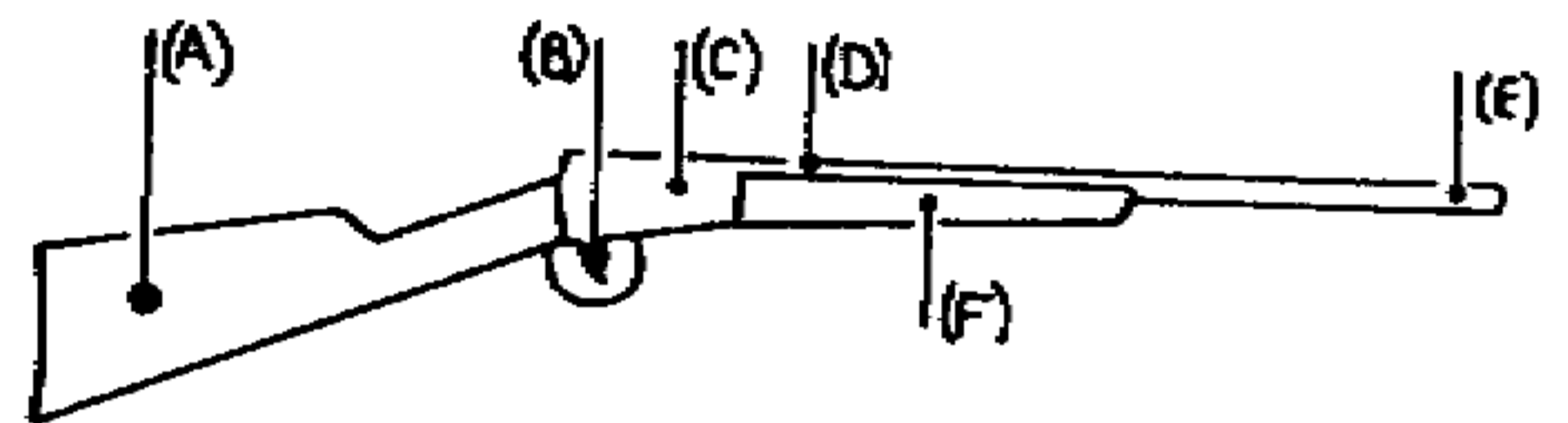

The **bore** is the inside of the barrel and the **chamber** is where the explosion occurs in the breech end.

There are two kinds of bore in firearms

A) **Smoothbore** barrels which have a smooth inner surface fire buckshot or roundball ammunition which are unstable in flight. There is often a gap between the shot and the barrel edge which causes unstable flight and results in less power and accuracy of the projectile.

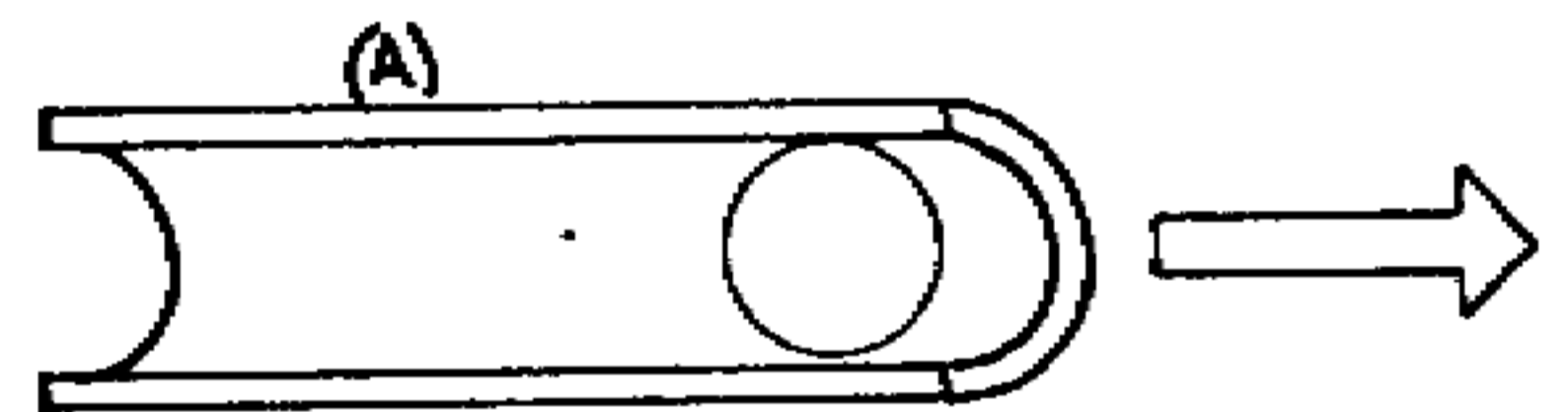

B) **Rifled** Barrels have raised spiral grooves cut into the bore called "lands". These bite into the bullet and spin it as it travels down the barrel. This stabilizes the bullet during flight. A bullets tight fit combined with the gyroscopic spin caused by the rifling make these firearms very accurate at distance.



## Scientific Principles of Improvised Warfare and Home Defense

When a bullet is fired, the small explosion in the chamber forces the bullet out the barrel. The energy from the back pressure and the bullet's forward motion creates a recoil which usually causes the muzzle to jump. Except for this effect, the muzzle must be raised when fired at a distant target because the bullet drops over distance due to gravity. The bullet's flight path where **aimed (a)** is different than its actual **trajectory (b)** which is a curved path. Once the bullet reaches its **culminating point (c)** the bullet falls steeply due to air resistance combined with gravity and loss of forward momentum. When firing at a distant target you adjust your rifle sights to combine the actual trajectory with your **line of sight (d)** so the bullet hits the target. The greater muzzle velocity or bullet speed, the flatter the trajectory and the easier it becomes to allow for range. No rifle will put all its bullets in exactly the same hole (at range) so a series of shots fired at the target forms a **group (e)** which is used to evaluate the accuracy of a rifle, its ammunition, and the rifleman.

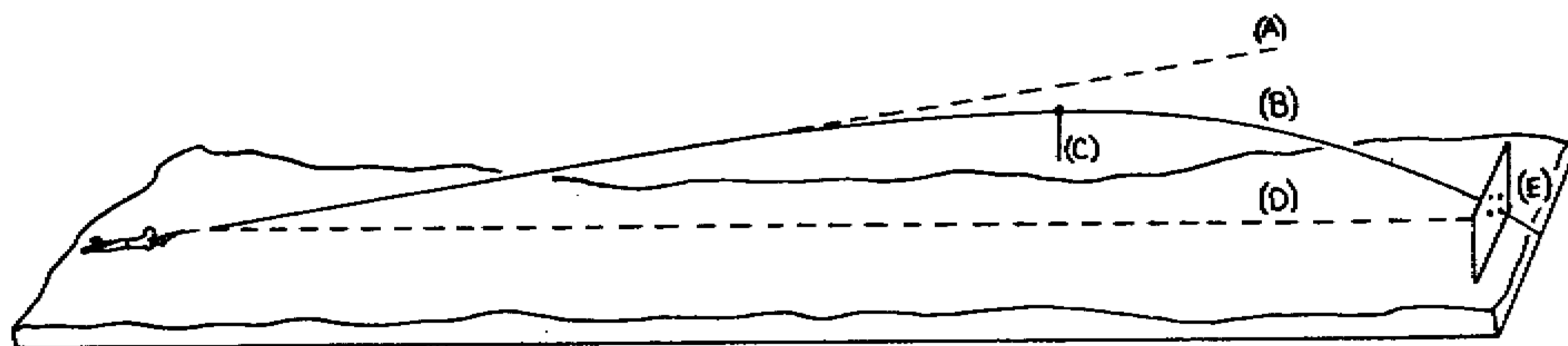

Firearms Ammunition has three main parts all contained within a cartridge or shell

A) **Primer**: which is usually a percussion cap designed to detonate and ignite the propellant. There are three main types of cartridge primers

- 1) **Pinfire**: where a pin is struck by the hammer on the gun and detonates the cap inside the cartridge case
- 2) **Rimfire**: where detonating compound inside the rim is crushed by the firing pin
- 3) **Centerfire**: where the gun's firing pin strikes a cap located in the base of the cartridge

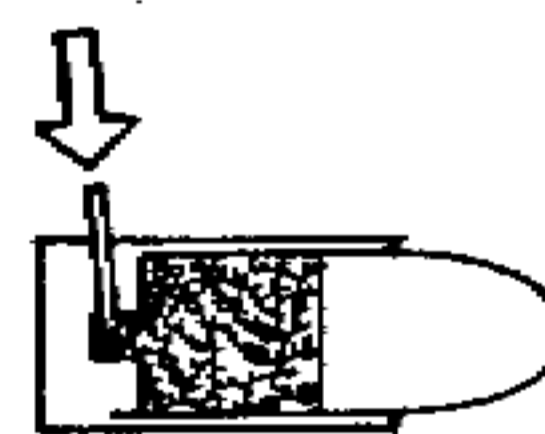

## Scientific Principles of Improvised Warfare and Home Defense

**B) Propellant:** which is the main explosive charge of the cartridge. The earliest gunpowder was the traditional "**black powder**" made from various proportions of **charcoal, sulfur, and saltpeter**. By 1880 the first smokeless propellant based on **nitrolycerin and nitrocellulose** were invented by Nobel in Sweden. These propellants could be shaped as powder, flakes, spheres, and thread. By varying the shape the speed of the burn could be adjusted. These powders were safer to store and handle and produced less smoke on firing and rarely fouled.

**C) Projectiles** can be almost any design or material that can be imagined.

1) A simple lead ball which has an unstable flight.

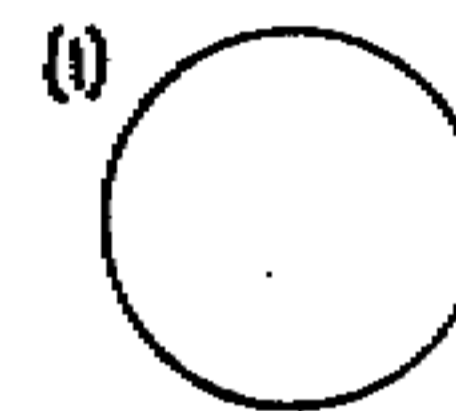

2) An elongated shape that flies point first. This permits a rifled barrel to spin and gyroscopically stabilize the bullet.



3) Longer and heavier bullets evolved with a jacket of harder metal to grip the rifling at high velocity permitting accurate long range firing.

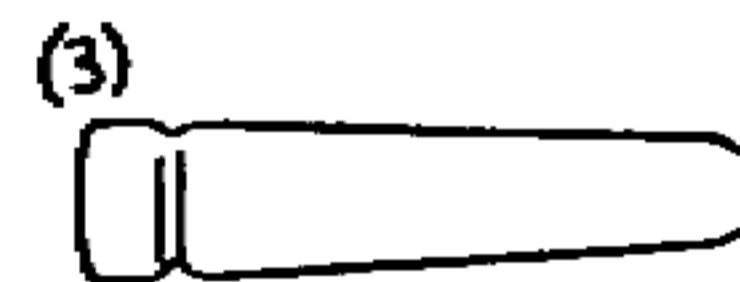

4) Spitzer shape with a streamlined boat-tail case.



5) Modern ideas include firing smaller caliber bullets at higher velocity to cause the same damage.



A modern cartridge has a brass case which holds the primer, propellant, and bullet. It fits snugly in the breach and seals it on firing so that gases do not seep around the firing mechanism. It is waterproof and safe to store and load.



## Scientific Principles of Improvised Warfare and Home Defense

The size of ammunition is usually given as an internal measurement of the bore size. this can be in caliber or more commonly in millimeters. A cartridge (at right) represents a German 7.62 mm x57. This means that the diameter of the bore that the cartridge fits is 7.62 mm in diameter and the case is 57 mm long. Case lengths can vary due to different muzzle velocities desired.

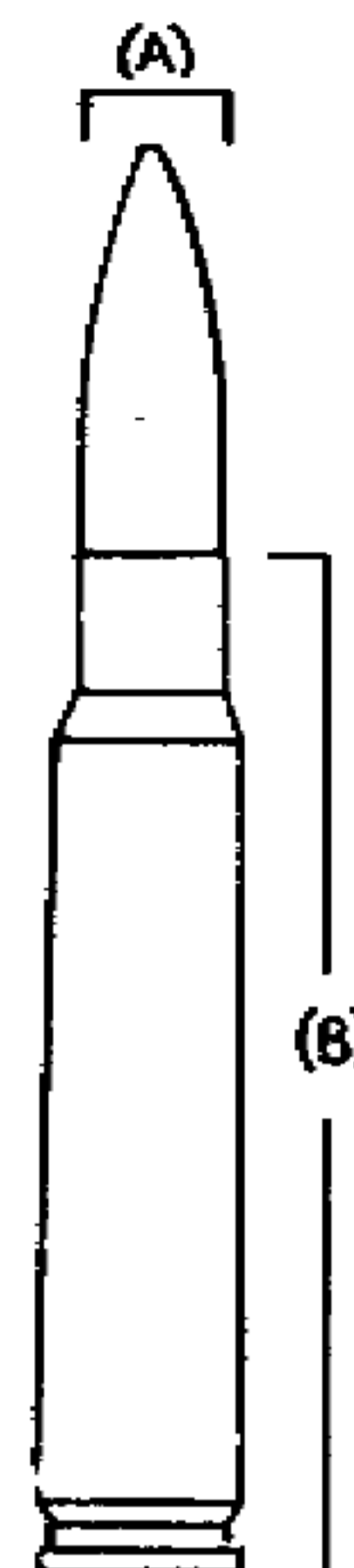

The following information describes the performance of the firing of a .30in U.S. Model 1906 rifle (from the handbook for US Rifle, Model of 1917)

	<u>Speed of bullet</u>	<u>Time of Flight</u>	<u>Penetration Through</u>		
			<u>Sand</u>	<u>Oak</u>	<u>Mild Steel</u>
At the Muzzle	2700fps	Nil	6.3in	34in	.528in
At 500 Yards	1668fps	.709sec	13in	14in	.01in
At 1000 Yards	1068fps	1.864sec	10.8in	?	Nil

When the same cartridge is fired, the following effects take place

- 1) The firing pin dents the cap
- 2) The cap in the cartridge case crushes a detonating compound against a brass anvil
- 3) The flash of the small primer ignites the main charge
- 4) The main charge explodes, burning rapidly. The temperature reaches 2700 degrees C and after .0005 seconds from ignition the propellant expands to 14,000 times its own volume in gas. The chamber pressure reaches 51,000 ft lbs. per sq.in.
- 5) The expanding gases force the sides of the cartridge case to seal so tightly against the walls of the chamber that no gas leaks to the rear
- 6) The pressure forces the bullet up the bore and out of the muzzle at very high velocities

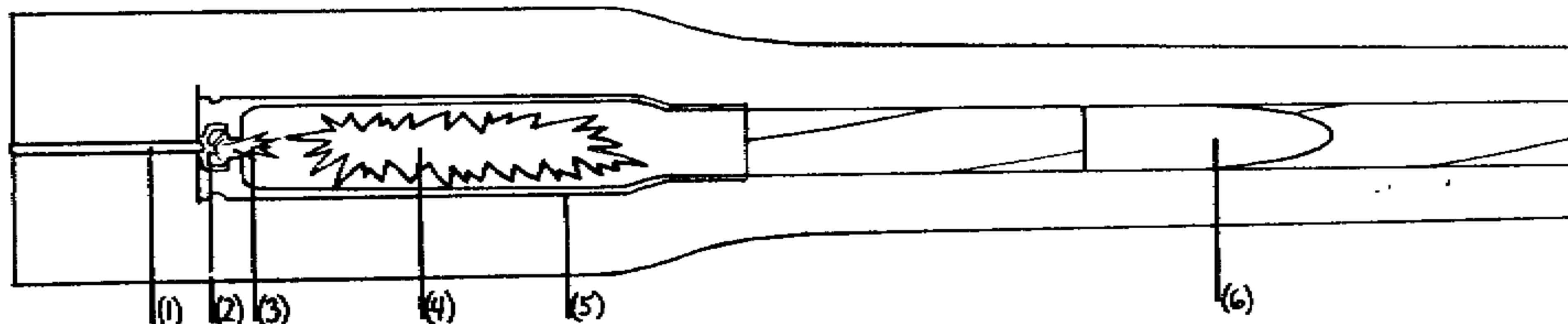

## **Scientific Principles of Improvised Warfare and Home Defense**

Commercial firearms are readily available in most free countries and it is considered by many in the United States to be a right to purchase and possess any firearms of choice. In countries undergoing civil or other types of wars access to a firearm for self defense becomes a life and death issue and are not readily available. This even happens on a national scale where the Bosnian Muslims were left to die in the face of superior Serb forces and armaments, and their people were left to face extermination all by themselves while the rest of a hypocritical world denied them the very means of even buying weapons to prevent their own genocide by declaring an arms embargo. Under these conditions, when the life and death of every single person is at stake and even surrender means certain death, everyone has a right to live and to fight for their own lives.

Even organized crime has long been aware of how to improvise the manufacture of their own armaments. It is in the spirit of the self defense of otherwise helpless populations that this chapter (and book) are written. With the following information, first released by the United States Army from its Improvised Munitions Handbook we will now teach you how to apply the basic principles of firearms already described.

The following can be assembled from any hardware or plumbing store shelf, or from cannibalizing parts from any home or business. Typical costs of newly purchased parts is \$40-100 plus tools. Improvised primer, and propellant will be described in the next chapter.

- 1) Reusable Primer and Rifle Cartridge
- 2) Pipe Pistol- 22 caliber  
38 caliber  
45 caliber  
9 mm
- 3) Low Signature System - Silencer
- 4) Pipe Shotgun - 12 gauge
- 5) Pipe Carbine - 7.62 mm
- 6) Match Head Gun for Improvised Projectiles

It is important to obtain the best quality materials as may be available locally. For example, pipe should be as thick and rated for as high of pressure as possible to reduce the likelihood of the barrel splitting or exploding during operation. Non steel barrels should be avoided because they will generally melt. Some ceramics may withstand the temperatures and may be a useful disposable substitute. They tend to be brittle and crack under shock. Certain Aramid (Kevlar Plastic) fibers may hold up for single use as well when metals are not the composition of choice.

## **Scientific Principles of Improvised Warfare and Home Defense**

As will be obvious, single shot guns are not very useful in defending a nation from military attack (which I cover in Chapter 12) but can be very effective in waging guerrilla warfare and allow at least some chance of resistance when they come to your door like the Nazi's did to the Jews in WW2. If everyone met the Nazi's at the door with this kind of resistance, their army would have attrited down significantly (or more likely they would have changed their procedures in the approach and attempted apprehension of private citizens).

It will also be obvious to anyone with machine shop experience that it is quite easy to produce all the essential firearm parts for an army as long as the steel is available (Bosnia should have established its own armaments industry and imported the machine tools and raw materials). With machine shop skills and access, breech loading and automatic parts and magazines are quite easily manufactured from scratch.

# Scientific Principles of Improvised Warfare and Home Defense

## 1) Reusable Improvised Primer and Rifle Cartridge

### Materials Required

- Used Cartridge (Make sure it fits the gun you are using)
- 2 Long Nails with the same diameter as the inside of the primer pocket
- Safety or Striking matches App. 2 or 3 for primer/ 50 or 60 for cartridge
- Vise
- Hammer
- Knife
- Saw
- Threaded Bolt that fits the neck of the cartridge
- File
- Rag Wad
- Bolt (small enough to fit in cartridge case)

### Procedure

- 1) File one nail to a needle point so that it is small enough to fit through hole in primer pocket.

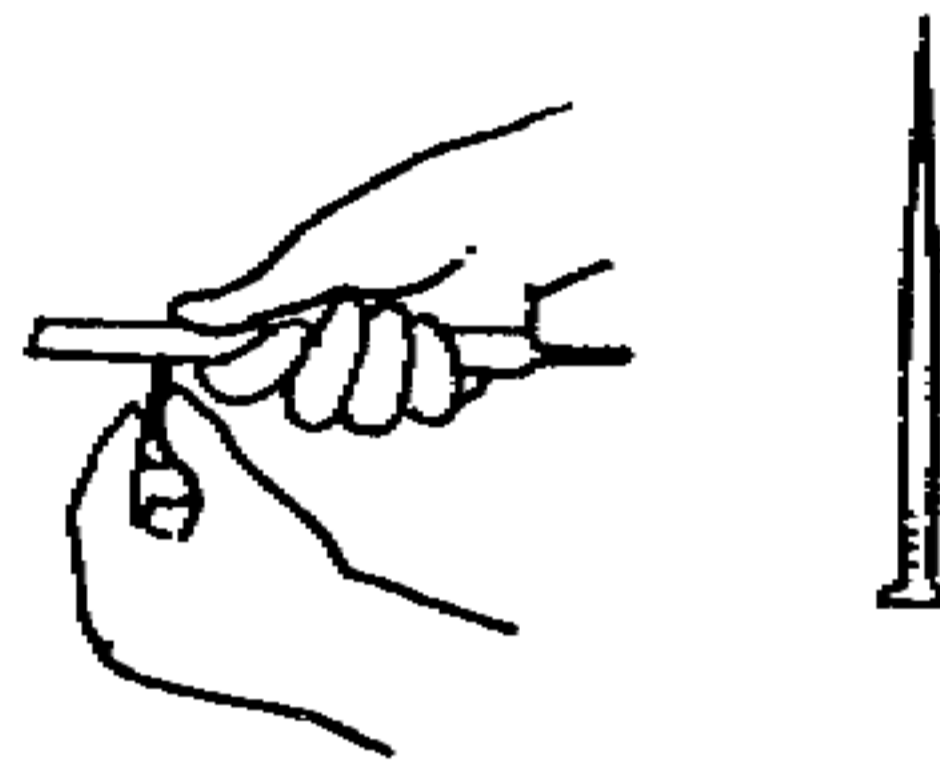

- 2) Place cartridge case and nail between jaws of vise. Force out fired primer with nail as shown.

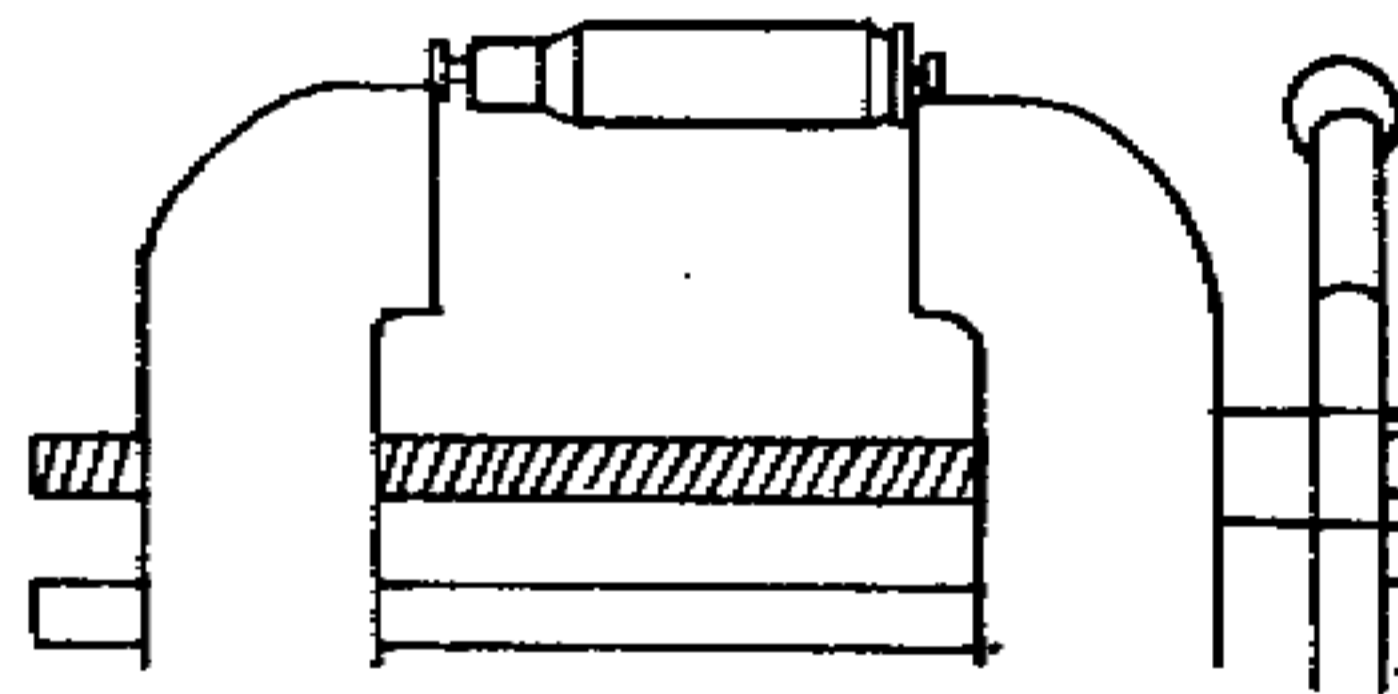

- 3) Remove anvil from primer cup



- 4) File down point of second nail until it is flat.



# Scientific Principles of Improvised Warfare and Home Defense

5) Remove indentations from face of primer cup with hammer and flattened nail.

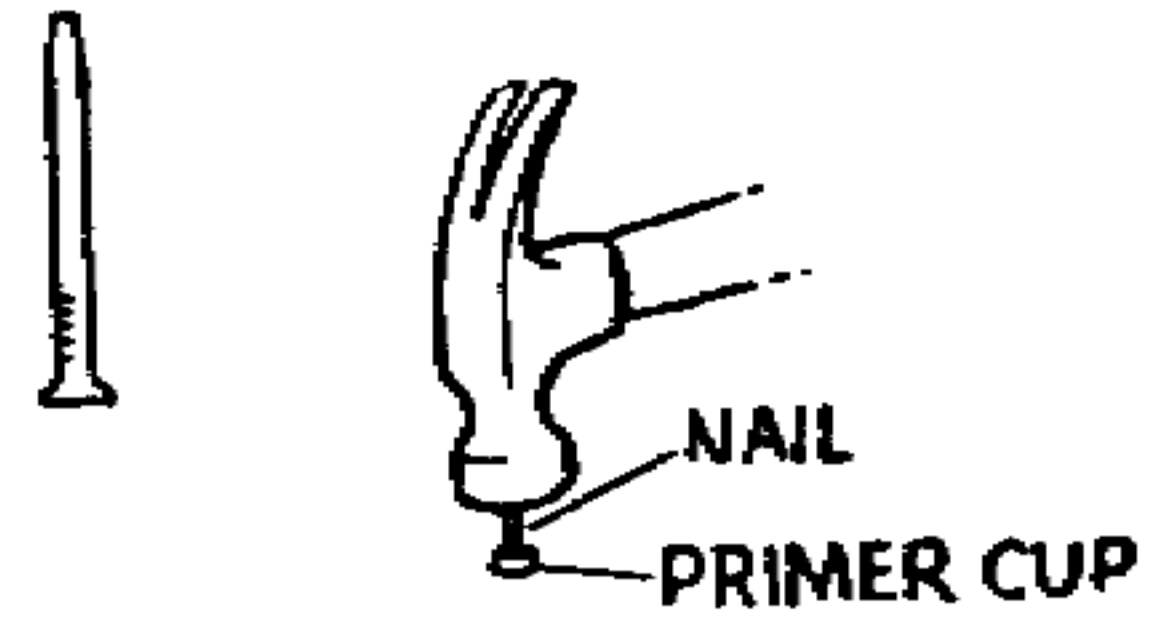

6) Cut the tips off the heads of the matches using knife. Carefully crush the match tips on dry surface with the wooden match stick until the mixture is the consistency of sugar.

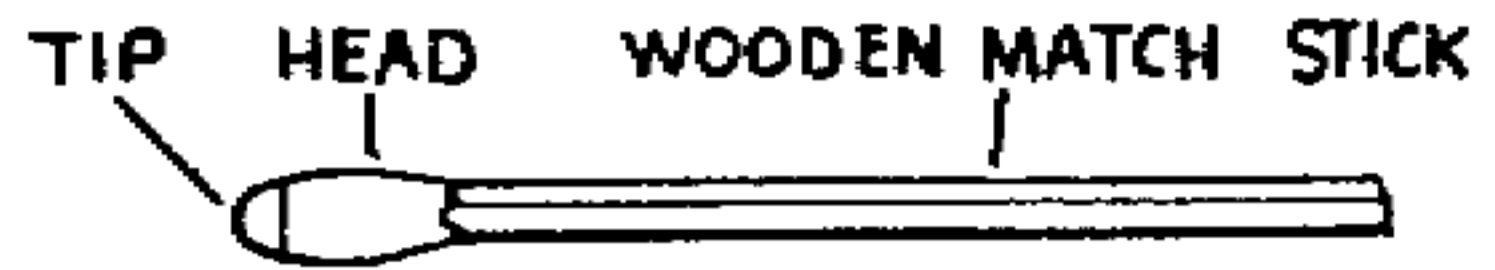

**Danger: Do not crush more than 3 match tips at one time or the mixture may explode**

7) Pour mixture into primer cup. Compress mixture with wooden match stick until primer cup is fully packed.

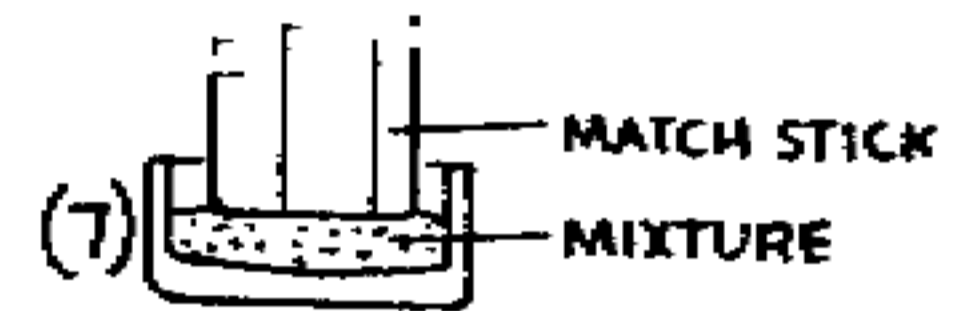

8) Place anvil in primer pocket with legs down.



9) Place cup in pocket with mixture facing downward.

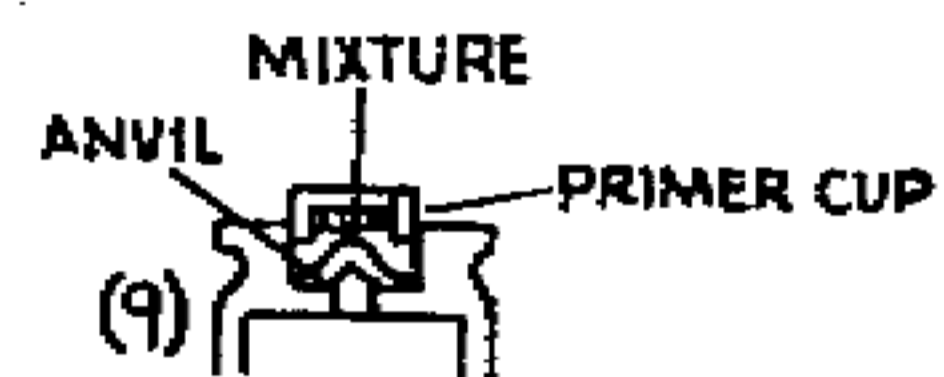

10) Place cartridge case and primer cup between vise jaws, and press slowly until primer is seated into bottom of pocket. The primer is now ready to use.

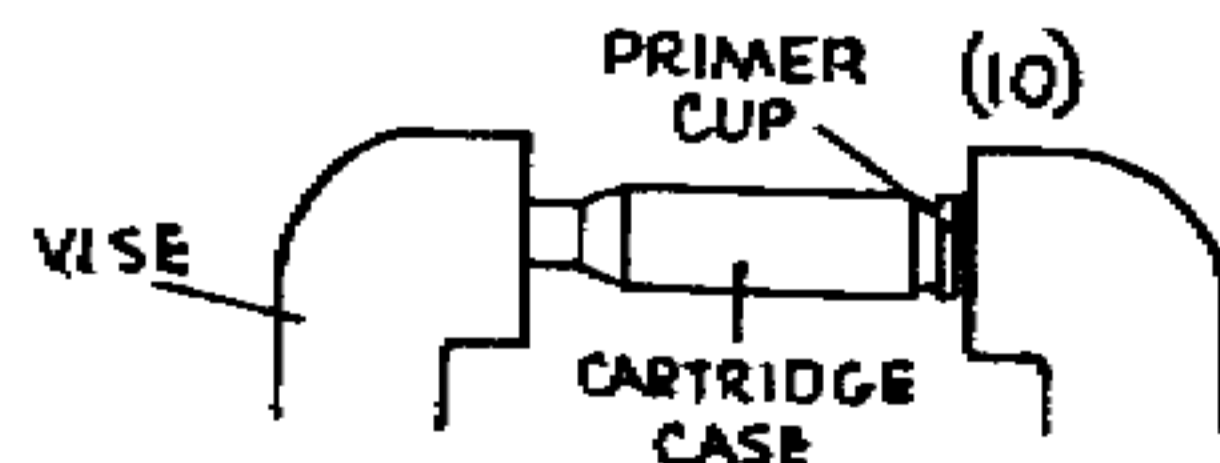

# Scientific Principles of Improvised Warfare and Home Defense

## Procedure for Cartridge

- 1) Remove coating on heads of matches by scraping match sticks with a sharp edge.

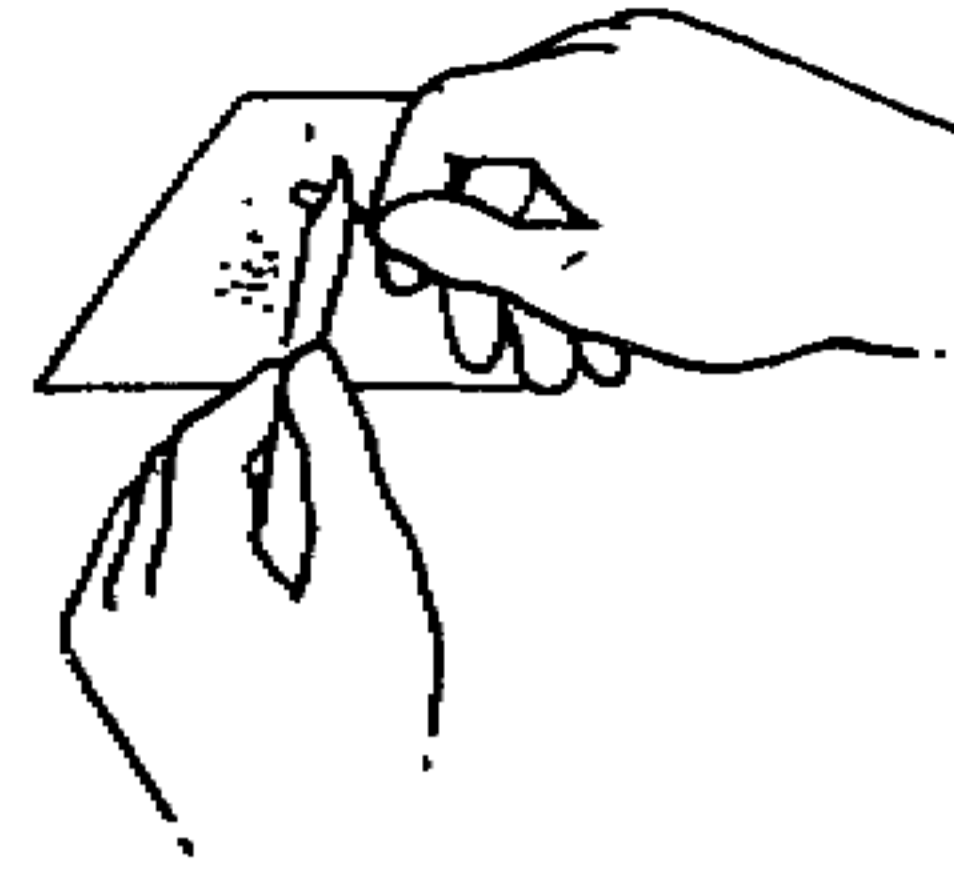

**Caution: If wooden striking matches are used, cut off tips first and use for reusable primer.**

- 2) Fill previously primed cartridge case with matchhead coatings up to its neck. Pack evenly and tightly with match stick. Remove head of match stick before packing so it does not explode. Stand to the side and pack gently. **Do not hammer.**



- 3) Place rag wad in neck of case. Pack with match stick from which head was removed.

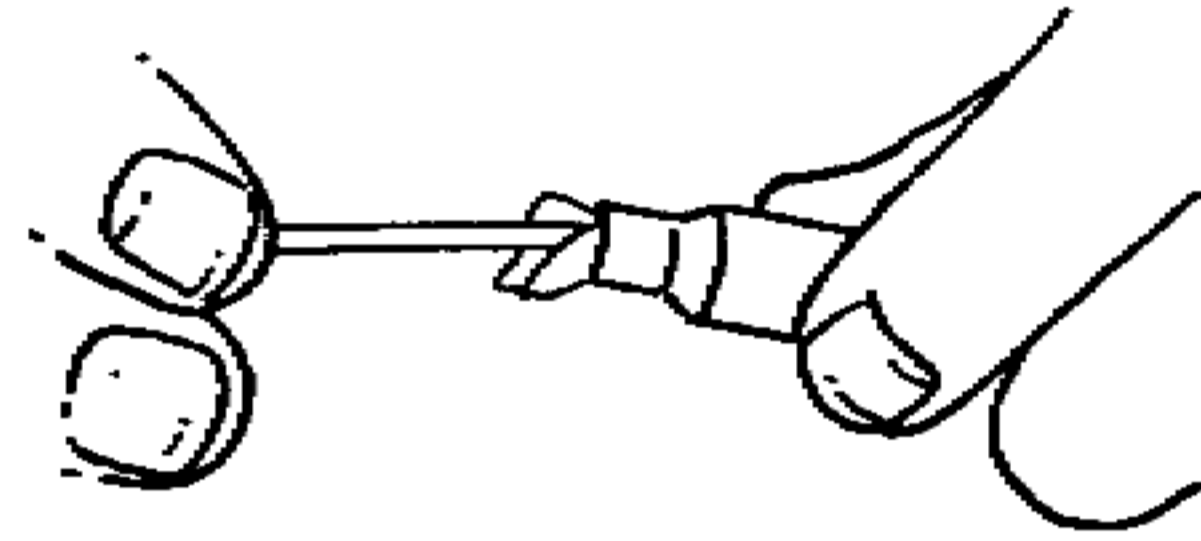

- 4) Saw off head end of bolt so remainder is app. the length of the standard bullet.

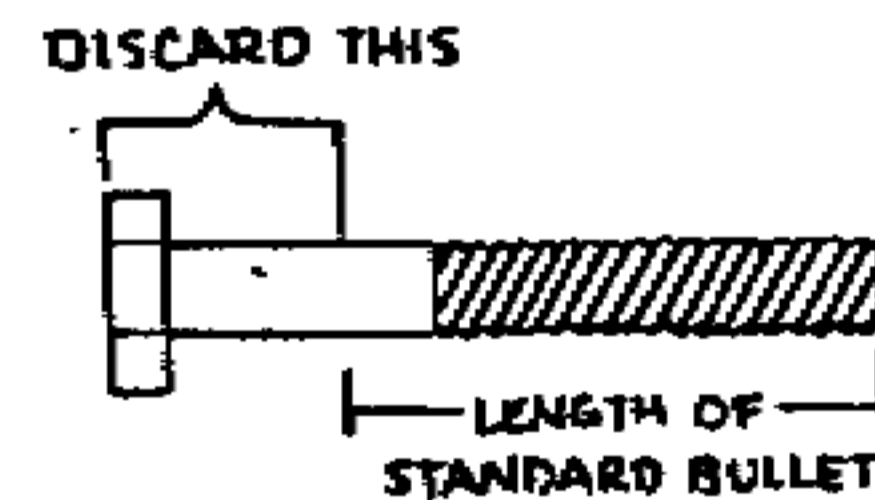

- 5) Place bolt in cartridge so that it sticks out about the same length as the original bullet.

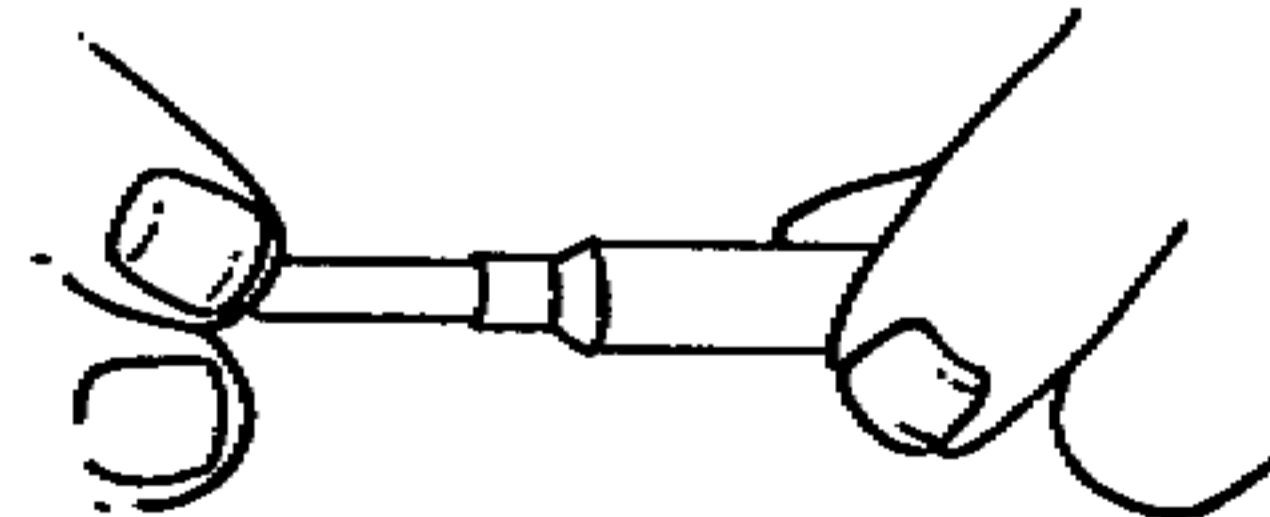

**If bullet does not fit snugly, force paper or match sticks between bolt and case, or wrap tape around bolt before inserting in case.**

## Scientific Principles of Improvised Warfare and Home Defense

- 2) Improvised Pipe Pistols for 22 Cal (Lethal Range - smoothbore = 15-30 Yards)  
38 Cal  
45 Cal  
9 MM Ammunition

### Materials Required

22 Cal - 1/8 inch (3 MM) Steel Pipe x 6" long with both male and female threaded ends.  
38 Cal - 1/4 inch (6 MM)  
45 Cal - 3/8 inch (10 MM)  
9 MM - 1/4 inch (6 MM) Pipe will be drilled out to fit cartridge

Solid pipe plug (male) to fit diameter of pipe gun above  
Two steel pipe couplings to fit ends of above pipe  
Metal strap 1/8" x 1/4" x 5" long (3 mm x 6 mm x 125 mm)  
Elastic bands  
Flat head nail 6D or 8D - 1/16th in. in diameter  
2 wood screws #8  
Drill and Bits  
Wood or metal rod 1/8" (3mm) x 8" long for 22 cal and 9mm  
1/4" (6mm) x 8" for 38 & 45 Cal.

Saw or Knife  
Hard wood block 8" x 5" x 1" thick for all except 45 Cal which requires  
8.5" x 6.5" x 1" thick

### Procedure

- 1) Carefully inspect pipe and fittings
  - A) Make sure there are NO cracks or other flaws in the pipe or fittings.
  - B) Check inside diameter of pipe using a cartridge of the correct ammunition, long or short, as a gauge. The bullet should fit closely into the pipe without forcing, but the cartridge case **should not** fit into the pipe.
  - C) Outside diameter of pipe **must not be** less than 1-1/2 times the bullet diameter.

# Scientific Principles of Improvised Warfare and Home Defense

## 22 Caliber

2) Drill a  $15/64$  in. (1/2 cm) diameter hole  $9/16$  in. (1-1/2cm) deep in pipe for long cartridge. Short cartridge only  $3/8$  in. (1cm) deep. When a cartridge is inserted into the pipe, the shoulder of the case should butt against the end of the pipe.

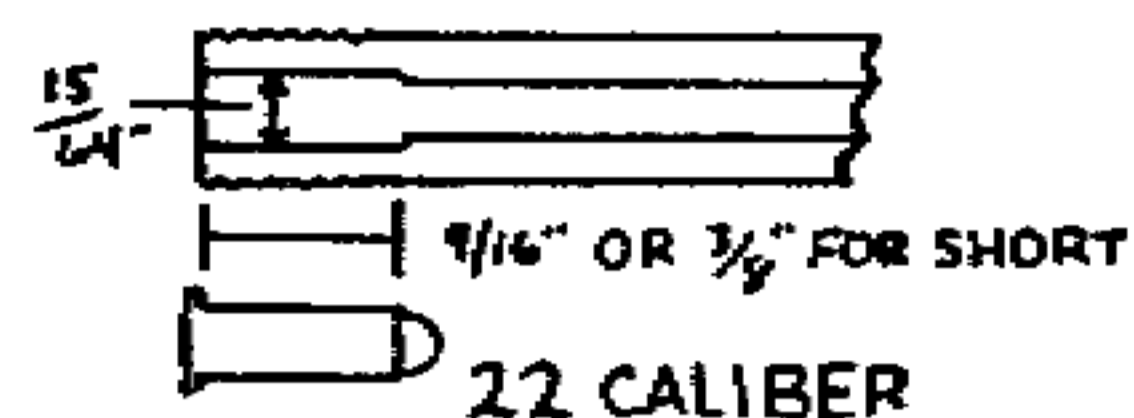

3) Screw the coupling onto the pipe. Cut coupling length to allow pipe plug to thread in pipe flush against the cartridge case.

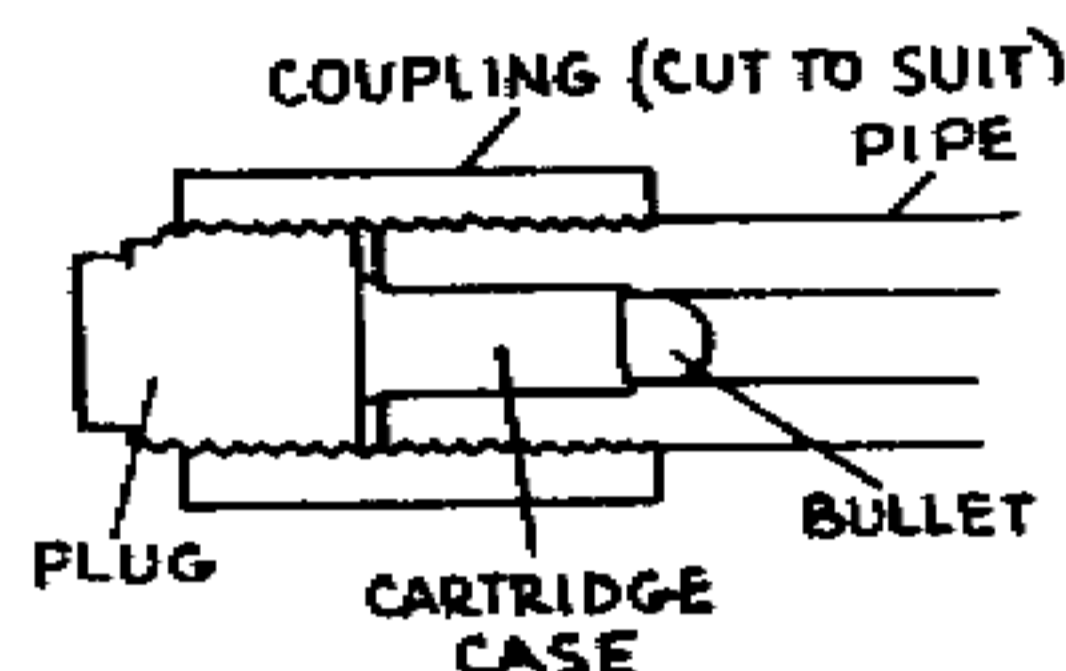

4) Drill a hole off center of the pipe plug just large enough for the nail to fit through.  
**Note:** Drilled hole **MUST BE OFF CENTER** in plug.

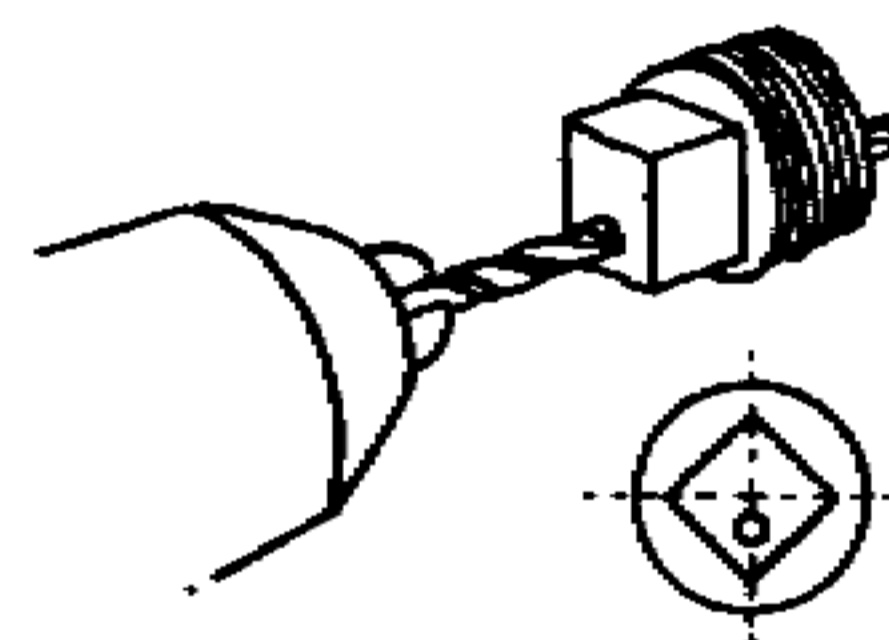

5) Push nail through pipe plug until head of nail is flush with square end. Cut nail off at other end  $1/16$  in. (1-1/2 mm) away from plug. Round off end with file.





# Scientific Principles of Improvised Warfare and Home Defense

## 38 Caliber

2) Drill a  $35/64$  in. (14mm) diameter hole  $3/4$  in. (2cm) into one coupling to remove the thread. Drilled section should fit tightly over smooth section of pipe.

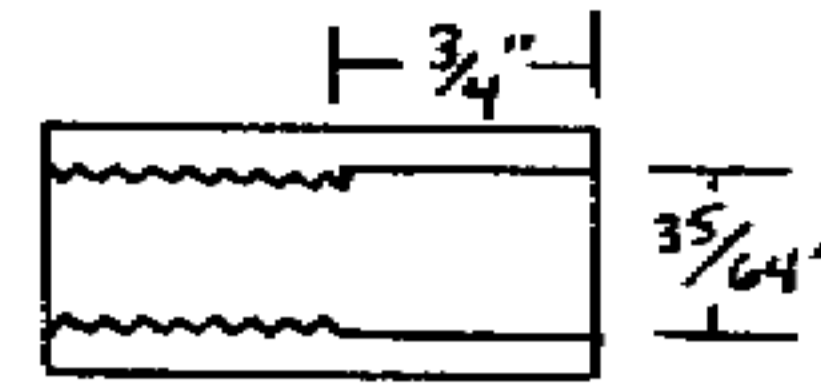

3) Drill a  $25/64$  in. (1cm) diameter hole  $1-1/8$  in. (2.86cm) into pipe. Use cartridge as a gauge; when cartridge is inserted into the pipe, the shoulder of the case should butt against the end of the pipe. Thread coupling tightly onto pipe, drilled end first.

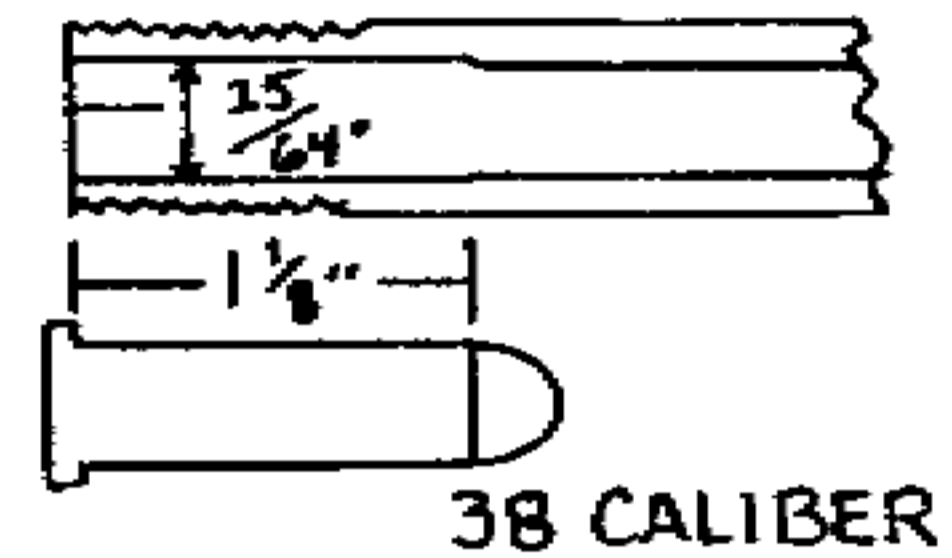

## 9 MM

2) Drill a  $9/16$  in. (1.43cm) diameter hole  $3/8$  in (app. 1cm) into one coupling to remove the thread. Drilled section should fit tightly over smooth section of pipe.

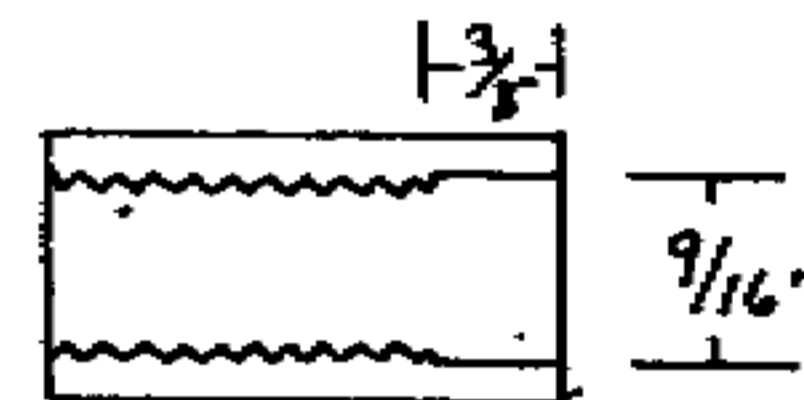

3) Drill a  $25/64$  in. (1cm) diameter hole  $3/4$  in. (1.9cm) into pipe. Use cartridge as a gauge; when a cartridge is inserted into the pipe, the base of the case should be even with the end of the pipe. Thread coupling tightly onto pipe., drilled end first.

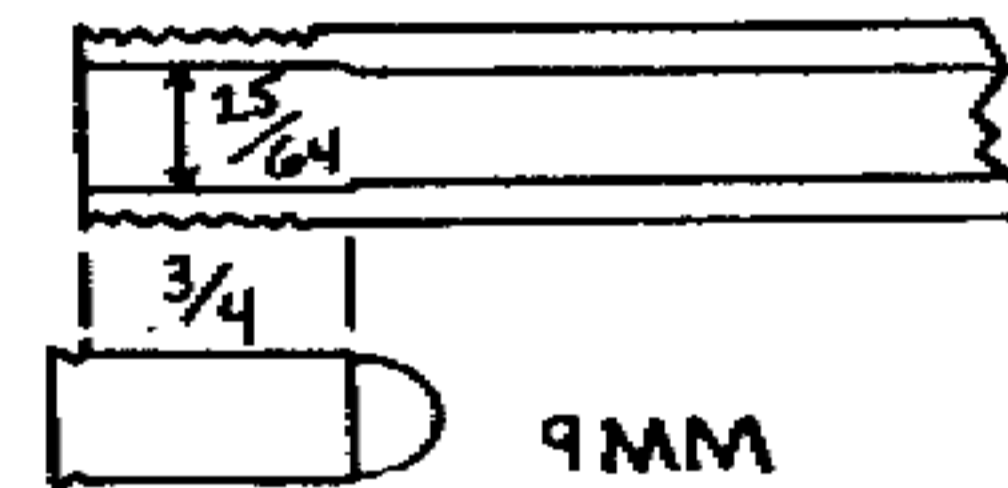

4) Drill a hole in the center of the pipe plug just large enough for the nail to fit through.

### **HOLE MUST BE CENTERED IN PLUG**

5) Push nail through plug until head of nail is flush with square end. Cut nail off at other end  $1/16$ th in. (.158cm) away from plug. Round off end of nail with file.

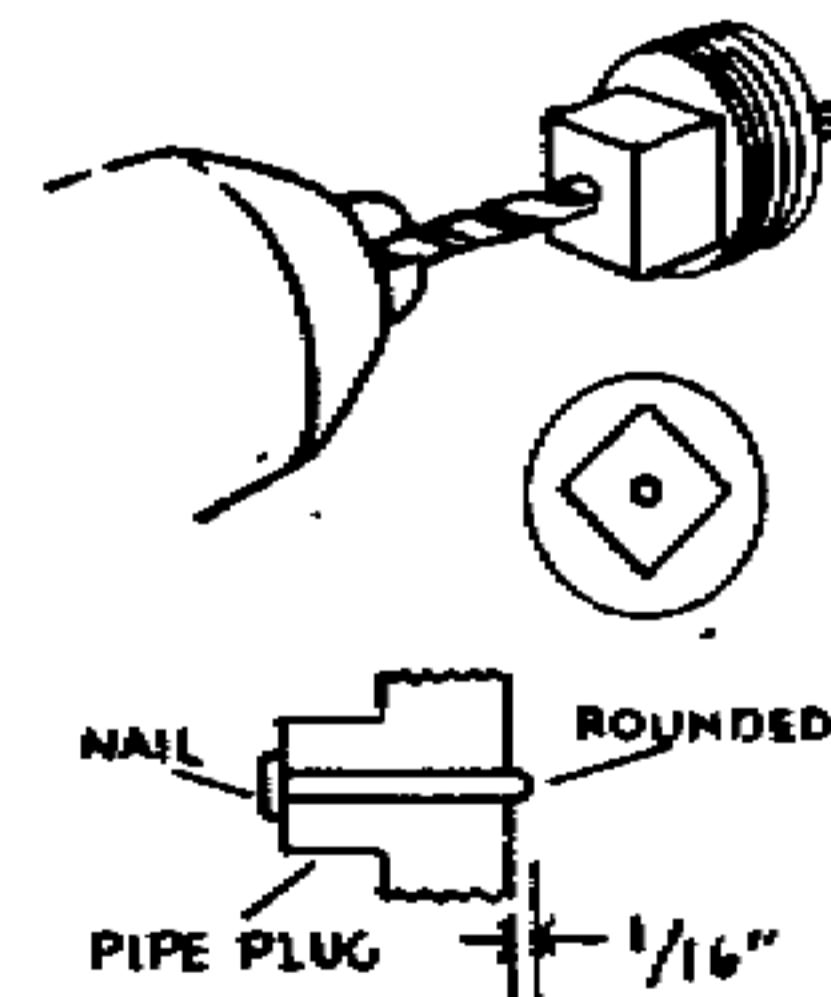

## Scientific Principles of Improvised Warfare and Home Defense

6) Bend metal strap to "U" shape and drill holes for wood screws. File two small notches at top.

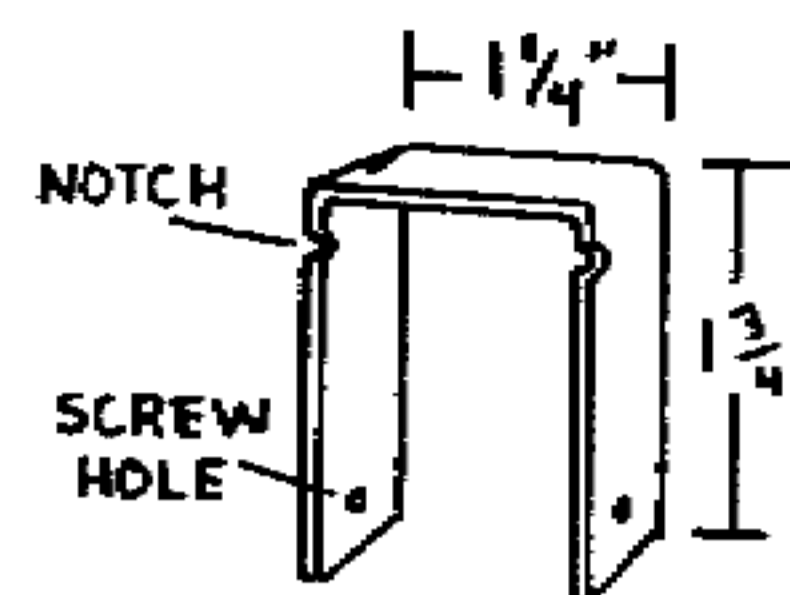

7) Saw or otherwise shape 1" (2.54cm) thick hard wood into stock.

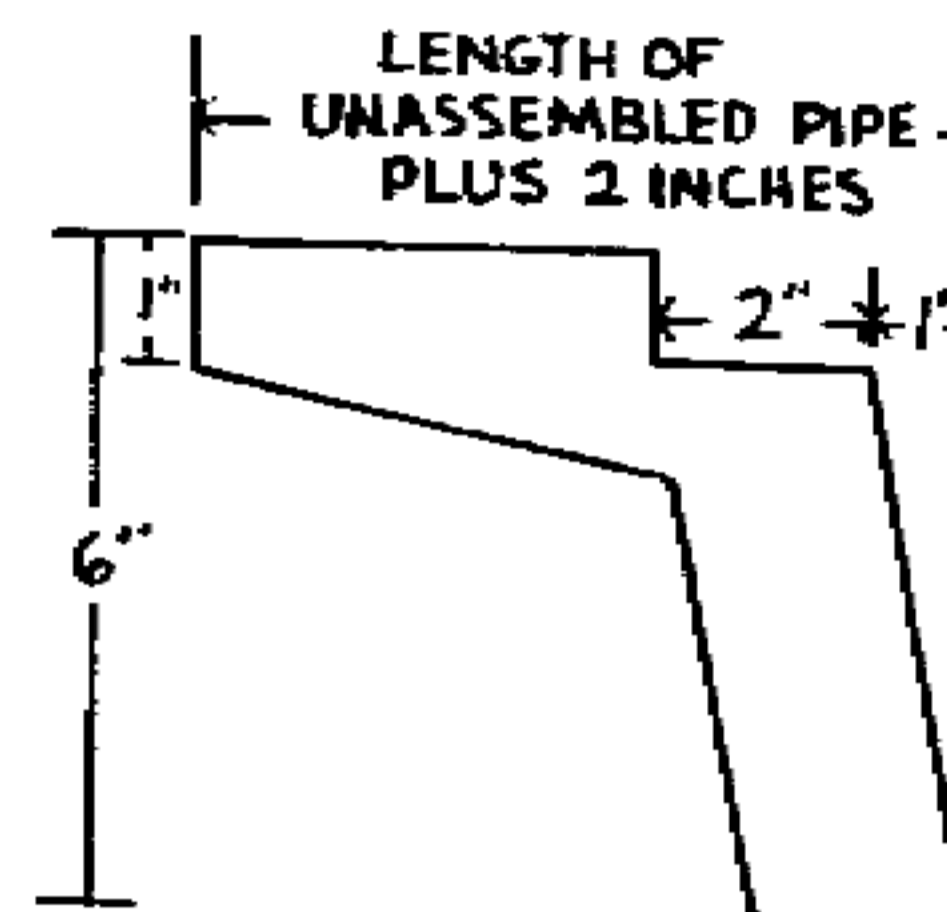

8) Drill a 9/16in. diameter (1.43cm) hole through the stock. The center of the hole should be app. 1/2in. (1.27cm) from the top.

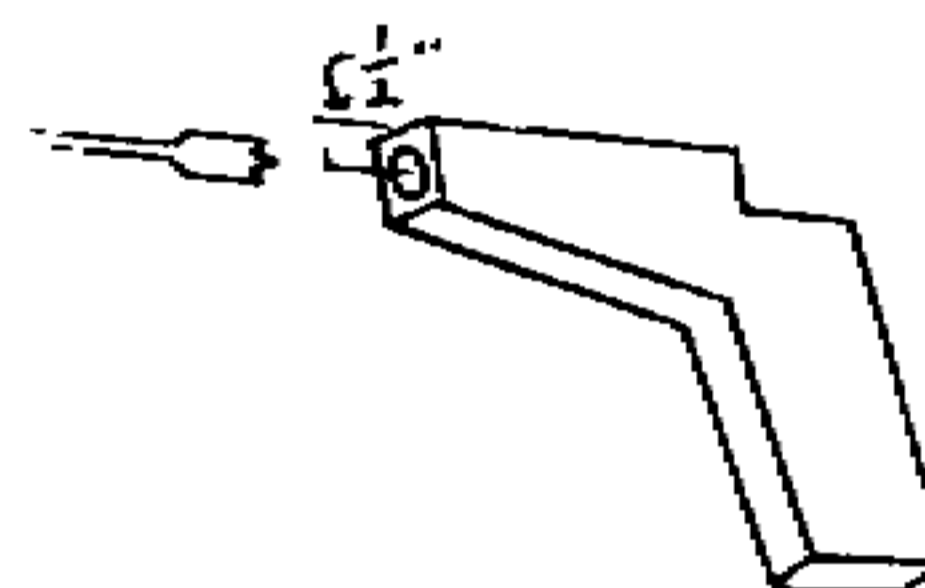

9) Slide the pipe through this hole and attach front coupling. Screw drilled plug into rear coupling.

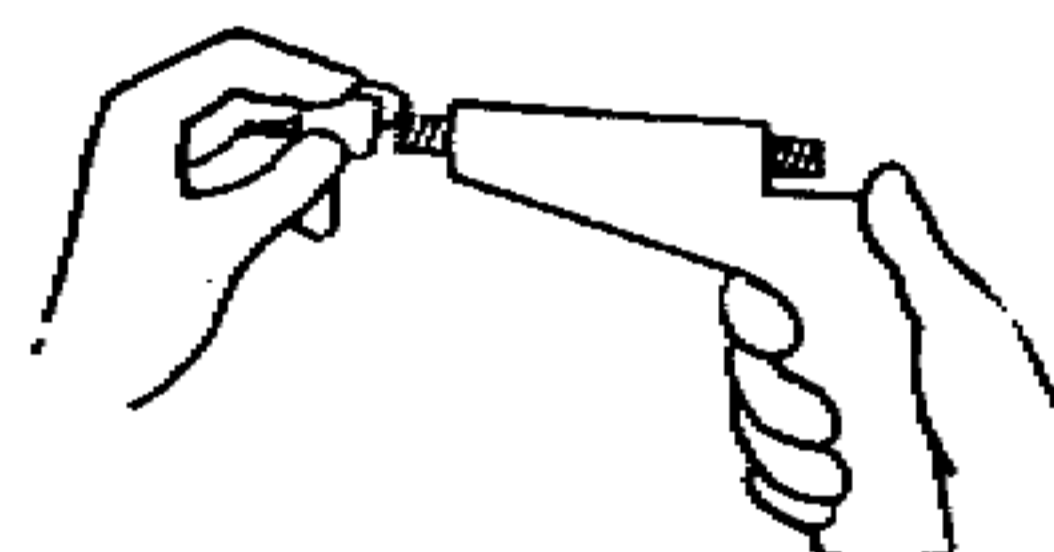

10) Position metal strap on stock so that top will hit the head of the nail. Attach to stock with wood screw on each side.

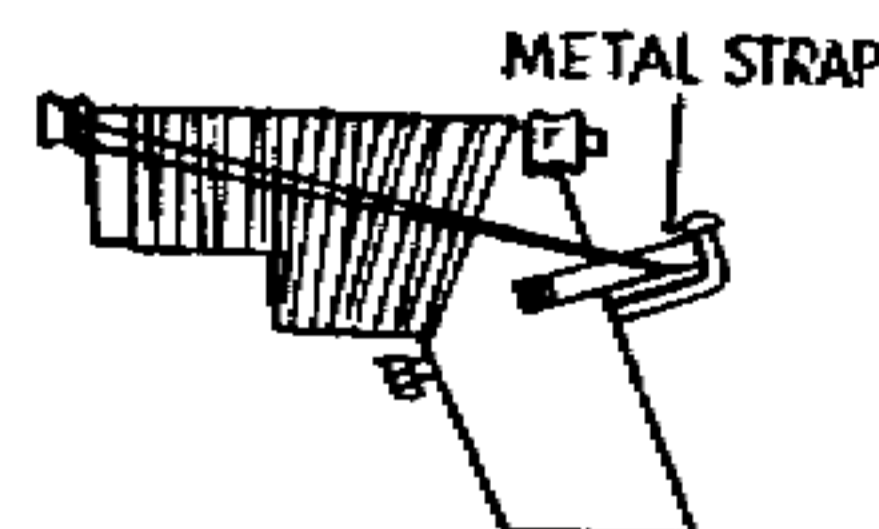

11) String elastic bands from front coupling to notch on each side of the strap

# Scientific Principles of Improvised Warfare and Home Defense

## 45 Caliber

Follow steps 4,5,and 6 for 9mm gun (above)

3) Cut stock from wood using saw or knife.

Inches	Centimeters
1-1/2	4
8-1/2	26.5
6	20
1-1/2	4
5	12.5

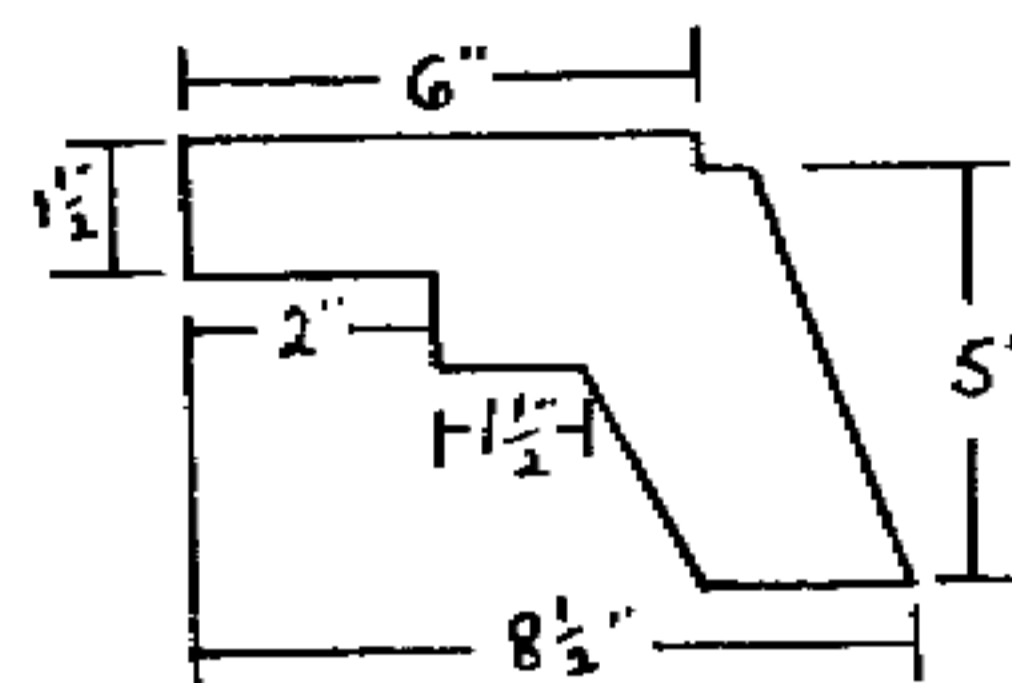

**NOTE:** If 9/16 drill is not available cut a "V" groove in the top of the stock and tape pipe securely in place.

4) Cut a 3/8in. (9.5mm) deep groove in top of stock.

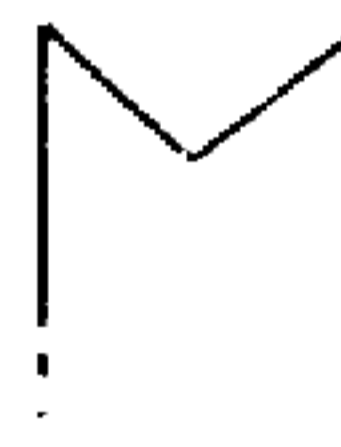

5) Screw couplings onto pipe. Screw plug into one coupling.

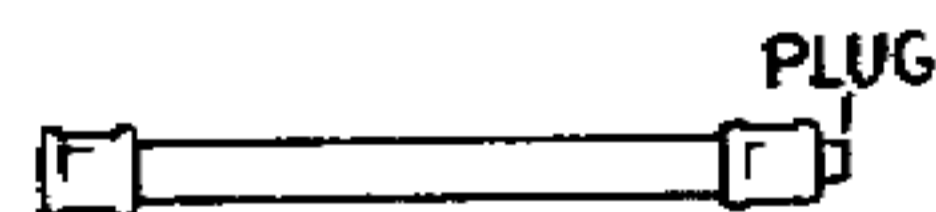

6) Securely attach pipe to stock using string or tape.

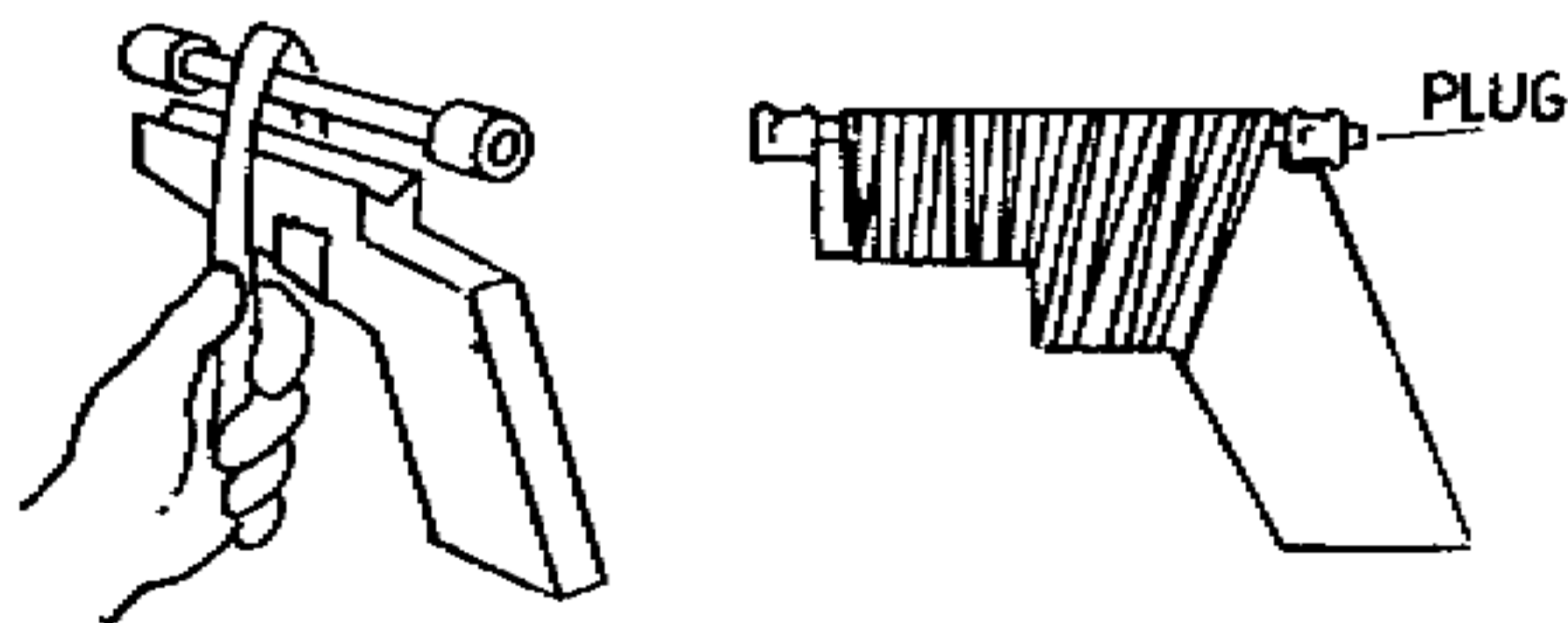

## Scientific Principles of Improvised Warfare and Home Defense

7) (Optional) Bend bolt for trigger. Drill hole in stock and place bolt in hole so strap will be anchored by bolt when pulled back. If bolt is not available use strap as trigger by pulling back and releasing.

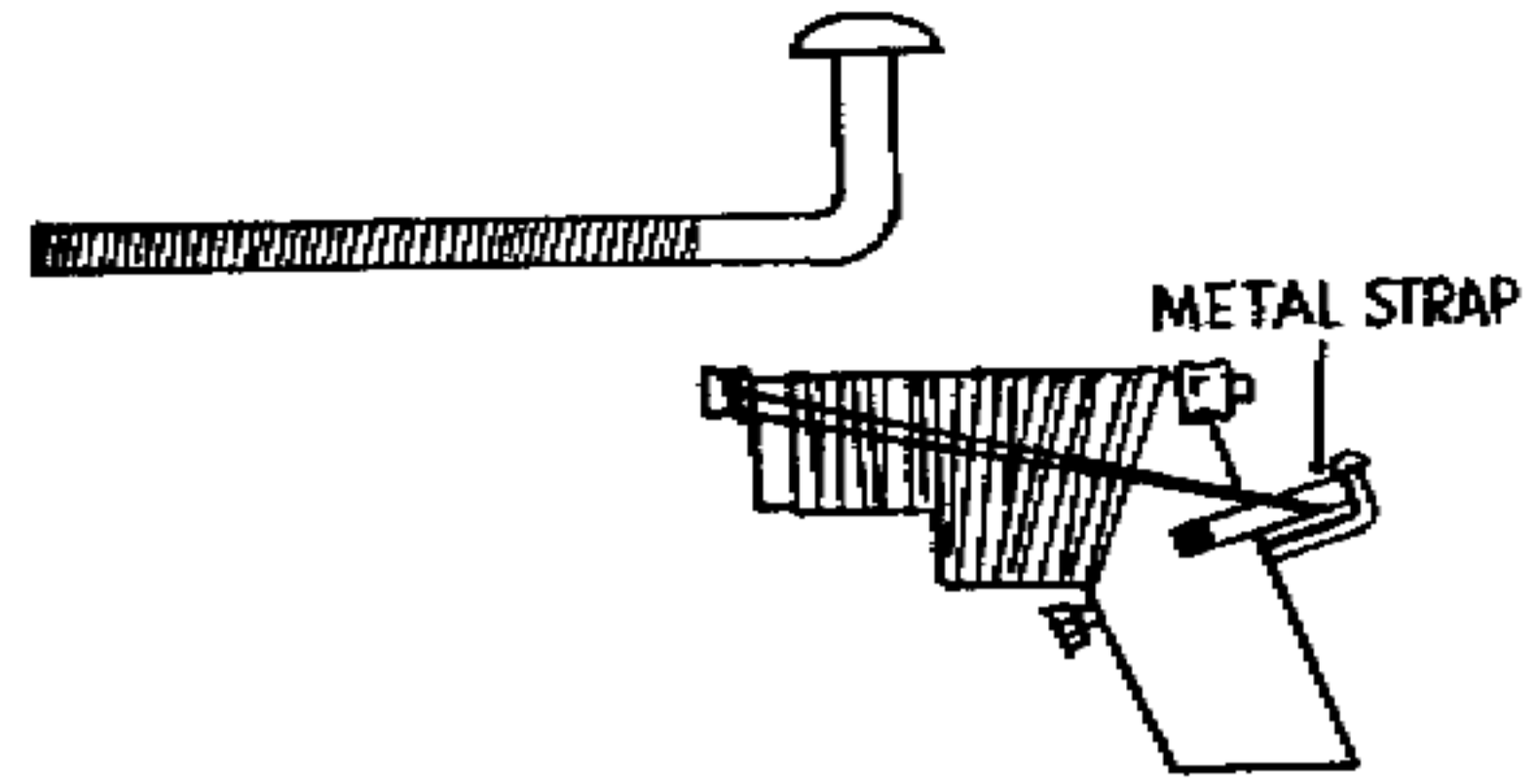

8) Follow steps 9, 10, and 11 from 9mm.

9) Position metal strap on stock so that top will hit head of the nail. Attach to stock with wood screw on each side.

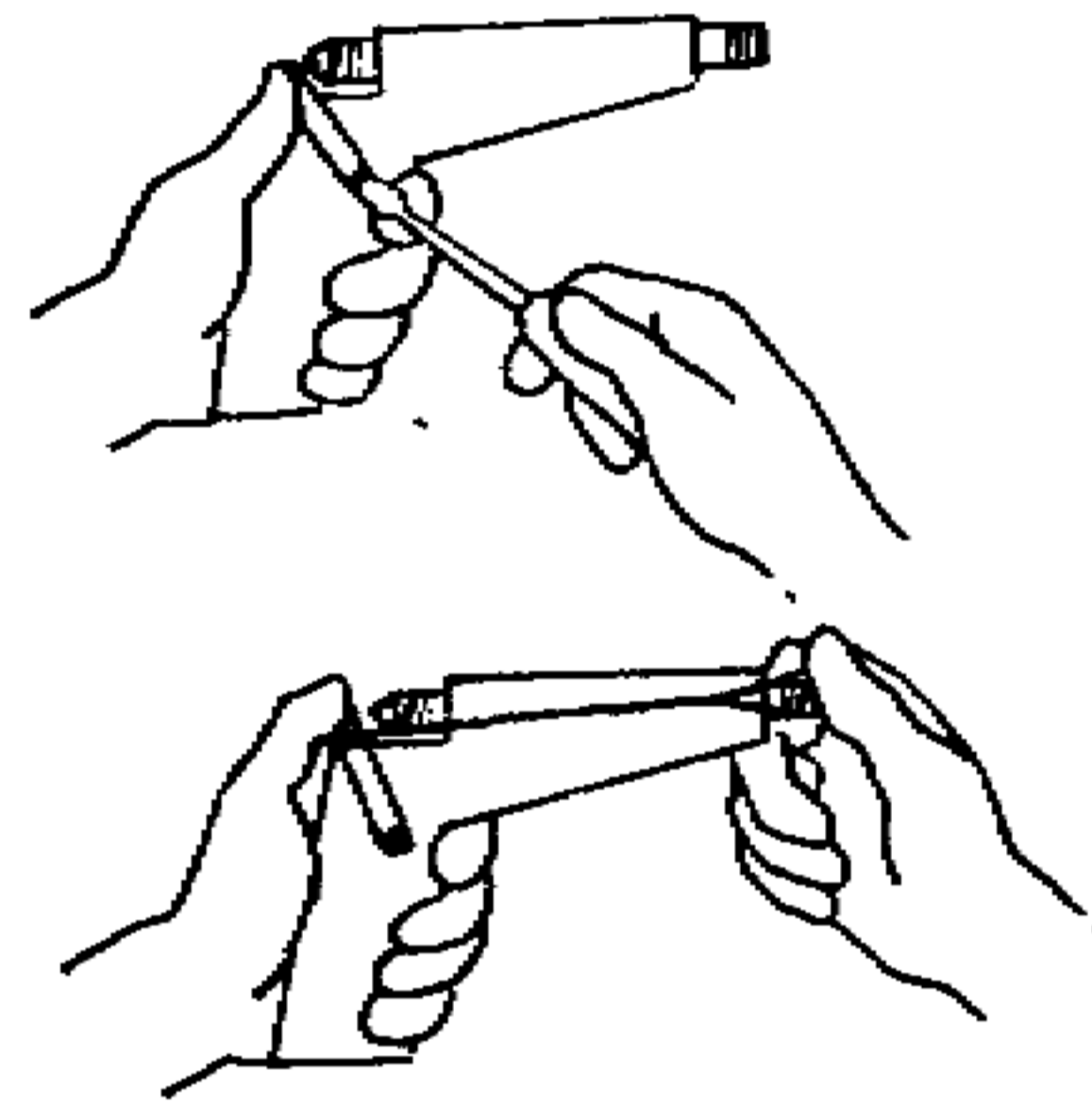

10) String elastic bands from front coupling to notch on each side of the strap.



## Scientific Principles of Improvised Warfare and Home Defense

### How to use 45 Cal.

#### 1) To load:

- a. Remove plug from rear coupling
- b. Wrap string or elastic band around extractor groove so case will seat into barrel securely.
- c. Place cartridge in pipe.
- d. Replace plug.

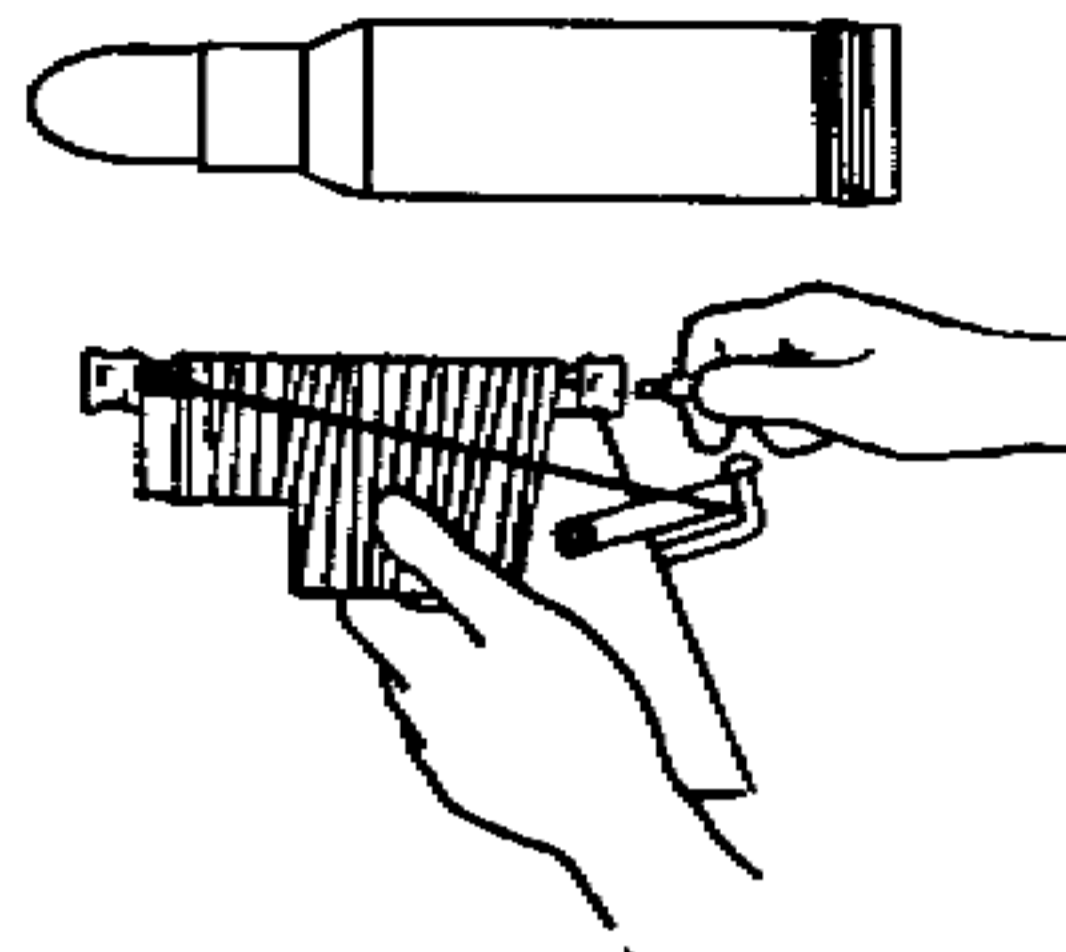

#### 2) To fire

- a. Pull metal strap back and anchor in trigger.
- b. Pull trigger when ready to fire.

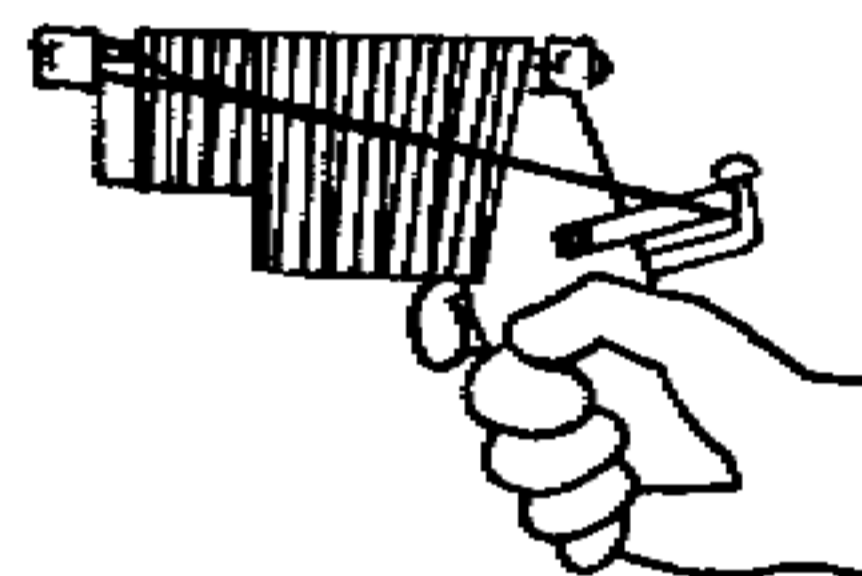

NOTE: If bolt is not used, pull strap back and release

#### 3) To remove cartridge case:

- a. Remove plug from rear coupling
- b. Insert rod in front of pistol and push cartridge case out.

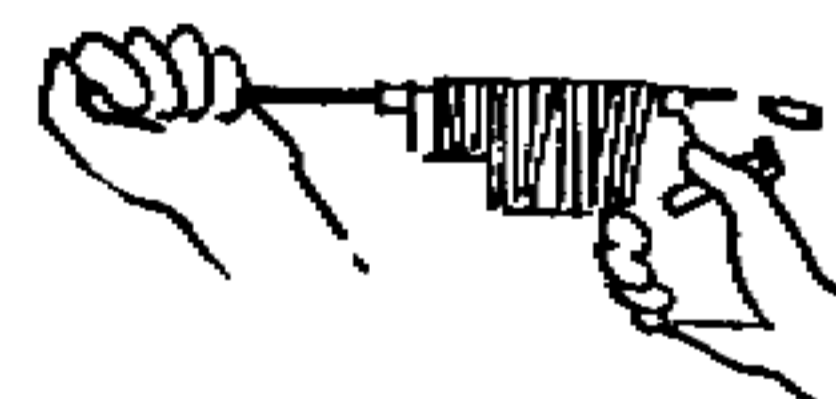

# Scientific Principles of Improvised Warfare and Home Defense

## How to use 22,38, and 9mm

### 1) To load

- a. Remove plug from rear coupling.
- b. Place cartridge into pipe.
- c. Replace plug.

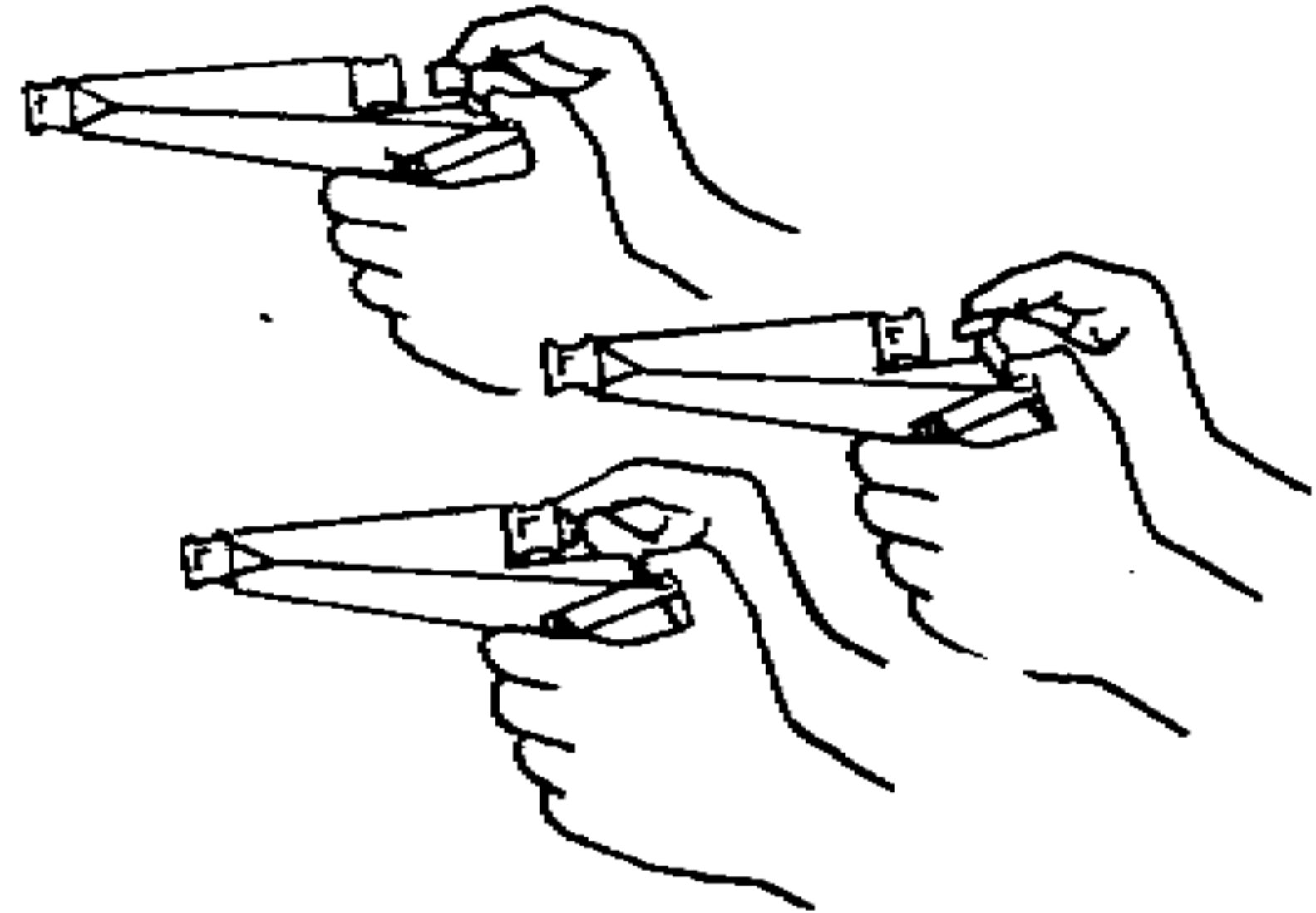

### 2) To fire

- a. Pull strap back and hold with thumb until ready.
- b. Release strap.

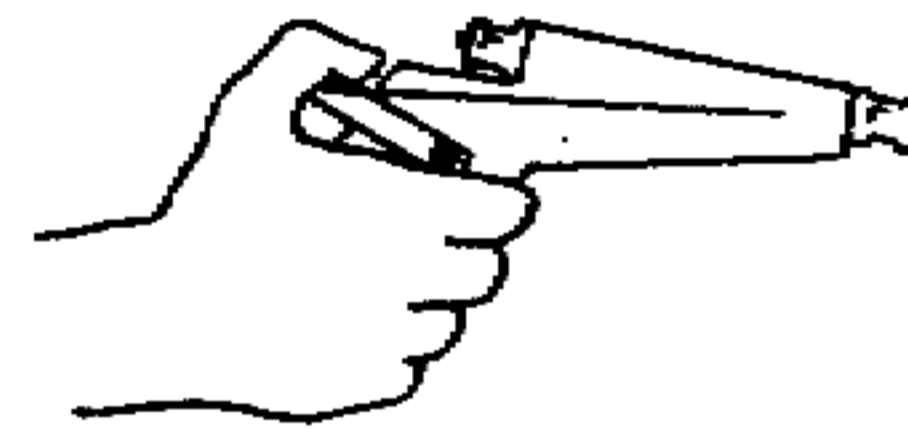

### 3) To remove shell case

- a. Remove plug from rear coupling
- b. Insert 1/4in. diameter steel or wooden rod into front of pistol and push shell case out.

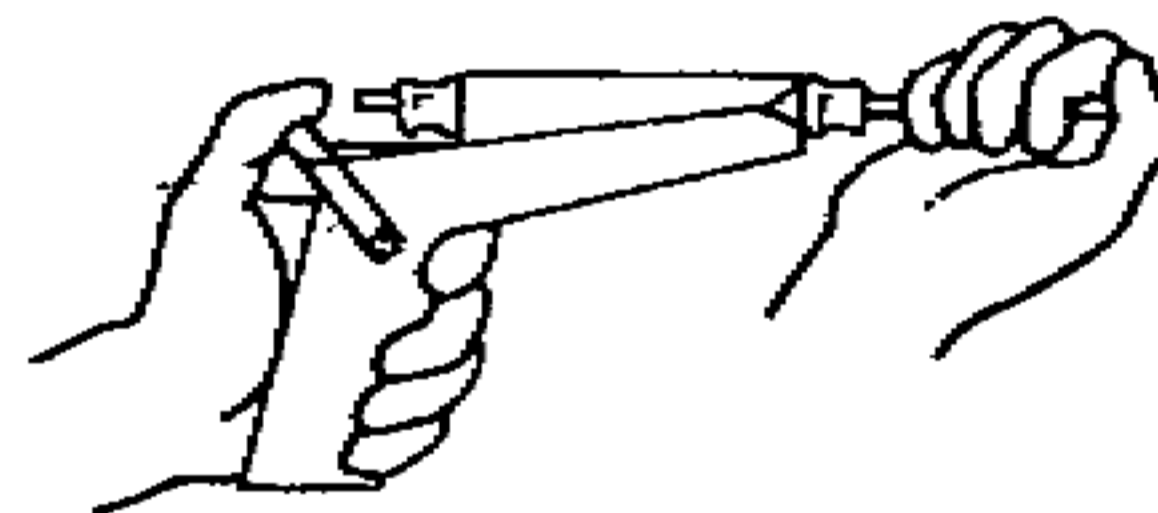

## **Scientific Principles of Improvised Warfare and Home Defense**

### **Safety Check - Test fire before Hand Firing**

1. Locate a barrier such as a stone wall or large tree which you can stand behind in case the pistol ruptures when fired.
2. Mount pistol solidly to a table or other rigid support at least 10 feet in front of the barrier.
3. Attach a cord to the firing strap on the pistol.
4. Holding the other end of the cord, go behind the barrier.
5. Pull the cord so that the firing strap is held back.
6. Release the cord to fire the pistol. (If pistol does not fire, shorten the elastic bands or increase their number.

# Scientific Principles of Improvised Warfare and Home Defense

## 3) Low Signature System (Silencer) For Pipe Guns or drilled barrel of firearm

### Material Required

Grenade container or long metal can 5" long x 2.5-3" in diameter

Steel pipe nipple, 6in. (15cm) long - see Table 1 for diameter

2 steel pipe couplings - see Table 2 for dimensions

Cotton cloth - see Table 2 for dimensions

Drill

Absorbent Cotton

### Procedure

1. Drill hole in grenade container at both ends to fit outside diameter of pipe nipple (See Table 1).

2. Drill 4 rows of holes in pipe nipple. (See Table 1)

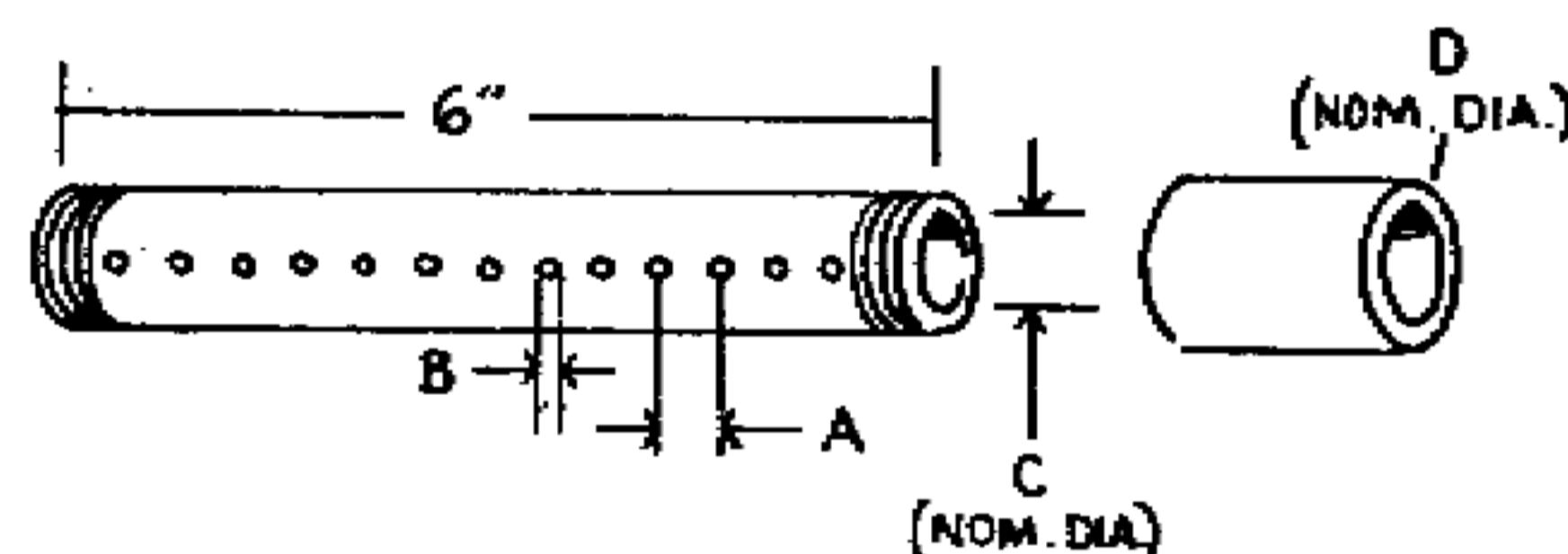
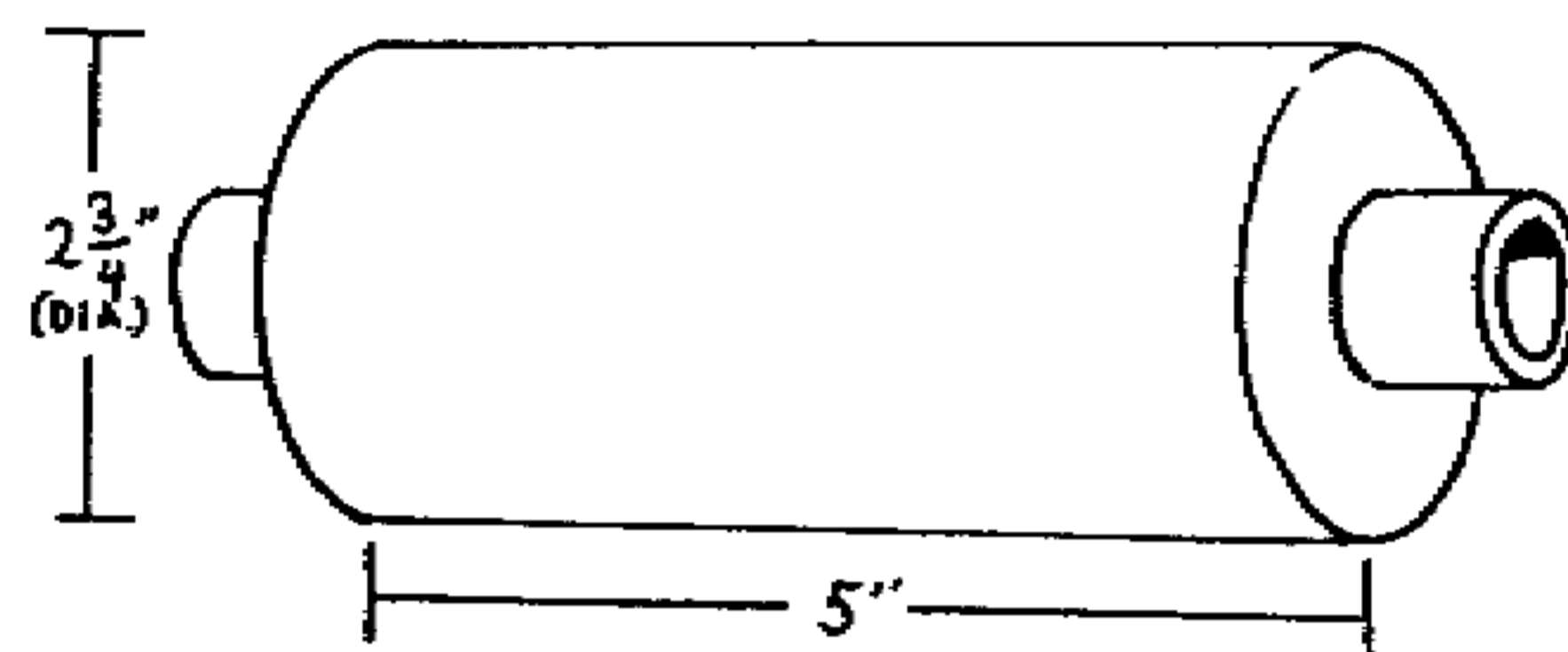

Table 1

	Holes (Coupling) per				Row	4 Rows Total
	A	B	C	D		
45 Cal.	3/8	1/4	3/8	3/8	12	48
38 Cal	3/8	1/4	1/4	1/4	12	48
9 mm	3/8	1/4	1/4	1/4	12	48
7.62 mm	3/8	1/4	1/4	1/4	12	48
22 Cal	1/4	5/32	1/8*	1/8	14	56

\*Extra Heavy Pipe

All dimensions in inches

3. Thread one of the pipe couplings on the drilled pipe nipple.

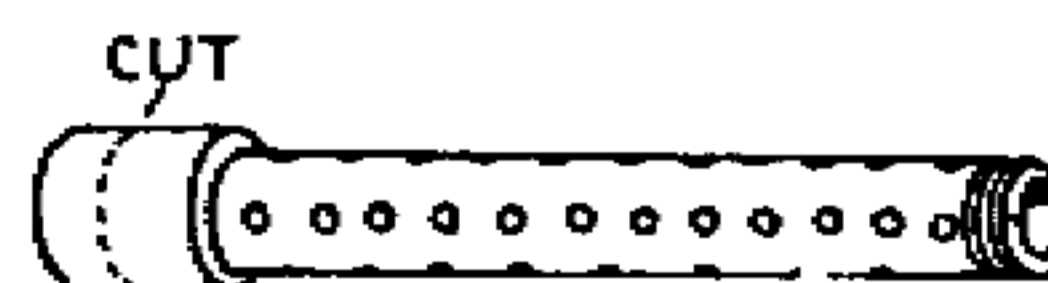



## Scientific Principles of Improvised Warfare and Home Defense

4. Cut coupling length to allow barrel of weapon to thread fully into the low signature system. Barrel should butt against end of the drilled pipe nipple.

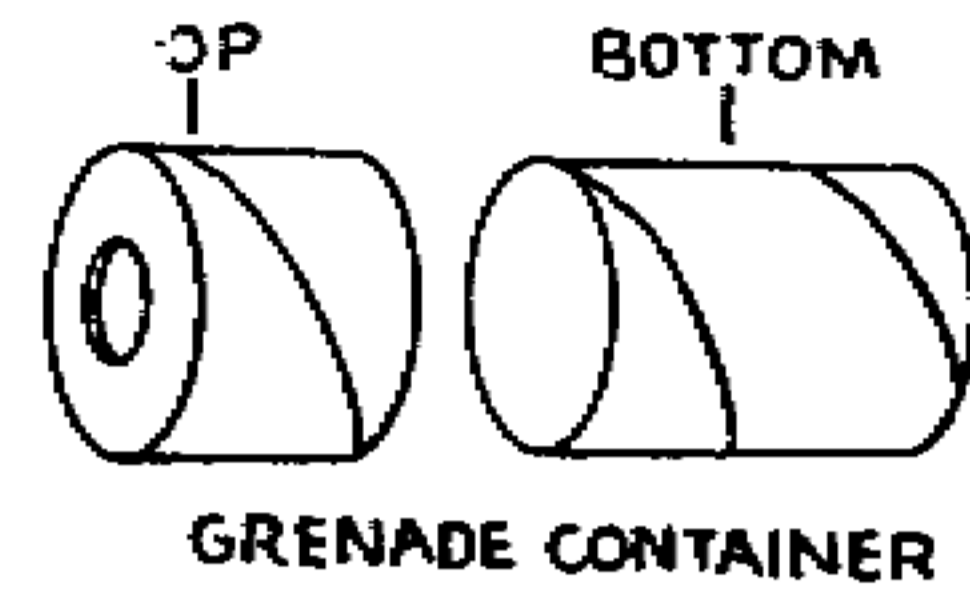

5. Separate the top half of the grenade container from the bottom half.

6. Insert the pipe nipple in the drilled hole at the base of the bottom half of container. Pack the absorbent cotton inside the container and around the pipe nipple.

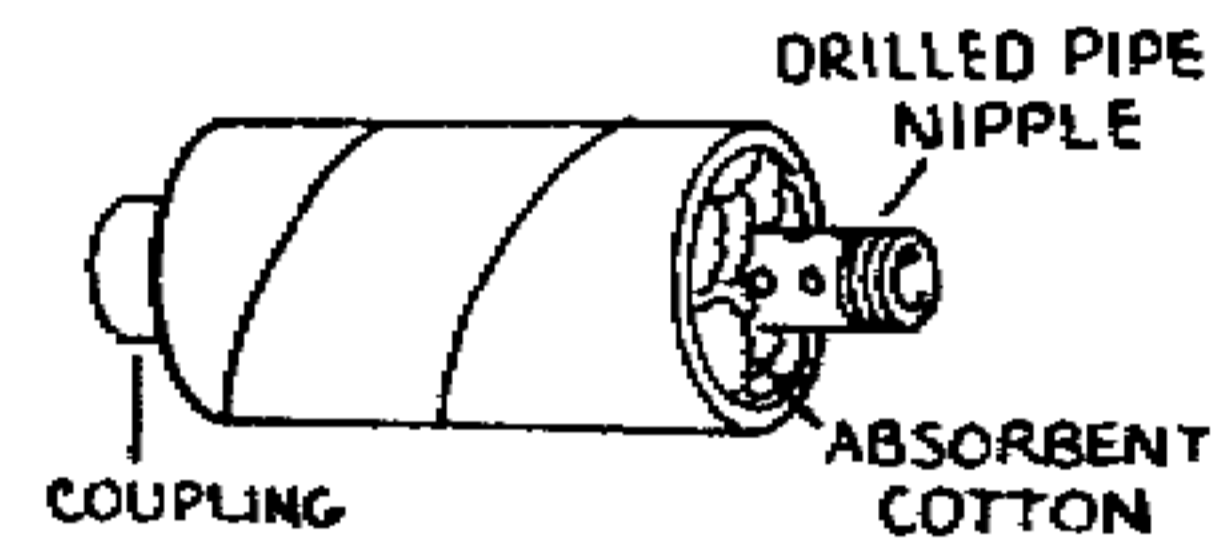

7. Pack the absorbent cotton in top half of Grenade container leaving hole in center. Assemble container to the bottom half.

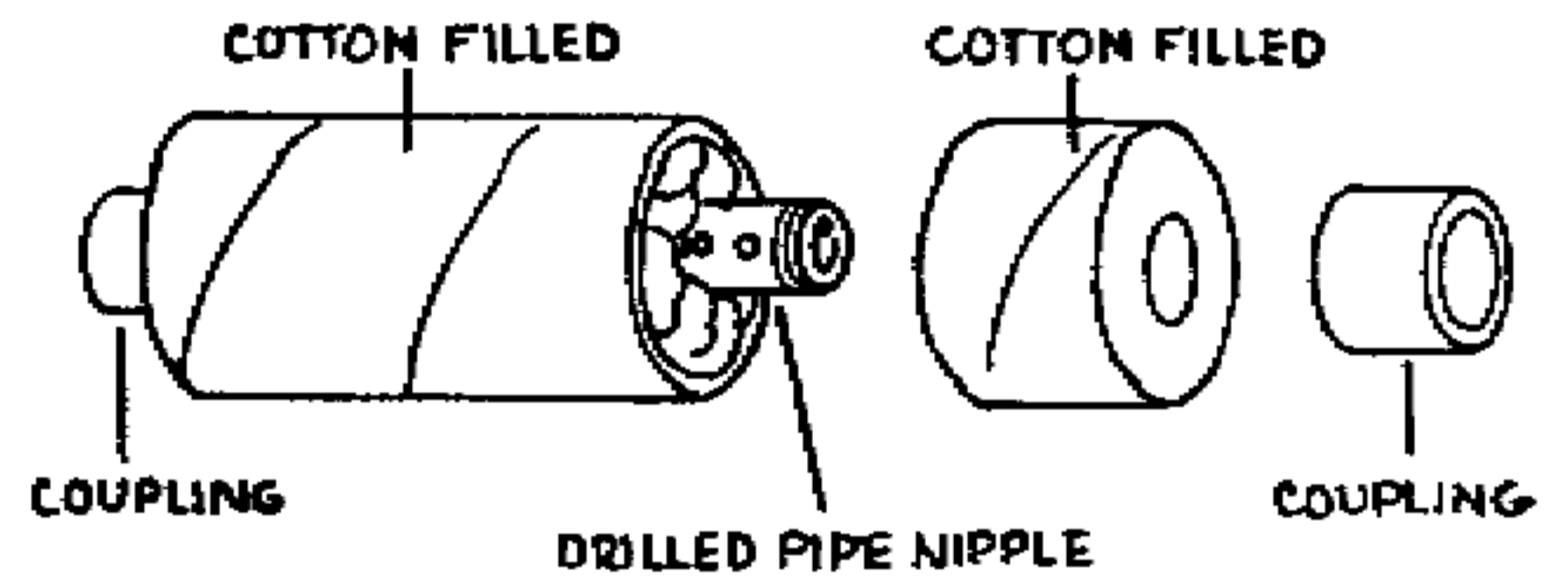

8. Thread the other coupling onto the pipe nipple.

**NOTE:** A longer container and pipe nipple, with same "A" and "B" dimensions as those given, will further reduce the signature of the system.

## Scientific Principles of Improvised Warfare and Home Defense

### How to use

1. Thread the low signature system on the selected weapon securely.
2. Place the proper cotton wad size into the muzzle end of the system.

Table II. Cotton Wadding - Sizes

45 Cal.	1.5 x 6 in.
38 Cal	1 x 4 in.
9mm	1 x 4 in.
7.62mm	1 x 4 in.
22 Cal	Not needed

### 3. Load Weapon

### 4. Weapon is ready for use.

Authors Note: There are two kinds of sound produced by the firing of a gun

- 1) Explosion of the primer and propellant which a silencer can absorb and reduce
- 2) Crack or mini sonic boom created by the bullet traveling faster than the speed of sound.  
A silencer does not prevent this sound. Subsonic ammunition with lower explosive propellant is used in military guns with silencers which have accuracy only at close range.

# Scientific Principles of Improvised Warfare and Home Defense

## 4) Pipe Shotgun (12 gauge)

### Materials Required

- Wood 2" x 4" x 32"
- 3/4" nominal size water or gas pipe 20" to 30" long threaded on one end
- 3/4" steel coupling
- Solid 3/4" pipe plug
- Metal Strap (1/4" x 1/16" x 4")
- Heavy Twine app. (100 Yards)
- 3 wood screws and screwdriver
- Flat head nail 6D or 8D
- Hand drill
- Saw or Knife
- File
- Shellac or Lacquer
- Elastic Bands

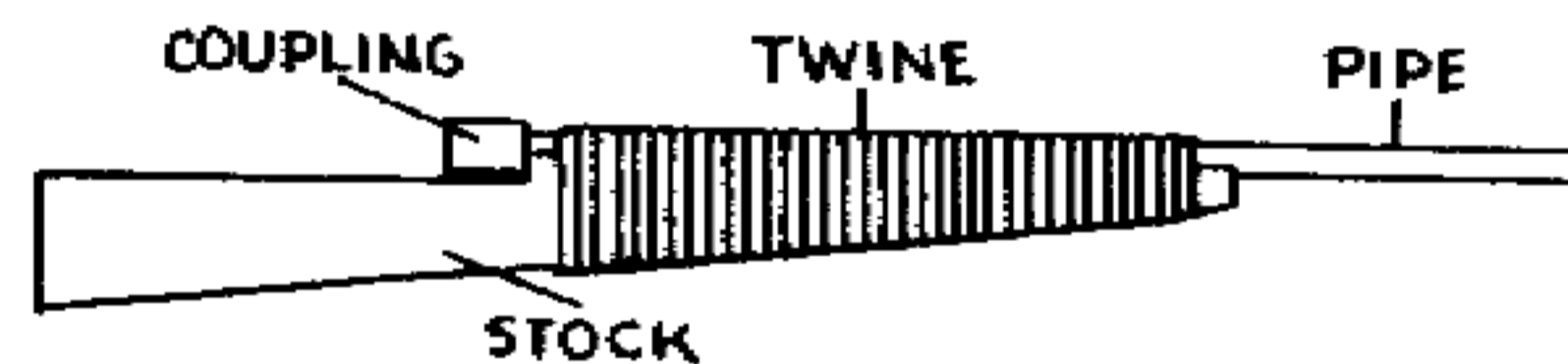
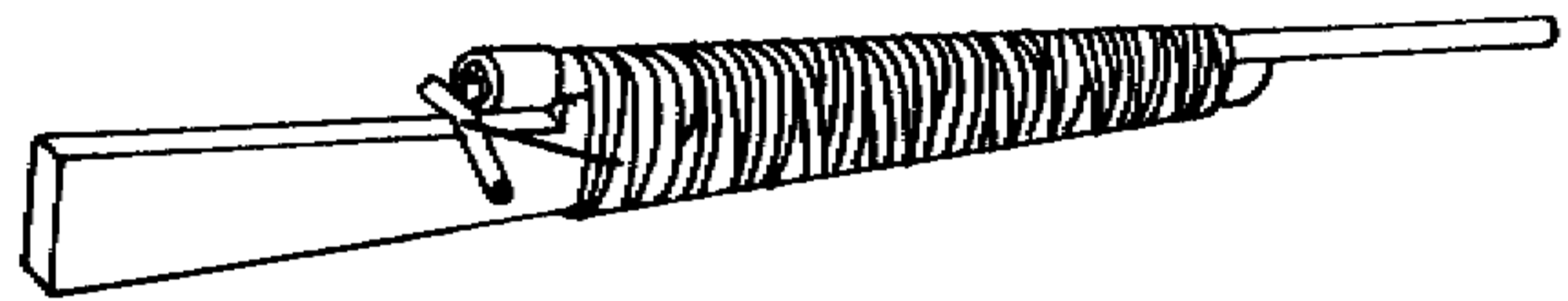

### Procedure

- Carefully inspect pipe and fittings.
  - Make sure there are no cracks or other flaws
  - Check inside diameter of pipe. A 12 gauge shot shell should fit into the pipe but the brass rim should not fit.
  - Outside diameter of pipe must be at least 1 in. (2.54cm)

2. Cut stock from wood using a saw or knife according to drawing and dimensions.

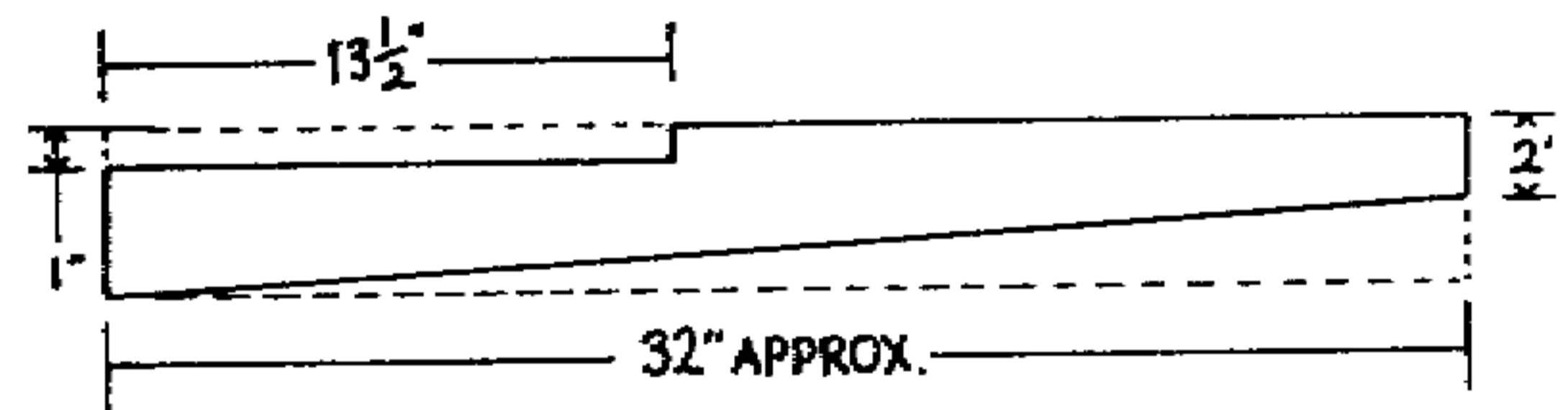

3. Cut a 3/8" deep "V" groove in top of the stock.

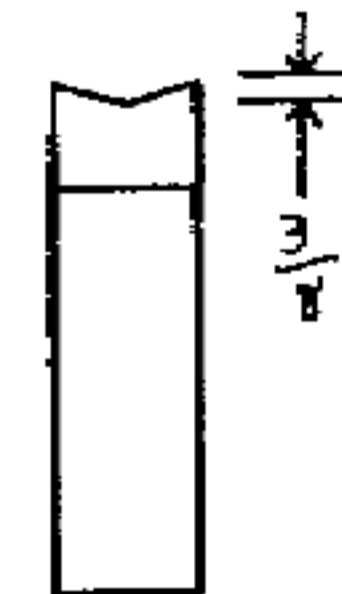

4. Turn coupling onto pipe until tight.

5. Coat pipe and "V" groove of stock with shellac or lacquer and, while still wet, place pipe in "V" groove and wrap pipe and stock together using two heavy layers of twine. Coat twine with shellac or lacquer after each layer.

**Scientific Principles of Improvised Warfare and Home Defense**

6. Drill a hole through center of pipe plug for nail to pass through.

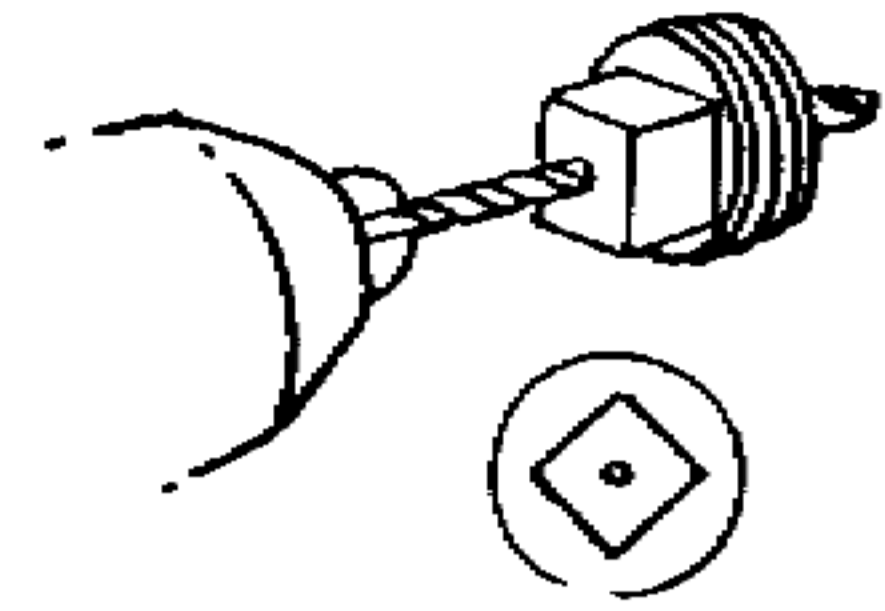

7. File threaded end of plug flat.

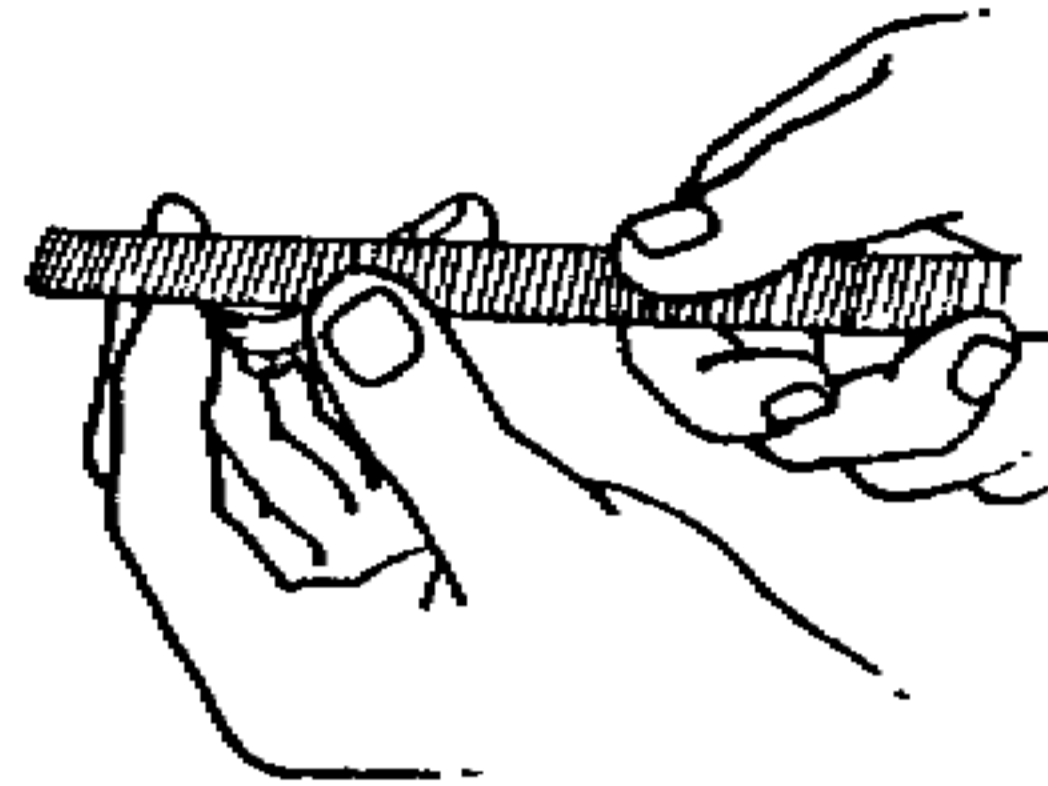

8. Push nail through plug and cut off flat 1/32" past the plug.

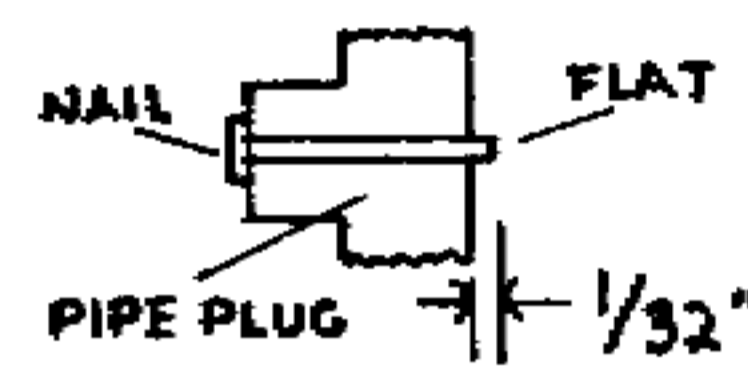

9. Screw the plug into coupling.

10. Bend 4" metal strap into "L" shape and drill hole for wood screw. Notch metal strap on the long side 1/2" from bend.

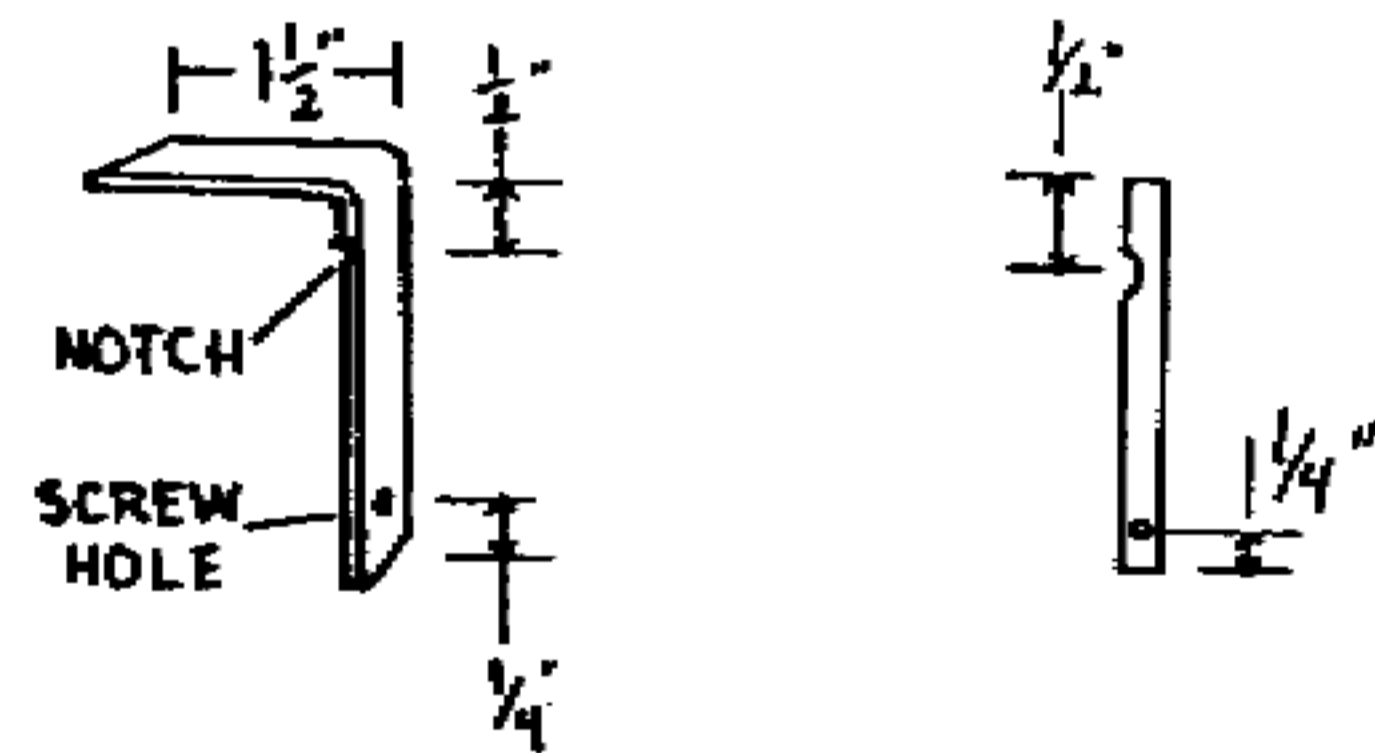

11. Position metal straps on stock so that top will hit the head of the nail. Attach to stock with wood screw.

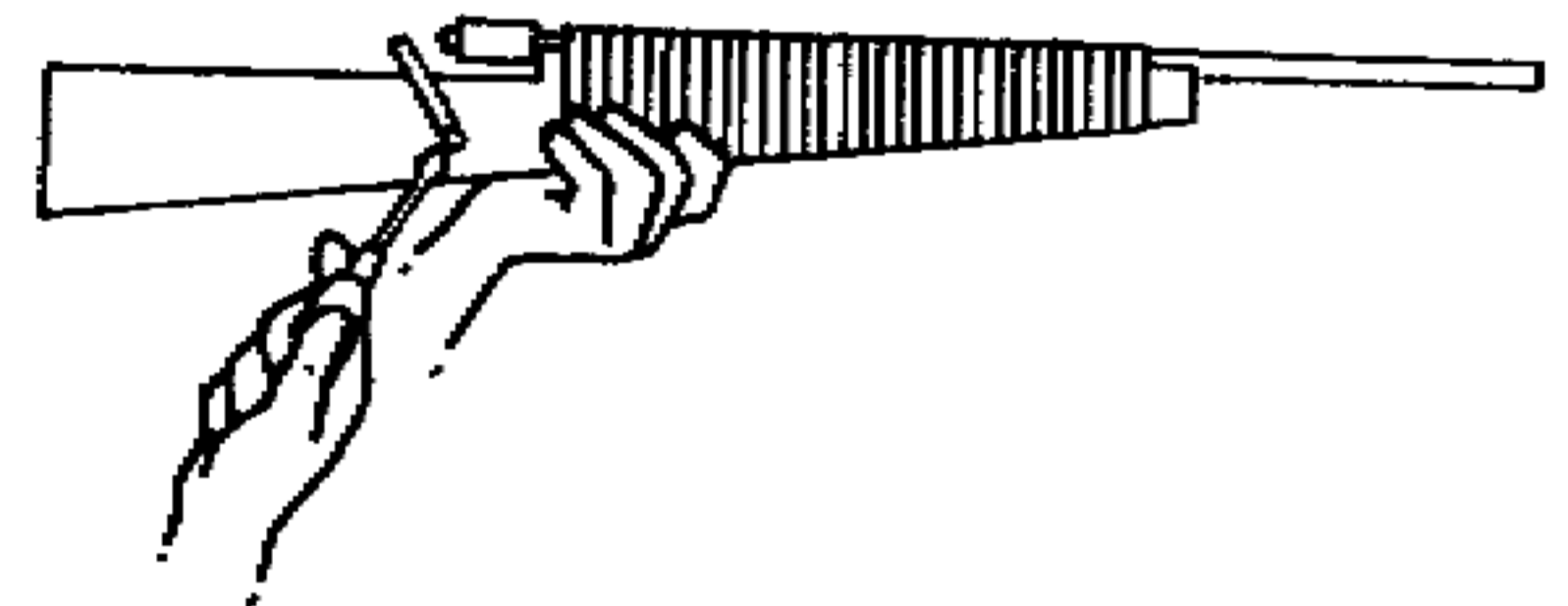

12) Place screw in each side of stock about 4" in front of metal strap. Pass elastic bands through notch in metal strap and attach to screw on each side of the stock.

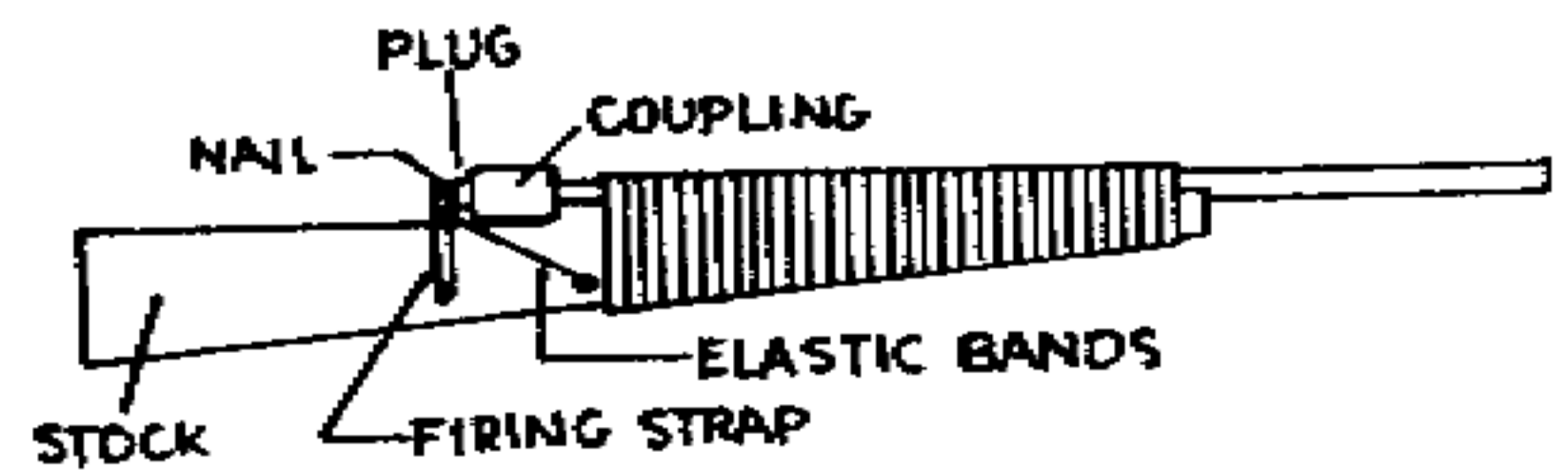



# Scientific Principles of Improvised Warfare and Home Defense

Safety Check: Follow safety instructions for improvised handguns

## How to operate shotgun

### 1. To load

a. Take plug out of coupling

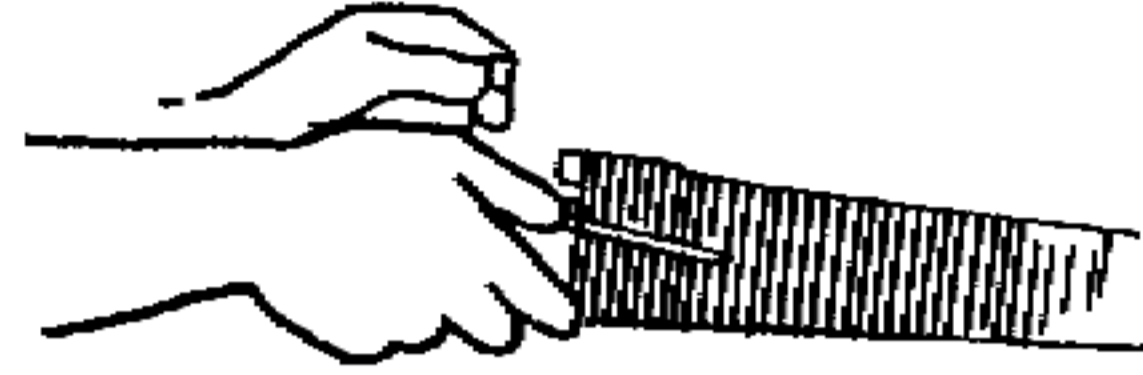

b. Put shotgun shell into pipe



c. Screw plug hand tight into coupling

### 2. To fire

a. Pull strap back and hold with thumb.

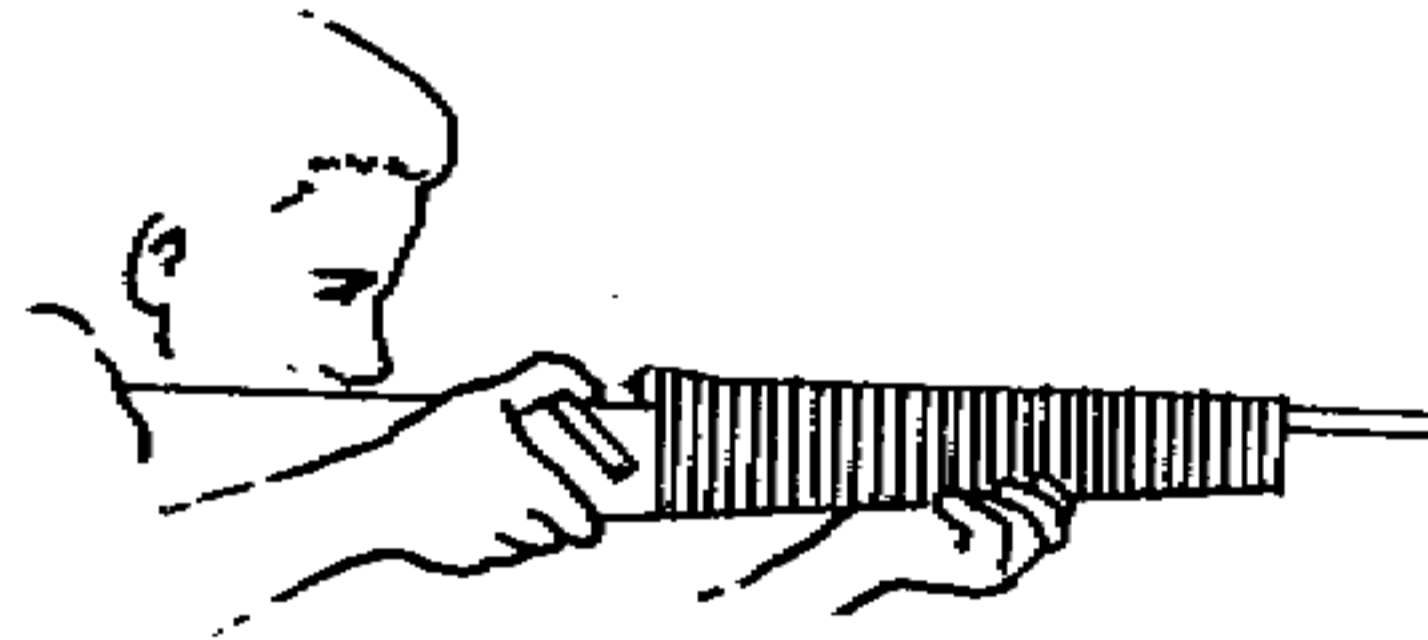

b. Release strap

### 3. To unload gun

a. Take plug out of coupling

b. Shake out used cartridge

## Scientific Principles of Improvised Warfare and Home Defense

### 5) Pipe Carbine 7.62mm

#### Material Required

Wood app. 2 in. x 4 in. x 30 in.

1/4 in. nominal size iron water or gas pipe 20" long threaded at one end

3/8 to 1/4" reducer

3/8 x 1-1/2" threaded pipe

3/8" pipe coupling

Metal strap app. 1/2" x 16" x 4"

Heavy Twine (app. 100 yards)

3 wood screws and screwdriver

Flat head nail about 1 in. long

Hand drill

Saw or Knife

File

Pipe Wrench

Shellac or Lacquer

Elastic Bands

Solid 3/8" pipe plug



#### Procedure

1. Inspect pipe and fittings carefully.
  - a. Be sure there are no cracks or flaws.
  - b. Check inside diameter of pipe. A 7.62 mm projectile should fit into 3/8" pipe.

2. Cut stock from wood using saw or knife.

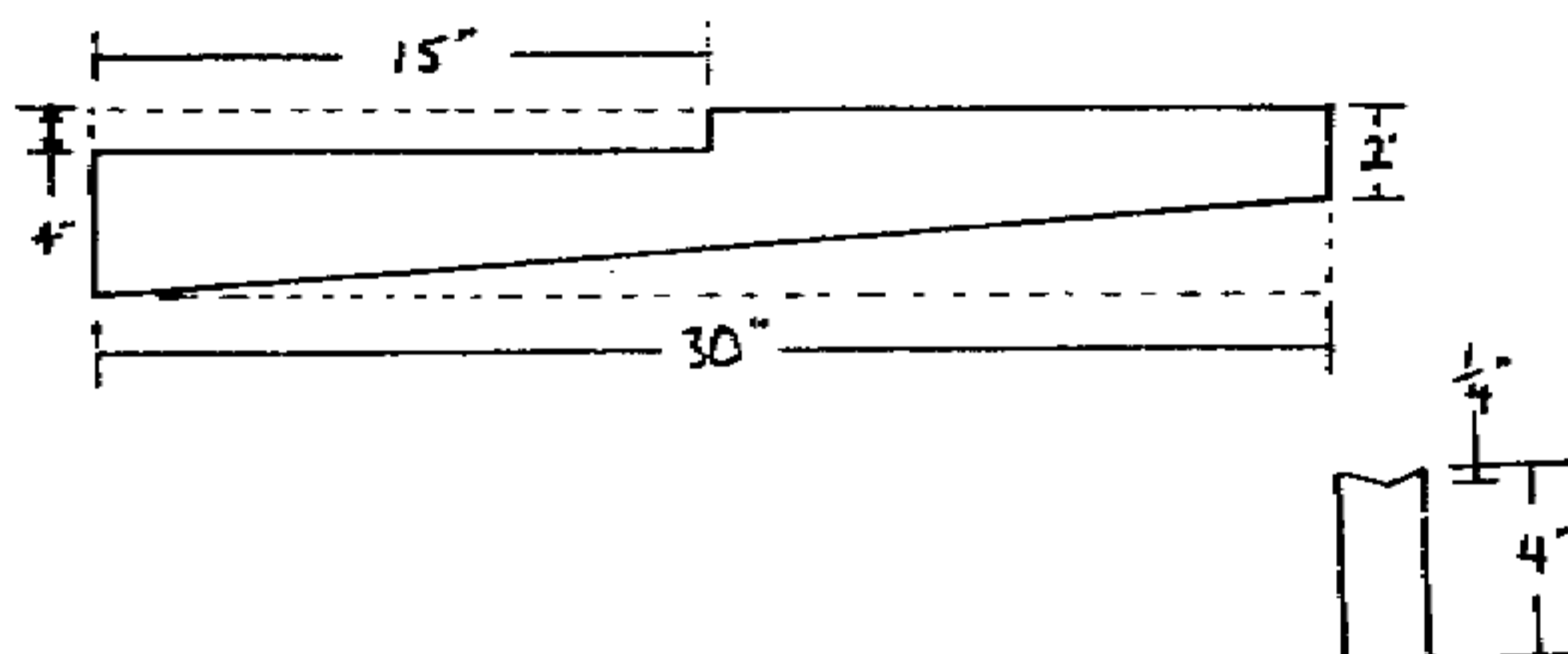

3. Cut a 1/4" deep groove in top of stock

4. Fabricate rifle barrel from pipe.

- a. File or drill inside diameter of threaded end of 20 in. pipe for about 1/4 in. so neck of cartridge case will fit in.
- b. Screw reducer onto threaded pipe using pipe wrench.
- c. Screw short threaded pipe into reducer.
- d. Turn 3/8" pipe coupling onto threaded pipe using pipe wrench. All fittings should be as tight as possible. Do not split fittings.

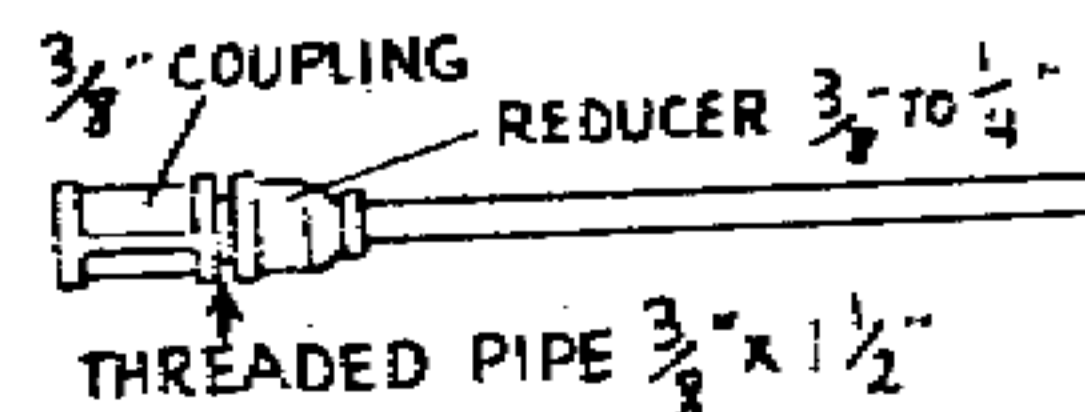

## Scientific Principles of Improvised Warfare and Home Defense

5. Coat pipe and "V" groove of stock with shellac or lacquer. While still wet, place pipe in "V" groove and wrap pipe and stock together using two layers of twine. Coat twine with shellac or lacquer after each layer.

6. Drill a hole through center of pipe plug large enough for nail to pass through.

7. File threaded end of plug flat.

8. Push nail through plug and cut off rounded  $\frac{1}{32}$ " (2mm) past the plug.

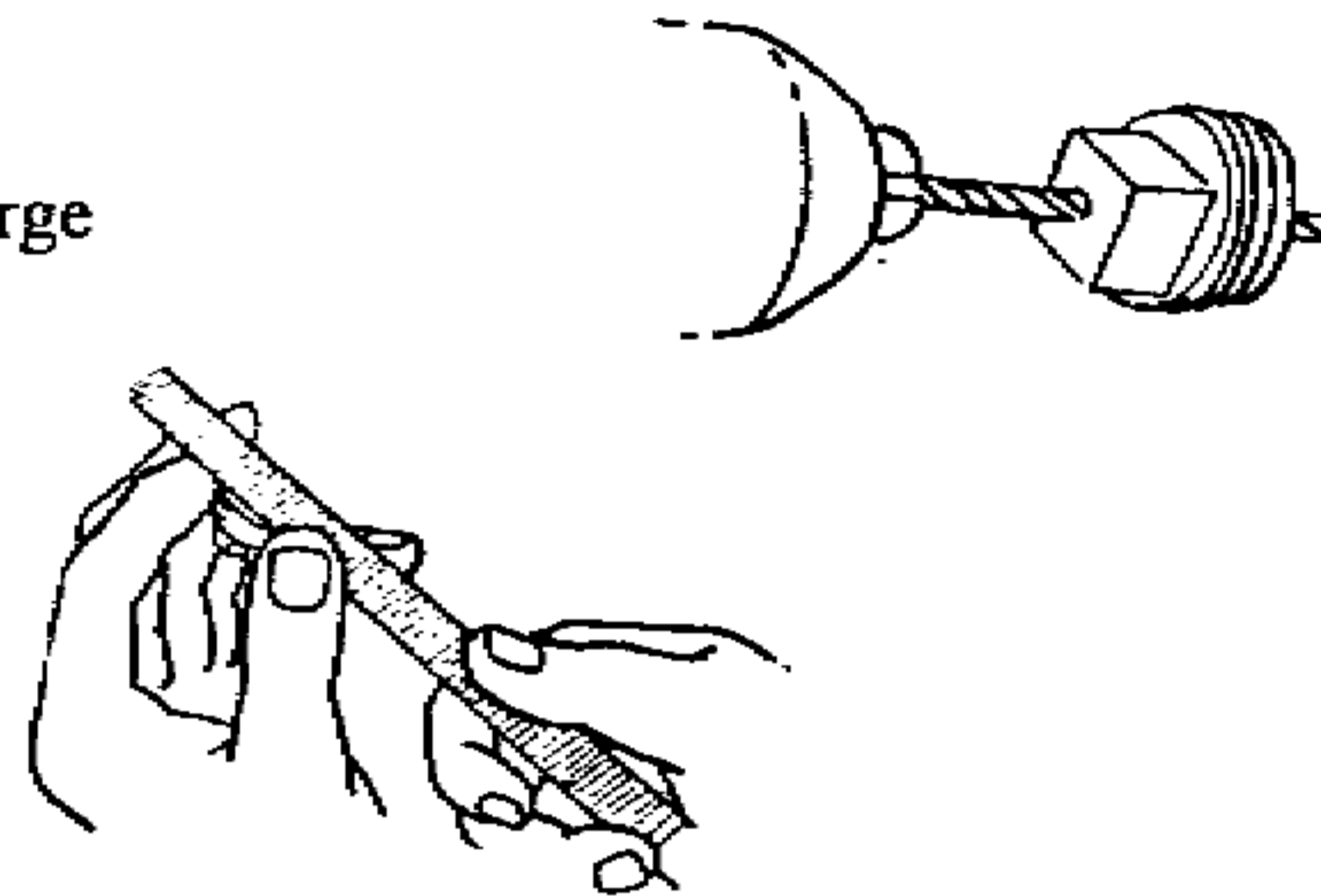

9. Screw plug into coupling

10. Bend 4" metal strap into "L" shape and drill hole for wood screw. Notch metal strap on the long side  $\frac{1}{2}$ " from bend.

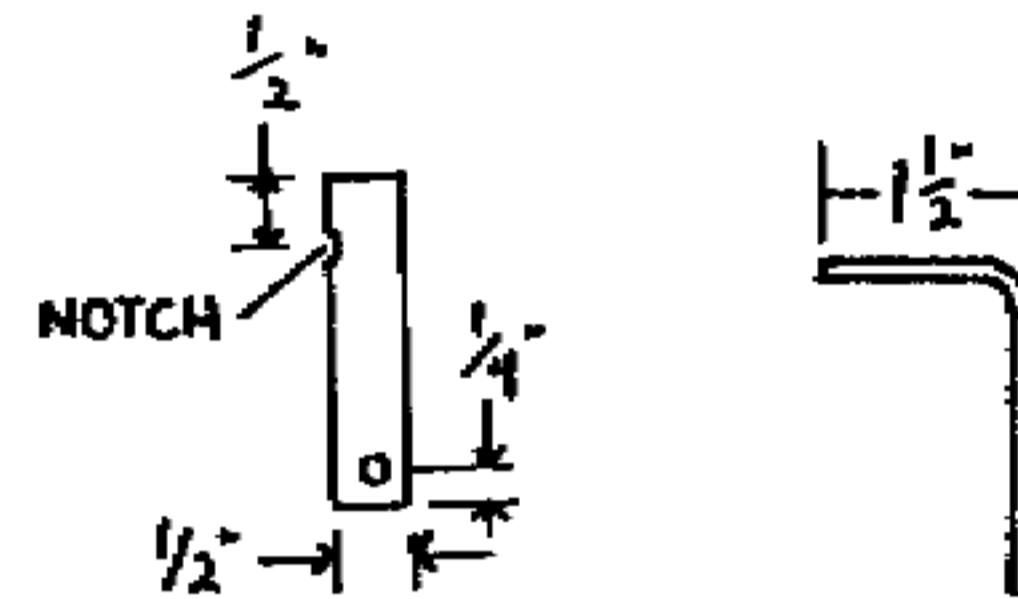

11. Position metal strap on stock so that top will hit the head of the nail. Attach to stock with wood screw.

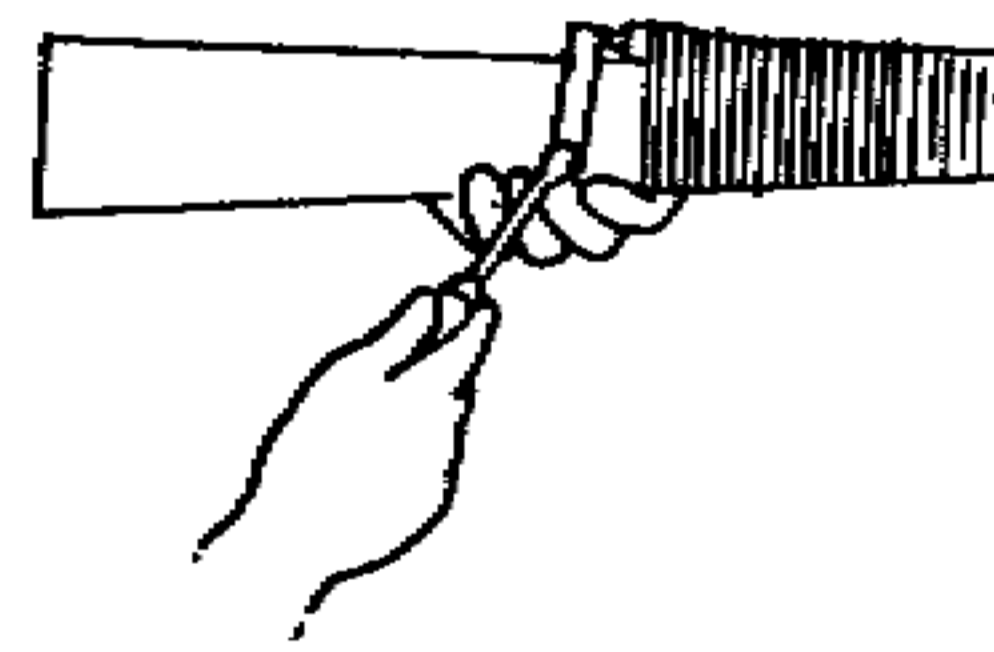

12. Place screw in each side of stock about 4 in. in front of metal strap. Pass elastic bands through notch in metal strap and attach to screw on each side of the stock.

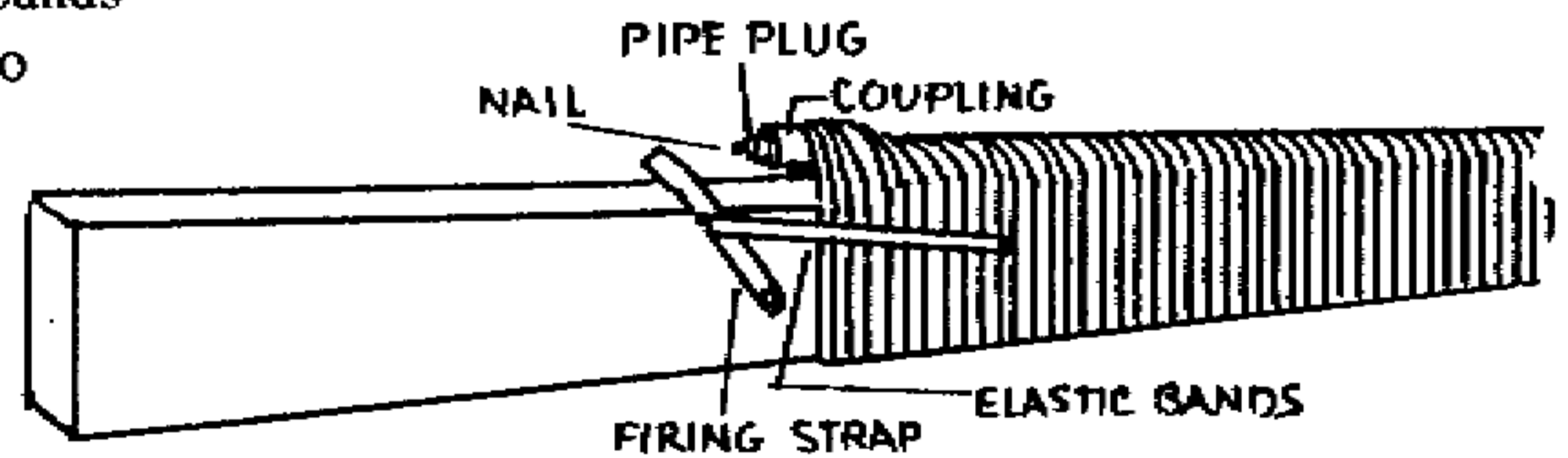

# Scientific Principles of Improvised Warfare and Home Defense

Safety Check- Test Fire before hand firing (follow instructions for pipe pistols)

## How to operate Rifle

### 1. To load

- a. Remove plug from coupling
- b. Put cartridge into pipe
- c. Screw plug hand-tight into coupling



### 2. To fire

- a. Pull strap back and hold with thumb
- b. Release strap

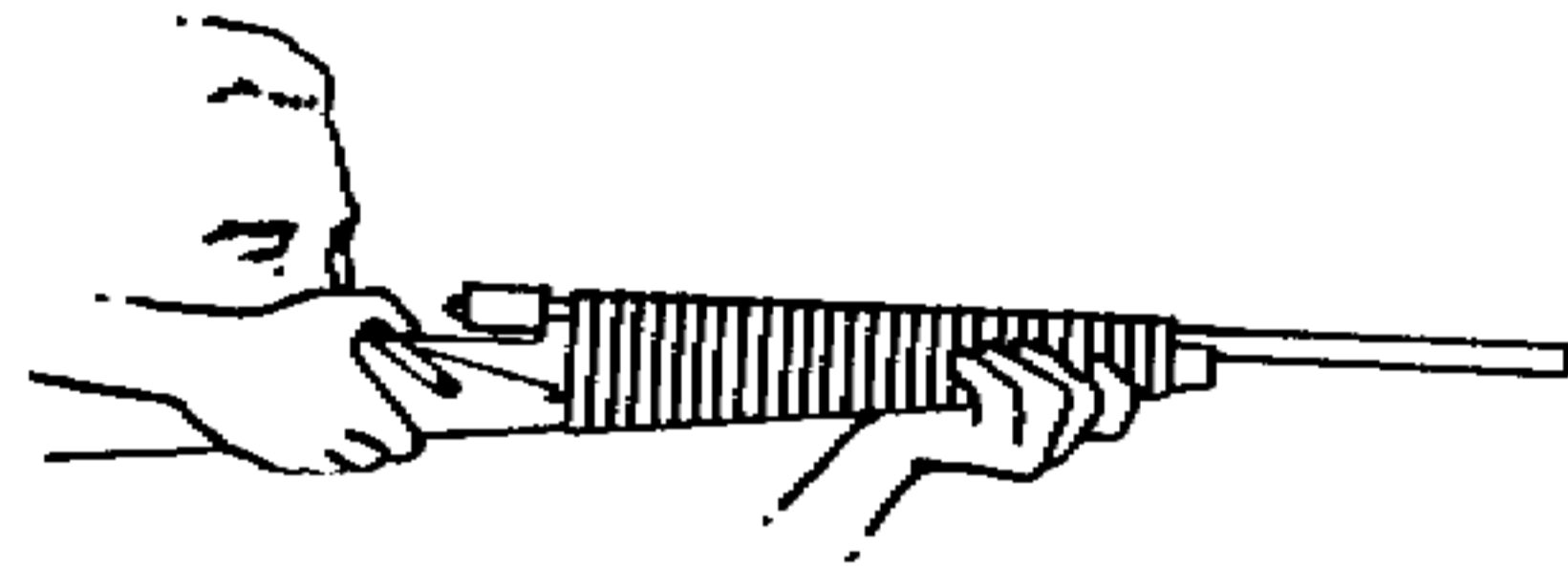

### 3. To unload gun

- a. Take plug out of coupling
- b. Drive out used case using stick or twig



## Scientific Principles of Improvised Warfare and Home Defense

### 6) Match Gun

An improvised weapon using safety match heads as the propellant and a metal object as the projectile. Lethal range is about 40 yards.

#### Materials required

Metal pipe 24" (61cm) long and 3/8" (1cm) in diameter, threaded on one end.

End cap to fit pipe

Safety matches - 3 books of 20 matches each

Wood - 28" x 4" x 1" (70cm x 10cm x 2.5cm)

Toy caps or safety fuse or strike anywhere matches (2)

Electrical tape or string

Metal strap, about 4" x 1/4" x 3/16" (10cm x 6mm x 4.5mm)

2 Rags about 1" x 12" and 1" x 3" (2.5cm x 30cm and 2.5cm x 8cm)

Wood screws

Elastic bands

Metal object (steel rod or bolt with head cut off 7/16" (11mm) in diameter

7/16" long (11mm) if iron or steel

1-1/4" long (31mm) if aluminum

5/16" long (8mm) if lead

Metal Disk 1 in. (2.5cm) in diameter and 1/16 in. (1-1/2mm) thick

Bolt, 3/32 in. (2.5mm) or smaller in diameter and nut to fit

Saw or Knife

#### Procedure

1. Carefully inspect pipe and fittings. Be sure that there are no cracks or flaws.

2. Drill small hole in center of end cap. If safety fuse is used, be sure it will pass through this hole.

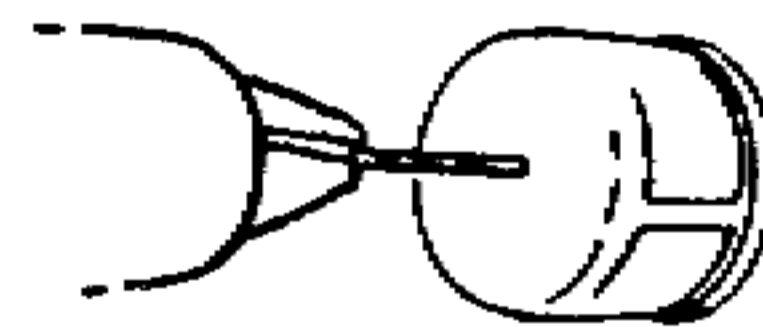

3. Cut stock from wood using saw or knife.

Metric	English
5cm	2 in.
10cm	4 in.
36cm	14 in.
71cm	28 in.

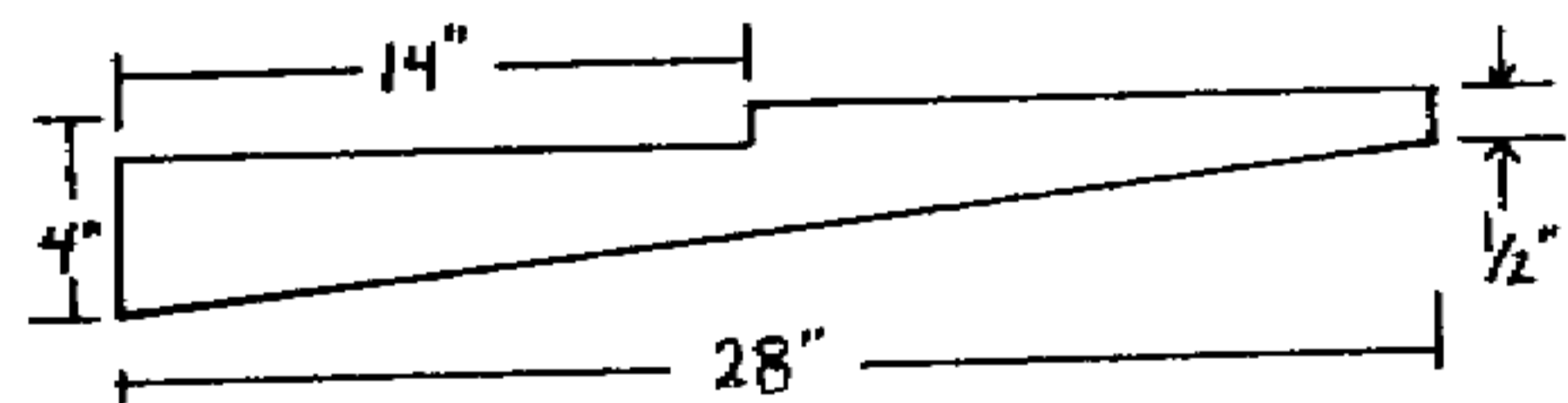

4. Cut 3/8 in. (9.5mm) deep "V" groove in top of stock.

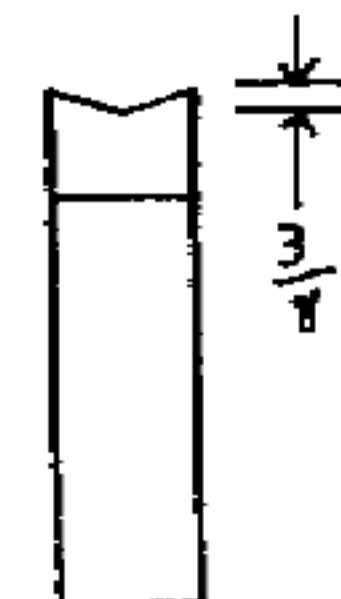

## Scientific Principles of Improvised Warfare and Home Defense

5. Screw end cap onto pipe until finger tight.

6. Attach pipe to stock with string or tape.



7. Bend metal strap into "L" shape and drill holes for wood screw. Notch metal strap on long side 1/2 in. (1cm) from bend.

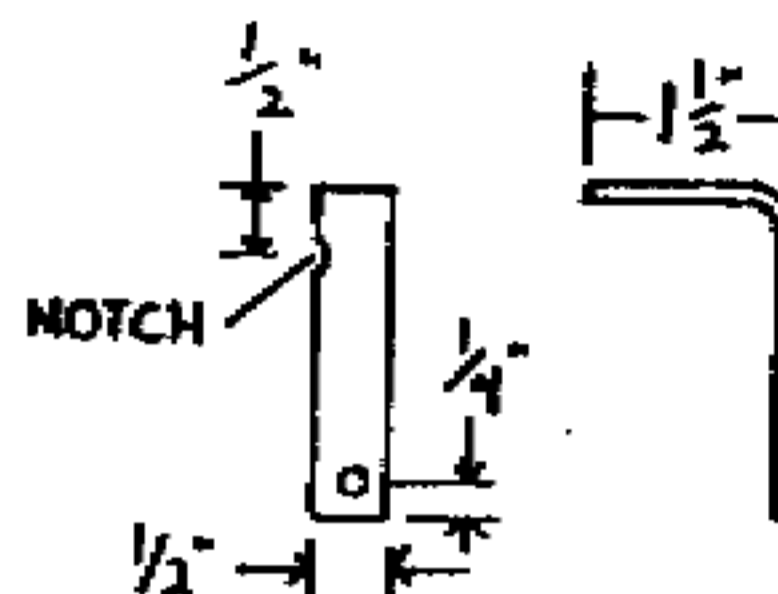

8. Position metal strap on stock so that the top will hit the center of the hole drilled in end cap.

9. Attach metal disk to strap with nut and bolt. This will deflect blast from hole in end cap when gun is fired. Be sure that head of bolt is centered on hole in end cap.

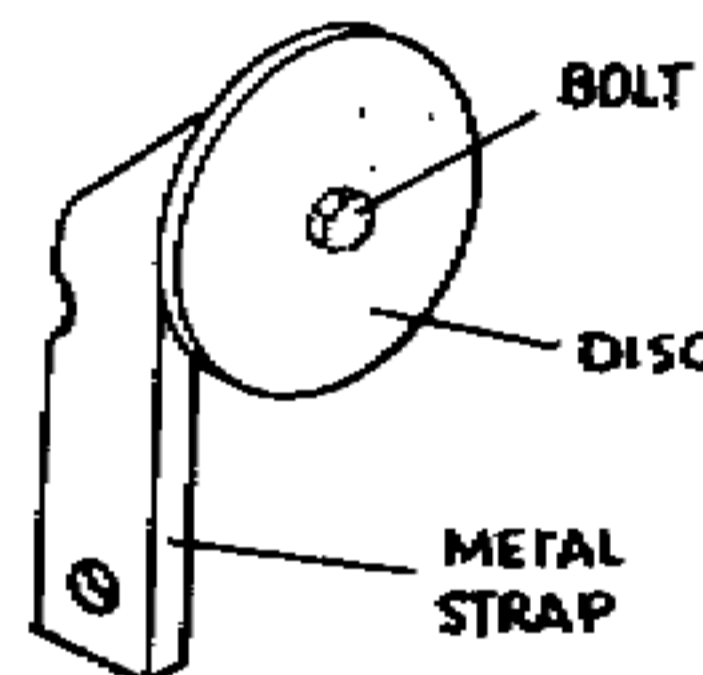

10. Attach strap to stock with wood screws.

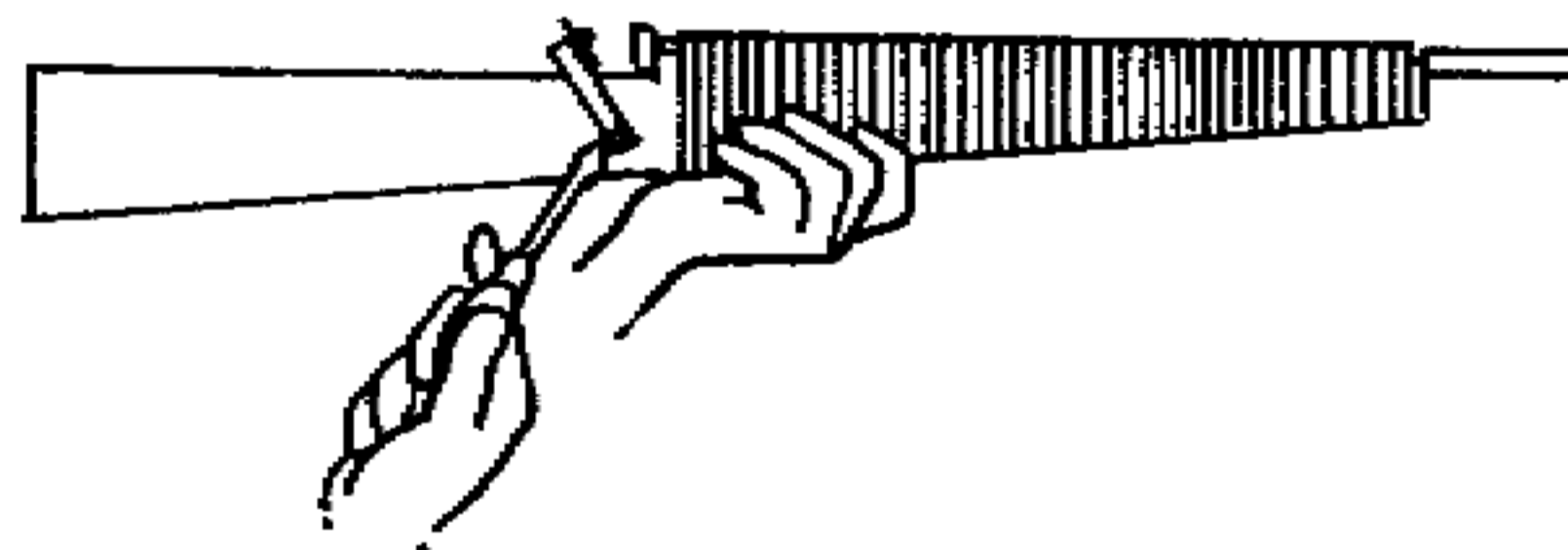

11. Place screw on each side of stock about 4 in. (10cm) in front of metal strap. Pass elastic bands through notch in metal strap and attach to screw on each side of stock.



# Scientific Principles of Improvised Warfare and Home Defense

## How to Use

### A. When toy caps are available

1. Cut off match heads from 3 books of matches with knife. Pour match heads into pipe.
2. Fold one end of 1" x 12" rag 3 times so that it becomes a one inch square of 3 thicknesses. Place rag into pipe to cover match heads, folded end first. Tamp firmly WITH CAUTION.

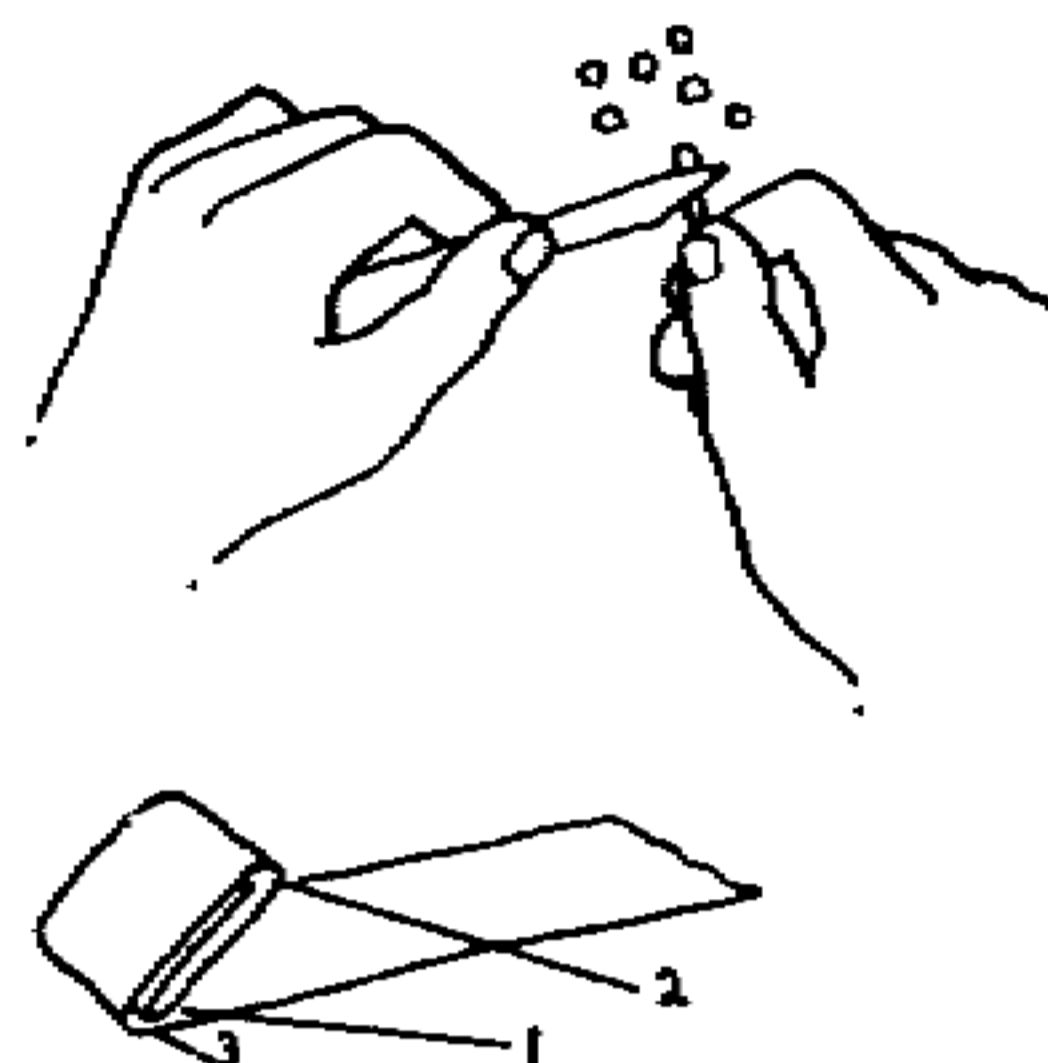

3. Place metal object into pipe. Place 1" x 3" rag into pipe to cover projectile. Tamp firmly WITH CAUTION.
4. Place 2 toy caps over small hole in end cap. Be sure metal strap will hit caps when it is released.

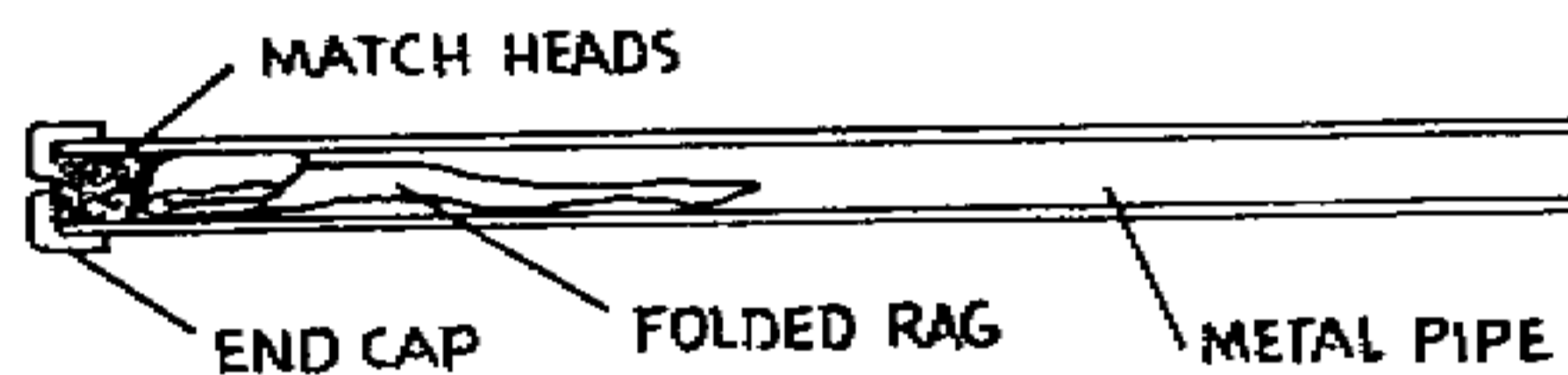

**Note:** It may be necessary to tape toy caps to end cap.

5. When ready to fire, pull metal strap back and release.

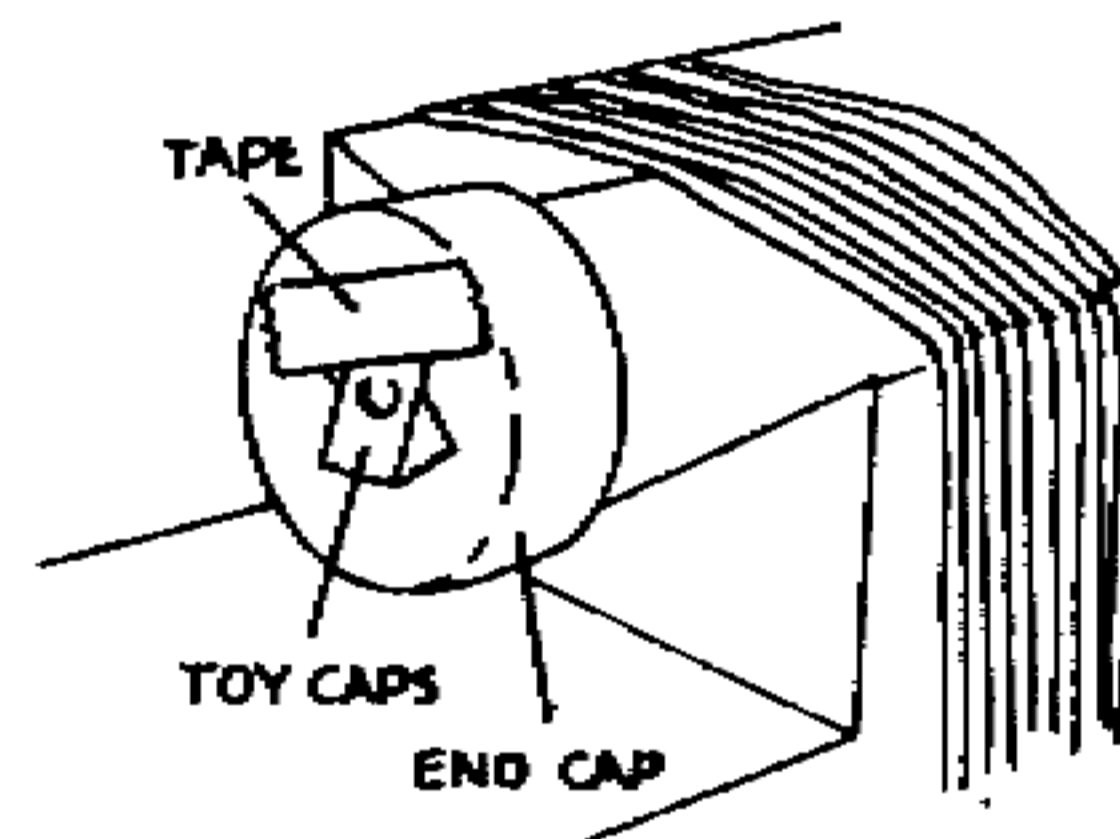

### B. When "Strike Anywhere Matches" are available

1. Follow steps 1-3 in "A".
2. Carefully cut off tips of heads of 2 "strike anywhere" matches with knife.
3. Place one tip in hole in end cap. Push in with wooden end of match stick.
4. Place second match tip on a piece of tape. Place tape so match tip is directly over hole in end cap.
5. When ready to fire, pull metal strap back and release.

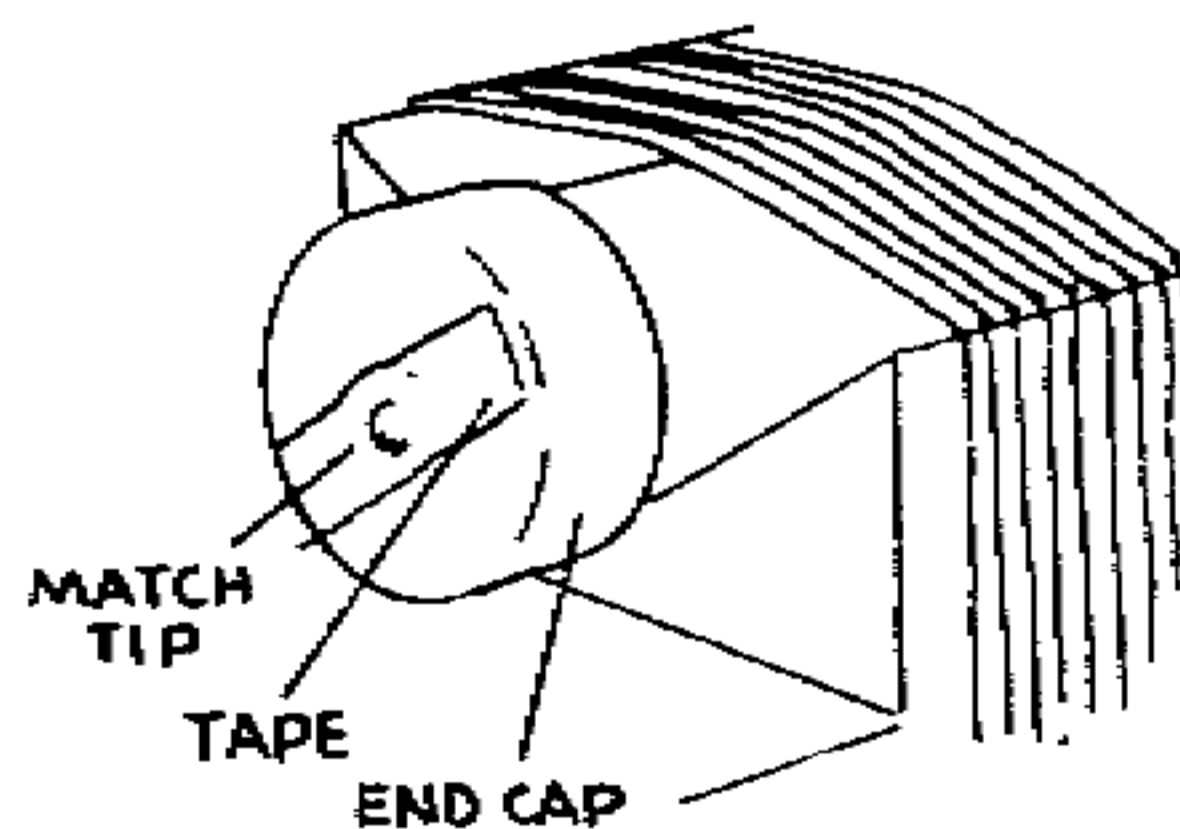
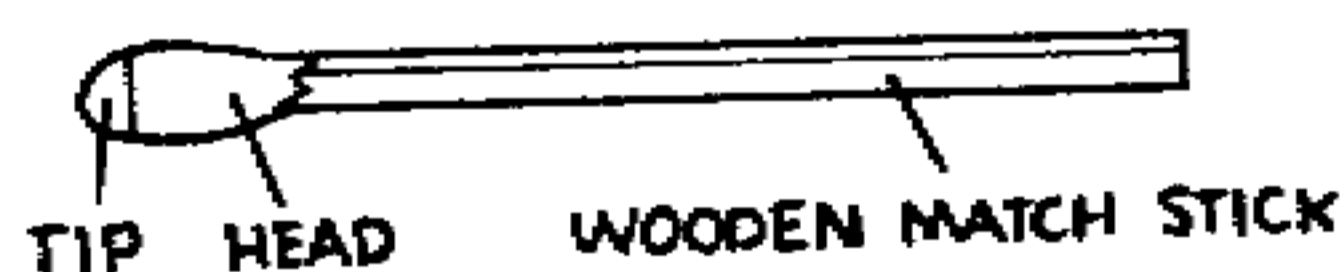

## Scientific Principles of Improvised Warfare and Home Defense

### C. When safety fuse is available: (Recommended for booby traps)

1. Remove end cap from pipe. Knot one end of safety fuse. Thread safety fuse through hole in end cap so that knot is on inside of end cap.
2. Follow steps 1-3 in "A".
3. Tie several matches to safety fuse near outside of end cap.

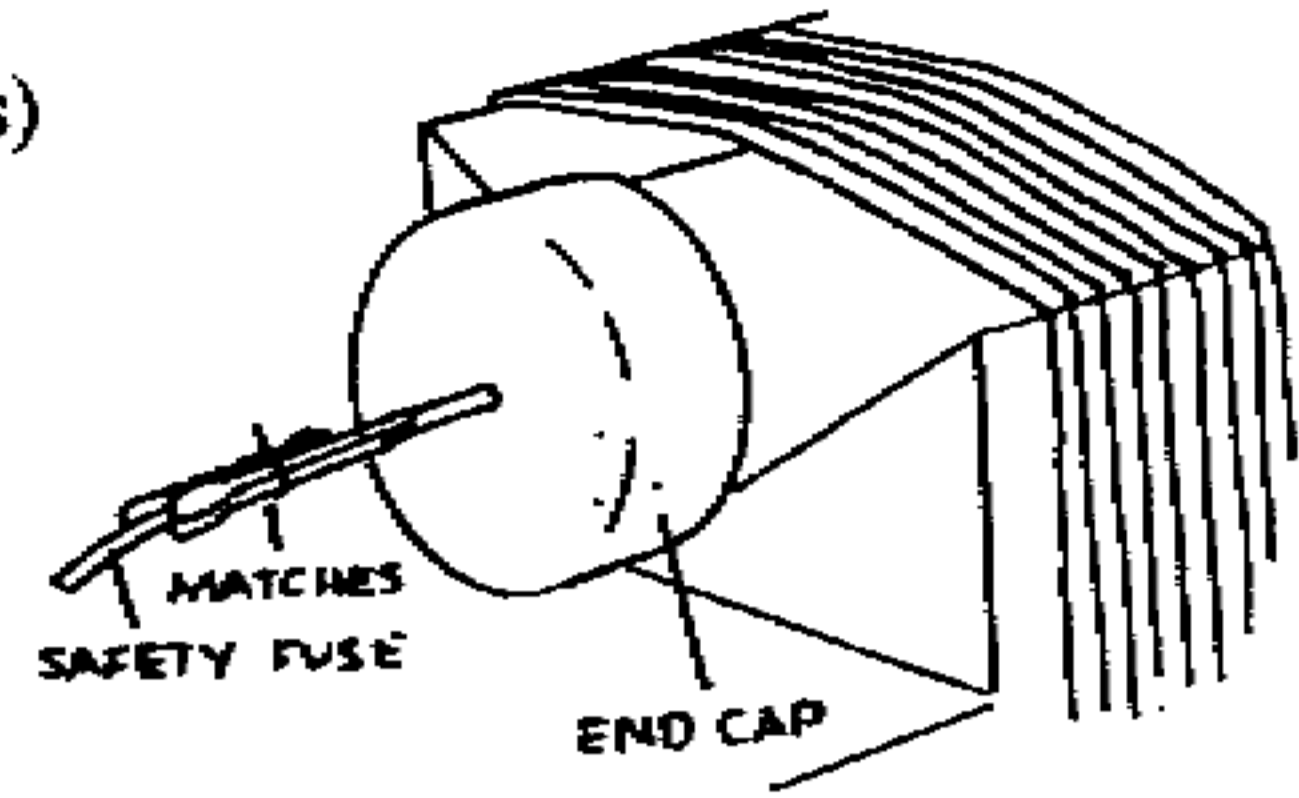

**Note:** Bare end of safety fuse should be inside match head cluster.

4. Wrap match covers around matches and tie. Striker should be in contact with match bands.
5. Replace end cap on pipe.
6. When ready to fire, pull match cover off with strong, firm, quick, motion.

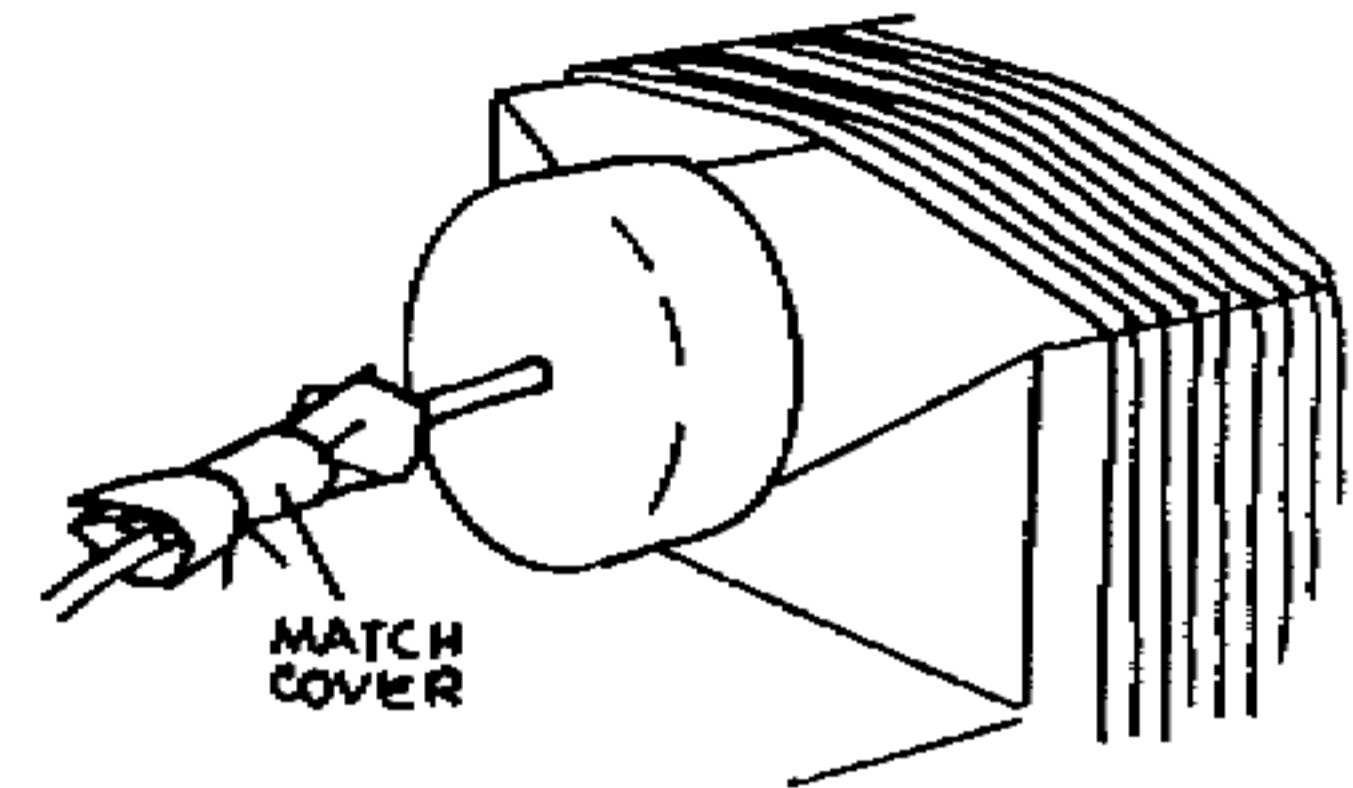

# Scientific Principles of Improvised Warfare and Home Defense

## Chapter 3 Chemistry Manufacture and use of explosives

The power generated by an explosive depends on

- 1) A small volume of liquid or solid explosive chemicals, that are capable , under detonating conditions, of changing into a large volume of gas, and at high temperature.
- 2) That this change takes place instantaneously and results in an enormous expanding force at the moment of detonation.
- 3) Most explosives require two types of materials
  - a. An oxygen source such as air, liquid oxygen, or an oxidizer such as a nitrate or chlorate
  - b. A combustible that burns in the presence of oxygen, such as gasoline or wood.
  - c. The materials must be intimately mixed so the burning is rapid and complete
  - d. A source of high heat causes the burning reaction to begin

An example is the basic chemical explosive reaction of black powder

### Black Blasting Powder

Potassium Nitrate (KNO <sub>3</sub> )		20 Moles
Charcoal	(C)	30 Moles
Sulfur	(S)	10 Moles

These ingredients are finely ground and thoroughly mixed to

- 1) bring all parts of the combustible (C and S) material into
- 2) close contact with the oxidizing ingredient (the KNO<sub>3</sub>).

This favors rapid and complete combustion. When this mixture is detonated, the Carbon (C) burns in the presence of an excess of oxygen and CO<sub>2</sub> is formed, or CO if there is a shortage of oxygen. When the carbon is present in large lumps (as in charcoal briquettes) and burns in air the combustion is slow and occurs on the surface. You can use the slow heat of this combustion to cook with. In the form of dust mixed with the oxygen source, the reaction is rapid and results in an explosion when all the conditions are met. Examples of dust explosions in mines and feed mills are plentiful.



## Scientific Principles of Improvised Warfare and Home Defense

The reaction is

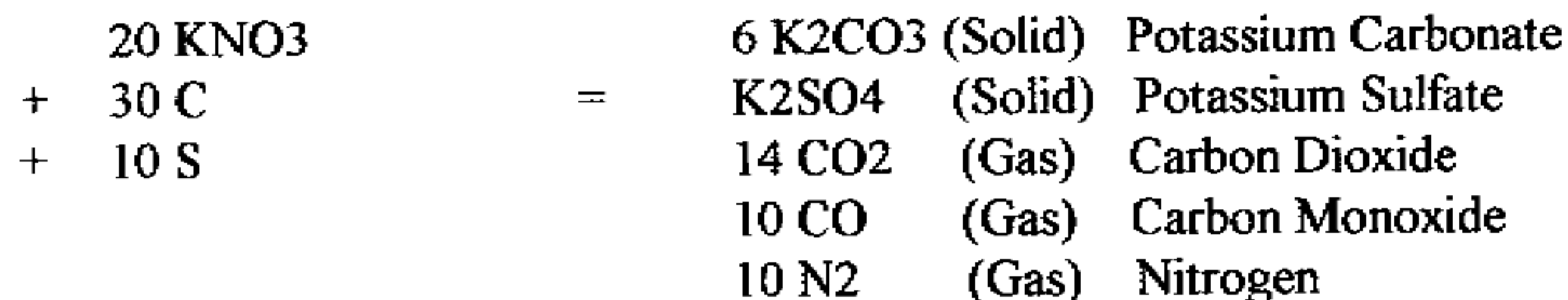

This explosion is accompanied by the evolution of heat (2000-3000 degrees F) which expands the gases to a very large volume creating very high pressure. The Nitrate supplied the oxygen for the combustion of Sulfur and Charcoal and does not need Oxygen from the air.

When Nitroglycerin (NG) explodes the reaction is

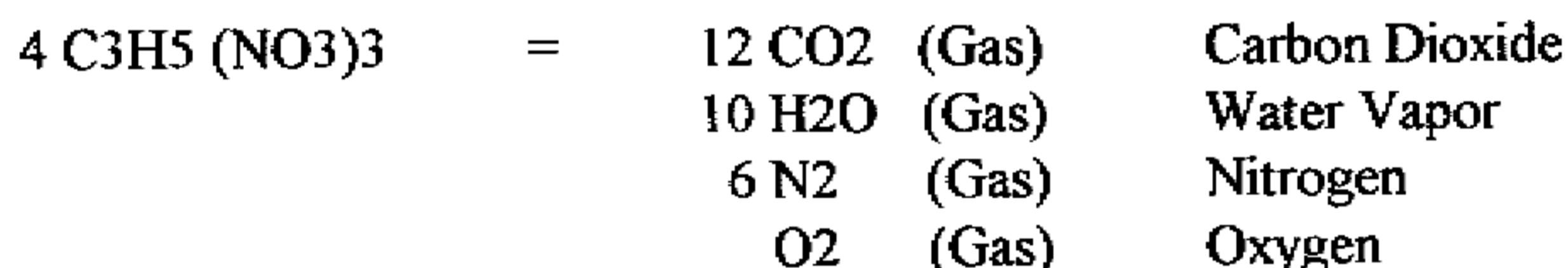

This reaction proceeds so rapidly that if you had a pipe 5 miles long filled with NG and you detonate one end with a blasting cap, the entire column would be converted to gas in about 1 second. The high temperature of explosion causes atmospheric pressures of about 1,000 times the volume of the original NG. The nitroglycerin contains both the oxygen and combustible making it a true explosive.

# Scientific Principles of Improvised Warfare and Home Defense

## Basic Ingredients of Commercial Explosives

<u>Ingredient</u>	<u>Formula</u>	<u>Function and Form</u>	
Nitroglycerin	$C_3H_5(NO_3)_3$	Explosive Base	Liquid, High Explosive
Nitrocellulose	$(C_6H_7(NO_3)_3 O_2)_x$	Explosive Base Gelatinizing Agent	Solid, Highly Flammable Explosive when dry
Nitrostarch	$(C_6H_7(NO_3)_3 O_2)_x$	Explosive Base	White Powder Highly Flammable Explosive when Dry
Ammonium Nitrate	$NH_4NO_3$	Explosive Base Oxygen Carrier	Solid, Hard to Detonate alone, Water Soluble
Potassium Chlorate	$KClO_3$	Explosive Base Oxygen Carrier	Highly Explosive when mixed with combustible Water Soluble
Potassium Perchlorate	$KClO_4$	Explosive Base Oxygen Carrier	Highly Explosive when mixed with Combustible Low solubility
Liquid Oxygen	$O_2$	Highly Volatile	Highly inflammable when mixed with Carbon
Sodium Nitrate Potassium Nitrate	$NaNO_3$ $KNO_3$	Oxygen Carrier	Not Explosive alone Water Soluble
Wood Pulp or Meal		Absorbent & Combustible	Good absorbent capacity
Ground Coal	$C$	Combustible	
Charcoal	$C$	"	
Flour	$C$	"	
Sulfur	$S$	"	
Chalk	$CaCO_3$	Antacid	

## Scientific Principles of Improvised Warfare and Home Defense

When explosives detonate, they produce gaseous products which may be poisonous and fatal to people using large amounts where ventilation is poor. This was a serious problem in early warships when vapors from reloading large guns were vented into the ship without proper exhausting. It is also a concern in mining and other confined areas.

There are 2 general classes of non nuclear explosives which are practical in warfare.

1) **Black Powders:** which are mixtures of combustible and oxidizing ingredients neither of which is an explosive by itself. These are usually mixtures of

A) Finely ground Coal, Charcoal, Sulfur, or Flour

B) A nitrate salt, liquid oxygen, chlorates, or other oxidizer

**Black Powders** are usually shock insensitive low explosives. This means that they explode by burning very rapidly and produce a heaving type of shock wave. They are used as propellants, slow fuses and to create the shock wave (primer) to set off a secondary detonating compound which creates a powerful shock wave to ignite an insensitive but powerful main charge. The normal formula by weight is 72% nitrate salt, 15% charcoal and 10% Sulfur. Granulation size affects how fast the powder burns. Fine, flour like powders burn very fast and can shatter surrounding constructions. Coarse, nugget like granules detonate with a slower heaving effect which "shoves" the surroundings breaking it into large pieces rather than shattering.

2) **High Explosives:** are materials where at least one ingredient is an explosive by itself. High explosives detonate much more rapidly than black powders.

All explosives exert equal pressure in all directions when detonated. When a black blasting powder is detonated on top of a rock it is unconfined and dissipates into the air without damaging the rock. High explosives under the same conditions may break the rock beneath it without confinement. Demolition experts usually drill holes into the mine rock or building supports to insure that the detonation shock wave is directed into the targeted structures.

Waxes, Oils, and other plasticizers (Vaseline for example) are added to suitable high explosives to allow a charge to be shaped or molded into a desired form. This allows the focusing of shock waves into small areas and are used in anti-armor and nuclear explosives designs.

## **Scientific Principles of Improvised Warfare and Home Defense**

We will describe the commercial manufacture and properties of several explosives ingredients here

### **Nitroglycerin**

Is manufactured by dropping glycerin through cooled Nitric Acid. This can be done by placing the Nitric Acid in a thick glass jar and encasing it in ice cubes. If the temperature rises during this reaction, it may explode. The mixture is stirred and washed repeatedly with water. Nitroglycerin is extremely sensitive to shock and heat and is a severe explosion risk in this form. It is widely used in the manufacture of other explosives that are not sensitive and are safe to store and handle.

### **Ammonium Nitrate**

Can be obtained in fertilizer form, or produced by the reaction (mixing) of Ammonia and Nitric Acid. The manufacture is accomplished by

- 1) Slowly adding Ammonia to Nitric Acid until the solution is neutralized and ensuring the temperature does not exceed 200 degrees C.
- 2) Evaporating off the water.
- 3) Grinding down to a fine usable powder without creating a spark which might ignite it.

### **Potassium Chlorate/Perchlorate**

May be obtained from fertilizer/feed outlets. The improvised manufacture of Sodium Chlorate is described presently. The Potassium salt may be made by the same method by using Potassium Chloride as the starting material. Potassium Chlorate can also be obtained as the substance found on the end of striking matches which may be scraped off and used.

### **Liquid Oxygen**

Obtained from chemical and welding supply houses. When mixed with finely ground Carbon source it forms a separate class of high explosives.

### **Potassium and Sodium Nitrate**

Manufactured by reacting (neutralizing) Nitric Acid with Sodium or Potassium Bicarbonate (Baking Soda) to a neutral solution and allow to dry. Can be improvised from soil.

# Scientific Principles of Improvised Warfare and Home Defense

## Wood Pulp/Meal

Sawdust and other forms obtained from the lumber industry. Must be fine (dust).

## Nitrocellulose

Sensitive high explosive used mainly as a propellant. Made from mixing Nitric Acid and cellulose. Improvised manufacture from paper is described presently.

## Picric Acid

Also known as Lyddite, Melenite, or Trinitrophenol, it was the main shell filler used by the allies in W.W.I. It is manufactured from reacting Phenol, Nitric Acid, and Sulfuric Acid. Its improvised extraction from Aspirin is described later. Will stain all contact surfaces a bright yellow.

## Ammonium Picrate

High Explosive, insensitive, used for Anti Tank shells. Manufactured by reacting Ammonia with Picric Acid until neutral and then dry and grind to a powder.

## Trinitrotoluene (TNT)

Made from reacting Toluene with Nitric Acid. This is the main high explosive used in WW2. It is insensitive and safe to handle. Is used to reduce freezing point in explosive formulations. Produces high levels of poisonous CO and should not be used in mines or other unventilated locations requiring later access.

## Amatol

A mixture of TNT and Ammonium Nitrate. It is an insensitive high explosive used as the principle air dropped bomb filler in WW2.

## Mercury Fulminate

Made from Mercury, Nitric Acid and Alcohol, it is a shock sensitive high explosive used as a primer, detonator and is easily ignited by spark, flame, friction, or shock.



# Scientific Principles of Improvised Warfare and Home Defense

## Dynamite

A mixture of Nitroglycerin, Sodium Nitrate, and wood pulp or other combustible. Ammonia dynamite is the addition of ammonium nitrate to the formula. Granulated dynamite is Sodium Nitrate, Sulfur, and Coal, sensitized by Nitroglycerin. Granulated dynamite is a very slow high explosive resembling black powder in detonation properties.

## Gelatin

Nitroglycerin, nitrocotton, Sodium Nitrate, and a combustible mixture. Ammonia Gelatin is the formula with Ammonium Nitrate added. Blasting Gelatin is made by adding Nitroglycerin and nitrocotton and is suitable for mining. Gelatins usually work well in water, can be molded to desired shapes, and produce few noxious fumes. The guncotton dissolved in Nitroglycerin makes a jelly which coats the other explosive ingredients and alters their explosive properties.

## Carbon Source

Finely ground coal, charcoal briquettes, grain dust, etc.

## Flour

Store bought grain flour, finely ground

## Sulfur

From fertilizer and chemical supply houses, drug stores. Commercially mined.

## Gasoline

A mixture of volatile hydrocarbons (Combustible) generally used in incendiary formulations. Can be formulated as a high explosive with an oxidizer and absorbent. Will not explode on its own which is why a full gas tank only burns on the surface where the gas is in direct contact with the oxygen in the air.

An empty gas tank is filled with gasoline vapors which are mixed with air. Both Combustible and Oxygen are present and completely mixed which is why the empty tank can explode.

## Scientific Principles of Improvised Warfare and Home Defense

### \* **Ammonium Chloride and Sodium Chloride** (table salt)

can be added to most formulations to reduce the temperature of detonation. This can be useful if you are trying to preserve part of what you are blowing up (so it doesn't catch fire as easily) such as coal layers during mining.

The properties of all the above can vary widely. Some are sensitive and others are not, some expand quickly, others more slowly. Freezing point, water sensitivity, density and many other properties change with small changes in formula, primer, method of containment and so on. An entire book can be written on every class of explosive by itself.

**"Cushion Blasting"** reduces the shattering effect of high explosives. This is accomplished by leaving air spaces of 6"-12" between the sides and top of the explosive and its containment.

**"Tamping"** is the act of compacting the explosive in a container so that no air spaces are left and allows the confined explosive to develop its full power. If air spaces are left they should be filled with any loose material available such as sand or clay. The stronger the confinement the more complete the explosive reaction. If a larger hole is required for the placing of explosives, it should be drilled out or a small explosive can be used to create a larger space.

### Safety Rules for storing and handling Explosives

Do not store sensitive primers and detonators in the same location as primary explosives.

Do not throw, drag, push or roll explosives when handling. They must be carefully lifted, moved and placed.

Do not make up primers in the storage area.

Do not smoke, have matches, any burning item such as a candle or lamp, firearms or cartridges, in or near the storage area.

Black Powders may cake over time and should be broken up gently before use.

Do not use metallic tools, welding equipment, or allow firearms practice anywhere near the storage facility.

If explosives freeze or get wet allow to air dry or warm. Do not try to apply artificial heat.

# Scientific Principles of Improvised Warfare and Home Defense

## Improvised field explosives

The following descriptions of improvised explosives and raw materials are taken from the improvised munitions manual of the U.S. Army and other sources.

- 1) Improvised Electric Detonator
- 2) Plastic Explosive Filler
- 3) Nitric Acid
- 4) Potassium Nitrate
- 5) Improvised Black Powder
- 6) Initiator for dust explosions
- 7) Fertilizer Explosive
- 8) AN- Aluminum Explosive
- 9) Red/White Powder Propellant
- 10) Nitric Acid Explosive
- 11) Nitrocellulose Explosive
- 12) Methyl Nitrate Dynamite
- 13) Urea Nitrate Explosive
- 14) HMTD Primary Explosive
- 15) Picric Acid from Aspirin
- 16) Sodium Chlorate
- 17) Mercury Fulminate
- 18) Sugar Aluminum Explosive
- 19) Fuel Air Explosive

# Scientific Principles of Improvised Warfare and Home Defense

## 1) Improvised Electric Detonator

The simplest and most widely available system for detonating explosives electrically in the field without commercial supplies is an automobile spark plug attached to a wire run to an ignition coil. The coil can be wired to a battery, or other power source and can include timer or radio controlled circuits where the circuit is open and closed only at the time desired.



If explosives are not available, a small amount of gasoline can be used in a closed container where the vapors have mixed with air. The spark plug and wire are placed in the container and the cap is replaced to close the container. The coil can be wired to a cigarette lighter adapter. The spark ignites the gasoline once the adapter is plugged into an automobile lighter. If your target is an enemy vehicle and its occupants, the spark plug may be placed in the vehicles gas tank and the wire run under the vehicle and attached to a disconnected spark plug wire. When the operator turns the ignition on to start the vehicle the spark ignites to detonate the gas tank.

**Note:** The gas tank must not be full. If the tank is full at least 1/2 must be siphoned out and some air mixed into the tank to create a volatile mixture.

If this type of detonator is used for solid explosives the plug should be placed with a small amount of primer (and gasoline-vaporized) in an enclosed blasting apparatus. The closed end of the primer should be pointed toward the bulk of the main explosive. If possible it should be imbedded in the explosive.

# Scientific Principles of Improvised Warfare and Home Defense

## 2) Plastic Explosive Filler

A plastic explosive filler can be made from potassium chlorate and petroleum jelly.

### Materials Required

Potassium Chlorate  
Petroleum Jelly (Vaseline)  
Piece of round stick  
Wide mixing bowl or container

### Procedure

1. Spread potassium chlorate crystals thinly on a hard surface. Roll the round stick over crystals to crush into a very fine powder until it looks like face powder or wheat flour.

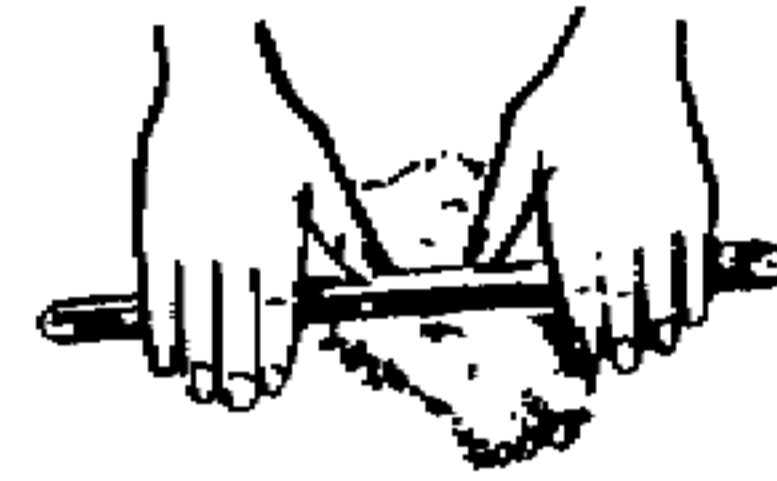

2. Place 9 parts powdered potassium chlorate and one part petroleum jelly in a wide bowl or similar container. Mix ingredients with hands (knead) until a uniform paste is obtained.



**Note:** Store explosive in a waterproof container until ready to use.



# Scientific Principles of Improvised Warfare and Home Defense

## 3 Nitric Acid

Nitric acid is used in the preparation of many explosives, incendiary mixtures, and acid delay timers. It may be prepared by distilling a mixture of potassium nitrate and concentrated sulfuric acid.

### Materials Required

Potassium Nitrate (2 Parts by volume)  
Concentrated Sulfuric Acid  
2 glass or ceramic bottles (narrow necks preferred)  
Pot or Frying Pan  
Heat Source (Wood coal or charcoal)  
Tape- Electrical or masking NOT Cellophane tape  
Paper or rags

### Sources

Drug store/ Fertilizer outlets  
Chemical Supply Stores/Auto Batteries

**Important:** If Sulfuric acid is obtained from auto battery, concentrate it by boiling until white fumes appear. Do not inhale fumes.

The amount of Nitric acid produced is equivalent to the amount of Potassium Nitrate. For 2 parts Nitric Acid use 2 parts Potassium Nitrate and 1 part Sulfuric Acid.

### Procedure

1. Place dry potassium nitrate in bottle or jug. Add sulfuric acid. Do not fill bottle more than 1/4 full. Mix until paste is formed.

**Caution:** Sulfuric and Nitric Acid will burn skin and destroy clothing. If any is spilled, wash it away with a large quantity of water. Fumes are also dangerous and should not be inhaled.

2. Wrap paper or rag around necks of 2 bottles. Securely tape necks of bottles together. Be sure bottles are flush against each other and that there are no air spaces.

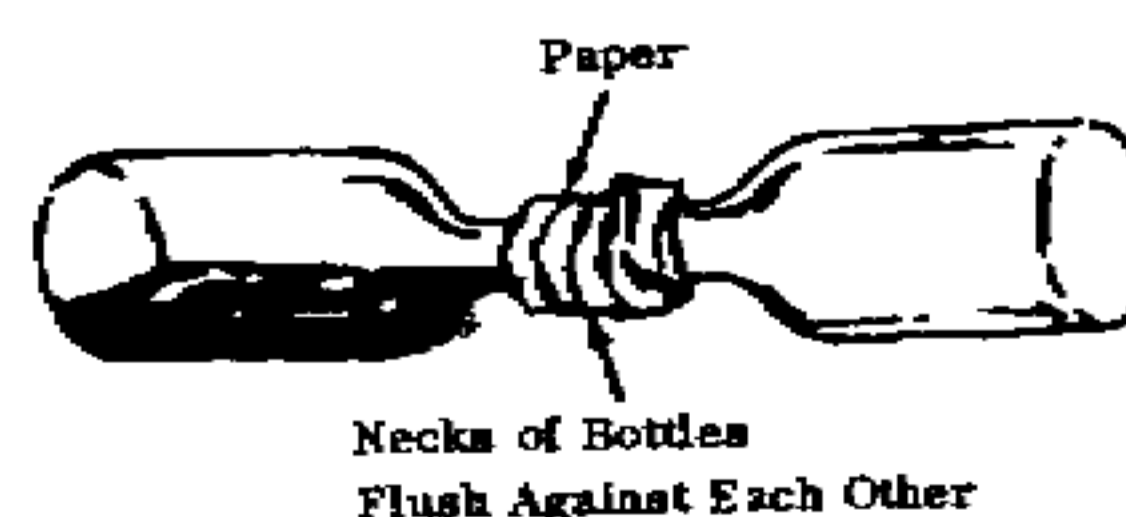
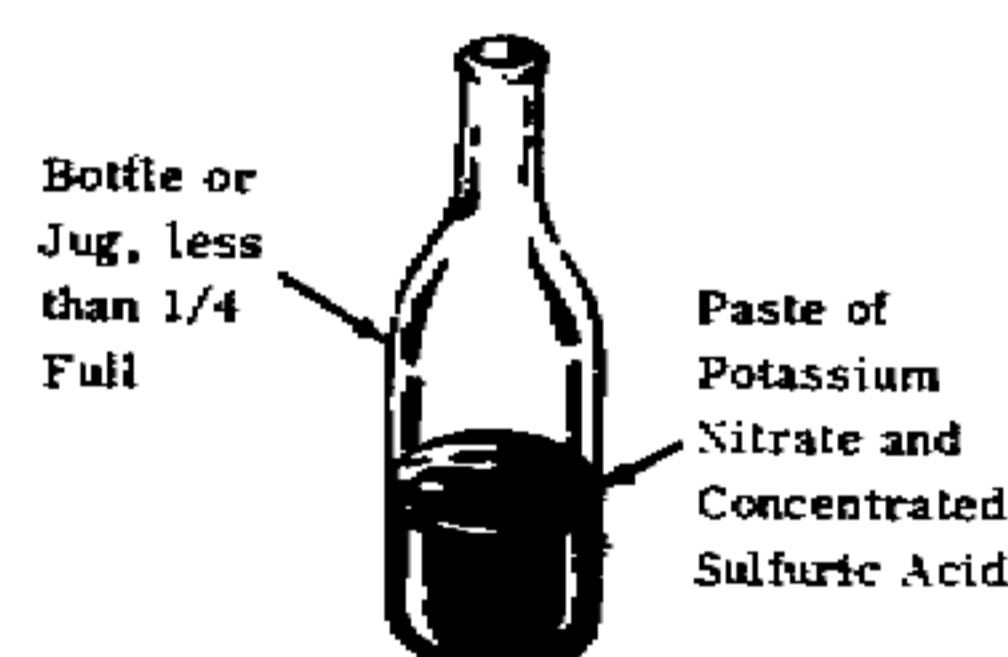

## Scientific Principles of Improvised Warfare and Home Defense

3. Support bottles so that empty bottle is slightly lower than bottle containing paste so that nitric acid that is formed in receiving bottle will not run back into paste bottle.

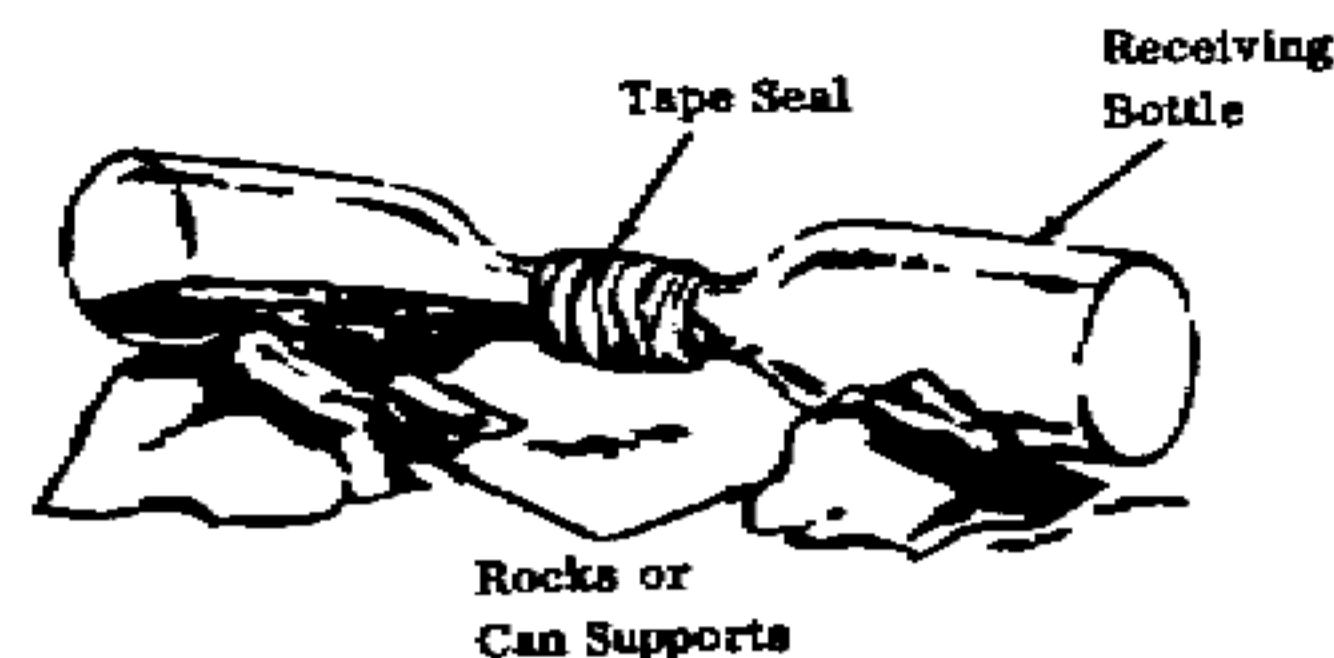

4. Build fire in pot or frying pan.

5. Gently heat bottle containing mixture by moving fire in and out. As red fumes begin to appear periodically pour cool water over empty receiving bottle. Nitric acid will begin to form in the receiving bottle.



**Caution:** Heat bottle slowly or it may shatter. If necessary place bottle to be heated in container filled with sand or gravel. By heating this outer container the heat transfer is gradual.

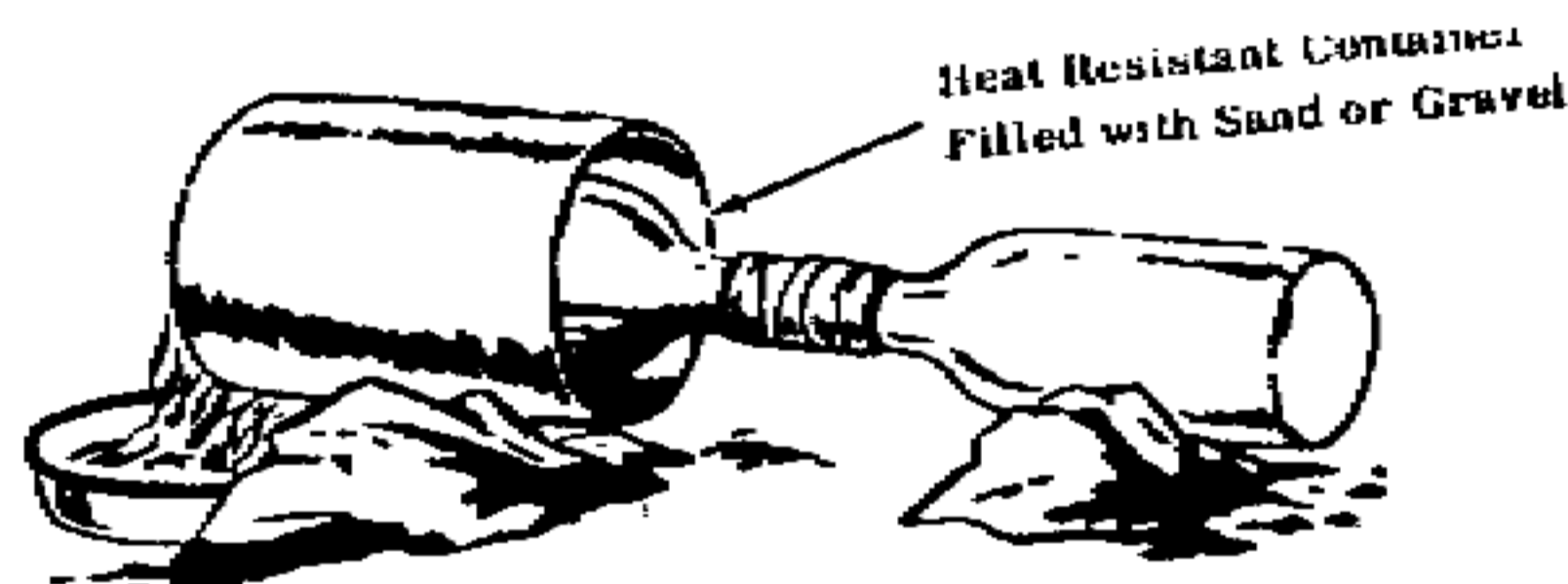

6. Continue heating until no more red fumes are formed. If the nitric acid is cloudy (not clear) pour into clean bottle and repeat steps 2-6.

Nitric Acid should be kept away from all combustibles and should be kept in a sealed glass or ceramic container.

## Scientific Principles of Improvised Warfare and Home Defense

### 4) Potassium Nitrate

Potassium Nitrate (saltpeter) can be extracted from many natural sources and can be used to make nitric acid, black powder and many pyrotechnics. The yield ranges from .1 to 10% by weight, depending on the fertility of the soil.

#### Materials

Nitrate bearing earth or other material,  
about 3.5 gallons (13.5 litres)

Fine wood ashes, about 1/2 cup

Bucket - 5 gallons (19 litres) capacity

2 pieces of finely woven cloth, each  
slightly larger than the bottom of the bucket.

Shallow pan or dish as wide as bucket bottom  
Shallow heat resistant container  
Water - 1-3/4 gallons (6-3/4 litres)  
Awl, knife, screwdriver or other hole producing  
instrument  
Alcohol, about 1 gallon (4 litres)  
Heat source  
Paper  
Tape

#### Source

Soil containing old decayed vegetable or  
animal matter  
Old Cellars or farm dirt floors  
Earth from old burial grounds  
Decayed stone or mortar building foundation

Totally burned whitish wood ash powder  
Totally burned paper (black)

[Authors Note: Historically, commercial amounts of Potassium Nitrate (Saltpeter, Niter) were produced from the mixtures of manure and earth in pigsties and horse stables where the nitre was produced by the bacterial action on the manure. Generally, the mix was boiled in water, sometimes with the addition of potash or lime and poured off. The resulting solution was boiled until water evaporated to the point where the ordinary salts precipitated out. The remaining solution contains concentrated potassium nitrate. It was obtained by pouring off the water and allowing it to cool and/or evaporate leaving behind fairly pure crystals. This was the source for all nitre for gunpowder and Nitric Acid production until commercial production of Nitric Acid from Ammonia and other sources became widely available in the 1900's.]

# Scientific Principles of Improvised Warfare and Home Defense

## Procedure

1. Punch holes in bottom of bucket. Spread one piece of cloth over holes inside of bucket.



Bottom of bucket

2. Place wood ashes on cloth and spread to make a layer about the thickness of the cloth. Place second piece of cloth on top of ashes.

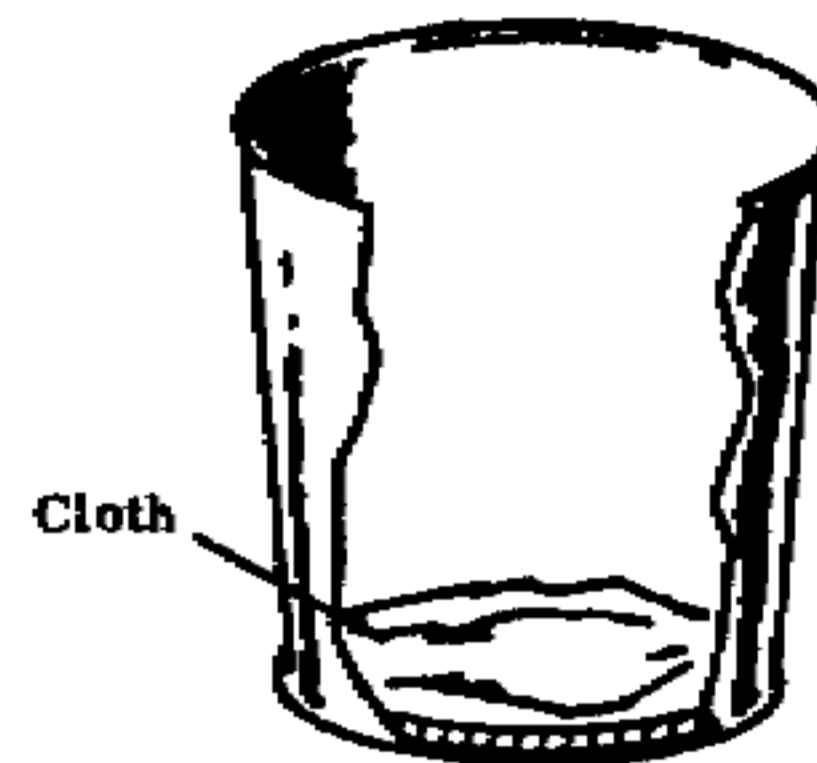

Cloth

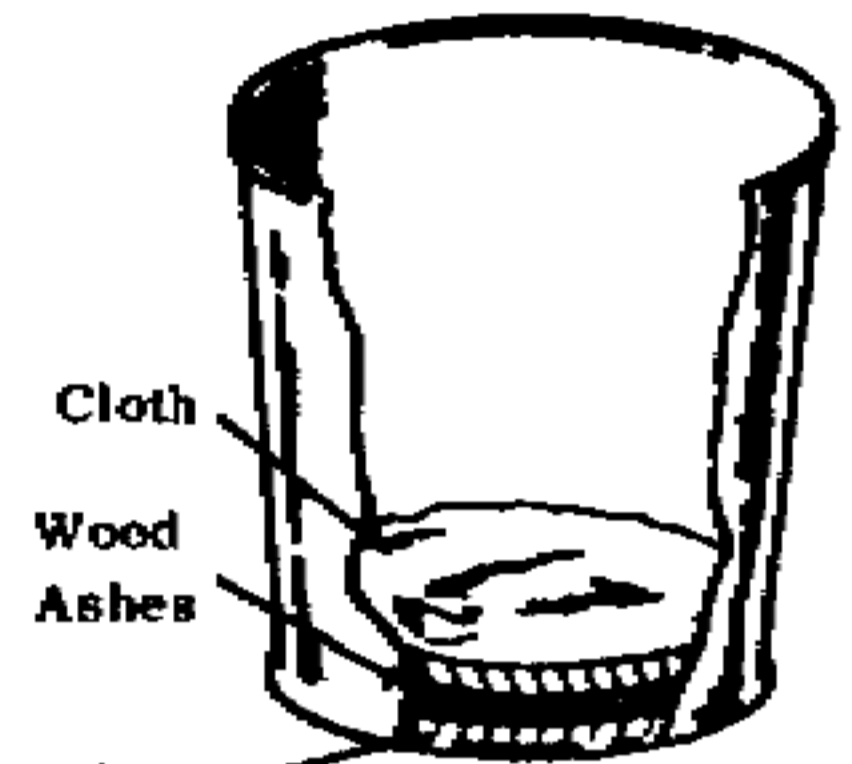

Cloth

Wood Ashes

Cloth

3. Place dirt in bucket.

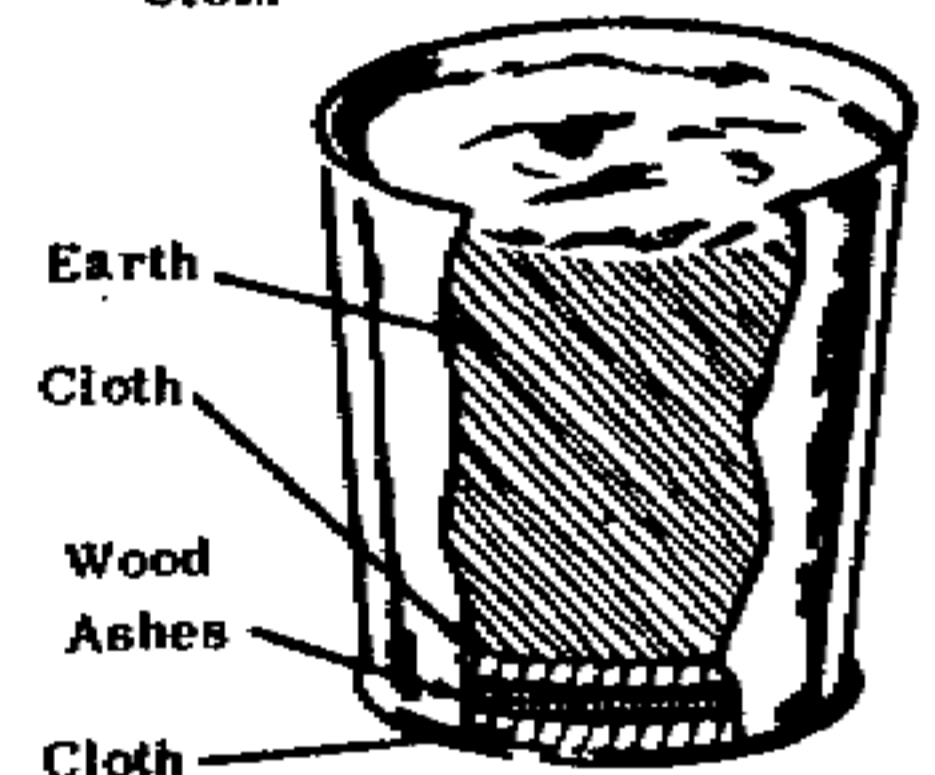

Earth

Cloth

Wood Ashes

Cloth

4. Place bucket over shallow container. Bucket may be supported on sticks if necessary.

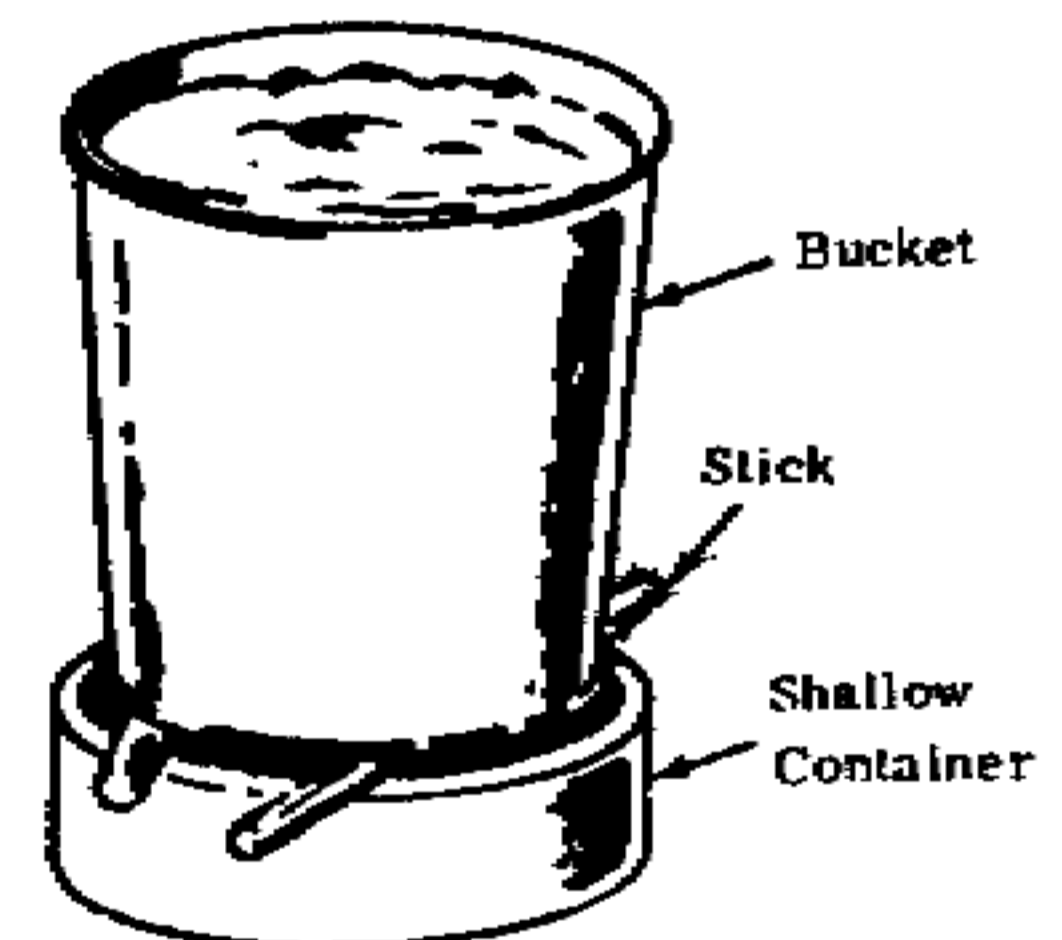

Bucket

Stick

Shallow Container

5. Boil water and pour it over earth in bucket a little at a time. Allow water to run through holes in bucket into shallow container. Be sure water goes through all of the earth. Allow drained liquid to cool and settle for 1-2 hours.

**Note:** Do not pour all the water at once, since this may cause stoppage.

## Scientific Principles of Improvised Warfare and Home Defense

6. Carefully drain off liquid into heat resistant container.  
Discard ant sludge remaining in bottom of shallow container.

7. Boil mixture over hot fire for at least 2 hours. Small grains of salt will begin to appear in the solution. Scoop these out as they form using any type of improvised strainer.

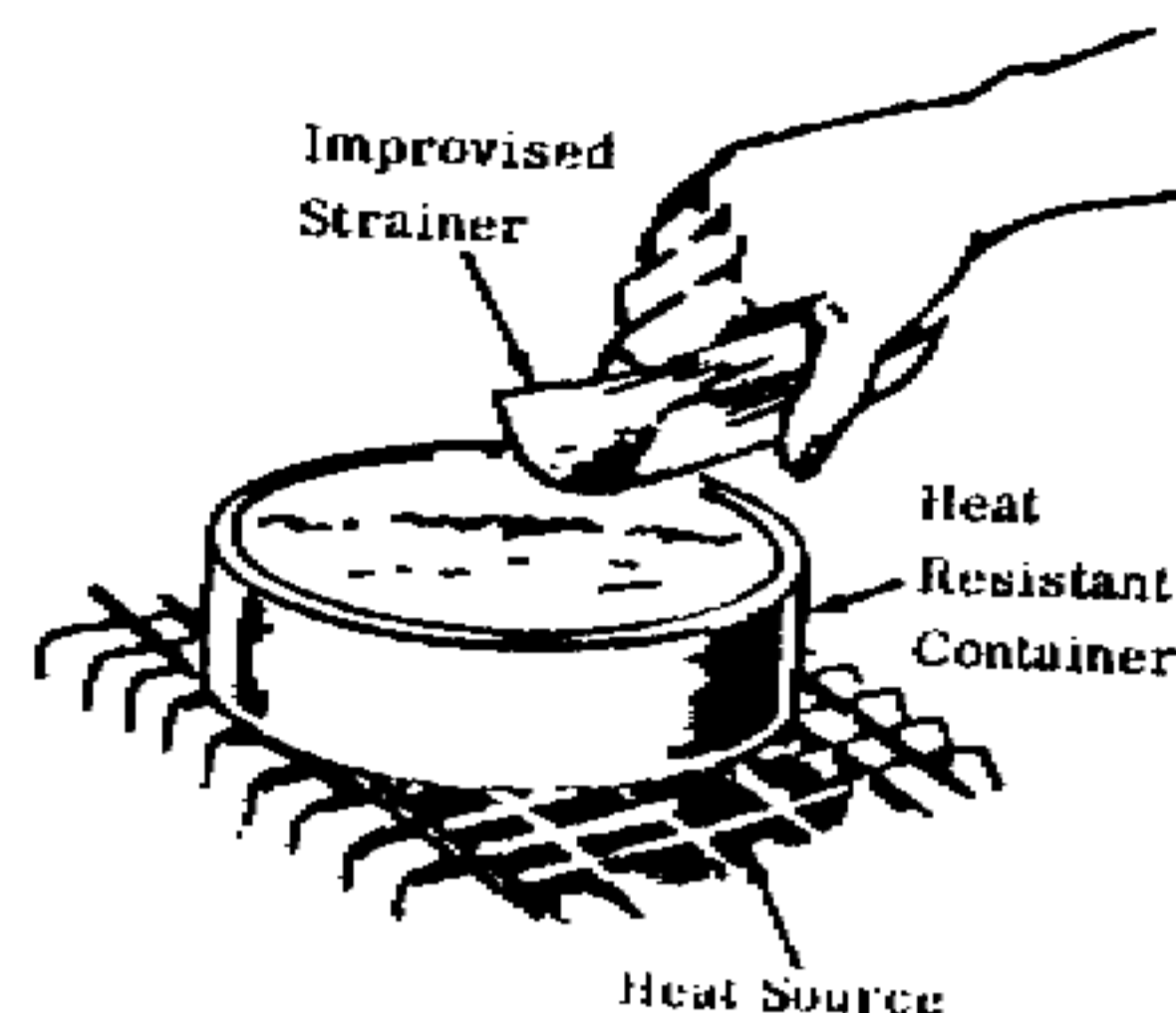

8. When liquid has boiled down to 1/2 its original volume remove from fire and let sit. After 1/2 hour add an equal volume of alcohol. When mixture is poured through paper, small white crystals will collect on top of it.

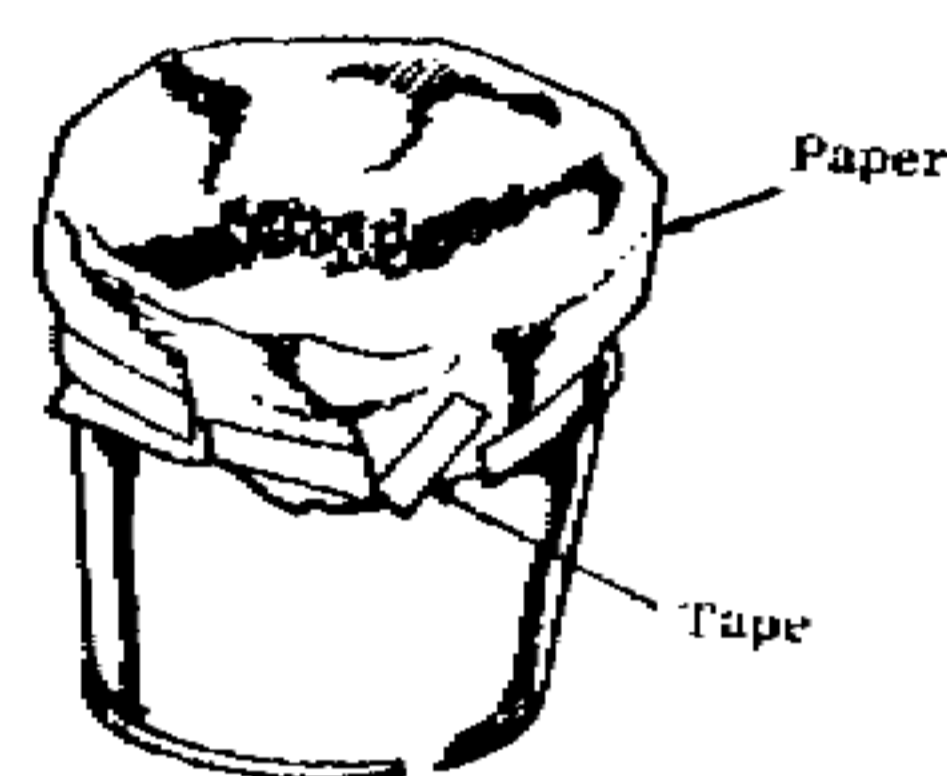

9. To purify the potassium nitrate, re-dissolve the crystals in the smallest amount of boiled water. Remove any salt crystals that appear (Step 7); pour through an improvised filter made of several pieces of paper and evaporate or gently heat the concentrated solution to dryness.

10. Spread crystals on a flat surface and allow to dry. The potassium crystals are now ready to use.



## **Scientific Principles of Improvised Warfare and Home Defense**

### **5) Improvised Black Powder**

Black powder can be prepared in a simple, safe manner. It may be used as blasting or gun powder.

#### **Material Required**

Potassium Nitrate, granulated, 3 cups (3/4 litre)  
Wood charcoal, powdered, 2 cups (1/2 litre)  
Sulfur, powdered, 1/2 cup (1/8 litre)  
Alcohol, 5 pints (2.5 litres)  
Water, 3 cups  
Heat source  
2 buckets - each 2 gallon (7.5 litres) capacity, one must be heat resistant  
Flat window screening  
Large wooden stick  
Cloth 2 sq. ft. (60cm)

**Note:** The above amounts will yield 2 # (900 grams) of black powder. To double the amount, double all quantities used in manufacture.

#### **Procedure**

1. Place alcohol in one of the buckets
2. Place Potassium Nitrate, charcoal and sulfur in the heat resistant bucket. Add one cup water and mix thoroughly with wooden stick until all ingredients are dissolved.
3. Add remaining water (2 cups) to mixture. Place bucket on heat source until small bubbles begin to form.

# Scientific Principles of Improvised Warfare and Home Defense

4. Remove bucket from heat and pour mixture into alcohol while stirring vigorously.



5. Let alcohol mixture stand about 5 minutes. Strain mixture through cloth to obtain black powder.

Discard liquid. Wrap cloth around black powder and squeeze to remove all excess liquid.

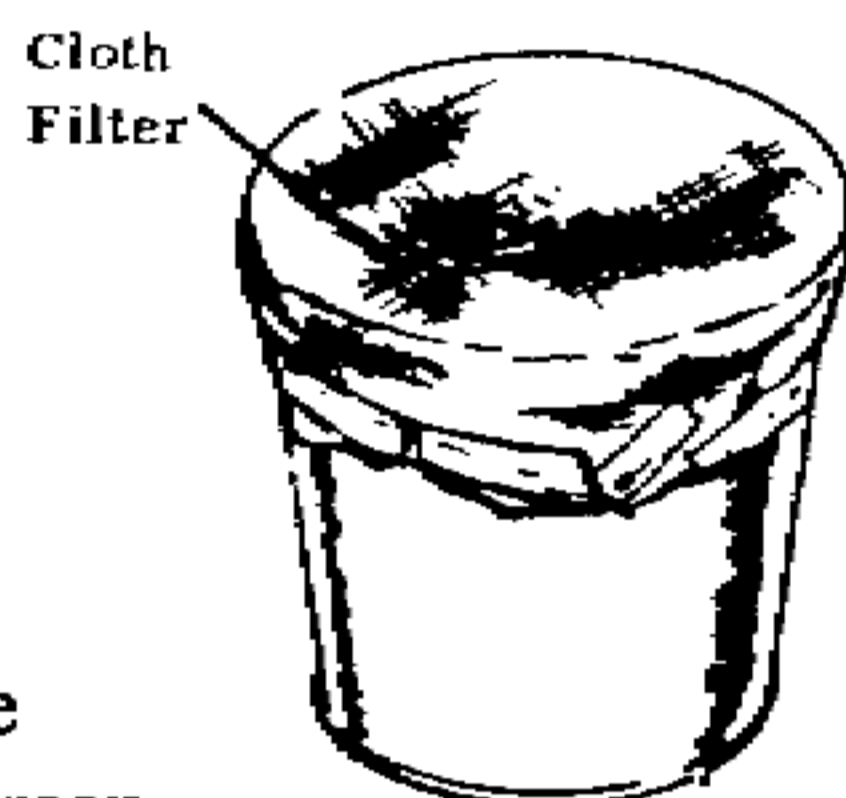

6. Place screening over dry bucket. Place workable amount of damp powder on screen and granulate by rubbing solid through screen.

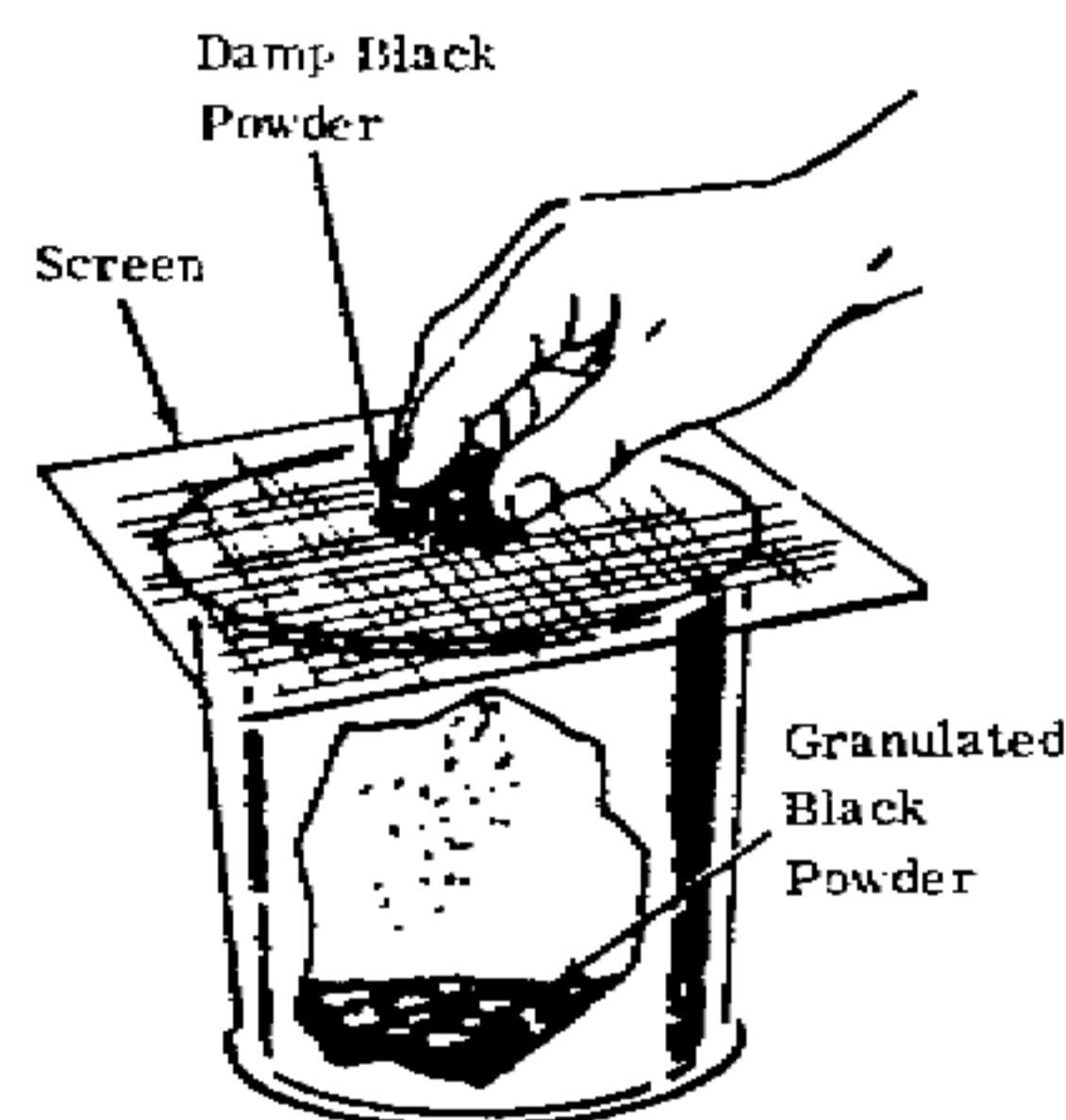

**Note:** If granulated particles appear to stick together and change shape, recombine entire batch of powder and repeat steps 5 and 6.

7. Spread granulated black powder on flat dry surface so that layer about 1/2 inch (1-1/4 cm) is formed. Allow to dry. Use radiator, car heater or direct sunlight. It should be dried in 1 hour. The longer the drying period, the less effective the black powder.

8. Remove from heat as soon as powder is dry. It is now ready to use.

[Authors Note: This method is superior to simply mixing the ingredients together. When granules are mixed, all the parts are physically separated by a large physical distance (in chemical terms). When they are dissolved and crystallized together the individual molecules are mixed much closer together making the powder much more effective.]

# Scientific Principles of Improvised Warfare and Home Defense

## 6) Initiator for dust explosions

An initiator which will initiate common material to produce dust explosions can be rapidly and easily constructed. This type of charge is ideal for the destruction of enclosed areas such as rooms or buildings.

### Materials Required

- A flat can, 3" (8 cm) diameter and 1.5" (3-3/4 cm) high  
(A tuna can works well)
- Blasting Cap
- Explosive
- Aluminum (wire, cut sheet, flattened can, or powder)
- Large Nail, 4 in. (10 cm) long
- Wooden Rod - 1/4" (6 mm) diameter
- Flour, gasoline and powder or chipped aluminum

**Note:** Plastic Explosives produce better explosions than cast explosives in dust initiators

### Procedure

1. Using the nail, press a hole through the side of the tuna can 3/8 to 1/2 in. (1-1.5 cm) from the bottom. Using a rotating and lever action, enlarge the hole until it will accommodate the blasting cap.

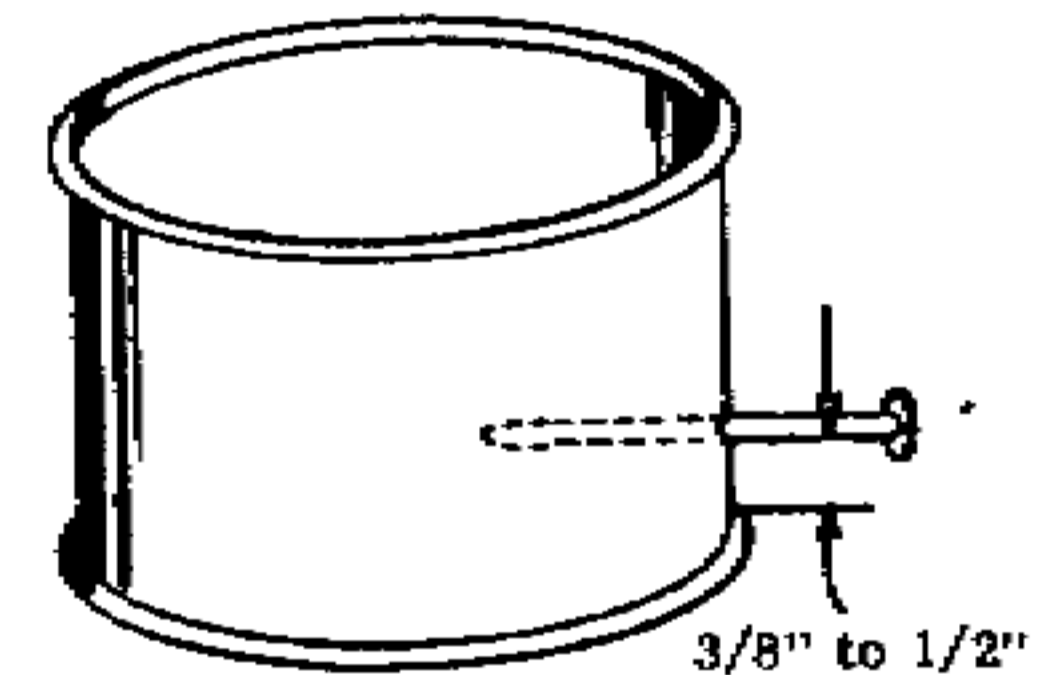

2. Place the wooden rod in the hole and position the end of the rod at the center of the can.

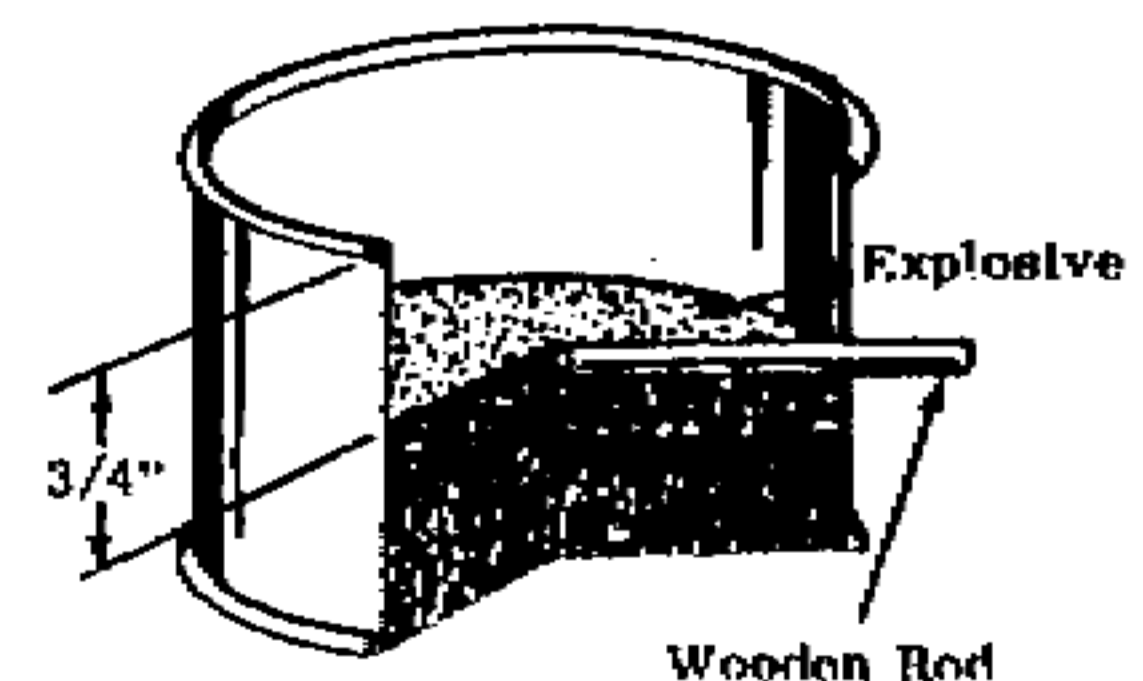

3. Press explosive into the can being sure to surround the rod, until it is 3/4" (2 cm) from top of the can. Carefully remove the wooden rod.

# Scientific Principles of Improvised Warfare and Home Defense

4. Place the aluminum metal on top of the explosive.

5. Just before use, insert the blasting cap into the cavity made by the rod. The initiator is now ready to use.

**Note:** If it is desired to carry the initiator some distance, cardboard may be pressed on top of the aluminum to insure against loss of material.

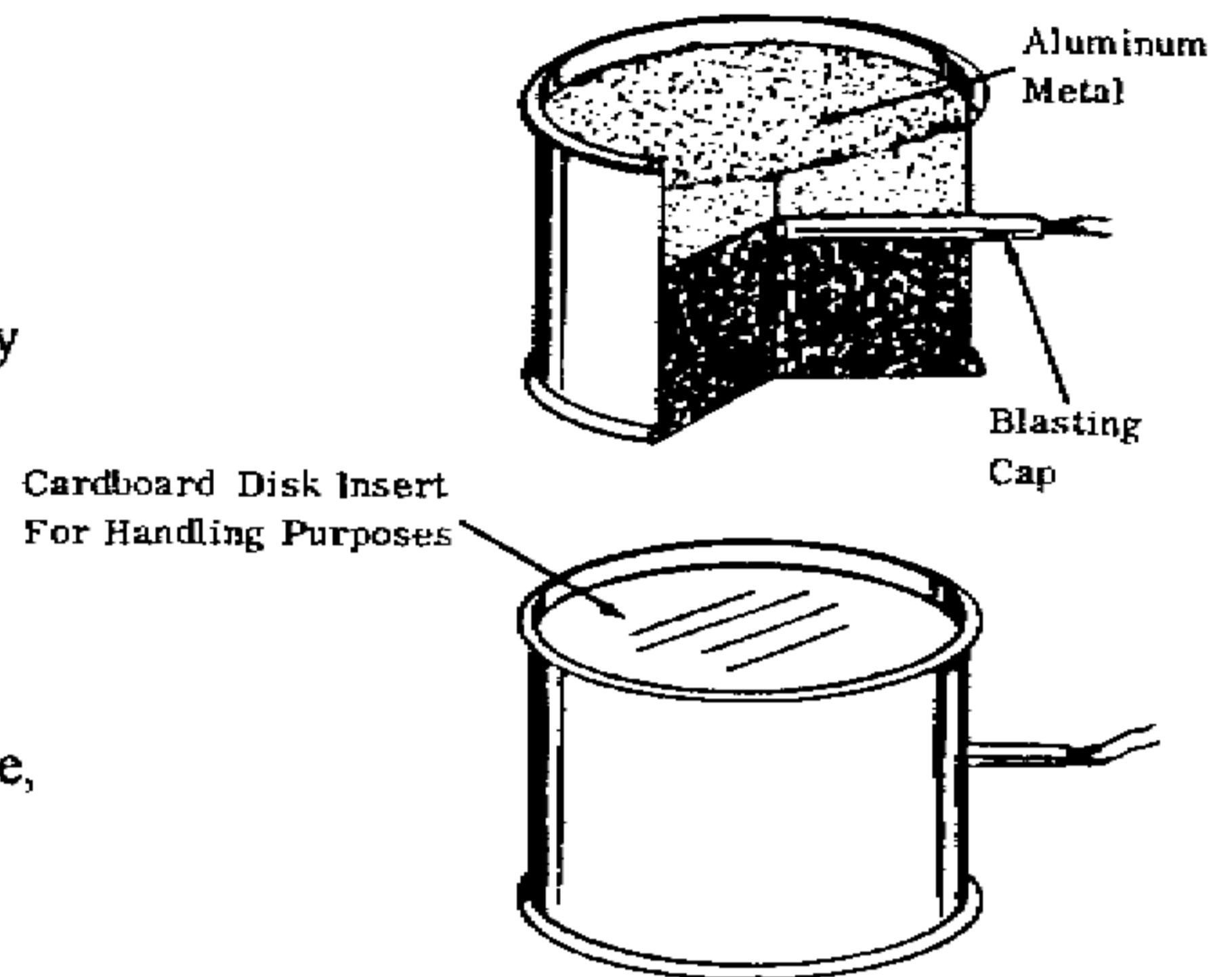

## How to use

This particular unit works quite well to initiate charges of 5 # of flour, 1/2 gallon (1.66 litres) of gasoline or 2 # of flake painters aluminum. The solid materials may merely be contained in sacks or cardboard cartons. The gasoline may be placed in plastic or glass milk bottles. The charges are placed directly on top of the initiator and the blasting cap is actuated electrically or by fuse. This will destroy a 2,000 cubic foot enclosure (10 x 20 x 10 feet) For larger enclosures, use proportionately larger initiators and charges.

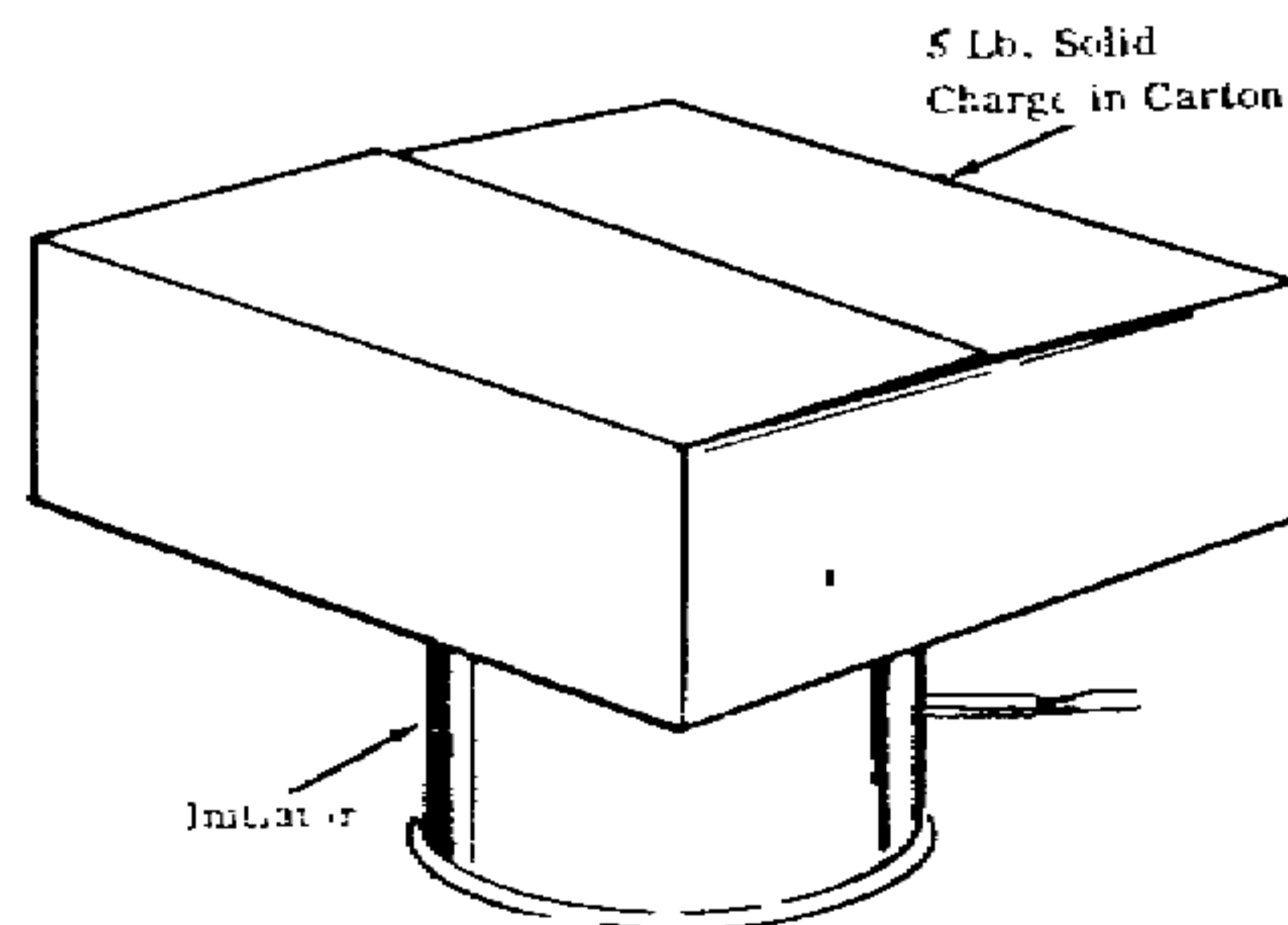

# Scientific Principles of Improvised Warfare and Home Defense

## 7 ) Fertilizer Explosives

An explosive munitions can be made from fertilizer grade ammonium nitrate and either fuel oil or a mixture of equal parts of motor oil and gasoline. When properly prepared, this explosive munition can be detonated with a blasting cap.

### Material Required

Ammonium Nitrate (not less than 32% Nitrogen)  
Fuel oil or gasoline and motor oil (1:1 ratio)  
Two flat boards. ( 2 x 4 and 36 x 36 inches)  
Bucket or container for mixing ingredients  
Iron or steel pipe or bottle, tin can or heavy walled cardboard tube  
Blasting cap  
Wooden rod - 1/4 in. diameter  
Spoon or other measuring container

### Procedure

1. Spread a handful of the ammonium nitrate on the large flat board and rub vigorously with the other board until the large particles are crushed into a very fine powder that looks like flour. (app. 10 min.)

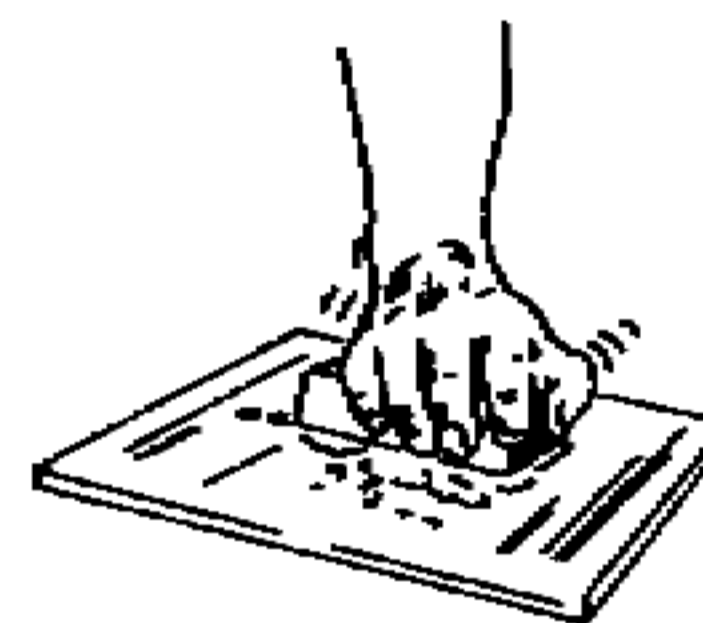

**Note:** Proceed with step 2 as soon as possible since the powder may take moisture from the air and become spoiled.

2. Mix one measure of fuel oil with 16 measures of the finely ground ammonium nitrate in a dry bucket or other suitable container and stir with the wooden rod.





## Scientific Principles of Improvised Warfare and Home Defense

If fuel oil is not available, use 1/2 measure of gasoline, and 1/2 of motor oil. Store in a waterproof container until ready to use.

3. Spoon this mixture into an iron or steel pipe which has an end cap threaded on one end. If a pipe is not available, you may use a dry tin can, a glass jar, or a heavy walled cardboard tube.

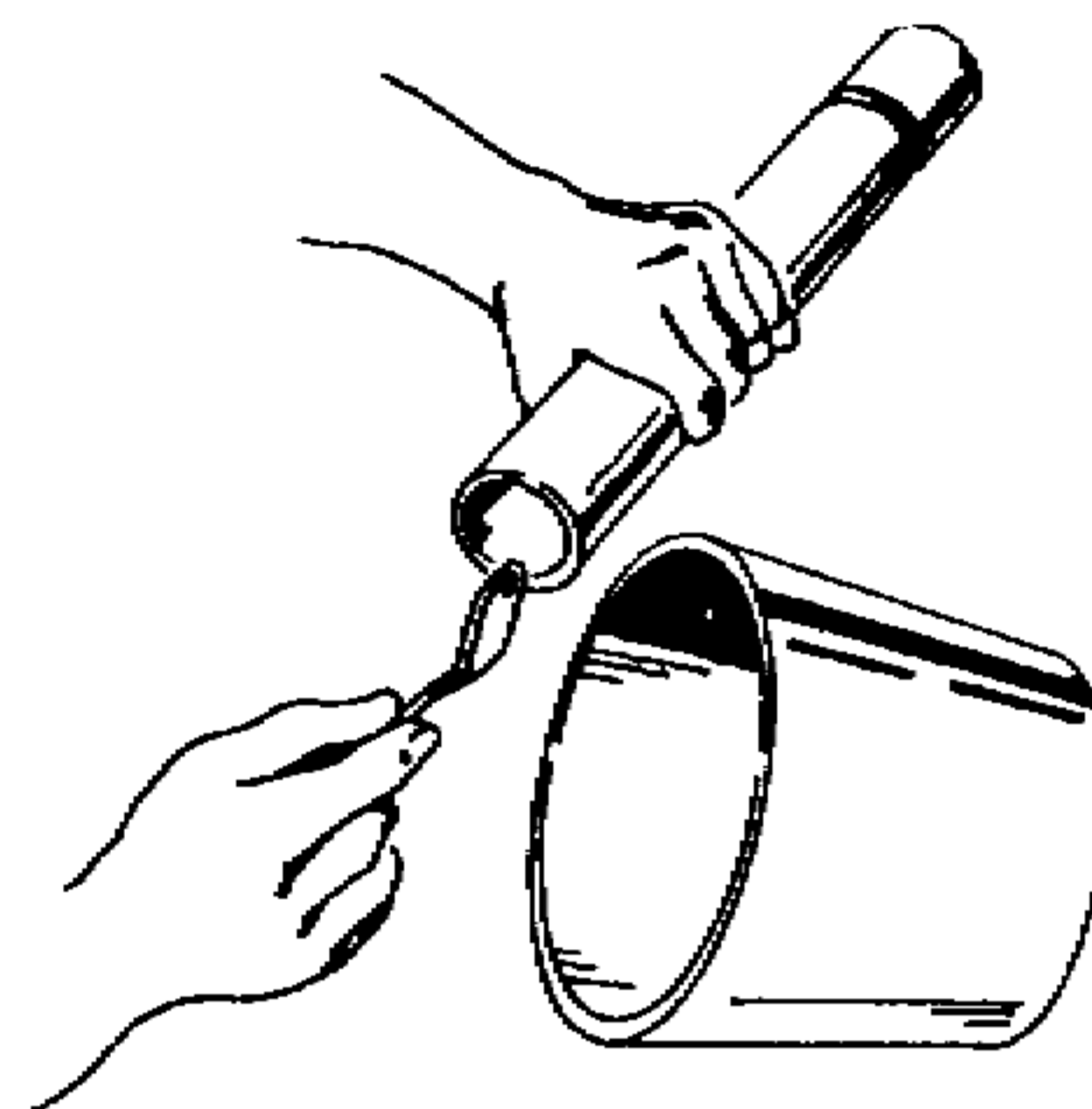

**Note:** Take care not to tamp or shake the mixture in the pipe. If mixture becomes tightly packed, one cap will not be sufficient to initiate the explosive.

4. Insert blasting cap just below the surface of the explosive mix.

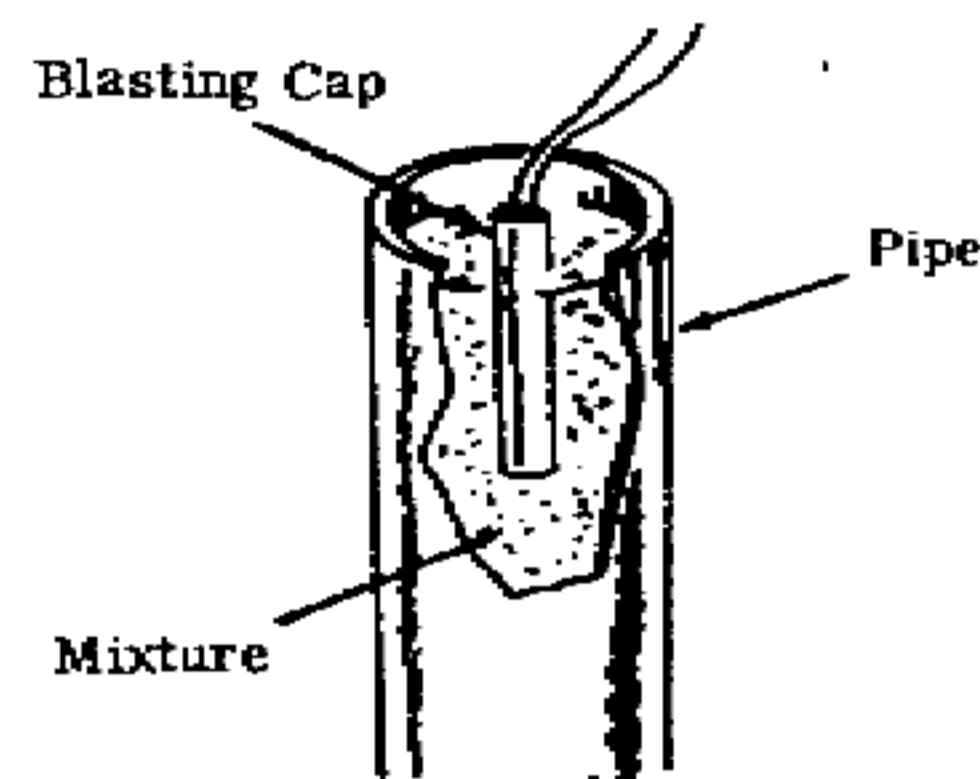

**Note:** Confining the end of the explosive will add to the effectiveness of the explosive.

# Scientific Principles of Improvised Warfare and Home Defense

## 8) AN Aluminum explosive

A dry explosive mixture can be made from ammonium nitrate fertilizer combined with fine aluminum powder. This explosive can be detonated with a blasting cap.

### Material Required

- Ammonium Nitrate fertilizer (min 32% Nitrogen)
- Fine Aluminum Bronzing Powder
- Measuring container
- Mixing container
- Two flat boards ( 2 x 4 and 36 x 36 Inches)
- Storage Container ( Jar, can, etc.)
- Wooden Rod - 1/4 in. diameter
- Pipe, can, or jar

### Procedure

#### Method 1 - to obtain a low velocity explosive

- Measure 4 parts fertilizer to 1 part aluminum bronzing powder and pour into the mixing container.
- Mix ingredients with the wooden rod

#### Method 2 - To obtain a high velocity explosive

- Spread a handful of the fertilizer on the large flat board and rub vigorously with the other board until the large particles are crushed to a very fine powder that looks like flour ( app 10 min.)
- Follow a and b above

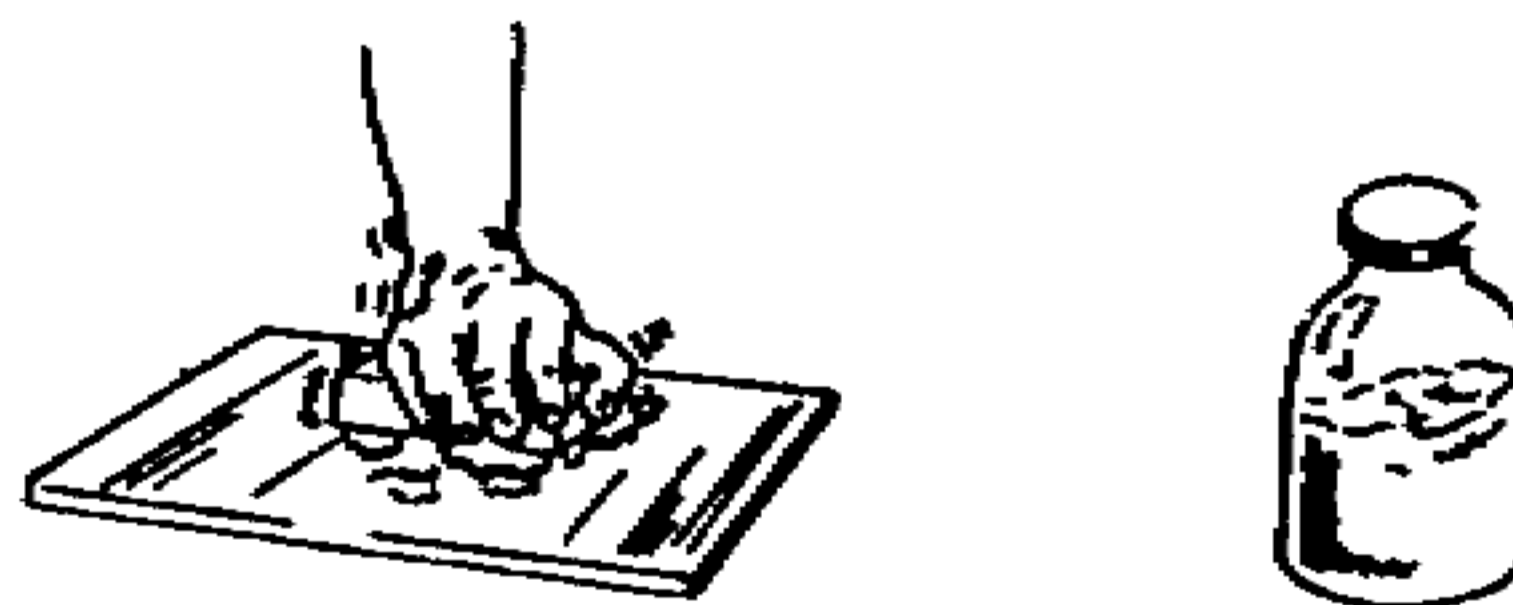

then store the mixture of methods 1 or 2 in waterproof container such as a glass jar, steel pipe, etc. and seal until ready to use.

When ready to use prepare as fertilizer explosive with blasting cap.

# Scientific Principles of Improvised Warfare and Home Defense

## 9) Red/ White powder propellant

Red or white powder propellant may be prepared in a simple, safe manner. The formulation described below will result in app. 2 1/2 # of powder. This is a small arms propellant and should only be used in weapons with 1/2 inch diameter or less, such as the match gun or 7.62 carbine, but not pistols.

### Material Required

Heat source  
2 gallon metal bucket  
Measuring cup (8 ounces)  
Wooden Spoon or rubber spatula  
Metal sheet or aluminum foil ( at least 1 sq. ft.)  
Flat window screen (at least 1 sq. ft.)  
Potassium Nitrate ( granulated 2 1/3 cups)  
White Sugar ( granulated 2 cups)  
Powdered Iron Oxide (rust) 1/8 cup if available  
Clear water, 3.5 cups

### Procedure

1. Place the sugar, potassium nitrate, and water in the bucket. Heat with a low flame, stirring occasionally until the sugar and potassium nitrate dissolve.

2. If available, add the iron oxide to the solution. Increase the flame under the mixture until it boils gently. ( The mixture will remain red)

3. Stir and scrape the bucket sides occasionally until the mixture is reduced to one quarter of its original volume, then stir occasionally.



## Scientific Principles of Improvised Warfare and Home Defense

4. As the water evaporates, the mixture will become thicker until it becomes the consistency of breakfast cereal or homemade fudge. At this stage of thickness, remove the bucket from the heat source, and spread the mass on the metal sheet.



5. While the material cools, score it with the spoon or spatula in furrows about 1 inch apart.

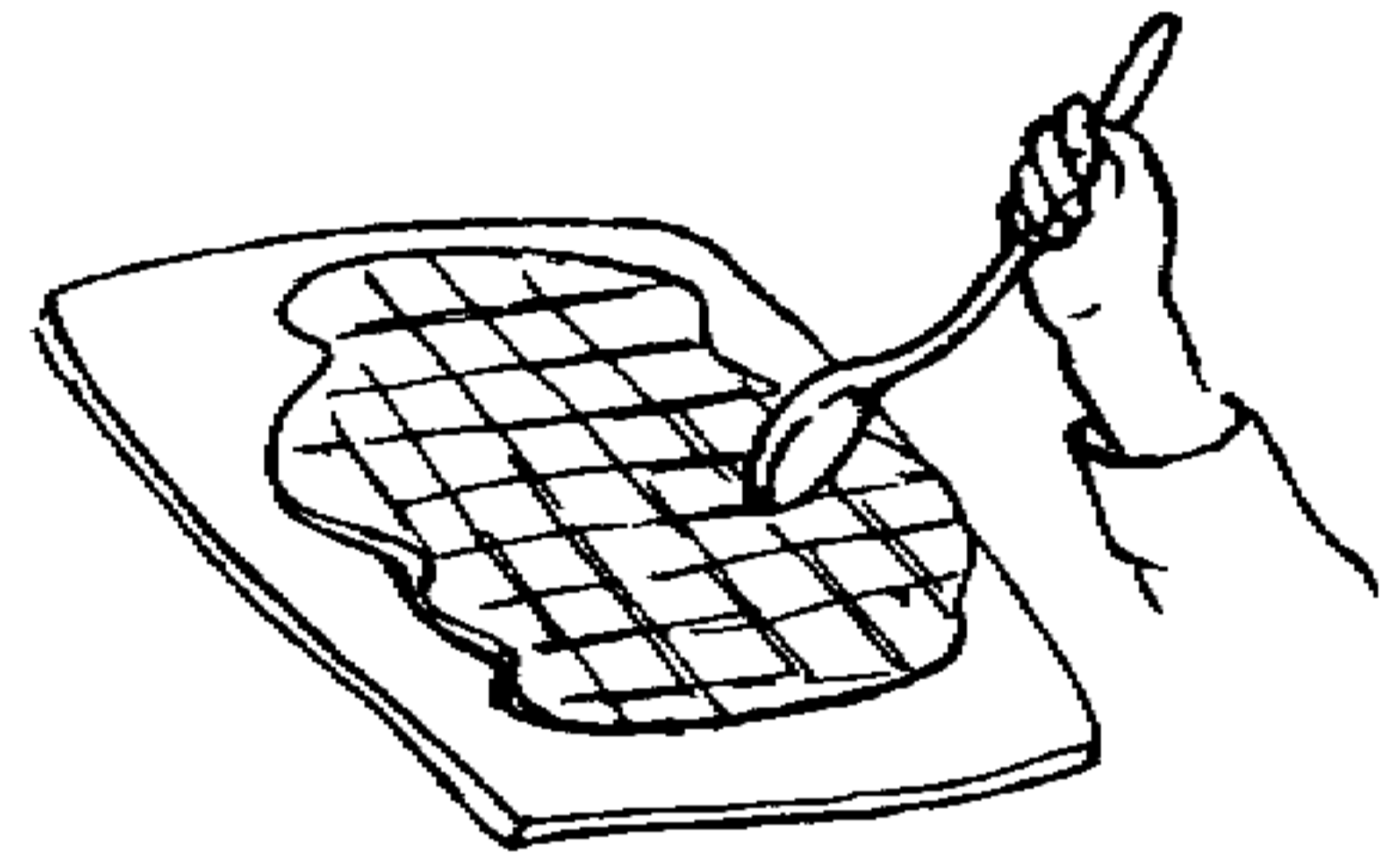

6. Allow the material to air dry, preferably in the sun. As it dries, rescore it occasionally ( about every 20 minutes) to aid drying.

7. When the material has dried to a point where it is moist and soft, but not sticky to the touch, place a small spoonful on the screen. Rub the material back and forth against the screen mesh with spoon or other flat object until the material is granulated into small wormlike particles.

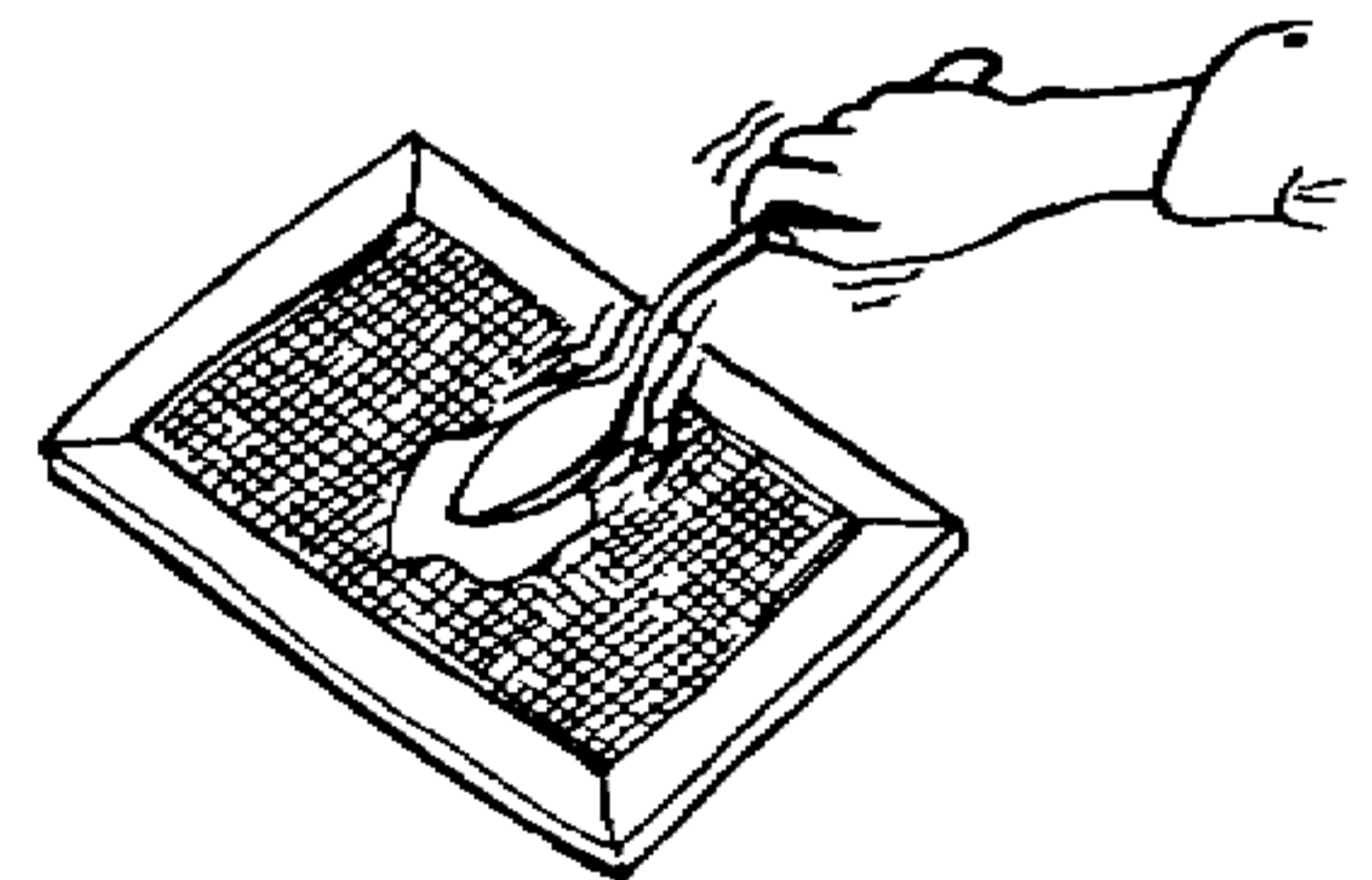

8. After granulation, return the material to the sun to dry completely.

# Scientific Principles of Improvised Warfare and Home Defense

## 10) Nitric Acid Explosive

An explosive munition can be made from mononitrobenzene and nitric acid. It is a simple explosive to prepare. Just pour the mononitrobenzene into the acid and stir.

### Material Required

Nitric Acid  
Mononitrobenzene (nitrobenzene)  
Acid resistant measuring container  
Acid resistant mixing rod  
Blasting Cap  
Wax  
Steel Pipe, end cap and tape  
Bottle or jar

### Sources

Field grade or 90% Conc.  
( specific gravity 1.48)  
Drug store (Oil of mirbane)  
Chemical and industry supply (solvent)  
Glass, clay, etc.

**Note:** Prepare mixture just before use.

### Procedure

1. Add 1 volume nitrobenzene to 2 volumes Nitric Acid in bottle or jar.
2. Mix ingredients well by stirring with acid resistant rod.

**Danger:** Nitric acid will burn skin and destroy clothing.  
Nitrobenzene is toxic - Do not inhale fumes.





# Scientific Principles of Improvised Warfare and Home Defense

## How to use

1. Wax blasting cap, pipe, and end cap.

2. Thread end cap onto pipe.

3. Pour mixture into pipe.

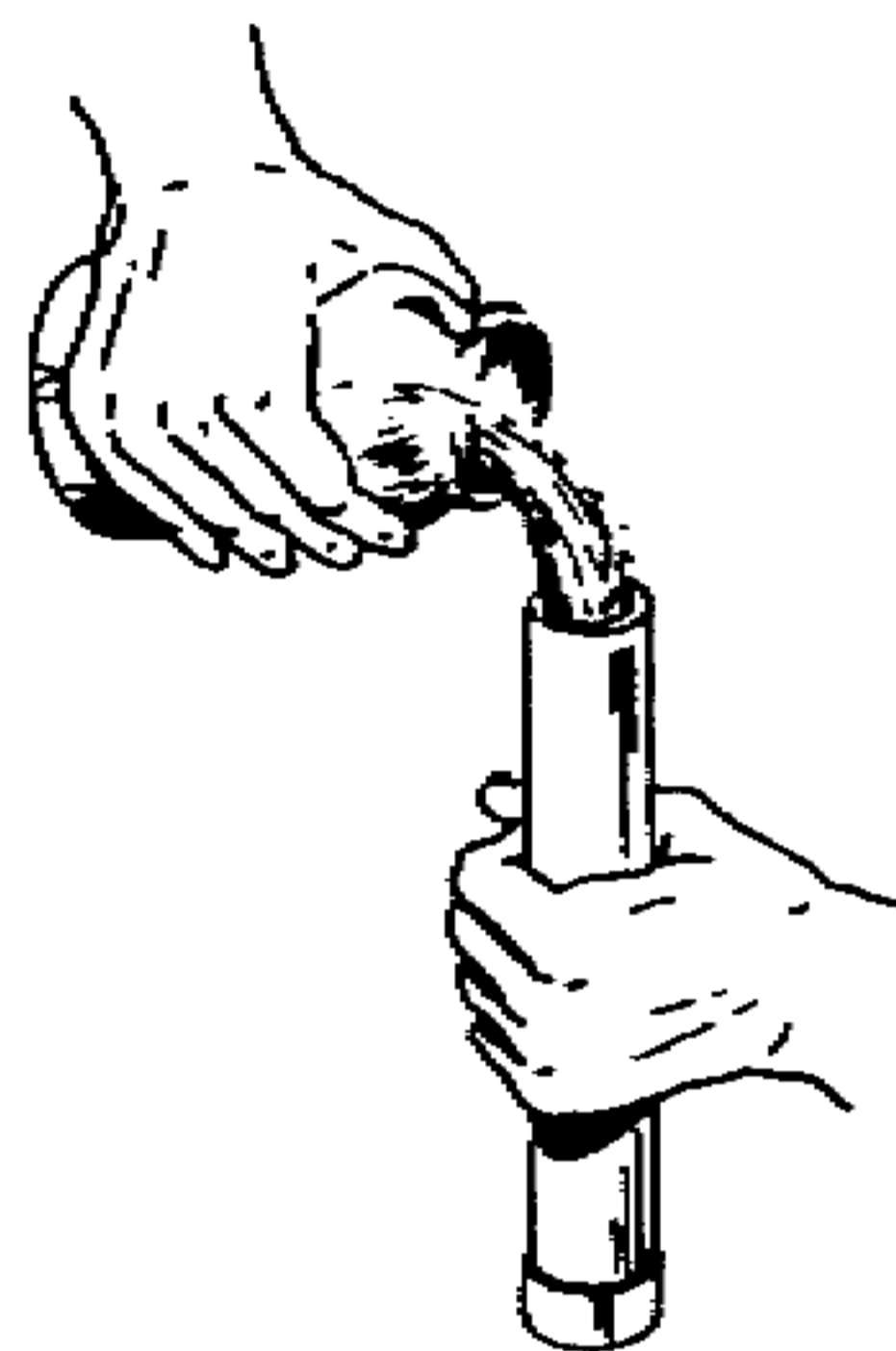

4. Insert and tape blasting cap just beneath surface of mixture.

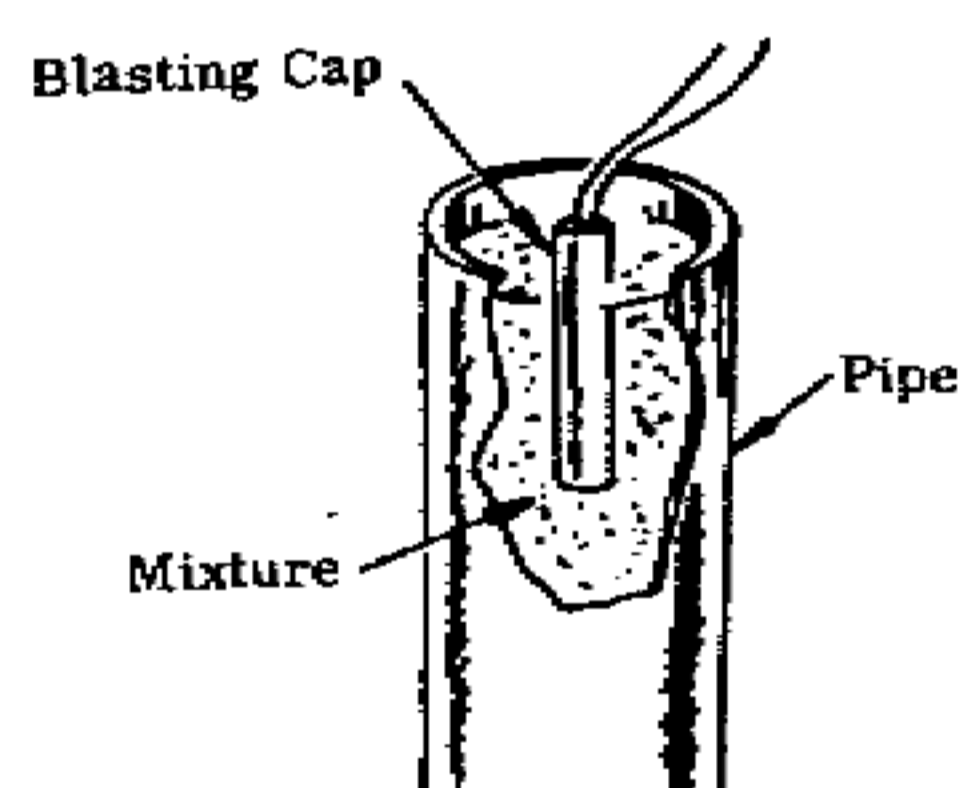

5. Use wax to seal end of the pipe.

Note: Confining the open end of the pipe will add to the effectiveness of the explosive

# Scientific Principles of Improvised Warfare and Home Defense

## 11 Nitrocellulose Explosive

An acid type explosive can be made from Nitric Acid and white paper or cotton cloth. This explosive can be detonated with a commercial #8 or any military blasting cap.

### Material Required

Nitric Acid  
White unprinted, unsized paper  
Clean white cotton cloth  
Acid resistant container  
Aluminum foil or acid resistant material  
Protective gloves  
Blasting Cap  
Wax

### Source

Chemical supply 90% (sp. gravity 1.48)  
Paper towels, napkins  
Clothing, sheets, etc.  
Wax coated pipe or can, ceramic, glass jar

### Procedure

1. Put on gloves
2. Spread out a layer of paper or cloth on aluminum foil and sprinkle with nitric acid until thoroughly soaked. If aluminum foil is unavailable use an acid resistant material (glass, ceramic, or wood).

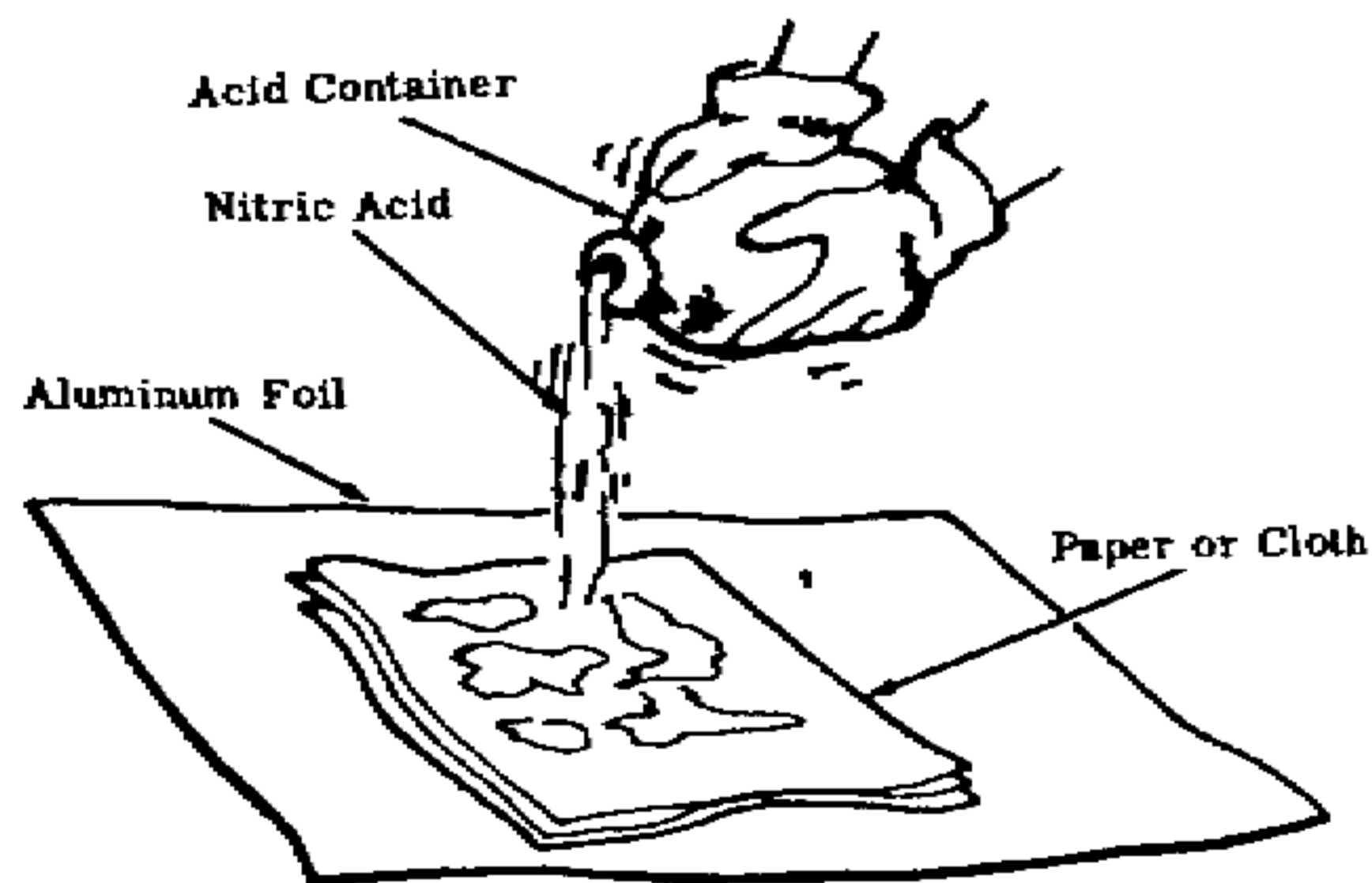

## Scientific Principles of Improvised Warfare and Home Defense

3. Place another layer of paper or cloth on top of the acid- soaked sheet and repeat step 2 above. Repeat as often as necessary.

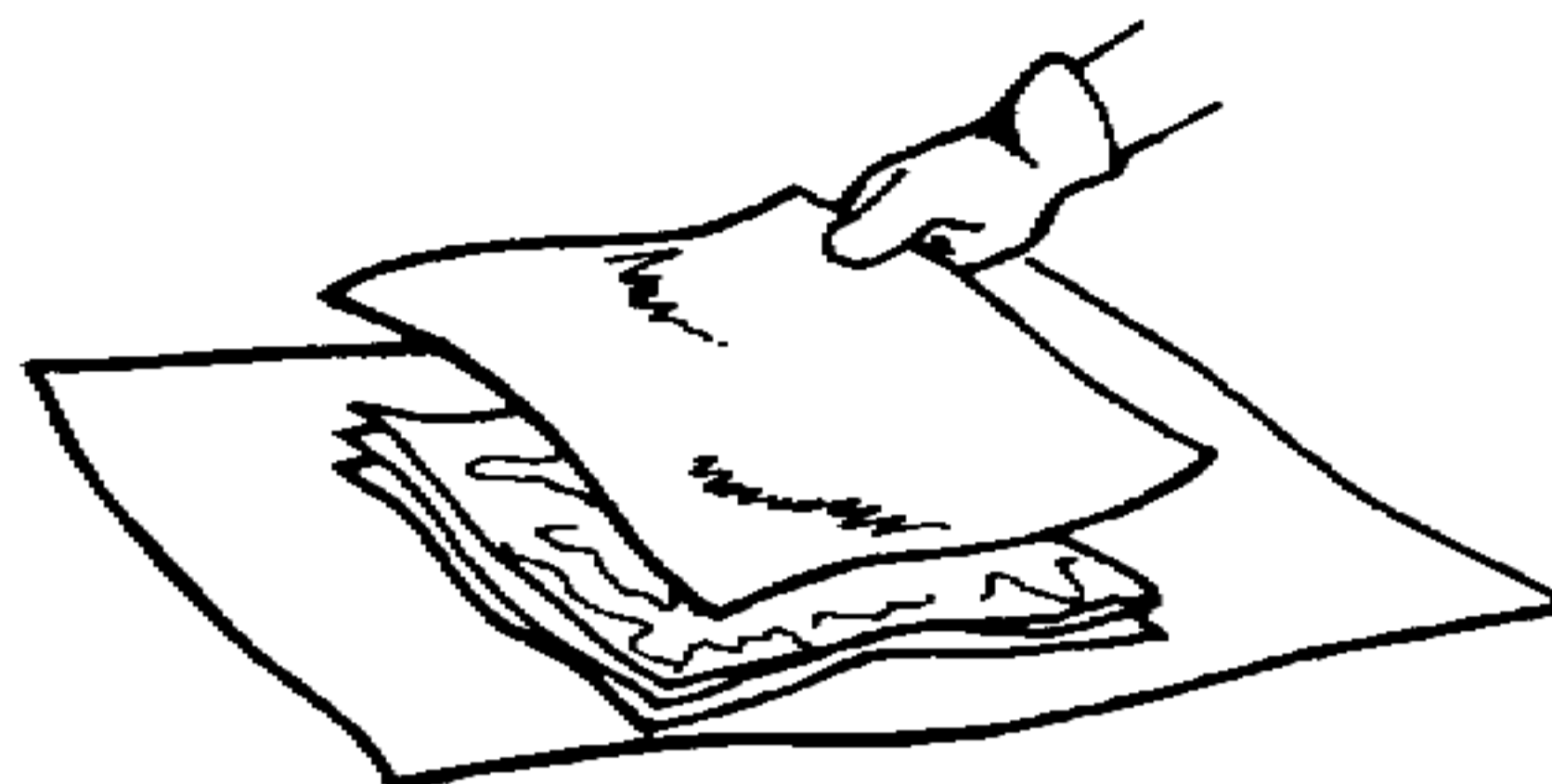

4. Roll up the aluminum foil containing the acid soaked sheets and insert the roll into the acid resistant container.

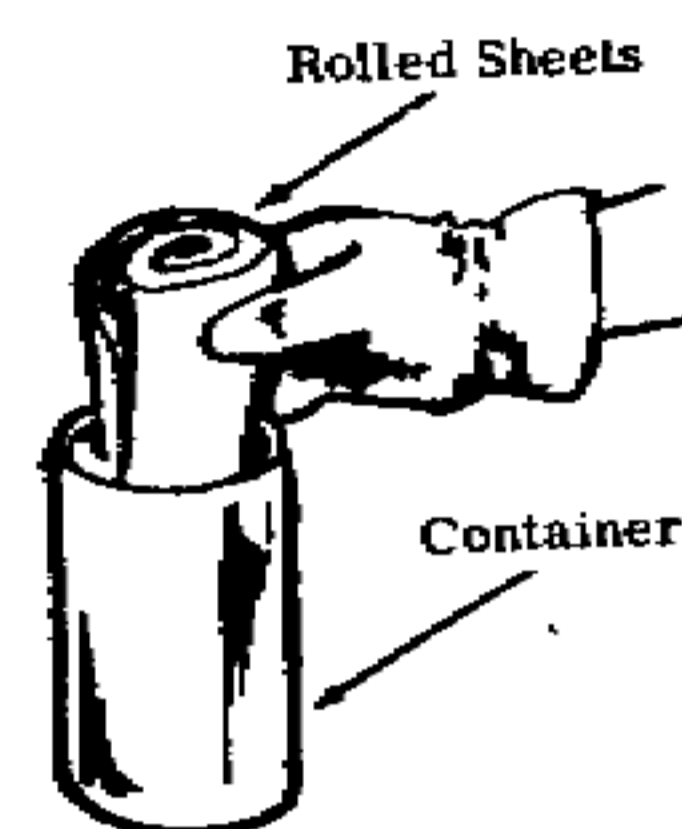

**Note:** If tray is used instead of foil, carefully roll up and move with wooden sticks or tongs.

5. Wax blasting cap.

6. Insert the blasting cap in the center of the rolled sheets. Allow 5 minutes before detonating the explosive.

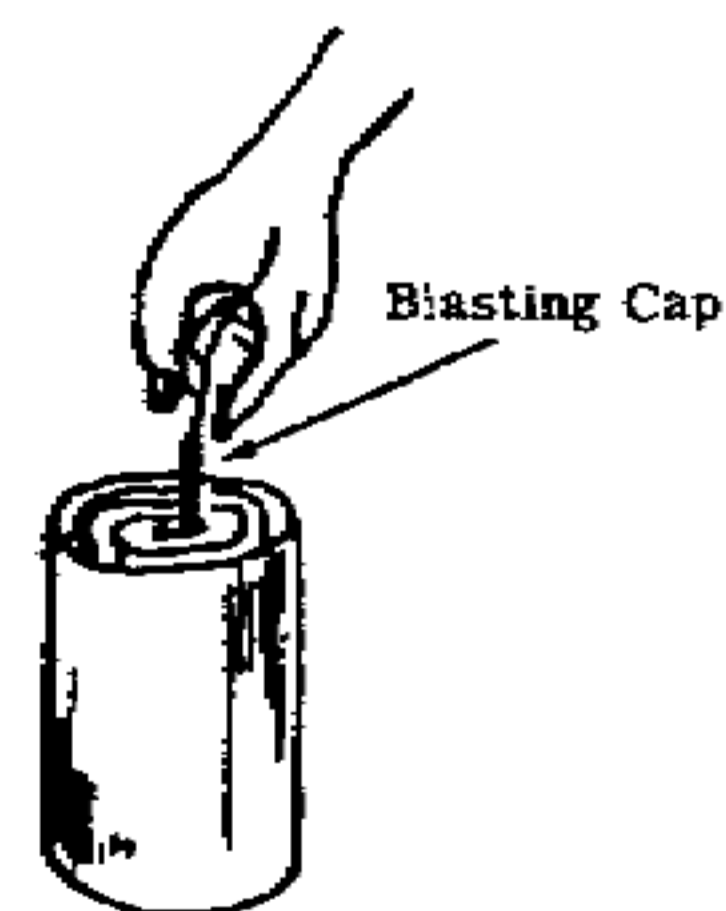

# Scientific Principles of Improvised Warfare and Home Defense

## 12) Methyl Nitrate Dynamite

An moist explosive mixture can be made from sulfuric acid, nitric acid, and methyl alcohol. This explosive can be detonated with a blasting cap.

### Material Required

Sulfuric Acid

Nitric Acid

Methyl Alcohol

Eyedropper or syringe with glass tube

Large diameter glass jar (2 qt.)

Narrow glass jars (1 qt)

Absorbent - fine sawdust, shredded paper or cloth

Cup

Pan ( 3-5 gallon)

Teaspoon

Wooden Stick

Steel Pipe with end cap

Blasting Cap

Water

Tray

### Sources

Clear battery acid boiled until white fumes appear

Field grade Nitric Acid 90%

Methanol or wood alcohol

Anti Freeze (non permanent)

### Procedure

1. Add 24 teaspoons of sulfuric acid to 16.5 teaspoons of nitric acid in the 2 qt. jar.

2. Place the jar in the pan ( 3-5 gallon) filled with cold water or a stream and allow acid to cool.



## Scientific Principles of Improvised Warfare and Home Defense

3. Rapidly swirl the jar to create a whirlpool in the liquid ( without splashing) while keeping the bottom portion of the jar in the water.

4. While continually swirling, add to mixture, 1/2 teaspoon at a time, 13.5 teaspoons of methyl alcohol, allowing mixture to cool at least one minute between additions.



**Danger:** If there is a sudden increase in the amount of fumes produced or if the solution turns much darker or begins to froth, dump solution in the water within 10 seconds. This will halt the reaction and prevent a runaway explosion.

5. After the final addition of methyl alcohol, swirl for another 30-45 seconds.

6. Carefully pour the solution into one of the narrow glass jars. Allow jar to stand in water for app. 5 minutes until 2 layers separate.



7. With an eyedropper or syringe, remove top layer and carefully put into another narrow glass jar. This liquid is the explosive.

**Caution:** Explosive is shock sensitive

8. Add an equal quantity of water to the explosive and swirl. Allow mixture to separate again as in step 6. The explosive is now the bottom layer.





## Scientific Principles of Improvised Warfare and Home Defense

9. Carefully remove the top layer with the eyedropper or syringe and discard.

10. Place one firmly packed cup of absorbent in the tray.

11. While stirring with the wooden stick, slowly add explosive until the mass is very damp but not wet enough to drip. Explosive is ready to use.

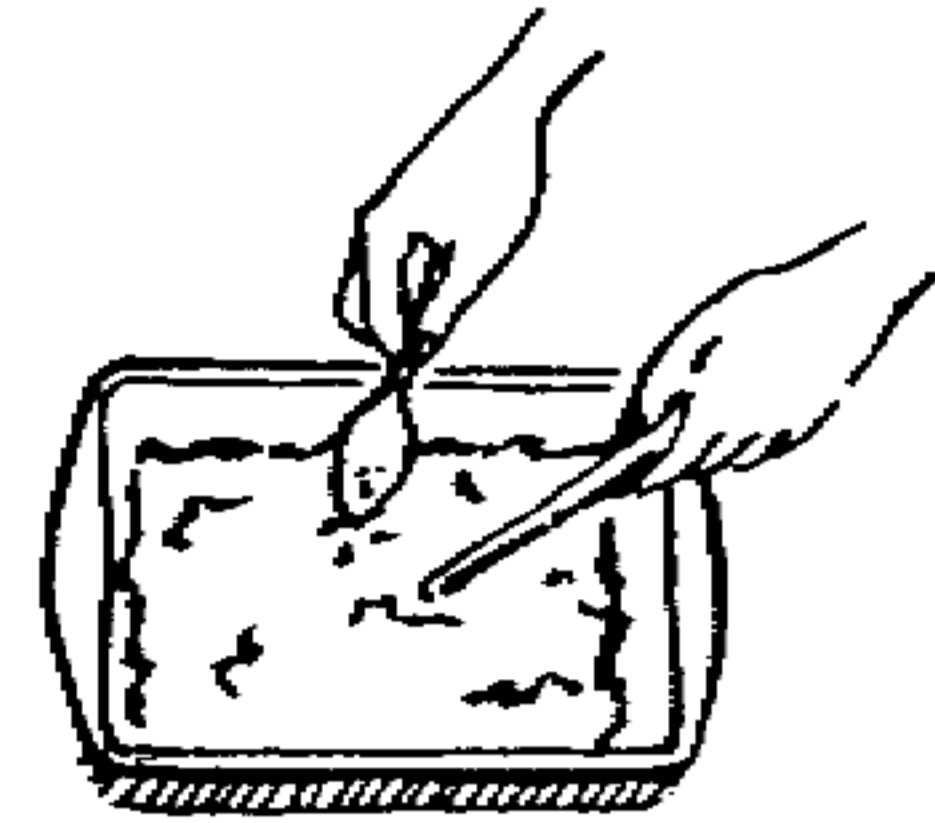

**Note:** If mixture becomes too wet, add more absorbent.

If storage is required, store in a sealed container to prevent evaporation.

Liquid explosive can burn. If it touches skin wash with water.

### How to use

1. Spoon the mixture into an iron or steel pipe which has an end cap threaded on one end. If a pipe is not available, you can use a dry tin can or glass jar.



2. Insert blasting cap just beneath the surface of the explosive mix.

**Note:** Confining the end of the container will increase the power of the explosive.

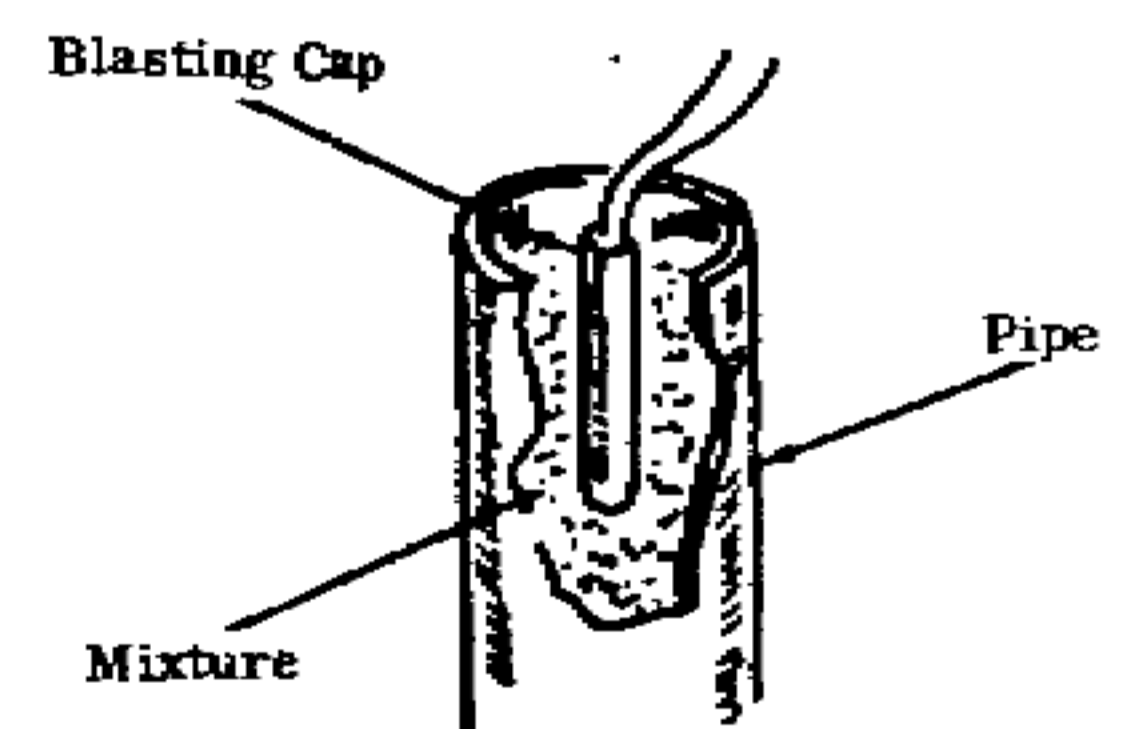

# Scientific Principles of Improvised Warfare and Home Defense

## 13 Urea Nitrate Explosive

Urea nitrate can be used as an explosive munition. It is easy to prepare from Nitric Acid and urine. It can be detonated with a blasting cap.

### Material Required

Nitric Acid 90%  
Urine  
2 one gallon heat and acid resistant containers  
Filtering material  
Aluminum powder  
Heat source  
Cup and spoon for measuring  
Water  
Tape  
Blasting Cap  
Steel Pipe and end caps

### Source

Supply house, field improvised from Niter  
Human or animal discharge (undiluted)  
  
Paper towel or fine textured cotton cloth  
Paint stores

**Note:** Prepare mixture just before use.

### Procedure

1. Boil a large quantity of urine (10 cups) to app. 1 cup in volume in one of the containers over the heat source.

2. Filter the urine into the other container through the filtering material to remove impurities.

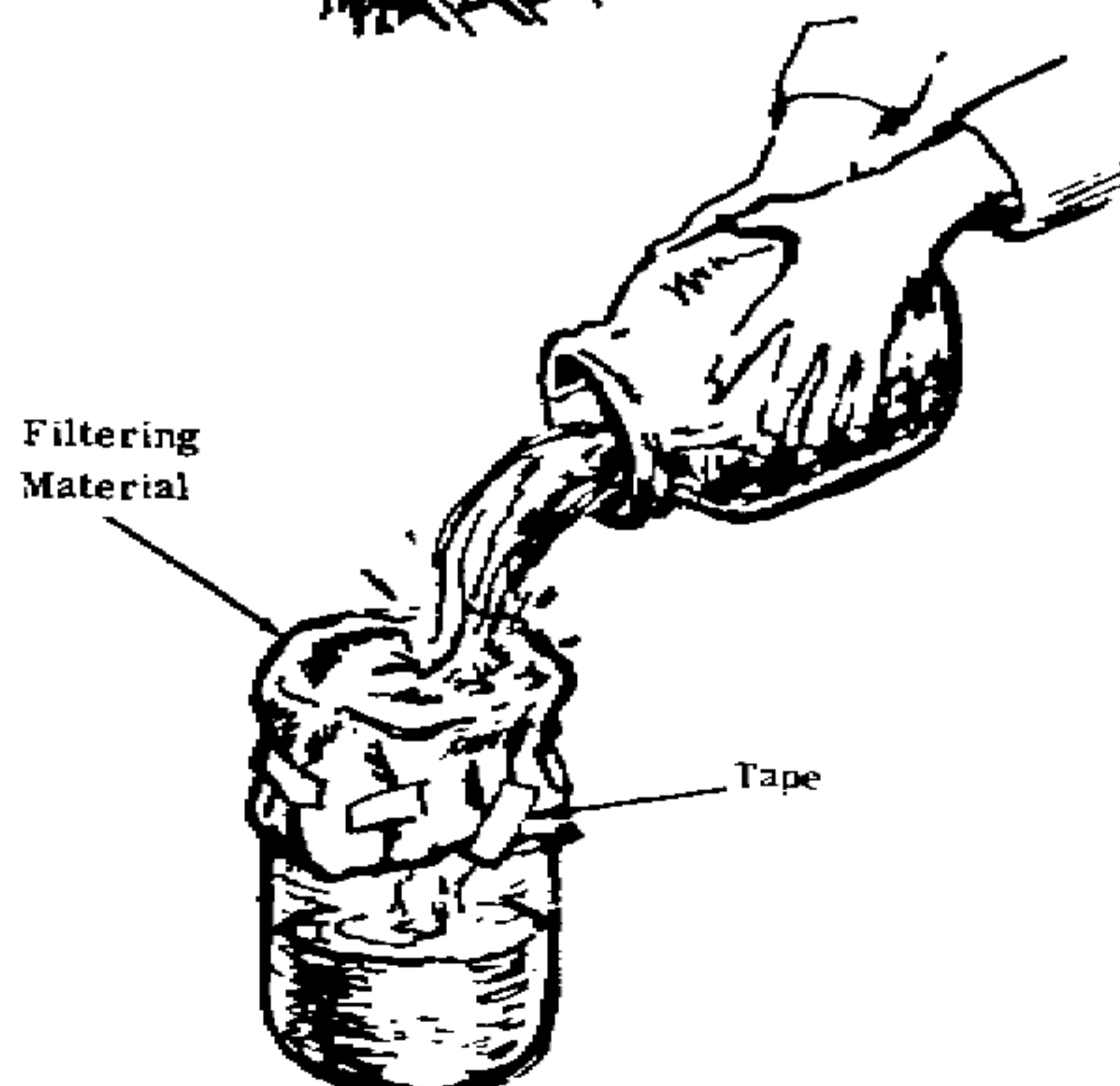

## Scientific Principles of Improvised Warfare and Home Defense

3. Slowly add 1/3 cup of nitric acid to the filtered urine, and let mixture stand for 1 hour.

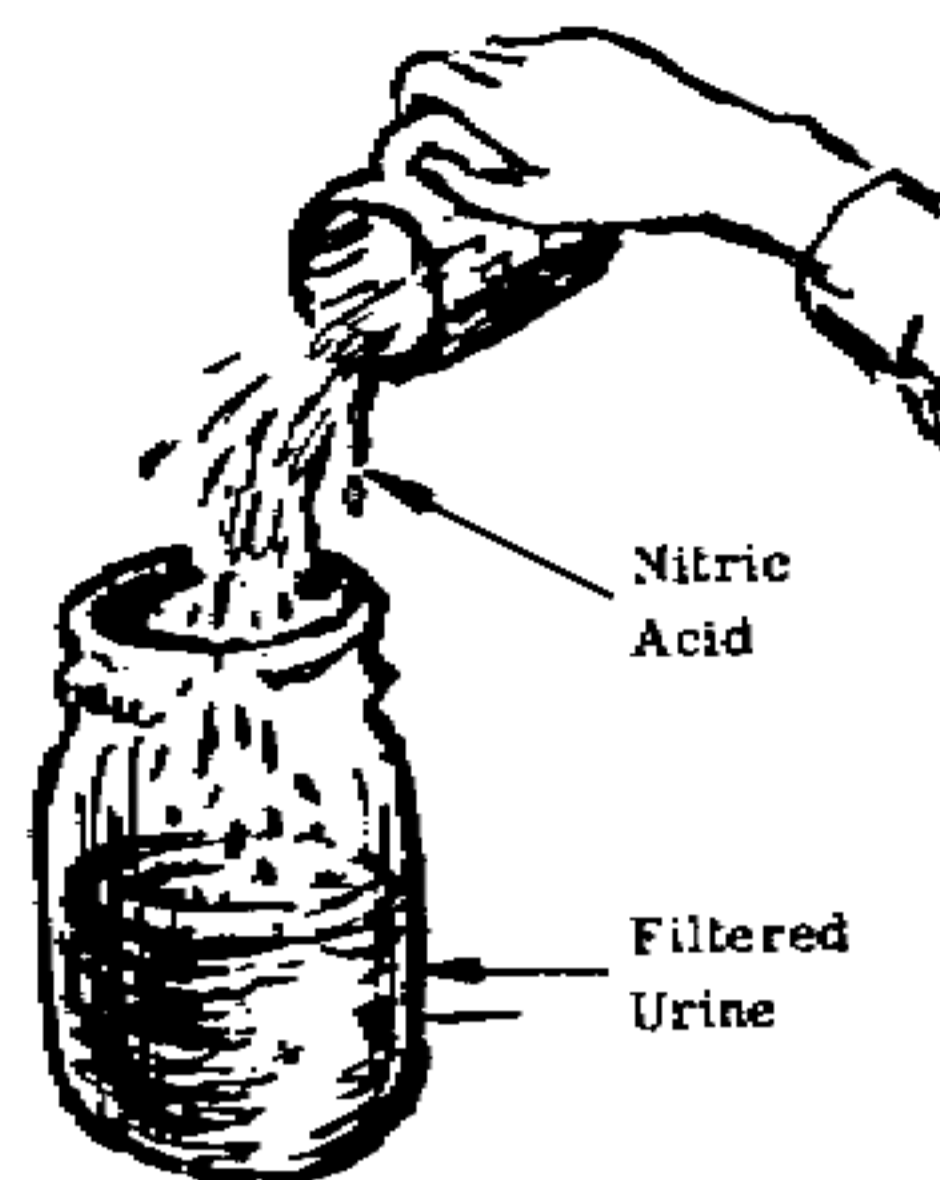

4. Filter mixture as in step 2. Urea nitrate crystals will collect on the paper.

5. Wash the urea nitrate by pouring water over it.

6. Remove urea nitrate crystals from the filtering material and allow to dry thoroughly (app. 16 hrs.).

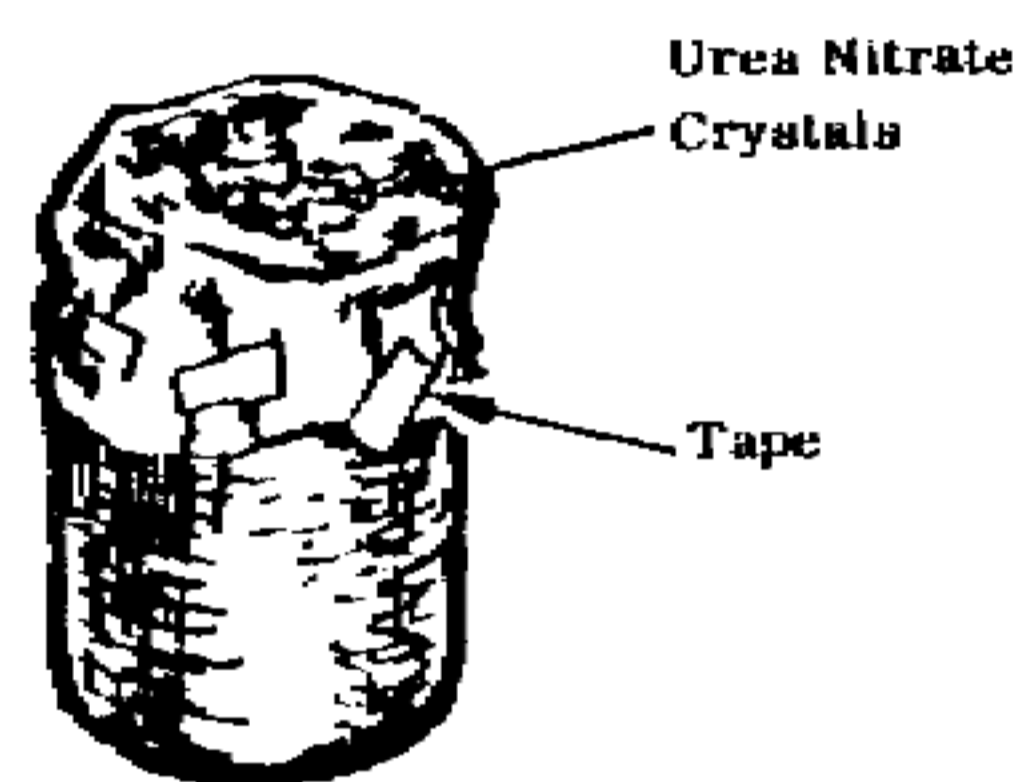

**Note:** Use a hot (not boiling) bath to dry in 2 hours.

### How to use

1. Spoon the urea nitrate crystals into an iron or steel pipe with an end cap threaded on one end.

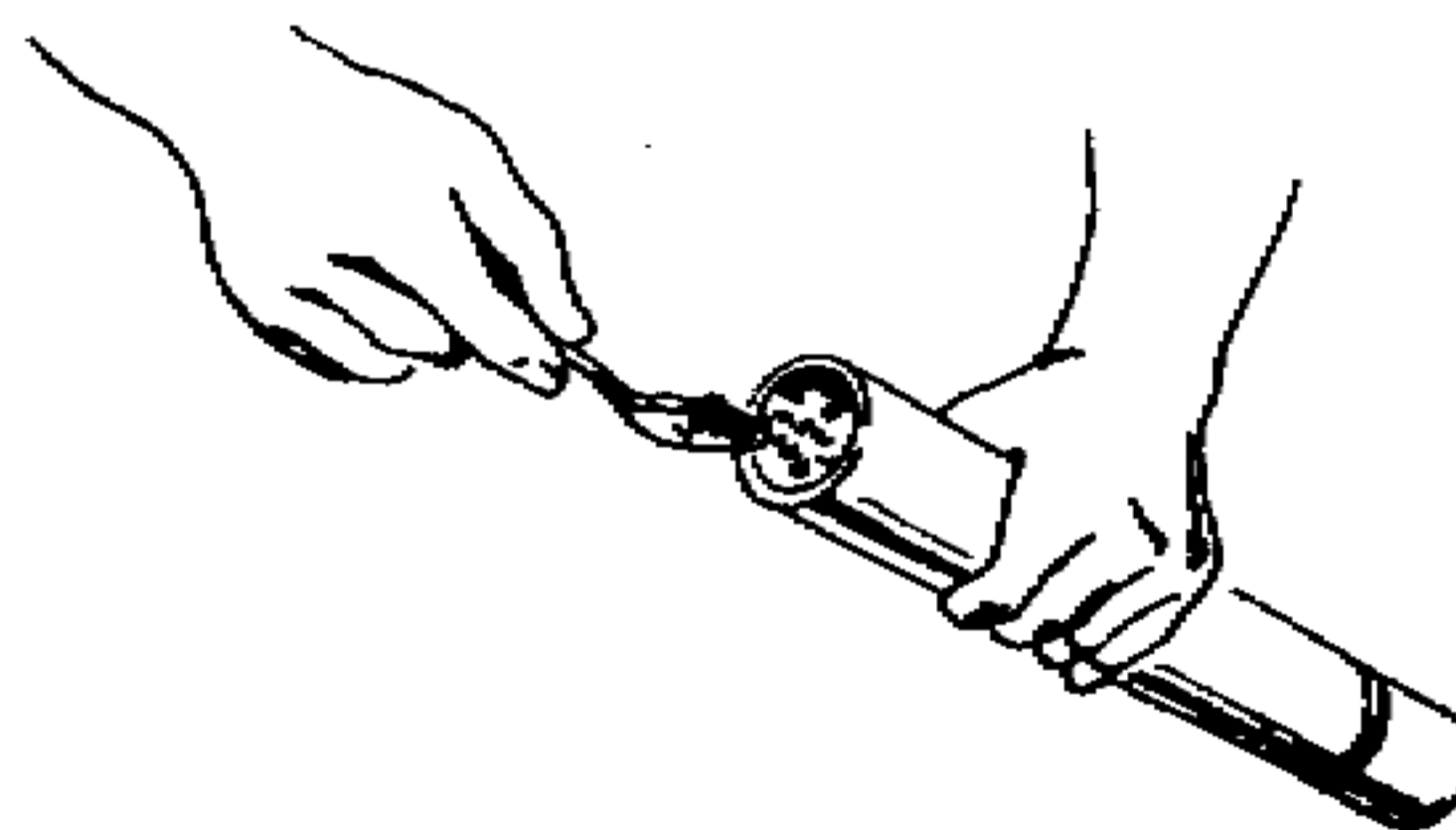

2. Insert blasting cap just beneath the surface of the urea nitrate crystals.

Option: 3. Add and mix 1 cup Aluminum Powder to 4 cups Urea Nitrate to make a more powerful explosive.

Confine end of explosive leaving no open space for maximum power of detonation.

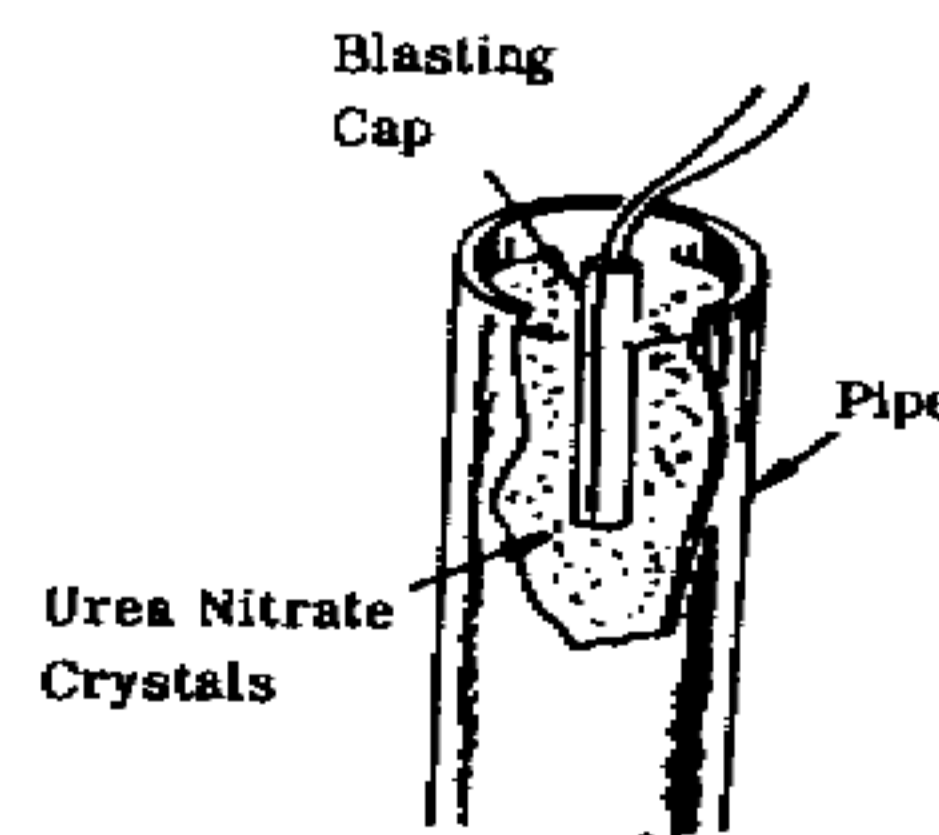

# Scientific Principles of Improvised Warfare and Home Defense

## 14 HMTD Primary Explosive

HMTD is a primary explosive that can be made from hexamethylenetetramine, hydrogen peroxide, and citric acid. This explosive is to be used with a booster explosive such as Picric Acid or RDX in the fabrication of detonators.

### Material Required

Hexamethylenetetramine

Hydrogen Peroxide

Citric Acid

Containers

Paper towels

Teaspoon

Pan

Water

Tape

### Sources

Drugstores as Urotropine, Hexamin, Methenamine. Army heat tablets, camping or chemical suppliers  
Improved from reaction of Ammonia on formaldehyde

6% hair bleach or pharmaceutical store  
Drug stores

### Procedure

1. Measure 9 teaspoons of hydrogen peroxide into a container.
2. In 3 portions, dissolve 2.5 teaspoons of crushed hexamethylenetetramine in the peroxide.
3. Keep the solution cool for 30 minutes by placing container in a pan of cold water.

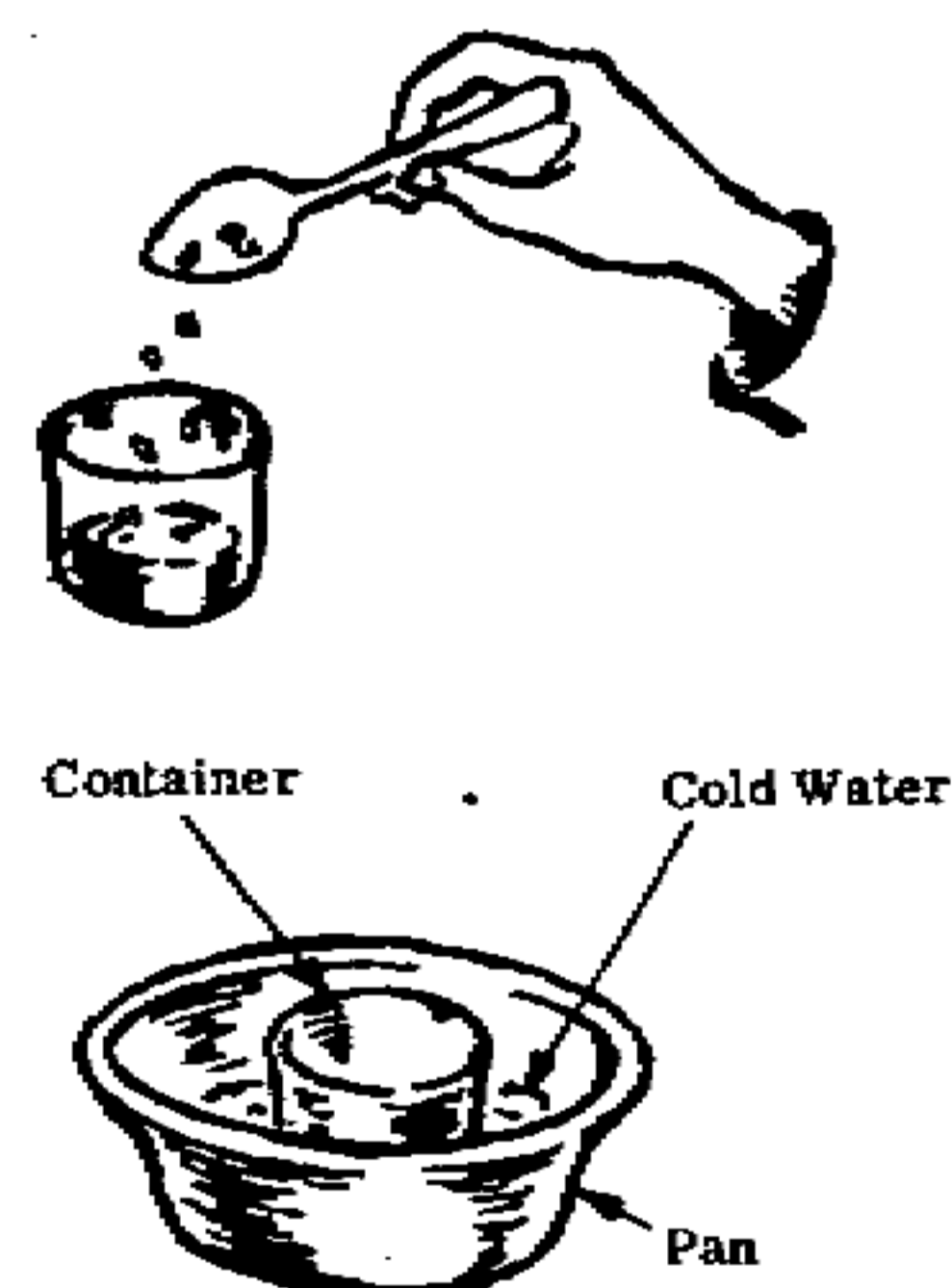

## Scientific Principles of Improvised Warfare and Home Defense

4. In 5 portions, dissolve 4.5 teaspoons of crushed citric acid into the solution.

5. Permit solution to stand at room temperature until solid particles form at the bottom of the container.



**Note:** Complete precipitation requires 8-24 hours

**Caution:** At this point the solution is a primary explosive. Keep away from flame

6. Filter the mixture through a paper towel into a paper to collect the solid particles.



7. Wash the solid particles collected in the paper towel with 6 teaspoons of water by pouring the water over them. Discard the liquid in the container.

8. Place these explosive particles in a container and allow to air dry.

**Caution:** Handle dry explosives with great care. Do not scrape or handle roughly. Keep away from sparks and open flame. Store in a cool dry place.



# Scientific Principles of Improvised Warfare and Home Defense

## 15) Picric Acid from Aspirin

Picric Acid can be used as a booster explosive in detonators, a high explosive charge, or as an intermediate to preparing lead picrate or DDNP.

### Material Required

- Aspirin Tablets ( 5 grains per tablet)
- Alcohol, 95% pure
- Sulfuric Acid, concentrated from battery acid boiled till white fumes appear
- Potassium Nitrate
- Water
- Paper Towels
- Canning Jar, 1 pint
- Rod (glass or wood)
- Glass containers
- Ceramic or glass dish
- Cup
- Teaspoon
- Tablespoon
- Pan
- Heat Source
- Tape

### Procedure

1. Crush 20 aspirin tablets in a glass container.  
Add 1 teaspoon of water and work into a paste.

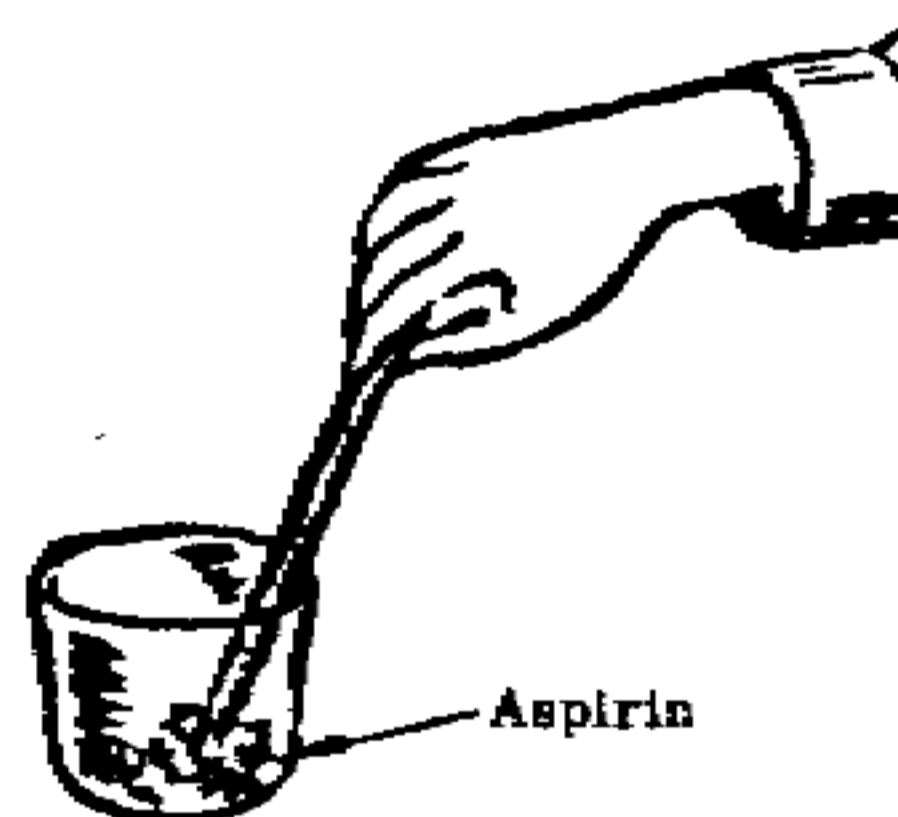

2. Add app. 1/3-1/2 cup of alcohol (100 ml.)  
to the aspirin paste, stir while pouring.

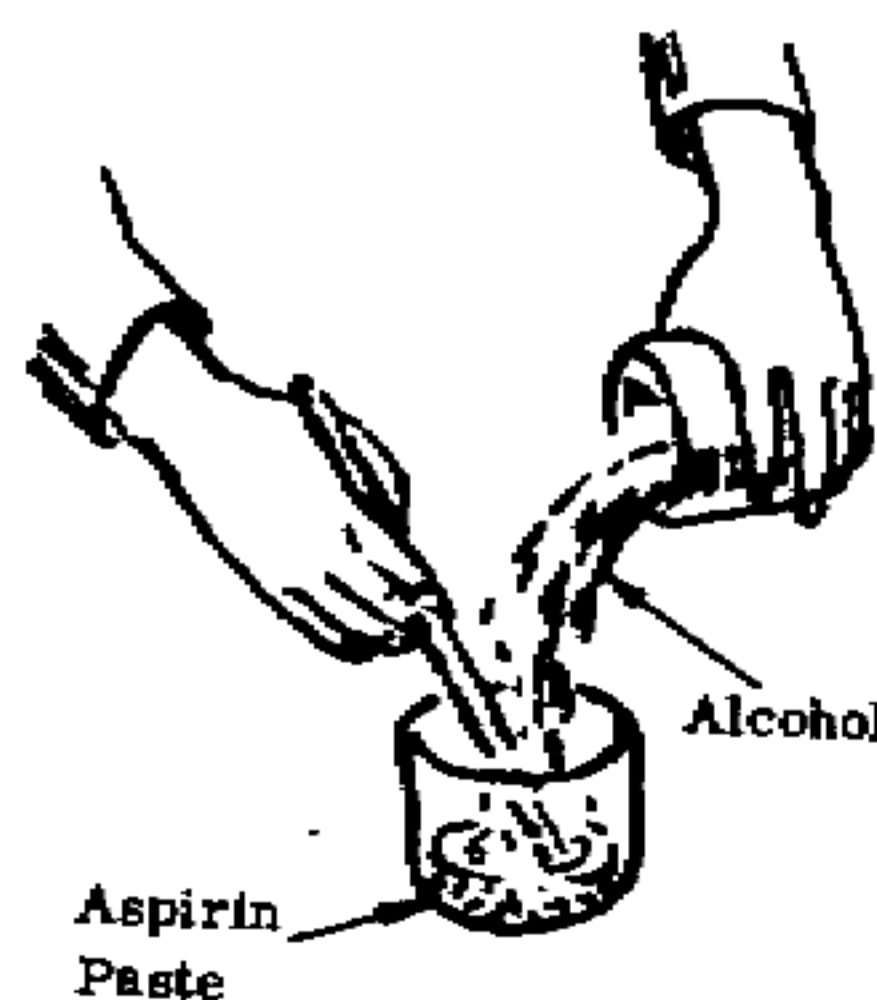

## Scientific Principles of Improvised Warfare and Home Defense

3. Filter the alcohol-aspirin solution through a paper towel into another glass container. Discard the solid left on the paper towel.



4. Pour the filtered solution into a ceramic or glass dish.

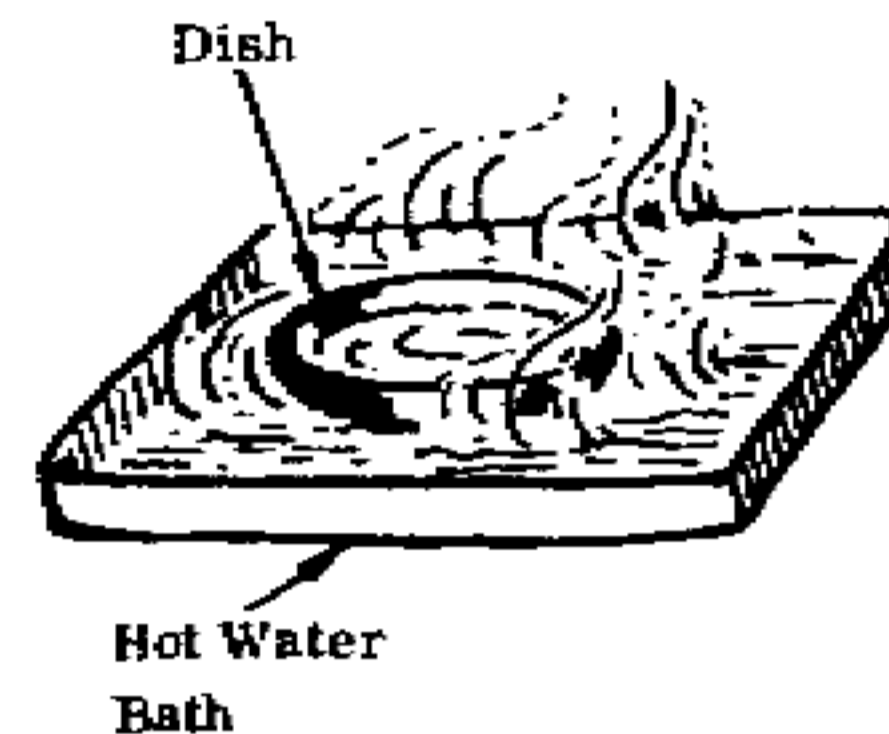

5. Evaporate the alcohol and water from the solution by placing the dish into a pan of hot water. White powder will remain in the dish after evaporation.

**Note:** Water in pan should be at hot bath temperature, not boiling, app. 160-180 degrees F. It should not burn the hands.

6. Pour 1/3 cup (80 ml.) of concentrated sulfuric acid into a canning jar. Add the white to the sulfuric acid.

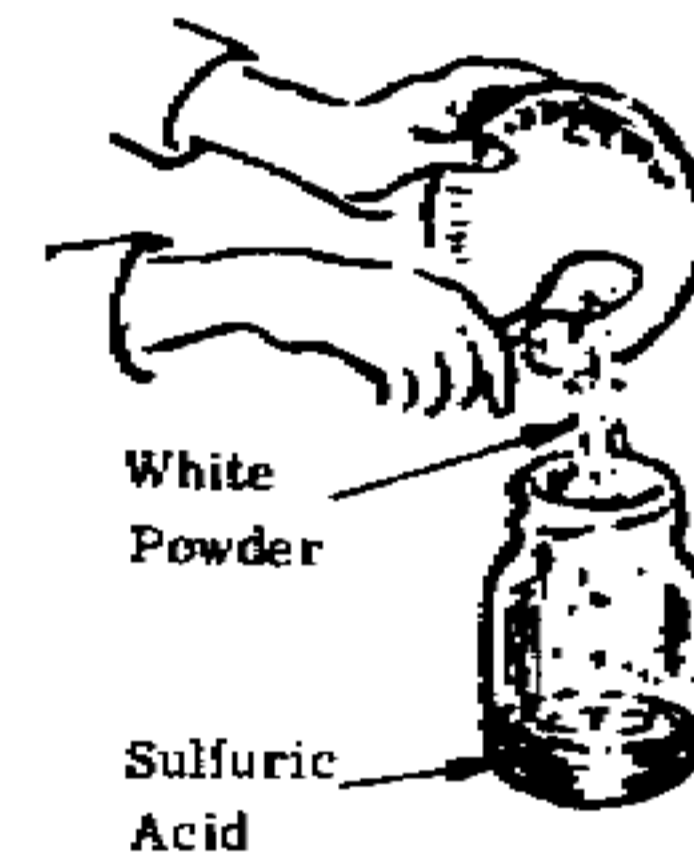

7. Heat canning jar of sulfuric acid in a pan of simmering hot water bath for 15 minutes; then remove jar from the bath. Solution will turn to a yellow-orange color.

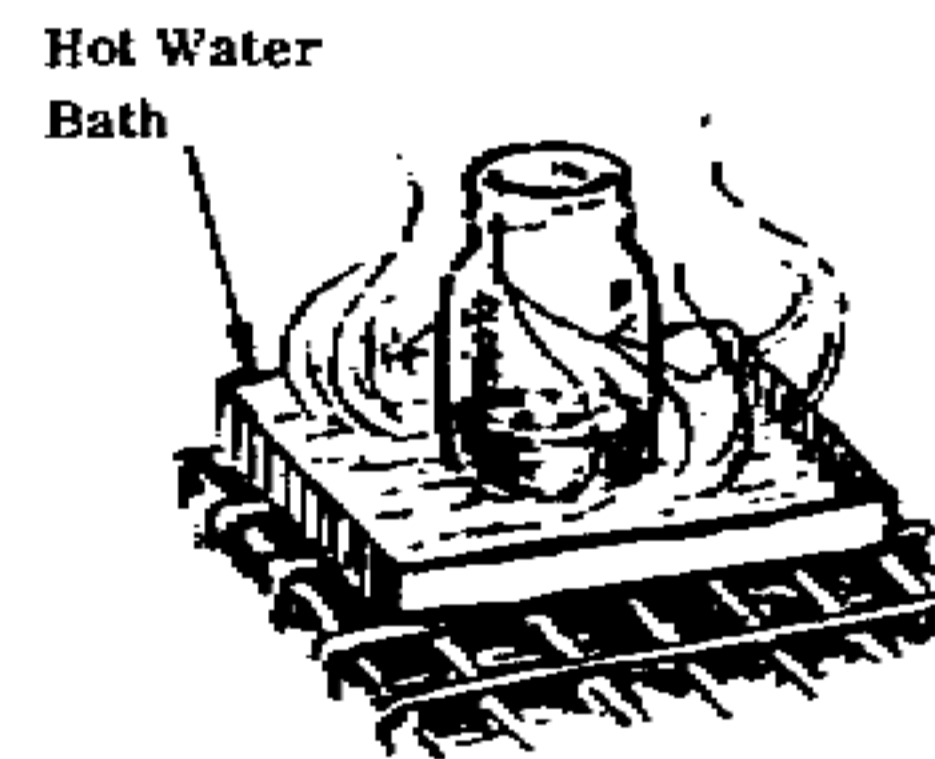

8. Add 3 level teaspoons (15 grams) of potassium nitrate in 3 portions to the yellow-orange solution; stir vigorously during additions. Solution will turn red, and then back to yellow-orange.

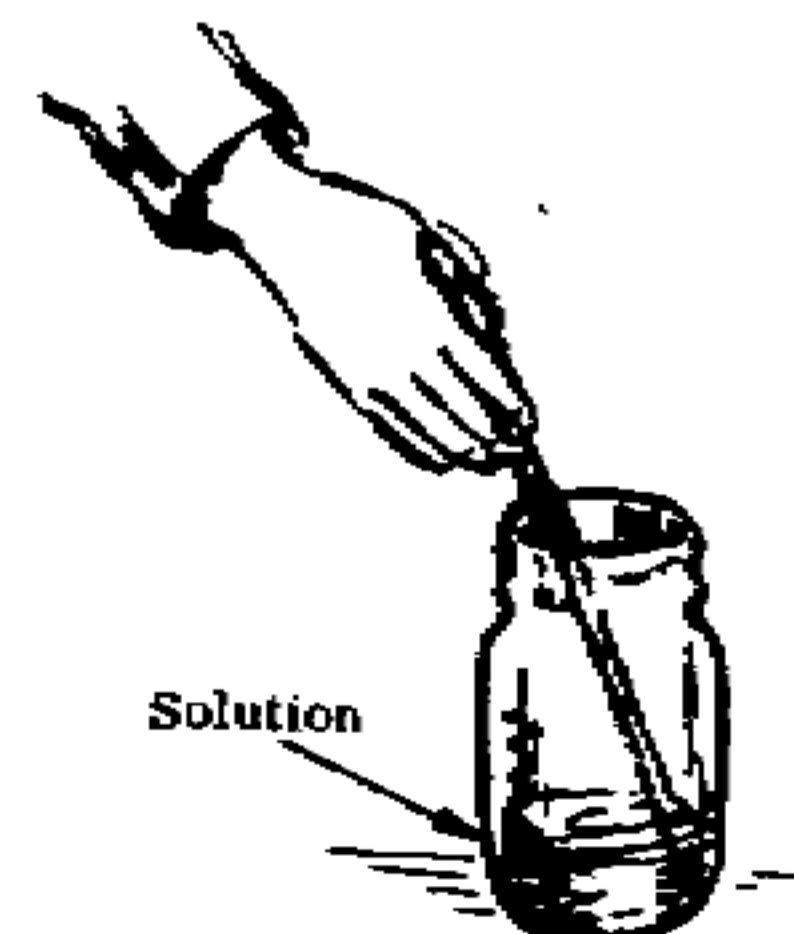

## Scientific Principles of Improvised Warfare and Home Defense

9. Allow the solution to cool to ambient or room temperature while stirring occasionally.

10. Slowly pour the solution, while stirring, into 1-1/4 cup ( 300 ml.) of cold water and allow to cool.



11. Filter the solution through a paper towel into a glass container. Light yellow particles will collect on the paper towel.

12. Wash the light yellow particles with 2 tablespoons ( 25 ml.) of water. Discard the waste liquid in the container.

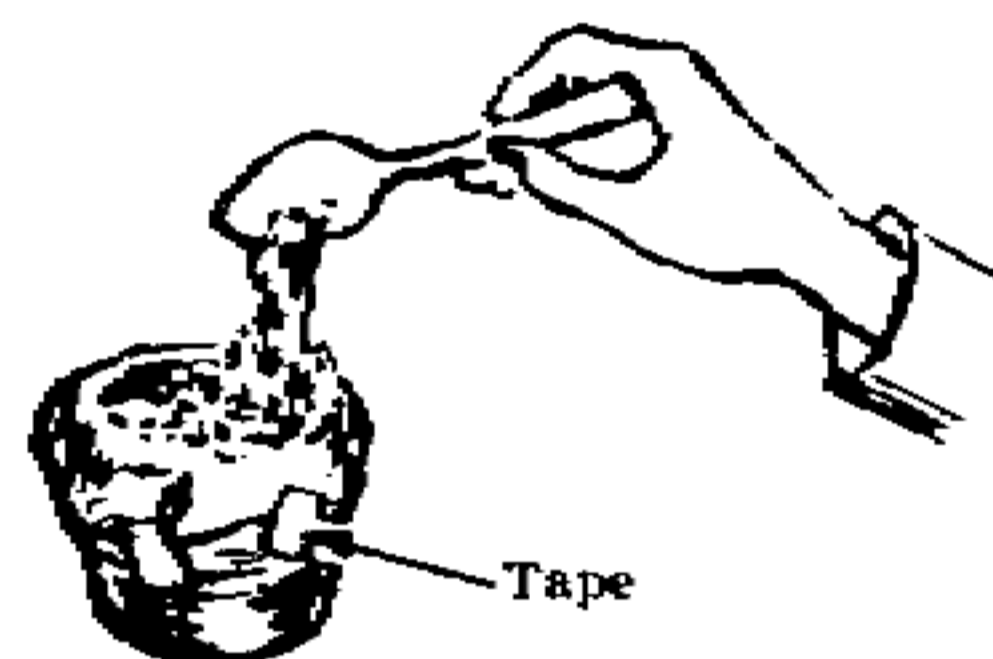

13. Place particles in ceramic dish and set in a hot water bath, as in step 5, for 2 hours.

# Scientific Principles of Improvised Warfare and Home Defense

## 16) Sodium Chlorate

Sodium Chlorate is a strong oxidizer used in the manufacture of explosives. It can be used in place of Potassium Chlorate or other nitrate salts.

### Material Required

2 carbon or lead rods  
(1 in. dia. x 5 in. long)  
Salt or ocean water  
Sulfuric Acid, diluted  
Motor vehicle  
Water  
2 wires, 16 gauge (3/64" dia.) x 6' long insulated  
Gasoline  
1 gallon glass jar, wide mouth (5" x 6" high)  
Sticks and String  
Teaspoon and Knife  
Trays and Large flat pan  
Cup  
Heavy cloth

### Procedure

1. Mix 1/2 cup of salt into the one gallon glass jar with 3 liters or quarts of water.
2. Add 2 teaspoons of battery acid to the solution and stir vigorously for 5 minutes.
3. Strip about 4 inches of insulation from both ends of the 2 wires.

### Sources

Dry cell batteries (2.5 x 7 in.)  
or plumbing supply store  
Grocery store or ocean  
Auto battery

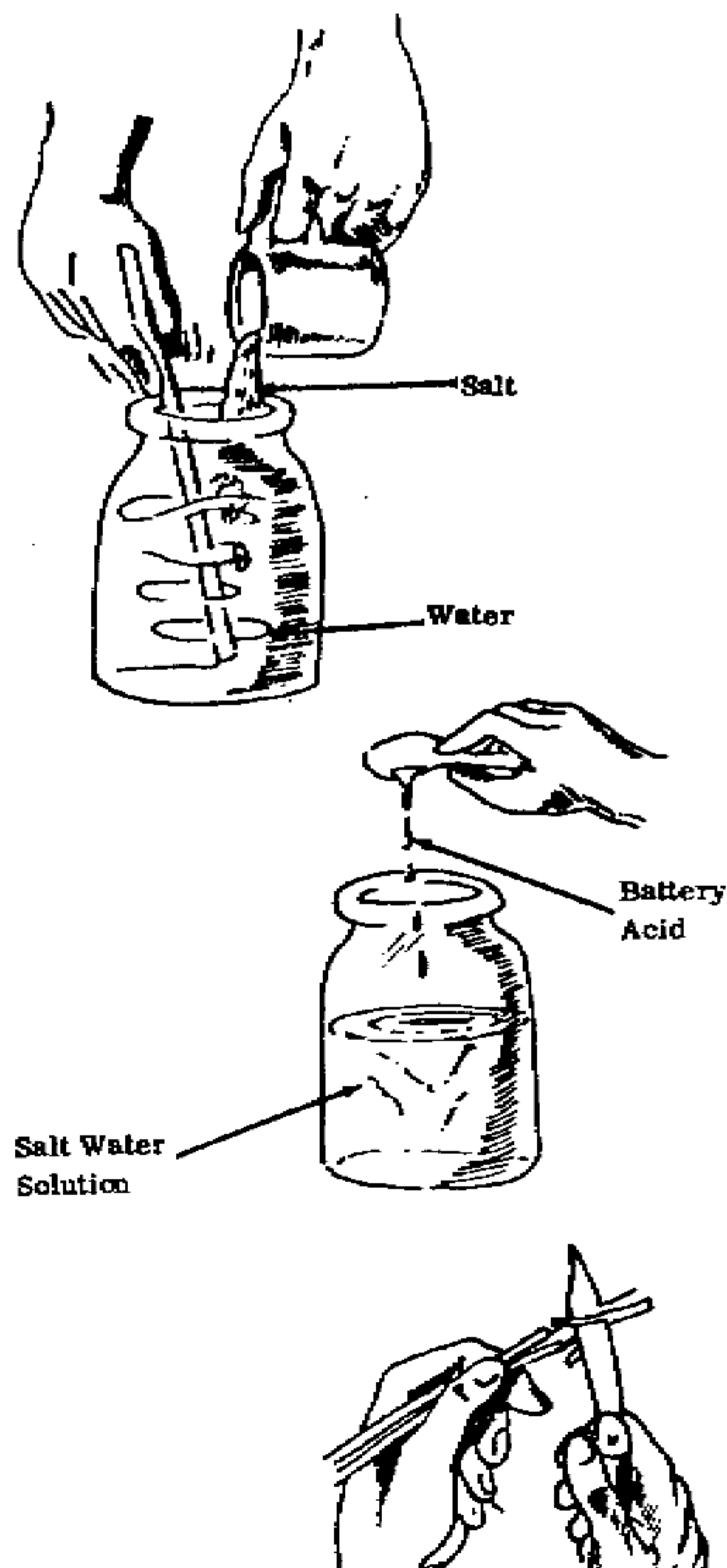

## Scientific Principles of Improvised Warfare and Home Defense

4. With knife and sticks shape 2 strips of wood 1 x 1/8 x 1-1/2". Tie the wood strips with string to the lead or carbon rods so that they are 1-1/2" apart.

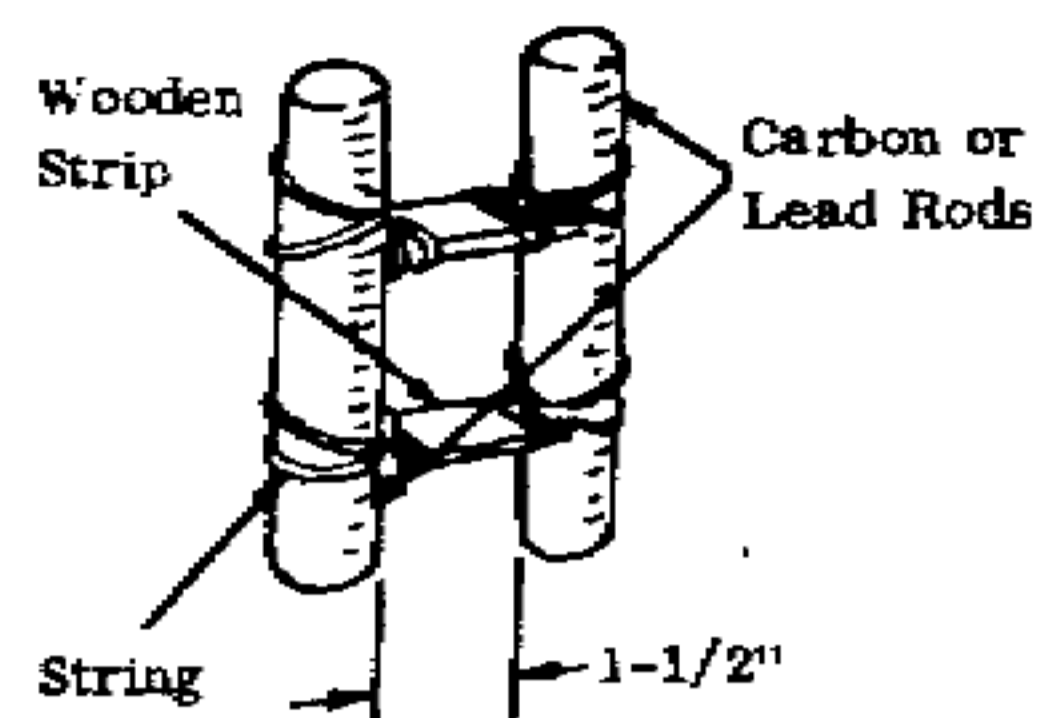

5. Connect the rods to a battery in a motor vehicle with the insulated wire.

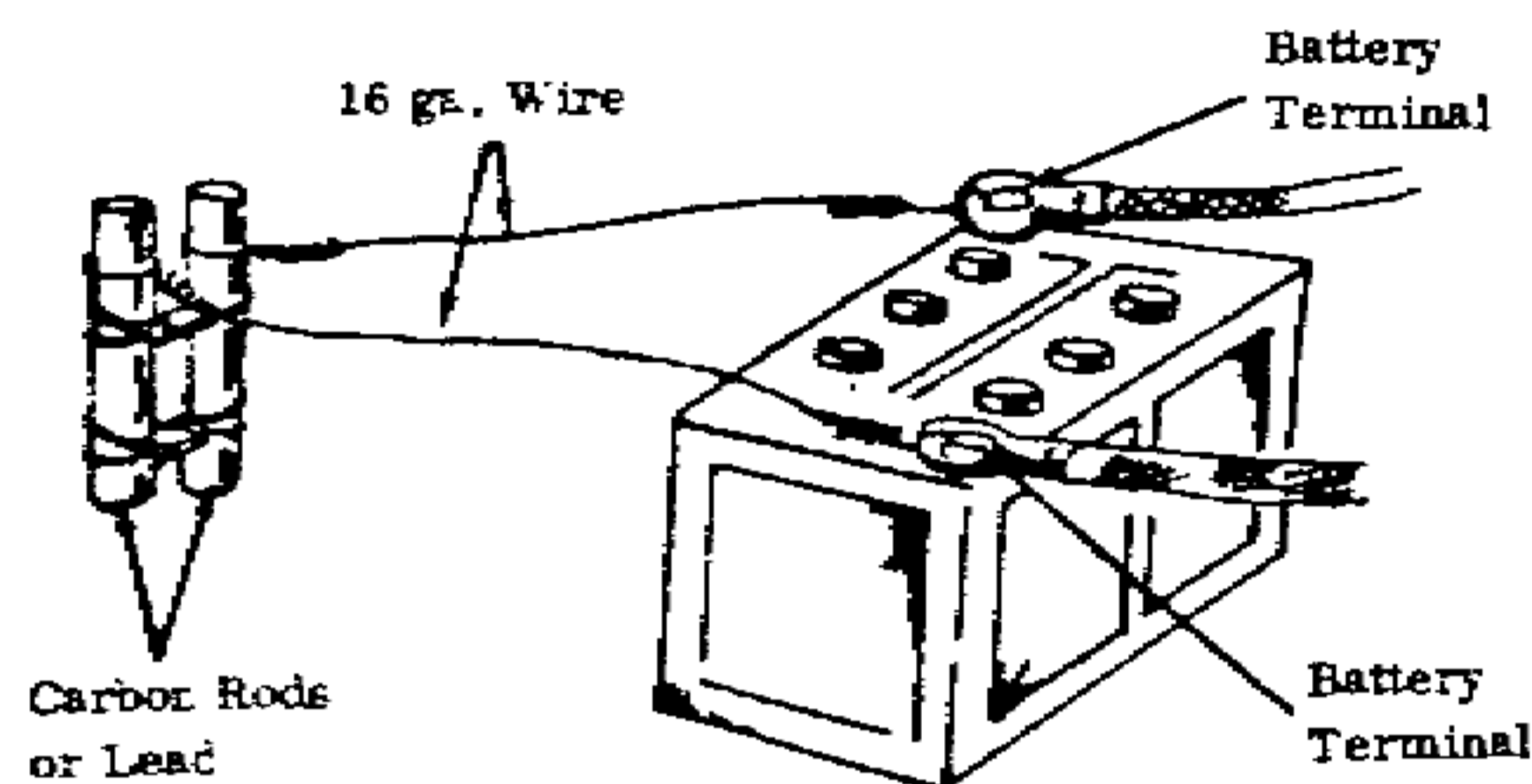

6. Submerge 4.5 in. of the rods into the salt water solution.

7. With gear in neutral position, start the vehicle engine. Depress the accelerator 1/5 of the distance to the floorboard.

8. Run the engine with the accelerator in this position for 2 hours, then shut it down for 2 hours.

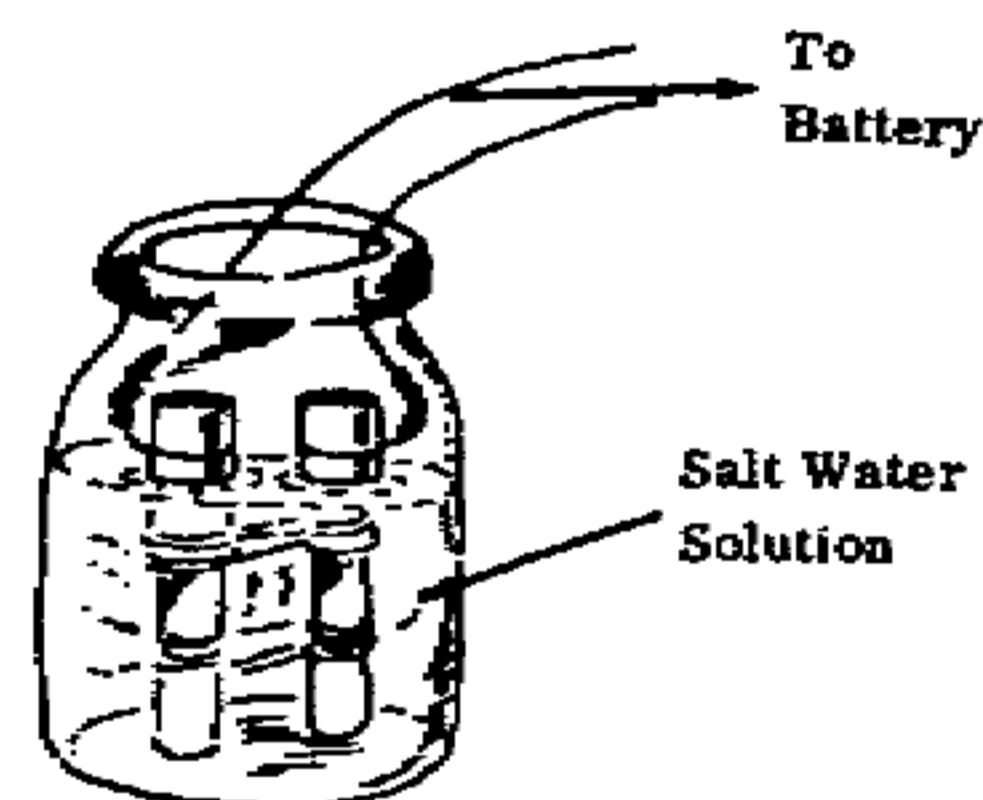

9. Repeat this cycle for a total of 64 hours while maintaining the level of the acid salt water solution in the glass jar.

Caution: Do not touch bare wire leads to avoid dangerous shock.

10. Shut off the engine. Remove the rods from the glass jar and disconnect wire leads from the battery.

11. Filter the solution through the heavy cloth into a flat pan or tray, leaving the sediment at the bottom of the glass jar.

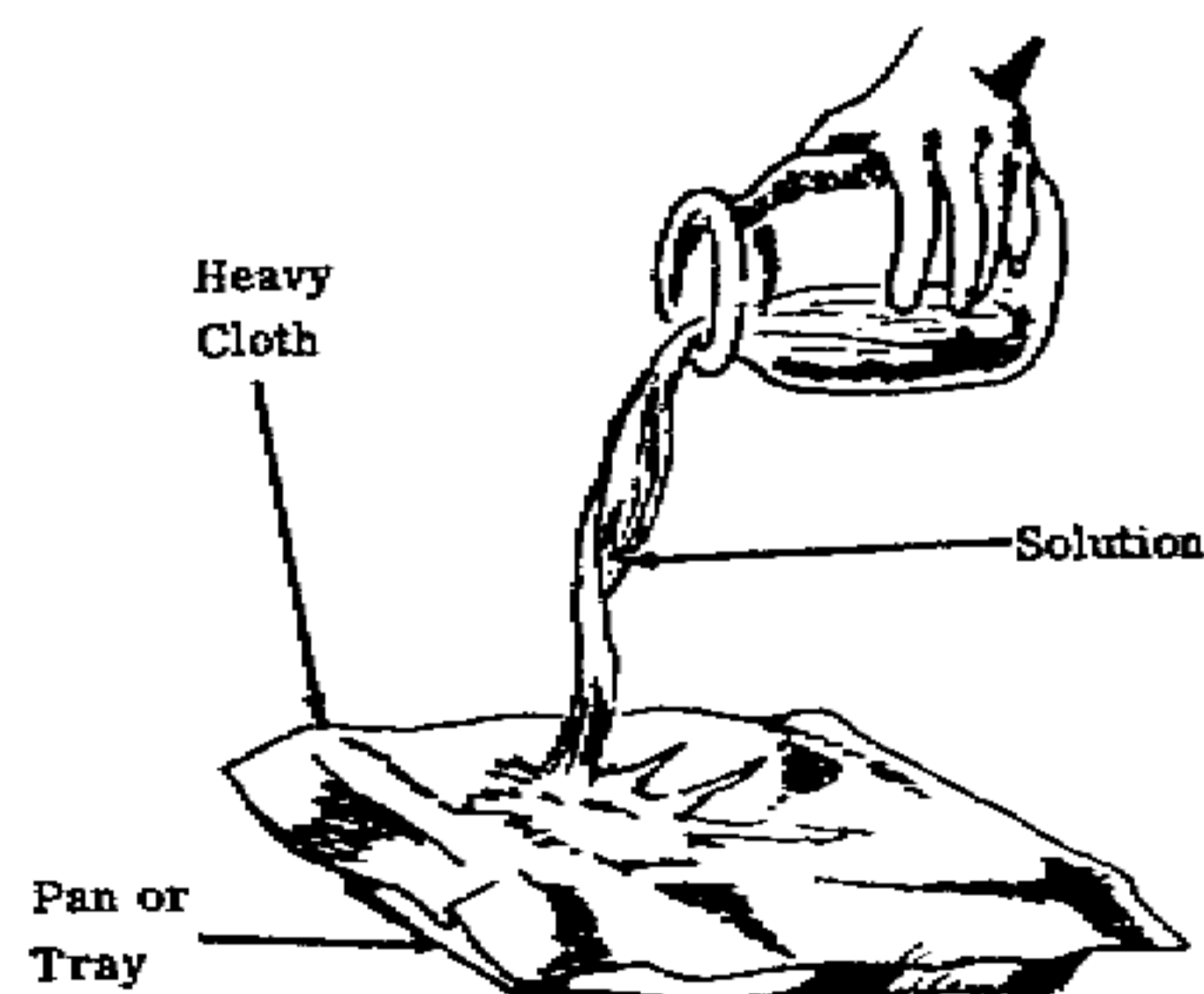

12. Allow the water in the filtered solution to evaporate at room temp. (app 16 hrs.). The residue is app. 60% or more Sodium Chlorate which is pure enough to be used as an explosive ingredient.



# Scientific Principles of Improvised Warfare and Home Defense

## 17) Mercury Fulminate

Mercury Fulminate is used as a primary explosive in the fabrication of detonators. It is to be used with a booster explosive such as picric acid or RDX.

### Material Required

Nitric Acid 90%  
Mercury  
Ethyl (grain) alcohol  
Filtering material  
Teaspoon measures ( 1/4, 1/2, and 1 teaspoon capacity)  
aluminum, stainless steel, or wax coated  
Heat source  
Clean wooden stick  
Clean water  
Glass containers  
Tape  
Syringe

### Source

Field Grade or chem. supplier  
Thermometer or mercury switches

Paper towels

### Procedure

1. Dilute 5 teaspoons of Nitric Acid with 2.5 teaspoons of clean water in a glass container by adding acid to the water.

2. Dissolve 1/8 teaspoon of mercury in the diluted nitric acid. This will yield dark red fumes.

**Note:** It may be necessary to add water, one drop at a time, to the mercury-acid solution in order to start reaction.

3. Warm 10 teaspoons of the alcohol in a container until the alcohol feels warm to the inside of the wrist.

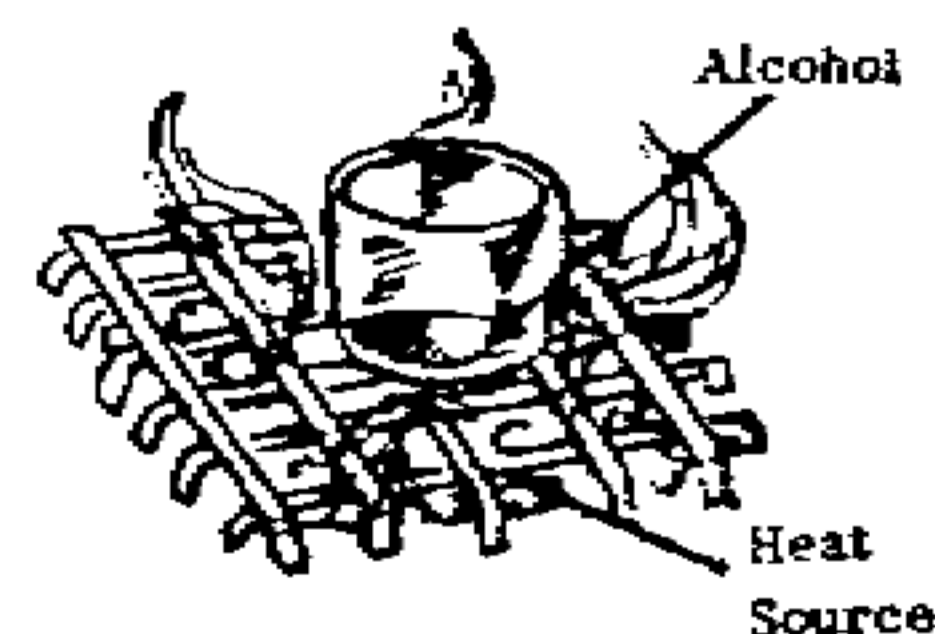
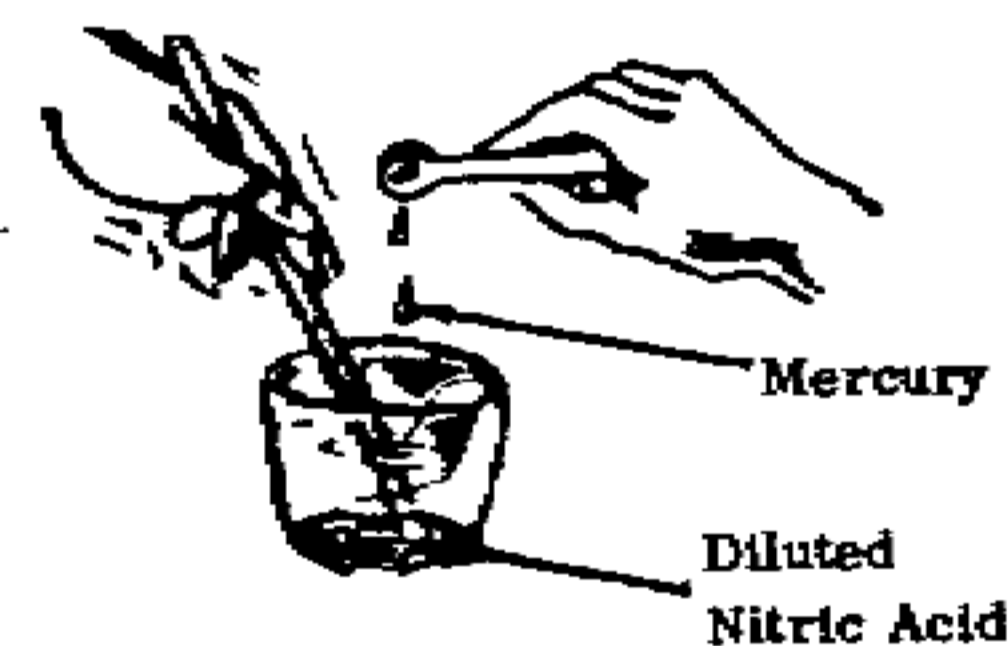

## Scientific Principles of Improvised Warfare and Home Defense

4. Pour the metal-acid solution into the warm alcohol. Reaction should start in less than 5 minutes. Dense white fumes will be given off during reaction. As time passes, the fumes will become less dense. Allow 10 to 15 minutes to complete reaction. Fulminate will settle to bottom.

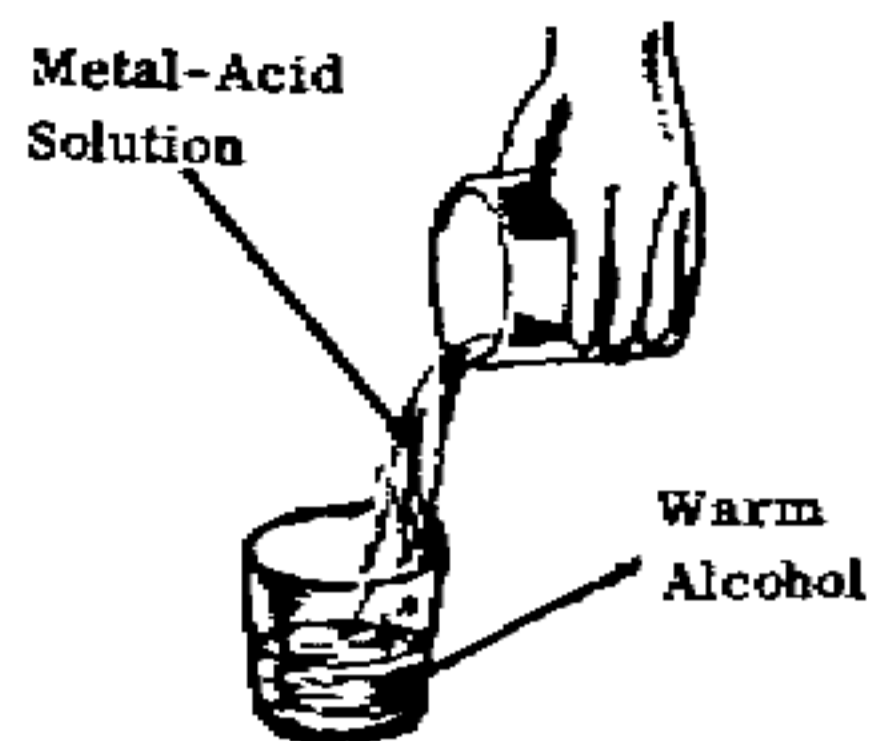

**Caution:** This reaction generates large quantities of toxic, flammable fumes. The process must be conducted outdoors or in a well ventilated area away from sparks and open flames.

5. Filter the solution through a paper towel into a container. Crystals may stick to the side of the container. If so, tilt and squirt water down the sides of the container until all the material collects on the filter paper.

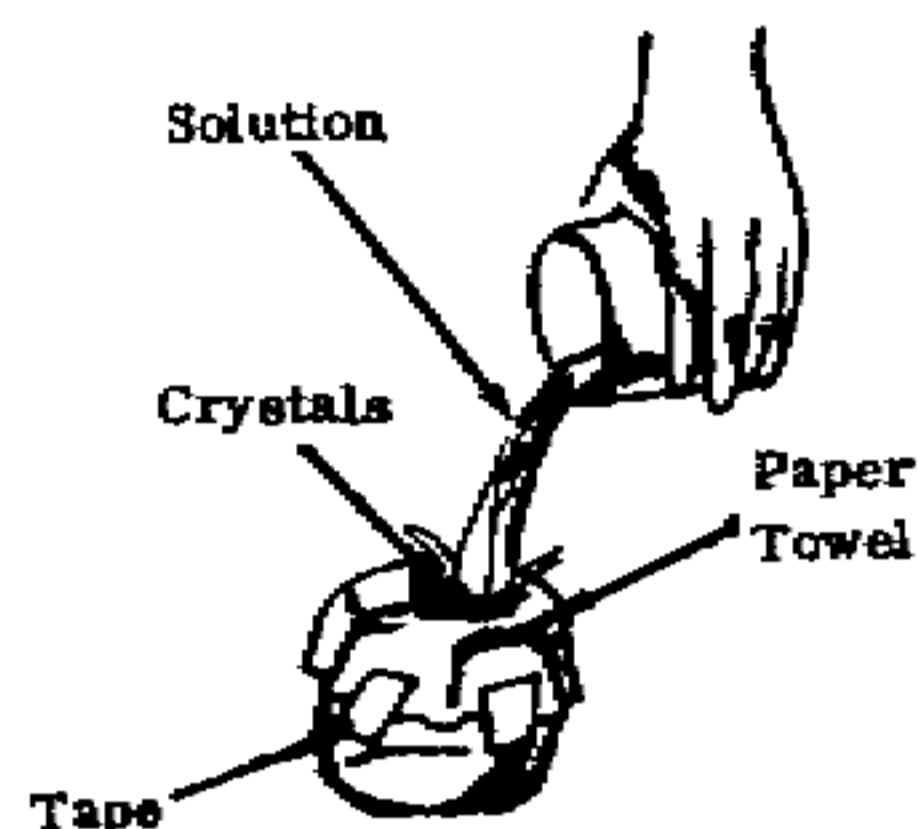

6. Wash the crystals with 6 teaspoons of ethyl alcohol.

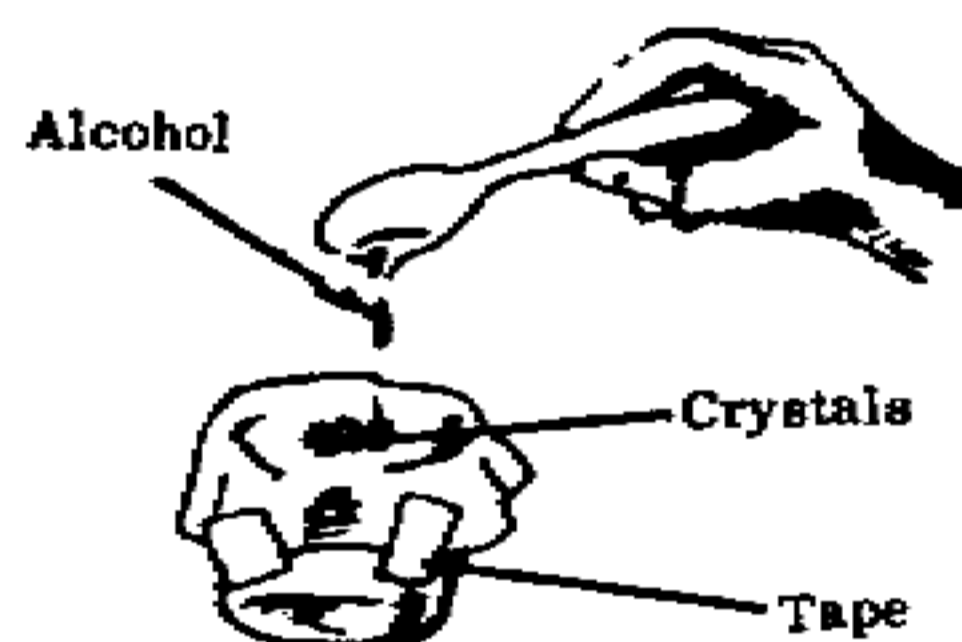

7. Allow these mercury fulminate crystals to air dry.

Handle with care!

# Scientific Principles of Improvised Warfare and Home Defense

## 18) Sugar/Aluminum Explosive

An explosive munition can be made from sodium chlorate combined with granular sugar, or aluminum powder. This explosive can be detonated with a #8 commercial or a military blasting cap.

### Material Required

Sodium Chlorate  
Granulated Sugar  
Aluminum powder  
Wooden rod or stick  
Bottle or jar  
Blasting Cap  
Steel Pipe threaded at one end, end cap and tape  
Wax  
Measuring container

### Procedure

1. Add three volumes sodium chlorate to one volume aluminum, or two volume granular sugar, in bottle or jar.
2. Mix ingredients well by stirring with the wooden rod or stick.

### How to use

1. Wax blasting cap, pipe and end cap.
2. Thread end cap onto pipe.
3. Pour mixture into pipe.
4. Insert and tape blasting cap just beneath surface mixture.

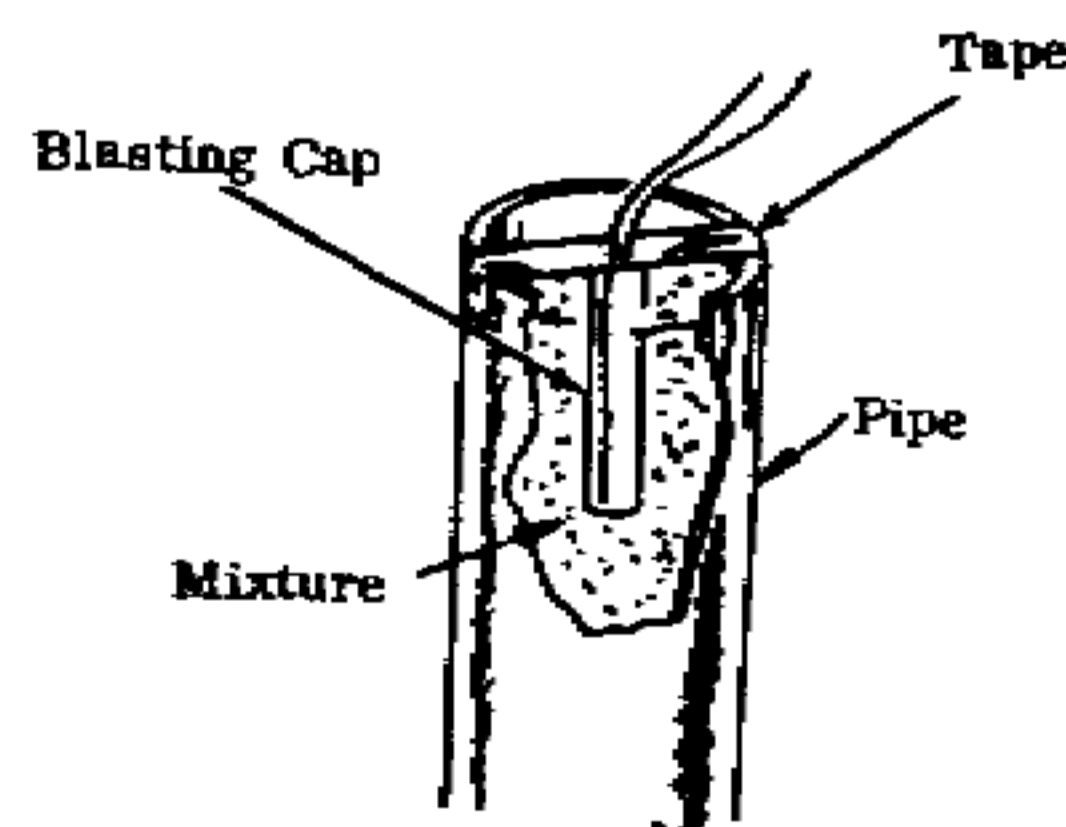
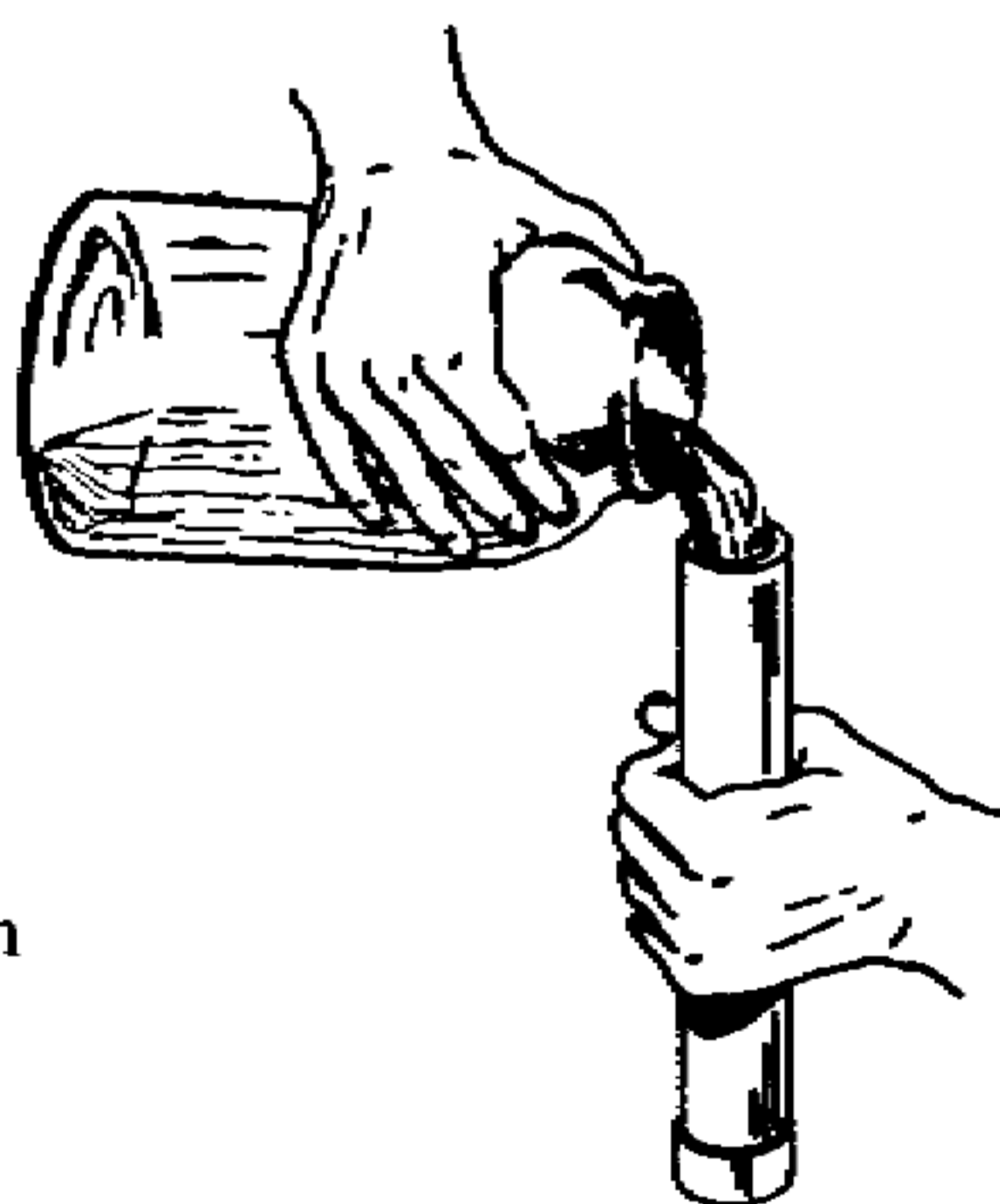
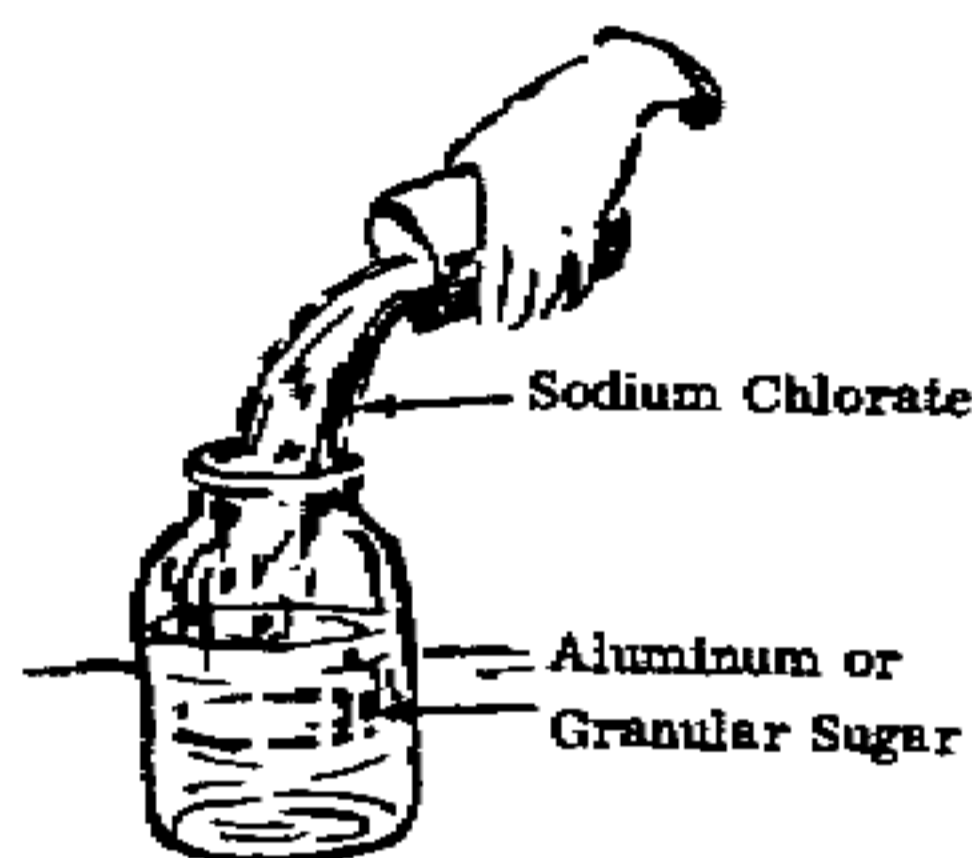

# Scientific Principles of Improvised Warfare and Home Defense

## 19) Fuel Air Explosive

The US Military constructs bombs with substantial destructive properties using the principle of dispersing a volatile fuel rapidly into the air creating an intimately mixed fuel air composition.

This mixture is then "ignited" generating a shock wave from the center which accumulates strength as it spreads outward in the presence of additional fuel. The operating principle of this mixing and explosion occurs millions of times in your automobile engine as the tiny amounts of gasoline mixed with air accelerates thousands of pounds of metal and passengers.

To construct a usable fuel air explosive for use against enemy armor and personnel requires applying these principles to a device suitable for the circumstances. Two of these will be described here.

1. Scorched Earth Trap
2. Suicide vehicle bomb

### 1. Scorched earth trap

Preparation of this device requires the following materials

- a. Storage tank for gasoline (use 100 gallons or app. 900# per square block)
- b. High volume pump(s) to rapidly disperse gasoline in air in 10-30 seconds
- c. Hoses and nozzles sufficient to transport gasoline
- d. Central detonating device

An area that the enemy is expected to travel through or overrun can be prepared for a gasoline based fuel-air demolition by

1. Placing a large storage tank (100 gallons per square block) in the center of the target area. It may be buried underground, hidden inside a building, or camouflaged on top of the ground.
2. High speed pumps, driven electrically off a battery or by gas engine are hoses to receive the gasoline from the tank by a valve.
3. Hoses are run from the pump to disperse the gasoline over a one block area. The discharge of the pump should be set up to accommodate many smaller hoses (such as ordinary garden hose) which are run up the sides of buildings or trees throughout the target area.

## **Scientific Principles of Improvised Warfare and Home Defense**

4. The ends of the hoses must be equipped with fine atomizing nozzles.

[ The reason for this is that gasoline is volatile and turns to vapor when mixed with air. This process occurs very slowly when gasoline is stored in an open bucket, because it only volatilizes on the surfaces in direct contact with air. By using fine mist spray from atomizer nozzles, most of the gasoline rapidly vaporizes ]

Water saving shower heads may be used if necessary.

5. Any explosive or an electrical spark may be used to ignite the gasoline once it has been dispersed completely in the air.

6. Once the enemy has entered the targeted area, the device is activated and the gasoline begins to be distributed in a fine mist shower. If the enemy becomes aware of the gas, it will be too late for them to run.

7. At 10-30 seconds, the detonator is ignited at the center. The resulting explosion yields a high temperature blast that will melt some metals and likely detonate ordnance stored on the inside of enemy tanks and other vehicles caught in the fireball. All individuals caught in the detonation wave will be incinerated.

If pumps are not available, a gravity flow system using the stored energy of compressed air can be improvised as follows.

The gasoline is stored in compressed air tanks with bottom discharge valves. The tank is located in elevated positions over the target area, such as inside a building window overlooking a street, or in a tree, alongside power poles, etc. The tank is half filled with gasoline and is compressed with air to the rating of the tank. The discharge valve is plumbed to hoses attached to rotating lawn sprinklers or shower heads. When the enemy is positioned in the target area, the valve is tripped open producing a shower of atomized gasoline. A delay timer then ignites the mist. The gas is distributed at velocity by the effects of gravity and the pressure of the compressed air.

These methods are effective in clearing underground tunnels and buildings.



# Scientific Principles of Improvised Warfare and Home Defense

## 2. Suicide Vehicle Fuel Air Explosive

A vehicle can be armed with an identical device described in the scorched earth trap as follows.

1. The gasoline reserve (tank) is placed inside the vehicle with the pump plumbed into it.
2. A telescoping manual, hydraulic or electric crane is mounted on the roof, on a pickup bed, or can be manually extended out of the windows.
3. The hoses are mounted as a group on the crane so they travel out with it as the crane(s) arms are extended
4. The ends of the hoses may use shower heads, or preferably use fine mist rotating lawn sprinklers to distribute the gasoline.
5. When ready to use, the vehicle is driven into the target area, the crane arms are extended and the pump and a timed detonator are set. The driver may escape by use of another vehicle, however, this may not be possible if he has driven into an enemy area where withdrawal at high speed would be opposed.
6. After 20-60 seconds of gasoline distribution, the detonator is ignited producing a localized fireball.

Use of this device near combustible enemy buildings or fuel and ordnance storage areas is ideal.

# Scientific Principles of Improvised Warfare and Home Defense

## Chapter 4 Hand Held Firearms and Explosives

The operating principles of various handguns, rifles, grenades, and recoilless guns will be covered in this chapter as well as the improvised manufacture of these arms and specialized shaped charges for use against armor and fortifications.

### Firearm operating principles

#### Single action revolvers

Are those requiring the operator to pull back the hammer - usually with the thumb before each shot (a)

You can then take accurate aim before squeezing the trigger (b)

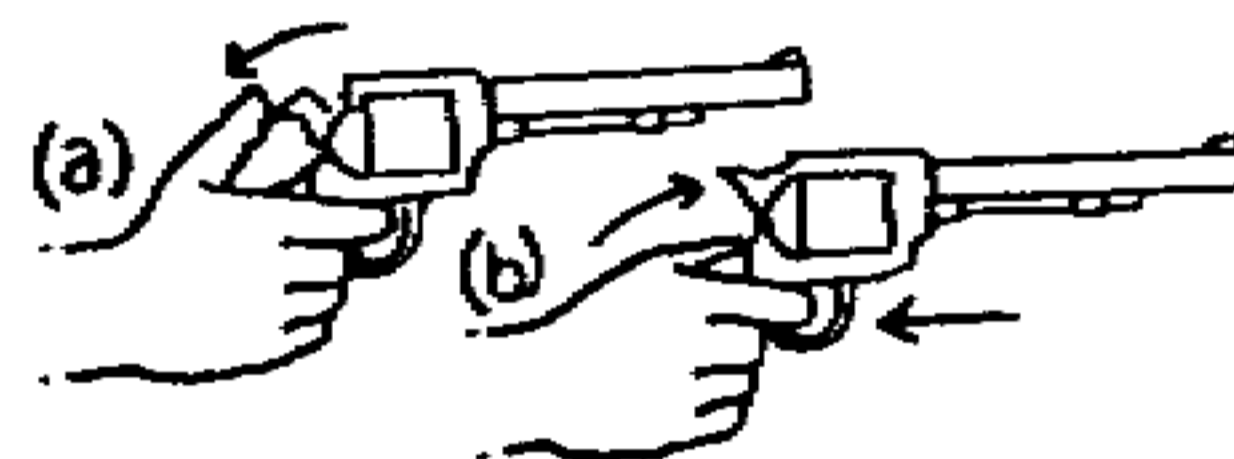

#### Double action (self cocking) revolvers

Those fired by pulling the trigger.

Pulling the trigger first cocks the hammer (a) and further pulling fires the shot (b).

This design is faster but the motion of the hand and recoil shakes the barrel making it less accurate.

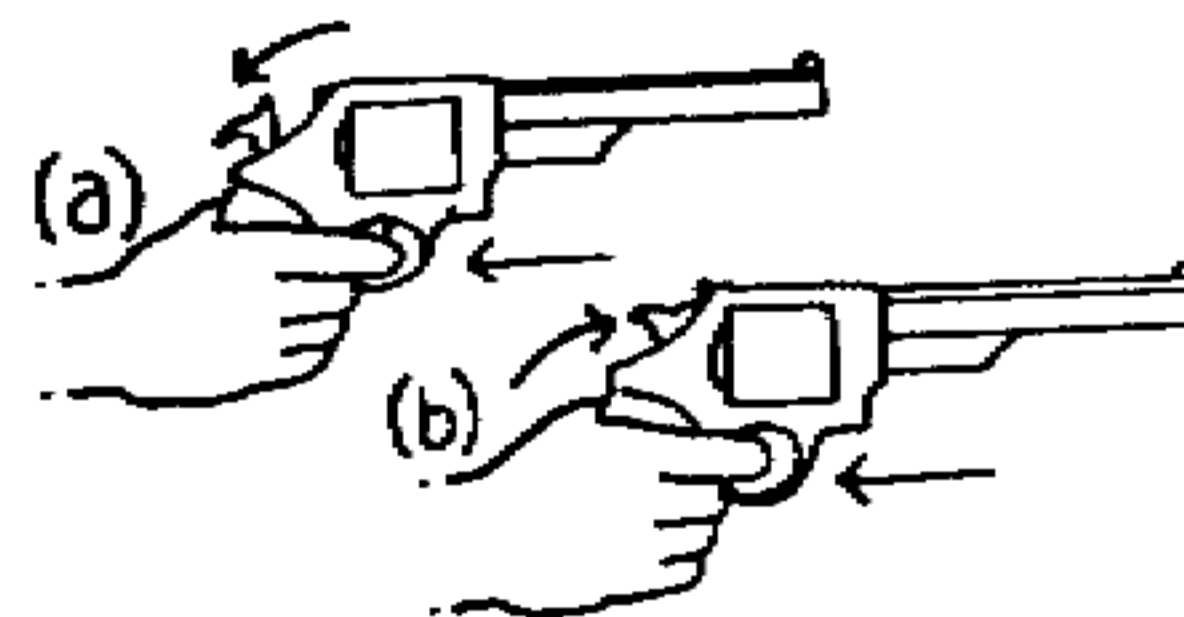

# Scientific Principles of Improvised Warfare and Home Defense

## Break Open

Multi-barreled shotguns and pistols are made with this design.

A latch is released (a) and the gun hinges open at its breech (b) which allows the spent cartridges to be removed by hand and the gun to be reloaded with fresh cartridges.

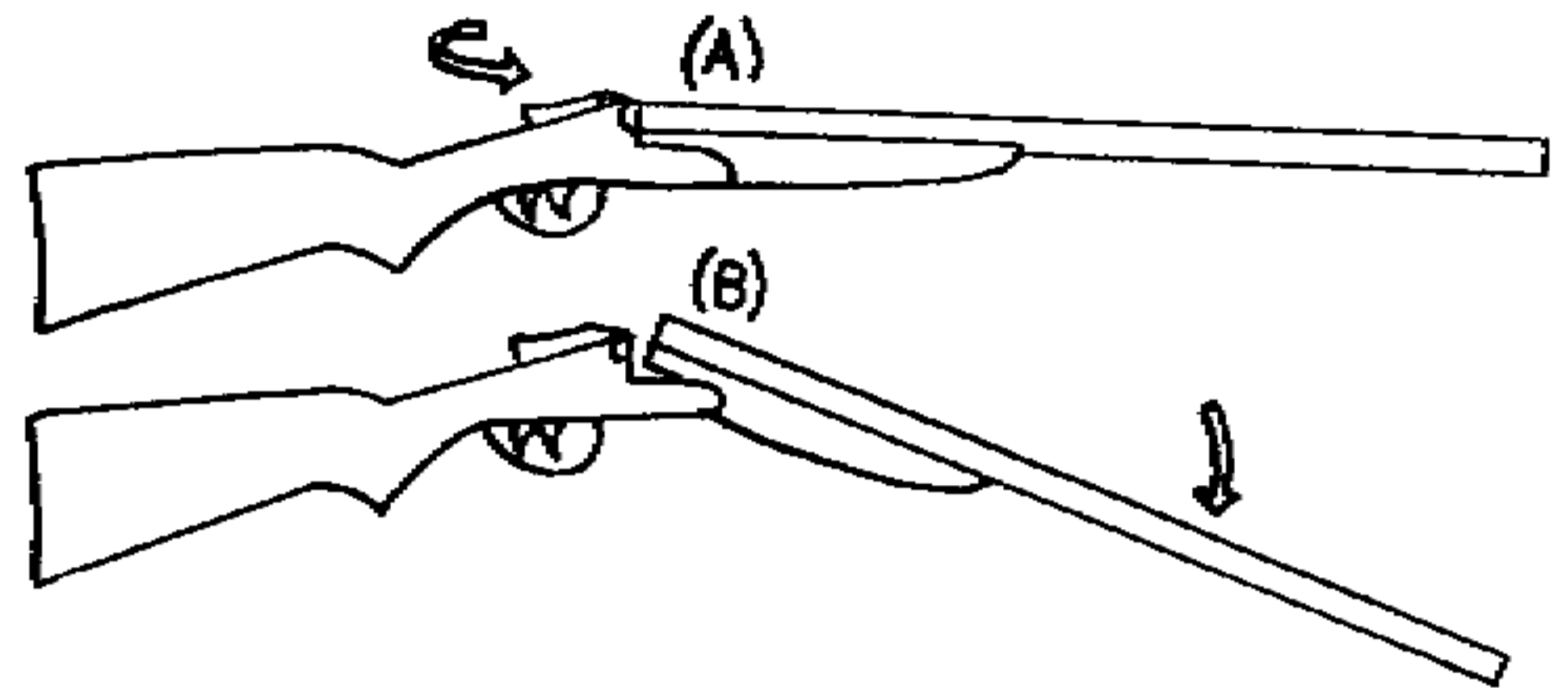

## Barrel Designs

The most common types are

a) side by side

b) over and under

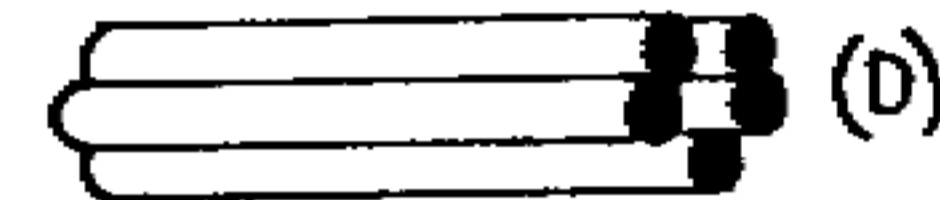
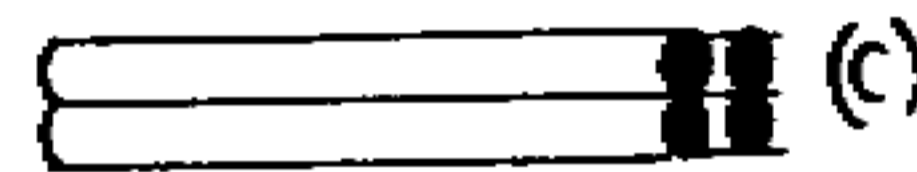
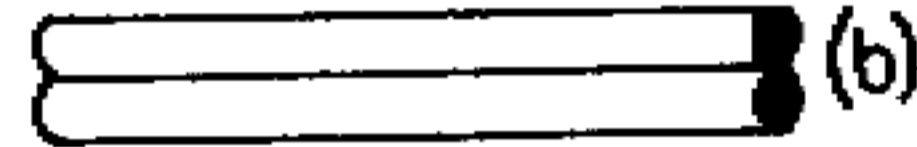
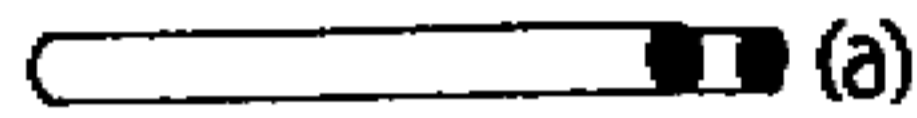

Multiple arrangements (c & d) can be found but are rare and have no common names.

**Repeating Action:** are named after the mechanical device that describes their operation.

1. Lever action, where a lever is operated to reload the chamber
2. Bolt action, where a bolt is rotated and drawn back to reload
3. Slide or pump action, where a tubular magazine is slid backward and forward to reload.

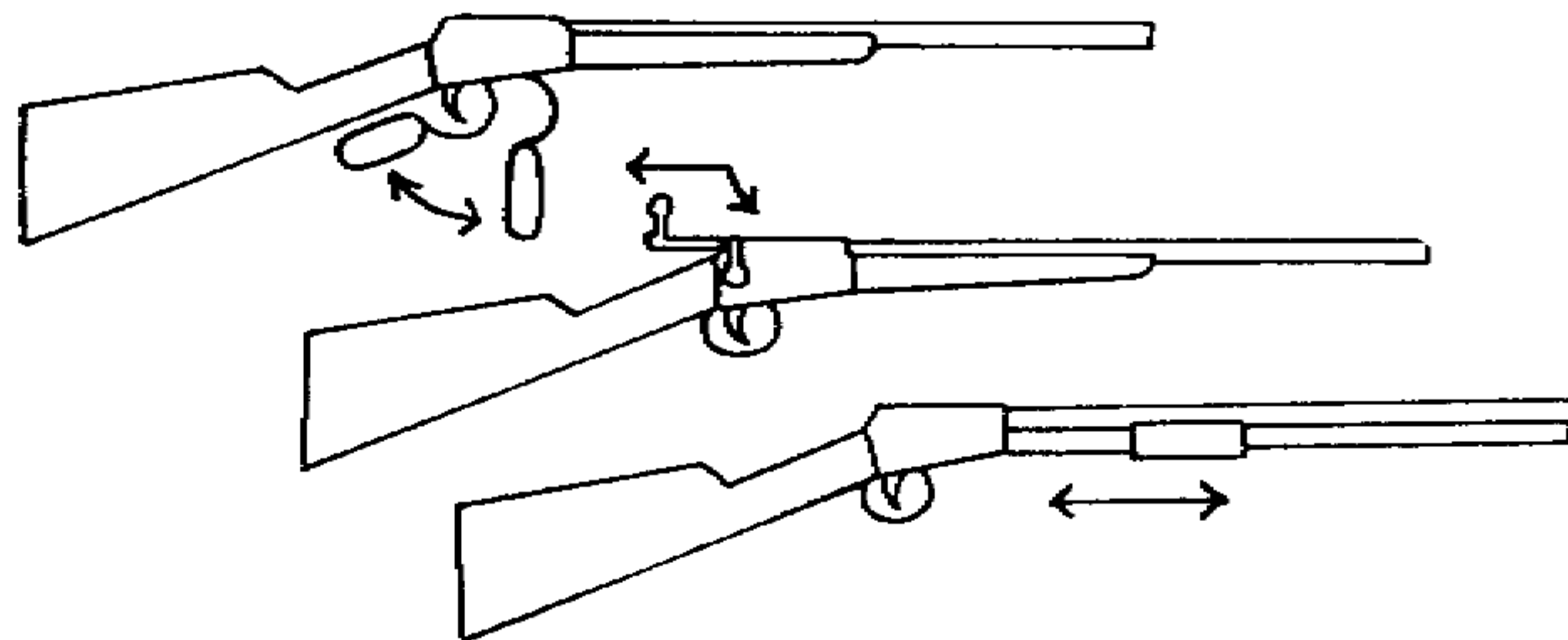

# Scientific Principles of Improvised Warfare and Home Defense

Ammunition storage systems (**magazines**) built into the firearms to permit rapid reloading include

1. Tubular magazine in the butt
2. Tubular magazine parallel to the gun barrel
3. Box magazine below the breech loading system

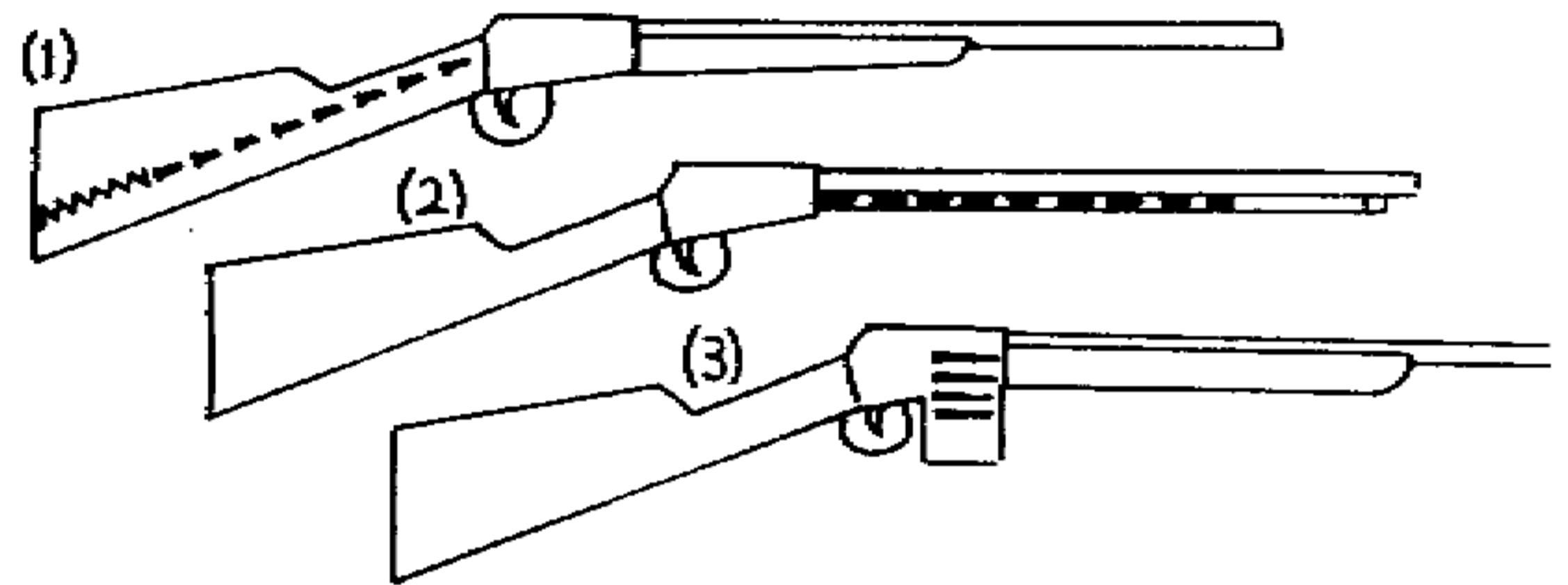

To speed up reloading of box magazines, steel clips were provided containing many cartridges, (early models were usually 5 cartridges).

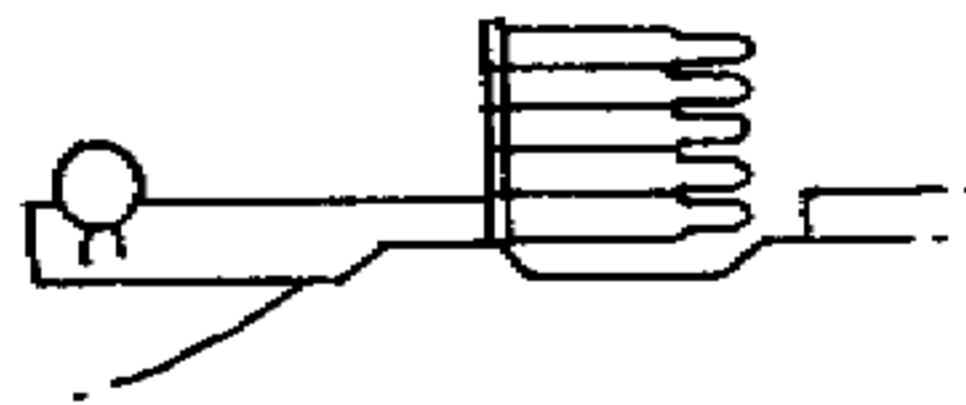

Most progress in weapon developments in this century have been in the refinement of safety features and especially in the use of lightweight and exceptionally strong steel alloys.

## Scientific Principles of Improvised Warfare and Home Defense

**Revolvers** and **autoloaders** are the 2 principle designs of handgun operation used today.

**Revolvers** vary in the way they are opened and their spent cartridges are replaced.

a. **Sliding gate**: each cartridge is pushed out toward the rear one at a time by a hand operated rod on the side of the barrel.

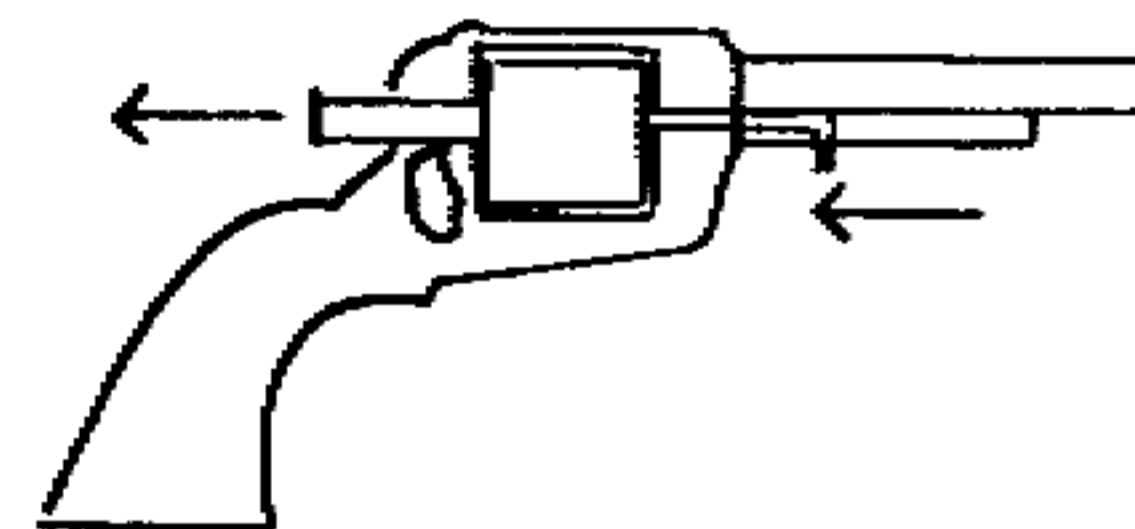

b. **Break open**: where all the cartridges are pushed out simultaneously by a radial pin which moves when the revolver is opened.

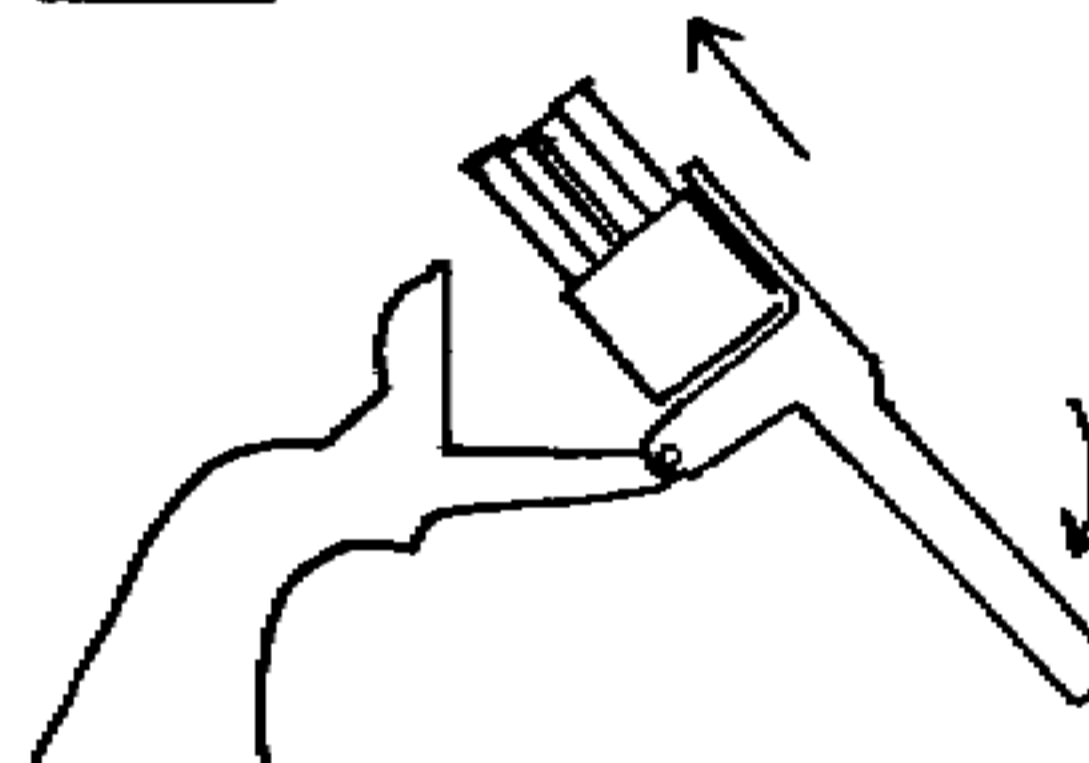

c. **Swinging cylinder**: where the cylinder is swung out to the side of the gun and the radial pin is manually pushed to discharge the cartridges.

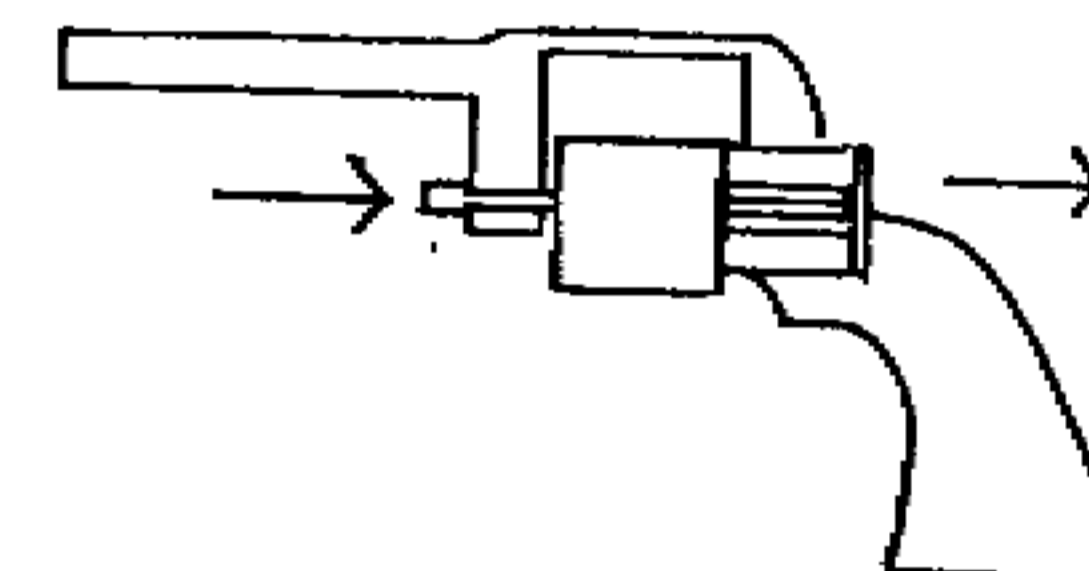
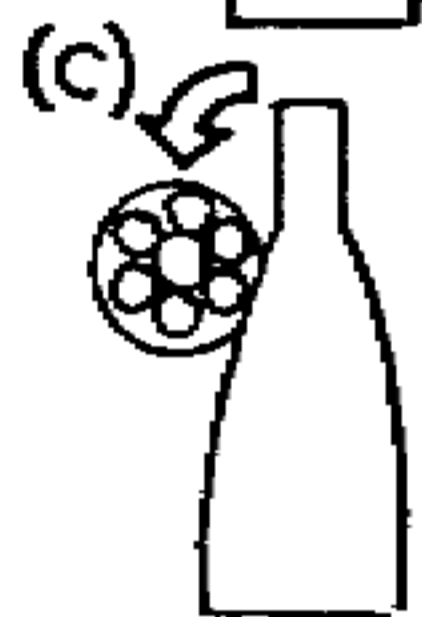

**Autoloaders** operate by having a clip of cartridges inserted into a magazine.

Designs included

a. Magazine in front of the trigger, like most rifle designs

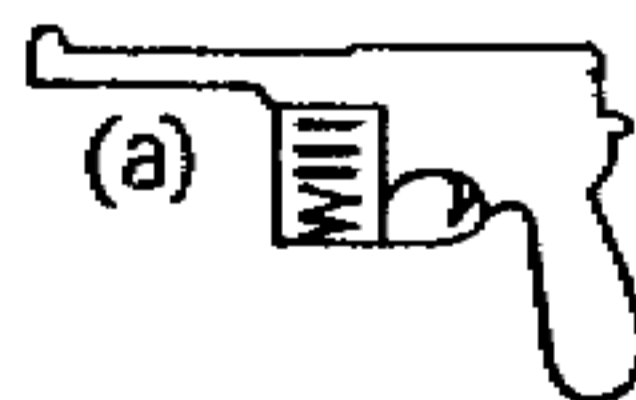

b. Magazine in the pistol grip





## Scientific Principles of Improvised Warfare and Home Defense

**Submachine Guns** are portable, automatic hand held guns which were designed with continuous reloading and light recoil so they can be easily fired by hand without requiring special mounting.

Designs included fitting the guns with

a. a collapsible stock

b. a telescoping stock  
for easy handling and concealment.

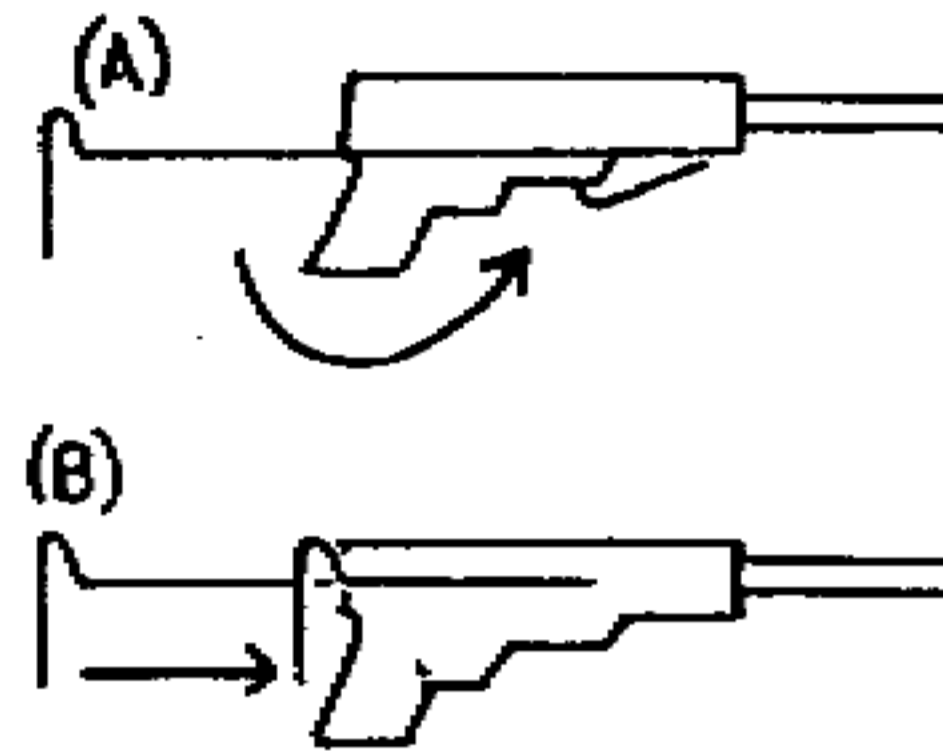

Most submachine guns use a simple blowback system to continuously reload.

1. When the cartridge is fired, the breech is kept closed by the strength of a spring (a) and by the weight and inertia of a breech block (b)

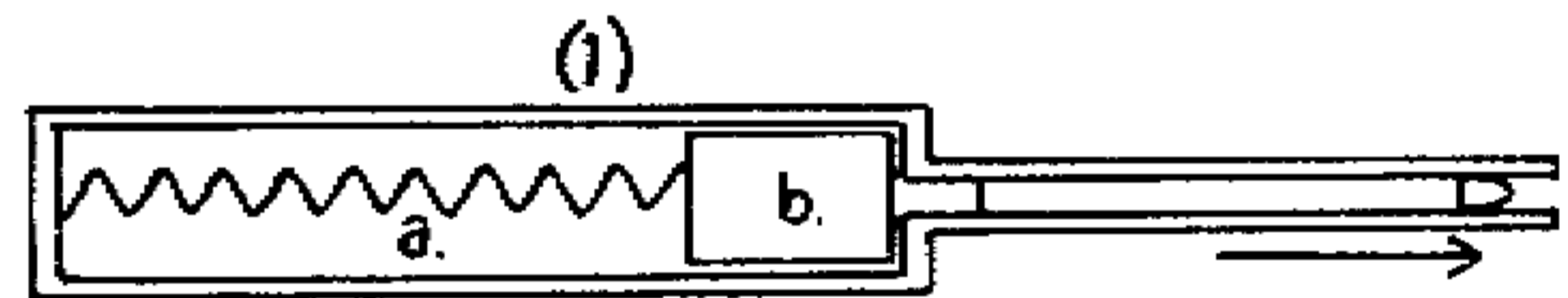

2. The breech opening and empty cartridge extraction is delayed until the pressure in the bore is reduced to a safe level. As the block is forced back, the empty case is ejected.

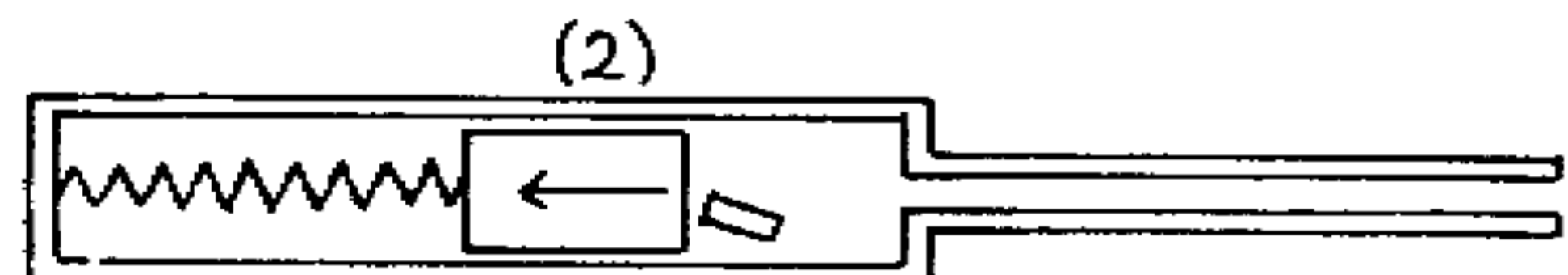

3. The coiled spring then rebounds forward which acts as a lever to feed a new cartridge into the breech and fire it.



Ammunition is fed from a box or drum like magazine. The ammunition is designed to be of lower power to minimize recoil. More powerful ammunition is used in mounted machine gun systems.

## Scientific Principles of Improvised Warfare and Home Defense

9MM MP5K Submachine gun with stock retracted, 30 round clip and scope.  
Firing rate is 800 rounds per minute.

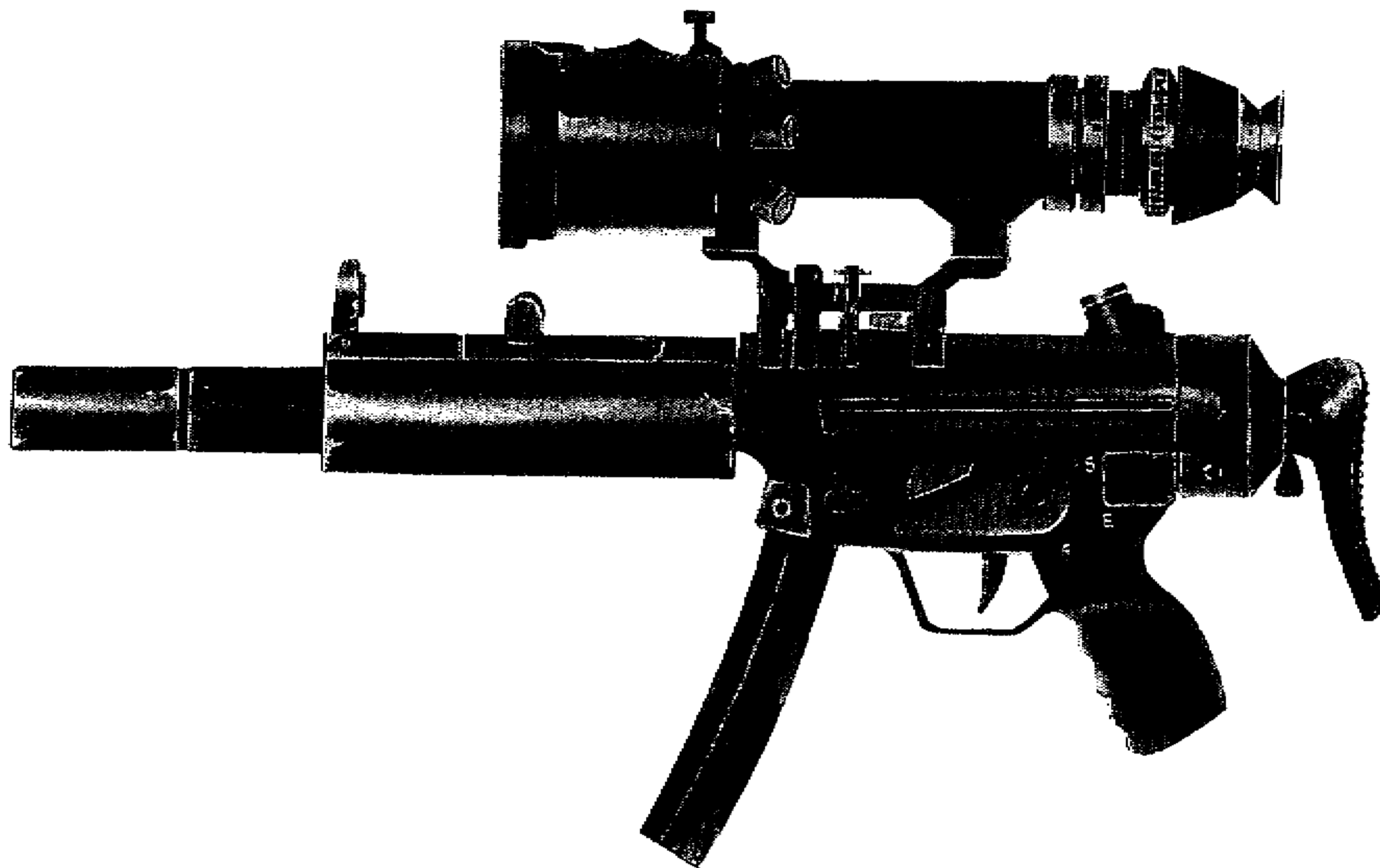

Most assault rifles use a gas operated mechanism to reload the gun.

1. When the bullet is fired, gas is bled off from behind the bullet into a chamber which contains a piston. This piston is forced back towards the breech block.

2. The force of the piston trips a lock on the breach and forces it backwards which opens it.

3. The empty cartridge is ejected and the coiled spring forces the block forward reloading the gun and repeating the cycle.

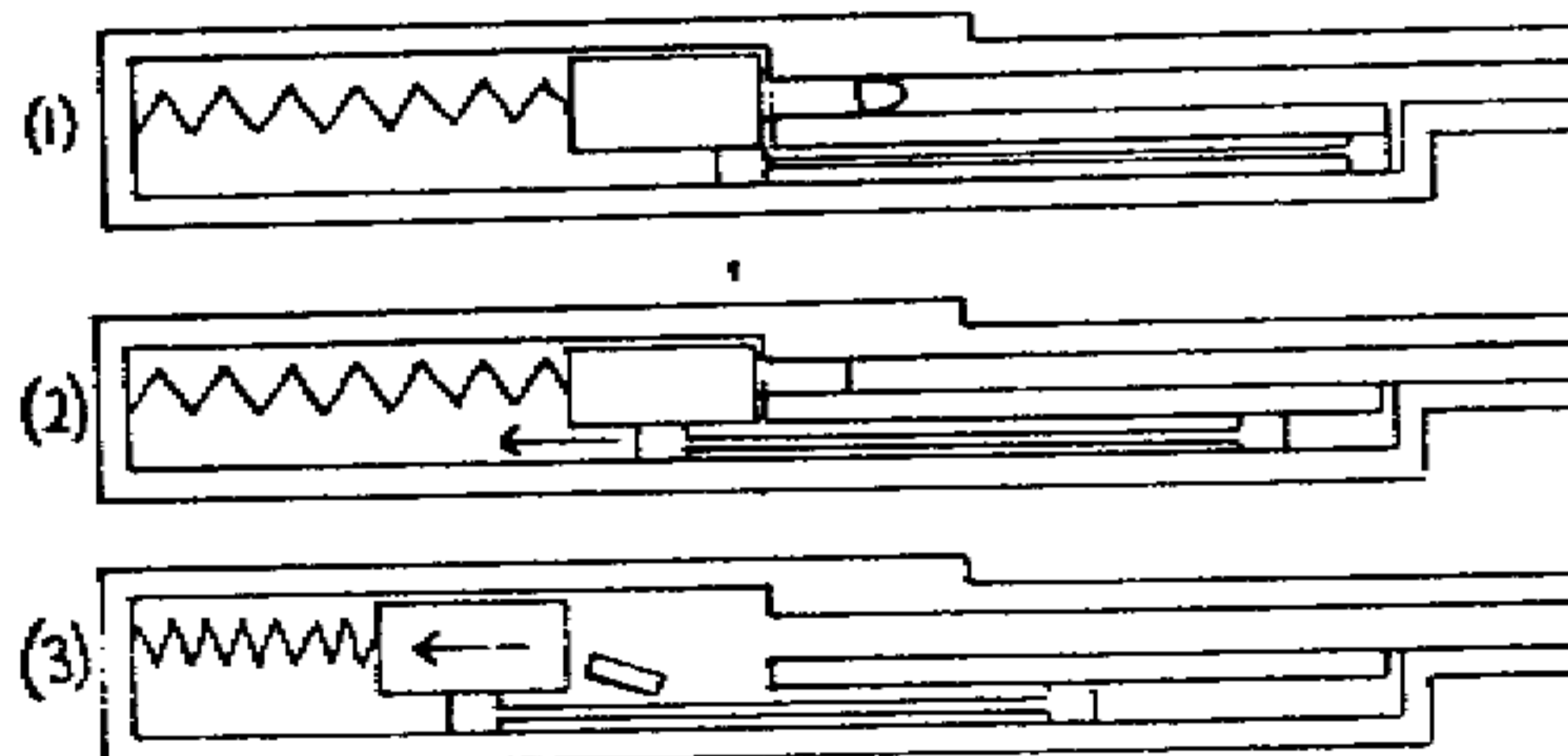

# Scientific Principles of Improvised Warfare and Home Defense

M16 Rifle with an M203 Grenade Launcher mounted under the stock

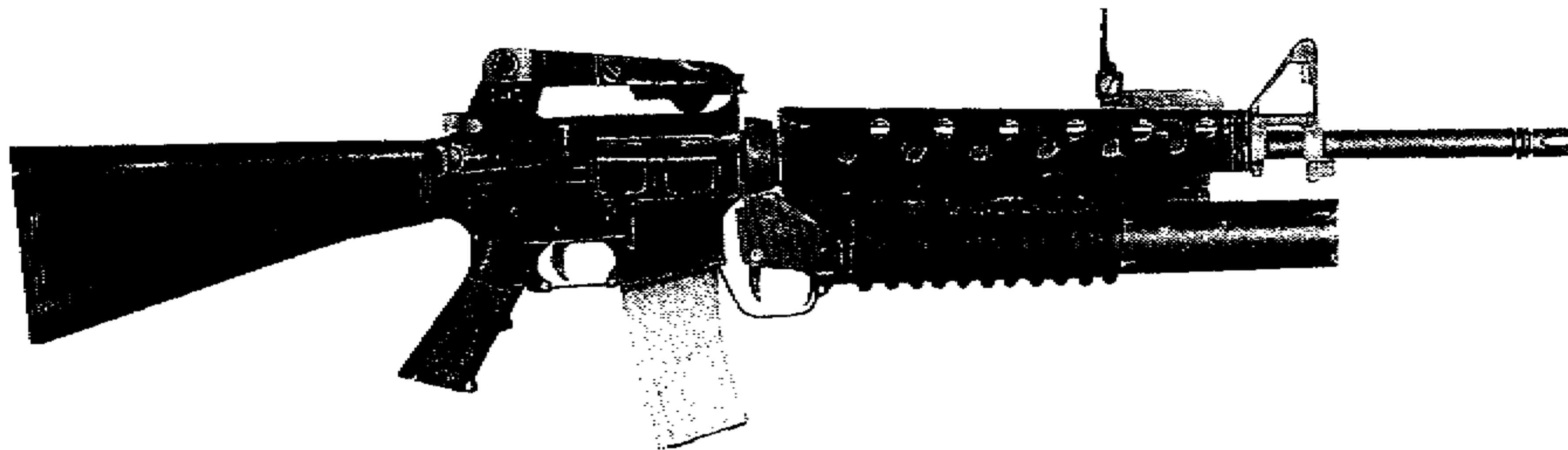

A futuristic Gas Operated automatic 12 Gauge shotgun "Pancor Jackhammer"



# Scientific Principles of Improvised Warfare and Home Defense

## Rifle end Gun Launched Grenade Systems

Devices for projecting a variety of large self contained munitions from various guns are described in this section. These munitions may have anti-tank, anti riot, anti personnel, and signaling roles.

Designs can simply be large caliber ( barrel diameter) firearms which fire a grenade instead of a bullet. They can be muzzle loaded, or, be breech loaded which is the common practice today.

Firing a heavy projectile produces large recoil and often requires shoulder, ground, or heavy foundation mounting. Some grenade launchers with short ranges fire like pistols, similar to flare guns.

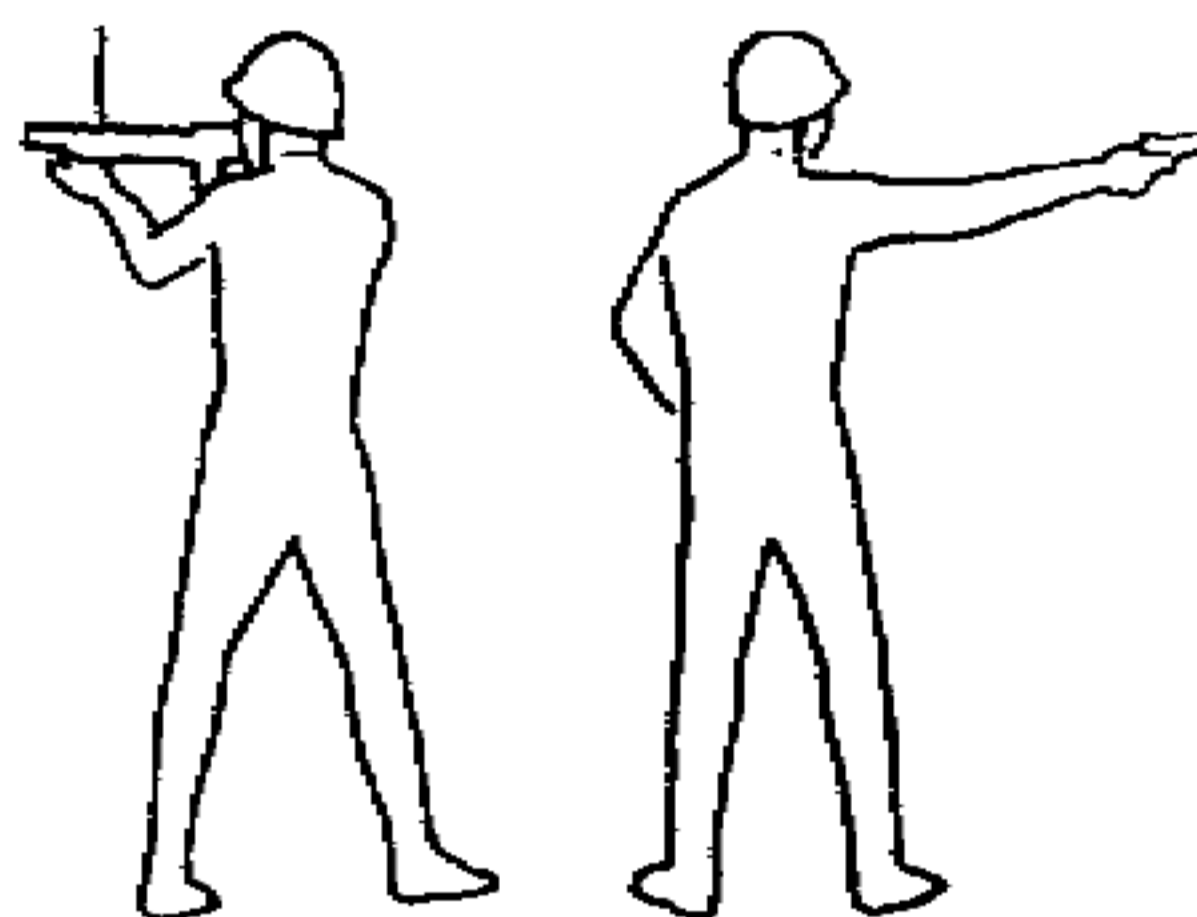

US M79 grenade launcher is a rifled, breech loading system. It fires a fixed cartridge and breaks open to load. Grenades are designed as high explosive and buckshot and can be fired 350 yards.

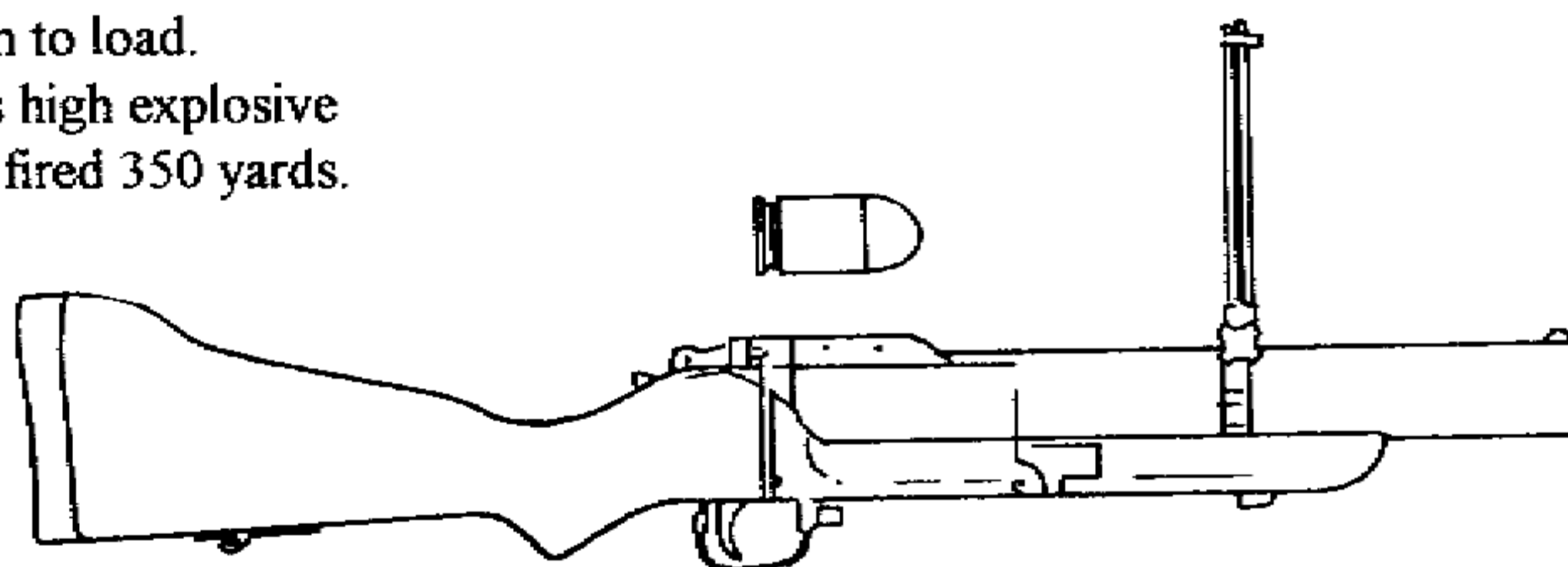

Rifle grenades are fired from the muzzle of assault rifles with a special propellant cartridge used in place of a bullet to launch the grenade.

Because of the recoil these fired from

a. ground based support

b. armpit supported

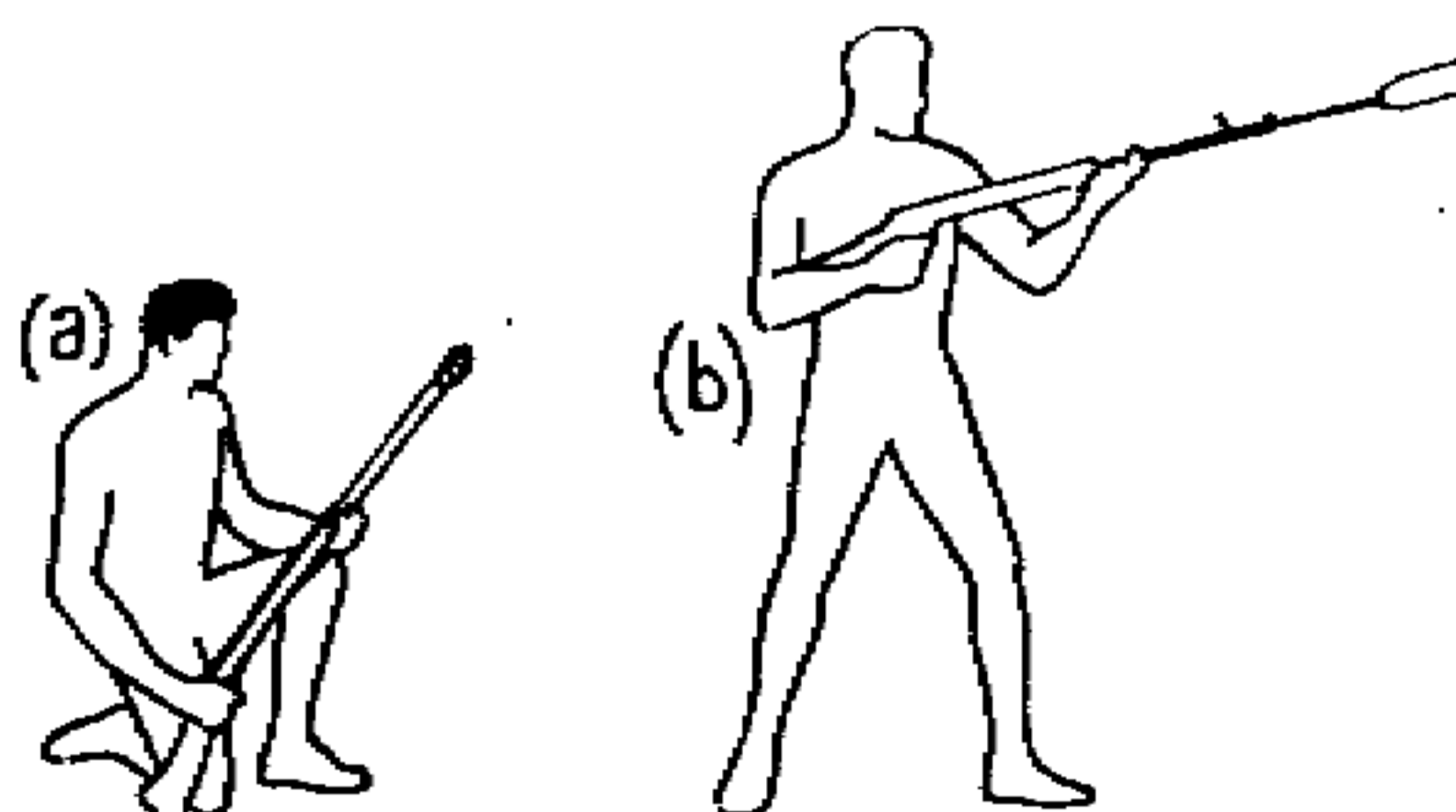

# Scientific Principles of Improvised Warfare and Home Defense

**Grenade guns** use several means of projection

1. **Cup launching:** where a wide diameter extension fitting the grenade diameter is fitted into the rifle muzzle. A grenade is loaded into the muzzle and is propelled by explosive gases from a special rifle cartridge. Most hand grenades are now propelled by this method. Some designs have hollow centers in the grenade allowing the firing of regular ammunition to launch the grenade.

2. **Rod grenades:** where the grenade has a steel rod built into it which fits into the rifle barrel and propelled by blank explosive gas cartridges.

3. **Spigot Grenade:** Grenades especially designed with fins which makes the grenade fly point first. This adds accuracy to the flight and is especially useful in anti-tank battles.

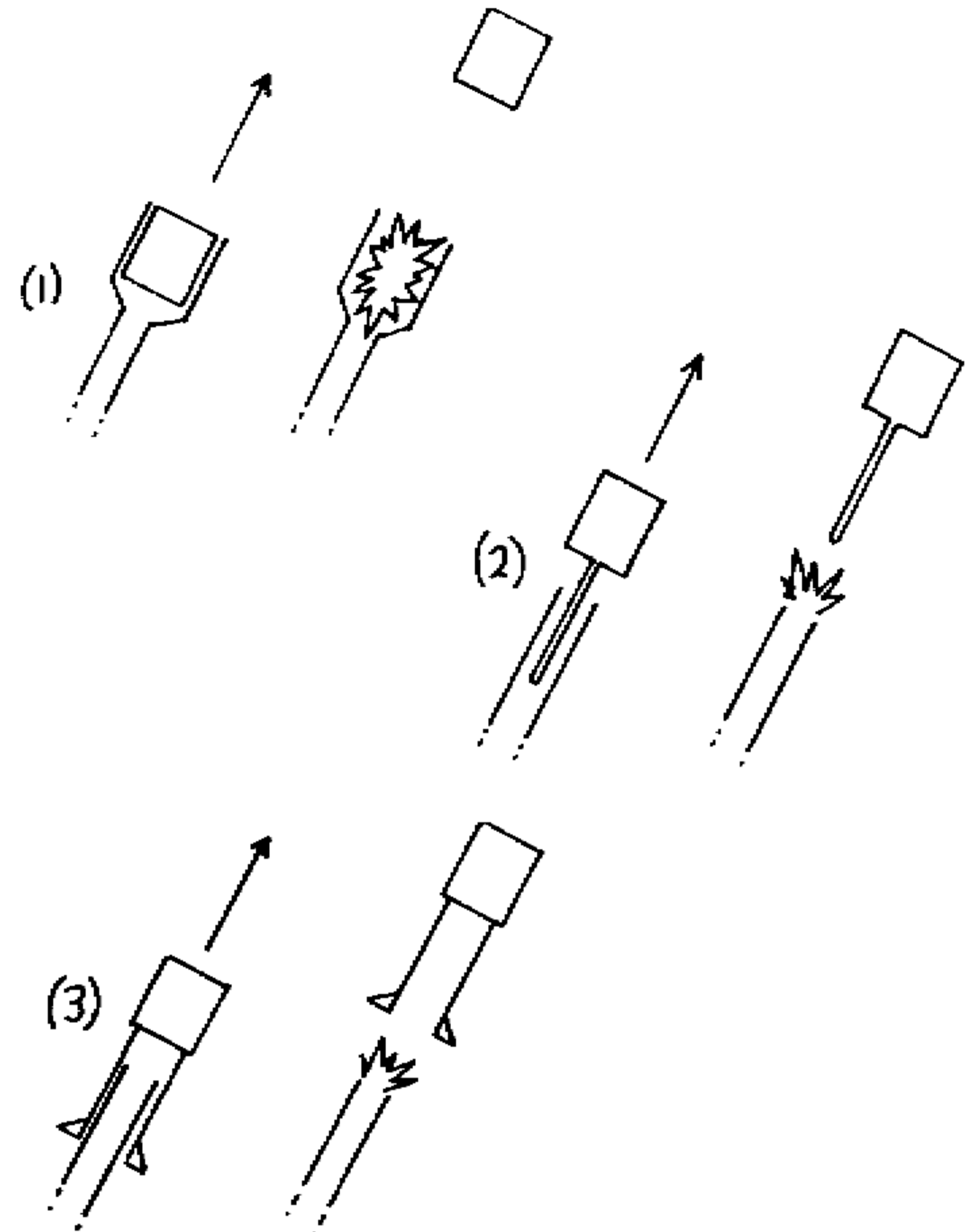

**Rifle grenade** designs in use include

a. **anti personnel:** which is a hand grenade adapted for cup discharge by fitting a base plate and cage around the grenade. The grenade produces an explosive blast and hurls metal fragments in all directions.

b. **anti-tank rifle grenade:** is spigot launched with stabilizing fins with a hollow charge warhead which must strike the tank point first.

c. **smoke:** designed to be spigot launched and obscure enemy vision. Modern designs contain white phosphorus which start fires, cause burns, and other anti personnel effects which are built in.

d. **tear gas:** designed for any launch system, the grenade contains irritant gas or smoke. Rubber grenades are also used in anti-riot roles.

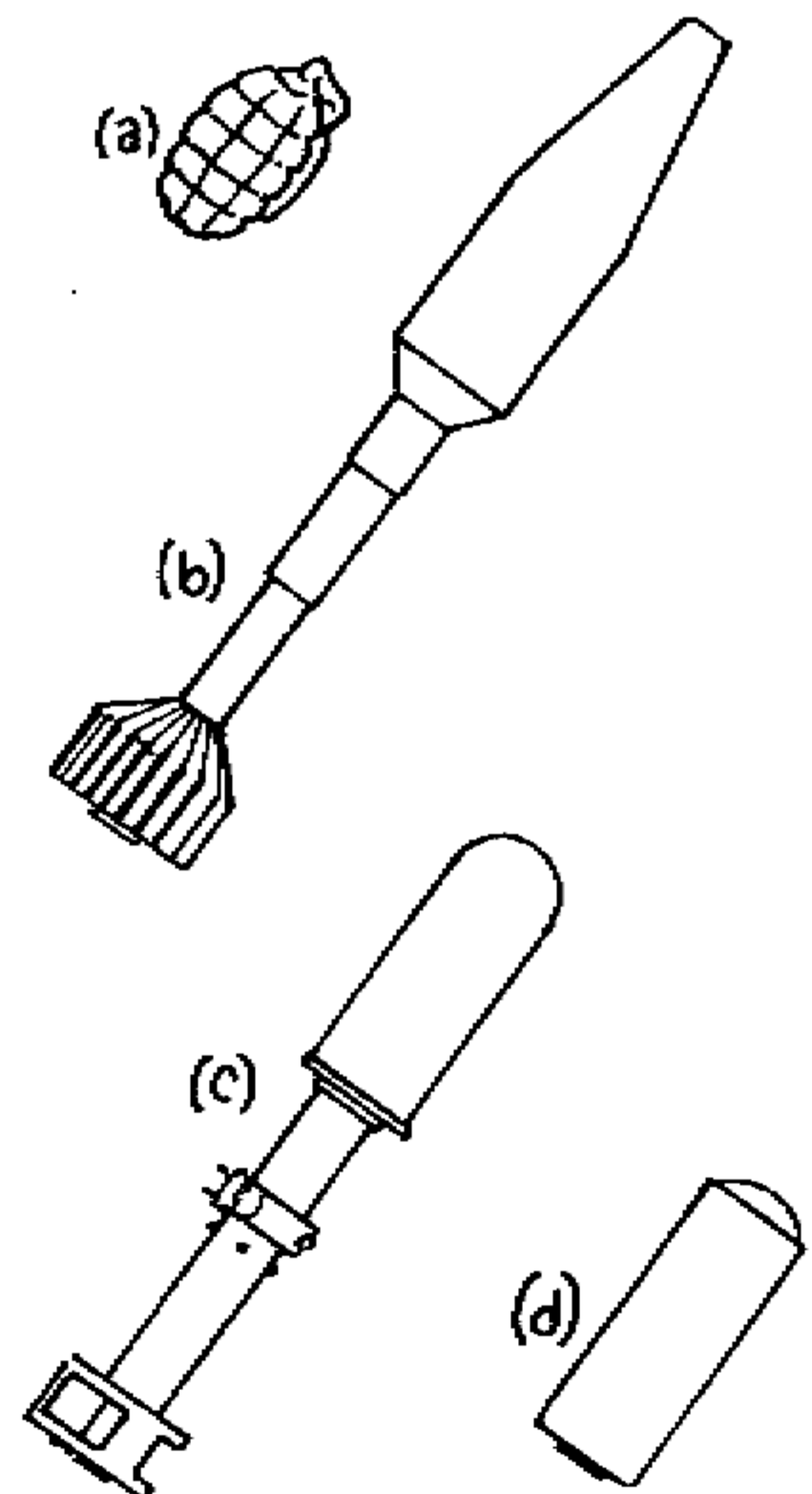



# Scientific Principles of Improvised Warfare and Home Defense

## Hand Held Recoilless Guns

Developed in WWII, it allowed the firing of an artillery shell to be fired from a mans shoulder. Its main use has been anti-tank but can be a very effective antipersonnel weapon.

It produces a huge rearward recoil blast because both ends of the firing tube are open. This can kill anyone standing behind the firer during operation and will produce a bright flash revealing the firers position.

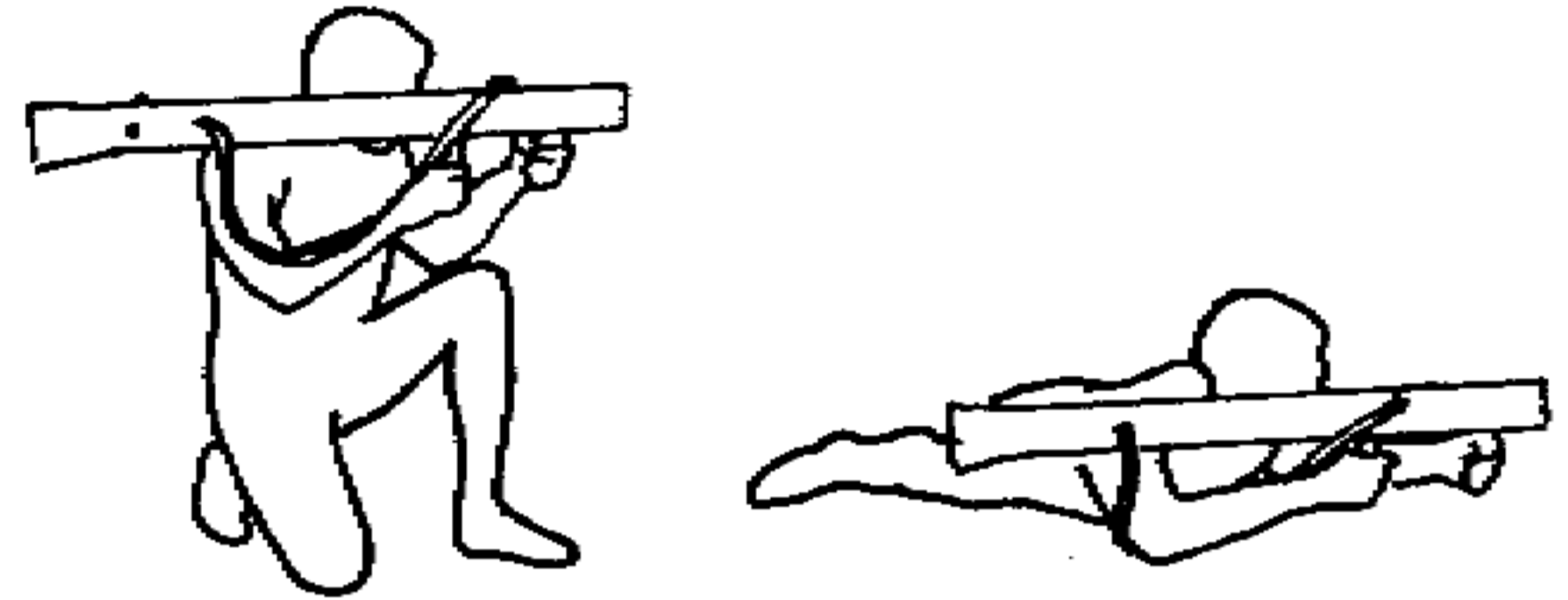

The operating principle of recoilless guns is based on Newton's third law of physics " For every action, there is an equal and opposite reaction". The forward motion of the shell is balanced by the rearward blast of

a. a counterweight designed as part of the shell

or

b. a mass of high velocity gas from the explosion of the shell firing which produces a violent backblast.

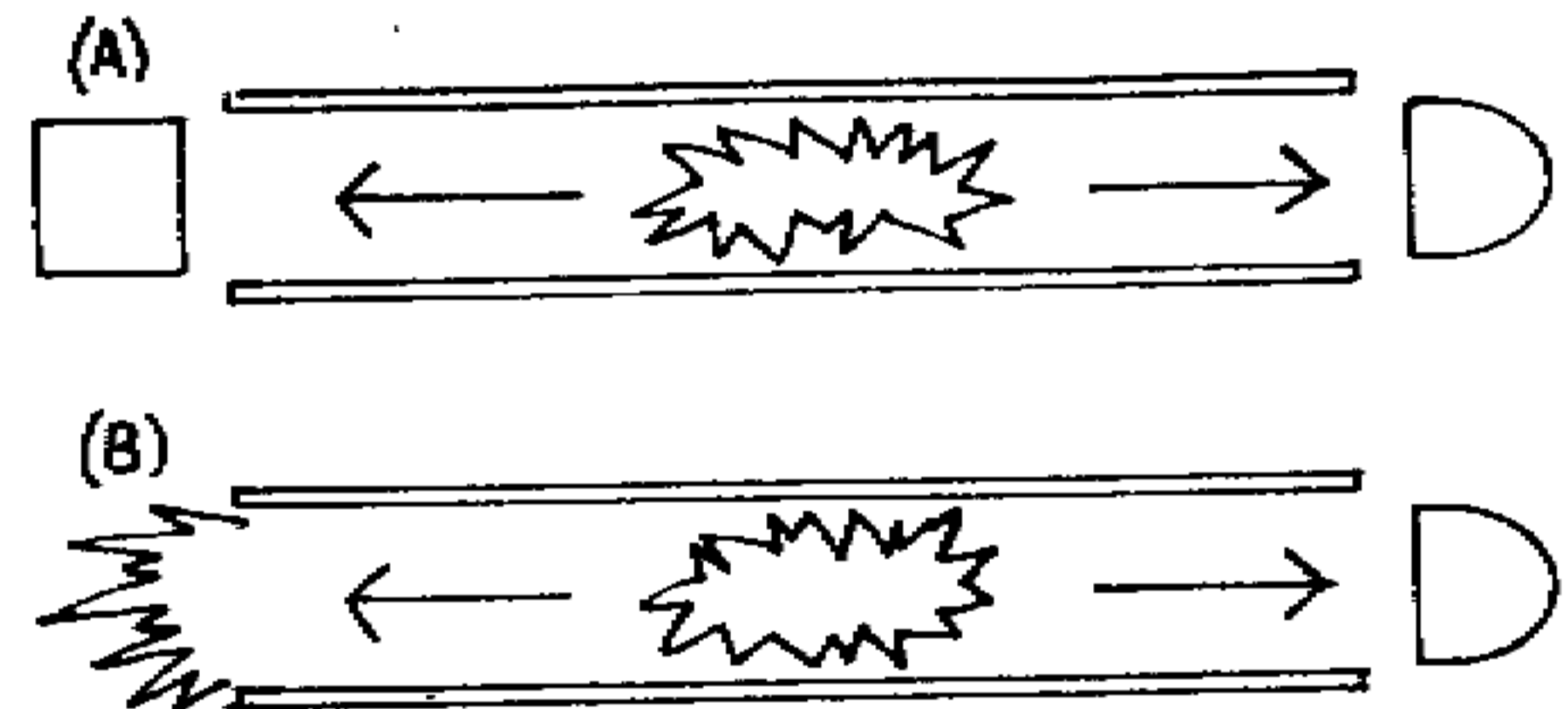

The barrels are designed to be light and because they lack recoil and only have to contain the unidirectional gas expansion and funnel it out the front and back they can be fired while standing, kneeling, or lying on the ground.

## Scientific Principles of Improvised Warfare and Home Defense

The barrels today are made from fiber reinforced plastics and fiberglass to provide strength and keep the outside of the barrel cool while being operated. The low cost and easy mass manufacture of this type of launching tube allow them to be built economically as follows-

1. preloaded with a perforated combustion chamber and shell.
2. During launching, an explosion propels the shell out the forward end of the tube. The perforations buffer the explosive sideways force against the tubesending the shell out the front and exhaust out the rear.

The spent tube is then discarded.

For **anti-tank and anti-armor**/fortifications a special shaped charge is designed into the shell.

A hollow cone explosive is designed so that when the shell is fired and reaches its target, it detonates at the cones apex when a forward tube comes in contact with the target.

The explosion forms and focuses into a jet of hot gas at high velocity which melts a small hole through the targets plating and injects hot fragments of the molten metal and gas throughout the interior. This is expected to kill the crew and/or explode the ammunition or fuel.

This design allows the shell to pierce armor at long ranges from the firer the same as at short ranges and do not depend on the sustained thrust of the launch to be effective.

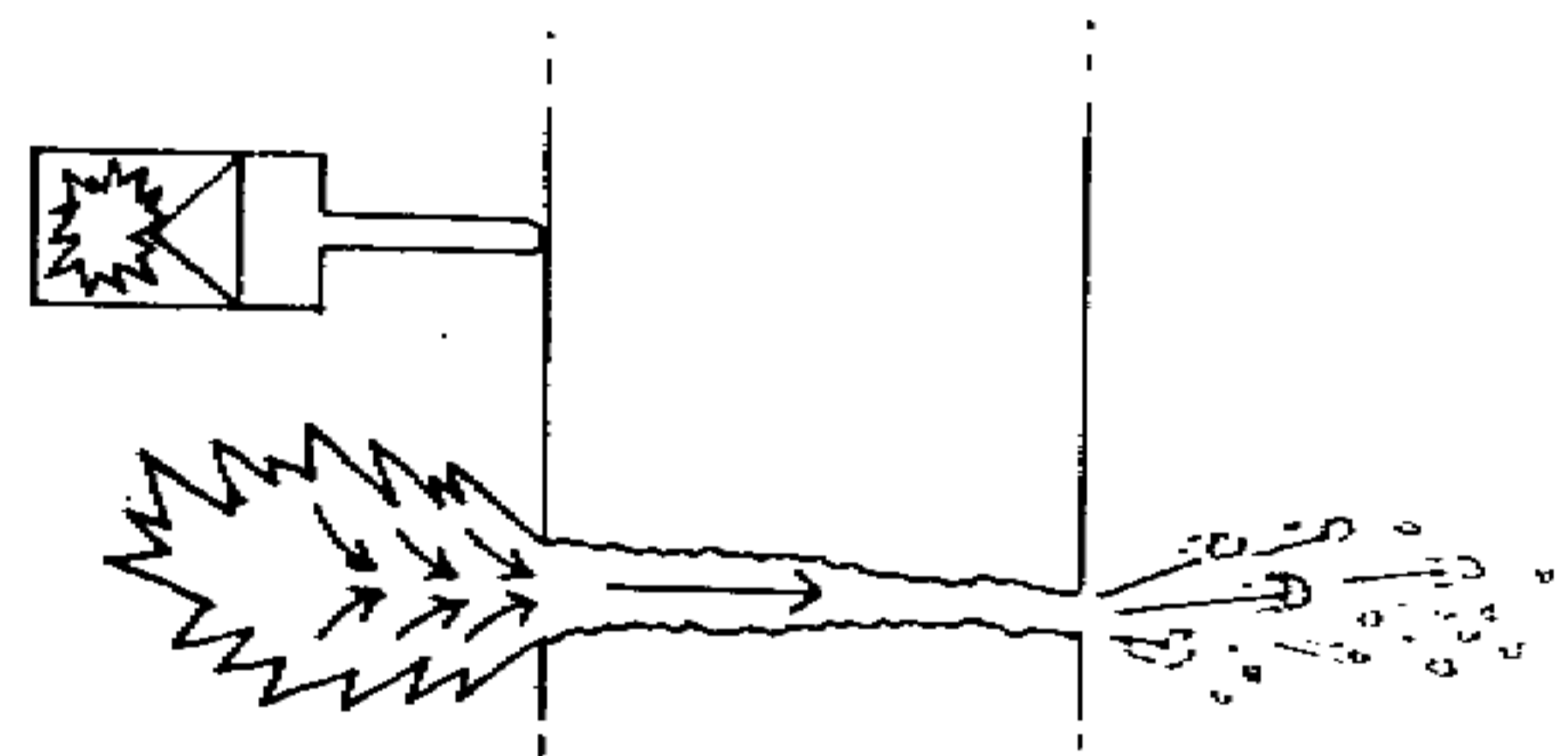
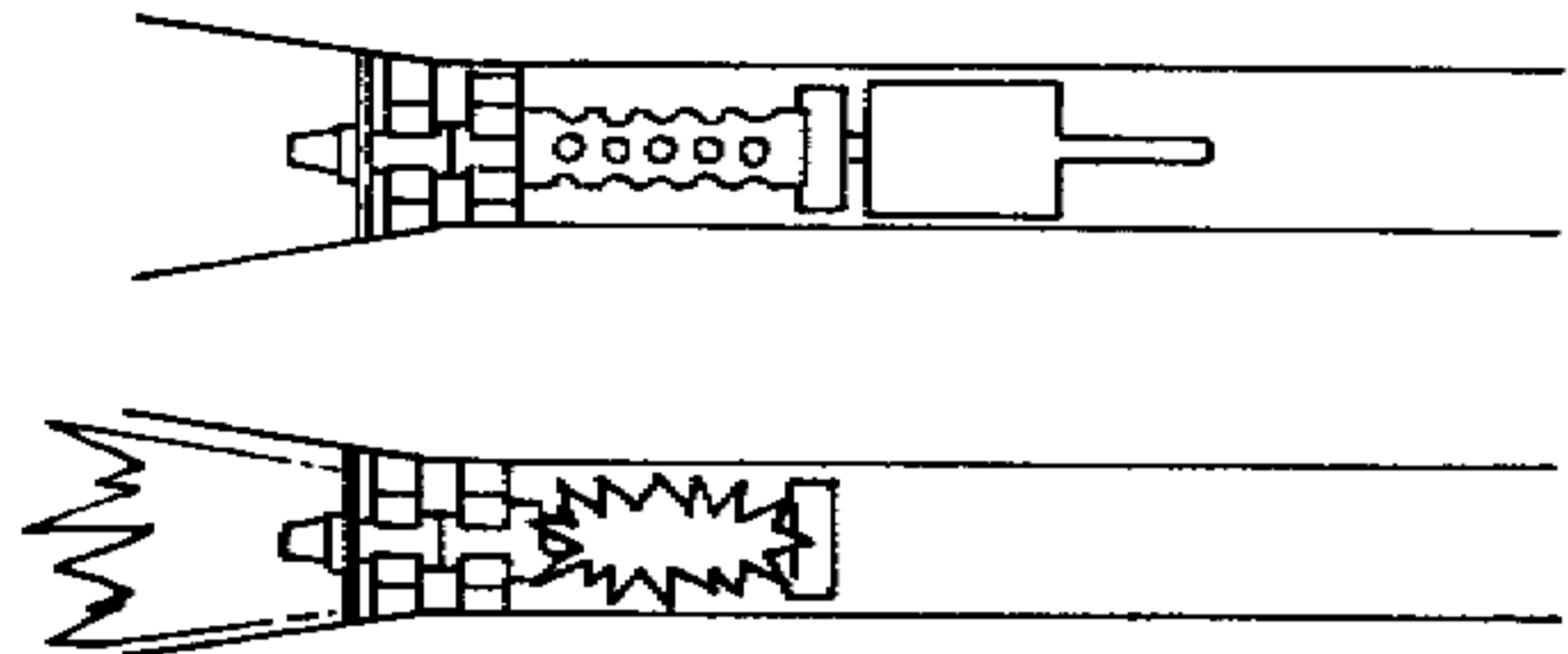

# Scientific Principles of Improvised Warfare and Home Defense

This type of shell is classified as "HEAT" for High Energy / Explosive anti-Tank

Variations in ideas of design include

1. The 84mm RCL (recoilless) Carl-Gustav
  - Uses a rifled steel tube
  - Has a rear venturi
  - Reloads from the rear
  - Fired by detonating a percussion cap in the shell
  - Propellant blast forces the shell forward and the balancing cartridge case out the back
  - The Venturi rotates open to reload
  - One man aims and fires
  - Another man loads and unloads

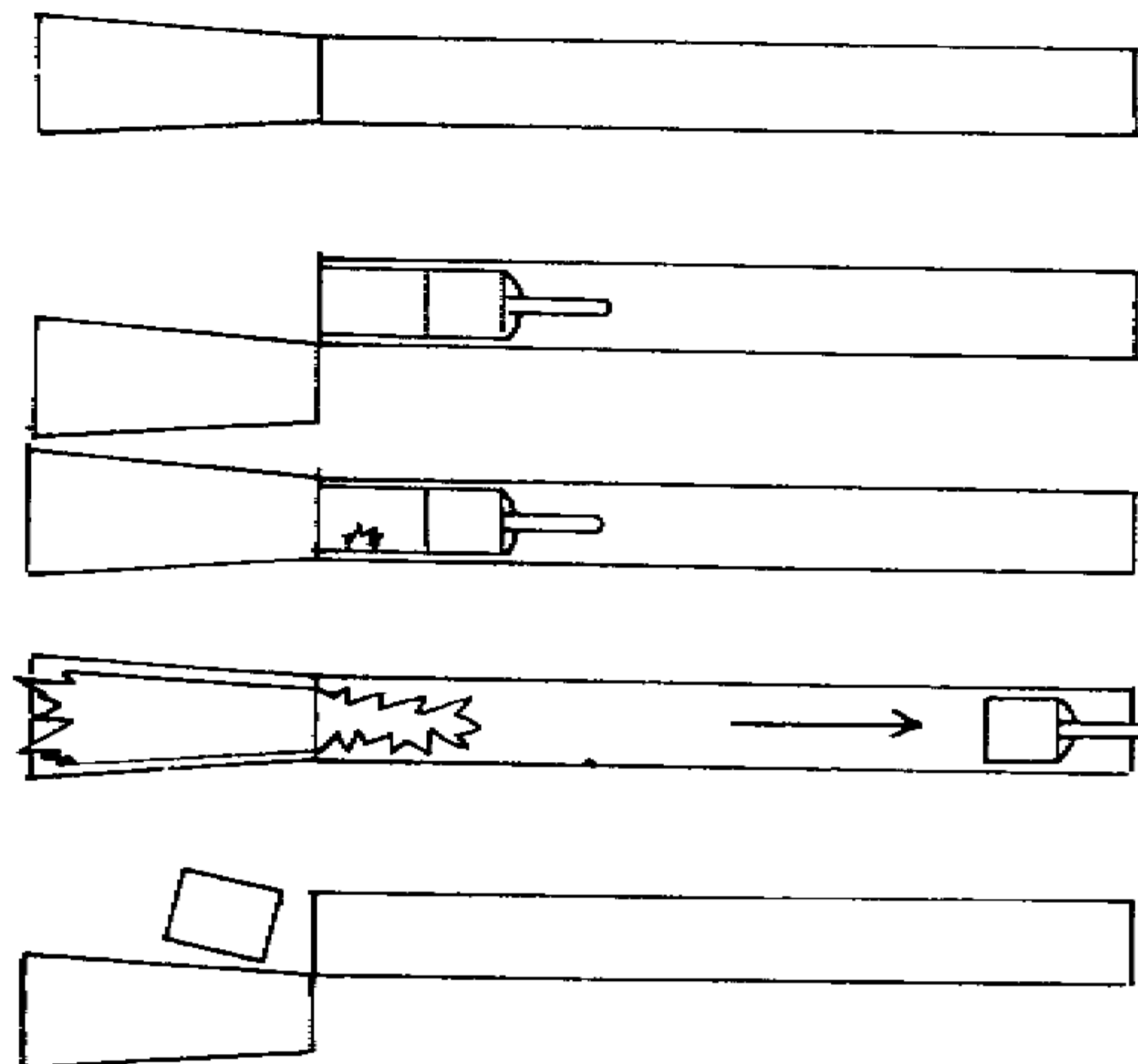

The shell is designed in 2 parts to allow it to be spin stabilized by the barrel and not lose penetrating power due to the spin. This is done by fitting the shell with

- a) a sleeve which rotates on bearings and spins independently of
- b) the explosive charge.



2. The Armbrust from West Germany which is

a. issued preloaded

On firing, the propellant

- a. explodes between 2 pistons
- b. the 2 pistons stop at the ends with the counterweight ejected rearward
- c. and the shell propelled forward

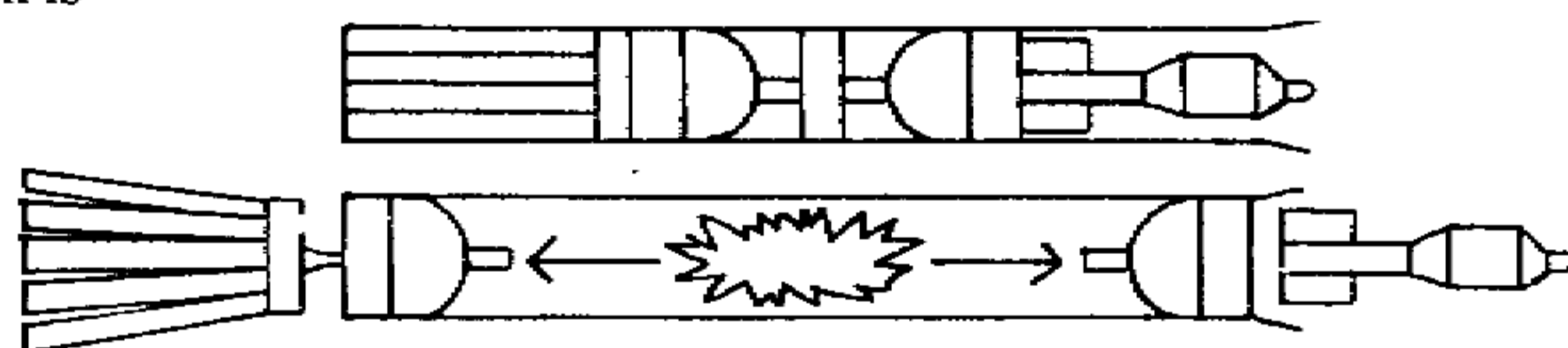

3. The French ACL-APX

which operates like other recoilless guns with a rocket motor igniting on the warhead after it leaves the launching tube and drives toward the target. The 80mm shell travels 660 yards in 1.25 seconds.

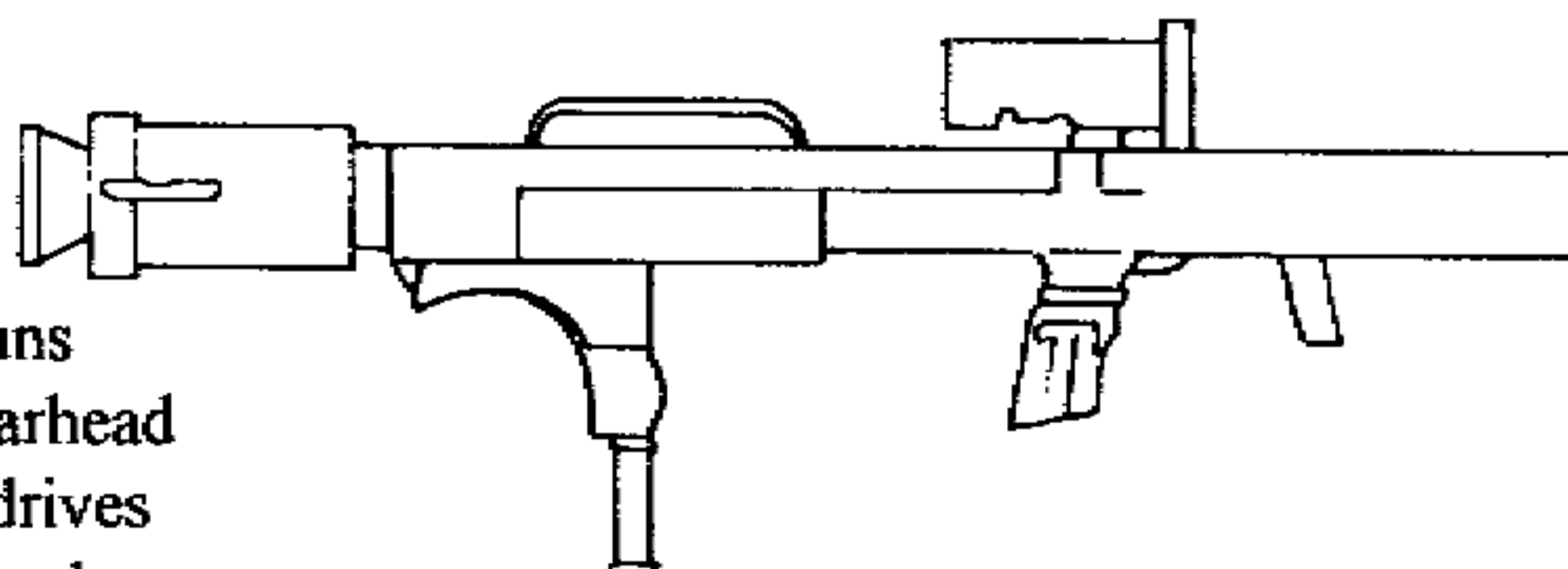

## **Scientific Principles of Improvised Warfare and Home Defense**

The following field devices are from the US Army Improvised Munitions Handbook

- 1) Recoilless Launcher
- 2) Grenade Launcher
- 3) 60 mm Mortar Launcher
- 4) Pipe hand grenade
- 5) Nail (shrapnel) grenade
- 6) Wine bottle cone charge
- 7) Coke bottle shaped charge
- 8) Cylindrical Cavity shaped charge
- 9) Funnel shaped charge
- 10) Linear shaped charge
- 11) Fire bottle launcher

# Scientific Principles of Improvised Warfare and Home Defense

## 1) Recoilless Launcher

A dual directional scrap fragment launcher which can be placed to cover the advancing troops.

### Material Required

- Iron Water Pipe app. 4' long and 2-4" in diameter
- Black Powder or salvaged artillery propellant (1/2#)
- Safety or improvised fuse or electrical igniter
- Stones and/or metal scrap pieces app 1/2" dia. - about 1#
- 4 rags for wadding, each 20" x 20"
- Wire
- Paper or rag

**Note:** Be sure the water pipe has no cracks or flaws



### Procedure

1. Place propellant and igniter in paper or rag and tie with string so contents cannot fall out.
2. Insert packaged propellant and igniter in center of pipe. Pull firing leads out one end of pipe.
3. Stuff a rag wad into each end of pipe and lightly tamp using a flat end of stick.
4. Insert stones or scrap metal into each end of pipe. Be sure the same weight of material is used in each side.
5. Insert a rag wad into each end of the pipe and pack tightly as before.

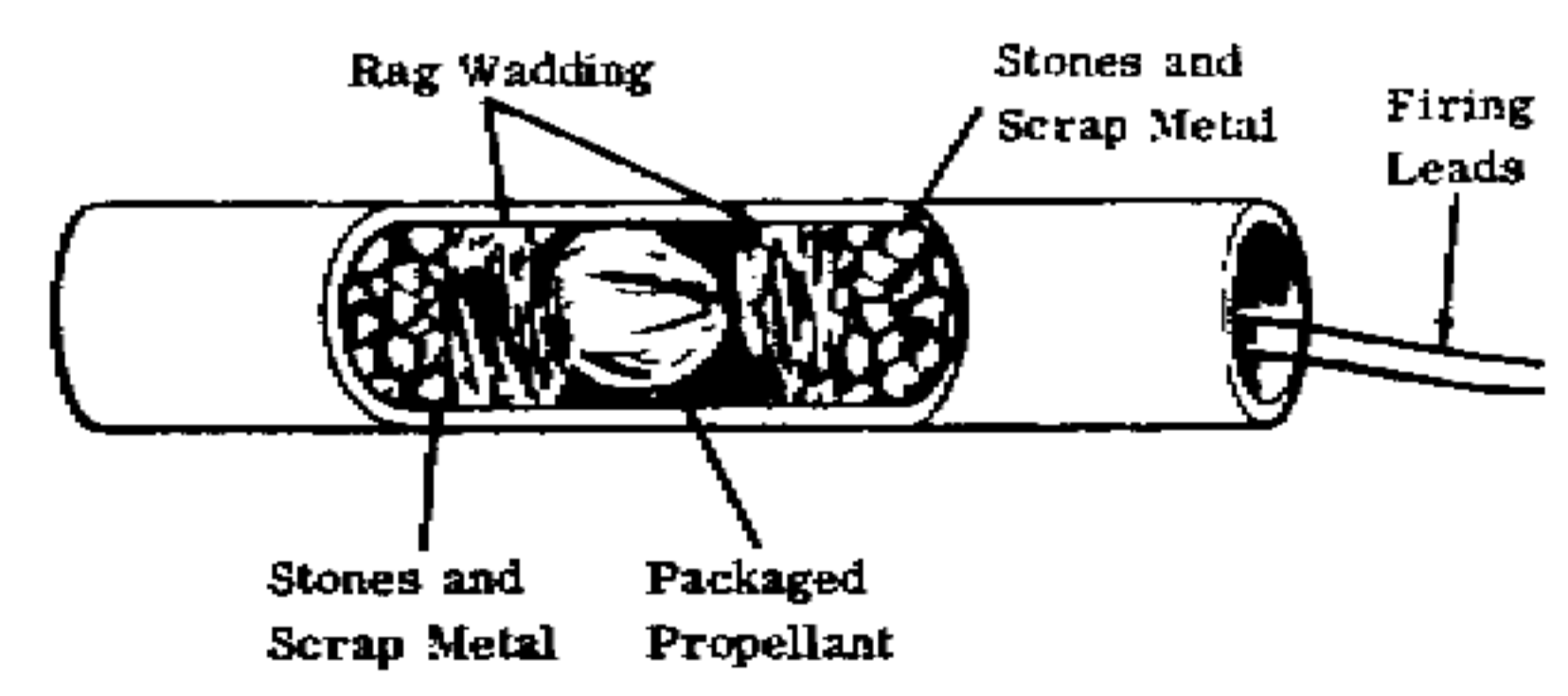
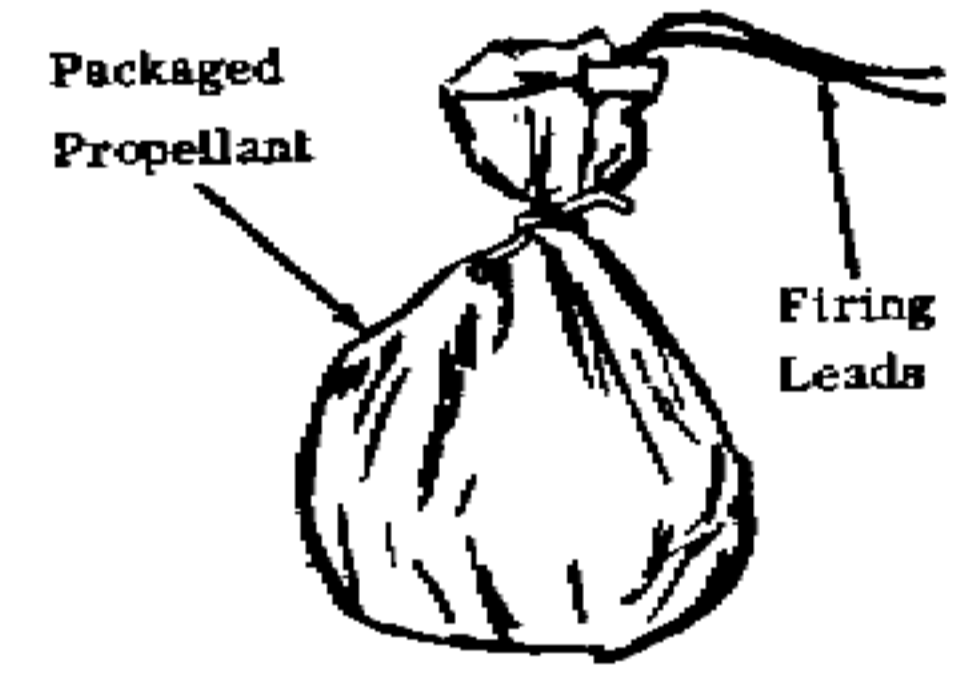



# Scientific Principles of Improvised Warfare and Home Defense

## How to use

1. Place scrap mine in a tree or pointed in the path of the enemy. Attach igniter lead to the firing circuit. The recoilless launcher is now ready to use.
  
2. If safety or improvised fuse is used instead of the detonator, place the fuse in the packaged propellant through a hole drilled in the center of the pipe. Light free end of fuse when ready to fire. Allow for normal delay time.

**Caution:** Scrap will be ejected from both ends of launcher.

# Scientific Principles of Improvised Warfare and Home Defense

## 2) Grenade Launcher

A variety of grenade launchers can be fabricated from metal pipes and fittings. Ranges up to 600 meters (660 Yards) can be obtained depending on length of tube, charge, number of grenades, and angle of firing.

### Material Required

Metal pipe, threaded on one end app. 2-1/2 in. in diameter and 14" to 4' long depending on range desired and number of grenades used.

End cap to fit pipe

Black Powder, 15 -50 grams (app 1-1/4 to 4-1/4 tablespoons)

Safety fuse, fast burning improvised fuse or electric bulb initiator

Grenades 1-6

Rags - 30 x 30" and 20 x 20"

Drill

String

**Note:** Examine pipe carefully to be sure there are no cracks or other flaws.

### Procedure

1. Drill small hole through center of end cap.

2. Make small knot near one end of fuse. Place black powder and knotted end of fuse in paper and tie with string.

3. Thread fuse through hole in end cap and place package in end cap. Screw end cap onto pipe, being careful that black powder package is not caught between the threads.

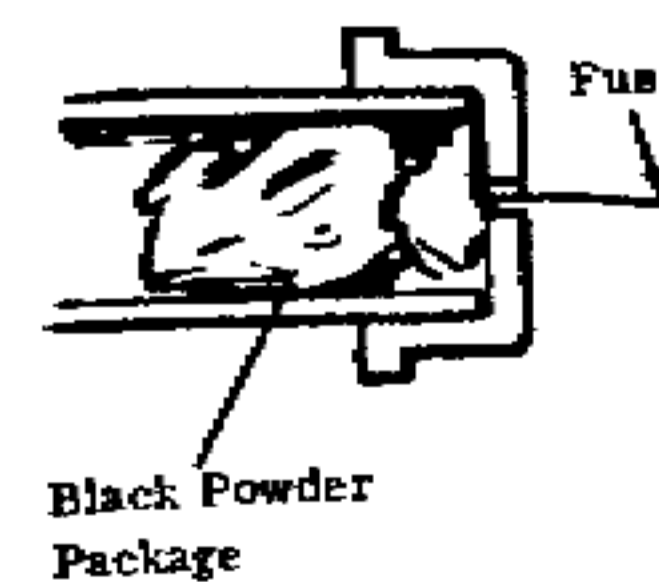
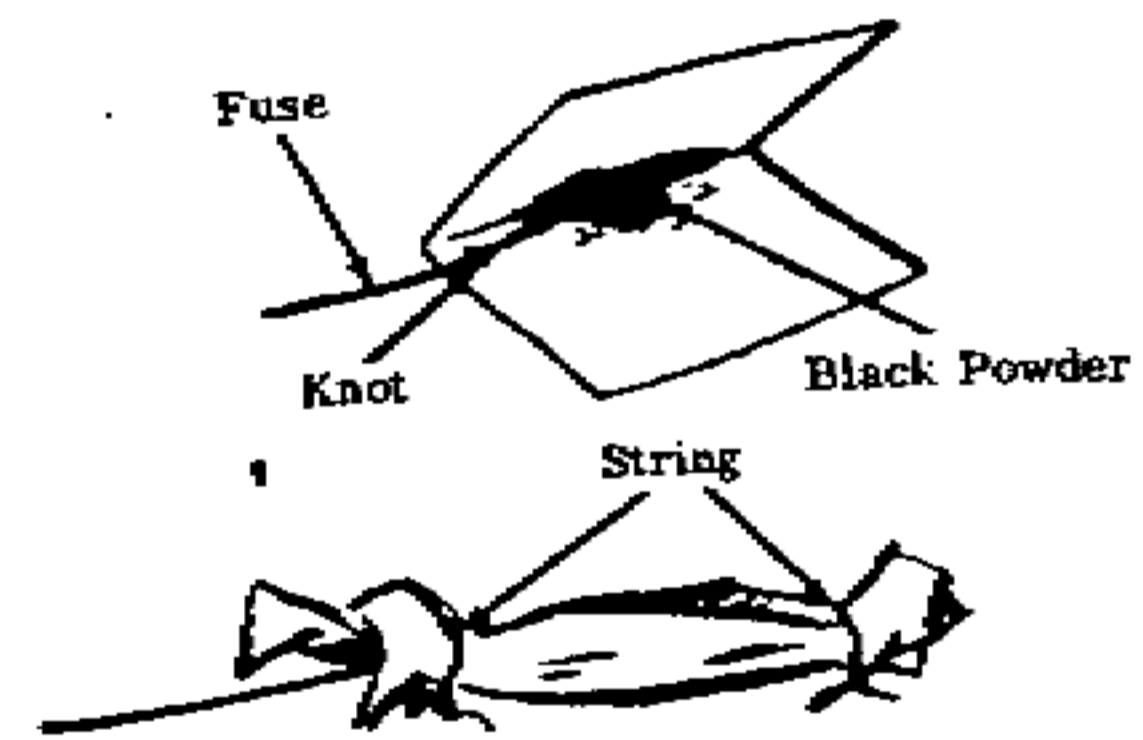
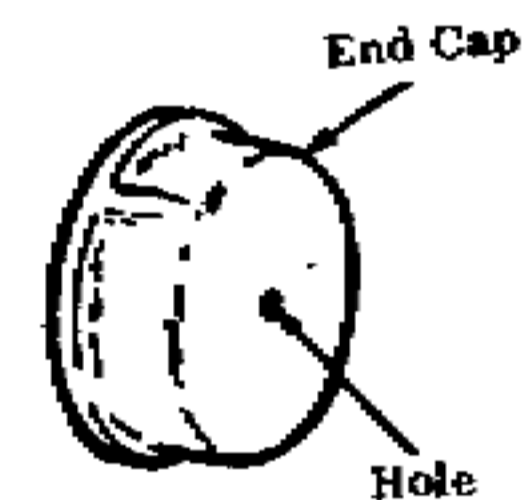

## Scientific Principles of Improvised Warfare and Home Defense

4. Roll rag wad so that it is about 6" long and has app. the same diameter as the pipe. Push rolled rag into open end of pipe until it rests against black powder package.

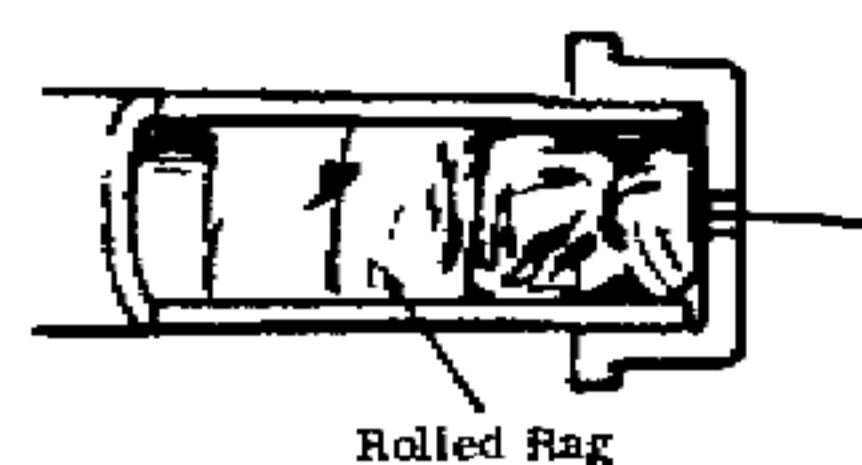

5. Hold grenade safety lever in place and carefully withdraw safety pin.



**Caution:** if grenade safety lever is released for any reason grenade will explode after set delay time. (4-5 sec.)

6. Hold safety lever in place and carefully push grenade into pipe, lever end first, until it rests against rag wad.

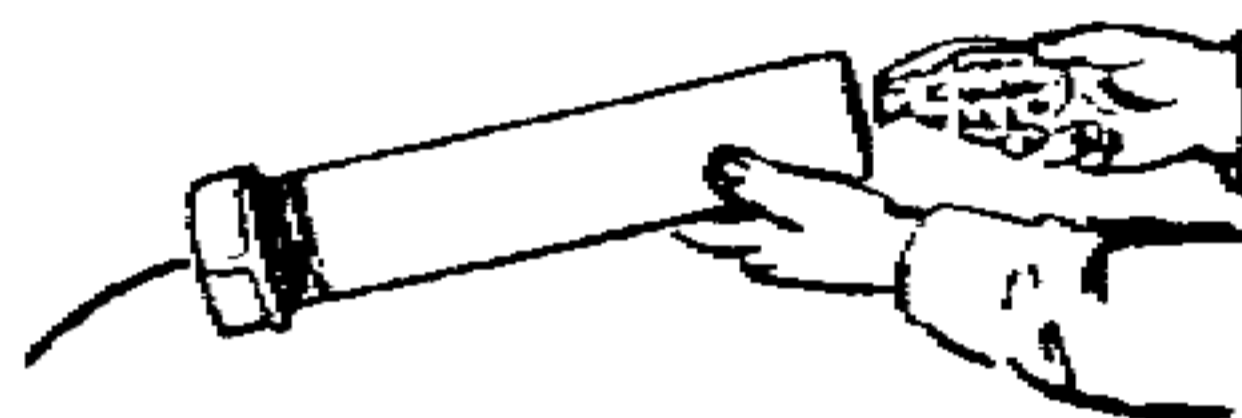

7. The following table lists types of grenade launchers and their performance characteristics.

<u>Desired Range</u>	<u># of Grenades Launched</u>	<u>Black Powder Charge</u>	<u>Pipe Length</u>	<u>Firing Angle</u>
250 m	1	15 gm	14"	30 degrees
500 m	1	50 gm	48"	10 "
600 m (a)	1	50 gm	48"	30 "
200 m	6 (b)	25 gm	48"	30 "

(a) For this range an additional delay is required.

(b) For multiple grenade launcher, load as shown.

Note: Performance of different black powders varies. Fire several test rounds to determine the exact amount of powder necessary to achieve the desired range.

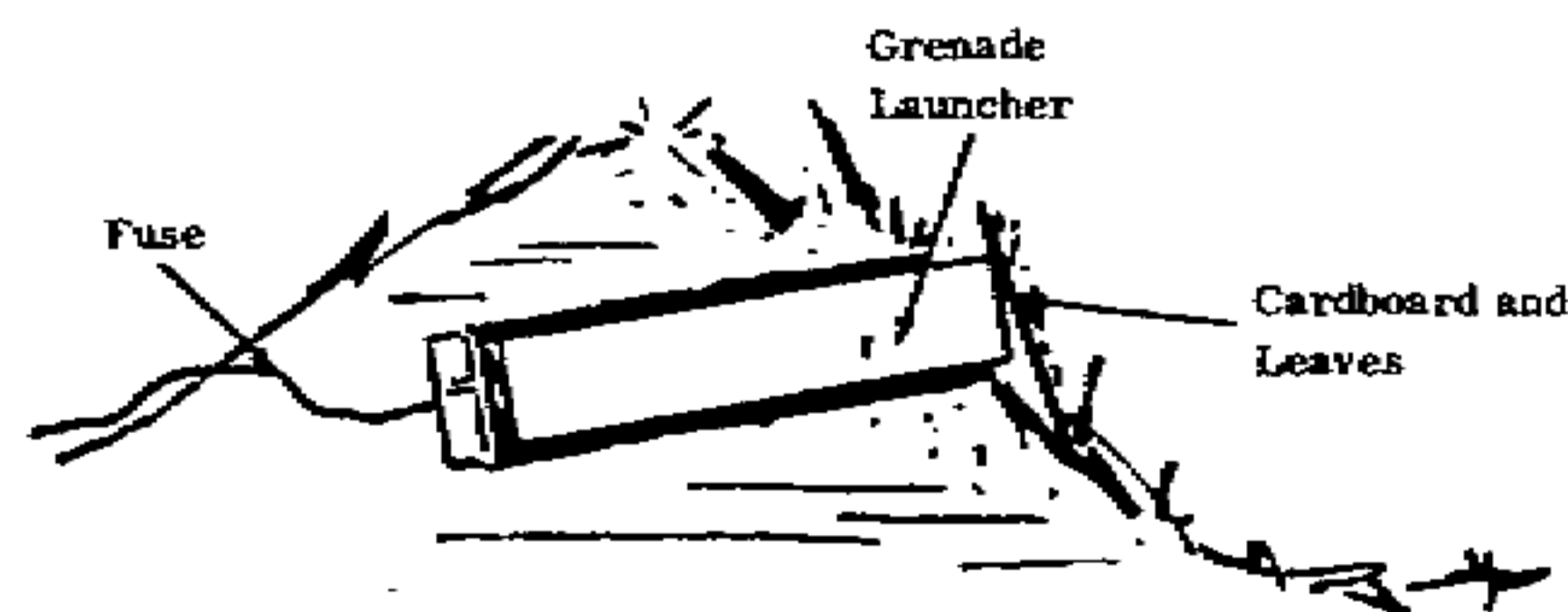

# Scientific Principles of Improvised Warfare and Home Defense

## How to use

1. Bury at least 1/2 of the launcher pipe in the ground at desired angle. Open end should face the expected path of the enemy. Muzzle may be covered with cardboard and a thin layer of dirt or other camouflage. Be sure cardboard prevents dirt from entering pipe.

**Note:** The 14" launcher may be hand held against the ground instead of being buried.

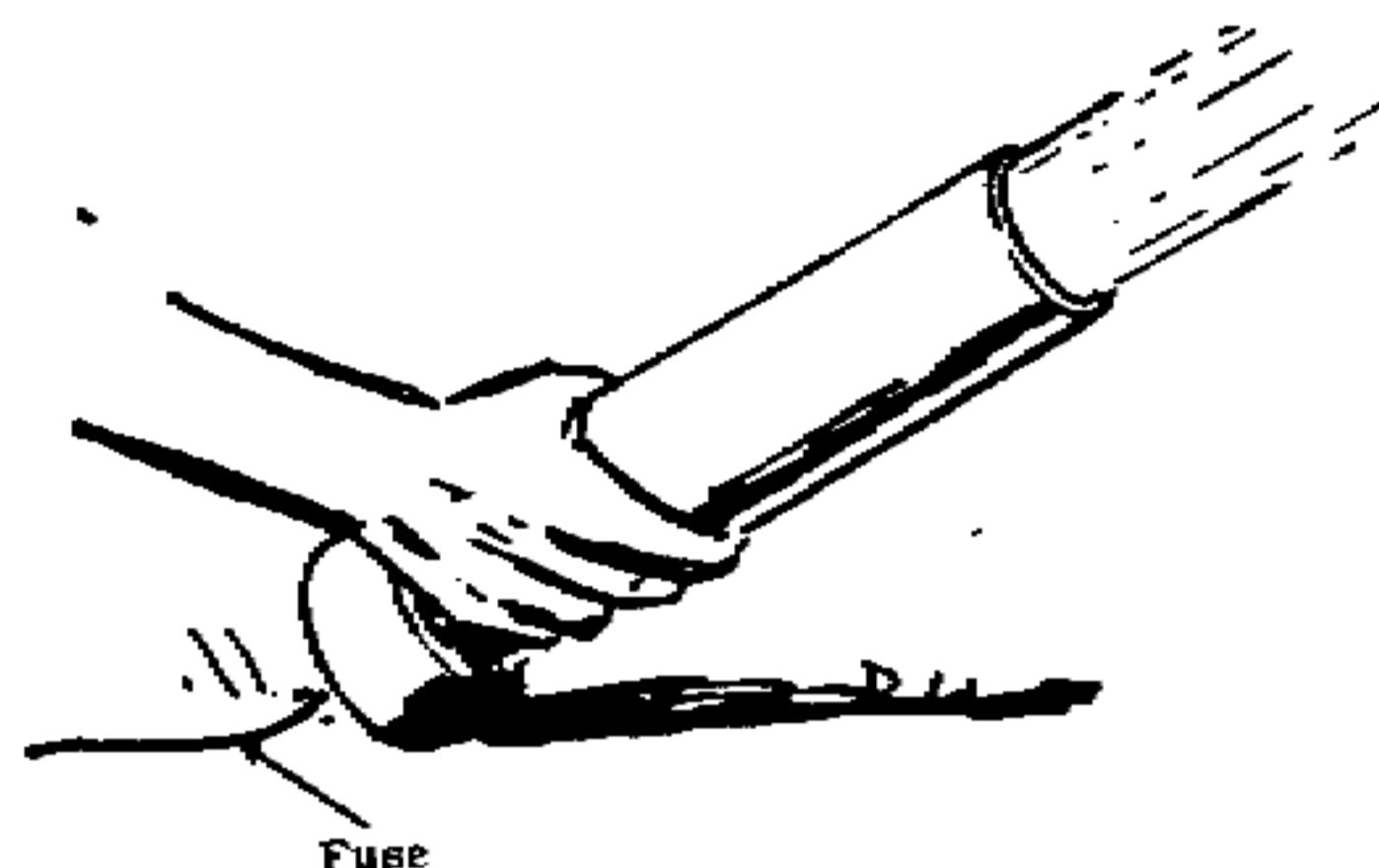

2. Light fuse when ready to fire

## Method for electrical igniter

**Note:** Be sure the bulb is in good operating condition.

1 Prepare electric bulb initiator as described in "Booby Traps" chapter.

2. Place electric initiator and black powder charge in paper. Tie ends of paper with string.

3. Follow 1st method, step 3 to end.

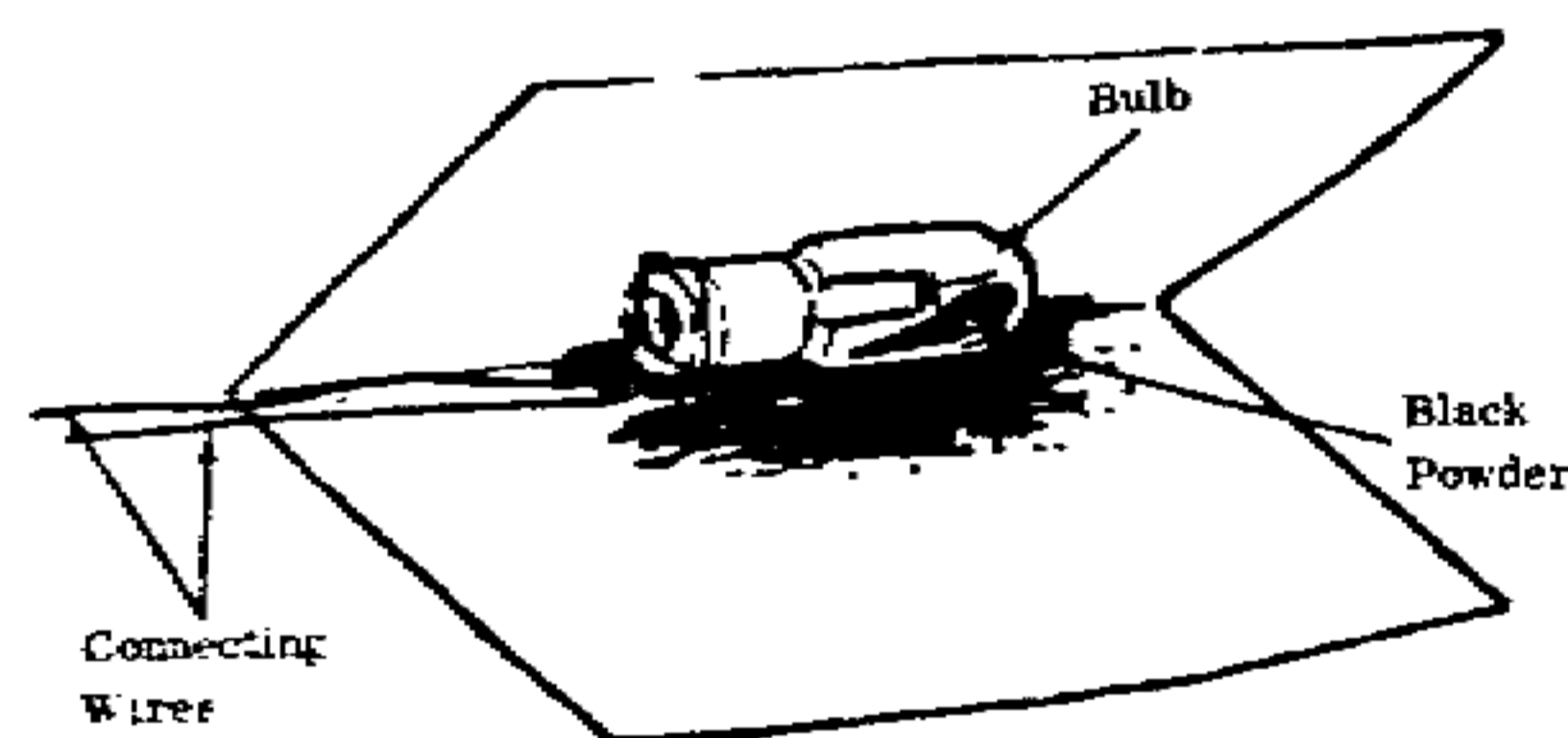

## How to use

1. Follow 1st method step 1

2. Connect leads to firing circuit. Close circuit when ready to fire.

# Scientific Principles of Improvised Warfare and Home Defense

## 3) 60 mm Mortar Launcher

A device to launch 60 mm mortar rounds using a metal pipe 2.5 " in diameter and 4' long as the launching tube.

### Materials Required

- Mortar projectile (60mm) and charge increments
- Metal Pipe 2.5" in diameter and 4' long, threaded on one end
- Threaded end cap to fit pipe
- Bolt, 1/8" in diameter and at least 1" long
- Two nuts to fit bolt
- File
- Drill

### Procedure

1. Drill hole 1/8" in diameter through center of end cap.

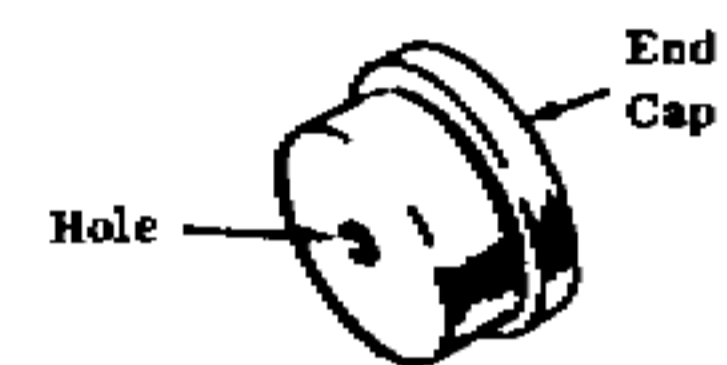

2. Round off end of bolt with file.

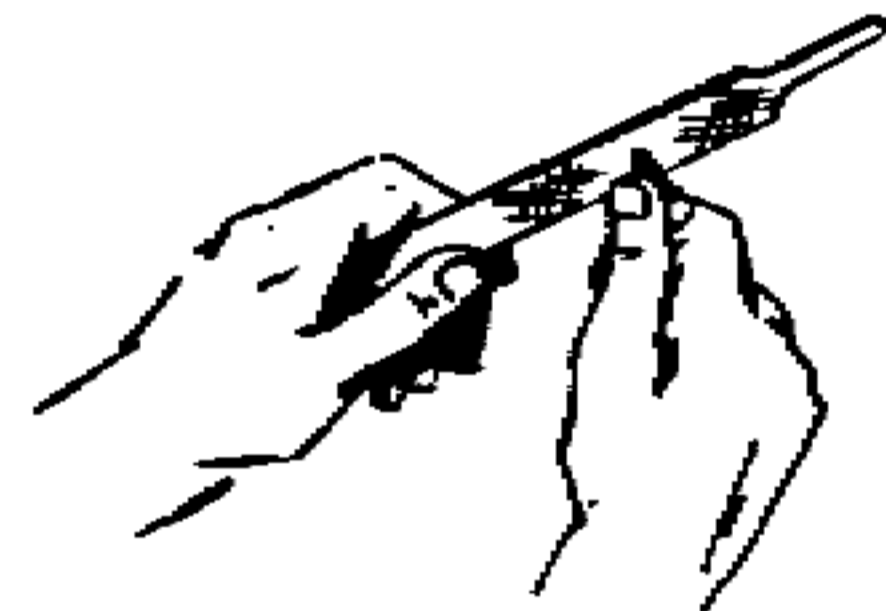

3. Place bolt through hole in end cap. Secure in place with nuts as illustrated.

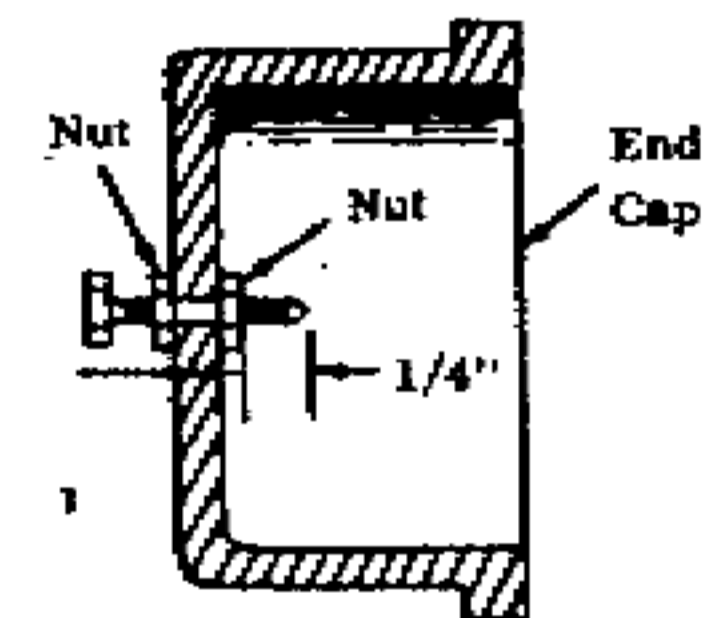

4. Screw end cap onto pipe tightly. Tube is now ready for use.

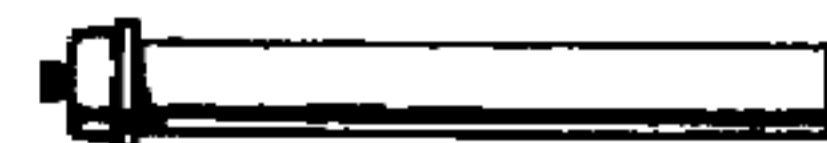



# Scientific Principles of Improvised Warfare and Home Defense

## How to use

1. Bury launching tube in ground at desired angle so that bottom of tube is at least 2 ft. underground. Adjust the number of increments in rear finned end of mortar projectile.

2. When ready to fire, withdraw safety wire from mortar projectile. Drop projectile into launching tube, FINNED END FIRST.

Caution: Be sure bore riding pin is in place in fuse when mortar projectile is dropped in tube. A live mortar round could explode in the tube if the fit is loose enough to permit the bore riding pin to come out partway.

Caution: The round will fire as soon as the projectile is dropped into tube. Keep all parts of body behind the open end of the tube.

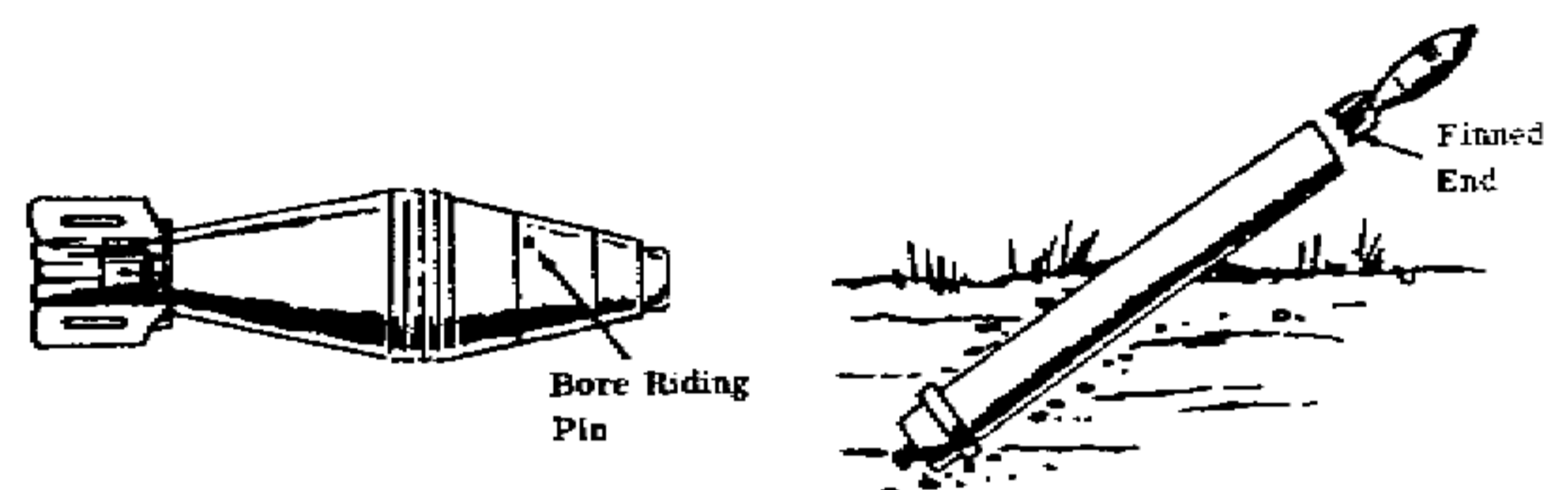
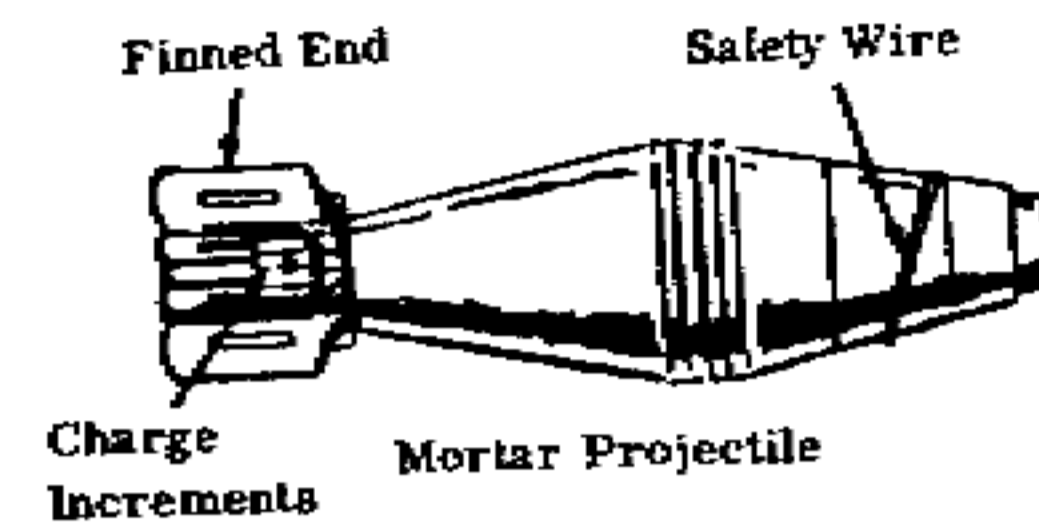
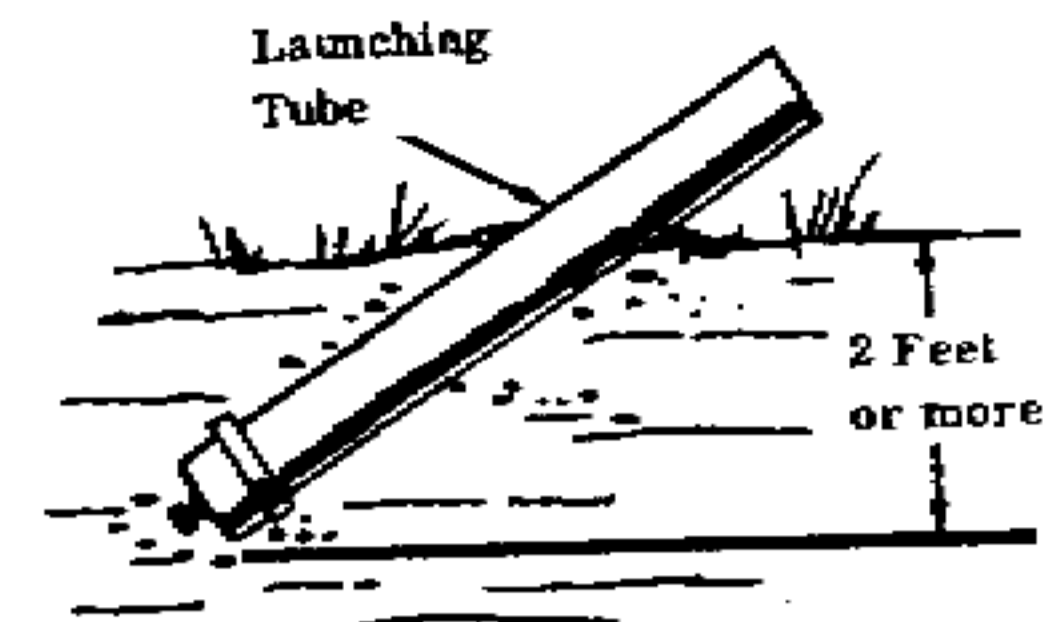

Desired Range	Maximum height mortar will reach (yards)	Required angle of elevation of tube ( horizontal degrees )	Charge - number of increments
150	25	40	0
300	50	40	1
700	150	40	2
1000	225	40	3
1500	300	40	4
125	75	60	0
300	125	60	1
550	250	60	2
1000	375	60	3
1440	600	60	4
75	100	80	0
150	200	80	1
300	350	80	2
400	600	80	3
550	750	80	4

# Scientific Principles of Improvised Warfare and Home Defense

## 4) Pipe Hand Grenade

Hand grenades can be made from a piece of iron pipe. The filler can be plastic or granular military explosive, improvised explosive, or propellant from shotgun or small arms ammunition.

### Material Required

- Iron pipe, threaded ends, 1 1/2" to 3" dia. to 8" long
- Two (2) iron pipe caps
- Explosive or propellant
- Nonelectric blasting cap
- Fuse cord
- Hand drill
- Pliers

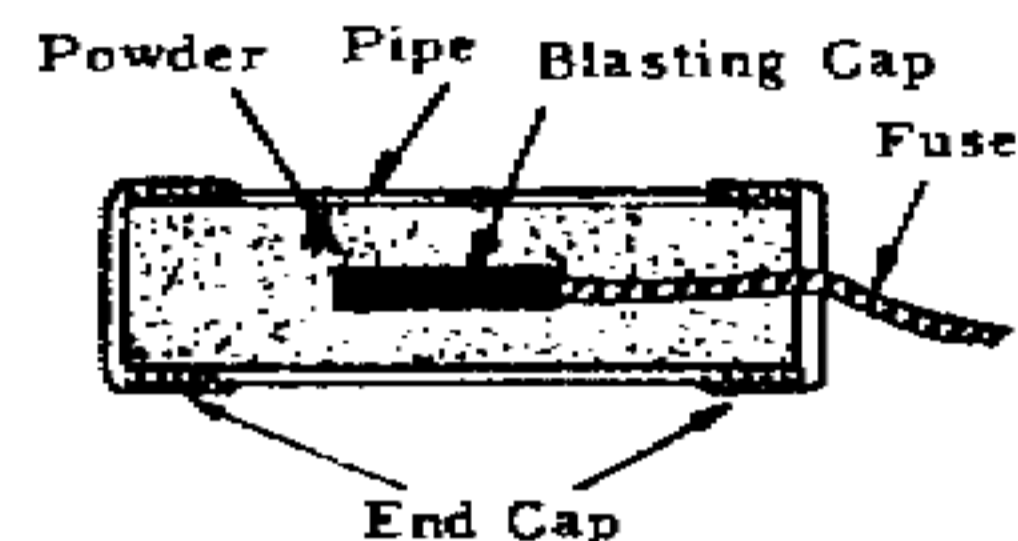

### Procedure

1. Place blasting cap on one end of fuse cord and crimp with pliers.

**Note:** To find out how long the fuse cord should be, check the time it takes to burn a known length. If 12 inches burn in 30 seconds, a 6 in. cord will ignite a grenade in 15 seconds.

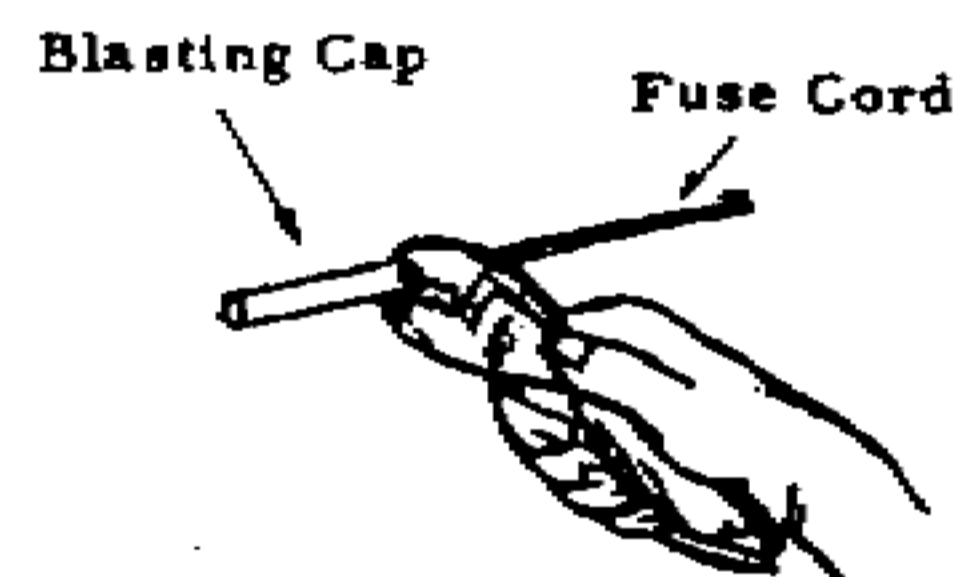

2. Screw pipe cap to one end of pipe. Place fuse cord with blasting cap into the opposite end so that the blasting cap is near the center of the pipe.

**Note:** If plastic explosive is to be used, fill pipe before inserting blasting cap. Push a round stick into the center of the explosive to make a hole and then insert the blasting cap.

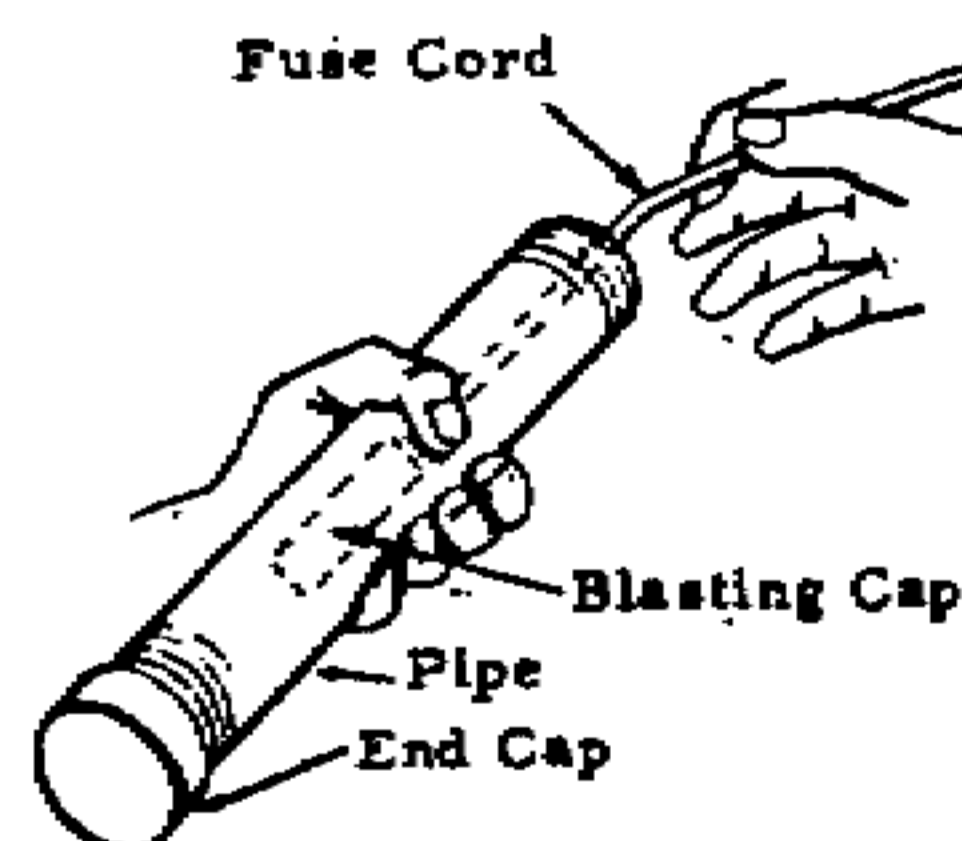

## Scientific Principles of Improvised Warfare and Home Defense

3. Pour explosive or propellant into pipe a little bit at a time. Tap the base of the pipe frequently to settle filler.

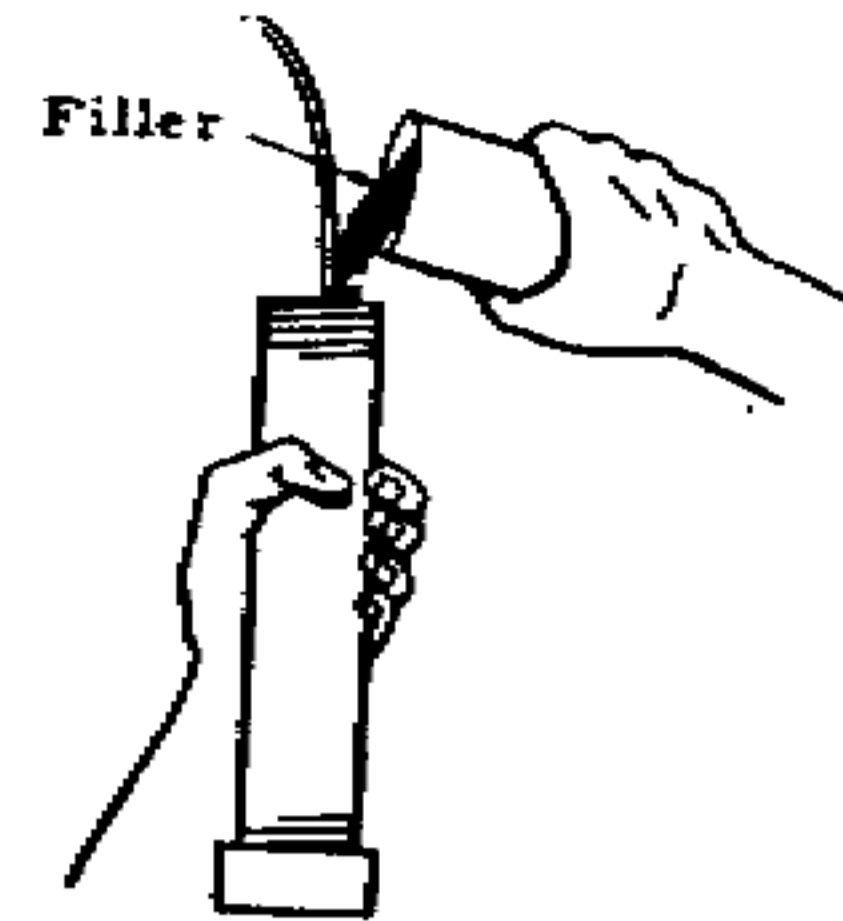

4. Drill a hole in the center of the unassembled pipe cap large enough for the fuse cord to pass through.

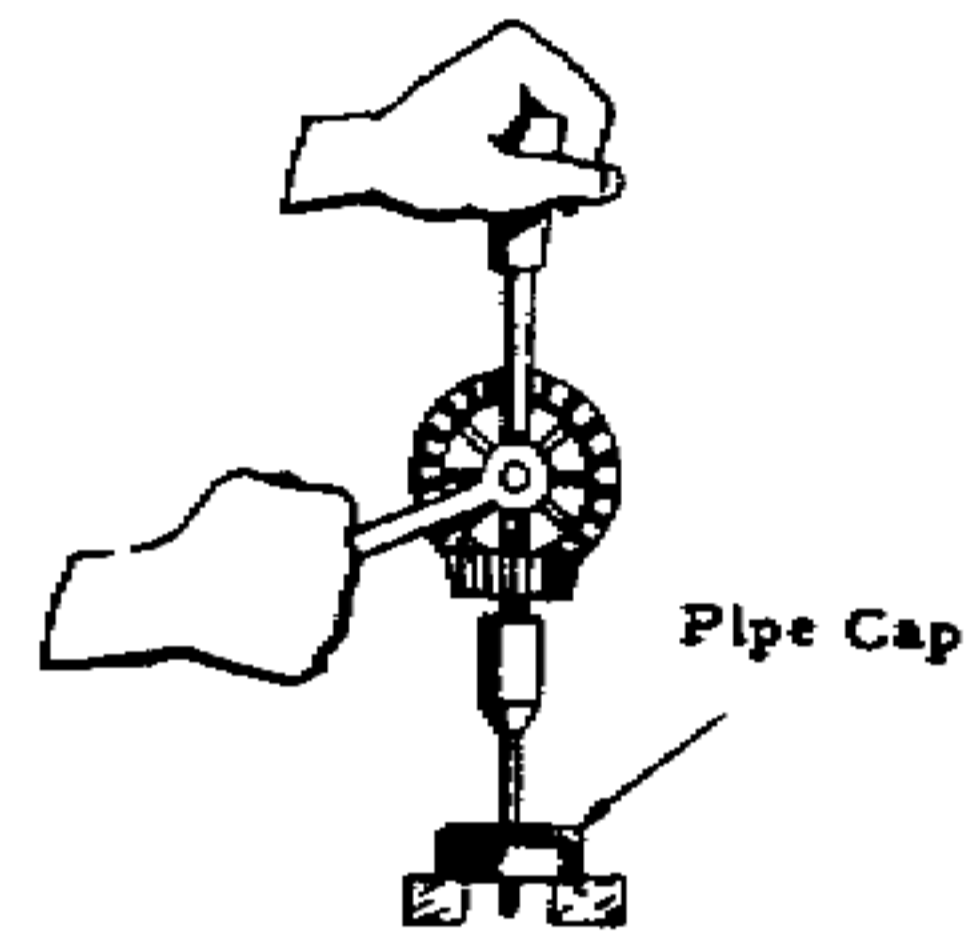

5. Wipe pipe threads to remove any filler material.

Slide drilled pipe cap over the fuse and screw handtight onto the pipe.

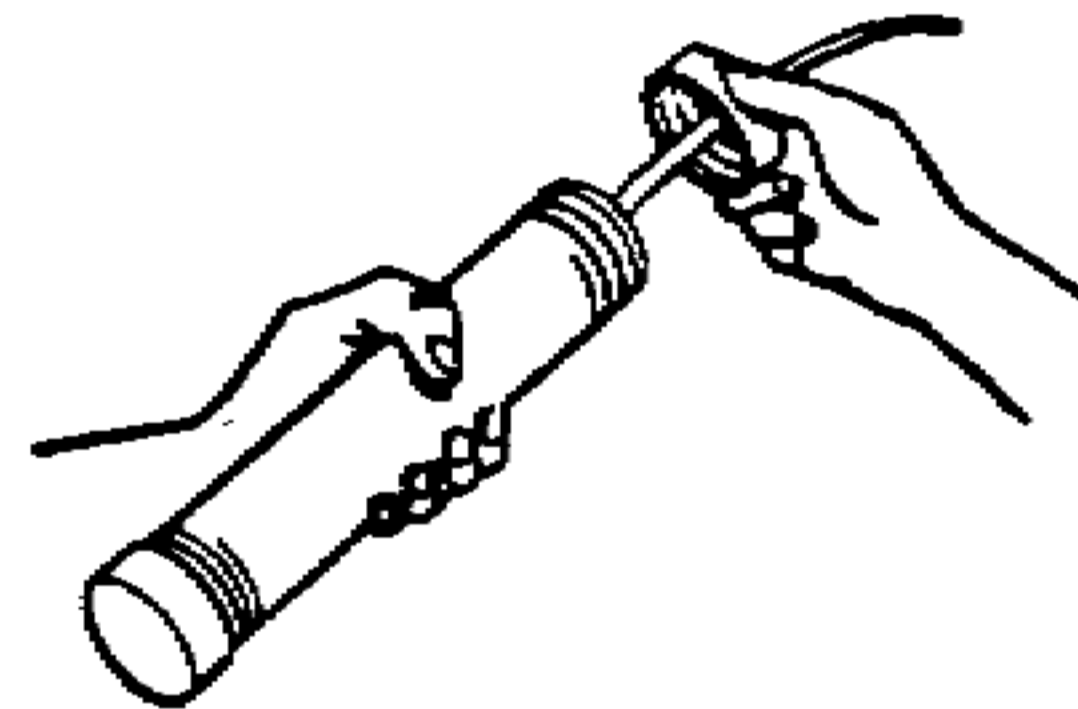

# Scientific Principles of Improvised Warfare and Home Defense

## 5) Nail (shrapnel) Grenade

Effective fragmentation grenade can be made from a block of TNT or other blasting explosive and nails.

### Material Required

- Block of TNT or other blasting explosive
- Nails
- Non electric blasting cap
- Fuse cord
- Tape, string, wire, or glue

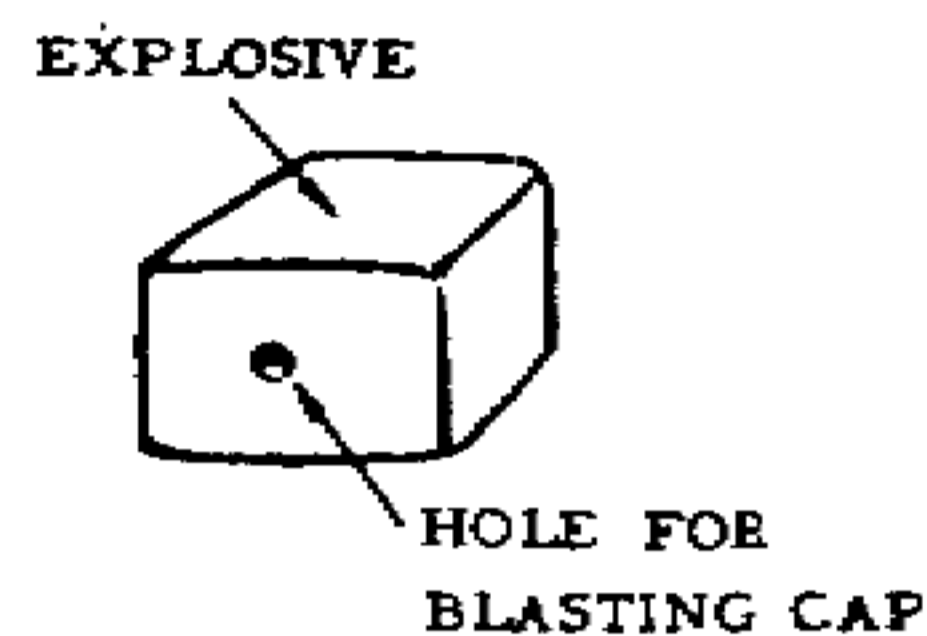
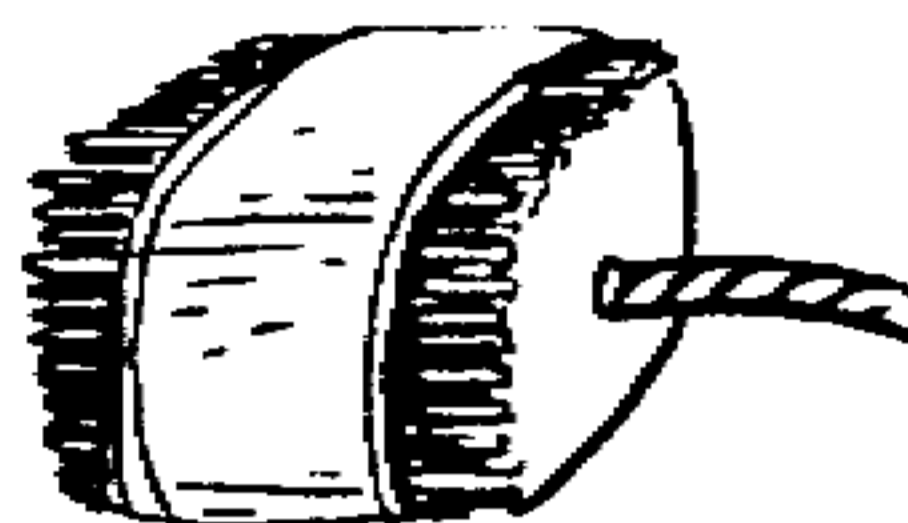

### Procedure

1. If an explosive charge other than a standard TNT block is used, make a hole in the center of the charge for inserting the blasting cap. TNT can be drilled with relative safety. With plastic explosives, a hole can be made by pressing a round stick into the center of the charge. The hole should be deep enough that the blasting cap is totally within the explosive.

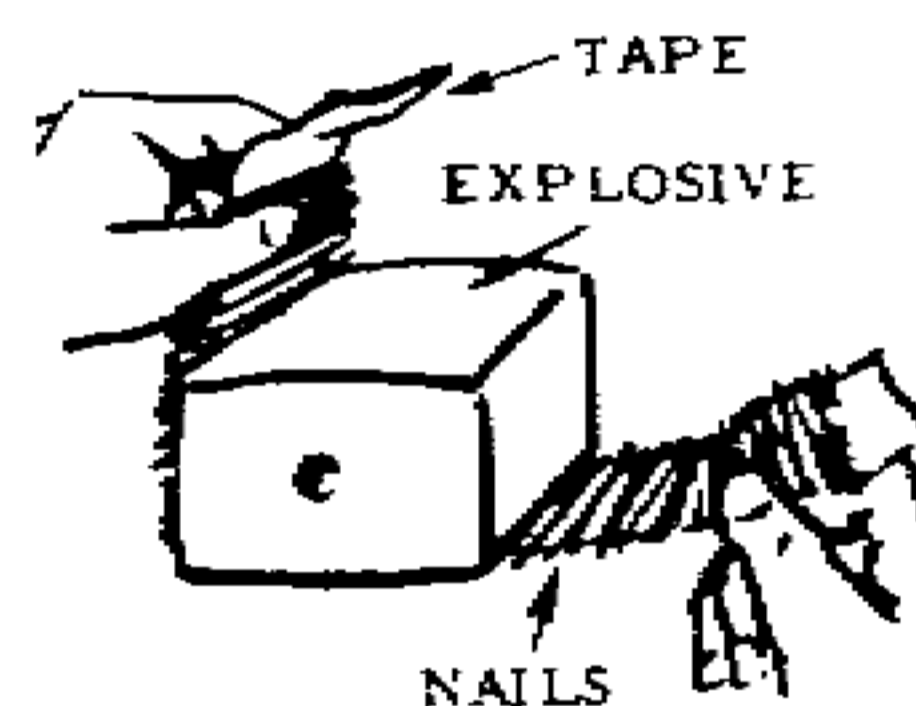

2. Tape, tie, or glue one or two rows of closely packed nails to sides of explosive block. Nails should completely cover the four surfaces of the block.

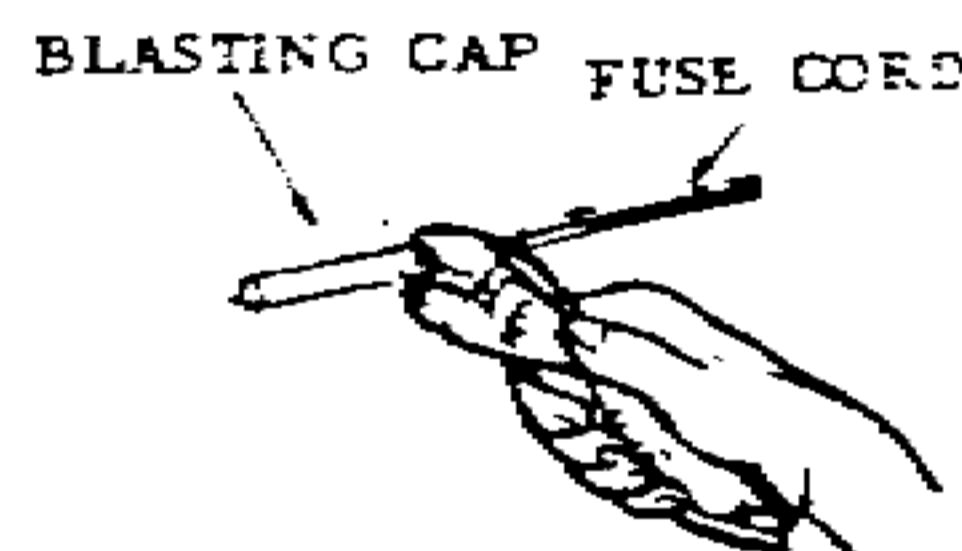

3. Place blasting cap on one end of the fuse cord and crimp with pliers.

Note: To find out how long the fuse cord should be, check the time it takes to burn 12 inches. If it takes 30 seconds, then a 15 second delay requires 6 inches, and a 10 second delay, 4 inches of fuse.

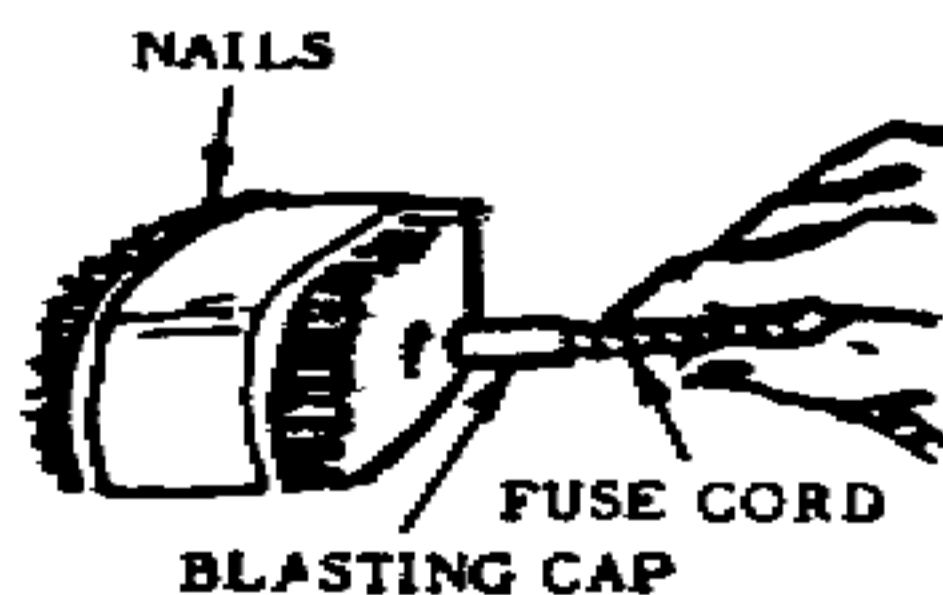

4. Insert the blasting cap in the hole in the block of explosive. Tape or tie fuse cord securely in place so that it will not fall out when the grenade is thrown.

### Alternate use

An effective directional anti-personnel mine can be made by placing nails on only one side of the explosive block. In this case an electric blasting cap can be used.

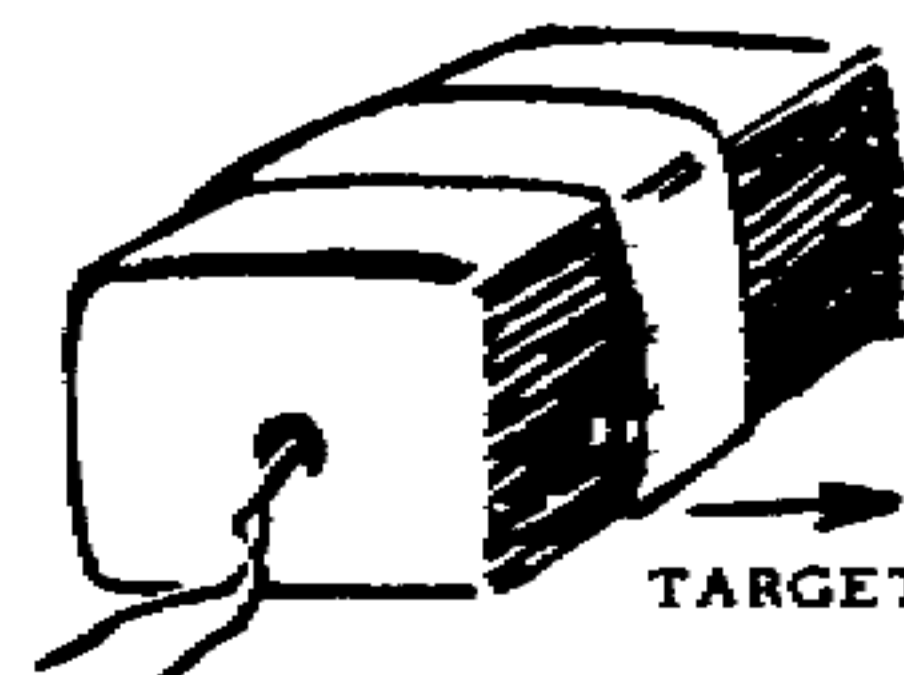

# Scientific Principles of Improvised Warfare and Home Defense

## 6) Wine Bottle Cone Charge

This cone charge will penetrate 3-4" of armor. Placed on an engine, engine compartment, fuel storage, or magazine, it will disable a tank or other vehicle.

### Material Required

- Glass wine bottle with false bottom ( cone shaped )
- Plastic or castable explosive
- Blasting Cap
- Gasoline or kerosene ( small amount)
- String
- Adhesive Tape



### Procedure

1. Soak a piece of string in gasoline or kerosene. Double wrap this string around the wine bottle app 3 in. above the top of the cone in the wine bottle bottom.

**Note:** A small amount of motor oil added to the gasoline or kerosene improves results.

2. Ignite the string and allow to burn for 1-2 minutes. Then plunge the bottle into cold water to crack the bottle. The top half can now be easily removed and discarded.

3. If plastic explosives are used: (a) pack explosives into the bottle a little at a time compressing with a wooden rod. Fill the bottle to the top. (b) press a 1/4" wooden dowel 1/2" into the middle of the top of the explosive charge to form a hole for the blasting cap.

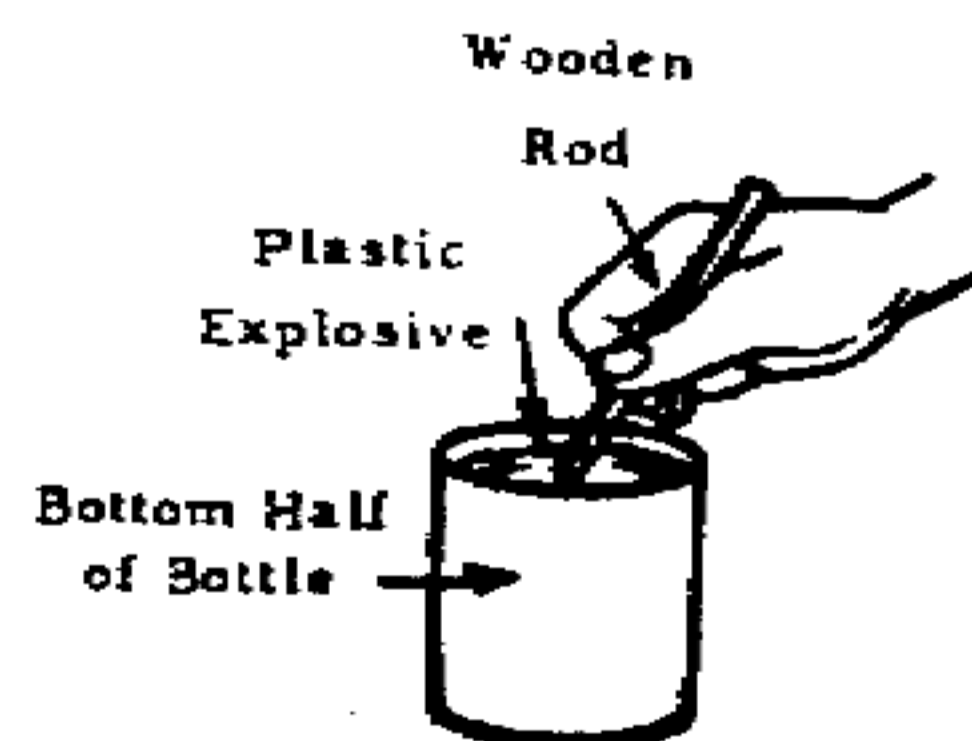
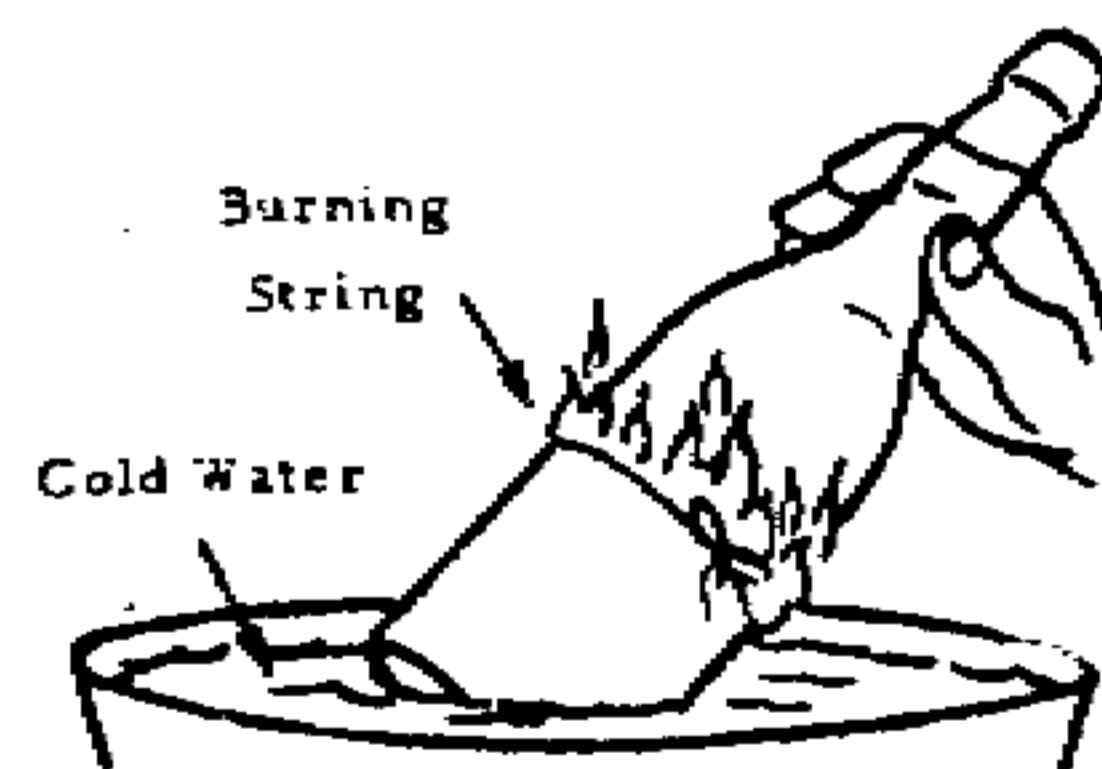
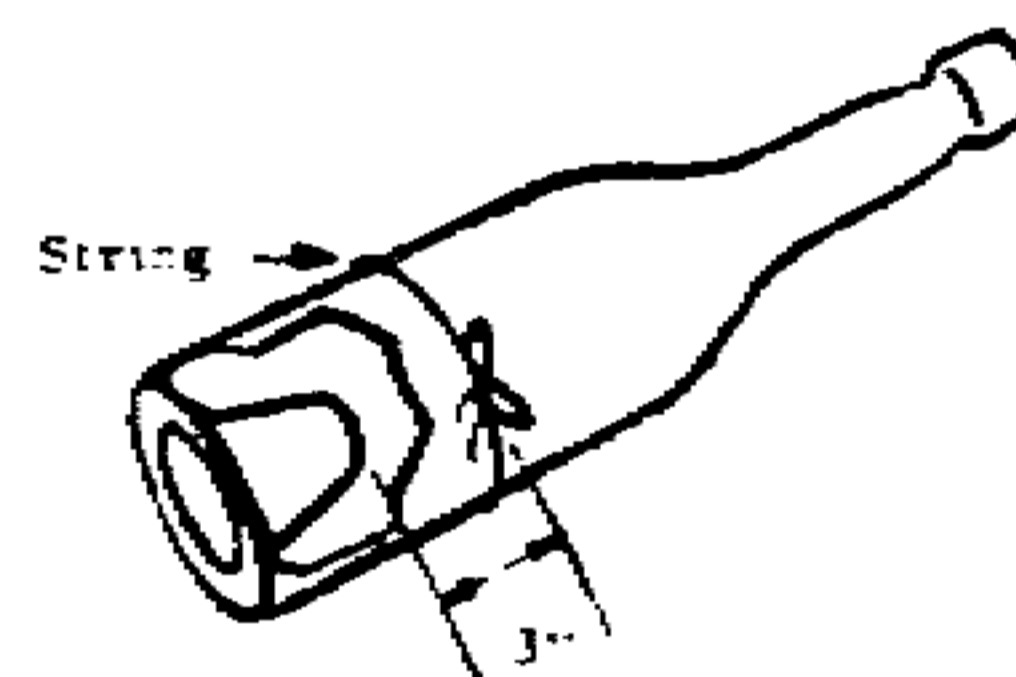



## Scientific Principles of Improvised Warfare and Home Defense

4. If TNT or other castable explosive is used:

(a) break explosive into small pieces using a wooden mallet or non sparking metal tools. Place pieces in a tin can.

(b) Suspend this can in a larger container which is partly filled with water. A stiff wire or stick pushed through the smaller can will accomplish this.

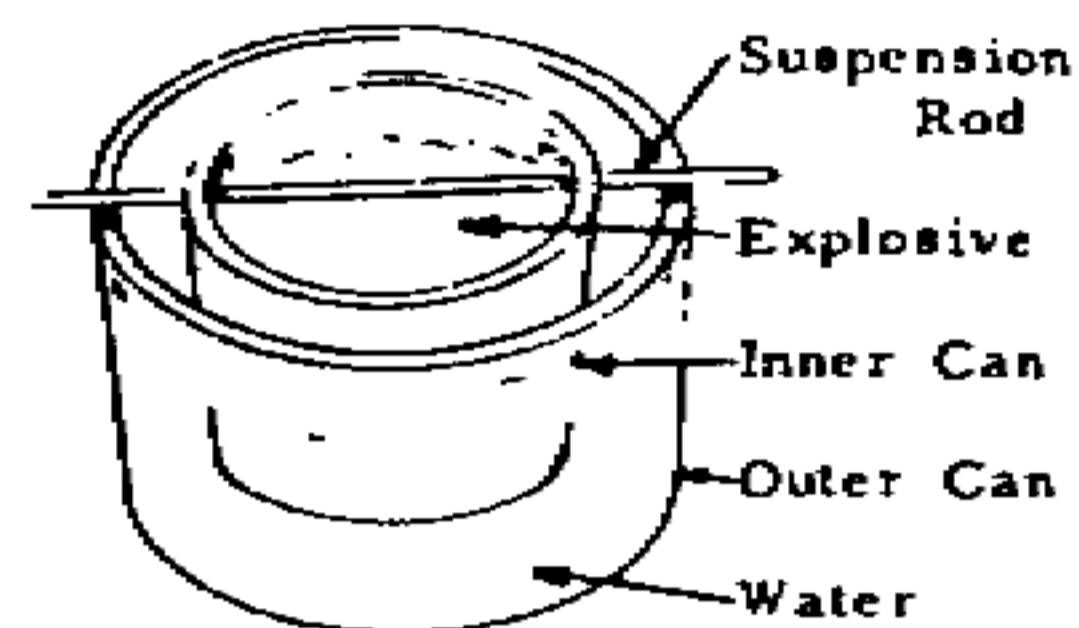

**Caution:** The inner can must not rest on the bottom of the outer container.

(c) Heat the container on an electric hot plate or other heat source. Stir the explosive frequently with a wooden stick while it is melting.

**Caution:** Keep area well ventilated while melting explosive. Fumes may be poisonous.

(d) When all the explosive has melted, remove the inner container and stir the molten explosive until it begins to thicken. During this time the bottom half of the wine bottle should be placed in the container of hot water. This will preheat the bottle so that it will not crack when the explosive is poured.

(e) Remove the bottle from hot water and dry thoroughly. Pour molten explosive into the bottle and allow to cool. The crust which forms on top of the charge during cooling should be broken with a wooden stick and more explosive added. Do this as often as necessary until the bottle is filled to the top.

(f) When explosive has completely hardened, bore a hole for the blasting cap in the middle of the top of the charge about 1/2" deep.

# Scientific Principles of Improvised Warfare and Home Defense

## How to use

1. Place blasting cap in the hole in the top of the charge. If non-electric cap is used be sure cap is crimped around fuse and fuse is long enough to provide safe delay.

2. Place the charge so that the bottom is 3-4" from the target. This can be done by taping legs to the charge or any other convenient means as long as there is nothing between the base of the charge and the target.

3. If electric cap is used, connect blasting cap wires to firing circuit.

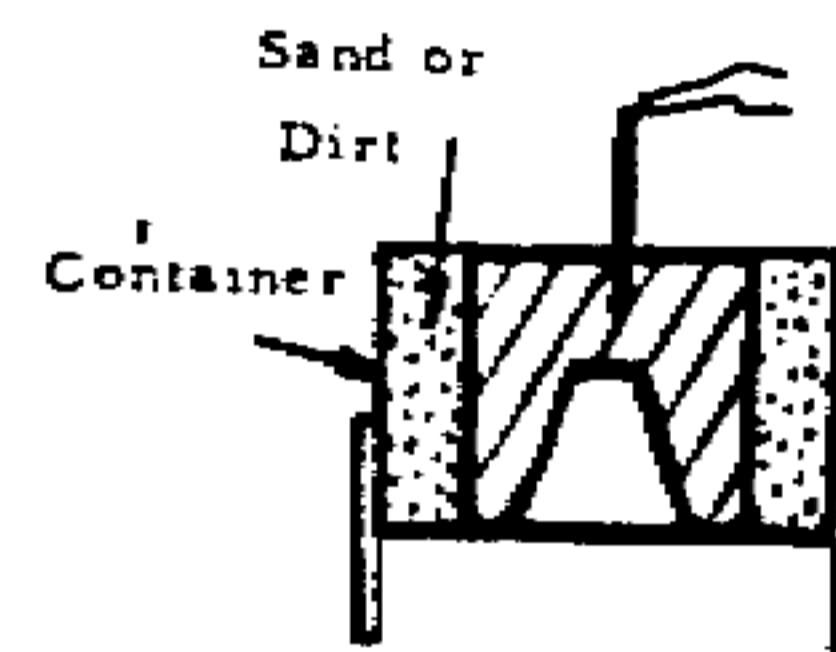
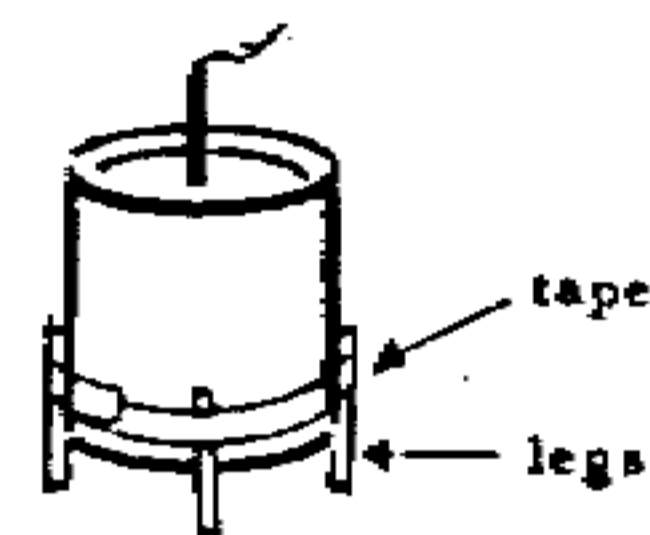

**Note:** The effectiveness of this charge can be increased by placing it inside a can, box, or similar container and packing sand or dirt between the charge and the container.

# Scientific Principles of Improvised Warfare and Home Defense

## 7) Coke Bottle Shaped Charge

This shaped charge will penetrate 3" of armor. It will disable a vehicle if placed on the engine, engine compartment, magazine or fuel storage.

### Material Required

Glass coke bottle 6.5 oz. in size

Plastic or castable explosive, about 1#

Blasting Cap

Metal cylinder, open at both ends, about 6" long and 2" inside dia.

Cylinder should be heavy walled for best results

Plug to fit mouth of coke bottle ( rags, metal, wood, paper, etc.)

Non metal rod about 1/4" in dia. and 8" long

Tape or string

2 tin cans if castable explosive is used



**Note:** Cylinder may be cardboard, plastic, etc. If castable explosive is used.

### Procedure

1. Place plug in mouth of bottle



2. Place cylinder over top of bottle until bottom of cylinder rests on widest part of bottle. Tape cylinder to bottle. Container should be straight on top of bottle.

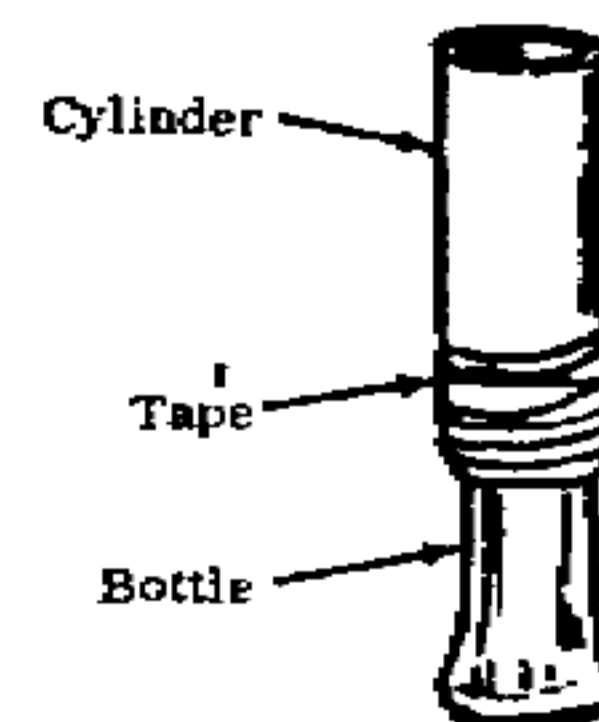

3. If plastic explosive is used

(a) Place explosive in cylinder a little at a time tamping with rod until cylinder is full.



# Scientific Principles of Improvised Warfare and Home Defense

(b) Press the rod about 1/2" into the middle of the top of the explosive charge to form a hole for the blasting cap.



4. If castable explosive is used, follow procedure of wine bottle cone charge.

## How to use

### Method 1 - For electrical blasting cap

1. Place blasting cap in hole in top of explosive.

**Caution:** Do not insert blasting cap until charge is ready to be detonated.

2. Place bottom of coke bottle flush against the target. If target is not flat and horizontal, fasten bottle to target by any convenient means, such as by placing tape or string around target and top of bottle. Bottom of bottle acts as stand off.

**Caution:** Be sure that base of bottle is flush against target and that there is nothing between the target and the base of the bottle.

3. Connect leads from blasting cap to firing circuit.

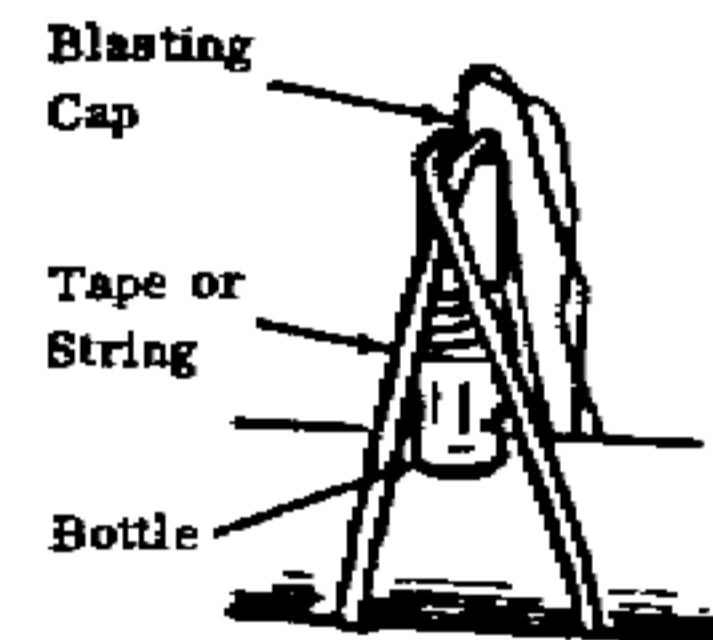
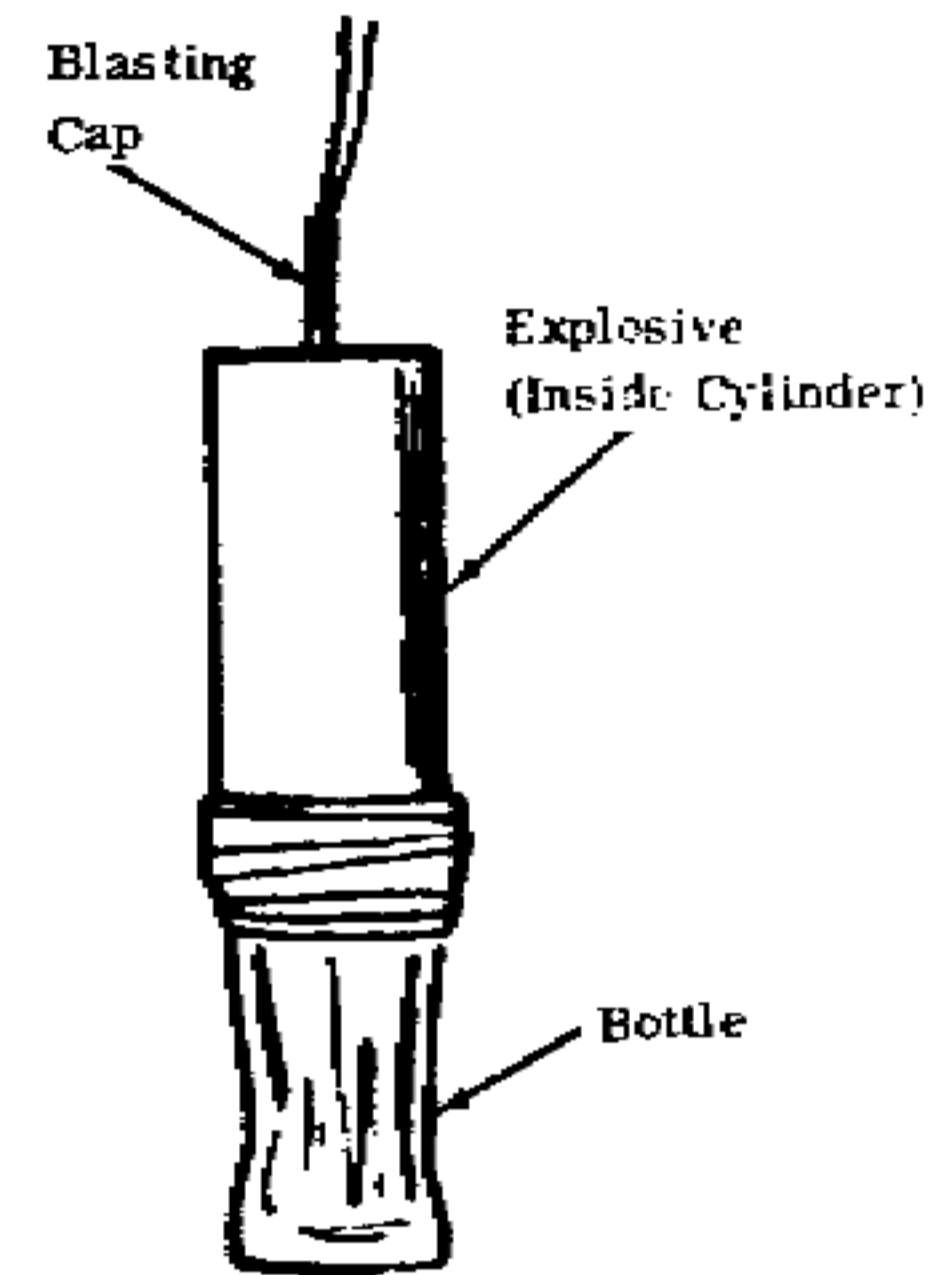

### Method 2 - for non electrical blasting cap

1. Crimp cap around fuse

**Caution:** Be sure fuse is long enough to provide a safe delay.

2. Follow 1,2, and cautions of method 1.

3. Light fuse when ready to fire.

# Scientific Principles of Improvised Warfare and Home Defense

## 8) Cylindrical Cavity Shaped Charge

A shaped charge can be made from common pipe. It will penetrate 1.5" of steel producing a hole 1.5" in diameter.

### Material Required

Iron or steel pipe, 2-2.5" in dia. and 3-4" long

Metal pipe 1/2-3/4" in dia. and 1.5 in. long, open at both ends. The wall of this pipe should be as thin as possible

Blasting Cap

Non-Metallic Rod, 1/4" in dia.

Plastic or castable explosive

2 metal cans of different sizes (If castable explosive is used)

Stick or wire "

Heat source "

### Procedure

1. If plastic explosive is used

a. Place larger pipe on flat surface. Hand pack explosive into pipe. Leave app. 1/4" space at top.

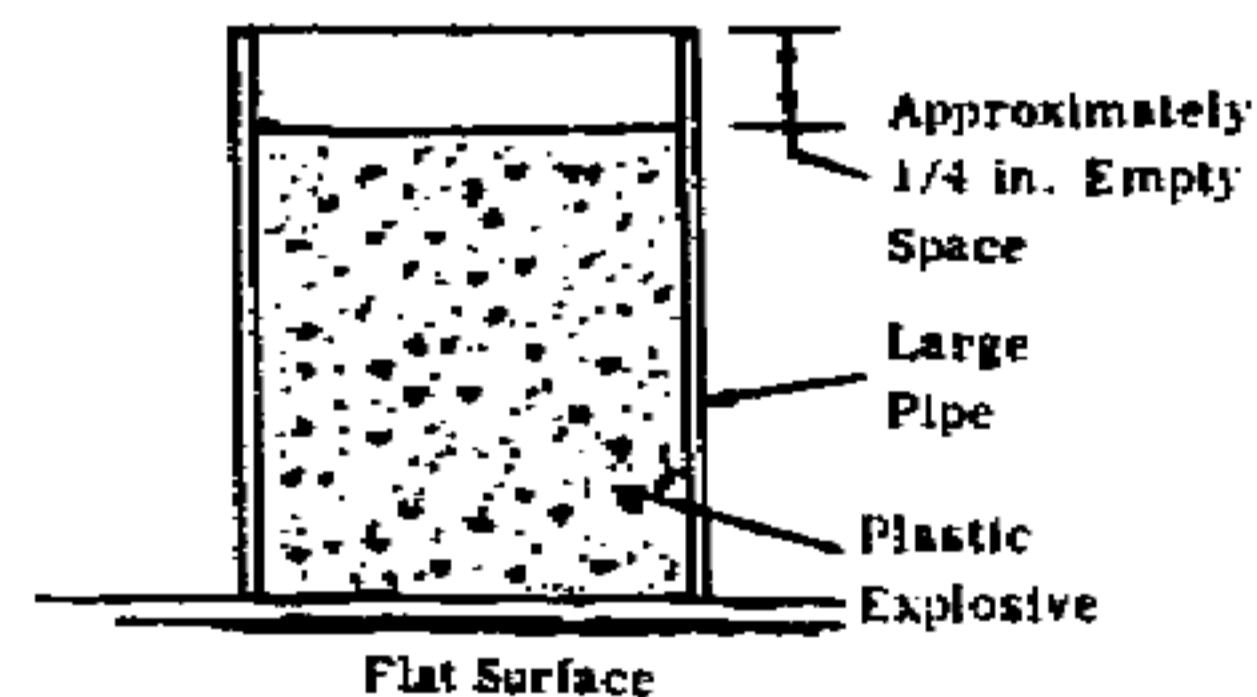

b. Push rod into center of explosive. Enlarge hole in explosive to diameter and shape of small pipe.

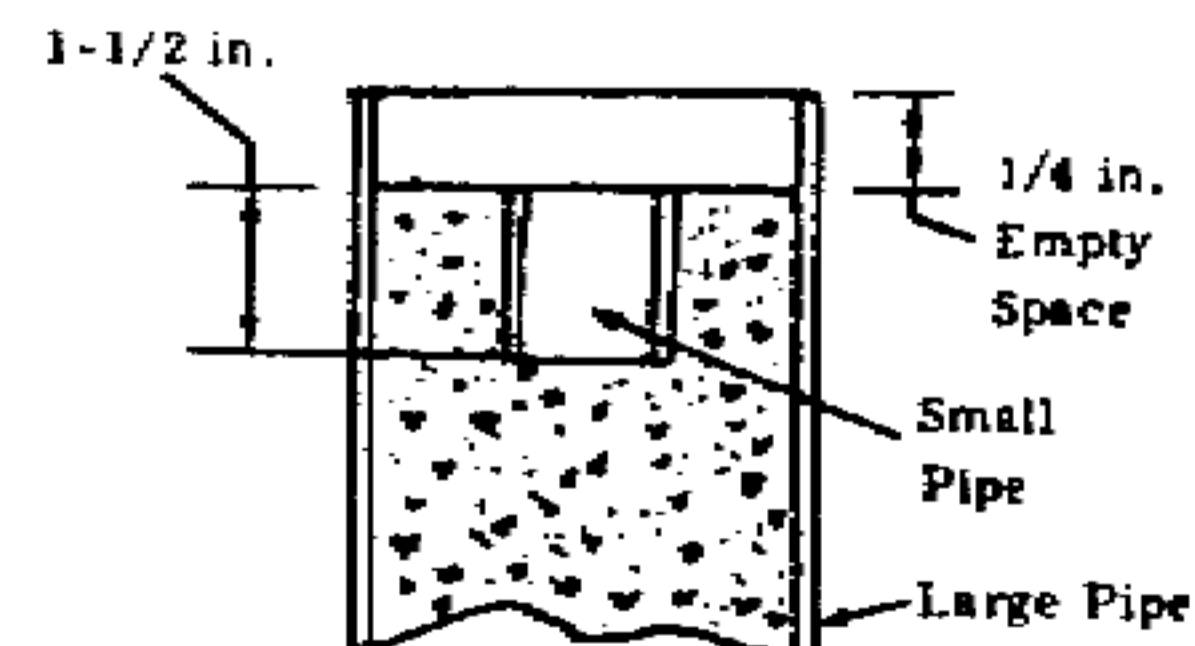

c. Insert small pipe into hole.



## Scientific Principles of Improvised Warfare and Home Defense

**Important:** Be sure direct contact is made between explosive and small pipe. Tamp explosive around pipe by hand if necessary.

d. Make sure that there is 1/4" empty space above small pipe. Remove explosive if necessary.

e. Turn pipe upside down and push rod 1/2" into center of opposite end of explosive to form a hole for the blasting cap.

**Caution:** Do not insert blasting cap in hole until ready to fire shaped charge.

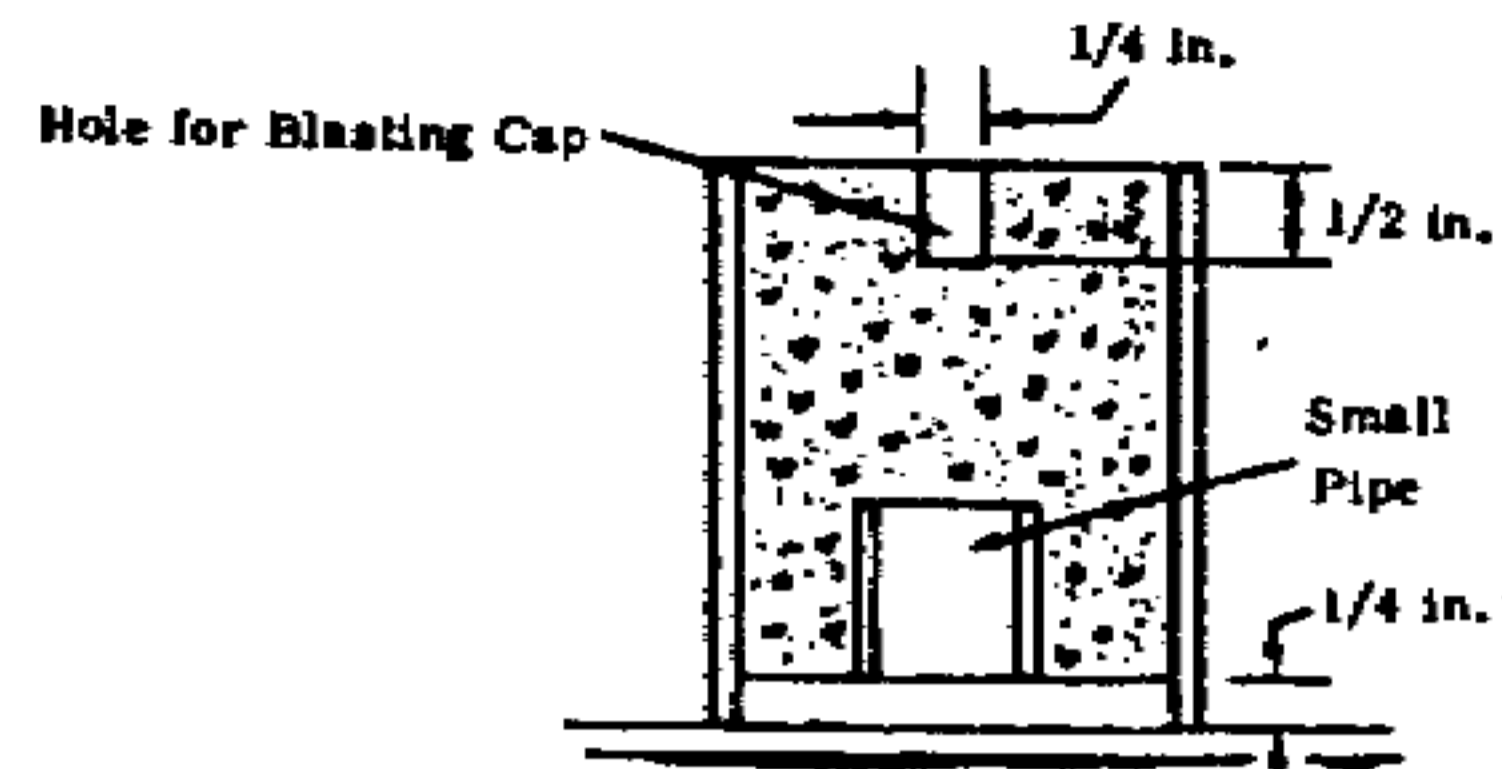

### 2. If TNT or other castable explosive is used

a. Follow step 4, parts a,b,and c of wine bottle cone charge

b. When all the explosive has melted, remove the inner container and stir the molten explosive until it begins to thicken.

c. Place large pipe on flat surface. Pour explosive into pipe until it is 1-3/4" from the top.

d. Place small pipe in center of large pipe so that it rests on top of explosive. Holding small pipe in place, pour explosive around small pipe until explosive is 1/4" from top of large pipe.

e. Allow explosive to cool. Break crust that forms on top of the charge during cooling with a wooden stick and add more explosive. Do this as often as necessary until explosive is 1/4" from the top.

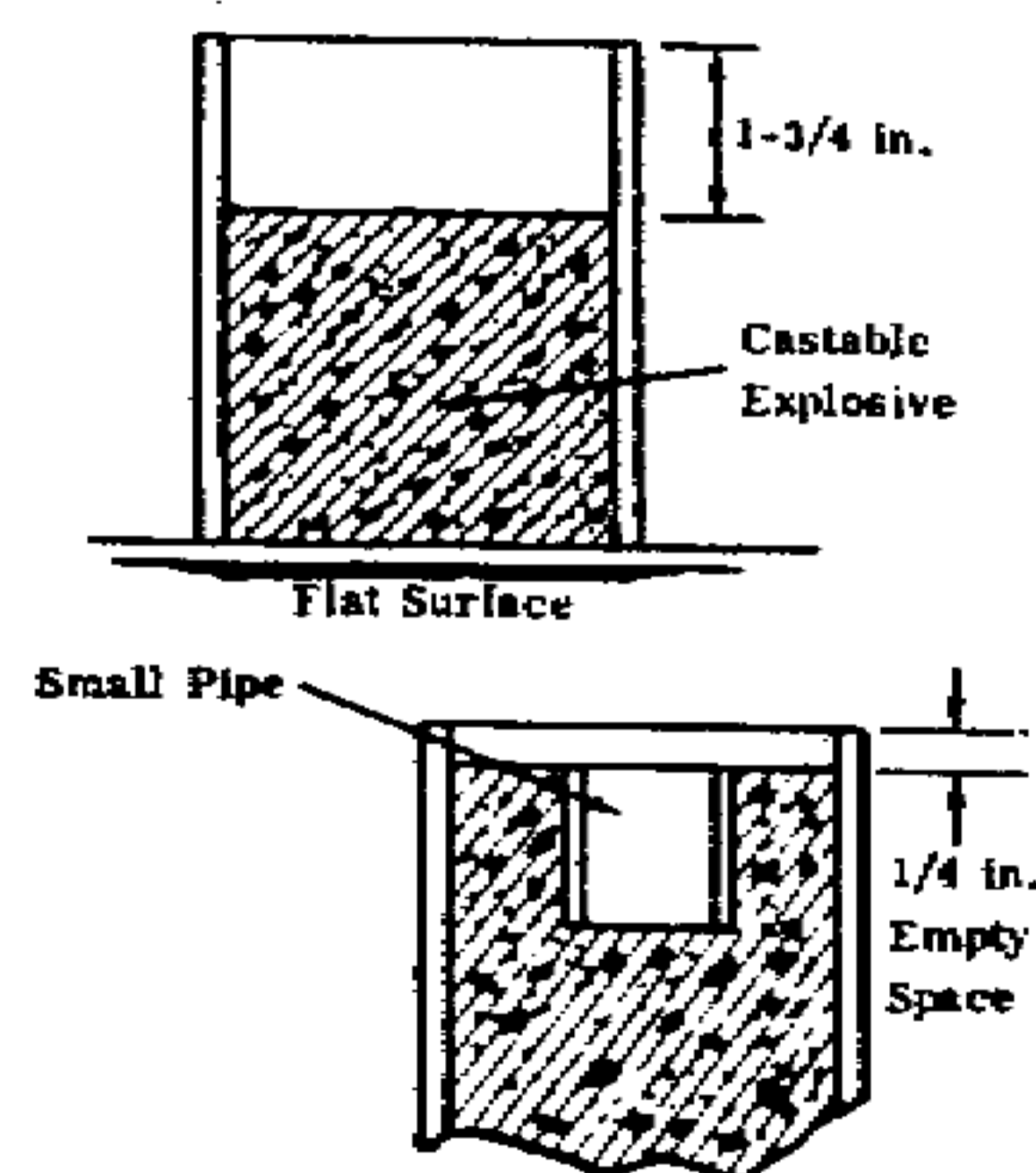

## Scientific Principles of Improvised Warfare and Home Defense

f. When explosive has completely hardened, turn pipe upside down and bore a hole for the blasting cap in the middle of the top of the charge about 1/2" deep.

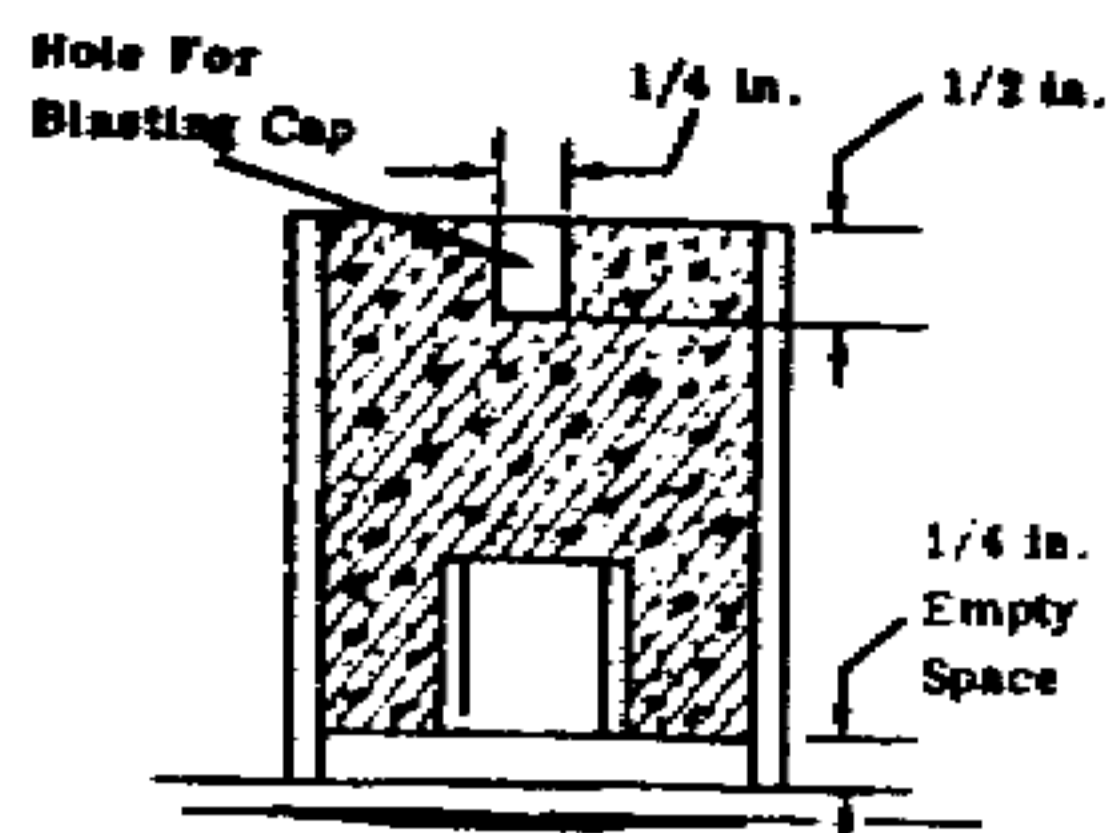

### How to use

#### Method 1 - if electrical blasting cap is used

1. Place blasting cap in hole made for it.

**Caution:** Do not insert blasting cap until charge is ready to be fired.

2. Place other end of pipe flush against the target. Fasten pipe to target by any convenient means, such as by placing tape or string around target and top of pipe, if target is not flat and horizontal.

**Caution:** Be sure the base of the pipe is flush against target and there is nothing between the target and the base of the pipe.

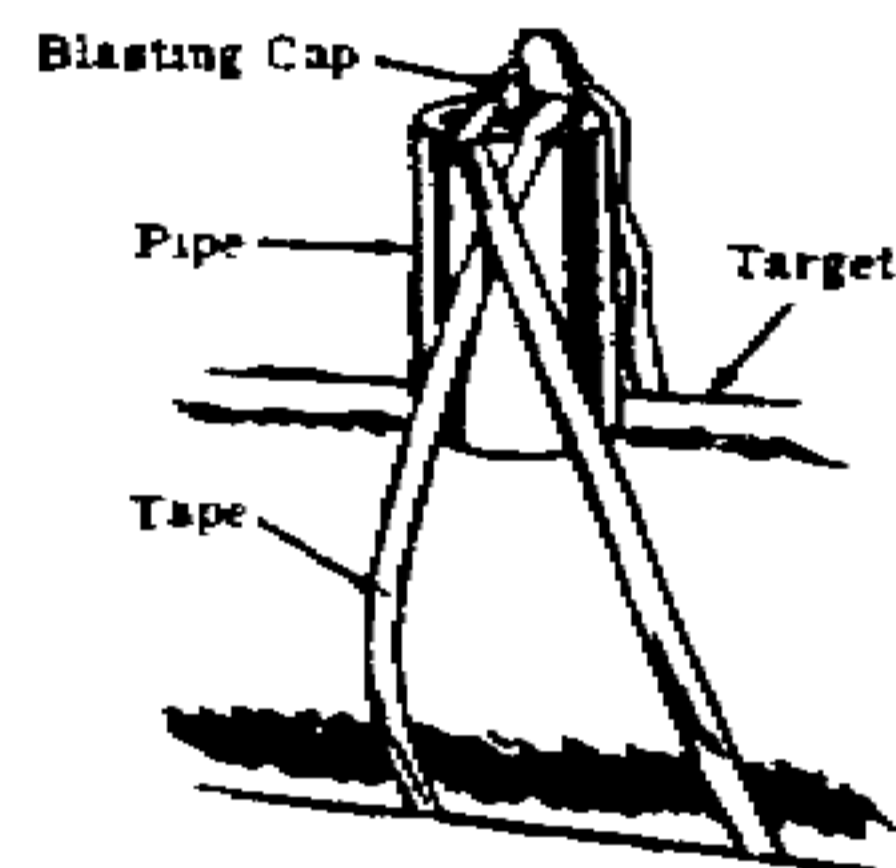

3. Connect leads from blasting cap to firing circuit.

#### Method 2 - for non electrical blasting cap

1. Crimp cap around fuse.
2. Be sure fuse is long enough for a safe delay.
3. Follow steps 1 and 2 of method 1.
4. Light fuse when ready.

# Scientific Principles of Improvised Warfare and Home Defense

## 9) Funnel Shaped Charge

An effective shaped charge can be made using various types of commercial funnels. See table for penetrating capabilities.

### Material Required

- Container ( soda or beer can) app 2.5" in dia. x 5" long
- Funnel(s) 2.5" in dia. at top
- Wooden rod or stick, 1/4" in dia.
- Tape
- Blasting Cap
- Sharp cutting edge
- Explosive

### Procedure

1. Remove the top and bottom of can and discard.

2. Cut off and throw away the spout of the funnels.

**Note:** When using 3 funnels (see table), place the funnels together as tight as straight as possible. Tape the funnels together at the outer ridges.

3. Place the funnels in the modified can. Tape on outer ridges to hold funnels to can.

4. If plastic explosive is used, fill the can with the explosive using small quantities, and tamp with wooden rod or stick.

**Note:** If castable explosive is used, follow step 4 of wine bottle cone charge.

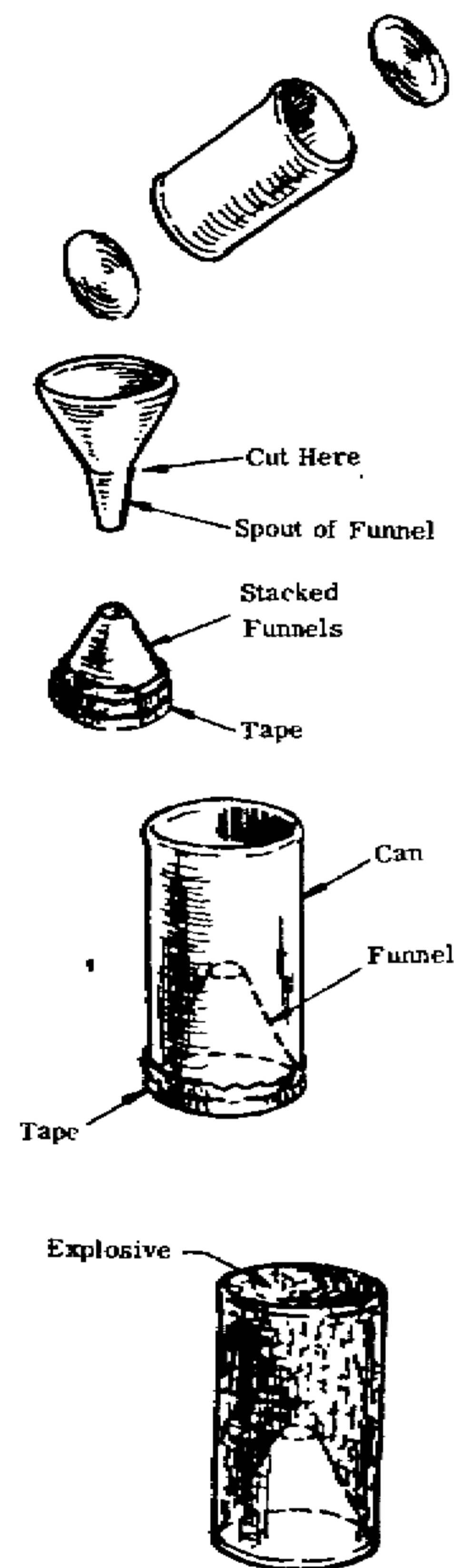

## Scientific Principles of Improvised Warfare and Home Defense

5. Cut wooden rod to lengths 3" longer than the standoff length (see table). Position 3 of these rods around the explosive filled can and hold in place with tape.

**Note:** The position of the rods on the container must conform to standoff dimensions to obtain the penetrations given in the table.

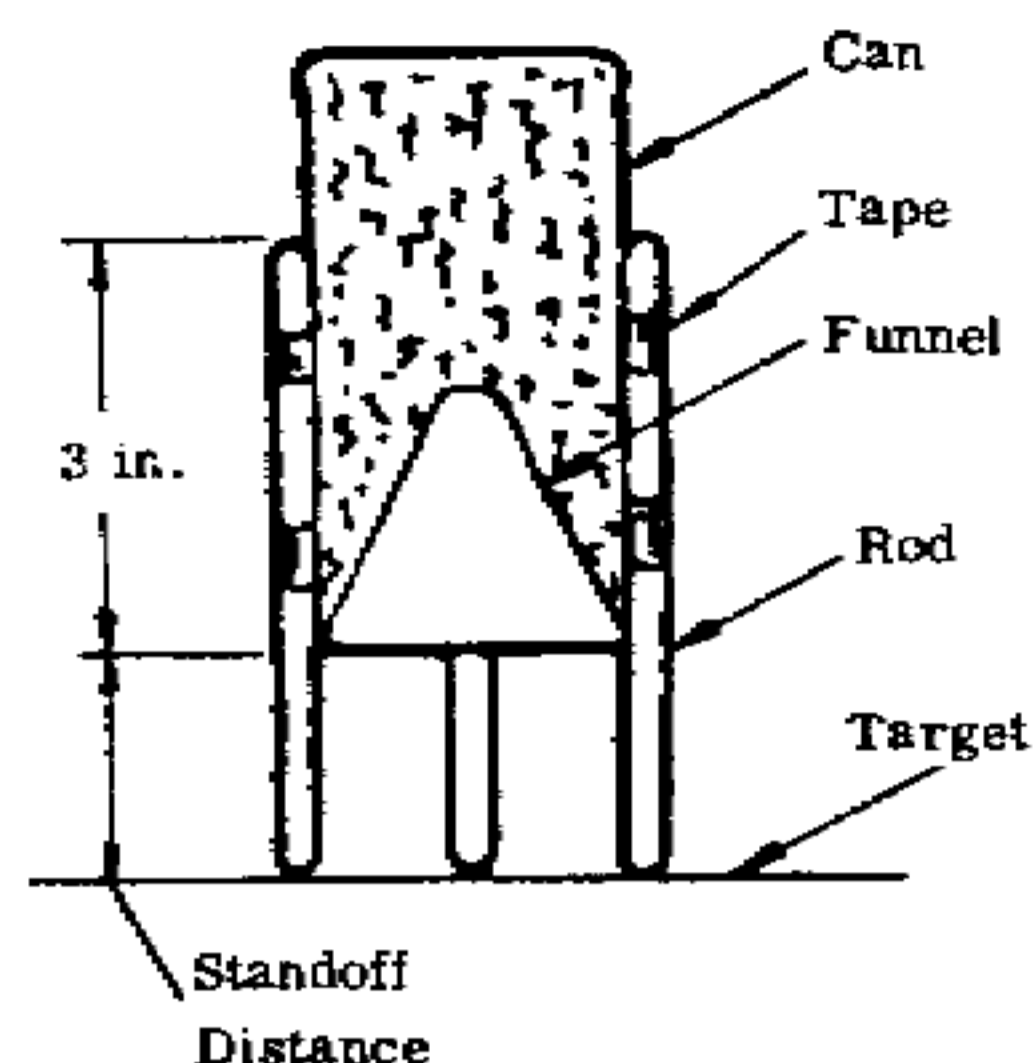

<u>Funnel Material</u>	<u># of funnels</u>	<u>Standoff</u>	<u>Penetration of steel armor</u>
Glass	1	3.5"	4"
Steel	3	1"	2.5"
Aluminum	3	3.5"	2.5"
Steel	1	1"	1.5"
Aluminum	1	1"	1.5"

( if only one steel or aluminum funnel are available, the standoff distance must be shorter and a loss of penetrating ability occurs)

6. Make a hole for blasting cap in the center of the explosive with rod or stick.

**Caution:** Do not place blasting cap in place until the funnel shape charge is ready to use.

### How to use

1. Place blasting cap in the hole in top of the charge. If non electric cap is used, be sure cap is crimped around fuse and fuse is long enough to provide safe delay.
2. Place (tape if necessary) the funnel shaped charge on the target so that nothing is between the base of charge and target.
3. If electric cap is used, connect blasting cap wires to firing circuit.

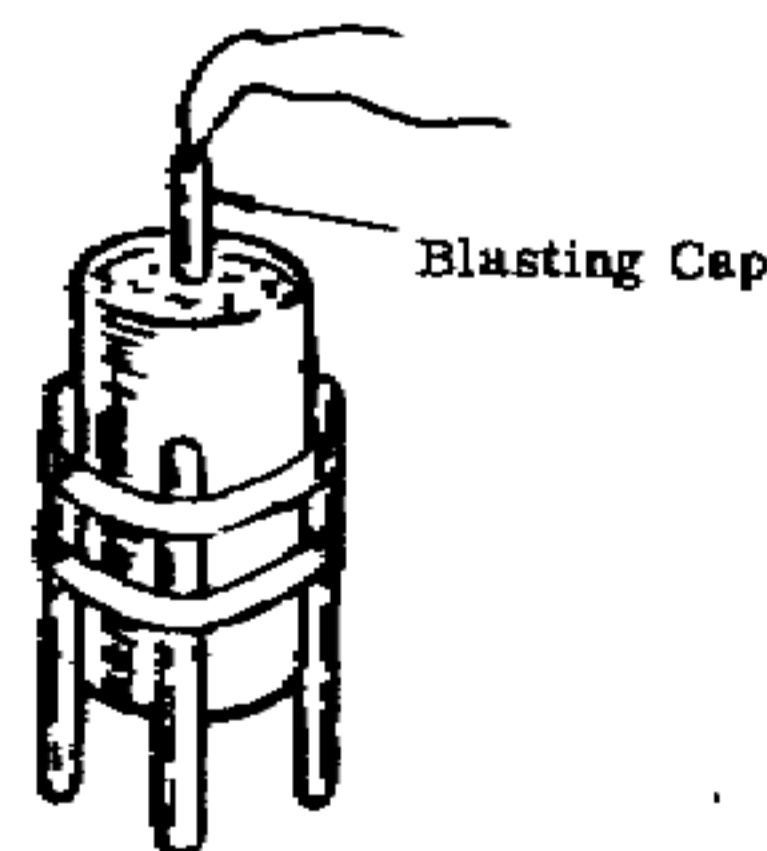
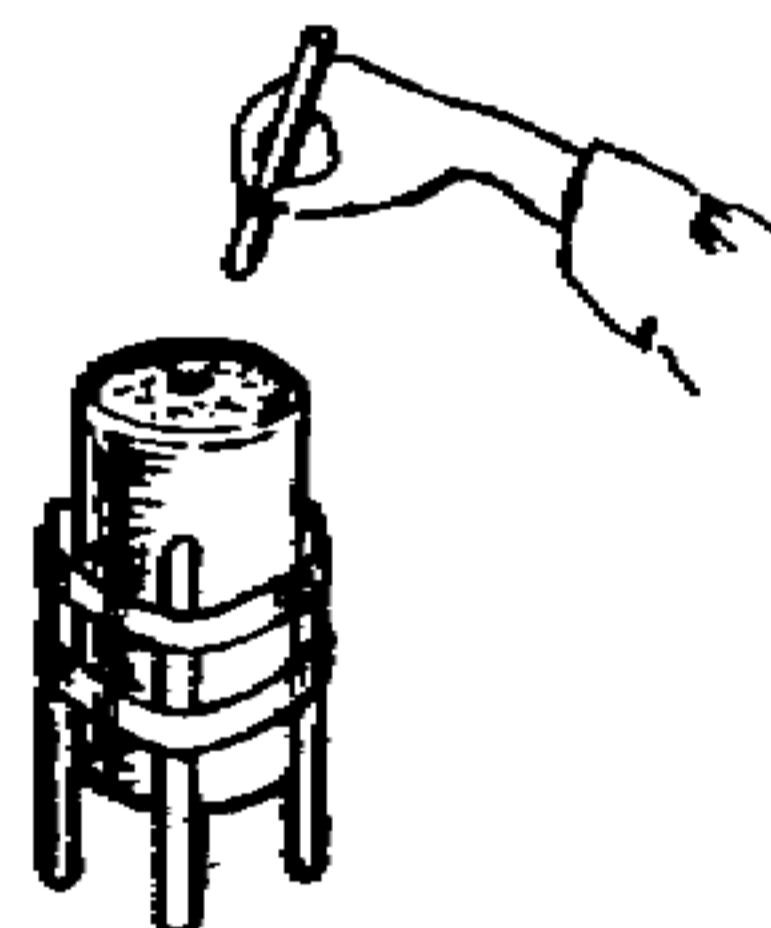

# Scientific Principles of Improvised Warfare and Home Defense

## 10) Linear Shaped Charge

This shaped charge made from construction materials will cut through up to nearly 3 inches of armor depending on the liner used. (see table)

### Material Required

- Standard structural angle or pipe (see table)
- Wood or cardboard container
- Hacksaw (If pipe is used)
- Vise "
- Wooden rod, 1/4" dia.
- Explosive
- Blasting Cap
- Tape

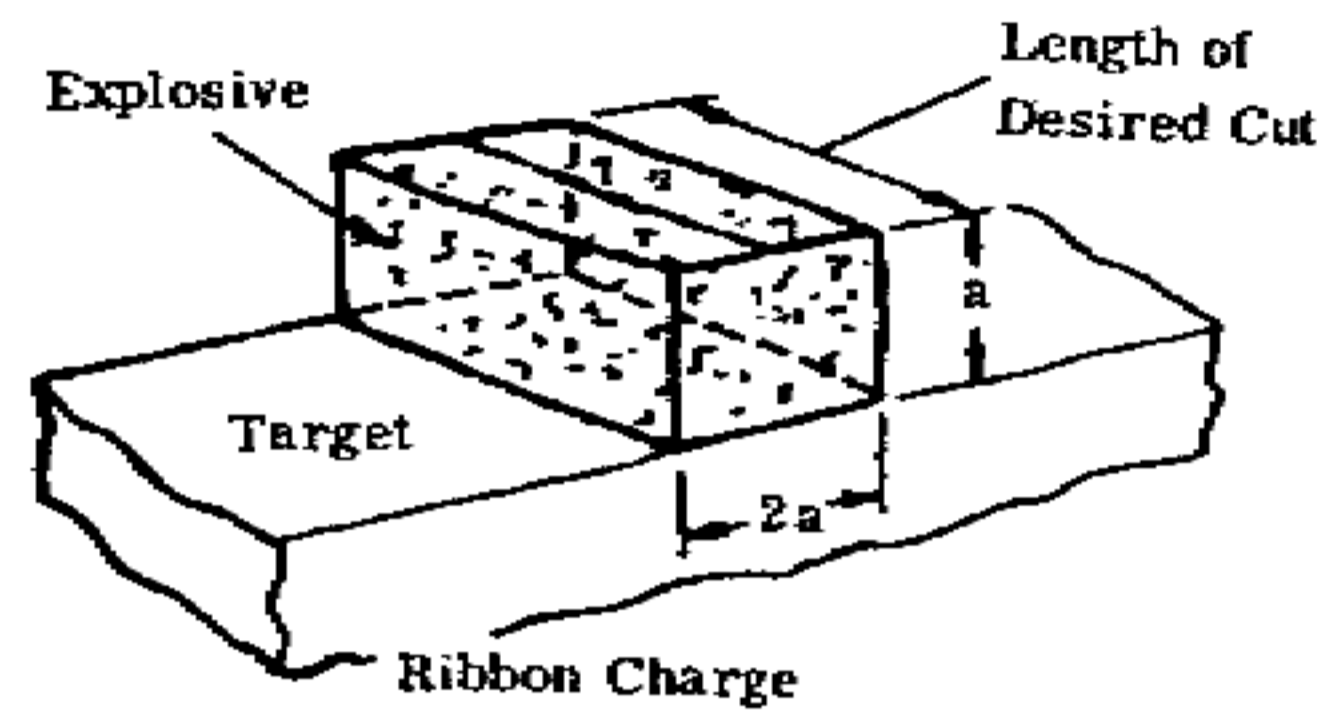

Table

Type	Material	Liner Size	Standoff	Penetration
angle	steel	3 x 3 legs x 1/4 web	2"	2-3/4"
angle	aluminum	2 x 2 legs x 3/16 web	5-1/2"	2.5"
pipe 1/2 section	aluminum	2 diameter	2"	2"
pipe 1/2 section	copper	2 diameter	1"	1-3/4"

If a flat ribbon shaped charge is used, no standoff is required  
 The above shapes were found to be more efficient than the ribbon shape

### Procedure

1. If pipe is used



## Scientific Principles of Improvised Warfare and Home Defense

a. Place the pipe in the vise and cut pipe in half lengthwise. Remove the pipe half section from vise.

b. Discard one of the pipe half sections, or save for another charge.

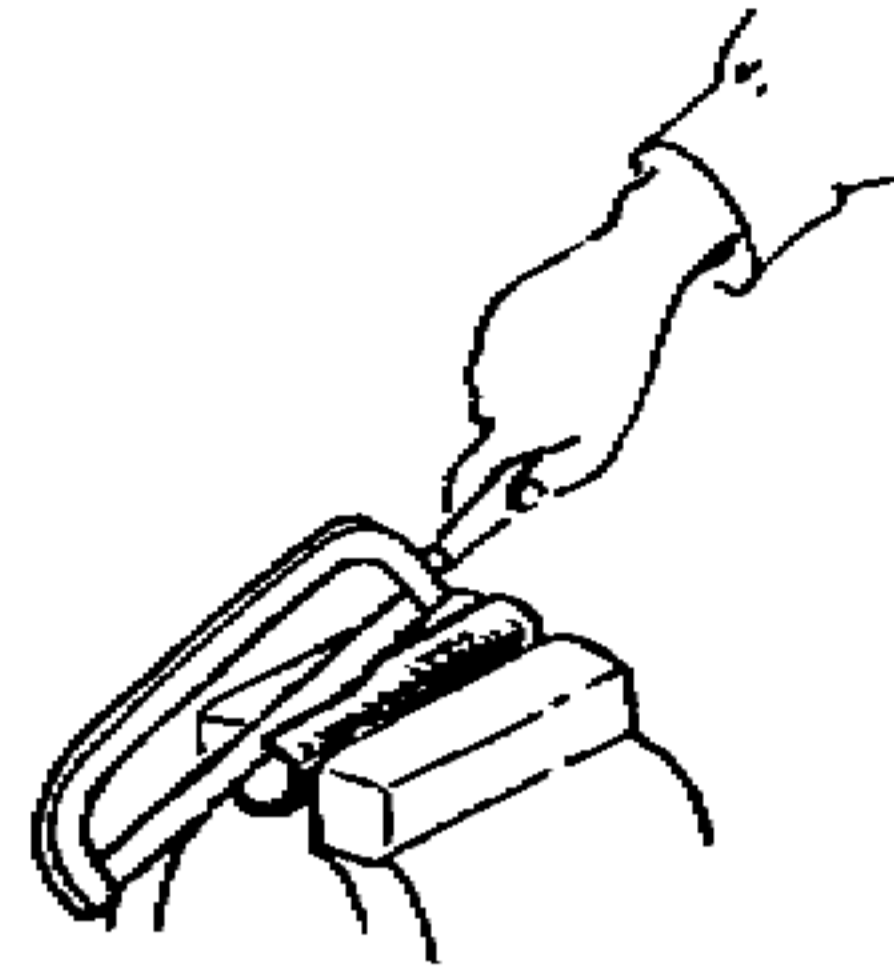

2. Place angle or pipe half section with open end face down on a flat surface.

3. Make container from any material available. The container must be as wide as the angle or pipe half section, twice as high, and as long as the desired cut to be made with the charge.

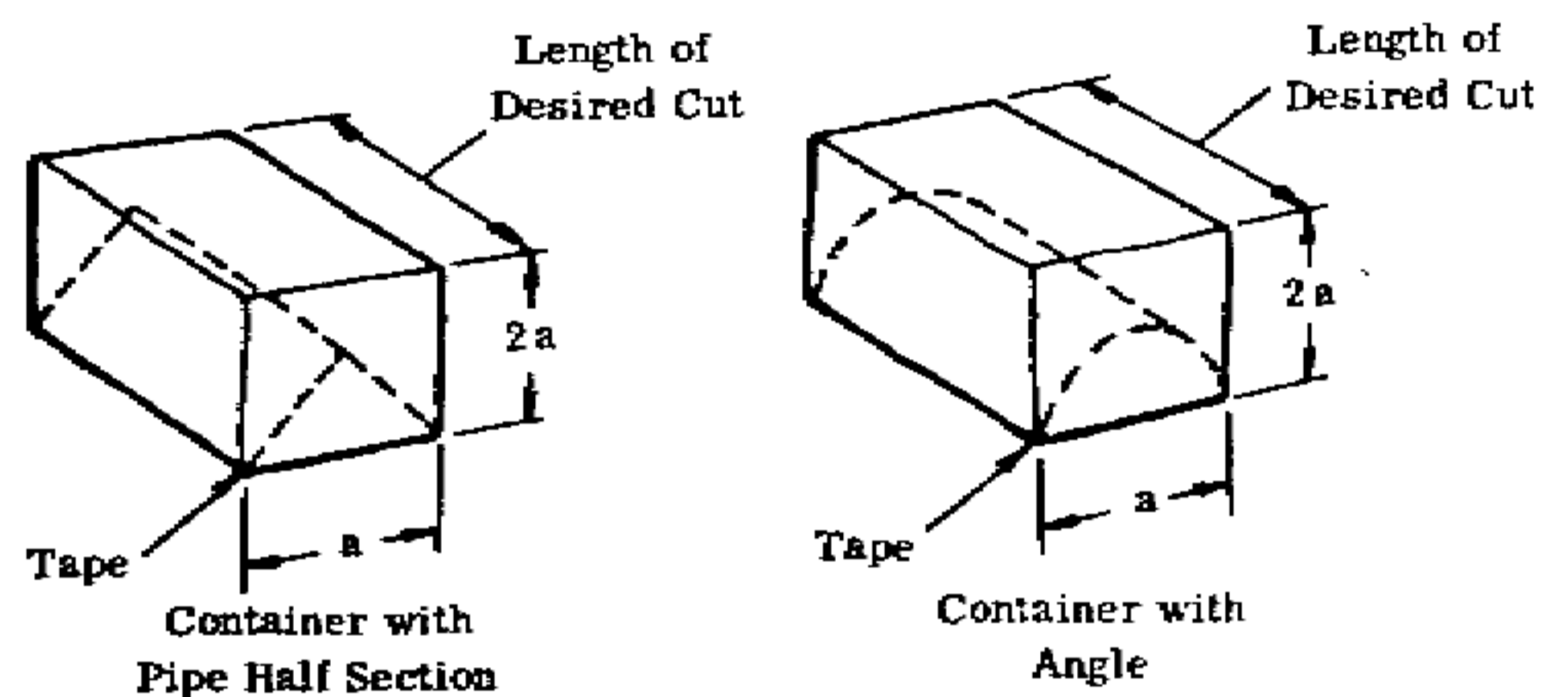

4. Place container over the liner (angle or pipe half section) and tape liner to container.

5. If plastic explosives are used, fill the container with the explosive using small quantities, and tamp with wooden rod or stick.

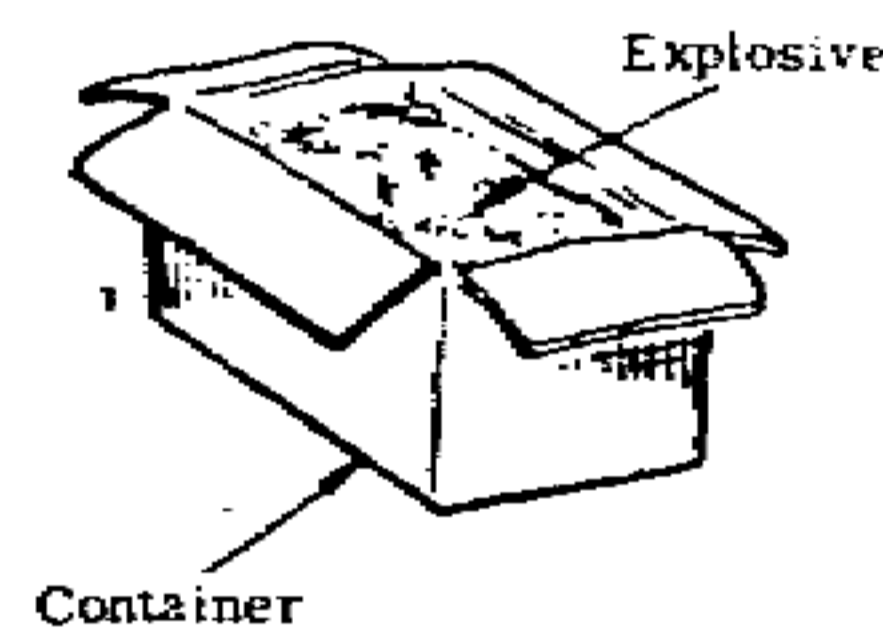

**Note:** If castable explosive is used, follow step 4 of wine bottle cone charge.

6. Cut wooden rod to lengths 2" longer than the standoff length (see table). Position the rods at the corners of the explosive filled container and hold in place with tape.

**Note:** The position of the rods on the container must conform to standoff and penetration dimensions given in the table.

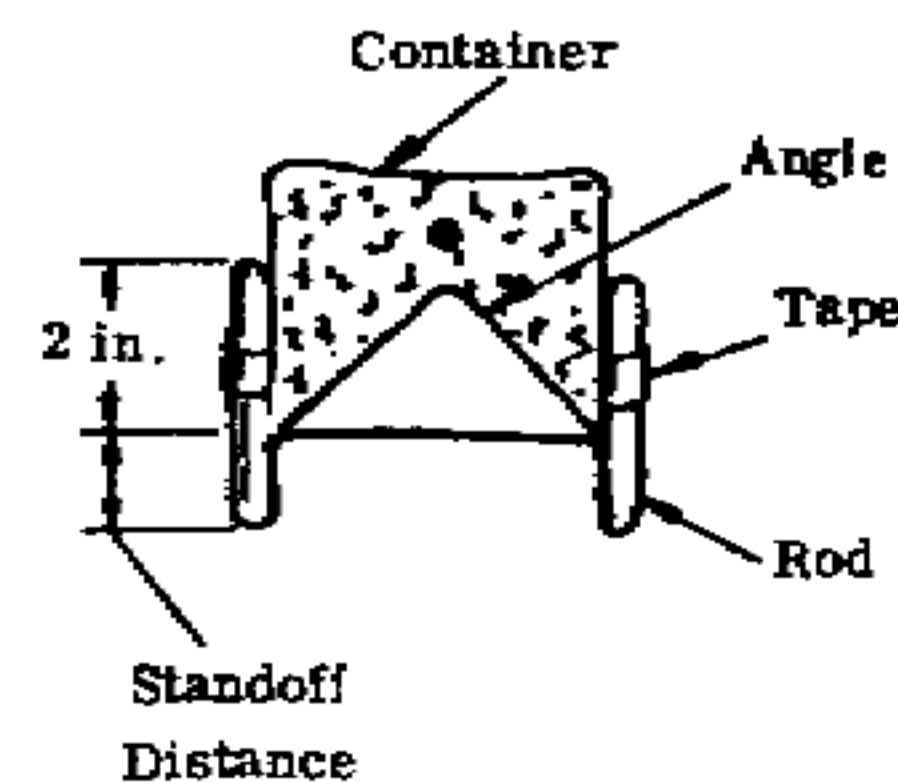

## Scientific Principles of Improvised Warfare and Home Defense

7. Make a hole for blasting cap in the side of the container 1/2" above the liner and centered with the wooden rod.

**Caution:** Do not place blasting cap in place until linear shaped charge is ready to use.

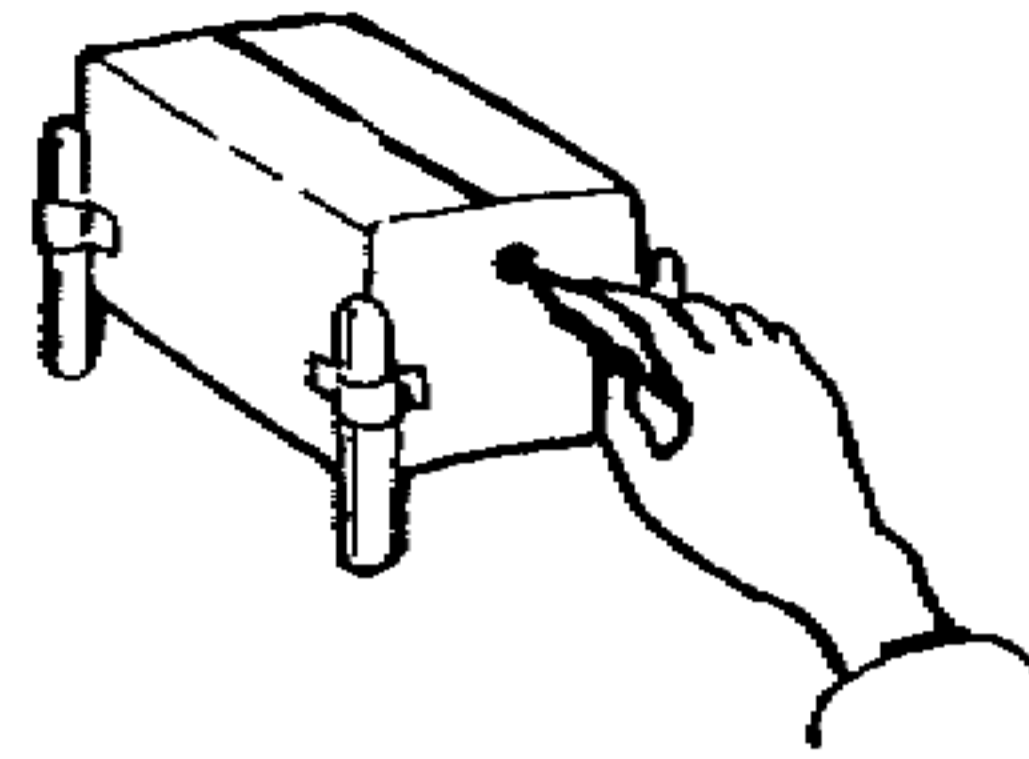

### How to Use

1. Place blasting cap into hole on the side of the container. If non electric cap is used, be sure cap is crimped around fuse and fuse is long enough to provide safe delay.
2. Place (tape if necessary) the linear shape charge on the target so that nothing is between the base of charge and target.
3. If electric blasting cap is used, connect blasting cap wires to firing circuit.

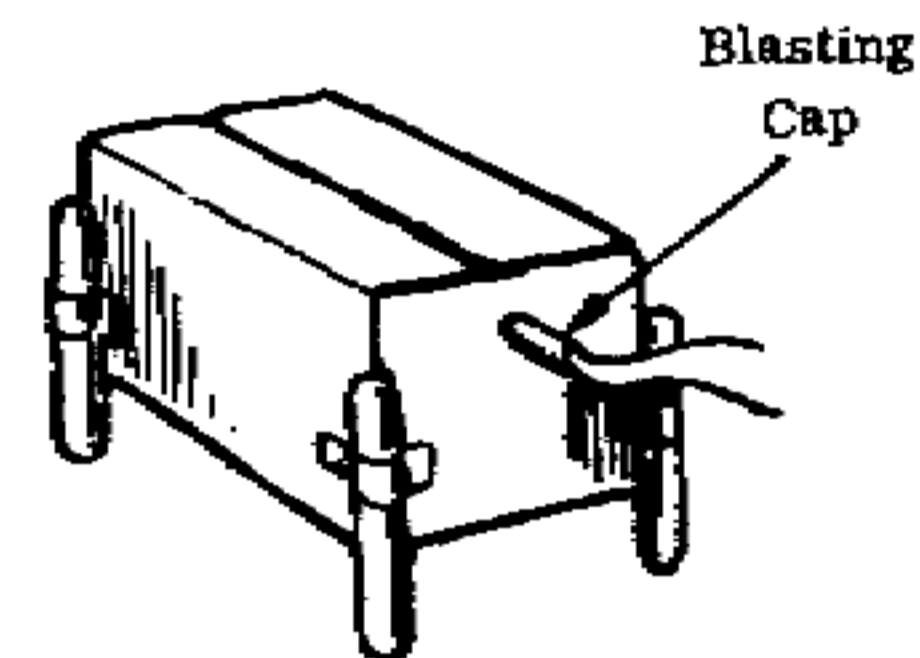

# Scientific Principles of Improvised Warfare and Home Defense

## Chapter 5 Mounted Weapons

Mounted Weapons are defined as those weapons too large and/or heavy to be carried or operated by hand. Usually, these are team weapons and are complex and unwieldy to be used as personal weapons. In most cases, these types of weapons cannot be easily improvised. They generally require large casting and metalworking industries and many complex technologies combined into many parts to assemble these larger weapons.

As you will see in chapter 12, not having these types of industries at your ready disposal does not mean you cannot piggyback on civilian industries to cobble together suitable substitutes. A little know how which we provide the basics of here can be applied to almost any defensive endeavor you may find yourself in.

Generally, mounted weapons are designed to fire (launch) large payloads and/or travel large distances, which is why they become too large for use as personal weapons. We will cover the ideas and concepts of these weapons from historical times to the present.

### Pre explosive (mechanical) Artillery

Before gunpowder became popular as a propellant, man developed three methods of storing and releasing energy to throw heavy objects. These early field artillery were usually used in long sieges of walled cities ( to knock down the walls).

#### 1. Spring Engine:

A simple leaf spring set up in a vertical plane to throw objects.

This drawing of Leonardo da Vinci is an early example.

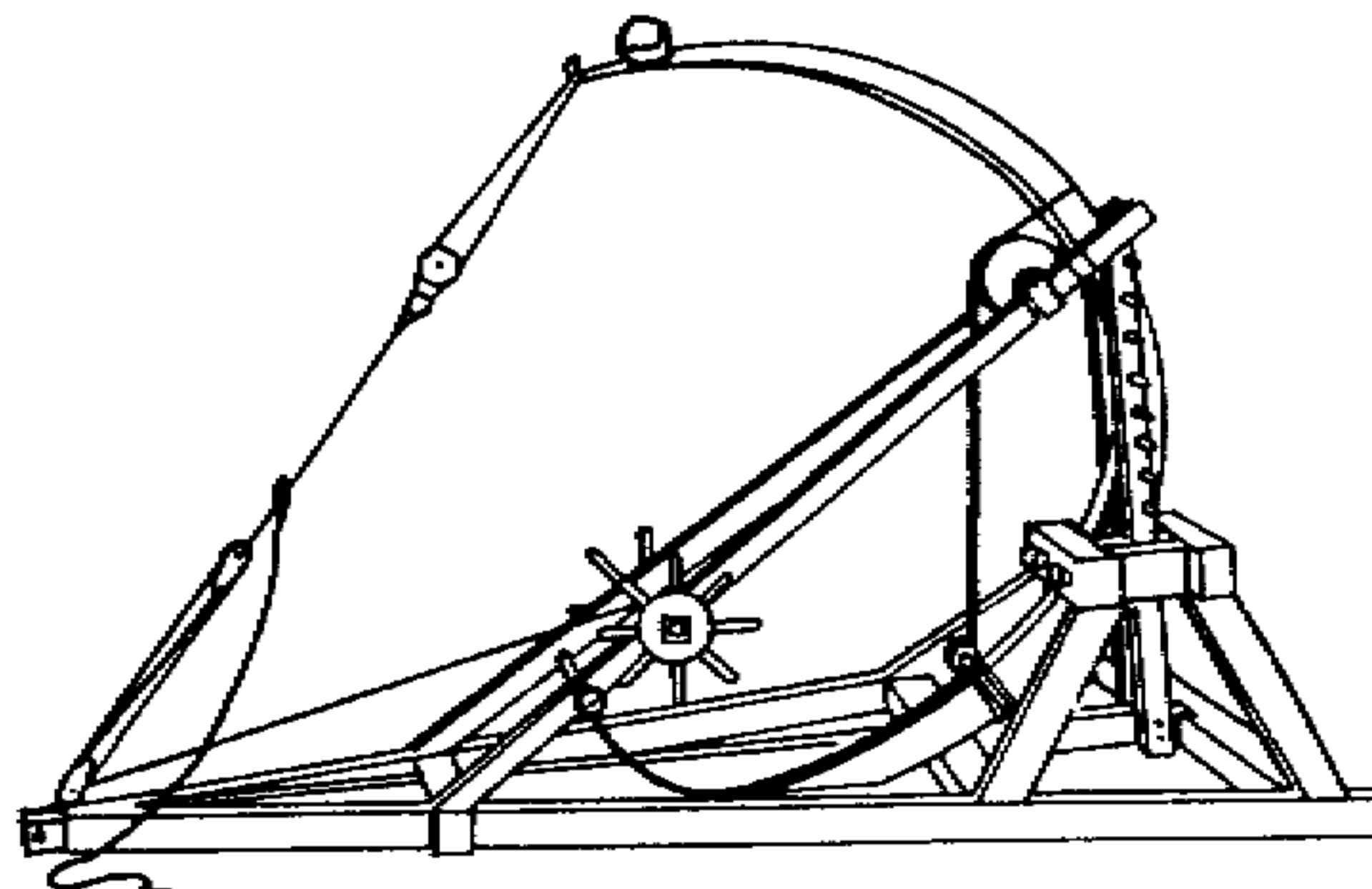

# Scientific Principles of Improvised Warfare and Home Defense

## 2. Torsion Powered Engine:

The using of the elastic properties of a twisted "skein" to propel a missile. Projectiles weighing up to 60# could be thrown 450 yards at high velocity and good accuracy.

- A skein is formed by
- (a) winding long strands of hair or cord around two axles
  - (b) and the base of the arm
  - (c) which is placed in the center.

The ends of the skein are then twisted by a series of ratchets and winches to store the mechanical energy until released by a latch. This catapult design from ancient Rome is one of the most efficient in history.

The Ballista was used to throw stones and javelins on a low trajectory with great accuracy but was complicated to build.

## 3. Counterweight powered engines:

A simple system using a massive counterweight attached to a throwing arm. This system could throw a 300# missile app. 300 yards. The counterweight could be as heavy as 10 tons of stones and dirt in a box. A system of pulleys and ropes are used to pull the arm down. A sling holds the stone in a pouch until the stayrope is pulled tight during launch which kinks the sling releasing the stone.

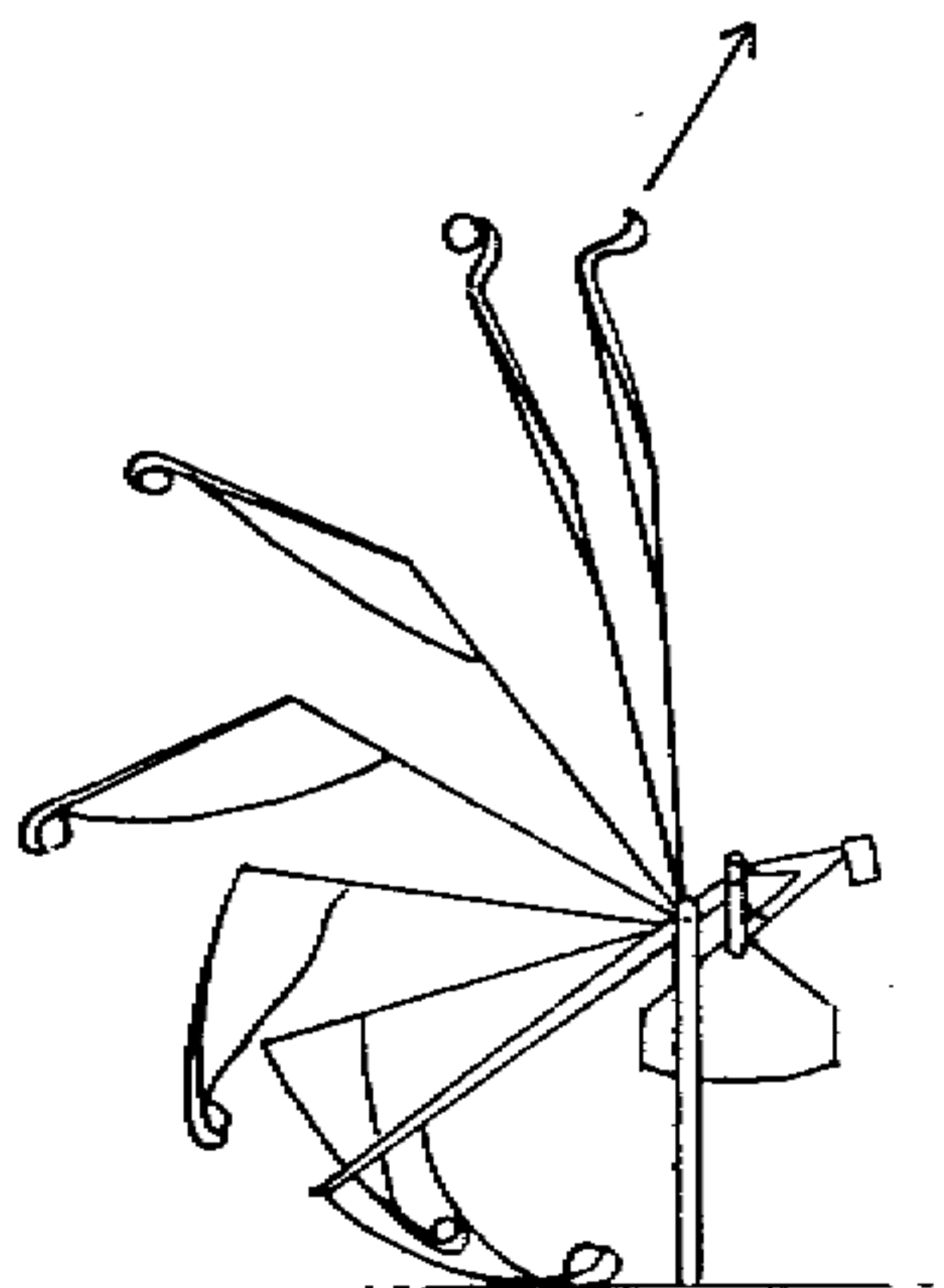
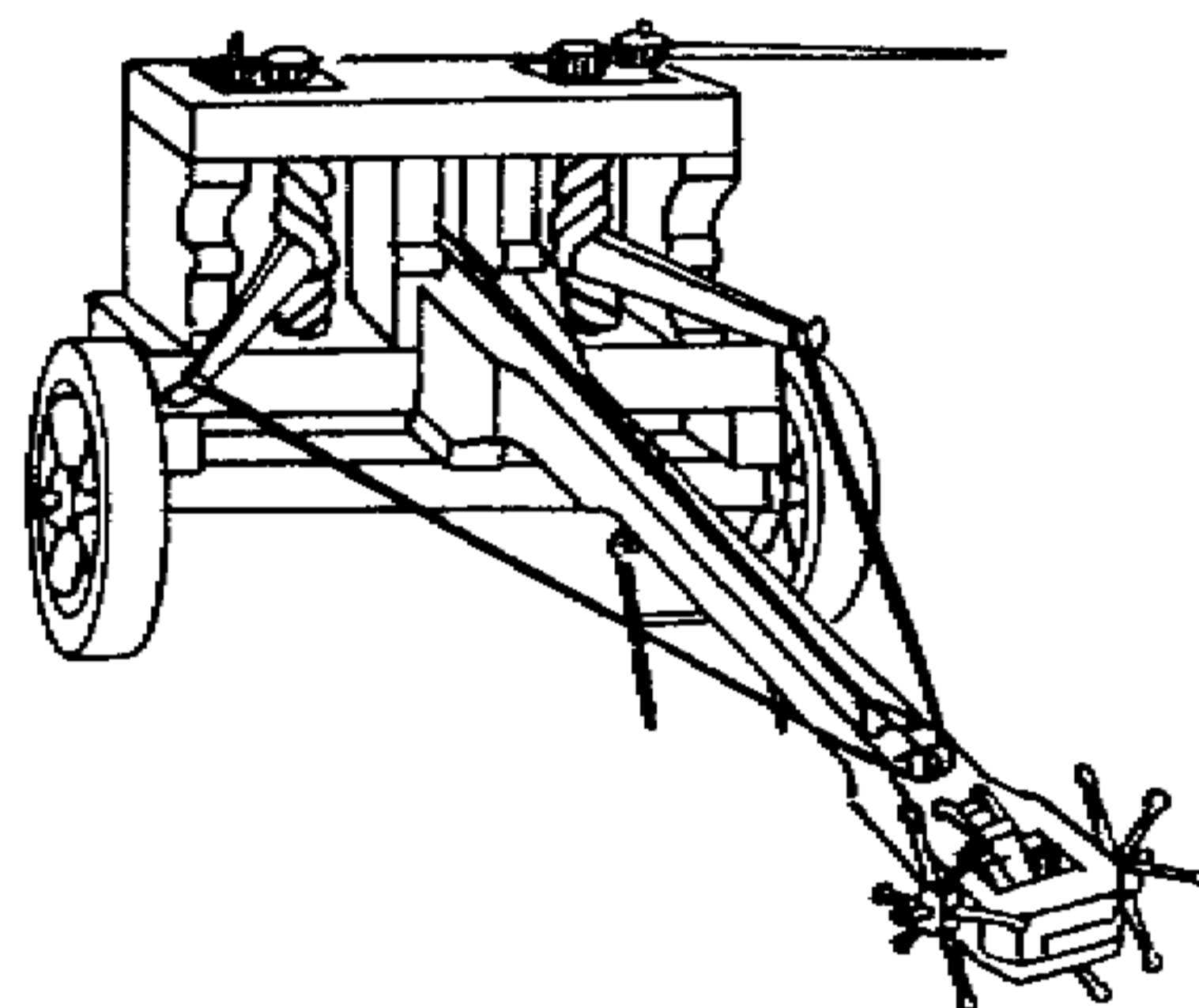
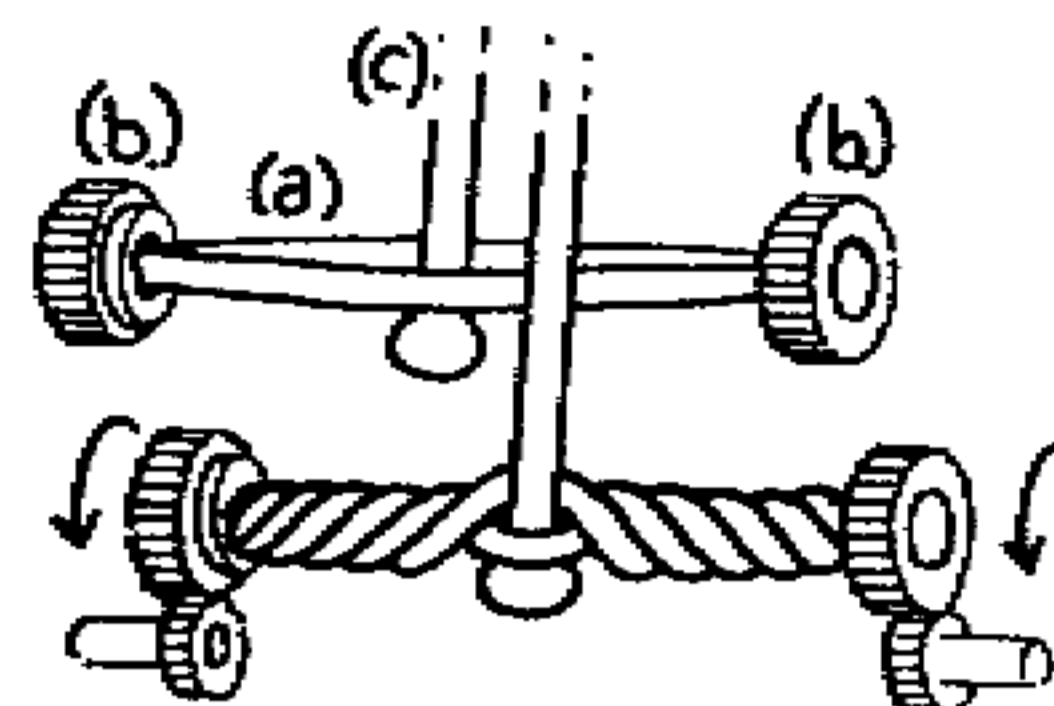



# Scientific Principles of Improvised Warfare and Home Defense

**Battering Rams:** Historically were carried by a large number of men and required both lifting and carrying motions. Improvements include

- a. A serrated metal tip on a suspended ram allowed all the energy of the "push" to be focused on a narrow point.
- b. A rope and pulley system was used to pull the ram back. The entire system is mounted on rollers and covered by a fireproof and sloped enclosure made of seaweed and oxhide. Modern versions of these systems can be improvised with modern block and tackle, pulleys, chains, and other hardware mounted on the back of trucks. Any type of ordnance may be used with these systems.

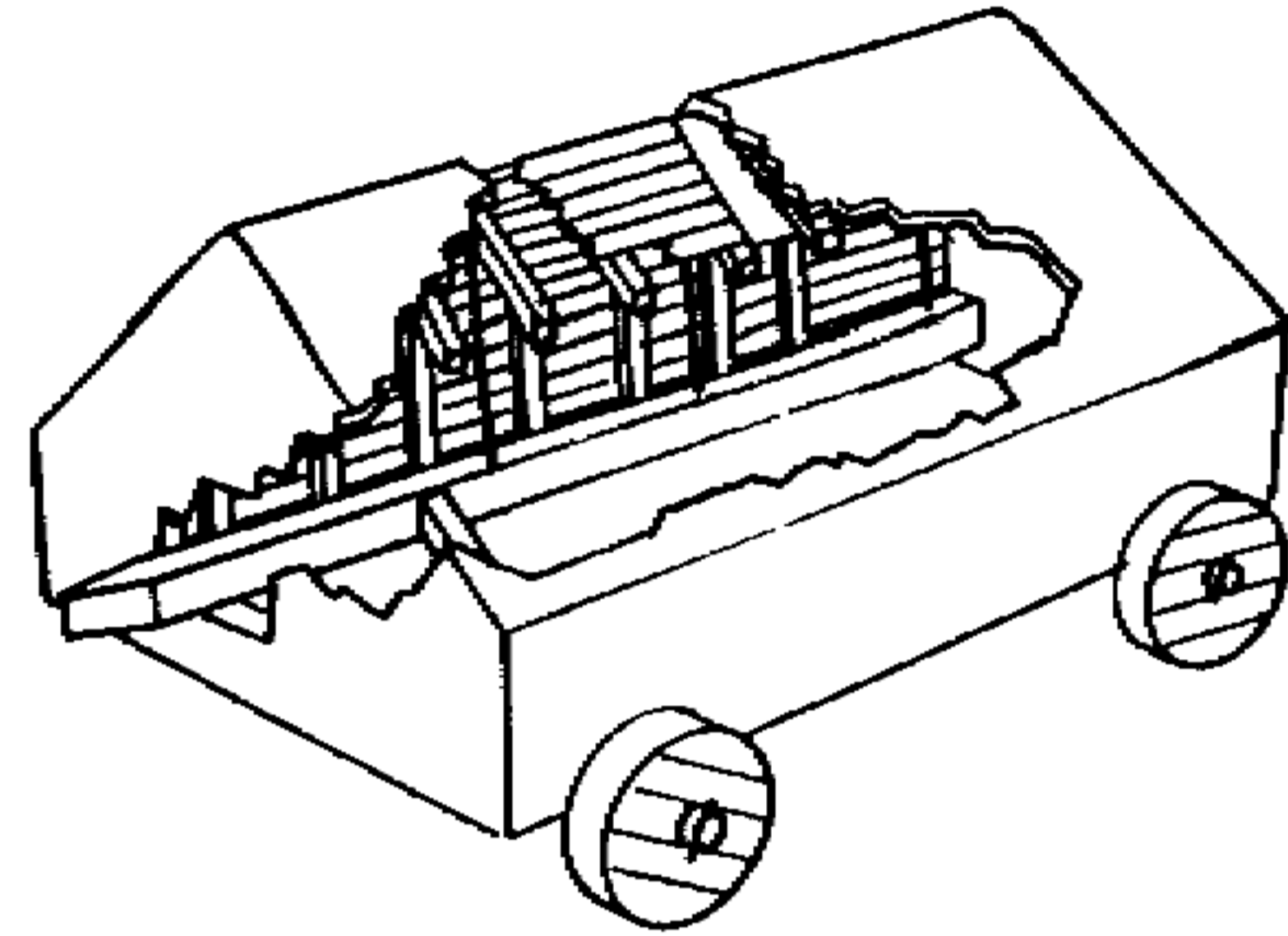

## Explosion Powered Artillery

Gunpowder was known in China in the 11th Century but was not used as an artillery propellant until the 1300's in Europe. Handguns, cannon, and muskets evolved fairly quickly after this time. Field Artillery has been used in almost every major ground combat since that time and has had considerable effect on the outcome of most battles. Artillery disheartens and destroys the enemy in large numbers, and its development has centered around maximizing rate of fire, range, and lethality of its ordnance to improve on these effects. Problems of smoke, flash, fouling (soot), recoil, noise, and overheating would evolve with those efforts.

Artillery designs have centered around 3 means of explosive propulsion.

- 1. The gun design of loading a projectile in front of the propellant in a closed tube
- 2. The spigot design where the projectile fits over the barrel as an oversize tube.
- 3. Recoilless gun in which the barrel is open at the rear and the explosive gases are vented out the back causing the gun to remain motionless during firing.

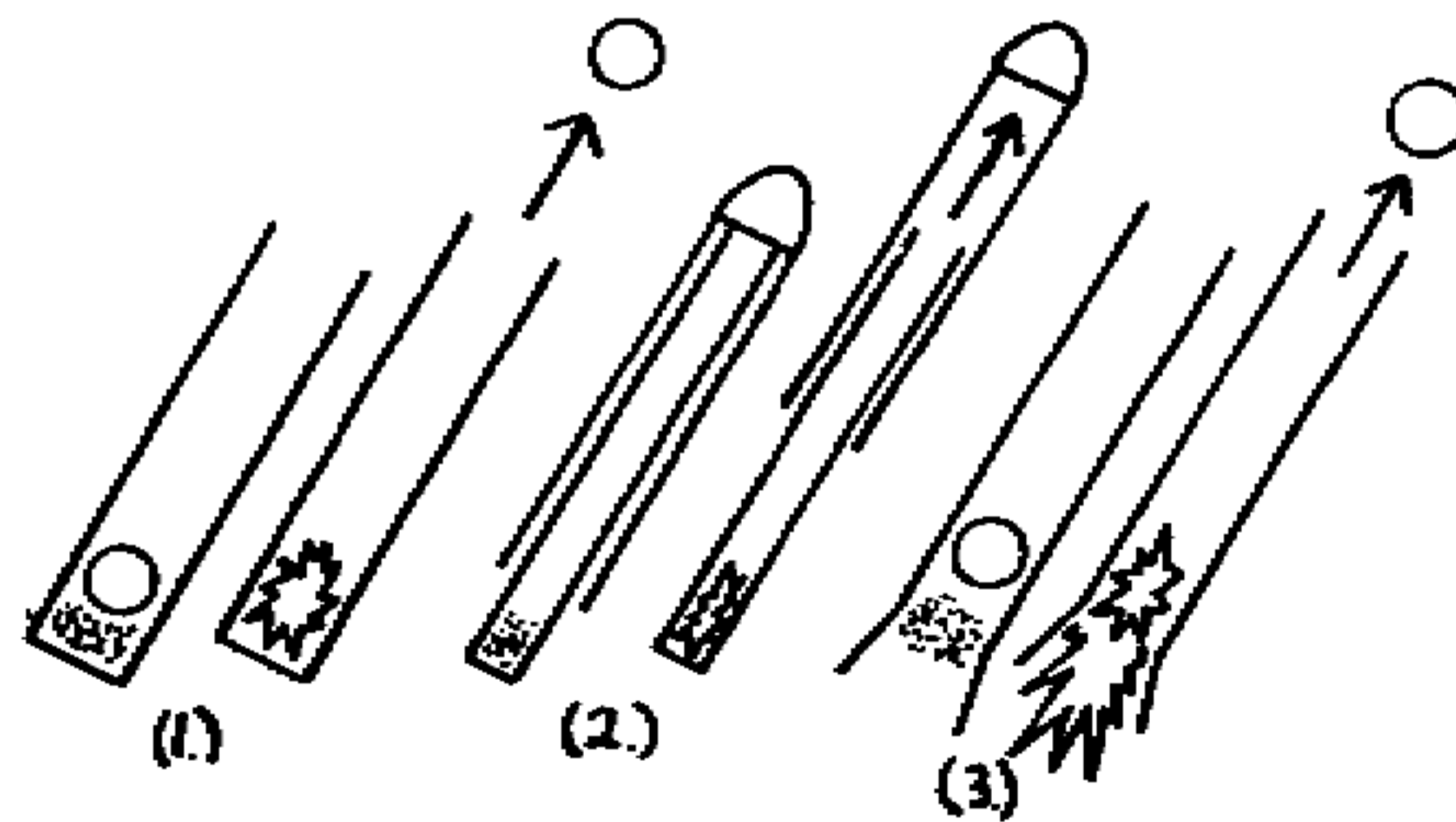



## Scientific Principles of Improvised Warfare and Home Defense

Artillery guns may be muzzle or breech loaded, and the barrels may be smoothbore or rifled. Their sheer size often permits the firing of shells from 1 to 50 miles away which usually demoralize even if they do not wound or kill.

Combustion powered artillery can also be classified by its trajectory

- a. The mortar which lobbs a shell in a parabola (high trajectory)
- b. The field gun which uses a direct, fast trajectory
- c. The howitzer which fires a larger shell with less powder from a lighter barrel at medium angles of trajectory.

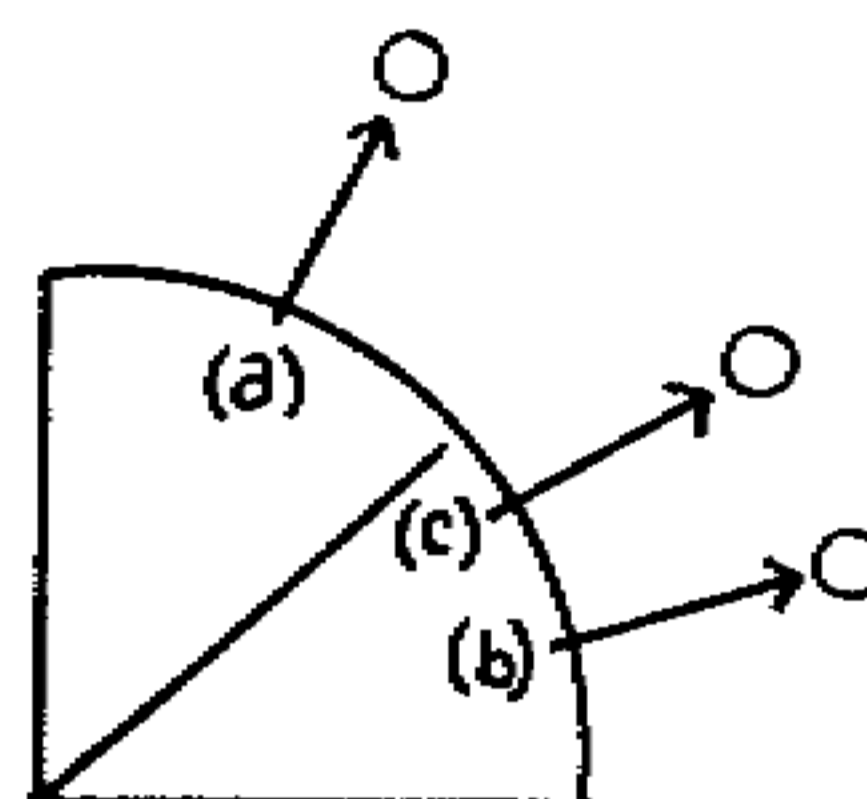

Early artillery barrels were cast from bronze, iron, or brass. Later, these barrels were reinforced with steel linings and eventually cast in a variety of steel alloys. They were designed as field, siege, naval, and fortress guns. Later, the roles of anti-tank, tank, and anti-aircraft were added.

Artillery propellants consisted of a mixture of 1 part sulfur, 6 parts niter, and 2 parts charcoal from 1242 to the year 1846 when Alfred Nobel of Sweden invented Nitrocellulose.

Black powder gave off dense clouds of white smoke which often choked the firers, obscured their vision, and revealed their position to the enemy. The new propellants were nearly "smokeless" as the nickname implies and their rate of burning could be controlled by design so that the shell receives a smoothly accelerated push up the barrel. Eventually, black powder would also be released as a shell filling. High explosives such as dynamite were too shock sensitive to be fired without detonating. This was overcome by formulation changes which first incorporated "Lyddite" (picric acid).

Early barrels were made from strips of wrought iron run lengthwise. They were bound together with hoops around the strips to hold everything in place during the radial stresses caused by the exploding propellant. Cast bronze, iron, and brass were produced in progressively larger sizes and by 1860 thick coiled or shrunken collars were being added to reinforce the breech of the larger bore sizes firing the new higher explosives.

The modern equivalent of improvising small diameter (8" or less) barrels would be taking iron pipe of the required diameter and length and attaching bearing collars to the entire length as reinforcing material.

## Scientific Principles of Improvised Warfare and Home Defense

Early projectile designs consisted of

1. Solid shot: consisting of round stones or cast iron roundshot. This was ideal for destroying walls and ranks of enemy soldiers, and destroying enemy hulls, cannon and sailing masts at sea.
2. Chain shot: Two roundshot with a chain attached to both. Upon firing, they would tumble and spread in flight increasing the chance of destroying enemy rigging at sea.
3. Grapeshot: Multiple lead or iron balls sealed in a canister or case which shattered by the shock of firing and spread out to cover a large area.
4. Explosive shell: which started as a hollow iron sphere filled with gunpowder and fitted with a fuse to detonate after firing. It was usually used to destroy buildings or, when filled with small shot as shrapnel, would be fired over the heads of enemy troop formations and were fused to detonate over their heads.

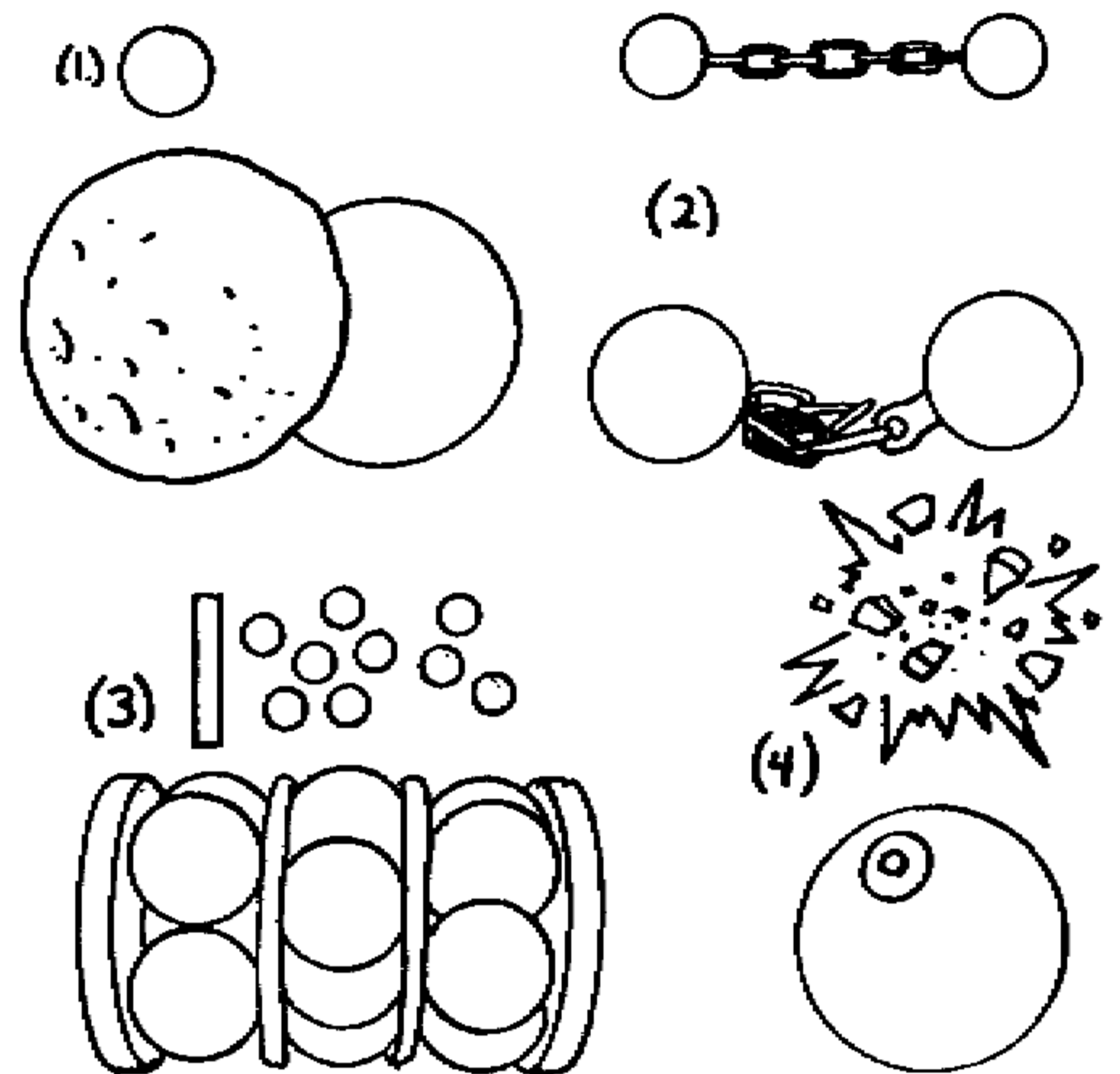

A strict gun drill is practiced in all armies to ensure that reloading is done properly in the heat of battle. Early muzzle loading practices included

- a. Sponging out the bore to dampen any sparks left over from the previous firing and soften the soot. Leftovers are snagged and withdrawn from the barrel.
- b. Powder and shot are rammed into the barrel while one man covers the touch hole with his thumb for safety.
- c. The gun is aimed and primed.
- d. The gun is fired, adjustments for aiming are made and the process repeated.

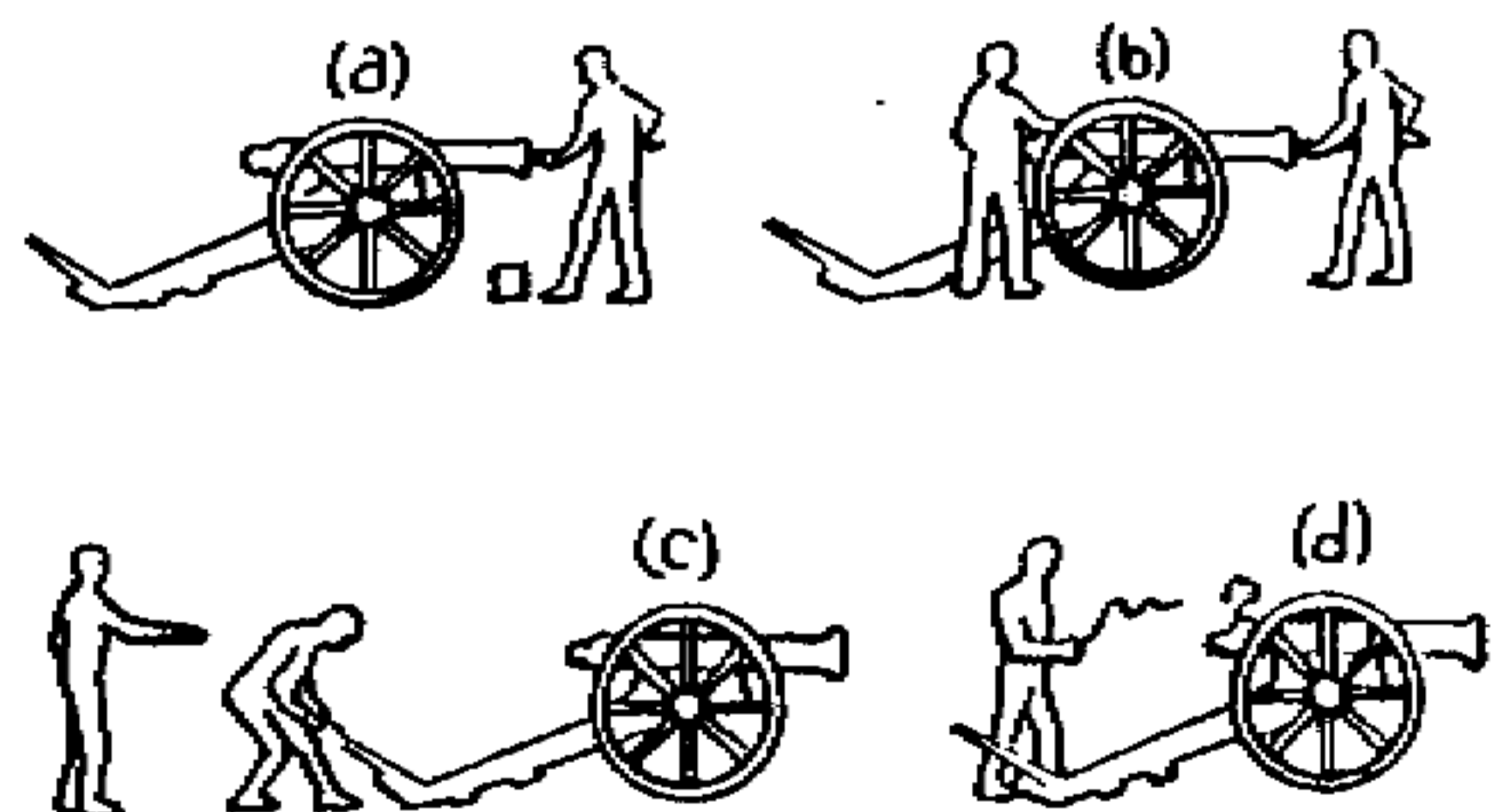

## Scientific Principles of Improvised Warfare and Home Defense

A comparison of US models of Gun and Howitzer (1841) same caliber 4.62" (12 pounder)

	<u>Gun</u>	<u>Howitzer</u>
Barrel Length	78 in.	53 in.
Barrel weight	1757#	788#
Carriage weight	1175#	900#
Propellant	2.5#	1#
Shell weight	12.3#	8.9#
Range at 5 degrees elevation	1663 Yards	1072 Yards

The howitzers smaller charge produces less "shock" to the shell which allows smaller shell walls and more powder. This allows for ammunition weight savings for greater detonation effect with only a 30% reduction in range.

By the time of the civil war, new changes began to change the way wars were fought. Artillery began to be mounted on railroad tracks which allowed giant weapons to be easily transported and could absorb the recoils of the heavy guns. Ironclads, made of steel hulls would cause most enemy shells to bounce off and the turret revolutionized warfare allowing the guns to be rotated to aim them rather than turning the ship to present the target. Eventually, this concept would be adapted to land warfare in the form of turreted tanks and artillery.

The shell was usually attached to the propellant by this time to speed reloading. The propellant would be enclosed in a cloth bag behind the shell. After loading, a sharp needle device would pierce the bag and a friction primer was inserted through a tiny hole in the barrel. When a cord was pulled on the friction primer, a matchlike composition was ignited sending a flash into the main powder charge.

Advanced shells were developed which had wooden bases to seal the bore and kept the fuse facing forward in the barrel. The fuses were lit by the flash of the firing.

The common shell (a) exploded after impact and utilized thick walls for shrapnel with the bursting charge inside.

The diagram shrapnel shell (b) was filled with tiny balls separated from the bursting powder by a thin wall. It was designed to burst in the air and shower enemy troops with fragments from above.

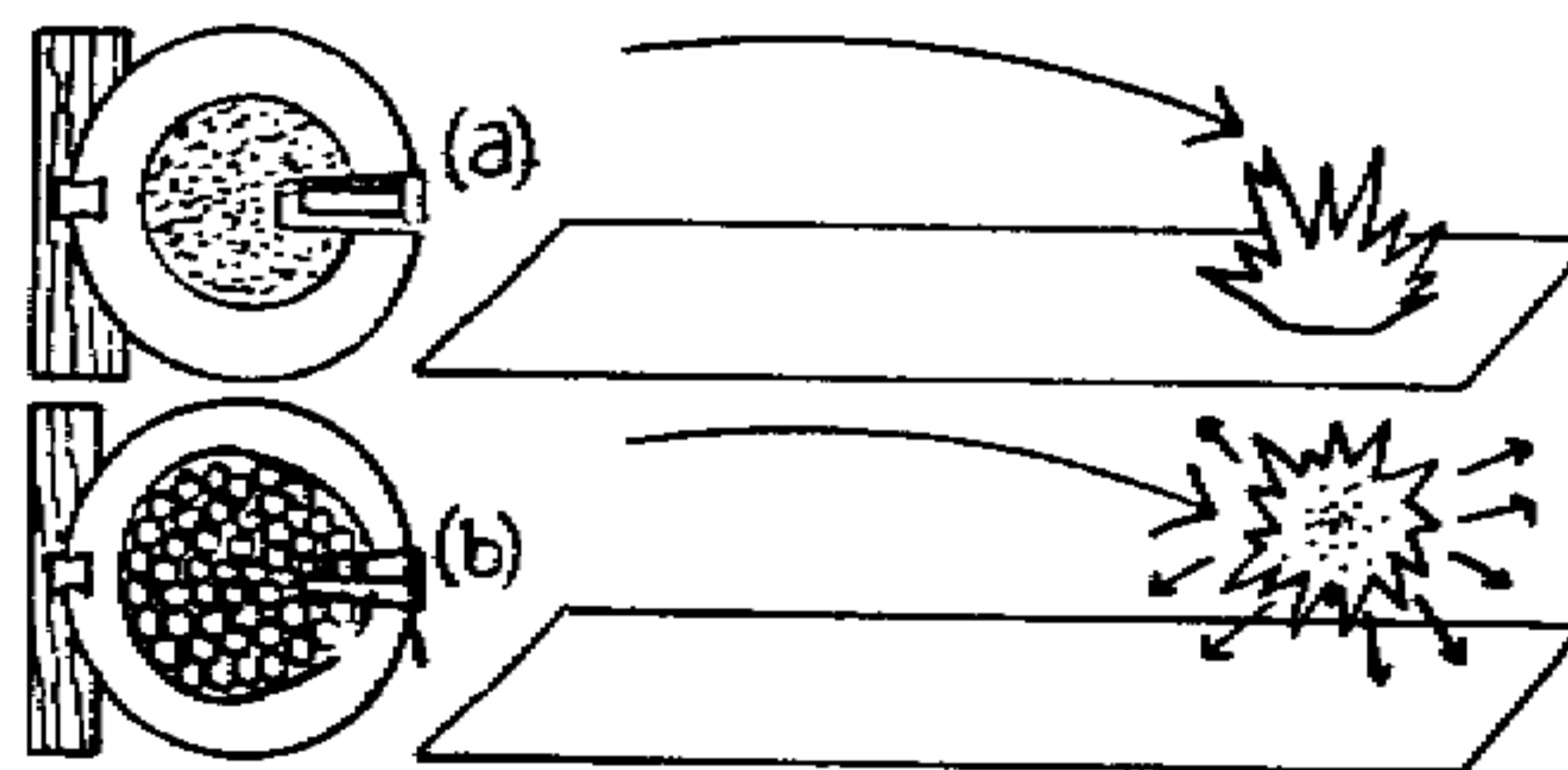



## Scientific Principles of Improvised Warfare and Home Defense

Smoothbore barrels had to use round balls

(a) because projectiles were unstable in flight and would tumble.



Rifled barrels (b) would impart a gyroscopic spin on the shell so it would fly point first. This allowed the use of longer shells with more payload.

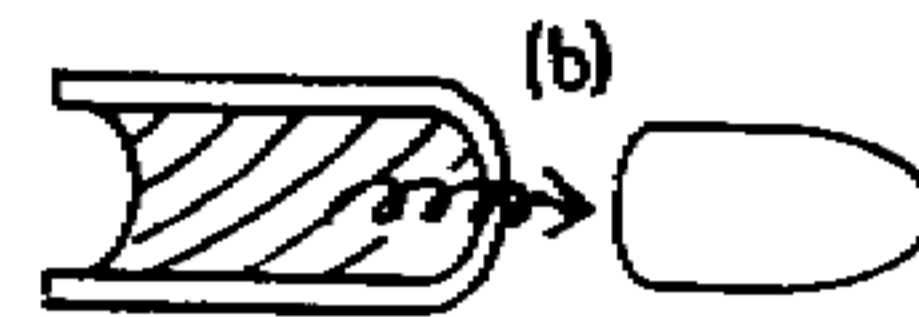

Barrels were reinforced by surrounding the casting with reinforced outer sleeves which applied compression on the barrel and countered the radial stresses of firing. This added great strength that cast metals lacked by themselves. This reinforcing became important in preventing cannon from bursting during use.

Shell design for rifled barrels included

a. Parrot shells which had a soft metal base which was expanded by the force of the firing into the grooves.

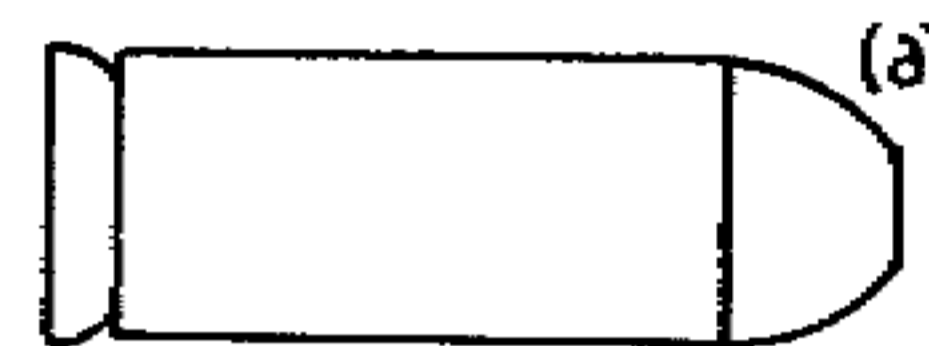

b. Studded shells had small projections to fit the bore which gripped the rifling during firing.

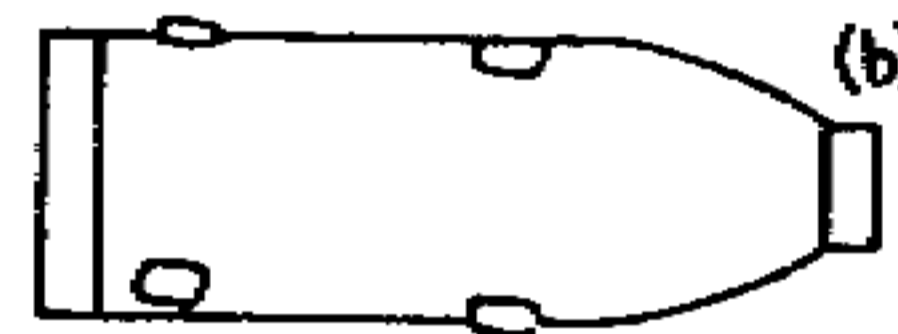

c. Percussion fuses were installed in the nose of the shell which would reliably detonate on nose first impact.

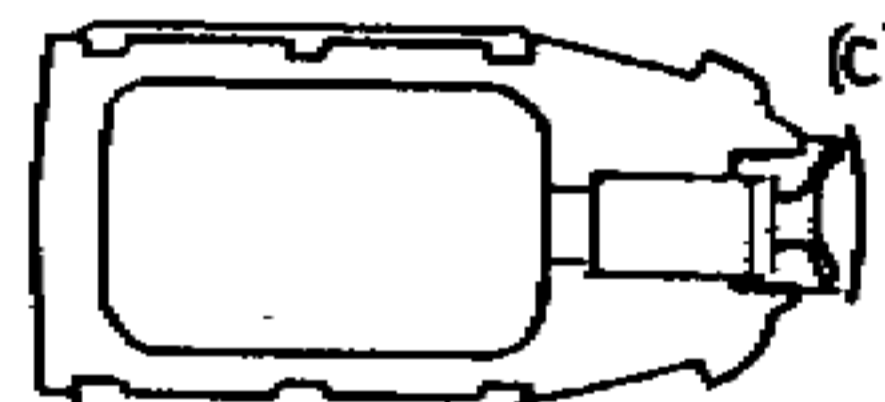

d. Solid shot could concentrate the entire mass of the shell onto a single point allowing the piercing of larger thicknesses of enemy armor and masonry.

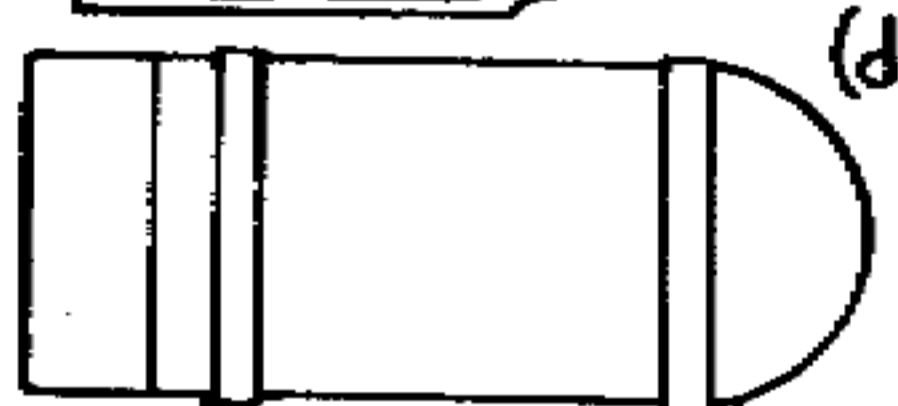

The only smoothbore Artillery in use today are the modern mortars. It provides infantry with its own means of launching indirect fire into enemy positions. The mortars are loaded by sliding a bomb down the muzzle.

The main mortar elements include the barrel, a tripod for aiming, and a base to prevent the recoil from pushing the tube into the ground.



## Scientific Principles of Improvised Warfare and Home Defense

The parts of a **fin stabilized bomb** include

- a. The fuse, to detonate the bomb at the required moment.
- b. The body which contains the payload.
- c. The primary propellant in the stem of the fins.
- d. Booster charges for longer range firing. These can be removed for shorter ranges.
- e. Fins so the bomb flies point first.
- f. Percussion cap to ignite the propellant.

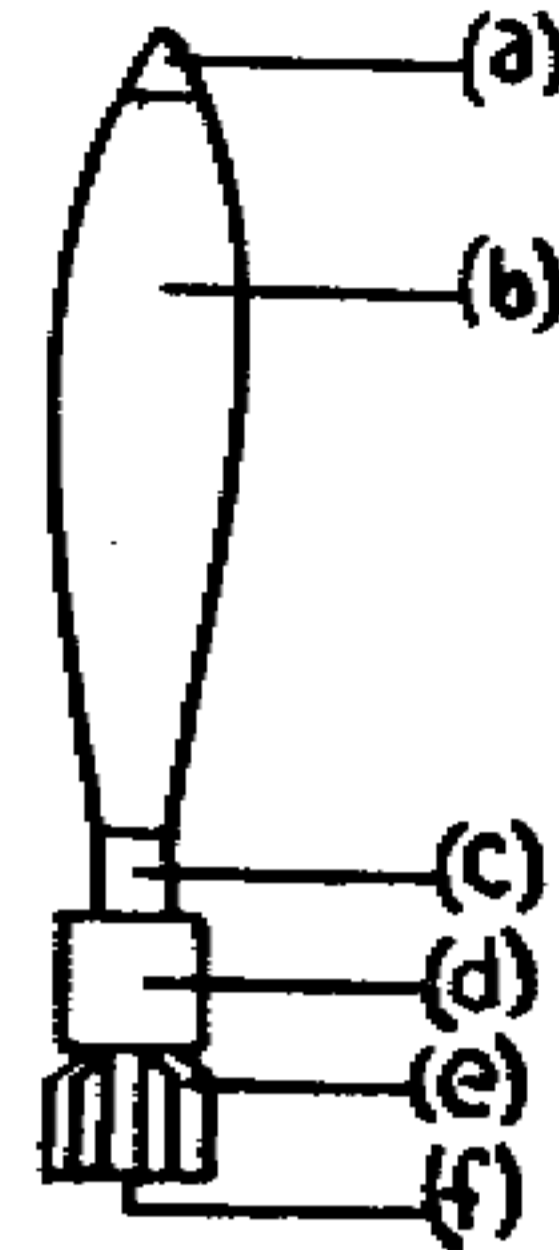

Mortar bombs use 3 main designs.

### 1. **High Explosive** with 3 different fusing methods

- a. Instant on impact
- b. Delay, for penetrating the target before exploding
- c. Air burst

2. **Smoke** which uses white phosphorus to make a thick cloud of white smoke over several minutes. This prevents enemy observation and may also be used for incendiary purposes.

3. **Illumination** which lights a bright flare high over the enemy and slowly descends on a parachute.

Mortars have been designed as disposable tubes with preloaded bombs or grenades, and are used to launch a variety of ordnance size.

Portable mortars are carried and operated by single individuals, and can be fired while lying on the ground. Medium mortars are carried in broken down sections by teams of men. These and the heavier types can be mounted on vehicles and fired out a top hatch which allows the carrying and firing of much larger ammunition loads and affords crew protection. Warsaw pact countries also mount heavy mortars on wheeled carriages.



## Scientific Principles of Improvised Warfare and Home Defense

Artillery fire requires the application of several targeting principles to be effective.

- a. Artillery can be fired directly at targets " over open sights " but it is more common to use
- b. Indirect fire which use a forward observer to direct fire on the target.

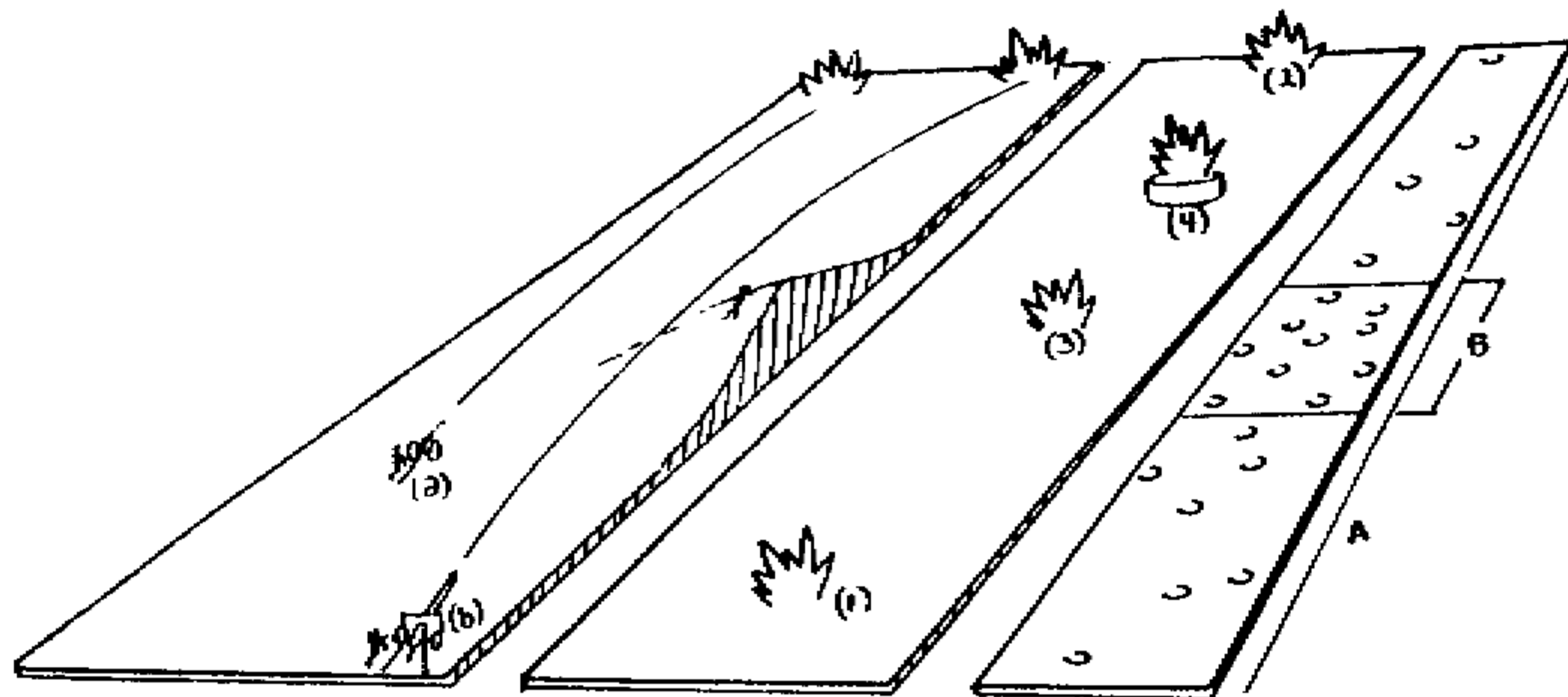

The observer provides the simple lateral corrections but judging distance without surveying equipment or modern lasers is difficult. A bracketing system was developed where (1) a shell falls short so a large overcorrection is made (2) and halving corrections are made (3,4) until the shells are on target.

Weather conditions such as wind speed, air pressure, spin stabilization drift, and for long range artillery, even the earth's rotation will affect the ability to land on target.

[Authors Note: Forward observing can be accomplished by aircraft or drones. In improvised conditions a video camera system can be mounted on commercial piggyback crane and lift tower systems on the back of a truck. These would raise the camera and other observation and recording systems to heights of 100 to 500' and would allow portable long distance observation of enemy movements and the ability to look over hills and other obstructions. It could be operated like a submarine periscope as needed and would be very effective at night when combined with infra red and low light systems. It could be made from low radar signature materials which reflect little light during daytime for modern army use.]

Artillery guns are only the delivery system. It is the projectile that actually causes the damage and modern ordnance design is important to insure effectiveness.

# Scientific Principles of Improvised Warfare and Home Defense

Breech loading artillery shells have several common features including

- a. an elongated shape with
- b. a driving band of soft copper to grip the barrel rifling
- c or d. A fuse is attached to the nose or base to ignite the payload.

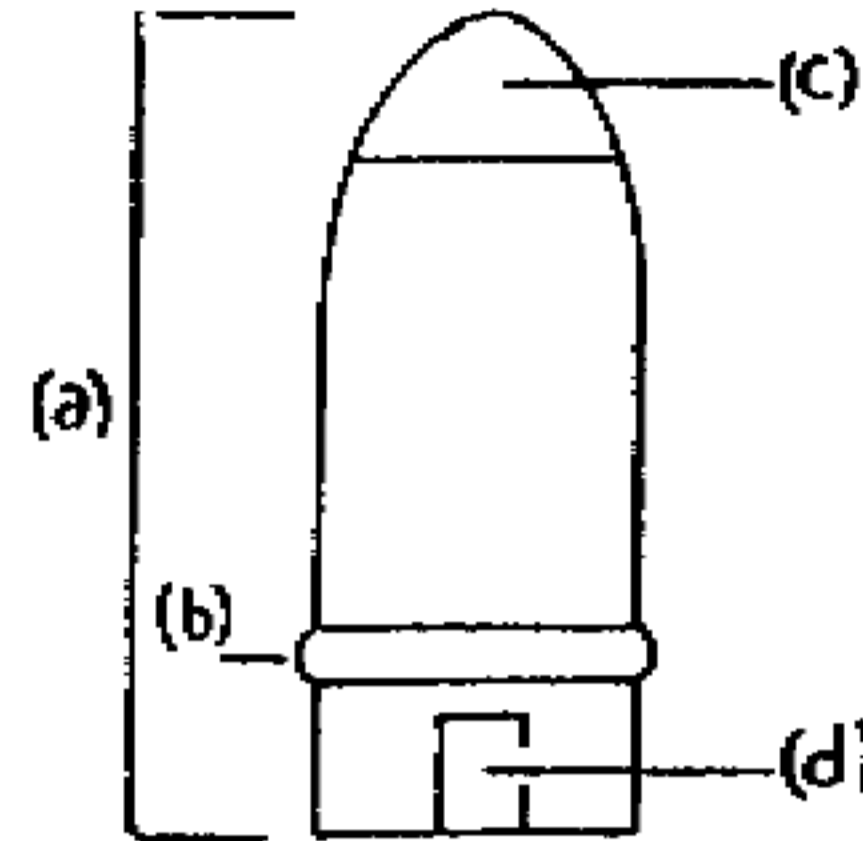

The weight of the shell determines how destructive it is. Rifling allows long, heavy shells to be fired.

A 100% increase in caliber (a) (barrel diameter)

results in a proportionate increase in (b) length

which produces a 700% increase in weight.

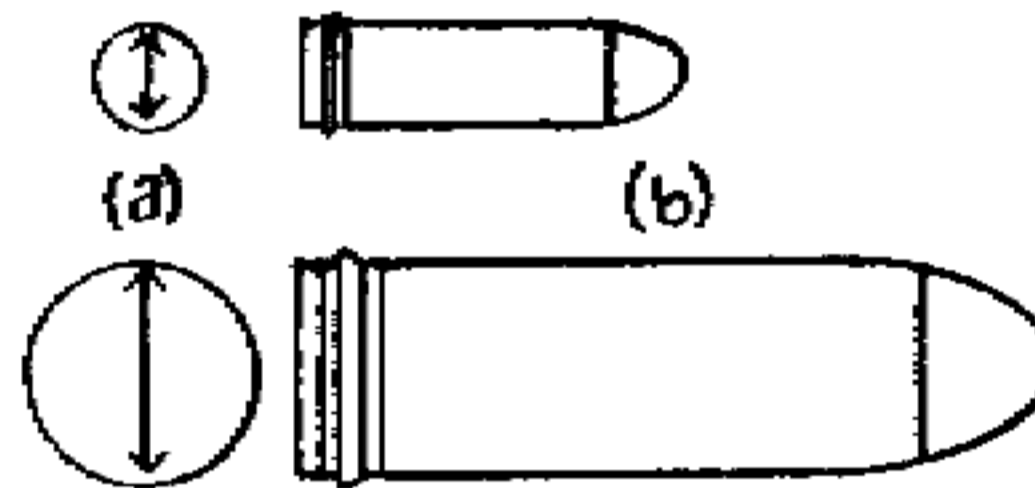

Artillery ammunition loads come in 3 main types

a. Fixed: loaded as a cartridge which contains both the shell and the primer.

b. Semi fixed: Shell is loaded first and the primer and main charge are loaded as a metal case afterwards.

c. Separate loading: where a separate spot in the breech allows the shell and the charge to be loaded simultaneously and the charge can be adjusted for trajectory and range.

The projectiles have different fusing and shell filling for the different jobs they are required to do.

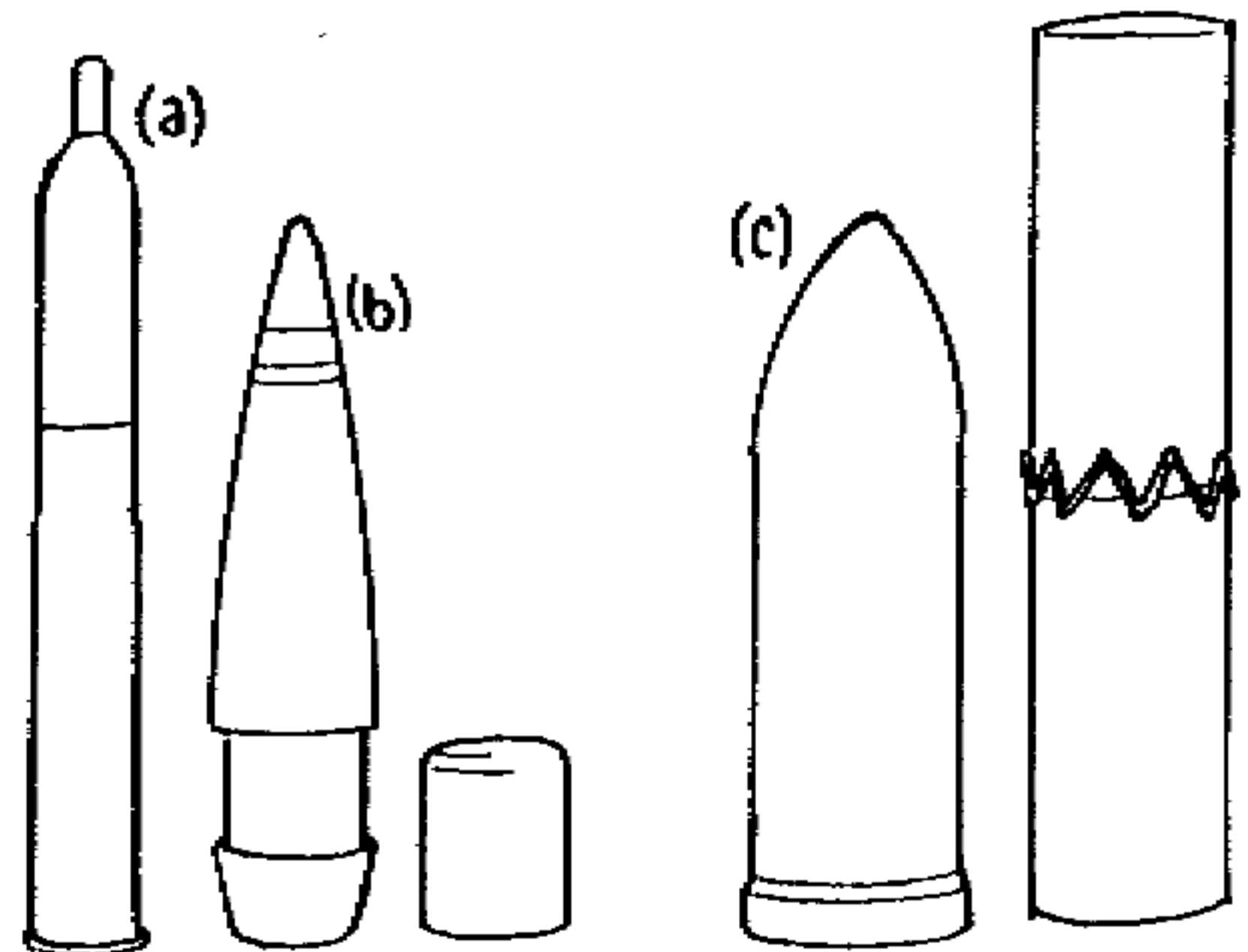

# Scientific Principles of Improvised Warfare and Home Defense

**Time fuses:** are ignited by combustion or clockwork

**Proximity fuses:** transmit and receive radar and detonate when close enough to the target to damage it.

**Impact fuses:** detonate on impact or with a slight delay to allow shell penetration.

**Passive proximity fuses:** have been designed to detonate on changes in electromagnetic field caused by the nearing of large metal objects. These types of fuses cannot be jammed.

<u>Shell target design</u>	<u>Type of filler</u>	<u>Type of fuse</u>
Anti Personnel	Shrapnel	Time/Time and Impact
	Explosive/Fragmentation	Time/Proximity
	Poison Gas	Impact
	White phosphorus	Impact
Anti Structure	Explosive/Fragmentation	Delay or instant impact
Anti Armor	Solid Shot	None
	Armor piercing	Delay impact base
	HEAT	Impact
	HESH	Impact base
Anti aircraft	Explosive/Fragmentation	Time Proximity Impact
	Shrapnel	Time

## Shrapnel shell design

- a. bursting charge
- b. bullets
- c. flash tube from fuse
- d. fuse

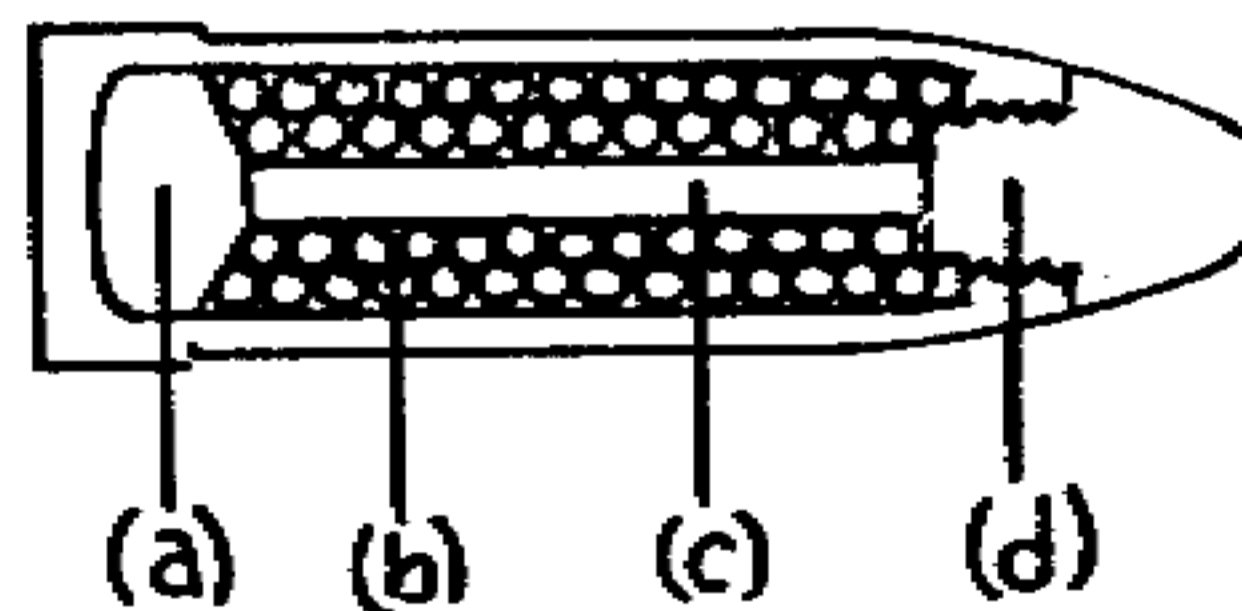

## Scientific Principles of Improvised Warfare and Home Defense

### High Explosive shell design

- a. high explosive filling
- b. fragmenting walls
- c. amplifying charge
- d. fuse

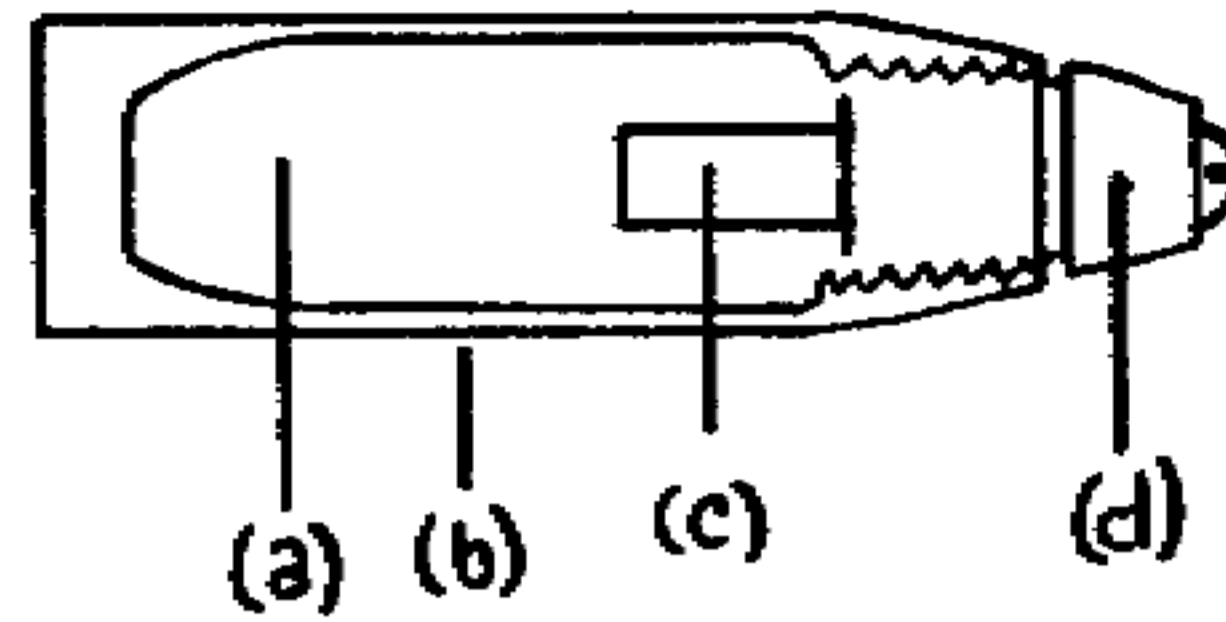

### Poison Gas or Phosphorus shell design

- a. chemical agent
- b. bursting charge
- c. fuse

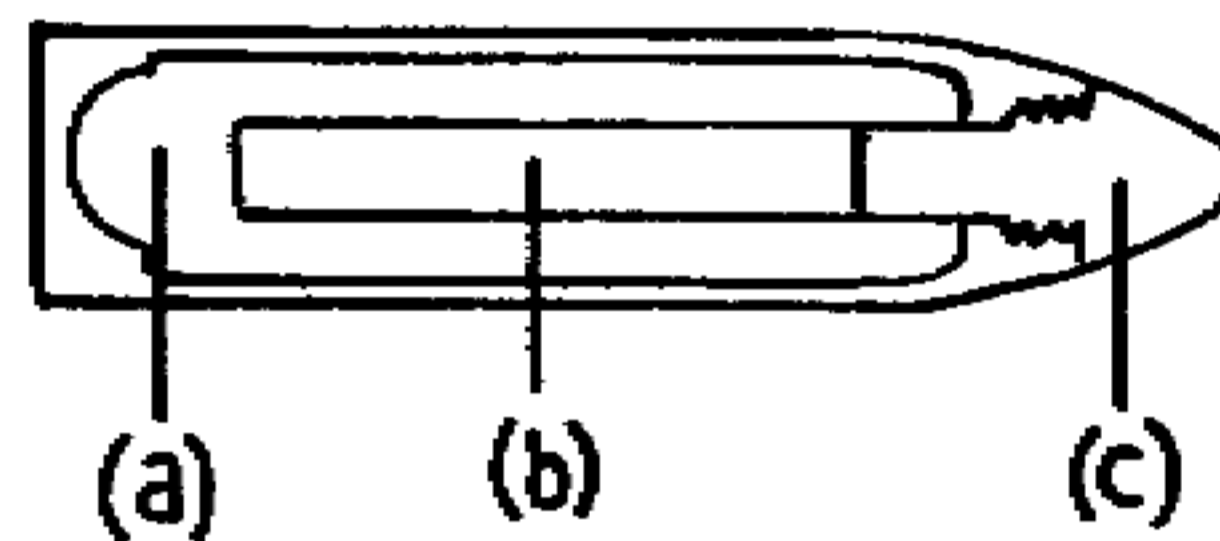

Field artillery have been transported in the field by

- 1. Towing by horses, mules or oxen
- 2. Horse artillery where the crew rode to keep up with cavalry
- 3. Towed behind vehicles
- 4. Self propelled or motorized and often armored

Artillery with high or automatic reload rates are smaller caliber or can be considered scaled up machine guns. When shells reach about 1/2" diameter, they are considered to be cannon shells.

These small artillery have special roles of

- 1. anti aircraft
- 2. armored vehicle support
- 3. anti torpedo boat
- 4. air to air or air to ground attack

Many of these designs use a multi barreled gatling gun design capable of firing 100 rounds per second ( the movie Terminator 2 illustrates the idea).

## Scientific Principles of Improvised Warfare and Home Defense

Cannon used for anti aircraft roles were mounted on pedestals which allow an all around traverse and used special projectiles.

1. **Shrapnel** with a time fuse sprayed in the path of a plane
2. **High explosive** with a time fuse to detonate at the planes altitude
3. **Proximity** fused HE which detonate on approach of target
4. **Impact** fused fired against low flying aircraft

Most guns have now been replaced by guided missile systems.

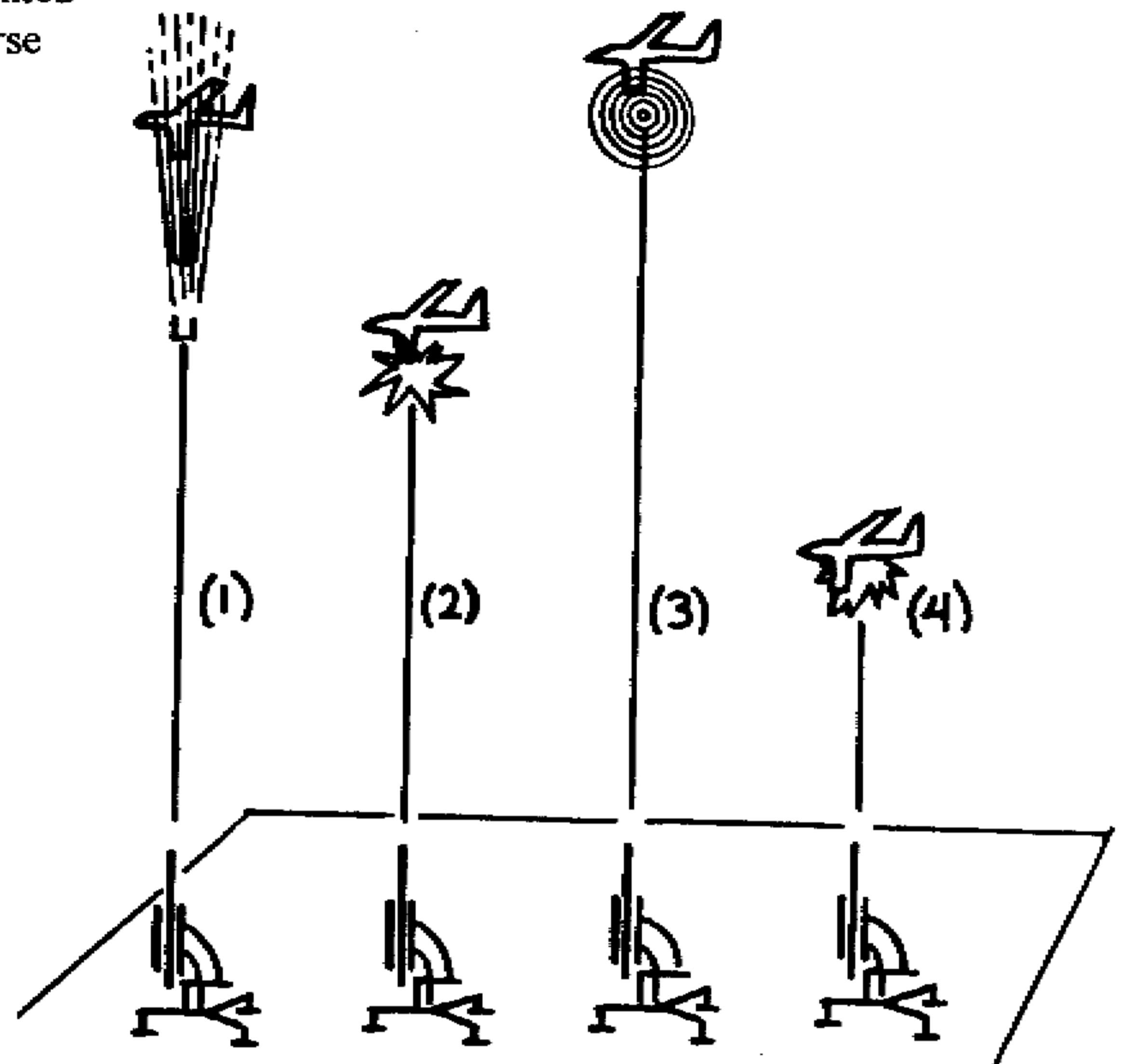

In WW1, artillery guns were mounted horizontally on armoured vehicles creating new war machines called armored cars and tanks and were used as direct fire weapons at the front lines in aggressive, fast moving operations.

The most common method of mounting a gun on an armoured vehicle was to copy the naval method of turreting the gun so it could be aimed independent of the orientation of the vehicle. Stabilization systems were added to maintain the guns aim in both planes while the tank body traveled over uneven ground. A machine gun was mounted adjacent to the main gun to provide tracer fire to target. When the target is struck, the main gun fires. The machine gun has been replaced by lasers in modern designs.

The Swedish S tank design allowed for a self loading breech mechanism which was impossible in a turret so the entire tank is designed to be turned and aimed in both planes

Most anti tank guns have historically been large high velocity rifles firing special ammunition and could be rapidly reloaded.



# Scientific Principles of Improvised Warfare and Home Defense

Anti armor ammunition designs include:

a. Armor Piercing solid shot with a soft metal cap to support the point during penetration.

b. Armor Piercing shell which contains a high explosive and a base fuse which explode after penetration.

c Composite Rigid shot which has a hard core surrounded by a soft hollow casing.

d and e. Armor piercing sabots with a tapered skirt squeezed during firing or discarded after firing.

f. HEAT which explodes a shaped charge a few inches from the target concentrating great force on a small spot and injecting blast and hot metal through this spot into the tank.

g. HESH-High Explosive Squash Head which spreads against armor on impact, and then detonates with the shock wave breaking and fragmenting tank lining into the tank interior.

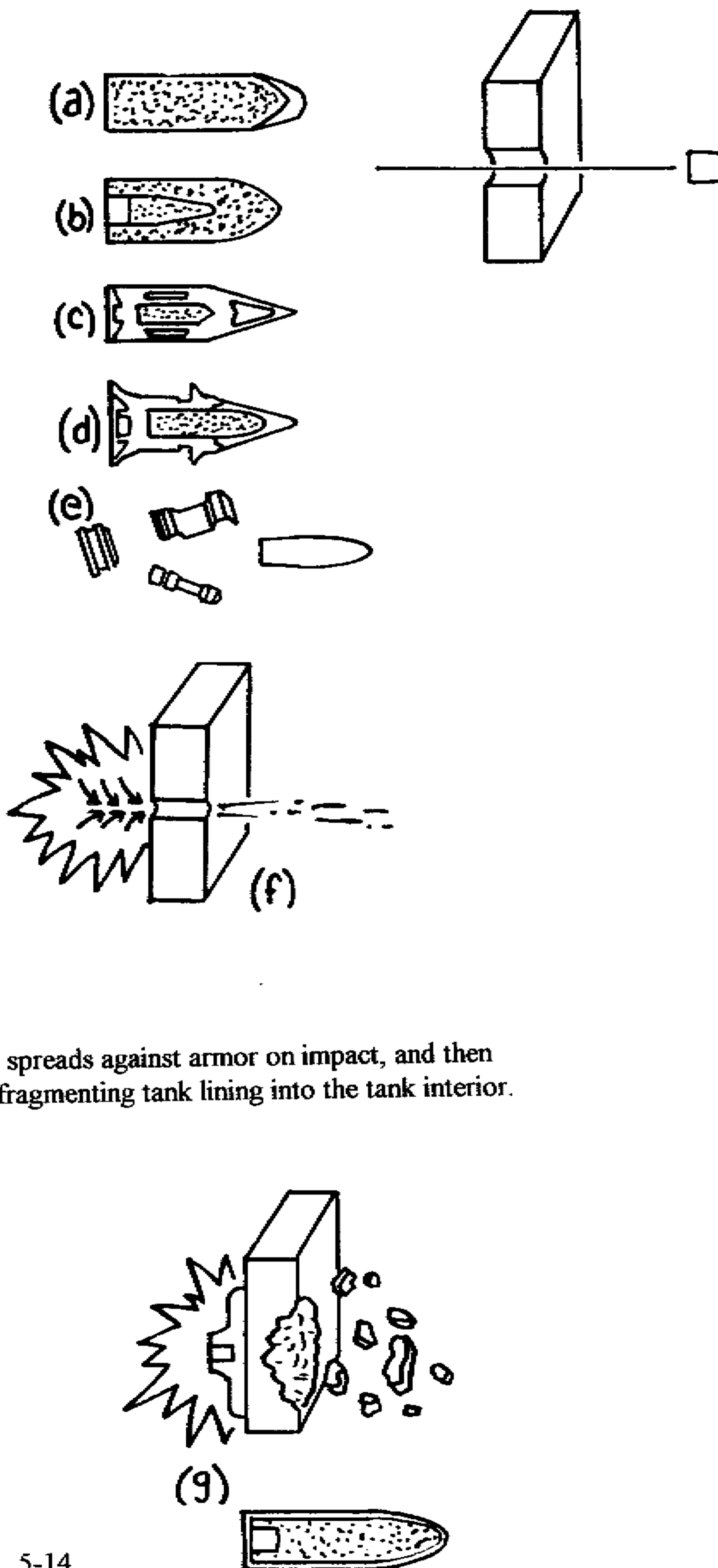

## Scientific Principles of Improvised Warfare and Home Defense

Mounted machine guns operate on the same principles as hand held machine guns with certain design advantages. Any machine gun will continue to fire itself as long as the trigger is pressed and ammunition is fed continuously and does not physically break down. Mounted systems provide for the continuous feeding of ammunition, suppressing noise and flash, and cooling the barrel.

Feed systems include

- a. Gravity feed hopper
- b. Box or drum magazines under spring pressure
- c. Strip clip of ammunition
- d. Continuous belt, usually made of canvas
- e. Metal link belt

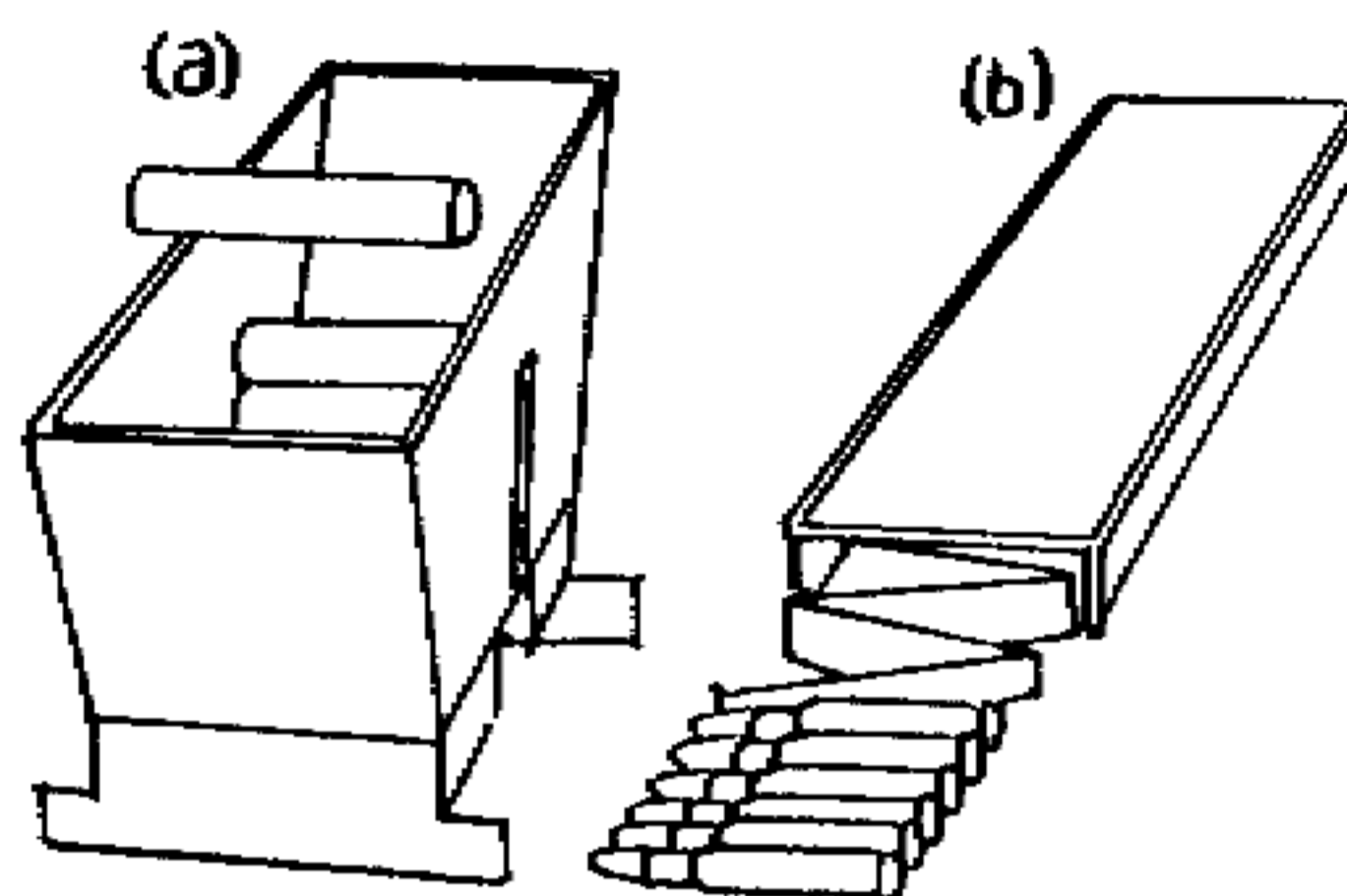

Cooling methods

1. Water cooled jackets around the barrel disperse the heat. As the water boils, the steam is condensed in an overflow can and reused.
2. Air cooled by radiating fins or extra large heat absorbing barrels or by quick change barrels.

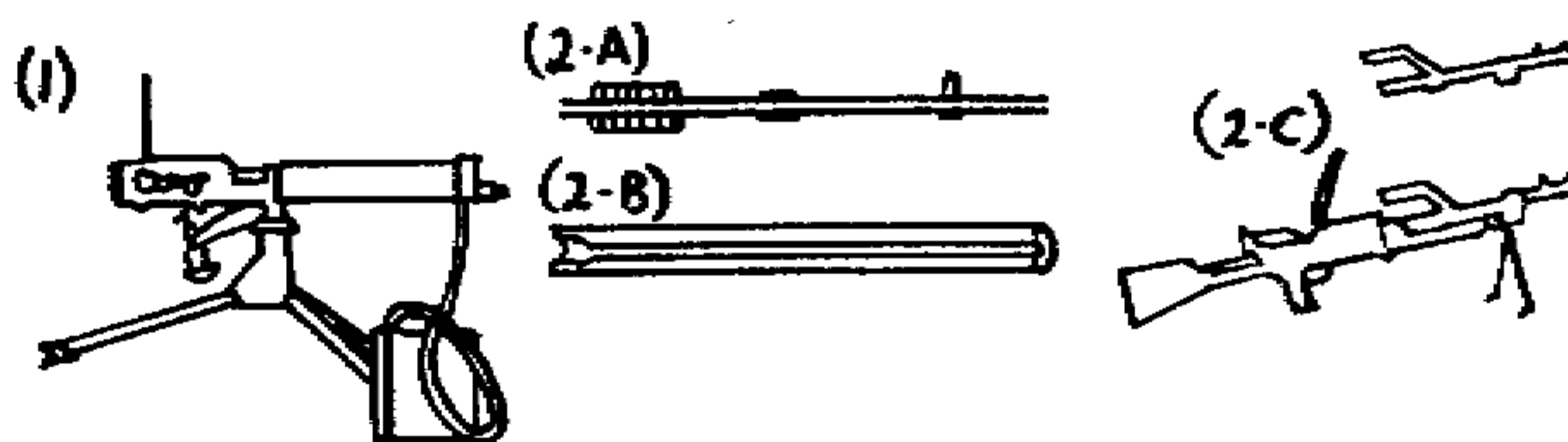
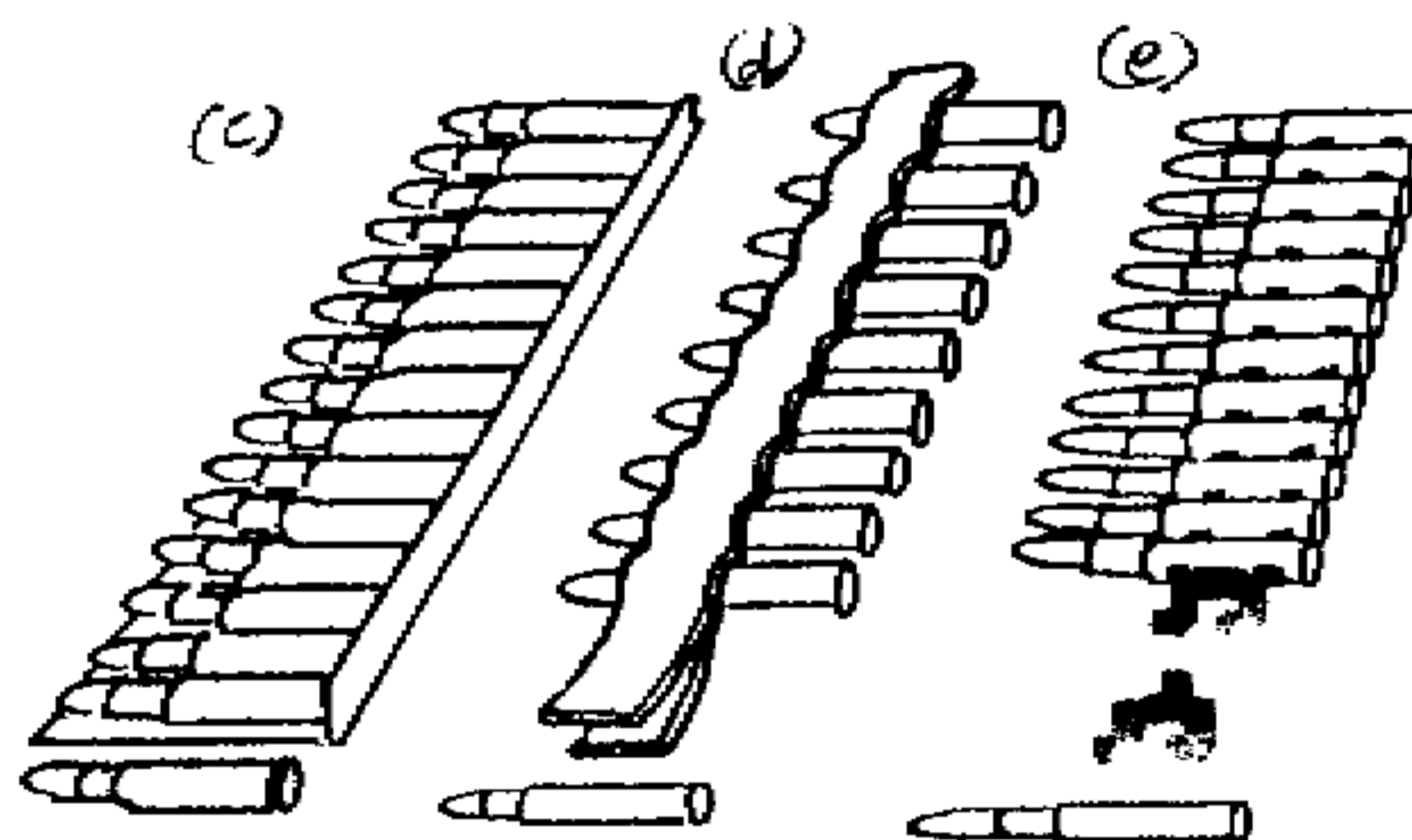

Self propelled rockets and missiles provide their own propulsion as a means of delivering a projectile (warhead) as accurately as possible to an enemy target.

All methods of propelling missiles and rockets are based on Newton's third law of motion "for every action there is an equal and opposite reaction. Every method either pushes air, water, or hot gases backward which thrusts whatever it is attached to forward.

## Scientific Principles of Improvised Warfare and Home Defense

This principle can easily be demonstrated with an elastic balloon. The air inside a blown up balloon exerts equal pressure in all directions. When the balloon is released

(a) the pressurized air rushes out producing an equal reaction of driving the light balloon in the opposite direction (b).

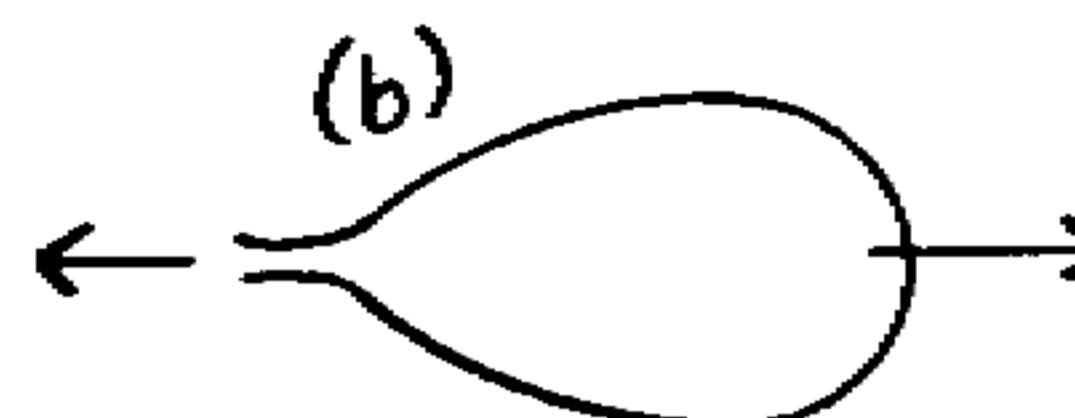
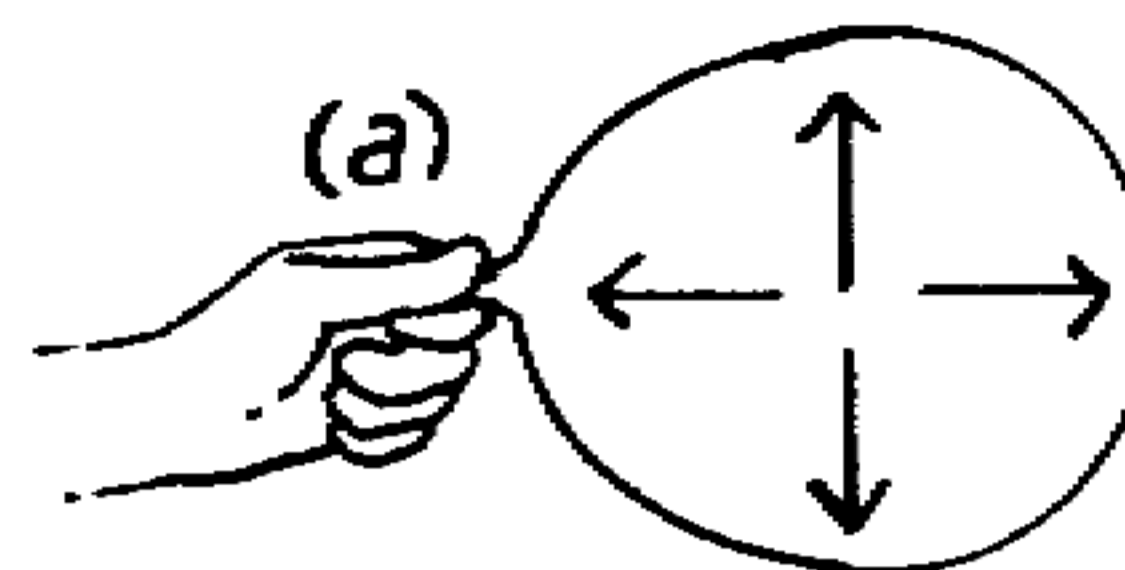

A rotating propeller on a torpedo ( or ship) pushes a large mass of water ( or air when on an aircraft) backward and creates a reaction (1) that thrusts the propeller and everything attached to it forward (2).

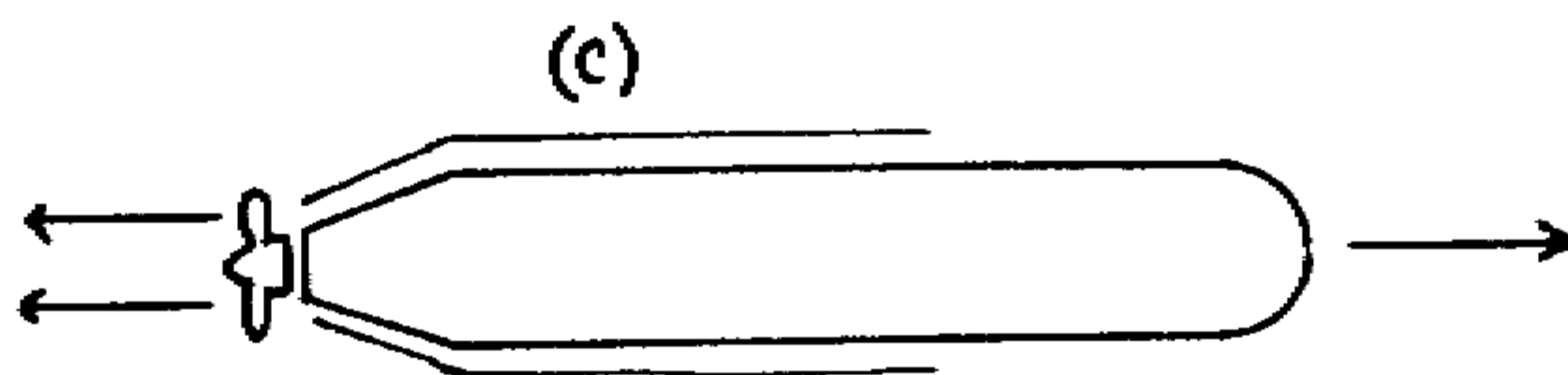

Jet or rocket engines work by generating a backward stream of accelerated gasses which push the device forward.

Jet engines accelerate air it takes in the front by mixing it with fuel (1). The fuel is burned (2) and the hot expanding gases flow out the rear at great speed (3).

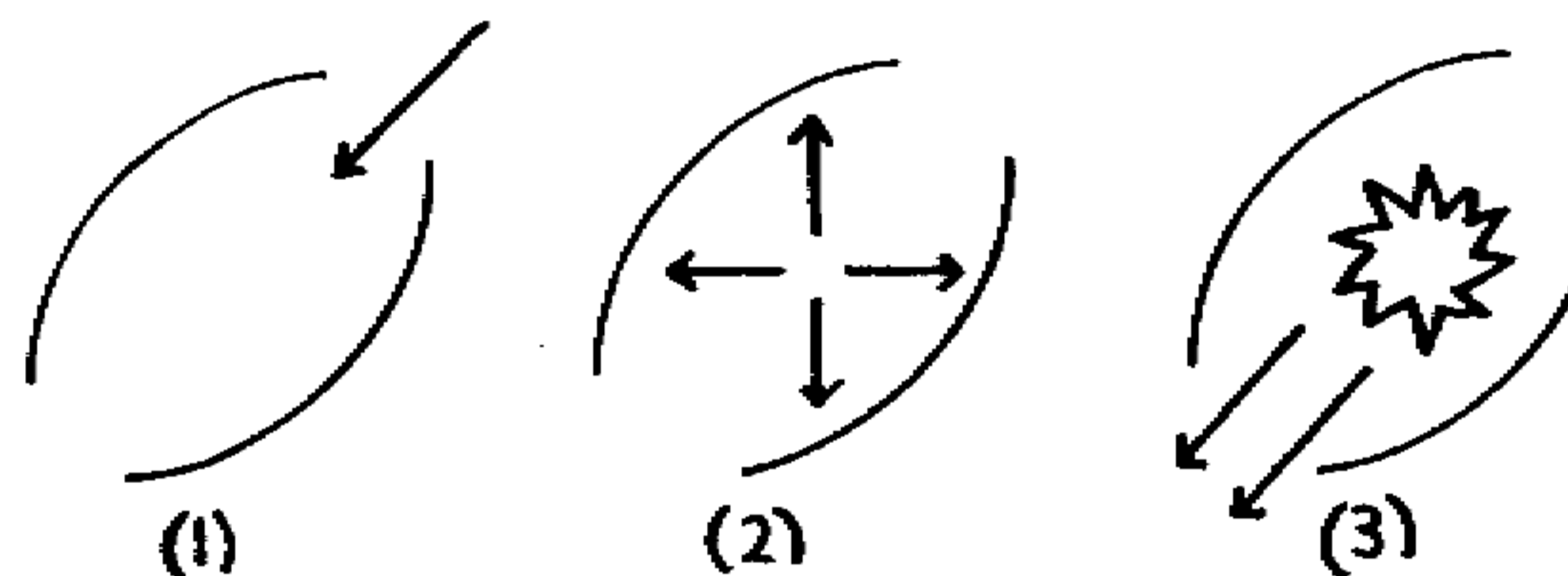

Rocket motors burn fuel in a combustion chamber (a) creating high pressure which push through a tapered opening (nozzle) and the rocket is thrust forward.

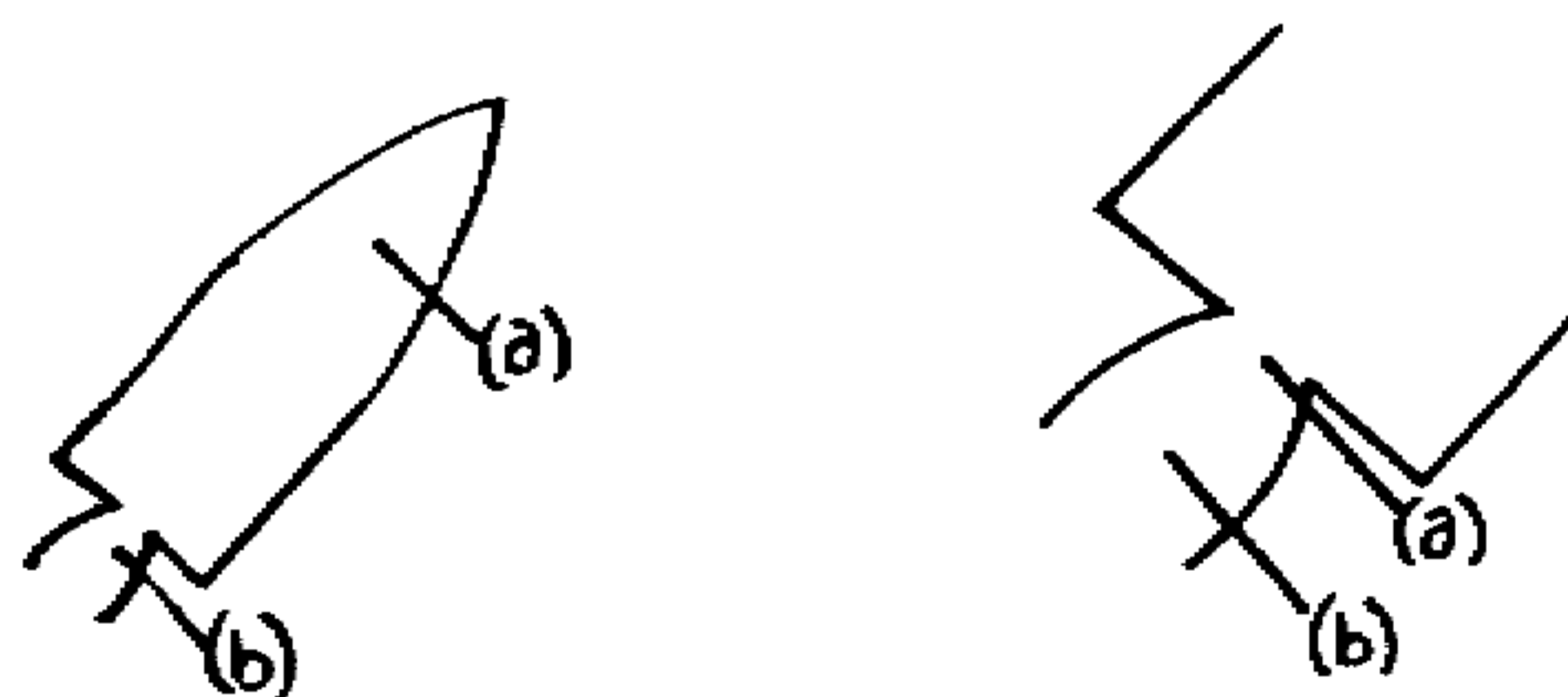

## Scientific Principles of Improvised Warfare and Home Defense

The rocket nozzle design is crucial.

The throat is the narrow opening where the gases exit the combustion chamber and must be narrow to maintain the high pressure in the chamber while still venting the gases at a continuous rate.

The cone shaped expansion chamber decreases turbulence and maintains a steady stream of directed gases.

The nozzle requires special inserts of heat resistant material (b) to protect it from the hot gases (a).

Cool burning propellant may be cast in a ring shape adjacent to the nozzle (c) which provides a protective layer of cool gas (d).

Improvised rockets may be produced using these diagrams as a general guide.

The rocket case should be large diameter iron or steel pipe with the explosive payload and fuse mounted in a separate chamber on the front of the rocket.

The main body of the pipe is provided with a rubber lining. A star shaped mold is then placed inside and the sides are filled in with a castable propellant explosive. After the propellant has set the mold is removed leaving a shaped cavity. This is so that the burning surface is kept constant.

This is used in fast burning formulas which produce high thrust over short periods of time. Long range surface to air missiles use end burning designs for slower initial thrust and longer burn periods.

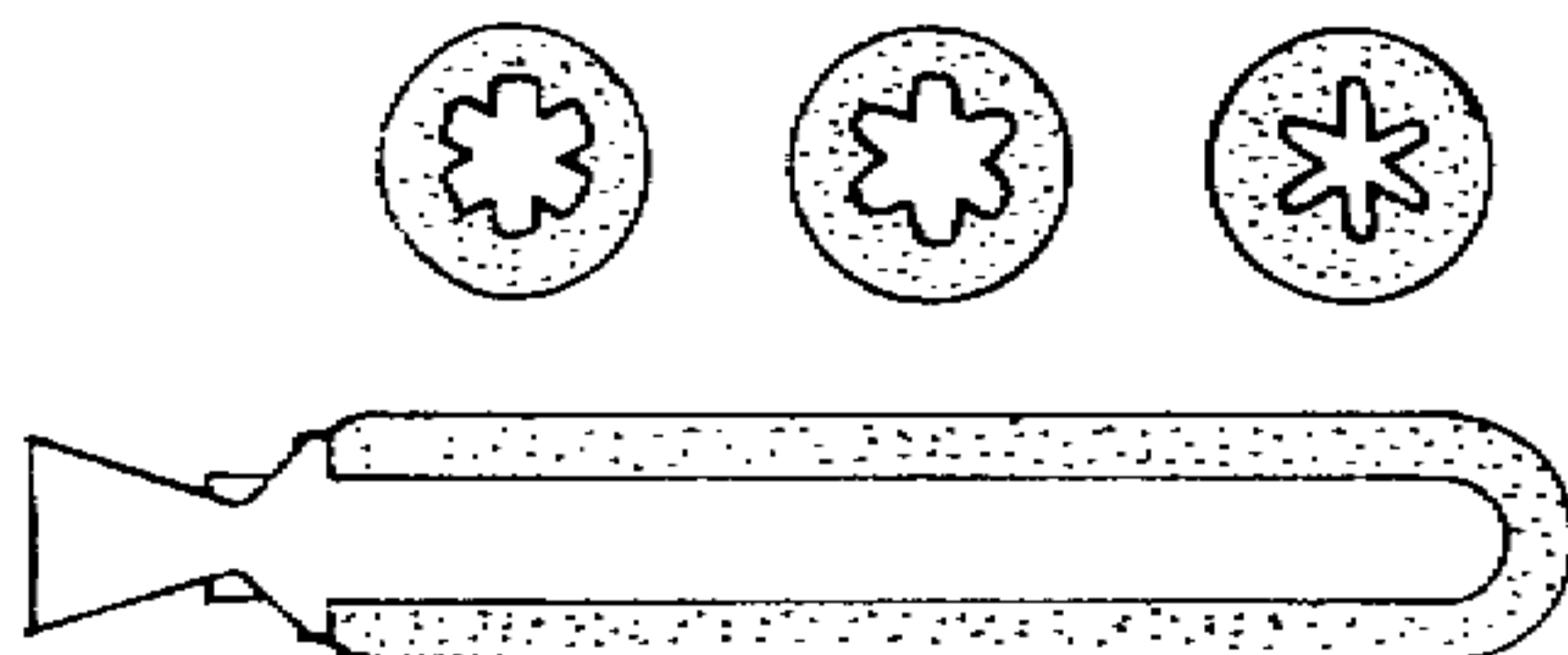
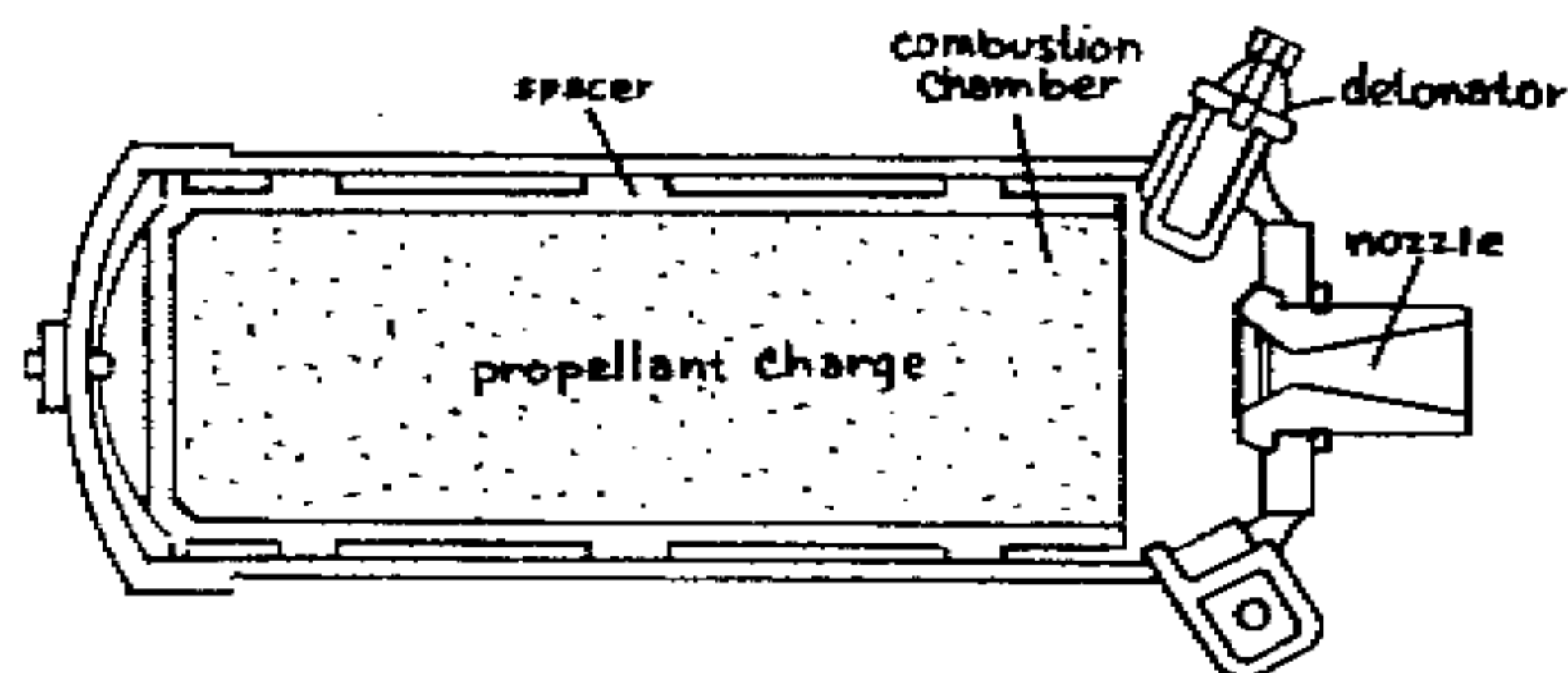
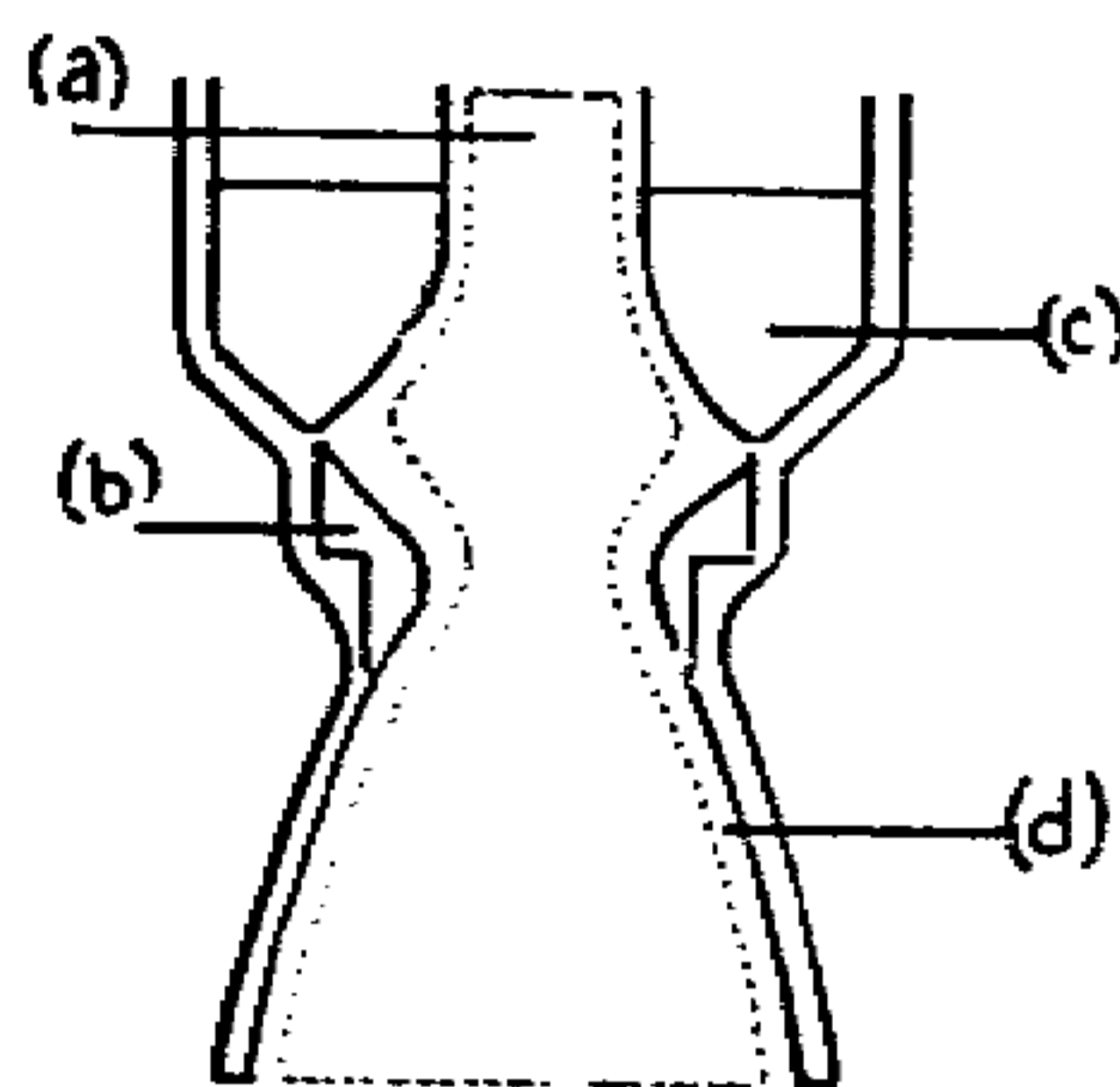
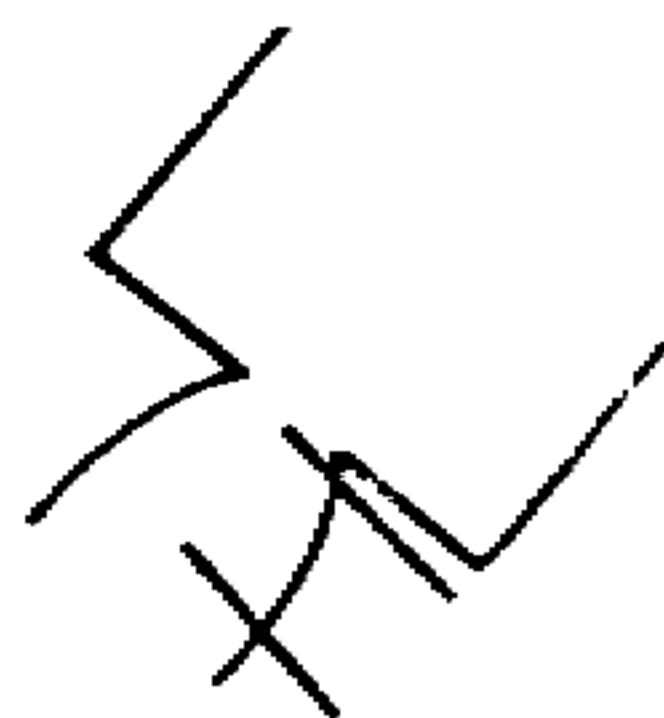

## Scientific Principles of Improvised Warfare and Home Defense

Unless you plan on using direct fire (like kids do with pop bottle rockets) every design should be field tested and charted for angle of fire, design of fuel burning system and amount of propellant.

A. End burning grain burns only the small surface area at the end for limited and constant thrust.

B. End burning with fast burning grain initially for a fast launch and a slower burning formula for sustained flight.

C. Circular center cavity (tubular) which allows progressive acceleration.

D. Tubular star which has a large boost at takeoff and sustained flight.

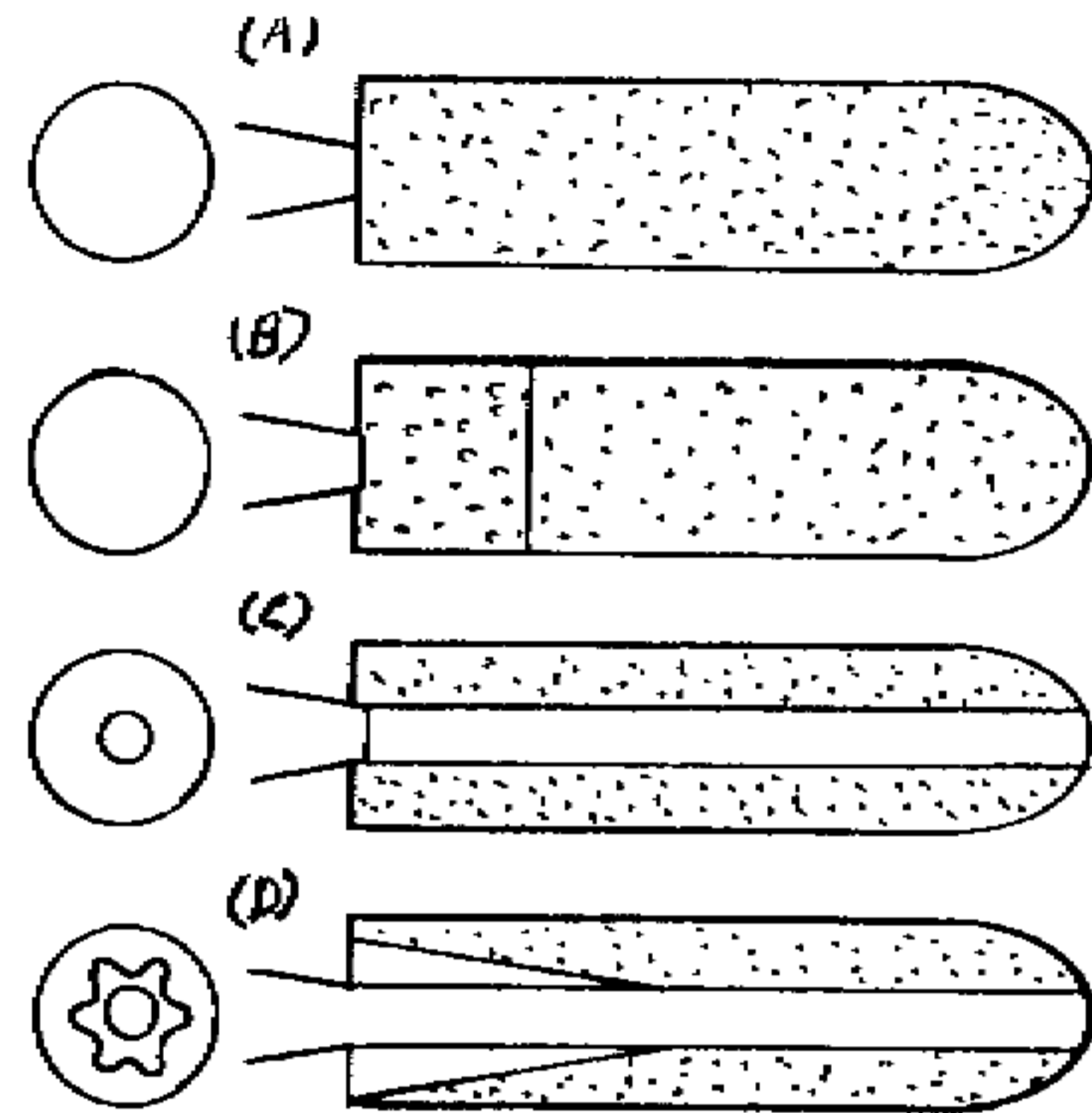

Solid rocket fuels are mixtures or composites of a fuel and an oxidant.

Most propellant oxidants used in rocket designs are

Potassium Perchlorate  
Ammonium Perchlorate  
Ammonium Nitrate

These are admixed with a fuel

Asphalt Oil (early designs)  
Polybutadienes  
Polyurethane fuels

Once mixed they have a thick syrupy consistency and are poured into the rocket casing and cured at 100-110 degrees F.

By adding 20% Aluminum Powder to the propellant mix you will increase the efficiency of the burn mixture.



## Scientific Principles of Improvised Warfare and Home Defense

Stability in flight can be achieved by the addition of fixed stabilizing fins or having the exhaust propellant act on spinning vanes as it exits the nozzle.

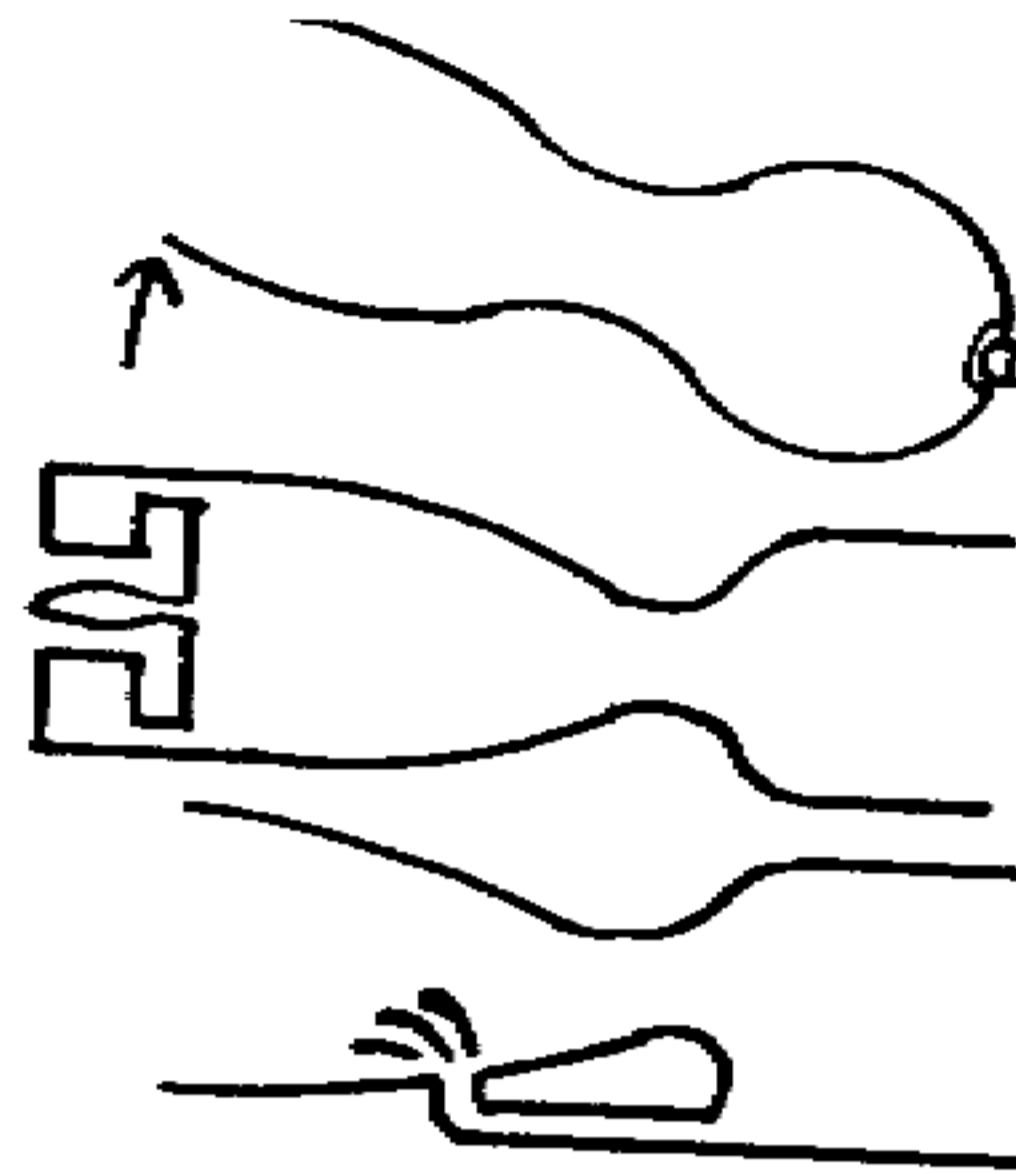

Rockets and missiles may be guided by adding control surfaces as adjustable vanes fitted on the wings or in the nozzle (or radio guided model aircraft wings for subsonic designs), a swiveling exhaust nozzle, or fuel injection into the sides of the nozzle deflecting the exhaust.

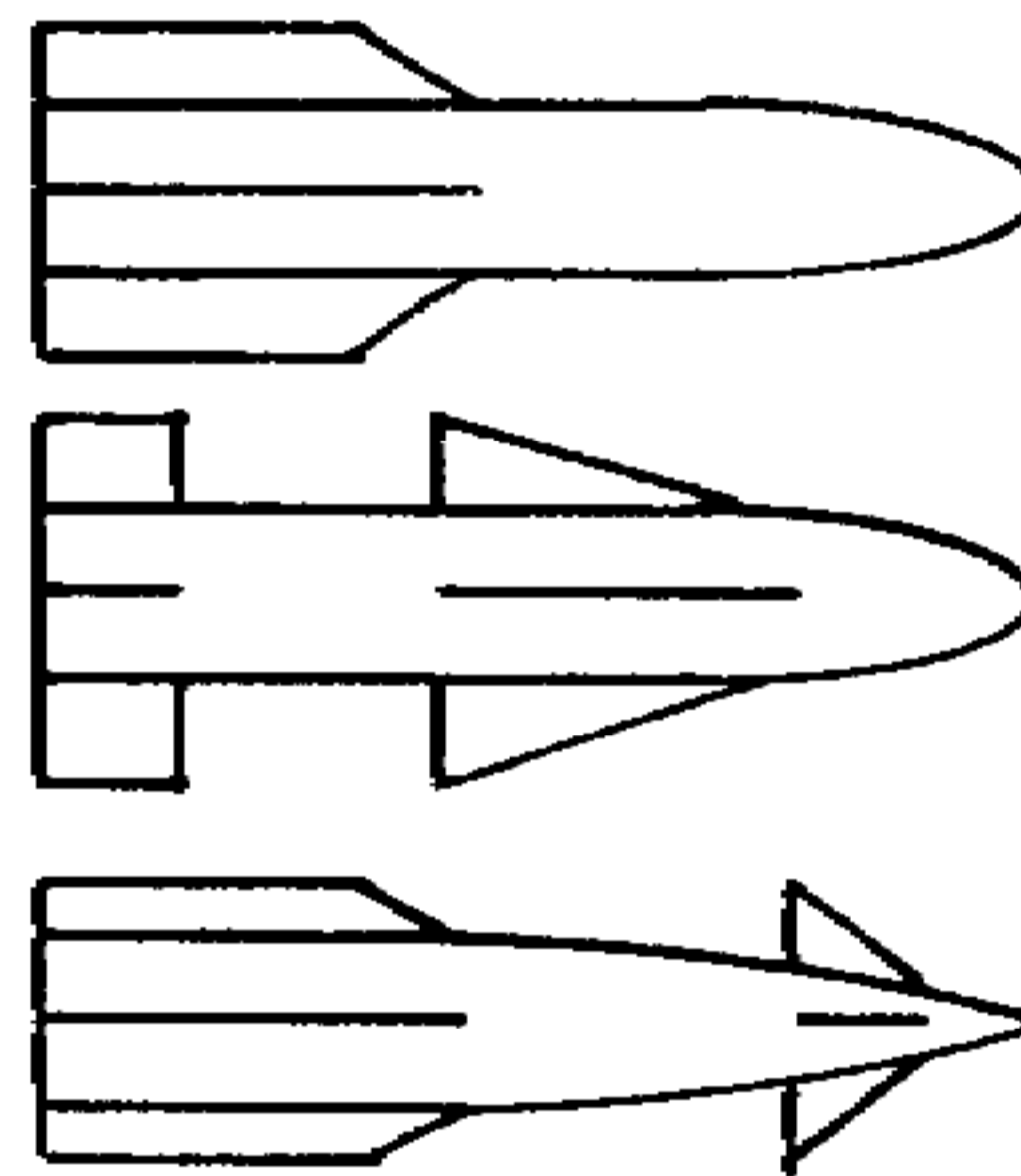

Guidance systems can be simple, such as mounting a radio controlled vane system on the rocket/missile and mounting a mini camcorder near the nose. The target area and end target are kept centered in the viewing area by a hand held remote control until it reaches the target. By using a VCR and recording the flight video, excellent airborne surveillance can be obtained. Adding commercial infra red and low light systems enhance this ability.

Military systems include homing on communications, radar, heat, laser illuminated, video designated, and geographically designated targets. Each of these involve onboard computers to calculate course changes and direct adjustments in control surfaces.

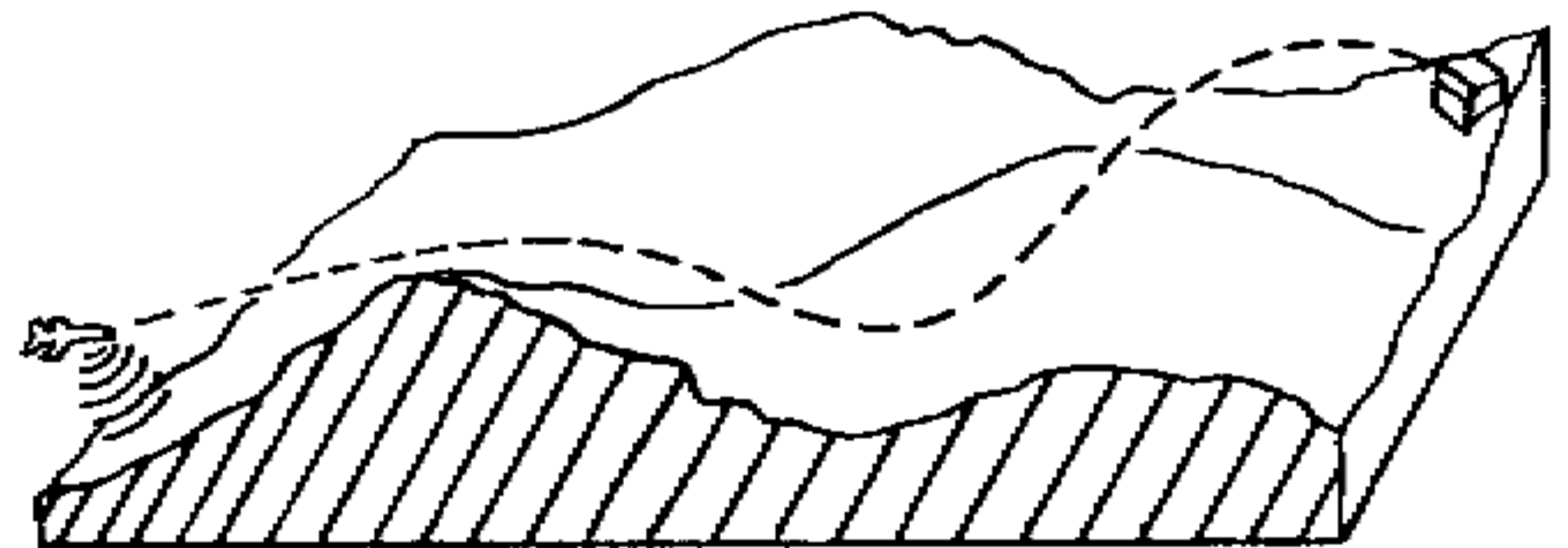

Other methods of propelling and guiding missiles require scientific and industrial support beyond the ordinary scope of improvisation.

# Scientific Principles of Improvised Warfare and Home Defense

Rockets and missiles can be launched from

1. Hillsides

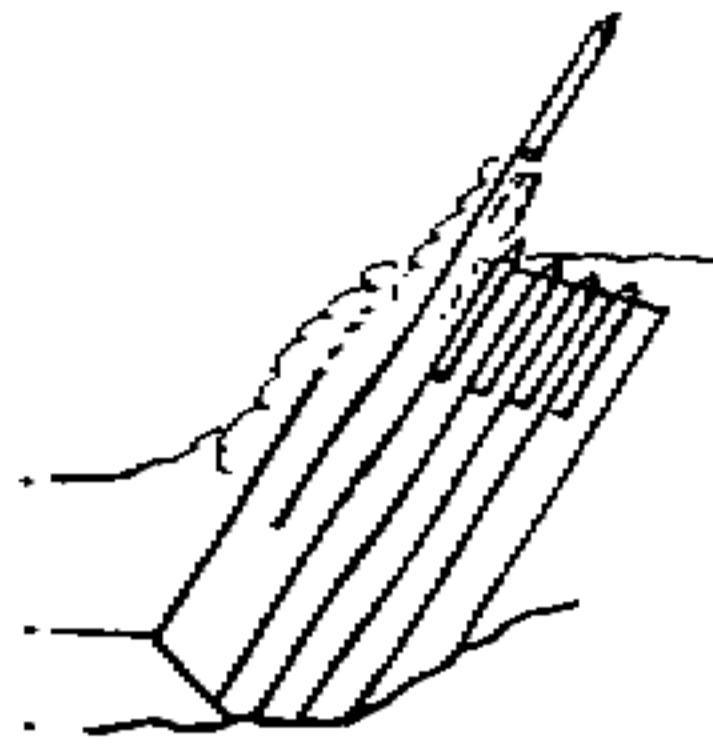

2. Platforms

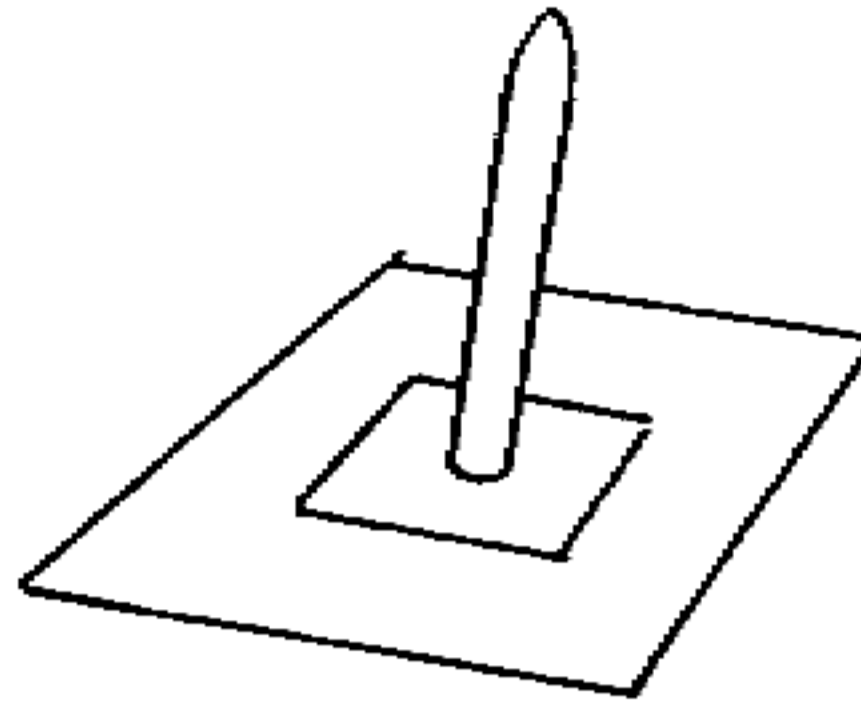

3. Ramps and rails

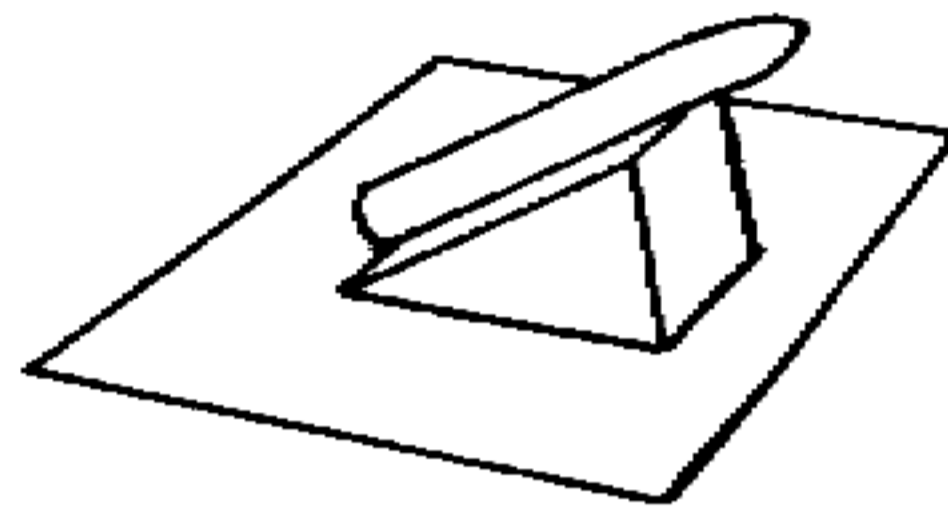

4. Tubes (manmade and held)

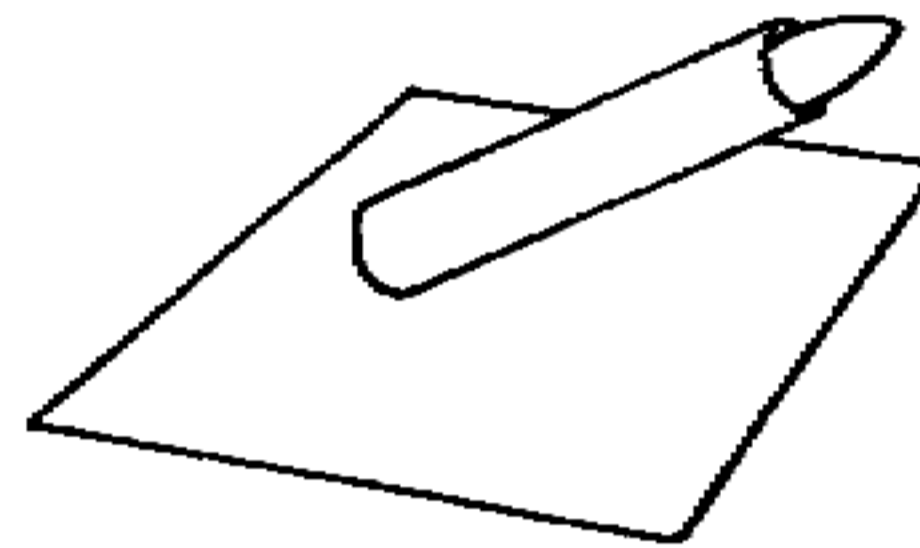

5. Silos

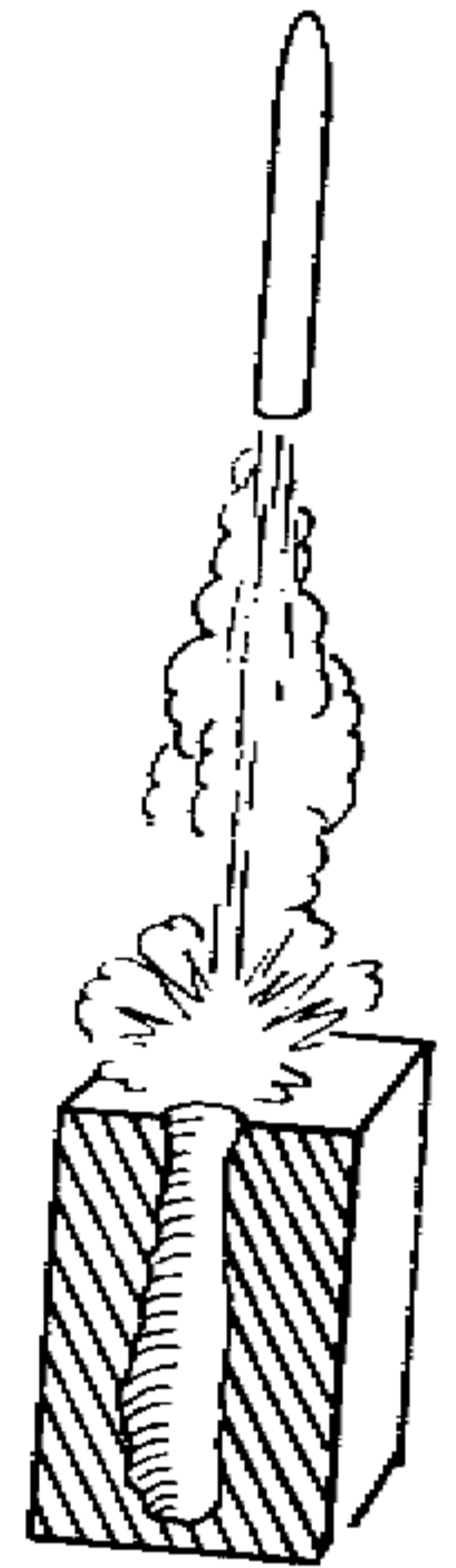

Improvised mountings for almost any weapon can be made with a welder and anything that moves on wheels.

Examples include

Motor Vehicles and Trucks  
Wheeled log splitters  
Engine hoists  
Drum trucks and carriers  
Self dumping and tilting hoppers

Livestock, Car, or U-Haul trailers  
Cement Mixers  
Hand dollies  
Elevating platforms and lifts  
Jib Cranes

# **Scientific Principles of Improvised Warfare and Home Defense**

## **Chapter 6 Non Explosive Chemical Weapons and Incendiaries**

- A) General principles and use in war
- B) Use in guerrilla and civil war
- C) Routes of attack
- D) Methods of obtaining, manufacturing, and concentration of primary chemicals
- E) Incendiary weapons
- F) Preparation of improvised incendiaries
- G) Unconventional delivery systems

Chemicals of Biological origin - see chapter 7

[Authors note - Nuclear and radiological explosives and poisons have been entirely omitted as they are generally beyond the scope of this book and cannot be easily improvised.

### **A) General principles and use in war**

Chemical poisons have long been used to assassinate individuals and the ancient Romans used Arsenic, Hemlock and a variety of metal salts to poison the wells, land and food supplies of conquered enemies to prevent their quickly rebuilding cities and states that could rise against them again. Organized chemical warfare against armies in time of war began on April 22nd, 1915 when poison gas was first used in WW1 in France. Non-lethal agents were also used to harass enemies which are now used in riot control. Iraq used lethal nerve gases as recently as 1984 against Kurdish rebels and civilians despite the indignation of most of the western world.

When chemical agents are used against humans they cause injuries by entering and affecting the human body in many ways. Entry areas of exposure are described as Inhalation, Dermal (skin exposure), Eye, and Ingestion.

# Scientific Principles of Improvised Warfare and Home Defense

Special clothing is required by armies to protect soldiers from chemical attack.

a. A respirator is used to protect the eyes and respiratory tract.

b,c, and d. rubber gloves, boots and full body suit to protect all the remaining body parts and clothing from exposure.

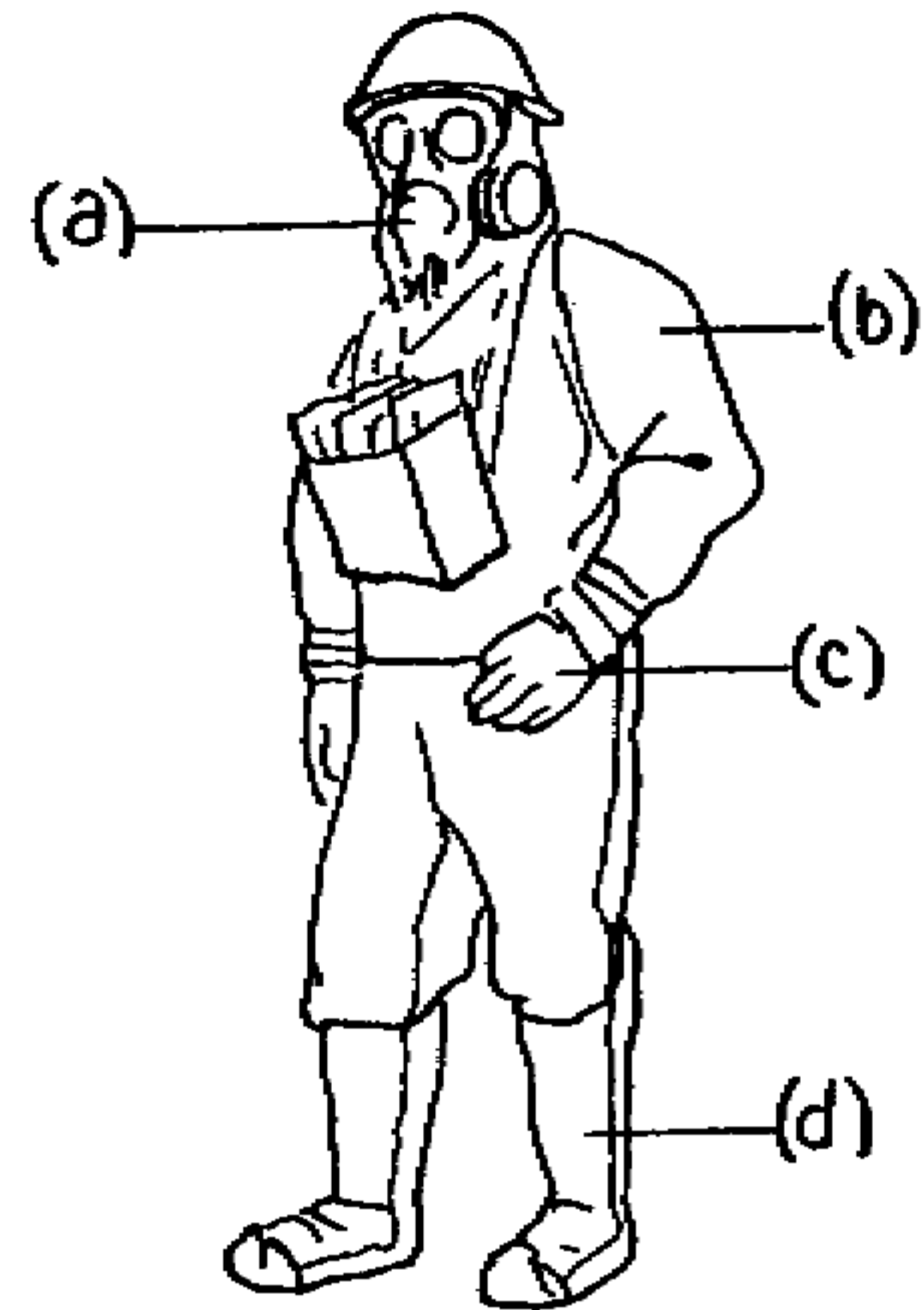

Nerve agents disrupt the nervous system

Blood agents stop oxygen exchange in tissues

Choking agents fill the lungs with fluids

Blister agents destroy exposed skin

Other uses are described in the following table

<u>Type of Agent</u>	<u>Form</u>	<u>Smell</u>	<u>Body Effects</u>	<u>LD50 Skin</u>	<u>Inhale</u>	<u>Dermal</u>
<b>Nerve Agents</b>						
Tabun "GA"	Liquid/Vapor	Fruit	Causes Paralysis	1000	400	40
Sarin "GB"	Liquid/Vapor	None	Causes Paralysis	1700	100	10
VX	Liquid	?	Causes Paralysis	15	36	5
<b>Blister Agents</b>						
Distilled Mustard	Liquid/Vapor	Garlic	Burns Tissues	4500	1500	50
Nitrogen Mustard	Liquid/Vapor	Fish/Soap	Burns Tissues	4500	1500	50
<b>Choking Agents</b>						
Phosgene	Colorless Gas	New-mown hay	Drown in Mucus		3200	
<b>Incapacitating Agents</b>						
"CN"	Visible Vapor	Apple Blossom	Eye, Skin, Lungs		11000	
"CS"	Visible Vapor	Pepper	Nervous system		61000	
"BZ"	Vapor	?	Lungs, stomach Heart, Nervous system Hallucinations		200,000	
<b>Biotoxins (see chapter 7)</b>						
Botulinum "X" "A"	Powder/Liquid	?	All Tissues	.00007 (via wound)	.1	.07
Saxitoxin "TZ"	Powder/Liquid	?	Causes Paralysis	.05 (via wound)	5	.5
Enterotoxin "B"	Powder/Liquid	?	All tissues	?	200	500

# Scientific Principles of Improvised Warfare and Home Defense

\*LD50 is the dose required to kill 50% of all exposed subjects

Skin dose is in mg/man

Inhalation dose is in mg/minute/cu. meter

Digestion dose is in mg/man

In WW1, these nations used chemical weapons in war in the following amounts ( tons )

Germany	52,000
France	26,000
Britain	14,000
Austria-Hungary	7,900
Italy	6,300
Russia	4,700
USA	1,000

about 1.1% of all fatalities in WW1 were caused by poison gas.

In December 1987, the USSR disclosed having 50,000 tons of chemical weapons.

Chemical Weapons delivery systems have included

## Gas Clouds

(a) Cylinders of gas are hidden in the front lines. When the wind is blowing in the right direction - toward the enemy- the cylinder taps are opened (b) and clouds of poison gas (c) drift toward the enemy. Friendly troops required gas masks/suits to follow up the attack on foot.

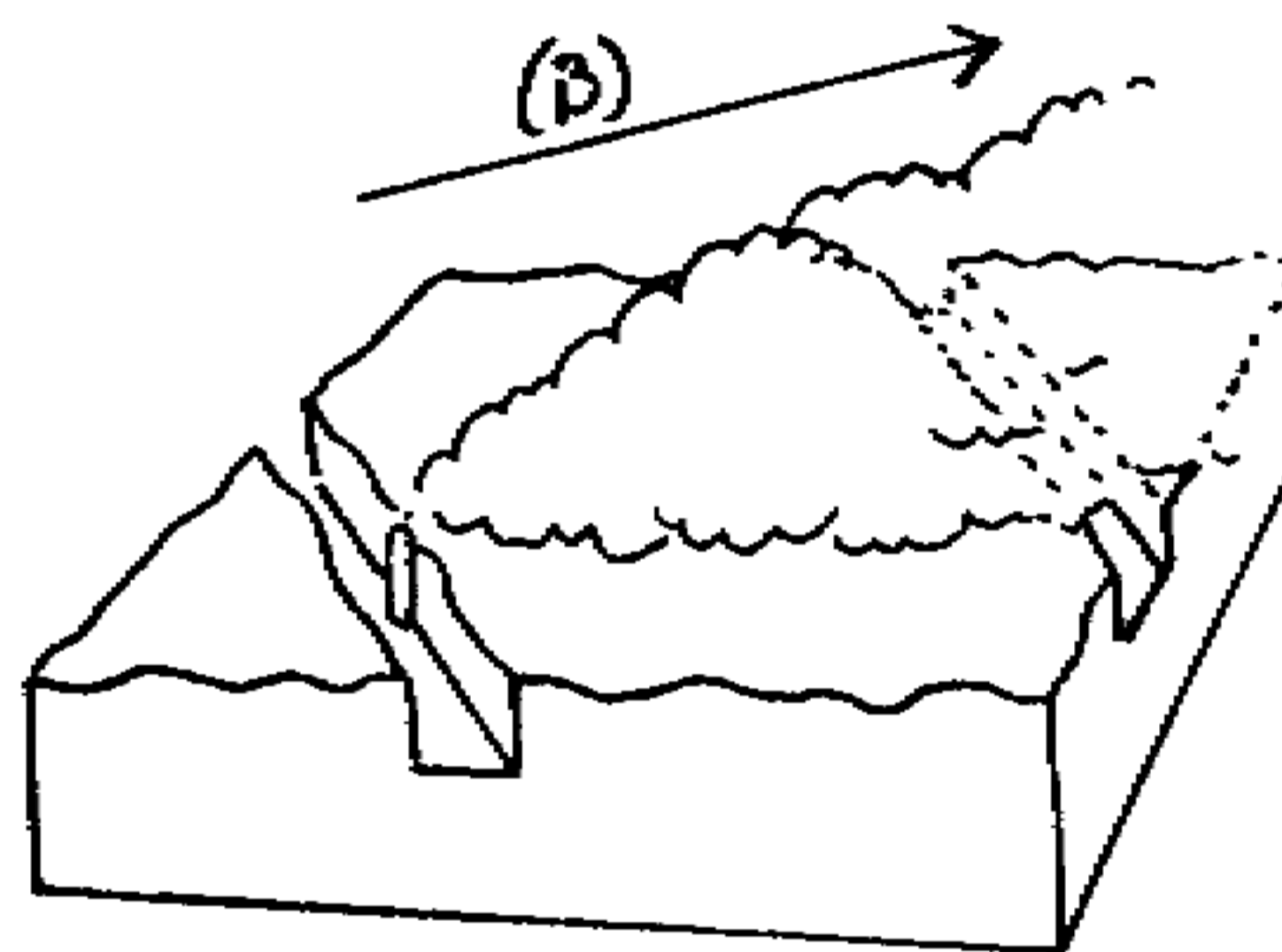

## Mortars

Fused for ground impact detonation with a bursting charge to rupture the outer casing and spread the liquefied gas.

- a. fuse
- b. bursting charge
- c. liquefied gas
- d. casing

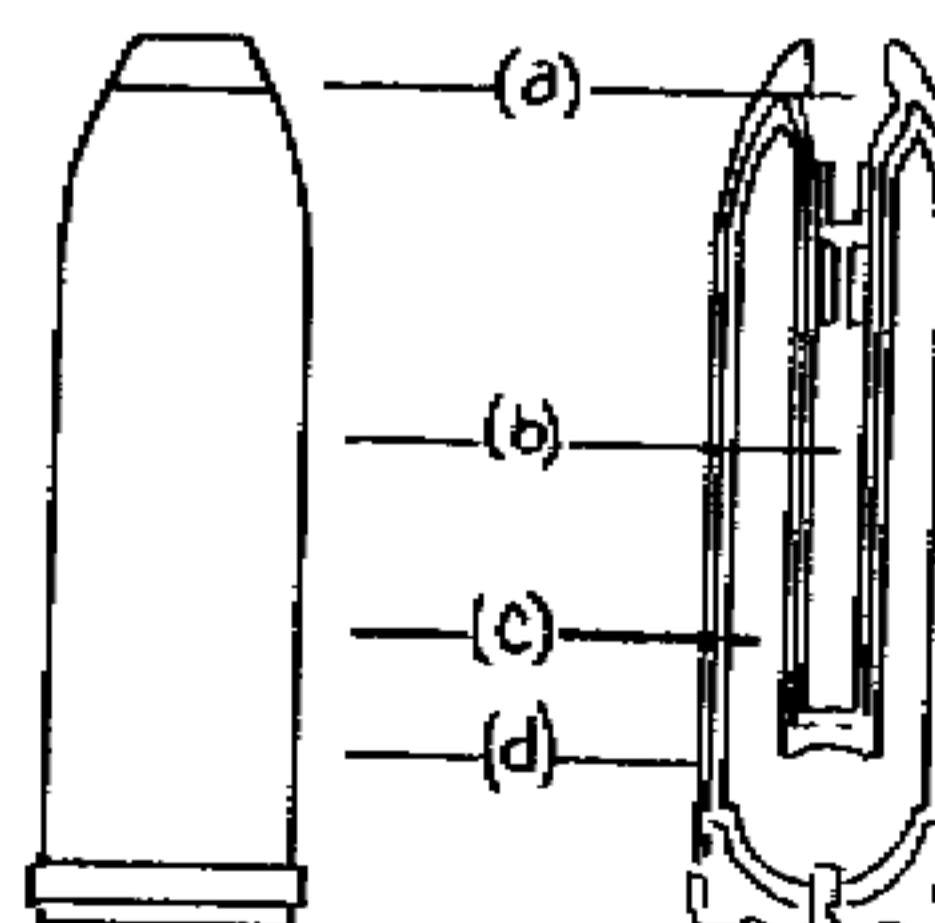



## Scientific Principles of Improvised Warfare and Home Defense

### Indirect methods

include spraying defoliants on jungle (agent orange in Vietnam), poisoning the water supplies of ancient cities during sieges or destroying enemy crops by spraying.

**Incapacitating agents** are now commonly used by all nations in riot control. The idea is to inflict great discomfort on the rioters so they look for relief over continuing the disturbance. This allows security forces a choice before using weapons that wound or kill. Anti riot gas is deployed as spray aerosols such as mace (a), gas grenades such as tear gas (b), or riot gun cartridges or grenades (c).

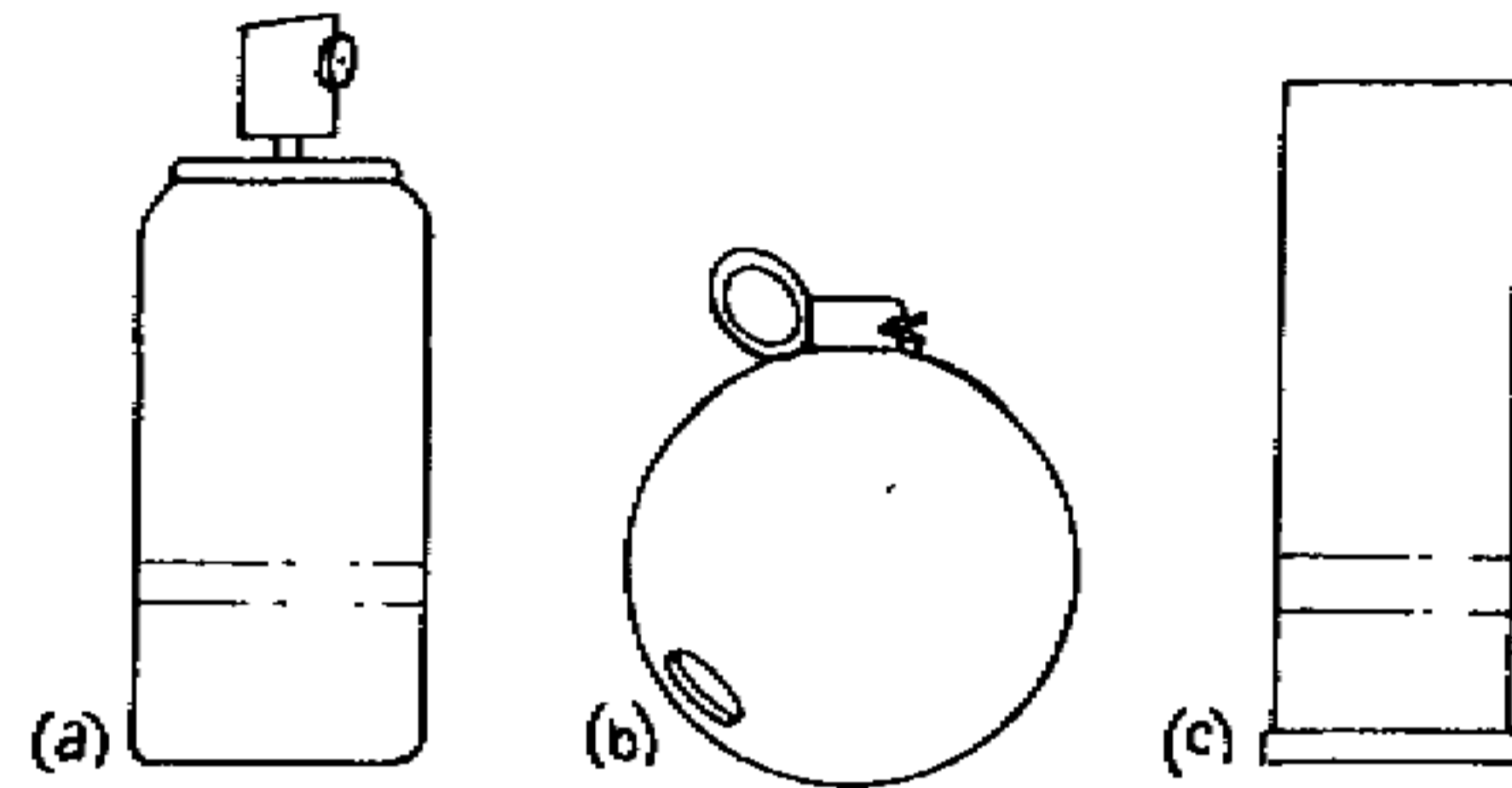

### B) Use in guerrilla and civil war

Many countries governments and controlling institutions oppress and torment their own populations to such a degree that these populations adopt unconventional means to fight back. Dictators often use obvious torture and murder to eliminate dissent and discourage future public opposition. Typically, they control all sources of combustibles, oxidants, explosives, and general hardware so that none of the ingredients or tools for armed resistance can be mobilized. Often, the only resource available to the general population is just what a local grocer may have as food and household supplies, or general industrial chemicals they encounter at state controlled enterprises. Nature may also supply resources in the form of minerals, or byproducts of animal, plant, and microbial life.

Nature made bio-toxins will be covered in chapter 7. Weapons that can be obtained, manufactured, or concentrated from public sources will be covered here. Also, the manufacture of nerve gases and their preparation as improvised binary weapons and unconventional delivery will be described.

While these methods generally illicit public indignation, all war waged by any method to kill an enemy is horrible to the participants. It is arguable that to settle life and death political issues, and to obtain freedoms, that an oppressed people have a right to wage war by any means. A close examination of the real life example of Bosnia will be examined in chapter 12.

## **Scientific Principles of Improvised Warfare and Home Defense**

During WW2, US Naval and Marine Commanders in the Pacific were given approval to use inventories of chemical weapons to overcome the fierce resistance of the Japanese and limit US casualties. In the event, the Commanders used their discretionary authority and resisted the temptation to reintroduce their use in modern warfare. They used bullets, incendiaries and, in the end, nuclear explosives, to kill, and burn out the Japanese and force their political surrender. The USA and USSR maintained considerable inventories of chemical weapons during the cold war and now have the undesirable and dangerous job of disposing of these inventories.

Saddam Hussein used poison gas on Kurdish rebels and civilians in 1984 and attempts to assassinate or overthrow his government by similar means would probably not be objected to by many western nations today given his history and first use of chemicals on his enemies. Likewise, during the brutal occupation of Afghanistan by Soviet forces and their use of gas and mines, few would disagree that the Afghan civilians were justified to use any means necessary to resist, to protect their families, and free their nation by any means available.

Chemical weapons, when used on a large scale, offer the means to depopulate and defoliate large areas, and even entire nations. These types of weapons are much easier and far less costly to produce than nuclear explosives while producing a comparable effect on civilian populations and leaving infrastructure intact. This is why there was great concern on the part of US leaders during the Persian gulf war of Saddams intentions. Bearing in mind that there are justifiable circumstances for the use of chemical weapons, here is an introduction to the "know how" of this field.

### **C) Routes of attack**

Chemical weapons can be used for a variety of intended results

1. To kill and thereby directly eliminate opposition.
2. To maim or wound horribly so as to create the greatest burden and anxiety on the enemy soldiers and civilian population which has to see and care for the wounded.
3. To intensify fear in an enemy government and provoke unpopular reactions.
4. To clear an area or make it uninhabitable ( such as a military base ).
5. To poison a food producing areas food and feed stocks, livestock, or cropland which can starve out an enemy population and act as effective method of economic warfare.
6. In areas where explosive weapons are unavailable or unsuited, chemicals may offer the only means of successfully laying siege to enemies in fortifications, tunnels, bunkers, and jungles.
7. To incapacitate a target such as rioters, hostage takers, or lightly armed prisoners without causing permanent injury or death.

## **Scientific Principles of Improvised Warfare and Home Defense**

Depending on what chemical is available and the nature of the targeted area, there are 4 routes of introducing chemicals to human targets. These are

1. Inhalation
2. Dermal
3. Ingestion
4. Eye

**Inhalation** attacks are made to kill, incapacitate, irritate, anesthetize, and demoralize targets.

**Dermal** attacks are generally intended to kill and severally maim.

**Ingestion** attacks are almost always intended to kill or occasionally to incapacitate to facilitate kidnappings.

**Eye** attacks are intended to irritate or incapacitate as in the use of tear gas.

A description of test methods for evaluating the effectiveness of each of these exposure routes will be given in chapter 7.

Once these tissues are exposed the chemicals involved either cause direct damage such as burns, indirect such as causing mucus to be formed, or is distributed to other tissues to cause harm.

### **D) Methods of obtaining, manufacturing, and concentration of primary chemicals**

Improvised manufacture of several chemicals used for explosives has already been described and will not be repeated here.

The chemicals will be grouped as follows

- 1) Acids and blistering gases
- 2) Alkalis
- 3) Pesticides
- 4) Solvents
- 5) Household-Industrial
- 6) Nerve Agents
- 7) Anesthetics



# Scientific Principles of Improvised Warfare and Home Defense

## 1) Acids and Blistering Gases

All acids and blistering gases cause direct tissue destruction on contact. Acids in the form of tiny droplets in the air (an aerosol) can be breathed in with the air and cause rapid and permanent lung damage. All acids rapidly destroy eye tissue. When heated ( especially to boiling) all acids cause rapidly accelerated tissue destruction and the blisters caused by a single boiling drop can cause searing, incapacitating pain and requiring considerable attention and efforts of medical and other personnel in providing aid and relief, provided they are not incapacitated as well.

Acids combined with incendiaries not only cause accelerated burns, at very high temperatures they decompose to deadly toxic gases which react with lung tissue causing instant and permanent destruction. If the target does not suffocate they will likely require extended care to survive infections and disability.

### Hydrochloric Acid

Damaging to eyes and skin. Acutely toxic by ingestion and inhalation. It is widely found in dilute solutions as a cleaner. These can be concentrated up by boiling the solution until the water vapor contains noticeable chlorine gas. In concentrated form this chemical can be used as a direct destructive agent. It can be combined with explosives to create high speed aerosols which penetrate under skin tissue and cannot be washed off. This acid can be combined with incendiaries to produce hot deadly toxic chlorine gas.

Chlorine bleach or hydrochloric acid, when mixed with other acids can rapidly release chlorine gas without requiring heating. Household ammonia reacting with these produce very toxic chloramines that penetrate and destroy deep lung tissue.

Binary weapons of glass containers taped together as

Part A: Hydrochloric Acid, Chlorine Bleach

Part B: Incendiaries, other acids, household ammonia, or explosives and detonators can make effective closed compound area weapons.

If gas is the intended end product, these weapons are best used indoors where the gas cannot be easily vented off or diluted. Hydrochloric acid can be made by reacting salt with sulfuric acid or by reversed hydrolysis of calcium or magnesium chloride. It may also be produced by heating dry salt to high temperature so that chlorine gas comes off. Sodium oxide is left behind that forms caustic soda (lye) when water is added to it.

## **Scientific Principles of Improvised Warfare and Home Defense**

The chlorine gas can be captured by a homemade scrubber. This scrubber consists of a large plastic canister ( garbage can size ) which is filled with golf ball size hollow plastic balls with many holes drilled through them. A series of shower heads with fine droplet sizes is fitted inside the enclosed top and circulates water continuously through the scrubbing canister. The gases from the heated salt are forced into the scrubber near its bottom by a forced air fan while the shower is operating. The very high surface area of flowing water and air droplets come into continuous and repeated contact with the chlorine gases capturing and absorbing them into the water stream. The water is drained into a storage tank and recirculated until it is concentrated to about 25% which is the highest concentration an improvised scrubber will achieve.

### **Hydrofluoric acid**

All of the effects described to hydrochloric acid can be applied to hydrofluoric acid as well. When heated hydrogen fluoride gas is given off and is one of the most reactive substances known and may be considered more dangerous than chlorine gas. Hydrofluoric acid can be manufactured by reacting calcium fluoride or sodium fluoride ( used to fluoridate water ) with Sulfuric Acid. This produces the hydrofluoric acid and a solid precipitated calcium or sodium sulfate. If sulfuric acid is not available the fluoride containing salts can be heated until giving off fluorine gas which can then be scrubbed as in the above example.

### **Sulfuric Acid**

is one of the worlds largest chemical industries by itself. It is readily available from chemical and laboratory supply houses the world over and can be obtained and concentrated up from automobile batteries by boiling battery acid until white fumes appear. It is used in a wide range of industrial and chemical processes by the trainload. It is found in some household and drain cleaning formulas as well. It cannot be easily made from scratch without special catalysts or lab equipment.

All of the previous descriptions for acids apply here as well with one notable addition. Concentrated sulfuric acid (90%) when diluted by 30-50% into other solutions such as water or acid will generate considerable heat all by itself. This makes it an effective binary weapon and has been formulated with some nerve and blister gases in the former Soviet Union republics and Iraq. The use of acid in combination with follow up bio weapons is very effective, or when combined with nerve gas because the acid destroys the protective skin tissues allowing easy and rapid absorption of gases and infective agents.



## **Scientific Principles of Improvised Warfare and Home Defense**

### **Oxalic Acid**

is a dry granule or powdered acid used in metal treating, cleaning radiators, and as a bleaching agent. It is not as corrosive as the other acids but is extremely poisonous if ingested, inhaled, or injected under the skin by booby traps, propellants or piercing weapons. It can be easily obtained from rhubarb leaves (known to kill grazing animals) by grinding the leaves to a fine flour like powder and leaching the acid out with a water or mild acid solution. This solution is then filtered by pouring the liquid over a fine cloth into a pan underneath and capturing the undissolved plant cellular material on the cloth. The material is then discarded. The solution is then allowed to dry (do not boil) resulting in dry concentrated oxalic acid crystals.

### **Phosgene**

This is an intentionally designed WW1 poison gas. It is easily produced by passing carbon monoxide gas and chlorine gas over activated carbon. Carbon monoxide can be obtained from car exhaust, and the chlorine gas from heated salt. This must be done with great care in an enclosed environment as doses as low as 1 part per million in the air continuously can be lethal.

### **Mustard Gas ( Dichlorodiethyl Sulfide)**

This other WW1 poison gas is produced by mixing or bubbling ethylene oxide through a solution of sulfur chloride ( or from thiodiglycol and hydrochloric acid ). This vapor can be directly and rapidly absorbed through the skin and is extremely poisonous. It causes immediate blindness and conjunctivitis.

**Binary weapons** from the components of these gases can be made by placing solutions or breakable containers with the chemicals together inside a 3rd metal container. The principle is that once the container is thrown, the inside containers break and release their contents which mix and evolve the end gas or solution. Small low temperature bursting charges can also be used.

It is also possible to premix the components in a sealed compressed air tank under pressure which can then be used as a spray canister. Full body protection and respirators must be worn while using these weapons in close proximity to your own troops. These are effective weapons against enclosed fortifications, tunnels and trenches. You can simply pump the chemicals into the enemy's stronghold.

## **Scientific Principles of Improvised Warfare and Home Defense**

### **2) Alkalis**

#### **Caustic Soda**

Known as Lye, Sodium Hydroxide, or by the brand name "Drano", it is widely used as a cleaning agent for ovens, metal pipes, and in many industrial chemical reactions. Potassium Hydroxide, or the peroxide forms have similar uses and properties. Caustic Soda releases explosive Hydrogen gas on contact with metals ( Aluminum, Zinc, Tin, Copper, Bronze, and Brass). When rapidly combined with sulfuric acid it produces a "hot" explosion. This is not a high explosive, but the incomplete mixing in the violent reaction throws unreacted boiling caustic and acid onto the targeted area making it an effective anti-personnel weapon.

Caustic Soda causes rapid destruction of eye and throat tissue and damages skin tissue more slowly. If swallowed, it causes violent pain and life threatening injuries. Liquid caustic is more dangerous to ingest than dry.

#### **Ammonia**

Household Ammonia is widely available and at a concentration of 5-10% in water is relatively safe to handle. At high concentrations in air, it can be an explosive gas. When mixed with chlorine bleach or hydrochloric acid, chloramines are released and are extremely toxic. Large toxic reservoirs of this gas can be made by heating household ammonia and bleach solutions, urea, or ammonium salts in a compressed air tank. When the safe pressure limits of the tank are reached, the gas can be temporarily stored until ready to use and the poison gas is then released by means of a valve similar to the WWI canisters described earlier.

Anhydrous Ammonia used by farmers is lethal when released in undiluted form in large concentrations in the open air. Permanent eye damage can occur in 5-10 seconds

### **3) Pesticides**

The definition of a pesticide is a substance bearing a label claim that it kills or harms living things. Generally, the intended targets are lower life forms such as rodents, weeds, and insects. Most can be purchased from mass merchandise, farms, and industrial supply houses. The following are potential weapons due to their poisonous properties. This means that they can be used to poison enemy food and water supplies and individual targets.

## Scientific Principles of Improvised Warfare and Home Defense

### Aldicarb

is a systemic poison that is sprayed onto plants, is absorbed through the leaves and roots, and is circulated throughout the plant where it then kills the chewing pests. It is a "**cholinesterase**" inhibitor which means it inhibits the enzyme cholinesterase which leads to paralysis of the lungs, suffocation and death. This is also how many of the major nerve gases work. Aldicarb is readily absorbed through the skin and is completely absorbed through the intestinal tract.

### Azinophos-Methyl

An organophosphate insecticide and **cholinesterase inhibitor** used on about 80 food crops. It is readily absorbed through the skin and is very toxic to humans when ingested, making it a fair booby trap additive or ingested food poison when used in concentrated form.

### Carbaryl

Also a **cholinesterase inhibitor**, it is widely available. High doses of this pesticide are required to be lethal by inhalation, dermal, or ingestion.

### Paraquat

is used in 130 countries as a non selective herbicide. It is highly toxic in concentrated form and can cause permanent lung damage if inhaled in cigarette smoke. The manufacturer adds a skunk like odor and a vomiting agent to prevent accidental poisoning. These can be inactivated by treating with mild alcohol or acid solutions.

### Parathion

is applied to nearly 100 food crops in the US. It is a **cholinesterase inhibitor**, is very toxic at extremely low doses and has been used in a number of publicized intentional poisonings. The toxic effects of a secondary nerve damage lead to a delayed paralysis and poisoning symptoms after exposure. Fine dusts and aerosols of concentrated Parathion can kill by 2 modes

1. **Cholinesterase inhibition** leading to paralysis of the respiratory center of the brain
2. Paralysis of the respiratory muscles (nerve damage)

This makes it an effective insecticide and it is the chief cause of accidental poisonings among farm workers in the US.



# Scientific Principles of Improvised Warfare and Home Defense

## VAPAM (Metham Sodium)

is a restricted use pesticide used to kill tree roots in sewer lines. It is a liquid with high vapor pressure. When sprayed on pipe surfaces as a thin layer in sewer lines it quickly turns to a toxic vapor that kills tree roots and surface vegetation where it seeps out of pipe cracks. On occasion it seeps into private residences which may have dry traps, however residents are rarely warned by the municipal contractors and employees because of the potential liability. Several breaths of the concentrated vapors are sufficient to kill. A rail spill along the Sacramento River in the early 1990's led to congressional hearings after the VAPAM killed most fish in the river for nearly 100 miles. The effects of this gas can best be described as "Drano as a gas". It causes skin blisters which are not noticed oftentimes until hours later when workers who spilled small amounts on their boots would pull off their socks at night and peel their skin off with the fabric. VAPAM may be considered as a potentially lethal antipersonnel weapon when used in confined areas. Because of the delayed skin damage it may be effective in combination weapons.

## 4) Solvents

### Acrolein

is a strong, foul smelling liquid used to make drugs, perfumes, and resins. It has also been used in military poison gas mixtures. It has an acrid, choking odor and is intensely irritating to the eyes and upper respiratory tract and can kill at low concentrations in the air. A half teaspoon swallowed by a 200# adult is lethal. Five PPM in air is considered immediately dangerous to life and health. Acrolein is sold under the trade names Aqualin, Aqualin-Biocide or Slimicide, or may be recognized on labels as Acrylaldehyde, Propenal, Allylaldehyde, and ethylene aldehyde.

### Dioxane

A liquid solvent which may be listed on labels as 1,4 dioxane , p-dioxan , di (ethylene oxide) , diethylenedioxide, diethylene ether, diethylene oxide.

Dioxane is an important commercial solvent used in industrial paints or in bio labs to remove water from tissue samples. Its vapors are not irritating until dangerous levels are present and it can be explosive in air. It is readily absorbed through the skin, lungs, and intestinal tract. Overexposure symptoms are delayed for hours which may make the condition untreatably fatal. Amounts delivered on large areas of the skin or clothing can kill without producing immediate irritating effects. When mixed together with chlorine in water, an incredibly toxic new compound is formed that may lower lethal exposure levels by 1000 times which approaches military nerve gas toxicity.

# Scientific Principles of Improvised Warfare and Home Defense

## Ethylene Glycol

Anti Freeze. This liquid causes many pet poisonings every year. It is very poisonous orally and when heated, gives off toxic vapors.

## 5) Household-Industrial Chemicals

### Acetic Acid

The acid substance in vinegar at about 5% concentration. Concentrated Acetic Acid gives off vapors which seriously irritates the eyes, nose, throat, and lungs and can cause skin ulcers if splashed on clothing or unprotected tissue. If swallowed, very small concentrated amounts will seriously burn the throat.

### Arsenic

is widely used in pesticides and wood preservatives. It has been used in many intentional and accidental poisonings since the dawn of man. The early Romans used it in the earliest examples of chemical warfare to poison the wells and farmland of cities under siege and to prevent Carthage from being quickly repopulated after sacking the city-state.

Arsenic is a metallic like substance recovered from copper and lead smelter dust and processed to a white powder. Ingestion or inhalation of 500 micrograms ( about 1/1000th of a lb..) is dangerous. Ten times this amount is usually fatal. Low level exposure results in a large incidence of lung cancer. Its ability to be propagated as a fine dust makes it a deadly aerosol.

### Barium

as Barium Chloride, lethal concentration is .2 to 1 gram  
as Barium Carbonate, Hydroxide, Nitrate, Acetate, and Sulfide, requires 15 to 20 grams to be effective as an oral poison.

Barium Sulfate is not absorbed and is used as an X-Ray contrast medium at hospitals to examine the digestive tract.

The Barium compounds listed are found in rat poisons, fireworks, paints, plastics, and in purer forms in chemical and laboratory supply houses. The one gram dose of both arsenic and barium chloride required to be fatal can be carried under a fingernail. A single deep scratch containing the listed dose can be lethal. Death occurs after a cascade of excruciating symptoms and there is no antidote.



## **Scientific Principles of Improvised Warfare and Home Defense**

### **Carbon Monoxide**

causes harm by depriving the body of oxygen. It binds to blood hemoglobin, displacing oxygen at the binding site as well as preventing the release of oxygen at the tissues. Carbon Monoxide is responsible for more accidental poisonings than any other agent on earth and is widely used in suicides and euthanasia.

Carbon Monoxide is produced from engine combustion (tailpipes) and other sources of combustion. It reaches lethal concentrations in enclosed garages in minutes. Forest fires generate enormous quantities, but the gas rapidly dissipates with the prevailing winds.

As CO levels increase, the central nervous system becomes depressed to the point where breathing stops. This effect causes drowsiness in the early stages and quietly incapacitates the individuals without generally causing pain. It has been used by Dr. Kevorkian in assisted suicides.

### **Ethylene Di Bromide**

is a heavy liquid with a chloroform like odor. It becomes a gas at 40 degrees F making it a highly toxic fumigant. Once used as a pesticide ( it has been banned ), it is still used in textile and PVC cleaning, metal degreasing, grain fumigation (overseas), and manufacturing paints, varnish removers, and soap.

EDB is acutely toxic by inhalation and dermally. Poisoning deaths result from circulatory and respiratory failure. A huge range of organ damage and cancers are caused by sublethal exposures.

### **Formaldehyde**

used as a preservative embalming fluid, fumigant, and disinfectant. It is widely used in the plastics and ceramics industry and is used in a water-alcohol solution in classroom frog dissections. Formaldehyde is lethal at air concentrations of 100 PPM which can be quickly reached by heating alcohol/water solutions containing this compound.

### **Mercury**

is the silver white liquid metal in thermometers. It is a potent neurotoxin that causes nervous system damage and produces " mad as a hatter" symptoms at sublethal exposures. Upon heating, mercury forms a more toxic vapor.

Mercury is found in thermometers, batteries, lamps, switches, and as an antimildew agent in paints. It can kill by ingestion, inhalation, and skin absorption in all its inorganic forms. It can produce symptoms at dosages as low as 40 micrograms ( as small as a single grain of dust ).

# Scientific Principles of Improvised Warfare and Home Defense

## Nitrogen Dioxide

is a yellowish brown gas that gives smog its brownish color. It is produced during automobile combustion and subsequent atmospheric chemical reactions. It can be produced by "burning" Nitric Acid with incendiaries. It causes deep lung damage that is largely symptomless except at high concentrations. Five to seventy two hours later, a progressive inflammation sets in leading to pulmonary edema and death. Occasionally, farm workers have died in silos with high concentrations of nitrogen dioxide without even being aware of any exposure. It can kill at doses as low as 10 PPM in air.

## Selenium

Obtained in feed and health food stores, it can be concentrated by mixing with water and leaching out from the insoluble carriers through a filter. The water is allowed to evaporate leaving high concentrations of selenium behind. 100 to 200 micrograms per day is recommended as a nutritional intake. At 1-5 grams daily exposure, early symptoms of hair loss and fingernail disfigurement occur and precede eventual death.

## 6) Nerve Agents

The phosphorus containing nerve gases are among the most deadly chemically (not biologically) produced poisons known to man. They block nervous system activity and cause death either very quickly or agonizingly slowly, depending on exposure conditions. Developed in Germany and Great Britain during WW2, and improved over the last 40 years, these gases are colorless, generally odorless, and toxic at tiny concentrations. They can be absorbed by inhalation, ingestion, through the skin, and the eyes.

One of the first gases developed was

### **Di isopropyl phosphoro fluoridate (DFP)**

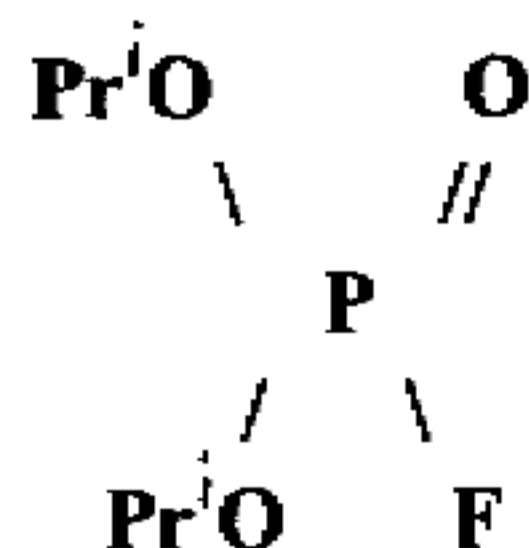

## Scientific Principles of Improvised Warfare and Home Defense

The starting material for all the nerve gases is **Phosphoric Acid (H<sub>3</sub>PO<sub>4</sub>)**

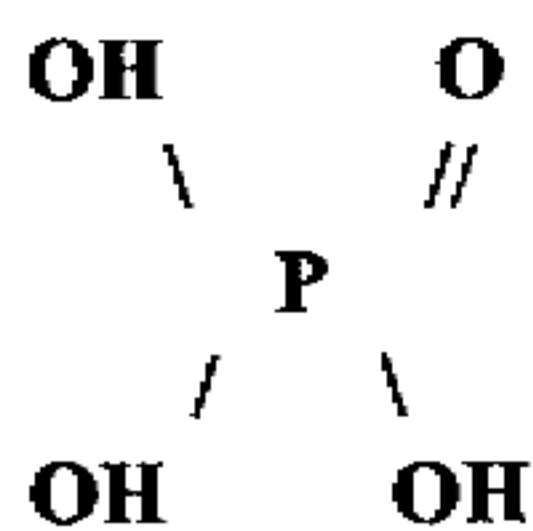

by substituting other groups attached to the phosphoric acid, other toxic nerve gases are formed.

The hydrogen-oxygen is replaced by reacting the phosphoric acid with the appropriate base or salt to produce the following structures

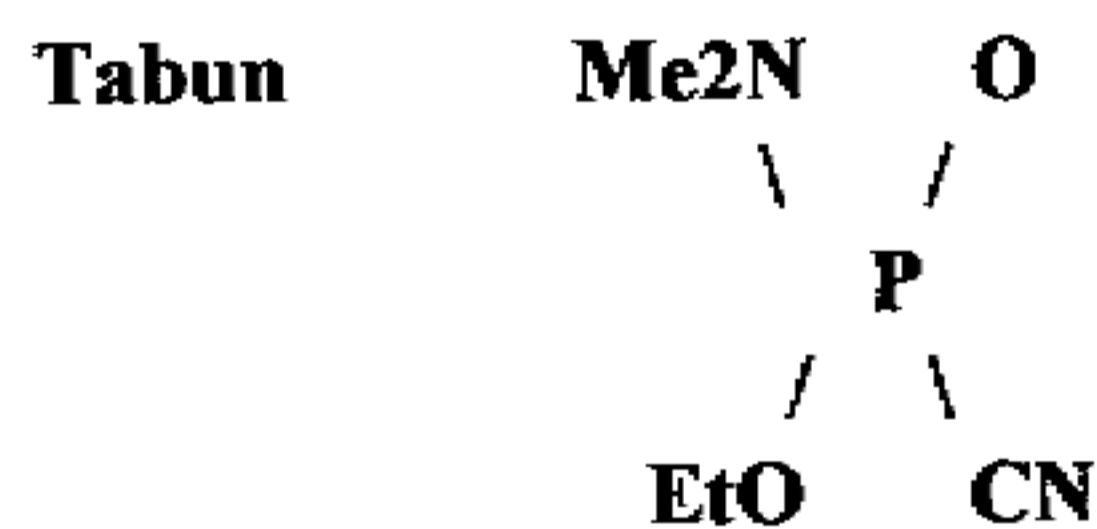
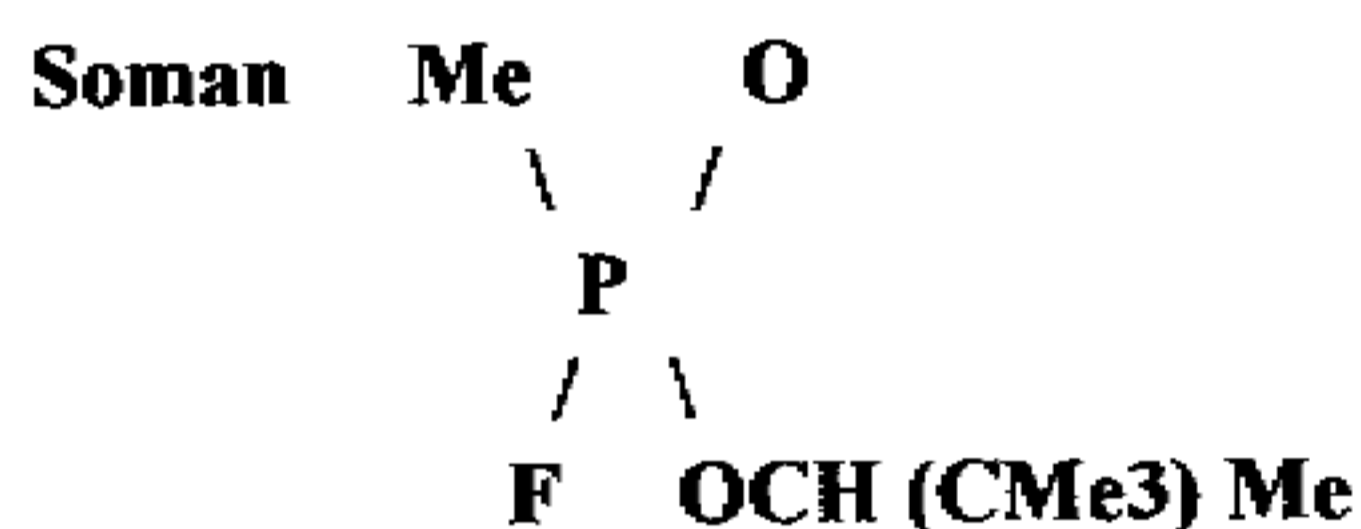
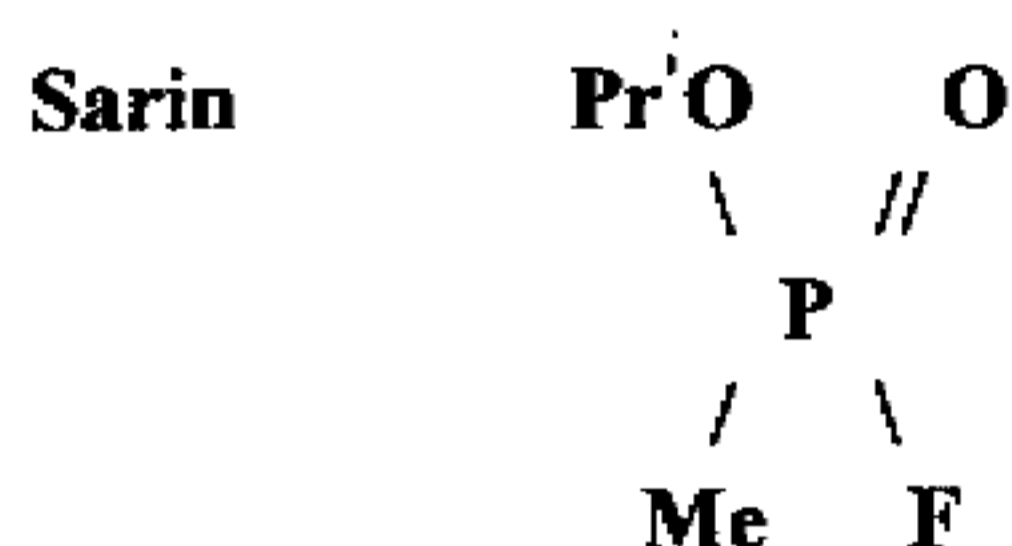

For example: **Sarin** can be prepared by mixing

Methylphosphonic Acid CH<sub>3</sub> PO<sub>4</sub> (OH)<sub>2</sub>  
 plus  
 Chlorine  
 to yield  
 Methylphosphonic Dichloride

## Scientific Principles of Improvised Warfare and Home Defense

This is then mixed with  
Isopropyl alcohol (CH<sub>3</sub>)<sub>2</sub> CHOH

This produces one part of the binary weapon

The 2nd part of the weapon is Hydrofluoric Acid (HF) or Sodium Fluoride which is mixed with the above compound. The Sarin gas is produced by the substituting of the fluorine into the phosphorus formula which by now is moderately toxic by itself. Sarin gas can kill at concentrations as low as 1 PPM continuously. A single gas contact on a scratch or cut may be enough to kill.

**Tabun** can be similarly prepared by the reaction

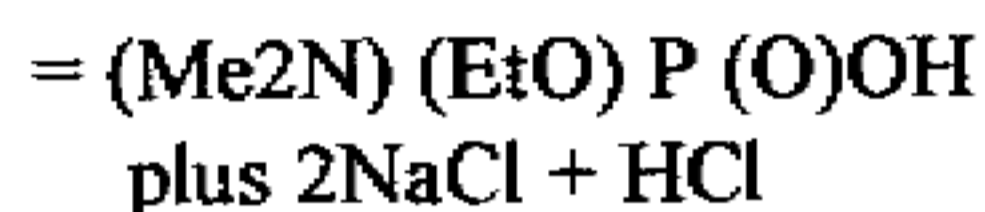

**Sarin** is extremely corrosive and silver lined vessels are the preferred storage containers if it is stored in final form.

Most of the poison gas molecules can be broken down quickly by the action of ammonia-water and/or hot Nitric Acid.

Nerve gases much more toxic than these have been developed in Europe, USA, and the former USSR, by substitutions in the phosphate molecules. These formulas are not in the public domain and are presumed to be classified secret and top secret.

Two other nerve gases are

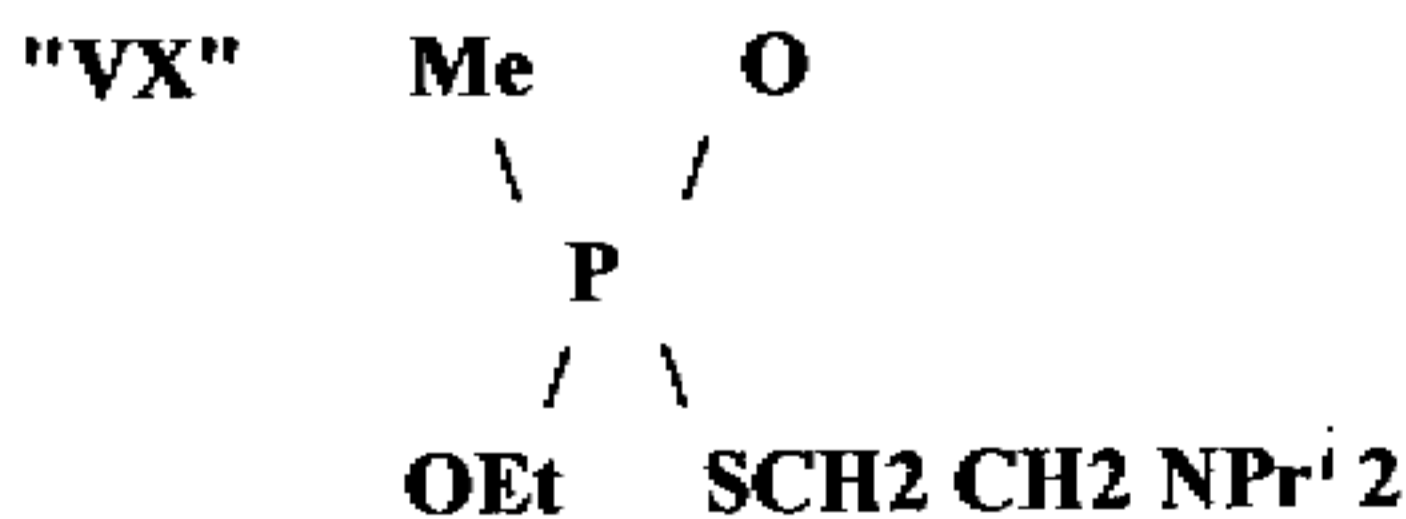
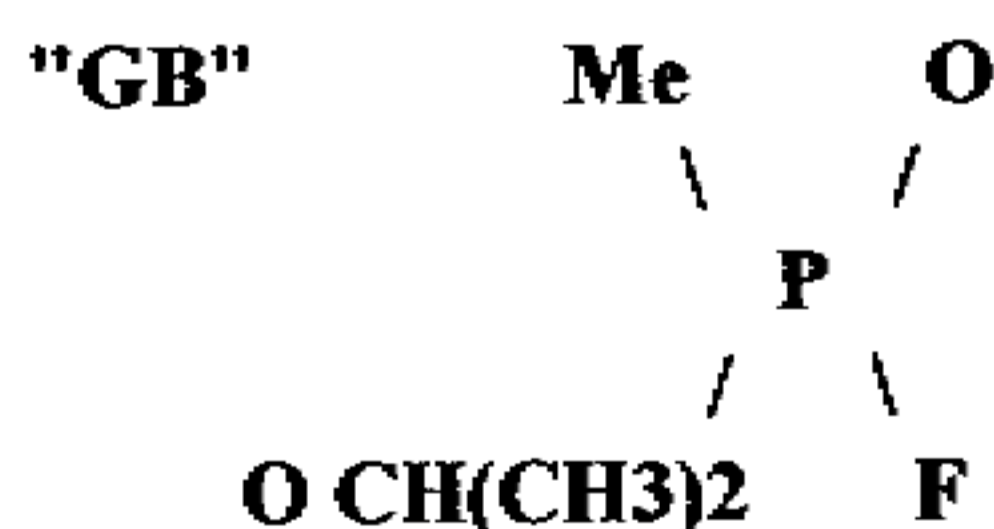



## Scientific Principles of Improvised Warfare and Home Defense

The lethal dose (LD50) in rabbits in mg/kg (PPM) of body weight are

	<u>Formula</u>	<u>LD50</u>
Phosphate	$(Pr^iO)_2 P (O)F$	.45
Phosphonate	$(Pr^iO) Me P (O)F$	.017
Phosphate	$(EtO)_2 P(O) SCH_2CH_2NPr_2$	.08
Phosphonate	$(EtO) MeP(O)SCH_2CH_2NPr_2$	.009

As illustrated here, the Phosphonate formulas can be 10-30 times more deadly than the phosphate forms.

A single breath of most nerve gases is fatal with toxicity as high as 10 micrograms per Kg exposures in air, skin, or ingested doses. Because they kill so quickly it is difficult to counteract their effects. In the movie "The Rock" actor Nicholas Cage plays a scientist who saves his own life after exposure to nerve gas by injecting Atropine directly into his own heart. In real life, Atropine, when injected into the thigh or butt muscle in large amounts, can relieve some symptoms, provided the recipient isn't already dead. More effective compounds than atropine have been developed such as Pyridine Aldoxime Methiodide which is effective in lower concentrations and is a suitable antidote if given in time. Most nerve gases have been disposed of in sea water which generally breaks them down into non toxic derivatives over time. Some of the more advanced formulas resist this breakdown and must be incinerated at high temperatures to insure their decomposition.

Some esters such as  $CH_3.CH_2-C(CH_2-O)_3 P=O$  produce convulsions and rapid death at low exposures. They do not act as cholinesterase inhibitors and there is no antidote.

[Authors Note: Making nerve gas is easy. Making it without killing yourself is hard. This is why only governments, large corporations, and other similar sized institutions attempt its manufacture. They are the only ones able to marshall the scientific and technical competencies to do it safely.]

### 7) Anesthesia Chemicals

This group of chemicals is used to induce loss of sensation and unconsciousness, generally for the purpose of preventing pain and discomfort during surgery or during transport of wounded on battlefields. These drugs are given by injection, inhalation, or both. Until the 1840's, natural substances such as opium, cannabis, and alcohol were used. In 1946, ether was first used and soon followed by chloroform and nitrous oxide.



## Scientific Principles of Improvised Warfare and Home Defense

In some situations where individuals need to be overcome, it is often desirable to do so without using deadly force. Anesthesia may be ideally suited for incapacitating hostile targets who may be prepared to use lethal force against you. Problems with this idea have centered around a reliable means of delivery (covered later in this chapter) and with the following possible side effects of high concentrations in air of the chosen anesthesia such as:

Hypertension (low blood pressure)	Cardiac Arrhythmia (irregular heartbeat)
Myocardial infarction (heart attack)	Inhibited respiration
Airway obstruction	Febrile reactions (fever)
Allergic reactions	Nausea
Vomiting	Aspiration (inhaling vomit into the lungs)
Hypoxia	Physical Injury (Muscle cramps and brain damage)
Death	

If your goal is to overcome individuals using this class of chemicals and to maintain their survival and health (if possible and reasonable) then a trained physician, preferably an anesthesiologist should accompany the force during the assault on targeted individuals. The following chemicals are used for anesthesia.

**Diazepam:** A central nervous system depressant (tranquilizer), it is a solid crystalline powder. One gram dissolves in 30 grams of water or 15 ml of alcohol, or 2 ml. of chloroform.

**Morphine:** A white crystalline alkaloid, extracted from opium (opium = 10% Morphine) by boiling in solution, filtering and evaporation-crystallization. Morphine is a narcotic.

**Atropine:** An Alkaloid obtained by leaching finely ground plant species of Atropa, Datura stamonium, or Hyoscyamus, in alcohol, ether, chloroform, or glycerol. It is an anesthetic and antidote for nerve gases. Other poisonous alkaloids are present in these plant species. The laboratory procedures for extraction and recovery from these plant species are published in the various scientific journals at most Universities and should be carefully followed.

**Thiopental Sodium:** A rapidly acting injected barbiturate used for both anesthesia and hypnosis. Commonly known as Sodium Pentathol or "truth serum", it is a serious respiratory failure hazard.

**Nitrous Oxide:** Is used as a propellant gas in food aerosols and as a gaseous anesthetic in dentistry and surgery. It can form an explosive mixture with air. It is widely available from bottled gas suppliers.

**Halothane:** FDA approved anesthetic gas as 2-bromo-2-chloro-1,1,1-trifluoroethane (CF<sub>3</sub>BrCl)

**Euflurane and Isoflurane:** other FDA approved anesthetic gases.

# Scientific Principles of Improvised Warfare and Home Defense

## E) Incendiary Weapons

Fire is one of the earliest weapons used by man. Its effectiveness has generally been limited by the difficulty of delivering it. Aerial bombing has become the most effective delivery means today as the fire bombing of Dresden and Tokyo during WW2 has illustrated.

1. **Molotov cocktails** are often the only improvised fire weapon available and consists of bottles filled with gasoline with a rag or wicks in the neck to act as a fuse.

2. **Incendiary grenades** usually contains white phosphorus which ignites on contact with air. It is usually issued as the primary incendiary weapon for foot soldiers.

3. **Flame throwers** squirt a flammable liquid out in a jet spray and is ignited by a hand controlled device. Soldiers wear full body protective clothing while operating flame throwers.

4. **Incendiary bullets**, artillery shells, one shot cartridges for tanks and flame throwers, and bombs have all been used to set fire to buildings and brush in enemy hands.

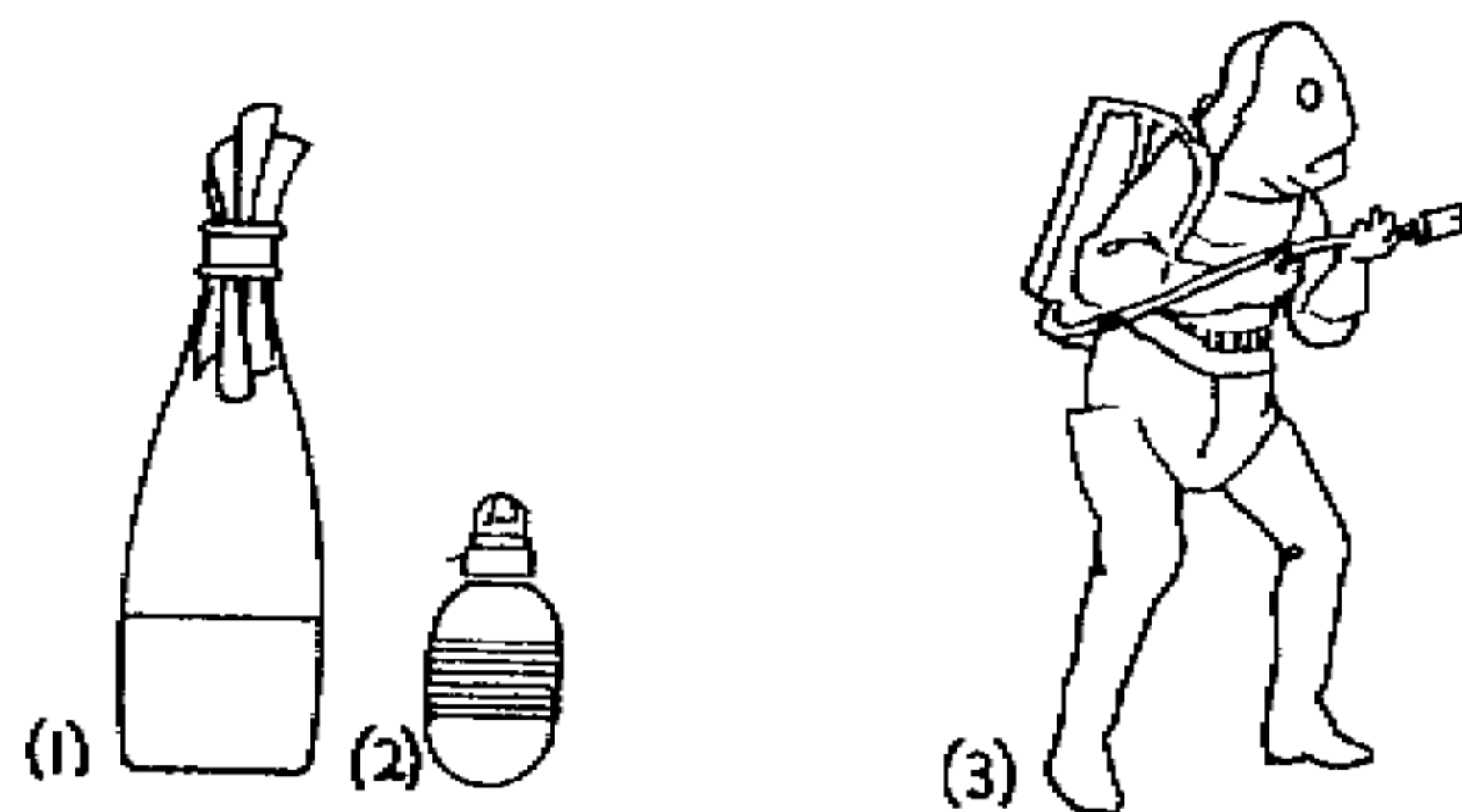

Some incendiaries are designed to burn the oxygen in the air.

Others use an oxidizing agent. Modern incendiary ingredients include

Igniters:	White Phosphorus Zirconium Depleted Uranium	Ignites spontaneously in air Produces sparks of very high temperature " "
Metals:	Magnesium Aluminum	Burns by itself in air with intense heat Burns in air with other combustibles
Pyrotechnic Mixtures:	Thermite Thermate	Powdered Iron Oxide and Powdered Aluminum Thermite + Pyrotechnic mixtures
Oil Based	Napalm Napalm B	50% Polystyrene thickener, 25% Benzene and 25% Gasoline

## Scientific Principles of Improvised Warfare and Home Defense

The original Napalm, invented in 1943, derived its name from the aluminum naphthenate and aluminum palmate that were used to thicken gasoline into a gel. Napalm B is actually a liquid rather than a gel, but it burns at 1562 degrees F for about 2-3 times as long causing more severe burning and has adhesive properties.

Incendiary bombing generally consists of 3 kinds of intended purpose

1. Intensive point bombing using very high temperature formulas to burn down the targets at the point of impact.
2. Area bombing in which a bomb bursts and spread burning fuel over a large area and causes multiple fire and has anti-personnel effects.
3. Firestorm bombing where enough incendiaries are dropped on a city or other large area to cause large masses of rising gas that result in gale force winds rushing in to fill the void feeding and greatly intensifying the flames.

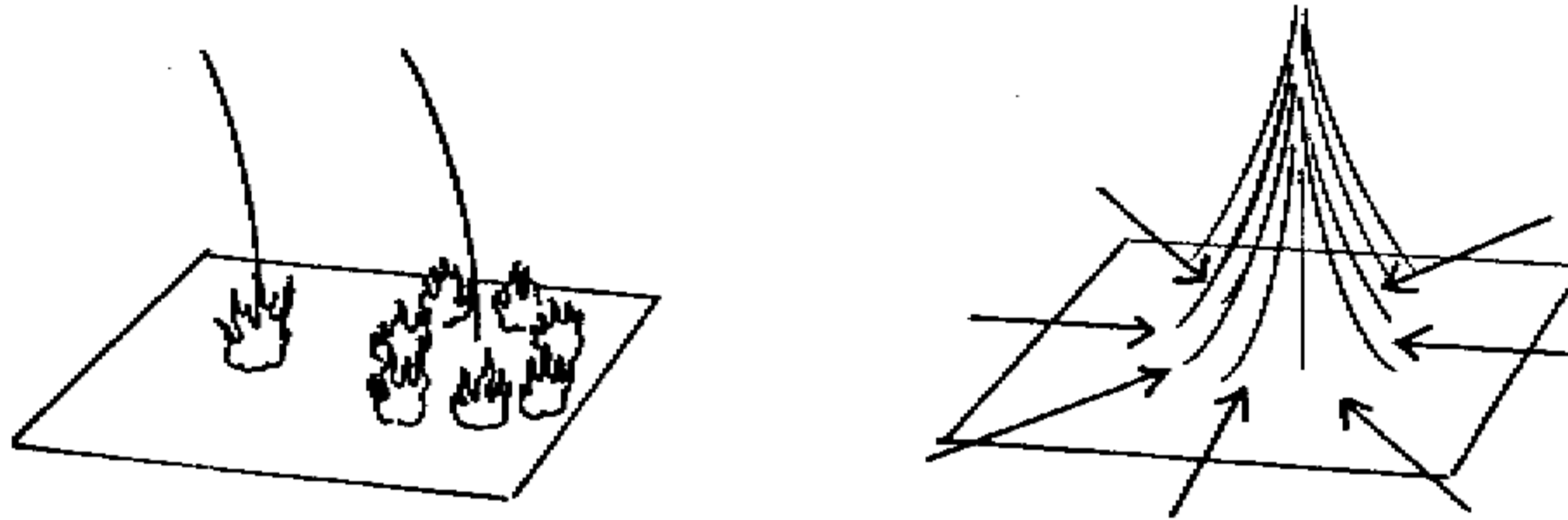

The following improvised incendiaries come from the US Army Improvised Munitions Handbook

1. Chemical Fire Bottle
2. Igniter from book matches
3. Mechanically initiated fire bottle
4. Gelled Flame Fuels -Lye Systems
5. Lye Alcohol Systems
6. Soap Alcohol Systems
7. Egg Systems
8. Latex Systems
9. Wax Systems
10. Animal Blood Systems
11. Acid Delay Incendiary

# Scientific Principles of Improvised Warfare and Home Defense

## 1) Chemical Fire Bottle

This incendiary bottle is self igniting on target impact

### Materials Required

- Sulfuric Acid
- Gasoline
- Potassium Chlorate
- Sugar
- Glass Bottle with stopper ( 1 quart )
- Small bottle or jar with lid
- Rag or absorbent paper such as paper towels or newspaper
- String or rubber bands

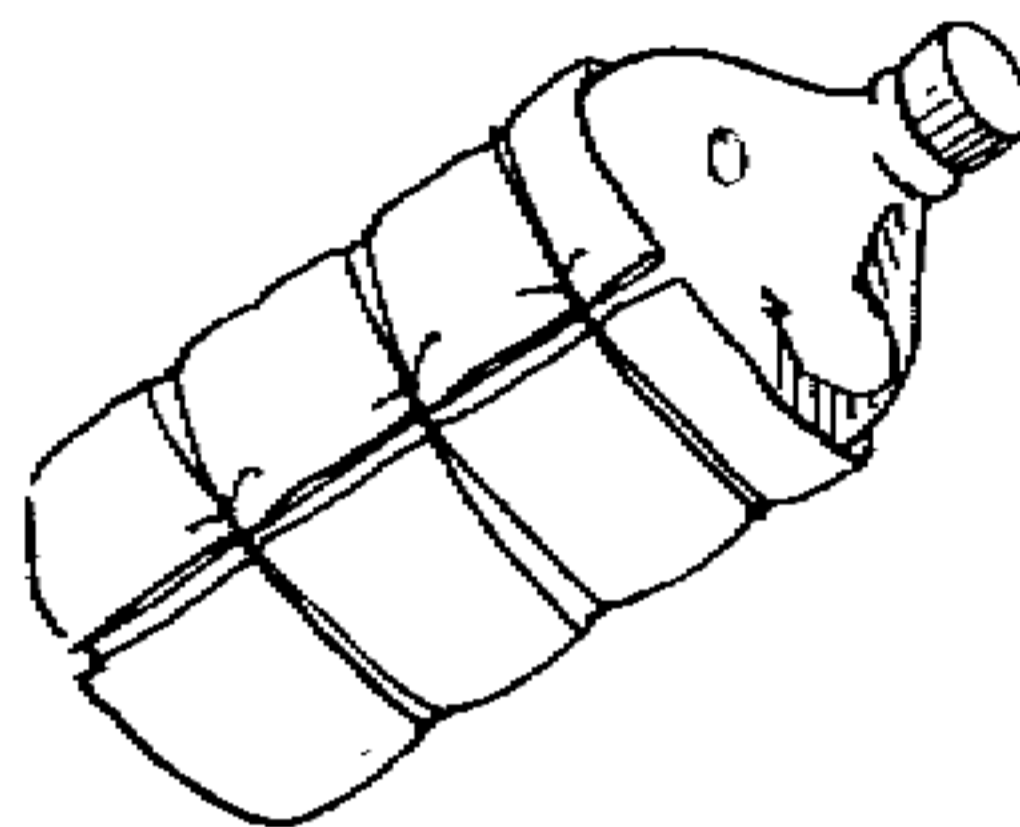

### Procedure

1. Sulfuric Acid must be concentrated. If battery acid or other dilute acid is used, concentrate it by boiling until dense white fumes are given off. Container used should be of enamel ware or oven glass.
2. Remove the acid from heat and allow to cool at room temperature.
3. Pour gasoline into the large ( 1 quart ) bottle until it is app. 2/3 full.
4. Add concentrated sulfuric acid to gasoline slowly until the bottle is filled to within 1" to 2" from top. Place the stopper on the bottle.
5. Wash the outside of the bottle thoroughly with clear water.

**Caution:** If this is not done the bottle may be dangerous to handle.

6. Wrap a clean cloth or several sheets of absorbent paper around the outside of the bottle. Tie with string or fasten with rubber bands.

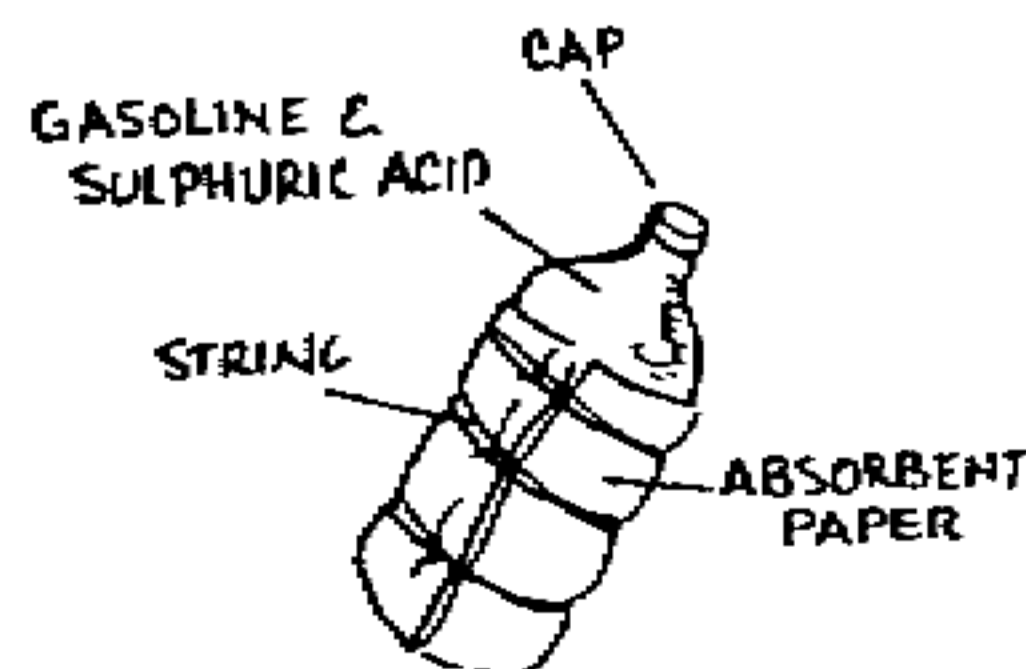

## Scientific Principles of Improvised Warfare and Home Defense

7. Dissolve 1/2 cup of potassium chlorate and 1/2 cup of sugar in one cup of boiling water.
8. Allow the solution to cool, pour into the small bottle and cap tightly. The cooled solution should be 2/3 crystals and 1/3 liquid. If there is more liquid than this, pour off excess before using.

**Caution:** Store this bottle separately from the large bottle.

### How to use

1. Shake the small bottle to mix contents and pour onto the cloth or paper around the large bottle.

Bottle can be used wet or after solution has dried. However, when dry, the sugar-potassium chlorate mixture is very sensitive to spark or flame.

2. Throw or launch the bottle. When the bottle breaks against a hard surface (target) the fuel will ignite.

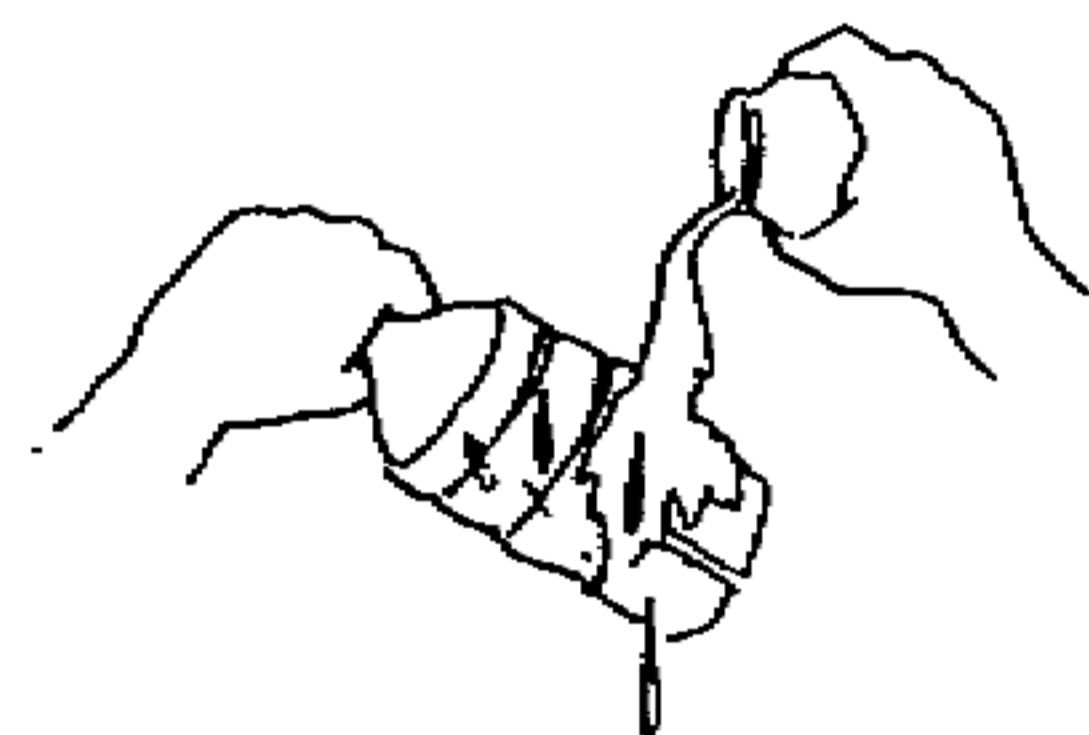



# Scientific Principles of Improvised Warfare and Home Defense

## 2) Igniter from book matches

This is a high temperature igniter made from paper book matches for use with Molotov cocktail and other incendiaries.

### Materials Required

Paper book matches  
Adhesive or friction tape

### Procedure

1. Remove the staples from match book and separate matches from cover.

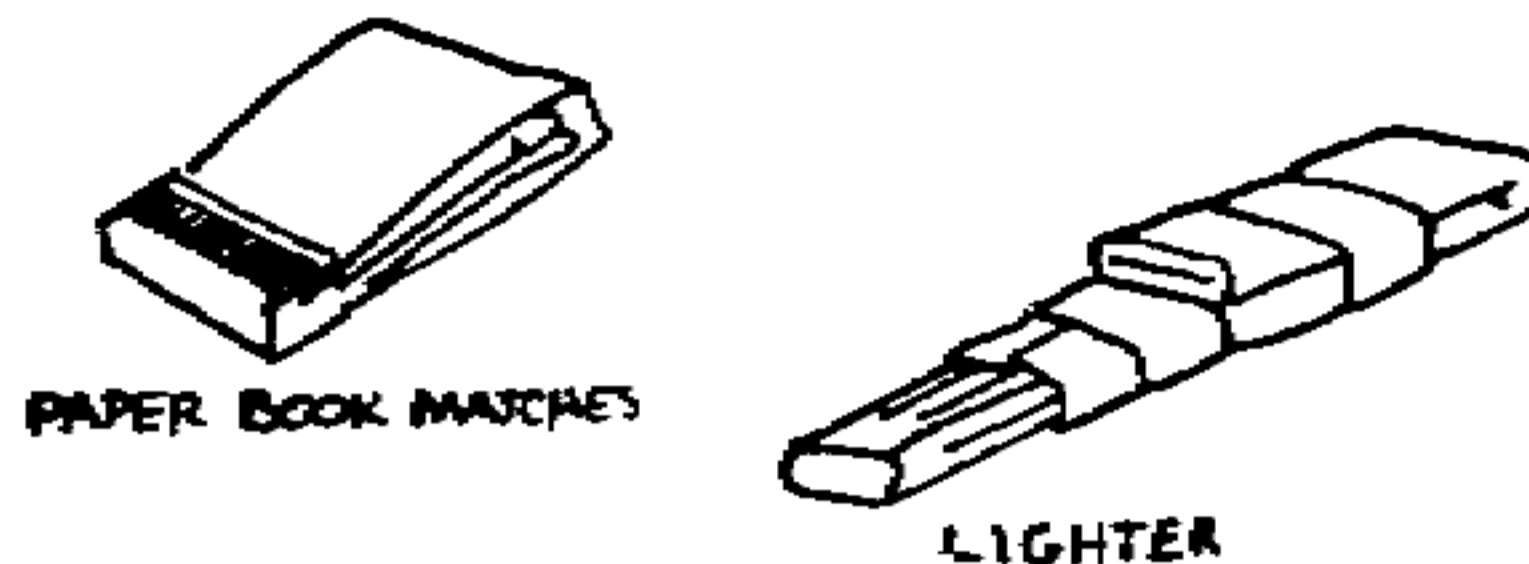

2. Fold and tape one row of matches.

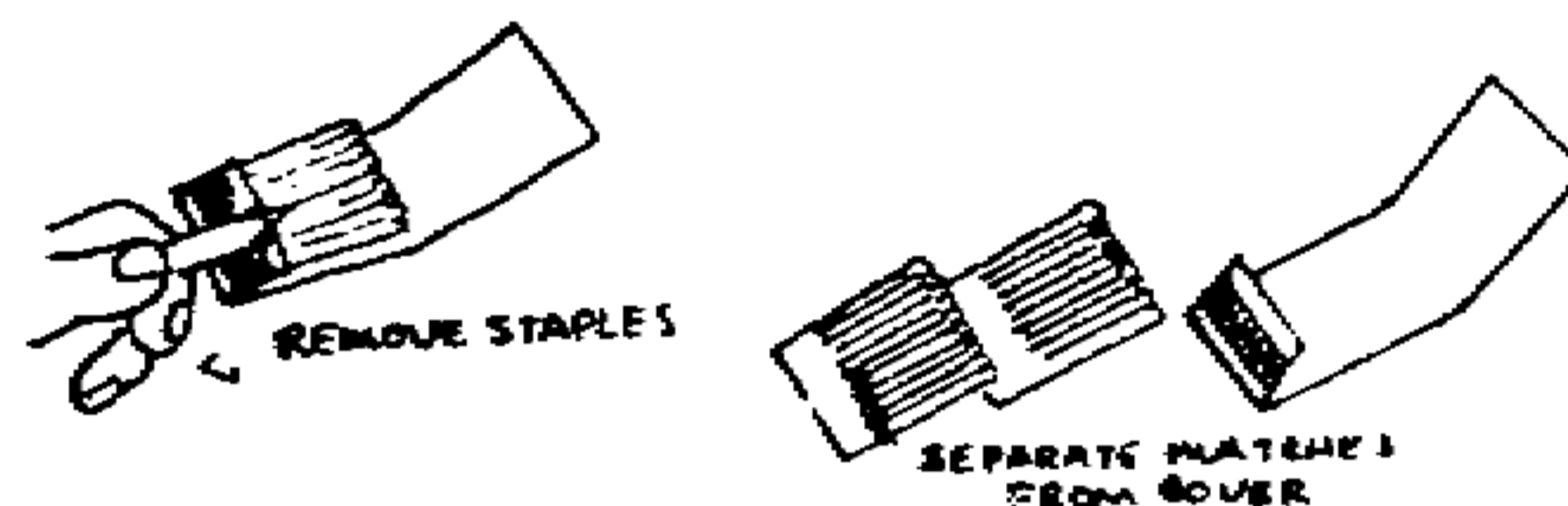

3. Shape the cover into a tube with striking surface on the inside and tape. Make sure the folded cover will fit tightly around the taped match heads. Leave cover open at opposite end for insertion of the matches.

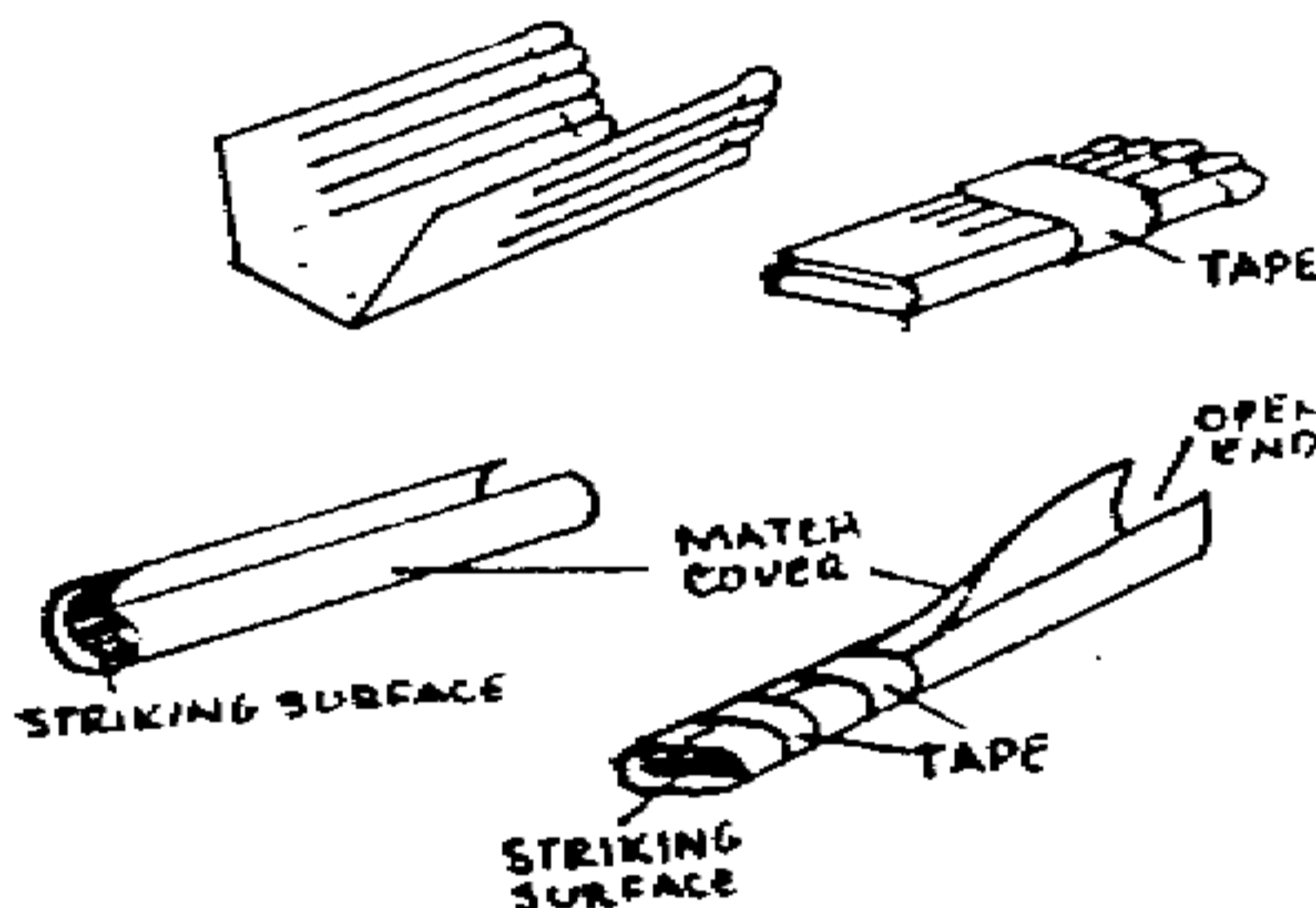

4. Push the taped matches into the tube until the bottom ends are exposed about 3/4".

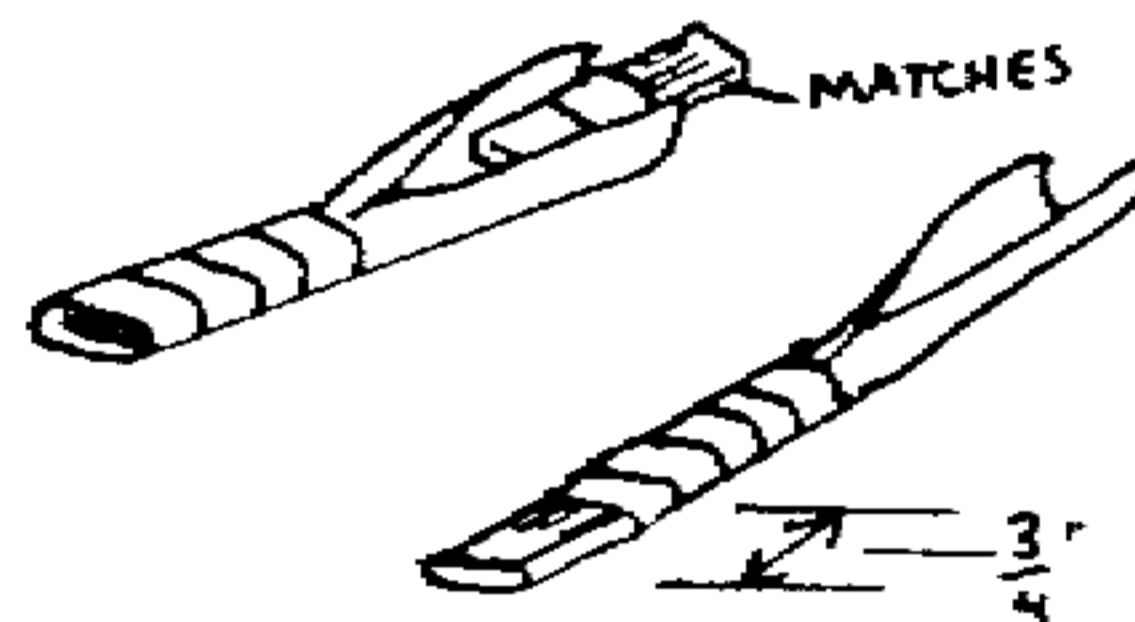

5. Flatten and fold the open end of the tube so that it laps over about 1" and tape in place.

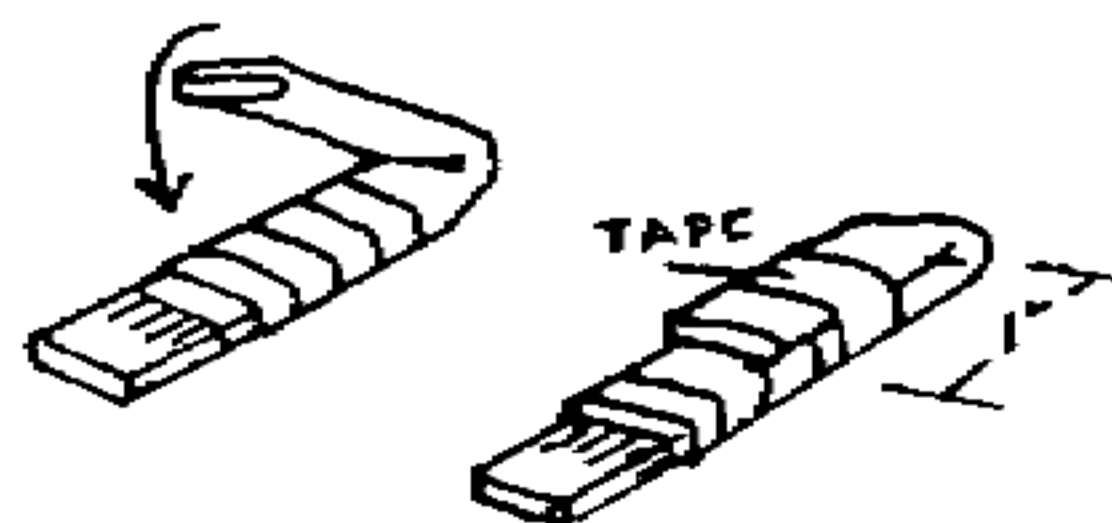

# Scientific Principles of Improvised Warfare and Home Defense

## Use with Molotov Cocktail

Tape the "match and tab" of the igniter to the neck of the molotov cocktail.

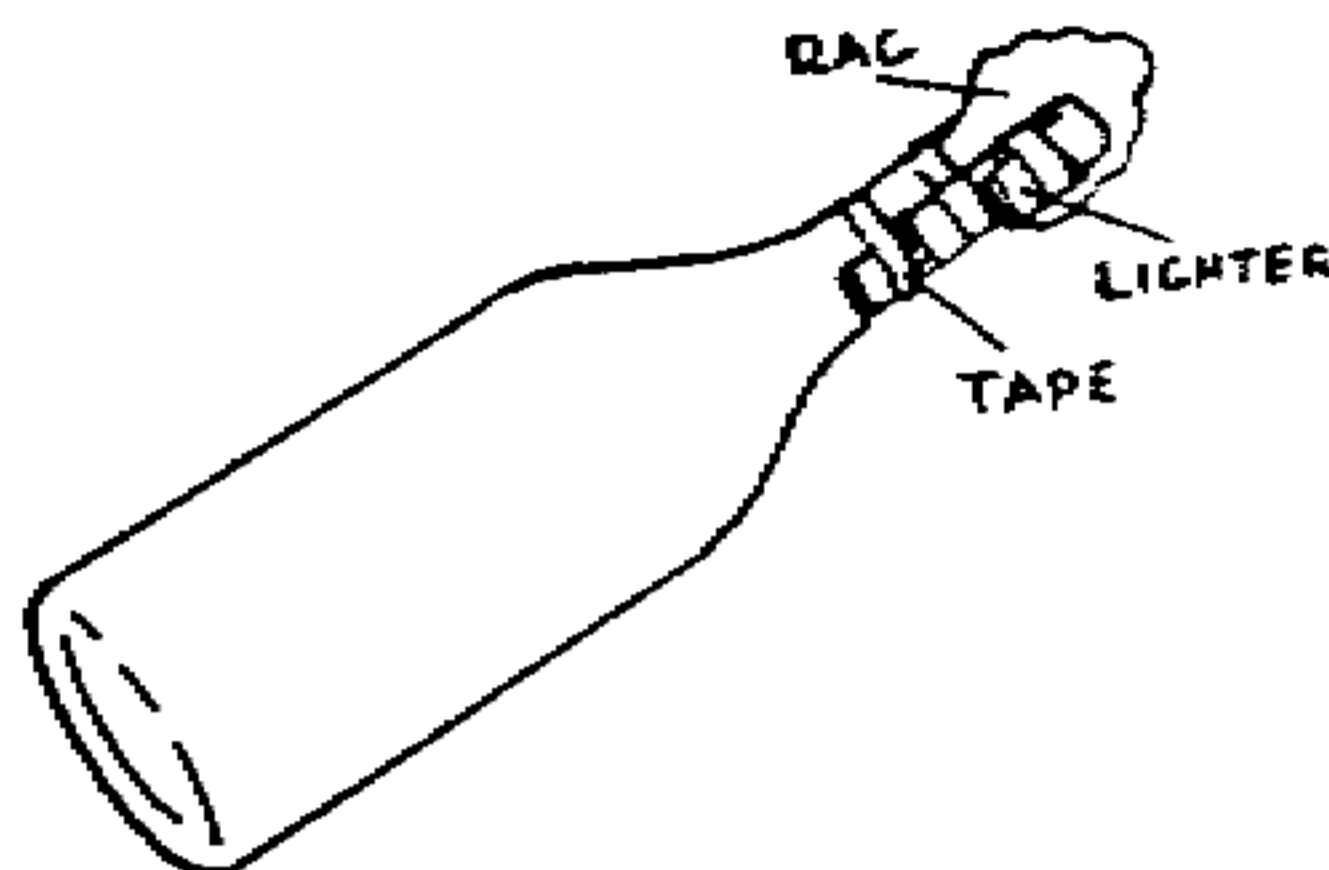

Grasp the "cover and tab" and pull sharply or quickly to ignite.

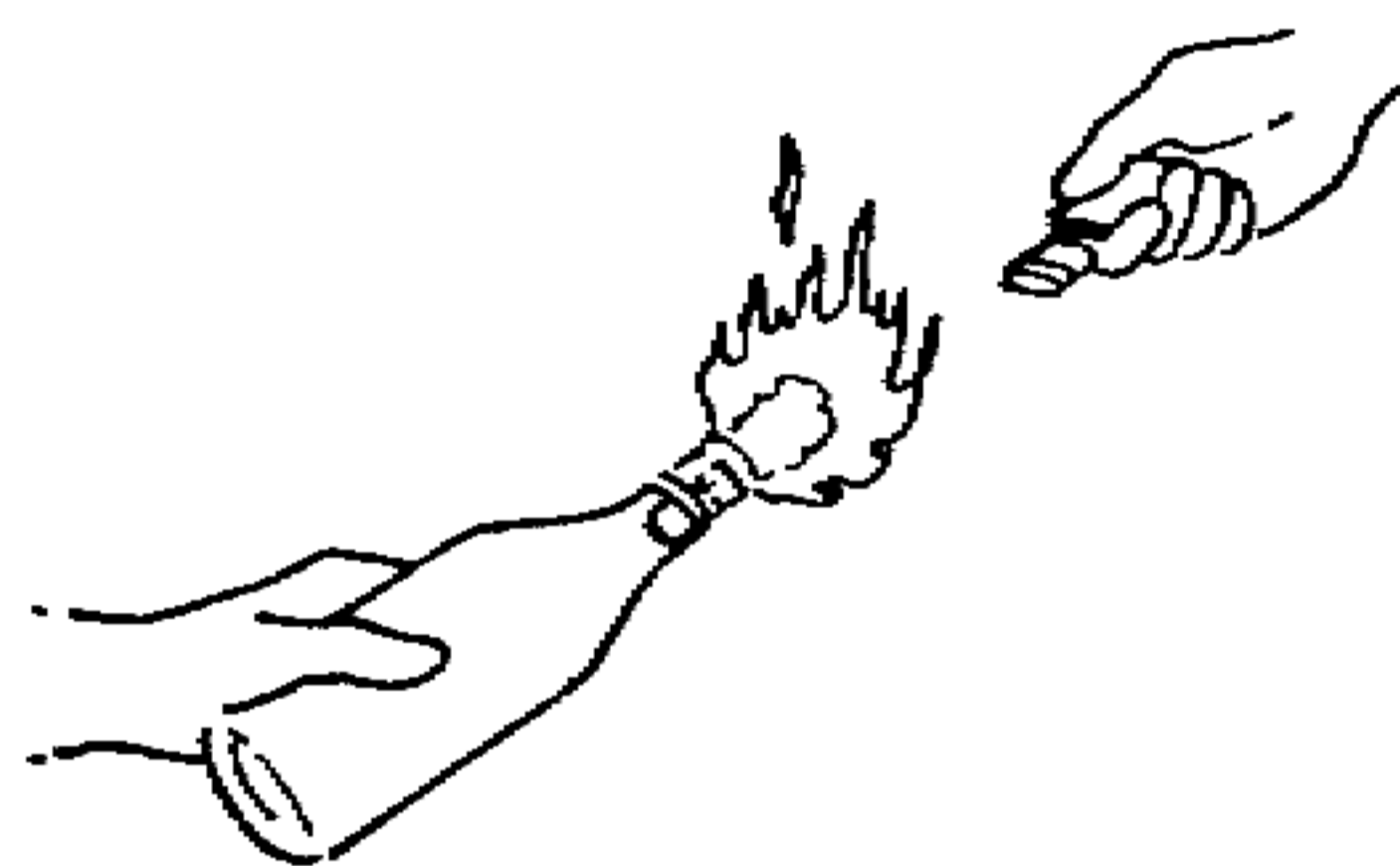

## General Use

The book match igniter can be used by itself to ignite flammable liquids, fuse cords and similar items requiring hot ignition.

**Caution:** Damp or wet paper book matches will not ignite.

# Scientific Principles of Improvised Warfare and Home Defense

## 3) Mechanically Initiated Fire Bottle

The mechanically initiated fire bottle is an incendiary device which ignites when thrown against a hard surface.

### Materials Required

- Glass, jar, or short necked bottle with a leakproof lid or stopper
- Tin can or similar container just large enough to fit over the lid of the jar
- Coil spring (compression) app. 1/2 the diameter of the can and 1-1/2 times as long
- Gasoline
- Four blue tip matches
- Flat stick or piece of metal ( 1/2" x 1/16" x 4" )
- Wire or heavy twine
- Adhesive tape

### Procedure

1. Draw or scratch 2 lines around the can- one 3/4" and the other 1-1/4" from the open end.

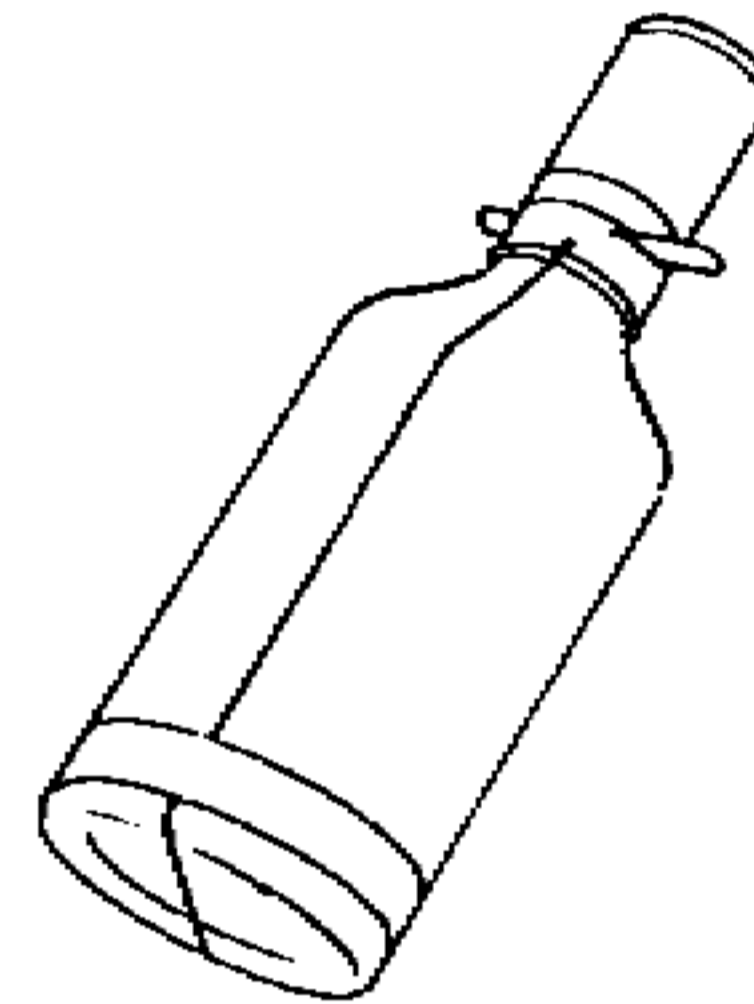

2. Cut 2 slots on opposite sides of the tin can at the line farthest from the open end. Make slots large enough for the flat stick or piece of metal to pass through.

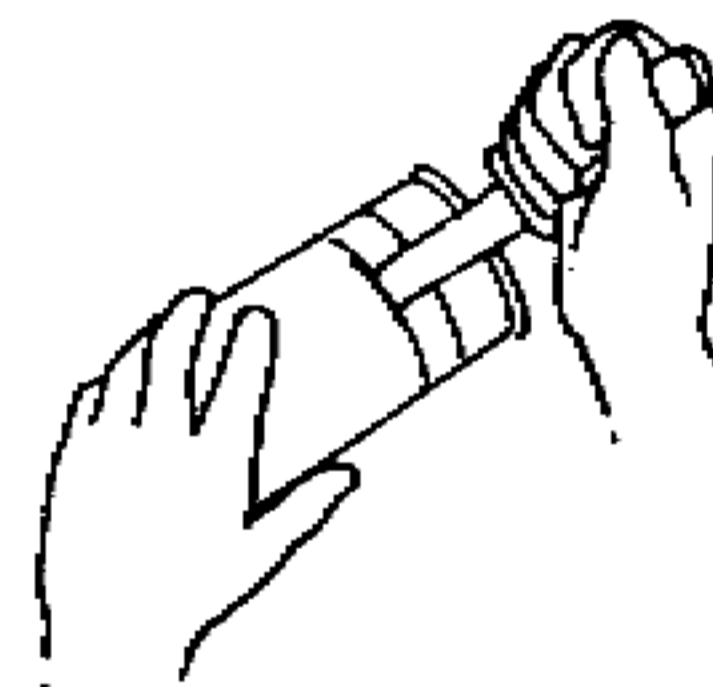
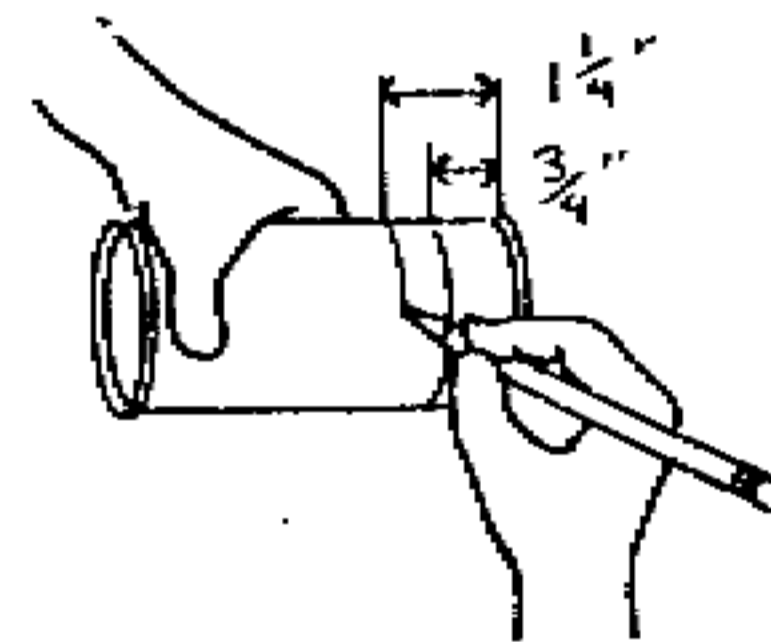

3. Punch 2 small holes just below the rim of the open end of the can.

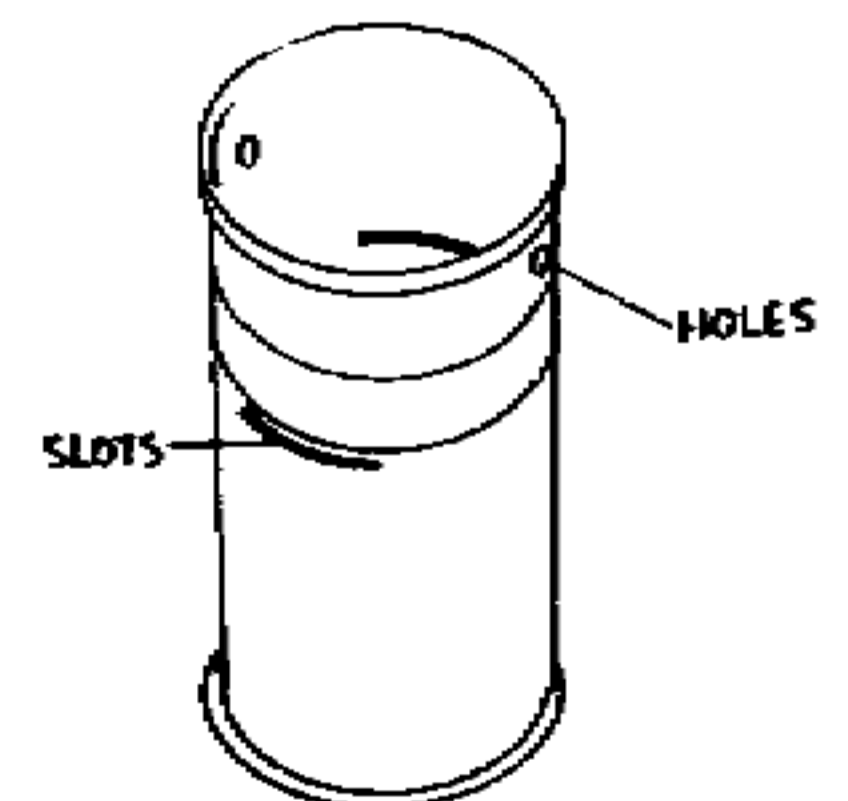

# Scientific Principles of Improvised Warfare and Home Defense

4. Tape blue tip matches together in pairs. The distance between the match heads should equal the inside diameter of the can. Two pairs are sufficient.

5. Attach paired matches to second and third coils of the spring, using thin wire.

6. Insert the end of the spring opposite the matches into the tin can.

7. Compress the spring until the end with the matches passes the slot in the can. Pass the flat stick or piece of metal through slots in can to hold spring in place. This acts as a safety device.

8. Punch many closely spaced small holes between the lines marked on the can to form a striking surface for the matches. Be careful not to seriously deform can.

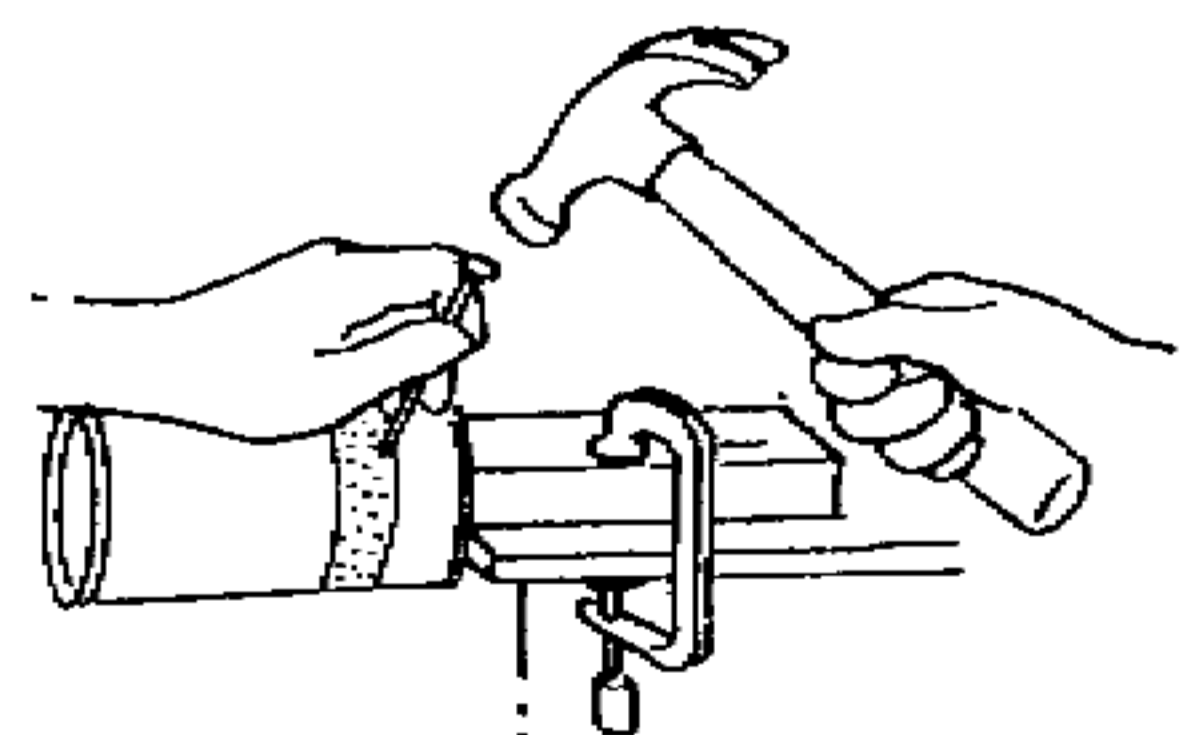
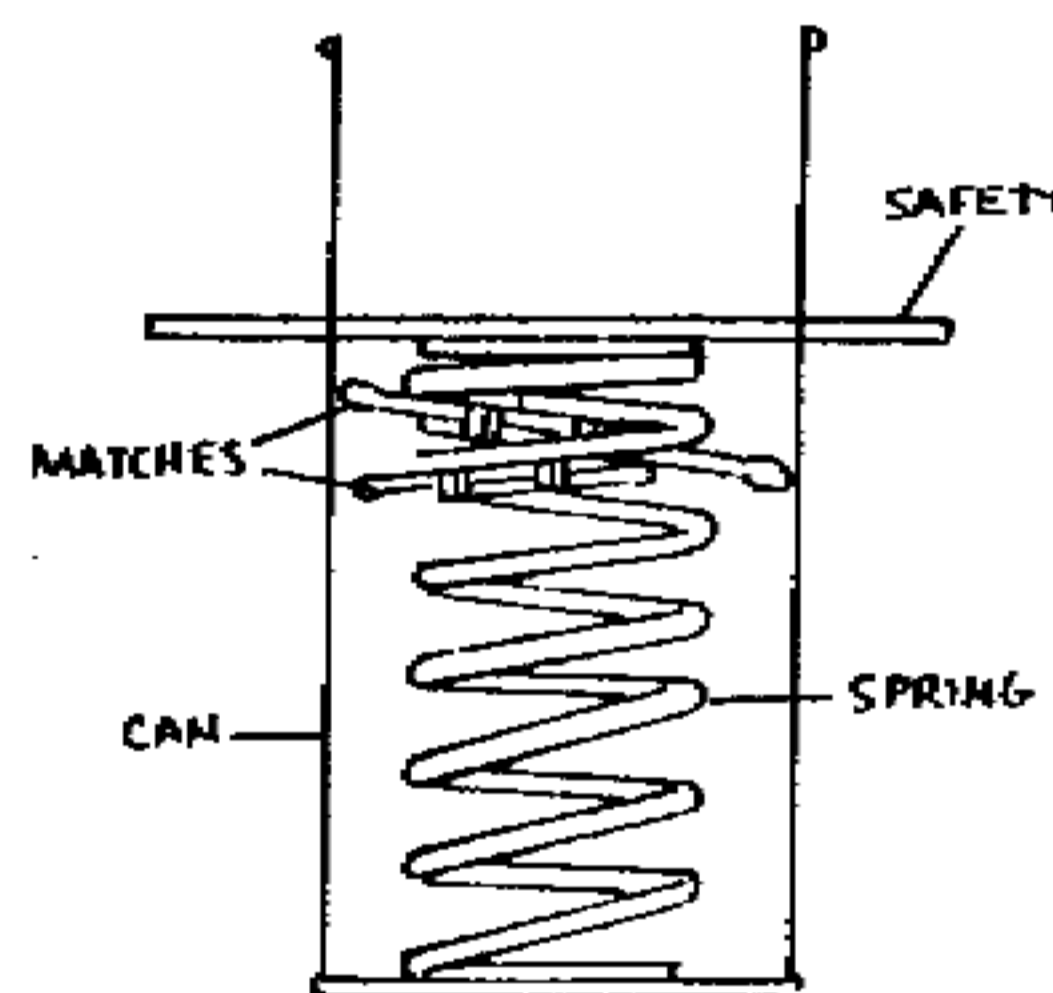
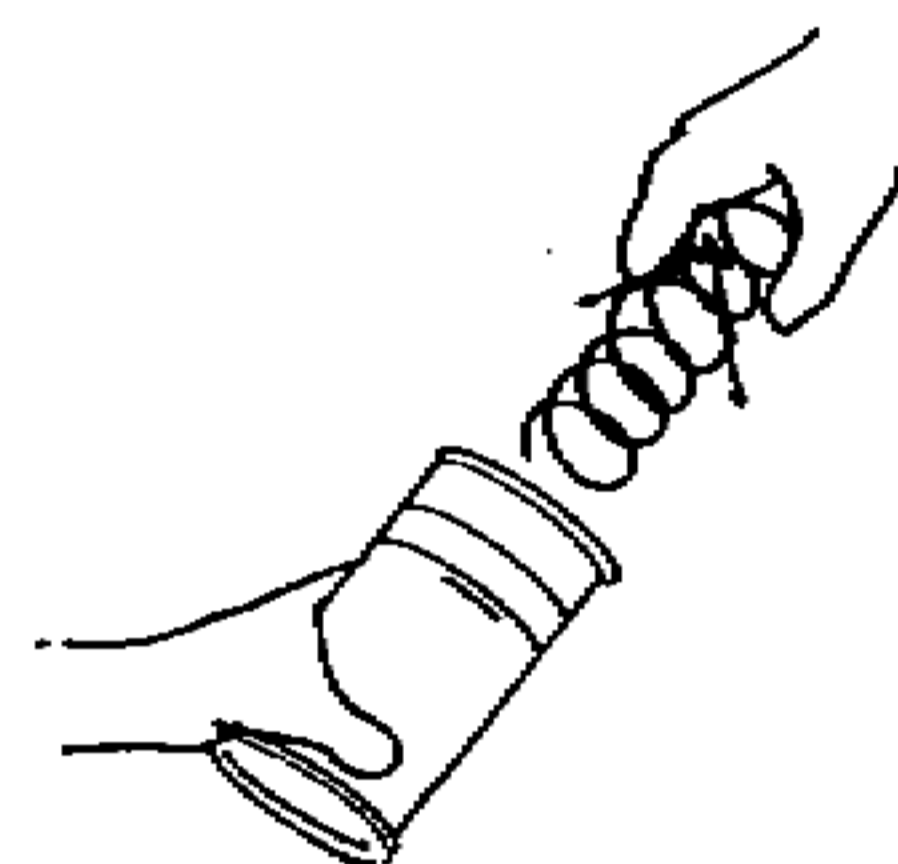
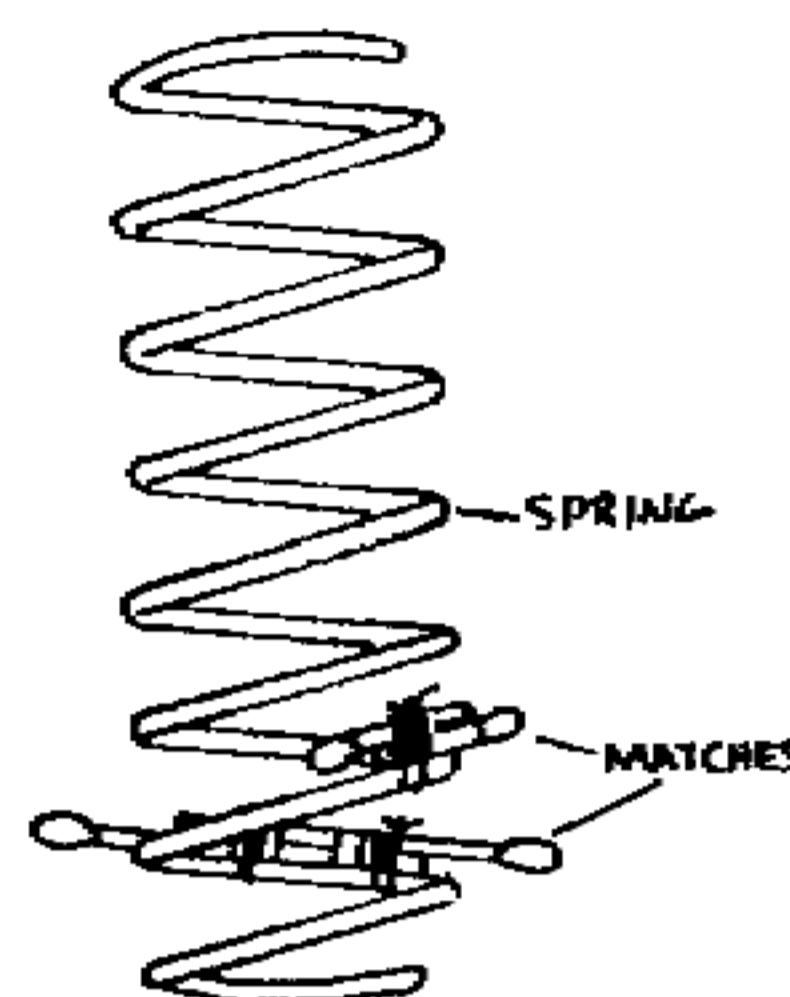

# Scientific Principles of Improvised Warfare and Home Defense

9. Fill the jar with gasoline and cap tightly.

10. Turn can over and place over the jar so that the safety stick rests on the lid of the jar.

11. Place wire or twine around the end of the jar. Thread end through holes in can and bind tightly to jar.



12. Tape wire or cord to jar near the bottom.



## How to use

1. Carefully withdraw flat safety stick.



2. Throw jar at hard surface.

[Authors note- 3. Run like crazy. (See, I still have a sense of humor).]



# Scientific Principles of Improvised Warfare and Home Defense

## 4) Gelled Flame Fuels - Lye Systems

Lye (caustic soda or sodium hydroxide) can be used in combination with powdered rosin or castor oil to gel gasoline for use as a flame fuel which will adhere to target surfaces.

**Note:** This fuel is NOT suitable for the chemical (sulfuric acid) fire bottle. The acid will react with the lye and break down the gel.

### Materials Required

<u>Parts by volume</u>	<u>Ingredient</u>	<u>How Used</u>	<u>Sources</u>
60	Gasoline	Motor fuel	Gas station
2 (Flake) or 1 (Powder)	Lye	Making Soap Drain Cleaner	Food or drug store
15	Rosin or Castor Oil	Mfg paint or varnish Medicine	Naval stores/Industry Food and drug stores

### Procedure

**Caution:** Make sure there are no open flames in the area when mixing the flame fuel.

1. Pour gasoline into jar, bottle, or other container. (Do not use an aluminum container)
2. If Rosin is in cake form, crush into small pieces.
3. Add Rosin or castor oil to the gasoline and stir for about 5 minutes to mix thoroughly.
4. In a second container (not aluminum), add lye to an equal volume of water slowly with stirring.

Caution: Lye solution can burn skin and destroy clothing. Wash away with water.

5. Add lye solution to the gasoline mix and stir until the mixture thickens.

**Note:** The sample will eventually thicken to a very firm paste. This can be thinned, if desired, by adding more gasoline.

# Scientific Principles of Improvised Warfare and Home Defense

## 5) Lye Alcohol Systems

Lye can be used in combination with alcohol and any of several fats to gel gasoline for use as a flame fuel.

**Note:** This fuel is not suitable for use in chemical fire bottle (sulfuric acid)

### Materials Required

<u>Parts by volume</u>	<u>Ingredient</u>	<u>How used</u>	<u>Common source</u>
60	Gasoline	Motor Fuel	Gas station
2 (flake) or 1 (powder)	Lye	Making soap Drain cleaner	Food or drug store
3	Ethyl alcohol	Whiskey, Medicine	Liqueur or drug store

**Note:** Methyl (wood) alcohol or isopropyl (rubbing) alcohol can be substituted for ethyl alcohol, but their use produces softer gels.

14	Tallow	Food/Making soap	Fat, rendered by cooking meat or suet of animals
----	--------	------------------	--

**Note:** The following can be substituted for the tallow

- a. Wool grease (lanolin-very good) -- fat extracted from sheeps wool
- b. Castor Oil
- c. Any vegetable oil (corn, cottonseed, peanut, linseed)
- d. Any fish oil
- e. Butter or oleomargarine

It is necessary when using substitutes (c) to (e) to double the amount of fat and lye for good bodying.

### Procedure (No smoking)

1. Pour gasoline into the bottle, jar or other container. (Do not use Aluminum container)
2. Add tallow (or substitute) to the gasoline and stir for about 1/2 minute to dissolve fat.
3. Add alcohol to the gasoline mixture.
4. In a separate container (not aluminum) slowly add lye to an equal amount of water. Mixture should be stirred constantly while adding lye.
5. Add lye solution to the gasoline mixture and stir occasionally until thickened (about 1/2 hour).

**Note:** This mixture will eventually thicken (1-2 days) to a very firm paste. This can be thinned, if desired by stirring in additional gasoline.

# Scientific Principles of Improvised Warfare and Home Defense

## 6) Soap Alcohol System

Common household soap can be used in combination with alcohol to gel gasoline for use as a flame fuel which will adhere to target surfaces.

### Material Required

<u>Parts by volume</u>	<u>Ingredients</u>	<u>How used</u>	<u>Common source</u>
36	Gasoline	Motor fuel	Gas station
1	Ethyl Alcohol	Whiskey/Medicine	Liqueur or drug store
<b>Note:</b> Methyl or Isopropyl alcohol may be substituted for the whiskey.			
20 (powdered) or 28 (flake)	Laundry soap	Washing clothes	stores

**Note:** Unless the word soap actually appears on the container, a washing compound is probably a detergent. These cannot be used.

### Procedure

#### **Caution: No smoking**

1. If bar soap is used, carve into thin flakes using a knife.
2. Pour alcohol and gasoline into a jar, bottle, or other container and mix thoroughly.
3. Add soap powder or flakes to gasoline-alcohol mix and stir occasionally until thickened (about 15 minutes).

# Scientific Principles of Improvised Warfare and Home Defense

## 7) Egg Systems

The white of any bird egg can be used to gel gasoline for use as a flame fuel which will adhere to target surfaces.

### Materials Required

<u>Parts by volume</u>	<u>Ingredient</u>	<u>How used</u>	<u>Common source</u>
85	Gasoline	Motor fuel	Gas station
14	Egg Whites	Food	Food store/Farms/Bird Nests
plus any one of the following			
1	Table Salt	Food	Sea water, food store
3	Ground coffee	Food	Coffee plant, food store
3	Dried tea leaves	Food	Tea plant, food store
3	Cocoa	Food	Cocoa trees, Food store
2	Sugar	Food	Sugar cane, food store
1	Salt peter	Explosives, matches	Drug store, improvised
1	Epsom salts	Medicine, mineral water	Drug store, food store
2	Washing soda	Washing cleaner, medicine	Food or drug store
1-1/2	Baking soda	Baking	Food or drug store
1-1/2	Aspirin	Medicine	Food or drug store

### Procedure

#### **Caution: No smoking**

1. Separate egg white from yolk. This can be done by breaking the egg into a dish and carefully removing the yolk with a spoon.

Note: Do not get the egg yolk mixed with into the egg white. If they get mixed, discard.

2. Pour egg white into a jar, bottle, or other container and add gasoline.

3. Add the salt (or other additive) to the mixture and stir occasionally until gel forms (about 5-10 minutes)

Note: A thicker gelled flame fuel can be obtained by putting the capped jar in hot (65 deg. C.) water for about 1/2 hour and letting them cool to room temperature. (DO NOT HEAT THE JELLED FUEL CONTAINING COFFEE).

# Scientific Principles of Improvised Warfare and Home Defense

## 8) Latex Systems

Any milky white plant fluid is a potential source of latex which can be used to gel gasoline.

### Materials required

<u>Ingredient</u>	<u>How used</u>	<u>Common source</u>
Gasoline	Motor Fuel	Gas station
Latex, commercial or natural	Paints, adhesives	Tree or plant, rubber cement
plus one of the following acids		
Acetic Acid (Vinegar)	Salad dressing, film developing	Food stores, photographic supply
Sulfuric Acid	Batteries, chem. processing	Motor vehicle batteries, Industry
Hydrochloric Acid	Industrial, pickling	Hardware stores, Industry

**Note:** If acids are not available, use acid salt such as aluminum sulfate or chloride or bi sulfates. Formic acid from crushed red ants can also be used.

### Procedure

#### **Caution: No smoking**

#### 1. With commercial rubber latex:

- a. Place 7 parts by volume of latex and 92 parts by volume of gasoline in a bottle. Cap bottle and shake and mix well.
- b. Add 1 part by volume of vinegar or other acid and shake until gel forms.

#### 2. With natural latex:

- a. Natural latex should form lumps as it comes from the plant. If lumps do not form, add a small amount of acid to the latex.
- b. Strain off the latex lumps and allow to dry in air.
- c. Place 20 parts by volume of latex in bottle and add 80 parts by volume of gasoline.

Cover bottle and allow to stand until a swollen gel mass is obtained (2-3 days).



# Scientific Principles of Improvised Warfare and Home Defense

## 9) Wax Systems

Any of several common waxes can be used to gel gasoline for use as a flame fuel which will adhere to target surfaces.

### Materials Required

<u>Parts by volume</u>	<u>Ingredient</u>	<u>How used</u>	<u>Common source</u>
80	Gasoline	Motor fuel	Gas station
plus any one of the following			
20	Ozocerite Mineral Wax Fossil wax Ceresin wax	Leather polish Sealing wax Candles Crayons Waxed Paper Textile sizing	Natural deposits General stores Dept. stores
	Beeswax	Furniture and floor wax Artificial fruit and flowers Lithographing Wax Paper and candles Textile finish	Honeycomb of bee General and Dept. stores
	Bayberry Wax Myrtle Wax	Candles, Soap Leather Polish Medicine	Natural form Myrica berries Dept., Drug, and General stores

### Procedure

1. Obtaining wax from natural sources: Plants and berries are potential sources of natural waxes. Place the plants and/or berries in boiling water. The natural waxes will melt. Let the water cool. The natural waxes will form a solid layer on the water surface. Skim off the solid wax and let it dry. With natural waxes which have suspended matter when melted, screen the wax through a cloth.
2. Melt the wax and pour into jar or bottle which has been placed in a hot water bath.
3. Add gasoline to the bottle.
4. When wax has completely dissolved in the gasoline, allow the water bath to cool slowly to room temperature.

Note: If a gel does not form, add additional wax (up to 40% by volume) and repeat the above procedure. If no gel forms with 40% wax mix a Lye solution of 50/50 with water and add 1/2% by volume to the gasoline wax mix and shake until a gel forms.

# Scientific Principles of Improvised Warfare and Home Defense

## 10) Animal Blood Systems

Animal blood can be used to gel gasoline for use as a flame fuel which will adhere to target surfaces.

### Material Required

<u>Parts by volume</u>	<u>Ingredient</u>	<u>How Used</u>	<u>Common source</u>
68	Gasoline	Motor fuel	Gas station
30	Animal blood serum	Food, medicine	Slaughterhouse, animals in wild
plus any one of the following			
2	Salt	Food	Sea water, stores
	Ground Coffee	Food, beverages	Coffee plant, stores
	Dried Tea Leaves	Food, beverage	Tea plant, stores
	Sugar	Food sweetener	Sugar cane, stores
	Lime	Mortar, plaster Medicine, ceramics Soil conditioner	From calcium carbonate Hardware, drug stores Garden supply
	Baking soda	Baking, Industrial	Food and drug stores
	Epsom salts	Medicine Mineral water	Drug and food stores

### Procedure

1. Preparation of animal blood serum.
  - a. Slit animals throat by jugular vein. Hang up-side down to drain.
  - b. Place coagulated (lumpy) blood in a cloth or on a screen and catch the red fluid which drains through.
  - c. Store in a cool place if possible.

**Caution:** Do not get aged animal blood or the serum into a cut or scratch. This can cause dangerous and possibly lethal blood infections.

2. Pour blood serum into jar, bottle, or other container and add gasoline.
3. Add the salt or other additive to the mixture and stir until a gel forms.

# Scientific Principles of Improvised Warfare and Home Defense

## 11) Acid Delay Incendiary

This device will ignite automatically after a given time delay.

### Materials Required

- Small jar with cap
- Cardboard
- Adhesive Tape
- Potassium Chlorate
- Sugar
- Sulfuric Acid
- Rubber sheeting (auto inner tube)

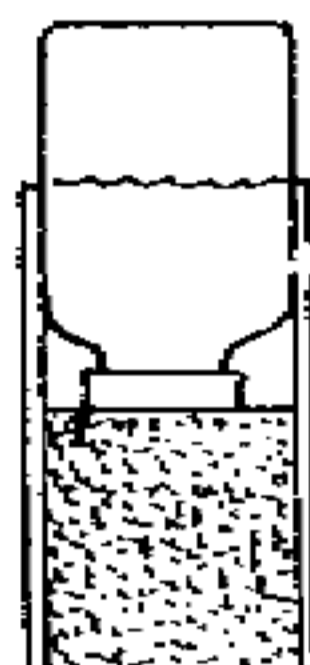

### Procedure

1. **Sulfuric Acid must be concentrated.** If battery acid or other dilute acid is used, concentrate it by boiling. Container used should be of enamelware or oven glass. When dense white fumes begin to appear, immediately remove the acid from heat and allow to cool at room temperature.

2. Dissolve 1 part by volume of Potassium Chlorate and one part by volume of sugar in 2 parts by volume of boiling water.

3. Allow the solution to cool. When crystals settle, pour off and discard the liquid.

4. Form a tube from cardboard just large enough to fit around the outside of the jar and 2-3 times the height of the jar. Tape one end of the tube closed.

5. Pour the Potassium Chlorate sugar crystals into the tube until it is about 2/3 full. Stand the tube aside to dry.

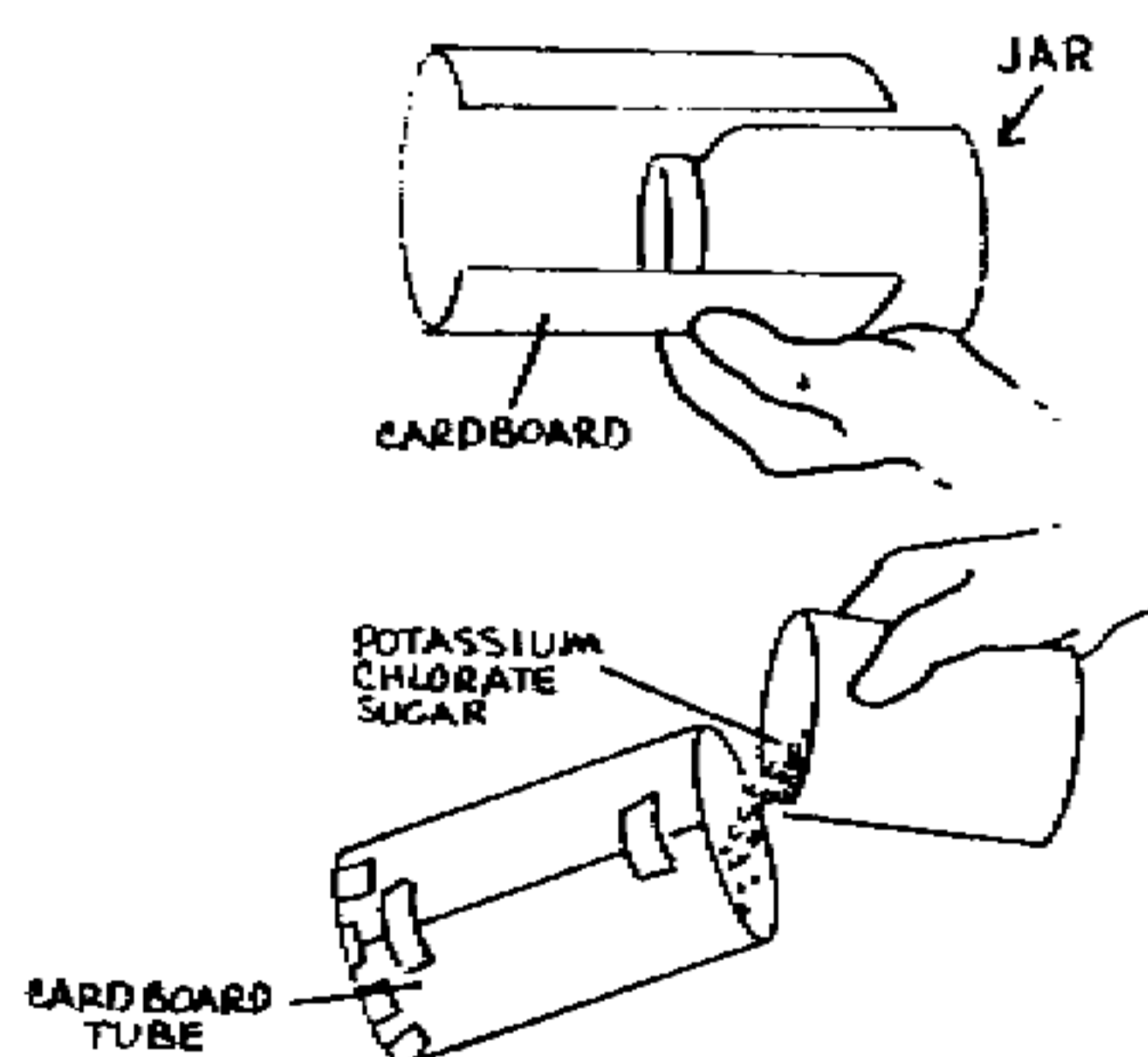

## Scientific Principles of Improvised Warfare and Home Defense

6. Drill a hole through the cap of the jar about 1/2" in diameter.

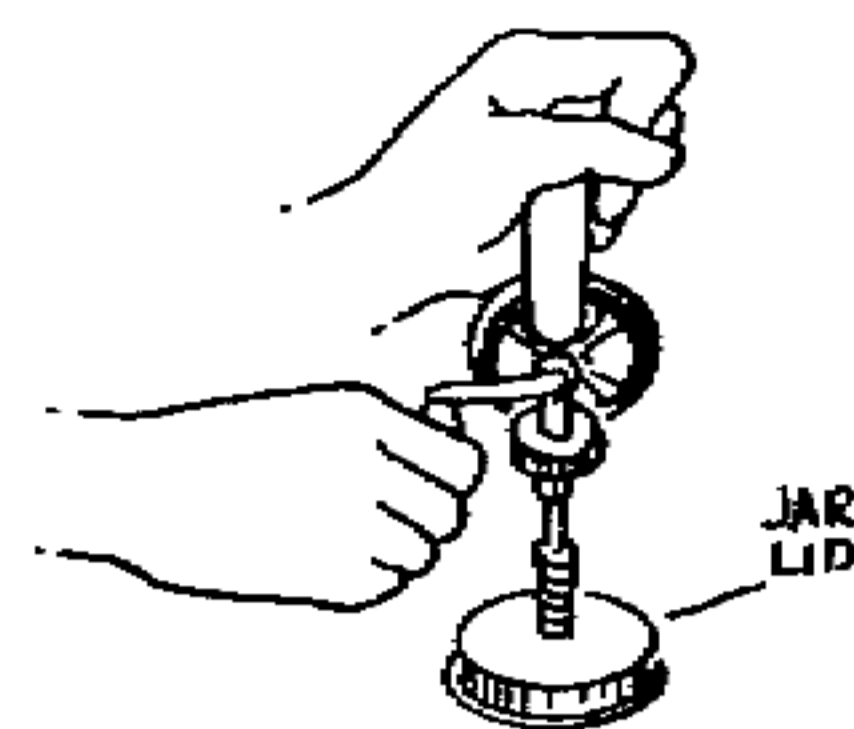

7. Cut a disc from rubber sheet so that it just fits snugly inside the lid of the jar.



8. Partly fill jar with water, cover with rubber disc and cap tightly with the drilled lid. Invert bottle and allow to stand for a few minutes to make sure that there are no leaks. This is extremely important.

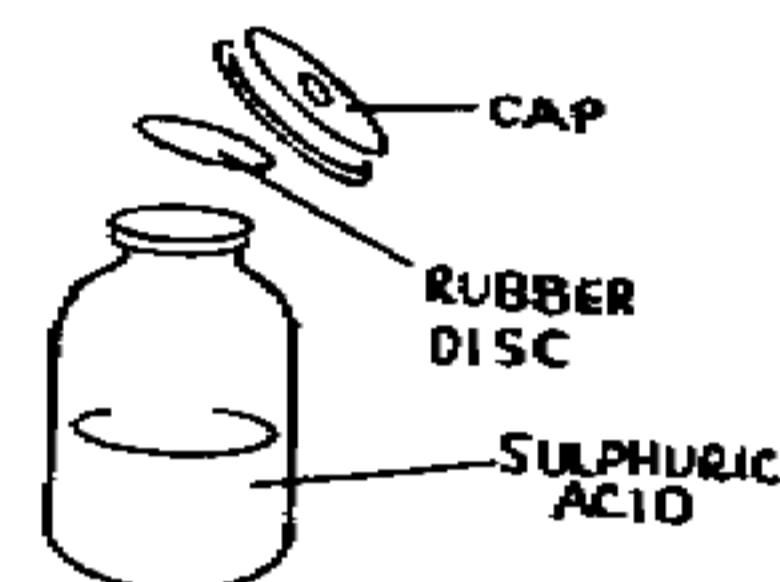

9. Pour water from jar and fill about 1/3 full with concentrated sulfuric acid. Replace the rubber disc and cap tightly.

**Important:** Wash outside of jar thoroughly with clear water. If this is not done, the jar may be dangerous to handle during use.

### How to use:

1. Place the tube containing the Sugar Chlorate crystals on an incendiary or flammable material taped end down.
2. Turn the jar of sulfuric acid cap end down and slide it into the open end of the tube.

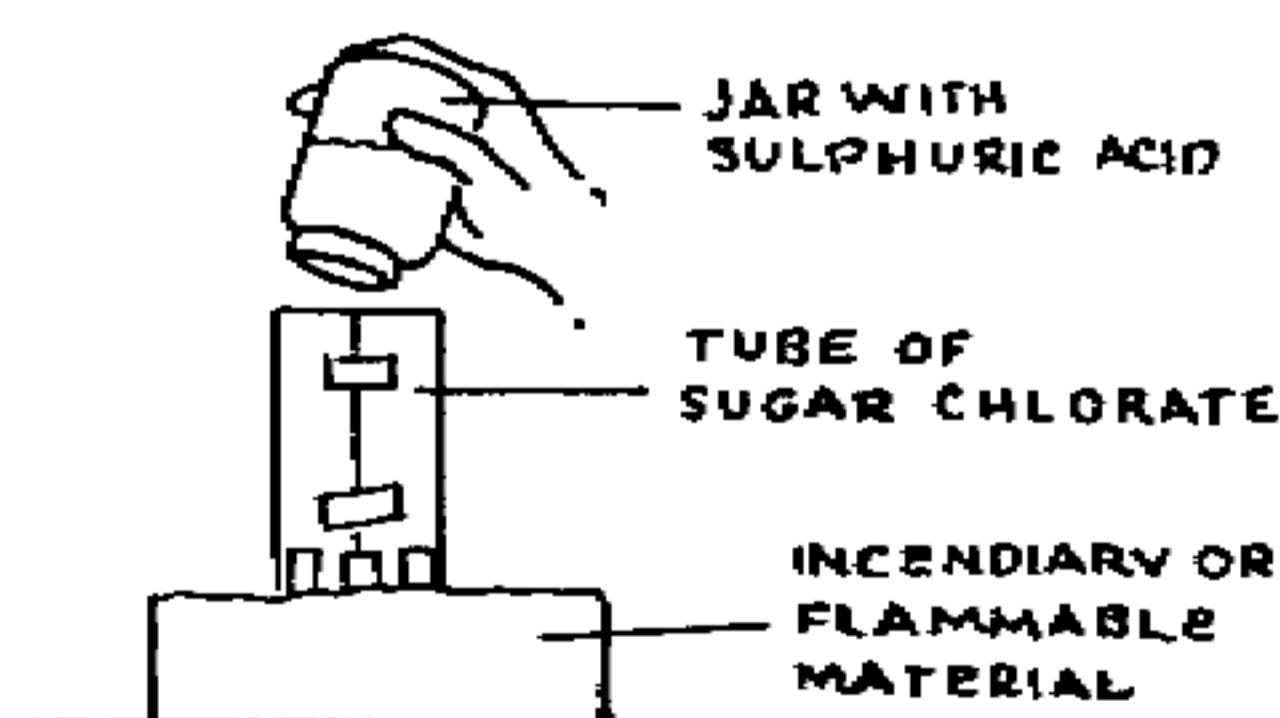

After a time delay, the acid will eat through the rubber disc and ignite the sugar chlorate mix. The delay time depends on the thickness and type of rubber used for the disc. Before using the device, tests should be conducted to determine the delay time that can be expected.

Note: A piece of standard auto inner tube (1/32" thick) will provide a delay time of about 45 minutes.



## **Scientific Principles of Improvised Warfare and Home Defense**

### **G) Unconventional Delivery Systems**

Chemical weapons may be delivered as gas, solid, or liquids. They may accompany any of the previously described conventional weapons by whatever means they are delivered. Hand held weapons may be soaked in, coated with, or impregnated by the various chemicals. Impregnation can be accomplished simply by drilling tiny reservoirs into the blade or piercing surfaces of weapons and filling them with the chemical of choice. Likewise, hollowpoint bullets can be enhanced by filling the hollowpoint with jelled or solid components. These methods are as old as mankind, and came about when it was first observed that wild game could be more easily brought down and quickly killed when arrow and spear tips and knife blades were dipped into known poisons. This gave some tribes considerable military advantages over competing tribes and the knowledge of poisonous materials and delivery methods was often a coveted and closely guarded secret. Even today, society prefers to keep such knowledge shrouded in secrecy.

Low temperature explosives, bursting charges, and propellants may be used to provide conventional delivery of chemical weapons over large areas (in bombs and artillery shells) thereby increasing their ability to incapacitate and demoralize an enemy. Incendiaries can be combined with many liquids in binary systems to rapidly evolve poisonous gases.

**Grenades:** Designs of hand thrown chemical weapons are limited only by the imagination of the designers and users. Generally, it consists of 2 internal parts which each contain a portion of a binary weapon. These can be made out of glass which shatters on impact when thrown allowing the 2 parts to mix and form the final agent, usually a gas which is then vented out the larger main canister. The internal parts may be made of soft plastic which easily tears. Any type of piercing primer may be used such as a pin pulling on a razor blade or needles to cause punctures during release. Conversely, the containers could have cork stoppers which can simply be pulled out and the contents drain out and mix when thrown. The principle canister requires some form of mixing primer and a vent which remains sealed until ready to use. Conventional designs with bursting charges, incendiaries to form gases, and explosives to carry combinations of shrapnel and chemicals may also be devised.

**Spray Systems:** High pressure washer spray systems (self powered) in wide commercial use can be used to spray liquids from supply drums or tanks at a high velocity on or in a targeted area. These systems were mounted on aircraft and used to distribute Agent Orange during the Vietnam War. Protective clothing must be worn and a barrier erected between the discharge nozzles and the operators to prevent reflected or drifting chemicals from contacting the applicator, equipment, or vehicles. It is also helpful to use telescoping extensions to physically place the nozzles as far away as possible from the operators, which affords greater safety and in the case of ground operations allows the remote delivery of the ordnance over obstacles, around corners, and reach 2nd and 3rd story building windows in urban combat situations.



## Scientific Principles of Improvised Warfare and Home Defense

Hi pressure water at 2000 to 5000 PSI can be used as a non-lethal anti-personnel weapon in many circumstances, especially if it is very hot or cold. When used at low volume (3-10 GPM) and high pressure, a single 55 gallon drum of water can be used in effective offense or defense for 5-20 minutes continuously.

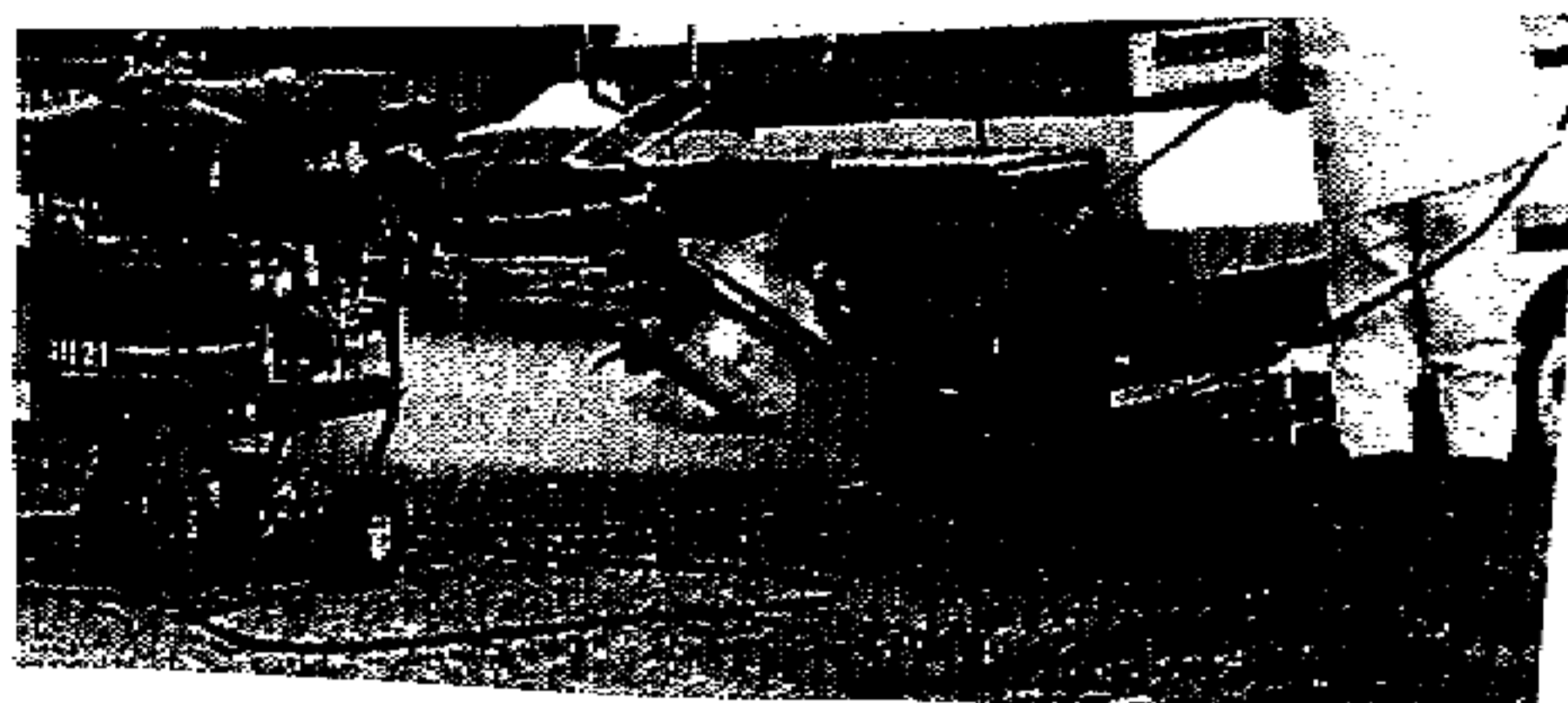

Likewise, a large tank mounted on the back of a truck (5,000 gallons) could act as a substantial ammo supply lasting several hours. The liquid can be mixtures of harmful chemicals or incendiaries in urban war situations and can be used in direct antipersonnel roles or to burn down enemy cover. They can be distributed by any pumping apparatus and the tank should be mounted inside sloped armor. They can also be useful using nonlethal or anesthesia chemicals in law enforcement crowd control and hostage situations.

Delivery of chemical weapons to population centers, lakes, or food and crop areas, generally require large amounts of chemical and a fast distribution system to be effective. Dropping large bombs and aerial spraying or dusting (if you can avoid being shot down) or spraying from armored tanker trucks are the only large scale direct delivery means that pose limited risk to friendly troops.

Delivery of gas, liquid, or dust to a specific, preferably closed target area can be economically accomplished by a small force using a variety of pneumatic delivery systems. All use the same basic principle of design.

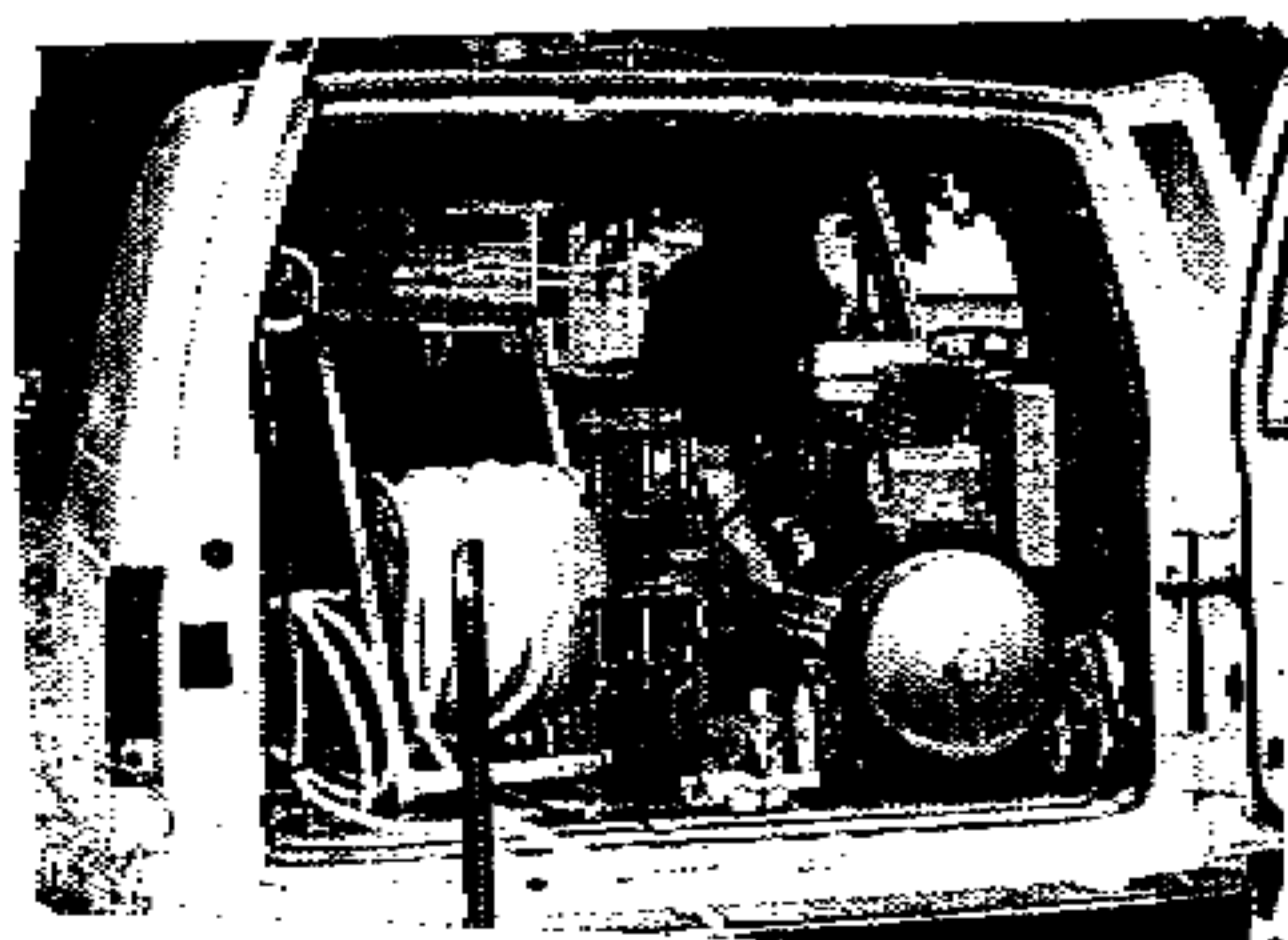

## Scientific Principles of Improvised Warfare and Home Defense

A gas powered air compressor fills a tank reservoir which is attached to a loaded valve or separate chemical reservoir tank. When needed the pressurized air is released and the feed valve is opened allowing an unrestricted flow through the chemical tank or valve and down the hose to the distribution nozzles. The system is shut off to reload the tanks and/or valve.

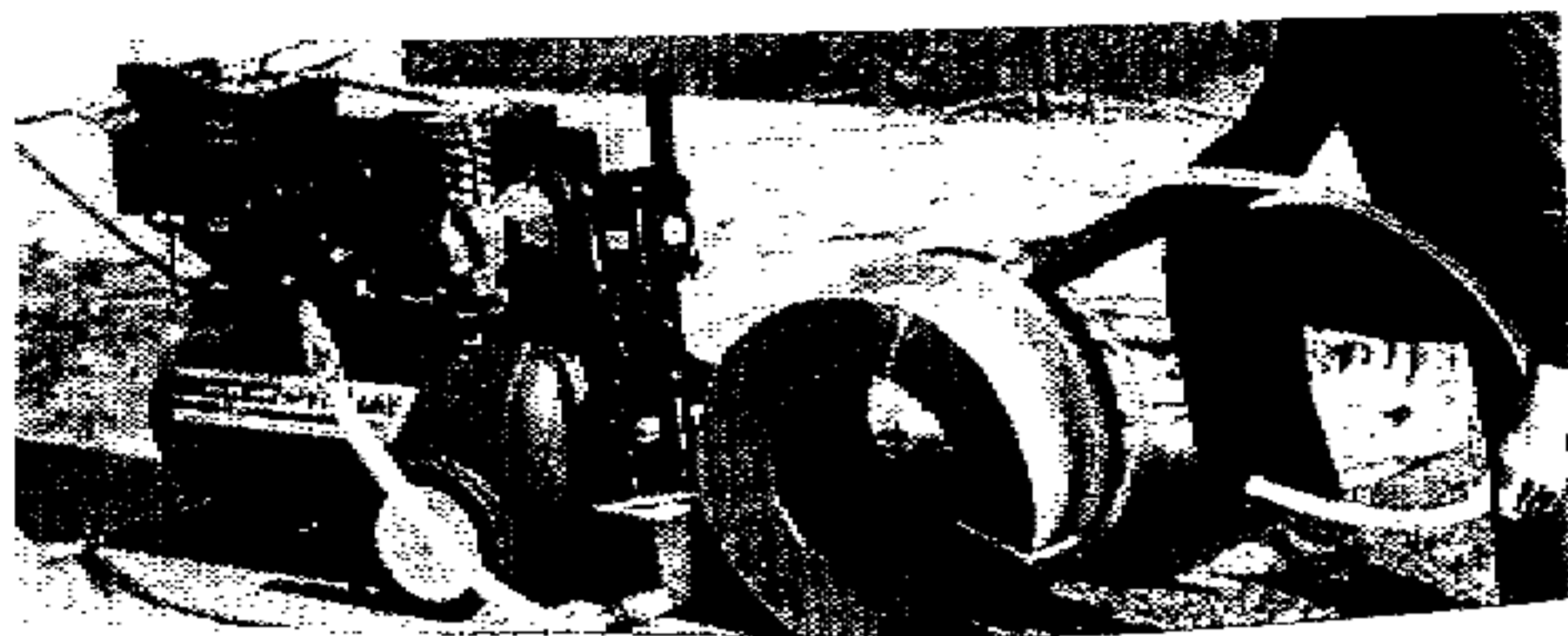

A large pre-pressurized tank can be used for clandestine delivery of chemical agents. Delivery in an end hose and nozzle can be accomplished by a conventional spray and extension wands. They can also be accomplished by the method of attaching the hose to a fiberglass or steel sewer rod. The hose and rod assembly is fed into the target tunnel, fortification, through any small drilled hole or vent, or around corners and up or down stairs until the targeted area is reached.

---

**[Authors Note:** I developed a system with a TV camera and hose on a rod to apply herbicides inside sewer lines directly onto tree roots. We routinely videotaped our sewer treatment operations and could treat locations by remote control from 300-600' away. With motorized mini tractors on the end the hose could be steered around corners and into other pipe attachments. It should be apparent that any ordnance, not just chemical weapons can be remotely delivered by this system. Explosives, concussion grenades, irritants, smoke, or anything else that can be imagined, carried, and ignited, may be delivered without drawing direct fire on your own troops. By drilling small (1/2") holes into air ducts, through walls, or other obstructions, almost any premises can be penetrated, videotaped and assaulted remotely. I actually did get a patent approved for the herbicide use in sewers after much haggling ( The patent examiner must have had satisfying sex the night before and used his godlike powers to grant the rare privilege of actually owning a patent claim). My general experiences with the patent office have so discouraged me that I have not applied for the many extensive hit-tech claims of using this system for military or law enforcement purposes (yet). In fact, many times I have wondered if patent approvals have more to do with the astrological horoscope, the days weather, and the sex life of the examiner than it does with any law passed by the Congress of the United States. And this is coming from a person who weathered the fights to receive approvals for over half my applications.



## **Scientific Principles of Improvised Warfare and Home Defense**

Even in the event the patent examiner might have satisfying sex for a second time (dead race horse odds again) and I would receive patent claims, the large defense contractors would simply adopt the following strategies to steal it.

1. They would file with the patent office to get the patent disallowed. This doesn't have to be a serious attempt. Its only necessary to drag out legal proceedings.
2. They then propose their own advanced remote infantry combat system for about \$100,000 per man to the Pentagon. A basic rod and cable system 200' long could be built by us for every infantrymen with remote ordnance systems for probably \$500-\$1,000 per man and could include fiber optic video and a mirror and rod system for looking around multiple corners without getting shot for about \$2,000 extra. This is our "Rambo Rooter". The big companies would lobby their own pre-engineered hardware and software built (invented ?) only by them with slightly enhanced capabilities (we will copy his system, paint it a different color, maybe add infra red). They then get the system specified by the military purchasers so that they can be the only supplier of the "Cadillac system". Now, they bid in \$100,000 per unit to the Army and Marines giving them a \$10 Billion contract to protect.

Meanwhile, in the courts, they tell the judge they have filed to invalidate our patent claims and have for filed their own patents with all these little differences (and they win by default if I run out of money - Justice and truth don't count - only money). They're tiny changes cause great additional expense and time for the courts which buys them the time to build their own manufacturing plants, obtain the government contracts, and start making money. To keep the profits down in case their arguments go sour in court, all the executives and engineers draw hundreds of millions of dollars in their well deserved bonuses for stealing the intellectual property rights (or "privilege" the way the patent office works) , getting the business, and putting up the infringement fight. (This is how big companies really operate). After 5-10 years of court battles, if my attorneys haven't caved in or settled for a token offer to buy my original patent filing, we finally go to court. Once in court, long expensive arguments are presented and he who buys the better (and more) arguments generally wins.

Lets just say for arguments sake that a jury of the "little guy" decides to see me as the honest inventor and developer and awards my side damages. The court only allows the damages to be lost profits which were deliberately manipulated to be small to start with by the big companies, so they are not actually out that much, and the people who plotted, planned, and carried out the theft of the property privilege by infringement not only have nothing to lose, they already have reaped enormous personal gains.

Now, lets pretend that even the judge sees things our way and orders them to quit making their \$100,000 toilet seat = of our Rambo Rooter system, then guess what happens. All they have to do is appeal and keep on buying more and newer arguments until they find someone who might agree with any of them.

## **Scientific Principles of Improvised Warfare and Home Defense**

Simultaneously, they argue with the government that we (lacking their million dollar engineered system) can't produce and meet the specs that only they can meet. Therefore, they should be exempted from court action on grounds of essential national defense and the additional loss of jobs and economic hardship they would suffer (and they shouldn't have to suffer because they have made themselves so essential for national defense). For anyone who doesn't believe this, what about the car makers who stole and used the intermittent windshield wipers. The inventor won his case in court and they ignored it and kept on using it in the cars they built anyway. This is why the laws that Congress pass don't mean anything because they don't apply to those in power who buy their own law in the courts anyway.

If, in some incredible stroke of fate that even the government finally took our side and they actually paid infringement damages, it would only be considered a routine cost of doing business. They can now move their plant and key trained personnel overseas to a country that doesn't recognize US patent laws and start using all their expertise in making and selling the system to overseas clients and prepare to duplicate the patent fight in any other country that is contested. For all the infringement, lawsuits, lobbying, and spec writing costs, they still come out ahead (at least for their executives-probably not for the shareholders). This is why deliberate patent infringement is institutionalized and is actually very profitable if worked correctly. The people who do it get rich, and never suffer personal consequences. Its also why our nation has institutionalized \$10,000 tools and plumbing parts in our armed forces.

You would think that our leaders would actually want every bright US citizen out their trying to create things to improve each others lives. They even give lip service to it by offering low small entity fees and putting on the occasional PR show of a 10 year old receiving a token patent claim to show how this is the land of opportunity.

In reality, when you apply with a new material substance, with all new and provable chemical properties, they don't even have to acknowledge it. The new dry acid I invented fitted this description. That is why such a thing as an inventors patent right is a fiction in the US. When you genuinely and honestly invent a new substance or material, or if your invention results in the creation of an entirely new art (such as new infantry remote combat tactics and systems practiced by armed forces using a Rambo-Rooter) you deserve to own the right to practice it yourself. Instead, you are simply weeded out by the process if you don't have the money to pursue your invention rights.

These should be no brainers and the patent claims allowed without the \$20,000 repeated legal efforts and hassles to go through the system for the privilege of being allowed to own your own intellectual property. It makes the small entity fees inconsequential. The concept of equal opportunity doesn't really apply here when only those wealthy enough to put up a costly fight actually have a chance to receive a patent and whether they are entitled or not doesn't even matter. Everyone else is weeded out. Does anyone wonder why I wrote this book now?]

And now back to our uneditorialized main text.

---



## **Scientific Principles of Improvised Warfare and Home Defense**

Gas, liquid, or solid dust can be pneumatically conveyed anywhere remotely making this an effective combat system. In assaulting buildings, especially clandestinely at night, small holes can be drilled in the walls allowing the chemical agents to be silently pumped in to target buildings and fortifications using compressed air or spray systems. Entire enemy zones of control can be overcome by this method.

Chemicals can also be incorporated into various positioned weapons or used in large scale depopulation of livestock, people, and foliage which will be studied in later chapters. Sometimes, assassination becomes the only way to bring about change in despotic political systems. Hitler, Stalin, Khadafi, Saddam Hussein ( and a few unnamed patent examiners) come to mind and are the best historical examples. Booby traps and commando raids may be impossible because of large personal security contingents, multiple secret police services, and fear of torture or revenge against family (effective tactics the patent office hasn't discovered yet). There are several possibilities to conduct successful assassination even under these circumstances.

Two examples would be:

1. Mixing both parts (liquid or powder) of a poison gas into toothpaste or one of the other gelled formulas described under incendiaries. (toothpaste is a methylcellulose gel and acids quickly break them down to a liquid). Once each part is mixed into a separate gel, your binary weapon is ready to be delivered. Ideal locations are placing one part and then the other part under a car door handle so that when the target opens the door and presses both parts together he receives an immediate dermal exposure from the formed gas and if he brings his hand close to his face to see what it was he receives a powerful inhalation and eye exposure as well. Large doses can also be injected into furniture cushions or concealed in almost any location where a small motion by the target creates a mixing of both components and lethal exposure.

2. Food poisoning has been used since long before Cleopatra's time. The principal precaution by despots has been to have food tasters routinely sample their foods before dining. This is easily foiled by injecting highly toxic poison into single localized spots in solid foods. The entry point of an injection needle is best near the stem and towards the core. That way, large pretesting bites can be made around the edges without fear. If no access to the food handlers is available, then the entire food supply may have to be shotgun treated to reach the intended target.

There is obviously no limit to delivery system ideas. You are limited only by your education and imagination. (Imagination is better)

Hint: better ideas and improvements come from imagining using these delivery systems on patent examiners shortly after a rejection.



When you need to know absolutely, positively, how to destroy it by tomorrow- Call STIP!

Published By STIP  
PO Box 59  
Silver Creek, Nebr. 68663

**Scientific Principles of Improvised Warfare and Home Defense \$30/Volume**

**Volume 1 Basic Training**

Hand Held Weapons

Chemistry, Manufacture and Use of Explosives

Mounted Weapons

Properties and Improvisation of Firearms

Hand Held Firearms and Explosives

Non Explosive Chemical Weapons and Incendiaries

**Volume 2 Basic Training**

Bio Toxic Weapons

Armor, Personal Protection, and Material Handling

Combat Support, Skills, and Equipment

Defensive Obstacle Construction and Countermeasure

Booby Traps, Mines and Positioned Weapons

Strategies, Tactics, Resistance, and Countermeasures

**Volume 3 History, Design, and Manufacture of Explosives**

**Volume 4 Incendiaries: The Science of Using Fire as a Weapon**

**Volume 5 Advanced Chemical Weapon Design and Manufacture**

**Volume 6-1 Advanced Biological Weapons Design and Manufacture**

Biological Entry

Bacteria Based Weapons