

HOW TO OPEN HANDCUFFS WITHOUT KEYS



**HOW TO OPEN
HANDCUFFS
WITHOUT KEYS**

DESERT PUBLICATIONS

**HOW TO OPEN HANDCUFFS
WITHOUT KEYS**

by
Carl Roper

ISBN 0 - 87947 - 120 - 4

© 1979
Desert Publications

DESERT PUBLICATIONS
Cornville, Arizona 86325

TABLE OF CONTENTS

| | page |
|--|------|
| Introduction | 1 |
| Background on Handcuffs. | 3 |
| Identification of Handcuffs. | 7 |
| Lockpicks & Shims | 11 |
| Background. | 11 |
| Materials, Tools & Equipment. | 11 |
| Construction of Handcuff Picks & Shims | 13 |
| Shims | 13 |
| Picks | 21 |
| Lockpicking Techniques | 29 |
| Handcuff Keys | 31 |
| S&W Model 94 Maximum Security Handcuff | 33 |

For a complete catalog listing hundreds of similar titles see your bookseller or write to the publisher.

INTRODUCTION

“Handcuffs,” “cuffs,” or “manacles” are all the same; merely a differentiation in their design, application and terminology. All have the same end purpose: the temporary restraint of a person upon their application.

This volume covers a selection of handcuffs in popular use today and discusses some of the specific features with which you should become familiar. Further, with the knowledge of these features and the specifics presented, you will be able to manufacture your own “personalized” set of lock-picks and be able to open a wide variety of handcuffs with them.

Over two hundred types of handcuffs are known to exist. By virtue of their uniqueness, but also their relation to other types, the handcuff stands out. In the United States alone, over a hundred types have been patented. Further many variations and derivative types, both U.S. and foreign, are on the market.

As a locksmith or a collector of locks, handcuffs — especially the more modern types are within easy grasp, while older ones, these being made before WWII and some dating back over 125 years, are extremely hard to come by. When you come across one, either in viewing, possessing, or having to open, repair, or make a key for it, at least examine it in as much detail as possible for future reference.

Some police departments and even private detective agencies still use handcuffs that were purchased many years ago. Some even use the many foreign types of handcuffs on the market. The Japanese and Spanish types of handcuffs are in many different models and varieties, but are fairly simple to work on, while the English and German handcuffs will be much more difficult. The reason for this is the craftsmanship and construction techniques that have been refined and the ‘precision’ of their manufacture. In England and Germany, “precision” is a by-word used constantly in this craft.

In this booklet on opening handcuffs, we will be discussing various techniques and methods for entry into

handcuffs when a key is not available. Also included will be a generous portion of detailed illustrations of the handcuffs, parts, identification of these, key types, and picks that you will be making.

No book can cover every type of handcuff made, nor can it foresee variations that have been developed, but not necessarily documented (as in a patent), and put into use. Thus, within this booklet, we will consider only the basics and their general application to the majority of handcuffs you may have an opportunity to work with.

The earlier handcuffs, even those back in the 1860's, used the ratchet principle that is still in use today. (FIG 1 illustrates an early handcuff.)

Today, the most current accepted types of handcuffs in use are the Smith & Wesson and the Peerless. They are almost the same in design and construction. Each has a double-locking mechanism which makes it harder for the uninitiated to open them. A newer one, but not yet in popular use, has been produced by Smith & Wesson, and instead of a flat or a 'pipe' key, uses the tubular key cylinder. Since they have not yet caught on in popularity, it is rare that you may be called upon to work with one of these.

In order to get the most out of this book on handcuffs, it would be wise to start collecting different makes, models, and varieties of handcuffs. Old, foreign and difficult handcuffs should also be considered. You have a definite advantage when you have more than one of a specific type; this allows you to disassemble one to study more closely its interior. With other types — especially those which are more difficult to obtain, by holding onto them several years, you may be able to sell them at a price which will compensate for that one you sold, a duplicate in your collection, and possibly another one; having one pay for the cost of several is definitely worthwhile in the long run.

BACKGROUND ON HANDCUFFS

Locks, and most especially handcuffs, are able to be picked for a variety of reasons:

1. Poor manufacturing process, i.e., shortcomings in the actual process of manufacturing resulting in a lack of precision between the parts in relationship to each other.
2. Design shortcomings, i.e., the initial designs, while they may be new in their parts relationship, do not improve upon an earlier model in the method of parts relationship and their applicability to the further security of the locking mechanism, nor in their overall security to ward off attempts to pick the lock or spring the shackle by other means.
3. The keyhole is too large — the key and lock mechanisms are left open to a variety of means of opening the handcuffs. Too simplified.

All of these flaws and shortcomings interrelate. The flaws allow simple everyday items, such as a standard lockpick, a hatpin, paperclip, metal pen inserts, and other devices to be turned into temporary makeshift keys or shims to open the handcuffs, thus thwarting their security features.

The loose tolerances developed in poor manufacturing processes mean a lower precision of interior locking parts, this, for the manufacturer, means a lower production cost — but a higher profit margin. After all, he is in the business to make money and sell his product. He does not necessarily concern himself with the overall precision of the product. This makes for weaker handcuffs, and means they are more easily opened than a set of handcuffs that have been designed and manufactured with as close as possible tolerances to each part. Thus, these tolerances allow shims to be inserted, and even homemade keys, or even a ‘wrong’ key, to enter and operate the mechanism or one of its many parts, and open the handcuff shackle.

Handcuffs have certain peculiarities that are created in the manufacturing process and thus make them quite susceptible to various forms of "manipulation" in order to open them without the proper key. As a prime example, consider the handcuff with too much space between the ratchet and the lock box. Here a thin shim comes into use to open the lock of the cuffs.

Another form — or uniqueness — in some handcuffs is one in which the biting of the key is exceptionally thin so that, with excess pressure, it breaks off inside the lock. Here an ordinary button hook is a valuable aid in opening the lock — after all, why use a key which may break when an ordinary household item will suffice!

Regrettably, many police department purchasers of handcuffs — and the police themselves, regrettably — are not concerned with these "peculiarities," but with the convenience and easy method of operation of the handcuffs when in use.

Another major flaw in handcuffs in use is that, unlike other types of locks, only a low number of keys are required to open a great variety of makes and models, (with the exception of the S & W High Security). THERE IS NO INDIVIDUALITY IN THE DESIGN OF THE KEY OR OF THE LOCKING MECHANISM. In fact, that is what makes it all the easier for you, the serious student of keys, locks, and now handcuffs, to be able to open these locks much more easily.

J. J. TOWER & H. W. KAHLKE.
Hand - Cuffs.

No. 200,950.

Patented March 5, 1878.

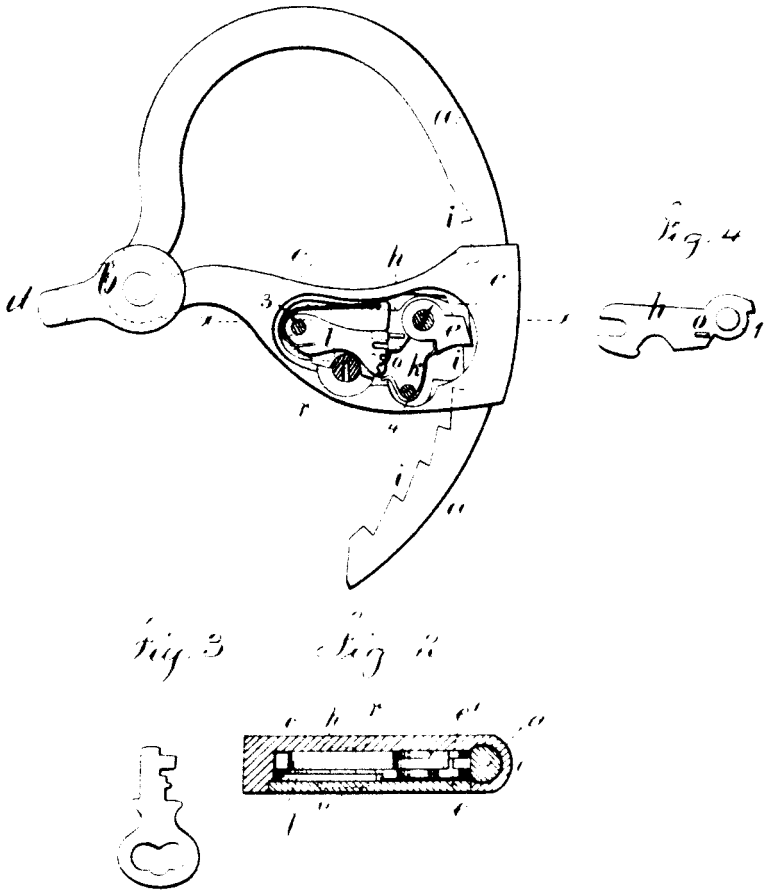

FIG 1

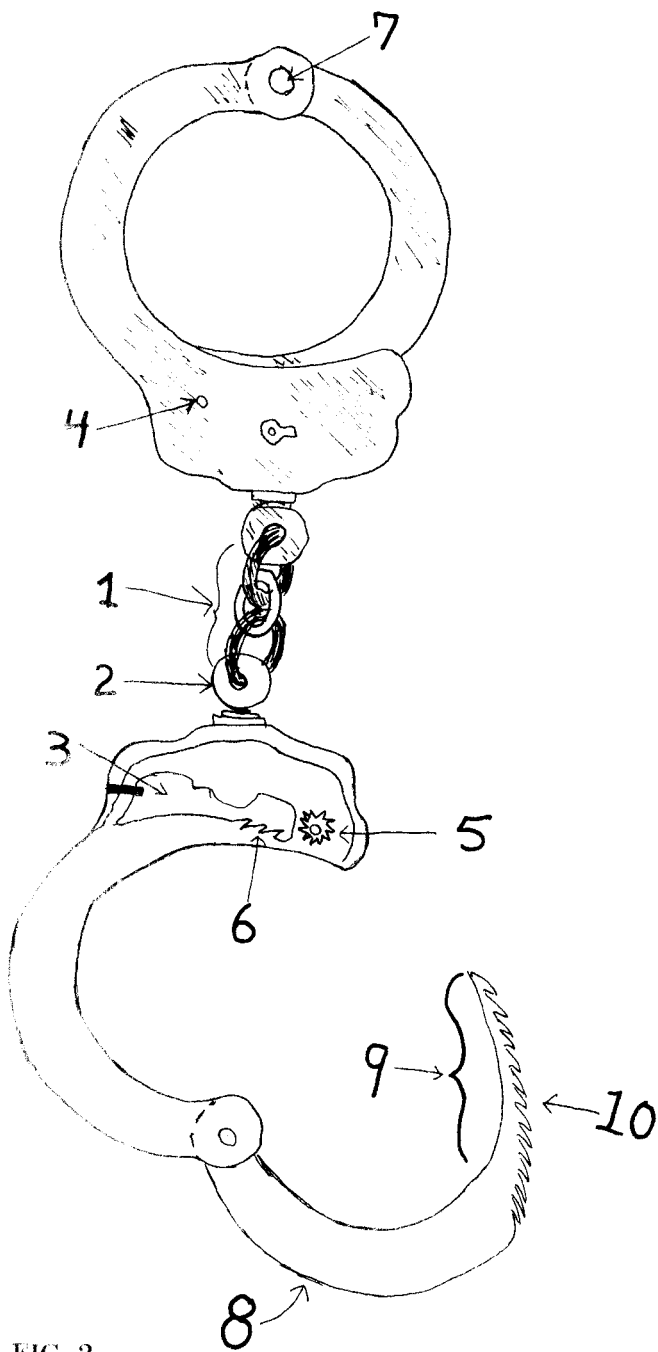

FIG 2

IDENTIFICATION OF HANDCUFF PARTS

The standard handcuff set is limited only by its size (exterior, overall, and interior space) to a limited number of lock parts. On the whole, FIG 2 illustrates the parts most common to handcuffs in use today. FIG 3 shows a variation for the cylinder pin handcuff, and FIG 4 illustrates a set of handcuffs with the tubular lock. Not all parts are integral to every type of handcuff in use.

The parts of the handcuff are: (the numbers are used to identify the parts on the various handcuffs)

1. Chain
2. Swivel
3. Latch Arm
4. Pivot Pin
5. Anti-shim Device (free-wheeling)
6. Latch
7. Hinge Pin
8. Bow (or shackle arm)
9. Ratchet
10. Ratchet Teeth

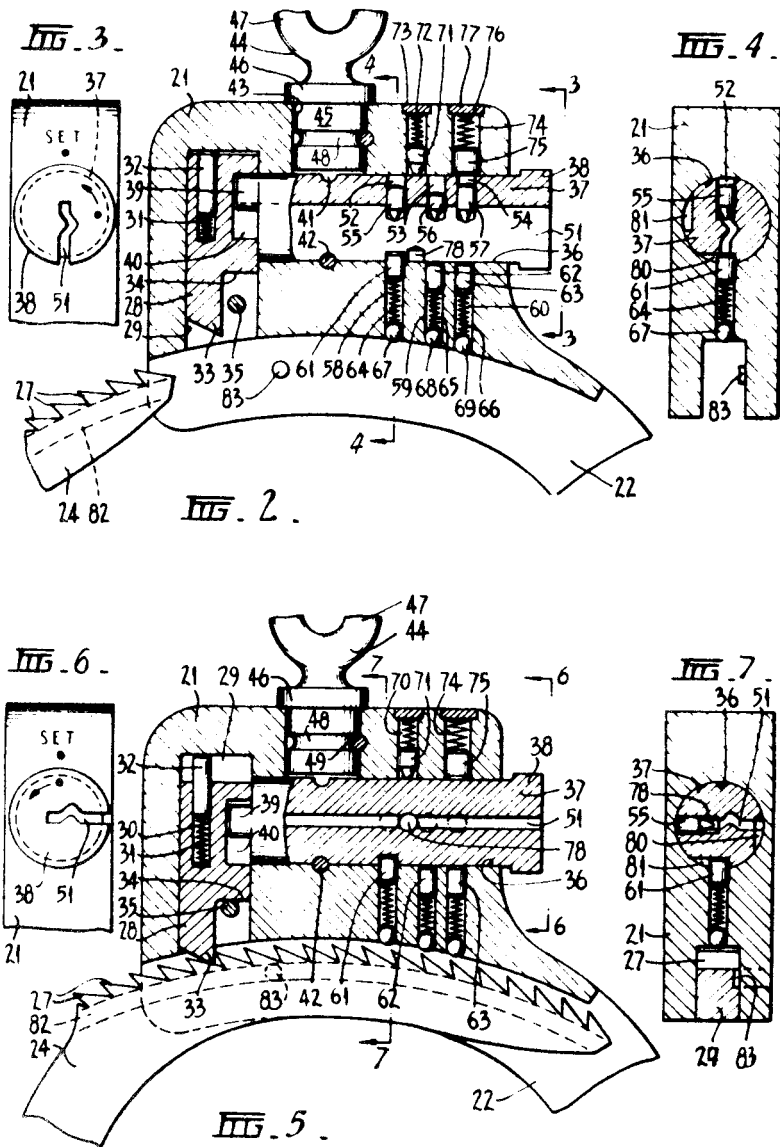

FIG 3



FIG 4

LOCKPICKS AND SHIMS

Background

Since the first lock mechanism was developed, there has been someone willing to try and open it — without a key. This individual might have been the locksmith who made it, the person who bought it, or the burglar who attempted and was caught . . . or succeeded and got away.

Through history, all types of people, from kings to peasants, have at one time or another, shown an interest in various locking devices and how to pick them.

During the 18th and 19th centuries, locks advanced on all fronts. At the same time so did the techniques of making tools — other than the key — to open them. Thus was created the lock pick, a new and somewhat “novel” way to open more than one lock without the proper key.

Even today, as with the early locksmiths, you cannot walk into a lock shop and “order” a set of lock picks for a certain type of locks. Thus, like the locksmith of old, and his criminal counterpart, you learn more about lock mechanisms — their strengths and weaknesses — by the construction of various types of lockpicks.

In making lock picks yourselves, you learn the intricacies of a lock, why the keyhole is a certain size and shape, where the weaknesses of the lock are, and how the strengths and innovations applied to various locking devices can slow, stop and/or absolutely defeat a lock pick . . . until, at some later date, a new method or technique is developed that will circumvent that particular lock’s mechanism and allow an individual to pick it open without the proper key and without damaging the lock itself.

Materials, Tools and Equipment.

Materials to be used in the construction of lockpicks, shims, and other devices for opening handcuffs, include the following:

1. hairpins
2. thin strips of steel

3. piano wire of varying degrees of thicknesses
4. watchspring wire (varying degrees of thickness also)
5. small dowelling (for lock pick handles)
6. metal can openers (preferably of steel; not cheap aluminum)
7. button hook

Not many tools and associated equipment are necessary for working on handcuffs. Basic to working are:

1. screwdriver set (standard size)
2. screwdriver set (jewelers size)
3. pliers (combination pliers & wire cutters) (FIG 5)
4. pocket knife
5. wire cutters
6. small vise
7. micrometer
8. assorted files
9. emery paper
10. wire bender
11. metal rule (such as a Stanley)
12. ruler

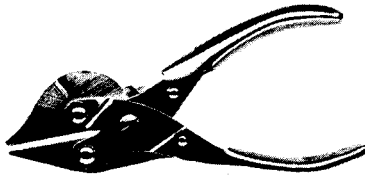

FIG 5

CONSTRUCTION OF HANDCUFF PICKS & SHIMS

Since different models of handcuffs do exist, the techniques for picking and shimming them require that a variety of picks be used. Sometimes you may use only two or three different picks and one shim on a small collection of handcuffs, but then you come across three or four other different models that — suddenly require a completely different pick or shim for each one. For this reason, a wide variety of picks and shims are necessary in your work area.

SHIMS

Shims can be made out of clockspring, piano wire, metal tape measure, and sometimes, thin hatpins and even paperclips.

In essence, the shim is used at only one point on a handcuff. FIG 6 illustrates how a shim would be used and at a particular point. The purpose of the shim is to create a smooth surface between the teeth and locking dog so that there is no point for the locking dog to catch and hold the teeth, thus keeping the handcuff in a locked position. By using the shim properly, you create a smooth surface and, at the same time, create a “buffer zone” between the teeth and the locking dog. This buffer zone means that nothing is holding the teeth and it allows the shackle arm to be removed, thus unlocking the shackle from the rest of the handcuff.

In considering the specific materials for a shim, look at metal that is roughly between .025 and .060” in thickness. Other thicknesses may be used, but these will more than likely be what will be used most of the time.

The most simple shim is made from piano wire, or in an emergency, a paperclip. Since piano wire has a longer life span and the strength makes it a better tool, we will consider it first.

The wire should be approximately 4 1/2” long. Of this, approximately 1 1/2” to 2” is for a handgrip. Use a piece of

small dowelling, maybe 2" long. Split the dowelling in half, lengthwise, and with an exacto knife, create a thin line, just a fraction of a 1/16th inch deep. Place the end of the wire into this artificial 'trench' and apply, lightly, airplane glue, and reapply the other piece of dowelling. Wrap with a rubber band until it has dried and then remove. FIG 7 illustrates this and another type of handle you may consider using.

At the tip of the shim, take a fine file and create a slight angle. This angle is necessary to allow the shim to slip more easily between the teeth and the locking dog of the handcuff. (FIG 8 is an exaggerated view of the shim tip.)

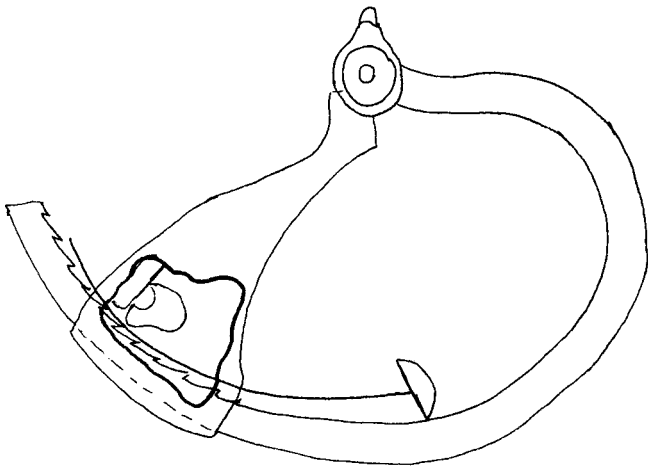

FIG 6

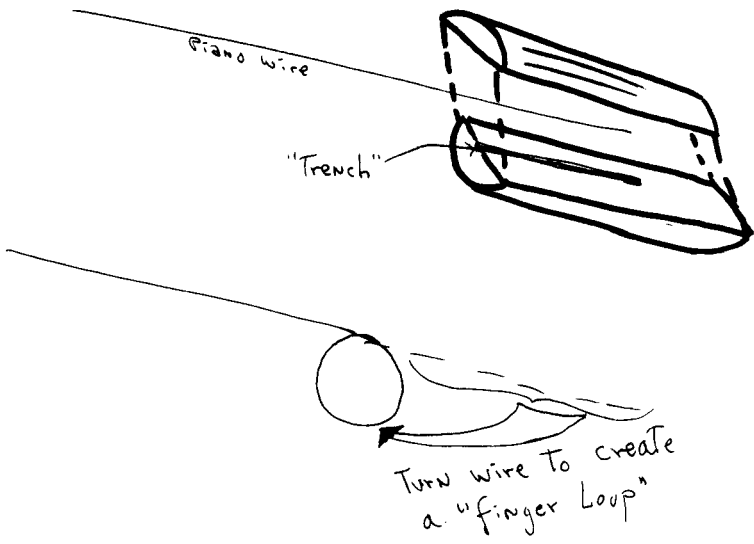

FIG 7

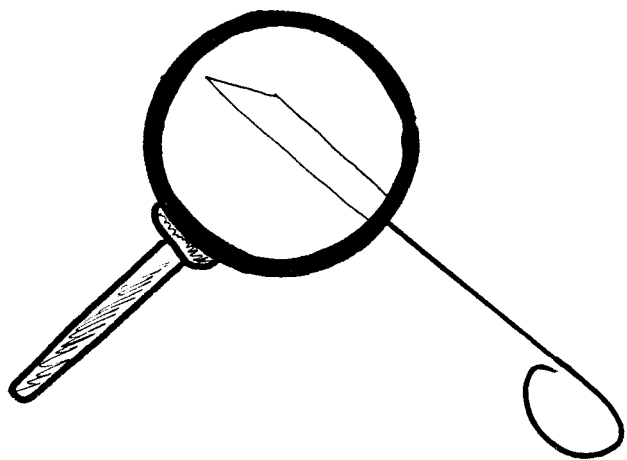

FIG 8

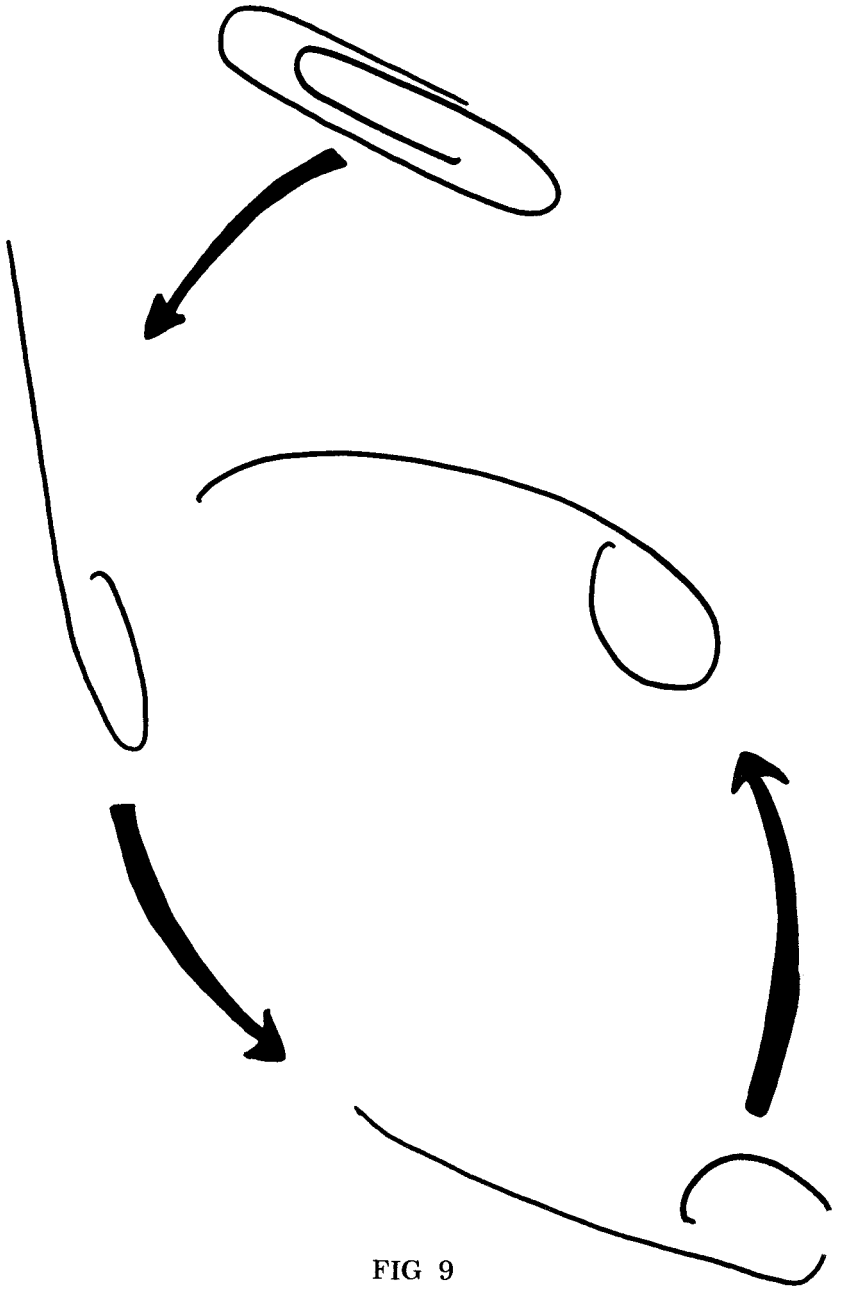

FIG 9

There may come a time when you need to shim open a set of handcuffs and do not have your regular tools with you. This is where a paperclip can come in useful. Take a standard paperclip and unbend. Create a loop at one end as a fingertip; the other end — the tip — is flat, and in an emergency, you will have to use it without a slight tapering tip as in a normal shim. The paperclip should be curved slightly, roughly that of the handcuff, so that when it enters, the movement will be smooth and sure — not rough. FIG 9 illustrates the steps necessary to use a paperclip as an emergency shim.

A fallacy may be created here; that of a paperclip always being a substitute shim. This is not the case. Many handcuffs are precise enough that a paperclip may enter part-way, and then become stuck. The reason: the diameter of the paperclip is greater than the area through which it must pass. Thus, paperclips can be used on many cuffs in emergencies, but never as a standard.

When considering clockspring for shims, two different types are made. The first is a single shim; the second, a double, or split, shim.

For each of the above shims, several should be made, of different lengths. The procedures are as follows:

SINGLE SHIM. Take a strip of clockspring, approximately 3" to 3 3/4" long. 'Roughly' flatten it out, but not to the point where it is actually flat. The tension of the spring itself should insure this. Cut the strip in half, lengthwise, and smooth down the edges. At the tip, create an angle as was done with the piano wire shim. Since the edge roughness has been smoothed down, no handle will be necessary. FIG 10 illustrates the steps for this shim.

SPLIT SHIM. Take a strip of clockspring, approximately 4" long. As above, cut it in half, lengthwise and smooth down the rough edge. The next step is creation of the 'split' in the shim. Carefully cut down the center of the shim, allowing yourself about 1 1/4" at the base for a handle. Finally, taper both tips, both on the sides and on the tip ends. FIG 11 illustrates the procedures required.

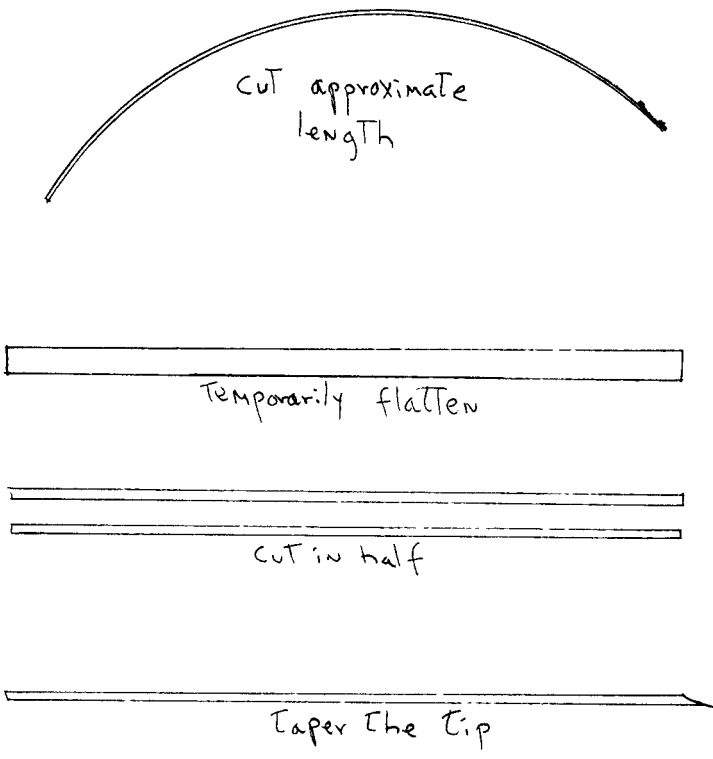

FIG 10

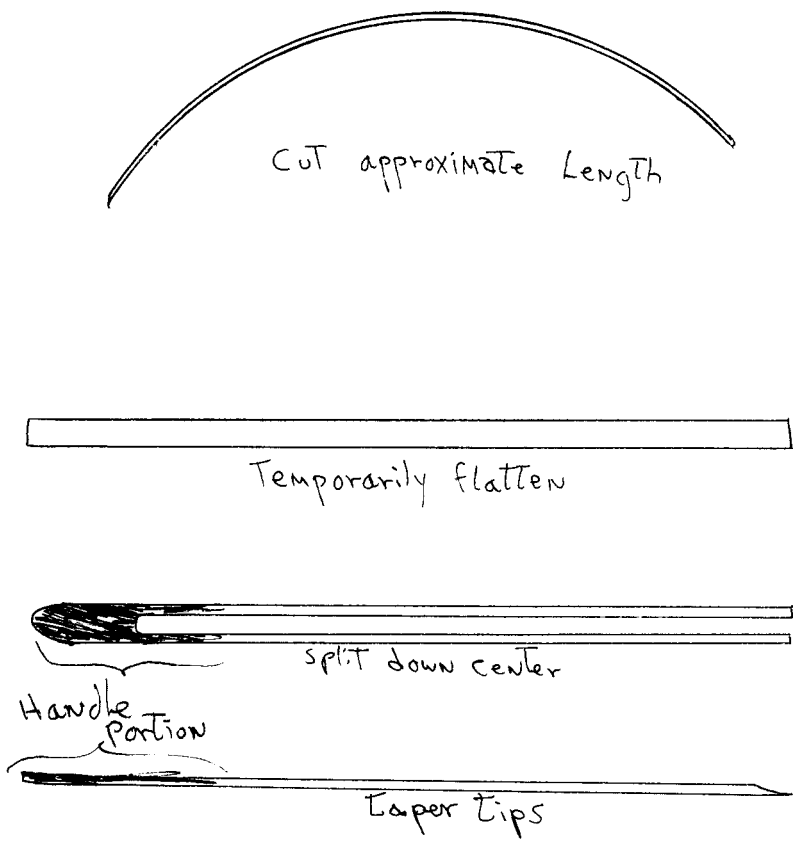

FIG 11

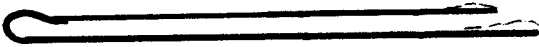

FIG 12

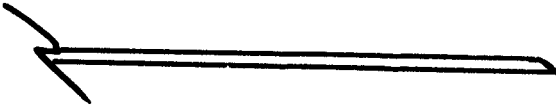

FIG 13

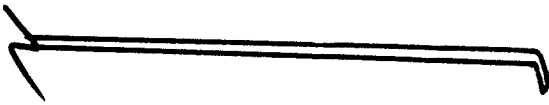

FIG 14

Several types and sizes of shims should be made. The first is the standard, or single, shim, as above. Handles are not necessary for these clockspring shims, but you can make them if you feel it is necessary. The maximum width of the standard shim is 1/8". 1/16th, 1/32nd, and 3/32 inch shims are also quite popular.

Shims can also be constructed from a portion of a metal tape ruler, such as that produced by the Stanley Corporation. In fact, from a strip 12" long, you should be able to make all the single and split shims that you will need. The procedure for making shims from a metal rule are the same as from a clockspring, as indicated above.

In the case of these shims, you should allow slightly more for a handle that can be wrapped with tape. It is exceptionally easy to cut your hand on these types of shims. As a final note, while the metal is the proper size, don't forget to put a slight bevel at the tip to allow the shim to operate more smoothly against the locking dog of the handcuffs.

PICKS

Essentially the technique for making each pick is basically the same. The variations come in the size of the pick; the amount of turn at the tip of the pick; the length of the pick; and the method in which each pick will be used.

Since bobby pins are found almost everywhere, and they are the correct size, it is quite easy to create various picks from them. USE LARGE and MEDIUM size bobby pins.

The first step is to remove the finish from the bobby pin; this can be done with an exacto knife, although using a metal wire wheel is much more effective and ensures that all of the finish is removed. (FIG 12)

Next, straighten out the bobby pin. You are actually concerned with only the flat end, not the opposite side.

Taper the end slightly. (FIG 13)

Now look at the next illustration (FIG 14). You will notice that the pick is, so far, ready. At the end of the pick, the tip has been turned 90° from the body of the pick. This corresponds to the bitting of the key that the pick

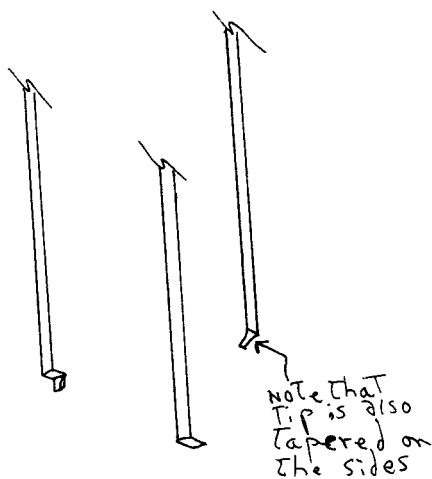

FIG 15

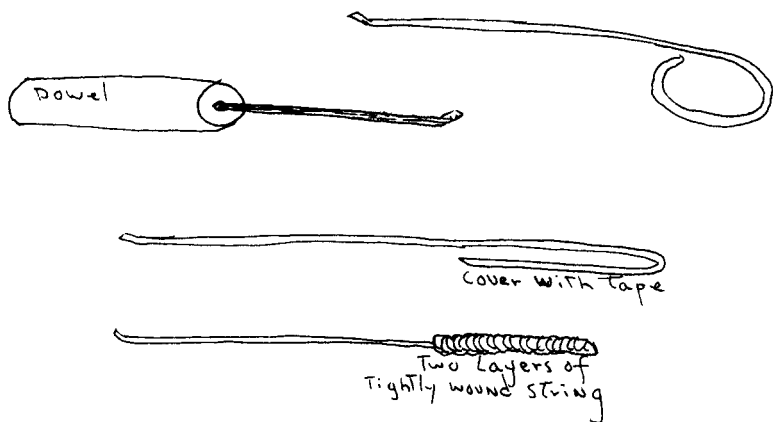

FIG 16

replaces. From the illustration, you will notice that the turned end is no larger than the bitting. If it were bigger, it would not fit into the keyhole, muchless be able to operate the locking mechanism. Since some handcuffs have a different size bitting on the keys, your various picks will also have to have a different sized tip that is turned. FIG 15 illustrates several different picks. All are full size so you only need to put your pick over the drawing to see if it corresponds correctly.

The next stage is to prepare some sort of handle. You can make one from a piece of dowelling, or you can make just a finger grip. Some of the better picks have no handle, so to speak, but rely upon either a piece of string wound about the opposite end over a fine layer of glue or a simple piece of masking tape. FIG 16 illustrates variations of handles.

The next pick should be a variation of the above. In this case, the tip will not be as long as before. See FIG 17 for a full sized illustration.

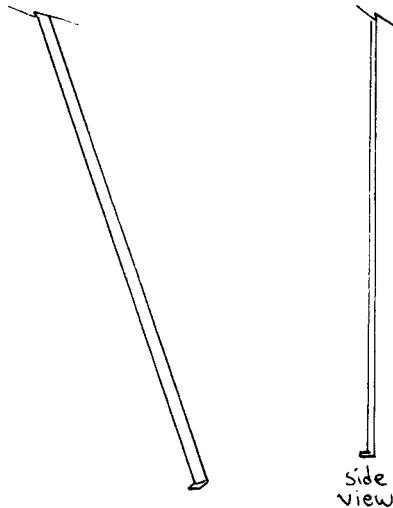

FIG 17

Picks do not necessarily have to follow the contours of a key and its biting, as above. The next pick under consideration is actually a long curved bobby pin. Also the sides have been filed down "just a hair," and again, the end is tapered. FIG 18 illustrates this pick.

Sometimes you will not need to put in a pick and turn it, but apply a curved pick instead, and just push back the locking dog with a gentle shove.

Now we consider a variation of both of the above types of pick. This one, illustrated in FIG 19, is tapered, and the tip is bent, but besides being bent at 90° from the direction of the body. An advantage with this is just inserting it into the keyway and pushing the opposite end (the handle) in the direction away from the direction you wish the pick to move. This also will open some types of handcuffs. This technique is illustrated in FIG 20.

FIG 21 illustrates a minimum set of lock picks that you should have in your collection. All of these are full size, based on the common bobby pin.

You may also consider making shims from bobby pins. If this is the case, after removal of the finish, taper the tip to a slight angle, and cut down the sides of the bobby pin. The wavy end of the bobby pin can be used as a handle for the shim by either applying string, tape, or making a finger-grip. Many individuals just rely upon their own grip, thus a bobby pin does not stand out in their pocket.

I have spoken of a wavy end on the bobby pin. Other manufacturers of bobby pins do not use a wavy side, but rather just a bent piece of metal, one half being a fraction shorter than the other. This shorter half would be considered the wavy side.

Lockpicks are also made of piano wire. Select piano wire from .020 to .060 for these picks. FIG 22 illustrates the necessary picks you should have available. All are full size so you need only lay your pick over the top to determine if it is correct.

NOTE: Sometimes a key breaks off inside the lock and a pick made from a bobby pin will not enter to open the lock; here is where a piano wire pick is quite useful.

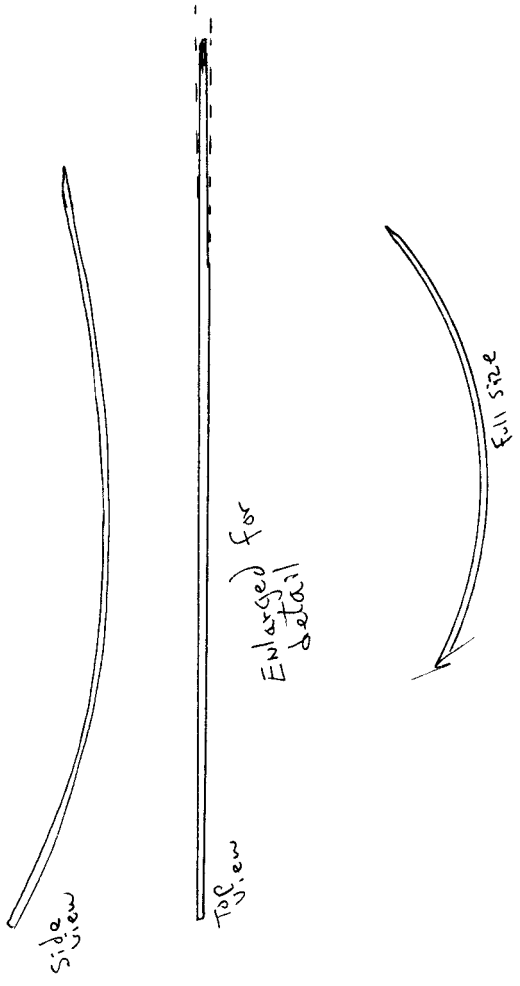

FIG 18

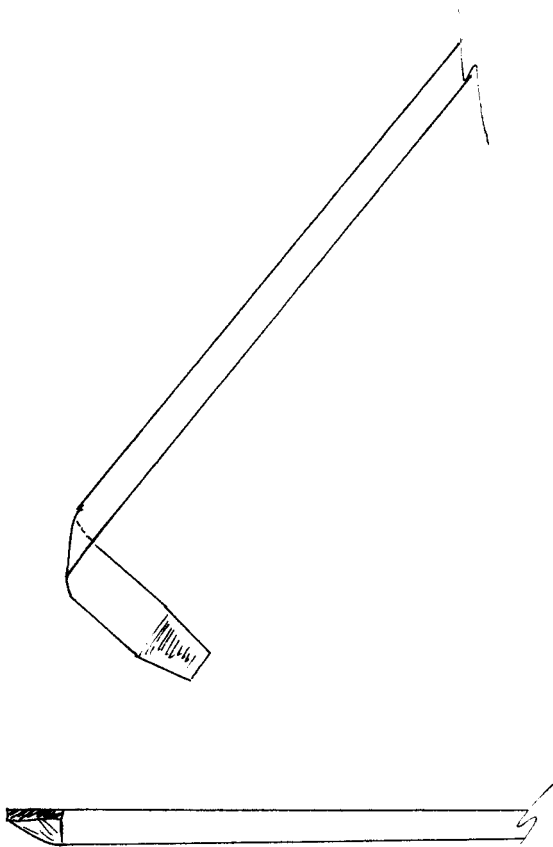

FIG 19

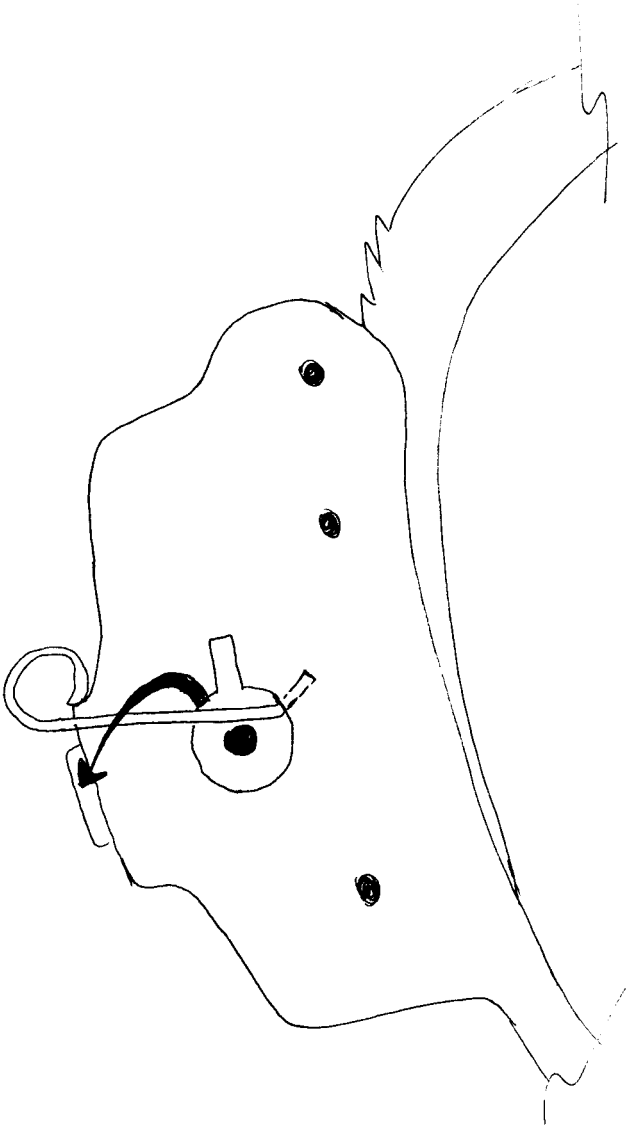

FIG 20

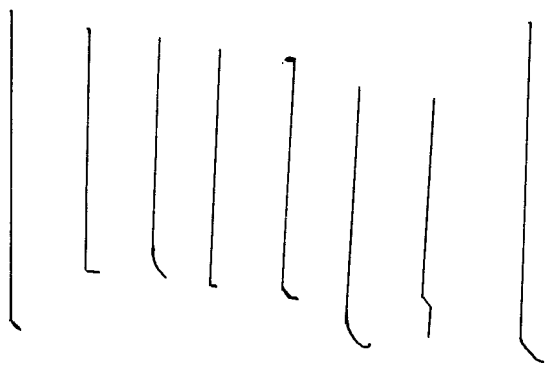

FIG 21

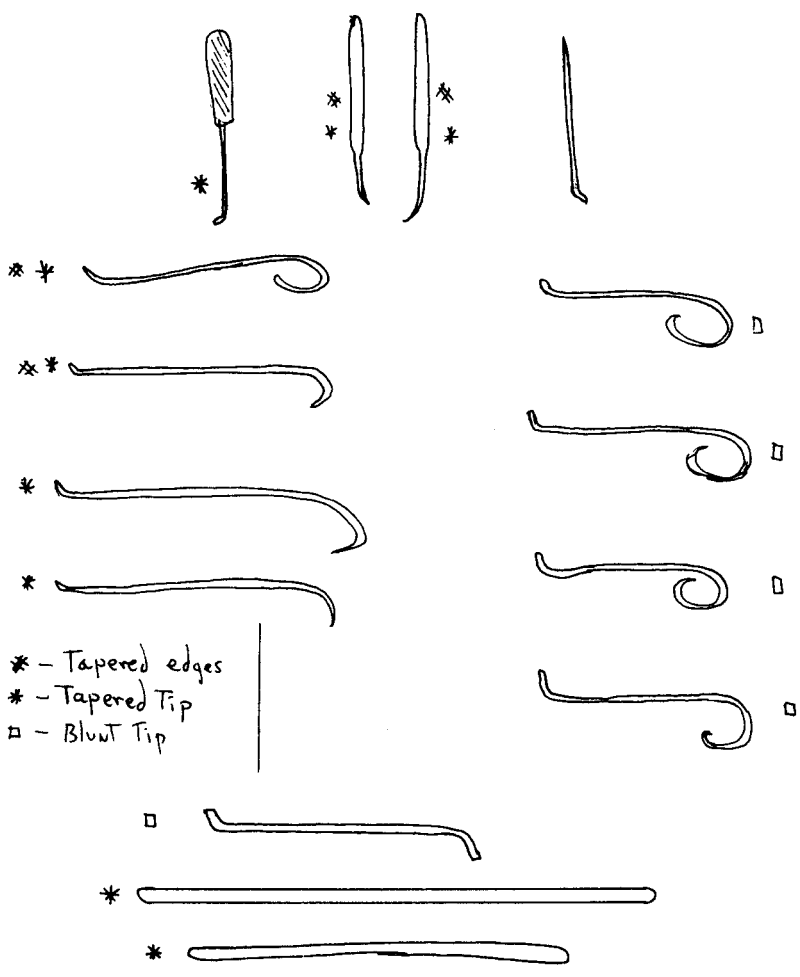

FIG 22

LOCKPICKING TECHNIQUES

Three basic techniques are used in the picking of handcuffs and their locks:

1. Rapping
2. Shimming
3. (Actual) picking of the lock mechanism

RAPPING. Rapping is not an actual lock picking technique, but it is integral to opening some types of locks. A prime example is the Peerless double-locking handcuff locks. In the Peerless model, you first turn the key to lock it the first time, then with the handle end of the key, you apply the protrusion to a pin set in the edge of the handcuff. This is the double, or second, lock of the handcuff. Until the key is inserted and turned opposite the normal direction of opening the cuff, there is no way you can open the cuff by picking or shimming. **BUT YOU CAN RELEASE THIS SECOND LOCK BY RAPPING THE HANDCUFFS, THUS ALLOWING YOU TO SHIM OR PICK THE OTHER LOCK.**

Rapping is best applied to handcuffs made before and during the early part of the 20th century, but as indicated above, it does have certain advantages on the more modern handcuffs. In essence, it is the application of a sharp "rap" to the side of the handcuffs, allowing the locking dog mechanism to bounce upwards for a fraction of a second, and thus, leaving the handcuff shackle free to be pulled outward. In actuality, a rap and a pulling action must be applied at approximately the same time.

In preparing to rap open a set of handcuffs such as this, a piece of elastic (medium strength) with a small hook such as a fishhook with the point filed off if necessary. When in use the hook end is hooked to the handcuff shackle, not quite half way between the shackle pin and the locking mechanism. The opposite end of the elastic can be hooked about the foot or the upper arm. Stretching the elastic somewhat creates a pulling tension force that will be required to put the shackle free of the locking mechanism. At this point, the handcuff is rapped, the locking dog bounces backward, and the shackle is pulled outward by the tension on the elastic.

Depending upon how far the shackle has been pushed inward, it may take two or three raps for the shackle notches (the teeth) to clear far enough to allow the hand to be removed.

In considering how, and on what to hit the handcuffs, you may well find the technique used by many magicians of value: Just above the knee of your trousers, create a small slip pocket and insert a slightly curved piece of steel. The curve should approximate that of your leg. It need not be more than 1" wide nor longer than four or five inches.

When working at home in your shop, the corner of the workbench can be used. Take care not to damage the handcuff when practicing this technique. Apply several layers of heavy masking tape, one over the other, onto the handcuff at the point which you will rap.

SHIMMING. Shimming is the time-honored technique whereby you would use a thin piece of wire, piano, thin steel, etc, and insert it along the end edge of the swinging shackle, and force back the catch mechanism of the locking dog (FIG 6). In doing this, you create the smooth surface which is necessary so the locking dog cannot catch and hold (any more) the teeth of the shackle on the handcuffs. This smoothness allows you to pull the shackle free from the locking mechanism.

PICKING. Picking the handcuff lock may be the last, and sometimes the only method available to you in opening a set of handcuffs. Since the handcuff lock can, for purposes herein, be considered a single lever locking mechanism (although double levers do exist), there is only one point you must concern yourself with. Thus, you must worry about only the movement of a single lever, and this lever must be shifted only slightly, in order to open the handcuffs.

In essence, you are inserting a pick (one of the different ones previously made) and applying pressure in such a fashion that it substitutes for the correct key, shifts the locking dog, and allows the shackle to open.

HANDCUFF KEYS

FIG 23 illustrates a variety of handcuff keys you should have. These are not to scale. At times you will come across a set of handcuffs that are either open or locked — but there is no key available. **YOU MUST MAKE A KEY.** Selecting the most appropriate blank, or trial key, insert it into the locking mechanism to see if it will turn at all. If you are using a trial key, it should open the handcuffs. When using a blank, sometimes you may have to cut it down slightly. In this case, blacken the bitting with smoke from a match or candle. Insert it and turn. Upon removal you can ascertain from the sharp marks left, where the locking dog is, and thus determine what portion to file away. Cut just slightly and carefully. Since the bitting is small, cutting too much off weakens the metal, which could cause it to break off inside the handcuff.

MASTER KEYS. Now and then you hear the phrase “master key” applied to a number of locks and their keys. Certainly they exist, but not for all handcuffs. Because of the individual peculiarities and design differences and the tolerances between different makes, models and styles, the best you may get is a “master key” that will fit 8 to 12 handcuffs at any one time. There is no true overall “master key” that will open every handcuff on the market. Even here, a number of these keys can cut down the amount of keys that must be carried in order to unlock a great number of different handcuffs.

Keys such as those found on ladies’ jewelry cases and children’s toys should be kept. Many times, they will fit a pair of handcuffs. Sometimes you may have another key in your collection that is just sitting there; it is possible that it may be cut down to fit a pair of handcuffs.

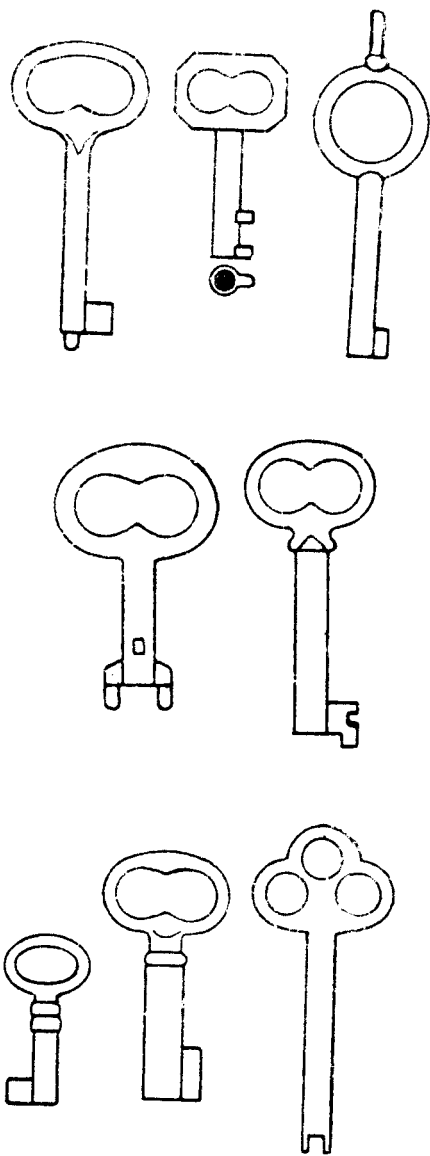

FIG 23

S&W Model 94
— Maximum Security Handcuff —

This latest addition to the Smith & Wesson handcuff line is unique. (See FIG 4) This model departed from their standard key and uses a tubular lock & key design. This design is similar to but not the same as the "Ace" tubular lock. The standard tubular lock has 7 tumblers, each with 7 different heights. The model 94 cuff has only 4 tumblers with 2 different heights, allowing for a maximum of 16 different keys. (See FIG 24)

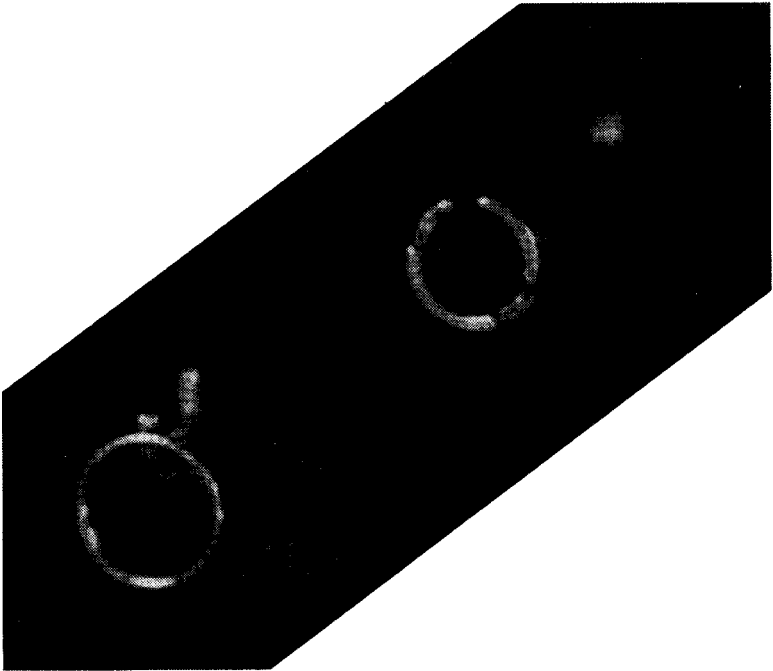

FIG 24

The above photograph shows the difference between an "Ace" type tubular lock key (left) and the Smith & Wesson Maximum Security handcuff key (right). The "Ace" key has an outside diameter of .375 inch and the S&W is .340 inch in diameter.

This handcuff was designed especially for the U.S. Marshal Service and is termed, by the manufacturer, as "Maximum Security." A better term might have been "complicated security."

In the design of a device such as a handcuff there is only so far you can go in the direction of security before suffering somewhere else. S&W put forth an effort to design a handcuff that departed from the standard cuff lock & key with everyone remotely associated with law enforcement having a key that fits nearly all commonly used handcuffs. What they created is one of the easiest to pick handcuffs available. On the plus side, however, they are strong and well constructed.

In picking the standard handcuff (Peerless & S&W) the inside of a ball point pen was used. To pick this "High Security" version we, again, look to our ball point pen — only this time we will fashion a torsion wrench from the clip. This is done by simply bending the spring portion of the clip out at a 90° angle to form a handle. (Take care not to break it off) The round portion of the clip that fit around the pen is a perfect fit into the round keyway.

We now have a very good improvised torsion wrench and the only remaining "tool" needed is a small flat piece of steel to use as a pick. A common bobby pin serves our purpose nicely. (See FIG 25)

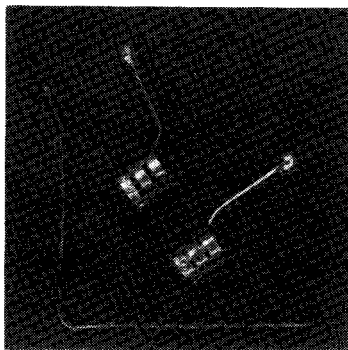

FIG 25

Shown above is the improvised tools needed to open the S&W maximum Security handcuffs. The two "tools" are easily recognizable as a straightened bobby pin and a ball point pen pocket clip with the spring bent outward 90° .

The picking procedure is quite simple. With the improvised torsion wrench inserted into the circular keyway, torque can be applied while each tumbler is picked to its shear line. (See FIG 27)

From a "neutral" position the lock can be turned slightly in a direction away from the chain, to open the shackle. It can be turned 90° toward the chain to activate the double lock feature. In this double lock position the key can be removed. (See FIG 28)

Since replacement keys are unavailable, even to locksmiths, a drawing for making a set of 16 keys that will open all handcuffs of this type is included. (See Fig 29 & 30)



FIG 26

In the photograph above we see a set of S&W Maximum Security handcuffs, their matching key, an "Ace" type key and a set of improvised picking tools.



FIG 27

The photograph above shows the actual picking process. Notice that tension is being applied with the improvised torsion wrench while the tumblers are picked to their shear line with a bobby pin. Take care not to insert the torsion wrench into the lock too far — where it touches the tumbler pins.

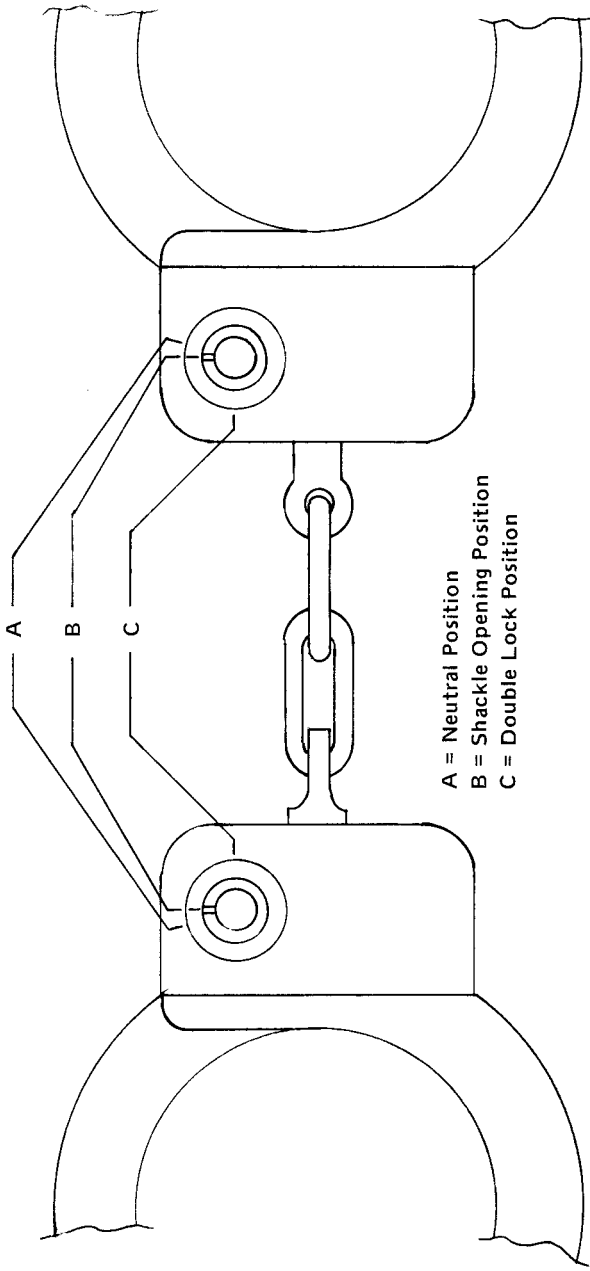

A = Neutral Position
B = Shackle Opening Position
C = Double Lock Position

FIG 28

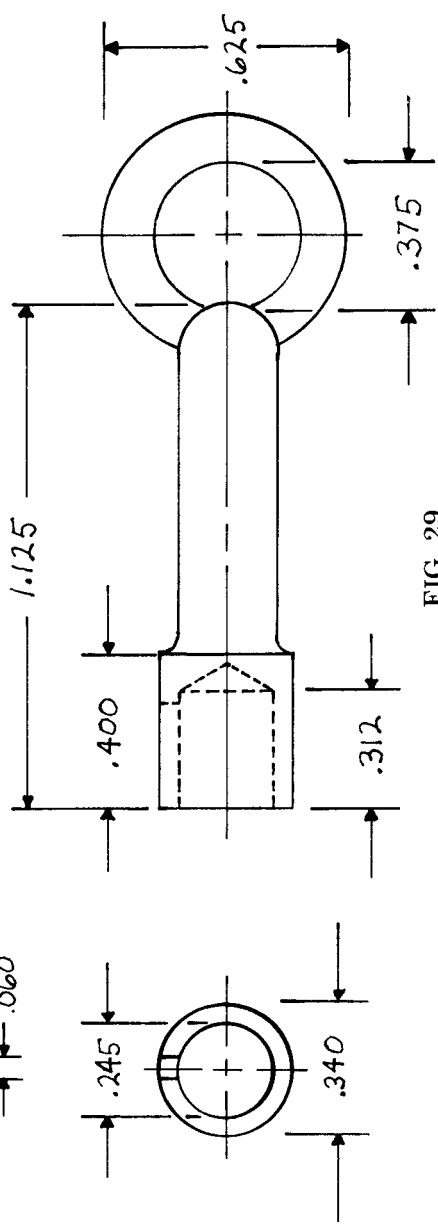
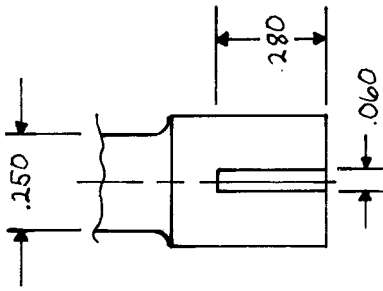
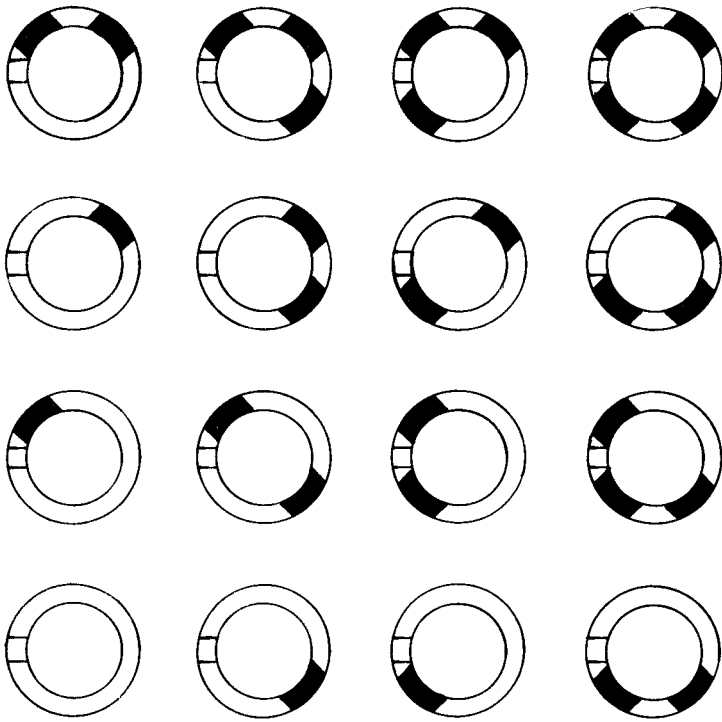
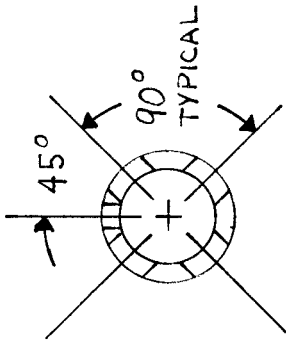

FIG 29

S&W MAXIMUM SECURITY HANDCUFF KEY BLANK



CUT LOCATION OF ALL 16 KEYS



LOCATION OF TUMBLER CUTS

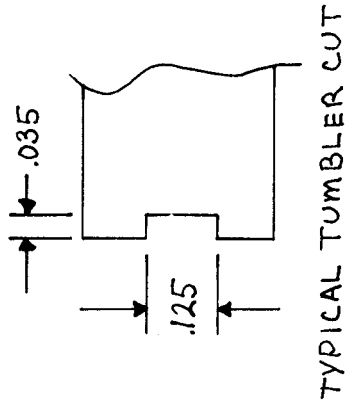

FIG 30

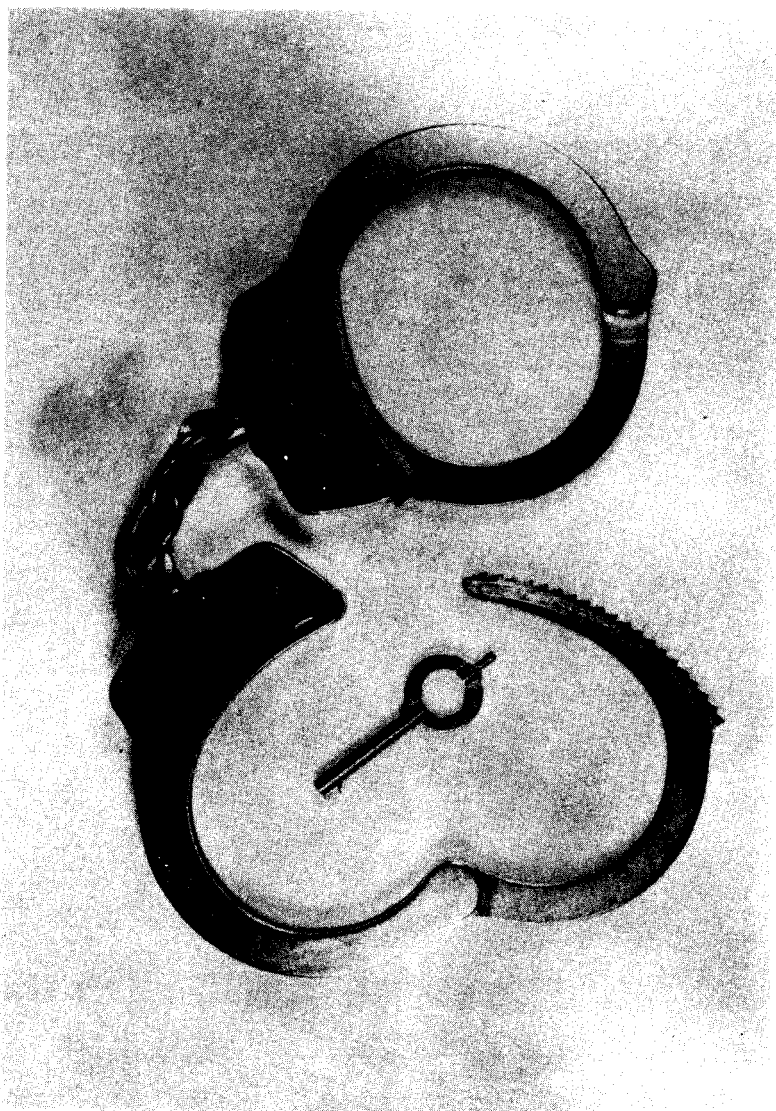

FIG 31
Standard S&W Model 90 handcuffs

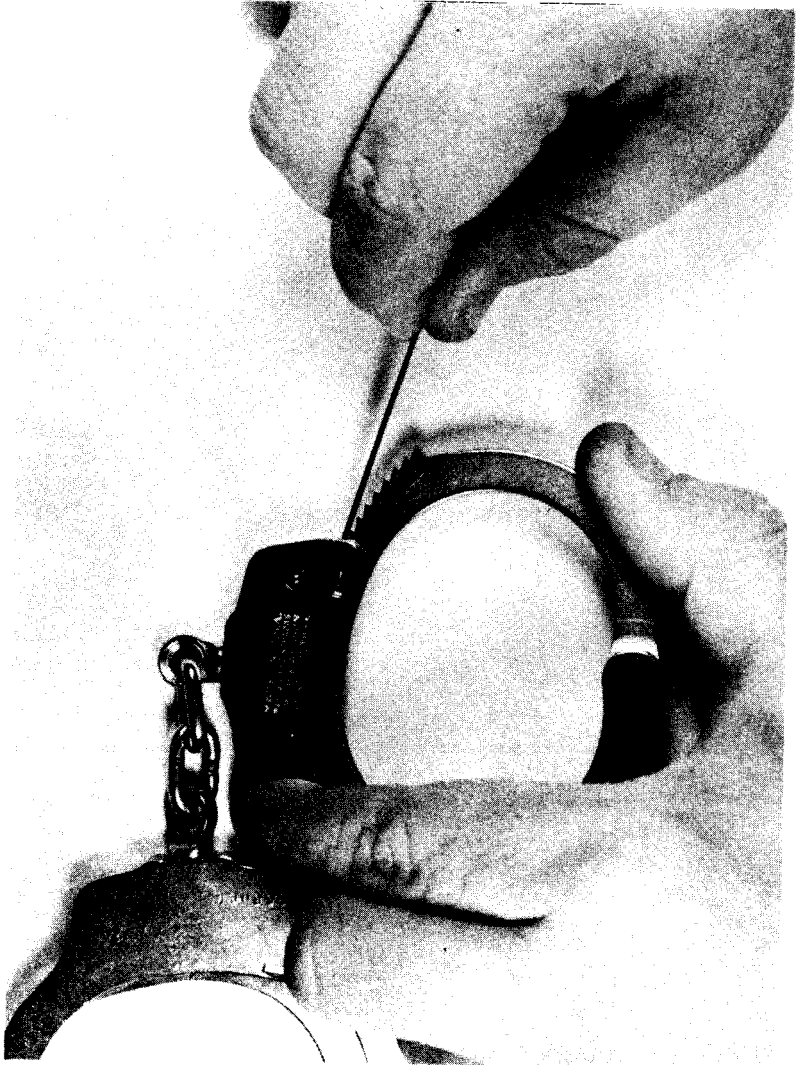

FIG 32

Shimming a standard handcuff open. Note: the double-lock feature must be disengaged or this method of opening cannot be accomplished.



FIG 33

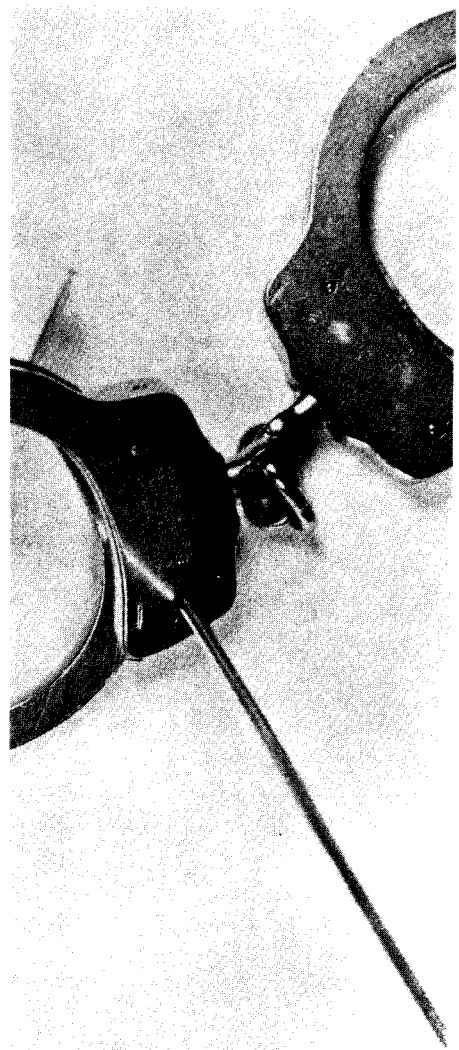

FIG 34

The two photographs above show how the "insides" of a ball point pen can be used to fashion an improvised key that will open all standard handcuffs such as S&W and Peerless.

NOTES TO THE READER

If you know that the handcuffs cannot be picked or shimmed, and you are sure that the set may be rusty, you might consider various lubricants on the market, such as “lock-ease” and naval jelly. With lock-ease, it should be squirted into the keyhole and allowed to ‘work’ for a short period of time before you attempt to shim or pick it again. Sometimes, several applications are necessary.

With naval jelly, force it into the keyhole, ensuring that enough is put in to allow all parts of the lock mechanism to be reached. Allow it to work from 15 minutes up to a half-hour. Next, force water through, washing away the residue. Follow this with either 3-in-1 Oil or lock-ease to ensure that the lock parts will not rerust. This slight film helps to prevent the rusting.

If, even after the above, you cannot open the lock, the final step is to dismantle the handcuffs. Locate the pins or rivets holding the handcuffs together and carefully remove them. Then lay out each part so you know its exact location when you put the handcuffs together again. Replace work or rusted parts and springs. Many times, in older models, you may have to make new parts by hand. In instances such as this use a good grade of steel and be careful in cutting the part so that it is not longer or smaller, and definitely not thicker or thinner than the original part. Many times you can adapt springs to replace the original spring. As a last resort here, you may have to make a spring from scratch.

Points to Consider

Keep a variety of small keys, both flat and ‘pipe’ types on hand; you may luck out and have one that will open a difficult lock, or be able to modify an existing key.

Consider having several sets of shims and picks available for use. A damaged or broken one means only obtaining another from your duplicates — and not having to stop and make one.

Handcuffs are made as a TEMPORARY RESTRAINING DEVICE. The overall security is temporary, and not exceptionally high.

Be fully prepared for any handcuff that may come your way. Research, view lock collections, talk with locksmiths and specialists in the security field. Above all, don't pass up even a small piece of information. It may fit in with something you learned elsewhere and solve a problem handcuff.

Simple locks on medium and low quality handcuffs can create problems. Only study and practice will allow you to pinpoint each and every flaw associated with a particular model or series of handcuffs.

Avoid over-exertion when using picks and/or shims.

Avoid letting other people see how you open the handcuffs with picks and/or shims. You learned the hard way; why should they do it the easy way. Also, you may not know who the person is, or what his motives are.