

SH 21-76

UNITED STATES ARMY



RANGER HANDBOOK

**RANGER TRAINING BRIGADE
UNITED STATES ARMY INFANTRY SCHOOL
FORT BENNING, GEORGIA
JULY 1992**

THE RANGER COURSE DEVELOPS STUDENTS BY REQUIRING THEM TO PERFORM EFFECTIVELY AS SMALL UNIT LEADERS IN A REALISTIC, TACTICAL ENVIRONMENT UNDER MENTAL AND PHYSICAL STRESS APPROACHING THAT FOUND IN COMBAT. RANGER SCHOOL INSTILLS CONFIDENCE AND COMPETENCE IN FUTURE RANGER LEADERS. PERHAPS ITS GREATEST CONTRIBUTION IS TO CREATE A CLIMATE OF RELATIVELY HIGH STRESS AND DEPRIVATION, IN WHICH RANGER STUDENTS LEARN HOW THEY AND OTHERS ACT AND REACT UNDER PRESSURE. LIKEWISE IT DEMONSTRATES THE CHALLENGES OF LEADING AND FOLLOWING WHILE OVERCOMING OBSTACLES. MORE THAN ANYTHING ELSE, RANGER SCHOOL BUILDS CHARACTER, IDENTIFIES THOSE WITH THE APTITUDE TO BE RANGER LEADERS, AND ENCOURAGES FURTHER DEVELOPMENT OF POSITIVE, CAN-DO ATTITUDES. IT PROVIDES THE STUDENT WITH PRACTICAL EXPERIENCE IN THE APPLICATION OF THE TACTICS AND TECHNIQUES OF RANGER OPERATIONS IN WOODED, DESERT, LOWLAND SWAMP AND MOUNTAINOUS ENVIRONMENTS. EMPHASIS IS PLACED ON DEVELOPMENT OF INDIVIDUAL LEADERSHIP ABILITIES THROUGH THE APPLICATION OF THE PRINCIPLES OF LEADERSHIP WHILE FURTHER DEVELOPING MILITARY SKILLS IN THE PLANNING AND CONDUCT OF DISMOUNTED INFANTRY, AIRBORNE, AIR ASSAULT AND AMPHIBIOUS SQUAD AND PLATOON-SIZE COMBAT OPERATIONS.

PREFACE

THIS PUBLICATION IS BOTH AN EXTRACT OF DOCTRINAL PUBLICATIONS AND A COMPILATION OF TACTICS, TECHNIQUES AND PROCEDURES TAUGHT IN THE U.S. ARMY RANGER SCHOOL. IT IS PRINCIPALLY DESIGNED AS A POCKET REFERENCE FOR STUDENTS OF THE U.S. ARMY RANGER SCHOOL. ITS SECONDARY USE IS FOR THE DEVELOPMENT OF SMALL UNIT LEADERS IN THE FIELD ARMY AND FOR THEIR USE AS A POCKET GUIDE.

THE TECHNIQUES LISTED HEREIN WILL BE TAUGHT AT THE U.S. ARMY RANGER SCHOOL. STUDENT GRADES ARE BASED ON THEIR EMPLOYMENT OF SOUND, DOCTRINAL PRINCIPLES, NOT ON THE EMPLOYMENT OF A SPECIFIC TECHNIQUE.

RANGER CREED

Recognizing that I volunteered as a Ranger, fully knowing the hazards of my chosen profession, I will always endeavor to uphold the prestige, honor, and high "esprit de corps" of the Rangers.

Acknowledging the fact that a Ranger is a more elite soldier who arrives at the cutting edge of battle by land, sea, or air, I accept the fact that as a Ranger my country expects me to move further, faster and fight harder than any other soldier.

Never shall I fail my comrades. I will always keep myself mentally alert, physically strong and morally straight and I will shoulder more than my share of the task whatever it may be. One Hundred-percent and then some.

Gallantly will I show the world that I am a specially selected and well trained soldier. My courtesy to superior officers, neatness of dress and care of equipment shall set the example for others to follow.

Energetically will I meet the enemies of my country. I shall defeat them on the field of battle for I am better trained and will fight with all my might. Surrender is not a Ranger word. I will never leave a fallen comrade to fall into the hands of the enemy and under no circumstances will I ever embarrass my country.

Readily will I display the intestinal fortitude required to fight on to the Ranger objective and complete the mission, though I be the lone survivor.

TABLE OF CONTENTS

- Ranger Creed

- Ranger Training Brigade Mission/Ranger School Intent

Chapter 1 - Leadership

.....Duties/Responsibilities.....1-2
.....Assumption of Command.....1-13

Chapter 2 - Operations

.....Mission Tactics.....2-1
.....Troop Leading Procedures.....2-4
.....Combat Intelligence.....2-12
.....Combat Orders.....2-17
.....Operation Order Annexes.....2-27
.....Tasks.....2-38
.....Coordination Checklists.....2-40

Chapter 3 - Fire Support

Chapter 4 - Movement

.....Techniques.....4-4
.....Tactical Marches.....4-11
.....Danger Areas.....4-19

Chapter 5 - Patrolling

.....Planning Considerations.....5-1
.....Five Point Contingency Plan.....5-13
.....Reconnaissance Operations.....5-14
.....Combat Patrol.....5-24
.....Raid.....5-43
.....DPT/Re-entry.....5-51
.....Link-up.....5-57
.....Patrol Base.....5-59
.....Movement to Contact.....5-72

Chapter 6 - Battle Drills

.....Platoon Attack.....6-2
.....Squad Attack.....6-11
.....React to Contact.....6-17
.....React to Ambush.....6-19

Chapter 6 - Battle Drills (Cont'd)

.....React to Indirect Fire.....6-21
.....React to Air Attack.....6-22
.....Knock Out a Bunker.....6-26
.....Enter Building/Clear Room.....6-30
.....Enter/Clear a Trench.....6-37
.....Breach a Mined Wire Obstacle.....6-45

Chapter 7 - Communications

.....Troubleshooting Guide.....7-13

Chapter 8 - Army Aviation

Chapter 9 - Stream Crossing and Waterborne Operations

Chapter 10 - Military Mountaineering

Chapter 11 - Evasion/Survival

Chapter 12 - First Aid

Chapter 13 - Combat Service Support

.....MEDEVAC Request.....13-17

Chapter 14 - Recon, Surveillance, and Target Acquisition

Chapter 15 - Demolitions and Mines

Glossary

References

Ranger's Standing Orders

CHAPTER ONE

LEADERSHIP

1-1. GENERAL. The most essential element of combat power is competent and confident leadership. Leadership provides purpose, direction, and motivation in combat. It is the leader who will determine the degree to which maneuver, firepower, and protection are maximized; who will ensure these elements are effectively balanced; and who will decide how to bring them to bear against the enemy.

While leadership requirements differ with unit size and type, all combat leaders must be men of character who must know and understand soldiers and the tools of war. They must act with courage and conviction during the uncertainty and confusion of battle. The primary function of tactical leaders is to inspire soldiers to do difficult things in dangerous, stressful circumstances.

A good leader will:

- Take charge of his unit by issuing appropriate orders, establishing priority of tasks, and establishing/maintaining security.
- Motivate his men by setting the example and always maintaining a positive can-do attitude.
- Demonstrate initiative by taking positive actions in the absence of orders and by making sound and timely decisions based on METT-T.
- Effectively communicate by giving specific instructions to accomplish the mission, keeping the unit informed, and by involving key leaders in the decision-making process, and;
- Supervise by inspecting to ensure tasks are accomplished to standard, making appropriate corrections, and holding immediate subordinates responsible for assigned tasks.

As a leader, there are certain things that you must be, know, and do:

a. BE -

(1) **TECHNICALLY AND TACTICALLY PROFICIENT:** can accomplish all tasks to standard that are required to accomplish the wartime mission.

(2) **POSSESS PROFESSIONAL CHARACTER TRAITS:**

Courage, Commitment, Candor, Competence and Integrity.

b. KNOW:

(1) Four major factors of leadership and how they affect each other: The Led, The Leader, The Situation, and Communications.

(2) Yourself and seek self-improvement: Strengths and weaknesses of your character, knowledge and skills. Continually develop your strengths and work on overcoming your weaknesses.

(3) Your soldiers and look out for their well-being. Know and care for your soldiers. Train them for the rigors of combat, take care of their physical/safety needs, and discipline/reward them.

c. DO:

(1) **SEEK RESPONSIBILITY AND TAKE RESPONSIBILITY FOR YOUR ACTIONS:** Leaders must exercise initiative, be resourceful, and take advantage of opportunities on the battlefield that will lead to victory. Accept just criticism and take corrective action for mistakes.

(2) **MAKE SOUND AND TIMELY DECISIONS.** Rapidly assess situations and make sound decisions. Gather essential information, announce decisions in time for soldiers to react, and consider short/long-term effects of your decision.

(3) **SET THE EXAMPLE.** Be a role model for your soldiers. Set high, but attainable standards, be willing to do what you require of your soldiers, and share dangers and hardships with your soldiers.

(4) **KEEP YOUR SUBORDINATES INFORMED.** Keeping your subordinates informed helps them make decisions and execute plans within your intent, encourages initiative, improves teamwork, and enhances morale.

(5) Develop a sense of responsibility in your subordinates: Teach, challenge, and develop your subordinates. Delegation indicates you trust your subordinates and will make them want even more responsibility.

(6) **ENSURE THE TASK IS UNDERSTOOD, SUPERVISED, AND ACCOMPLISHED:** Soldiers need to know what you expect from them; what you want done, what the standard is, and when you want it.

(7) **BUILD THE TEAM:** Train and cross train your soldiers until they are confident in the team's technical/tactical abilities. Develop a team spirit that motivates them to go willingly and confidently into combat.

(8) **EMPLOY YOUR UNIT IN ACCORDANCE WITH ITS CAPABILITIES:** Know the capabilities and limitations of your unit. Use the battle focus process to identify those vital tasks essential to mission accomplishment and conduct tough, challenging, and realistic training to ensure your unit achieves Army standards on those tasks.

1-2. DUTIES AND RESPONSIBILITIES

To complete all assigned tasks, every soldier in the platoon must do his job. Each soldier must accomplish his specific duties and responsibilities and be a part of the team.

a. Rifle Platoon Leader. He is responsible for all that the platoon does or fails to do. This includes the tactical employment, training, administration, personnel management, and logistics of his platoon. He does this by planning, making timely decisions, issuing orders, assigning tasks, and supervising platoon activities. He must know his men and how to employ the platoon's weapons. He is responsible for positioning and employing all assigned or attached crew-served weapons. He must also

know how to employ supporting weapons. The rifle platoon leader--

- (1) Sets the example and the standards.
- (2) Leads the platoon in support of company and or battalion missions.
- (3) Takes the initiative to accomplish the mission in the absence of orders. Informs his commander of his actions when operating without orders.
- (4) Plans with the help of the platoon sergeant, squad leaders, and other key personnel (FO, leaders of attachments, and so on).
- (5) Stays abreast of the situation and goes where he is needed to supervise, issue FRAGOs, and accomplish the mission.
- (6) Requests more support for his platoon from the company commander to perform its mission, if needed.
- (7) Assists the platoon sergeant in planning and coordinating the platoon's CSB effort.
- (8) During planning, receives on-hand status reports from the platoon sergeant, squad leaders, or both.
- (9) Reviews platoon requirements based on the tactical plan.
- (10) Develops a casualty evacuating plan.
- (11) During execution, positions himself where he can influence the most critical task for mission accomplishment (usually with the main effort).
- (12) Commands through his squad leaders using the intent of the company and battalion commanders.

b. Rifle Platoon Sergeant. This soldier is the senior NCO in the platoon and second in succession of command. He helps and advises the platoon leader, and leads the platoon in the platoon leader's absence. He supervises the platoon's administration, logistics, and maintenance. He may prepare and issue paragraph 4 of the platoon OPORD. The rifle platoon sergeant is responsible for individual training. He must ensure that soldiers can perform their individual MOS tasks.

(1) Organizes and controls the platoon CP IAW the unit SOP, platoon leader guidance, and METT-T factors.

(2) Receives squad leaders' requests for rations, water, and ammunition. Works with the company's first sergeant or XO to request resupply. He also directs the routing of supplies and mail.

(3) Directs the platoon medic and platoon aid and litter teams in moving casualties to the rear.

(4) Maintains platoon strength information, consolidates and forwards the platoon's casualty reports (DA Forms 1155 and 1156), and receives and orients replacements.

(5) Monitors the morale, discipline, and health of platoon members.

(6) Takes charge of task-organized elements in the platoon during tactical operations. This can include, but is not limited to, the following:

- Quartering parties.
- Security forces in withdrawals.
- Support elements in raids or attacks.
- Security patrols in night attacks.

(7) Coordinates and supervises company-directed platoon resupply operations.

(8) Ensures that supplies are distributed IAW the platoon leader's guidance and direction.

(9) Ensures that ammunition, supplies, and loads are properly and evenly distributed (a critical task during consolidation and reorganization).

(10) Ensures the casualty evacuation plan is complete and executed properly.

The following checklist outlines his duties and responsibilities during specific actions:

- a. Actions during movement and at halts.

- (1) Take action necessary to facilitate movement.
 - (a) Normally supervises rear security during movement.
 - (b) Supervise, establish and maintain security during halts.
 - (c) Navigation - know where you are!
- (2) Perform additional tasks as required by the platoon leader and assist him in every way possible. Focus on control on the platoon (especially during movement) and security.
 - b. Actions at Danger Areas.
 - (1) Directs positioning of near-side security (usually conducted by the trail squad or team).
 - (2) Ensures everyone crosses and sends up report to the PL.
 - c. Actions in the objective area.
 - (1) Assist in the occupation of the DRP.
 - (2) Supervise, establish and maintain security in the DRP.
 - (3) Supervise the final preparation of weapons and equipment in the DRP as per guidance from platoon leader.
 - (4) Assist the platoon leader in control and security.
 - (5) Supervise the reorganization and redistribution of ammo and equipment. Ensure accountability and status of personnel is maintained, to include MIA's and KIA's.
 - (6) Perform additional tasks assigned by the platoon leader.
 - d. Actions in the Patrol Base.
 - (1) Assist in the occupation of the patrol base.
 - (2) Assist in supervising the establishment and adjustment of the perimeter.
 - (3) Maintain security in the patrol base.
 - (a) Keep movement and noise to a minimum.
 - (b) Supervise camouflage and perimeter separation.

- (c) Periodically inspect the perimeter to ensure sectors of fire are assigned.
- (d) Ensure designated personnel remain alert and that equipment is maintained in a high state of readiness.
 - (4) Requisition supplies, water, ammo and supervise their distribution.
 - (5) Supervise the priority of work and ensure its accomplishment.
 - (a) Security plan.
 - (b) Maintenance plan.
 - (c) Hygiene plan.
 - (d) Messing plan.
 - (e) Water plan.
 - (f) Rest plan.
 - (6) Perform additional tasks assigned by the platoon leader and assist him in every way possible.
- e. Rifle Squad Leader. This soldier is responsible for all that the rifle squad does or fails to do. He is a tactical leader and, as such, leads by example, he is third in the platoon chain of command. The rifle squad leader--
 - (1) Controls the maneuver of his squad and its rate and distribution of fire.
 - (2) Trains his squad on the individual and collective tasks required to sustain combat effectiveness.
 - (3) Manages the logistical and administrative needs of his squad. He requests and issues ammunition, water, rations, and special equipment.
 - (4) Maintains accountability of his soldiers and equipment.
 - (5) Completes casualty feeder reports and reviews the casualty reports completed by squad members.
 - (6) Directs the maintenance of the squad's weapons and equipment.
 - (7) Inspects the condition of soldiers' weapons, clothing, and equipment.

- (8) Ensures that material and supplies are distributed to the soldiers in the squad.
- (9) Keeps the platoon sergeant/leader informed on squad supply status and squad requirements.

The following checklist outlines his duties and responsibilities during specific actions:

- a. Actions throughout the mission.
 - (1) Sets the example by personally adhering to established standards and procedures.
 - (2) Obtain status report from team leaders and submit reports to platoon leader/platoon sergeant.
 - (3) Makes recommendations to the platoon leader and platoon sergeant when problems are observed.
 - (4) Ensures tasks are accomplished by delegating tasks to team leaders and by establishing a priority of tasks in accordance with orders received from the platoon leader.
 - (5) Uses initiative in the absence of orders.
 - (6) Follows the platoon leader's plan.
- b. Actions during movement and at halts.
 - (1) Rotates heavy equipment and difficult duties.
 - (2) Ensures platoon leader is notified when rest halts and water replenishment is required.
 - (3) Maintains proper movement techniques while monitoring route, pace and azimuth.
 - (4) Takes all actions to prevent breaks in contact.
 - (5) Checks personnel at halts.
- c. Actions in the objective area.
 - (1) Ensures special equipment has been prepared for actions at the objective.
 - (2) Maintains security and control during conduct of the assault.
 - (3) Obtains status reports from team leaders and ensures ammunition is redistributed.

- d. Actions in the patrol base.
 - (1) Ensures patrol base is occupied according to the platoon leader's plan.
 - (2) Ensures personnel cover the entire sector; make final adjustments, if necessary.
 - (3) R&S team is sent out in front of assigned sector.
 - (4) Ensures priorities of work are being accomplished and report accomplished priorities to the platoon leader/platoon sergeant.
 - (5) Adheres to time schedule.
 - (6) Ensures personnel know the alert and evacuation plan, the locations of key leaders, OPs and the location of the alternate patrol base.
- e. Weapons Squad Leader (Infantry, Airborne, and Air Assault Divisions Only). This soldier is responsible for all that the weapons squad does or fails to do. His duties are the same as the rifle squad leader. He also controls the machine guns and MAWs in support of the platoon's mission. He advises the platoon leader on employing his squad.
 - f. Machine Gun Squad Leader (Ranger Rifle Company Only). This soldier is responsible for all that the machine gun squad does or fails to do. His duties are the same as the rifle squad leader, and he also controls the machine guns in support of the platoon's mission. He advises the platoon leader on employing the squad.
 - (1) Supervise machine gun teams to ensure they follow priority of work.
 - (2) Inspect machine gun teams for correct range cards, fighting positions, and understanding of fire plan.
 - (3) Supervise maintenance of machine guns (done correctly, deficiencies corrected, reported and does not violate security plan).
 - (4) Assist PL in planning.
 - (5) Position machine guns not attached to squads according to platoon SOP at halts and danger areas.
 - (6) Rotate loads, machine gunners normally get tired first.

- (7) Submit ACE report to PSG.
 - (8) Designate targets for each gun.
 - (9) Give additional fire commands to achieve maximum effectiveness.
 - Shifting fires.
 - Correcting windage or elevation to increase accuracy.
 - Alternate firing guns.
 - Prevent lulls in fire.
 - (10) Keep aware of location of assault elements or break elements and prevent fratricide.
 - (11) Report to higher.
- g. Team Leader: This soldier is a fighting leader who leads by personal example and helps the squad leader as required. He controls the movement of his fire team and the rate and placement of fire by leading from the front and using the proper commands and signals. He maintains accountability of his soldiers and equipment. He ensures his soldiers maintain the unit standards in all areas. The following checklist outlines specific duties and responsibilities of team leaders during mission planning and execution. These duties/responsibilities may be performed by either team leader.
- a. Actions During Planning and Preparation.
 - (1) Warning Order
 - (a) Assist in control of the squad.
 - (b) Monitor squad during issue of the order.
 - (2) OPORD Prep
 - (a) Post changes to time schedule.
 - (b) Update team duties on warning order board.
 - (c) Post team duties on warning order board.
 - (d) Assemble ammo and supply lists.
 - (e) Turn in and pick up supply requests.
 - (f) Distribute ammo and special equipment.
 - (g) Perform all tasks given by the SL in the special instructions paragraph.
 - (3) Operation Order
 - (a) Monitor squad during issue of order.
 - (b) Assist SL during rehearsals.
 - b. Actions During Movement and at Halts.
 - (1) Take actions necessary to facilitate movement.
 - (a) Supervise rear security during movement.
 - (b) Supervise, establish, and maintain security during halts.

- (2) Perform additional tasks as required by the SL and assist him in every way possible, particularly control and security.
 - c. Actions in the objective area.
 - (1) Assist in the occupation of the DRP.
 - (2) Assist in the supervision, establishment and maintenance of security.
 - (3) Supervise the final preparation of men, weapons, and equipment in the DRP as per the squad leader's guidance.
 - (4) Assist in control of personnel departing and entering the DRP.
 - (5) Reorganize perimeter after recon party departs.
 - (6) Maintain commo with higher headquarters.
 - (7) Upon return of recon party, assist in the reorganization of personnel and redistribution of ammo and equipment; ensure accountability of all personnel and equipment is maintained.
 - (8) Disseminate FIR to his team.
 - (9) Perform additional tasks assigned by the SL.
 - d. Actions in the Patrol Base.
 - (1) Assist in occupation.
 - (2) Assist in supervising the establishment and adjustment of the perimeter.
 - (3) Assist in maintaining patrol base security.
 - (a) Keep movement and noise to a minimum.
 - (b) Assist in crew served weapons placement and range card preparation.
 - (c) Inspect the perimeter to ensure squad has interlocking sectors of fire; prepare team sector sketch.
 - (4) Ensure that the LP/OP is rotated and alert
 - (5) Request supplies, water, and ammo, and supervise their distribution.
 - (6) Supervise the priority of work and ensure it is accomplished properly.
 - (7) Perform additional tasks assigned by the SL and assist him in every way possible.
 - e. Actions During Link Up.
 - (1) Assist in the preparation of men and equipment
 - (2) Ensure all personnel are knowledgeable of their tasks and the operation.

4. Air Assault Operations.

- (1) Assist in rehearsals
- (2) Assist in manifest preparation
- (3) Control bump plan

g. Platoon Aidman. This soldier helps the platoon sergeant direct aid and litter teams; he monitors the health and hygiene of the platoon. The platoon aidman--

- (1) Treats casualties and assists in their evacuation under the control of the platoon sergeant.
- (2) Aids the platoon leader/sergeant in field hygiene matters, personally checks the health and physical condition of platoon members.
- (3) Requests Class VIII (medical) supplies through the platoon sergeant.
- (4) Provides technical expertise and supervision of the combat lifesavers.
- (5) Carries out other tasks assigned by the platoon leader and platoon sergeant.

h. Platoon Radiotelephone Operator. The platoon RATELO must know the use and care of the radio to include waterproofing and presetting frequencies, the use of the SOI, and how to construct and erect field-expedient antennae. Responsible for establishing and maintaining communications with higher headquarters and within the platoon.

i. Fire Support Team. The company has a fire support team attached from the DS FA battalion. This team provides each platoon with a two-soldier FO party--an FO and his RATELO.

NOTE: FO party for a Ranger rifle company is assigned not attached.

1. Forward observer. The FO acts as the eyes of the FA and mortars. He works for the platoon leader. The FO's main responsibilities are to locate targets and to call for and adjust indirect fire support. The FO must be familiar with the terrain that the platoon is operating in and the tactical situation. He must know the mission, the

concept, and the unit's scheme of maneuver and priority of fires. The FO must--

- (a) Inform the FIST headquarters of platoon activities and the fire support situation.
- (b) Prepare and use situation maps, overlays, and terrain sketches.
- (c) Call for and adjust fire support.
- (d) Operate as a team with the RATELO.
- (e) Select targets to support the platoon's mission based on the company OPORD, platoon leader's guidance and an analysis of METT-T factors.
- (f) Select OPs and movement routes to and from them.
- (g) Maintain communications as prescribed by the FSO.
- (h) Operate the digital message device.
- (i) Maintain the six-digit grid coordinates of his location.

2. Radiotelephone operator. The RATELO's main duties are to set up, operate, and maintain the FO party's communications equipment. At times, he must also perform the duties of the FO for the platoon.

1-3. ASSUMPTION OF COMMAND.

a. Any platoon/squad member may have to take command of his unit in an emergency. When this occurs, planning in the field for continued operations may be necessary. During an assumption of command, situation permitting, the following tasks must be accomplished applying METT-T. Tasks are not necessarily accomplished in the following order:

- (1) Inform the unit of the command change (use subordinate leaders) and notify higher HQ.
- (2) Check security.
- (3) Check crew-served weapons.

- (4) Pinpoint your location.
- (5) Coordinate and check equipment.
- (6) Check personnel status.
- (7) Issue FRAGO (if required).
- (8) Reorganize as needed and move out as soon as possible.
- (9) Maintain noise and light discipline.
- (10) If done in a patrol base, do not violate the activities of a patrol base, especially security.

b. SEQUENCE OF EVENTS.

- (1) Follow all procedures of patrol base activities when the need for a patrol base is appropriate.
- (2) Supervise and check on activities throughout the planning phase; use subordinate leaders.
- (3) Reorganize the unit according to METT-T, but hold changes to the original unit organization to a minimum. Maintain unit integrity.
- (4) Mission already received.
- (5) Issue warning order.
- (6) Make a preliminary plan.
- (7) Move if necessary.
- (8) Make your reconnaissance (at a minimum, a map recon).
- (9) Make the necessary coordinations, i.e., fire support, special logistics support, updated information on enemy and friendly if not already given, air movement, etc.
- (10) Finalize your plan.
- (11) Issue your operation order (issue a FRAGO if time does not permit an operation order).
- (12) Supervise and conduct inspections and rehearsals; techniques must be modified to fit the situation and to maintain security.
- (13) Execute the mission.

CHAPTER TWO

OPERATIONS

This chapter provides procedures used by infantry platoons and squads. These procedures are used throughout the planning and execution phases of platoon and squad tactical operations. This section discusses mission tactics, troop-leading procedures, combat orders, and technique for preparing a unit to fight. These topics pertain to all combat operations. Their application requires time. With more time, leaders can plan and prepare in depth. With less time, they must rely on previously rehearsed actions, battle drills, and standing operating procedures.

2-1. MISSION TACTICS

Mission tactics is the term used to describe the exercise of command authority by a leader. Mission tactics places the relationship of command, control, and communications in proper perspective by emphasizing the predominance of command. This emphasis on command, rather than control, provides for initiative, the acceptance of risk, and the rapid seizure of opportunities on the battlefield. Mission tactics can be viewed as freedom of action for the leader to execute his mission in the way he sees fit, rather than being told how to do it. Mission tactics reinforced by the knowledge of the higher commander's intent and focused on a main effort establishes the necessary basis for small-unit leadership.

a. The philosophy of mission tactics extends throughout all levels of command. Leaders must be provided the maximum freedom to command and have imposed on them only the control necessary to synchronize mission

accomplishment. Sometimes leaders must issue specific instructions. Normally, this is necessary when the unit's actions must be synchronized with other actions. Mission tactics, as a command philosophy, recognizes the many tools available to the leader, but emphasizes that there is no substitute for the personal element of command.

b. Execution of mission tactics requires initiative, resourcefulness, and imagination. Initiative must be driven by the commander's intent, not merely by a desire for independent action. Leaders must be resourceful enough to adapt to situations as they are, not as they were expected to be.

c. Platoon and squad leaders also must effectively control their subordinates. Control restricts command. Generally, increased control leads to less application of command. Not all control is bad or counterproductive. For example, common doctrine is a form of control in that all leaders expect their subordinates to understand and apply the tenets of doctrine. Another common source of control is the use of graphics for operation overlays. While optional and situationally-dependent, these are restrictive and must be reviewed by the leader before implementation. Each control measure must have a specific purpose that contributes to mission accomplishment. If it does not pass this purpose test, it unnecessarily restricts freedom of action and should not be used.

d. Control is necessary to synchronize the actions of elements participating in an operation. The more complex the operation, the greater the amount of control. The challenge to leaders is to provide the minimal amount of control required and still allow for decentralized decision making in each situation.

(1) Mission tactics requires that leaders learn how to think rather than what to think. It recognizes that the subordinate is often the only person at the point of decision who can make an informed decision. Guided by the commander's intent, the mission, and the concept of the operation, the leader can make the right decision.

(2) At platoon and squad level, useful forms of control include common doctrine, mission, concept of the operation, time, and control measures.

(a) Doctrine, especially in the form of battle drills and unit SOPs that prescribe a way of performing a task, provides an element of control. By limiting the ways in which a task is performed to standard, battle drills and unit SOPs provide a common basis for action; allow for quick, practiced response; decrease the probability for confusion and loss of cohesion; and reduce the number of decisions to the essential minimum.

(b) The mission statement of the unit is also a form of control. Its purpose provides the basis for decision and allows freedom of action. Its task provides a basis for establishing the main effort and focuses all other actions toward mission accomplishment.

(c) The concept of the operations identifies the main and supporting efforts for the higher unit and describes how a commander sees the execution of the operation. This allows the maximum possible freedom of action for the subordinate leader tasked with executing the main effort. Leaders executing the supporting effort will have less freedom of action because they must lay their actions on the main effort. The concept of the operation also details the control of fires and other combat multipliers which must be synchronized and focused on the main effort.

(d) Leaders use time to control units or individuals by establishing specifically when a task should begin or be complete. Control using time is especially critical when the unit's actions must be synchronized with other units or supporting elements.

(e) Another source of control is the use of control measures. These include instructions to subordinate units, fire commands, and the use of operational graphics in overlays. While normally optional and situationally-dependent, control measures are potentially restrictive and must be reviewed by leaders before incorporating them into their plans. To ensure the proper amount of control, each control measure must have a specific purpose that contributes to mission accomplishment. If it does not pass this test, it unnecessarily restricts freedom of action and should not be used.

e. Platoon and squad leader use mission tactics to accomplish the mission. They give orders and instructions that communicate the higher commander's intent; the mission (task and purpose) of the unit; and the concept of the operation, to include control measures. They also use mission tactics to ensure that subordinates understand that they are expected to use initiative in making decisions when the situation is no longer what it was expected to be.

2-2. TROOP-LEADING PROCEDURES.

The troop-leading procedures are the dynamic process by which a commander receives a mission, plans it, and executes it. It should be an instinctive and familiar way of thinking for a platoon leader. The sequence of the individual TLPs is not rigid. It is modified to meet the mission, situation, and available time. Some steps are done concurrently while others may go on continuously throughout the operation. The TLPs are time savers; as such, the leader conducts them in the order that most effectively uses the available time.

a. Receive the Mission. (STEP 1) A mission may be received in the form of either a written or oral warning order, operation order, or fragmentary order. At times, a leader may deduce a change in mission, based on a change in the situation. When the OPORD is issued, the leader should have his FO with him.

(1) Once an upcoming mission is identified, actions to begin preparing the unit are conducted. The leader conducts an initial METT-T analysis to determine the requirements for his warning order.

(2) With the information available, the leader sets his time schedule by identifying the actions that must be done (time-critical tasks) to prepare his unit for the operation. These preparatory actions are identified by a preliminary consideration of the information on the mission, enemy, terrain, and own troops available. An initial reconnaissance (may be a map reconnaissance) is conducted to allow the leader to more fully understand the time requirements for the mission. He then develops his time schedule by starting at "mission time" and working backward to the time it is now (reverse planning). The mission time is normally the most critical time in the operation.

(3) The leader must ensure that all subordinate leaders have sufficient time for their own planning needs. A general rule of thumb for leaders at all levels is to use no more than one-third of the available time for planning and issuance of the OPORD. This will leave the rest of the available time for subordinate leaders to use for their planning and preparation. This is a tentative time schedule, which may require adjustment as the TLP process continues.

- 0600, execute mission.
- 0530, finalize/adjust the plan, based on the leader's reconnaissance.
- 0400, establish ORP; begin leader's reconnaissance.

- 0200, begin movement.
- 2100, conduct inspections.
- 1900, hold rehearsals.
- 1800, eat meals (tray packs).
- 1630, issue platoon OPORD.
- 1500, hold briefbacks.
- 1045, conduct reconnaissance.
- 1030, update warning order, if required.
- 1000, receive OPORD.
- 0900, receive warning order, issue warning order.

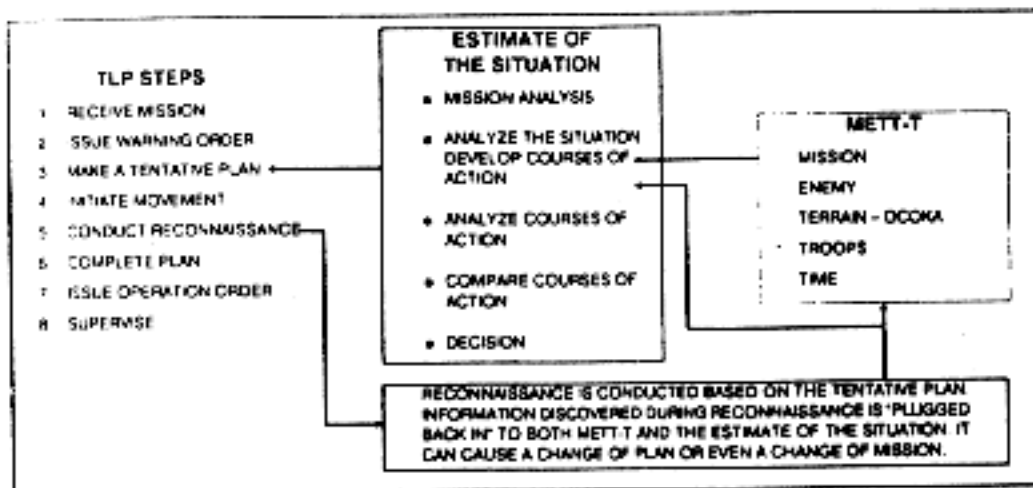

Figure 2-1. Tools of the tactician relationship.

b. Issue a Warning Order. (STEP 2) Do not wait for more information. Issue the best warning order possible with the information at hand and update it as needed with additional warning orders. The warning order lets units prepare for combat as soon as possible after being alerted of an upcoming mission. This normally involves a number of standard actions that should be addressed by SOP. The warning order should address those items not covered in the SOP that must be done to prepare for the mission. The specific contents for each warning order will vary, based upon the unique tactical situation.

c. Make a Tentative Plan. (STEP 3) The leader develops an estimate of the situation to use as the basis for his tentative plan. The estimate is the military decision making process. It consists of the following steps:

(1) Mission Analysis.

- (a) Mission and intent of commander two levels up.
- (b) Mission and intent of immediate commander.
- (c) Purpose.
- (d) Assigned tasks.
- (e) Mission-essential tasks.
- (f) Constraints and limitations.
- (g) Restated mission.
- (h) Tentative time schedule.

(2) Estimate of the situation and determination of course of action.

- (a) Terrain and weather.
 - Terrain - OCOKA.
 - Weather - visibility, mobility, survivability.
- (b) Enemy situation and probable course of action.
 - Intentions.
 - Capabilities.
 - Most probable course of action (doctrine and situation).
- (c) Friendly situation.
 - Troops available.
 - Time available.

- (d) Friendly courses of action.
- Determine decisive points and time to focus combat power.
 - Determine the results that must be achieved at the decisive points to accomplish the mission.
 - Determine the purposes to be achieved by the main and supporting efforts. (The supporting purposes must be clearly linked to the main effort's assigned purpose).
 - Determine the essential tasks for subordinate units (main and supporting efforts) that achieve these purposes.
 - Task-organize squads to accomplish each mission that has been determined. (The loss of cohesion when moving a squad to another platoon is critical. Normally, platoons do not cross-attach squads).
 - Assign C2 headquarters.
 - Complete a generic task organization by assigning all organic or attached units.
 - Establish control measures that clarify and support the accomplishment of the platoon's assigned mission. (This may also include critical timings for key events).
 - Prepare a COA statement and sketch.
 - Repeat this process for additional courses of action. (Other COAs may begin with a different potential decisive point, or they may concentrate combat power at the same one using different tasks, purposes, positions, and so forth).

(3) Analysis of courses of action.

- (a) Significant factors.
- (b) Wargame.

(4) Comparison of courses of action.

(5) Decision.

d. Initiate Movement. (STEP 4) This can be done by having a subordinate leader move the unit to an assembly area or attack position. The instructions for this move can be given in the warning order. The leader ensures that security is provided and fire are integrated for all movements.

e. Conduct Reconnaissance. (STEP 5) Reconnaissance is a continuous process during the TLP. The tentative plan should include an R&S plan. Plan and conduct reconnaissance to confirm or adjust the tentative plan. A thorough tentative plan helps the reconnaissance because specific R&S guidance can be given to subordinates. In every tactical operation the leader requires additional information, and at the same time, he must deny the enemy information about his unit. These requirements provide the focus for the unit R&S plan.

(1) Prepare the plan. The leader determines:

- What are his information requirements?
- What are his security requirements?
- What are the priorities for these requirements?
- What assets are available to meet these requirements?
- How much time is available to collect the information or establish security?
- What is most critical (and thus the focus) for his personal reconnaissance?
- To whom will he assign tasks to meet the R&S needs?

(2) Issue the plan. The leader provides additional instructions to supplement the assigned tasks to his subordinates. The amount of detail depends on the specific situation. A leader's reconnaissance that has several subordinate units involved requires more specific instructions. These may include the following:

- A specific tasking for selected soldiers from subordinate units, such as the RATELO.
- A specific time schedule for the reconnaissance (report, inspection, departure, and return times).
- Specified routes and formations.
- Special equipment required.
- Likely contingency plans.

- Fire support coordination.
- Withdrawal plan from the reconnaissance site.
- Link up with the company.

(3) Select the technique. The leader's reconnaissance is crucial to every operation. An effective leader reconnaissance provides the required information without being detected by the enemy. The risk of detection and the effect that his loss of surprise will have on the mission must be weighed against the benefit of collecting the information. Generally, the closer the reconnaissance element is to the objective, the greater the risk of detection. The two primary techniques for conducting the leader's reconnaissance are:

(a) Long-range observation/surveillance.

Reconnaissance personnel generally stay beyond small-arms range from the objective. This will usually be outside the enemy's security positions also. Tentative OP sites are selected from a map reconnaissance and confirmed after the unit has occupied the DRP. This technique is generally more effective during daylight hours. When possible, OPs should provide 360 degree coverage and may require repositioning at night.

(b) Short-range observation/surveillance. This technique generally requires the reconnaissance personnel to move inside the enemy's security positions and small-arms fire range. It depends on stealth and effective use of available cover and concealment. Limited visibility may support this technique. OPs are also designated for short-range observation.

(4) Conduct the reconnaissance. The leader's reconnaissance should be conducted as any reconnaissance patrol; only essential personnel should take part. The smaller this element is, the less likely the enemy will detect them. This should include a leader from each of the key elements. Additional tasks during the reconnaissance may include:

- Testing communications if authorized.
- Making final coordination on precise timings, signals, weapons/personnel locations, and sub-unit responsibilities.
- Establishing security/surveillance on the objective area.

f. Complete the Plan. (STEP 6) The leader must be prepared to adjust his tentative plan based on the results of the reconnaissance. He may have to change COAs if the situation is not what he expected. In this case, one of the previously analyzed and discarded COAs may be adjusted to quickly finalize his new plan. Coordination continues with all supporting agencies, higher headquarters, and adjacent units. This, along with his recon, gives the leader the information he needs to expand the tentative plan into a five-paragraph OPORD.

g. Issue the Order. (STEP 7) Preferably issue the order while viewing the avenues of approach/objective area. Make maximum use of visual aids (sketches and terrain models) to enhance the presentation of the order. When the leader issues the tentative plan before the leader's reconnaissance, he issues a FRAGO to finalize the plan prior to execution.

h. Supervise. (STEP 8) The best plan may fail if it is not managed right. Briefbacks, rehearsals, inspections, and continuous coordination of plans must be used to supervise and refine troop-leading procedures. Briefbacks and rehearsals are not the same; briefbacks focus on the planning process, and rehearsals focus on execution.

- (1) Inspect. During pre-combat inspections, check-
- Weapons and ammunition.
 - Uniforms and equipment.
 - Mission-essential equipment.
 - Soldiers' knowledge and understanding of the mission and their specific responsibilities.
 - Communications.
 - Rations and water.
 - Camouflage.

(2) Rehearse. They are essential to ensure complete coordination and subordinate understanding. The warning order should provide subordinate leaders sufficient detail for them to schedule and conduct rehearsals of drills/SOPs before receiving the OPORD. Rehearsals conducted after the OPORD can then focus on mission specific tasks. Rehearsals are conducted as any other training exercise except the training area should be as much like the objective area as possible, including the same light and weather conditions. Mock-ups of the objective should be used for these practices. Rehearsals include holding soldier and leader briefbacks of individual tasks and using sand tables or sketches to talk through the execution of the plan. These are followed by walk-through exercises and then full-speed, blank-fire or live-fire rehearsals. The leader should establish the priority for rehearsals based on the available time. The priority of rehearsals, as CDA development, flows from the decisive point of operation. For example, actions on the objective, battle drills for maneuver, actions on enemy contact, special teams, movement techniques, and others as required. Security must be maintained during the rehearsal.

(3) Briefback. Subordinates should briefback the leader right after the OPORD to ensure they understand their instructions. Briefbacks of the subordinates' plan should also be conducted. These briefbacks may be given collectively at a meeting of the orders group. Such a technique allows exchange of information, coordination among units, and rapid distribution of changes to the initial plan.

(4) Coordinate. The leader visits his subordinates and adjacent units to discuss their plans. The leader ensures all necessary preparations are being made. These may include coordination of fire support and engineer activities, maintenance, resupply, movement, and other required actions.

(a) Any departures from the plan, both before and during the operation, are coordinated with the company commander.

(b) During execution, the company commander issues FRAGDs to modify or refine the operation as the situation develops. He personally supervises and or leads the critical actions.

2-3. COMBAT INTELLIGENCE.

1. General. Gathering information is one of the most important aspects of conducting patrolling operations. The following is a reminder to leaders as to what information to collect and how to report it.

2. Reporting. All information must be quickly, completely, and accurately reported. Use SALUTE report format for reporting and recording information.

SIZE	Seven enemy soldiers
ACTIVITY	Traveling SW
LOCATION	Crossed road junction, BL123456
UNIT/UNIFORM	OD Fatigues with red six- point star on left shoulder
TIME	211300 August
EQUIPMENT	Carrying one machine gun and one rocket launcher

3. Field Sketching. When reporting information, it is desirable to include a sketch of the objective or other areas observed. A sketch is a large-scale free-hand drawn map or picture of an area or route of travel, showing enough detail and having enough accuracy to provide useful tactical information.

a. The amount of detail necessary in the sketch should be limited to those things of military importance such as targets, objectives, natural or manmade obstacles, sector limits, or troop dispositions and locations.

b. The symbols used should be the standard Army symbols IAW FM 101-5-1. Notes should be used to explain the drawing, but they should not clutter up the sketch.

c. Personnel/weapons and equipment should not be used on the sketch as it is a part of the "SALUTE" report (see paragraph 7a.)

4. Captured documents. Prior to searching enemy dead and installations for papers, maps, messages, orders, etc., personnel should first check for booby traps. Documents are then collected by the leader and turned in when he makes his reports. The documents should be marked as to time and place of capture.

5. Prisoners. If prisoners are captured during a patrolling operation, they should be treated IAW the Geneva Convention and handled by the 5-S rules:

- (a) Search
- (b) Silence
- (c) Segregate
- (d) Safeguard
- (e) Speed

6. Debriefing. Immediately upon return from a mission, the unit will be debriefed using the standard NATO report format.

7. Field Sketch (see figure 2-2)

a. SALUTE

Size: 25 men

Activity: Improving positions at ADA site.

Location: South of hill 408, BL 123456

Unit/Uniform: Field uniform, no protective mask

Time: 210200 Sep

Equipment: 2 BRDMs, 2 tracked missile launchers, 3 rockets per track, 1 radar, 1 automatic weapon

b. Notes:

1. Enemy ADA site approximately 400 meters long East to West and 300 meters wide North to South. Surrounded by single wire fence. Site has been cleared of brush. Wooded on all sides. Wolf Creek is good covered and concealed route.

2. Bridge is concrete and steel, one lane. 50 meters in length.

3. Command Bunker - logs and dirt, approx. 8 ft by 6 ft with radar dish.

4. SAM on track (like PT-76). Three two-stage rockets on rails. Fins at bottom and halfway up missile pointed on 130 degree AZ at 45 degree angle. About 6am in length.

5. Same type missiles as #2, but pointed on AZ of 125 degrees with 70 degree angle.

6. BRDM's one block access road. Vehicles started every hour.

7. Trenches approx. 20 meters in length, oriented toward south.

8. Fighting positions dug in with overhead cover under construction.

9. One light machinegun.

10. Two-man LP/OP rotated hourly, no com seen at main site. Noise discipline poor.

11. Abbreviations. SP - Surveillance position; RS - R&S team vantage points.
12. Map corrections: Dirt road running East to West at GL 234568, not on map.



Figure 2-2. Field Sketch.

2-3. WARNING ORDER.

Warning orders give subordinates advance notice of operations that are to come. This gives them time to prepare. The order should be brief, but complete. A sample format follows.

1. Situation: Brief description, for example, the enemy is defending and our battalion is attacking to the north. Attachments and detachments to the platoon or squad.
2. Mission: Use the restated mission from the mission analysis.
3. General Instructions:
 - a. Chain of command (call out by name).
 - b. Special teams or task organization within platoon or squad. (Try not to violate unit integrity).
 - c. Uniform and equipment common to all (changes from SOP; e.g., drop rucks, drop or pick up helmets).
 - d. Special weapons, ammunition, or equipment (different from SOP); e.g., mines, satchel charges, grappling hooks, drop or pick up night observation devices.
 - e. Tentative time schedule. This is formed on the basis of mission analysis. It includes at least:
 - (1) Earliest time of move.
 - (2) Time and place of OPORD and who will attend.
 - (3) Probable execution time.
 - (4) Inspection times and items to be inspected (SOP).
 - (5) Rehearsal times and actions to be rehearsed; e.g., actions at the objective, special teams for bridge, searches, PWs, or other actions as time allows.
 - f. Additional general instructions as needed or by SOP.

4. Special Instructions.

a. To subordinate leaders:

- (1) Platoon sergeant.
- (2) Squad leader.
- (3) RATELD.
- (4) Medic.
- (5) Forward observer.
- (6) Attachments.

b. To persons helping in preparation of OPORD (SOP).

c. As needed or by SOP.

2-4. OPERATION ORDER.

An Operation Order (OPORD) is a directive issued by a leader to his subordinates in order to effect the coordinated execution of a specific operation. A five-paragraph format (shown below) is used to organize the briefing, to ensure completeness, and to help subordinate leaders understand and follow the order. Use a terrain model or sketch along with a map to explain the order. When possible, such as in the defense, give the order while observing the objective. The platoon/squad leader briefs his OPORD orally off notes that follow the 5-paragraph format.

OPORD FORMAT

TASK ORGANIZATION:

States how the unit is organized to conduct the operation.

1. SITUATION.

a. Enemy Forces:

The enemy situation in higher headquarter's OPORD (paragraph 1.a.) is the basis for this, but the leader refines this to provide the detail required by his subordinates. The results of his enemy analysis is considered to determine the information included. This should include the enemy's composition, disposition, strength, recent activities, and capabilities. Also included is the enemy's most probable course of action.

(1) Weather and light data general forecasts:

High	Moonrise	Sunrise
Low	Moonsset	Sunset
Windspeed	Moonphase	BMNT
Wind Direction	% Illumination	EENT

(2) Terrain: DCOKA

Note the effects on the enemy and friendly for lines (1) and (2) above.

(3) Identification of enemy forces (composition).

(4) Location(s): Known and suspected (disposition).

(5) Activity.

(6) Strength, morale, and capabilities/equipment.

(7) Probable course of action.

b. Friendly Forces:

This information is in paragraphs 1b, 2 and 3 in higher headquarter's OPORD.

- (1) Mission and concept of next higher unit to include higher leader's intent.
- (2) Location and planned actions of units on the left, right, front, and rear. State how such actions influence your unit, particularly adjacent unit patrols.
- (3) Units providing fire support:
 - (a) List the fire support means available to your unit: Mortars, artillery, CAB, etc.
 - (b) Means to request support.
 - (c) Location of units, if known.

c. Attachments and Detachments.

When not shown under "Task Organization," list here, or in an annex, units attached or detached from the platoon, together with the effective times.

2. MISSION.

The unit's mission is a clear, concise statement of the task(s) to be accomplished by the unit and the purpose for doing it. The mission statement is derived from the mission analysis during the Estimate of the Situation. The mission is always stated twice, in full, and must stand alone without reference to any other documents except a map.

3. EXECUTION.

Intent:

Intent is the stated vision that defines the purpose of an operation and the end state with respect to the relationship among the force, the enemy, and the terrain. Intent provides clarity to the overall operation and informs subordinates what operational aspects are the most important; it also affords subordinates the ability to accomplish the mission in the absence of additional guidance, orders, or communications. Note: At battalion level and below, this subparagraph may be required and should only be used if there is a need to expand on the purpose of the operation in more detail than paragraph 2 permits.

a. Concept of the Operation:

This paragraph describes, in general terms, how the unit will accomplish its mission from start to finish. It should identify the most important task, designate and focus on the decisive action (usually actions on the objective), and identify the main effort. If applicable, designate the decisive point, form of maneuver or defensive technique, and any other significant factors or principles. Refer to the operation overlay and concept sketch when doing so.

(1) Maneuver:

The maneuver paragraph addresses, in detail, the mechanics of the operation. Specifically address all subordinate units and attachments by name, giving each its mission in the form of a task and purpose. The main effort must be designated and all other subordinates' missions must relate to the main effort. Actions on the objective will comprise

the majority of this paragraph and therefore could address the plan for actions on the objective, engagement/disengagement criteria, an alternate plan in the event of compromise or unplanned movement of enemy forces, and a withdrawal plan. A plan for dissemination of information and where the unit will assemble after the mission may also be stated. Use a sketch, terrain model, or overlay as you address the scheme of maneuver. Note: It is imperative that the concept define the relationship of each subordinate unit, and that the concept is clearly understood.

(2) Fires:

This paragraph describes how the leader intends for the fires to support his maneuver (such like a "scheme" of fire support). It states the purpose to be achieved by the fires, the priority of fires, the allocation of any priority targets, and any restrictive control measures on the use of fires. A target list and overlay should be referenced here, if applicable. Specific targets should be discussed and pointed out on the terrain model.

b. Tasks to Maneuver Units:

In this paragraph, specify those tasks and purposes not listed in paragraph 3.a.(1) for all maneuver units (Infantry, Armor, Attack Aviation) attached or OPCON to your unit. Each of these subunits will have a separate paragraph and the reserves will be addressed last. Tasks or information common to two or more subunits will be addressed in coordinating instructions.

Company commanders task platoons, and platoon leaders task their subordinate squads. Those squads may be tasked to provide any of the following special teams: recon and

security, assault, support, security, aid and litter, EPW and search, clearing, and demolition. Detailed instructions may also be given to the platoon sergeant, RTGs, compassman, and pacesman.

c. Tasks to Combat Support Units:

This paragraph is identical to paragraph 3.b. except that combat support units such as mortars, artillery, engineers and ADA that are attached or OPCON to your unit are addressed here.

d. Coordinating Instructions:

This paragraph lists the details of coordination and control applicable to two or more subunits. These also may have been assigned by higher or required by the COA developed by the leader. If they do not apply to all subunits, clearly state those units that must comply. Items that might be addressed include:

1. Order of movement, formation, and movement technique.
2. Actions at halts (short/long).
3. Routes (primary/alternate).
4. Departure and re-entry of friendly lines.
5. Rally points and actions at rally points (Plan must include IRP, ORP, PB and RRP and all other planned rally points to include grid location and terrain reference).
6. Actions at danger areas (General plan for unknown linear, small open areas and large open danger areas; specific plan for all known danger areas the unit will encounter along the route. Include, also, a plan for mines and boobytraps).

Note: Use terrain model and state azimuths, directions, and grid coordinates, where applicable, for items 3 - 6.

7. Actions on enemy contact (chance contact, far ambush, near ambush, sniper fire, indirect fire, aerial attack). Note detailed description for actions other than Battle Drills or Unit SOP.
8. Reorganization and consolidation instructions (other than SOP items).
9. Fire distribution measures: point fire vs. area fire.
10. Fire control measures: Range cards, TRP's, visual/sound signals.
11. MOPP levels.
12. Troop safety and operational exposure guidance.
13. Time schedule (rehearsals, backbriefs, inspections, movement).
14. Priority Intelligence Requirements.
15. Debriefing requirements.
16. Reports.
17. Rules of Engagement.

4. SERVICE SUPPORT.

This paragraph provides the critical logistical information required to sustain the unit during the operation. Also included are combat service support instructions and arrangements that support the operation.

a. General.

- (1) SOPs in effect for sustainment operations.
- (2) Current and proposed trains/re-supply/cache points.
- (3) Casualty and damaged equipment.
- (4) Special instructions to medical personnel.

b. Material and Services.

(1) Supply.

- | | |
|--------------------------|------------------------------|
| (a) Class I; | Rations plan |
| (b) Class VI; | Ammunition |
| (c) Class VII; | Major End Items
(weapons) |
| (d) Class VIII; | Medical |
| (e) Class IX; | Repair parts |
| (f) Distribution Methods | |

(2) Transportation.

(3) Services. (Laundry, showers)

(4) Maintenance. (Weapons and Equipment)

c. Medical Evacuation. Method of evacuating dead and wounded, friendly and enemy. Include priorities.

d. Personnel. Method of handling EPWs and designation of the EPW collection point.

e. Miscellaneous.

- (1) Special Equipment
- (2) Captured Equipment

5. COMMAND AND SIGNAL.

This paragraph states where command and control facilities and key leaders will be located during the operation.

a. Command.

- (1) Location of the higher unit commander and CP.
- (2) Location of key personnel (PL, PSG) and CP during each phase of the operation.
- (3) Succession of Command.
- (4) Adjustments to the unit SOP (Instructions to PSG).

b. Signal.

- (1) SOI index in effect.
- (2) Methods of communication in priority.
- (3) Pyrotechnics and signals, to include arm and hand signals.
- (4) Codewords.
- (5) Challenge and password (behind friendly lines).
- (6) Number Combination (forward of friendly lines).
- (7) Running Password.
- (8) Recognition signals (near/far and day/night).
- (9) Special Instructions to RTGs.

6. ISSUE ANNEXES.

7. GIVE TIME HACK.

8. ASK FOR QUESTIONS.

b. The leader uses a fragmentary order (FRAGO) to change an existing order. He normally uses the OPORD format but addresses only those elements that have changed. The leader should make his instructions brief, simple, clear, and specific. The FRAGO's content is based on METT-T.

c. Annexes provide the instructions for conducting specific operations such as air assault, boat, and truck movement, stream crossings, establishing patrol bases, and airborne insertions, if they are so detailed that a unit SOP is insufficient for a particular situation. The format is the same as the five-paragraph OPORD.

d. An operation overlay is a tracing of graphic control measures on a map. It shows boundaries, unit positions, routes, objectives, and other control measures. It helps to clarify the operation order. Platoons normally trace their overlays from the company operations map. Squad leaders transfer control measures on to their maps as needed. The subordinate's need for higher unit graphics must be balanced against the risk of the enemy obtaining this information.

2-5. OPERATION ORDER ANNEXES.

Operation order annexes are necessary to complete the plan and to provide greater clarity and understanding during complex or critical aspects of the operation. Information that may be issued in annex form include: aerial resupply, fire support, truck movement, air assault, patrol

base, small boat, link up, and stream crossing annexes. Annexes are prepared only if the subject is not addressed thoroughly enough in the OPORD; brevity and conciseness remain the standard. Annexes are always issued after the operation order.

A. AIR ASSAULT/MOVEMENT ANNEX.

1. Situation.
 - a. Enemy situation
 - (1) Enemy air capability
 - (2) Enemy ADA capability
 - (3) Include in Weather: % illum, illum angle, NVG Window, Ceiling/Visibility.
 - b. Friendly situation
 - (1) Unit(s) supporting operation
 - (2) Friendly ADA status
2. Mission.
3. Execution.
 - a. Concept of operation
 - b. Sub-unit missions
 - (1) Air Cavalry
 - (2) Attack
 - (3) Lift
 - (4) CH-47
 - (5) Pathfinders
 - c. Coordinating instructions
 - (1) PZ
 - (a) Name/Number
 - (b) Coordinates
 - (c) Load Time
 - (d) Takeoff Time
 - (e) Markings
 - (f) Control
 - (g) Landing Formation
 - (h) Approach/Departure Direction

- (i) Alternate PZ Name/Number
 - (j) Aircraft Load/Slingload
 - (k) Penetration Points
 - (l) Extraction Points
- (2) LZ
 - (a) Name/Number
 - (b) Coordinates
 - (c) H-Hour
 - (d) Markings
 - (e) Control
 - (f) Landing Formation/Direction
 - (g) Alt LZ Name/Number
 - (h) Deception Plan
 - (i) Extraction LZ
 - (3) Lager Site
 - (a) Communications
 - (b) Security Force
 - (4) Flight Routes and Alternates
 - (5) Abort Criteria
 - (6) Down Aircraft/Crew
 - (7) Special Instructions
 - (8) Cross-FLOT Considerations
 - (9) Aircraft Speed
 - (10) Aircraft Altitude
 - (11) Aircraft Crank Time
 - (12) Rehearsal Schedule/Plan
 - (13) Actions on Enemy Contact (Enroute and on the Ground)

4. Service Support.
 - a. Forward Area Refuel/Rearr Points
 - b. Class I, III, and V specifies
5. Command and Signal.
 - a. Command.

(1) Location of platoon leader/squad leader in air and at landing site.

(2) Location of platoon sergeant in air and at landing site.

b. Signal.

- (1) Air/ground call signs and frequencies.
- (2) Air/ground emergency code.
- (3) IFF Mode IV
- (4) Passwords/Number Combinations
- (5) Fire Net/Quick Fire Net
- (6) Time Zone
- (7) Time Hack

B. AERIAL RESUPPLY ANNEX.

1. Situation.

- a. Enemy Forces (Include Weather)
- b. Friendly Forces
- c. Attachments and Detachments.

2. Mission.

3. Execution.

- a. Concept of operation
 - (1) Maneuver
 - (2) Fires
- b. Tasks to Combat Units
 - (1) Command and Control
 - (2) Security
 - (3) Marking.
 - (4) Recovery/Transport
- c. Tasks to Combat Support Units
- d. Coordinating Instructions
 - (1) Flight Route
 - (a) General
 - (b) Checkpoints
 - (c) Communication checkpoint (CCP)
 - Marking of CCP
 - Report time
 - (d) Heading from CCP

(2) Landing/Drop Zone

- (a) Location.
 - Primary
 - Alternate
- (b) Marking
 - Near
 - Far

(3) Drop Information.

- (a) Date/time or resupply (and alternates)
- (b) Code letter at DZ/LZ
- (c) Length of DZ in seconds or dimensions of LZ
- (d) Procedures for turning off DZ/LZ
- (e) Formation, altitude, and air speed.
 - Enroute
 - At DZ/LZ

(4) Actions on enemy contact during resupply

- (5) Abort Criteria: Enroute and at DZ/LZ
- (6) Actions at DZ/LZ
 - Rehearsals

4. Service Support.

5. Command and Signal.

a. Command.

- (1) Location of platoon leader.
- (2) Location of platoon sergeant.
- (3) Location of members not involved in resupply.

b. Signal.

- (1) Air to ground call signs and frequencies (primary and alternate).
- (2) Long range visual signals
- (3) Short range visual signals
- (4) Emergency procedures and signals
- (5) Air drop communication procedures
- (6) Code Words

C. PATROL BASE ANNEX

1. Situation
 - a. Enemy Forces
 - b. Friendly Forces
 - c. Attachments and Detachments
2. Mission.
3. Execution.
 - a. Concept of Operation.
 - (1) Maneuver
 - (2) Fires
 - b. Tasks to Combat Units
 - (1) Teams
 - Security
 - Recon
 - Surveillance
 - LP/OPs
 - (2) Individuals
 - c. Tasks to Combat Support Units
 - d. Coordinating instructions
 - (1) Occupation plan.
 - (2) Operations plan.
 - Security Plan.
 - Alert Plan.
 - Priority of work.
 - Evacuation plan.
4. Service Support.
 - a. Water plan.
 - b. Maintenance plan.
 - c. Hygiene plan.
 - d. Messing plan.
 - e. Rest plan.
5. Command and signal
 - a. Command
 - (1) Location of platoon leader
 - (2) Location of platoon sergeant
 - (3) Location of platoon/squad CP

- b. Signal.
 - (1) Call signs and frequencies.
 - (2) Code words.
 - (3) Emergency signals.

D. SMALL BOAT ANNEX

1. Situation
 - a. Enemy forces.
 - (1) Weather.
 - (a) Tide.
 - (b) Surf.
 - (c) Wind.
 - (2) Terrain.
 - (a) River width.
 - (b) River depth.
 - (c) Current.
 - (d) Vegetation.
 - (3) Identification, location, activity and strength.
 - b. Friendly forces (Unit furnishing support)
 - c. Attachments and detachments
 - d. Organization for movement
2. Mission
3. Execution.
 - a. Concept of operation.
 - (1) Maneuver
 - (2) Fires
 - b. Tasks to Combat Units
 - (1) Security
 - (2) Tie-down teams
 - (a) Load equipment
 - (b) Secure equipment
 - (3) Designation of coxswains and boat commanders.
 - (4) Selection of navigator(s) and observer(s)

- c. Coordinating instructions.
 - (1) Formations and order of movement.
 - (2) Route and alternate route of return.
 - (3) Method of navigation.
 - (4) Actions on enemy contact.
 - (5) Rally points.
 - (6) Embarkation plan.
 - (7) Debarcation plan.
 - (8) Rehearsals.
 - (9) Time schedule
 - 4. Service Support.
 - a. Ration plan
 - b. Area and ammunition
 - c. Uniform and equipment.
 - (1) Method of distribution of paddles and life jackets.
 - (2) Disposition of boat, paddles and life jackets upon debarkation.
 - d. Method of handling dead and wounded, friendly and enemy, by priority.
 - 5. Command and Signal.
 - a. Command.
 - (1) Location of platoon leader.
 - (2) Location of platoon sergeant.
 - b. Signal.
 - (1) Signals to be used between and in boats.
 - (2) Code words.
- E. STREAM CROSSING ANNEX.
- 1. Situation.
 - a. Enemy forces.
 - (1) Weather.
 - (2) Terrain.
 - (a) River width.
 - (b) River depth.

- (c) Current.
 - (d) Vegetation.
 - (e) Obstacles.
 - (3) Enemy location, identification, activity.
- b. Friendly forces.
- c. Attachments and detachments
- 2. Mission
- 3. Execution
 - a. Concept of operation.
 - (1) Maneuver
 - (2) Fires
 - b. Tasks to Combat Units
 - (1) Elements.
 - (2) Teams.
 - (3) Individuals.
 - c. Tasks to Combat Support Units
 - d. Coordinating Instructions
 - (1) Crossing procedure/techniques
 - (2) Security.
 - (3) Order of crossing.
 - (4) Actions on enemy contact.
 - (5) Alternate plan.
 - (6) Rallying points.
 - (7) Rehearsal plan.
 - (8) Time schedule.
- 4. Service Support
- 5. Command and Signal.
 - a. Command.
 - (1) Location of platoon leader.
 - (2) Location of platoon sergeant.
 - (3) Location of CP.
 - b. Signal
 - (1) Emergency signals.
 - (2) Signals.

F. LINK UP ANNEX.

1. Situation.
 - a. Enemy Forces
 - b. Friendly forces
 - c. Attachments and Detachments
2. Mission.
3. Execution.
 - a. Concept of operation.
 - (1) Maneuver
 - (2) Fires
 - b. Tasks to Combat Units
 - (1) Security Teams
 - (2) Surveillance Teams
 - (3) Link-Up element
 - c. Tasks to Combat Support Units
 - d. Coordinating instructions.
 - (1) Time of link up.
 - (2) Location of link up site (primary and alternate).
 - (3) Rally points.
 - (4) Actions upon enemy contact.
 - (5) Actions at the link up site.
 - (6) Actions following link up.
 - (7) Rehearsals.
 - (8) Restrictive Fire Lines.
 - (9) Time Schedule.
4. Service Support.
5. Command and Signal.
 - a. Command.
 - (1) Location of platoon leader and platoon sergeant.
 - (2) Location of platoon headquarters.
 - b. Signal.
 - (1) Call signs and frequencies.

- (2) Spares and code words.
 - (a) Far recognition signal
 - (b) Near recognition signal
 - (c) Link up complete
- (3) Posting authentication (verbal)
- (4) Brevity codes (spares)
- (5) Emergency signals
- (6) Abort criteria and signals

F. TRUCK ANNEX.

1. Situation.
 - a. Enemy Forces
 - b. Friendly Forces
 - c. Attachments and Detachments
2. Mission.
3. Execution.
 - a. Concept of operation.
 - (1) Maneuver
 - (2) Fires
 - b. Tasks to Combat Units
 - c. Tasks to Combat Support Units
 - d. Coordinating Instructions
 - (1) Time of departure and return
 - (2) Loading plan and order of movement
 - (3) Route (primary and alternate)
 - (4) Air Guards
 - (5) Actions on enemy contact (vehicle ambush) during movement, loading, and unloading
 - (6) Actions at the de-trucking point
 - (7) Rehearsals
 - (8) Vehicle speed, separation, and recovery plan
 - (9) Broken vehicle instructions
4. Service Support.

5. Command and Signal.

- a. Command.
Location of platoon leader and platoon sergeant
- b. Signal.
 - (1) Radio call signs and frequencies
 - (2) Code words

The following list includes doctrinally correct and frequently used operational tasks which formulate the mission statement.

- A. CONTAIN: To stop, hold or surround the forces of the enemy or to cause the enemy to center activity on a given front and to prevent his withdrawing any part of his forces for use elsewhere.
- B. BREACH(ING): The employment of any means to secure a passage through an enemy minefield or fortification.
- C. ATTRITION (ATTRIT): The reduction in effectiveness of a force caused by loss of personnel and material. This task must be qualified mathematically.
- D. INTERDICT: To prevent or hinder by any means, enemy use of any area or route.
- E. SECURE: To gain possession of a position or terrain feature with or without force, and to make such disposition as will prevent, as far as possible, its destruction or loss by enemy action.
- F. BLOCK: To deny the enemy access to a given area or to prevent enemy advance in a given direction. It may be for a specified time. Units may have to retain terrain and accept decisive engagement.

G. CANALIZE: To restrict operations to a narrow zone by use of existing or reinforcing obstacles or by direct or indirect fires.

H. FIX: Actions taken to prevent the enemy from moving any part of his forces from a specific location and/or a specific period of time by holding or surrounding them to prevent their withdrawal for use elsewhere.

I. SUPPRESS: Direct or indirect fires, electronic countermeasures (ECM), or smoke brought to bear on enemy personnel, weapons, or equipment to prevent effective fire on friendly forces.

J. DELAY: To trade space for time, inflict maximum damage on the enemy and avoid decisive engagement.

K. DENY: To prevent or hinder enemy forces' occupation of, or benefit from, areas or objects.

L. DESTROY: To physically disable the majority of an enemy force ability or will to generate combat power.

M. DISRUPT: To counter the enemy's initiative and synchronization to prevent him from concentrating overwhelming combat power.

N. RETAIN: To occupy and hold terrain or a sector free of enemy occupation or use.

O. SUPPORT: To aid, complement, protect, or sustain any other force.

P. CLEAR: To destroy or force the withdrawal of all enemy forces, and reduction of any obstacle which may interfere with subsequent operations.

Q. SEIZE: To gain physical possession of the objective. Although consolidation is accomplished, units must anticipate additional taskings, in addition to merely occupying the objective.

2-6. GENERAL. The following checklists are items which a platoon/squad leader must check when planning for a combat operation. In some cases, he will coordinate directly with the appropriate staff section; in most cases this information will be provided by the company commander or platoon leader. Copies of these checklists may be carried by the platoon/squad leader to keep him from overlooking anything that may be vital to his mission. (NOTE: Some items on the checklists may need coordination with more than one staff section; for this reason, some items are under more than one heading.)

2-7. INTELLIGENCE. In this coordination, the platoon/squad leader is informed by the platoon leader/company commander of any changes in the situation as given in the operation order or mission briefing. He must keep himself constantly updated to ensure the plan is sound.

- a. Identification of enemy unit.
- b. Weather and light data.
- c. Terrain update.
 - (1) Aerial photos.
 - (2) Trails and obstacles not on map.
- d. Known or suspected enemy locations.
- e. Weapons.
- f. Strength.
- g. Probable course of action.
- h. Recent enemy activity.
- i. Reaction time of reaction forces.
- j. Civilian activity in area.
- k. Priority intelligence requirements (PIR) and information requirements (IR).

2-8. OPERATIONS. This coordination occurs with the platoon leader/company commander so that the platoon/squad leader can confirm his mission and operational plan, receive any last-minute changes to his mission or plan, and to update his subordinate or issue a FRAGO if required.

- a. Mission backbrief.
- b. Identification of friendly units.
- c. Changes in the friendly situation.
- d. Route selection, LZ/PZ/DZ selection.
- e. Linkup procedure.
- f. Transportation/Movement plan.
- g. Resupply (in conjunction with B4.)
- h. Signal plan.
- i. Departure and reentry of forward units.
- j. Special equipment requirements.
- k. Adjacent units operating in the area of operations.
- l. Rehearsal areas.
- m. Method of insertion/extraction.

2-9. FIRE SUPPORT. The platoon/squad leader will normally coordinate the following with the platoon forward observer (FO).

- a. Mission backbrief.
- b. Identification of supporting unit.
- c. Mission and objective.
- d. Routes to and from the objective (include alternate routes.)
 - e. Time of departure and expected time of return.
 - f. Unit target list (Fire plan).
 - g. Fire support means available (artillery, mortar, naval gunfire, and aerial fire support to include the Army, Navy, and Air Force).
 - h. Ammunition available (to include different fuzes).
 - i. Priority of fire.
 - j. Control measures for fire support.
 - (1) Checkpoints.
 - (2) Boundaries.

- (3) Phase lines.
- (4) Fire support coordination measures.
- (5) Priority targets (list TRP's.)
- (6) RFA
- (7) RFL
- (8) No fire areas
- (9) Pre-coordinated authentication.

k. Communication (include primary and alternate means, emergency signals, and code words and signals).

2-10. COORDINATION WITH FORWARD UNIT. A platoon/squad that requires foot movement through a friendly forward unit must coordinate with that unit's commander for a safe and orderly passage. If no time and place has been designated for coordination with the forward unit, the platoon/squad leader should set a time and place when he coordinates with the S3. He must talk with someone at the forward unit who has the authority to commit that unit in assisting the platoon/squad during departure. Coordination entails a two-way exchange of information.

- a. Identification (yourself and your unit).
- b. Size of platoon/squad.
- c. Time(s) and place(s) of departure and return, location(s) of departure point(s), IRP and detrucking points.
- d. General area of operation.
- e. Information on terrain and vegetation.
- f. Known or suspected enemy positions or obstacles.
- g. Possible enemy ambush sites.
- h. Latest enemy activity.
- i. Detailed information on friendly positions (e.g., crew served weapons, FPF).
- j. Fire and barrier plan.
- k. Support the unit can furnish. How long and what can they do.

- (1) Fire support.
- (2) Litter teams.
- (3) Navigational signals and aids.
- (4) Guides.
- (5) Communications
- (6) Reaction units.
- (7) Other.

l. Call signs and frequencies and exchange of Vinson crypto variables.

- m. Pyrotechnic plans.
- n. Challenge and password, running password, number combination forward of FFU.
- o. Emergency signals and code words.
- p. If the unit is relieved, pass the information to the relieving unit.
- q. Recognition signals.

2-11. ADJACENT UNIT COORDINATION. Immediately after the operation order or mission briefing, the platoon/squad leader should check with other platoon/squad leaders who will be operating in the same areas. If the platoon/squad leader is not aware of any other units operating in his area, he should check with the S3 during the operations coordination. The S3 can help arrange this coordination if necessary. The platoon/squad leaders should exchange the following information with other units operating in the same area.

- a. Identification of the unit.
- b. Mission and size of unit.
- c. Planned times and points of departure and reentry.
- d. Route(s).
- e. Fire support (planned). Control measures.
- f. Frequency and call signs and exchange of Vinson crypto variables.
- g. Challenge and password, running password, and number combination.

- h. Pyrotechnic plans.
- i. Any information that the unit may have about the enemy.
- j. Recognition signals.

2-12. REHEARSAL AREA COORDINATION. This coordination is conducted with the platoon leader/company commander to facilitate the unit's safe, efficient, and effective use of rehearsal areas prior to its mission.

- a. Identification of your unit.
- b. Mission.
- c. Terrain similar to objective site.
- d. Security of the area.
- e. Availability of aggressors.
- f. Use of blanks, pyrotechnics, live ammunition.
- g. Mockups available.
- h. Time the area is available (preferably when light conditions closely approximate expected light conditions for patrol).
- i. Transportation.
- j. Coordination with other units using area.

2-13. ARMY AVIATION COORDINATION. This coordination is conducted with the platoon leader/company commander and/or S3 Air to facilitate the timely, detailed and effective use of aviation assets as they apply to your tactical mission.

- 1. Enemy Forces.
 - A. Location, activity, probable course of action, enemy air defense.
 - B. Weather, decision time, POC, any delay for mission.
 - C. Friendly Forces: Main mission, activity, boundaries, axis of movement/corridor/routes.
- 2. Mission.
- 3. Execution.

A. Concept of the operation: Overview of what requesting unit wants to accomplish with the air assault/air movement.

B. Tasks to Combat Units.

- (1) Infantry
- (2) Attack Aviation

C. Tasks to Combat Support Units.

- (1) Artillery
- (2) Aviation (Lift)

D. Coordinating Instructions

PZ Operations

- (1) Direction of landing.
- (2) Time of landing/flight direction.
- (3) Location of PZ/Alt PZ.
- (4) Loading procedures.
- (5) Marking of PZ (panel, smoke, SM, lights).
- (6) Flight route planned (BP, ACP, RP).
- (7) Formations: PZ/Enroute/LZ.
- (8) Codewords, PZ secure (prior to landing); PZ clear (lead bird, last bird); Alt PZ (at PZ, enroute, at LZ); Names of PZ/Alt PZ.
- (9) TAC air/artillery.
- (10) Number of pax/bird, for entire lift.
- (11) Equipment carried by individuals.
- (12) Marking of key leaders.
- (13) Abort Criteria (PZ/Enroute/LZ)

LZ Operations

- (14) Direction of landing.
- (15) False insertions planned, locations.
- (16) Time of landing (LZ time)
- (17) Location of LZ, Alt LZ.
- (18) Marking of LZ (panel, smoke, SM, lights).
- (19) Formation of landing.
- (20) Codewords, LZ name, Alt LZ name.

(21) TAC air/artillery prep, fire support coordination.

(22) Secure LZ or not.

4. Service Support

lifts.

A. Number of aircraft per lift and number of

B. Refuel/rearm during mission or not.

for weapons carried by unit personnel.

C. Special equipment/aircraft configuration

D. Bump plan.

5. Command and Signal

A. Frequencies, callsigns and codewords.

tactical commander, and air assault task force commander.

B. Location of air mission commander, ground

2-14. VEHICULAR MOVEMENT COORDINATION. This is coordinated with the supporting unit through the platoon sergeant/first sergeant to facilitate the effective, detailed, and efficient use of vehicular support and/or assets.

a. Identification of the unit.

b. Supporting unit identification.

c. Number and type of vehicles and tactical preparation.

d. Entrucking point.

e. Departure/loading time.

f. Preparation of vehicles for movement.

(1) Driver responsibilities.

(2) Platoon/Squad responsibilities.

(3) Special supplies/equipment required.

g. Availability of vehicles for preparation/rehearsal/inspection (time and location).

h. Route.

(1) Primary

(2) Alternate

(3) Checkpoints

i. Detruck points.

(1) Primary

(2) Alternate

j. March interval/speed.

k. Communications (frequencies, call signs, codes).

l. Emergency procedures and signals.

2-15. FRAGMENTARY ORDER.

A Fragmentary Order (FRAGO) provides timely changes to existing orders. The format for a FRAGO is the five-paragraph OPORD format. Only those items that have changed since the last OPORD should be discussed. If a significant change in the mission occurs or a new mission is received, a complete OPORD may be issued rather than a FRAGO.

3-3. SYMBOLS.

a. Target Symbols. Standard symbols are used in the preparation of maps, charts, and overlays to identify targets by type (standard, linear, rectangular, circular, FPF, target reference point). These symbols are shown below.

(1) Standard Target. A standard target normally is a target area 200 meters (m) in size. Minimum accuracy of the target location on the target list is a six-digit or eight-digit grid (Figure 3-2). The symbol for a standard target is a cross with relevant information and the quadrants as shown.



Figure 3-2. Standard Target

(2) Linear Target. A linear target is one that is more than 200 meters but less than 600 meters long (e.g., a trench line). Targets longer than 600 meters will require additional fire support assets or be made into multiple targets. A linear target is designated in the target list (Figure 3-3) by two grids or a center grid, length, and altitude.



Figure 3-3. Linear Target.

(3) Rectangular Target. A rectangular target is one that is wider and longer than 200 meters (e.g., a landing strip or city block). It is designated on the target list by four grids or a center grid, length, width, and altitude (Figure 3-4).



Figure 3-4. Rectangular Target.

(4) Circular Target. A circular target is one that is in a circular pattern or is vague as to exact composition. It is designated by center grid and radius (suspect enemy com center) (Figure 3-5).



Figure 3-5. Circular Target.

(5) Final Protective Fire (FPF). The symbol for final protective fire is similar to that for a linear target. It includes the target number and FPF/unit to fire (Figure 3-6).



Figure 3-6. FPF.

(6) Target Reference Point. Maneuver units use a target reference point (TRP) to orient direct fire weapons system; e.g., tube-launched, optically tracked, wire-guided missile (TOW); and tanks. The symbol is the same as that for a standard target with a target number and TRP number. TRPs are to be included in target lists (Figure 3-7).



Figure 3-7. TRP.

b. Two or more targets on which fire is desired simultaneously compose a group of targets, i.e. AIA (figure 3-8). Each target within the group has a target number for quick reference in order for the unit leader to request fire on single targets, i.e., AA3412 (figure 3-8).

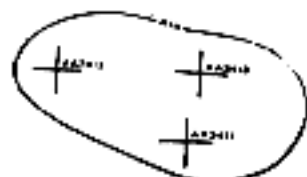

Figure 3-8. Group of Targets.

c. A series of targets consists of a number of targets and/or group of targets planned to be fired in predetermined sequence in support of a maneuver phase. Direct FA battalion is the lowest level echelon authorized to form and designate a series of targets. This is normally planned to support a limited attack, final assault, counter-attack, or phased withdrawal. This is graphically depicted by circling the targets and/or group of targets and assigning a nickname or code name as shown in figure 3-9.



Figure 3-9. Series of Targets.

3-4. TGT LIST AND OVERLAY.

a. The first TGT list work sheet (figure 3-10) is a collection of data pertaining to TGT's planned to support an operation. The TGT list includes the description, location, and pertinent remarks for each TGT. It may also include information concerning the TGT such as altitude, size, attitude, and source. Fires should be planned to the left, right and beyond the objective to cut off escape and reinforcement routes.

FIRST TARGET LIST WORK SHEET									
Target List by REGT, CO (1-70)									
NO.	DESCRIPTION	GRID	ALTITUDE	ATTITUDE	SIZE	SOURCE	REMARKS	DATE	TIME
1	AA 2111	242200					Grouped T		
2	AA 2112	242200					Grouped T		
3	AA 2113	242200					Grouped T		
4	AA 2114	242200					Grouped T		
5	AA 2115	242200					Grouped T		
6	AA 2116	242200					Grouped T		
7	AA 2117	242200					Grouped T		
8	AA 2118	242200					Grouped T		
9	AA 2119	242200					Grouped T		
10	AA 2120	242200					Grouped T		
11	AA 2121	242200					Grouped T		
12	AA 2122	242200					Grouped T		
13	AA 2123	242200					Grouped T		
14	AA 2124	242200					Grouped T		
15	AA 2125	242200					Grouped T		
16	AA 2126	242200					Grouped T		
17	AA 2127	242200					Grouped T		
18	AA 2128	242200					Grouped T		
19	AA 2129	242200					Grouped T		
20	AA 2130	242200					Grouped T		

Figure 3-10. First Target List Worksheet.

b. The Operations Overlay shows the scheme of maneuver that will be used to seize objective Bravo.

c. The First Target Overlay (figure 3-11) shows the fires planned to the left, right, on the objective to cut off escape and reinforcement routes. This overlay is superimposed on the Operations Overlay. First Target Overlays should be kept as sterile as possible for tactical and patrolling missions.

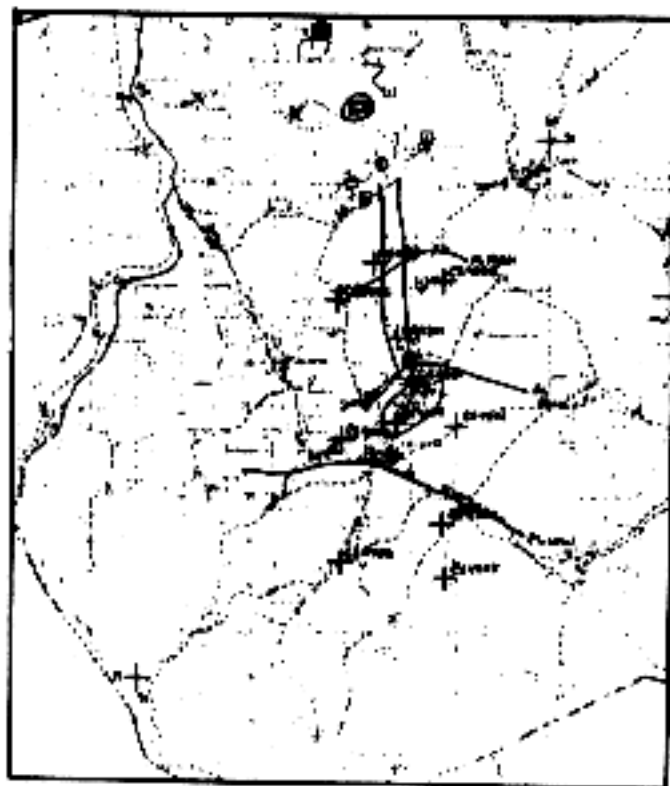

Figure 3-11. First Target Overlay.

3-5. CALL FOR FIRE. When a squad/platoon does not have an FO, the platoon leader sends the call-for-fire to either the FIST chief (probably located with the company headquarters) or the fire direction center (FDC) of the company's mortars. A call-for-fire has three parts consisting of six elements and is transmitted, with a break and readback after each part. The three parts are as follows:

- a. Observer identification and warning order indicating adjustment of fire methods, i.e., adjust fire/fire for effect (AF/FFE).
- b. Target location.
- c. Description of target, method of engagement, and method of fire and control.

3-6. TARGET LOCATION. The three methods for locating targets are "grid," "polar" and "shift from a known point." Only "polar" and "shift" are announced to the FDC. If the observer does not say either "polar" or "shift," then the FDC knows that the grid method is being used. The word "grid" is not used in the warning order.

a. Grid method. In a grid mission, six-digit grids normally are sent. The direction from the observer to the target (OT) is normally sent at the end of the initial call for fire, since it is not needed by the FDC to locate the target. Examples:

- (1) "157, THIS IS 271, ADJUST FIRE, OVER."
- (2) "GRID 180513, OVER."
- (3) "INFANTRY PLATOON IN THE OPEN, ICM IN EFFECT, OVER."

b. Polar-Plot Method. This method requires that the observer and the FDC know the observer's exact location. The observer determines the direction (to the nearest ten mils) of the observer-target (OT) line and the distance (to the nearest 100 meters) from his position to the target. A vertical shift (to the nearest 5 meters) tells the FDC how far the target is located above (up) or below (down) the observer's location. Example:

- (1) "256, THIS IS 231, FIRE FOR EFFECT POLAR, OVER."

(2) "DIRECTION 4520, DISTANCE 2300, DOWN 35, OVER."

(3) "INFANTRY COMPANY IN OPEN, ICM, OVER." c.

Shift-From-A-Known-Point. If the observer and the FDC have a common known point, the target can be located by first finding the direction to the target (OT line) to the nearest 10 mils. If the observer has no compass, the FDC can be given a cardinal direction, for example, north, southwest, etc. The observer then determines the lateral and range shifts. Lateral shifts are left or right from the known point to the OT line and are given to the nearest 10 meters. Range shifts are given as ADD (when target is beyond the known point) or DROP (when target is closer than the known point). Range shifts are given to the nearest 100 meters. Example:

(1) "H66, THIS IS H44, ADJUST FIRE, SHIFT AA7733, OVER."

(2) "DIRECTION 5210, LEFT 380, ADD 400 DOWN 35, OVER."

(3) "COMBAT OP IN OPEN, ICM IN EFFECT, OVER."

(4) "I AUTHENTICATE PAPA, OUT."

3-7. ADJUSTMENT OF INDIRECT FIRE.

a. After the initial call for fire has been sent to the FDC, data is computed for the initial round. Once that initial round impacts, a spotting is made. A spotting is the observer's determination of the location of the burst (or the mean point of impact [MPI] of a group of bursts) with respect to the adjusting point as observed along the Observer Target (OT) line. Spotting is made for deviation (the number of mils right or left of the DT line, for range whether the burst occurred beyond or short of the target). Spotting should be made the instant the burst occurs, except when spottings are delayed because of smoke and dust.

(1) Deviation Corrections.

(a) The distance in meters, that the burst is to be moved (right or left) is determined by multiplying the observer's deviation spotting, in mils, by the OT distance, in thousands of meters (the OT factor). Deviation corrections are expressed to the nearest 10 meters.

(b) Easy way to remember this is the WORM Formula.

W-width = R-range X-times H-mils W = R X M

Determination of deviation corrections using above formula is shown in Figure 3-12.

EXAMPLE	OT DISTANCE (THOUSANDS)	OT FACTOR	SPOTTING	DEVIATION CORRECTION
1	4.00	4	400	1600
2	3.00	3	300	900
3	2.00	2	200	400
4	1.00	1	100	100
5	0.50	0.5	50	25

NOTE: OT distance of 1.00 and 2.00 meters are incorrect in the manual with OT factor

Figure 3-12. Deviation Corrections.

(2) Range corrections:

(a) When conducting an adjustment onto a target, the observer should establish a range bracket as soon as possible. When the first definite range spotting is made, the observer should make a range correction that will cause the spotting of the next round (rd) to be opposite that of the previous round. For example, if the first definite range spotting is SHORT, the observer should add enough to get an OVER spotting on the next round. Likewise, if the spotting is OVER, he should drop enough to get a SHORT spotting on the next round. The observer then reduces each subsequent range correction and moves each round closer to the target.

(b) The successive bracket technique:

400
200
100
50 FFE

(c) When necessary, the observer may use his hand and fingers as a measuring device when binoculars are not available, as shown in figure 3-14.



NOTE: ARM MUST BE FULLY EXTENDED.

Figure 3-13. Hand Mil Determination.

(d) The reticle in M17 field glasses are as shown in figure 3-14. Horizontal tick marks are in 10 mil increments.



Figure 3-14. M17 Field Glasses Reticle.

3-8. CREEPING FIRE (DANGER CLOSE)

- The technique of creeping fire to a close-in target helps ensure troop safety.
- If artillery/mortar fires will impact within 600 meters of friendly troops, the observer must tell the FDC by transmitting DANGER CLOSE.
- The creeping method of adjustment is used exclusively during danger close missions. The observer should make range changes by creeping the rounds to the target using corrections of 100 meters or less, instead of making large range corrections.
- The observer must keep in mind the position of all nearby friendly troops to ensure that a correction will not cause rounds to endanger them.
- All weapons that will fire for effect are used in the adjustment.

SECTION II. Close Air Support (CAS)

3-9. There are two types of close air support requests, planned and immediate. Planned requests are processed by the Army chain to corps for approval. Immediate requests may be initiated at any level and processed by the battalion S-3 FBO, and Air Liaison Officer. A determination will be made as to how appropriate the target is for a close air support mission. If the target is determined to be appropriate, the Air Liaison Officer will submit an immediate close air support request over Air Force nets. If the request is approved by the Air Support Operations Center (ASOC), an aircraft will be diverted to attack the target. CAS may be used for many purposes, i.e., to divert enemy attention; to assist a unit in breaking contact; or to attack a target of opportunity. The following elements must be submitted when requesting immediate CAS:

- Observer identification.
- Warning Order (REQUEST CLOSE AIR).
- Target location (Grid).
- Target description. Target description must include, as a minimum, type and number of targets; activity or movement; if it is a point or an area target, desired results on target (neutralize/destroy); and time on target, if specified.

3-10. COMMUNICATIONS.

a. Communications is the key to requesting and directing CAS. Immediate CAS requests must be relayed on the Air Force Long Range high-frequency (HF) net which is normally accomplished through the ground or Air FAC. Only F-16, A-37, A-7 and A-10 aircraft have FM frequency capability. Another fighter aircraft uses UHF frequencies which requires UHF radios or a relay through an airborne FAC or Aray aircraft.

b. A prominent landmark or smoke should be used when directing a CAS attack on a target. Use the clock method (nose of the aircraft is 12 o'clock) to put the pilots eyes where you want them. Examples: The white smoke is at your 2 o'clock position. Once the pilot identifies the smoke or landmark, describe the target in terms of direction and distance. Example: The target is 200 meters north of the smoke. Establish a unit of measurement with the pilot, e.g., "let's call the width of the river 50 meters."

c. Once the pilot correctly identifies the target, you must give him permission to attack it by saying "Cleared Hot." "Cleared Hot" must be given for each successive pass or the pilot will not drop his ordinance. To stop the mission for any reason you must say "Stop-Stop-Stop." Keep all transmissions brief, clear and simple.

3-11. METHODS OF TARGET IDENTIFICATION.

a. Threat coordinates are usually given in six digit UTM's for visual strikes; however, if using beacon bombing, eight digit coordinates must be available for the beacon and target.

b. Smoke or WP from mortars/artillery and burning targets may be used to identify both targets and friendly positions, but you must ensure pilot knows which is which. Colored panels may be used to mark friendly positions and indicate direction of attack, however they are very hard to see from fighter aircraft.

c. Prominent landmarks or terrain features may be used in directing the pilot to the general area. Dry runs may be made to positively identify the target, but must be kept to a minimum to maintain the element of surprise and aircraft survivability.

CHAPTER FOUR

MOVEMENT (SQUAD AND PLATOON)

4-1. General. To survive on the battlefield, stealth, dispersion, security and simplicity must be enforced in all tactical movements. The leader must be skilled in all movement techniques and principles.

a. Definition of Formations. Formations are arrangements of elements and soldiers in relation to each other. Squads use formations for control based on their analysis of the factors of METT-T. Leaders are up front in formations. This allows the fire team leader to lead by example, "Follow me and do as I do." All soldiers in the team must be able to see their leader.

b. Techniques. A movement technique is the manner a unit uses to traverse terrain. There are three movement techniques: traveling, traveling overwatch, and bounding overwatch. The selection of a movement technique is based on the likelihood of enemy contact and the need for speed. Factors to consider for each technique are control, dispersion, speed, and security. Movement techniques are not fixed formations. They refer to the distances between soldiers, teams, and squads that vary based on mission, enemy, terrain, visibility, and any other factor that affects control. Soldiers must be able to see his fire team leaders. The platoon leader should be able to see his lead squad leader. Leaders control movement with arm-and-hand signals. They use radios only when needed. Any of the three movement techniques (traveling, traveling overwatch, bounding overwatch) can be used with any formation.

c. Standards.

(1) Unit moves on designated route or arrives at

specified location per OPORD maintaining accountability of all assigned/attached personnel.

(2) Unit uses movement formation and technique ordered by the leader based on METT-T.

(3) Leaders remain oriented (within 200m) and follow planned route unless METT-T dictates otherwise.

(4) Unit will maintain 360 degree security and 100% alert during movement.

(5) Unit maintains 360 degree security and a minimum of 75% alert (based on METT-T) during halts.

(6) If contact with the enemy is made, it is made with the smallest element possible (fire team).

(7) Unit sustains no more than 10% casualties (subjective).

(8) Control measures are used during movement (head counts, phase lines, rally points, rest halts, etc.).

d. Fundamentals.

(1) Have men who can navigate: Preparation and plans are worthless if a patrol cannot find its objective or worse yet, stumbles onto it because of poor navigation. Plan to use at least two compassmen, and pacemen per patrol. Additionally, consider all aids to navigation, e.g., radar, STAND, marking rounds, and guidance from the air.

(2) Avoid Detections: Patrols must move by stealth and exploit the cover and concealment of the terrain. Move when visibility is reduced such as during darkness, fog, snow, or rain. Use rough, swampy, or heavily vegetated terrain to help hide from the enemy. Exploit known weaknesses in enemy detection capabilities and plan movements when other operations may divert his attention.

(3) Maintain Constant Security: Even with well thoughtout plans for movement, the patrol must take both active and passive security measures at all times. Give men or subunits responsibility for security enroute, at danger areas, at patrol bases, and most importantly in the objective area.

(4) Plan for Use of Support Fires: Plan for fire support, (artillery, tactical air, attack helicopter, naval gunfire) even if you think you may not need it during movement. Having a fire plan gives you a tool to help you move or navigate. For example, you can aid detection by planning fires at known points along the route; you can avoid detection by planning fires to destroy known enemy sensor fields or observations posts; you can have fires planned to divert the enemy's attention away from an area through which the patrol is moving; you have fire planned and ready to engage any threat to the patrol.

(5) The enemy situation determines which of the three movement techniques will be used. When contact is: not likely - TRAVELING; possible - TRAVELING OVERWATCH; expected - BOUNDING OVERWATCH. Squads/platoons usually move by traveling overwatch because they are usually behind enemy lines and contact is possible.

(6) In open terrain, keep men widely dispersed. When enemy contact is possible, have one fire team well forward and overwatch with the other fire team. Assign duties for the movement.

(7) Fire teams maintain visual contact, but the distance between them is such that the entire patrol does not become engaged if contact is made. Fire teams can spread their formations as necessary to gain better observation to the flanks. Although widely spaced, men retain their relative position in their wedge and follow their team leader. Terrain or weather may make it necessary to modify the wedge. Extreme situations may require the use of a single file.

(8) The lead squad must secure the front. It should be the one best qualified to navigate and provide forward security for the patrol while enroute. For a long movement, the PL may rotate the lead squad or rotate the fire team of the lead squad. The fire team or squad in the rear is charged with rear security.

(9) Movement of a patrol is the same as in any other operation.

(10) Vary movement techniques to meet the changing situation. If you need to put the lead squad into traveling overwatch and then have the patrol (-) overwatch the lead squad, do it. This may be good for crossing a large open area.

(11) Leaders, except fire team leaders, move within the formation where they can best control the situation and do their job. They can shift their men around. For instance, a PL may want to have the paceman walk near him so that he can get an accurate distance report quickly.

e. Movement techniques.

(1) The traveling is used when enemy contact is not likely and when speed is necessary.

(2) The traveling overwatch is used when enemy contact is possible.

(3) The bounding overwatch is used when enemy contact is expected or crossing a danger area.

MOVEMENT TECHNIQUE	WHEN NORMALLY USED	CHARACTERISTICS			
		CONTROL	DISPERSION	SPEED	SECURITY
TRAVELING	CONTACT NOT LIKELY	MORE	LESS	FATEST	LEAST
TRAVELING OVERWATCH	CONTACT POSSIBLE	LESS	MORE	SLOWER	MORE
BOUNDING OVERWATCH	CONTACT EXPECTED	MOST	MOST	SLOWEST	MOST

Figure 4-1. Movement techniques, uses, and characteristics.

f. Traveling. In the traveling technique, the distance between individuals is about 10 meters with 20 meters between squads. It has the following characteristics:

- (1) More control than traveling overwatch but less than bounding overwatch.
- (2) Minimum dispersion.
- (3) Maximum speed.
- (4) Minimum security forward, but some security may be added by speed.

g. Traveling Overwatch. The traveling overwatch technique is the basic movement technique.

(1) The distance between individual soldiers is about 20 meters, and the distance between fire teams is about 50 meters.

(2) In platoon traveling overwatch, the lead squad must be far enough ahead of the rest of the platoon to detect or engage any enemy before the enemy observes or

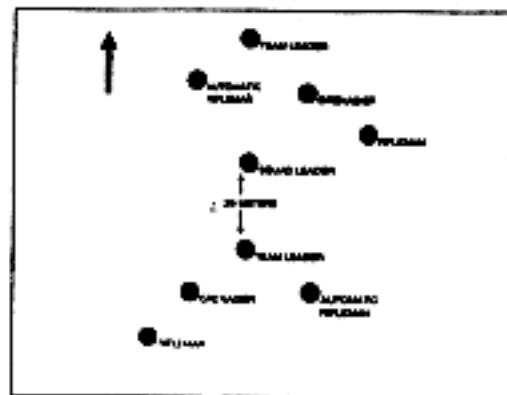

Figure 4-2. Squad traveling.

fires on the main body. However, it must be close enough to be supported by the platoon's small arms fires. This is normally between 50 to 100 meters, depending on terrain, vegetation, and light and weather conditions.

(3) In a column formation, only the lead squad should use the traveling overwatch; however, if greater dispersion is desired, all squads may use it.

(4) In other formations, all squads use traveling overwatch unless the platoon leader specifies not to.

(5) Traveling overwatch has the following characteristics:

- (a) Good control.
- (b) Good dispersion.
- (c) Good speed.
- (d) Good security forward.

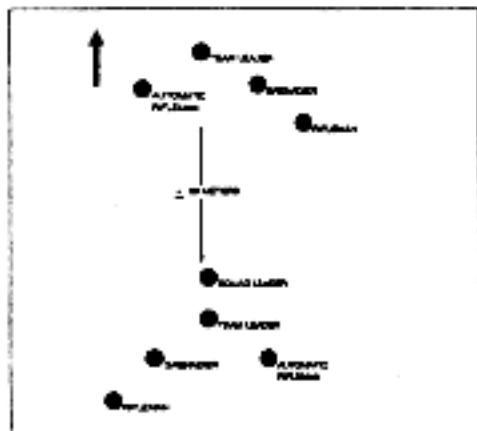

Figure 4-3. Squad traveling overwatch.

h. Bounding Overwatch.

(1) In the bounding overwatch technique, the distance between men remains approximately 20 meters. The distance between teams and squads varies.

(2) The squad or platoon has a bounding element and an overwatch element. The bounding element moves while the overwatch element occupies an overwatch position that can cover the route of the bounding element by fire. Each bound is within supporting range of the overwatch element.

(3) The length of a bound depends on the terrain, visibility, and control.

(4) Before a bound, the leader gives the following instructions to his subordinates:

- (a) Direction of location (if known) of the enemy.
- (b) Position of overwatch elements.
- (c) Next overwatch position.
- (d) Route of the bounding element.
- (e) What to do after the bounding element reaches the next position.

(f) How the elements receive follow-on orders.

(5) The characteristics of bounding overwatch are:

- (a) Maximum control.
- (b) Maximum dispersion.
- (c) Minimum speed.
- (d) Maximum security.

i. Squad Bounding Overwatch.

(1) When using squad bounding overwatch, one fire team moves forward while the other team overwatches. Attached weapons are with the overwatch element. If the bounding team makes contact, the overwatch team supports the bounding team with fire and movement.

(2) Teams can bound successively or alternately. Successive bounds provide more control (See figure 4-4). Alternate bounds can be executed faster than successive bounds. Use the alternate bounds method when the overwatch element can observe the bounding element pass to its flank and advance to a new position.

(3) The team moves as a team if there is good cover and concealment. If there is not good cover, the soldiers move singularly or in pairs by short rushes from cover to cover or by crawling (Figure 4-4).

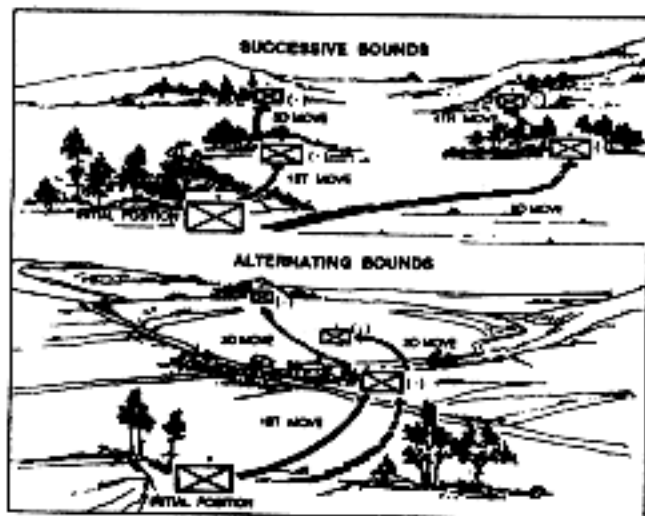

Figure 4-4. Squad Bounding Overwatch: Alternate Bounds.

j. Platoon Bounding Overwatch.

(1) Method One. When platoons use bounding overwatch, one squad bounds and one squad overwatches; the third squad awaits orders. Forward observers stay with the overwatching squad to call for fire. Platoon leaders normally stay with the overwatching squad who use machine guns and attached weapons to support the bounding squad (See Figure 4-5).



Figure 4-5. Platoon bounding overwatch.

(2) Method Two. Another way is to have one squad use bounding overwatch and have the other two squads use traveling or traveling overwatch technique.

(3) Movement Considerations. When deciding where to move the bounding element, consider:

- (a) Where the enemy is likely to be.
- (b) The mission.
- (c) The routes to the next overwatch position.
- (d) The weapons ranges of overwatching unit.
- (e) The responsiveness of the rest of the unit.
- (f) The fields of fire at the next overwatch position.

(4) Platoons conduct bounding Overwatch using successive or alternate bounds (See Figure 4-6 and 4-7).

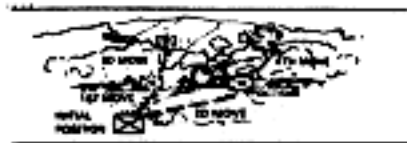

Figure 4-6. Movement by successive bounds.



Figure 4-7. Movement by alternate bounds.

4-2. Tactical Marches. Platoons conduct two types of tactical marches with the company. They are foot marches and motor marches.

a. Purpose/General. A successful foot march is when troops arrive at their destination at the prescribed time, physically able to execute their tactical mission. Keep in mind that a Ranger moves further, faster and fights harder than any other soldier.

b. Standard.

(1) The unit crosses the start point and release point at the time specified in the order.

(2) The unit follows the prescribed route, rate of march, and interval without deviation unless required otherwise by enemy action or higher headquarters orders.

c. Fundamentals.

(1) Effective control.

(2) Detailed planning.

d. Considerations.

(1) METT-T

(a) Mission - Task and Purpose.

(b) Enemy - Intentions, Capabilities, and Courses of Action.

(c) Terrain and Weather - Road condition and visibility (DAKOC).

(d) Troops and Equipment - Condition of troops and weight of their loads, availability of radios, N.O.D.'s.

(e) Time - Start time, release time, rate of march (day 4 kph, night 3.2 kph), time available for planning.

- (2) Task Organization.
 - (a) Headquarters - Command and Control.
 - (b) Security - One squad (lead and trail team).
 - (c) Main body - Two remaining line squads and weapons squad.
- (3) Command and Control.
 - (a) Control measures.
 - (1) Start point and release point (given to you by higher).
 - (2) Check points - report to higher, utilize to remain oriented.
 - (3) Rally or rendezvous points - utilized in the event elements become separated.
 - (b) Location of Leaders - Where they can best control their unit.
 - (c) Commo Plan - Location of radios, frequencies, call signs, and OP skids.
 - (d) Movement techniques.
 - (1) 2 - 5 meters a day.
 - (2) 1 - 3 meters a night.
- (4) March Order. May be issued as an OPORD, FRAGO, or Annex to either (must utilize operation overlay, or a strip map).
- (5) Formations and Order of Movement.
 - (a) Route of March - Assembly area, start point, release point, rally points, check points, break/halt points.

- (7) Start point time, release point time, and the rate of march.
- (8) March interval - squads, teams, and individuals.
- (9) Actions on enemy contact - air and ground.
- (10) Actions at halts.
- (11) Fires - A detail plan of fire support for the march.
- (12) Water supply plan.

e. Duties and Responsibilities.

- (1) Platoon Leader:
 - (a) Before - Issue Warning Order, FRAGO, inspect, and supervise (allow subordinates time to prepare for mission).
 - (b) During - Makes Start Point time, ensures interval is maintained, maintains control, enforces security, remains oriented.
 - (c) At Halts - Notifies PSB and SL's two minutes prior to halts, maintains security, checks condition of men, enforces water discipline and field sanitation. Informs PSB and SL's five minutes prior to move out.
 - (d) After the march - Ensures men are prepared to accomplish their mission, supervises SL's, and ensures medical attention is provided to men as needed.
- (2) Platoon Sergeant:
 - (a) Before - Assists Platoon Leader, makes recommendations, and enforces uniform and packing list.
 - (b) During - Controls stragglers, assist platoon leader in maintaining proper interval, and security.
 - (c) At Halts - Enforces security, ensures welfare of men, enforces field sanitation.
 - (d) After March - Coordinates for water, rations, and medical supplies. Recovers casualties.
- (3) Squad Leaders
 - (a) Before - Provides detailed instruction to TL's, inspects boots and socks for serviceability/proper fit, adjustment

of equipment, full canteens, and equal distribution of loads.

(b) During - Controls squad, maintains proper interval between men and next squad, maintains accountability of men and equipment, enforces security, and remains oriented.

(c) At Halts - Ensures security is maintained, provided men for water resupply as detailed. Physically checks men in his squad, ensures they drink water, and change socks as necessary. Rotates heavy equipment.

(d) After March - Occupies squad sector of assembly area, conducts foot inspection and report condition of men to Platoon Leader, prepares men for accomplishment of the mission.

(4) Security Squad.

(a) Lead Team - Point element for platoon, recon route to SP, call in check points, provide early warning, and maintain rate of march.

(b) Trail Team - Move well to the rear of the main body, provide early warning, maneuver in support of main body (NETT-T). Secure Start Point for main body, and maintain rate of march.

(5) Pace Setter

(a) An experienced soldier carrying the same load as the majority of the soldiers. Should be of medium height.

(b) Move 4-10 meters in front of main body and maintain rate ordered by PL.

(6) Medic - Assist Platoon leadership in the assessment and treatment of march casualties. Advise the chain of command on the evacuation and transportation requirements of casualties.

(7) Individual - Maintains interval, follows TL's examples, relays hand and arm signals, and remains alert during movement and at halts.

Halts - First halt generally after first 45 minutes, 15 minutes long. Thereafter, every 50 minutes for 10 minutes (Long marches).

a. Short Halts - Water breaks.

b. Long Halts - Foot maintenance.

c. May have 15 minute halt half-way point of long movements.

ACCORDIAN EFFECT -

4-3. Motor Marches. The platoon conducts motor marches like any other tactical movement. Special requirements may include--

- Protection. Sandbagging the bottom of the truck to protect the soldiers from mines.

- Observation. Removing bows and canvas to allow 360-degree observation and rapid dismount.

- Inspection. Inspecting vehicle and driver to ensure they are ready. Checking fuel level and driver's knowledge of the route, speed, and distance between vehicles.

- Loading. The platoon should load vehicles keeping fire team, squad, and platoon integrity. For example, fire teams and squads intact on the same vehicle and platoons in the same serial. Additionally, key leaders, weapons, and equipment should be cross-loaded.

- Rehearsals. Rehearsing immediate action to enemy contact (near and far ambush, air attack) ensuring the driver knows what to do.

- Air guards. Posting air guards for each vehicle.

4-4. Movement during limited visibility conditions.

At night or when visibility is poor, a platoon must be able to function the same as during day. It must be able to control, navigate, maintain security, move, and stalk at night or during limited visibility.

a. Control. When visibility is poor, the following methods aid in control:

- Selected personnel use of night vision devices.
- Leaders move closer to the front.
- The platoon reduces speed.
- Each soldier uses two small strips of luminous tape on the rear of his helmet to allow the soldier behind him to see.
- Leaders reduce the interval between soldiers and between units to make sure they can see each other.
- Leaders conduct headcounts at regular intervals and after each halt to ensure personnel accountability.

b. Navigation. To assist in navigation during limited visibility, leaders use--

- Terrain association (general direction of travel coupled with recognition of prominent map and ground features).
- Dead reckoning (compass direction and specific distances or legs). At the end of each leg, leaders should verify their location.
- Resection.
- Movement routes that parallel identifiable terrain features.
- Guides or marked routes.
- GBRs to vector units to the proper location.
- Position-location devices.

c. Security. For stealth and security in night moves, squads and platoons--

- Designate a point man to maintain alertness, the lead team leader to navigate, and a pace man to count the distance traveled. Alternate compass and pace men are designated.
- Allow no smoking, no lights, and no noise.
- Use radio-listening silence.
- Camouflage soldiers and equipment.
- Use terrain to avoid detection by enemy surveillance or night vision devices.
- Make frequent listening halts.
- Mask the sounds of movement with artillery fires.

d. Night walking. Proficiency in night walking is gained through practice. A soldier walking at night looks ahead, then slowly lifting his right foot, eases it forward about 6 inches to the front of the left foot. While easing his foot forward and keeping his toes pointed downward, the soldier feels for twigs and trip wires. He slowly places his foot on the ground. Confident of solid, quiet footing, the soldier slowly moves his weight forward, hesitates, then repeats the process with the other foot. This technique is slow and time-consuming.

e. Stalking. Soldiers stalk to get as close as they can to an enemy sentry, patrol, or base. This is best described as a slow, crouching night walk. The soldier watches the enemy continuously. When close to the enemy, the soldier squints to help conceal light reflected by his eyes. He breathes slowly through his nose. If the enemy looks in his direction, the soldier freezes. He takes advantage of the background to blend with shadows and to prevent glare or contrast. Soldiers move during distractions such as gusts of wind, vehicle movement, loud talking, or nearby weapons fire.

f. Rally Points. Actions to be taken at rally points must be planned in detail. The plan must provide for continuation as long as there is a good chance to accomplish the mission. Some form of communications must be left in the rally point to inform stragglers of how many men linked up and the direction they took. There are two techniques for actions at rally points:

(1) Men Available. The assembled members will wait until a set number of men arrive and then go on with another mission under the senior man present. This plan is good for a reconnaissance patrol when two or three men may be able to accomplish the mission.

(2) Time Available. The assembled members wait for a set period of time, after which the senior man present will decide whether or not to continue the mission, based on troops and equipment present. This may be the plan when a minimum number of men, or certain items of equipment, or both, are needed to accomplish the mission.

g. Actions at Halts. During halts, security must be posted and all approaches into the sector will be covered with key weapons. This is best accomplished during short halts, 30 seconds or less on one knee, using the cigarshaped perimeter (see figure 4-7). Except for the security halt conducted after the patrol first departs friendly lines, the PSG moves forward through the halted patrol, checking security as he goes, and meets the platoon leader to determine the reason for the halt and to render assistance.

4-5. Danger Areas.

a. Danger Areas: A danger area (DA) is any place on a unit's route where the leader's estimate process tells him his unit may be exposed to enemy observation or fire. Some examples of danger areas are open areas, roads and trails, native villages, enemy positions, and obstacles such as minefields, streams, and barbed wire. Avoid danger areas whenever possible. If they must be passed or crossed, use great caution.

b. Standards:

- (1) The unit prevents the enemy from surprising the main body.
- (2) The unit moves all personnel and equipment across the danger area.
- (3) The unit prevents decisive engagement by the enemy.
- (4) No more than 10% casualties.

c. Fundamentals:

- (1) Designate near and far side rally points.
- (2) Secure near side, left and right flank, and rear security.
- (3) Recon and secure the farside.
- (4) Cross the danger area.
- (5) Plan for fires (when possible).

d. Technique for crossing danger areas:

- (1) Linear Danger Area Crossing for a Squad:
 - STEP 1: The Alfa Team Leader (ATL) observes the linear danger area and sends the hand and arm signal to the squad leader who determines the bound across.
 - STEP 2: Squad leader directs the ATL to move his team across the DA far enough to fit the remainder of the squad on the far side of the DA. B team moves to the DA to the right or left to provide an overwatch position prior to A team crossing.
 - STEP 3: SL receives the hand and arm signal that it is safe to move the rest of the squad across. (B team is still providing an overwatch).

STEP 4: BL moves himself, RTD and B team across the DA. (A team provides overwatch for squad missions.)

STEP 5: A team on azimuth at BL's command or hand and arm signal.

- (2) Linear Danger Area Crossing for a Platoon
- (a) The lead squad halts the platoon, and signals danger area.
 - (b) The platoon leader moves forward to the lead squad to confirm the danger area.
 - (c) The platoon leader confirms danger area and establishes near and far side rally points.
 - (d) On the platoon leader's signal, the A team (ATM) of the lead squad establishes an overwatch position to the left of the crossing site. Prior to crossing, the compassman with the lead two squads confirm azimuth and pace data.
 - (e) B team (BTM) of the lead squad establishes an over-watch position to the right of the crossing site.
 - (f) Once overwatch positions are established - the platoon leader gives the second squad in movement the signal to bound across by fire team.
 - (g) Once across, the squad is now lead in movement and continues on azimuth.
 - (h) One Stop, Look, Listen and Smell (SLLS) is conducted, squad leader signals platoon leader all clear.
 - (i) Day time - Hand and arm signals thumbs up. Night time - Two flashes of red light.
 - (j) Platoon leader receives all clear and crosses with RTD, FD, WBL and 2 gun teams.
 - (k) Once across, PL signals the 3d squad in movement to cross at their location.
 - (l) PSG with medic and 1 gun team crosses after 2d squad is across (sterilizing central crossing site).
 - (m) PSG signals security squad to cross at their location.

Note 1: Platoon Leader will plan for support fires on all danger areas.

Note 2: Squads in overwatch 2d and 3d) will sterilize where they cross.

Sequence -

- A and B teams of lead squad occupy overwatch positions.
- Second squad crosses, and continues on azimuth.
- PL crosses with RTD, FD, WBL, and 2 gun teams.
- Third squad crosses in movement, linkup with 1st squad.
- PSG crosses with medic and gun team.
- Security squad crosses, linkup with 2d squad.
- With the new order of movement (formerly 2d squad in movement now leading and the former 1st squad in movement in trail) the platoon continues movement on azimuth.

(3) Danger Area (Small/Open).

- (a) The lead squad halts the platoon, and signals danger area.
- (b) The platoon leader moves forward to the lead squad to confirm the danger area.
- (c) The platoon leader confirms danger area and establishes near and far side rally points.
- (d) The platoon leader designates lead squad to bypass danger area using the detour-bypass method.
- (e) Upon signal to move, lead squad offsets compass 90 degrees left or right as designated and moves in that direction. Paceman stops pace count and starts new pace count.
- (f) After moving set distance (as instructed by platoon leader). Lead squad assumes original azimuth, paceman original pace count.
- (g) After passing by the open area, the lead squad once again stops and again offset compass 90 degrees left or right and paceman starts pace once again.

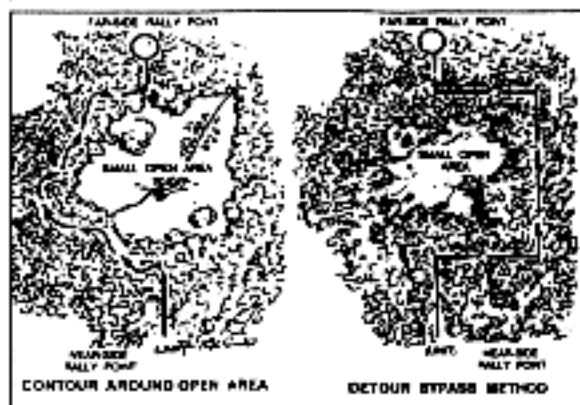

Figure 4-11. Danger Area (Small/Open)

(4) Danger Area (Series):

- (a) A series of danger areas are two or more danger areas within an area that can be either observed, or supported by fire.
- (b) Double linear danger area - (use linear danger area technique cross as one danger area).
- (c) Linear/small open danger area - (use bypass-detour technique).
- (d) Linear/large open danger area - (use platoon wedge in crossing).

Note: Series of danger areas will be crossed using the technique which provides the most security.

(5) Danger Area (Large):

- (a) Lead squad halts the platoon, and signals danger area.
- (b) The platoon leader moves forward with RATELO and F.O. and to confirm danger area.
- (c) The platoon leader confirms danger area and establishes near and far side rally points.
- (d) Platoon leader designates direction of movement.
- (e) Platoon leader may designate change of formation (i.e., IAW METT-T) as necessary.

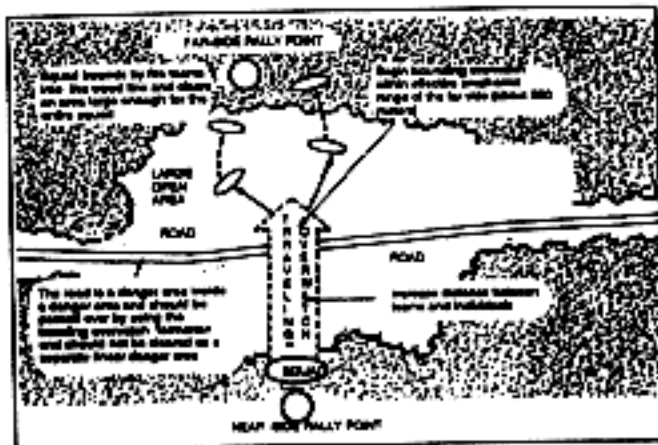

Figure 4-14. Danger Area Large.

Note 1: Prior to the point man stepping into the danger area. The PL and F.O. will plan for fires.

Note 2: If far side of danger area is less than 250 meters - PL establishes overwatch, and designates lead squad to clear woodline on far side.

CHAPTER FIVE

PATROLLING

Patrols are missions to gather information or to conduct combat operations. Infantry platoons and squads conduct three types of patrols: reconnaissance, combat, and tracking. This chapter describes the planning considerations used in preparation for patrols, conduct of patrols, and establishment of and actions taken in a patrol base.

5-1. PLANNING CONSIDERATIONS

This paragraph provides the planning considerations common to most patrols. It discusses the required tasks that guide the platoon and squad leader in organizing patrols, the initial planning and coordination requirements, and the coordination requirements for the departure and reentry of friendly lines.

a. Organizing for a patrol mission. This paragraph discusses the different tasks that may be required of a unit for a reconnaissance, combat, or tracking patrol. A patrol is a mission, not an organization. To accomplish the patrolling mission, a platoon or squad must perform specific tasks; for example, secure itself, danger area crossings, or rally points; reconnoiter the patrol objective; demolish, breach, support, or assault. As with other missions, the leader tasks elements of his unit in accordance with his estimate of the situation. He identifies those tasks his unit must perform and decides which elements of his unit will perform which tasks. Where possible, in assigning tasks, the leader should maintain squad and fire team integrity. The chain of command

continues to lead its elements habitually during a patrol. In the discussion that follows, the terms "element" and "team" refer to the squads, fire teams, or buddy teams that perform the tasks as described. Squads and fire teams may perform the tasks as described. Squads and fire teams may perform more than one task in an assigned sequence; others may perform only one task. The leader must plan carefully to ensure that he has identified and assigned all required tasks in the most efficient way. Elements and teams for platoons conducting patrols include the following:

(1) Elements common to all patrols.

(a) Headquarters element. The headquarters consists of the platoon leader, RATELO, platoon sergeant, FO and FO RATELO. It may consist of any attachments that the platoon leader decides that he or the platoon sergeant must control directly.

(b) Aid and litter team. Aid and litter teams are responsible for treating and evacuating casualties.

(c) Enemy prisoner of war team. EPW teams are responsible for controlling enemy prisoners IAW the five B's and the leader's guidance.

(d) Surveillance team. The surveillance team keeps watch on the objective from the time that the leader's reconnaissance ends until the unit deploys for actions on the objective. They then join their element.

(e) En route recorder. The en route recorder records all information collected during the mission.

(f) Compass man. The compass man assists in navigation by ensuring the lead fire team leader remains on course at all times. Instructions to the compass man must include an initial azimuth with subsequent azimuths provided as necessary. The compass man should preset his compass on the initial azimuth before the unit moves out, especially if the move will be during limited visibility

conditions. The platoon or squad leader should also designate an alternate compass man.

(2) Combat patrols.

(a) Assault element. The assault element seizes and secures the objective and protects special teams as they complete their assigned actions on the objective.

(b) Security element. The security element provides security at danger areas, secures the ORP, isolates the objective, and supports the withdrawal of the rest of the platoon once it completes its assigned actions on the objective. The security element may have separate security teams, each with an assigned task or sequence of tasks.

(c) Support element. The support element provides direct and indirect fire support for the unit.

(d) Demolition team. Demolition teams are responsible for preparing and exploding the charges to destroy equipment, vehicles, or facilities on the objective.

(e) Search team. The assault element may comprise two-man (buddy teams) or four-man (fire team) search teams to search bunkers, buildings, or tunnels on the objective. These teams will search the objective or kill zone for casualties, documents, or equipment.

(3) Reconnaissance patrols.

(a) Reconnaissance team. Reconnaissance teams reconnoiter the objective area once the security teams are in position. Normally these are two-man teams (buddy teams) to reduce the possibility of detection.

(b) Reconnaissance and security team. R&S teams are normally used in a zone reconnaissance, but may be useful in any situation when it is impractical to separate the responsibilities for reconnaissance and security.

b. Initial planning and coordination. Leaders plan and prepare for patrols using the troop-leading procedure and the estimate of the situation. Leaders identify required actions on the objective, then plan backward to the departure from friendly lines and forward to the reentry of friendly lines. They normally receive the OPORD in the battalion or company CP where communications are good and key personnel are available. Because patrolling units act independently, move beyond the direct-fire support of the parent unit, and operate forward of friendly units, coordination must be thorough and detailed. They coordinate continuously throughout the planning and preparation phases. They use checklists to preclude omitting any items vital to the accomplishment of the mission.

(1) Items coordinated between the leader and the battalion staff or company commander include--

- Changes or updates in the enemy situation.
- Best use of terrain for routes, rally points, and patrol bases.
- Light and weather data.
- Changes in the friendly situation.
- The attachment of soldiers with special skills or equipment; for example, engineers, sniper teams, scout dog teams, FOs, or interpreters.
- Use and location of landing zones.
- Departure and reentry of friendly lines.
- Fires support on the objective and along the planned routes, including alternate routes.
- Rehearsal areas and times. The terrain for rehearsal should be similar to that at the objective, to include buildings and fortifications if necessary.

Coordination for rehearsals includes security of the area, use of blanks, pyrotechnics, and live ammunition.

- Special equipment requirements.
- Transportation support, including transportation to and from the rehearsal site.
- Signal plan--call signs, frequencies, code words, pyrotechnics, and challenge and password.

(2) The leader coordinates with the unit through which his platoon or squad will conduct its forward and rearward passage of lines. The specific items for coordination are discussed later in this paragraph.

(3) The leader also coordinates his unit's patrol activities with the leaders of other units that will be patrolling in adjacent areas at the same time.

c. Completion of the Plan. As the platoon leader completes his plan he considers the following:

(1) Essential and supporting tasks. The leader ensures that he has assigned all essential tasks to be performed on the objective, at rally points, at danger areas, at security or surveillance locations, along the route(s), and at passage lanes to a squad or fire team as appropriate.

(2) Key travel and execution times. The leader estimates time requirements for movement to the objective, leaders reconnaissance of the objective, establishment of security and surveillance, completion of all assigned tasks on the objective, movement to an objective rally point to debrief the unit, and return to and through friendly lines.

(3) Primary and alternate routes. The leader selects primary and alternate routes to and from the objective (figure 5-1). The return routes should differ from the routes to the objective.

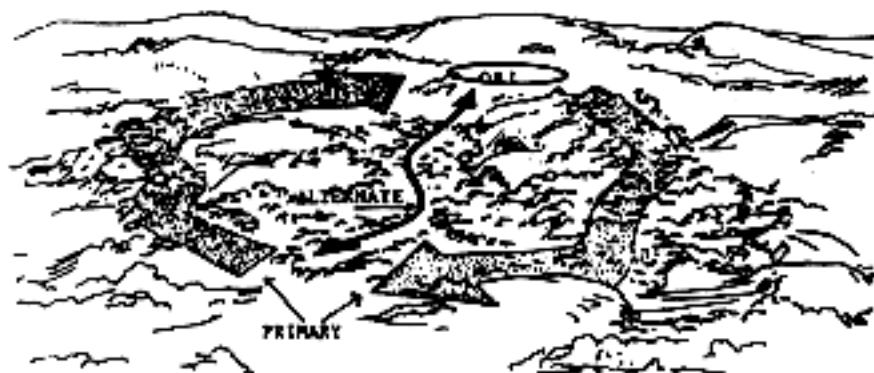

Figure 5-1. Primary and alternate routes.

(4) Signals. The leader should consider the use of special signals. These include arm-and-hand signals, flares, voice, whistles, radios, and infrared equipment. All signals must be rehearsed so that all soldiers know what they mean.

(5) Challenge and password forward of friendly lines. The challenge and password from the unit's SOI must not be used beyond the FEBA.

(a) The unit can use the odd-number system. The leader specifies an odd number. The challenge can be

any number less than the specified number. The password will be the number that must be added to it to equal the specified number.

(b) The unit can also designate a running password. This code word alerts a unit that friendly soldiers are approaching in a less than organized manner and possibly under pressure. This may be used to get soldiers quickly through a compromised passage of friendly lines. The running password is followed by the number of soldiers approaching ("Moosebreath five"). This prevents the enemy from joining a group in an attempt to penetrate a friendly unit.

(6) Location of leaders. The leader considers where he and the platoon sergeant and other key leaders should be located for each phase of the patrol mission. The platoon sergeant is normally with the following elements for each type of patrol:

- On a raid or ambush, he normally controls the support element.
- On an area reconnaissance, he normally stays in the ORP.
- On a zone reconnaissance, he normally moves with the reconnaissance element that sets up the link-up point.

(7) Actions on enemy contact. Unless required by the mission, the unit avoids enemy contact. The leader's plan must address actions on chance contact at each phase of the patrol mission. The unit's ability to continue will depend on how early contact is made, whether the platoon is able to break contact successfully (so that its subsequent direction of movement is undetected), and whether the unit receives any casualties as a result of the contact.

(a) The plan must address the handling of seriously wounded soldiers and KIAs.

(b) The plan must address the handling of prisoners who are captured as a result of chance contact and are not part of the planned mission.

(8) Contingency Plans. The leader leaves his unit for many reasons throughout the planning, coordination, preparation, and execution of his patrol mission. Each time the leader departs without radio or wire communications, he must issue a five-point contingency plan to the leader left in charge of the unit. The contingency plan includes--

- Where the leader is going.
- Who he is taking with him.
- The amount of time he plans to be gone.
- The unit's actions if the leader does not return.
- The unit's and the leader's actions on chance contact while the leader is gone.

d. Departure From Friendly Lines. The departure from friendly lines must be thoroughly planned and coordinated.

(1) Coordination with the commander of the friendly unit includes:

- Items the platoon leader will provide the unit; for example, unit identification, size of the patrol; departure and return times, and the area of the patrolling unit's operation.

- Items that will be provided by the forward unit to the platoon leader:

- Additional information on terrain.
- Known or suspected enemy positions.
- Likely enemy ambush sites.
- Latest enemy activity.
- Detailed information on friendly

positions and obstacle locations. This includes the location of OPs.

-- Friendly unit fire plan.

-- Support that the unit can provide; for example, fire support, litter teams, guides, communications, and reaction force.

- BOI information, signal plan, running password, and procedures for departure and reentry of lines.

- Locations of dismount point, initial rally point, and departure and reentry points.

(2) The platoon leader coordinates with the leaders of other units that will be patrolling in the same or adjacent areas.

- Identification of the patrolling units.

- Missions of the patrolling units.

- Routes.

- Fire plan.

- Signal plan.

- Times and points for departure and reentry.

- Any information about the enemy.

(3) In his plan for the departure of friendly lines, the leader should consider the following sequence of actions:

- Making contact with friendly guides at the contact point.

- Movement to the coordinated initial rally point.

- Completion of final coordination with the friendly unit.

- Final preparations at the initial rally point.

- Movement to and through the passage point.

The platoon should remain in single file. The platoon sergeant follows directly behind the guide so that he can count each soldier that passes through the unit's obstacle

system. He gives the count to the guide, tells him how long to wait at the passage point (or when to return), and confirms the running password.

Note: If the platoon makes contact after it is past the departure point, it fights through. Soldiers return to the departure point only if the unit becomes disorganized. They then reoccupy the initial rally point and the leader reports to higher headquarters.

- Establishment of a security-listening halt beyond the friendly unit's final protective fires.

e. Rally points. The leader considers the use and locations of rally points. A rally point is a place designated by the leader where the unit moves to reassemble and reorganize if it becomes dispersed.

(1) Selection of rally points. The leader physically reconnoiters routes to select rally points whenever possible. He selects tentative points if he can only conduct a map reconnaissance. He confirms them by actual inspection as his unit moves through them. Rally points must--

- Be easy to find.
- Have cover and concealment.
- Be away from natural lines of drift.
- Be defensible for short periods.

(2) Types of rally points. The most common types of rally points are initial, enroute, objective, reentry, and near-and-far-side rally points. Soldiers must know which rally point to move to at each phase of the patrol mission should they become separated from the unit. They should know what actions are required there and how long they are to wait at each rally point before moving to another.

(a) Initial rally point. An initial rally point is a place inside of friendly lines where a unit may assemble and reorganize if it makes enemy contact during the departure of friendly lines or before reaching the first en route rally point. It is normally selected by the commander of the friendly unit.

(b) Enroute rally point. The leader designates enroute rally points every 100 to 400 meters (based on the terrain, vegetation, and visibility). When the leader designates a new enroute rally point, the previously designated one goes into effect. This precludes uncertainty over which one soldiers should move to if the unit makes contact immediately after the leader designates a new rally point. There are three ways to designate a rally point:

- Physically occupy them for a short period. This is the preferred method.
- Pass by at a distance and designate using arm-and-hand signals.
- Walk through and designate using arm-and-hand signals.

(c) Objective rally point. The objective rally point (ORP) is a point out of sight, sound, and small-arms range of the objective area. It is normally located in the direction that the unit plans to move after completing its actions on the objective. The ORP is tentative until the objective is pinpointed. (See figure 5-2).

- Actions at or from the ORP include--
 - Reconnoitering the objective.
 - Issuing a FRAGO, if needed.
 - Disseminating information from reconnaissance, if contact was not made.
 - Making final preparations before continuing operations; for example, reconcealing; preparing demolitions; lining up rucksacks for quick recovery;

preparing EPW bindings, first aid kits, and litters; and inspecting weapons.

- Accounting for soldiers and equipment after actions at the objective are complete.
- Reestablishing the chain of command after actions at the objective are complete.

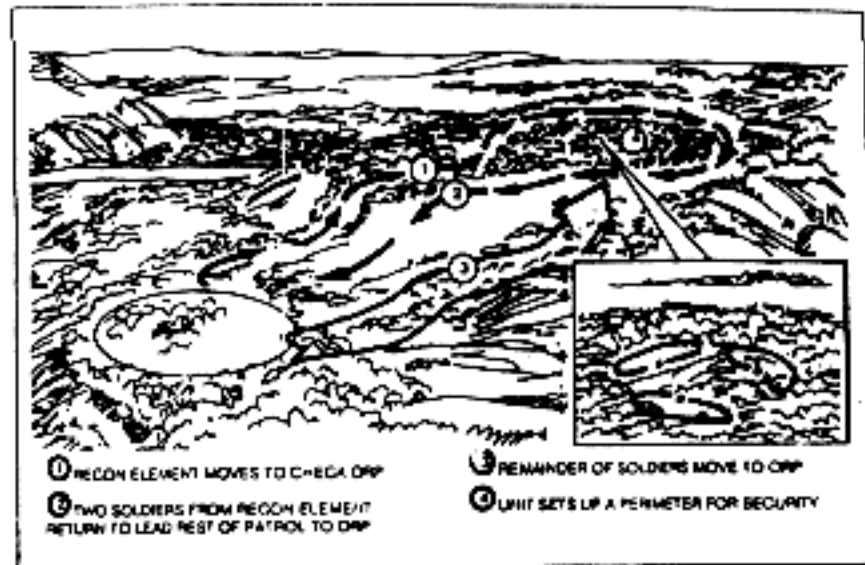

Figure 5-2. Objective rally point.

(d) Leader's Reconnaissance of the Objective. The plan must include a leader's reconnaissance of the objective once the platoon or squad establishes the ORP. Before departing the leader must issue a 5 point contingency plan:

FIVE POINT CONTINGENCY PLAN FORMAT

1. Going. Where the platoon/squad leader is going.
2. Others. Who is the PL/BL taking with him.
3. Time. Time he will be gone.
4. What. What to do if he does not return in time.
5. Actions. Actions on enemy contact, you and me:
 - a. If the PL/BL have enemy contact:
 1. The PL/BL will _____.
 2. The unit(-) will _____.
 - b. If the unit (-) has enemy contacts:
 1. The PL/BL will _____.
 2. The unit(-) will _____.

Use the acronym SOTWA, shown above, to facilitate quick and effective use of the 5-point contingency plan.

- (1) During his reconnaissance, the leader--
 - Pinpoints the objective.
 - Selects security, support, and assault positions for his squads and fire teams.
 - Adjusts his plan based on his observation of the objective.
- (2) Each type of patrol requires different tasks during the leader's reconnaissance. The platoon leader will bring different elements with him. (These are discussed separately under each type of patrol).

(3) The leader must plan time to return to the ORP, complete his plan, disseminate information, issue orders and instructions, and allow his squads to make any additional preparations.

f. Actions on the Objective. Each type of patrol requires different actions on the objective. (They are discussed separately under each type of patrol).

5-2. RECONNAISSANCE OPERATIONS.

General. There are three types of reconnaissance operations: area, zone and route reconnaissance. The two types discussed will be area and zone. Recon patrols provide timely and accurate information on the enemy and terrain. They confirm the leader's plan before it is executed. Units on reconnaissance operations collect specific information Priority Intelligence Requirements (PIR) or general information Information Requirements (IR) based on the instructions from their higher commander.

a. Area Recon

Task Standards:

- (1) The unit determines all PIR and other intelligence requirements specified in the order for the area.
- (2) The unit reconnoiters without the enemy learning the strength, location, or intention of the main body.
- (3) The unit completes the reconnaissance and reports all information by the time specified in the order.

Fundamentals of Reconnaissance:

Fundamentals: In order to have a successful area reconnaissance, the platoon leader must apply the fundamentals of the reconnaissance to his plan during the conduct of the operation.

Gain All Required Information: The parent unit tells the platoon leader (PL) what information is required. This is in the form of PIR (Priority Intelligence Requirements). The platoon's mission is then tailored to what information is required. During the entire patrol, members must continuously gain and exchange all information acquired. The platoon reports all information it has gathered but cannot consider it's mission accomplished unless all PIR has been gathered.

(b) Avoid Detection by the Enemy: A patrol must not let the enemy know that it is in the objective area. If the enemy knows he is being observed, he may move, change his plans, or increase his security measures.

Methods of avoiding detection are:

- (1) Minimize movement in the objective area (Area Recon).
- (2) Move no closer to the enemy than necessary.
- (3) If possible use long range surveillance devices or night observation devices.
- (4) Camouflage, stealth, noise and light discipline.
- (5) Minimize radio traffic.

(c) Employ security measures: A patrol must be able to break contact and return to the friendly unit with what information it has gathered. If necessary break contact and continue the mission. Security elements should be replaced so that they can overwatch the reconnaissance elements, and suppress the enemy so the reconnaissance element can break contact.

(d) Task Organization: When the platoon leader receives the order, he analyzes his mission to ensure he understands what must be done. Then he task organizes his platoon to the mission.

- (1) The element will occupy the DRP as per the security perimeter occupation previously discussed during formations and order of movement training.
- (2) RATELO calls in spare for occupation of DRP.
- (3) The leader confirms his location on map while subordinate leaders make necessary perimeter adjustments.
- (4) Subordinate leaders report to center of perimeter and the leader gives specific guidance to prepare for actions on the objective. The following, as a minimum, will be accomplished:
 - (a) Personnel camouflage.
 - (b) NODs and Binos are prepared.
 - (c) Weapons are on safe with a round in the chamber.
- (5) Once the leader receives a report from each subordinate leader informing him that all members going forward on the recon are prepared, the leader will begin inspecting them.
- (6) One team (R&S team #1, R&S team #2 surveillance team) at a time will come to the leader's location and be inspected, told where to position the rucksack, and wait for remaining personnel.

Note: Operating in squad size element greater than 10 men in the squad, two three-man R&S teams will be used for the recon. If there are 10 men or less in the squad, only one three-man R&S team will be used.

- (7) Once all personnel have been inspected, the leader will issue the P&B a five-point contingency plan and have him readjust the perimeter after he moves out.
- (8) The leader moves to where the recon personnel are waiting and gives them the signal to begin movement toward the objective. The prescribed movement formation is established as they begin moving toward the objective.

(The recon element will move in two wedge formations during daylight). The subordinate leader will be at the apex of wedge #1 with the security personnel from R&S team #1 to the left and the security personnel from R&S team #2 to the right. The leader will be at the apex of the second wedge, with the surveillance team personnel to his left and right.

(9) The leader gives the signal to halt when he reaches an area that he feels will make a suitable release point. It should be out of sight and sound distance from the objective (if possible), but at a minimum out of sight of the objective. It should also possess good rally point characteristics.

(10) The release point should be occupied as prescribed in the OPORD and 360 degree security will be established. The leader must allow all personnel to become familiar with the release point and the surrounding area.

(11) The leader will then issue the surveillance team a five-point contingency plan. He will also issue the senior man remaining in the release point a five-point contingency plan.

(12) The leader will then take the surveillance team and subordinate leader forward to pinpoint the objective, establish a limit of advance, and emplace the surveillance team. The surveillance team is positioned with one man facing the objective, and one facing back in the direction of the release point.

(13) After the leader gets a preliminary look at the objective (along with the subordinate leader) and they establish a limit of advance and pick tentative vantage points, they will return to the release point.

(14) The leader will then confirm his plan with the subordinate leader. He will issue his subordinate leader a five-point contingency plan.

(15) The two R&S teams then move out to begin the reconnaissance of the objective site. The clover

leaf method will be the method used for the reconnaissance. Prior to beginning the recon, each R&S team will check with surveillance by moving forward within visibility of the men facing toward the release point and gets a thumbs up if no significant changes have occurred on the objective, or a thumbs down if there has been a significant change. In the event of a thumbs down, the squad leader will move forward to the vicinity of the surveillance position to determine at what is going on. He may have to adjust his original plan if necessary.

(16) In the event that the R&S team leaders get thumbs up, they will move around the objective gathering information. They should:

- (a) Avoid parallel in the objective site.
- (b) Maintain extreme stealth.
- (c) Not cross the limit of advance.
- (d) Maximize the use of available cover and concealment.

(17) During the conduct of the recon, each R&S team will return to the release point when any of the following occurs:

- (a) They have gathered all their PIR.
- (b) They have reached the limit of advance.
- (c) The allocated time to conduct the recon has elapsed.
- (d) Contact has been made.

(18) At the release point, the leader will compare what he has gathered with what the subordinate leader gathered and determine if he has met the PIR requirements.

Note: If the leader determines that he has not gathered sufficient information to meet the PIR requirements, or if the information he and the subordinate leader gathered

differs drastically, he may have to send his R&S teams back up to the objective site. Before doing this, he will issue new five-point contingency plans all around and may even have to return to the DRP to alert the PSG of the change. Once everyone has been informed of the change in plan, the R&S team leaders will flip-flop. The leader will take the subordinate leader's original security man and recon around the side of the objective the subordinate originally reconed. The subordinate leader will do likewise with the leader's security man.

(19) Once PIR requirements have been met, the leader will move with one other man toward the surveillance position and, once within site of the man facing back toward the release point, will signal them to withdraw from their position to the release point.

(20) The recon element will then depart the release point using the same formation and return to the DRP.

(21) The recon element will halt outside the DRP and the PSG will call in one team at a time to secure their rucksacks and move back to their original positions on the perimeter.

(22) The PSG and squad leaders will also ensure that any mission essential equipment is accounted for and packed away (and properly tied down).

(23) The leader will make a decision on whether to conduct dissemination in the DRP or whether to move a safe distance away and then disseminate his information. If he elects to move a safe distance away, he will move his element out using the appropriate movement technique and formation, occupy a security perimeter as described earlier, and disseminate information.

(24) To disseminate, the leader has the RATELO draw a sketch of the objective site based on his (the leader's) sketch.

(25) The leader will then relieve the R&S team #2 leader from his position of the perimeter. The subordinate leader will then go to the RATELO, look at the sketch he has made, and add any additional information he may have discovered while on the recon. Once complete, the subordinate leader will then go relieve the leader.

(26) The leader will then go to the perimeter and relieve the surveillance team member that was facing the objective. This man will report to the RATELO and repeat the actions of the subordinate leader. He will then return to his perimeter position and relieve the leader.

(27) The leader will then check the final product and have the RATELO make three copies.

(28) Once the RATELO is finished all the copies of the objective site, the leader will have all the subordinate leaders report to his position. He will give a copy of the sketch to each subordinate leader, and brief them on the sketch. He will then give the subordinate leaders a specific amount of time to brief all their personnel on the sketch.

(29) The subordinate leaders will move to each man's position on the perimeter and brief them on the objective sketch. While this is taking place, the leader will spot check behind the subordinate leaders to ensure they are putting out the correct information. When the subordinate leaders have briefed all their personnel, they will report to the leader.

(30) The leader, subordinate leaders, and RATELO will each secure a copy of the sketch in their upper left breast pocket.

(31) Once dissemination is complete, the leader will have the RATELO call in the spare for mission complete (and for leaving the ORP if dissemination was conducted there) and has the subordinate leaders alert their personnel that they are going to move out.

(32) If contact is made:

(a) Moving to the release point: The recon element will attempt to break contact and return to the ORP, secure rucksacks, and quickly move out of the area. Once they have moved a safe distance away, the leader will inform higher HQ of the situation and take further instructions from them.

(b) While emplacing surveillance: These individuals will withdraw through the release point to the ORP and follow the same procedures as above.

(c) While conducting the recon: All personnel will fire a full magazine on to the objective site. Surveillance will fire a LAW on the biggest weapon on the objective. All elements will pull off the objective and move to the release point. The senior man will quickly account for all personnel and return to the ORP. Once in the ORP, the procedures as outlined in (i) above will be followed.

b. Zone Recon.

Task Standards:

(1) The platoon determines all PIR and other intelligence requirements specified in the order for its assigned zone.

(2) The platoon reconnoiters without the enemy learning the strength, location, or intentions of the main element.

(3) The platoon completes the reconnaissance and reports all information by the time specified in the order.

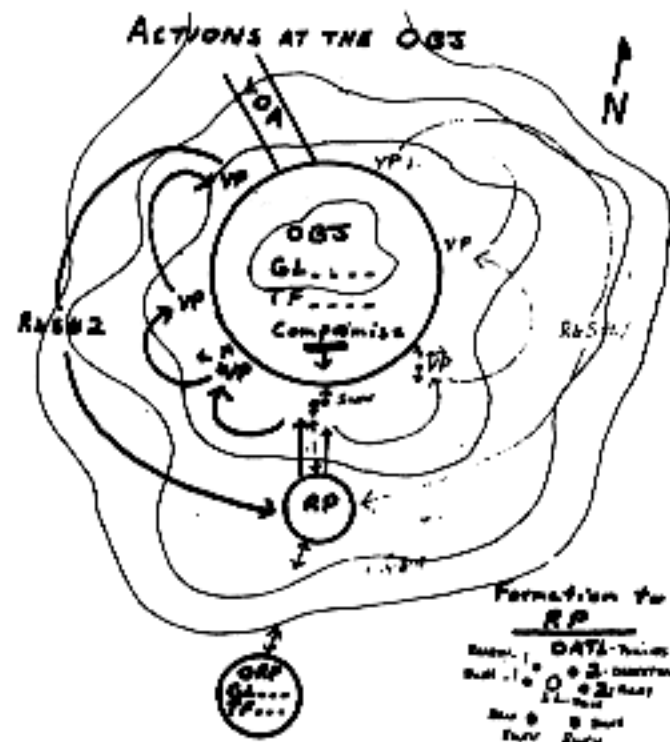

(Sec
NA47)

Figure 5-3. Actions at the Objective.

5-3. CONDUCT A ZONE RECONNAISSANCE USING THE FAN TECHNIQUE: It can be performed by stationary teams or moving elements, or by a series of area reconnaissances. Listed below is a step by step narrative on the conduct of a zone reconnaissance at squad and platoon level.

a. Platoon:

(1) The platoon leader organizes the platoon into a minimum, reconnaissance and security teams based on METT-T and DAKOC.

(2) PL conducts a mission analysis and selects a series of ORPs or rendezvous points throughout his zone of operation.

(3) Once the platoon arrives at the initial ORP, the PL selects a method of reconnaissance based on METT-T and DAKOC. The method selected should best aid him and control his unit.

b. Squad:

(1) Squad leader organizes squad into teams in support of PL's orders, METT-T and DAKOC.

(2) Once the platoon arrives at the ORP, the SL will move to the PL's location and receive final briefing from the PL prior to leaving the ORP. He will leave one of his team leaders in charge of his squad while he is with the PL.

(3) After receiving final instructions from PL, SL formulates an order for his squad and briefs team leaders, ensuring to allow team leader enough time to brief their teams.

(4) Once the squad departs the ORP by a designated route (route is either planned by PL or SL), the squad will proceed to the next rendezvous point or ORP.

(5) During movement the squad will gather all information specified by PL's order.

(6) SL will ensure sketches are drawn of all enemy hard sites, roads and trails.

(7) When the squad arrives at new rendezvous point or DRP, the SL will report to PL and give him all information gathered.

(8) SL will receive briefing from PL of information gathered by other squads, then return to squad and disseminate all information to team leaders and allow them time to brief their teams.

(9) SL will ensure squad is prepared to continue mission as ordered by the PL.

c. Debriefing. Immediately after the platoon or squad returns, personnel from higher headquarters conduct a thorough debrief. This may include all members of the platoon or the leaders, RATELOs, and any attached personnel. Normally the debriefing is oral. Sometimes a written report is required. NATO forces use the patrol report form specified by STANAG 2003. Information on the written report should include--

- Size and composition of the unit conducting the patrol.
- Mission of the platoon (type of patrol, location, purpose).
- Departure and return times.
- Routes. Use checkpoints, grid coordinates for each leg or include an overlay.
- Detailed description of terrain and enemy positions that were identified.
- Results of any contact with the enemy.
- Unit status at the conclusion of the patrol mission, including the disposition of dead or wounded soldiers.
- Conclusions or recommendations.

5-4. COMBAT PATROL.

General. Units conduct combat patrols to destroy or capture enemy soldiers or equipment; destroy installations,

facilities, or key points; or harass enemy forces. They also provide security for larger units. The two types of combat patrol missions are ambush and raid. In planning a combat patrol, the platoon leader considers the following:

a. Tasks to Subordinate Units. Normally the platoon headquarters element controls the platoon on a combat patrol mission. He must make every attempt to maintain squad and fire team integrity as he assigns tasks to subordinate units.

(1) The platoon leader must consider the requirements for assaulting the objective, supporting the assault by fire, and security of the entire unit throughout the mission.

(a) For the assault on the objective, the leader must consider the required actions on the objective, the size of the objective, and the known or presumed strength and disposition of the enemy on and near the objective.

(b) The leader must consider the weapons available, and the type and volume of fires required to provide fire support for the assault on the objective.

(c) The leader must consider the requirement to secure the platoon at points along the route, at danger areas, at the DRP, along enemy avenues of approach into the objective, and elsewhere during the mission.

(2) The leader must assign additional tasks to his squads for demolition, search of enemy killed and captured, guarding of EPWs, treatment and evacuation (litter teams) of friendly casualties, and other tasks required for successful completion of the patrol mission (if not already in the SOP).

(3) The platoon leader must determine who will control any attachments of skilled personnel or special equipment.

b. Leader's Reconnaissance of the Objective. In a combat patrol, the leader has additional considerations for the conduct of his reconnaissance of the objective from the ORP.

(1) Composition of the leader's reconnaissance party. The platoon leader will normally bring the following personnel:

- Squad leaders.
- Surveillance team.
- Forward Observer.

(2) Conduct of the leader's reconnaissance. In a combat patrol, the platoon leader should consider the following additional actions in the conduct of his leader's reconnaissance of the objective.

(a) The leader should designate a release point half way between the ORP and the objective. Squads and fire teams separate at the release point and move to their assigned positions.

(b) The platoon leader will confirm the location the objective or kill zone. He notes the terrain and identifies where he can place mines or claymores to cover dead space. Any changes to his plan will be issued to the squad leaders (while overlooking the objective if possible).

(c) If the objective is the kill zone for an ambush, the leader's reconnaissance party should not cross the objective, to do so will leave tracks that may compromise the mission.

(d) The platoon leader should confirm the suitability of the assault and support positions and routes from them back to the ORP.

(e) The platoon leader should post the surveillance team and issue a five-point contingency plan before returning to the ORP.

c. Ambush--Planning Considerations. An ambush is a surprise attack from a concealed position on a moving or temporarily halted target. Antiarmed ambushes are established when the mission is to destroy enemy armed or mechanized forces. Ambushes are classified by category--hasty or deliberate; type--point or area; and formation--linear or L-shaped. The leader uses a combination of category, type, and formation in developing his ambush plan. The key planning considerations include--

- Covering the entire kill zone by fire.
- Using existing or reinforcing obstacles (Claymores and other mines) to keep the enemy in the kill zone.
- Protecting the assault and support elements with mines, claymores, or explosives.
- Using security elements or teams to isolate the kill zone.
- Assaulting into the kill zone to search dead and wounded, assemble prisoners, and collect equipment. (The assault element must be able to move quickly through its own protective obstacles.)
- Timing the actions of all elements of the platoon to preclude loss of surprise.
- Using only one squad to conduct the entire ambush and determining movement time of rotating squads from the ORP to the ambush site. This technique is useful when the ambush must be manned for a long time.

(1) Categories.

(a) Hasty ambush. A unit conducts a hasty ambush when it makes visual contact with an enemy force and

has time to establish an ambush without being detected. The actions for a hasty ambush must be well rehearsed so that soldiers know what to do on the leader's signal. They must also know what action to take if the unit is detected before it is ready to initiate the ambush. The conduct of a hasty ambush is discussed below.

(b) Deliberate ambush. A deliberate ambush is conducted against a specific target at a predetermined location. The leader requires detailed information in planning a deliberate ambush:

- Size and composition of the targeted enemy
- Weapons and equipment available to the enemy.

(1) Types.

(a) Point ambush. In a point ambush, soldiers deploy to attack an enemy in a single kill zone.

(b) Area ambush. In an area, soldiers deploy in two or more related point ambushes.

(2) Formations.

(a) Linear. In an ambush using a linear formation, the assault and support elements deploy parallel to the enemy's route (see figure 5-4). This positions both elements on the long axis of the kill zone and subjects the enemy to flanking fire. This formation can be used in close terrain that restricts the enemy's ability to maneuver against the platoon, or in open terrain provided a means of keeping the enemy in the kill zone can be effected.

d. Standards.

(1) Point ambush.

(a) Movement to and occupation of the ambush site is undetected.

(b) Surprise is achieved.

(c) Unit accomplishes mission IAN commander's intent:

- 30% of OPFOR is killed (subjective unless MILES is used) or captured.
- Specific equipment or personnel are captured.
- Specific equipment or entire column is destroyed.

(d) 100% of PIR gathered is reported to higher headquarters.

(e) Ambush is initiated per OPORD.

(f) Ambush is established at designated point.

(g) Ambush is established by NLT time prescribed in OPORD.

(h) Unit sustains 10% or less friendly casualties (subjective unless MILES is used).

(i) Unit sustains no casualties from friendly fires (subjective unless MILES is used).

(j) Unit withdraws from the ambush position on order.

(2) Area Ambush.

(a) The platoon surprises the enemy (subjective).

(b) All ambush site(s) are replaced not later than the time specified in the order and without being detected by the enemy.

(c) The ambushes are initiated in the order specified by the leader.

(d) The ambushes accomplish the platoon's assigned task.

(1) Kill (subjective unless MILES is used), wound, or capture 30% enemy, or destroy all specified vehicles in the kill zone.

OR

(2) Delay the enemy from reaching the specified location for the specified period.

OR

(3) Force the enemy to withdraw from the platoon zone.

OR

(4) Prevent enemy elements larger than squad-size from penetrating the specified boundary.

(e) The unit sustains no more than 10 percent casualties (subjective unless MILES is used).

(f) The unit sustains no casualties from friendly fire (subjective unless MILES is used).

(g) The unit consolidates all personnel and equipment and withdraws from the zone, on order.

(h) The unit obtains and reports 100% PIR.

(3) Antiarior Ambush:

(a) The platoon emplaces the ambush NLT the time specified in the order.

(b) The platoon surprises the enemy.

(c) The platoon engages the specified enemy element (type or portion of the unit: security, main body, reaction force).

(d) The platoon destroys all of the specified vehicles in the kill zone (armor, C2 vehicles, bridging equipment, ADA).

(e) The platoon withdraws all personnel and equipment from the objective, on order.

(f) The platoon sustains no more than 10 percent casualties.

(g) The platoon sustains no vehicle losses.

(h) The platoon sustains no casualties from friendly fire.

(i) All specified PIR and other intelligence requirements are obtained from the ambush site.

e. Conduct of a point ambush. The platoon leader should consider the following sequence of actions when planning a deliberate point ambush:

(1) The security or surveillance team(s) should be positioned first. The support element should be in position before the assault element moves forward of the release point. The support element must overwatch the movement of the assault element into position.

(2) The platoon leader signals the surveillance team to pull back to the local rear security area or rejoin the assault element.

(3) Actions of the assault element should include--

- Identify individual sectors of fire as assigned by the platoon leader. Emplace aiming stakes.
- Emplace claymores and other protective devices.
- Emplace claymores, mines, or other explosives in dead space within the kill zone.
- Camouflage positions.

(4) Actions of the support element include--

- Identify sectors of fire for all weapons, especially machine guns. Emplace limiting stakes to prevent friendly fires from hitting and the assault element in an L-shaped ambush.
- Emplace claymores and other protective devices.

(5) Instructions to security teams must include how to notify the platoon leader of the enemy's approach into the kill zone. The security element must also keep the platoon leader informed if any enemy forces are following the lead force.

(6) The platoon leader must determine how large an element his ambush can engage successfully. He must be prepared to let units pass that are too large. He must report to higher headquarters any units that pass his ambush unengaged.

(7) The platoon leader initiates the ambush. He may use a command detonated claymore. He must also plan a backup method for initiating the ambush should the primary means fail. This should also be a casualty-producing device such as his individual weapon. This information must be passed out to all soldiers and practiced during rehearsals.

(8) Soldiers must have a means of engaging the enemy in the kill zone during periods of limited visibility if it becomes necessary to initiate the ambush under this situation. Use of tracers must be weighed against how it might help the enemy to identify friendly positions. The platoon leader may use handheld or indirect illumination flares.

(9) The platoon leader should include indirect fire support as a part of his plan. Indirect fires can cover the flanks of the kill zone to help isolate it. They can

also help the platoon to disengage if the ambush is compromised or the platoon must depart the ambush site under pressure.

(10) The platoon leader must have a good plan to signal the advance of the assault element into the kill zone to begin its search and collection activities. Smoke may not be visible to the support element. All soldiers must know and practice relaying this signal during rehearsals.

(a) The assault element must be prepared to move across the kill zone using individual movement techniques if there is any return fire once they begin to search. Otherwise, the assault element moves across by bounding fire teams. Other actions in the kill zone include:

- Collect and secure all EPWs and move them out of the kill zone before searching bodies. Establish a location for EPWs and enemy wounded who will not be taken out that provides them cover, yet allows them to be found easily by
- Search from one side to the other and mark bodies that have been searched to ensure the area is thoroughly covered. their units.

- Use the two-man search techniques.
 - As the search team approaches a dead enemy soldier, one man guards while the other man searches. First, he kicks the enemy weapon away. Second, he rolls the body over (if on the stomach) by laying on top and when given the go ahead by the guard (who is positioned at the enemy's head), the searcher rolls the body over on his. This is done for protection in case the enemy soldier has a grenade with the pin pulled underneath him.
 - The searchers then conduct a systematic search of the dead soldier from head to toe removing all papers and anything new (different type rank, shoulder boards, different unit patch, pistol, weapon, or NVD). They note if the enemy has a fresh or shabby haircut and the condition of his uniform and boots. They take note of the radio frequency, SOI, and maps. Once the body has been thoroughly searched, the search team will continue in this manner until all enemy personnel in and near the kill zone have been searched. Enemy bodies should be marked (for example, fold arms over chest) to avoid duplication.
- Identify and collect equipment to be carried back. Prepare it for transport. (Clear all weapons and place them on SAFE).

- Identify and collect remaining equipment for destruction. The demolition team prepares dual-primed explosives (C4 with two M60 fuse lighters and time fuse) or incendiary grenades and awaits the signal to initiate. This is normally the last action performed before the unit departs the objective and may signal the security elements to return to the ORP.

- Treat friendly wounded first, then enemy wounded, time permitting.

(b) Actions on the objective with stationary assault line; all actions are the same with the exception of the search teams. They must work in 3 man teams in order to provide security within the team to the far side of the kill zone while the search is being conducted. All KIAs should be dragged to the near side of the kill zone prior to the search.

(c) The flank security teams may also place out antiarmor mines after the ambush has been initiated if the enemy is known to have armor capability.

(d) If a flank security team makes contact, it fights as long as possible without becoming decisively engaged. It uses a prearranged signal to let the platoon leader know it is breaking contact. The platoon leader may direct a portion of the support element to assist the security team in breaking contact.

(e) The platoon leader must plan the unit's withdrawal from the ambush site:

- Elements normally withdraw in the reverse order that they established their positions.
- The elements may return first to the release point, then to the ORP, depending on the distance between elements.
- The security element at the ORP must be alert to assist the platoon's return to the ORP. It maintains security for the ORP while the rest of the platoon prepares to leave.

(f) Actions back at the ORP include accountability of personnel and equipment and recovery of rucksacks and other equipment left at the ORP during the ambush.

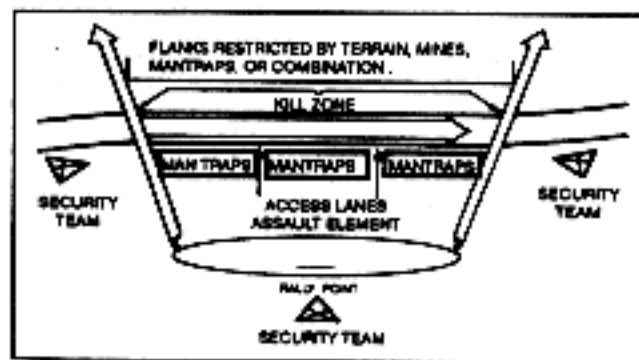

Figure 5-4. Linear ambush formation.

(g) L-shaped. In an L-shaped ambush the assault element forms the long leg parallel to the enemy's direction of movement along the kill zone. The support element forms the short leg at one end of and at right angles to the assault element. This provides both flanking (long leg) and enfilading fires (short leg) against the enemy. The L-shaped ambush can be used at a sharp bend in a trail, road, or stream. It should not be used where the short leg would have to cross a straight road or trail. (see figure 5-5).

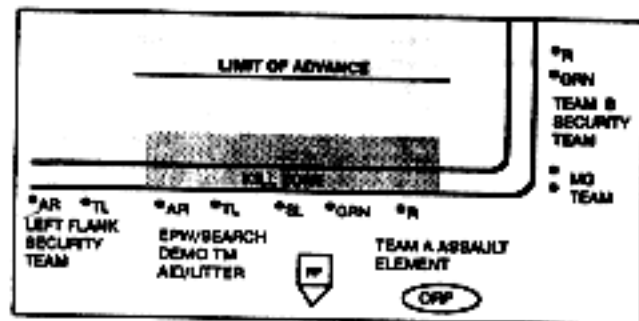

Figure 5-5. L-shaped ambush formation.

(h) Conduct of a hasty ambush. In planning and rehearsing a hasty ambush the platoon leader should consider the following sequence of actions:

- Using visual signals, any soldier alerts the unit that an enemy force is in sight. The soldier continues to monitor the location and activities of the enemy force until he is relieved by his team or squad leader.
- The platoon or squad halts and remains motionless.
- The leader determines the best nearby location for a hasty ambush. He uses arm-and-hand signals to direct the unit members to covered and concealed positions.

- The leader designates the location and extent of the kill zone.
- Security elements move out to cover each flank and the rear of the unit. The leader directs the security elements to move a given distance, set up, and rejoin the unit on order or, after the ambush (the sound of firing ceases). At squad level, the two outside buddy teams normally provide flank security as well as fire into the kill zone. At platoon level, fire teams make up the security elements.

(i) Conduct of an area ambush. The platoon leader should consider the following sequence of actions when planning a deliberate area ambush.

(1) A platoon is the smallest unit to conduct an area ambush. Units conduct area ambushes where enemy movement is largely restricted to trails or streams (see figure 5-6).



Figure 5-6. Area ambush.

(2) The platoon leader should select one principal ambush site around which he organizes outlying ambushes. These secondary sites are located along the enemy's most likely approach to and escape from the principal ambush site. Squad-sized elements are normally responsible for each ambush site. They establish an point ambush as described above.

(3) The platoon leader must determine the best employment of his machine guns. He normally positions them both with the support element of the principal site.

(4) Squads responsible for outlying ambushes do not initiate their ambushes until after the principal one is initiated. They then engage to prevent enemy forces from escaping or reinforcing.

(j) Conduct of an antiarmor ambush. Platoons and squads conduct antiarmor ambushes to destroy one or two armored vehicles. (see figure 5-7). If a squad is given the mission to conduct an antiarmor ambush, it should have a MAW team attached to it. The leader considers the following when planning an antiarmor ambush.

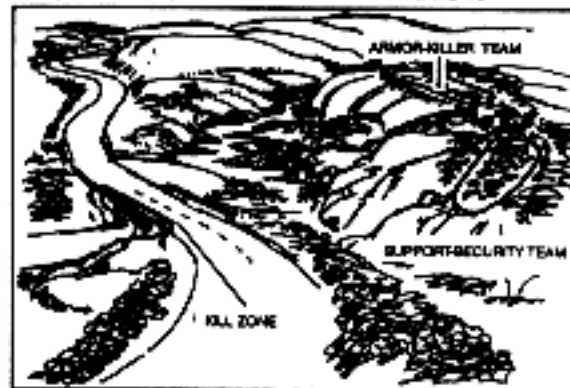

Figure 5-7. Antiarmor ambush.

(1) The armor-killer team is built around the MAW team. The leader must consider additional weapons available to supplement its fires. These are normally LAWs or AT4s. The leader must carefully position all antiarmor weapons to ensure the best shot (rear, flank, or top).

(2) The remainder of the unit must function as support and security elements in the same way that they do for other combat patrols.

(3) In a squad antiarmor ambush, the platoon leader selects the general site for the ambush. The squad leader must find a site that restricts the movement of armored vehicles out of the kill zone. The leader should attempt to place his elements so that an obstacle is between them and the kill zone.

(4) Security elements must consider dismounted avenues of approach into the ambush site.

(5) The leader should consider the method for initialing the antiarmor ambush. The preferred method is to use a command-detonated antiarmor mine placed in the kill zone. The MAW can be used to initiate the ambush, but its signature and slow rate of fire make it less desirable.

(6) If possible, the armor-killer team attempts to kill the first and last vehicles in the column.

(7) All other weapons open fire once the ambush has begun. If the kill zone is within range of light antiarmor weapons, each soldier fires one during the ambush.

(8) The leader must consider how the presence of dismounted enemy with the tanks will affect the success of his ambush. The leader's choices include--

- Initiate the ambush as planned.
- Withdraw without initiating the ambush.
- Initiate the ambush using only automatic weapons without firing antiarmor weapons.

(9) Because of the speed with which other armored forces can reinforce the enemy in the ambush site, the leader should plan to keep the engagement short, and the withdrawal quick. The unit will not clear through the kill zone as in other ambushes.

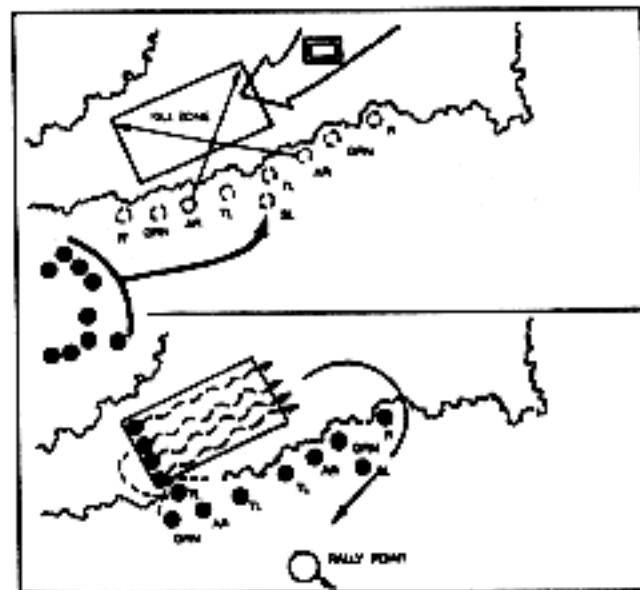

Figure 5-8. Squad hasty ambush

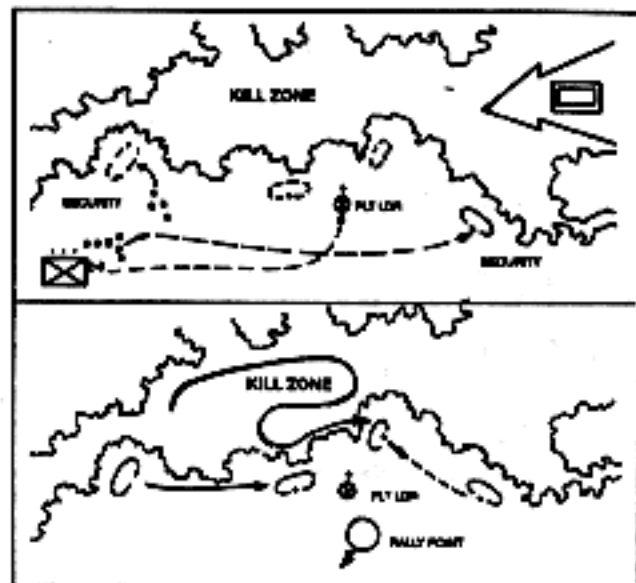

Figure 5-9. Platoon hasty ambush.

5-5. RAID.

a. **Raid.** A raid is a combat operation to attack a position or installation followed by a planned withdrawal. Squads do not conduct raids. The sequence of platoon actions for a raid is similar to those for an ambush. Additionally, the assault element of the platoon may have to conduct a breach of an obstacle. It may have additional tasks to perform on the objective; for example, demolition of fixed facilities.

b. **Raid Standards:**

- The platoon surprises the enemy.
- The platoon initiates the raid NLT the time specified in the order.
- The platoon assaults the objective and accomplishes its assigned task within the commander's intent.
 - Forces the enemy to withdraw from the objective.
 - Kills, wounds, captures, or forces the withdrawal of 100 percent of the enemy.
 - Captures specified personnel.
 - Destroys specified equipment or installation.
- The platoon does not become decisively engaged.
- The platoon withdraws all personnel and equipment from the objective area, on order.
- The platoon obtains all PIR from the raid site.
- The platoon sustains no casualties from friendly fire.
- The platoon sustains no more than 10 percent casualties.
- The platoon sustains no more than one vehicle loss.

c. Raid Fundamentals.

- Surprise (infiltration/insertion/surprise enemy).
- Coordinated fires (seal off objective).
- Violence of action.
- Planned withdrawal.

(1) Security Halt: At 200-400 meters from the tentative site, the platoon will halt, the PL will issue the PSG a contingency plan and move out to reconnoiter and secure the ORP. The reconnaissance party and security party will be determined by the PL using METT-T.

(2) Reconnaissance, secure, and occupy the ORP:

(a) The squad leader establishes security halt for PL short of tentative ORP (distance is METT-T dependent). Rangers move to cover and concealed positions.

(b) SL/PL gathers key personnel for leaders recon of ORP.

(c) SL/PL issues 5-point contingency plan to team leader/PSG, counts them out.

(d) SL/PL verifies ORP site-location and determines suitability.

- If suitable - clears/secures ORP location. ORP will be cleared using the zig-zag method.
- If not suitable, recons for alternative site. (Repeats step mentioned above once site is selected).
- SL/PL issues a 5-point contingency plan to ORP clear/secure team leader.
- SL/PL returns to unit. (Note: The SL/PL may opt to call the main body forward based on METT-T).

- Unit occupies ORP using clock method IAW figure 5-10 for squads and figure 5-11 for platoons. Direction of movement is 12 o'clock. Perimeter is adjusted as required.

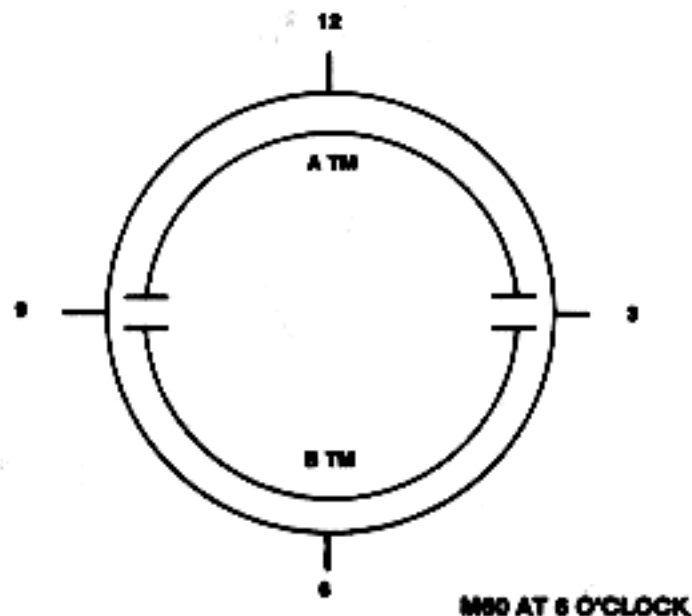

Figure 5-10. Squad ORP Clearance

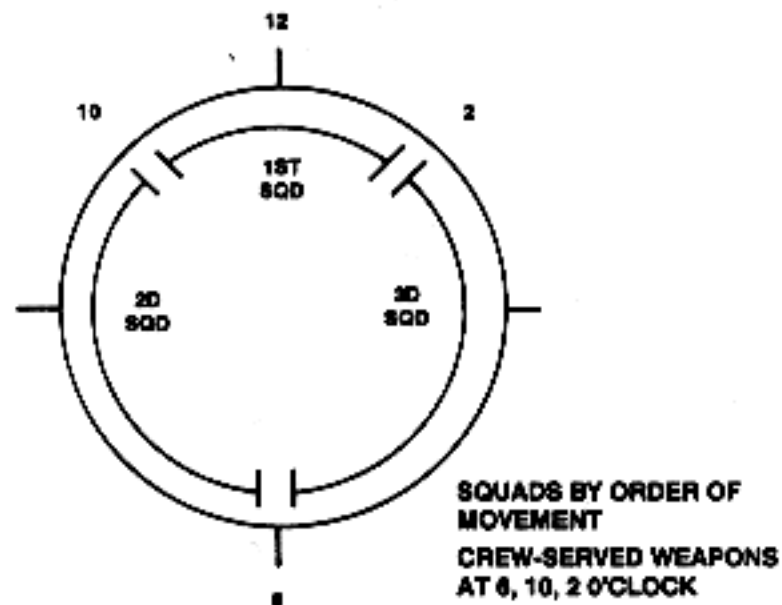

Figure 5-11. Platoon DRP Clearance.

(3) Designates the release point, drops off release point security.

(4) Pinpoints objective site and establishes surveillance.

(4) Reconnoiters location for assault and support elements.

(5) Confirms or denies play, leaves contingency plan with the surveillance team and returns to the release point.

(6) Once at the release point, the platoon leader will brief the security element leader on the tentative security positions. If time permits, the squad leader and the platoon leader should emplace the security teams. Their positions are critical in the successful accomplishment of the mission. If the security teams were brought forward on the leaders reconnaissance, the security leader can begin moving security into position while the platoon leader and the remainder of the leaders reconnaissance party move back to the DRP.

(7) Moving elements into positions; once back in the DRP, the platoon leader will issue any changes to the plan based on the leaders reconnaissance. After the information has been disseminated, the leaders prepare to move the elements into position. Communication is vital - the support element cannot move into position until security is in place. If support is going to be integrated into the assault line, the two elements will move in together. Once the platoon leader has confirmation that the security element is in position, he can move the support element into position. Prior to releasing the support element he must issue the contingency plan. Once the support element leader has confirmed he is in position and ready to support the assault movement, the assault element can move into position. Prior to moving forward the platoon leader must conduct a quick debrief

with the surveillance team to ensure nothing has changed on the objective site. If nothing has changed, move the assault into final position so that all positions are occupied and sectors of fire are designated.

(8) Movement from the assault position to the objective. The assault position is normally the last covered and concealed position before reaching the objective.

(a) As it passes through the assault position, the platoon deploys into its assault formation; that is, its squads and fire teams deploy to place the bulk of their firepower to the front as they assault the objective. A platoon sometimes must halt to complete its deployment and to ensure synchronization so that all squads assault at the designated time.

Note: Units should avoid halting in the assault position, because it is dangerous and may cause the loss of momentum.

(b) The assaulting squads move from the assault position and onto the objective. The platoon must be prepared to breach the enemy's protective obstacles.

(c) As the platoon moves beyond the obstacle, supporting fires should begin lifting and shifting away from the objective. Both direct and indirect fires shift to suppress areas adjacent to the objective, to destroy enemy forces retreating, or to prevent enemy reinforcement of the objective.

(9) Assaulting the Objective. As the platoon or its assault element moves onto the objective, it must increase the volume and accuracy of fires. Squad leaders assign specific targets or objectives for their fire teams. Only when these discreet fires keep the enemy

suppressed can the rest of the unit maneuver. As the assault element gets closer to the enemy, there is more emphasis on suppression and less on maneuver. Ultimately, all but one fire team may be suppressing to allow that one fire team to break into the enemy position. Throughout the assault, soldiers use proper individual movement techniques, and fire teams retain their basic shallow wedge formation. The platoon does not get "on-line" to sweep across the objective.

(10) Consolidation/Reorganization:

- (a) The platoon -
 - Reestablishes security.
 - Remans key weapons.
 - Provides first aid and prepares wounded soldiers for MEDEVAC.
 - Repairs damaged obstacles and replaces mines (Claymore) and booby traps.
 - Redistributes ammunition and supplies.
 - Relocates selected weapons to alternate positions if leaders believe that the enemy may have pinpointed them during the attack.
 - Adjusts other positions to maintain mutual support.
 - Reestablishes communications.
 - Reoccupies and repairs positions, and prepares for renewed enemy attack.
- (b) Squad and team leader provide ammunition, casualty, and equipment (ACE) reports to the platoon leader.
- (c) The platoon leader -
 - Reestablishes the platoon chain of command.
 - Consolidates squad ACE and provides ACE report to the company commander.
- (d) The platoon sergeant coordinates for resupply and supervises the execution of the casualty and EPW evacuation plan.

(g) The platoon continues to improve positions. The platoon quickly reestablishes DPs and resumes patrolling as directed.

(15) Conduct organized withdrawal; using prearranged signals the assault line will begin an organized withdrawal from the objective site maintaining control and security as the withdrawal is conducted. The assault element will bound back in the vicinity of the original assault line and will begin a single file withdrawal through the platoon sergeant's choke point. It is critical for all men to move through the choke point and an accurate count is maintained. Once the assault element is a safe distance from the objective and the headcount is confirmed, the platoon leader can withdraw the support element. If the support element was part of the assault line they will withdraw together and the security would be given the signal to withdraw. Once the support is a safe distance off the objective they will notify the platoon leader and the platoon leader will contact the security element and give them the signal to withdraw. All security teams will linkup at the release point and notify the platoon leader prior to moving to the DRP. As personnel return to the DRP they immediately secure their equipment and establish 360 degree security. Once the security element returns, the platoon will move out of the objective area as soon as possible, normally within 2 - 3 minutes.

5-7. DPT/RE-ENTRY.

a. General. Departure from Friendly Lines. Movement in and around forward units must be controlled, coordinated, and kept to a minimum to preclude the possibility of being engaged by friendly forces and/or activating their reconnaissance, surveillance, and target acquisition devices. Additionally, the forward unit positions are considered danger areas and it must be assumed that they are under enemy surveillance at all times.

b. Standards.

(1) The unit moves all personnel and equipment through the stationary unit not later than the time specified in the order.

(2) Neither unit main body is surprised by the enemy.

c. Procedure:

(1) Squad/Platoon:

Step 1: The squad/platoon will lock and load weapons prior to departure of the assembly areas.

Step 2: The squad/platoon will be halted at the contact point by a guide. They will exchange the challenge and password.

Step 3: The guide will bring the squad to its security halt location.

Step 4: The squad/platoon will occupy this location by force and set up a 360 degree security perimeter.

Step 5: The squad leader/platoon leader will issue a five point contingency plan to the B team leader/PBG who will disseminate this to the squad/platoon. He will re-check men, weapons, and equipment, ensure a round is chambered and the weapon is on safe, all equipment is secure and tied down, and re-check camouflage.

Step 6: The squad leader/platoon leader will then leave with the compassman and the guide and move to the forward unit command post, where the squad leader/platoon leader will effect final coordination with the unit commander. The squad leader/platoon leader will not tell the unit commander about his mission only that the squad/platoon is conducting a forward passage of lines.

Step 7: The squad leader/platoon leader, guide, and compassman will return to the security halt location upon completion of coordination.

Step 8: The squad leader/platoon leader will disseminate information gathered from the forward unit command to the team leaders, and give them time to put this information out to their personnel. The squad leader/platoon leader should spot check to ensure the information is disseminated.

Step 9: The squad leader/platoon leader will now make any final needed adjustments prior to moving out.

Step 10: The guide will lead the squad/platoon to the Passage Point (PP). Enroute to the PP, the guide will designate the Initial Rally Point (IRP) using the appropriate hand and arm signal, and all personnel will ensure they know its location.

Note: The IRP can be designated any of three ways:

- Pass by the IRP and designate it using hand and arm signals.
- Pass through the IRP and designate it using hand and arm signals.
- Actually occupy the IRP.

Note: If the guide does not designate an IRP, the squad leader will.

Step 11: Once the B team leader/PBG receives the IRP hand and arm signal, he will make his way forward in the formation and take up a place immediately behind the guide. If the B team leader/PBG does not reach this position once the squad hits the entrance to the PP, the A team/Lead Squad leader will halt the squad and wait for him.

Step 12: Once the squad hits the entrance to the PP, the B team leader/PBG will step to the side and count everyone into the PP. He will take up the position as the last man and send up a head count.

Step 13: The squad/platoon will follow the guide through the PP without halting.

Step 14: Once the squad/platoon hits the enemy side of the PP, the guide will step to the side and stop.

Step 15: As each man exits the PP, he will take up his appropriate position in the movement formation. The pacemen will start their paces at this point, and the compassmen will take up their first azimuths from the point.

Step 16: As the B team leader/PSB exits the PP, he will step to the side with the guide and re-confirm that the guide knows the running password, the number of persons in the squad, and the time the guide will wait on the enemy side of the PP. The B team leader/PSB will then take up his position in the formation.

Step 17: The B team leader/PSB will also send up either a verbal or visual thumbs up when he is out of the wire.

Step 18: The squad/platoon will continue to move out on azimuth until it is outside the friendly forward units Final Protective Fire (FPF) or has at least placed one terrain feature between it and the PP.

Step 19: The squad leader/platoon leader will then halt the squad/platoon and conduct a security listening halt. To do this, he takes a knee and removes his hat (or, if at night, simply passes the word). At this time, all members of the squad/platoon will pass the signal that the security listening halt is being conducted. They will seek out any local cover and concealment and get down on a knee facing out. The last two men will turn about for rear security.

Step 20: The B team leader/PSB will not come forward during the security listening halt.

Step 21: The RATELO will muffle his handset in his shirt.

Step 22: Everyone will remain this way, keeping completely silent and pulling security. They will get used to the signals, sounds, and smells of the battlefield.

Step 23: Once the squad/platoon leader feels he has been in this location an appropriate amount of time he will put his cap back on (or simply pass the word at night) and get the squad up and moving out on azimuth.

Step 24: The RATELO will then call in the spare for passage complete.

Step 25: Actions on enemy contact while conducting a forward passage of lines are as follows:

- If contact is made while the squad/platoon is at the security halt location and the

squad leader/platoon leader is at the friendly forward unit's command post, the B team leader/PSB will keep the unit in the security halt location unless a representative from that unit moves the clearly identified targets. If contact is made while the squad/platoon is moving toward the PP, the squad/platoon will occupy the IRP as a security perimeter, call higher for orders, and stay in the IRP unless a representative from the friendly unit moves the squad/platoon.

- If contact is made while the squad/platoon is in the PP, they will turn around and move back through the PP and occupy the IRP. They will inform higher of the situation and take orders from them.
- If the squad/platoon gets outside the PP but not yet gone beyond the friendly forward unit's FPF and contact is made, the squad leader will issue verbal instructions as to whether to go forward or back to the guide. If the squad/platoon goes back, they will use the running password to enter the PP and occupy the IRP and inform higher. Otherwise, the squad/platoon leader will simply attempt to break contact using the appropriate battle drill and then continue on the mission.
- If the squad/platoon is already outside the FPF and makes contact, they will use the appropriate battle drill to break contact.

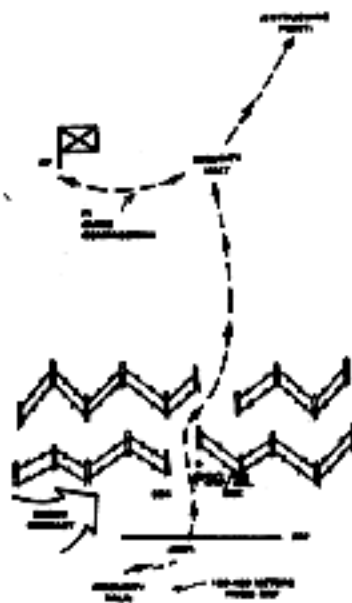

Figure 5-12. Re-entry of FFL.

(c). Re-entry of Friendly Lines (Platoon/Squad)

Step 1: The platoon/squad occupies the Reentry Rally/Point (RRP) as discussed earlier (same as security perimeter).

Step 2: The RRP location should be planned for so that if it is in a location that has at least one significant terrain feature between the RRP and the PP to ensure that the squad will not get hit by the effects of the friendly fire.

5-B. LINK-UP

a. A linkup is a meeting of friendly ground forces. Linkups depend on control, detailed planning, and stealth. Linkup procedure begins as the unit moves to the linkup point. The steps of this procedure are:

(1) If using radio communications, the unit reports its location using phase lines, checkpoints, or other control measures.

(2) The first unit at the site stops and sets up a linkup rally point about 300 meters from the linkup point.

(3) The first unit sends a security team to find the exact location of the linkup point.

(4) The security team clears the immediate area around the linkup point. It then marks the linkup point with the coordinated recognition signal. The unit moves to a covered and concealed position and observes the linkup point and immediate area around it.

(5) The next unit approaching the site repeats steps one through three. When its security team arrives at the site and spots the coordinated linkup point recognition signal, it gives the far recognition signal.

(6) The first security team responds, and the second team advances to the first team's location. The teams exchange near recognition signals.

(7) If entire units must link up, the second team returns to its unit's rally point and brings the unit forward to the linkup point. The first security team guides the entire second unit to the linkup rally point. Both teams are integrated into the security perimeter.

(8) When more than two units use the same linkup point, the first unit leaves a security team at the linkup point. They repeat the linkup procedure as other units arrive.

b. Link-up Site Selection. The leader identifies a tentative linkup site by map reconnaissance or a linkup site is designated by higher headquarters. The linkup site should have the following characteristics:

- (1) Easy to recognize.
- (2) Provides cover and concealment.
- (3) Away from natural lines of drift.
- (4) Defensible.
- (5) Provides multiple access and escape routes.

c. Coordination Checklist. The platoon leader coordinates or obtains the following information from the unit that his platoon will linkup with:

- (1) Frequencies.
- (2) Signals and alternates (near and far recognition signals).
- (3) Codes.
- (4) Recognition signals, far and near.
- (5) Fire coordination measures (for example, restrictive fire lines).
- (6) Command relationship with the linkup unit.
- (7) Actions following linkup.
- (8) Controls measures (contact points, checkpoints, phase lines, and others, as required).

5-6. PATROL BASE

a. Patrol Bases.

(1) General: A patrol base is a position setup when a squad or platoon conducting a patrol halts for an extended period. Patrol bases should not be occupied for more than a 24 hour period (except in emergency). The unit never uses the same patrol base twice.

(2) Patrol bases are used for:

- (a) To avoid detection by eliminating movement.
- (b) To hide a unit during a long detailed reconnaissance.
- (c) To perform maintenance on weapons/equipment, eat, and rest.
- (d) To plan and issue orders.
- (e) To reorganize after infiltrating an enemy area.
- (f) To establish a base from which to execute several consecutive or concurrent operations (i.e., ambushes, raid, etc).

b. Standards.

(1) Occupation.

- (a) Establish patrol base on terrain IAW METT-T that is free of enemy.
- (b) Unit must remain undetected while occupying the location as specified by their leader (subjective - unless miles used).
- (c) Priorities of work per OPORD are accomplished.
- (d) If discovered, unit defends and repels enemy or evacuates patrol base with 10% or less casualties (subjective unless MILES is used).

(2) Activities.

- (a) Unit must maintain noise and light discipline and remain undetected (subjective).
- (b) All tasks and priorities of work must be conducted in accordance with the platoon leader's instructions.
- (c) All personnel are aware of alert plan, evacuation plan, and priorities of work.

c. Fundamentals. Keep the following fundamentals in mind during patrol base operations:

(1) Site Selection. The leader selects the tentative site from a map or by aerial reconnaissance. The site's suitability must be confirmed; it must be secured before the unit moves into it. Plans to establish a patrol base must include selecting an alternate patrol base site. The alternate site is used if the first site is unsuitable or if the patrol must unexpectedly evacuate the first patrol base.

(2) Planning Considerations. Leaders planning for a patrol base must consider the mission and passive and active security measures.

(a) Mission. A patrol base must be located so it allows the unit to accomplish its mission.

(b) Security Measures. Security measures involve the following:

- (c) The leader selects:
 - Terrain that the enemy would probably consider of little tactical value.
 - Terrain that is off main lines of drift.
 - Difficult terrain that would impede foot movement such as an area of dense vegetation, preferably bushes and trees that spread close to the ground.

- Terrain near a source of water.
- Terrain that can be defended for a short period and that offers good cover and concealment.

(d) The leader plans for:

- Observation posts.
- Communication with observation posts.
- Defense of the patrol base.
- Withdrawal from the patrol base to include withdrawal routes and a rally point, or rendezvous point or alternate patrol base.
- A security system to make sure that specific soldiers are awake at all times.
- Enforcement of camouflage, noise, and light discipline.
- The conduct of required activities with minimum movement and noise.

(e) The leader avoids:

- Known or suspected enemy positions.
- Built-up areas.
- Ridges and hilltops, except as needed for maintaining communications.
- Small valleys.
- Roads and trails.

Note: This action is METT-T dependent; if there is nothing to be gained by doing this step, then the unit does not do it (for example, flat desert terrain).

d. Technique. One way of occupying and running a patrol base is:

(1) Occupation (Squad). The primary method for occupying a squad patrol base is as follows:

- (a) Leaders recon technique (see figure 5-13).
- (b) Squad leader issues contingency plan.
- (c) Make 90 degree dog leg and move to tentative patrol base.

(d) Clearing team clears and secures patrol base using the zig-zag technique as depicted in figure 5-16.

(e) Squad leader issues contingency plan to clearing team; one man at 6 o'clock, one at 12 o'clock positions.

(f) Squad leader and compassman return to squad and issue any changes to original plan.

(g) Squad leader has DP positioned in front of formation and gives them contingency plan.

(h) Unit moves out of security halt in order of movement that will facilitate occupation of patrol base.

(i) Unit establishes perimeter and security.

(j) Deploy R&S team. At night an R&S team is not sent out for a squad sized patrol base.

(k) After R&S team returns, squad leader makes final adjustment to perimeter and calls in brevity codes to higher, as required.

(l) Squad leaders ensures 360 degree interlocking fires.

(m) Squad leader confirms and disseminates evacuation, alert, fire plan and alternate patrol base--azimuth, distance and terrain feature (recon if time allows).

(n) Leader determines that temporary patrol base is satisfactory and begin patrol base activities.

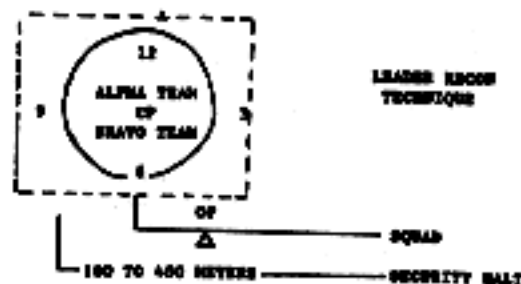

Figure 5-13. Occupation of patrol base (squad).



Figure 5-14. Clearing techniques.

(2) Additional method for occupying a patrol base are listed below. METT-T dependent. Occupy by force technique (RECON BY-PASS Fig 5-17).

- (a) Security and listening halt should be at a safe distance away from tentative patrol base.
- (b) Entire squad move on original azimuth to vicinity of tentative patrol base.
- (c) Begin series of 90 degree turns a safe distance from tentative site.
- (d) On last turn into patrol base, drop off DP and ensures five point contingency plan is issued.
- (e) Squad occupies seeks cover and concealment (conduct listening halt 3-5 minutes).
- (f) Deploy R&S teams (METT-T).
- (g) Squad leader adjusts perimeter, RTD reports to higher headquarters.
- (h) Squad leader ensures 360 degree interlocking fires.
- (i) Squad leader confirms and disseminates evacuation, alert and fire plan also the alternate patrol base location. (azimuth, distance and terrain feature, recon if time allows).
- (j) Initiates priorities of work.

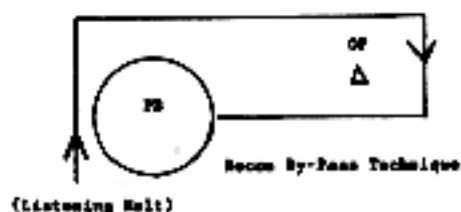

Figure 5-15. Recon By-Pass technique.

(3) Passive Patrol Base (Squad).

- (a) Purpose of passive patrol base is for rest of a squad of smaller size element.
- (b) Unit moves as a whole and occupies in force.
- (c) Squad leader ensures that the unit moves in at 90 degree angle.
- (d) Claymore mine(s) is replaced on route entering patrol base.
- (e) Alpha and Bravo teams sit back to back facing outward. (Figure 5-16), ensuring that at least one individual per team is alert and providing security.

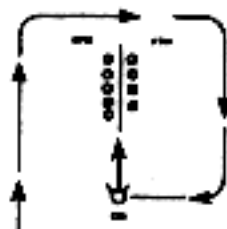

Figure 5-16. Passive Patrol Base.

(4) Occupation (Platoon). Leaders Recon Technique. (Triangular perimeter - see figure 5-18).

- (a) Platoon leader, RATELD, and security element secures tentative patrol base. Which personnel are taken for this mission in METT-T dependent.
- (b) Issues contingency plan to platoon sergeant prior to departure. (Platoon Sergeant disseminates plan to subordinates).

(c) Recon party conducts dog leg into tentative site.

(d) Leaders recon stops and establishes the 6 o'clock position.

(e) Platoon leader sends a clearing/security team forward to clear an area large enough for the platoon. (see figure 5-17) using the zig-zag technique. Size based on NETT-T.



ZIG-ZAG TECHNIQUE

Figure 5-17. Clearing technique.

(f) Platoon Leader, RATELD, weapons squad leader and 2 man security team recon the entire patrol base location for suitability.

- (g) During reconnaissance platoon leader will:
- Identify location and fires for crew-served weapons.
 - Identify interlocking fires (at squad level) to ensure 360 degree security.
 - Ensure terrain provides cover and concealment for the platoon.
 - Leave M60 tripod/assistant gunner at the 10 o'clock, 2 o'clock and 6 o'clock position.

(h) Platoon leader issues contingency plan to element leader prior to leaving. (Two Rangers from the security element secure 6 o'clock area).

(i) Platoon leader, RATELD, and security/compassman return to security halt and the platoon leader issues any changes to original plan.

(j) Platoon moves to tentative patrol base and drops off DP at the dog leg.

(k) Establish perimeter and security:

(1) Platoon leader replaces lead squad from 6 o'clock to 10 o'clock.

(1) Second squad in movement occupies 6 o'clock to 2 o'clock.

(m) The squad leader guides trail gun and trailing squad from 2 o'clock to 12 o'clock and then moves left and right to occupy 10 o'clock to 2 o'clock.

(12) Deploy R&S teams around patrol base using box clearing method.

(13) RATELD calls in spare to higher.

(14) Platoon leader confirms and disseminates evacuation, alert and fire plan; also alternate patrol base.

(15) Initiates priorities of work.

e. Priority of Work (Platoon and Squad). Once the platoon leader is briefed by the R&S teams and determines area is suitable for a patrol base, the leader establishes

or modifies defensive work priorities in order to establish the defense of the patrol base. Priorities of work (determined by METT-T):

- (1) Security:
 - (a) Prepare to utilize all passive and active measures.
 - (b) Readjust after R&S teams return. Employ all weapons, elements, and personnel to meet the conditions of terrain, situation and enemy.
 - (c) Assign sectors of fire to all personnel and weapons. Develop squad sectors sketches and platoon fire plan. (see figure 5-18)
 - (d) Confirm location of fighting positions. (if applicable)
 - (2) Communication with higher headquarters.
 - (3) Weapons and equipment maintenance.
 - (4) Personal hygiene.
 - (5) Water/Mess plan.
 - (6) Rest/sleep plan management.
 - (7) Stand to/Move out time.
- f. Maintain 360 degree security at all times.
- g. Establish OP's.

9. Patrol Base Activities.

(a) Security must be maintained at all times to include when moving into the patrol base, initial occupation and during operation. Items to be considered are:

- (1) OP or stay behind ambush.
 - (2) R&S teams.
 - (3) Squads maintain security within assigned sectors. As a minimum, 33% of platoon (or METT-T dependent) will be alert at all times.
- (b) Communication - RATELOS must establish a radio watch together to:
- (1) Monitor radios continuously.
 - (2) Perform maintenance on radios.

(3) Act as runners for platoon leader.

(4) Establish rest plan.

(c) Noise and light discipline must be adhered to by everyone and supervised by the chain of command. It is advantageous for the R&S team to check out surrounding area at first light.

(d) Watering party-men must have water to function in combat.

(1) A small unit must be used to obtain water, normally a fire team.

(2) Must have communications with main body of unit.

(3) Compassman.

(4) Empty rucks are used to carry unit's canteens. This affords good noise discipline.

(5) Contingency plan is issued to water party.

(e) Mess-usually done at squad level unless that will compromise overall platoon security.

(1) As a minimum, security must be established and weapons maintenance should be performed prior to anyone eating.

(2) Personnel should eat as a buddy team. One man on security, one man behind him (1-3 meters) eating.

(f) Maintenance of individual and crew-served weapons.

(1) Individual weapons maintenance should be accomplished as soon as security is attained. Must determine if a full breakdown or partial cleaning is needed. Should not have more than 25% broken down at one time.

(2) Crew-served - platoon sergeant establishes priority for crew-served weapons maintenance.

(3) Guns must be set in first and range cards completed.

(4) Maintenance is performed on one machinegun at a time. Security is increased while maintenance is being performed.

(5) Leaders specify partial or detailed breakdown of weapons.

(g) Hygiene—should be performed daily.

(h) Rest—must have a high priority on all operations.

(1) Rotation plan by positions.

(2) Platoon sergeant must ensure platoon leader rests.

(3) Must relieve OP personnel.

(4) RATELO'S must have a scheduled rest.

(i) Stand-to procedures.

(1) Morning—30 minutes prior to and after BMNT, packed up, 100% alert.

(2) Night—30 minutes prior to and after EENT, equipment required for night, easy to locate, rest packed up.

(j) Sector sketch and withdrawal plan.

(1) Sector sketch—squad to higher.

Squad leaders send plan to platoon leader. Platoon leader draws platoon sector sketch (see figure 5-19).

(2) Integrate the fire plan and withdrawal plan to ensure suppression of enemy if patrol base is discovered.

(a) Designated/established from higher to

lower.

(b) Alternate patrol base indicated to all

personnel.

(c) Contingency plan in case alternate patrol base is unusable.

(d) Rally point.

(e) Sterilize area. Police and take trash with

you.

(3) Unless an enemy force is much larger than the platoon, it is better to fight and destroy the enemy than it is to leave in a disorganized manner. Upon termination of contact, withdraw to an alternate position immediately.

(4) Establish priorities. Centralized (all do one task), or decentralized (each man for himself). Team leaders/squad leaders supervise.

(5) Redistribute ammo and supplies as needed. (Platoon sergeant controls distribution).

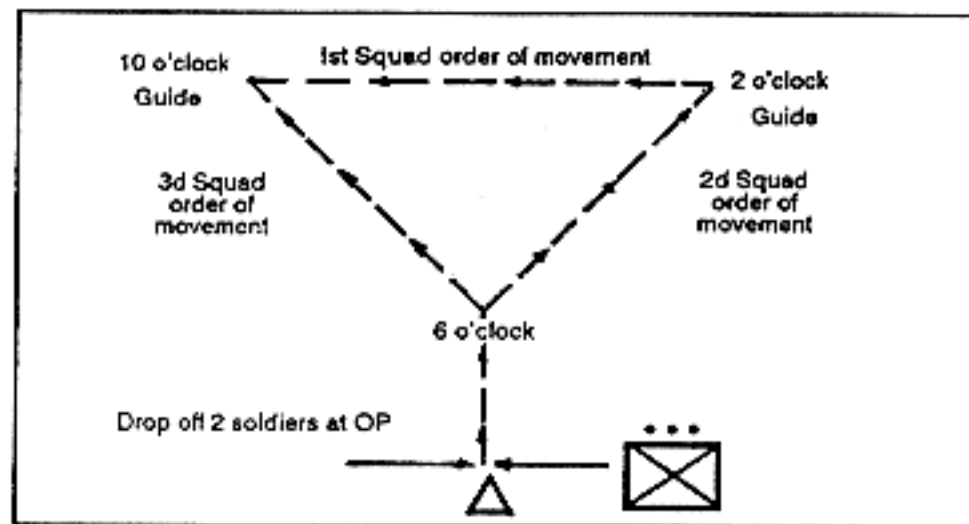

Figure 5-18. Triangular Patrol Base.

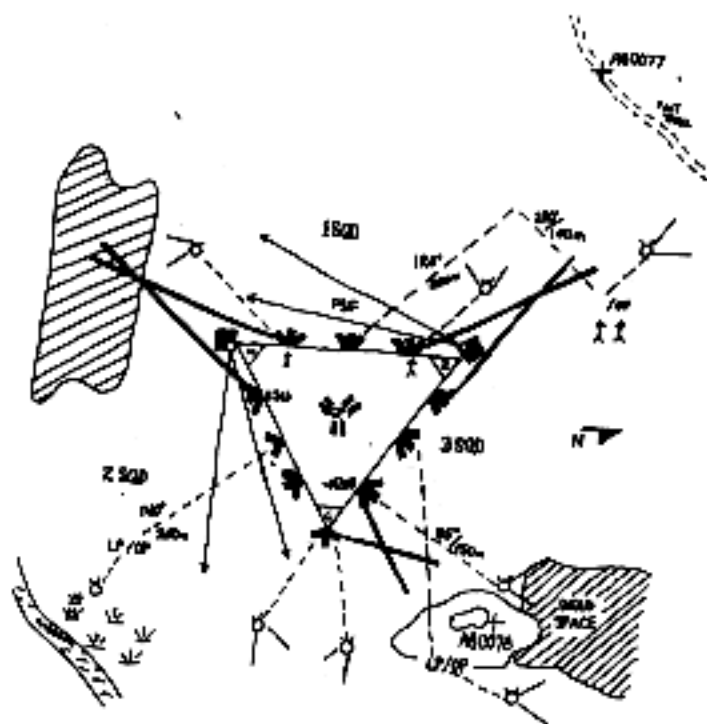

Figure 5-19. Platoon Sector Sketch.

5-10. MOVEMENT TO CONTACT.

a. Purpose/General: The movement to contact (MTC) is one of the five types of offensive operations. A movement to contact gains or regains contact with the enemy. When the enemy situation is unknown—once contact is made, the unit develops the situation by learning the enemy's strengths and weaknesses. Normally a platoon conducts a movement to contact as part of a larger force (i.e., company, battalion, etc). There are two methods of conducting a movement to contact: Approach march and search and attack.

(1) Search and Attack. This technique is utilized when the enemy is dispersed, is expected to avoid contact, disengage or withdraw, or you have to deny his movement in an area. The search and attack method is conducted by using multiple coordinated patrols to make contact. Once contact is made, the company attacks.

(2) Approach March. A platoon uses the approach march method as part of a larger unit. It can be tasked as the advance guard, move as part of the main body, or provide flank or rear security for the company or battalion. They may also receive on-order missions as part of the main body.

b. Standards:

Task Standards:

- (1) The unit departs on time.
- (2) Enemy contact is gained and maintained.
- (3) Contact is made with smallest element (fire team).
- (4) Reports of enemy location are forwarded.
- (5) If not detected by the enemy, the platoon leader initiates a hasty attack.
- (6) 30% of enemy is killed (subjective unless MILES is used), captured, or driven off. Momentum is maintained.

(7) The platoon sustains 10% or less friendly casualties (subjective unless MILES is used).

(8) The platoon sustains no casualties from friendly fire (subjective unless MILES is used).

(9) The platoon is prepared to continue movement within 25 minutes of contact.

(10) All personnel and equipment are accounted for.

(11) 100% PIR gathered is reported to higher headquarters.

c. Fundamentals:

(1) Make enemy contact with smallest element possible (i.e. R&S team).

(2) Rapidly develops combat power upon enemy contact.

(3) Provides all-round security for the unit.

(4) Supports higher unit's concept.

(5) Reports all information rapidly and accurately and strives to gain and maintain contact with the enemy.

(6) Requires decentralized execution.

(7) The following issues should be considered for MTC operations:

(a) Factors of METT-T.

(b) Soldiers Load.

d. Techniques: Both the search and attack - and approach march methods will be used during the Ranger course. Determination of which method to be utilized will be based on the unit's movement using the traveling, traveling overwatch or bounding overwatch techniques.

CHAPTER SIX

BATTLE DRILLS

Infantry battle drills describe how platoons and squads apply fire and maneuver to commonly encountered situations. They require leaders to make decisions rapidly and to issue brief oral orders quickly.

6-1. DEFINITION

FM 25-101 defines a battle drill as "a collective action rapidly executed without applying a deliberate decision-making process."

a. Characteristics of a battle drill are--

- They require minimal leader orders to accomplish and are standard throughout the Army.
- Sequential actions are vital to success in combat or critical to preserving life.
- They apply to platoon or smaller units.
- They are trained responses to enemy actions or leader's orders.
- They represent mental steps followed for offensive and defensive actions in training and combat.

b. A unit's ability to accomplish its mission often depends on soldiers, leaders, and units executing key actions quickly. All soldiers and their leaders must know

their immediate reaction to enemy contact as well as follow-up actions. Drills are limited to situations requiring instantaneous response; therefore, soldiers must execute drills instinctively. This results from continual practice. Drills provide small units with standard procedures essential for building strength and aggressiveness.

- They identify key actions that leaders and soldiers must perform quickly.
- They provide for a smooth transition from one activity to another; for example, movement from offensive action to defensive action.
- They provide standardized actions that link soldier and collective tasks at platoon level and and below. (Soldiers perform individual tasks to CTT or SDT standard.)
- They require the full understanding of each individual and leader, and continual practice is also required.

6-2. FORMAT

The format for drills discussed in this chapter includes the title, the SITUATION that would cue the unit or the leader into initiating the drill, the REQUIRED ACTIONS in sequence, and supporting illustrations. Where applicable drills are cross-referenced with material in other chapters, other drills, or both. Training standards for battle drills are in the mission training plan (MTP).

BATTLE DRILL 1. PLATOON ATTACK

SITUATION: The platoon is moving as part of a larger force conducting a movement to contact or a hasty or deliberate attack.

REQUIRED ACTIONS: (Figure 6-1.)

STEP 1. Action on Enemy Contact.

a. The platoon initiates contact. The platoon leader plans when and how his base-of-fire element initiates contact with the enemy to establish a base of fire. This element must be in position and briefed before it initiates contact. If the platoon has not been detected, STEPs 1 and 2 consist of positioning the support element and identifying the enemy's positions.

b. The enemy initiates contact. If the enemy initiates contact, the platoon takes the following actions:

(1) The squad in contact reacts to contact (Battle Drill 2). It attempts to achieve suppressive fires with one fire team and maneuvers the other team to attack the enemy in the flank.

(2) The platoon leader, his RATELO, the platoon FO, the squad leader of the next squad, and one machine gun team move forward to link up with the squad leader of the squad in contact.

(3) The squad leader of the trail squad moves to the front of his lead fire team.

(4) The platoon sergeant moves forward with the second machine gun team and links up with the platoon leader. He assumes control of the base-of-fire element and

positions the machine guns to add suppressive fires against the enemy.

(5) The platoon leader assesses the situation. He follows the success of the squad's flank attack by leading the trail squads along the covered and concealed route taken by the assaulting fire team of the squad in contact.

(6) If the squad in contact cannot achieve suppressive fire, the squad leader reports to the platoon leader.

(a) The squad in contact establishes a base of fire. The squad leader deploys his squad to provide effective, sustained fires on the enemy position. The squad leader reports his final position to the platoon leader.

(b) The remaining squads (not in contact) take up covered and concealed positions in place and observe to the flanks and rear of the platoon.

(c) The platoon leader moves forward with his RATELD, the platoon FO, the squad leader of the nearest squad, and one machine gun team.

STEP 2. Locate the Enemy.

a. The squad leader of the squad in contact reports the enemy size and location, and any other information to the platoon leader. The platoon leader completes the squad leader's assessment of the situation.

b. The squad continues to engage the enemy's position.

c. The platoon sergeant moves forward with the second machine gun team and links up with the platoon leader.

STEP 3. Suppress the Enemy.

a. The platoon leader determines if the squad in contact can gain suppressive fire against the enemy based on the VOLUME and ACCURACY of the enemy's return fire.

(1) If the answer is YES, he directs the squad (with one or both machine guns) to continue suppressing the enemy:

(a) The squad in contact destroys or suppresses enemy weapons that are firing most effectively against it; normally crew served weapons.

(b) The squad in contact places screening smoke (M203) to prevent the enemy from seeing the maneuver element.

(c) The platoon FO calls for and adjusts fires based on the platoon leader's directions. (The platoon leader does not wait for indirect fires before continuing with his actions.)

(2) If the answer is still NO, the platoon leader deploys the last squad to provide flank and rear security and to guide the rest of the company forward as necessary, and reports the situation to the company commander. Normally the platoon will become the base-of-fire element for the company and may deploy the last squad to add suppressive fires. The platoon continues to suppress or fix the enemy with direct and indirect fire, and responds to orders from the company commander.

STEP 4. Attack.

If the squad(s) in contact together with the machine gun(s) can suppress the enemy, the platoon leader determines if the remaining squad(s) not in contact can maneuver. He makes the following assessment:

- Location of enemy positions and obstacles.
- Size of enemy forces engaging the squad. (The number of enemy automatic weapons, the presence of any vehicles, and the employment of indirect fires are indicators of enemy strength.)
- Vulnerable flank.
- Covered and concealed flanking route to the enemy position.

a. If the answer is YES, the platoon leader maneuvers the squad(s) into the assault:

(1) Once the platoon leader has ensured that the base-of-fire element is in position and providing suppressive fires, he leads the assaulting squad(s) to the assault position.

(2) Once in position, the platoon leader gives the prearranged signal for the base-of-fire element to lift or shift direct fires to the opposite flank of the enemy position. (The assault element MUST pick up and maintain effective fires throughout the assault. Handover of responsibility for direct fires from the base-of-fire element to the assault element is critical.)

(3) The platoon FO shifts indirect fires to isolate the enemy position.

(4) The assaulting squad(s) fight through enemy positions using fire and maneuver. The platoon leader

controls the movement of his squads. He assigns specific objectives for each squad and designates the main effort or base maneuver element. (The base-of-fire element must be able to identify the near flank of the assaulting squad(s).)

(5) In the assault, the squad leader determines the way in which he will move the elements of his squad based on the volume and accuracy of enemy fire against his squad and the amount of cover afforded by the terrain. (Figure 6-1) In all cases, each soldier uses individual movement techniques as appropriate.

(a) The squad leader designates one fire team to support the movement of the other team by fires.

(b) The squad leader designates a distance or direction for the team to move. He accompanies one of the fire teams.

(c) Soldiers must maintain contact with team members and leaders.

(d) Soldiers time their firing and reloading in order to sustain their rate of fire.

(e) The moving fire team proceeds to the next covered position. Teams use the wedge formation when assaulting. Soldiers move in rushes or by crawling.

(f) The squad leader directs the next team to move.

(g) If necessary, the team leader directs soldiers to bound forward as individuals within buddy teams. Soldiers coordinate their movement and fires with each other within the buddy team. They maintain contact with their team leader.

(h) Soldiers fire from covered positions. They select the next covered position before moving. They either rush forward (no more than 5 seconds), or use high or low crawl techniques based on terrain and enemy fires.

b. If the answer is NO, or the assaulting squad(s) cannot continue to move, the platoon leader deploys the squad(s) to suppress the enemy and reports to the company commander. The platoon continues suppressing enemy positions and responds to the orders of the company commander.

STEP 5. Consolidate and Reorganize.

a. Consolidate. Once the assaulting squad(s) has seized the enemy position, the platoon leader establishes local security. (The platoon must prepare to defeat an enemy counterattack. The platoon is most vulnerable at the conclusion of the assault.)

(1) The platoon leader signals for the base-of-fire element to move up into designated positions.

(2) The platoon leader assigns sectors of fire for each squad.

(3) The platoon leader positions key weapons to cover the most dangerous avenue(s) of approach.

(4) The platoon sergeant begins coordination for ammunition resupply.

(5) Soldiers take up hasty defensive positions.

(6) The platoon leader and his FO develop a quick fire plan.

(7) The squads place out OPs to warn of enemy counterattacks.

b. Reorganize.

(1) The platoon performs the following tasks (only after it completes the consolidation of the objective):

- (a) Reestablish the chain of command.
- (b) Redistribute and resupply ammunition.
- (c) Man crew-served weapons first.
- (d) Redistribute critical equipment (radios, NBC, NVDs).
- (e) Treat casualties and evacuate wounded.
- (f) Fill vacancies in key positions.
- (g) Search, silence, segregate, safeguard, and speed EPWs to collection points.
- (h) Collect and report enemy information and materiel.

(2) Squad leaders provide ammunition, casualty, and equipment (ACE) reports to the platoon leader.

(3) The platoon leader consolidates ACE reports and passes them to the company commander (or XO).

(4) The platoon continues the mission after receiving guidance from the company commander. The company follows the success of the platoon's flanking attack.

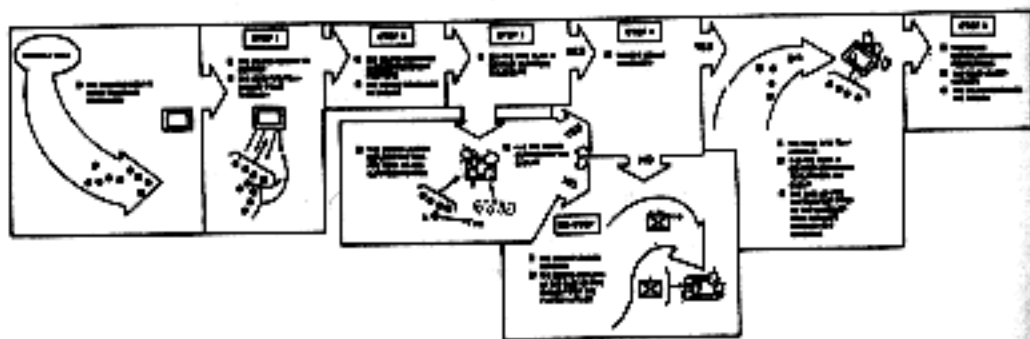

Figure 6-1. Platoon attack.

BATTLE DRILL 1A. SQUAD ATTACK.

SITUATION: The squad is moving as part of the platoon conducting a movement to contact or a hasty or deliberate attack.

REQUIRED ACTIONS:

STEP 1. Action on Enemy Contact.

a. Soldiers receiving fire take up nearest positions that afford protection from enemy fire (cover) and observation (concealment).

b. The fire team in contact immediately returns heavy volume of suppressive fire in the direction of the enemy.

(1) Soldiers in the fire team in contact move to positions (bound or crawl) from which they can fire their weapons, position themselves to ensure that they have observation, fields of fire, cover, and concealment. They continue to fire and report known or suspected enemy positions to the fire team leader.

(2) The team leader directs fires using tracers or standard fire commands.

(3) The fire team not in contact takes covered and concealed positions in place and observes to the flanks and rear of the squad.

(4) The squad leader reports contact to the platoon leader and moves toward the fire team in contact.

STEP 2. Locate the Enemy.

a. Using sight and sound, the fire team in contact acquires known or suspected enemy positions.

b. The fire team in contact begins to place well-aimed fire on suspected enemy positions.

c. The squad leader moves to a position where he can observe the enemy and assess the situation.

d. The squad leader requests immediate suppression indirect fires (normally 60-mm mortars) through the platoon leader.

e. The squad leader reports the enemy size and location, and any other information to the platoon leader.

(As the platoon leader comes forward, he completes the squad leader's assessment of the situation.)

STEP 3. Suppress the Enemy.

The squad leader determines if the fire team in contact can gain suppressive fire based on the volume and accuracy of the enemy fire.

a. If the answer is YES, the fire team leader continues to suppress the enemy:

(1) The fire team destroys or suppresses enemy crew-served weapons first.

(2) The fire team places smoke (M203) on the enemy position to obscure it.

(3) The fire team leader continues to control fires using tracers or standard fire commands. Fires must be well-aimed and continue at a sustained rate with no lulls.

(4) Buddy teams fire their weapons so that both are not reloading their weapons at the same time.

b. If the answer is NO, the squad leader then deploys the fire team not in contact to establish a support-by-fire position. He reports the situation to the platoon leader. Normally, the squad will become the base of fire element for the platoon. The squad continues to suppress the enemy and responds to orders from the platoon leader. (The platoon leader, his RATELO, the platoon FO, one machine gun team, and the squad leader of the next squad, as well as the platoon sergeant and the other machine gun team, are already moving forward IAW Battle Drill 1, Platoon Attack.)

STEP 4. Attack.

If the fire team in contact can suppress the enemy, the squad leader determines if the fire team not in contact can maneuver. He makes the following assessment:

- Location of enemy position(s) and obstacles.
- Size of enemy force engaging the squad. (The number of enemy automatic weapons, the presence of any vehicles, and the employment of indirect fires are indicators of enemy strength.)
- Vulnerable flank.
- Covered and concealed flanking routes to the enemy position.

a. If the answer is YES, the squad leader maneuvers the fire team in the assault:

(1) The squad leader directs the fire team in contact to support the movement of the other fire team. He then leads the assaulting fire team along the covered and concealed route to the flank of the enemy position. (The assaulting fire team must pick up and maintain fire superiority throughout the assault. Handover of responsibility for direct fires from the supporting fire team to the assaulting fire team is critical.)

(2) Once in position, the squad leader gives the prearranged signal for the supporting fire team to lift fires or shift fires to the opposite flank of the enemy position.

(3) The assaulting fire team fights through enemy positions using fire and movement. (The supporting fire team must be able to identify the near flank of the assaulting fire team.)

(a) The team leader determines whether to move his fire team by bounding buddy teams or by individual movement techniques. The team maintains the basic wedge formation.

(b) Soldiers move by rushes or crawling. Someone is always firing while some moves. At the end of each move, soldiers take up covered and concealed positions and resume firing.

b. If the answer is NO or the assaulting fire team cannot continue to move, the squad leader deploys the assaulting fire team to add its fires against the enemy, reports to the platoon leader and requests instructions. The squad continues suppressing enemy positions and responds to the orders of the platoon leader.

STEP 5. Consolidate and Reorganize.

a. Once the assaulting fire team has seized the enemy position, the squad leader establishes local security. (The squad leader must quickly prepare to defeat any enemy counterattack. At the conclusion of the assault, the squad is most vulnerable.)

(1) The squad leader signals for the supporting fire team to move up into a designated position.

(2) The squad leader assigns sectors of fire for both fire teams.

(3) The squad leader positions key weapons.

(4) All soldiers take up hasty defensive positions.

(5) The squad leader develops an initial fire support plan against an enemy counterattack. (As the platoon moves up, he hands the plan to the platoon leader for further development.)

(6) The squad leader posts an OP to warn of enemy activity.

b. The squad performs the following tasks:

(1) Reestablish the chain of command.

(2) Redistribute and resupply ammunition.

(3) Man crew-served weapons first.

(4) Redistribute critical equipment (for example, radios, NBC, NVGs).

(5) Treat casualties and evacuate wounded.

(6) Fill vacancies in key positions.

(7) Search, silence, segregate, safeguard, and speed EPWs to collection points.

(8) Collect and report enemy information and material.

c. Team leaders provide ammunition, casualty, and equipment (ACE) reports to the squad leader.

d. The squad leader consolidates the ACE report and passes it to the platoon leader (or platoon sergeant).

e. The squad continues the mission after receiving instructions from the platoon leader. (The platoon follows the success of the squad's flanking attack with the remaining squads as part of the platoon attack.)

f. The squad leader reports the situation to the platoon leader.

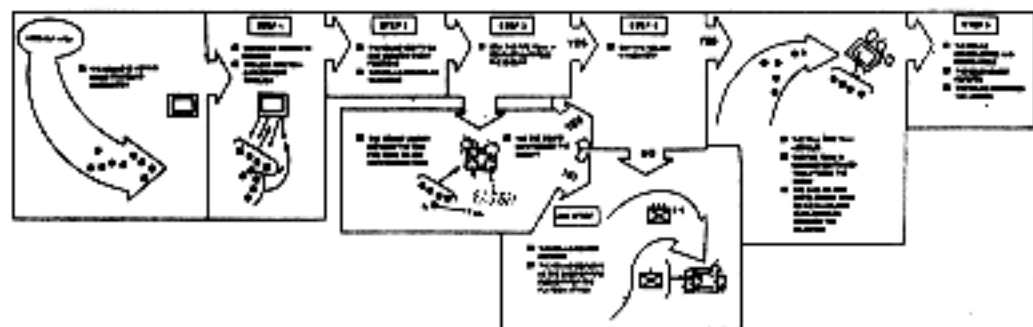

Figure 6-2. Squad attack.

6-2. BATTLE DRILLS. Survivability may well depend upon a unit's ability to react rapidly and aggressively in certain situations that may be encountered during a patrolling mission. Examples of situations that a unit could encounter are outlined below together with an example of a reaction that could be anticipated in advance. These are single courses of action which require a minimum of command and signal to initiate, and could be initiated by any member of the unit. They must, by design, be simple, executed swiftly, and be well rehearsed.



Figure 6-3. React to Contact.

a. React to Contact (Platoon/Squad). The enemy fires on the platoon/squad. The platoon/squad immediately assumes the best available covered and concealed positions and returns fire; locates the enemy and places well-aimed fire on their positions immediately (figure 6-3).

1. Platoon/squad members immediately assume best available covered/positions and simultaneously return fire when an enemy engages the platoon.

2. Platoon/squad member locate actual or suspected enemy positions and engage them with well-aimed fire.

3. Platoon/squad member make contact (visual or oral) with men on left and right.

4. Squad members make frequent visual contact with squad leader and indicate the location of the enemy positions.

5. Leaders (visually or orally) check status of personnel.

6. The squad leaders make frequent visual contacts with the platoon leader.

7. The leader leads his men by example. They follow his direction and do as he does.

8. Relay all commands and signals from the platoon chain of command.

9. The platoon/squad leader makes a quick assessment of the situation (enemy size, location, and so forth). He decides on an appropriate course of action (conduct fire and movement, provide a base of fire, break contact).

b. Break Contact (Platoon/Squad). Squad/platoon is moving and the enemy fires on the unit. Squad/platoon leader orders unit to break contact (figure 6-4).

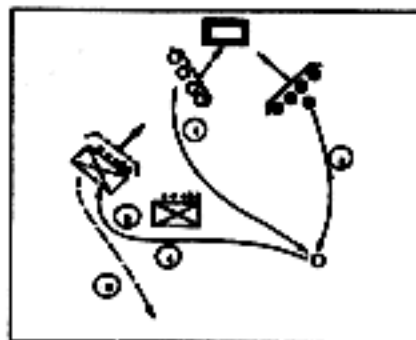
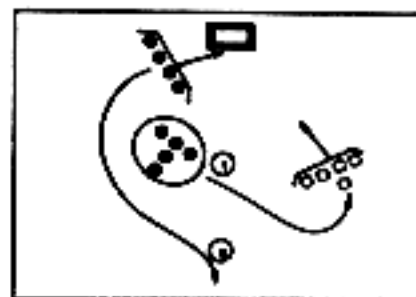

Figure 6-4. Break Contact.

1. The leader gives the order to break contact.
2. The leader designates which element will be the support element, and which element will move to initiate break contact. For a squad, the initial support element will usually be a fire team and the initial movement element will be a fire team. For a platoon, it will be a squad.
3. The squad/platoon leader orders a distance and direction ("nine o'clock," "hilltop") to move.
4. The support element increases the rate of fire to suppress the enemy.

c. React to Ambush (Platoon/Squad). Enemy initiates ambush (Figure 6-5).

1. Near Ambush: Within hand grenade range (35m).

(a) Depending on the terrain, personnel in the kill zone will carry out one of the following two actions:

(1) If cover is not available, without order or signal, immediately assume the prone position, return fire, and throw concussion and smoke grenades.

(2) If cover is available, without order or signal,

immediately seek the nearest covered position, return fire, and throw concussion and smoke grenades.

(b) Immediately after explosion of concussion grenades, personnel in the kill zone return fire and assault the ambush position using fire and movement.

(c) Personnel not in the kill zone identify the enemy location and then place accurate suppressive fire against enemy position. Fire is shifted as the personnel in the kill zone begin to assault.

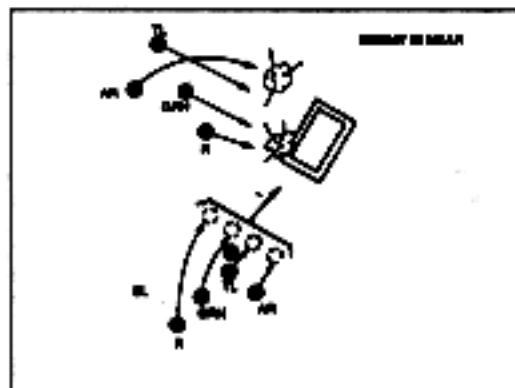

Figure 6-5. React to Near Ambush.

(d) Personnel in the kill zone continue the assault to eliminate the ambush or until contact is broken.

2. Far Ambush: Beyond hand grenade range (figure 6-6).

(a) Personnel in the kill zone, without order or signal, assume the prone position and immediately return fire. They take the best available covered position and continue well-aimed fire at the ambush position. Smoke grenades are used to impair enemy observation of the kill

zone and affect his ability to place aimed fire into the kill zone.

(b) The element not in the kill zone continues the assault until the ambush is eliminated or contact is broken.

(c) Squad/Platoon leader requests indirect fire when the enemy withdraws or the separation between the elements is far enough to avoid friendly casualties. Use smoke to impair enemy observation.

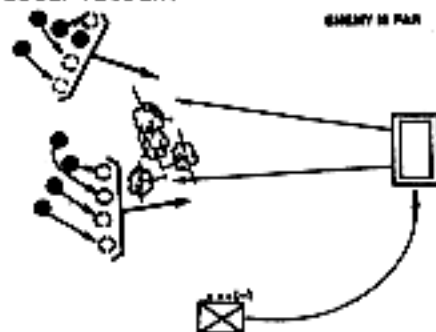

Figure 6-6. Far Ambush.

d. React to Indirect Fire (Platoon/Squad). Any member of the platoon alerts: "Incoming" or a round impacts. Personnel run out of the impact area in the direction and for the distance ordered by the platoon leader/squad leader, and seek protection of overhead cover in the fighting position. The platoon reacts according to the situation they are in at the time.

(1) While Moving:

(a) Any member of the platoon alerts: "Incoming!"

(b) Squad/Platoon members assume prone position immediately.

(c) When indirect fire impacts, the leader gives the direction and distance to move. For example, "three o'clock, two hundred meters."

(d) The platoon runs out of the impact area in the direction and for the distance indicated.

(2) When in Defensive Position.

(a) Any member yells: "Incoming."

(b) Squad/Platoon personnel seek protection under the overhead cover of their fighting positions and don protective masks.

6-3. AIR DEFENSE. To effectively defend against air attack, units must make maximum use of cover, concealment, camouflage, dispersion, and early warning. The best way to avoid an air attack is to be concealed. Units must also be proficient in the use of their weapons in air defense.

Enemy aircraft can attack any ground force whose locations has been discovered. The sighting of a few soldiers or vehicles can lead to the disclosure of a whole unit, even if the rest of the unit is well hidden.

a. Action When Attacked. The alarm must be given as early as possible if troops in the open are to have a chance to take cover. This warning is the responsibility of every man in the area and is passed by whistle, voice, radio, or any other method.

b. Engagement of Hostile Aircraft. Rules for firing at aircraft vary. These are guides:

(1) First, positively identify the aircraft as hostile. If friendly air defense artillery crews fire at it, the unit may also fire. However, commanders may restrict air defense fire if friendly aircraft are in the area.

(2) If aircraft attack the unit, the unit returns fire.

(3) If aircraft are not attacking, the unit withholds fire to avoid disclosing its position.

(4) Small arms may be fired at attacking aircraft during or after its first attack. All unit members fire to saturate the air space through which the plane will fly. They should not try to track the plane but concentrate fire on one area through which the plane must fly.

(a) General. For aircraft flying directly toward the unit, troops aim slightly above the nose (figure 6-7).



Figure 6-7. Engaging aircraft flying directly at the unit.

(b) Jet Aircraft. To engage a jet plane flying a crossing course, all troops aim and fire their weapons two football-field lengths in front of the plane (figure 6-8).



Figure 6-8. Engaging jet flying a crossing course.

(c) Low Performance Aircraft. For helicopters and propeller-driven aircraft, troops aim and fire at a point approximately a football-field length in front of the aircraft (Figure 6-9).



Figure 6-9. Engaging a low performance aircraft flying a crossing course.

c. Fire Control. The leader can control the fire in one of two ways:

- (1) He can order JET, FIRE, and troops able to do so shoot as fast as they can until the plane passes.
- (2) He can select reference points.
 - (a) The leader alerts his troops to get ready.
 - (b) As an aircraft approaches a reference point, he orders, REFERENCE POINT 2, FIRE.
 - (c) All troops point their weapons at the reference point, raise their weapons at a 45-degree angle, and fire (figure 6-10).



Figure 6-10. Firing by reference point.

6-4. KNOCK OUT A BUNKER.

1. **General.** During a movement to contact or attack, rarely will one bunker by itself be encountered; typically bunkers are arranged and prepared as part of a larger defensive system. When a platoon or squad encounters bunkers, enemy crew-served weapons must be destroyed or suppressed first, friendly positions and movement must be obscured by smoke, and suppressive fires must be sustained at the lowest point.

2. The platoon initiates contact:

- a. The squad in contact establishes a base of fire.
- b. The platoon leader, his RATELO, platoon FO, and one machine gun team move forward to link up with the squad leader of the squad in contact.
- c. The platoon sergeant moves forward with the second machine gun team and assumes control of the base-of-fire element.

- d. The base-of-fire element--
 - (1) Destroys or suppresses enemy crew-served weapons first.
 - (2) Obscures the enemy position with smoke (M203).
 - (3) Sustains suppressive fires at the lowest possible level.
 - e. The platoon FO calls for and adjusts indirect fires as directed by the platoon sergeant.
3. The platoon leader determines that he can maneuver by identifying--
- a. The enemy bunkers, other supporting positions, and any obstacles.
 - b. The size of the enemy force engaging the platoon. (The number of enemy automatic weapons, the presence of any vehicles, and the employment of indirect fires are indicators of enemy strength.)
 - c. A vulnerable flank of at least one bunker.
 - d. A covered and concealed flanking route to the flank of the bunker.
4. The platoon leader determines which bunker is to be assaulted first and directs one squad (not in contact) to knock it out.
5. If necessary, the platoon sergeant repositions a squad, fire team, or machine gun team to isolate the bunker as well as to continue suppressive fires.
6. The assaulting squad, with the platoon leader and his RATELO, move along the covered and concealed route and take action to knock out the bunker.
- a. The squad leader moves with the assaulting fire team along the covered and concealed route to the flank of the bunker.
 - (1) The assaulting fire team approaches the bunker from its blind side and does not mask the fires of the base-of-fire element.
 - (2) Soldiers constantly watch for other bunkers or enemy positions in support of it.

b. Upon reaching the last covered and concealed position--

(1) The fire team leader and the automatic rifleman remain in place and add their fires to suppressing the bunker (includes the use of LAW/ATAs).

(2) The squad leader positions himself where he can best control his teams. On the squad leader's signal, the base-of-fire element lifts fires or shifts fires to the opposite side of the bunker from the assaulting fire team's approach.

(3) The grenadier and rifleman continue forward to the blind side of the bunker. One soldier takes up a covered position near the exit. The other soldier cooks off (two seconds maximum) a grenade, shout FRAG OUT, and throws it through an aperture.

(4) After the grenade detonates, the soldier covering the exit enters the bunker, firing short bursts, to destroy the enemy. The soldier who throws the grenade should not be the first one to clear the bunker.

c. The squad leader inspects the bunker to ensure that it has been destroyed. He reports, reorganizes as needed, and continues the mission. The platoon follows the success of the attack against the bunker and continues the attack of other bunkers.

7. The platoon leader repositions base-of-fire squads as necessary to continue to isolate and suppress the remaining bunkers, and maintain suppressive fires.

8. The platoon leader redesignates one of the base-of-fire squads to move up and knock out the next bunker; or, directs the assaulting squad to continue and knock out the next bunker.

NOTE: The platoon leader must consider the condition of his assaulting squad(s) (ammunition and exhaustion) and rotate squads as necessary.

a. On the platoon leader's signal, the base-of-fire element lifts fires or shifts fires to the opposite side of the bunker from which the squad is assaulting.

b. At the same time, the platoon FO shifts indirect fires to isolate enemy positions.

9. The assaulting squad takes action to knock out the next bunker (see paragraph 6, above).

10. The platoon leader reports, reorganizes as necessary, and continues the mission. The company follows up the success of the platoon attack and continues to assault enemy positions.

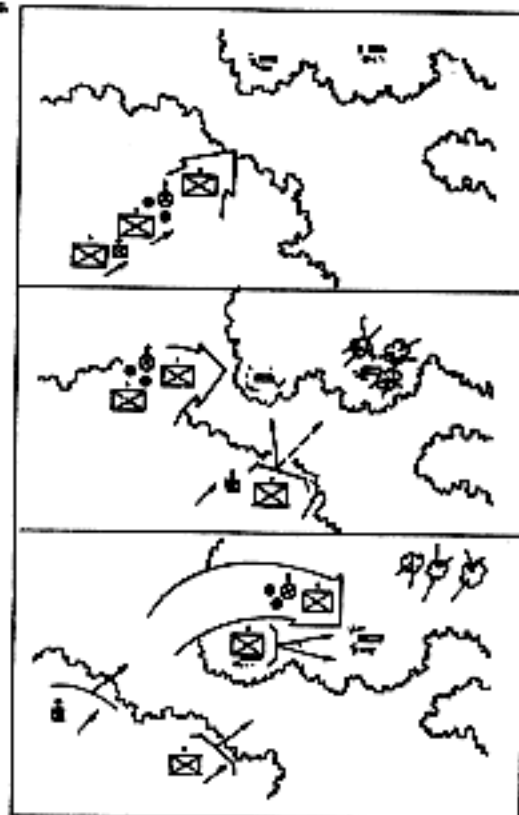

6-5. ENTER BUILDING/CLEAR ROOM.

Situation: Operating as part of a larger force, the squad is moving and identifies an enemy force in a building.

Required Actions: (See figures 6-12 and 6-13)

NOTE: The discussion that follows assumes that the infantry squad is supported only by the platoon's organic weapons. The preferred method of entering a building is to use a tank main gun round, direct fire artillery round, or TDW, Dragon, or Hellfire missile to clear the first room. Additionally, some MOUT situations may require precise application of firepower. This is true of a MOUT environment where the enemy is mixed with noncombatants. The presence of civilians can restrict the use of fires and reduce the combat power available to a platoon leader. His platoon may have to operate with "no fire" areas. Rules of Engagement (ROE) can prohibit the use of certain weapons until a specific hostile action takes place. The use of hand grenades and suppressive fire to enter rooms may be prohibited to preclude noncombatant casualties and collateral damage. All leaders must be aware of the ROE. They must include the precise use of weapons in their planning for MOUT missions. This includes how the platoon will employ its organic weapons including snipers and other weapon systems it may have in support; for example, AC 130 or AH 64 aircraft. They must coordinate the use of marking systems to prevent casualties due to friendly fire. FM 90-10 and FM 90-10-1 provide additional techniques for platoons and squads in MOUT.

1. The fire team initiating contact establishes a base of fire and suppresses the enemy in and around the building.

2. The squad leader determines that he can maneuver by identifying--

- a. The building and any obstacles.
- b. The size of the enemy force engaging the squad.
- c. An entry point. (Assaulting fire teams should enter the building at the highest level possible.)
- d. A covered and concealed route to the entry point.

3. The fire team in contact--

- a. Destroys or suppresses enemy crew-served weapons first.
- b. Obscures the enemy position with smoke (M203).
- c. Sustains suppressive fires.

4. The squad leader directs the fire team in contact to support the entry of the other rifle team into the building.

5. If necessary, the supporting fire team repositions to isolate the building as well as continue suppressive fires. (Normally, the platoon has added its supporting fires against the enemy.)

6. The squad leader designates the entry point of the building. The platoon and squad shift direct fires and continue to suppress the enemy in adjacent positions and to isolate the building. The platoon FO lifts indirect fires or shifts them beyond the building.

7. The squad leader and the assaulting fire team approach the building and position themselves at either side of the entrance. (Soldiers should avoid entering buildings through doors and windows, because they will normally be covered by enemy weapons inside the building.)

8. Allowing cook-off time (two seconds maximum), and shouting FRAG OUT, the lead soldier of the assaulting fire team prepares and throws a grenade into the building.

9. After the explosion, the next soldier enters the building and positions himself to the right (left) of the entrance, up against the wall, engages all identified or likely enemy positions with rapid, short bursts of automatic fire, and scans the room. The rest of the team provides immediate security outside the building.

a. The size and shape of the room may cause the soldier entering the room to move to the left or right. The first soldier in the room decides where the next man should position himself and gives the command NEXT MAN IN, LEFT (or RIGHT). The next man shouts COMING IN, LEFT (RIGHT), enters the building, positions himself to the left of the entrance, up against the wall, and scans the room. Once in position, he shouts NEXT MAN IN (RIGHT OR LEFT).

b. Depending on the enemy's situation, the size of the entry and the training of the squad, two soldiers can enter the room simultaneously after the grenade detonates. The soldier from the right side of the entry enters, fires from left to right, and moves to right with back to the wall. At the same time, the soldier on the left enters from the left, fires from right to left, and moves to the left with his back to the wall. One soldier goes high, the other low, to prevent firing at one another. This method puts more firepower in the room more quickly, but is more difficult and requires more practice. When both soldiers are in position, the senior soldier gives the command NEXT MAN IN (RIGHT or LEFT).

10. The assaulting fire team leader shouts COMING IN (RIGHT or LEFT), enters the building initially moving left or right and against the wall, and positions himself where he can control the actions of his team. He does not block the entrance way. He makes a quick assessment of the size and shape of the room, and begins to clear the room. He determines if the remaining man in his team is required to assist in clearing the room.

a. If the team leader decides to bring the last man in, he shouts NEXT MAN IN LEFT (or RIGHT). The last man in the fire team shouts COMING IN LEFT (or RIGHT), enters the building, and begins to clear through the room.

b. If the team leader decides not to bring the last man in, he shouts NEXT MAN, STAND FAST. The last man remains outside the building and provides security from there. The team leader then directs the soldier on the right of the entrance to begin clearing. The team leader reports to the squad leader and then assumes the duties of the soldier on the right of the entrance to provide support.

11. Once the room is cleared, the team leader signals to the squad leader that the room is cleared.

12. The squad leader enters the building and marks the entry point in accordance with the unit SOP. The squad leader determines whether or not his squad can continue to clear rooms and still maintain suppressive fires outside the building. Normally, it takes a platoon to clear a building.

13. The squad leader and assault fire team move to the entrance of the next room to be cleared and position themselves on either side of the entrance. The squad enters and clears all subsequent rooms by repeating the actions discussed in paragraphs 8 through 12, above.

14. The squad leader directs the team to continue and clear the next room. The squad leader rotates fire teams as necessary to keep the soldiers fresh, to equitably distribute the dangerous duties, and to continue the momentum of the attack.

15. The squad leader follows the fire team that is clearing to ensure that cleared rooms are properly marked in accordance with the unit SOP.

16. The squad leader assesses the situation to determine if he can continue clearing the building. He reports the situation to the platoon leader. The platoon follows the success of the entry into the building.

17. The squad consolidates its position in the building and then reorganizes as necessary. Leaders redistribute ammunition.

NOTE: Normally the squad/platoons will suppress enemy in buildings with large caliber weapons (particularly if HMMWVs with caliber .50, BFs, or tanks are available).

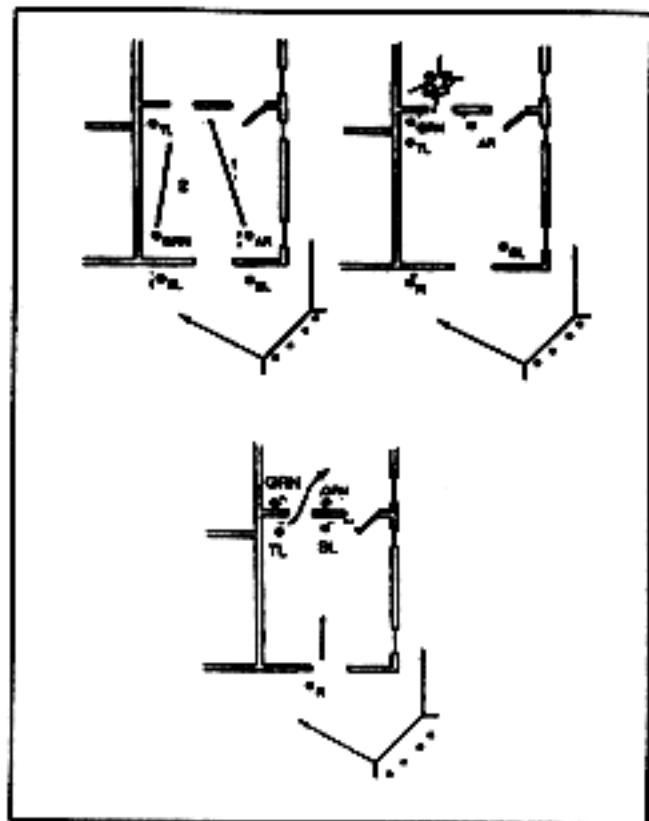

Figure 6-12. Enter a building (Squad).

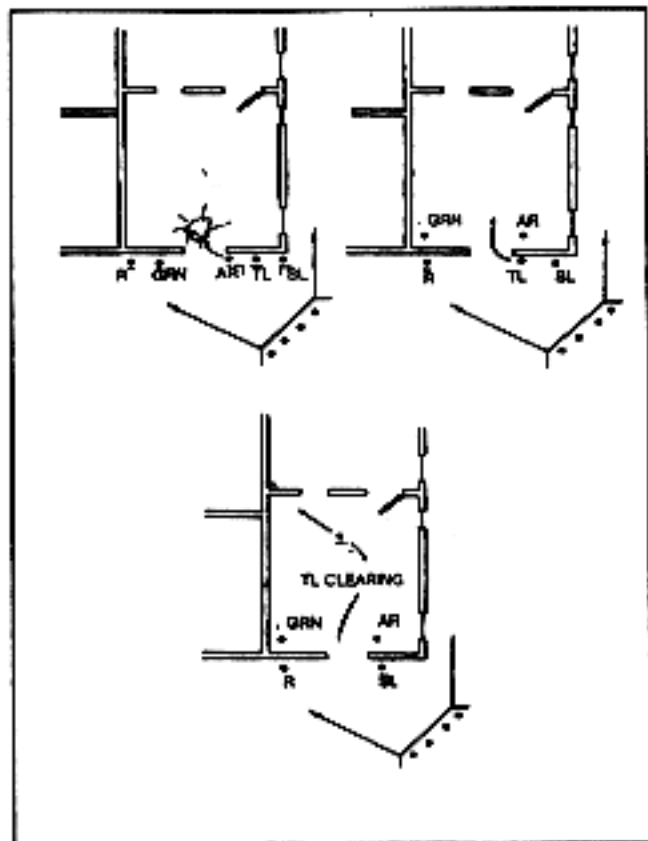

Figure 6-13. Clear a building (squad).

6-6. ENTER/CLEAR A TRENCHLINE.

1. Situation: The platoon is attacking as part of a larger force and identifies enemy in a trench line. The platoon deploys and establishes a base of fire. The platoon leader determines that he has sufficient combat power to maneuver and assault the trench line.

2. Required Actions: (See figures 6-14 and 6-15).

- a. The platoon leader directs one squad to enter the trench and secure a foothold.
- b. The platoon leader designates the entry point of the trench line and the direction of movement once the platoon begins clearing.
- c. The platoon sergeant positions soldiers and machine guns to suppress the trench and isolate the entry point.
- d. The assaulting squad executes actions to enter the trench and establish a foothold. The squad leader directs one fire team to assault and one fire team to support by fire initially, then follow and support the assaulting fire team. He designates the entry point of the trench line.

(1) The squad leader and the assault fire team move to the last covered and concealed position short of the entry point.

- (a) The squad leader marks the entry point.
- (b) The base-of-fire element shifts direct fire away from the entry point and continues to suppress adjacent enemy positions or isolate the trench as required.
- (c) The assault fire team leader and the automatic rifleman remain in a position short of the trench to add suppressive fires for the initial entry.

(d) The two remaining soldiers of the assault fire team (rifleman and grenadier) continue toward the entry point. They move in rushes or by crawling.

(e) The squad leader positions himself where he can best control his teams.

(2) The first two soldiers (rifleman and grenadier) of the assault fire team move to the edge of the trench, parallel to the trench and on their backs; on the squad leader's command, cook-off grenades (two seconds maximum), shout FRAG OUT, and throw the grenades into the trench.

(a) After ensuring that both grenades detonate, the soldiers roll into the trench, landing on their feet, and back-to-back. They fire their weapons down the trench in opposite directions. Immediately, both soldiers move in opposite directions down the trench, continuing to fire three-round bursts. Each soldier continues until he reaches the first corner or intersection. Both soldiers halt and take up positions to block any enemy movement toward the entry point.

(b) Upon detonation of the grenades, the assault fire team leader and the automatic rifleman immediately move to the entry point and enter the trench. The squad leader directs them to one of the secured corners or intersections to relieve the rifleman or grenadier who then rejoins his buddy team at the opposite end of the foothold.

(3) The squad leader remains at the entry point and marks it.

(4) The squad leader reports to the platoon leader that he has entered the trench and secured a foothold. The platoon follows the success of the seizure of the foothold with the remainder of the platoon as part of the platoon actions to clear a trench line.

(5) The squad reorganizes as necessary. Leaders redistribute ammunition.

e. The platoon leader directs one of the base-of-fire element squads to move into the trench and begin clearing it in the direction of movement from the foothold.

f. The base-of-fire element repositions as necessary to continue suppressive fires.

g. The platoon leader moves into the trench with the assaulting squad.

h. The assaulting squad passes the squad that has secured the foothold and executes actions to take the lead and clear the trench.

(1) The squad leader designates a lead fire team and a trail fire team.

(2) The lead fire team and the squad leader move to the forward-most secure corner or intersection. The squad leader tells the team securing that corner or intersection that his squad is ready to continue clearing the trench. The trail fire team follows maintaining visual contact with the last soldier of the lead team.

NOTE: Throughout this technique, the team leader positions himself at the rear of the fire team to have direct control (physically, if necessary) of his soldiers. Other soldiers in the fire team rotate the lead. Soldiers rotate the lead to change magazines and prepare grenades. Rotating the lead provides constant suppressive fires down the trench and maintains the momentum of the attack as the squad clears the trench.

(3) The lead fire team passes the element securing the foothold.

(a) The lead soldier of the fire team moves abreast of the soldier securing the corner or intersection, taps him, and announces TAKING THE LEAD.

(b) The soldier securing the corner or intersection acknowledges that he is handing over the lead by shouting OKAY. He allows the fire team to pass him.

(4) The lead fire team starts clearing in the direction of movement. They arrive at a corner or intersection.

(a) Allowing for cook-off (two seconds maximum) and shouting FRAB DUT, the second soldier prepares and throws a grenade around the corner.

(b) Upon detonation of the grenade, the lead soldier moves around the corner firing three round bursts and advancing as he fires. The entire fire team follows him to the next corner or intersection.

(5) The squad leader--

(a) Follows immediately behind the lead team.

(b) Ensures that the trailing fire team moves up and is ready to pass the lead at his direction.

(c) Rotates fire teams as necessary to keep his soldiers fresh and to maintain the momentum of the attack.

(d) Requests indirect fires, if necessary, through the platoon leader.

i. At each corner or intersection, the lead fire team performs the same actions described above (paragraph d).

j. If the lead soldier finds that he is nearly out of ammunition before reaching a corner or intersection, he announces AMPD.

(1) Immediately, the lead soldier stops and moves against one side of the trench, ready to let the rest of the team pass. He continues to aim his weapon down the trench in the direction of movement.

(2) The next soldier ensures that he has a full magazine, moves up abreast of the lead soldier, taps him and announces TAKING THE LEAD.

(3) The lead soldier acknowledges that he is handing over the lead by shouting OKAY, positions rotate, and the squad continues forward.

k. The trailing fire team secures intersections and marks the route within the trench as the squad moves forward. The trailing fire team leader ensures that follow-on squads relieve his buddy teams to maintain security.

l. The squad leader reports the progress of the clearing operation. (The base-of-fire element must be able to identify the location of the lead fire team in the trench at all times.)

9. The platoon leader rotates squads to keep soldiers fresh and to maintain the momentum of the assault.

10. The platoon sergeant calls forward ammunition resupply and organizes teams to move it forward into the trench.

11. The base-of-fire element ensures that all friendly forces move into the trench ONLY through the designated entry point. (All movement must be made in the trench to avoid fratricide.)

12. The platoon leader reports to the company commander that the trench line is secured, or that he is no longer able to continue clearing.

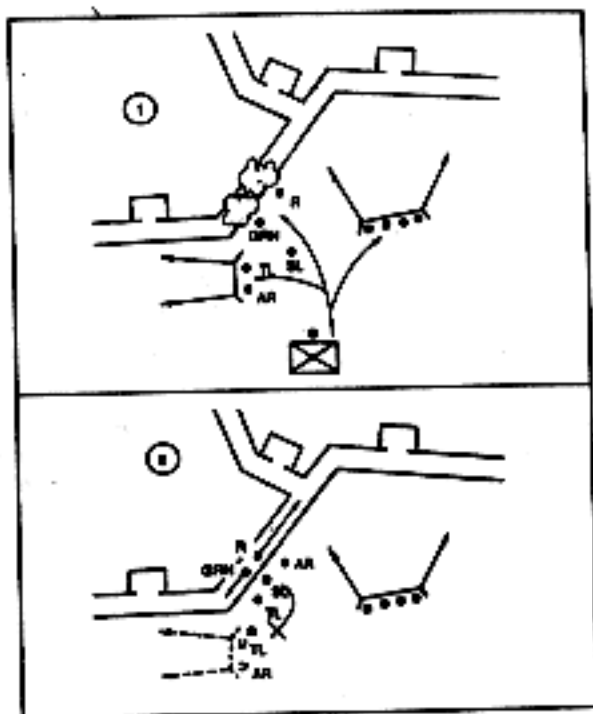

Figure 6-14. Enter a trench (squad).

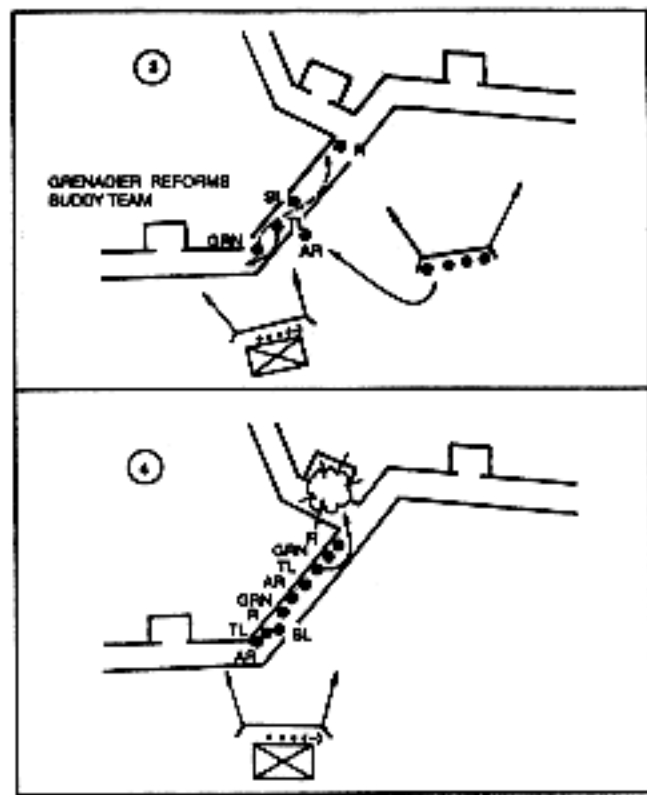

Figure 6-14. Clear a trench line (squad) (continued)

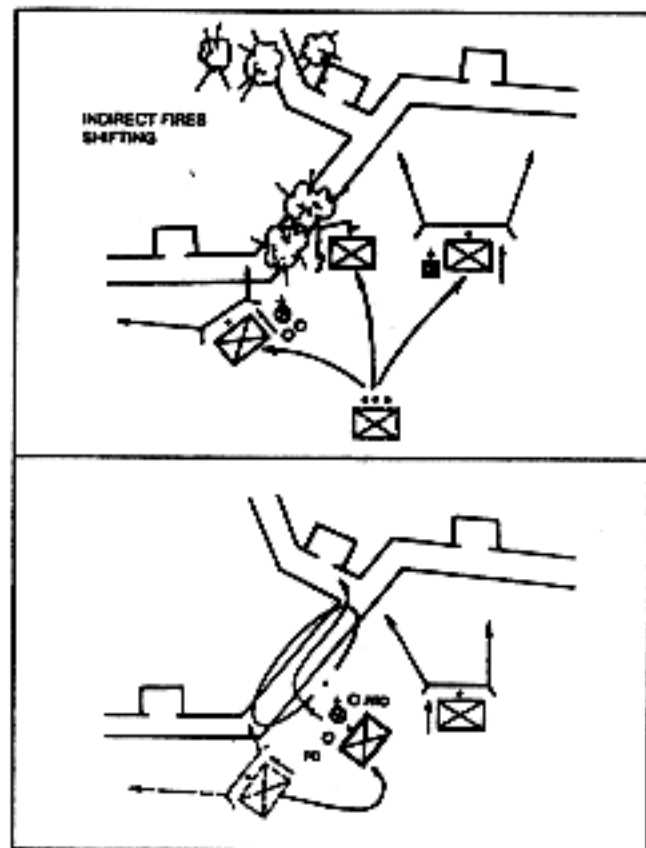

Figure 6-15. Clear a trenchline (platoon).

6-7. CONDUCT INITIAL BREACH OF A MINED WIRE OBSTACLE.

Situation: The platoon is operating as part of a larger force. The lead squad identifies a wire obstacle, reinforced with mines, that cannot be bypassed and enemy positions on the far side of the obstacle.

Required Actions: (Figures 6-16 and 6-17).

a. The platoon leader, his RATELO, platoon FO, and one machine gun team move forward to link up with the squad leader of the lead squad.

b. The platoon leader determines that he can maneuver by identifying--

(1) The obstacle and enemy positions covering it by fire.

(2) The size of the enemy force engaging the squad. (The number of enemy automatic weapons, the presence of any vehicles, and the employment of indirect fires are indicators of enemy strength.)

(3) A breach point.

(4) A covered and concealed route to the breach point.

(5) A support-by-fire position large enough for a squad reinforced with machine guns.

c. The platoon leader directs one squad to support the movement of another squad(s) to the breach point. He indicates the support-by-fire position, the route to it, the enemy position to be suppressed, the breach point, and the route that the rest of the platoon will take to it. He also gives instructions for lifting and shifting fires.

d. The platoon leader designates one squad as the breach squad, and the remaining squad, as the assault squad once the breach has been made. (The assault squad may add its fires to the base-of-fire element. Normally, it follows the covered and concealed route of the breach squad and assaults through immediately after the breach is made.)

e. The designated squad moves to and establishes a base of fire.

f. The platoon sergeant moves forward to the base-of-fire element with the second machine gun team and assumes control of the element.

g. On the platoon leader's signal, the base-of-fire element--

- (1) Destroys or suppresses enemy crew-served weapons, first.
- (2) Obscures the enemy position with smoke (M203).
- (3) Sustains suppressive fires at the lowest possible level.

h. The platoon leader designates the breach point and leads the breach and assault squads along the covered and concealed route to it.

i. The platoon FD calls for and adjusts indirect fires as directed by the platoon leader.

j. The breach squad executes actions to breach the obstacle.

(1) The squad leader directs one fire team to support the movement of the other fire team to the breach point.

(2) The squad leader identifies the breach point.

(3) The base-of-fire element continues to provide suppressive fires and isolates the breach point.

(4) The breaching fire team, with the squad leader, move to the breach point using the covered and concealed route.

(a) The squad leader and breaching fire team leader employ smoke grenades to obscure the breach point. The platoon base-of-fire element shifts direct fires away from the breach point and continue to suppress key enemy positions. The platoon FD lifts indirect fires or shifts them beyond the obstacle.

(b) The breaching fire team leader positions himself and the automatic rifleman on one flank of the breach point to provide close-in security.

(c) The grenadier and rifleman of the breaching fire team probe for mines, and cut the wire obstacle, marking their path as they proceed. (Bangalore is preferred, if available.)

(d) Once the obstacle has been breached, the breaching fire team leader and the automatic rifleman move to the far side of the obstacle and take up covered and concealed positions with the rifleman and grenadier. The team leader signals to the squad leader when they are in position and ready to support.

(5) The squad leader signals the supporting fire team leader to move his fire team up and through the breach. He then moves through the obstacle and joins the breaching fire team, leaving the grenadier and rifleman of the supporting fire team on the near side of the breach to guide the rest of the platoon through.

(6) Using the same covered and concealed route as the breaching fire team, the supporting fire team moves through the breach and takes up covered and concealed positions on the far side.

(7) The squad leader reports to the platoon leader and consolidates as needed.

k. The platoon leader leads the assault squad through the breach in the obstacle and positions them beyond the breach to support the movement of the remainder of the platoon or assaults the enemy position covering the obstacle.

l. The platoon leader reports the situation to the company commander and directs his base-of-fire element to move up and through the obstacle. The platoon leader leaves guide to guide the company through the breach point.

m. The company follows up the success of the platoon as it conducts the breach and continues the assault against the enemy positions.

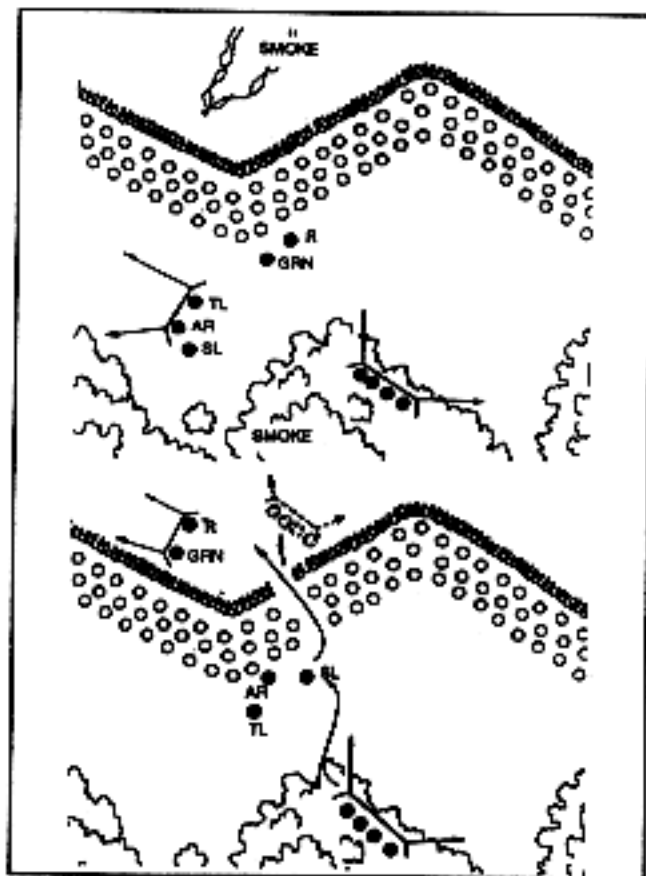

Figure 4-16. Conduct initial breach of a mined wire obstacle (squad).

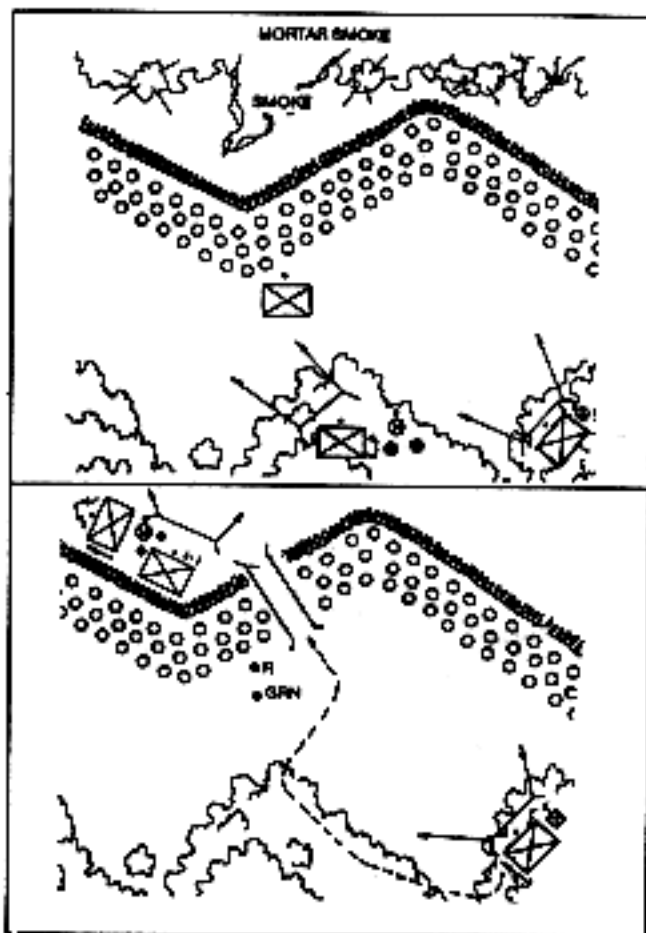

Figure 4-17. Conduct initial breach of a mined wire obstacle (platoon).

CHAPTER SEVEN

COMMUNICATIONS

7-1. The primary means of communications for most units with any type combat patrolling mission will normally be radio. Unit leaders should be aware and know the planning range of their communications equipment as it is essential to maintain communications with higher elements at all times. They also should know how to increase the range of their communications equipment by expedient antennas. It is critical that operators maintain communications security through the proper use of the SOI, using short to the point transmissions and other authorized codes. When using basic component antennas, ensure that the antenna is not grounded and the whip antenna is kept in a vertical position when transmitting. Most antennas transmit/require line of sight for most effective communications, thereby causing leaders to select and move to a more ideal location such as a hilltop, crest or ridge. In some cases, the use of a directional antenna to minimize detection by enemy forces may be necessary. Since radio is the key means of communications the leader must weigh the advantages and disadvantages to determine its use during patrolling operations.

ADVANTAGES

Easy to use
Long range
Very mobile

DISADVANTAGES

Can be jammed
Can be intercepted
Vulnerable to direction
finding equipment

7-2. Communications Security.

a. The disadvantages of radio communications causes security to become an essential element when transmitting. Listed below are some methods to aid in communications security:

(1) Unit members should constantly practice commo security.

- (2) DO NOT transmit if it can be avoided.
- (3) Change frequencies and call signs often as possible (SOI).
- (4) YOU SHOULD use a varied transmission schedule, so the probability of enemy intercept can be reduced.
- (5) Encode all messages or use voice secure equipment.
- (6) Whenever possible, use directional antennas.
- (7) Use SOI spars and brevity codes to reduce transmission time.

b. If the enemy intercepts your transmission, he may try to use jamming techniques. To determine if you are being jammed, disconnect the antenna, if the noise stops and starts again when you reconnect the antenna you are probably being jammed. If the noise continues after the antenna is disconnected internal radio problems exist. Employ the following countermeasures to reduce the effects of jamming.

- (1) If the radio has variable power, use the highest setting.
- (2) Relocate the radio set, terrain may mask the jamming signal.
- (3) Use a directional antenna, this will concentrate your radio signal in the direction of the receiving station.
- (4) Turn the squelch off, this may raise the level of the desired signal.

c. During jamming the operator should continue to operate. This will deny the enemy knowledge of his success. Never acknowledge jamming in the clear. All messages should be authenticated, in case the enemy tries to "use imitative deception" (imitate the voice of friendly operators). The key defense against all electronic warfare efforts by the enemy are like all other defenses:

- (1) DO NOT let the enemy know where you are, DO NOT transmit unless it is mission essential.
- (2) Keep the terrain between you and the enemy, it will help block out radio signals. Once you transmit, MOVE

d. Typical Radio Planning Ranges.

- (1) AN/PRC-68 300 meters short antenna, 1.6 km (1 mile) long antenna.
- (2) AN/PRC-70 FM 25 km (16 miles), AM SSB 25 km (16 miles) with whip antenna; 25 miles with doublet antenna.
- (3) AN/PRC-77 8 km (5 miles)
- (4) AN/PRC-126 1-1.5km short whip/3-5km long whip antenna.

7-3. ANTENNAS.

a. Repair Techniques. When a whip antenna is broken into two sections, the portion of the antenna that is broken off can be connected to the portion attached to the base by joining the two sections as shown in figure 7-1. Use the method in figure 7-1(a) when both parts of the whip are available and usable. Use the method in figure 7-1(b) when the whip portion is so badly broken it cannot be used or it is lost. To restore the antenna to its original length, add a piece of wire that is the same length as the missing whip, then lash the pole support securely to both sections of the antenna.

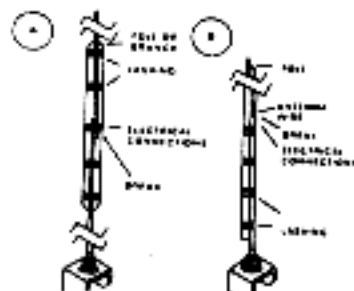

Figure 7-1. Emergency repair of broken whip antenna.

b. Antenna Insulators. If the transmitting element of a field antenna is not properly insulated, it may become shorted to the ground and be ineffective. Many items can be used as field expedient insulators. The best items are plastic or glass which include plastic spoons, buttons, bottle necks, and plastic bags. Wood and rope or both in that order are less effective than plastic or glass, but are still better than no insulator at all. The radiating element—the actual antenna wire—should touch only the antenna terminal and should be physically separated from all other objects, other than the supporting insulator. Figure 7-2 shows various methods of making expedient insulators.

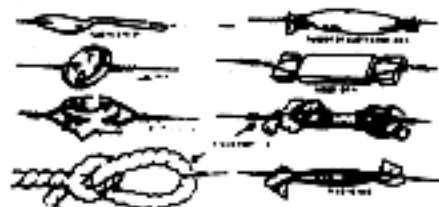

Figure 7-2. Field Expedient Insulators

7-4. Expedient Antennas. Expedient antennas are antennas designed and constructed by the user to increase the range of tactical radio sets. Antennas that are components of tactical radio sets are, for the most part, vertical antennas resulting in the signal being transmitted equally in all directions. Expedient antennas increase the operating range of a given radio setting. Provide increased efficiency through the use of an antenna specifically designed for the operating frequency in use, elevation of the antenna above ground, or by concentrating the signal along a given direction.

7-5. Antenna Length. In order to achieve the most efficient expedient antennas, it is necessary to know the wavelength of the frequency being used. The physical length in feet of an antenna can be determined by using the constant numeral below for the appropriate antenna.

- 234 for a 1/4 wavelength antenna.
- 468 for a 1/2 wavelength antenna.
- 936 for a full wavelength antenna. The length in feet of a 1/4 wavelength antenna can be figured as shown below:

$$\text{LENGTH (feet)} = \frac{234}{\text{Operating frequency (MHZ)}}$$

EXAMPLE: Operating Freq, 50.00 MHZ Antenna 1/4 wave = 234, 50 = 4.68 Antenna length = 4 ft. 8 In.

Computation for 1/2 wavelength and full wavelength is computed the same but use 468 as a constant for the 1/2 wave and 936 for the constant for a full wave antenna. 1/4 wavelength is the minimum size antenna, 1/2 wave or greater provides greater reliability. Five full wavelengths provides the optimum antenna length for any given frequency.

7-6. Examples of Expedient Antennas.

a. Suspended vertical antennas Figure 7-3. Vertical antennas improve radio set performance by virtue of antenna wavelength and height above ground. The most effective height for an antenna is equal to or greater than 1/2 wavelength of the operating frequency in feet. Elevation above this height requires ground plane elements.



Figure 7-3. Expedient Vertical Antenna.

b. Expedient vertical antenna figure 7-3. The field expedient vertical antenna is easily constructed and will increase the range of a FM radio set since it is 1/2 wave antenna instead of the 1/4 wavelength antenna. Determine the antenna length by using the formula in paragraph 7-5 for a 1/2 wave antenna, cut the wire and strip 2 inches of insulation from one end. Attach this end to the long whip base and the other end to an insulator. Hoist the antenna into a tree and ensure it does not touch any branches (figure 7-3). Ground the radio as shown in figure 7-3 and attempt communications.

c. Expedient 292 type antenna (jungle antenna). The expedient 292 type antenna was developed for use in the jungle and if used properly, will increase your ability to communicate. You can fabricate a complete expedient 292 antenna using WD-1 (or similar wire) and other readily available materials. Determine the 1/4 wavelength of your operating frequency and cut 4 elements (1 radiating and 3 ground planes) as in figure 7-4(a). Cut 3 spacing sticks figure 7-4(b) the same length. Place the ends of the sticks together to form a triangle and tie the ends with wire, tape or rope. Attach an insulator to each corner. Attach a ground plane wire to each insulator. Bring the other ends of the ground plane wires together, attach them to an insulator figure 7-4(c), and tie securely. Strip about 3 inches of insulation from each wire and twist them together. Tie one end of the radiating element to the other side of insulator C, and the other end to another insulator figure 7-4(d). Cut enough WD-1 wire to reach from the proposed location of the antenna to the radio set. Attach the radiating element to one of these wires and then to the long whip attached to the radio. Attach the other to the ground plane wires and to the radio set case (ground). Hoist the antenna to the desired height and attempt communications.

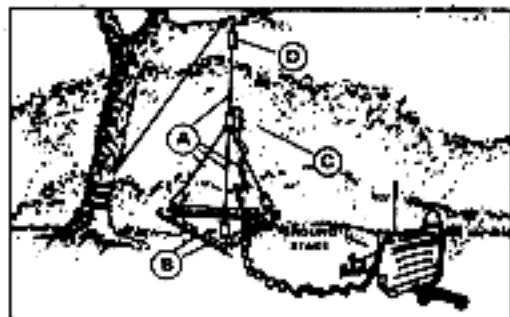

Figure 7-4. Expedient 292-type antenna

d. Expedient Directional Antennas. The vertical half-rhombic figure 7-5, and the long wire antenna figure 7-6, are two expedient directional antennas. These antennas consist of a single wire, preferably, 2 or more wavelengths long, supported at a height of 3 to 7 meters (10 to 20) feet above ground. The antennas will, however, operate well as low as 1 meter above ground. The far end of the antenna is connected to a resistor of 500 to 600 ohms. Your commo sergeant can assist you in getting a resistor or you can fabricate one as in figure 7-7. A good ground, such as a number of tent stakes driven directly under the antenna or a counterpoise should be used to ensure that the earth does not absorb most of the radio's output. The radiation pattern is directional towards the end with the resistor.

e. Vertical Half-Rhombic Antenna. To fabricate a vertical half-rhombic antenna, determine the antenna length, 1 (one) to 5 (five) FULL wavelengths of your operating frequency. Attach a small piece of wire or tie down to a stake and then to insulator. Attach one end of the antenna wire to the other side of the insulator and run the antenna wire thru insulator, attach the other end of the antenna wire to the resistor, then attach the antenna wire to insulator and terminate the wire at the stake at the far end of the antenna. Another piece of wire (the counterpoise) is connected below the insulators A and D to reflect the radio signal. Attach the antenna wire to the long whip base of the radio set and attach the counterpoise to the radio set case (ground). Turn on the radio set and attempt communications.

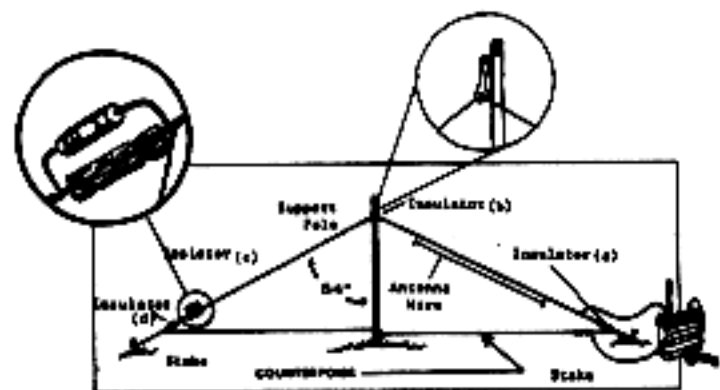

Figure 7-5. Vertical half-rhombic antenna.

f. Expedient Long Wire Antenna. The expedient long wire antenna is a directional antenna that can be easily fabricated out of readily available materials. A 500 to 700 ohm resistor should be used at the far end of the antenna, this can be acquired from your commo sergeant or made as in figure 7-7. To construct this antenna, cut the antenna wire (WD-1) to a minimum of 2 and up to 5 full wavelengths of your operating frequency. Attach one end of the wire to the long whip base of the radio set then run it thru the insulator as shown in figure 7-6(a); run the wire thru the second insulator 7-6(b) down to the resistor 7-6(c) and terminate the antenna wire at the ground stake. Attach another wire to the opposite end of the resistor and run this wire back to the radio set and attach it to the radio set case (ground). Direction of transmission will be towards the end of the antenna with the resistor. Turn on radio and attempt communications.

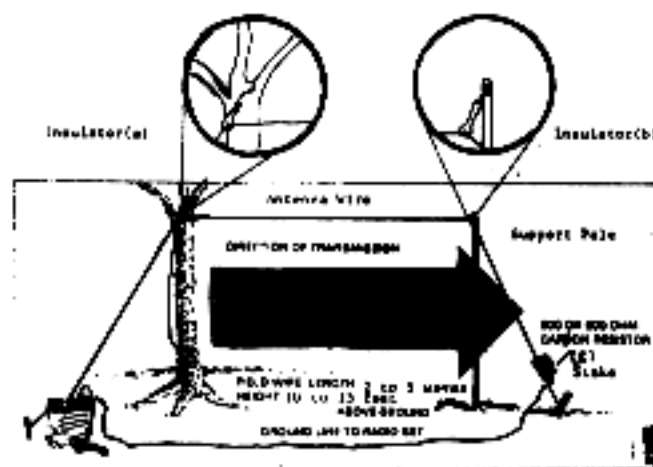

Figure 7-6. Long-wire antenna

7-7. Field Expedient Resistors. Resistors are used in the construction of some antennas to make the antenna uni-directional (directional one-way). In many cases, it may be difficult to get a manufactured resistor. Listed below are some easy ways to fabricate a field expedient resistor:

a. An old cylindrical type ear-plug case makes the simplest and most adequate resistor. To make a resistor, cut the chain on the earplug case close to the center. Open the case and fill it with water from your canteen, pour 1 to 2 packets of salt from your MRE accessory pouch into the water and reseal the container. Attach one end of the antenna wire to one side of the earplug case figure 7-7, attach the other side of your antenna wire to the opposite side of the earplug case and complete the circuit as in the instructions for the specific antenna.

b. Another field expedient resistor can be made from the carbon core of the BA-30 battery. Cut the battery open and remove the core and use only the carbon core. Attach this resistor to your antenna the same way the earplug resistor is attached. Both these resistors provide approximately 500 to 1000 ohms resistance, which is sufficient for most low power military radio sets.

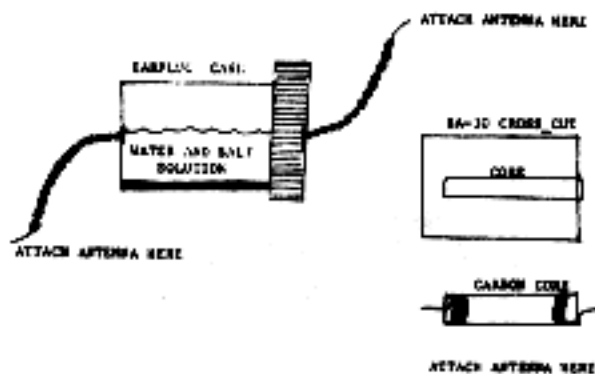

Figure 7-7. Expedient resistors. 500 to 1000 ohms (approx.)

7-8. SOI. The SOI (Signal Operating Instructions) should be utilized at all times. Proper use of the CEDI can reduce transmission times, which reducing the enemy's capability of locating your unit using radio direction finding equipment. Unit CEDI's usually include several alternate means of communications; i.e., pyrotechnic and panel systems, and emergency ground to air signals. Never mix plain messages with coded messages. Brevity codes are provided for more commonly used phrases. All messages should be authenticated to prevent the enemy from using imitative deception.

- a. Encoding using the KTC-600E Tac Ops Code.
- (1) Write out the plain text message, leave space above each line to write out coded values.
 - (2) Turn to the code set for the time period (periods start with the 1st day of the problem and each period is 48 hours long).
 - (3) Find the code word or number to be coded and write the 3 letter code group over the message.

- b. Decoding using the KTC-600E Tac Ops Code
- (1) Write down the coded message.
 - (2) Turn to the code set for the time period being used.
 - (3) Find the 3 letter code and the word or phrase or number to its right.
 - (4) Write the solution above the coded message.

- c. Authentication using the KTC-1400D Authentication Tables.
- (1) Randomly select 2 letters for the set indicator (SI).
 - (2) Find the first SI in the far left column.
 - (3) Read to the right of that letter to find the second SI letter.
 - (4) The letter directly under the second SI is the proper response.

- 7-9. Maintenance. Conduct a commo check before the mission. Replace any missing or broken equipment.
- Ensure that all component parts are present.
 - Install battery and inspect spares.
 - Tighten all screws.
 - Waterproof the handset, use the plastic bag off the radio battery and tape it securely.
 - DO NOT waterproof the radio set, it is already waterproof in its case.
 - Tie down all equipment in accordance with unit SOP.
 - Clean and dry audio connectors on radio and handset, battery terminal, and antenna connectors.

7-10. Basic operator troubleshooting for military type radios.

MALFUNCTION

PROBABLE CAUSE

- | | |
|---|---|
| <ol style="list-style-type: none"> Rushing noise is not heard when function switch is set to on, volume set to midrange or higher. | <ol style="list-style-type: none"> POWER connector is not connected. Defective battery. Dirty or corroded audio contacts. Defective handset |
|---|---|

CORRECTIVE ACTION

- Tighten Power connector.
- Perform the following:
 - Set function switch to LITE, the dial lamp should light.
 - Key the radio and talk, you should hear yourself.
 - If neither 1 or 2 above work, replace the battery.
- Clean audio contacts (use pencil eraser).
- Replace handset.

MALFUNCTION

PROBABLE CAUSE

- | | |
|--|---|
| <ol style="list-style-type: none"> Communications cannot be conducted with distant station on assigned freq., side tone is heard on transmission. | <ol style="list-style-type: none"> Defective radio Radio is located in a poor position. The distance is too great to the next radio set. |
|--|---|

CORRECTIVE ACTION

- Perform the following:
 - Rotate the MC and KC knobs back and forth, also change the band switch a few times.
 - Try alternate freqs.
- Relocate radio
- Install the long whip.
- Construct a field expedient antenna.

MALFUNCTION

3. Receiving is intermittent and whistling or crackling noise heard when transmitting.

PROBABLE CAUSE

- a. Dirty audio connectors
- b. O ring missing from handset
- c. Defective handset or handset cable.

CORRECTIVE ACTION

- a. Clean contacts w/eraser.
- b. Replace O ring or handset.
- c. Replace handset.

MALFUNCTION

4. Communications cannot be conducted with a distant radio but can communicate with a close radio (1/4 mile or less).

PROBABLE CAUSE

- a. Defective antenna.
- b. Dirty audio contacts.
- c. Radio in a poor location
- d. Weak battery.

CORRECTIVE ACTION

- a. Replace antenna.
- b. Clean contacts with a pencil eraser.
- c. Relocate radio set (a few feet may help).
- d. Change battery.

MALFUNCTION

5. Reception good, but motor-boating (loud buzzing) heard when transmitting.

PROBABLE CAUSE

Defective battery.

CORRECTIVE ACTION

Replace battery.

CHAPTER EIGHT

ARMY AVIATION

B-1. Army aviation and infantry units can be fully integrated with other members of the combined arms team to form powerful and flexible air assault task forces that can project combat power throughout the entire depth, width, and breadth of the modern battlefield with little regard for terrain barriers. Air assault operations are those in which assault forces using the firepower, mobility and total integration of helicopter assets, maneuver on the battlefield under the control of the ground or air maneuver commander to engage and destroy enemy forces or to seize and hold key terrain. These operations are deliberate, precisely planned, and vigorously executed combat operations assigned to strike the enemy when and where he is most vulnerable.

B-2. Attack Helicopters. Attack helicopter battalions are normally placed OPCON to a maneuver brigade. Attack helicopters are not suited for missions requiring occupation of terrain nor against heavily fortified positions without sufficient ground elements to drive the enemy from their positions. Employment of attack helicopters in fire support or combat support roles is discouraged.

B-3. Air Assault.

a. Successful air assault execution is based a careful analysis of METT-T and detailed, precise reverse planning. Five basic plans that comprise the reverse planning sequence are developed for each air assault operation. They are:

- (1) The ground tactical plan.
- (2) The landing plan.
- (3) The air movement plan.
- (4) The loading plan.
- (5) The staging plan.

b. The above stated plans are normally coordinated and developed by the Air Assault Task Force (AATF) to make best use of available time. If time is limited, planning steps may be compressed or conducted concurrently; detailed written plans and orders may be supplemented by standing operating procedures or lessons learned in previous training. Previous training and the development of SOP's cannot be overemphasized. The battalion is the lowest level that has sufficient personnel to plan, coordinate, and control an air assault operation. When company size or lower operations are conducted, the bulk of the planning takes place at battalion or higher headquarters.

c. Ground Tactical Plan. The foundation of a successful air assault operation is the commander's ground tactical plan. All additional plans must support this plan. The plan specifies actions in the objective area to ultimately accomplish the mission and address subsequent operations.

d. The Landing Plan. The landing plan must support the ground tactical plan. This plan sequences elements into the area of operations, ensuring that units arrive at designated locations and times prepared to execute the ground tactical plan.

e. The Air Movement Plan. The air movement plan is based on the ground tactical and landing plans. It specifies the schedule and provides instructions for air movement of troops, equipment, and supplies from PZ's to LZ's.

f. The Loading Plan. The loading plan is based on the air movement plan. It ensures that troops, equipment, and supplies are loaded on the correct aircraft. Unit integrity is maintained when aircraft loads are planned. Cross-loading may be necessary in order to ensure survivability of command and control assets, and the mix of weapons arriving at LZ ready to fight. The platoon/squad leader should always ensure that the aircraft is loaded so that dismounting soldiers react promptly and contribute to mission accomplishment.

g. The Staging Plan. The staging plan is based on the loading plan and prescribes the arrival time of ground units (troops, equipment and supplies) at the PZ in the proper order of movement.

h. PZ/LZ Criteria.

(1) Size. PZ and LZ size requirements depend on type and number of aircraft and are based on minimum acceptable distances between aircraft. Each aircraft should be provided a circular landing point separated from other aircraft and free of obstacles. Minimum recommended landing point sizes (diameter of circle in meters) are:

(a) Observation helicopters--25 meters.

(b) UH-1, AH-1--35 meters.

(c) UH-60, AH-64--50 meters.

(d) Cargo helicopters--80 meters.

(2) Surface Conditions. Surface conditions in the PZ and LZ should not conceal the touchdown point or create hazards to landing (e.g., sand, blowing dust, snow). The surface of the zone should be free of obstacles that could damage landing aircraft (no tree stumps, large rocks). It must be firm enough to support the traffic. Drainage should be adequate for rainfall runoff. If the surface is contaminated (chemical or radiological) to an unacceptable degree, it may preclude use of the area. If part of the area is unsatisfactory for any reason, that part is not used.

(3) Ground Slope - Landing. As a guide, if the ground slope is 0 to 6 percent, land upslope; if the slope is 7 to 15 percent, land sidelandslope; over 15 percent, no touchdown (aircraft may hover to drop off or pick up personnel and/or equipment).

(4) Obstacles. For planning purposes, an obstacle clearance ratio of 10 to 1 is used on the approach and departure ends of the PZ and LZ. That is, a landing point requires 100 feet of horizontal clearance if a helicopter must approach or depart directly over a 10-foot tall tree (Figure B-1). A lesser ratio may be used if the helicopter executes a steep approach or departure in emergency situations or with light loads.

All obstacles within the PZ and LZ are marked with red lights at night (turned on only when PZ or LZ is in use), or red panels during the day. The markings are not used if they cause the position to be seen by the enemy.



Figure B-1. Obstacle Clearance.

(5) Approach/Departure. The terrain surrounding possible PZ or LZ is analyzed for air traffic patterns. In a tactical situation, constantly approaching the PZ or LZ over the same ground track should be avoided. Still, there are only so many ways to get into an area. Approaches should be free of obstacles, and landings should be made into the wind, ideally, approach and departure are made along the long axis of the LZ over the lowest obstacle, and into the wind.

(6) Loads. When a helicopter is loaded to near maximum lift capacity, it requires longer distances of lift-off and land (it cannot ascend or descend vertically). The greater the load (near or at maximum), the larger the PZ and LZ must be to accommodate a light.

1. Selection and Marking of PZ's/LZ's.

(1) Small unit leaders should be proficient in selection and marking of PZ's and/or LZ's.

(2) Marking LZ's and PZ's.

(a) Day. A ground guide will mark the PZ or LZ for the lead aircraft by holding an M16 rifle over his head, by displaying a folded VS-17 panel chest high, or by other identifiable means.

(b) Night. The code letter Y (inverted Y) is used to mark the landing point of the lead aircraft at night. Chemical light sticks or "beanbag" lights may be used to maintain light discipline (figure B-2).

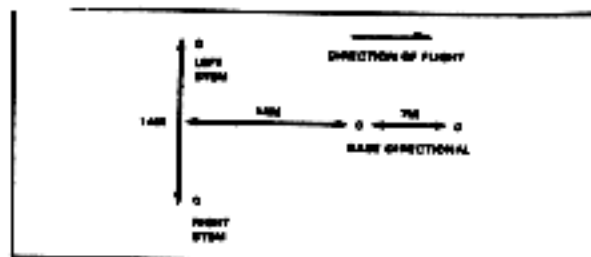

Figure B-2. Inverted Y.

When more than one aircraft will be landing in the same PZ or LZ, there will be an additional light for each aircraft. For observation, utility, and attack aircraft, each additional aircraft landing point will be marked with a single light placed at the exact point that each aircraft is to land. For cargo aircraft (CH-47, CH-53, CH-54), each additional landing point will be marked with two lights. The two lights will be placed 10 meters apart and will be aligned in the aircraft direction of flight.

(c) Obstacles. These include any obstruction in flight which might interfere with aircraft operation on the ground (trees, stumps, rocks) and cannot be induced. During daylight, the aircrew is responsible for avoiding obstacles on the PZ or LZ. For night and limited visibility operations, all obstacles will be marked with red lights. The following criteria will be used in marking obstacles:

(1) If the obstacle is on the aircraft approach route, both the near and far sides of the obstacle will be marked.

(2) If the obstacle is on the aircraft departure route, the near side of the obstacle will be marked.

(3) If the obstacle protrudes into the PZ or LZ, but is not on the flight route of the aircraft, the near side of the obstacle will be marked.

(4) Large obstacles on the approach route will be marked by circling the obstacle with red lights.

(5) Control of Aircraft. Approaching aircraft are controlled by the use of arm-and-hand signals to transmit terminal guidance for landing. The signaller is positioned to the right front of the aircraft where he can best be seen by the pilot. Signals at night are given by using lighted batons or flashlights in each hand. When using flashlights, care will be taken to avoid blinding the pilot. Batons and flashlights will remain lighted at all times when signaling. The speed of arm movement indicates the desired speed of aircraft compliance with the signal.

J. Air Assault Formations. Aircraft supporting an operation may use any of the following PZ/LZ configurations which will be prescribed by the Air Assault Task Force (AATF) Commander working in conjunction with the Air Mission Commander (AMC):

(1) Heavy Left or Right. Requires a relatively long, wide landing area; presents difficulty in pre-positioning loads; restricts suppressive fire by inboard gunners; provides firepower to front and flank (figure B-3).



Figure B-3. Heavy Left/Heavy Right.

(2) Diamond. Allows rapid deployment for all-round security; requires relatively small landing area; presents some difficulty in pre-positioning loads; restricts suppressive fire of inboard gunners (Figure B-4).



Figure B-4. Diamond

(3) Vee. Requires a relatively small landing area; allows rapid deployment of forces to the front; restricts suppressive fire of inboard gunners; presents some difficulty in pre-positioning loads (Figure B-5).



Figure B-5. Vee

(4) Echelon Left or Right. Requires a relatively long, wide landing area; presents some difficulty in pre-positioning loads; allows rapid deployment of forces to the flank; allows unrestricted suppressive fire by gunners (Figure B-6).



Figure B-6. Echelon Left/Echelon Right

(5) Trail. Requires a relatively small landing area; allows rapid deployment of forces to the flank; simplifies pre-positioning loads; allows unrestricted suppressive fire by gunners (Figure B-7).



Figure B-7. Trail

(6) Staggered Trail Left or Right. Requires a relatively long, wide landing area; simplifies pre-positioning loads; allows rapid deployment for all round security; gunners' suppressive fire restricted somewhat (Figure B-8).



Figure B-8. Staggered Trail Left/Staggered Trail Right

k. PZ Operations. Prior to arrival of the aircraft, the PZ must be secured, PZ control party positioned and the troops and equipment positioned in platoon/squad assembly areas.

(1) Occupation of platoon/squad assembly area. Platoon leader/squad leader should accomplish the following:

- (a) Maintain all-around security of the assembly area.
- (b) Maintain communications.
- (c) Organize Rangers and equipment into chinks and loads.
- (d) Conduct safety briefing and equipment check of troops.
- (e) Establish priority of loading for each man.
- (f) Brief on the location of straggler control points.

(2) Movement to and occupation of Chalk Assembly Area. Linkup guides from the P2 control party will meet with designated squads in the platoon assembly area and coordinate movement of squads to a release point. As squads arrive at the release point, squad guides will move each squad to its assigned chalk assembly area. To reduce the number of personnel required, the same guide may be used to move the squad from the platoon assembly area to the chalk assembly area. If part of a larger air assault, no more than three chalks should be located in the chalk assembly area at one time. Noise and light discipline will be maintained throughout the entire movement in order to maintain the security of the P2. Additionally, no personnel should be allowed on the P2 unless loading aircraft, rigging vehicles for slingload, or directed by P2 control. While remaining in chalk order, each Ranger is assigned a security (firing) position by the squad leader and emplaced in the prone position, weapon at the ready, and facing out (away from P2) to provide immediate close-in security. An example of a large, one-sided P2 is depicted in Figure B-9.

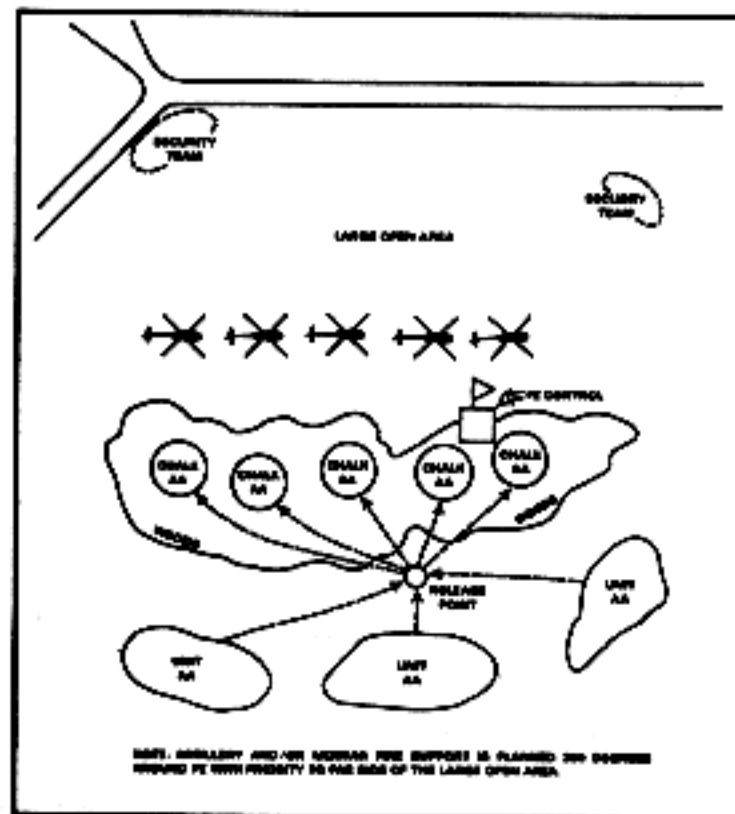

Figure B-9. Large, one-sided P2

(a) An example of a small two-sided P2 with unit and platoon assembly areas is depicted in figure B-10.

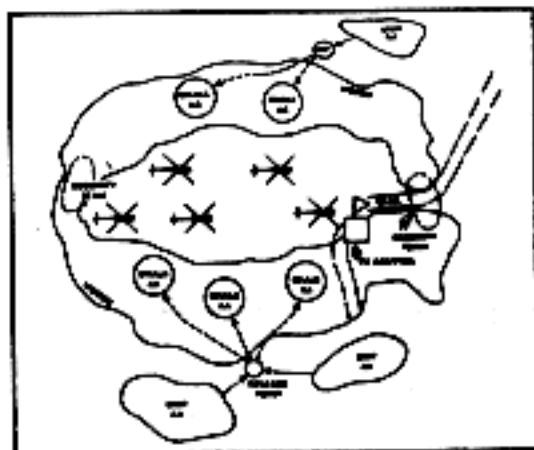

Figure 8-10. Small two-sided PZ.

(b) While in the chalk assembly area, units should adhere to the following principles for loading the aircraft:

- (1) Maintain tactical integrity by keeping fire teams and squads intact.
- (2) Maintain self-sufficiency by loading a weapon and its ammunition on the same aircraft (Dragon).
- (3) Ensure key men, weapons, and equipment are cross-loaded, among aircraft to prevent the loss of control, or all of a particular asset, if an aircraft is lost.
- (4) Prior to loading, ensure all troop gear is tied down and checked; short antennas placed on radios, folded down, and secured.

(5) Squad and team leaders check the equipment of their men to ensure it is complete and operational.

(6) Radios on and communications check performed (unless directed otherwise).

(7) Specific aircraft seats are assigned to each man.

(c) PZ Closure. During platoon air assault operations the platoon sergeant is responsible for ensuring all personnel and equipment are loaded (clear the PZ) and security is maintained.

(1) Single Lift. The platoon sergeant positions himself at the last aircraft and collects "bumped" men, if required. He will be the last man to load the aircraft. Once on the aircraft, the platoon sergeant will notify the crew chief and/or AMC (using the troop commander's radio handset) that all personnel and equipment are loaded. Close-in security will be provided by the aircraft door gunners.

(2) Multiple Lift. The duties of the platoon sergeant are the same as for a single lift. During a multiple lift, the security teams will maintain security of the PZ and be the last element to depart with the platoon sergeant. Depending on the initial location(s) of the security teams, repositioning closer to the PZ may be necessary. Whenever possible, the aircraft will land as close to the security team positions as possible to enhance security and minimize the movement required by the teams.

(d) UH-60 Loading Sequence. (Figure 8-11).

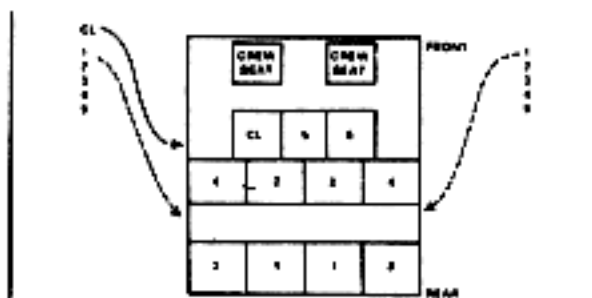

Figure 8-11. UH-60 Loading Diagram - Split Chalk

- (1) Chalk leader (squad leader) initiates movement once the aircraft has landed.
- (2) The farside and nearside groups move to the aircraft in file with the chalk leader (CL) always leading the nearside group.
- (3) Chalk leader should:
 - (a) Ensure all personnel know which aircraft and which position to load.
 - (b) Ensure all personnel wear or carry rucksacks on the aircraft.
 - (c) Notify the crew chief when all chalk members are on board and are ready for lift-off.
 - (d) All personnel will buckle up as soon as they are seated in their assigned seats. The chalk leader will always sit in the left front seat unless a platoon leader or company commander is on the same aircraft.
 - (e) The chalk leader will hand the chalk board to the pilot and answer any questions the pilot may have utilizing the aircraft intercommunication (troop commander's) headset.

(e) UH-60 Loading Sequence (Figure B-12).

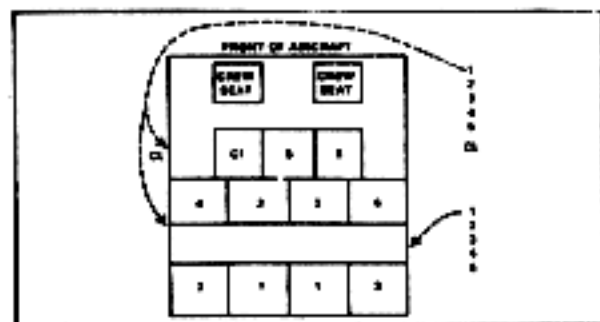

Figure B-12. UH-60 Loading Diagram, Whole Chalk

(1) The chalk leader (squad leader) initiates movement once the aircraft has landed.

(2) The farside and nearside groups move to the aircraft in file with the No. 1 man leading the load to the appropriate side (Figure B-12).

NOTE: The farside group will always move around to the front of the aircraft.

(3) The chalk leader will stop at the nearside of the aircraft to ensure the nearside group loads properly; then he moves around the front of the aircraft to the farside and checks the other half of the chalk.

(4) All personnel will buckle up as soon as they are seated in the correct seat.

(5) The chalk leader will hand the chalk board to the pilot and answer any questions the pilot may have, utilizing the aircraft's intercommunication (troop commander's) headset.

(f) Landing Zone Operations. Just as there is a priority of work for defensive operations, there is a priority of actions upon landing in an LZ.

(1) Unloading. Unloading of the aircraft does not begin until directed by the crew chief or pilot (Figure B-13).

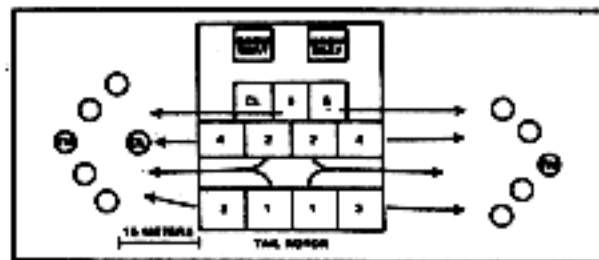

Figure B-13. UH-60 Unloading Diagram

(2) Once the aircraft has landed, personnel will unbuckle seatbelts and exit aircraft as fast as possible with all equipment.

(3) Prior to leaving the aircraft, the chalk leader will obtain the landing direction from the pilot if not determined during the approach into the LZ. This will aid in orientation to the LZ, particularly at night.

(4) Individuals will move 15 to 20 meters out from the side of the aircraft and assume the prone position facing away from the aircraft, weapons at the ready, until the aircraft has departed the LZ.

(5) Immediate Action on Hot LZ. If the decision is made to use a hot LZ, or contact is made upon landing, troops quickly dismount and move 15 to 20 meters away from the aircraft and immediately return the enemy fire to allow the aircraft to depart.

(6) If the contact is similar to a far ambush, troops will fire and maneuver off the LZ to the closest side offering cover and concealment.

(7) If troops are engaged from nearby enemy positions, they treat it as a near ambush by immediately returning fire. Troops who consider themselves in the kill zone may assault the enemy position(s) or attempt to get out of the kill zone. Troops not in the kill zone will provide supporting fire to support the movement of troops in the kill zone.

(8) The squad or platoon leader will call for fire support if it is available.

(9) Once disengaged from the enemy force, the squad or platoon leader will move the unit to a covered and concealed position, account for personnel and equipment, and assess the situation as to whether or not the unit can continue the mission.

(10) Chalk Assembly on Cold LZ. Upon unloading from the aircraft, the chalk leader (squad leader) will move the chalk to its predetermined locations using traveling overwatch movement techniques. All troops will move at a fast pace to the nearest concealed positions. Once at the concealed assembly point, the chalk leader will make a quick count of personnel and equipment and then proceed with the mission.

(f) Duties of Key Personnel. To ensure that an air assault is executed in an effective and efficient manner, key personnel are designated to perform specific duties. This section will address the duties and responsibilities of unit leaders during air assault operations and discuss the duties and responsibilities of key personnel in the PZ control party.

Platoon Leader:

Has overall responsibility for the air assault operation. May act as the PZCO. Plans the operation.

Briefs subordinate leaders. Issues OPORD.

Conducts rehearsals.

Rides in the air mission commander's aircraft to ensure better command, control, and communication.

Platoon Sergeant:

Sets up the PZ.

Supervises the marking of the PZ. Supervises the clearing of obstacles from the PZ.

Briefs all chalk leaders.

Supervises all activity on the PZ, PZ security. Movement of troops and equipment. Placement of chinks and slingloads. Devises and disseminates the bump plan. Rides in the last aircraft for control purposes and will ensure that the PZ is cleared.

(g) Helicopter Characteristics (Figure B-14).

	AH-1	AH-64	UH-1	UH-60	CH-47D
Max Gross Weight (lbs)	10,000	17,400	9500	20,250	50,000
Cruise airspeed (knots)	90	161	90	145	155
Flight Time	2+30	1+45	2+15	2+15	2+30
Troop Seats (ACL)	-	7	13	33	
Load (ACL) (lbs)	3,402	6895	4368	6195	27,501
Weapons					
7.62mm (w/ps)	"	2	2	2	
20mm (rds)	975				
30mm (rds)	1200				
2.75" (rds)	76	76			
TOW	8				
HELLFIRE		16			
STINGER		16			
Dimensions					
L (Blades unfolded)	53'1"	57'1"	52'10"	64'10"	99'
W (Rotor diameter)	44'	48' 44'	53'8"	60'	
H	13'9"	12'8"	12'8"	17'6"	18'8"

Figure B-14. Helicopter Characteristics.

AERIAL RESUPPLY OPERATIONS.

A. Drop Zone (DZ) Selection

1. A DZ is a designated area where troops and/or equipment are to be delivered by means of parachute or free drop. The ground unit commander selects the general area of the DZ where it will best suit the tactical plan.

2. The following factors should be considered in the selection of a drop zone,

- Type aircraft employed
- Altitude of delivery
- Type of load (cargo or personnel)
- Obstacles
- Adequate approach and departure routes
- Method of airdrop (high velocity, low velocity, free drop)
- Access to area

3. **SIZE:** The size required for a DZ is dependent on the type of aircraft and the load being delivered. As a guide, the ground space required for one parachutist, is 300m x 300m (Army aircraft)/700m x 700m (Air Force aircraft). The length of the drop zone is dependent on the ground speed of the aircraft, and the time needed to release its load.

B. Drop Zone Calculations.

1. The following formulas are necessary for determining the required length of a Drop Zone, and the amount of Drift:

A. The formula used to compute the required length of Drop Zone, in meters, is $D = RT$.

1. D = Length of the Drop Zone, in meters.

2. R = Speed of the aircraft multiplied by a constant of .51 (converts to meters per sec).

3. T = Time required for the drop (number of jumpers on the pass minus 1 or number of bundles per pass minus 1 times 3).

EXAMPLE

AIRCRAFT SPEED PARACHUTISTS
C-130 125 Knots 64 (32 per
pass)

STEP 1. 125 Air speed
x .51 Constant
63.75 M/sec

STEP 2. 63.75 M/sec
x31 Number of Jumpers minus 1 1,976.25m = Length
of drop zone needed to
drop 32 parachutists from a C-130 flying at
a speed of 125 knots.

NOTE: Always round the final answer up to the next higher whole number, 1977 meters. For personnel drops, a 100 meter safety factor is added to each end of the computed ground dispersion pattern (for a total of 200 meters). Therefore, use the above figures in the examples:
 $D = 1,977 + 200 = 2,177$ meters.

B. The formula used to compute amount of drift is
 $D = KAV$.

1. D = The drift of the parachute (in meters) from a given altitude.
2. K = The constant that represents the characteristic drift of a parachute; 2.5 for cargo parachutes and 4.1 for personnel parachutes.
3. A = Altitude (expressed in hundreds of feet).
4. V = Velocity (in knots) of the surface wind.
5. Forward throw must also be calculated when using the $D = KAV$ formula. Forward throw is the lateral distance covered by the jumper or bundle from the time he or it leaves the aircraft until the time the parachute is fully deployed. Forward throw for Army aircraft is calculated by taking 1/2 the speed of the aircraft. To compensate for forward throw walk on the back azimuth of the drop heading half the speed of the aircraft in meters (figure 8-15).

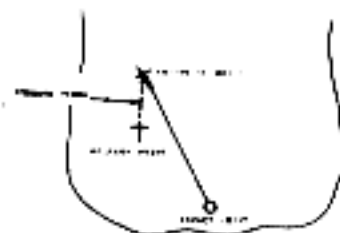

Figure 8-15. $D = KAV$

Aircraft (UH-1H) is at an altitude of 500 feet, speed 70 knots. Airdrop is rations using a G-13 parachute. Ground wind is 5 knots $D = 2.5$ (constant) \times 5 (altitude in hundreds of feet) \times 5 (ground wind) $D = 62.5$ round up to 3 meters in windward direction from the desired impact point, move into the wind 63 meters. Then move on a back azimuth of the drop heading 1/2 of airspeed (70 ; 2 = 35m). This is the release point.

C. Marking of the Drop Zone, (1) U.S. Air Force Aircraft - Ground marker release system (GMRB).

(a) Various visual ground markings are used by the Air Force CCT to identify both the DZ and the release point for an airdrop. Normally, the Air Force CCT marks only the point of impact on the ground using a code letter, and Air Force crew members determine the CARP, or point to exit the parachutists. This does not take place during GMRB operations.

(b) When using the GMRB, DZSOs always use the inverted L to designate the exact release point on the ground to the aircrew and jumpmaster. The inverted L does not identify the point of impact as does the CARP system, but identifies to the aircrew and jumpmaster the exact point over which the parachutists exit in order to hit a point on the ground selected by the DZSO.

(2) Computing the release point, and the subsequent placement of the inverted L, is the key to a successful airborne operation using GMRS. The release point is the exact point on the DZ over which exit from the aircraft is made. The release point is computed with three factors, dispersion, wind drift, and forward throw.

(a) Dispersion. This is the length of the pattern formed by the impact of the parachutists. The desired point of impact for the first parachutist depends on how the calculated dispersal pattern is fitted into the available DZ space. Use the following formula, $D = RT$.

(b) Wind drift and forward throw. DZSOs compute the wind drift using the $D = KAV$ formula. This method does not incorporate altitude winds; however, it requires the least equipment. Also, when using this formula, the DZSO uses the forward throw, (the effect that inertia has on a falling object). When an object leaves the aircraft, it is traveling at a speed equivalent to the speed of the aircraft. The parachutists or bundle continues to move in the direction of flight momentarily until the dynamics of parachuting take effect and stop lateral movement across the DZ. The standard distances used to indicate forward throw from Air Force aircraft follows:

	C-141	C-130
Personnel	220 meters	220 meters
HE	670 meters	410 meters
CDB	745 meters	460 meters

(c) Marking the DZ. From the desired impact point (selected by the airborne commander), move into the wind the number of meters calculated using the $D = KAV$ formula. Then, (2) move on a back azimuth of the drop heading the number of meters calculated on the forward throw. This is the (3) release point see figures B-16 and B-17).

(d) Positioning of Markings 1. Markings must be placed so they are visible only from the direction of aircraft approach.

2. Panels should be positioned at a 45 degree angle to present the maximum surface toward the approaching aircraft.

3. Markings must not be placed where obstacles will mask the pilots line of sight. As a guide, a mask clearance of 15:1 is used (figure B-18). If the Inverted L falls inside the 15:1 ratio, an Army code letter is placed on the far end of the Drop Zone on drop heading and on line with the release point.

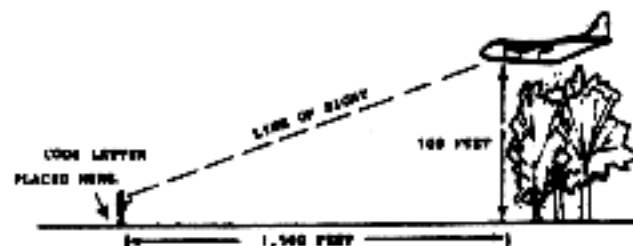

Figure B-18.

(2) Army Aircraft

(a) Day

(1) When marking a drop zone for Army aircraft there are four letters that can be used as the code letters. These letters form the word H, E, A, T. The letter used is determined by the unit SDP or by the Airborne Commander.

(2) V8-17B panels are used to form the code letter. These panels have two sides; orange and carise (cherry colored). The carise side is used for marking the code letter, flank panel and far panel. The orange side is used to mark obstacles on the drop zone that are too large to remove. All code letters will be two panels high and one panel wide.

(3) All code letters have a base panel. The top of the base panel is placed at the release point (figure B-19). The flank panel is positioned parallel to the code letter with the top of the flank panel aligned with the top of the base panel. The flank panel is placed 200 meters from the left edge of the base panel or at the edge of the drop zone, whichever is less. The far panel is positioned a distance of 500 meters from the base panel or at the end of the drop zone, whichever is less. The far panel will be placed on the desired drop heading with the top of the panel elevated 45 degrees and in line with the base panel.



Figure B-19. Code Letters (Day).

(b) Night

(1) The procedure for marking a night drop zone is the same as a day drop zone, except incandescent lights are used (for example Mx290 lanterns). When forming the code letter with lights, all code letters are 4 lights high and 3 lights wide (figure B-20).

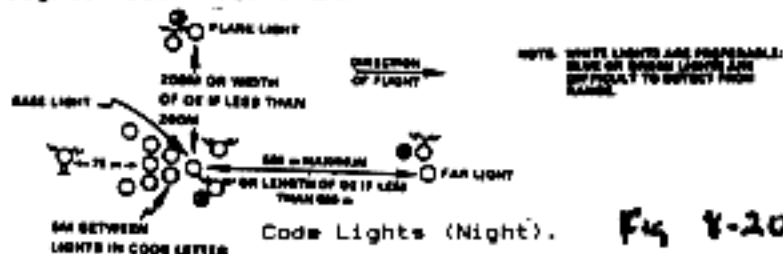

Fig B-20

(2) If there are any vertical obstacles on the drop zone that cannot be removed, then a single red light must be placed as high as possible on the obstacle. Large obstacles are marked on three sides with red lights.

CHAPTER NINE

STREAM CROSSING AND WATERBORNE OPERATIONS

9-1. GENERAL. The availability of ready-made bridges to a unit is not only uncertain, but is highly unlikely. Therefore, it is necessary to be able to negotiate expedient stream crossings. The leader will need to know various techniques in order to make a successful stream crossing. The stream crossing team is designated and instructed to prepare ropes and equipment, and to conduct team rehearsals. This team should be highly proficient in the mechanics of a stream crossing. This proficiency is gained by realistic rehearsals, close inspections, organization and good control.

9-2. Organization of River Crossing Team.

- a. Number 1 man: Lead safety swimmer and farside lifeguard.
- b. Number 2 man: Rope puller, he swims water obstacle pulling 120-foot rope, ties off rope on farside anchor point.
- c. Number 3 man: Nearside lifeguard, he is the last man to cross water obstacle.
- d. Number 4 man: Bridge Team Commander (BTC).
- e. Number 5 and 6 men: Rope Tighteners.

9-3. One Rope Bridge (Wet Crossing).

- a. Special Equipment:
 - (1) Two snaplinks per piece of heavy equipment.
 - (2) Two snaplinks for every 120 feet of rope.
 - (3) One 14-foot utility rope per person.
 - (4) Two snaplinks per person.
 - (5) One waterproof bag per RATELO.
 - (6) Three B-7 life preservers.
 - (7) Three floatation work vests.
 - (8) Two 120-foot nylon ropes.

b. Planning. A stream crossing annex is prepared in conjunction with the unit's operation order. Special organization is accomplished at this time. For a platoon, a squad is normally given the task of providing the bridge team and the squad leader is the Bridge Team Commander.

c. Rehearsals and inspections:

(1) The stream crossing team always rehearses.

(2) Rehearse the entire stream crossing

emphasizing:

(a) Security and actions on enemy contact.

(b) Actual construction of the rope bridge within six minutes on dry land.

(c) Individual preparation.

(d) Order of crossing.

(e) All signals and control measures.

(f) Reorganization.

(3) Conduct rehearsals as realistically as possible (e.g., use of blindfolds to simulate darkness or conduct rehearsal at night).

(4) Ensure personnel are proficient in the mechanics of a stream crossing operation.

(5) Inspect for equipment completeness, correct rigging and preparation, personnel knowledge and understanding of the operation.

(6) Actions of the #4 man (Bridge Team Commander (BTC) during the preparation phase.

(a) Rehearse the bridge team.

(b) Accounts for all equipment in the bridge kit.

(c) Ensures 120-foot rope is coiled.

d. Execution Phases:

(1) Steps for the establishment and conduct of a one-rope bridge stream crossing.

(a) Unit leader halts short of the river, local security is established, and a recon is conducted of the area for the presence of the enemy and for crossing site suitability/necessity. He directs the BTC to construct the bridge.

(b) Security is established up and downstream while unit leader briefs BTC on anchor points. The unit leader counts individuals across.

(c) The bridge team begins to establish the rope bridge while unit members begin individual preparation.

(d) The BTC is responsible for construction of one-rope bridge and selection of the nearside anchor point as well as the farside anchor point if visibility permits. He ties all wireman's knots and hooks all individuals onto the bridge checking for a rope around their chest and a bowline and an end of the rope bowline on the running end of the sling rope less than an arm length away from the chest.

(e) Noise and light discipline is enforced and security is maintained.

(f) Individual soldiers put a snaplink in their end-of-the rope bowline and the sight blade of every M-16 or M203. M60 gunners put a snaplink through the front sight blade and rear swivel of their M60. RATELOS (and others with heavy rucksacks) place an additional snaplink on their rucksack frame, top center.

(2) The responsibilities of the bridge team while erecting the rope bridge is as follows:

(a) Number 1 man (lead safety swimmer and farside lifeguard.

(1) Grounds rucksack (with snaplink through top of frame) to the rear of the nearside anchor point. Wears equipment in the following order (body out): Waterborne Uniform (top buttoned, pants unbloused), B7 life preserver or engineer workvest, LCE, weapon (across the back), carrying a safety line to assume duties of farside lifeguard.

(2) The Number 1 man enters the water upstream from Number 2 man and stays an arm's length away from the Number 2 man on the upstream side. He identified the far side anchor point upon exiting the water and once the Number 2 man has exited the water, moves to his farside lifeguard position downstream of the rope bridge with knotted safety line on wrist and LCE/weapon and workvest grounded. He continues to wear the B7. The engineer workvest is grounded where he can easily pick it up and toss it to someone in need of a flotation device.

(b) Number 2 man (rope puller) in waterborne uniform (same as Number 1 man) wears his equipment in the following order, Workvest, LCE, weapon (across the back), Australian rappel seat with snaplink to the rear. He grounds his rucksack (with snaplink through top of frame) to the rear of the nearside anchor point. His duties are to swim across the water obstacle pulling the 120-foot rope. He ties off the rope on the anchor point identified by the Number 1 man with a round turn and two half hitches with a quick release. The direction of the round turn is the same direction as the flow of water (current) to facilitate exit off the rope bridge.

(c) Number 3 man (nearside lifeguard) in waterborne uniform wears: B-7 workvest and inotted safety line on wrist (LCE/weapon and workvest grounded on the bank behind him). The Number 3 man positions himself on the downstream side of the bridge before the number 1 and 2 men enter the water, grounding his rucksack (with snaplink through top of frame) on rear of nearside anchor point. His duties include untying the quick release at the nearside anchor point after the platoon sergeant crosses and verifies the headcount. The Number 3 man reties his safety line into an Australian rappel seat, hooks the end of line bowline into his snaplink, connects his snaplink to the snaplink to the end-of-line bowline of the 120 foot rope, and is the last man pulled across the water obstacle. He puts on the workvest prior to crossing the water obstacle with his equipment order of B7, workvest, LCE and weapon.

(d) Number 4 man (Bridge Team Commander BTC).

1) He is in the waterborne uniform with LCE and sling rope tied in safety line (round the waist bowline with end of line bowline at arms length). He is responsible for construction of rope bridge and organization of bridge team. He is also responsible for backfeeding the rope and tying end of line bowlines.

(2) He designates the nearside anchor point, ties the wireman's knot of the transport tightening system, and hooking all personnel to the rope bridge. He ensures that the transport tightening knot is on the upstream side of the rope bridge. He ensures that all individuals are in waterborne uniform, hooked into the rope facing the current with the safety line routed through the trailing shoulder of the individual's LCE and rucksack. He ensures that the weapon is hooked onto the rope. He controls the flow of traffic on the bridge. He is responsible for crossing with the Number 1 man's rucksack. He is generally next to the last man to cross (follows platoon sergeant who is keeping headcount).

(e) Number 5 and 6 man (rope tightners) in waterborne uniform with LCE and safety line. They are responsible for tightening the transport tightening knot. They are also responsible for taking the rucksacks of the Number 2 and 3 men across. Once on the far side, they are responsible for pulling the last man (Number 1 man) across.

(f) The rucksacks of 1/2/3 men are transported across by 4/5/6 men. The rucksacks of 1/2/3 are hooked into the rope by the snaplink through the top of the frames and the 4/5/6 men pull them across. The weapons of 4/5/6 men are attached between the 4/5/6 man and the rucksack that they are pulling across the bridge.

(g) Bridge Team Commander rehearses the bridge team during the planning sessions and directs construction and emplacement. The unit leader selects the crossing site which should complement the tactical plan.

(1) Number 3 man positions himself downstream of crossing site.

(2) Number 1 man enters water upstream of number 2. He stays one arm's length from the number 2 man and is prepared to render any assistance to the number 2 man. Both swim in conjunction upstream to compensate for the current. BTC feeds rope out of rucksack positioned on the downstream side of nearside anchor point.

(h) The number 1 man exits and identifies (hugs) the farside anchor point (if BTC cannot identify it for the Number 2 man). Number 2 man exits on the upstream side of the farside anchor point. The rope is now routed to facilitate movement onto and off the bridge.

(i) Radios and heavy equipment are waterproofed and rigged. All individuals don waterborne uniform and tie safety lines. Platoon sergeant moves to anchor point and maintains accountability through headcount.

(j) Number 2 man signals the BTC that the rope is at the farside anchor point, and the BTC pulls out excess slack and ties a wireman's knot and replaces snaplink. The BTC signals the number 2 man who pulls the rope 1/5 of the way across. The number 2 man selects a point on the farside anchor point that is 18 - 24 inches off the water. After this is done, the number 2 man ties a round turn and two half hitches, the first half hitch is tied in a quick release. Number 2 man signals the BTC and the pulling team (4,5,6) tightens the bridge, pulling the wireman's knot as close as possible to the nearside anchor point.

(i) The number 1 man moves downstream and assumes his duties as the farside lifeguard.

(j) The bridge team commander will tie off the rope with a round turn and two half hitches around the nearside anchor point. The BTC will place himself in the upstream side of the bridge (facing downstream). He begins to hook individuals into the rope inspecting them for safety.

(k) Number 2 man moves upstream to provide farside security. Number 5 and Number 6 cross (taking the rucks of 2/3). The number 5 man maintains farside headcount and unhooks all individuals on the farside the positions himself in the upstream side of the bridge facing downstream). Number 6 precedes the remainder of the platoon.

(l) The BTC maintains the flow of traffic ensuring that no more than three individuals are on the bridge at any one time (one hooking up, one near the center, and one being unhooked). Once the platoon sergeant has accounted for all individuals on the nearside, he withdraws L/R security, sending them across. Platoon sergeant follows security across. Number 3 man hooks the BTC (with number 1's rucksack) onto the rope. Once the BTC has crossed, number 3 unhooks nearside anchor point and the BTC unties farside anchor point. Number 3 man ties an Australian rappel seat with snaplink to the front, hooks onto the snaplink that is in the end of the line bowline on the 120-foot rope and signals 4/5/6 men to take in slack. Number 3 man extends arms in front of his head, slightly upstream to fend off debris and is pulled across by 4/5/6. All individuals (except 1/2/3 and RATELDA) wear rucksacks across. The 4/5/6 men hook the rucksacks of 1/2/3 men onto bridge by the snaplink. All individuals cross facing upstream.

(m) Once the farside headcount, weapons and equipment are verified (between platoon sergeant and Number 5 man), personnel reorganize and continue mission.

(n) Personnel with heavy equipment:

(1) M-60 - all major groups will be tied together with 1/4-inch cord. An anchor line bowline runs through the rear swivel, down the left side of gun. Tie a round turn through the trigger guard. Route the cord down the right side and tie off two half hitches around the forearm assembly with a round turn and two half hitches through the front sight posts. The remainder of the working end is tied off with an end of the rope bowline approximately one foot from the front sight post large enough to place leading hand through. The M-60 is secured to the bridge by snaplinks on the front sight post and rear swivel. The M-60 is pulled across by the trailing arm of the M-60 gunner.

(2) PRC 77's will be waterproofed prior to conducting a one rope bridge crossing. A snaplink will be placed in the top center of the rucksack frame (same as for 1/2/3 men). The BTC will hook the rucksack to the 120 foot rope.

NOTE: The use of 2 snaplinks invariably leads to the load binding on the 120 foot rope. The arm straps are adjusted all the way out and the radio is pulled across the rope bridge by the RATELO.

9-4. PONCHO RAFT. Normally a poncho raft is constructed to cross rivers and streams when the current is not swift. A poncho raft is especially useful when the unit is still dry and the platoon leader desires to keep the individuals equipment dry.

a. Equipment Requirements:

- (1) Two serviceable ponchos.
- (2) Two weapons (poles can be used in lieu of weapons).
- (3) Two rucksacks per team.
- (4) 10 feet of utility cord per team.
- (5) One sling rope per team.

b. Conditions: Poncho rafts will be used to cross water obstacles when any or all of the following conditions are found:

- (1) The water obstacle is too wide for a 20-foot rope to be used.
- (2) No sufficient near or far shore anchor points are available to allow rope bridge construction.
- (3) Under no circumstances will poncho rafts be used as a means to cross a water obstacle if an unusually swift current is present.

c. Choosing a crossing site: Before a crossing site is to be used, a thorough reconnaissance of the immediate area must be made. Analyzing the situation using METT-T, the platoon leader chooses a crossing site that offers as much cover and concealment as possible and has entrance and exit points that are as shallow as possible. For speed of movement it is best to choose a crossing site that has near and far shore banks that can be easily traversed by an individual Ranger.

d. Execution Phase: Steps for the construction of a poncho raft:

- (1) Pair off the unit/platoon in order to have the necessary equipment.
- (2) Tie off the hood of one poncho and lay it out on the ground with the hood up.
- (3) Weapons are then placed in the center of the poncho, approximately 18 inches apart, muzzle to butt.
- (4) Next, rucksacks and LCE are placed between the weapons with the two individuals placing their rucksacks as far apart as possible.
- (5) The two will then start to undress (bottom to top), first with their boots, taking the laces completely out for subsequent use as tie downs (if necessary).
- (6) The boots are then placed over muzzle/butt of weapon toe in.
- (7) They then continue to undress, folding each item neatly and placing on top of their boots.
- (8) Once all of the equipment is placed between the two weapons or poles, the poncho is snapped together. The snapped portion of the poncho is then lifted into the air and tightly rolled down to the equipment. Start at the center and work out to the end of the raft creating pigtails at the end. This is accomplished much easier if done by both soldiers together. The pigtailed ends are then folded in toward the center top of the raft and tied off with a single bootlace.
- (9) The other poncho is then laid out on the ground with the hood up and the first poncho with equipment is placed in its center. The second poncho is then snapped, rolled and tied in the same manner as the first poncho. The third and fourth bootlaces (or utility cord) are then tied around the raft approximately one foot from each end for added security. The poncho raft is now complete.

NOTE: The unit leader must analyze the situation using METT-T and make a decision on the uniform for crossing the water obstacle, i.e., weapons inside the poncho raft or slung across the back, remaining dressed or stripped down with clothes inside raft.

9-5. FIELD EXPEDIENT EQUIPMENT. At times while out on operations, you may be called upon to cross an unfordable water obstacle without the proper equipment for construction of a one-rope bridge. Some of the equipment your unit has can be used as valuable assets.

a. Equipment your unit/platoon may be carrying which could be of use:

- (1) Commo wire.
- (2) Ammo cans.
- (3) Pistol belts.
- (4) Canteens.
- (5) Air mattresses.
- (6) Waterproof bags.
- (7) Water cans.

b. Execution Phases:

(1) Commo wire can be pulled across the obstacle by a strong swimmer and tied off with a suitable anchor point on the far shore with a round turn and two half-hitches. The wire can then be pulled tight and tied off in the same manner as the far shore. Care must be taken not to pull the wire too tight as extreme tension will cause it to break under a load.

(2) Ammo cans can be tied to the ends of a pistol belt and used as water wings.

(3) Five empty canteens tied to each end of a pistol belt will support a non-swimmer.

(4) Air mattresses will make excellent rafts.

(5) Waterproof bags, with an individual's equipment placed inside and the neck of the bag tied securely will support a person.

(6) An empty water can will float an individual and his equipment safely across.

(7) A pair of BDU trousers tied off at each end of the ankles can be inflated and used as waterwings (will hold air if wet).

c. Heavy equipment may be transported across by constructing a litter with two poles and a poncho. The litter is then supported by a poncho raft tied to each end.

SECTION II: WATERBORNE OPERATIONS (ASSAULT BOAT).

9-6. GENERAL: Use of inland and coastal waterways may add flexibility, surprise, and speed to tactical operations. Use of these waterways will also increase the load carrying capacity of normal dismounted units.

9-7. EQUIPMENT. F470 Commando ZODIAC Assault Boat.

a. Description of uses, reconnaissance and assault operations.

b. Inflatable with foot pumps using four separate valves located on the inside of the bouyancy tubes. Each of the four valves are used to section off the assault boat into eight separate airtight compartments. To pump air into the boat, turn all valves into the "orange" section of the valve. Once the assault boat is filled with air, turn all valves onto the "green" or "navigation" section. This will section the assault boat into eight separate compartments.

c. Overall length - 15 feet, 5 inches.

d. Overall width - 6 feet, 3 inches.

e. Weight - 265 pounds.

f. Maximum payload - 2,710.

g. Crew - 1 coxswain, 10 paddlers, can be powered by 40 HP - 65 HP short shaft outboard motor.

9-8. ORGANIZATION,

a. Assign each individual a specific boat position (see figure 9-1).

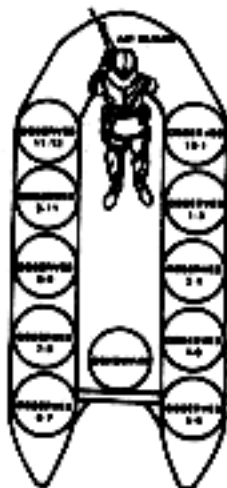

Figure 9-1. Boat positions.

b. Designate a Commander for each boat (normally coxswain).

c. Designate a navigator - observer team as necessary.

d. Crew is positioned as shown in figure 9-2.

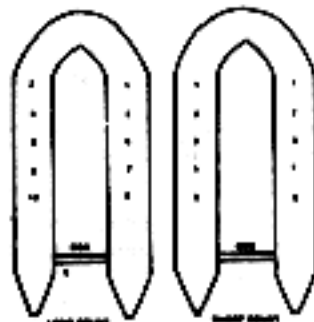

Figure 9-2. Crew positions, long count and short count.

- e. Crew duties,
 - (1) Coxswain:
 - (a) Responsible for control of the boat and actions of the crew.
 - (b) Supervises the loading, lashing and distribution of equipment.
 - (c) Maintains the course and speed of the boat.
 - (d) Gives all commands.
 - (2) Number two paddler (long count) is responsible for setting the pace.
 - (3) Number one paddler is the observer and is responsible for the storage and use of the bowline, if no observer has been assigned.

9-9. PREPARATION OF PERSONNEL AND EQUIPMENT:

- a. All personnel will wear workvest or kapoks (or another suitable positive flotation device).
- b. LCE will be worn, unbuckled at the waist.
- c. Individual weapon will be slung across the back, muzzle pointed down and facing toward the inside of the boat.
- d. Crew served weapons, radios, ammunition and other bulky equipment must be lashed securely to the boat to prevent loss if the boat should overturn. Machineguns with hot barrels must be cooled prior to being lashed inside the boats.
- e. Radios and batteries must be waterproofed.
- f. Pointed objects must be padded to prevent puncturing the boat.

9-10. COMMANDS: Commands will be issued by the coxswain to ensure the boat can be transported over land and controlled in the water. All crew members will learn and be able to react immediately to all commands issued by the coxswain. The various commands/meanings are as follows:

- a. "Short Count-----count off," Crew counts off their position by pairs, i.e., 1,2,3,4,5 (passenger #1, #2, if applicable) coxswain.

- b. "Long Count-----count off;" Crew counts off the position by individual, i.e., 1,2,3,4,5,6,7,8,9,10 (passenger #1, #2, if applicable) coxswain.

- c. "Boat Stations", Crew takes positions along side the boat.

- d. "High Carry-----Move," (used for long distance move overland).

- (1) On the preparatory command of "high carry," the crew faces the rear of the boat and squats down grasping carrying handles with the inboard hand.

- (2) On the command "move," the crew swivels around, lifting the boat to the shoulders so that the crew is standing and facing to the front with the boat on their inboard shoulders.

- (3) Coxswain guides the crew during movement.

- e. "Low Carry-----move ," (used for short distance moves overland).

- (1) On preparatory command of "low carry," the crew faces the front of the boat, bent at the waist, and grasps the carrying handles with the inboard hand.

- (2) On the command of "move," the crew stands up straight raising the boat approximately six to eight inches off the ground.

- (3) Coxswain guides the crew during movement.

- f. "Lower the Boat-----move," Crew lowers the boat gently to the ground using carrying handles.

- g. "Give Way Together" crew paddles to front with number 2 setting the pace.

- h. "Hold," Entire crew keeps paddles straight downward motionless in the water thereby stopping the boat.

- i. "Hold Left (Right)," Left crew holds, right crew continues with previous command.

- j. "Back Paddle," Entire crew paddles backwards, propelling the boat to the rear.

- k. "Back Paddle Left" (Right) - Left crew back paddles causing the boat to turn left, right crew continues with previous command.

1. "Rest Paddles:" Crew members place paddles on their laps with blades outboard. This command may be given in pairs. (e.g., "Number 1's, rest paddles").

9-11. EMBARKING AND DEBARKING PROCEDURES:

a. When launching, the crew will maintain a firm grip on the boat until they are inside it; similarly, when beaching or debarking, they hold on to the boat until it is completely out of the water. Loading and unloading is done using the bow as the entrance and exit point.

b. Keep a low center of mass when entering and exiting the boat to avoid capsizing. Maintain 3 points of contact at all times.

c. The long count is a method of loading and unloading by which the boat crew embarks or debarks individually over the bow of the boat. It is used at river banks, on loading ramps, and when deep water prohibits the use of the short count method.

d. The short count is a method of loading or unloading by which the boat crew embarks or debarks in pairs over the sides of boat while the boat is in the water. It is used in shallow water allowing the boat to be quickly carried out of the water.

e. Beaching the boat is a method of debarking the entire crew at once into shallow water allowing the boat to be quickly carried out of the water.

9-12. CAPSIZE: The following commands and procedures are used for capsize drill or to right an overturned boat.

a. "Prepare to capsize," This command alerts the crew and they raise paddles above their heads, with the blades pointed outward.

b. "Pass paddles:" All paddles are passed back and collected by the number nine and ten men.

c. "Capsize the boat:" All personnel slide into the water except the number three, five, and seven men. They grasp the capsize lines (ensuring the lines are routed under the safety lines) and stand on the buoyancy tubes opposite the capsize lines anchor points. The boat is then turned over by the three, five and seven men by leaning back and straightening their legs as they pull back on the capsize lines. As the boat lifts off the water, the number four man grasps the center carrying handle and rides the boat over. Once the boat is over, the number four man helps the number three and seven men back onto the boat at which time the number five man holds onto the center carrying handle and again, the boat is turned over the same way. The number five man rides the boat back over and helps the rest of the crew into the boat.

d. Coxswain's duties. As soon as the boat is capsized, the coxswain commands a long count to ensure that no one is trapped under the boat or sank. Every time the boat is turned over, a long count must be conducted.

9-13. RIVER MOVEMENT:

a. Characteristics of Rivers:

(1) Know local conditions prior to embarking on river movement.

(2) A bend is a turn in the river course.

(3) A reach is a straight portion of river between two curves.

(4) A slough is a dead end branch from a river. They are normally quite deep and can be distinguished from the true river by their lack of current.

(5) Dead water is a part of the river, due to erosion and changes in the river course, that has no current. Dead water is characterized by excessive snags and debris.

(6) An island is usually a pear-shaped mass of land in the main current of the river. Upstream portions of islands usually catch debris and should be avoided.

(7) The current in a narrow part of a reach is normally greater than in the wide portion.

(8) The current is greatest on the outside of a curve; sandbars and shallow water are found on the inside of the curve.

(9) Sandbars are located at those points where a tributary feeds into the main body of a river or stream.

(10) The coxswain and the #1 man must land the observer, if designated, watch the water for obstacles and overhanging vegetation and projections from the bank.

b. Navigation: The unit commander is responsible for navigation. There are three acceptable methods of river navigation which may be used.

(1) Checkpoint and general route. These methods are used when the drop site is marked by a well-defined checkpoint and the waterway is not confused by many branches and tributaries. They are best used during daylight hours and for short distances.

(2) Navigator-observer method. This method is the most accurate means of river navigation and can be used effectively in all light conditions.

(a) Equipment needed:

Compass

- Photo map (1st choice)
- Topo map (2nd choice)
- Poncho (for night use)
- Pencil/Grease pencil
- Flashlight (for night use)

(b) Navigator is positioned in center of boat and does not paddle. During hours of darkness, he uses his flashlight under the poncho to check his map. The observer (or #1 man) is at the front of the boat.

(c) The navigator keeps his map and compass oriented at all times.

(d) The navigator keeps the observer informed of the configuration of the river by announcing bends, sloughs, reaches and stream junctions as shown on his map.

(e) The observer compares this information with the bends, sloughs, reaches and stream junctions he actually sees and when these are confirmed the navigator confirms the boat's location on his map.

(f) The navigator also keeps the observer informed of the general azimuths of reaches as shown in his map and the observer confirms these with actual compass readings of the river.

(g) The navigator announces only one configuration at a time to the observer and does not announce another until it is confirmed and completed.

(h) A strip-map drawn on clear acetate backed by luminous tape may be used. The drawing may be to scale or a schematic. It should show all curves and the azimuth and distance of all reaches. It may also show terrain features, stream junctions and sloughs.

9-14. SECURING THE LANDING SITE:

a. If the landing site cannot be secured prior to the waterborne force landing, some form of early warning (i.e., scout swimmers) should be considered. These personnel will swim into shore from the assault boats and signal the boats to land. All signals and actions must be rehearsed prior to the actual operation.

b. If the platoon or company is going into an unsecured landing site it can provide security by having a security boat land, reconnoiter the landing site and then signal to the remaining boats to land. This is the preferred technique.

c. The landing site can also be secured by force with all the assault boats landing simultaneously in a line formation. While this is the least desirable method of securing a landing site, it should be rehearsed in the event the tactical situation requires its use.

9-15. FORMATIONS: Various boat formations can be used (day and night) for control, speed and security. The choice of which is used depends on the tactical situation and the discretion of the unit leader. He should use hand and arm signals to control his assault boats. The formations are:

- a. Wedge.
- b. Line.
- c. File.

- d. Echelon.
e. Vee (figure 9-3)

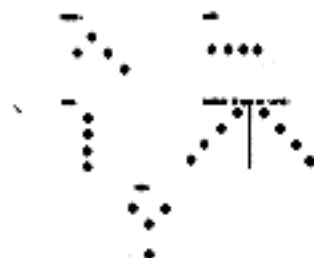

Figure 9-3. Formations

9-16. SURF OPERATIONS

- a. Launchings:
- (1) Use short count method of loading.
 - (2) Crew must keep their weight forward until beyond the surf.
 - (3) The bow of the boat must be kept perpendicular to the waves.
- b. Landings:
- (1) The stern of the boat must be kept perpendicular to the waves.
 - (2) Crews must keep their weight well to the rear after entering the surf.
 - (3) Paddlers do not look seaward.
 - (4) Crew debarks using the short count or beaching method.
 - (5) Crew holds onto the boat until it is out of the water.
- c. Ship to shore operations:
- (1) This ship to shore operation is one by which assault boats are launched from an LCM as a means of inserting soldiers from a body of water to a beach.

- (2) Abbreviations used:
- (a) Primary Control Officer (PCO).
 - (b) Secondary Control Officer (SCO).
 - (c) Safety Officer (SO).
 - (d) Landing Force Commander (LFC).
 - (e) Mission Commander (MC).
 - (f) Assistant Mission Commander (AMC).
 - (g) Assault Boat Commander (ABC).
 - (h) Landing Craft Mechanized (LCM).
 - (i) Final Coordination Line (FCL).
- (3) Characteristics, Duties and Responsibilities:
- (a) Primary Control Officer (PCO):
1. Overall in charge of operation.
 2. Ranking individual from the transportation company.
 3. Is not a member of the LCM crew.
 4. Stays with the lead LCM.
 5. Controls all LCM operations (to include safety boats).
 6. Selects the release point and drops the "No Earlier Than" marker, once the SCO has radioed that the "No Earlier Than" marker has been reached by the trail LCM, the PCO will cease movement, drop the NLT marker, and prepare to launch the assault boats.
 7. Obtains surf/beach conditions and Go/No Go recommendations from Safety Officer and Operations Staff prior to authorizing the LFC to launch boats.
 8. Directs launching of assault boats.
 9. Maintains FM communications on the boat control net with the Operations Staff, Safety Boats, and SCO.
- (b) Secondary Control Officer (SCO):
1. Provided by the Transportation Company (every LCM will have a SCO except the lead LCM).
 2. Grade of E5 or above.
 3. Not a member of LCM crew.
 4. Maintains FM communications with PCO, Operations Staff, and Safety Boat.
 5. Is prepared to assume duties of PCO.
 6. Controls all operations of LCM on which embarked as directed by PCO.

7. Keeps LCM 400 meters to rear of lead LCM conducting maneuver operations until directed by the PCO to move to release point. Radios the PCO once his LCM has reached the "No Earlier Than" marker. At this point the trail LCM will stop and prepare to launch assault boats. After releasing assault boats upon PCO order, moves back 400 meters to rear of lead LCM.

(c) Safety Boats:

1. Provided by unit conducting operation.
 2. Is the last boat loaded on the lead LCM.
 3. Is the first boat off loaded at the boat release point.
 4. Positions itself between the lead and trail LCM once off-loaded at the boat release point.
 5. Rescues personnel in water, as directed by PCO.
 6. Spots and marks area where equipment is lost.
 7. Maintains FM communications with the PCO, SCD, and Operations Staff.
- B. Safety boat kit will consist of the followings:

- (a) One PRC 77, complete (waterproofed)
- (b) One Motorola.
- (c) One first aid kit.
- (d) Three red star clusters.
- (e) Five parachute illumination flares.
- (f) Five chemical lights.
- (g) One spotlight.
- (h) One marker buoy with 40 feet of line.
- (i) One life ring and 60 feet of line.
- (j) Two anchors with line.
- (k) One list of call signs and frequencies.
- (l) Two marker floats to use as "NET/NLT" buoys.

NOTE: Unit provides safety swimmer.

(d) Landing Force Commander:

1. Provided by unit conducting operations.
2. Co-locates with PCO.
3. Controls operations of all mission force.
4. Informs PCO when all assault boats are ready for launch.
5. Directs MC to launch assault boats once authorized by PCO.
6. Remains with LCM throughout exercise.
7. Maintains FM communications via TAC Net with each MC and with the Operations Staff.

(e) Mission Commander:

1. Provided by unit conducting operation.
2. Overall responsible for the tactical mission of his element.
3. Maintains FM communications via TAC Net with the LFC and Operations Staff.
4. Supervises the inspection conducted by Assault Boat Commander, for each member of the force, uniform, equipment, weapons, life vests and rigging of assault boats prior to LCM debarkation.
5. Gives list of all personnel by assault boat number to the LFC prior to LCM debarkation.

(f) Assistant Mission Commander:

1. Provided by unit conducting operation.
2. Prepared to assume all duties of MC.
3. Maintains visual contact with MC during conduct of all boat operations.
4. Occupies last assault boat off LCM.
5. Monitors TAC Net and assumes MC mission, if MC is unable to perform his mission.

(g) Assault Boat Commander/Coxswain:

1. Squad Leader/Platoon Leader.
2. Controls all operations of his assault boat.
3. Supervises and inspects each member of his assault crew for uniform, equipment, weapons and life vests, prior to debarkation of LCM.
4. Ensures all equipment is secured properly to the assault boat prior to debarkation of LCM.
5. Informs MC when ready to launch from LCM.
6. Launches on direction of MC.

7. Maintains visual/voice contact with MC.
8. Notifies MC upon reaching FCL.
9. In an emergency situation, directs immediate actions required to maintain control of his assault boat and save the life of any crew member verboard.

(h) Safety Officer (SO):

1. Provided by unit conducting operation.
2. Is a commissioned officer or NCO.
3. Co-locates with the Operations Staff/

Navigation Team.

4. Makes the overall decision in matters concerning safety.

(i) Operations Staff/Navigation Team:

1. Provided by unit conducting operation.
2. Consists of the S-3, 2 Asst's, and a

RATELO.

3. Maintains FM communications with PCO, SCQ, Safety Boat via Boat Control Net.

4. Provides an estimate of beach and surf conditions to the PCO via Boat Control Net.

5. Reports any unsafe acts/hazardous conditions to PCO via Control Net.

6. Controls medics.

7. Marks the beach landing site with appropriate markers.

(4) Concept of Operation. A coordination meeting involving all participating units will be conducted prior to the start of ship to shore operations. Attendance of the Landing Force Commander, Primary and Secondary Control Officers from the Transportation Company and the Operations Staff is mandatory. During this meeting aspects of the operation will be discussed and finalized. On the day of the operation, the S-3 will check with the S-4 to ensure the proper number of boats, life vests and equipment have been drawn. The assault boats will be rigged under the supervision of unit cadre. Rigged boats will report to the Land Force Commander when they are ready for loading on the LCMs. The Landing Force Commander will inform the Primary Control Officer, who will give the Landing

Force Commander permission to load them on the LCMs. The Primary Control Officer is ultimately in charge of all operations during LCM movement. Upon reaching the release point, the Landing Force Commander, with the Mission Commanders will report that assault boats are ready to launch. The Primary Control Officer will also receive a GO report from the Operations Staff, Safety Boat and Secondary Control Officers via the Control Net. Upon agreement of a GO status from all three parties (Secondary Control Officer, Safety Boat and Operations Staff), the Primary Control Officer will then direct the Landing Force Commander to launch the assault boats. When the LCM ramp is lowered, the Mission Commander will direct the off-loading of all assault boats. Once all the boats are launched, the Primary Control Officer remains in control until the assault boats have passed the Final Coordination Line (FCL). At this time, control is passed to the Landing Force Commander. The Mission Commander is responsible for his assigned assault boats throughout the operation.

(5) LCM

(a) While soldiers are moving around the ramp of the LCM, extreme caution will be taken to avoid the ramp retaining chains. Ramp retaining logs will be present before any LCM operations commence. (Retaining logs fill in the gap between the Ramp and Cargo Deck).

(b) Any individual who falls off the ramp will immediately swim away from the ramp and wait for a life ring to be thrown or an assault boat to be launched. If the assault boat is already in the water, individual will attempt to reenter the assault boat, not the LCM. When approaching the LCM, either swimming, floating or in a boat, avoid the rear of the LCM due to the propeller and suction.

(c) In an emergency situation, instructions will be provided by the LCM commander.

(6) Assault Boat Operations:

(a) Assault Boat Commander (ABC) must be familiar with crew drill. The ABC must be able to steer the assault boat. Nobody in the boat should say anything except the ABC.

(b) The ABC in an emergency situation, directs immediate actions required to maintain control of his assault boat and to save the life of any crew member overboard.

(c) Assault Boat Instructions:

1. No more than one foot of the bow of the assault boat should be on the ramp of the LCM during launching. The assault boat must remain perpendicular to the ramp at all times. Loading must be accomplished using the long count method, in an orderly manner and as quickly as possible. Again, all individuals will load from the bow and will stay low in the boat and maintain three points of contact.

2. When paddling with the waves, the weight should be toward the rear; when paddling against the waves, the weight should be well forward. The boat should always be perpendicular to the waves.

3. Breakers indicate a reef or shallow water. Reefs should be avoided whenever possible. Reefs are very sharp and could injure individuals, or puncture the boat causing capsizing.

4. When it is evident that a reef cannot be avoided, land the assault boat on the reef, disembark, hold onto the boat and walk it across the reef.

5. Pair off crew in buddy teams with a weak and strong swimmer paired together. Two weak swimmers will not be paired together for any reason. Neither will radio operators and crew-served weapon crews be paired together.

(7) Capsizing:

(a) If the boat capsizes, a head count (long count) must be rendered immediately by all crew members. If conditions prevent the boat from being uprighted, all personnel will hold onto the sides (any injured soldier will be placed on top) and signal for assistance. Following a headcount, if anyone is missing, all personnel along the sides of the boat will attempt to feel with their feet and hands for trapped personnel underneath.

simultaneously. The individual(s) trapped will move hand-over-hand underneath the boat until free. Immediately after being picked up or arriving on shore, another headcount and inventory of equipment will be made. Any shortages will be reported to the next higher commander immediately. In the event the boat is capsized near the shore and the surf is breaking (white water waves), do not attempt to upright the boat; instead have each man hold onto the boat and float with it to shore. The boat should be kept between the reef and personnel as a "buffer".

(b) If an assault boat capsizes close to an LCM, personnel will be instructed not to swim toward the LCM ramp. They will observe normal capsize procedures. If an individual soldier falls into the water close to the LCM, he too will be instructed to stay away from the LCM ramp and wait for assistance.

(c) If the boat capsizes prior to the FCL, the PCO will attempt to assist the crew with either the LCM or Safety Boat.

(d) The MC will direct other assault boats to assist capsized crews if it is feasible and/or other boats that are in the proximity.

(e) Once the assault boats have passed the FCL and due to circumstances, the MC is unable to provide assistance, crew members will hold onto the sides of the boat and ride the waves to the beach. The LFC will direct all emergency actions beyond the FCL.

(8) Abort Procedures (Contingency and Emergency Signals):

(a) A verbal BO from three sources (PCO, LFC's, and Operations Staff) is required for approval to launch the assault boats from the LCM. Each BO must have approval from the PCO.

(b) FM communications between PCO and SCO, as well as between PCO and Operations Staff on shore is required prior to approval to launch.

(c) Emergency signal to stop all action at night is a red star cluster; backup will be shore "blackout" of initial guide light. Illumination will be available on call when possible.

(d) Emergency signal to stop all action during day is red star cluster; backup with a red panel.

(9) Abort Identifiers:

(a) If the safety boat operator cannot safely move from the lagoon into the open sea to the release point, he will notify the PCD and on order from the PCD, moves to a designated alternate site.

(b) If the LCM ramp, when lowered, leaves the water more than one-foot the PCD will be given a NO-GO for launching assault boats from the LCM.

(c) Thunderstorms within five miles and moving towards launch site.

(10) Assault Boat Actions Upon Abort:

(a) All operations will immediately STOP and assault boats will cease to be off-loaded from the LCM.

(b) Boats enroute to the FCL will return to the LCM.

(c) Boats beyond the FCL will move to the beach landing site, or upon verbal command from their MC or LFC will execute new instructions.

CHAPTER TEN

MILITARY MOUNTAINEERING

10-1. GENERAL. The success of a unit operating in mountainous terrain depends on its ability to use a number of skills in overcoming a great variety of obstacles. These include knot tying, constructing rope installations, mountain evacuation, rappelling, and mountain climbing techniques on rock, snow and ice.

10-2. SPECIAL EQUIPMENT:

a. Ropes:

(1) Ropes are intended to provide security for climbers and equipment in operations involving steep ascents and descents. It is also used for establishing rope installations and hauling equipment.

(2) Selection. Nylon laid ropes are normally used for military mountaineering (climbing/rappelling/installations) vs. kernmantle.

(a) Should be selected/cut based on mission and intended use.

(b) Impact force (the jerk on a climber caused by a fall) should be low.

(c) Elasticity (stretch) should be considered (dynamic vs. static ropes for ascending and descending).

(d) Weight should be considered (rope length and diameter).

(e) Versatility and multi-use ropes should be selected.

(f) Know the tensile strengths and characteristics/capabilities of the rope you select.

(3) Care of Ropes:

(a) Inspect ropes thoroughly before, during, and after use for cuts, excessive fraying, abrasions, mildew, soft and worn spots.

(b) When wet, hang rope to drip dry on a rounded peg, at room temperature (do not apply heat).

(c) Do not step on rope or drag on ground unnecessarily.

(d) Avoid running ropes over sharp or rough edges (pad if necessary).

(e) Keep the rope away from oil, acids, and other corrosive substances.

(f) Avoid rubbing ropes together under tension (i.e., nylon to nylon friction will harm the rope).

(g) Do not leave rope knotted or tightly stretched longer than necessary.

(h) Clean in cool water, loosely coil and hang to dry (out of direct sunlight, since ultraviolet light rays harm the synthetic fibers). Store in a cool, dry, shaded area on pegs.

b. Nylon Webbing:

(1) Used for making runners, striders (stirrups) and other general purpose slings. Flat or tubular nylon webbing is either 7/16 inch or 1 inch wide.

(2) Care:

(a) Cut with a hot knife to fuse the ends to prevent fraying.

(b) Keep away from oil, acids, and other corrosive substances.

(c) Inspect before, during, and after use for fraying, cuts, and excess dirt.

(d) Clean in cool water, air dry, and store in a cool dry area out of direct sunlight.

c. Snaplinks:

(1) Snaplinks are metal devices used to attach a climbing rope to protection, conducting rappels, and erecting rope installations for the movement of men and equipment in mountainous terrain.

(2) Know characteristics of snaplink selected.

Steel, aluminum, chromemolybdenum, or steel alloys; oval, D-shape, modified D-shape, pear shape. Locking and non-locking gate snaplinks.

(3) Check gate for safety and proper locking.

Check the threads and locking nut on locking snaplinks.

(4) Correctly position to prevent accidental opening of gate. Single vs. multiple snaplink employment.

(5) Inspect before, during, and after use for cracks, burrs, grooves, and defects. Remove all rust with steel wool. Use dry graphite on hinges and moving parts. Store in a dry area when not in use.

d. Pitons:

(1) A well placed piton can withstand a force of several hundred pounds (wafer) to more than 2,000 pounds (angle). Advantage over chocks is that pitons provide for an omnidirectional pull, and are well-suited for anchors and rope installations. Piton placements can be extended by attaching runners (utility ropes or nylon webbing). Insert a snaplink through the eye of the piton.

(2) Types:

(a) Vertical - for narrow vertical cracks.

(b) Horizontal - for narrow horizontal cracks.

(c) Angle - for wide deep cracks.

(d) Wafer - for small shallow cracks.

(3) Use. Test the rock to determine if it is suitable. Select the appropriate size piton and insert it into the crack. Hammer the piton into the rock. Test by pulling up, down, sideways and out with increasing weight. Several pitons can be stacked on top of each other to fit the crack structure.

e. Piton Hammers:

(1) Use:

(a) Driving and removing pitons.

(b) Testing rock (avoid hollow or rotten rock).

(c) Cleaning out cracks of dirt and debris.

(d) Chipping rock or ice.

(2) Always secure hammer to person with lanyard before starting the climb.

f. Chocks:

(1) Chocks are angled metal stoppers which are used to provide artificial protection when climbing, rappelling, erecting rope installations and replacing security. A well placed chock is quicker and easier to replace than pitons, and are well suited for assault climbing.

(2) Types:

(a) Hexagonal - Six sides in a variety of sizes for a wide variety of small to immediate crack structures.

(b) Wired stoppers - These are the smallest chocks and are tapered at the ends to wedge into small cracks. Comes in a variety of sizes.

(c) Cammed chocks.

(1) Half moon shaped, wired and looped chocks come in a variety of sizes and are well suited for small to intermediate placements.

(2) Mechanical spring activated camming devices can be employed easily with one hand, and are easy to retrieve.

(3) Use. Chocks, by nature, provide protection for a single direction of pull. Placing chocks in opposition gives additional security when the lead climber passes a chock placement. Insert a proper size chock into the crack and rotate so that at least two sides are wedged into the crack. Test by pulling up, down, sideways and out with increasing weight. Retrieve by pushing in and turning side to side or up and down. Well wedged chocks may require tapping out with a piton hammer.

10-3. KNOTS:

a. Joining knots (knots to tie ends of ropes together).

(1) Square knot - Two interlocking bights, running ends exit on same side of standing portions of rope, 180 degrees away from each other. Each running end half hitched (or tied with overhand knots with kernmantle ropes) to standing part of rope (figure 10-1).



Figure 10-1. Square knot

(a) Used to tie ropes of equal diameter together.

(b) Always secured to the rope (with half hitches or overhand knots).

(2) Double sheet bend - Two wraps securing a bight held in place by a locking bar. The two standing parts form an "L" and exit the knot at a 90 degree angle from each other. Used to tie ropes of equal or unequal diameter together; or to tie several ropes to one rope (figure 10-2).

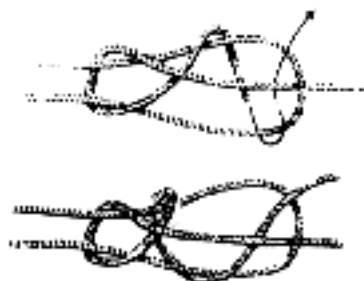

Figure 10-2. Double sheet bend

b. Anchor knots:

(1) Bowline - Round turn with a bowline is the preferred knot for anchoring systems. Bight secured by loop with half hitch (or overhand knot), 4 to 6 inch tail (figure 10-3).



Figure 10-3. Bowline

NOTE: All bowlines must be completed with a half hitch or overhand knot (Kernmantle ropes).

(2) Round Turn with two half hitches - Used to tie the end of a rope to an anchor, and it must have constant tension. Two wraps that do not cross, secured by two half hitches on the standing part of rope. More than six inch tail remaining. Used with tension applied at all times (figure 10-4).

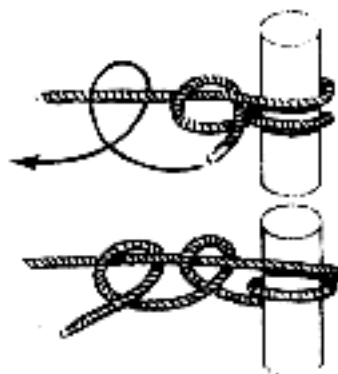

Figure 10-4. Round turn w/2 half-hitches

(3) Clove Hitch - Two wraps around the anchor which do not cross secured by locking bar facing 90 degrees in the direction of pull, with more than a 6 inch tail remaining. Running ends exit knot 180 degrees apart. Used as an anchor knot in the middle or at the end of the rope. This knot must have constant tension, once tied, to prevent slipping (figure 10-5).

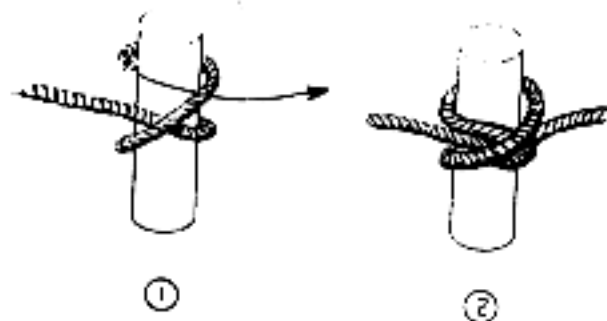

Figure 10-5. Clove hitch

c. Special Knots.

(1) Butterfly - Forms a single fixed loop in the middle of a rope. The wings of the knot must be dressed down tightly and close together. The ropes between the wings must be parallel with no cross over. The loop should be large enough to accept a snaplink. All ropes in the knot must be tightly dressed (figure 10-6).

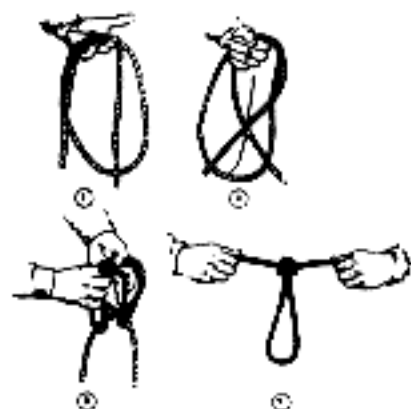

Figure 10-6. Butterfly

(2) Wireman's Knot - Forms a directional single fixed loop in the middle of a rope used in a transport tightening system. Four separate interlocking bights locking down on themselves, with a fixed loop exiting from the top of the knot, and laying back toward the near side anchor point (figure 10-7).



Figure 10-7. Wireman's knot

(3) Bowline on a bight - Forms two fixed loops in the middle of a rope. Two fixed loops that will not slip, no twists in the knot, and a double loop locked in place by a bight (figure 10-8).



Figure 10-8. Bowline on a bight

(4) Prusik (end of rope) - Used to put a moveable knot on a fixed rope so that the knot will lock down or secure itself to the rope passing through the knot. Four wraps secured by locking bar. The knot is tight and dressed down with no ropes twisted or crossed. The knot is secured with a bowline 4-6 inches from the prusik (figure 10-9).

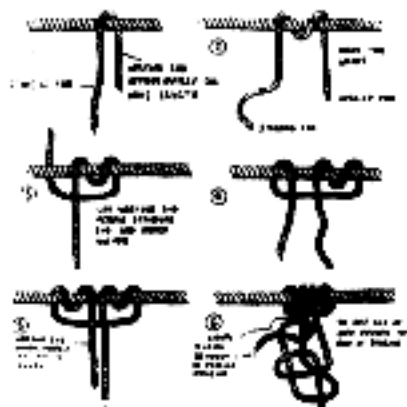

Figure 10-9. End of rope prusik.

(5) Prusik (middle of rope) - Used to put a moveable knot on a fixed rope. Four wraps secured by locking bar. The knot is tight and dressed down with no ropes twisted or crossed. The knot is secured with an overhand knot 4-6 inches from the prusik (figure 10-10).

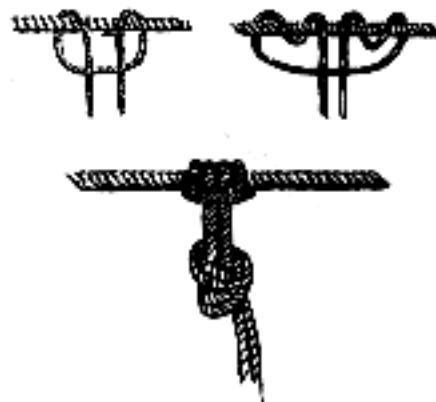

Figure 10-10. Middle of the rope prusik

(6) Three loop bowline - Used to form three fixed loops in the middle of a rope. Rope is doubled (use bight to form knot). Double bights, secured by double loops. No half hitch, three loops same diameter (figure 10-11).

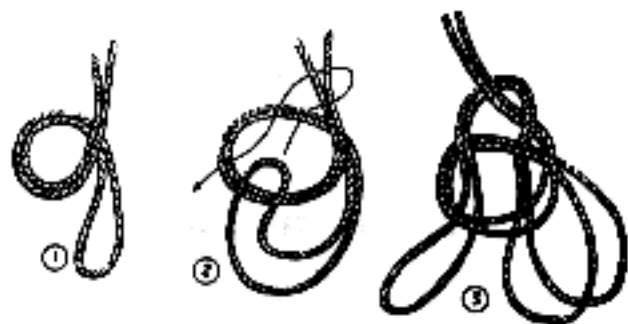

Figure 10-11. Three loop bowline

(7) Bowline on a coil - Used by climbers in party climbing when harnesses are not available. Four to six parallel wraps around the body (above the hips and below the ribs). The top and bottom ropes cross forward of the hips. The loop must be under all wraps. The parallel wraps are visible through the bight. Half hitch on the top rope (figure 10-12).

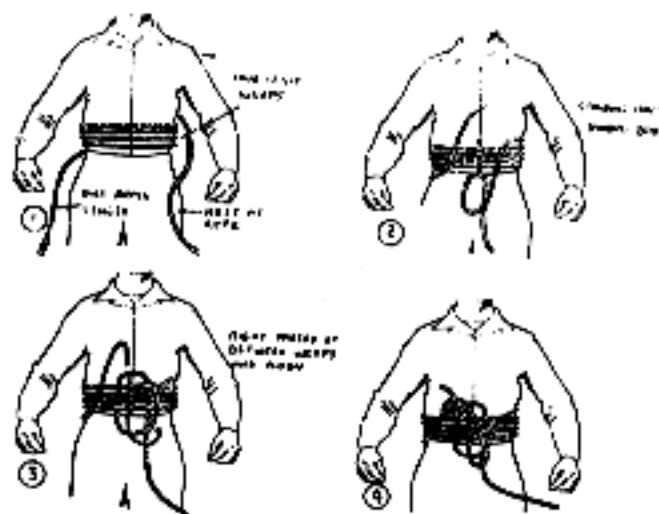

Figure 10-12. Bowline on a coil

(B) Munter hitch - Used for rappelling or in a mechanical belay. Loop laid alongside a bight forming two parallel "windows." Snaplink through windows (figure 10-13).

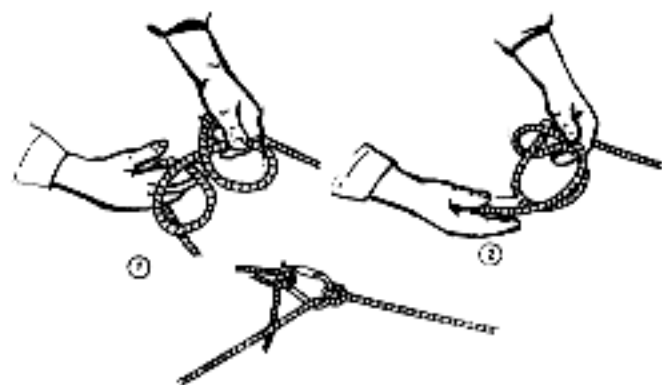

Figure 10-13. Munter hitch

d. Tightening systems:

(1) Transport tightening system. Tie a fixed loop knot (wireman's knot) on the near side, insert a snaplink into the loop. Route the rope around the near side anchor. Insert the rope running around the nearside anchor into the snaplink. The wireman's knot is tied far enough in front of the nearside anchor to allow for tightening of the rope, or the wireman's knot can be pulled away from the nearside anchor by the far side team. Secure the far side anchor point with a round turn and two half hitches. The near side pulling team pulls all slack out of the rope and ties off the rope behind the wireman's knot with two half hitches on a bight.

(2) Prusik tightening system. Same as transport tightening system except, tie a finger prusik into the loop of the wireman's knot. Insert a snaplink into the top bight of the wireman's knot (not the loop). Route the rope running around the near side anchor through the finger prusik, and clip the rope into the snaplink. Pull on the rope and slide the finger prusik back as required. Tie off to an offset anchor point (figure 10-14).

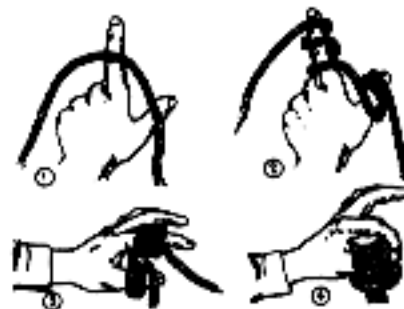

Figure 10-14. Finger prusik.

10-4. MOUNTAIN WALKING TECHNIQUES:

a. Mountain walking is divided into four techniques dependent upon the general formation of the terrain: walking on hard ground, grassy slopes, scree slopes, and talus slopes.

b. Proper Technique. Applies to all mountain walking techniques.

- (1) Weight centered over feet at all times.
- (2) Maintain as much boot sole-to-ground surface contact as possible.
- (3) Straighten the trail knee after each step to rest the leg muscle.
- (4) Keep a slow rhythmic pace maintaining good balance taking small steps.
- (5) Use all available hand and footholds.
- (6) Normal progression as the slope steepens would be from walking straight up the slope, to a herring bone step (toes point out), and then to a traverse (zig zag pattern) on the steeper areas.
- (7) On steep or slippery slopes, climbers should use a roped party climb to increase mutual safety.

c. Walking on hard ground. Hard ground is firmly packed dirt that does not give way under the weight of the soldier's step.

- (1) Ascending
 - (a) Steep slopes are traversed rather than walked straight up.
 - (b) In traversing, the full sole (boot) principle is accomplished by rolling the ankle away from the hill on each step.
 - (c) For small stretches, the herring bone step may be used---ascending straight up with the toes pointed out.
- (2) Descending
 - (a) The soldier walks straight down the slope without traversing.
 - (b) Keep the back straight and the knees bent.

d. Grassy slopes. Grassy slopes are usually composed of small tussocks of growth rather than one continuous field.

(1) Ascending. The upper side of each hummock or tussock is stepped on where the ground is more level.

(2) Descending. It is best to traverse because of the uneven nature of the ground.

(3) Traversing. The uphill foot points in the direction of travel. The downhill foot points about 45 degrees off the direction of travel.

e. Scree slopes. Scree slopes consist of small rocks and gravel that vary in size from grains of sand to that the size of a fist. It may occur as a mixture of all sizes, but usually scree slopes consist of the same size particles.

- (1) Ascending.
 - (a) Kick in with the toe of the upper foot so that a step is forced in the scree.
 - (b) Weight is transferred from the lower to the upper foot, and the process is repeated.
- (2) Descending.
 - (a) Descend scree slopes straight down using a short shuffling step with the knees bent, back straight and feet pointed downhill.
 - (b) When several climbers descend a scree slope, together, they should be as close together as possible, one behind the other, to prevent injury from a dislodged rock.
 - (c) Avoid running down a scree slope to avoid loss of control.
 - (d) Caution is used when the bottom of the route cannot be seen since drop-offs may be encountered.

f. Talus slopes. Talus slopes are formed by the accumulation of rock debris which are larger than a man's fist. When ascending or descending, ALWAYS step on the top of and on the uphill side of the rock. Avoid dislodging rocks which may cause a rockslide. Climbers must stay in close columns while traversing.

g. Rockfall is the most common mountaineering hazard. The mountain walking techniques discussed above are designed to reduce the likelihood of rockfall. Whenever rock, debris, or equipment falls, the warning "Rock" or "Equipment" is shouted. Personnel below immediately lean into the cliff to reduce their exposure, and do not look up.

h. Route Selection.

(1) Considerations.

- (a) Tactical considerations.
- (b) Time element.
- (c) Skill, condition, and number of soldiers involved.
- (d) Equipment available.
- (e) Support required.
- (f) Effects of weather and difficulty of terrain.

(2) Scope.

- (a) Map and photo reconnaissance.
- (b) Aerial reconnaissance.
- (c) Ground reconnaissance.
 - (1) Approach. Scan routes with binoculars/ODs. Identify primary and alternate routes for ascents and descents.
 - (2) Type of terrain, nature of difficulty.
 - (3) Belay and anchor positions.
 - (4) OKDCDA
 - (5) Special equipment needed.
 - (6) Dangers from weather changes.
 - (7) Tactical considerations (security through overwatch positions).

10-5. ANCHORS.

a. Natural anchors.

- (1) Trees - sufficient size, well rooted.
- (2) Rock-nubbins, tunnels, and chockstones check for firmness, avoid sharp edges.

b. Artificial Anchors.

- (1) Deadman
- (2) Picket holdfast
- (3) Three or four piton anchor
- (4) Bolts with carriers
- (5) Well placed chocks

10-6. ROCK CLIMBING TECHNIQUES.

a. Balance climbing.

- (1) Techniques

- (a) Weight centered over the feet
- (b) Feet and legs carry weight
- (c) Hands mainly for balance
- (d) As much boot sole as possible in contact with the rock.
- (e) Keep handholds low, between waist and shoulder height. This position aids the desired upright, balanced position and gives maximum rest for the arms.
- (f) Keep the body out and away from rock to counter the gravitational pull on the body.
- (g) Three points of contact with rock (i.e., 2 hands and 1 foot, or 2 feet and 1 hand).
- (h) Relaxed slow rhythmic and deliberate motions.
 - (1) Plan route two or three moves ahead.
 - (j) Use all available hand and footholds. Avoid over stretching and thus ending in a spread eagle position.

- (k) In ascent,
 - (1) Face sideways - climbing easy to difficult.

- (e) Face inward - climbing more difficult.

(2) In descent:

- (a) Face out - climbing very easy, not steep.
- (b) Face sideways - climbing easy to difficult.
- (c) Face inward - climbing more difficult, very steep.

(3) Types of holds. Holds need not be large to be safe. Plan each move in advance, knowing exactly where the hands and feet are going to be placed. All hand and foot holds are tested before use by gradually applying weight.

(a) Footholds.

- (1) Step
- (2) Friction
- (3) Jam
- (4) Cross pressure

(b) Handholds.

- (1) Pull
- (2) Push
- (3) Pinch
- (4) Jam
- (5) Friction
- (6) Cross pressure (inward or outward pressure)

(c) Combination. Use combinations and variations of the previously mentioned hand and foot holds.

- (1) Lie back
- (2) Chimney
- (3) Cross pressure (inward or outward pressure)
- (4) Inverted pull or push (undercling)
- (5) Manteling
- (6) Change step, transfer body weight only when necessary using hop-skip.

(d) Variations.

(1) Slab. A smooth portion of rock, laying at an angle.

- (a) Full sole to surface contact to increase balance and friction of the foot.
 - (b) Use all irregularities in rock.
 - (c) Point lower foot downhill in traversing.
 - (d) Upper foot pointed in direction of movement.
 - (e) Stand erect, maintain balance and control.
 - (f) Keep moving in a rhythmic pace.
- (2) Crab walk, facing away from the slope squatting over feet and hands when ascending, traversing, or descending slopes. The weight is evenly maintained over the hands and feet. This technique relies mainly on friction.
- (3) Shoulder stand.
- (a) Lower man well braced.
 - (b) Lower man anchored (roped in).
 - (c) Climber uses the lower man's body as a ladder to overcome a difficult section.

(4) Precautions.

- (a) Margin of safety. Stay within individual abilities.
 - (b) Use roped party climbs as the slope steepens and difficulty increases.
 - (c) Plan entire route - prevents getting "stuck."
 - (d) Avoid overstretching, i.e., "spread eagle" position.
 - (e) Avoid "hugging" the rock.
 - (f) Loose rock is tested before placing weight on it.
 - (g) Avoid using knees, elbows, and buttocks.
 - (h) Do not dislodge rocks intentionally. Vocal signal "rock" when causing rock to fall. (When in a non-tactical situation).
 - (i) Never climb alone or expose yourself unnecessarily.
 - (j) Do not jump or lunge to reach a hold.
 - (k) Avoid wet rock.
 - (l) Clean boot sole (cleats) before climbing.
 - (m) Do not use vegetation or artificial protection foot and hand holds. Do not use snaplinks as hand holds.
 - (n) Avoid wearing gloves when climbing.
 - (o) Remove jewelry from the hands before climbing.
 - (p) When a climber falls, should the warning "falling" to signal the belayman and to warn climbers below.
- b. Belays - Belaying.
- (1) Procedure (all body belays).
 - (a) Tie a safety line (bowline around the waist with an end-of-the-rope bowline with snaplink inserted) and hook the snaplink into an anchor point.
 - (b) Backfeed the climbing rope so it will run freely through the brake hand to the climber.
 - (c) Place the climbing rope through guide hand around body to brake hand; make sure rope will slide freely.

(d) Never allow braking hand to go forward of guide hand when taking up rope, nor to release the grasp of the climbing rope.

(e) Anticipate climber's needs.

(f) Do not allow excessive slack to accumulate between the belaymen and climber.

(g) Prepare for the climber's fall by keeping the body braced and head and eyes on the climber in the direction of pull. The guide hand should be on the uphill side of the slope.

(2) Types of Belay:

(a) Static - Does not allow rope to run through brake hand when climber falls.

(b) Dynamic - Allows rope to run through brake hand, apply braking action slowly bringing the descent to a slow, smooth stop. Gloves are worn with all dynamic belays (i.e., suspension traverse).

(3) Belay positions:

(a) Sitting hip belay.

- Normally the most secure position, or a downward pull.
- Legs well braced; straight if possible.
- The climbing rope passes between the belayer's feet.
- Rope placed over hips, around small of back above the safety line.
- The guide hand controls the rope and is held in front of the body with the elbow extended and locked. The grasp on the rope is loose to allow the rope to flow freely through the guide hand.
- The brake hand is used to regulate descent. To brake, the climbing rope is grasped firmly and placed on the guide hand shoulder (the hollow portion of the shoulder).
- If slack is desired, the guide hand is relaxed and the brake hand is extended out to the side.
- To take up slack rope, the brake hand pulls the rope out to the side (arm extended) and lays the rope into the guide hand. The brake hand never moving forward of the guide hand slides back to the brake hand side hip. The process is repeated.

(b) Standing Hip Belay.

(4) Downward pull.

(a) Used only when a sitting hip belay is not possible.

(b) Belayer is secured to an anchor with the safety line.

(c) Legs are positioned shoulder width apart with the guide hand leg well braced and forward with the knee slightly bent. The brake hand leg is the trail leg with the knee slightly bent.

(d) The back is straight with the head and eyes on the climber in the direction of pull.

(e) The rope is placed around the small of the back above the safety line.

(f) The guide hand procedures are the same as for sitting hip belay.

(g) To brake, grasp the rope firmly and place the brake hand to the hollow portion of the guide hand side shoulder.

(h) Up rope - same as for sitting hip belay.

(2) Upward Pull.

(a) Same as standing hip belay for a downward pull (b) through (d) above.

(b) Signal from the climber, "belay for piton" to signal a change in direction of pull.

(c) Belayer signals "off belay" (changes climbing rope to suit the direction of pull) and signals "on belay."

(d) The climbing rope is placed beneath the buttocks cheeks and below the safety line.

(e) Guide hand - same as for sitting hip belay.

(f) To brake, grasp the ropes firmly and place the brake hand to the hollow portion of the guide hand side hip.

(g) Up rope - same as for sitting hip belay.

(h) Rock or tree belay.

(i) Use of rock projections or trees for intermediate anchor points, instead of a piton.

- (7) Same procedure as for (b) 2 above.
 (8) Belayer signals "belay for rock or tree."
 c. Party Climbing (roped).

(1) General.

- (a) Only one man climbs at a time.
 (b) Do not climb until so ordered by your belayman.
 (c) Do not outclimb your rope or overclimb the belayman's ability to take up slack rope.
 (d) Employ all the techniques of balance climbing.
 (e) Route selection (ability, margin of safety).
 (f) Rope Commands.

Belayman	Climber
On Belay Test	Testing
On Belay	
Climb	Climbing
Belay for Piton/Rock	
Up Rope	
Slack	
Rock/Equipment	Rock/Equipment
Falling	
Tension	
Six Meters	
Off Belay	

- (g) Determination of equipment needed.

(2) Equipment.

- (a) Climbing rope.
 (b) Slings rope/runners/webbing.
 (c) Snaplinks (as required).
 (d) Pitons (as required).
 (e) Piton hammer.
 (f) Chocks (as required).
 (g) Harness (if available).

(3) Two-man party.

- (a) Tying in.
 - Leader (best qualified) bowline on a coil or bowline around the waist (if harness is not available).

- Second man (least qualified) bowline on a coil or bowline around the waist (if harness is not available).

(b) Sequence

- No. 1 (leader) climbs belayed by No. 2 (belayman). The leader replaces protection (piton or chock) as required.
 - No. 2 (second man) climbs (belayed by No. 1). Joins No. 1. No. 2 clears the pitch of all hardware (pitons, chocks and snaplinks) as he climbs.
 - No. 1 climbs (belayed by No. 2).
 - Same procedure repeated.

- (c) When both climbers are of equal ability No. 2 may continue to climb, belayed by No. 1, in alternating lead (leap frog method).

d. Rappelling.

(1) Selection of a rappel point.

- (a) Select proper rappel point, close to edge if possible (natural or artificial anchor).
 (b) Rappel anchor higher than landing platform if possible.
 (c) Test anchor for safety and retrievability of rope. If possible, tie a secondary anchor point.
 (d) Remove loose rocks or other obstacles from the rappel platform as well as rappel lane/route.
 (e) Avoid rope running over sharp edges, pad the edge if necessary.
 (f) Ensure rope reaches bottom, or a good unloading platform and further progress is possible. Tie the two ends of the rope together at the bottom of the rappel lane if the length is doubtful.

(2) Method of Tying Off.

- (a) A rappel lane should have equal tension between all anchor points. Establish primary and secondary anchor points. The rappel rope should not extend if one anchor point fails.
 (b) The method of tying off the rappel lane will depend upon the availability and quantity of natural or artificial anchors.
 - Four piton anchor system. Tie off with a 3-loop bowline.

- Three Piton anchor system. Tie off with a bowline on a bight.
- Single fixed anchor point. Tie off with a round turn anchor bowline.
- Whenever possible tie off the rappel line to a primary and an alternate anchor point.

(3) Seat hip rappel

- (a) Tie rappel seat (figure 10-15).



Figure 10-15. Rappel seat.

- Place center of sling rope on hip opposite brake hand.
- Bring one end of the sling rope around the back of the waist, tie two overhand wraps above the belt buckle.
- Ends of rope brought between legs without crossing under the buttocks cheeks; passed over the rope around the waist, to form a half hitch on each hip. Bring the ends of the rope to the side opposite the brake hand and tie with a square knot and two half hitches.
- Place snaplink through single rope around waist and through two ropes forming the overhand wraps.
- Snaplink is rotated one-half turn so gate opens down and away from body.

(b) Execution of Rappel.

- Stand on one side of rope; so the square knot faces the anchor point.
- Place doubled rope into snaplink. Pull an arms length of slack between the snaplink and the anchor point.

- Make round turn around the solid shaft of the snaplink (with the rope between anchor and body).
- Rappel rope held with brake hand to the rear in the small of the back, guide hand on rope with arm extended, in front of snaplink.
- Legs straight, feet shoulder width apart; maintain a good "L" shaped body position, with the legs parallel with the ground and the back straight.
- In a walk down rappel the brake hand is kept in the small of the back. Regulate descent by opening and closing your fist.
- In a pounding rappel (always without equipment) the brake hand is moved out to the rear of the body (45 degree angle with the elbow locked) during the descent. To brake, bend the elbow and gradually grasp the rope while simultaneously moving the brake hand to the small of the back.
- Look over brake should to observe the route of descent.

(4) Seat shoulder rappel.

- (a) Tie rappel seat as in (3) (a) above.
- (b) Stand on one side of rope, face anchor point.
- (c) Snap doubled rope into snaplink.
- (d) Pick up rope behind snaplink and lay it over the shoulder and back to the opposite hand (i.e., left shoulder to right hand).
- (e) Grasp rope with brake hand, palm up.
- (f) Body position same as for seat hip rappel. Look over the brake hand shoulder while descending.
- (g) Brake by bringing brake hand across chest; to the hollow portion of the guide hand shoulder.

(5) Boddy rappel.

- (a) Face anchor; straddle rope.
- (b) Bring rope from behind, around one hip diagonally across chest; over opposite shoulder, across the back to the brake hand.
- (c) Legs apart, full sole, back straight.
- (d) Lean well out at an angle to the rock.

- (e) The rappeller leads with the brake hand pointed downhill and faces slightly sideways.
- (f) Lead with downhill foot (corresponding to the brake hand).
- (g) To brake, bring brake hand across chest and lean back to face the cliff so that the feet are horizontal to the ground.
- (h) Keep guide hand on the rope above the rappeller (uphill) for balance (not to brake).

(6) Hasty Rappel.

- (a) Face sideways to anchor.
- (b) Place rappel rope across the back.
- (c) The hand nearest the anchor is the guide hand; the downhill hand is used to brake.
- (d) Descend sideways, full sole, body is almost perpendicular to rock.
- (e) To stop, bring brake hand in front of body and turn facing anchor point.

- (7) Upon completion of all rappels, separate and clear ropes; give voice or rope signal, "off rappel."

10-7. ROPE INSTALLATIONS.

a. A-Frame.

- (1) Two sturdy poles, 8 to 10 feet long, about 4 to 6 inches in diameter.
- (2) Two 13 foot sling ropes tied together.
- (3) Tie one end of the sling rope to one Pole 2 to 3 feet below top where the apex of the A-frame will be located, with clove hitch leaving a 18 inch pigtail, with the locking portion to the outside.
- (4) Place both poles side by side and make 6 to 8 horizontal wraps around both poles, wrapping down from clove hitch. When two sling ropes are used, two locking wraps are needed below the joining knot (square knot with two half hitches).
- (5) Make 4 to 6 vertical wraps around both poles, around horizontal wraps, wrapping as tight as possible.
- (6) Tie the remaining rope to the tail of the clove hitch with a square knot secured with overhand knots. Ensure that the two ends come from opposite sides so that the clove hitch will not become unlocked.

- (7) Tie a spreader rope between poles at bottom with round turn and two half hitches (soft ground) or clove hitches (hard ground) to prevent legs from spreading. There is no slack in the rope between the legs.

b. Fixed ropes.

(1) Equipment.

- (a) Climbing rope(s).
- (b) Approximately one sling rope (or runner) for every 10 feet of the overall length of the installation.
- (c) Pitons, piton hammer.
- (d) Chocks.
- (e) Bolts, carriers, and hand drill.

(2) Establishment procedure.

- (a) Route reconnaissance.
 - Most suitable location (shelves, traverse, east of negotiation, avoiding obstacles).
 - Availability and choice of anchor points (natural and artificial).
 - Cross-overs kept to a minimum.
 - Area safe from falling rock or ice.
 - Tactical considerations.

(b) Installation.

- Two man party minimum for installation and maintenance. The leader is tied into a climbing rope which the second man belays.
- Installing from top-down.

a. Upon identification of a suitable anchor site, the installer prepares it by driving a piton, bolt, or replacing a chock. He inserts a snaplink and routes his climbing rope through the snaplink.

b. The installer continues climbing and establishing intermediate anchors (approximately one every 10 feet) until he reaches the final, uppermost anchor point at the end of the route.

c. The installer unties from the climbing rope and securely ties the rope into the upper most anchor.

d. The installer connects a snaplink from his safety line or harness into the fixed rope and down climbs to the nearest intermediate anchor.

e. Intermediate anchors are tied coming down utilizing prusik knots, figure eights, and butterflies; tightening the fixed rope from the top down (leaving slack sections where needed).

f. Installation is secured at the bottom anchor or with a transport tightening system.

(1) Installing from bottom up.

(a) Rope anchored to bottom anchor point.

(b) Intermediate anchors tied and fixed rope is tightened on way-up (slack sections where needed).

(c) Installation secured at top anchor with tightening system.

(2) Technique for negotiating the fixed rope.

(a) Use mountain walking and balance climbing techniques.

(b) One man between anchors.

(c) At least one hand on rope at all times.

Lean away from the slope holding onto the fixed rope.

g. Vertical Hauling Line.

(1) Equipment.

(a) Climbing ropes (3 minimum, anchor rope, fixed rope, and hauling rope).

(b) Sling ropes (to construct the A-frame).

(c) Snaplinks.

(d) A-frame poles.

(e) Pulley (snaplinks can be used).

(2) Establishment procedure.

(a) Selection of site.

- Suitable for anchor point.
- Natural loading and unloading platforms.
- Sufficient clearance for loads.

(b) Construction (using A-frame).

- Construct A-frame (see paragraph 10-7a above).
- Double one climbing rope to serve as the anchor rope.
- Lay a one foot bight of anchor rope over apex of A-frame.
- Clove hitch both ropes forming the bight so that the locking bars of the clove hitches are on the inside and above the A-frame lashings on A-frame poles.

- Anchor the A-frame with the anchor rope using a transport tightening system to the rear of the installation.

- Adjust the angle of the A-frame as it leans out over the cliff edge (no more than a 45 degree angle when the system is under load).

- Insert the pulley or two snaplinks, gates opposed, into the anchor rope bight.

- Hauling rope inserted into snaplinks, after tying ends together with interlocking bowlines to form endless rope.

- Butterfly knots tied in hauling line at loading and unloading platforms on opposite sides of rope. Personnel and equipment are attached to the butterfly knots.

- Knotted handling rope for personnel placed between the legs of the "A" frame, over the spreader rope and anchored to an anchor point at the top of the installation. Overhand knots spaced 8 to 10 inches apart.

- Two men are stationed at the top of the installation on the unloading platform to retrieve loads.

- A pulling team is located at the base of the installation near the loading platform to pull the load to the top.

(3) Precautions.

- Eliminate excessive friction.
- Remove obstacles.
- Monitor the entire installation (A-frame, ropes, and anchors), correct deficiencies as they are identified.

(4) Suspension traverse.

- Equipment.

(a) Static line-nylon climbing rope (double); for heavy loads and long spans.

(b) Belay rope(s); nylon climbing rope.

(c) Snaplinks.

(d) Sling ropes.

(e) A-frame (when necessary).

(5) Establishment Procedure.

(a) Selection of site.

(b) Suitable upper and lower anchors.

(b) Goods loading and unloading platforms.

(a) Sufficient clearance for loads.

(b) Construction.

- Construct an A-frame (if needed).
- Secure two climbing ropes to the top or bottom anchor (round turn and 2 half hitches).
- Place a transport tightening system in each rope at the opposite anchor. Run the static ropes around the anchor in opposite directions and tighten.
- Once the static lines are tightened, the A-frame (if needed) is positioned with the two static lines running over the apex. Anchor the legs of the A-frame.
- Take a sling rope and tie a clove hitch (locking bar to the inside) around one of the A-frame poles (above the apex). Secure each end of the clove hitch to the same static rope with prusik knots -- one forward and one to the rear of the A-frame.
- Construct a carrying rope. Join the ends of a sling rope with a square knot and two half hitches. Offset the square knot one third of the distance down and tie an overhand knot above and below the square knot.
- Attach the carrying rope to the static rope by means of the pulley or snaplinks.
- Tie a single fixed loop (butterfly or wireman's knot) in the center of a sling rope. Tie each end of the sling rope to the A-frame (below the apex) poles with a round turn and two half hitches. There is no slack in the rope and the fixed loop is centered beneath the apex. Insert a snaplink to the fixed loop.
- Attach a belay rope to the fixed loop snaplink between the A-frame poles. Tie the belay rope to the carrier with an end of the rope prusik knot.
- With a sling rope, tie a middle of the rope Prusik knot to both static ropes at the far side off-loading point, this acts as a buffer.

- Equipment or personnel are attached to the carrier.

- The load is dynamic belayed and/or pulled across, depending upon the angle of the static line and direction of movement.

(7) Precautions.

(a) Belayer in position to watch descending personnel or loads from an offset position.

(b) Loads braked before hitting buffer knot at lower anchor.

(c) Constant check of all ropes and anchors for wear.

(d) Ensure belay rope is properly back coiled to allow feeding from top of coil.

(e) Rope Bridges.

- One rope bridge.

(f) Equipment.

- Nylon climbing rope (Note: Remember that the nylon laid rope has a 1/3 stretch factor and this will affect the transport tightening system).

- Snaplink.

- Two snaplinks and one sling rope for each piece of heavy equipment to be transported.

- One sling rope and two snaplinks for each soldier.

(g) Establishment procedure.

- Select sturdy anchors on each side of stream or ravine. Ensure good on and off loading platforms are available.

- Select best swimmer to carry rope to far side. Use climber if crossing ravine.

- Tactical considerations.

- Waterproof sensitive items and equipment.

-

(h) Construction.

- Anchor on far side with suitable anchor knot (round turn and two half hitches).

- Tighten on near side using transport tightening system (see paragraph 10-3d).

- The rope should be as tight as possible and knee to waist high.

(i) Method of crossing.

- Commando Crawl.

- Tyrolean Traverse.
- One man crosses at a time.
- Two rope bridge.

(B) Equipment.

- (a) Two nylon climbing ropes.
- (b) Snaplinks (minimum of two).
- (c) Sling ropes (one per 15 feet of span to use as spreaders).
- (d) Two snaplinks and one sling rope for each piece of heavy equipment to be transported.
- (e) One sling rope and two snaplinks for each soldier.

c. Construction.

(1) Construct two one-rope bridges, one above the other approximately 3 feet apart at both anchors (chest high between top and bottom ropes).

(2) Tie spreader ropes between the top and bottom ropes every 15 feet using a round turn with two half hitches on each rope.

d. Method of use: Grip top rope with both hands, and feet on the lower rope; sidestep across. One man between spreaders; men facing in opposite directions.

e. Precautions.

- (1) Limit span to 60 feet when using the 20 foot nylon rope.
- (2) Check ropes and anchors for excessive friction and wear.

10-8. CLIFF EVACUATION.

a. Litter evacuation.

(1) Preparation of litter.

(a) Lash two sturdy skid poles (10 feet long, 3 inches in diameter) with wire or rope to bottom for litter stirrups. Poles even with litter handles to bottom end. Poles at the top of the litter will extend beyond the litter handles (approximately 2 feet).

(b) Lash spreader bars along each hinge point with wire or cord to prevent hinge joint from collapsing.

(c) Tie belay rope to head end of litter.

(2) Pass end of belay rope through one stirrup and form turn around the stirrup.

(a) Two half hitches are made around the spreader bar, one on each side of the hinged joint.

(b) Make round turn around opposite stirrup.

(c) Tie off with bowline, halfway between end of canvas and litter handles.

(d) The end thus prepared becomes the head of the litter.

(3) Lashing casualty to the litter.

(a) Two sling ropes are needed to secure the upper part of the body. Tie a bowline around the upper part of the leg (near the groin). Repeat on the other leg.

(b) The ends of the ropes are then brought diagonally across the body, under the arms, to the stirrups on the opposite side of the litter.

(c) Round turns made through each stirrup (routing the rope from inside to outside); ropes are brought across chest and tied together with square knot and two half hitches.

(d) Ends of two additional sling ropes are tied to the upper stirrups with a round turn and bowline.

(e) Ropes are brought diagonally across body to lower stirrups.

(f) Round turns made through each stirrup; ropes wrapped around both feet (wrapping from the bottom to the top of the feet), and tied together with a square knot on bottom or sides of feet.

(4) Evacuation procedure.

(a) Belayer goes "on belay."

(b) Rappellers set up two suitable rappel lanes; not more than six feet apart.

(c) The two rappellers (one right hand brake and one left hand brake) using the seat hip rappel go over the edge and rappel down approximately 8 feet, move in opposite direction to allow room for the litter, and call for "litter".

(d) Litter eased over edge to the rappellers by relayman.

(e) Litter is belayed down slowly; rappellers hold to litter handles with guide hands; stay below the litter and guide it down, calling for "slack" or "brake" from the belayer as appropriate.

(f) Lower all the way to ground and move immediately away from slope to avoid falling rocks.

b. Rappel carrier (piggy back) evacuation.

(1) Preparation.

(a) Belay rope is tied around casualty's chest with a bowline.

(b) Belayer goes "on belay."

(c) Rappeller hooks up for seat hip rappel.

(2) Lashing the casualty.

(a) Casualty straddles rappeller's back.

(b) End of the sling rope is placed on the rappeller's guide hand hip and passed under the casualty's buttocks around to the front of the rappeller and run diagonally across his chest over his guide hand shoulder, under the patient's arm pit and horizontally across his back, under the other arm pit, over the rappeller's shoulder and run diagonally across the rappeller's chest to his guide hand hip. Tie the two ends together with a square knot and two half hitches.

(3) Evacuation procedure.

(a) Rappellers braking hand goes over casualty leg with a rope passing under casualty leg.

(b) Rappeller backs over edge and executes a normal seat hip rappel.

(c) Belayman regulates the descent by providing slack or braking as required.

10-9. TREE EVACUATION.

a. Preparation.

(1) One man climbs the tree taking one end of the rope with him.

(2) He passes the rope over a branch of the tree above the position of the casualty.

(3) He then ties a bowline on a bight.

b. Lashing the casualty.

(1) Slip one loop over each thigh of the casualty.

(2) With same rope, tie a butterfly knot large enough to place over the casualty's head and chest.

c. Evacuation procedure.

(1) A man on the ground belays the casualty and lowers him from the tree.

(2) The climber can also belay the casualty from above by making a round turn around a branch or by using a snaplink above the casualty.

(3) Climber escorts the casualty during the descent and prevents his movement from being impeded by intervening limbs or branches by rappelling using a seat hip rappel.

CHAPTER ELEVEN

EVASION/SURVIVAL

11-1. **EVASION.** When you become isolated or separated in a hostile area, either as an individual or as a group, your evasion and survival skills will determine whether or not you return to friendly lines.

a. When unable to continue the mission or unable to rejoin your unit, leave the immediate area and move to your last rally point.

b. Observe activity in the area and form a plan.

c. Traveling alone offers the least possibility of detection, but traveling in groups of two or three's more desirable.

d. Plan a primary and alternate route. Consider distance, cover, food and water. The easiest and shortest route may not be the best.

e. Food and water are daily requirements. You can do without food for several days; water, however, is essential.

f. Move at night. Use the daylight to observe, plan, and rest in a hide position.

g. Linkup only during daylight hours. Place friendly lines under observation.

h. Attempt to identify the unit you will approach, note their movements and routine.

i. After carefully considering your approach route, make voice contact with the unit as soon as possible.

11-2. **SURVIVAL.**

a. With training, equipment, and the WILL TO SURVIVE, you will find you can overcome any obstacle you may face. You will survive. You must understand the emotional states associated with survival, "knowing thyself" is extremely important in a survival situation. It bears directly on how well you cope with serious stresses, anxiety, pain, injury, illness; cold, heat, thirst, hunger, fatigue, sleep deprivation, boredom, loneliness and isolation.

b. You can overcome and reduce the shock of being isolated behind enemy lines if you keep the key word S-U-R-V-I-V-A-L foremost in your mind. Its letters can help guide you in your actions.

(1) S - Size up the situation; size up your surroundings; size up your physical condition; size up your equipment.

(2) U - Undue haste makes waste; don't be too eager to move. Plan your moves.

(3) R - Remember where you are in relation to, the location of enemy units and controlled areas. The location of friendly units and controlled areas. The location of local water sources (this is especially important in the desert). Areas that will provide good cover and concealment. The above information will allow you to make intelligent decisions when you are in a survival/evasion situation.

(4) V - Vanquish fear and panic.

(5) I - Improve; the situation can be improved. Learn to use natural things around you for different needs. Use your imagination.

(6) V - Value living. Remember your goal - getting out alive. Stubbornness, a refusal to give into problems and obstacles that face you, will give you the mental and physical strength to endure.

(7) A - Act like the natives; watch their daily routines. When, where, and how they get their food. Where they get their water.

(8) L - Live by your wits, learn basic skills.

11-3. NAVIGATION. In a survival situation, an individual may well find himself without a compass. The ability to determine directions may enable an individual to navigate back to his unit or to a friendly sanctuary. Two methods that are easy to use when there is sunlight are the shadow-tip and the watch.

a. Use the sun to find approximate true north. This method can be used any time the sun is bright enough for a stick to cast a shadow. Find a fairly straight stick about three feet long and follow these steps (figure 11-1).

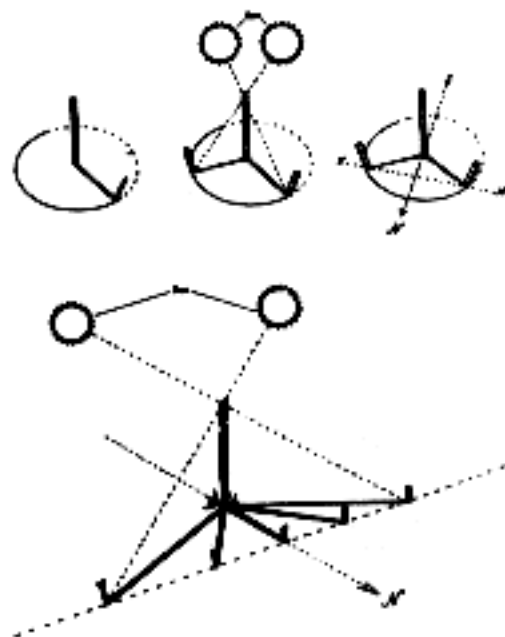

Figure 11-1. Shadow-tip method.

b. Watch method. You can also determine direction using a watch (figure 11-2). The steps you take will depend on whether you are in the northern temperate zone or in the southern temperate zone. The northern temperate zone is located between 23.4 north and 26.6 north. The southern temperate zone is located between 23.4 south and 66.6 south.

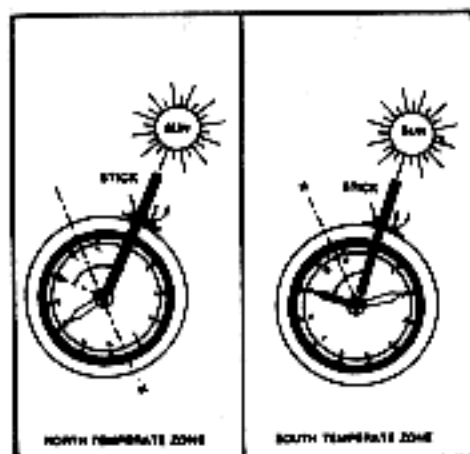

Figure 11-2. Watch method

c. Procedures in the northern temperate zone using a conventional watch are as follows:

- (1) Place a small stick in the ground so that it casts a definite shadow.
- (2) Place your watch on the ground so that the hour hand points toward and along the shadow of the stick.
- (3) Find the point on the watch midway between the hour hand and 12 o'clock and draw an imaginary line from that point through and beyond the center of the watch. This imaginary line is a north-south line. You can then tell the other directions.

NOTE: If your watch is set on daylight savings time, then use the midway point between the hour hand and 1 o'clock to draw your imaginary line.

d. Procedures in the southern temperate zone using a conventional watch are as follows:

- (1) Place a small stick in the ground so that it casts a definite shadow.
- (2) Place your watch on the ground so that 2 o'clock points to and along the shadow.
- (3) Find the midway point between the hour hand and 12 o'clock and draw an imaginary line from the point through and beyond the center of the watch. This is a north-south line.

e. A hasty shortcut using a conventional watch is simply to point the hour hand at the sun in the northern temperate zone (or point the 12 at the sun in the southern temperate zone) and then follow the last step of the watch method above to find your directions. This shortcut, of course, is not as accurate as the regular method, but it is quicker. Your situation will dictate which method to use.

4. Celestial navigation. On a clear night many stars are visible, and if you walk toward the North Star, you will be walking northward. The North Star, however, is not the brightest star in the sky and is sometimes hard to find. In order to locate the North Star, you should now that:

(1) All other stars revolve around the North Star.

(2) The North Star is the last star in the handle of the constellation Ursa Minor (Little Dipper), but the complete Little Dipper is often difficult to see.

g. The easiest way to locate the North Star is by using the constellation Ursa Major (Big Dipper). A straight line drawn between the two stars (pointers) at the end of the Big Dipper's bowl will point to the North Star. The distance to the North Star is about five times the distance between the pointers (figure 11-3).

h. Directly across from the Big Dipper is the constellation Cassiopeia. It is made up of five stars and resembles a lopsided "M" or "W" depending on its position in the sky. The North Star is straight out from the center star of Cassiopeia. It is almost equidistant between the Big Dipper and Cassiopeia.



Figure 11-3. The Big Dipper

1. South of the equator you can use the constellation Southern Cross to help you determine the general direction of south (figure 11-4). The Southern Cross is a group of four bright stars in the shape of a cross that is tilted to one side. The two stars forming the long axis, or stem, of the cross are called pointers. To determine which direction is south - - -

(1) Imagine the long axis extends from the foot five times its length. The point where this imaginary line ends is in the general direction of south.

(2) Look straight down from this imaginary point to the horizon and select a landmark.

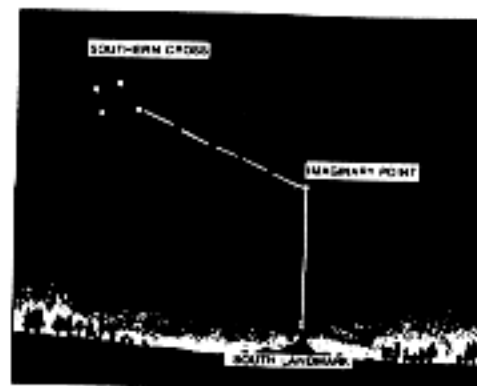

Figure 11-4. Southern Cross

11-4. WATER. Water is one of your most urgent needs in a survival situation. You can't live long without it, especially in hot areas where you lose so much through sweating. Even in cold areas, you need a minimum of 2 quarts of water a day to maintain efficiency. More than three-fourths of your body is composed of fluids. Your body loses fluid as a result of heat, cold, stress, and exertion. The fluid your body loses must be replaced for you to function effectively. So, one of your first objectives is to obtain an adequate supply of water.

a. Purification. Purify all water before drinking, either (1) by boiling for at least one minute, plus 1 minute for each additional 1,000 feet above sea level or boil for 10 minutes no matter where you are; (2) by using water purification tablets; or (3) by adding 8 drops of 2-1/2% solution of iodine to a quart (canteen full) of water and letting it stand for 10 minutes before drinking. Rain water collected directly in clean containers or on plants is generally safe to drink without purifying. Don't drink urine or sea water -- the salt content is too high. Old bluish sea ice can be used, but new, gray ice may be salty. Glacier ice is safe to melt and drink.

b. Desert Environment. In a desert environment water has a tremendous physiological effect on soldiers. If a unit does not plan properly and cannot be resupplied, their water supply could run out. There are four indicators or signs of water that you should look for in the desert. They are, animal trails, vegetation, birds, and civilization. Adequate water supply is critical in a hot desert environment if a unit is to survive and maintain the soldier's physical condition necessary to accomplish the mission. Unit leaders must enforce water discipline and plan for water resupply. The leader can use the following planning considerations for water resupply.

- (1) Units average water consumption rate.
- (2) Drop sites.
- (3) Aviation support.
- (4) DZ and LZ parties.
- (5) Caches.
- (6) Targets of opportunity (enemy).

c. Survival water still. For the below ground still (figure 11-5), you will need a digging tool.

(1) You should select a site where you believe the soil will contain moisture (such as a dry stream bed or a low spot where rainwater has collected), where the soil will be easy to dig, and where sunlight hits most of the day. Proceed as follows:

(a) Dig a bowl-shaped hole approximately 3 feet across and 2 feet deep.

(b) Dig a sump in center of the hole. The depth and the perimeter of the sump will depend on the size of the container that you have to set in it. The bottom of the sump should allow the container to stand upright.

(c) Anchor the tubing to the bottom of the container by forming a loose overhand knot in the tubing.

(d) Place the container upright in the sump.

(e) Extend the unanchored end of the tubing up, over, and beyond the lip of the hole.

(f) Place plastic sheeting over the hole, covering the edges with soil to hold it in place.

(g) Place a rock in the center of the plastic.

(h) Allow the plastic to lower into the hole until it is about 15 inches below ground level. The plastic now forms an inverted cone with the rock at its apex. Make sure that the apex of the cone is directly over your container. Also make sure the plastic cone does not touch the sides of the hole because the earth will absorb the condensed water.

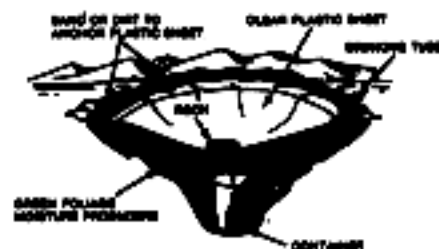

Figure 11-5. Survival water still.

(i) Put more soil on the edges of the plastic to hold it securely in place and to prevent loss of moisture.

(j) Plug the tube when not being used so that moisture will not evaporate.

d. You can drink water without disturbing the still by using the tube as a straw. You may want to use plants in the hole as a moisture source. If so, when you dig the hole you should dig out additional soil from the sides of the hole to form a slope on which to place the plants. Then proceed as above.

11-5. PLANT FOOD. There are many, many plants throughout the world. Tasting or swallowing even a small portion of some can cause severe discomfort, extreme internal disorders, or death. Therefore, if you have the slightest doubt as to the edibility of a plant apply the universal edibility test described below before eating any part of it.

a. Universal Edibility Test. Before testing a plant for edibility, make sure there are a sufficient number of plants to make testing worth your time and effort. You need more than 24 hours to apply the edibility test outlined below:

(1) Test only one part of a potential food plant at a time.

(2) Break the plant into its basic components, leaves, stems, roots, buds, and flowers.

(3) Smell the food for strong or acid odors. Keep in mind that smell alone does not indicate a plant is edible.

(4) Do not eat for 8 hours before starting the test.

(5) During the 8 hours you are abstaining from eating, test for contact poisoning by placing a piece of the plant you are testing on the inside of your elbow or wrist. Usually 15 minutes is enough time to allow for reaction.

(6) During the test period, take nothing by mouth except purified water and the plant part being tested.

(7) Select a small portion on a single component and prepare it the way you plan to eat it.

(8) Before putting the prepared plant part in your mouth, touch a small portion (a pinch) to the outer surface of the lip to test for burning or itching.

(9) If after 3 minutes there is no reaction on your lip, place the plant part on your tongue, holding it there for 15 minutes.

(10) If there is no reaction, thoroughly chew a pinch and hold it in your mouth for 15 minutes. DO NOT SWALLOW.

(11) If no burning, itching, numbing, stinging, or other irritation occurs during the 15 minutes, swallow the food.

(12) Wait 8 hours. If any ill effects occur during this period, induce vomiting and drink a lot of water.

(13) If no ill effects occur, eat 1/2 cup of the same plant part prepared the same way. Wait another 8 hours. If no ill effects occur, the plant part as prepared is safe for eating.

b. DO NOT eat unknown plants that have the below characteristics:

(1) Have a milky sap or a sap that turns black when exposed to air.

(2) Are mushroomlike.

(3) Resemble onion or garlic.

(4) Resemble parsley, parsnip, or dill.

(5) Have carrot-like leaves, roots, or tubers.

11-6. ANIMAL FOOD.

a. Animal Food. Animal food contains the most food value per pound. Anything that creeps, crawls, swims, or flies is a possible source of food, however you must first catch, kill and butcher it before this is possible. There are numerous methods for catching fish and animals in a survival situation. You can catch fish by using nets across a small stream, (figure 11-6) or by making fish traps and baskets.



Figure 11-6. Setting a gill net in the stream.

Improvise fish hooks and spears as indicated in figure 11-7, and use them for conventional fishing, spearing and jigging.

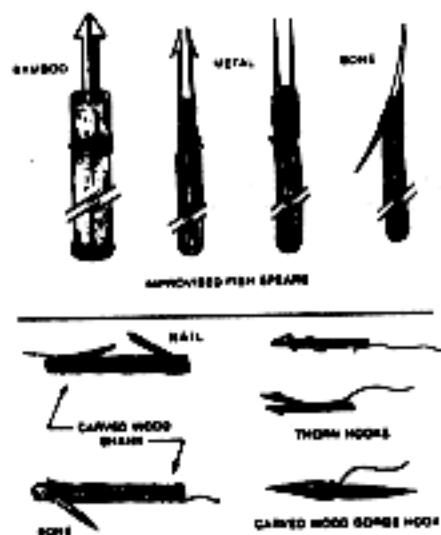

Figure 11-7. Spears and fish hooks.

Trapping game can be accomplished through the use of snares, traps, or deadfalls. A snare is a noose that will slip and strangle or hold any animal caught in it. You can use inner core strands of parachute suspension lines, wire, bark of small hardwood saplings as well as hide strips from previously caught animals to make snares.

The drag noose snare, figure 11-8, is usually the most desirable in that it allows you to move away from the site, plus it is one of the easiest to make and fastest to set.



Figure 11-8. Drag noose

It is especially suitable for catching rabbits. To make the drag noose snare, make a loop in the string using a bowline or wireman's knot. (When using wire, secure the loop by intertwining the end of the wire with the wire at the top of the loop); pull the other end of the string (or wire) through the loop to form a noose that is large enough for the animal's head but too small for its body; tie the string (or attach the wire) to a sturdy branch. The branch should be large enough to span the trail and rest on the bush or support (two short forked sticks) you have selected. A snared animal will dislodge the drag stick, pulling it until it becomes entangled in brush. Any attempt to escape tightens the noose, strangling or holding the animal.

Another type snare is the locking type snare loop (figure 11-9) that will lock when pulled tight, ensuring the snared animal cannot escape.



Figure 11-9. Forming a locking-type snare loop.

Use lightweight wire to make this snare, i.e., trip wire, from vehicle or aircraft electrical system. To construct this snare, cut a piece of wire twice the length of the desired snare wire; double the wire and attach the running ends to a securely placed object, such as the branch of a tree; place a stick about 1/2 inch in diameter through the loop end of the wire; holding the wire taut, turn the stick in a winding motion so that the wire is twisted together. You should have four to five twists per inch; detach the wire from the branch and then remove the loop from the stick; make a figure 8 in the 1/2-inch loop by twisting the loop over itself, then fold the figure 8 so the small loops are almost overlapping; run the loose wire ends through these loops. This forms a stiff noose that is strong, then, tie the loose end to the stick (for a drag noose square) or branch you are using to complete the snare. This is an excellent snare for catching large animals.

Another means of obtaining game is the use of the deadfall trap as indicated at figure 11-10A and figure 11-10B.

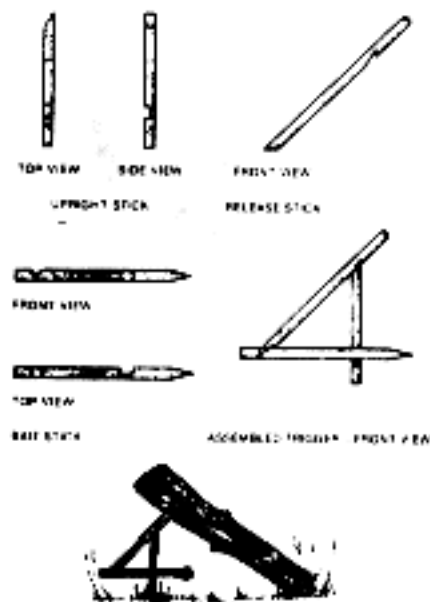

Figure 11-10A. Trigger with deadfall.



Figure 11-10B. Trip-string deadfall trap.

b. Once you have obtained your fish or game you must clean/butcher and cook/store it. Improper cleaning or storing can result in inedible fish and game.

(1) Fish. You must know how to tell if fish are free of bacterial decomposition that makes the fish dangerous to eat. Although cooking may destroy the toxin from bacterial decomposition, do not eat fish that appear spoiled. Signs of spoilage are-

- A peculiar odor.
- A suspicious color. (Gills should be red or pink. Scales should be a pronounced-not faded shade of gray).
- A dent remaining after pressing the thumb against the flesh.

- A slimy rather than moist or wet body.
- A sharp or peppery taste.

(a) Eating spoiled or poisoned fish may cause diarrhea, nausea, cramps, vomiting, itching, paralysis, or a metallic taste in the mouth. These symptoms appear suddenly 1 to 6 hours after eating. If you are near the sea, drink sea water immediately upon onset of such symptoms and force yourself to vomit.

(b) Fish spoil quickly after death, especially on a hot day, so prepare fish for eating as soon as possible after you catch them.

(c) Cut out the gills and large blood vessels that lie next to the backbone. (You can leave the head on if you plan to cook the fish on a spit).

(d) But fish that are more than 4 inches long. To do so, cut along the abdomen and scrape out the intestines.

(e) Scale or skin the fish.

(f) You can impale a whole fish on a stick and cook it over a "open fire". However, boiling the fish with the skin on is the best way to get the most food value. The fats and oil are under the skin, and by boiling the fish, you can save the juices for broth. Any of the methods used for cooking plant food can be used for cooking fish. Fish is done when the meat flakes off.

(g) To dry fish in the sun, hang them from branches or spread them on hot rocks. When the meat has dried, splash it with sea water, if available, to salt the outside. Do not keep any seafood unless it is well dried or salted.

(2) Snakes. All poisonous and nonpoisonous fresh water and land snakes are edible. CAUTION: Take extreme care in securing snakes as the bite of some poisonous snakes can be fatal. Even after a snake's head is cut off, its reflex action can cause it to bite, injecting poison. The best times to capture snakes is in the early morning or late evening when temperatures are low and they move slow. Kill or use a long stick to pin down its head and capture it. To pick up a snake, place the index finger on the top rear of its head with your thumb and middle finger

on either side of the head behind the jaws. Keep your index finger on top of snake's head to prevent it from turning inside its skin and biting you. To prepare snakes for eating use the following steps (figure 11-11):

- (a) Grip the snake firmly behind the head and cut off the head with a knife.
- (b) Split the belly and remove the innards. (You can use the innards for baiting traps and snares).
- (c) Skin the snake. (You can use the skin for improvising, belts, straps, or similar items).



Figure 11-11. Cleaning a snake

(3) Fowl. Your first step after killing a fowl for eating or preserving is to pluck its feathers. If plucking is impractical, you can skin the fowl. Keep in mind, however, that a fowl cooked with the skin on retains more food value. Waterfowl are easier to pluck while dry, but other fowl are easier to pluck after scalding. After you pluck the fowl --

(a) Cut off its neck close to the body.
 (b) Cut an incision in the abdominal cavity and clean out the insides. Save the neck, liver, and heart for stew. Thoroughly clean and dry the entrails to use for cordage.

(c) Wash out the abdominal cavity with fresh clean water. You can boil fowl or cook it on a spit over a fire. You should boil scavenger birds such as vultures and buzzards for at least 20 minutes to kill any parasites. Use the feathers from fowl for insulating your shoes, clothing, or bedding. You can also use feathers for fish lures.

(4) Medium-sized Mammals. The game you trap or snare will generally be alive when you find it and therefore dangerous. Be careful when you approach a trapped animal. Use a spear or club or kill it so you can keep a safe distance from it. After you kill an animal, immediately bleed it by cutting its throat. If you must drag the carcass any distance, do so before you cut off the hide so that the carcass is protected from dirt and debris that might contaminate it. Clean the animal near a stream if possible so that you can wash and cool the carcass and edible parts. Fleas and parasites will leave a cooled body so if the situation allows, wait until the animal cools before cleaning and dressing the carcass. To skin and dress the animal (figure 11-12 and 11-13).

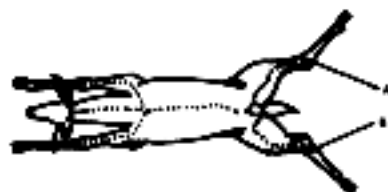

Figure 11-12. Skinning and butchering large game



Figure 11-13. Skinning small game

- (a) Place carcass, belly up, on a slope if available. You can use rocks or brush to support it.
- (b) Remove genitals or udder by cutting circular area shown in figure 11-12.
- (c) Remove musk glands at points A and B to avoid tainting meat (figure 11-12).
- (d) Split hide from tail to throat. Make the cut shallow so that you do not pierce the stomach.
- (e) Insert your knives under the skin, taking care not to cut into the body cavity. Peel the hide back several inches on each side to keep hair out of the meat.
- (f) Open the chest cavity by splitting the sternum. You can do this by cutting to one side of the sternum where the ribs join.
- (g) Reach inside and cut the windpipe and gullet as close to the base of the skull as possible.
- (h) With the forward end of the intestinal tract free, work your way to the rear, lifting out internal organs and intestines. Cut only where necessary to free them.

(i) Carefully cut the bladder away from the carcass so that you do not puncture the bladder (urine can contaminate meat). Pinch the urethra tightly and cut it beyond the point you are pinching.

(j) Remove the bladder.

(k) From the outside of the carcass, cut a circle around the anus.

(l) Pull the anus into the body cavity and out of the carcass.

(m) Lift or roll the carcass to drain all blood.

NOTE: Try to save as much blood as you can as it is a vital source of food and salt. Boil the blood.

(n) Remove the hide, make cuts along the inside of the legs to just above the hoof or paw. Then peel the skin back, using your knife in a slicing motion to cut the membrane between the skin and meat. Continue this until the entire skin is removed.

(o) Most of the entrails are usable. The heart, liver, and kidneys are edible. Cut open the heart and remove the blood from its chambers. Slice the kidneys and if enough water is available, soak or rinse them. In all animals except those of the deer family, the gall bladder—a small, dark-colored, clear-textured sac—is attached to the liver. Sometimes the sac looks like a blister on the liver. To remove the sac, hold the top portion of it and cut the liver around and behind the sac. If the gall bladder breaks and gall gets on the meat, wash it off immediately so the meat will not become tainted. Dispose of the gall.

(p) Clean blood splattered on the meat will glaze over and help preserve the meat for a short time. However, if an animal is not bled properly, the blood will settle in the lowest part of its body and will spoil in a short time. Cut out any meat that becomes contaminated.

(q) When temperatures are below 40 degrees, you can leave meat hanging for several days without danger of spoilage. If maggots get on the meat, remove the maggots and cut out the discolored meat. The remaining meat is edible. Maggots, which are the larvae of insects, are also edible.

(r) Blood, which contains salts and nutrients, is a good base for soups.

(s) Thoroughly clean the intestines and use them for storing or soaking food or lashings for general use. Make sure they are completely dry to preclude rotting.

(t) The head of most animals contains a lot of meat, which is relatively easy to get. Skin the head, saving the skin for leather. Clean the mouth thoroughly and cut out the tongue. Remove the outer skin from the tongue after cooking. Cut or scrape the meat from the head. If you prefer, you can roast the head over an open fire before cutting off the meat. Eyes are edible. Cook them but discard the retina (this is a plastic like disc). The brain is also edible; in fact, some people consider it a delicacy. The brain is also used to tan leather, the theory being that the brain of an animal is adequate to tan its hide.

(u) Use the tendons and ligaments of the body of large animals for lashings.

(v) The marrow in bones is a rich-food source. Crack the bones and scrap out the marrow, and use bones to make weapons.

(w) If the situation and time allow, you should preserve the extra meat for later use. If the air is cold enough, you can freeze for meat. In warmer climates, however, you will need to use a drying or soaking process to preserve it. One night of heavy smoking will make meat edible for about 1 week. Two nights will make it remain edible for 2 to 4 weeks. To prepare meat for drying or soaking, cut it with the grain in one-quarter inch strips. To air dry the meat, hang it in the wind and hot sunout of the reach of animals; cover it so that blowflies cannot land on it.

(x) To smoke meat, you will need an enclosed area--for instance, a teepee (figure 11-14) or a pit. You will also need wood from deciduous trees, preferably green. Do not use conifer trees such as pines, firs, spruces, or cedars as the smoke from these trees give the meat a disagreeable taste.

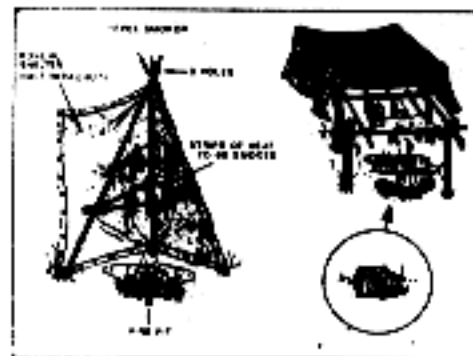

Figure 11-14. Smoking meat

(y) When using the paratseepe or other enclosed area with a vent at the top, set the fire in the center and let it burn down to coals, then stake it with green wood. Place the strips of meat on a grate or hang them from the top of the enclosure so that they are about 2 feet above the smoking coals. To use the pit method of smoking meat, dig a hole about 3 feet (1 meter) deep and 1 1/2 feet (1/2 meter) in diameter. Make a fire at the bottom of the hole. After it starts burning well, add chipped green wood or small branches of green wood to make it smoke. Place a wooden grate about 1 1/2 feet (1/2 meter) above the fire and lay the strips of meat on the grate. Cover the pit with poles, boughs, leaves, or other material.

11-7. SHELTERS. A shelter can protect you from the sun, insects, wind, rain, snow, hot or cold temperatures, and enemy observation. In some areas your need for shelter may take precedence over your need for food, possibly even your need for water.

a. Types of shelters. After determining your shelter site, you should keep in mind the type of shelter (protection) you need. The below listed factors should be considered:

(1) How much time and effort are needed to build the shelter?

(2) Will the shelter adequately protect you from the elements (rain, snow, wind, sun, etc.)?

(3) Do you have tools to build it? If not, can you improvise tools from materials in the area?

(4) Do you have the type and amount of manmade materials needed to build it? If not, are there sufficient natural materials in the area? You need to know how to make different types of shelters. Only two will be described in this handbook. Additional information can be obtained in FM 21-76.

b. Poncho Lean-to. It takes only a short time and minimal equipment to build this lean-to (figure 11-15). You need a poncho, 6 to 10 feet of rope, three stakes about 6 inches long, and two trees (or two poles) 7 to 9 feet apart. Before you select the trees you will use (or decide where to place the poles), check the wind direction. Make sure the back of your lean-to will be into the wind. To make the lean-to,

(1) Tie off the hood of the poncho. To do this, pull the drawcord tight; roll the hood longways, fold it into thirds, and tie it with the drawcord.

(2) Cut the rope in half; on one long side of the poncho, tie half of the rope to one corner grommet and the other half to the other corner grommet.

(3) Attach a dripstick (about a 4-inch stick) to each rope 1/4 to 3/4 inch away from the grommet. These dripsticks will keep rainwater from running down the ropes into the lean-to. Using driplines is another way to prevent dripping inside the shelter. Tie lines or string about 4 inches long to each grommet along the top edge of the shelter. This allows water to run to and down the line without dripping into the shelter.

(4) Tie the ropes about waist high on the trees (uprights). Use a round turn and two half hitches with a quick-release knot.

(5) Spread the poncho into the wind and anchor it to the ground. To do this, put three sharpened sticks through the grommets and into the ground.



Figure 11-15. Poncho used for lean-to

If you plan to use the lean-to for more than one night, or if you expect rain, make a center support to the lean-to. You can do this by stretching a rope between two upright poles or trees that are in line with the center of the poncho. Tie another rope to the poncho hood; pull it upward so that it lifts the center of the poncho, and tie it firmly to the rope stretched between the two uprights. Another method is to cut a stick to place upright under the center of the lean-to. This method, however, will restrict your space and movements in the shelter. To give additional protection from wind and rain, place boughs, brush, your rucksack, or other equipment at the sides of the lean-to. To reduce heat loss to the ground, place some type of insulating material, such as leaves or pine needles, inside your lean-to.

NOTE: When at rest, as much as 80 percent of your body heat can be lost to the ground.

To increase your security from enemy observation, lower the silhouette of the lean-to by making two modifications, secure the support lines to the trees knee-high rather than waist-high, use two knee-high sticks in the two center grommets (sides of lean-to), and angle the poncho to the ground, securing it with sharpened sticks as above.

c. Field Expedient Lean-to. If you are in a wooded area and have sufficient natural materials, you can make an expedient lean-to (figure 11-16) without the aid of tools or with only a knife. You need more time to make it than the shelter previously mentioned, but it will protect you from most environmental elements. You will need two trees (or two upright poles) about 6 feet apart; one pole about 7 feet long and 1 inch in diameter five to eight poles about 10 feet long and 1 inch in diameter for beams, cord or vines for securing, the horizontal support to the trees; and other poles, saplings, or vines to crisscross the beams. To make this lean-to:



Figure 11-16. Field Expedient Lean-to

(1) Tie the 7-foot pole to the two trees at point about waist to chest high. This is your horizontal support. If there is a fork in the tree, you can rest the pole in it instead of tying the pole in place. If a standing tree is not available, construct a bipod using Y-shaped sticks or two tripods.

(2) Place one end of the beams (10-foot poles) on one side of the horizontal support. As with all lean-to type shelters, make sure the backside of the lean-to is placed into the wind.

(3) Crisscross sapling or vines on the beams.
(4) Cover the framework with brush, leaves, pine needles, or grass, starting at the bottom and working your way up like shingling.

(5) Place straw, leaves, pine needles, or grass inside the shelter for bedding.

(6) In cold weather you can add to the comfort of your lean-to by building a fire-reflector wall (figure 11-16). Drive four stakes about 4 feet long into the ground to support the wall. Stack green logs on top of one another between the support stakes. Bind the top of the support stakes so the green logs will stay in place. Fill in the spaces between the logs with twigs or small branches. With just a little more effort you can have a drying rack; cut a few 3/4 inch diameter poles (length depends on distance between the lean-to support and the top of the fire-reflector wall). Lay one end of the poles on the lean-to horizontal support and the other ends on top of the reflector wall. Place and tie into place smaller sticks across these poles. You now have a place to dry clothes, meat, or fish.

11-8. FIRE BUILDING. A fire can fulfill several needs. It can keep you warm, it can keep you dry; you can use it to cook food, to purify water, and to signal. It can also cause you problems when you are in enemy territory; it creates smoke, which can be smelled and seen from a long distance; it causes light, which can be seen day or night and it leaves signs of your presence. Remember, you should always weigh your need for a fire against your need to avoid enemy protection. When operating in remote areas you should always take a supply of matches in a waterproof case and keep them on your person.

a. When selecting a site to build a fire, you should consider the following:

(1) The area (terrain and climate) in which you are operating.

(2) The material and tools available.

(3) How much time you have.

(4) Why you need a fire.

(5) The nearness of the enemy.

b. To prepare a site for a fire, look for a dry spot that has the following:

- (1) That is protected from the wind.
- (2) That is suitably placed in relation to your shelter (if any).
- (3) That will concentrate the heat in the direction you desire.
- (4) Where a supply of wood or other fireburning material is available.
- (5) If you are in a wooded or brush-covered area, clear brush away and scrape the surface soil from the spot you selected. The cleared circle should be at least 3 feet (1 meter) in diameter so that there is little chance of the fire spreading.

c. Dakota fire hole. In some situations you may find that an underground fireplace will best meet your need. It conceals the fire to some extent and serves well for cooking food. To make an underground fireplace or Dakota fire hole (figure 11-17):

- (1) Dig a hole in the ground.
- (2) On the upwind side of this hole, poke one large connecting hole for ventilation.
- (3) Build your fire in the hole as illustrated.

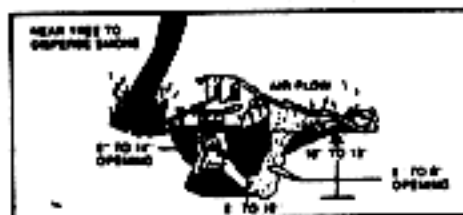

Figure 11-17. Dakota Fire Hole

d. Above ground fire. If you are in a snowcovered or wet area, you can use green logs to make a dry base for your fire (figure 11-18). Trees with wrist-size trunks are easily broken in extreme cold. Cut or break several green logs and lay them side by side on top of the snow. Add one or two more layers, laying the top layer logs in a direction opposite those on the layer below it.



Figure 11-18. Base for fire in snow-covered area

e. There are several methods for laying a fire for quick firemaking. Three easy methods are cone, lean-to, and cross-ditch.

(1) Cone (figure 11-19). Arrange tinder and a few sticks of kindling in the shape of a cone. Fire the center. As the core burns away, the outside logs will fall inward, feeding the heart of the fire. This type of fire burns well even with wet wood.

(2) Lean-to (figure 11-19). Push a green stick into the ground at a 30 degree angle. Point the end of the stick in the direction of the wind. Place some tinder (at least a handful) deep inside this lean-to stick. Lean pieces of kindling against the lean-to stick. Light the tinder. As the kindling catches fire from the tinder, add more kindling.

(3) Cross-ditch (figure 11-19). Scratch a cross about 1 foot in size in the ground. Dig the cross 3 inches deep. Put a large wad of tinder in the middle of the cross. Build a kindling pyramid above the tinder. The shallow ditch allows air to sweep under the fire lay to provide a draft.



Figure 11-19. Methods for Laying a Fire

CHAPTER TWELVE

FIRST AID

12-1. GENERAL. The semi-independent nature of patrolling operations causes casualties to become a much greater consideration than on other missions. For this reason it becomes essential that all personnel know how to diagnose and treat injuries, wounds, and illnesses. The unit should also have a plan for handling KIA's.

12-2. LIFESAVING STEPS (Applies to all injuries).

- a. Open the airway and restore breathing.
- b. Stop the bleeding and protect the wound.
- c. Check and treat for shock.

12-3. TREATMENT OF WOUNDS AND INJURIES.

- a. Wounds (all) - Expose wound, control bleeding, apply sterile dressing, treat for shock. Look for exit wound. Do not clean the wound.
- b. Jaw Wounds - Clear and maintain airway, stop bleeding with direct pressure, do not bandage mouth shut, support jaw, position head to allow drainage from mouth.
- c. Head Wounds - Elevate head. Clear the airway and protect the wound. Position head to allow drainage from mouth. DO NOT GIVE MORPHINE.
- d. Belly Wounds - Do not touch or replace organs. Use loose, dry, sterile dressing. Give no food or liquids.
- e. Chest Wounds - Make wound airtight immediately with plastic or foil. Cover with dry, sterile dressing. Do not give morphine.
- f. Fractures - "Splint him where he lies."

g. Burns.

(1) 1st Degree - skin is red; 2nd Degree skin is blistered; 3rd Degree - skin is charred and tissue destroyed.

(2) When treating 3rd degree burns, do not remove clothing from wound - cut away clothing around the burn. Cover burn with dry, sterile dressing or cleanest material available. Do NOT apply grease or ointment. Avoid infection. Give cool salt/soda water slowly. Treat or prevent shock.

h. Shock.

(1) Pale, clammy, wet skin, nervousness and thirst. Patient may pass out.

(2) Lay patient on back, elevate feet, loosen clothing, keep warm and comfortable. Feed warm liquids if conscious. Turn head to side if unconscious.

i. Heat injuries include sunburn, heat cramps, heat exhaustion, and heat stroke. Physical workload, lack of acclimatization, obesity, dehydration, excessive consumption of alcohol, lack of sleep, age, poor health, cumulative "fatigue" and accumulated body heat storage (due to lack of adequate recovery periods) are examples of conditions which decrease a person's ability to withstand high temperatures, listed below are the definitions, symptoms and treatment for heat injuries stated above.

(1) Sunburn: Sunburn is caused by overexposure to ultraviolet rays of the sun. Sunburn is prevented through proper use of clothing, shelter, sun lotions, and limited sequential exposure.

(2) Attempt to shield the affected areas from further exposure. Sunburn predisposes one to other heat injuries.

(3) Heat Cramps:

(a) Heat cramps result from excessive salt loss in perspiration. They are painful cramps occurring in the arms, legs, and abdominal muscles.

(b) First aid administered by non-medical personnel should consist of resting in a cool, shady area, and the drinking of cool fluids. If the cramps persist or recur, treatment by medical personnel should be obtained. Only medical personnel will determine need for salt replacement and oversee its administration as necessary.

(4) Heat Exhaustion (Prostration):

(a) This occurs as a result of excessive loss of water from the body. Characteristic signs and symptoms include profuse sweating, rapid feeble pulse, body temperature will be normal or slightly above or below normal. Skin will usually feel cold and moist (clammy).

(b) Immediate first aid should consist of removal from the heat, loosening of clothing, elevation of the casualty's legs, the drinking of cool fluids, and medical attention.

(5) Heatstroke:

(a) Heatstroke results when the body is unable to dissipate or lose heat. HEATSTROKE REPRESENTS A TRUE MEDICAL EMERGENCY. HEATSTROKE MAY CAUSE DEATH (statistically, one of four). Its onset is frequently sudden with a loss of consciousness and convulsions or delirium. The soldier will not regain consciousness after he has lain on the ground for a few minutes. The skin will be dry and hot; sweating is absent or greatly reduced. Body temperature is invariably high sometimes in excess of 106 degrees F.

(b) The following actions should be taken IMMEDIATELY to prevent heat exhausted victims from going into heatstroke and for heatstroke itself:

- The most important treatment is LOWERING THE SOLDIER'S BODY TEMPERATURE. This should be accomplished concurrent with EXPEDITIOUS EVACUATION TO A HOSPITAL. MEDEVAC is normally accomplished by air evacuation; however, the most rapid evacuation possible should be used in the given situation.
- Place the patient in the shade.

(c) Remove all clothing.

(d) Do not provide fluids by mouth unless the patient is conscious.

(e) Immerse victim in water if it is cooler than the air temperature or keep the victim's body wet by pouring water (again cooler than the air) over the entire body and institute fanning and use ice. Cooling the head, the chest, and the abdomen are the most important parts of the body to be cooled. Additionally, overcooling is not desired due to problems with hypothermia. Rectal temperatures should be taken every 10 minutes. Leaders should be schooled in the use of thermometers.

Temperature readings and times should be annotated and provide to the medical facility.

(f) Evacuate to hospital emergency room or nearest TMC ASAP.

(g) Continue all first aid measures described above during evacuation.

j. Cold weather injuries can be divided into two categories, "freezing" type is the well known frostbite. The "non-freezing" type includes hypothermia, dehydration, trenchfoot, and immersion foot. Cold injury results from impaired circulation and the action of ice formation and cold upon the tissues of the body. Temperature alone is not a reliable guide as to whether or not a cold weather injury can occur. Many additional factors in various combinations determine cold injury production. These factors include humidity, wind speed, exposure time, activity, type and condition of clothing, and numerous host factors.

(1) Factors influencing cold injury are listed below:

(a) Previous Cold Injuries: A previous episode of cold injury increases the soldier's risk of subsequent cold injury.

(b) Race: Blacks are more vulnerable to frostbit than caucasians.

(c) Geographic Origin: Personnel from warmer climates are more predisposed to cold injury.

(d) Ambient Temperature: The temperature of the air (or water) surrounding the human body is critical to heat regulation. The body loses more heat to maintain the temperature of the skin when the temperature of the surrounding air is 32 degrees F than when it is 50 degrees F.

(e) Wind Chill Factor. Commanders should be familiar with the workings and meanings of the Wind Chill Factor. Wind velocity accelerates body heat loss under both wet and cold conditions. When the forecast gives a figure which falls within the increased danger zone or beyond, extra precautions must be exercised to minimize cold injury. The equivalent wind chill temperature is especially important when the ambient temperature is 32 F or less. There can be actual freezing of exposed tissue if exposure is prolonged and frequent warming of the part is not practiced. The lower the wind chill, the faster tissue freezing can occur.

(f) Type of Mission: Combat action requiring prolonged immobility, long hours of exposure to low temperatures, or lack of opportunity to rewarm increase the incidence of cold injury.

(g) Terrain: Minimal cover and wet conditions increase the potential for cold injury.

(h) Clothing: Clothing for cold weather should be worn loose (to trap air) and in layers (to conserve body heat). Clothing should be clean since prolonged wear reduces the air-trapping fluffiness and logs air spaces with dirt and body oils. Wet clothing loses insulation value, therefore care must be taken to prevent accumulation of perspiration. The uniform should be worn completely and correctly to avoid injury to exposed body surfaces. The cold weather uniform is not complete without gloves and inserts. Appropriate measures should be taken when a change in weather or activity alters the amount of clothing needed to prevent cold injury and on the other hand, overheating.

(i) Moisture: Water conducts heat more rapidly than air. When the skin or clothing becomes damp or wet, the risk of cold injury is significantly increased.

(j) Dehydration: Probably the most overlooked predisposing factor causing cold injuries is dehydration. Individuals must retain their body fluids. In cold weather the human body needs special care and the consumption of water is very important to retain proper hydration. Since coffee, tea, and hot chocolate are diuretics, the consumption of these beverages should not be relied upon for hydration and/or re-hydration of the body. An acceptable substitute is hot apple juice with cinnamon which is pleasing to taste, therefore more likely to be consumed in amounts appropriate to prevent dehydration.

(k) Age: Within the usual age range of combat personnel, age is not a significant factor.

(l) Fatigue: Mental weariness may cause apathy leading to neglect of acts vital to survival.

(m) Concomitant injury: Injuries resulting in shock or blood loss reduce blood flow to extremities and predispose the injured individual to cold injury.

(n) Discipline, Training, and Experience: Well trained and disciplined soldiers suffer less than others from cold.

(a) Nutrition: Good nutrition is essential to provide the body with fuel to produce heat in cold weather. The number of calories consumed normally increases as the weather gets colder. On the other hand, adequately clothed and protected personnel in cold climates do not require more than the normally provided ration of 3600-4600 calories per day.

(p) Activity: Excess activity results in loss of large amounts of body heat by perspiration. This loss of body heat combined with the loss of insulation value provided by the clothing due to the contamination of the clothing with perspiration will provide the commander with an individual susceptible to cold injury.

(q) Alcohol, Drugs, and Tobacco: Certain drugs, medications, alcohol, chewing or dipping tobacco, and smoking have adverse effects on the circulation, perspiration, hydration, and judgement of individuals and therefore should be avoided under conditions of extreme cold.

(r) Sharp changes in the weather.

(2) Prevention of cold weather injuries, properly wearing cold weather clothing goes a long way toward preventing cold injuries. Listed below are tips commanders can use in the prevention of cold weather injuries:

(a) Ensure personnel are properly trained with respect to the hazards of cold weather.

(b) Adequate PLANNING, to include timely requisition, and receipt of supplies and proper clothing.

(c) Effective method for the receipt, dissemination, and utilization of weather data.

(d) Proper foot care which includes,
- Personal hygiene and care of blisters.
- Proper care of boot and boot fitting.
- Proper changing of socks, at least twice daily.

(e) Proper use of gloves and headgear. The pile cap, wool cap, and balaclava conserve heat and protect the ears. The wool scarf gives added protection to the neck against the cold.

(f) Proper care of skin by using non-water based hand cream such as (Eucerin and Desitin). Use of chapsticks on lips, nose and eyelids. Topical steroid ointment should be carried for rashes.

(g) Proper undergarments. Material containing polypropylene, capalene, thermal or similar material as underwear are the state of the art cold weather clothing.

(3) Listed below are the definitions, symptoms, and treatment for cold weather injuries:

a. All personnel identified as having a cold weather injury (CWI) or suspected CWI should be immediately sent to the rear to be checked at a medical clinic.

b. Hypothermia.

(1) Both wind chill and water chill are forms of hypothermia. When a person dies of "exposure" it usually means from hypothermia. The term means a lowering of the body's inner core temperature. The condition results when heat loss exceeds the production of body heat. Hypothermia may result from conditions other than wind chill or water chill. The body can lose heat by radiation, conduction, convection, evaporation, and respiration. Thus, wet clothing, sitting on cold surfaces, handling cold objects,

contact with liquid fuels at low temperatures, and even breathing extremely cold air can cause hypothermia. An unprotected head in weather of 50F, can lose up to three-quarters of the total body heat produced. Wet clothing can extract heat from your body up to 240 times as fast as dry clothing.

(2) Symptoms include intense shivering, feeling of deep cold/numbness, muscle tensing, fatigue, poor coordination, disorientation, blueness of skin, slow/weak/irregular pulse, slurred speech, retreat inward psychologically, dullness, and apathy.

(3) Treatment: Shelter individual from wind and weather, insulate from ground, replace any wet clothing with dry, increase level of exercise if possible, give hot drinks and food. Get in a warm sleeping bag (if need be, with buddy to buddy warming via body heat). Evacuate immediately to care of a physician.

c. Dehydration.

(1) First indication of dehydration will be the dark yellow color of urine. Other indications are higher temperature, upset stomach, and dizziness. Dehydration can be prevented by drinking plenty of liquids (4-10 quarts [desert]) and using a normal amount of salt on your foods. Do not drink liquids that contain alcohol. Forced drinking in the absence of thirst is mandatory to prevent dehydration.

(2) It is important to note that the symptoms of severe dehydration are similar to those of hypothermia. To distinguish between the two, open the victim's clothing and feel the belly wall. If the belly is cold, the victim is probably hypothermic; if it is warm, he is probably dehydrated. However, this test is not foolproof because cold weather dehydration can also lead to total body cooling.

(3) Treatment: Keep the dehydrated victim warm, but loosen his clothes so circulation is not restricted. Gradually feed him warm liquids. Don't let him eat snow; eating snow uses up body heat. The victim needs plenty of rest. Get him to medical personnel as soon as possible.

d. Trench Foot.

(1) Trench foot is an injury sustained as a result of exposure to cold and wet, ground freezing.

(2) In the early stages of trench foot, feet and toes are pale and feel numb, cold and stiff. If preventive action is not taken at this stage, the feet will swell and become painful. Because the early stages are not painful, you must be constantly alert to prevent trench foot.

(3) If trench foot occurs, the feet should be handled very gently. They should never be rubbed or massaged. The feet should be cleaned carefully with soap and water, dried, elevated, and allowed to remain exposed to room temperature. Attempt to stay off your feet if you have trench foot. See a medic immediately.

e. Immersion Foot.

(1) Immersion foot is incurred by prolonged immersion in cold water (usually below 50 F) or in wet footgear. Exposure time is usually in excess of 12 hours.

(2) The symptoms are aching and stinging pain on prolonged exposure; initially there may be no unusual sensations or pain; skin becomes shrivelled and soft.

(3) Treatment: As in trench foot, the feet should be handled very gently. They should never be rubbed or massaged. The feet should be cleaned carefully with soap and water, dried, elevated, and allowed to remain exposed to room temperature. Attempt to stay off your feet if you have immersion foot. See a medic immediately.

f. Frostbite.

(1) Frostbite is the freezing of some part of your body by exposure to temperatures at freezing or below; skin and tissue freezes. Exposure time can be minutes. Wind or contact with wet clothing may produce an effective temperature in the freezing range then the air temperature is above freezing. Freezing may be instantaneous if an exposed skin surface comes into contact with very cold fluids (gasoline, cleaning solvent, etc.), metal surfaces, or high velocity air flow.

(2) Symptoms of frostbite are recognized by aching, tingling, and stinging sensation, with cold and numbness. The skin usually turns red. Later it becomes pale gray and waxy white. It is easier to thaw and take care of frozen flesh. Individuals must stay aware of their feet and toes. They should scratch with their toes inside the toe cap of the boot to make sure they can feel their toes.

(3) The buddy system is one of the prime preventors of frostbite. Buddies must watch each other for signs of frostbite and to provide mutual aid if frostbite occurs.

(4) Immediate action can stop frostbite. If the cheeks are frostbitten, cover them with warm hands until the pain returns. Place frostbitten fingers, uncovered, under the armpit or on the belly, next to the skin. Place bare, frostbitten feet against the belly of a companion, under the clothing. Avoid rubbing or massaging. Don't pop blisters. Wearing a properly fitted uniform, keeping socks and clothing dry, and protecting oneself from the absolute temperature and from the chilling effects of wind can prevent frostbite. Routine exercise of the face, fingers and toes keep them warm.

(5) Handle all individuals with frostbite of the feet as litter cases. Restrict the patient from his usual activities until the severity of the injury can be evaluated by medical personnel and evacuate to a hospital ABAP.

12-4. Evaluate, categorize, and prioritize the medical support needed in order to save as many lives as possible. Always have a plan.

a. The Leader must consider:

- (1) The situation - METT-T. It may be necessary to treat casualties at the conclusion of the fight instead of during it.
- (2) The number and location of the injured.
- (3) The security of the treatment area. It may be necessary to move undercover to reach a casualty or to move him to a more secure area.
- (4) Determine the assistance available, buddy aid, self aid, medical and non-medical personnel (EMT qualified, pre-med, etc.).
- (5) Consider the need to support the battle with the maximum available manpower, including soldiers with minimal injuries, who are still fit to fight.
- (6) Consider the need for resuscitation and emergency aid to save lives.
- (7) Consider evacuation support available.
- (8) Contact higher.
- (9) Futility of aid because of potentially fatal wounds.

b. Sort the casualties into categories for treatment and evacuation priorities. Rapidly conduct individual assessments of the casualties looking for injuries that pose a threat to life or limb. Sort the casualties into the following areas and render assistance:

- (1) Identify minor injuries which do not render the soldier unfit to fight. Render self aid, buddy aid and return to duty.
- (2) Identify casualties with urgent needs for attention. The main concern goes to problems connected with the (A) airway, (B) breathing, and (C) circulation. These problems are life threatening and are often easily correctable. Take the appropriate first aid and evacuate on a priority basis.
- (3) Identify patients with multiple, severe wounds and questionable chances of survival. Provide supportive assistance as feasible and evacuate IAW below.

12-5. CATEGORIES OF PRECEDENCE DEFINITION.

URGENT Utilized for emergency cases that need to be evacuated as soon as possible and in no case more than two hours to save life, limb, and eyesight.

PRIORITY Used when the patient should be evacuated within four hours or his medical condition will deteriorate to such a degree that he will become an urgent precedence.

ROUTINE Requires evacuation, but condition is not expected to deteriorate seriously within the next 24 hours.

TACTICAL IMMEDIATE

Used when condition is not urgent or priority but evacuation is required as soon as possible so as not to endanger the requesting unit's tactical mission.

12-6. ARMY AEROMEDICAL EVACUATION REQUEST

LINE 1. LOCATION
LINE 2. RADIO FREQUENCY, CALL SIGN AND SUFFIX
LINE 3. PRECEDENCE.
URGENT PRIORITY ROUTINE TAC IMMED
LINE 4. SPECIAL EQUIPMENT
(HOIST, JUNGLE PENETRATOR)
LINE 5. NUMBER OF PATIENTS BY TYPE
LITTER AMBULATORY
LINE 6. SECURITY-TO-PICKUP SITE
LINE 7. METHOD OF MARKING PICKUP SITE
LINE 8. PATIENT'S NATIONALITY AND STATUS
LINE 9. NBC CONTAMINATION

12-7. EMERGENCY BURIALS. Emergency burials are those made in locations other than cemeteries because of the tactical situation. When military personnel make emergency burials, they will try to keep the burials like those in a cemetery, if the tactical situation permits. Burials must be reported to the next higher headquarters. They are a last resort. Organization Commander's procedural guide for emergency burials.

a. Ensure remains are always treated in a reverent, respectful manner.

b. Make an effort to keep burials like those in a cemetery. Bury remains away from areas that could be flooded.

c. Keep identification tags, clothing and personal effects with remains.

d. Shroud each remain in a poncho, blanket, shelter half or other suitable material before burial.

e. Prepare a DD Form 551 for each remain buried.

f. As a minimum, record eight digit map grid coordinates of each burial site.

g. Bury a bottle, can or other suitable container, open-end down, at the head of the grave. Place a copy of DD Form 551 in container.

h. Conduct a brief religious service of the appropriate religion.

i. Notify appropriate headquarters. Graves registration personnel can recover remains at a later date.

CHAPTER THIRTEEN

COMBAT SERVICE SUPPORT

CSS operations at platoon level are a vital part of infantry operations. They consist of logistical and personnel functions. CSS is integrated into the tactical planning process from the starting phases of operations. Well-planned and executed CSS is a large part of mission accomplishment and success of combat operations. Like CS, CSS is a combat multiplier. Soldiers well supplied with food, water, ammunition, shelter, and medical care are more successful in accomplishing their missions than those who are not.

13-1. PLANNING OF COMBAT SERVICE SUPPORT

The company headquarters plans, coordinates, and executes CSS functions for the company. The platoon leader is responsible for CSS, just as he is for everything that relates to his unit. He constantly stays abreast of the platoon's CSS status and, along with the platoon sergeant, plans and executes CSS. The platoon sergeant, however, carries the bulk of this load. He consolidates information from the squad leaders, requests support from the XO or 1SG, and assigns responsibilities to squads. Squad leaders plan and implement CSS operations for their squads, and they can delegate some functions to their team leaders. Unit SOPs address additional responsibilities and duties in detail. They should standardize as many of the routine and recurring CSS operations as possible.

13-2. RESUPPLY OPERATIONS

Squad leaders must know the supply status for each member of the squad. As materials and supplies are used, squad leaders request resupply through the platoon sergeant.

Platoon and squad SOPs should establish levels of depletion for specified items of supply (for example, water, ammunition). All soldiers and leaders should report supply status once that level is reached. The platoon sergeant combines requests from all squads and forwards them to the 1SG or XO. There is no administrative/logistic net for the platoon. Logistics reports, when required, are sent on to the commander. Most resupply requests take a lot of time to transit--line numbers should be used to save time. When operating on a nonsecure net, the platoon sergeant should encode all requests. The request is filled then or during the next resupply operation, depending on urgency. One of the most critical resupply functions is water. Even in cold areas, all personnel must drink at least two quarts of water a day to maintain efficiency. Water can be resupplied either by collecting and filling empty canteens or by distributing water cans to the platoons.

a. When water is not scarce, leaders must urge soldiers to drink water even when not thirsty. This is due to the body's thirst mechanism, which does not keep pace with the loss of water through normal daily activity. The rate at which dehydration occurs will depend on the weather conditions and the level of physical exertion.

b. If water is in short supply, soldiers must use water sparingly for hygiene purposes. When in short supply, water should not be used to heat MREs. Water used for coffee or tea may also be counterproductive because both increase the flow of urine. However, soups are an efficient means of providing both water and nutrition when water is scarce, particularly in cold weather when heated food is desirable. A centralized heating point can be used to conserve water yet provide warmed MREs.

c. In most environments, water is available from natural sources. Soldiers should be trained to find, treat (chemically or using field expedients), and use natural water sources. The use of iodine tablets is the most common and easiest method to treat water. (Iodine tablets that are not uniformly gray in color or no longer have a firm consistency should not be used.) (See FM 21-10 and FM 21-76 for more information.)

13-3. RESUPPLY TECHNIQUES

Platoon resupply is mainly a "push" system. The platoon receives a standard package of supplies based on past usage factors and planning estimates. The following discusses the three platoon and squad resupply techniques. Whatever resupply technique they select, leaders must ensure security. This involves security at the resupply point and rotating personnel to ensure continuous manning of crew-served weapons and OPs, leader availability, and unit preparedness in case of enemy attack. Units use backhauling to remove residue, casualties, damaged equipment, or excess ammunition to the rear. During each resupply operation, the platoon must plan for backhauling of excess items. Backhauling can be by manpack, vehicle, or aircraft. Effective backhauling lessens the platoon's need to bury, camouflage, or otherwise dispose of unneeded material.

a. In-Position Technique. The company brings forward supplies, equipment, or both to individual fighting positions. This technique--

- Is used when an immediate need exists.
- Is used to resupply single classes of supply during contact or when contact is imminent.
- Enables leaders to keep squad members in their fighting positions.

b. **Service Station Technique.** To use this technique, soldiers must leave their fighting positions. Selected soldiers move to a company resupply point to the rear of the platoon position, conduct resupply, and return to their fighting position. This technique is used when contact is not likely, and for one or several classes of supplies.

NOTE: The platoon order should state the sequence for moving squads or portions of squads out of position. Companies may vary the technique by establishing a resupply point for each platoon and moving the supplies to that point.

c. **Pre-Position Technique.** In this technique, the company pre-positions supplies and equipment along a route to or at a platoon's destination. The company then directs the platoons to the sites. Though this method is used often during defensive operations to position supplies and equipment in subsequent BPs, it can be equally effective in other operations as a cache. A cache is a pre-positioned and concealed supply point that--

- Can be set up for a specific mission or contingency.
- Can be used effectively by platoons and squads to reduce the soldier's load.
- Can be either above or below ground.

NOTE: An above-ground cache is easier to use but more likely to be found by the enemy, civilians, or animals.

13-4. AERIAL RESUPPLY

Aerial resupply is often used to get supplies and equipment to the platoon. Rotary-wing aircraft are usually more precise in delivering supplies than fixed-wing aircraft.

Rotary-wing aircraft deliver supplies and equipment to an LZ. Fixed-wing aircraft deliver to DZs. The unit must secure the LZ or DZ. This helps protect the aircraft and ensure that the platoon receives the supplies. The platoon leader uses the estimate process to find the best way to move to and secure the LZ or DZ, and to receive the supplies.

13-5. MAINTENANCE

Proper maintenance is the key to keeping equipment and materiel in good condition. It includes inspecting, testing, servicing, repairing, requisitioning, recovering, and evacuating.

a. The platoon leader is responsible for the maintenance practices within his unit. He must coordinate his platoon's maintenance efforts with the XO to ensure that the platoon is acting IAW the company maintenance effort. The platoon sergeant coordinates and supervises the platoon's maintenance efforts. The squad leader is responsible for the maintenance of his squad's equipment.

b. Platoon communications equipment that needs repair is turned in to the company communications chief. Platoon weapons and other equipment are recovered to the platoon or the company collection points during battle, or turned in to the supply sergeant during resupply operations.

c. All soldiers must understand how to maintain their individual and squad weapons and equipment IAW the related technical manuals. The platoon leader, platoon sergeant, and squad leaders must understand maintenance for each piece of equipment in the platoon. The unit SOP should specify maintenance periods (at least once a day in the field) and standards for equipment and who inspects which

items (usually the squad leader, with spot-checks by the platoon sergeant and platoon leader).

13-6. TRANSPORTATION

Since the infantry platoon leader has no organic transportation, he requests transportation, he requests transportation support through the first sergeant or XO. They, in turn, request it from the battalion S4 or S3 Air if it involves helicopters. Whenever possible, rucksacks and excess equipment should be transported by vehicle, unless there is a specific reason not to.

13-7 SOLDIER'S LOAD

The soldier's load is a main concern of the leader. How much is carried, how far, and in what configuration are important mission considerations. Leaders must learn to prepare for the most likely contingencies based on available intelligence--they cannot be prepared for all possible operations. In some cases, leaders must accept risks in order to lighten loads, even if some equipment must be left behind. Soldiers should not carry more than 30% of their body weight as a fighting load. No more than 45-50% of body weight during infiltration or approach marches. See FM 7-10 and FM 21-18 for detailed discussions on load planning, calculating, and management.

13-8. PERSONNEL SERVICE SUPPORT

The main platoon combat personnel service support functions are strength accounting and casualty reporting. The platoon leader and NCOs are also responsible for handling EPWs and for the program to counter the impact of stress and continuous operations. Platoon leaders coordinate personnel service support provided by the battalion S1, PAC, and unit ministry team through the company headquarters.

a. Strength Accounting. Leaders in the platoon use battle rosters to keep up-to-date records of their soldiers. They provide strength figures to the company at specific intervals. During combat, they provide hasty strength reports upon request or when important strength changes occur. Control and accountability of personnel in combat operations is of paramount importance.

b. Casualty Reporting. During lulls in the battle, platoons give by-name or roster number (SDP dependent) casualty information to the company headquarters. Soldiers with direct knowledge of an incident must complete a DA Form 1155. This form is used to report KIAs who were not recovered and missing or captured soldiers. DA Form 1156 is used to report those soldiers who have been killed and recovered and soldiers who have been wounded. The platoon leader or platoon sergeant reviews these forms for accuracy, then forwards them to the company headquarters.

c. Services. Services include mail, financial matters, awards and decorations, leaves and passes, command information, religious activities, legal assistance, welfare, rest and relaxation, and any other services related to the welfare and morale of the soldiers. Many services are standard procedure. The platoon leader must ensure that these services are available to the platoon. The first sergeant requests services for the platoon.

d. Enemy Prisoners of War. Soldiers must handle EPWs IAW international law and treat them humanely; they must not abuse them physically or mentally. EPWs must be allowed to keep their personal protective equipment. The senior officer or NCO present is responsible for their care. If a platoon cannot evacuate EPWs in a reasonable time, they must give EPWs food, water, and first aid. Soldiers should not give EPWs comfort items such as cigarettes or candy.

(1) EPWs who receive favors and those who are mistreated make poor interrogation subjects. Use the five B's in handling EPW.

(a) Search the EPW. One soldier should guard the EPW while another searches. The soldier searching should not get between the EPW and the guard. Position the EPW spread-eagled against a tree or wall or have him get on the ground in a push-up position with his knees touching the ground. Search him and search all his gear and clothing. Take his weapons and papers, except identification papers. Give the EPW a written receipt for any personal property and documents taken.

(b) Segregate all EPWs into groups of males and females and subgroups of officers, NCOs, enlisted soldiers, civilians, and politicians. This keeps the leaders from promoting escape efforts. Keep groups segregated as they move to the rear.

(c) Silence EPWs. Do not let EPWs talk to each other. This keeps them from planning an escape and from cautioning each other on security. Report anything an EPW says or tries to say to another EPW.

(d) Move EPWs to the rear. Platoons turn EPWs over to the company where they are assembled and moved to the rear for questioning by qualified intelligence soldiers.

(e) Safeguard EPWs when taking them to the rear. Make sure they arrive safely. Watch out for escape attempts. Do not let them bunch up, spread too far out, or start diversions, such as fist fights, that creates a chance for escape. At the same time, do not allow anyone to abuse them.

(2) If an EPW is wounded and cannot be evacuated through normal channels, he is treated by an aidman and evacuated through medical channels. The EPW must be guarded by other than medical soldiers.

(3) Before evacuating an EPW, tag him with an EPW tag and equipment/document tag (figure 13-1) or a minimal tag (figure 13-2). The tag should be perforated into three parts and made of durable material. It should measure about 10 centimeters by 10 centimeters for each part. It should be pierced at the top and bottom, and reinforced for security for ease of attachment.

(4) Battlefield interrogation may be appropriate on Ranger operations, however, under normal circumstances, interrogation will be conducted by trained intelligence personnel after the five B's have been executed.

f. Captured Enemy Equipment and Associated Technical Documents. Equipment and documents (operator's manuals, TMs, and so on) are a valuable source of information. They must be kept together and guarded throughout the capture and evacuation process to prevent looting, misuse, or destruction. Equipment and documents must be tagged. Captured enemy medical equipment and supplies will not be used on U.S. casualties. It should be turned in for use on wounded EPWs.

13-9. HEALTH SERVICES SUPPORT

Platoon health services support consists of the prevention, treatment, and evacuation of casualties. Prevention is emphasized; soldiers can lose their combat effectiveness because of nonbattle injuries or disease. Understanding and applying the principles of field hygiene and sanitation, preventing weather-related injuries, and considering the soldier's overall condition can eliminate many casualties. (See FMs 21-10 and 21-11.)

a. The unit SOP should address casualty evacuation procedures in detail. It must clearly state that personal protective equipment remains with and is evacuated with the casualty. The casualty's weapon and equipment is retained by the unit, redistributed as appropriate (ammunition, food, water, special equipment) or evacuated to the field trains by backhaul at the next LOGPAC. Machine guns, M203s, and other special weapons are never evacuated but are reassigned to their soldiers.

(1) The unit SOP must include the following:

- Duties and responsibilities of key personnel in planning and evacuating casualty evacuation.
- Priorities of evacuation.
- Provisions for retrieving and safeguarding weapons, ammunition, and equipment.

(2) Paragraph 4 of the OPORD must provide the following:

- Location of casualty collection points (battalion, company, platoon).
- Procedures and responsibilities for medical evacuation.
- Planned use of nonmedical transportation assets for evacuation.
- Procedures for treating and evacuating EPWs and civilian casualties.
- Communication nets for evacuation requests.
- A time when the evacuation mission will begin and the nonmedical soldiers can aid in collection and evacuation. This prevents combat power from being diverted from the mission.

b. Leaders must be prepared to treat and evacuate casualties. They must understand the plan for casualty evacuation and immediately begin to execute it once casualties occur. The platoon aidman is trained to assess, to triage, and to begin treatment of casualties. If he becomes a casualty, both the combat lifesavers and the leaders in the platoon must be prepared to evacuate, treat, and evacuate casualties. Treatment of serious casualties means stabilizing the soldier until he can be evacuated to the battalion aid station. The company and battalion casualty evacuation plans should assume responsibility for the casualties as far forward as possible. Ambulances (ground and air) should pick up the casualties as far forward as possible and the tactical situation permits. Any vehicle in the AO can be used to transport casualties.

c. At least one soldier in each squad must be trained as a combat lifesaver to help the aidman treat and evacuate

casualties. The lifesavers are part of the unit aid and litter team(s). They provide initial treatment until medical personnel can treat casualties, but only after their primary infantry duties are complete. They can also help in triage, treatment, or both for soldiers after medical personnel arrive, if the tactical and medical situations allow. The platoon sergeant supervises this effort.

d. Treatment of casualties normally begins at the conclusion of the engagement, during the reorganization of the unit. Casualties are treated where they fall (or under nearby cover and concealment) by the casualty himself, a buddy, an aidman, or a combat lifesaver. They are then evacuated by improvised or lightweight litters to the platoon casualty collection point. This point is chosen by the platoon leader in the OPORD or by the platoon sergeant as needed on site. When selecting the evacuation point, the leader must consider cover and concealment, security, space in which to treat casualties, route access, and air access. KIA are not collected in or near the casualty collection or evacuation points. As the casualties are collected, they are triaged (sorted) and separated for treatment. The goal is to accomplish the greatest good for the greatest number. The casualty categories are immediate, delayed, minimal, and expectant.

(1) Immediate--to save Life or Limb

- (a) Air obstruction.
- (b) Respiratory and cardiorespiratory failure (cardiorespiratory failure is not considered an "immediate" condition on the battlefield; it is classified as expectant).
- (c) Massive external bleeding.
- (d) Shock.

(e) Sucking chest wound, if respiratory distress is evident.

(f) Second or third degree burns of the face and neck, or perineum (causing shock or respiratory distress).

(g) After casualty with life- or limb-threatening conditions has been initially treated, no further treatment will be given until other "immediate" casualties have been treated.

(2) Delayed--Less Risk by Treatment Being Delayed.

(a) Open Chest Wound.

(b) Penetrating abdomen wound.

(c) Severe eye injury.

(d) Avascular limb without apparent blood supply.

(e) Other open wounds.

(f) Fractures.

(g) Second and third degree burns not involving the face and neck or perineum.

(3) Minimal--Can be Self Aid or Buddy Aid.

Patients in the category are not evacuated to a medical treatment facility.

(a) Minor lacerations.

(b) Contusions.

(c) Sprains.

(d) Minor combat stress problems.

(e) Partial thickness burns (under 20%).

(4) Expectant--Little Hope of Recovery. This category should be used only if resources are limited.

(a) Massive head injury with signs of impending death.

(b) Burns on more than 85 percent of the body surface area.

NOTE: Casualties with minor injuries can assist with recording treatment, emergency care, and defense of the area.

e. The platoon can use any of several evacuation methods. (See FM 8-10-4.1)

(1) Dedicated medical evacuation assets can evacuate the casualties directly to the BAS from the point of injury or planned patient-collection points.

NOTE: If casualties are evacuated by MEDEVAC, they are taken to the medical facility that can give the proper level of care to the most serious casualty onboard, usually at least the medical clearing station in the brigade support area (BSA).

(2) The casualties can be moved by vehicle or litter to the company casualty collection point for evacuation. The OPORD should state how and when this should be done. Medical platoon ambulances attached to the company then move the casualties to the rear.

(3) The platoon sergeant can direct platoon aid and litter teams to carry the casualties to the rear.

(4) Casualties with minor wounds can either walk by themselves or help carry the more seriously wounded soldiers.

(5) In rough terrain (or on petrols), casualties can be evacuated to the BAS by aid and litter teams, carried with the unit until transportation can reach the unit, or cached and picked up later.

(6) Dead soldiers should be evacuated by backhaul on supply vehicles--not in ambulances or MEDEVAC helicopters.

f. The information in Table 2-1 is essential in the format shown when requesting MEDEVAC.

LINE	ITEM	EXPLANATION	WHERE/WHEN OBTAINED	WHO RESPONSIBLE FOR OBTAINING	REMARKS
1	Location of Patient Site.	Describe the grid coordinates of the patient site. When using the GRAF Manual Codes the name "NET" line will be used to convey the grid line letters and the coordinates. To provide unambiguous information to make the grid easy to use or located in the message, letters SOP applies to use of all lines.	From map	1SG Leader(s)	Required on message. Patient location is not up to date. Also, advise the grid coordinates of the evacuation site, plus the route to the evacuation site if the evacuation site must pick up from there then, who located.
2	Radio Frequency, Call Sign, and Calls	Supply the frequency if the radio of patient site, and a way frequency. The call sign and calls if power to be provided or pickup site may be identified in the case.	From SOP	FIELD	Required on that information available without requesting call signs or calls. Provide additional information if change in situation is observed.
3	Number of Patients by Precedence	Report only applicable information and arrange the priority order. A - IMMEDIATE B - URGENT C - PRIORITY D - ROUTINE E - DEFERRED If one or more categories must be reported in the same request, insert the word "OR" between each category.	From Backhaul at Pickup	Adjutant or Senior Platoon Leader	Required by and including the number of vehicles to assist prioritizing patients.
4	Special Equipment Required	Specify the applicable levels codes: A - None B - First C - Intermediate D - Ventilator.	From Backhaul at Patient Location	Adjutant or Senior Platoon Leader	Required so that the equipment needs present on hand the evacuation site prior to the start of the evacuation.

Table 2-1. Procedures for information collection and MEDEVAC request preparation.

13-10. FRAGMENTARY ORDER.

A Fragmentary Order (FRAGO) provides timely changes to existing orders. The format for a FRAGO is the five-paragraph OPORD format. Only those items that have changed since the last OPORD should be discussed. If a significant change in the mission occurs or a new mission is received, a complete OPORD may be issued rather than a FRAGO.

FIVE POINT CONTINGENCY PLAN.

During a tactical mission, the platoon/squad leader must issue a five-point contingency plan before departing his unit. Reasons for such a departure would be a leader's recon, link-up, or forward coordination, for example. Five-point contingency plans give specific, situational instructions to the stay-behind leader. They provide him and the unit specific information on the leader's mission and guidance from the departing leader on how to preserve the unit without compromising the mission, in his absence.

FIVE POINT CONTINGENCY PLAN FORMAT

- | | |
|-------------|---|
| 1. Going. | Where the platoon/squad leader is going. |
| 2. Others. | Who is the PL/SL taking with him. |
| 3. Time. | Time he will gone. |
| 4. What. | What to do if he does not return in time. |
| 5. Actions. | Actions on enemy contact, you and me:
a. If the PL/SL have enemy contact:
1. The PL/SL will _____.
2. The unit (-) will _____.
b. If the unit (-) has enemy contact:
1. The PL/SL will _____.
2. The unit (-) will _____. |

*Use the acronym BDTWA, shown above, to facilitate quick and effective use of the 5-point contingency plan.

CHAPTER FOURTEEN

RECONNAISSANCE, SURVEILLANCE, AND TARGET ACQUISITION (RSTA)

14-1. GENERAL. Training is the cornerstone for success in battle. The philosophy for training in the use of night vision devices (NVDs) is underpinned by realistic, sustained, multi-echelon training focused on light infantry missions. To sustain the soldier's skill in using night vision devices, leaders must train them often enough to prevent skill decay.

a. Night vision device operators must be rotated during training; relief operators must be trained to the same proficiency level as the primary operators.

b. Training with night vision devices should, as a minimum, include equipment adjustment, maintenance, employment, and target acquisition. Developing proficiency in using and employing night vision devices is necessary prior to conducting night tactical training.

c. Types of night vision devices normally found in TDE units include:

(1) Night vision sight, individual served weapons AN/PVS-4 (figure 14-1). The sight is a second generation starlight system, employed primarily as a means for accurate, aimed individual weapons fire at night. It may be used as a hand-held night observation device. "It does not have a tendency to "white-out" as the first generation starlight system." The device mounts on the M14 and M16 rifles, M60 machine gun, M67 recoilless rifle, M72A2 LAW, and the M79 grenade launcher. Its characteristics are:

Weight:	3.7 Pounds
Range:	600 meters-moonlight 300 meters-starlight
Magnification:	3.8X
Field of view:	15 degrees
Power:	BA5567/U (2.7 volt lithium battery)

13-10. FRAGMENTARY ORDER.

A Fragmentary Order (FRAGO) provides timely changes to existing orders. The format for a FRAGO is the five-paragraph OPORD format. Only those items that have changed since the last OPORD should be discussed. If a significant change in the mission occurs or a new mission is received, a complete OPORD may be issued rather than a FRAGO.

FIVE POINT CONTINGENCY PLAN.

During a tactical mission, the platoon/squad leader must issue a five-point contingency plan before departing his unit. Reasons for such a departure would be a leader's recon, link-up, or forward coordination, for example. Five-point contingency plans give specific, situational instructions to the stay-behind leader. They provide him and the unit specific information on the leader's mission and guidance from the departing leader on how to preserve the unit without compromising the mission, in his absence.

FIVE POINT CONTINGENCY PLAN FORMAT

- | | |
|-------------|---|
| 1. Going. | Where the platoon/squad leader is going. |
| 2. Others. | Who is the PL/SL taking with him. |
| 3. Time. | Time he will gone. |
| 4. What. | What to do if he does not return in time. |
| 5. Actions. | Actions on enemy contact, you and me:
a. If the PL/SL have enemy contact:
1. The PL/SL will _____.
2. The unit (-) will _____.
b. If the unit (-) has enemy contact:
1. The PL/SL will _____.
2. The unit (-) will _____. |

*Use the acronym BDTWA, shown above, to facilitate quick and effective use of the 5-point contingency plan.

CHAPTER FOURTEEN

RECONNAISSANCE, SURVEILLANCE, AND TARGET ACQUISITION (RSTA)

14-1. GENERAL. Training is the cornerstone for success in battle. The philosophy for training in the use of night vision devices (NVDs) is underpinned by realistic, sustained, multi-echelon training focused on light infantry missions. To sustain the soldier's skill in using night vision devices, leaders must train them often enough to prevent skill decay.

a. Night vision device operators must be rotated during training; relief operators must be trained to the same proficiency level as the primary operators.

b. Training with night vision devices should, as a minimum, include equipment adjustment, maintenance, employment, and target acquisition. Developing proficiency in using and employing night vision devices is necessary prior to conducting night tactical training.

c. Types of night vision devices normally found in TDE units include:

(1) Night vision sight, individual served weapons AN/PVS-4 (figure 14-1). The sight is a second generation starlight system, employed primarily as a means for accurate, aimed individual weapons fire at night. It may be used as a hand-held night observation device. "It does not have a tendency to "white-out" as the first generation starlight system." The device mounts on the M14 and M16 rifles, M60 machine gun, M67 recoilless rifle, M72A2 LAW, and the M79 grenade launcher. Its characteristics are:

Weight:	3.7 Pounds
Range:	600 meters-moonlight 300 meters-starlight
Magnification:	3.8X
Field of view:	15 degrees
Power:	BA5567/U (2.7 volt lithium battery)



Figure 14-1. AN/PVS-4

(2) Night Vision goggles AN/PVS-5 (figure 14-2). The goggles are a lightweight, battery powered, passive night vision device worn on the head. It provides capabilities for reading, performing manual tasks, patrolling, and conducting surveillance. It has a built-in infrared source used to provide added illumination for close-up viewing. Its characteristics are:

Weight: 1.9 pounds
Range: 150 meters-moonlight
50 meters-starlight
(man-size targets)
Magnification: 1X (UNITY)
Field of view: 40 degrees Power, BA5567/U (2.7 volt battery). AA (alkaline battery).



Figure 14-2. AN/PVS-5

(3) Night vision goggles AN/PVS-7 (figure 14-3). These goggles will replace the AN/PVS-5. They provide improved night vision in lower light levels than the AN/PVS-5. Its characteristics are:

Weight: 1.5 pounds
Range: 150 meters-moonlight
50 meters-starlight
(man-size targets)
Magnification: 1X (UNITY)
Field of view: 40 degrees Power, BA 5567/U
(2.7 volt battery). AA (alkaline battery).



Figure 14-3. AN/PVS-7.

(4) Remote sensors (REMS). REMS are among the newer items added to the reconnaissance, surveillance and target acquisition family of equipment. They are used extensively on surveillance missions. REMS provide information for target acquisition, intelligence and alert or early warning, depending on the unit mission.

(5) Platoon early warning system (PEWS) (figure 14-4). It is a light-weight, self-powered, portable intrusion detection system designed for small units. The sensors are emplaced (unattended), in forward combat zones. The number and type of sensors to be employed in a PEWS set varies and depends upon specific mission requirements. Its characteristics are:

Weight:	13 pounds
Type sensing:	Type I Sensor, Seismic, magnetic, soil conductance
Type II Sensor:	Electromagnetic, seismic, soil conductance
Detection Range:	15 meters (seismic and electromagnetic)
Delivery Means:	Hand employed



Figure 14-4. PEWS

14-2. EMPLOYMENT:

a. The employment of night vision devices must be done with care to prevent any light escaping from the eyepiece of the device. Also, the employment of the infrared portion of the device is a command decision. Unnecessary battlefield illumination must be suppressed, and all infrared radiation must be coordinated as to extent and direction within range of the receivers. Care must be taken to avoid detection by the enemy.

b. Light and Atmospheric Conditions. Night vision devices are most effective on nights with bright moonlight and starlight. The blinding effect of artificial light from searchlights, flares, illuminating shells, or a concentration of mortar and artillery fires may be offset by not looking directly at these light sources or by rapidly closing your eyes against sudden flashes. Rain or fog reduces effective range. Condensation on lenses may be reduced by applying an anti-fog compound.

c. In the Defense. Sentries with night vision devices are better able to cover their areas of responsibility during hours of darkness, and designate targets to weapon crews in the vicinity.

d. Patrol Operations:

(1) Operations during periods of limited visibility may utilize night vision devices for detecting and bypassing or destroying enemy elements. This equipment may also be used during movement, e.g., a linear danger area by near and far side security elements to provide early warning.

(2) A unit properly utilizing night vision equipment may infiltrate enemy areas to a vantage point where it can accurately and effectively observe the objective.

(3) Ambushes can be made more effective by utilizing night vision devices to observe the party to be ambushed. The enemy and their weapons can be reconnoitered and the most favorable moment to initiate the ambush can be chosen. The ambush can be effectively exploited by observing the enemy's actions and defensive measures taken after the initiation of the ambush.

(4) On a raid, night vision equipment may be at security positions, support weapons positions and the ORP.

(5) In the patrol base, the night vision goggles can be used to recon, clear, and secure the area. The leader can use the equipment to verify fields of fire and avenues of approach as well as soldiers verifying their sectors of fire.

(6) Night observation devices can be used on reentry of friendly lines to find the passage point and signalling with infrared source.

a. A rotation system must be employed when using night vision devices for an extended period of time due to eye fatigue. Only 50 percent of a unit's personnel should be employing night vision devices. The remainder should be using their natural senses to detect the enemy.

CHAPTER FIFTEEN

DEMOLITIONS & MINES

15-1. DEMOLITIONS. A working knowledge of explosives and demolitions is essential for the successful completion of many patrolling missions. Units may use explosives in many different ways to destroy enemy equipment or to create obstacles to impede enemy movement. Leaders must learn how to compute and place charges for destruction of common types of military targets. A reproduction of the Demolition Card, GTA 5-10-28, appears on the following pages.

Cratering Charges

DRILL REPAIR ROAD CRACK

ALTERNATE 1.5m (5FT) AND 2.3m (7 1/2 FT) HOLE SPACES ON 1.5m (5FT) CENTERLINE

NO TWO 1.5m (5FT) HOLES ARE TO BE PLACED NEXT TO EACH OTHER

2ND HOLES ALWAYS 5.1m (17FT)

USE 1/2" (1 1/2") CHARGES ON 1.5m (5FT) HOLES AND 3/4" (1 3/4") CHARGES ON 2.3m (7 1/2 FT) HOLES

REINFORCING GRATES APPROX 3.0m (10 FT) SPAC AND 7.6m (25 FT) LONG

$$\text{FORMULA FOR NUMBER OF HOLES} = \frac{N}{S} + 1$$

ROADY ROAD CRACK

HOLES OF EQUAL DEPTH TO A MAX DEPTH OF 1.5m (5FT)

USE 1/2" (1 1/2") CHARGES ON 1.5m (5FT) HOLES

REINFORCING GRATES APPROX 7.6m (25 FT) LONG & 3.0m (10 FT) DEEP

NOTE: ALL CRATERING CHARGES TO BE EQUAL SPACED WITH AT LEAST ONE LB OF ANCHORAGE FOR SAFETY FROM CLAMPING DOWN BY SET BARS

REINFORCED PAVE CRACKS

LAYOUT FRANKLY NOW ROAD AS SHOWN. LAYOUT STAGGERED NOW WITH HOLES STAGGERED BETWEEN FRANKLY HOLES. DISTANCE FROM JOINT FIRST

STAGGERED FRANKLY NOW IS IN 15.0m (50 FT) DELAY AFTER STAGGER NOW

FORMULA FOR NUMBER OF HOLES FRANKLY NOW -

$$N_f = \frac{L}{S_f} + 1$$

FORMULA FOR NUMBER OF HOLES STAGGER NOW

$$N_s = N_f - 1$$

Cratering Charges

BREACHING CHARGES REINFORCED CONCRETE ONLY

FOR OTHER TYPES OF CONSTRUCTION SEE TABLE

CHARGE	DEPTH OF FLAMMABLE						
	1.5	2.0	2.5	3.0	3.5	4.0	4.5
10"	200	200	200	200	200	200	200
12"	200	200	200	200	200	200	200
14"	200	200	200	200	200	200	200
16"	200	200	200	200	200	200	200
18"	200	200	200	200	200	200	200
20"	200	200	200	200	200	200	200
22"	200	200	200	200	200	200	200
24"	200	200	200	200	200	200	200
26"	200	200	200	200	200	200	200
28"	200	200	200	200	200	200	200
30"	200	200	200	200	200	200	200
32"	200	200	200	200	200	200	200
34"	200	200	200	200	200	200	200
36"	200	200	200	200	200	200	200
38"	200	200	200	200	200	200	200
40"	200	200	200	200	200	200	200

TABLE ABOVE IS FOR REINFORCED CONCRETE ONLY. FOR OTHER TYPES OF CONSTRUCTION SEE TABLE

SEE TABLE, SEE WITH TABLE

CHARGE	REINFORCING GRATE	ANCHORAGE
1.5	2.0	3.0



MATERIAL	FOR 100 LB BOMB		FOR 75 LB BOMB	
	QUANTITY	NO. OF HOLE	QUANTITY	NO. OF HOLE
TRIPWIRE	100 lb (100')	10	75 lb (75')	7
TRIPWIRE	100 lb (100')	10	75 lb (75')	7
TRIPWIRE	100 lb (100')	10	75 lb (75')	7
TRIPWIRE	100 lb (100')	10	75 lb (75')	7
TRIPWIRE	100 lb (100')	10	75 lb (75')	7
TRIPWIRE	100 lb (100')	10	75 lb (75')	7
TRIPWIRE	100 lb (100')	10	75 lb (75')	7
TRIPWIRE	100 lb (100')	10	75 lb (75')	7
TRIPWIRE	100 lb (100')	10	75 lb (75')	7

TRIPWIRE
 1. 1/2" DIA. WIRE
 2. 1/2" DIA. WIRE
 3. 1/2" DIA. WIRE
 4. 1/2" DIA. WIRE
 5. 1/2" DIA. WIRE
 6. 1/2" DIA. WIRE
 7. 1/2" DIA. WIRE
 8. 1/2" DIA. WIRE
 9. 1/2" DIA. WIRE
 10. 1/2" DIA. WIRE
 11. 1/2" DIA. WIRE
 12. 1/2" DIA. WIRE
 13. 1/2" DIA. WIRE
 14. 1/2" DIA. WIRE
 15. 1/2" DIA. WIRE
 16. 1/2" DIA. WIRE
 17. 1/2" DIA. WIRE
 18. 1/2" DIA. WIRE
 19. 1/2" DIA. WIRE
 20. 1/2" DIA. WIRE
 21. 1/2" DIA. WIRE
 22. 1/2" DIA. WIRE
 23. 1/2" DIA. WIRE
 24. 1/2" DIA. WIRE
 25. 1/2" DIA. WIRE
 26. 1/2" DIA. WIRE
 27. 1/2" DIA. WIRE
 28. 1/2" DIA. WIRE
 29. 1/2" DIA. WIRE
 30. 1/2" DIA. WIRE
 31. 1/2" DIA. WIRE
 32. 1/2" DIA. WIRE
 33. 1/2" DIA. WIRE
 34. 1/2" DIA. WIRE
 35. 1/2" DIA. WIRE
 36. 1/2" DIA. WIRE
 37. 1/2" DIA. WIRE
 38. 1/2" DIA. WIRE
 39. 1/2" DIA. WIRE
 40. 1/2" DIA. WIRE
 41. 1/2" DIA. WIRE
 42. 1/2" DIA. WIRE
 43. 1/2" DIA. WIRE
 44. 1/2" DIA. WIRE
 45. 1/2" DIA. WIRE
 46. 1/2" DIA. WIRE
 47. 1/2" DIA. WIRE
 48. 1/2" DIA. WIRE
 49. 1/2" DIA. WIRE
 50. 1/2" DIA. WIRE
 51. 1/2" DIA. WIRE
 52. 1/2" DIA. WIRE
 53. 1/2" DIA. WIRE
 54. 1/2" DIA. WIRE
 55. 1/2" DIA. WIRE
 56. 1/2" DIA. WIRE
 57. 1/2" DIA. WIRE
 58. 1/2" DIA. WIRE
 59. 1/2" DIA. WIRE
 60. 1/2" DIA. WIRE
 61. 1/2" DIA. WIRE
 62. 1/2" DIA. WIRE
 63. 1/2" DIA. WIRE
 64. 1/2" DIA. WIRE
 65. 1/2" DIA. WIRE
 66. 1/2" DIA. WIRE
 67. 1/2" DIA. WIRE
 68. 1/2" DIA. WIRE
 69. 1/2" DIA. WIRE
 70. 1/2" DIA. WIRE
 71. 1/2" DIA. WIRE
 72. 1/2" DIA. WIRE
 73. 1/2" DIA. WIRE
 74. 1/2" DIA. WIRE
 75. 1/2" DIA. WIRE
 76. 1/2" DIA. WIRE
 77. 1/2" DIA. WIRE
 78. 1/2" DIA. WIRE
 79. 1/2" DIA. WIRE
 80. 1/2" DIA. WIRE
 81. 1/2" DIA. WIRE
 82. 1/2" DIA. WIRE
 83. 1/2" DIA. WIRE
 84. 1/2" DIA. WIRE
 85. 1/2" DIA. WIRE
 86. 1/2" DIA. WIRE
 87. 1/2" DIA. WIRE
 88. 1/2" DIA. WIRE
 89. 1/2" DIA. WIRE
 90. 1/2" DIA. WIRE
 91. 1/2" DIA. WIRE
 92. 1/2" DIA. WIRE
 93. 1/2" DIA. WIRE
 94. 1/2" DIA. WIRE
 95. 1/2" DIA. WIRE
 96. 1/2" DIA. WIRE
 97. 1/2" DIA. WIRE
 98. 1/2" DIA. WIRE
 99. 1/2" DIA. WIRE
 100. 1/2" DIA. WIRE

Special Demolition Techniques

15-2. INSTALL A MECHANICAL AMBUSH WITH DETONATING WIRE FIRING SYSTEM.

a. **Materials.** Claymore mine, firing wire, tripwire, three stakes, nonconductive material, one clothespin, (if clothespin is not available a deadman firing device can be devised), one nail, electric blasting caps, detonating cord, power source.

b. **Installation:**

- (1) Cut shorting plug from end of firing wire, remove one inch of insulation and twist wires together.
- (2) Run firing wire to tripwire stake in middle of kill zone.
- (3) Attach clothespin to tripwire stake friendly side.
- (4) Prepare firing wire and attach to clothespin (see figure 15-1).
- (5) Run wire from stake on enemy side and attach spoon with wire attached to clothespin (see figure 15-2).
- (6) Emplace claymores from tripwire stake five meters apart.
- (7) Run firing wire with blasting cap attached to either claymore on extreme right or left side.
- (8) Emplace blasting cap into fuse well of claymore (secure wire to stake).
- (9) Prepare detonating cord with nonelectric blasting cap on each side of detonating cord and insert into fuse well of first claymore with electric cap already inserted and run detonating cord to successive claymores to complete the circuit.
- (10) Move back to power source (far enough away from back blast and attach firing wire to power source must be at least three volts of electricity). Mechanical ambush layout (figure 15-3).

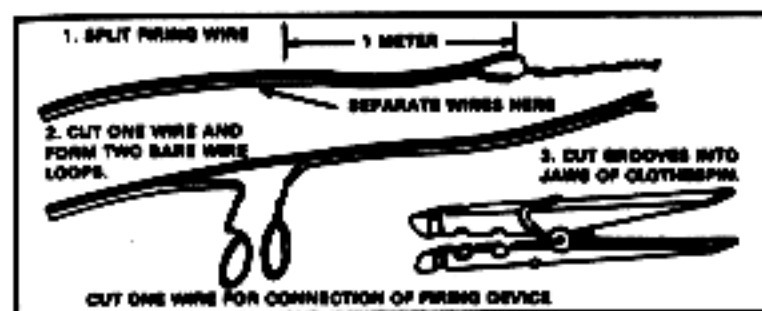

Figure 15-1. Prepare clothespin firing device

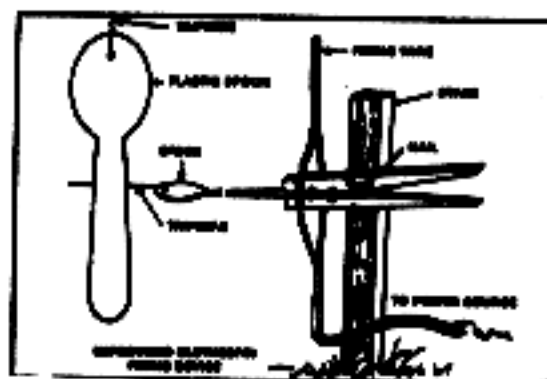

Figure 15-2. Complete firing device

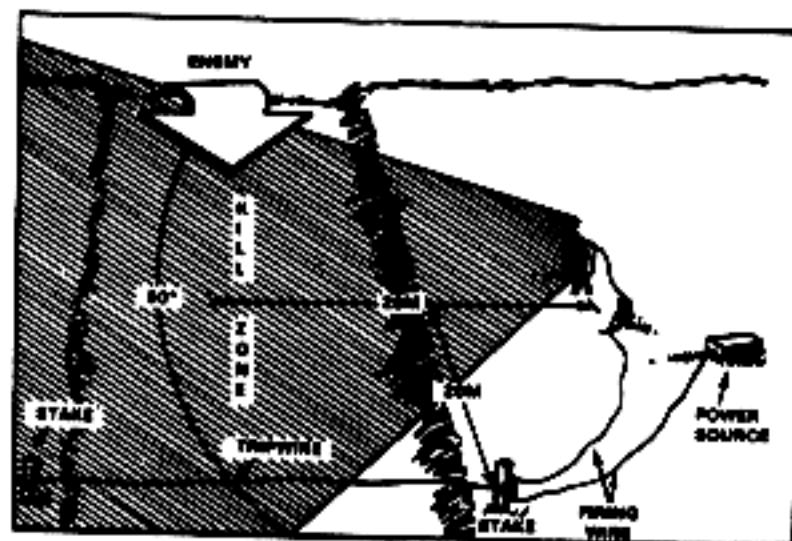

Figure 15-3. Mechanical Ambush Layout

15-3. NONELECTRIC FIRING SYSTEMS.

a. Components and assembly for detonation, Nonelectric fuse igniter (M60), time fuse, crimping, nonelectric blasting cap.

b. Procedures for assembly:

- (1) Cut and discard a six-inch length of time fuse.
- (2) Cut off a three-foot length of time fuse and check burning rate.
- (3) Note time it takes for the fuse to burn.
- (4) Compute the burning rate per foot by dividing the time in seconds by the length in feet.
- (5) Cut the time fuse long enough to permit person to move a safe distance away at a normal pace.
- (6) Secure one blasting cap. Inspect for foreign matter. If foreign matter does not come out, dispose of the cap and secure another.
- (7) Place blasting cap on time fuse.
- (8) Crimp the blasting cap at a point 1/8 to 1/4 of an inch from the open end (figure 15-4).



Figure 15-4. Crimping on the Cap.

(9) Pass the end of the time fuse without the blasting cap through the priming adapter. If priming adapter is not available, insert cap into well and secure with string or tape.

(10) Attach M60 fuse igniter (figure 15-5).

NOTE: If smoke does not appear two seconds after pull ring has been pulled, rearm by pushing pull rod back into position and try to ignite again. If this does not work, clear area, and treat as a dud.

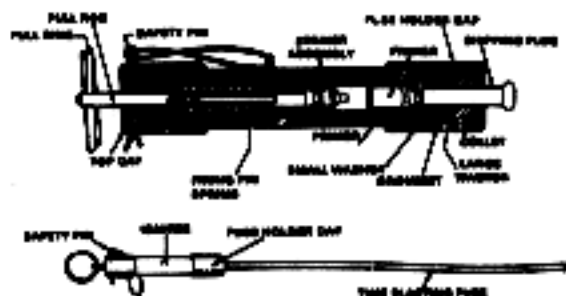

Figure 15-5. M60 fuse igniter

NOTE: If a fuse lighter is not available, split the end of the fuse. Insert a match head into the split end, and light the match with another match, or rub the abrasive side of the matchbox against the match head (figure 15-6).



Figure 15-6. Lighting time blasting fuse with match

c. Detonating cord firing systems:

(1) Methods of use. A detonating cord firing system is the most versatile and easily installed. It is useful for underwater and underground blasting because the blasting cap of the initiating system may remain above the water or ground.

(2) To initiate the detonating cord, use an electric system consisting of an electric blasting cap, initiated by a blasting machine or other power source, or a nonelectric blasting cap, initiated by a fuse igniter and a length of time blasting fuse.

(3) Attach the blasting cap, electric or nonelectric, to a point 6 inches from the free end of the detonating cord by numerous wraps of string, wire, cloth, tape or by an M1 detonating cord clip.

(4) Detonating cord connections:

(a) Square knot connection (figure 15-7).

Square knot should be pulled tight to splice ends of the detonating cord. To ensure detonation from a dry portion of the cord, at least a 6-inch length should be left free at both sides of the knot. DO NOT remove fabric when it covers the detonating cord. The knot may be placed in water or in the ground, but detonate the cord from the dry end.

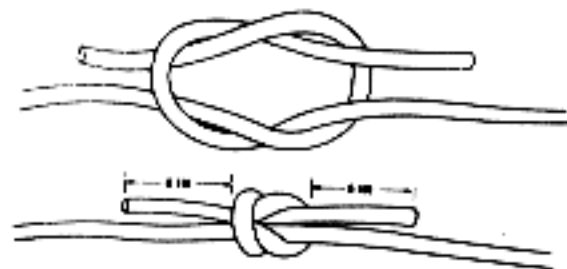

Figure 15-7. Square knot connections

(b) Branch line connections. Girth hitch is utilized with one extra turn (figure 15-8). The angle formed by the branch line and the cap end of the main line should not be less than 90 degrees from the direction from which the blast is coming. At a smaller angle, the branch line may be blown off the main line without being detonated. To ensure positive detonation from the dry end of the line, at least 6 inches of the running end of the branch line should be left free beyond the tie (figure 15-8).

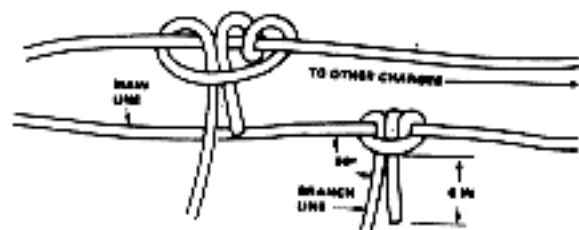

Figure 15-8. Girth hitch with one extra turn.

(c) Ring main with branch lines (figure 15-9). Make a ring main by bringing the main line in the form of a loop and attaching it to itself with a girth hitch with one extra turn. This will detonate an almost unlimited number of charges.

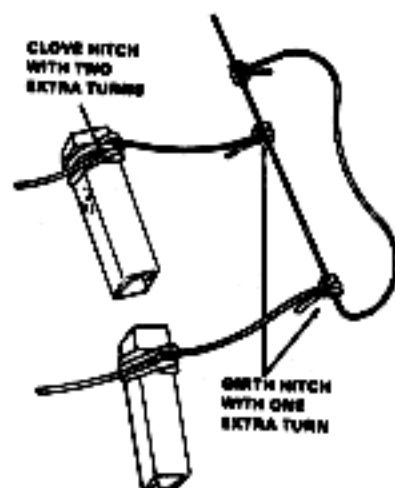

Figure 15-9. Ring main with branch lines.

(d) **Nonelectric dual firing system.** This system consists of two independent nonelectric systems for firing a single charge or set of charges. If two or more charges are to be fired simultaneously, lay out two detonating cord ring mains and tie each branch line from each charge into each ring main. Figure 15-10 illustrates the layout for a nonelectric dual firing system.

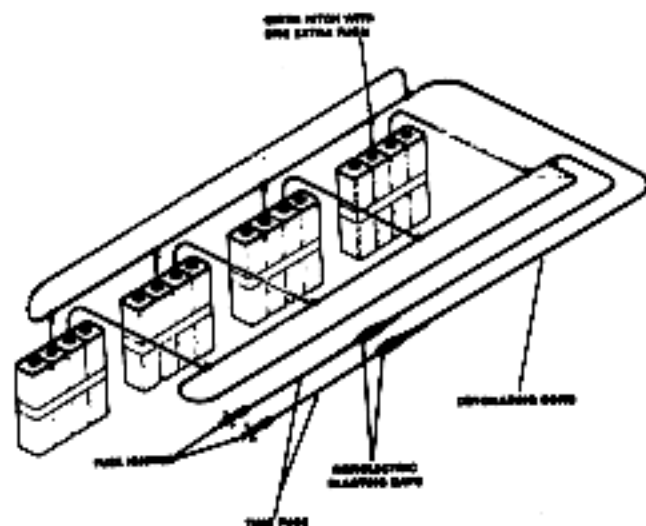

Figure 15-10. Nonelectric dual firing system.

15-4. PRIMING CHARGES.

a. **Detonating cord priming.** Demolition blocks can be primed with detonating cord in several ways.

NOTE: A 6-inch length of detonating cord equals the power output of a blasting cap. However, it will not detonate explosives as reliably as a cap because its power output is not as concentrated. Use the methods that follow to prime demolition blocks with detonating cords. The most reliable method is to affix a nonelectric blasting cap to the end of the detonating cord and place it in the demolition block in the same way as for nonelectric priming. Initiate the assembly by an electric or nonelectric system. The common method is shown in figure 15-11. Lay one end of a 4-foot length of detonating cord at an angle across the explosive. Then give the running end three wraps around the block, and lay the end at an angle. On the fourth wrap, slip the running end under all wraps parallel to the other end and draw tight. Initiate by an electric or nonelectric system.



Figure 15-11. Priming charge

(1) Alternate method number 1 is shown in figure 15-11A. Tie the detonating cord around the explosive block (on top of the booster, if present) with a clove hitch and two extra turns. Fit the cord snugly against the blocks, and push the loop close together. Initiate by an electric or nonelectric system.



Figure 15-11A. Alternate method #1.

(2) Alternate method number 2 is shown in figure 15-11B. Place a loop of detonating cord on the explosive with four wraps around the block and loop. Ensure that in starting the first wrap that it immediately goes over the short leg of the loop. Pull the running end through the eye of the loop and tighten. Initiate by an electric or nonelectric system.

NOTE: Alternate method number 2 is more applicable to short than long detonating cord branch lines or primers.

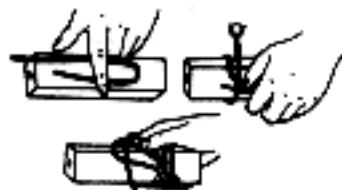

Figure 15-11B. Alternate method #2.

(3) Alternate method number 3 is shown in figure 15-11C. Form a Ull knot with a minimum of eight wraps using a 20 to 24-inch length of detonating cord. This knot equals the power output of three to four blasting caps. Tape the knot tightly to the demolition charge to be detonated.

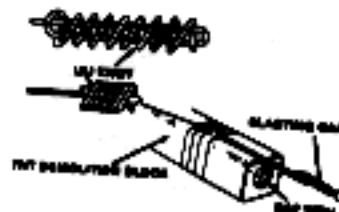

Figure 15-11C. Alternate method #3.

b. Composition C4 Demolition Blocks. Nonelectric and electric priming may be used. Use whole blocks or portions of blocks of plastic explosives (Composition C4), and prime the same way as demolition blocks without cap walls. Cut plastic explosives with a knife and form into any shape.

(1) Detonating cord-priming. To prime plastic explosives with detonating cord, form either of the three knots shown in figure 15-12.

(2) Insert the knot into a block of explosive or a molded piece of explosive. For positive detonation, ensure that there is at least 1/2 inch of explosive in all sides of the knot.

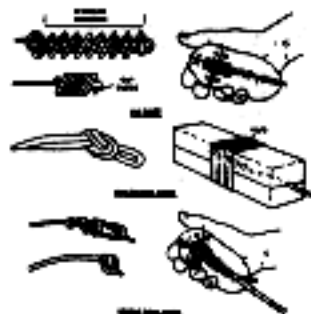

Figure 15-12. Detonating cord priming of plastic explosive

c. Nonelectric and priming of dynamite. There are three possible methods that can be used to prime dynamite nonelectrically:

(1) One is the end priming method (figure 15-13A). Prime as follows:

- Make a cap well in the end of the dynamite cartridge using the cap crimpers.
- Insert a fused blasting cap. - Tie the cap and fuse securely in the cartridge with a string.

END PRIMING METHOD



Figure 15-13A. End priming method.

(2) A second is the weatherproof and priming method (figure 15-13B). Follow these steps:

- Unfold the wrapping at the folded end of the dynamite cartridge.
- Make a cap well in the exposed dynamite using the cap crimpers.
- Insert a fused blasting cap into the cap well.
- Close the wrapping around the fuse and fasten securely with a string or tape.
- Apply weatherproof sealing compound to the tie.

WEATHERPROOF END PRIMING



Figure 15-13B. Weatherproof and priming method.

(3) A third is the side priming method (figure 15-14). Follow these steps:

- Make a cap well about 1-1/2 inches from one end of the dynamite cartridge using the cap crimpers. Slant the cap well so that the blasting cap, when inserted, will be nearly parallel with the side of the cartridge and the explosive end of the cap will be at a point nearest the middle of the cartridge.
- Insert a fused blasting cap into the hole.
- Tie a string securely around the fuse, and then wrap it tightly around the cartridge, making two or three turns before tying it.
- Weatherproof the primed cartridge by wrapping a string closely around the cartridge, extending it an inch or so on each side of the hole to cover it completely. Cover the string with a weatherproof sealing compound.

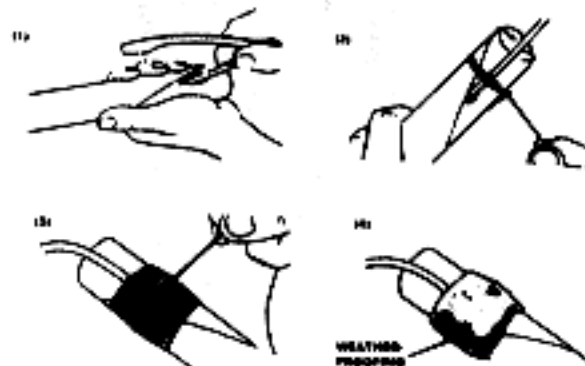

Figure 15-14. Nonelectric side priming of dynamite

15-5. MINES

a. Anti-Personnel Mines (figure 15-15).



Figure 15-15. Anti-personnel mines.

b. Anti-tank Mines (figure 15-16).

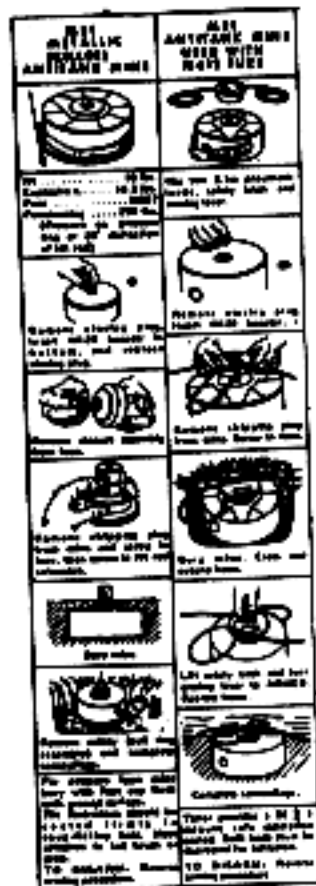

Figure 15-16. Anti-tank mines.

c. Field Expedient Techniques.

(1) Improvised shape charge (figure 15-17).

Concentrate the energy of the explosion released on a small area. Almost any kind of container is useable, making a tubular or linear fracture in the target. Bowls, funnels, coneshaped glasses (champagne glasses with the stem removed), copper, tin, or zinc may be used as cavity liners, or wine bottles with a cone in the bottom; champagne or cognac bottles are excellent. If none of these are available, a reduced effect is obtained by cutting a cavity into a plastic explosive block.

(2) Optimum shaped charge characteristics are:

(a) Angle of cavity - between 30 and 60 degrees (most high explosive anti-tank [HEAT] ammunition has a 42 to 45 degree angle).

(b) Standoff distance - $1\frac{1}{2}$ x height of cone.

(c) Height of explosive in container - 2 x height of cone measured from the base of the cone to the top of the explosive.

(d) Point of detonation - exact top center of charge. Cover cap, if any part of it is exposed or extends above the charge, with a small quantity of C4 explosive.

NOTE: The narrow necks of bottles or the stems of glasses may be cut by wrapping them with a piece of soft, absorbent type of twine or string soaked in gasoline and lighting it. Two bands of adhesive tape, one on each side of the twine or string, will hold it firmly in place. The bottle or stem must be turned continuously with the neck up, to heat the glass uniformly. Also, a narrow band of plastic explosive placed around the neck and burned gives the same result. After the twine or plastic has burned, submerge the neck of the bottle in water and tap it against some object to break it off. Tape the sharp edge of the bottle to prevent cutting hands while tamping the explosive in place.

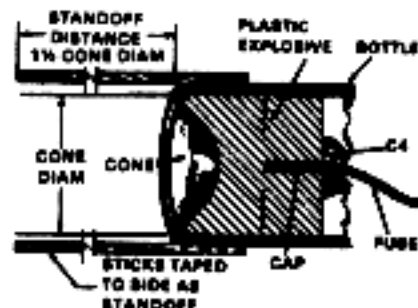

Figure 15-17. Improvised shape charge

(3) Platter Charge. This device utilizes the Miznay-Shardin effect. It turns a metal plate into a powerful blunt-nosed projectile (figure 15-18). The platter should be steel (preferably round, but square is satisfactory) and should weight from two to six pounds.

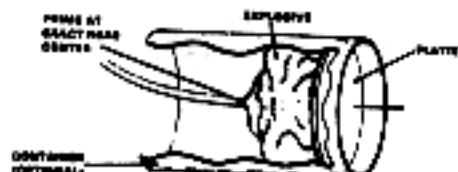

Figure 15-18. Platter Charge

(a) Calculations. Weight of explosive - approximately the weight of the platter.

(b) Preparation:

- Pack the explosive uniformly behind the platter. A container is not necessary if the explosive can be held firmly against the platter. Tape is acceptable.
- Prime the charge from the exact rear center. Cover cap, if any part is exposed, with a small quantity of C4 explosive to ensure detonation.
- Aim the charge at the direct center the target.

(c) Effect. The effective range (primarily a problem of aim) is approximately 35 yards for a small target. With practice a demolitionist may hit a 25 gallon drum, a relatively small target, at 25 yards about 90 percent of the time. A gutted M60 fuse igniter can be used as an expedient aiming device.

(d) Barbed Wire, Anti-personnel, Fragmentation Mine (figure 15-19). One roll of standard barbed wire (FSN-5660-00-251-4482) is placed into position and one block of composition C4 is placed in the center of the roll and primed. This mine can be made directional by placing wire against an embankment or fixed object to cause the force of the explosion to expel the barbed wire fragments in the direction desired.



Figure 15-19. Barbed wire anti-personnel mine.

(e) Field Expedient (pole charge). Used for breaching wire obstacles. Materials needed: C4, electric or nonelectric blasting caps, time fuse, detonating cord, electric or nonelectric ignition system, one large pole. Construction: Attach C4 to pole, place next to picket, prime with appropriate ignition system (figure 15-20).



Figure 15-20. Field expedient pole charge.

REFERENCES

CHAPTER	REFERENCE
1. Leadership	FM 7-8 FM 22-100
2. Operations	FM 7-8 FM 100-5 FM 100-5-1 FM 30-5
3. Fire Support	FM 6-20 FM 6-30
4. Movement	FM 7-8
5. Patrolling	FM 7-8
6. Battle Drills	FM 7-8
7. Communications	FM 21-60 FM 24-1
8. Army Aviation	FM 90-4 RTB ASDP
9. Stream Crossing and Waterborne Operations	RTB BOP
10. Military Mountaineering	TC 21-24
11. Evasion/Survival	FM 21-76

REFERENCES (CONTINUED)

12. First Aid	FM 21-10 FM 21-11
13. Combat Service Support	FM 7-8
14. Recon, Surveillance and Target Acquisition	FM 7-8
15. Demolitions and Mines	FM 5-34 FM 20-32 FM 5-25

STANDING ORDERS, ROGER'S RANGERS

Rangers were organized in 1756 by Major Robert Rogers, a native of New Hampshire, who recruited nine companies of American colonists to fight for the British during the French and Indian War. Ranger techniques and methods were an inherent characteristic of the frontiersmen in the colonies, but Major Rogers was the first to capitalize on them and incorporate them into a permanently organized fighting force. His "Standing Orders" were written in the year 1759. Even though they are over 200 years old, they apply just as well to Ranger operations conducted on today's battlefield as they did to the operations conducted by Rogers and his men.

1. Don't forget nothing.
2. Have your musket clean as a whistle, hatchet scoured, sixty rounds powder and ball, and be ready to march at a minute's warning.
3. When you're on the march, act the way you would if you was sneaking up on a deer. See the enemy first.
4. Tell the truth about what you see and what you do. There is a Army depending on us for correct information. You can lie all you please when you tell other folks about the Rangers, but don't never lie to a Ranger or officer.
5. Don't never take a chance you don't have to.
6. When you're on the march we march single file, far enough apart so no one shot can't go through two men.
7. If we strike on soft ground, we spread out abreast, so it's hard to track us.
8. When we march, we keep moving till dark, so as to give the enemy the least possible chance at us.
9. When we camp, half the party stays awake while the other half sleeps.
10. If we take prisoners, we keep 'em separate till we have had time to examine them, so they can't cook up a story between 'em.

11. Don't ever march home the same way. Take a different route so you won't be ambushed.

12. No matter whether we travel in big parties or little ones, each party has to keep a scout twenty yards ahead, twenty yards on each flank and twenty yards in the rear, so the main body can't be surprised and wiped out.

13. Every night you'll be told where to meet if surrounded by a superior force.

14. Don't sit down to eat without posting sentries.

15. Don't sleep beyond dawn. Dawn's when the French and Indians attack.

16. Don't cross a river by a regular ford.

17. If somebody's trailing you, make a circle, come back onto your tracks, and ambush the folks that aim to ambush you.

18. Don't stand up when the enemy's coming against you. Kneel down, lie down, hide behind a tree.

19. Let the enemy come till he's almost close enough to touch. Then let him have it and jump out and finish him up with your hatchet.