

UNCLASSIFIED

TRADOC LIBRARY

UNITED STATES ARMY TRAINING AND DOCTRINE COMMAND

TRADOC BULLETIN 3^U

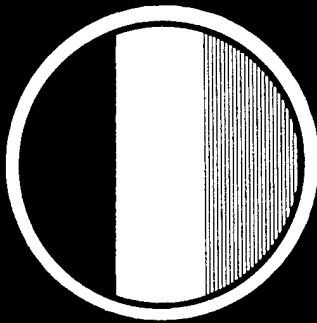

- **WEAPONS**
- **TACTICS**
- **TRAINING**

**SOVIET RPG-7 ANTITANK
GRENADE LAUNCHER**

NOVEMBER 1976

UNCLASSIFIED

20010803 017

REPORT DOCUMENTATION PAGE

Form Approved
OMB No. 0704-0188

Public reporting burden for this collection of information is estimated to average 1 hour per response, including the time for reviewing instructions, searching existing data sources, gathering and maintaining the data needed, and completing and reviewing the collection of information. Send comments regarding this burden estimate or any other aspect of this collection of information, including suggestions for reducing this burden, to Washington Headquarters Services, Directorate for Information Operations and Reports, 1215 Jefferson Davis Highway, Suite 1204, Arlington, VA 22202-4302, and to the Office of Management and Budget, Paperwork Reduction Project (0704-0188), Washington, DC 20503.

| | | | |
|--|---|---|--|
| 1. AGENCY USE ONLY <i>(Leave blank)</i> | 2. REPORT DATE NOVEMBER 1976 | 3. REPORT TYPE AND DATES COVERED FINAL | |
| 4. TITLE AND SUBTITLE TRADOC BULLETIN 3. SOVIET RPG-7 ANTITANK GRENADE LAUNCHER. | | 5. FUNDING NUMBERS | |
| 6. AUTHOR(S) | | 8. PERFORMING ORGANIZATION REPORT NUMBER | |
| 7. PERFORMING ORGANIZATION NAME(S) AND ADDRESS(ES) HQ U.S. ARMY TRAINING AND DOCTRINE COMMAND ATTN: ATCG-T FORT MONROE VIRGINIA 23651 | | 10. SPONSORING / MONITORING AGENCY REPORT NUMBER | |
| 9. SPONSORING / MONITORING AGENCY NAME(S) AND ADDRESS(ES) | | 11. SUPPLEMENTARY NOTES See TRADOC Bulletin 2 dated February 1975, and TRADOC Bulletin 2, dated April 1975 (Don't ask me, I just input this) | |
| 12a. DISTRIBUTION / AVAILABILITY STATEMENT APPROVED FOR PUBLIC RELEASE; DISTRIBUTION IS UNLIMITED. | | 12b. DISTRIBUTION CODE | |
| 13. ABSTRACT <i>(Maximum 200 words)</i> This bulletin will focus on the RPG-7 antitank grenade launcher, the most numerous and widely distributed of all the Soviet antitank weapons. Introduced in 1962, is now the standard Soviet and Warsaw Pack squad antitank weapon (except in Czechoslovakia which has a weapon of its own design similar to the older Russian RPG-2). The RPG-7 has been a standard weapon in the Israeli inventory since 1967. It has been used in Northern Ireland where it has been reportedly fired from <i>inside</i> buildings. Of all the Soviet antitank weapons, the RPG-7 is probably the best known to U.S. commanders. In Vietnam its efficiency in all types of combat, including fire at helicopters, was well established after its introduction in 1967. This bulletin describes the RPG-7: how it works, the capabilities and weakness of the weapon, its crew training and its tactical employment. These factors provide considerations for developing effective countermeasures against the RPG-7 and, finally, thoughts on training to insure countermeasures are learned before the battle starts. | | | |
| 14. SUBJECT TERMS | | 15. NUMBER OF PAGES 35 | 16. PRICE CODE |
| 17. SECURITY CLASSIFICATION OF REPORT UNCLASSIFIED | 18. SECURITY CLASSIFICATION OF THIS PAGE UNCLASSIFIED | 19. SECURITY CLASSIFICATION OF ABSTRACT UNCLASSIFIED | 20. LIMITATION OF ABSTRACT UNLIMITED |

THIS IS AN ARTEP* SUPPORTING DOCUMENT

***ARMY TRAINING AND EVALUATION PROGRAM**

**UNITED STATES ARMY
TRAINING AND DOCTRINE COMMAND
BULLETIN NO. 3^U**

SOVIET RPG-7 ANTITANK GRENADE LAUNCHER Capabilities and Countermeasures

TABLE OF CONTENTS

| | Page |
|---|-------------|
| I The Soviet RPG-7 Antitank Grenade Launcher | 2 |
| II Analysis of the Weapon System | 4 |
| III Countermeasures | 29 |
| APPENDIX | |
| A Ordering TRADOC Bulletins | 33 |

This TRADOC BULLETIN is intended to provide to commanders, and others concerned with military training, timely technical information on weapons, tactics, and training. It is not intended to supplant doctrinal publications, but to supplement material on "how to fight" with data derived from tests, recent intelligence, or other sources, which probe "why."

TRAINERS' NOTE: The format of this bulletin is designed to help trainers identify and extract needed information. TASOs have master copies of the diagrams and pictures in this bulletin, from which you can order slides for use in unit schools or other training.

Comment or criticism is welcome, and should be directed to:

**COMMANDER
US ARMY TRAINING AND DOCTRINE COMMAND
ATTN: ATCG-T (TEL: AUTOVON 680-2972/3153)
FORT MONROE, VIRGINIA 23651**

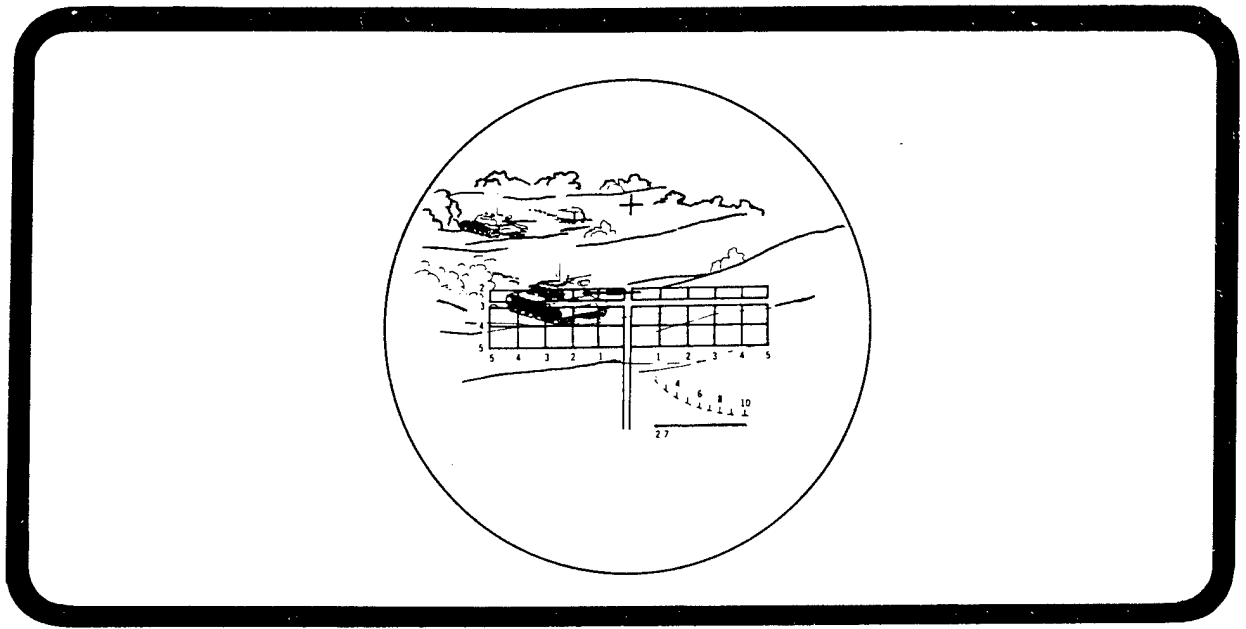

I THE SOVIET RPG-7 ANTITANK GRENADE LAUNCHER

Soviet doctrine for the modern battlefield is identical to American doctrine in one important way. Both doctrine stress that the tank, because of its armor, speed, fire power, and relative invulnerability to nuclear weapons, is necessary for decisive offensive combat. Since main battle tanks are roughly equal in capability, the force that can maintain the greatest number of tanks on the battlefield has the dominant edge in mobile warfare. Hence, both forces seek to reduce the number of opposing tanks as a prerequisite for their own success and have developed an array of powerful antitank weapons. The effectiveness of Soviet antitank weapons was clearly shown in the Arab-Israeli conflict of 1973. But that war also proved that each system can be degraded or nullified by sound tactics, by an understanding of the weapons, and by aggressive and imaginative commanders in the field.

TRADOC Bulletin TWO discussed the longer range SAGGER and SWATTER antitank guided missile (ATGM) systems. This bulletin will focus on the RPG-7 antitank grenade launcher, the most numerous and widely distributed of all the Soviet antitank weapons. Introduced in 1962, it is now the standard Soviet and Warsaw Pact squad antitank weapon (except in Czechoslovakia which has a weapon of its own design similar to the older Russian RPG-2). The RPG-7 has been a standard weapon in the Israeli inventory since 1967. It has been used in Northern Ireland where it has been reportedly fired from *inside* buildings.

Of all the Soviet antitank weapons, the RPG-7 is probably the best known to U.S. commanders. In Vietnam its efficiency in all types of combat, including fire at helicopters, was well established after its introduction in 1967.

This bulletin describes the RPG-7: how it works, the capabilities and weaknesses of the weapon, its crew training and its tactical employment. These factors provide considerations for developing effective countermeasures against the RPG-7 and, finally, thoughts on training to insure countermeasures are learned before the battle starts.

The Soviet Antitank Defensive System

The following diagram portrays in a basic way what the Soviets call a "zone of continuous antitank fire." Each weapon complements and supports another weapon to provide coverage throughout the battalion defensive zone. Note that the RPG-7 serves as the final defensive anchor completely around the position. The RPG-7 is backed up with antitank hand grenades that are effective out to 25 meters. Similar weapons and tactics will be used by other armies which have been trained by the Soviets.

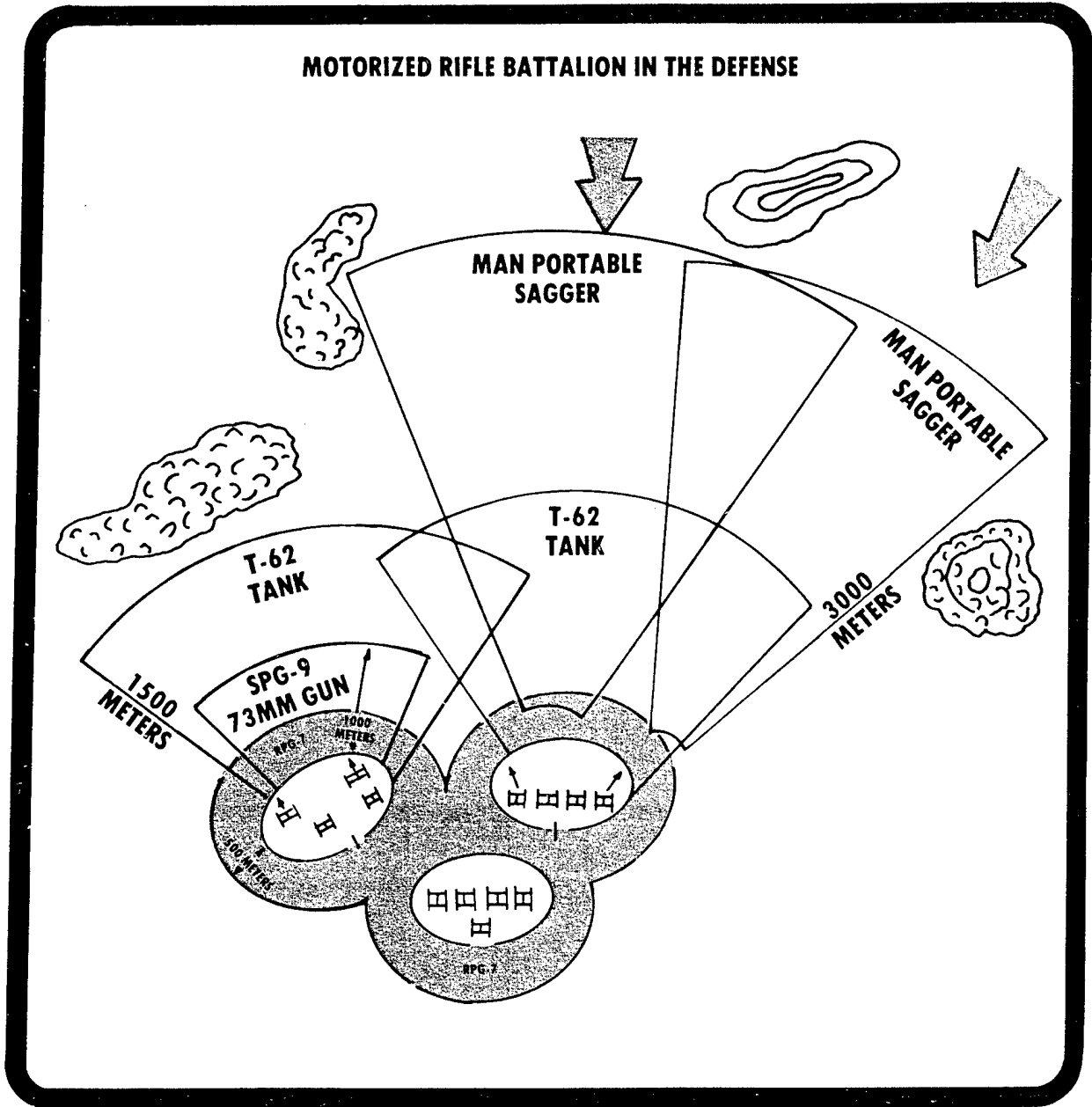

II ANALYSIS OF THE WEAPON SYSTEM

The battlefield effectiveness of a weapon relates to the three elements of the weapon system. These are:

- **Weapon Capabilities**
- **Gunner Proficiency**
- **Tactical Employment**

If we understand each of these parts and their inter-relationship we can begin to:

- **Predict lethality**
- **Discover vulnerabilities**
- **Devise countermeasure**
- **Train to defeat the weapon before the battle starts**

Weapon Capabilities

All weapons have certain important design capabilities that can be scientifically measured. Some of these are:

- **Minimum Range**
- **Maximum Range**
- **Range Dispersion**
- **Velocity**
- **Penetration Capability**
- **Operator Safety Distances**

These features are built into the weapon and remain relatively constant. They are starting points. True combat capability is realized only when these effects are considered in combination with battlefield conditions and gunner training.

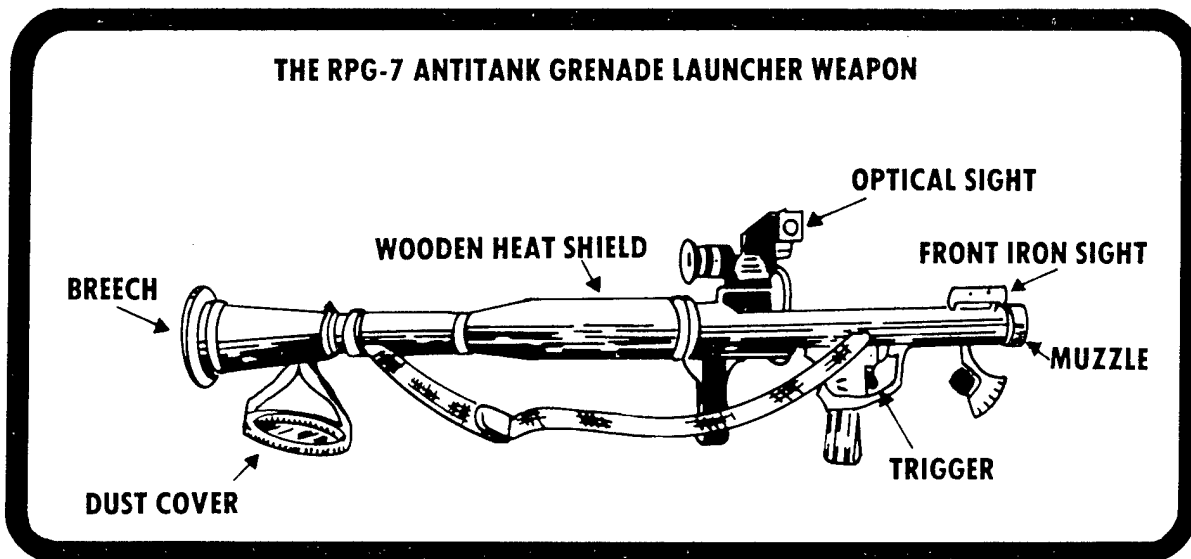

Airborne Model (RPG-7D)

The RPG-7D is a modified launcher designed for airborne troops. It can be broken down into two parts and jumped in on a parachute assault. It is otherwise identical to the basic RPG-7 launcher.

Although the RPG-7 is not identical to the U.S. LAW, its function in battle is similar and a comparison of characteristics between the two weapons is useful.

The RPG-7 is an assigned weapon while the LAW is classified as a round of ammunition and can be issued in quantity.

| CHARACTERISTICS | RPG-7 | LAW |
|-----------------------------------|--|--|
| Length | 37.8 inches (unloaded) 52.6 inches (loaded) | 26 inches (closed) 35 inches (extended) |
| Weight | | |
| Unloaded | 14.5 pounds | |
| Loaded | 19.0 pounds | 5.2 pounds |
| Caliber | | |
| Tube | 40mm | 66mm |
| Round | 85mm | 66mm |
| Rate of Fire | 4-6 rounds per minute | |
| Range | | |
| Arming | 5 meters | 9 meters |
| Sighting Range (Max.) | 500 meters | 350 meters |
| Maximum Range | 900 meters --- Self destructs | 1000 meters |
| Velocity | | |
| Initial | 117 meters per second | 144 meters per second |
| Rocket Assist. | 294 meters per second | |
| Armor Penetration at zero degrees | 13 inches | 14 inches |
| Type Warhead | HEAT | HEAT |
| Lead Capability | 20 miles per hour | 15 miles per hour |
| Tracer Element | Yes | No |

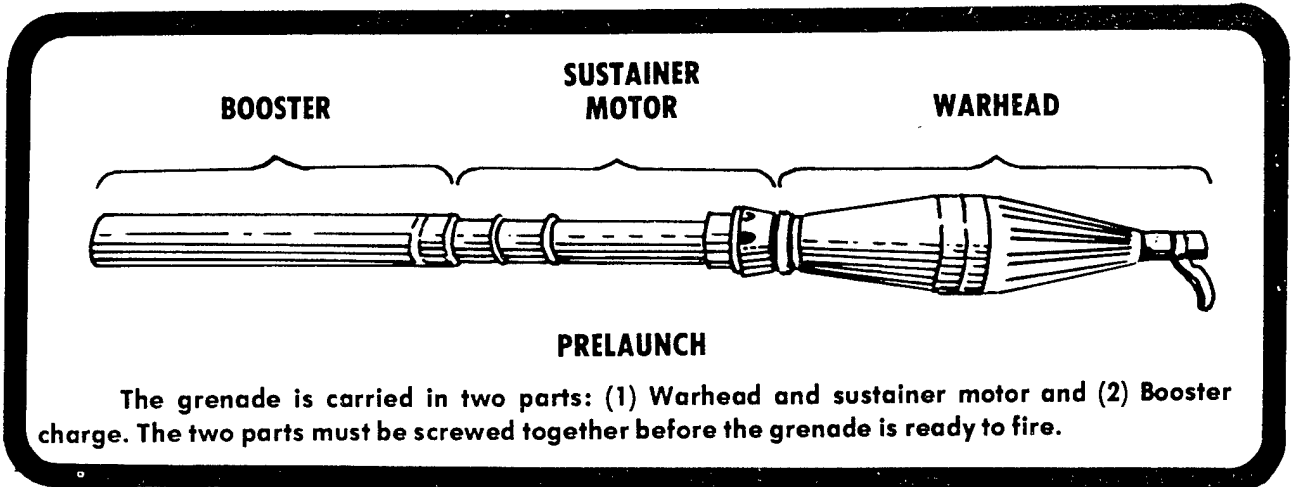

The PG-7 grenade is a rocket assisted projectile. It is first ejected from the launcher at a velocity of 117 meters per second by a small strip powder charge. This reduces backblast and protects the gunner. Approximately 11 meters from the launcher a sustainer rocket ignites and boosts the rocket to a maximum velocity of 294 meters per second. Thus the RPG-7 combines the advantages of reduced backblast with increased accuracy and range.

Accuracy is enhanced by a set of fins that open after initial launch. These fins have a canted surface which spin the rocket and provide improved stability in flight.

PG-7 GRENADE CHARACTERISTICS

| | | |
|-----------------|---|----------------------------------|
| Length | — | 36.62 inches |
| Weight | — | 4.6 pounds |
| Color | | |
| HEAT | — | Olive drab |
| Practice | — | Black |
| Type Fuse | — | Point Impact with base detonator |
| Propellant | — | Smokeless Powder |
| Spin Stabilized | — | Yes |

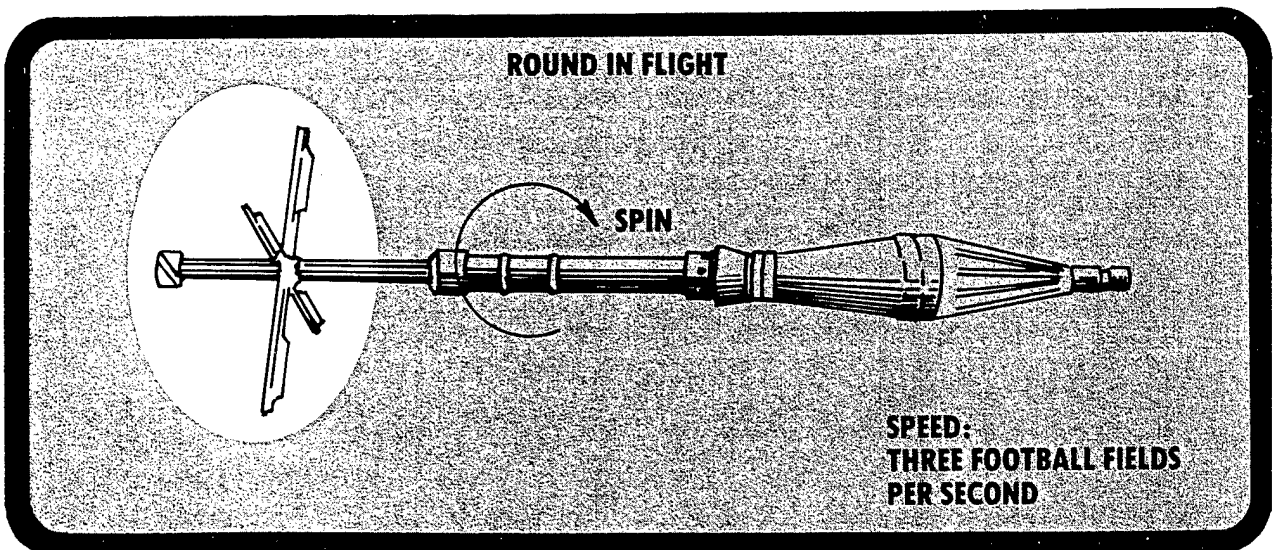

Firing Signature

Tests have shown that the smoke from the initial firing backblast is slightly larger than that of the US M72A2 LAW. The initial booster produces a smoke puff 3 to 4 feet in diameter which lingers up to eight seconds in low winds. The sustainer rocket ignites about 11 meters from the launcher and produces a bright flash and a second smoke puff similar to the initial blast. The possibility of locating a RPG-7 from its firing signature is of course dependent on battlefield conditions. Smoke and wind will reduce the initial backblast smoke, but in a position in woods or some cover, the smoke will stay longer. The flash and smoke from the sustainer motor will probably be more visible and provide a general indication of weapon type and location, particularly at night.

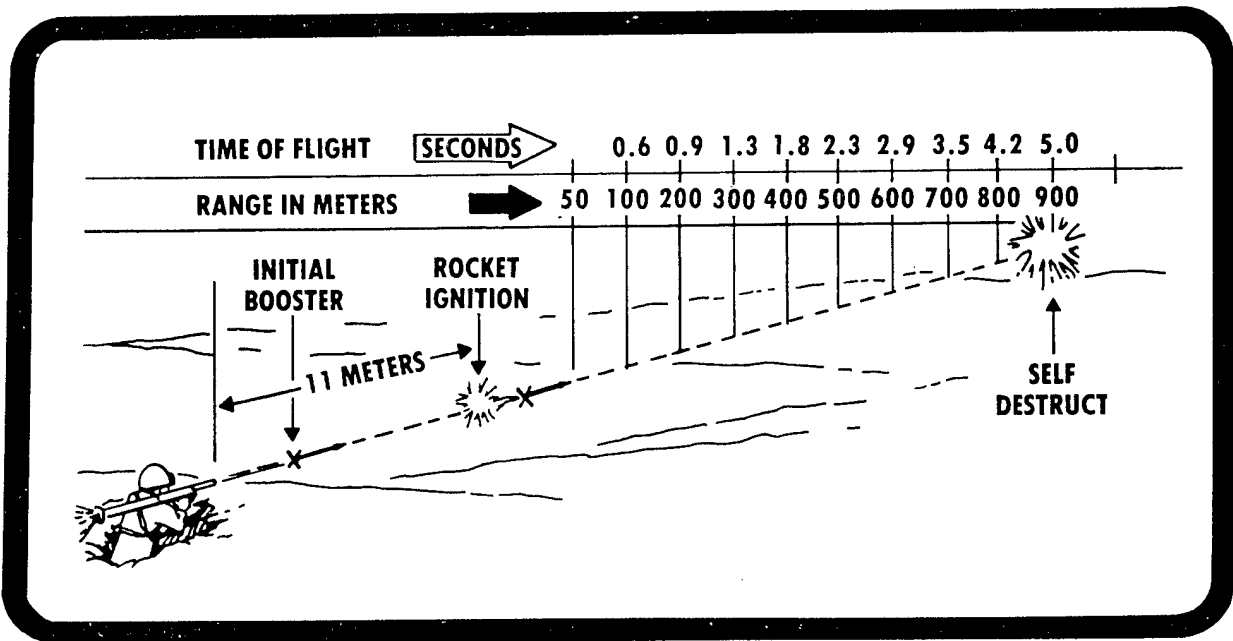

Note: The PG-7 grenade self-destructs approximately 900 meters from the launcher.

Killing Effects

The warhead uses the shaped charge effect to penetrate the target. When the warhead is detonated, a small core of metal forms and burns through the armor. There is no explosive action after the core penetrates and often the core will continue out the other side of an APC.

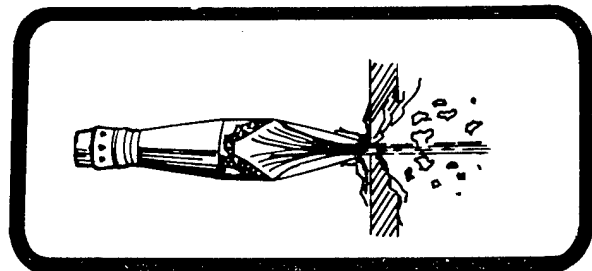

The RPG-7 Sights

Weapon Sights

RPG-7 battlefield effectiveness is directly related to the gunner's ability to aim and fire quickly and accurately. The RPG-7, like most direct fire weapons, is affected by range estimation and by the ease with which the sight can lead a moving target. Further, crosswinds affect the projectile's flight. Normally a projectile, the LAW as an example, will move with the direction of the wind. The PG-7 works exactly opposite from the LAW — the PG-7 grenade flies into the wind.

THIS FACT SERIOUSLY COMPLICATES FIRING THE RPG-7 IN CROSSWINDS.

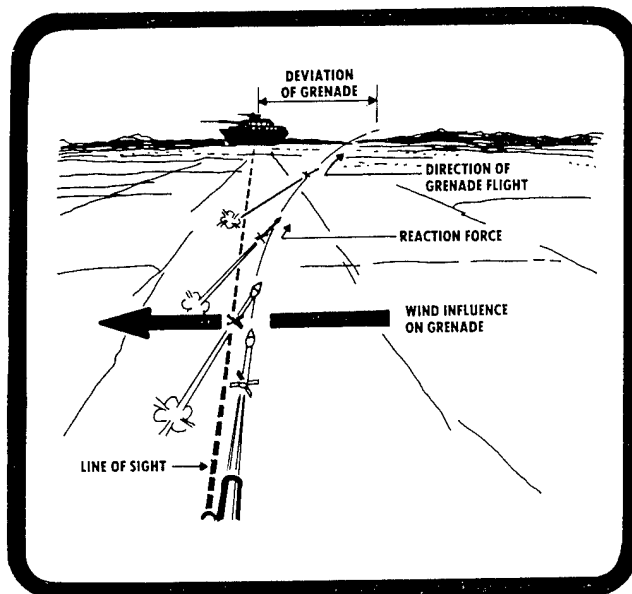

Crosswind Velocity Effects

If he fires into a crosswind, an RPG-7 gunner must correct his sight picture for both wind direction and velocity. The chart below illustrates the average effect on 1st round hits as the wind velocity increases.

IN A 7 MPH WIND THE GUNNER CANNOT EXPECT TO GET 1ST ROUND HITS MORE THAN 50% OF THE TIME BEYOND 180 METERS.

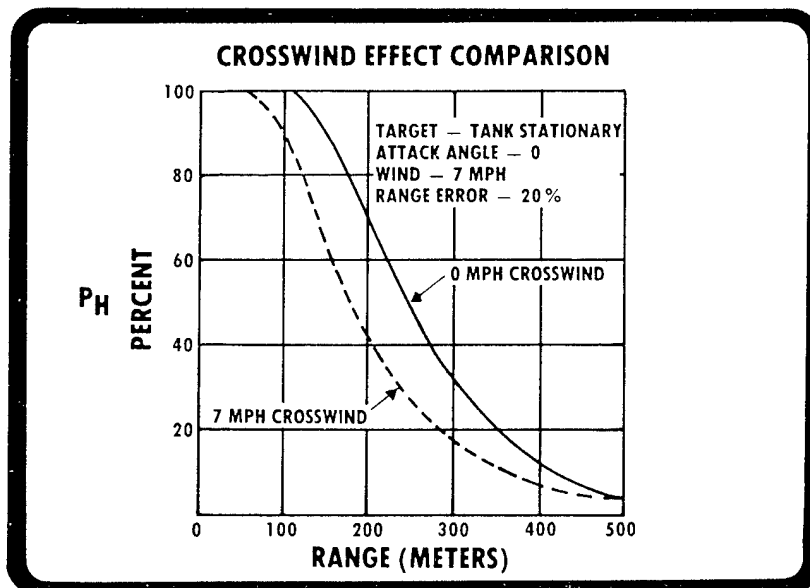

THE RPG-7 HAS TWO STANDARD SIGHTS:

- Iron sights
 - Permanently attached
 - effective from 200 to 500 meters
 - no wind or lead adjustment
 - the back-up system
- Telescopic sight
 - the primary system

The following illustration shows the various parts of the 2½ power optical sight.

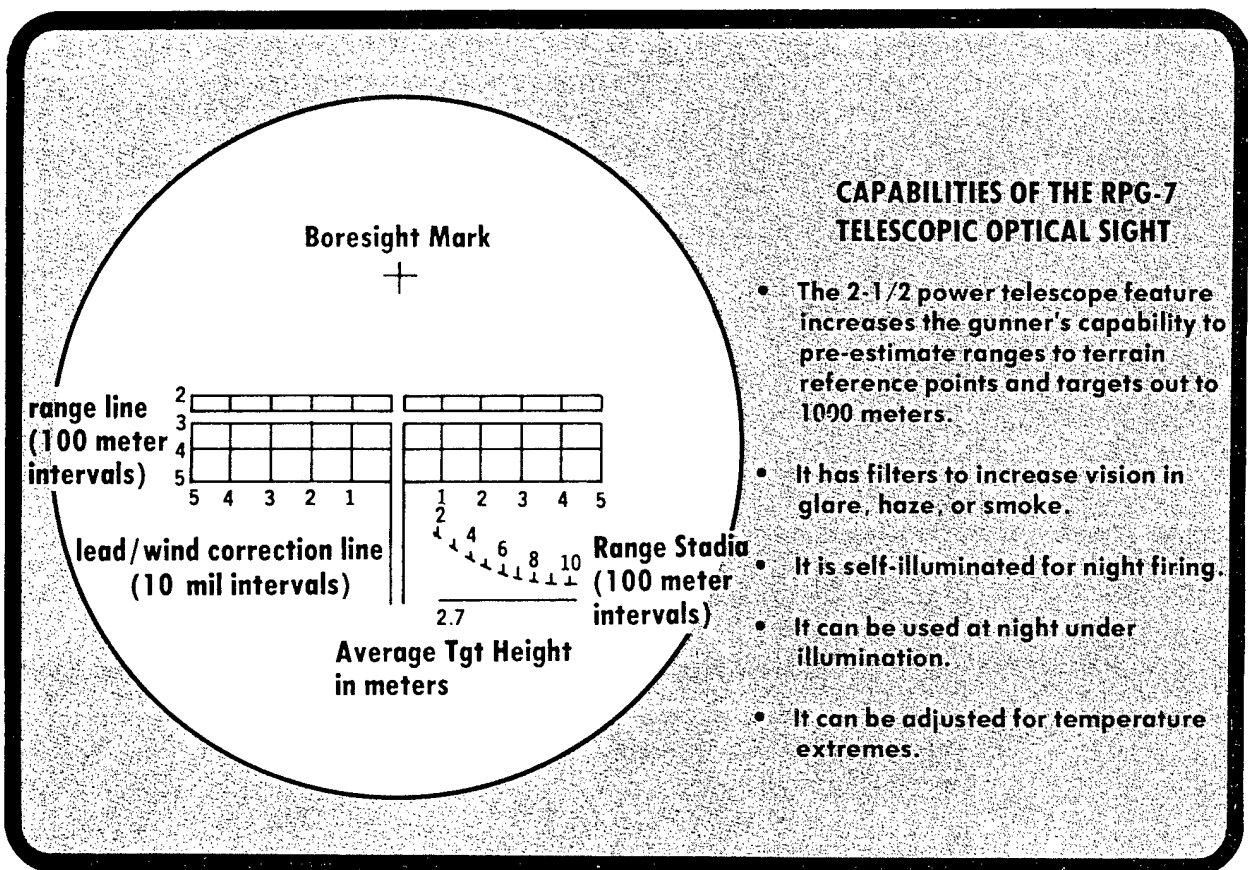

CAPABILITIES OF THE RPG-7 TELESCOPIC OPTICAL SIGHT

- The 2-1/2 power telescope feature increases the gunner's capability to pre-estimate ranges to terrain reference points and targets out to 1000 meters.
- It has filters to increase vision in glare, haze, or smoke.
- It is self-illuminated for night firing.
- It can be used at night under illumination.
- It can be adjusted for temperature extremes.

Aiming with the Optical Sight

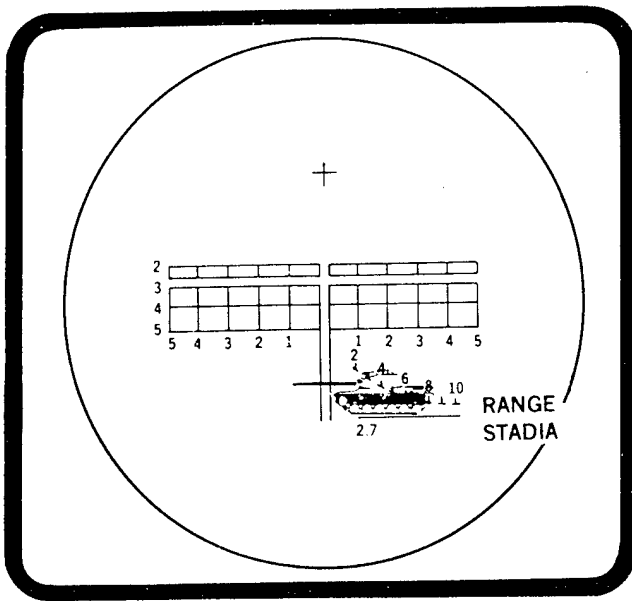

- Center the full height of the target between the stadia lines. The tank treads rest on the bottom line.
- Read the range, in 100s of meters, on the upper stadia line where the top of the target touches the upper line.
- The target in the example above is at about 300 meters from the gunner.

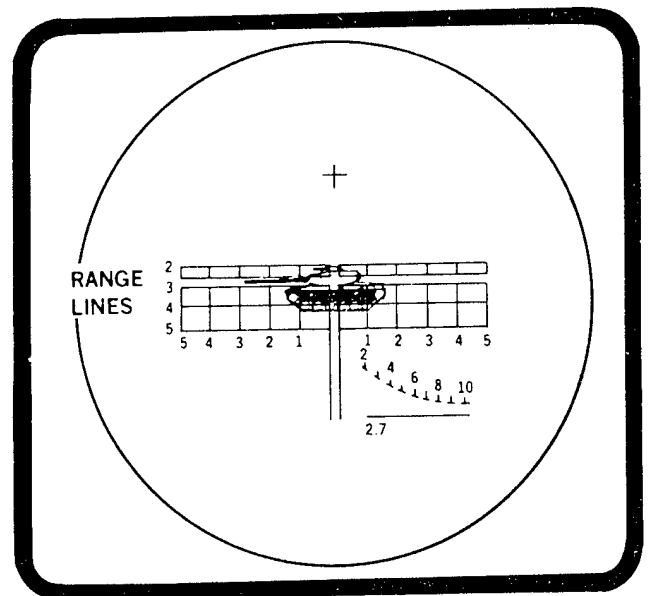

- Move the center of the sight reticle over the center of the target mass along the line of the measured range.
- The example above depicts a stationary tank at 300 meters.
- If there were no cross winds, the gunner could fire with this sight picture.

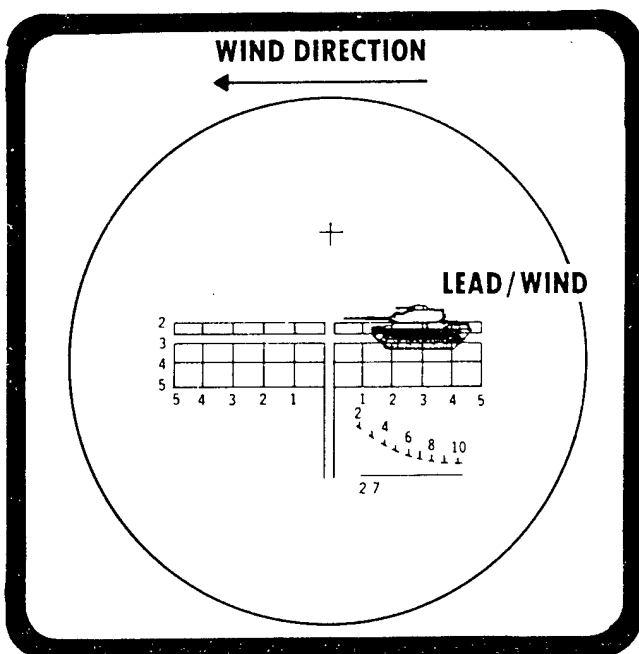

- If a cross wind is blowing from right to left, move the center reticle to the left of the target. 10 mils for each 10 MPH of wind speed.
- In a cross wind blowing from left to right, move the reticle to the right of the target along the measured range line.
- The sight picture above shows the correction for a stationary target in a wind blowing from the right.

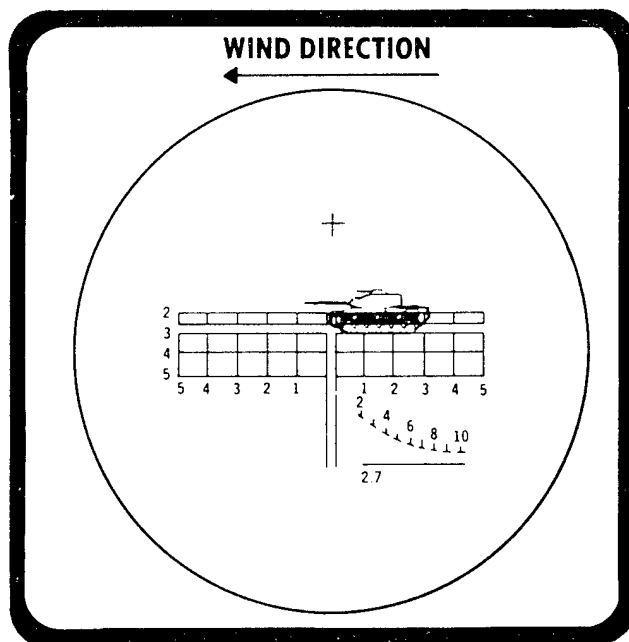

- If the target is moving, establish a lead in the direction of target travel by moving the sight in the direction of travel 10 mils for each MPH of speed.
- For a moving target in a cross wind, the lead is added or subtracted from the wind correction depending on the wind direction.
- The example above depicts a target moving left 15 MPH in a 10 MPH cross wind blowing from the right.

Important Facts About the Sight

Because of the difficulty associated with accurate sighting, sight procedures are covered more extensively than any other subject in the Soviet RPG-7 Field Manual.

- Range stadia measures full target height to obtain range estimate
- Range line is placed over the horizontal center line of the target mass at the measured range. Double line at 300 meters indicates the maximum range that the Soviets expect to get at least 50% first round hits.
- Center lead line is moved first left or right of the target for moving target lead and then again for cross wind corrections.

Night Vision Devices

Two night vision devices can be mounted on the RPG-7 launcher in place of the optical sight.

| | NSP-2 | PNG-1 |
|---|--|--|
| Type | Active Infrared | Passive-Starlight |
| Entered Service | 1956 | 1969 |
| Weight | 13.23 pounds | 7.72 pounds |
| Distribution | Unknown | One per Motorized Regiment and Airborne Platoon Three per Antitank Battery (SAGGER) One per Division Reconnaissance Bn. One per Regimental Engineer Company |
| Capabilities (Average target detection range on moonless, starlit night) | 150-200 meters | 400 meters |
| | Can passively detect IR sources in excess of 6 km | Can detect small light sources such as cigarettes, flashlight and vehicle instrument panel lights at long ranges |

PGN-1 Starlight Scope

The PGN-1 starlight scope was issued in quantity to the Arab forces in the October War, and is designed specifically for the RPG-7 while the infrared sight is used on other small arms.

Countermeasures

- Light discipline
- Smoke
- Terrain shielding
- Infrared sights can be flooded with illumination
- Careful use of IR and laser range finders—illuminate, move, illuminate, move again

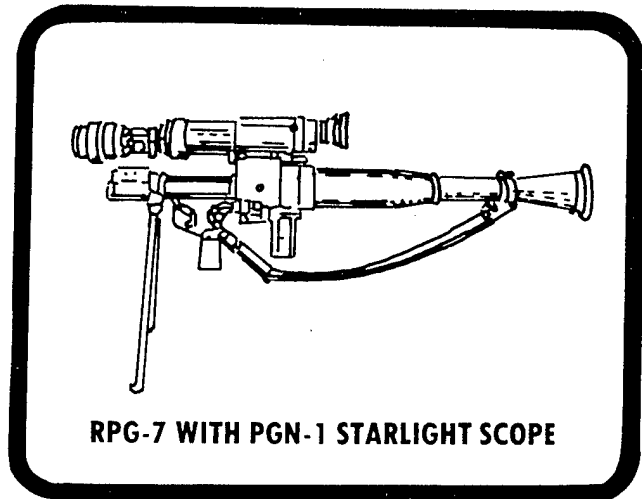

Tactical Implications of the Sighting System

- The optical sight provides good range estimation when it can observe the full target height.
- A tank or APC which does not expose its full height is less vulnerable to accurate range estimation.
- The optical sight can be used at night under illumination.
- The starlight scope enables the gunner to get an accurate sight picture in near total darkness out to 400 meters.
- Light discipline is necessary to avoid long range detection at night.
- The optical sight requires a well trained gunner to put together lead and wind corrections.
- Concealment blocks the gunner's vision.
- Concealment is necessary even at night.
- Smoke is an effective countermeasure.
- A moving target is more difficult to sight accurately.
- To see a target with any sight the gunner must partially expose himself and become vulnerable to counterfire.

RPG-7 Hit and Kill Capabilities

Soviet tactical firing doctrine for the RPG-7 tells the gunner that: "The most effective fire from the grenade launcher is delivered against tanks, self-propelled guns, and other targets of two meters height and more at a point-blank range equalling 300 meters. The sighting range of fire is 500 meters." Combining that doctrine with the optical sight capabilities would produce a sequence of moving target engagements something like this:

- Use the range stadia to estimate target range beginning at the 1000 meter maximum stadia line.
- Begin tracking the target at the 500 meter maximum sighting range.
- Continue tracking until the target reaches the double line at 300 meters and fire.
- Observe the burst, reload, correct for range, and fire a second round if the first round missed or did not kill the target. This takes about 14 seconds.

A 300 meter shot reduces target reaction time either to take evasive action or to return suppressive fire. The last point is important to the gunner because even if he hits the target, he probably will require a second shot to kill it.

U.S. analysis of the weapon system indicates that perhaps the Soviet doctrine is overly optimistic. The following series of graphs are based on U.S. exploitation tests and compare Soviet doctrine with U.S. estimates of weapon performance.

Hit Probabilities

Range Estimation Errors

Errors in judging range by an RPG-7 gunner have a significant impact on his chances of hitting a target with the first round. Note the difference in probability of hit at 300 meters against a stationary target with no crosswinds as shown in the graph below.

Considerations

- Range estimation is more difficult for targets in defilade
- Well trained gunners normally misjudge range by about 15% to 20% on the first shot
- 2d round range error will be much lower because the gunner can correct using burst on target methods

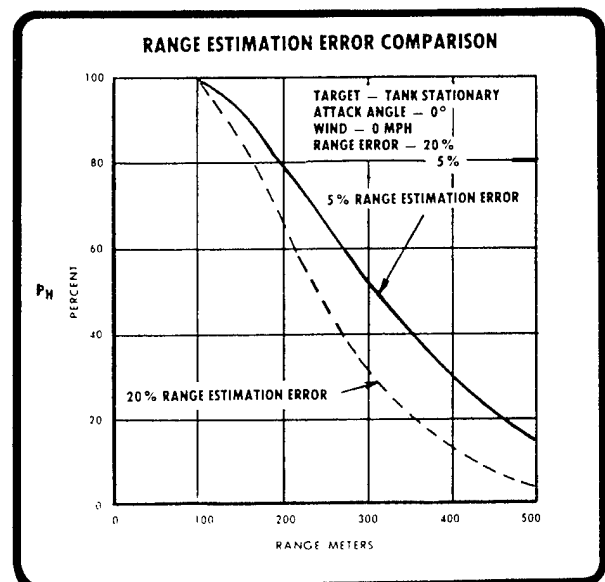

1st Round Hit Probability vs. M60 Tank — Stationary

1st round hit probability at 300 meters is much lower than Soviet expectation: an exposed target at this range has less than a 30% chance of being hit with the 1st round.

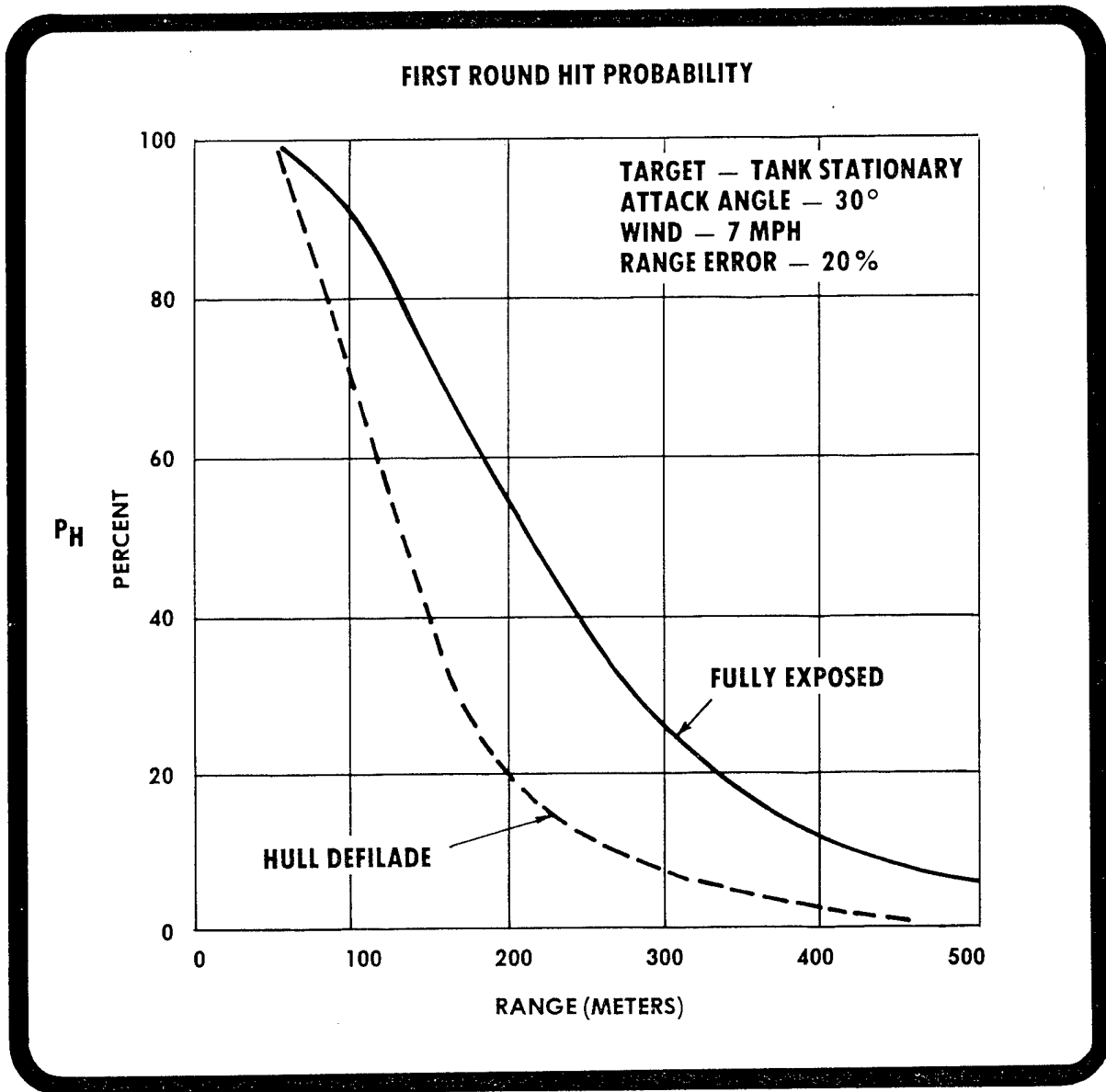

AT 300 METERS THE CHANCE OF HITTING A FULLY EXPOSED TARGET IS 4 TIMES THAT OF HITTING A TARGET WHICH STOPS IN HULL DEFILADE.

NOTE: 1st round hit probability is essentially the same for both stationary and moving targets because range errors and crosswind correction problems override target movement errors.

**2d Round Hit Probability vs. a Tank — Moving and Stationary
(1st Round Missed)**

A gunner who is allowed to fire a second shot can make a range correction and will be significantly more accurate: at 300 meters he has better than a 50-50 chance of hitting an exposed stationary tank.

AT 300 METERS THE CHANCE OF HITTING A FULLY EXPOSED STATIONARY TANK IS ABOUT TWICE THAT OF HITTING AN EXPOSED TANK MOVING AT 10 MPH, AND 3 TIMES THAT OF HITTING A TANK STOPPED IN HULL DEFILADE.

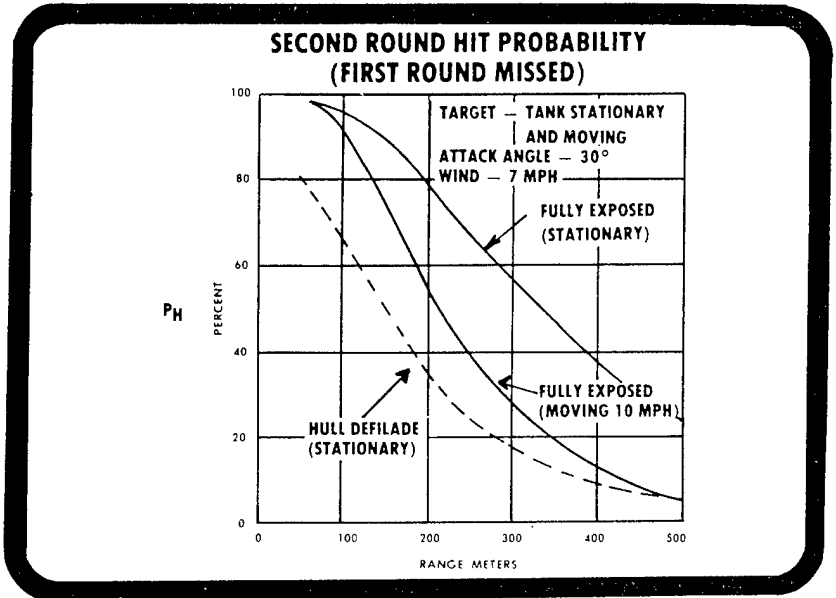

Kill Probability

Hitting a target is only part of the gunner's problem. Even if the round hits, the shaped charge has to penetrate the armor and cause enough damage to the vehicle or to the crew to stop the tank and prevent it from shooting back even if stopped.

The RPG-7 warhead can punch a hole 2 inches in diameter through more than 11" of armor. When it penetrates, hot metal fragments from the armor are scattered violently around the inside of the vehicle and can cause personnel casualties and ignite ammunition and fuel.

SOME RPG-7 ROUNDS WILL PENETRATE UP TO 13 INCHES OF ARMOR, BUT ON THE AVERAGE, PENETRATION IS LESS THAN 11 INCHES IN ROLLED HOMOGENOUS STEEL AT 0° OBLIQUITY. THE FOLLOWING CHART ILLUSTRATES THE CHANGE IN PENETRATION OVER RANGE.

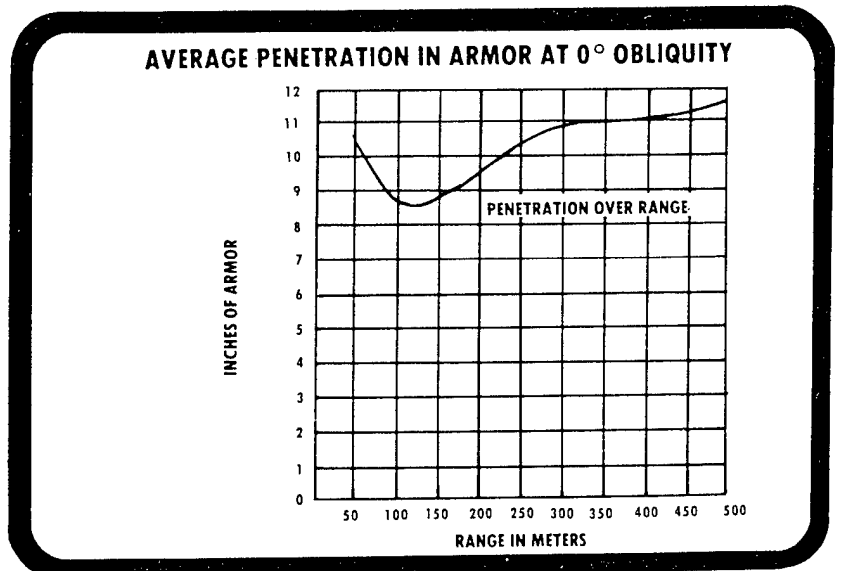

Probability of a 1st Round Kill vs. a Stationary Tank

Although the probability of a 1st round hit is relatively high, the probability of getting a 1st round firepower or mobility kill against a tank is somewhat lower because of warhead effects after penetration.

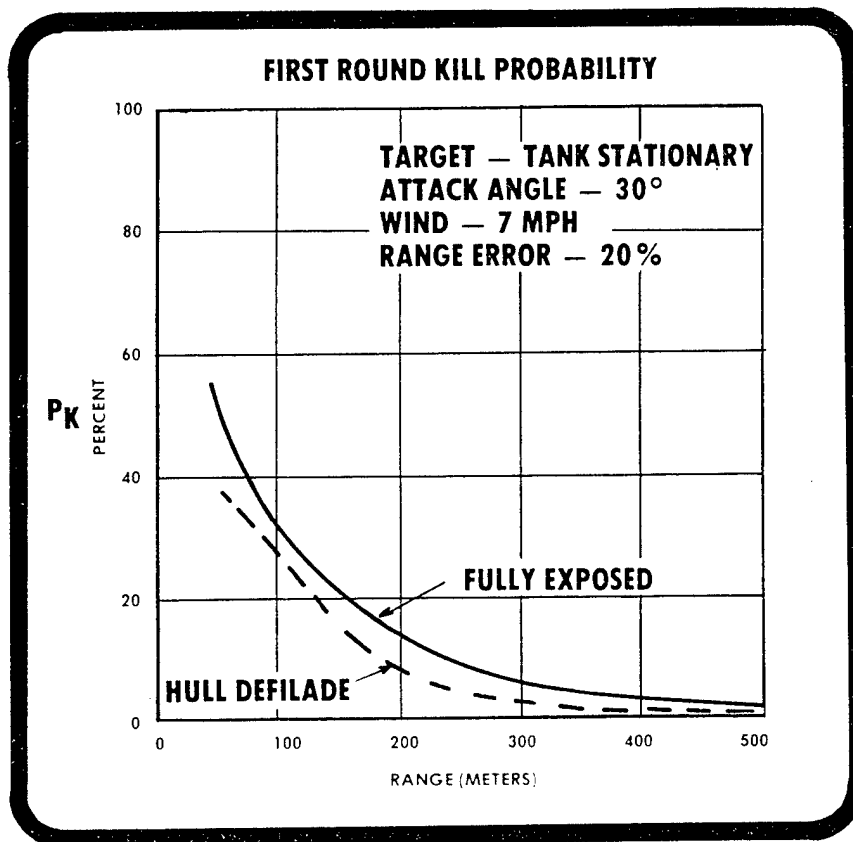

AT 300 METERS THE CHANCE OF KILLING A FULLY EXPOSED TANK IS TWICE THAT OF KILLING ONE THAT STOPS IN HULL DEFILADE; HOWEVER, KILL POSSIBILITY IS SMALL FOR BOTH CONDITIONS.

Tactical Implications

- An exposed stationary tank or APC is at least 2 times more vulnerable than a stationary target in hull defilade.
- A moving target gains some protection.
- React immediately when fired at by an RPG-7. A second round will probably hit, even if the first one missed.
- Make the gunners sighting problems tougher. If he cannot see, he cannot aim.
 - suppress with machine guns
 - obscure his vision with smoke, darkness, or concealment
 - keep moving

Penetration of Other Materials

The RPG-7 can penetrate other materials such as sandbag bunkers and concrete buildings, but the round is *not* a wall-buster. It will put a hole up to 2 inches in diameter through a concrete or brick wall, but will not knock it down. It can be effective in urban warfare against troops located in buildings. For example, in Vietnam, during the battle for Hue in 1968, two U.S. Marine battalion commanders stated that the RPG-7 was the most dangerous weapon encountered over the entire battle.

PENETRATION IN OTHER MATERIALS

| Material | Inches |
|---------------------|--------|
| Sandbags | 90" |
| Reinforced Concrete | 18" |
| Earth Log Bunkers | 60" |

The Stand-off Countermeasure

If the round can be detonated *before* it hits the target, penetration is reduced according to the distance of the stand-off detonation. The following graph relates the effect of stand-off versus tank armor using hit range of 270 meters. The round can be detonated by almost any type material, including concertina wire and chain link fencing.

STANDOFF EFFECT ON PENETRATION AT 270 METERS

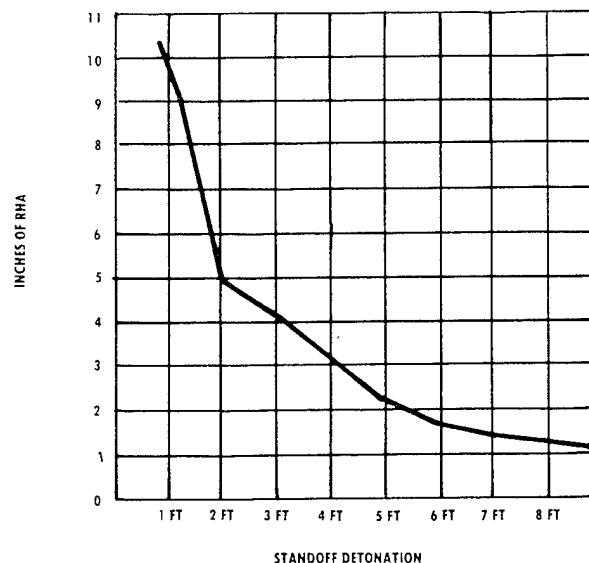

Stand-off Protection to Stop Penetration

| Material | Minimum Stand-off Distance |
|-------------------|----------------------------|
| M113 Armor | 12 FT |
| 4-1/2" Brick Wall | 25 FT |
| 6" Concrete | 25 FT |

The RPG Screen Countermeasure

The RPG Screen was first used in Vietnam and was designed as a portable stand-off for tanks and APCs. But, in fact, the screen will electrically dud the grenade and prevent any detonation in approximately 50 percent of the rounds fired into it. This happens because the nose fuse of the round can pass through the wire without striking a wire strand, but this will bend metal ogive on the warhead against the inner cone. This cone carries the firing signal from the nose fuse to the base detonator and shorts when the ogive touches the cone. When this happens, the round completely duds.

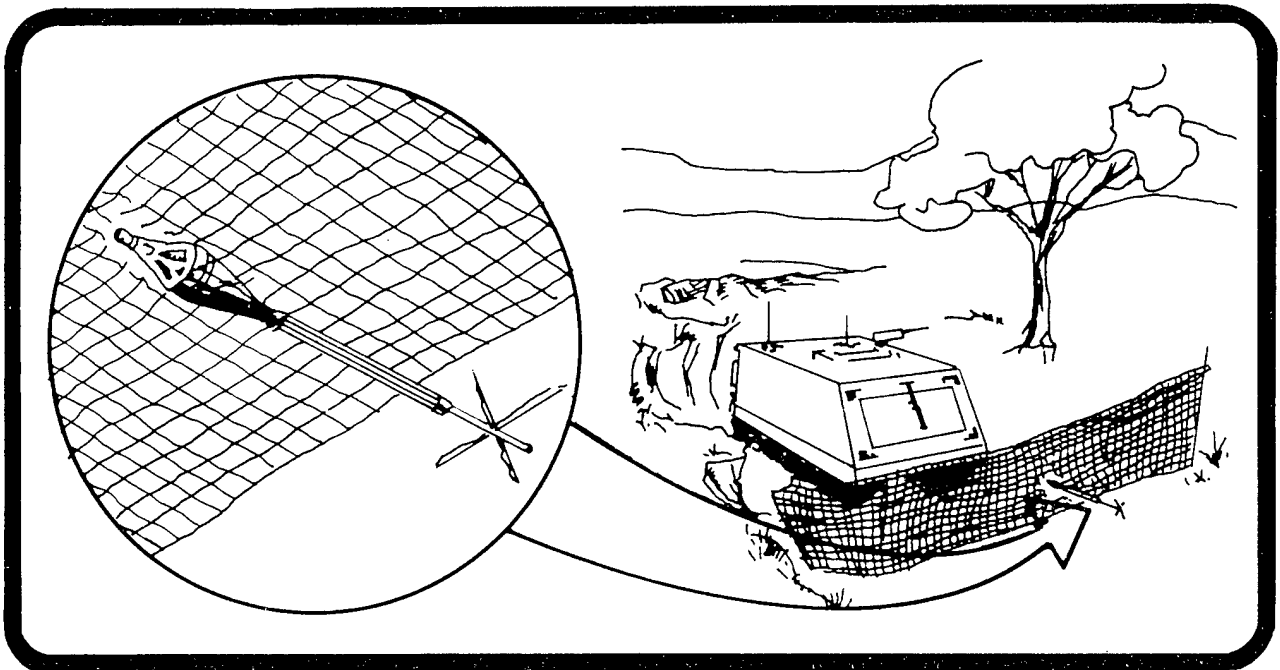

Effects Against Aircraft

The sighting required for the RPG-7 makes a hit on a moving aircraft or helicopter highly unlikely. However, it could be devastating against a flight of helicopters on final approach or just leaving a LZ if two or three RPG-7's were placed in ambush around the LZ.

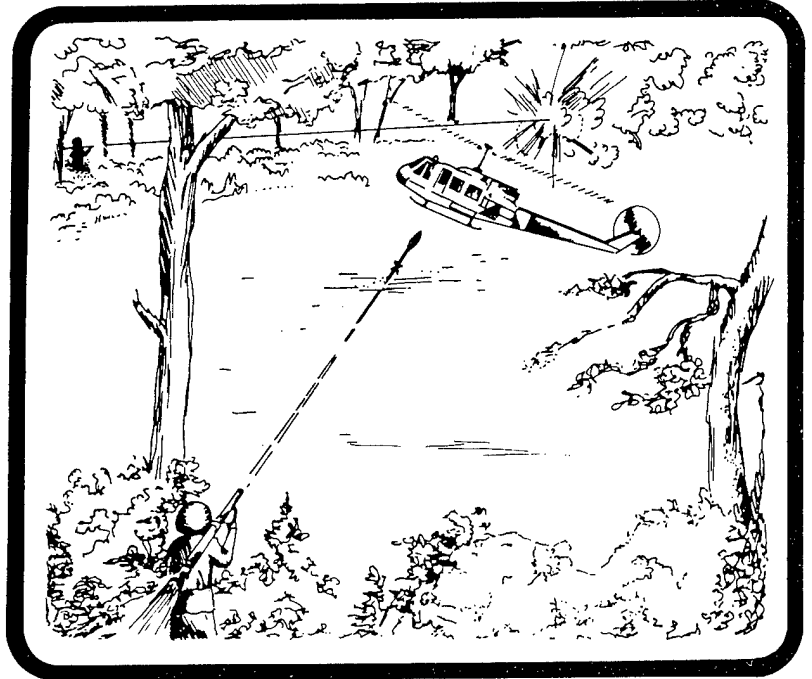

Effects Against Personnel

The RPG-7 Heat grenade is not designed for fragmentation effect, but:

- lethal metal fragments from the warhead and rocket can fly as far as 150 meters from the point of detonation.
- soldiers riding on top of tanks and APCs can be hit by round fragments which spray from around the point of impact.
- the round can penetrate through foxhole berms and sandbagged and concrete structures and can reach personnel that are otherwise protected from small arms and artillery fire. Camouflage and concealment provides additional protection for defensive fighting positions.

Improvement Trends

The RPG-7 is an evolutionary improvement of the older RPG-2 which was introduced in 1949. Both weapons use the rocket assist principle and point out the Soviet preference for that method of gaining range and accuracy. The Soviets are thought to be developing an improved rocket-assist antitank weapon to replace the RPG-7 in the 1970s. The newer version will have a 600 meter range capability, versus the 500 meter range for the RPG-7, and the sighting system will be improved.

The Chinese have copied the RPG-7 and modified it for their needs. Their version is 3 pounds lighter than the Soviet model and has improved iron and optical sights. Both of the Chinese sights simplify the crosswind correction problem which, in turn, reduces the training requirements and tends to increase accuracy. The optical sight has two range stadia, one for US Armor and one for Warsaw Pact Armor, and also has an additional stadia for estimating range using target length.

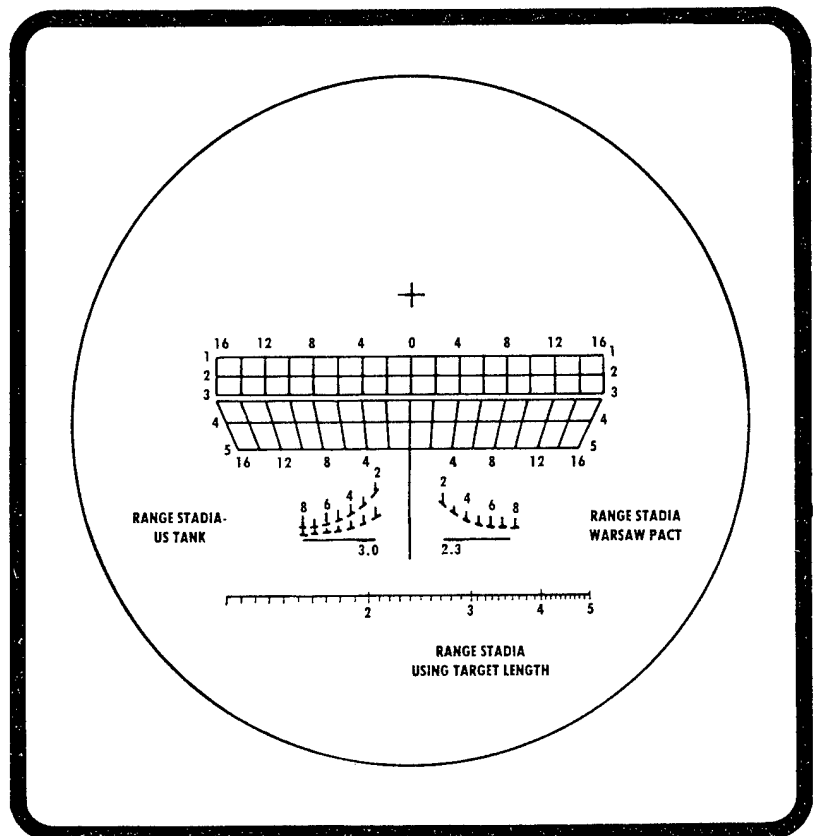

Gunner Training

Russian soldiers are normally assigned to the same position for their entire two year service. That fact, coupled with the information on training he receives, indicates that the RPG-7 gunner is well trained in the basics of firing and the tactical use of his weapon. Gunner training includes:

- The RPG-7 gunner is trained to fire rapidly from the prone, kneeling, and standing positions.
- In the offense, the gunner is taught to carry the launcher loaded.
- The assistant gunner is expected to be as competent on the weapon as the gunner.
- Instruction on sighting techniques is detailed and thorough.
- The gunner is taught where to shoot at tanks to hit the most vulnerable areas.
- The crew is taught to avoid prominent terrain features or hillcrests when selecting a firing position.
- The gunner is taught to fire first and foremost at the closest tank to his position and fire only at APCs or other targets when tanks are not present.

The following chart to gauge wind effect highlights the type of useful combat information found throughout the service manual for the weapon.

| Objects | Wind | | |
|--------------------|--------------------------|--|------------------------------|
| | weak, (2-3 m.p.h.) | moderate, (4-6 m.p.h.) | strong, (8-12 m.p.h.) |
| Thread | Deviates inconsiderably | Deviates considerably | Keeps in horizontal position |
| Handkerchief | Waves and slightly flies | Flies | Hardly held in hand |
| Smoke from chimney | Deviates inconsiderably | Deviates and drifts | Sharply deviates and breaks |
| Grass | Waves | Bends to ground | Creeps on the ground |
| Branches of trees | Branches and leaves wave | Thin branches deviate and leaves wave strongly | Big branches deviate |

Training aids and devices are also available for training RPG-7 gunner. For example, the 7.62mm subcaliber device is mounted inside a specially adapted RPG-7 rocket assembly.

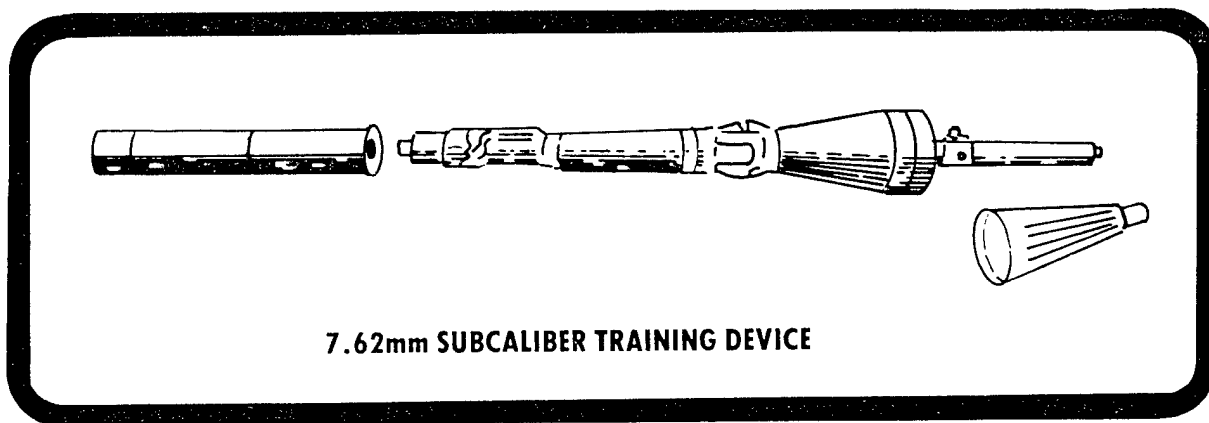

7.62mm SUBCALIBER TRAINING DEVICE

Weapons Distribution

Every squad in motorized and airborne divisions is assigned one RPG-7. The diagram below indicates where and in what numbers the RPG-7 is located in the Motorized Rifle Regiment in the defense.

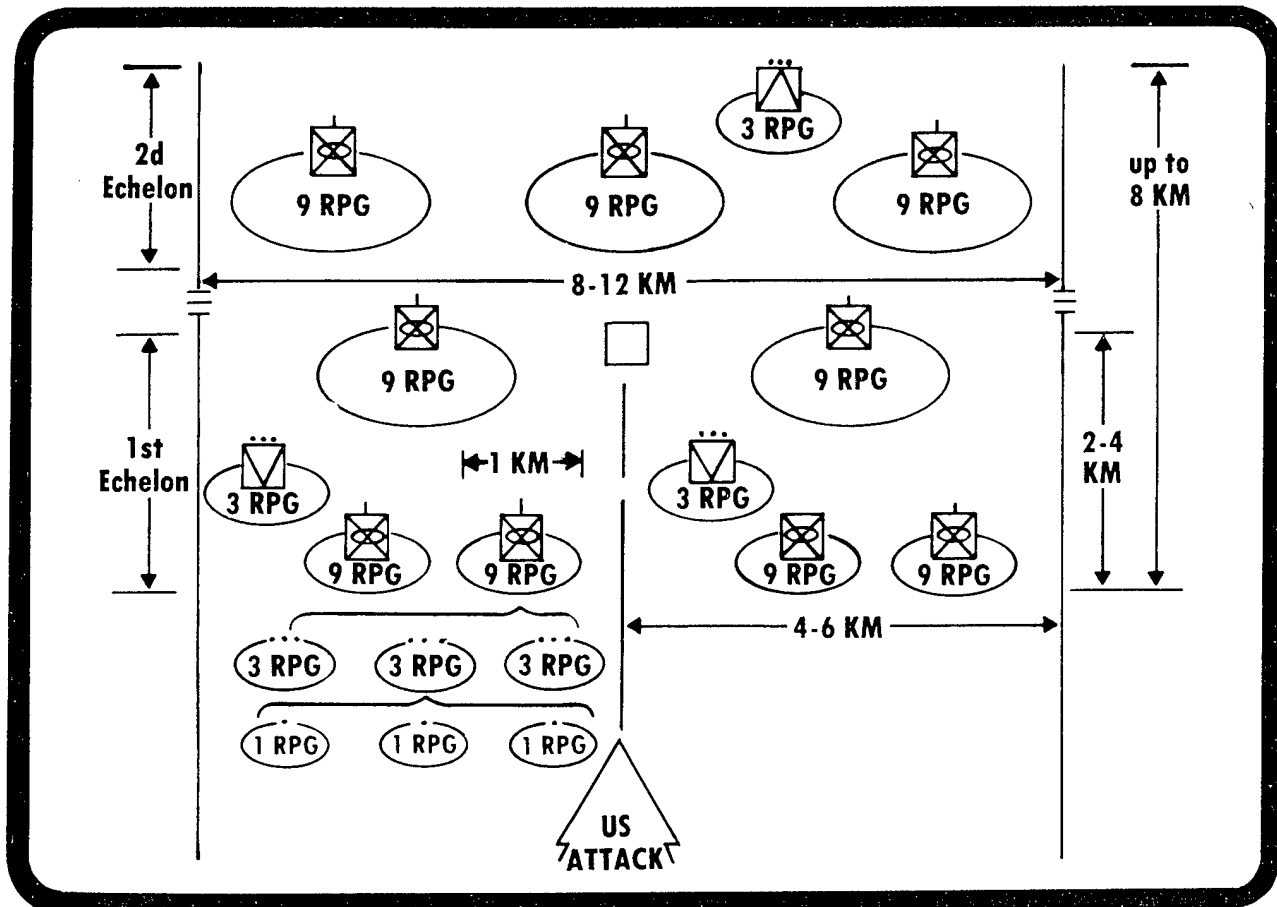

There is no handy rule of thumb that will accurately predict what kind of what size unit you have encountered when you are fired at by one or more RPG-7s. They are too widely distributed to do that. It is better to keep this in mind:

The RPG-7 is habitually employed as part of an interlocking array of antitank weapons. When you are fired at by larger weapons, you can expect to find RPG-7 supporting those weapons. When you are fired at by RPG-7s, you can expect to receive fire from other antitank weapons.

Tactical Employment

EMPLOYMENT LIMITATIONS

- Personnel, ammunition, and inflammables must be at least 30 meters behind the breech to avoid the firing back blast.
- The breech must clear any solid objects by at least 2 meters.
- The launcher muzzle must be at least 8 inches from any cover or fortifications to prevent the grenade stabilizer fins from hitting any object after firing.

The RPG-7 can be employed in a hasty position either in the offense or defense.

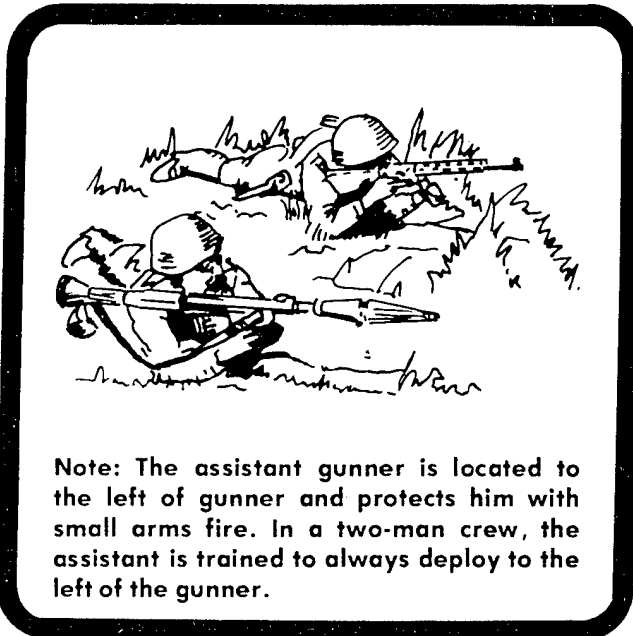

The gunner can fire from the BMP without dismounting.

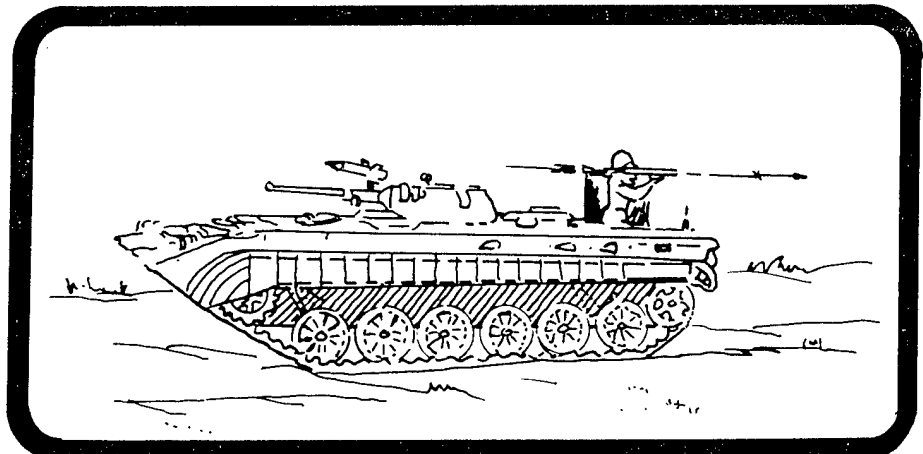

The RPG-7 can be employed *in* all types of constructed fortifications to include positions with overhead cover and inside buildings.

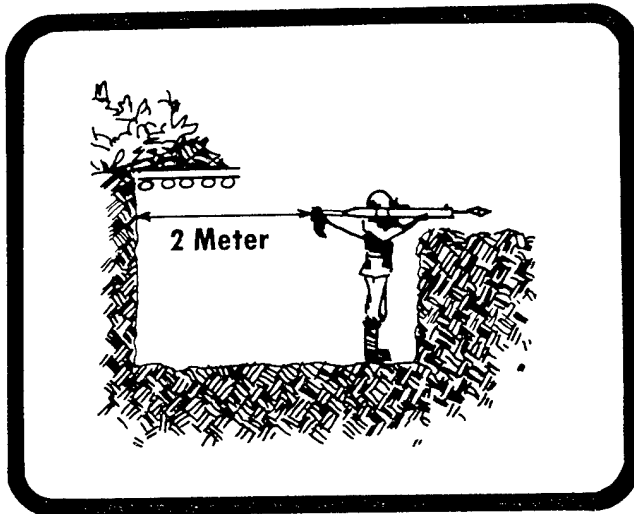

The gunner needs only the two meter safety distance from the rear bunker wall.

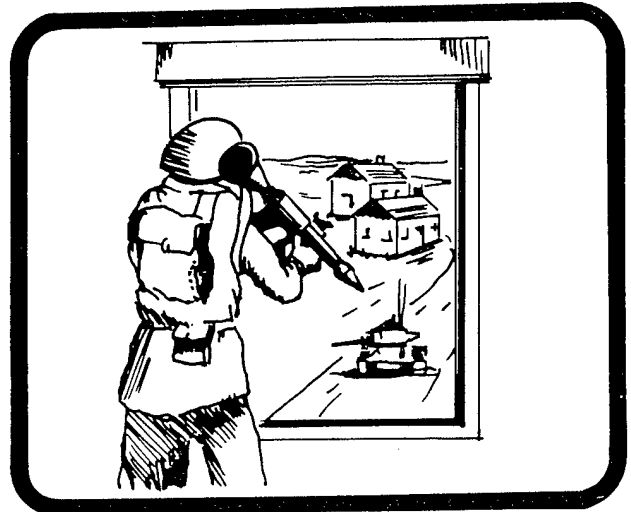

Tests also indicate that the RPG-7 can be fired safely from inside buildings.

The capability to fire from inside buildings has added significance. Increasing urbanization, particularly in Europe, will create more situations for fighting in cities and towns. Thus the RPG-7 must always be considered when moving tanks and APCs through built-up areas where they can be engaged at close ranges from inside or atop buildings.

Tactics for the RPG-7

Soviet tactical doctrines does have certain characteristics that are important in identifying the way RPG-7s will be employed. Some of the more important ones are:

- All round antitank security on the move.
- Company strongpoints on the defense.
- Defense in depth.
- Use of fire pockets to destroy armor by massed fire.
- Integration of motorized infantry with tanks in the defense.
- Extensive reconnaissance on both the offense and defense.
- Use of company and battalion size airborne forces for deep penetration against rear echelon units.

Ambush and Tank-Killer Tactics

RPG-7 tank-killer teams are a normal part of Soviet defense tactics. One or more teams could be located on the flank of a defending company and along wood lines to engage armor moving through, or close to, tree covered terrain. You can also expect to find the RPG-7 used in ambushes on both offense and defense. Ambushes may be part of a main defense or can be employed by reconnaissance elements to capture prisoners, destroy nuclear firing sites, or delay advancing forces.

Meeting Engagements and Movements

A reinforced platoon normally leads a battalion. This platoon moves as an advance guard platoon. Therefore, a minimum of three RPG-7s are available to counter the immediate threat in a meeting engagement. The main body will have squads out as flank protection and a company will provide rear security. In a meeting engagement, the leading elements will try to stop the opposing force, while the trailing units conduct a quick attack to the flanks. If the vehicles are forced to halt, the RPG-7s are used to provide a close-in antitank perimeter.

Offense

Soviet units try to attack mounted whenever possible. Motorized squads fire from inside buttoned-up BMPs. The RPG-7 cannot be fired from inside the BMP, but the gunner can engage on the move if he stands up in an access hatch. This makes him vulnerable to suppressive fire and his accuracy would be seriously degraded. If the attack cannot penetrate or bypass mounted, the unit will resort to a dismounted attack. In addition, dismounted attacks are usually conducted:

- **At night.**
- **When terrain precludes fast movement by tanks and BMPs.**
- **When forced by heavy antitank defenses.**

The RPG-7 will be used in the attack to:

- **Engage tanks and APCs at close range.**
- **Attack bunkers and fortifications.**

Defense

A motorized battalion conducting a hasty defense employs company strongpoints and will try to canalize enemy armor into a fire pocket. The RPG-7s of the platoons on the strong point would be employed as part of that fire pocket.

The RPG-7s will normally hold their fire until the attacking unit closes to about 300 meters from the defensive position.

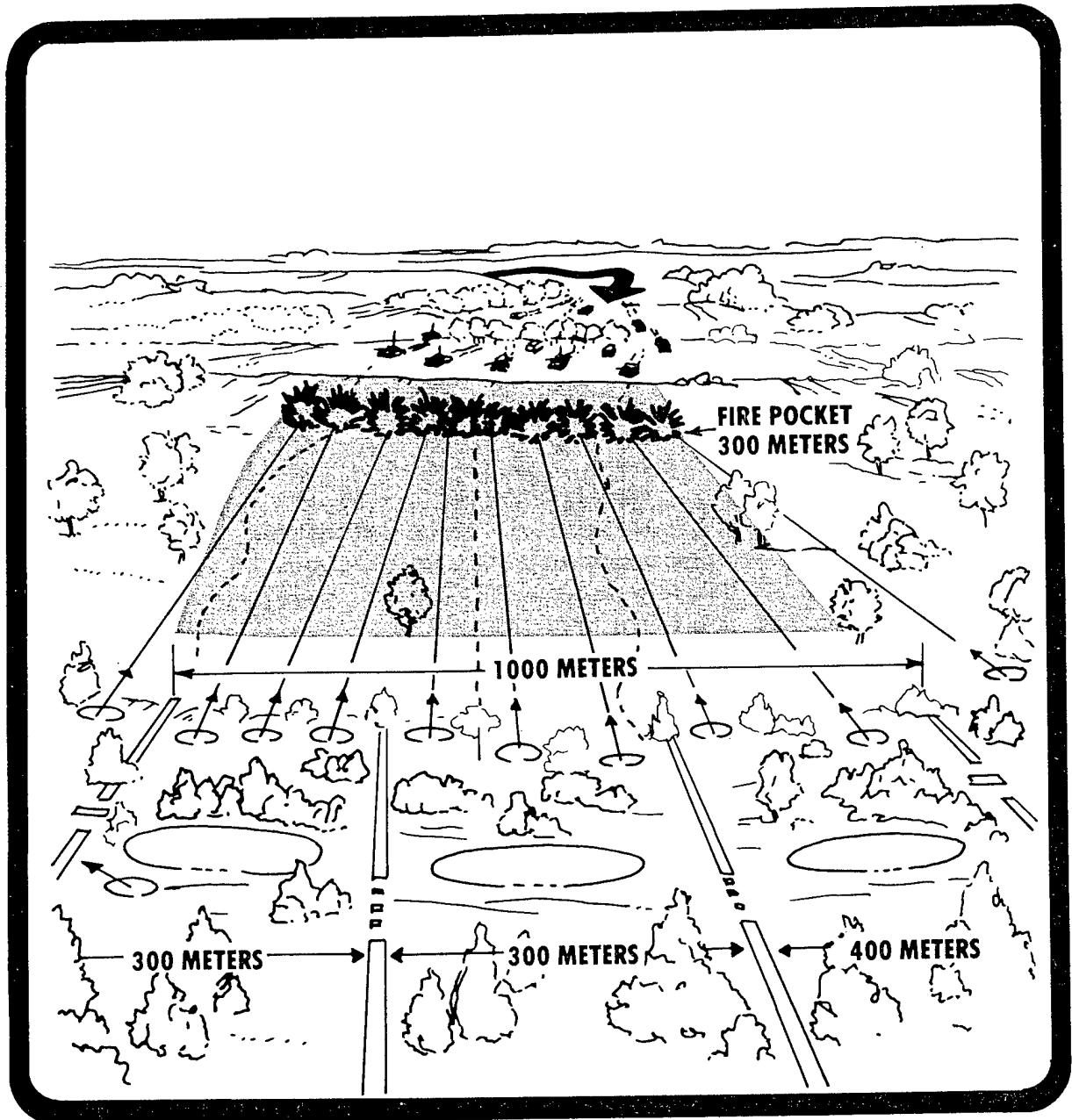

The company strongpoint depicted is part of the battalion main defense. But if there were no covering force, the battalion commander would establish a reinforced platoon strongpoint about 1000 meters in front of his main defense. The platoon would be deployed and employed identically to a platoon of the main defense in order to deceive the attacker as to the true location of the main defense.

THE RPG-7 HAS THESE MAIN STRENGTHS:

- Easily employed in all types of terrain.
- Widely distributed.
- Difficult to detect.
- Can be used in built-up areas.
- Can penetrate bunkers and buildings.
- Difficult to evade after firing.
- Has an effective passive night sight.
- Optical sight can be used under illumination.
- Lethal at all ranges.

THE RPG-7 HAS THESE MAIN WEAKNESSES:

- Requires well trained gunners to aim in crosswinds.
- Hard to hit a moving target.
- Requires 14 seconds to reload and re-aim.
- Warhead can be defeated or degraded by standoff.
- Smoke is effective.
- Gunner is vulnerable to suppressive fires.

III

COUNTERMEASURES

U.S. combined arms tactics are the basis for effective countermeasures against the RPG-7. Tanks and mechanized infantry, supported by artillery, can defend or attack successfully against an enemy which has heavy concentrations of RPG-7s — if the captains, lieutenants, and sergeants understand what the weapon can and cannot do, and plan and train accordingly.

U.S. Defensive Countermeasures

- RPG-7 gunners must expose themselves to fire their weapons and to observe the strike of their rounds. Accordingly, they are vulnerable to any antipersonnel round. Indirect fire from artillery and mortars will suppress them, as will accurate automatic weapons and rifle fire.
- U.S. tanks and APCs on defensive positions should be located to minimize the area of exposed armor. Defilade should be sought, including protection from flanking and rear attack, as well as frontal fire.
- Positions in trees and underbrush are advantageous not only because of the concealment they offer, but also because they will act as an RPG screen. Where time and material are available, consideration should be given to erecting artificial RPG screens.
- Units moving within a defensive position — for example, from one blocking position to another — must anticipate RPG attack, and select their routes and provide suppressive fire accordingly.
- U.S. artillery commanders should site their pieces in firing positions which provide defilade, and minimize vulnerability to RPG attack. Battery defense plans should include provisions for antipersonnel fires against RPGs at night.
- All units should anticipate night attacks by RPG-7 gunners exploiting the effective passive night sights of the weapon. Provision should be made for prompt counterfire, to suppress second shots.

U.S. Offensive Countermeasures

- U.S. tank and mechanized forces moving to attack must anticipate fighting through a system of integrated antiarmor fires which can start as far as 3,000 meters from the enemy's defensive positions. Heavy RPG fire must be expected whenever the attackers close with an enemy unit, of whatever size.
- Attackers should seek routes of approach providing cover and concealment, since both significantly reduce the RPG-7s effectiveness. Careful use of terrain and continuous rapid movement make it difficult for RPG-7 gunners to deliver aimed fire. Trees and bushes can predetonate or disarm the round, and obscure the gunner's vision.
- Obscuration is an effective counter to the RPG: smoke delivered in front of known or suspected RPG positions will curtain effective fire. High winds, particularly crosswinds, may make the use of smoke difficult, but such winds also make it hard for the RPG unit to aim effectively.
- The RPG-7 gunner must expose himself to fire, and to observe the strike of his rounds. He is therefore vulnerable to suppressive fire. Preplanned suppression, especially for artillery and mortars, should anticipate RPG positions. But when the attacking force comes under RPG fire, the machineguns of the tanks and APCs are the quickest and most effective counter. Prompt suppression from attacking tanks or infantry can kill the gunner, or drive him to ground.
- When contact with RPGs is anticipated, tank platoon leaders should consider having one tank in each section carry a loaded APERS round for immediate RPG counterfire.
- RPG-7 gunners are particularly vulnerable to artillery rounds bursting overhead, so suppression should exploit VT and time fire.
- Enemy defensive doctrine teaches ambush of attacking armor from covered positions. U.S. Infantry accompanying our armor must be prepared to attack into such positions.
- Close combat with RPG-7s — within 300 meters — demands swift, effective use of cover, concealment, suppression, and teamwork: training of tank-infantry teams should emphasize reaction to RPG fire.

Combat in Built-up Areas

Fighting among buildings literally adds a third dimension: an RPG-7 can be fired from within buildings, and from atop roofs down onto attacking armor. This added dimension increases the responsibilities of US Infantry for protecting our armor by suppression and attack of RPG positions. Both on the attack and defense, the enemy can be expected to use numerous RPG, the most effective counter to which will be our machineguns, rifles, grenades, and LAWs.

Training

Publications which describe techniques for training the combined arms team to operate on the highly lethal modern battlefield are or will be soon available to the unit commander through normal distribution channels. Here is a list of publications which will provide training guidance.

Armor and Mech Infantry — Use of Terrain and Suppression

TC 7-1
TC 7-3
TC 7-4
TC 7-50
TC 17-15-3
TC 17-36-2
TC 71-4-2
TRADOC Bulletin 1
TRADOC Bulletin 1^U
TRADOC Bulletin 2
TRADOC Bulletin 2^U

Arty-Suppression/Obscuration

TC 6-20-1
TC 6-20-2

RPG-7 Training Aids

Each TASO has master copies of the diagrams and pictures in this Bulletin from which you can order 35mm slides or vugraphs for use in officer schools, or unit training.

Each TASO can also order a realistic mockup of the RPG-7 launcher and round which can be used for recognition training, and added realism in field training.

APPENDIX A ORDERING TRADOC BULLETINS

Purpose. A series of TRADOC Bulletins are being published by HQ TRADOC to provide commanders timely technical information on weapons, tactics and training technique. It is not intended to supplant doctrinal publications, but to supplant material on "How to fight" with data derived from tests, recent intelligence, or other sources, which probe "why?"

Applicability. TRADOC Bulletins are developed by Headquarters, TRADOC using the most comprehensive and current military and civilian data available. Army Training and Evaluation Programs (ARTEP), Field Manuals (FM) and Training Circulars (TC) will continue to be the primary training references. TRADOC Bulletins will supplement them with an explanation of why we are training in a given manner. TRADOC Bulletins should enable commanders to better stimulate and motivate subordinates to understand why we train the way we do.

Index of Series. TRADOC Bulletins are cataloged in DA Pamphlet 310-3, "Index of Doctrinal, Training and Organizational Publications." The series are numbered consecutively and each TRADOC Bulletin is announced at time of printing in the information bulletin distributed to all pinpoint account holders by the US Army AG Publications Center.

Additional Copies. Submit DA Form 17 to order more copies of this TRADOC Bulletin.

Permanent Distribution. Pinpoint account holders receiving TRADOC Bulletin Number 1 from Baltimore will automatically receive two copies of all subsequent issues unless a DA Form 12-11B is submitted to change that quantity. Others desiring to be added to the permanent distribution list for TRADOC Bulletins must submit a DA Form 12-11B. Units which are required to submit publication requests through another headquarters should send the completed excerpt through proper authority.

Reference for Distribution Procedures. DA Pamphlet 310-10 explains the pinpoint distribution system and how to establish or update an existing account at the US Army AG Publications Center.

Enter pinpoint account number established with USA AG Pub Cen, Baltimore, MD.

| REQUISITION FOR PUBLICATIONS AND BLANK FORMS (AR 310-1) | | PAGE NO. | NO. OF PAGES | DATE OF REQUISITION | ACCOUNT NUMBER | REQUISITION NUMBER (Assigned by Supply Source) |
|---|---|-------------------|---------------------------------------|---|--------------------|--|
| 1. TYPE OF REQUISITION <input checked="" type="checkbox"/> REGULAR <input type="checkbox"/> SPECIAL | | 1 | | <input checked="" type="checkbox"/> | | |
| 2. JUSTIFICATION FOR SPECIAL REQUISITION | | | | | | |
| 3. REQUIRED DATE (Use Julian date) <input checked="" type="checkbox"/> | | | | | | |
| 4. ITEMS REQUESTED HEREON ARE <input type="checkbox"/> CLASSIFIED <input type="checkbox"/> FOUO <input type="checkbox"/> ACCOUNTABLE <input type="checkbox"/> SENSITIVE <input type="checkbox"/> SCHOOL REQUIREMENTS <input type="checkbox"/> TO BE PACKED WITH EQUIPMENT <input type="checkbox"/> ACT ARMY <input type="checkbox"/> ARNG <input type="checkbox"/> USAR <input type="checkbox"/> GRANT AID <input type="checkbox"/> FMS | | | | | | |
| 5. SHIP TO: (Complete address, include ZIP Code) | | | | | | |
| TO: Commanding Officer USA AG Publications Center 2800 Eastern Boulevard Baltimore, Maryland 21220 | | | | | | |
| 7. REQUIREMENTS | | | | | | |
| LINE NO. | NUMERICAL DESIGNATION OF REQUISITIONED ITEM | UNIT (Forms only) | QUANTITY REQUIRED | 9. SUPPLY ACTION BY SOURCE OTHER THAN USAAGPC | | |
| a | b | c | <input checked="" type="checkbox"/> d | S | D | O |
| | TRADOC BULLETIN 3U | | | H | I | P |
| 8. TYPED NAME AND GRADE OF COMMANDING OFFICER, ADJUTANT, PUBLICATIONS OR PROPERTY OFFICER | | | | a | b | c |
| SIGNATURE <input checked="" type="checkbox"/> | | | | 10. SHIPPED BY <input type="checkbox"/> MAIL <input type="checkbox"/> AIRMAIL <input type="checkbox"/> REGISTERED MAIL <input type="checkbox"/> OTHER (Specify) | | |
| SIGNATURE <input checked="" type="checkbox"/> | | | | 11. CARTONS (Number) | 12. BOXES (Number) | 13. WEIGHT |
| | | | | 14. DATE SHIPPED | | |
| | | | | 15. B/L OR REGISTRY NUMBER(S) | | |
| | | | | 16a. EDITED BY | | b. DATE |
| | | | | 17a. FILLED BY | | b. DATE |

DA FORM 17
1 JAN 70

PREVIOUS EDITIONS WILL BE USED.

To obtain additional copies of this bulletin, complete all checked items, fold, and mail.

DEPARTMENT OF THE ARMY

OFFICIAL BUSINESS
PENALTY FOR PRIVATE USE \$300

POSTAGE AND FEES PAID
DEPARTMENT OF THE ARMY

DOD-314



Commander
US Army AG Publications Center
2800 Eastern Boulevard
Baltimore, Maryland 21220

(Fold and mail to above)

C
U
T
H
E
R
E

DA Form 12-11B EXCERPT

Enter account number that has been established with the USA AG Pub Cen, Baltimore, Md.

| | | | |
|--|--|--|--|
| REQUIREMENTS FOR ARMY DOCTRINAL PUBLICATIONS (FM) | | 1 TYPE OF REQUIREMENTS | |
| For use of this form, see AR 310-2; the proponent agency is The Adjutant General's Office. | | <input type="checkbox"/> a. INITIAL <input type="checkbox"/> b. CHANGE | |
| | | 2 DATE | |
| | | 3 ACCOUNT NUMBER | |
| See DA Form 12-11 for Instructions | | | |
| 4 THRU: (Include P Code) | | 6 FROM: (Include ZIP Code) | |
| 5 TO: Commanding Officer USA AG Publications Center 2800 Eastern Boulevard Baltimore, MD 21220 | | | |
| 7. LOCATION AND COMPONENT | | | |
| <input type="checkbox"/> CONTINENTAL UNITED STATES <input type="checkbox"/> USARAL <input type="checkbox"/> USARHAW <input type="checkbox"/> OVERSEAS <input type="checkbox"/> ACTIVE ARMY <input type="checkbox"/> ARNG <input type="checkbox"/> USAR | | SUBJECT OR SUBJECT CLASSIFICATION | |
| WRITE IN ITEMS | | QUAN RQR | |
| | | 430 | |
| | | TRADOC BULLETINS | |

Note: Complete items 1, 2, 4, 6, and 7 as appropriate.

Enter number of copies required for TRADOC Bulletins in block # 430.

(Signature of Reviewing Authority)

(Signature of Requisitioner)

DEPARTMENT OF THE ARMY

OFFICIAL BUSINESS
PENALTY FOR PRIVATE USE \$300

POSTAGE AND FEES PAID
DEPARTMENT OF THE ARMY

DOD-314



Commander
US Army AG Publications Center
2800 Eastern Boulevard
Baltimore, Maryland 21220

(Fold and mail to above)

C
U
T
H
E
R
E

FEEDBACK

TRADOC Bulletins present information aimed at communicating principles, facts, the "why" of our doctrine, and other data important to soldiers. We'd like to know if we hit the target. Please respond to this questionnaire, cut out, fold and mail. Your reply will help in our efforts to fit your needs.

1. *Did this bulletin*
 - give you information you didn't know before
 - remind you of data you already know
 - just rehash data you already knew.
2. *Whom do you think is the appropriate target audience of this bulletin? (Check any or all)*
 - platoon leaders company commanders
 - battalion commanders division commanders
3. *Where do you think this data should be used?*
 - service schools unit training (EM) unit training (Officers)
4. *Are you convinced that the latest RPG-7 data is correct?*
 - Yes
 - No Explain:
5. *Which TRADOC Bulletins have you read?*
 - #1 (C) Range and Lethality of US and Soviet Anti-Armor Weapons (U)
 - #1 (U) Range and Lethality of US and Soviet Anti-Armor Weapons (U)
 - #2 (C) Soviet ATGMs: Capabilities and Countermeasures (U)
 - #2 (U) Soviet ATGMs: Capabilities and Countermeasures (U)
 - #3 (C) Soviet RPG-7 Anti-Tank Grenade Launcher (U)
 - #4 (C) Soviet ZSU-23-4: Capabilities and Countermeasures (U)
 - #5 (U) Training with LAW (U)
 - #6 Countersurveillance and Camouflage
 - #8 Modern Weapons on the Modern Battlefield
6. *Other comments*

DEPARTMENT OF THE ARMY

**OFFICIAL BUSINESS
PENALTY FOR PRIVATE USE \$300**

**POSTAGE AND FEES PAID
DEPARTMENT OF THE ARMY**

DOD-314



**COMMANDER
US ARMY TRAINING AND DOCTRINE COMMAND
ATTN: ATCG-T (TEL: AUTOVON 680-2445/3135)
FORT MONROE, VIRGINIA 23651**

(Fold and mail to above)

C
U
T
H
E
R
E