

ARMY, MARINE CORPS, NAVY, AIR FORCE



**MULTISERVICE TACTICS,
TECHNIQUES, AND
PROCEDURES FOR NUCLEAR,
BIOLOGICAL, AND CHEMICAL
RECONNAISSANCE**

**FM 3-11.19
MCWP 3-37.4
NTTP 3-11.29
AFTTP(I) 3-2.44**

JULY 2004

DISTRIBUTION RESTRICTION: Approved for public release;
distribution is unlimited.

MULTISERVICE TACTICS, TECHNIQUES, AND PROCEDURES

FOREWORD

This publication has been prepared under our direction for use by our respective commands and other commands as appropriate.

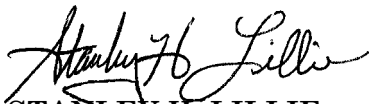

STANLEY H. LILLIE
Colonel (P), CM
Commandant
United States Army Chemical School

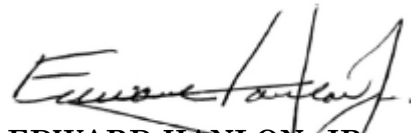

EDWARD HANLON, JR.
Lieutenant General, USMC
Commanding General
Marine Corps Combat
Development Command

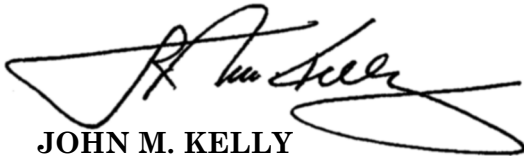

JOHN M. KELLY
Rear Admiral, USN
Commander
Navy Warfare Development Command

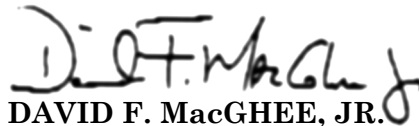

DAVID F. MacGHEE, JR.
Major General, USAF
Commander
Headquarters Air Force Doctrine
Center

**This publication is available at Army Knowledge Online
<www.us.army.mil>.**

PREFACE

1. Scope

a. This publication provides multiservice tactics, techniques, and procedures (MTTP) for planning and conducting nuclear, biological, and chemical (NBC) reconnaissance operations to detect, define the limits of, mark, sample, and identify NBC and toxic industrial material (TIM) contamination that United States (US) forces may encounter in an NBC environment. The term *NBC environment* as used in this publication refers to an environment in which there is deliberate or accidental employment of NBC weapons, release of industrial chemicals, or contamination with radiological materials.

NOTES:

1. The terms *NBC defense* and *chemical, biological, and radiological (CBR) defense* are synonymous. The United States Army (USA), United States Marine Corps (USMC), and United States Air Force (USAF) use the term *NBC defense*. The United States Navy (USN) uses the term *CBR defense*.

2. The term *military decision-making process (MDMP)* is the Army's planning process. The USMC uses a similar planning process called the *Marine Corps planning process (MCPPE or MC2P)*. (For more information, see *Marine Corps Warfighting Publication [MCWP] 5-1*.)

3. The USMC uses the acronym *METT-T (mission, enemy, terrain and weather, troops available, and time)*. Civilian considerations are inherently measured within the context of this acronym.

b. The users of this manual are NBC staff officers and noncommissioned officers (NCOs), unit commanders, and others who are involved in planning and conducting NBC reconnaissance operations.

2. Purpose

This publication provides commanders, staffs, and unit leaders with a key reference for planning and conducting NBC reconnaissance operations. It addresses concepts, principles, and fundamentals for multiservice considerations. It also serves as a key source document for developing other multiservice manuals and refining existing training support packages (TSPs), training center exercises, and service school curriculum. The information furnished provides data that can be used to support NBC reconnaissance planning and operations based on intelligence preparation of the battlespace (IPB).

3. Application

This publication is designed for use at operational and tactical levels. It supports the command staff plan for preparing and conducting NBC reconnaissance operations. It is prepared as a multiservice publication to define service capabilities when conducting

NBC reconnaissance. The manual also provides guidance on dismounted and mounted techniques for NBC reconnaissance leaders and personnel who are conducting NBC reconnaissance missions.

4. Implementation Plan

Participating service command offices of primary responsibility (OPRs) will review this publication, validate the information, and reference and incorporate it in service and command manuals, regulations, and curriculum as follows:

Army. The USA will incorporate this publication in appropriate training and doctrinal publications as directed by the Commander, United States Army Training and Doctrine Command (TRADOC). Distribution is according to Department of the Army (DA) Form 12-99-R (Initial Distribution Requirements for Publications).

Marine Corps. The USMC will incorporate this publication in appropriate training and doctrinal publications as directed by the Commanding General (CG), United States Marine Corps Combat Development Command (MCCDC). Distribution is according to the Marine Corps Publication Distribution System.

Navy. The USN will incorporate this publication in appropriate training and doctrinal publications as directed by the Commander, Navy Warfare Development Command (NWDC). Distribution is according to the military standard requisitioning and issue procedure (MILSTRIP) desk guide and Naval Supply Systems Command (NAVSUP) Publication 409.

Air Force. The USAF will validate and incorporate appropriate procedures in this publication according to applicable governing directives. Distribution is in accordance with Air Force Instruction (AFI) 33-360.

5. User Information

a. The United States Army Chemical School (USACMLS) developed this publication with the joint participation of the approving service commands.

b. We encourage recommended changes for improving this publication. Key your comments to the specific page and paragraph, and provide a rationale for each recommendation. Send comments and recommendations directly to—

Army

**Commandant
US Army Chemical School
ATTN: ATSN-CM-DD
401 MANSCEN Loop, Suite 1029
Fort Leonard Wood, MO 65473-8926
COMM (573) 596-0131, extension 3-7364**

Marine Corps

**Commanding General
US Marine Corps Combat Development Command
ATTN: C42 (Director)
3300 Russell Road
Quantico, VA 22134-5001
DSN 278-6234; COMM (703) 784-6234**

Navy

**Commander
Navy Warfare Development Command
ATTN: N5
686 Cushing Road
Newport, RI 02841-1207
DSN 948-4201; COMM (401) 841-4201**

Air Force

**HQ Air Force Doctrine Center
ATTN: DJ
155 North Twining Street
Maxwell AFB, AL 36112-6112
DSN 493-7442; COMM (334) 953-7442
Web site: www.doctrine.af.mil**

Unless this publication states otherwise, masculine nouns and pronouns do not refer exclusively to men.

*FM 3-11.19
MCWP 3-37.4
NTTP 3-11.29
AFTTP(I) 3-2.44

FM 3-11.19 US Army Training and Doctrine Command
Fort Monroe, Virginia

MWCP 3-37.4 Marine Corps Combat Development Command
Quantico, Virginia

NTTP 3-11.29 Navy Warfare Development Command
Newport, Rhode Island

AFTTP(I) 3-2.44 Headquarters, Air Force Doctrine Center
Maxwell Air Force Base, Alabama

30 July 2004

**MULTISERVICE TACTICS, TECHNIQUES, AND PROCEDURES
FOR
NUCLEAR, BIOLOGICAL, AND CHEMICAL RECONNAISSANCE**

TABLE OF CONTENTS

	Page
EXECUTIVE SUMMARY	xiii
CHAPTER I MISSIONS, CAPABILITIES, AND PRINCIPLES	I-1
Background	I-1
Mission	I-1
Capabilities	I-2
Principles	I-2
Situational Awareness	I-3
CHAPTER II OPERATIONAL ENVIRONMENT	II-1
Background	II-1
Threat Environment	II-1
Land Environment	II-3
Maritime Environment	II-3
Air Environment	II-4

DISTRIBUTION RESTRICTION: Approved for public release; distribution is unlimited.

*This publication supersedes FM 3-19, 19 November 1993.

	Page
Space Environment.....	II-4
Civil/Infrastructure Environment.....	II-4
Weather Factors.....	II-5
CHAPTER III SUPPORT TO MILITARY OPERATIONS	III-1
Background	III-1
Peacetime Preparedness.....	III-1
Transition to Operations	III-7
During Attack and Postattack.....	III-8
Sustained Combat Operations	III-10
Conflict Termination.....	III-22
CHAPTER IV PLANNING.....	IV-1
Background	IV-1
Levels.....	IV-1
Concept	IV-1
Military Decision-Making Process	IV-1
CHAPTER V CAPABILITIES.....	V-1
Background	V-1
Equipment Capabilities.....	V-1
United States Army	V-2
United States Marine Corps.....	V-3
United States Air Force	V-4
United States Navy.....	V-5
CHAPTER VI TASKS	VI-1
Background	VI-1
Search	VI-1
Survey.....	VI-2
Surveillance.....	VI-3
Sampling.....	VI-4
Route Reconnaissance.....	VI-5
Zone Reconnaissance	VI-6
Area Reconnaissance	VI-7
CHAPTER VII SAMPLING OPERATIONS.....	VII-1
Background	VII-1
Agent Indicators.....	VII-1
Sample Collection.....	VII-2
Responsibilities	VII-5
Execution.....	VII-9
Sampling Teams.....	VII-15

	Page
CHAPTER VIII	REPORTING AND MARKING VIII-1
	Background VIII-1
	Reporting VIII-1
	Marking VIII-4
CHAPTER IX	TOXIC INDUSTRIAL MATERIAL RECONNAISSANCE IX-1
	Background IX-1
	Nature of the Problem IX-1
	Risk Analysis..... IX-1
	Safety IX-3
	Organization and Equipment..... IX-7
	Operations IX-8
	Dos and Don'ts IX-15
APPENDIX A	OPERATIONS IN SPECIAL ENVIRONMENTS..... A-1
	Background A-1
	Mountain Environment A-1
	Jungle Environment A-2
	Desert Environment A-2
	Arctic Environment A-3
	Urban Environment..... A-3
	Littoral Environment..... A-4
	Subterranean Environment A-4
APPENDIX B	STANDING OPERATING PROCEDURES B-1
APPENDIX C	UNIT CHECKLIST C-1
APPENDIX D	INTELLIGENCE PREPARATION OF THE BATTLESPACE D-1
	Background D-1
	Define the Battlespace Environment..... D-1
	Describe the Battlespace Effects on Threat and Friendly Capabilities D-1
	Evaluate the Adversary D-3
	Determine Adversary Courses of Action..... D-9
APPENDIX E	SAMPLING E-1
	Background E-1
	Plan..... E-1
	Operations E-2
	Documentation E-9
	Identification and Control E-13
	Reporting and Shipping..... E-22
	Witness Interviews E-24
	Handling and Packaging Materials E-27
	Techniques and Procedures..... E-31
	Chemical and Biological Sampling (Environment) E-32
	Medical Specimens..... E-36
	Radiological-Agent Sampling E-37
	Background Samples E-45

	Page
Transfer Operations.....	E-45
Labeling and Documentation	E-50
Packaging of Samples for Shipment	E-52
Transfer of Samples to a Laboratory or Lead Agency.....	E-58
APPENDIX F ORGANIZATIONS AND EQUIPMENT	F-1
Background	F-1
United States Army Capabilities	F-1
United States Marine Corps Capabilities.....	F-11
United States Air Force Capabilities	F-12
United States Navy Capabilities.....	F-14
Unit Level Chemical and Radiological Detection Equipment	F-20
Chemical Detector Capabilities and Interferents	F-22
Special-Purpose Equipment	F-26
APPENDIX G MOVEMENT FORMATIONS AND MOVEMENT, SURVEY, AND SEARCH	
TECHNIQUES	G-1
Background	G-1
Movement Formations	G-1
Movement Techniques	G-6
Survey Techniques	G-7
Search Techniques	G-13
APPENDIX H SURVEILLANCE TECHNIQUES	H-1
Background	H-1
Establishing an Automatic Chemical-Agent Alarm	
Detector Network (Monitoring)	H-1
Observing Specified Areas (Named Areas of Interest)	H-5
Conducting Standoff Chemical-Agent, Line-of-Sight	
Detection (Monitoring).....	H-6
Establishing a Biological-Agent Detector Array (Monitoring)	H-6
Conducting Biological-Agent Surveillance (Standoff Detection).....	H-8
Conducting Medical Surveillance.....	H-10
APPENDIX I RADIOLOGICAL SEARCH AND SURVEY DETECTION METHODS ...	I-1
Background	I-1
Area Monitoring	I-1
Monitoring Techniques	I-2
Correlation Factors	I-3
Recording	I-4
Radiological Surveys	I-4
Radiological Monitoring (Search).....	I-10
APPENDIX J UNITED STATES ARMY NUCLEAR, BIOLOGICAL, AND	
CHEMICAL RECONNAISSANCE UNIT OPERATIONS	J-1
Background	J-1
Equipment.....	J-1

	Page
Functions and Responsibilities	J-3
Types of Reconnaissance Units	J-4
Planning	J-7
Search and Survey	J-10
Surveillance.....	J-12
Sampling.....	J-15
Unit Employment	J-16
APPENDIX K MONITORING, RECONNAISSANCE, SURVEILLANCE, AND SURVEY REPORTS	K-1
Background	K-1
Types of Reports.....	K-1
Integrated, Automated Warning and Reporting	K-7
Reporting.....	K-7
APPENDIX L CHEMICAL SERVICES ORGANIZATIONS	L-1
Background	L-1
General	L-1
Support to Special Operations Principal Missions.....	L-2
Support to Special Operations Collateral Missions	L-3
Five-Man LB Team	L-4
Special Forces Chemical Reconnaissance Detachment	L-7
Communications	L-9
Command and Staff Relationships	L-9
Premission Activities	L-10
Mission Activities.....	L-13
Postmission Activities.....	L-16
APPENDIX M ADVANCED STANDOFF CHEMICAL DETECTOR.....	M-1
Background	M-1
Concept of Operations.....	M-3
Air Base Fixed-Site Employment.....	M-8
Aerospace Configuration	M-10
Maritime Configuration.....	M-10
APPENDIX N JOINT-SERVICE, LIGHTWEIGHT NUCLEAR, BIOLOGICAL, AND CHEMICAL RECONNAISSANCE SYSTEM AND STRYKER NUCLEAR, BIOLOGICAL, AND CHEMICAL RECONNAISSANCE VEHICLE.....	N-1
Background	N-1
Description	N-1
Employment	N-2
Tasks.....	N-4
Task Organization	N-5
Communications	N-5
REFERENCES	References-1
GLOSSARY	Glossary-1
INDEX	Index-1

	Page
FIGURES	
Figure I-1. NBC Reconnaissance Information Management	I-6
Figure III-1. Chemical-Agent Attack Over a Port Area.....	III-11
Figure III-2. Corps Movement to Contact With an ACR Covering Force.....	III-13
Figure III-3. Division Movement to Contact With a Brigade Advanced Guard	III-14
Figure III-4. Attack With Division as Corps Main Attack.....	III-15
Figure III-5. NBC Reconnaissance Squad Supporting a Battalion TF	III-16
Figure III-6. NBC Reconnaissance Squad Supporting a River Crossing Operation.....	III-17
Figure III-7. NBC Reconnaissance Units Supporting a Defensive Operation	III-19
Figure III-8. NBC Reconnaissance Units Supporting Rear Area Operations	III-20
Figure III-9. NBC Reconnaissance Operations in the Corps Theater Rear Area.....	III-21
Figure IV-1. Concept of NBC Reconnaissance	IV-2
Figure IV-2. NBC Reconnaissance OPORD Annex	IV-5
Figure VI-1. NBC Survey	VI-2
Figure VI-2. NBC Surveillance	VI-4
Figure VI-3. NBC Route Reconnaissance	VI-5
Figure VI-4. NBC Zone Reconnaissance	VI-7
Figure VI-5. NBC Area Reconnaissance.....	VI-8
Figure VII-1. Sampling Process.....	VII-6
Figure VII-2. Suggested Operational Structure for a Sampling Mission	VII-6
Figure VII-3. Sample Collection OPORD Annex.....	VII-12
Figure VIII-1. NBC Report Flow	VIII-3
Figure VIII-2. NBC Contamination Marking Set	VIII-5
Figure VIII-3. Standard NBC Hazard Markers.....	VIII-6
Figure VIII-4. Expedient NBC Hazard Markers.....	VIII-7
Figure VIII-5. Contamination Bypass Marker.....	VIII-7
Figure VIII-6. NBC Hazard Warning Tag.....	VIII-8
Figure IX-1. Levels of PPE	IX-10
Figure IX-2. Downwind Search.....	IX-12
Figure IX-3. Upwind Search	IX-13
Figure IX-4. Crosswind Search	IX-14
Figure B-1. SOP Outline.....	B-1
Figure C-1. Sample Unit Checklist	C-1

	Page
Figure D-1. Sample Contamination Footprint for a Liquid-Agent Artillery Attack	D-6
Figure D-2. Airburst Warhead Deposition Time (Notional)	D-6
Figure E-1. Sample CW/BW Report.....	E-10
Figure E-2. Sample Chain-of-Custody Form	E-14
Figure E-3. Example of a Sample Identification Number	E-16
Figure E-4. Sample CB Incident Interview Form	E-25
Figure E-5. Sample Label.....	E-51
Figure E-6. Sample Seal	E-51
Figure E-7. Sample Evidence/Sample Log	E-53
Figure E-8. Sample Photographic Log.....	E-54
Figure E-9. Sample Diagram/Sketch Form.....	E-55
Figure E-10. Sample Administrative/Logistics Form	E-56
Figure E-11. Sample Recovery Log.....	E-57
Figure E-12. Sample Affidavit.....	E-59
Figure F-1. Chemical Company (Smoke/Decontamination/ Reconnaissance) (ACR).....	F-1
Figure F-2. Chemical Company (Reconnaissance/ Decontamination) (ACR) (Light)	F-2
Figure F-3. Chemical Detachment (Reconnaissance)	F-3
Figure F-4. Chemical Company (Reconnaissance)	F-3
Figure F-5. Chemical Company (Reconnaissance/ Decontamination) (Force XXI Digitized Division).....	F-4
Figure F-6. Chemical Company (Biological Detection)	F-5
Figure F-7. NBC Reconnaissance Platoon, SBCT	F-5
Figure F-8. Chemical Company (Heavy Division).....	F-6
Figure F-9. TEU	F-7
Figure F-10. WMD Civil-Support Team	F-8
Figure F-11. CBRN Installation Support Team	F-10
Figure G-1. Staggered Column Formation	G-2
Figure G-2. Wedge Formation.....	G-3
Figure G-3. Column-of-Wedges Formation	G-3
Figure G-4. V Formation	G-4
Figure G-5. Split V Formation	G-4
Figure G-6. Echelon (Left and Right) Formations.....	G-5
Figure G-7. Herringbone Formation.....	G-6
Figure G-8. Coil Formation	G-6
Figure G-9. Nearside-Farside Survey Technique	G-8
Figure G-10. Contamination Area Extending Past the Initial Right Limit of the Survey	G-8
Figure G-11. Box Survey Technique on Orientation A.....	G-10
Figure G-12. Box Survey Technique on Orientation B.....	G-10
Figure G-13. Box Survey Technique on Orientation C	G-11
Figure G-14. Box Survey Technique on Orientation D.....	G-11
Figure G-15. Star Survey Technique.....	G-12
Figure G-16. Star Survey Technique With Two Vehicles	G-12
Figure G-17. Bounce-and-Bypass Survey Technique	G-13
Figure G-18. Zigzag Search Technique.....	G-14

	Page
Figure G-19. Multiple Sweeps Using the Zigzag Search Technique	G-14
Figure G-20. Lane Search Technique.....	G-15
Figure G-21. Cloverleaf Search Technique.....	G-16
Figure H-1. Dice Five Pattern Detector Placement.....	H-2
Figure H-2. Fixed Emplacement of ACAAs	H-3
Figure I-1. Sample Survey Data (Monitoring or Point Technique)	I-8
Figure I-2. Sample Survey Data (Route or Course Leg Technique)	I-9
Figure I-3. Sample Mission Order Format	I-11
Figure K-1. Sample NBC 3 Report (Nuclear).....	K-2
Figure K-2. Sample NBC 3 Report (CB).....	K-3
Figure K-3. Sample NBC 3 Report (Release-Other-Than-Attack).....	K-4
Figure K-4. Sample NBC 4 Report (CB or Release-Other-Than-Attack).....	K-5
Figure K-5. Sample NBC 5 Report (Release-Other-Than-Attack).....	K-6
Figure K-6. Sample NBC 6 Report (Release-Other-Than-Attack).....	K-7
Figure L-1. LB Team.....	L-5
Figure L-2. CRD.....	L-8
Figure L-3. LB Team/CRD Scope of Employment Within the Operational Environment	L-8
Figure M-1. Advanced Standoff Chemical Detector Performance Parameters.....	M-2
Figure M-2. Single-System Detection Technique	M-5
Figure M-3. Multiple-System Detection Technique	M-5
Figure M-4. Positioning Detectors at Fixed-Site Locations.....	M-7
Figure M-5. Operator Display Unit Indicating Detection of a Blister Agent	M-7
Figure N-1. Stryker NBCRV Main-Menu Sample Screen	N-4

TABLES

Table III-1. Suggested Equipment for a Two-Party Survey Team	III-6
Table III-2. Common Team and Unit Actions.....	III-6
Table IX-1. Safe and Hazardous Concentrations of Selected Chemicals, in Parts Per Million	IX-4
Table IX-2. Protection Levels.....	IX-5
Table IX-3. Approach Selection Criteria	IX-11
Table E-1. Selecting the Sampling Location	E-7
Table E-2. Country Codes	E-17
Table E-3. Container Selection.....	E-28
Table E-4. CB Sample Collection Equipment	E-29
Table E-5. Recommended Sizes of Samples	E-31
Table F-1. USAF Deployable Teams	F-15

	Page
Table F-2. Chemical Detector and Monitor Capabilities	F-23
Table F-3. Chemical Detector Limits and Miosis Levels.....	F-24
Table F-4. Interferents	F-25
Table F-5. Environmental Conditions	F-26
Table G-1. Movement Techniques	G-6
Table H-1. Number of Detectors Required	H-3
Table J-1. M93 Capabilities and Limitations	J-2
Table J-2. M93A1 Capabilities and Limitations	J-2
Table J-3. Comparison of the NBCRS and the NBCRV	J-3
Table J-4. MM1 Methods	J-10
Table J-5. Search and Survey Patterns.....	J-12
Table L-1. Representative CRD Equipment.....	L-10
Table L-2. Sample Mission Tasking and Planning Process....	L-12
Table L-3. Outline for a Mission Back Brief.....	L-14
Table L-4. Checklist for Mission Considerations.....	L-15

EXECUTIVE SUMMARY

Multiservice Tactics, Techniques, and Procedures for Nuclear, Biological, and Chemical Reconnaissance

Chapter I Missions, Capabilities, and Principles

Chapter I introduces NBC reconnaissance and defines searches, surveys, surveillance, monitoring, and sampling. It addresses the reconnaissance information requirements (IR) of the commander. The principles of NBC reconnaissance and the management of information resulting from NBC reconnaissance are discussed as they relate to command decisions.

Chapter II Operational Environment

Chapter II discusses NBC conditions and the effects on the operational environment. It discusses the threat environment and NBC capabilities of adversary states. It provides and discusses potential scenarios to assist in understanding the threat. Chapter II also discusses the land, maritime, air, space, weather, and civil infrastructure environments as they impact reconnaissance operations.

Chapter III Support to Military Operations

Chapter III focuses on NBC reconnaissance support to military operations. It addresses the need for peacetime preparedness and provides a checklist to assess the readiness for NBC reconnaissance. It discusses the transition to operations and the sustained combat operations planning for NBC reconnaissance. Chapter III addresses preattack, during-attack, and postattack NBC reconnaissance. It also provides examples of the employment of NBC reconnaissance assets and addresses the actions required during conflict termination.

Chapter IV Planning

Chapter IV discusses general planning considerations for NBC reconnaissance and the MDMP, with emphasis on IPB and developing NBC priority intelligence requirements (PIR) as part of the commander's critical information requirements (CCIR). It addresses the levels of NBC reconnaissance planning and the development of the reconnaissance plan.

Chapter V Capabilities

Chapter V focuses on NBC reconnaissance organizations that are available to support military operations. It discusses NBC reconnaissance capabilities common to components and provides descriptions of equipment common to the services. It addresses service component capabilities and discusses specialized support elements.

Chapter VI Tasks

Chapter VI provides information on the various types of NBC reconnaissance tasks (search; survey; surveillance; sampling; and route, zone, and area reconnaissance) used to support military operations.

Chapter VII Sampling Operations

Chapter VII provides information on NBC sampling operations, teams, responsibilities, planning considerations, types of units to sample, and staff actions.

Chapter VIII Reporting and Marking

Chapter VIII discusses the NBC reporting system. It describes NBC reports, their use, when they are to be prepared, and who is responsible for completing them. It focuses on the importance of accurate reporting in NBC reconnaissance operations, discusses NBC contamination marking, and provides marking procedures.

Chapter IX Toxic Industrial Material Reconnaissance

Chapter IX provides a detailed overview of potential TIM and describes the hazards that deployed forces may encounter. This chapter also discusses TIM planning and safety considerations and provides information on the reconnaissance organization and equipment requirements that are necessary for TIM operations. It discusses reconnaissance techniques for use when encountering TIM and provides a safety checklist for TIM operations, including personal protective equipment (PPE) selection.

PROGRAM PARTICIPANTS

The following commands and agencies participated in the development of this publication:

Joint

Joint Chiefs of Staff, J5, Nuclear and Counterproliferation Division, The Pentagon, Room 2S938, Washington, DC 20318

Defense Threat Reduction Agency, 8725 John J. Kingman Road, Fort Belvoir, VA 22060

Army

United States Army Chemical School, 401 MANSCEN Loop, Suite 1029, Fort Leonard Wood, MO 65473

United States Army Medical Department Center and School, 1400 E Grayson Street, Fort Sam Houston, TX 78234

United States Army Soldier Biological Chemical Command, Aberdeen Proving Ground, MD 21040

Marine Corps

United States Marine Corps NBC Defense School, 1273 Iowa Avenue, Fort Leonard Wood, MO 65473

United States Marine Corps Combat Development Command, 3300 Russell Road, Suite 318A, Quantico, VA 22134-5021

Navy

United States Navy Warfare Development Command, 686 Cushing Road, Sims Hall, Newport, RI 02841

United States Navy Surface Warfare Officer School Command, 446 Cushing Road, Newport, RI 02841

United States Navy, Chief of Navy Operations N70 CP, 2812 Summerfield Road, Falls Church, VA 22032

United States Navy Facilities Command, 1322 Patterson Avenue, Washington, DC 20374

United States Navy Surface Warfare Development Group, 2200 Amphibious Drive, Norfolk, VA 23521

Air Force

Air Combat Command, 129 Andrews Street, Suite 102, Langley AFB, VA 23655

United States Air Force Civil Engineer Support Activity, 14A Barnes Drive, Suite 1,
Tyndall AFB, FL 32403

United States Air Force Special Operations Command, 100 Bartley Street, Suite 153W,
Hurlburt Field, FL 32544

United States Air Force Doctrine Center, Detachment 1, 216 Sweeney Boulevard, Suite
109, Langley AFB, VA 23665

United States Air Force Counterproliferation Center, 325 Chennault Circle,
Montgomery, AL 36112

Chapter I

MISSIONS, CAPABILITIES, AND PRINCIPLES

1. Background

NBC reconnaissance is a contamination avoidance measure that provides commanders with information on NBC hazards in an area of operations (AO). NBC reconnaissance elements perform five critical tasks—detection, identification, marking, reporting, and sampling.

- **Detection.** Detection is required for the timely warning of units.
- **Identification.** Identification supports protection level selection, preventive measures, and casualty treatment.
- **Marking.** Marking allows friendly forces to avoid the hazard.
- **Reporting.** Reporting allows resource status assessment and mission asset assignment.
- **Sampling.** Sampling aids the identification process.

2. Mission

NBC reconnaissance elements conduct searches, surveys, surveillance, sampling, and reconnaissance (route, area, or zone) to confirm the presence or absence of NBC hazards or attacks. NBC reconnaissance is conducted to obtain information via observation, sensors, detectors, or other methods. It may include gathering information on the enemy use of NBC weapons, associated hazards, or meteorological data for NBC hazard prediction.

- **Searches.** Searches are conducted to find the contamination.
- **Surveys.** Surveys determine the location and size of the contamination.
- **Surveillance.** Surveillance is the systematic observation of aerospace, surface and subsurface areas, persons, places, and things by visual, aural, electronic, and other means. The surveillance process can also include medical surveillance, which is the ongoing systematic collection of health data essential to the evaluation, planning, and implementation of public health practices.
- **Sampling.** Sampling is the process of selecting, collecting, documenting, and packaging specimens.
- **Reconnaissance.**
 - **Route.** Route reconnaissance focuses on obtaining information along a specific line of communications (LOC) (route), such as a road, railway, or cross-country mobility corridor. The route may be a single road or an axis of advance.
 - **Area.** Area reconnaissance (sometimes referred to as *point reconnaissance*) focuses on obtaining information within a prescribed area. The area may be a town, installation, ridgeline, airhead, bridge, or

another feature that is critical to operations. Areas are normally smaller than zones, and an area reconnaissance is usually quicker than a zone reconnaissance.

Zone. Zone reconnaissance focuses on obtaining information within a specific zone, such as all routes, obstacles, terrain, and enemy forces within a zone defined by boundaries. A zone reconnaissance may include several route or area reconnaissance missions assigned to subordinate elements. It may be appropriate when previous knowledge of the area is limited and there are indications or reports of NBC hazards.

NOTE: Route, area, and zone reconnaissance may include finding a bypass (clear) route that allows forces to avoid contamination.

3. Capabilities

Military operations require information to support the commander's IR. NBC reconnaissance must ensure timeliness, survivability, reliability, suitability, and connectivity.

- **Timeliness.** Reconnaissance assets must be responsive to meet the needs of the commander. The commander uses NBC reconnaissance assets to provide information when and where needed.
- **Survivability.** Planners assess the survivability for NBC reconnaissance system (NBCRS) platforms, sensors, and communications and data links. Survivability is commensurate with the threats to which NBC reconnaissance assets will be exposed during the course of operations. Careful mission planning, intelligent tasking, effective employment tactics, and capability overlap to ensure the survivability of specific capabilities and functions.
- **Reliability.** NBC reconnaissance assets must provide reliable information concerning NBC agents and TIM.
- **Suitability.** Planning provides mission tasking that is based on asset suitability within the context of the overall plan.
- **Connectivity.** NBC reconnaissance assets must transmit information accurately and timely, taking into account connectivity and interoperability, which are crucial to overall responsiveness.

4. Principles

Reconnaissance capabilities provide information for the detection and identification of NBC and TIM hazards. Reconnaissance produces information that allows friendly forces to avoid contaminated areas and take required protective measures. NBC reconnaissance is conducted throughout the battlespace from the combat forward area to the theater rear area (continental United States [CONUS] and outside the continental United States [OCONUS]). Reconnaissance is dedicated to the detection of NBC hazards and generally adheres to the following principles:

- **Maximizing the probability of detection.** This is done by using IPB to determine where and when to employ sensors.

- **Retaining freedom of action.** By avoiding contaminated areas, the commander maintains freedom of action. Knowing the location of contaminated areas allows units to practice contamination avoidance. This permits air base (AB), maritime, and ground forces to continue their operations relatively unimpeded.
- **Orienting on the reconnaissance objective.** The commander orients his reconnaissance assets by identifying a reconnaissance objective within the AO. The reconnaissance objective may be a terrain feature, geographical area, or enemy activity about which the commander wants to obtain additional information. The commander assigns reconnaissance objectives based on the PIR that result from the IPB process.
- **Reporting information rapidly and accurately.** This is important because—
 - NBC reconnaissance is performed to support critical decisions, such as warning, protection, and treatment decisions.
 - Critical information loses value quickly.
 - Negative reports tell as much as positive reports.
 - Accurate reporting provides information on the current NBC hazards in the air, in water, on land, on personnel, on equipment, or in facilities. It also provides the physical state of the hazard (gas, liquid, solid).
- **Developing the situation rapidly.** Once contamination is encountered, the unit providing the information must—
 - Determine the agent type, the intensity or concentration, and the geographic area affected.
 - Select a course of action (COA) for the NBC reconnaissance unit.
 - Recommend a COA to the supported unit.
 - Implement the commander's decision.
- **Ensuring continuous reconnaissance and maximizing the capabilities of NBC reconnaissance units.** The unit uses all available capabilities and integrates them to increase the probability of detection.

5. Situational Awareness

Decisions rely on information input to support situational awareness (SA). Information sources that furnish warning, protection, treatment, verification, confirmation, all clear, and surface contamination data support SA maintenance.

a. **Warning.** Detection for warning (standoff detection) provides warning in sufficient time to implement protective, preventive, and treatment measures before exposure to agent contamination occurs. When there are insufficient automatic standoff detectors for chemical and biological (CB) agents, it is necessary to rely on available detectors, attack indicators, and preventive medicine (PVNTMED) sampling and analysis.

(1) For attacks upwind of a unit, detection must occur at sufficient upwind distances to provide a reasonable amount of time for processing and transmitting information. Detecting the leading edge of the cloud is preferable because it allows more warning time; however, this requires greater detector sensitivity because the agent is less concentrated at the leading edge of the cloud than in the middle of the cloud.

(2) Warning of an upwind attack may come from a unit's own upwind detectors or from other assets monitoring the upwind area. Lacking the necessary point or standoff detectors, commanders must decide when the possibility of attacks warrants an increased protective posture based on intelligence indications. Reports from upwind units can also provide warning of an attack, assuming that the units have the necessary detectors, have observed enemy activities indicative of an attack, or have identified an agent through detection by sampling and analysis.

(3) For direct attacks on a unit (e.g., submunitions released from a theater ballistic missile [TBM]), rapid detection and warning of agents will be difficult, if not impossible. It is preferable to don PPE in response to a general TBM attack warning when a CB attack is possible.

b. Protection and Treatment. Detection for protection and treatment focuses on identifying the agent dispersed in an attack so that the best possible protection and medical treatment can be rendered early. Since some aspects of treatment are agent-specific, agent discrimination is extremely important.

(1) Agent sampling and analysis are the primary means of accomplishing this. Sampling is a local action, while analysis can occur locally or at Department of Defense (DOD)-designated reference laboratories. The PVNTMED staff shares responsibility with the NBC staff for this type of detection. Medical personnel collect and submit clinical samples from patients, and NBC and medical personnel perform environmental sampling and detection functions.

(2) Medical surveillance is a key aspect of protection and treatment. The systematic collection of health care data is essential to the surveillance process. For example, establishing baseline health care data is an important contributor to biological warfare (BW) defense SA.

c. Verification and Confirmation. Detection for verification has implications at the strategic, operational, and tactical levels.

- **Strategic level.** Definitive identification and confirmation at the strategic level provide critical information to support decisions regarding national strategic direction and integration. Using such information, the President and the Secretary of Defense (SecDef) determine how best to respond in a timely manner.
- **Operational level.** Field confirmation and identification from medical laboratories provide critical information to support timely and effective protection and treatment decisions for affected units and personnel.
- **Tactical level.** Presumptive identification from a detector array provides important information to support warning decisions and actions, such as avoiding contamination or taking protective measures.

d. All Clear. Detection for all clear (dewarning) determines when contamination is reduced below detectable levels with available detectors; however, based on the

available information (e.g., detector capabilities and results, meteorological data, type of agent), the commander conducts risk assessment before considering a decision to lower the unit's protective posture.

e. **Surface Contamination.** Detection for surface contamination identifies deposited contamination on surfaces to determine if decontamination is necessary. There is a risk of cross contamination (e.g., transferring an agent from a contaminated surface to the eyes, mouth, or broken skin). Checking for surface contamination also detects NBC or TIM contamination in water.

(1) Commanders and staff conduct timely risk assessments and use information from multiple sources (e.g., NBC warning and reporting systems). The commander's risk assessment also addresses the TIM hazard that may exist within an AO.

(2) Units obtain relevant data (see *Figure I-1*, page I-6) from multiple sources (e.g., sensors, detectors, and other reconnaissance and surveillance assets). The appropriate data (e.g., type of agent, time of detection, weather data, location) is processed, extracted, formatted, and forwarded. Commanders and their staffs evaluate the information to assess its impact on operations. The risk assessment may lead to directives and orders to help mitigate the impact of the assessed hazard. Commanders may direct an integrated series of NBC defense (i.e., increased mission-oriented protective posture [MOPP]) measures to decrease the level of risk (e.g., decrease exposure opportunity). SA is an ongoing process, and the plan is revised as updated information is received.

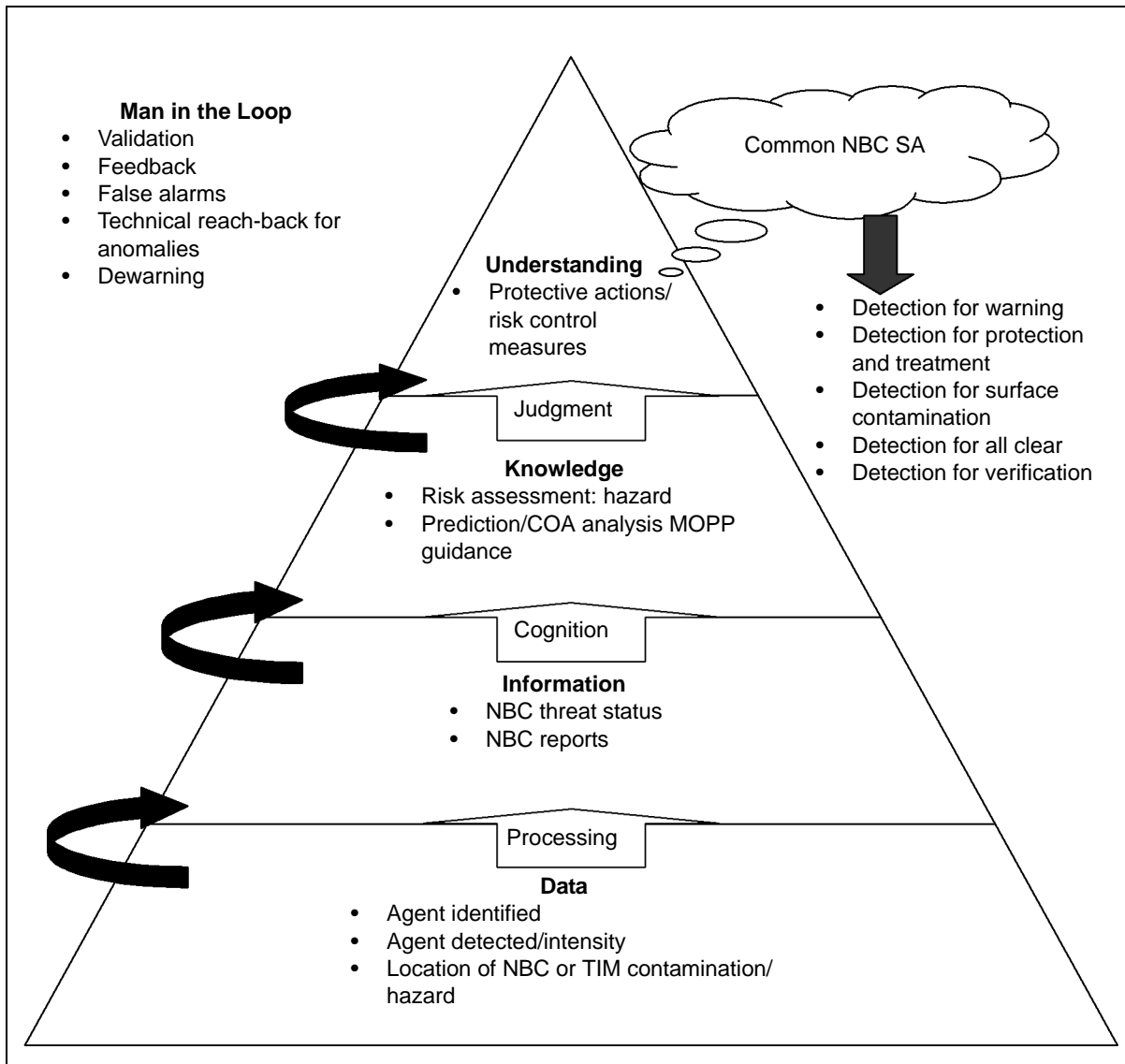

Figure I-1. NBC Reconnaissance Information Management

Chapter II

OPERATIONAL ENVIRONMENT

1. Background

The operational environment for reconnaissance is affected by multiple factors, including—

- Threat environment.
- Land environment.
- Maritime environment.
- Air environment.
- Space environment.
- Civil/infrastructure environment.
- Weather factors.

2. Threat Environment

a. In the foreseeable future, the proliferation of NBC weapons and long-range delivery systems will enable adversaries to threaten US forces at greater ranges with increased lethality and precision. To operate successfully, the US armed forces will prepare to conduct prompt, sustained, and decisive operations in NBC environments according to *Multiservice Tactics, Techniques, and Procedures for Nuclear, Biological, and Chemical Defense Operations*. The continuous IPB process accounts for confirmed—as well as plausible, but unconfirmed—adversary capabilities, plans, and actions. The IPB process addresses the capabilities and limitations of adversary NBC weapons and delivery systems and the indicators of intent to employ NBC weapons. These factors combined create a fundamental basis for determining the threat environment.

b. Adversaries will also seek to shape conditions to their advantage by changing the nature of the conflict or by using capabilities that they believe are difficult for US forces to counter. Adversaries may use modernized intelligence, surveillance, and reconnaissance (ISR) assets and NBC capabilities in attempts to conduct sophisticated ambushes, destroy key operating systems, or inflict casualties within and outside the theater of operations (TO).

c. Because potential adversaries know that they cannot win a conventional war against us, they are more likely to try asymmetric warfare—a method of warfare that seeks to counter an adversary's strengths by focusing on its weaknesses. Some states may see such asymmetric strategies (such as the use of NBC weapons or TIM) as a means of avoiding direct engagements with dominant US conventional forces. Thus, the conventional military superiority of the US may create an incentive for adversary states to acquire NBC weapons. Terrorist groups intent on inflicting a large number of casualties or causing panic can also employ this strategy.

d. The threat of using chemical, biological, radiological, and nuclear (CBRN) weapons occurs across the spectrum of military operations. The number of nations

capable of developing and possessing these weapons is steadily increasing. Developing nations are receiving these weapons or the means to develop them through technological transfer, overt or covert direct transfer, or support to belligerent groups or governments. The use of these weapons can range from blackmail and acts of terrorism during peacetime to escalation during conflict or war.

(1) NBC threats may include attacks by overt or covert means using air, ground, missile, special operations forces (SOF), or terrorists. An adversary can employ NBC weapons against multiple locations or single bases or as part of a terrorist attack. The means of delivery varies and may include bursting or spray devices or the use of improvised devices (e.g., explosives in proximity to solid radioactive material). Biological agents may also be spread through an infected person, food, or water.

(2) The methods and conditions for delivering weapons to their targets are affected by several factors, such as the type of delivery system available to an adversary, meteorological conditions, and agent type. For example, the rate of action may be hours to days for biological agents or minutes to hours for chemical agents.

(3) The tactics used by an adversary may include direct (on target) or indirect (off target) weapon delivery. Direct delivery to a target can provide immediate effects. Indirect delivery is generally upwind of the target area so that the resulting aerosol, vapor cloud, or spray stream drifts to the target.

e. It is increasingly likely that the US armed forces could encounter NBC weapons and improvised devices at the operational and tactical levels in CONUS or during a regional conflict. The use of these weapons at the operational level would be effective against rear area targets (such as ABs, ports, or logistics support facilities) since they are critical to US efforts. TBMs are especially serious threats to overseas bases, many of which are within the effective range of one or more TBM systems and potential adversaries. An adversary could also use delivery means to employ nuclear weapons or radiological materials. Their residue creates radioactive particles that can be disseminated over considerable distances.

f. TIM hazards exist wherever US troops, allied troops, or local civilians are located. TIM exists in every area of the world, and it plays a key role in virtually every human activity. For example—

- Pesticides and fertilizers are prevalent in agricultural areas.
- Acids, bases, chlorine, insecticides, and compressed flammable gasses are common in residential areas.
- Harsh chemicals and solvents are found in industrial areas.
- Fuel and fuel by-products are located by transportation hubs.
- A significant amount of low-level radioactive material is found in hospitals and dental facilities.
- Virtually every chemical can be found in storage areas and shipping sites, such as ports, airfields, and rail yards.

g. Like chemical warfare (CW) agents, TIM can attack through inhalation, direct skin contact, or ingestion. Unlike CW agents, most common TIM can pass through protective masks. In certain circumstances, TIM may displace or consume the oxygen

needed to breathe, creating a deadly, indirect hazard that is not protected by protective masks.

3. Land Environment

The analysis of the land environment concentrates on terrain features, surface materials, natural obstacles, and mobility characteristics. To judge appropriate defensive measures, it is important to analyze the combined effects of wind, temperature, humidity, sunlight, topography, and precipitation on NBC weapons. The military aspects of the terrain are also analyzed to evaluate how the land environment could shape NBC reconnaissance operations. Consider the following:

- **Observation.** Observation is the ability to *see* the adversary's use of NBC agents via NBC reconnaissance detection devices, such as observation posts (OPs) or standoff detection devices. However, several factors can hinder observation, including vegetation, buildings, relief features (hills, defiles), sensor capabilities, precipitation, and cloud cover. The analysis of each limiting factor can be combined into a single product, usually in the form of an overlay that indicates the line of sight (LOS).
- **Obstacles.** Obstacles are obstructions that are designed or employed to disrupt, fix, turn, or block movement. Obstacles can be man-made and may include areas an adversary can contaminate with NBC agents. NBC reconnaissance capabilities may be used to confirm or deny the presence of contamination.
- **Key terrain.** Key terrain (such as an urban complex) can directly affect NBC reconnaissance, and there is a higher possibility that TIM may be present. An adversary may also contaminate water sources. Contingency planning provides for detailed reconnaissance of a zone, which includes testing the water and selecting the necessary countermeasures (decontamination, purification).
- **Avenues of approach (AAs).** Planners analyze the military aspect of the terrain (observation, key terrain features, obstacles, cover, concealment, and AAs) to evaluate how the land environment could shape NBC reconnaissance operations.

NOTE: See *Appendix A* for information on mountain, jungle, desert, arctic, urban, littoral, and subterranean areas.

4. Maritime Environment

The maritime environment is the sea and the littoral in which all Navy operations (sea control, power projection, amphibious operations) take place. NBC reconnaissance in the maritime environment is influenced by the sea, littorals, and adjacent land masses. Key military aspects to consider include maneuver spaces, choke points, natural harbors, anchorages, ports, airfields, and naval bases. Coastal terrain features are also critical factors in planning and conducting NBC reconnaissance. Consider the following:

- **Maneuver spaces and choke points.** The closer a surface ship is to land, the greater the potential threat. A ship operating in confined waters or choke points near an adversary's shore-based air or missile assets has decreased

warning time. This effect is magnified for task force (TF) operations since some ship formations may be forced to close up in a confined water space.

- **Natural harbors and anchorages.** An integrated reconnaissance plan should be prepared for all natural harbors and anchorages within the AO.
- **Man-made infrastructures.** All man-made infrastructures (ports, airfields, and naval bases) capable of influencing Navy operations within an AO are analyzed in preparing NBC reconnaissance plans.

5. Air Environment

The battlespace air environment includes the operating medium for fixed- and rotary-wing aircraft, air defense systems, unmanned aerial vehicles, cruise missiles, and some TBM. Consider the following:

- **Airfields and support infrastructures.** Identify and analyze NBC reconnaissance requirements for support of AB operations.
- **AAs.** Identify air AAs for standoff NBC monitoring and survey.
- **NBC collateral effects.** Atmospheric stability can play a key factor in analyzing when an adversary may use NBC weapons. Production and storage facilities for NBC weapons present special problems. For each known NBC facility location, analyze the surrounding terrain and the forecasted weather conditions and patterns to aid in modeling postattack effluent contamination. To clarify the possible extent of collateral effects, draw potential dispersal patterns downwind from each site.
- **Standoff detection.** Identify standoff detection capabilities, and use IPB to determine how their use can support mission requirements.

6. Space Environment

Forces with access to information from the space environment have additional options to influence and enhance military monitoring capabilities. The United States Strategic Command (USSTRATCOM) is responsible for monitoring foreign space activity, performing all-source analysis of foreign space operations, and supporting appropriate requests for information. For example, a combatant command (COCOM) commander may request support from the USSTRATCOM for information to support PIR. The strategic- or operational-level commander uses multiple sources of intelligence within the affected AO, and space-based platforms can provide another key source of information.

7. Civil/Infrastructure Environment

Civil/infrastructure environments pose special problems for reconnaissance planning. Consider the following:

- **Environmental and health hazards.** The presence of communicable diseases (endemic diseases in man, animals, and plants); locations of epidemics; methods of disease transmission; and the location, type, and extent of environmental pollution (radiation, oil spills, contamination of drinking

water) affect NBC reconnaissance. Industrial activity can also increase the risk of accidental or deliberate use of TIM.

- **Infrastructure.** Sources of potable water, transportation means and systems (road and rail networks, canals, pipelines, waterways), communications nodes, power production facilities and transmission grids, and TIM impact NBC reconnaissance planning.
- **Industry.** Bulk fuel storage and transport systems, natural resources, industrial centers, scientific and technological capabilities, and chemical and nuclear facilities may affect the selection of areas of interest (AOIs) or PIR. Industrial activity may also increase the risk of accidental or deliberate use of TIM.
- **Civil control.** The ability and mobility of government and commercial entities to secure and operate the infrastructure and industrial areas are key factors. The effectiveness of local emergency response teams (ERTs), medical facilities, and public health programs also impact the operational environment.

8. Weather Factors

Weather is the state of the atmosphere, and atmospheric stability can be a key factor in analyzing when an adversary may use NBC weapons. Weather factors that impact NBC reconnaissance include—

- Visibility (fog, clouds).
- Wind velocity and direction.
- Precipitation and moisture.
- Temperature.
- Humidity.
- Barometric pressure.

NOTE: See *Field Behavior of NBC Agents (Including Smoke and Incendiaries)* for more information on how weather influences NBC agents.

Chapter III

SUPPORT TO MILITARY OPERATIONS

1. Background

This chapter focuses on NBC reconnaissance actions that could be taken during peacetime preparedness, transition to operations, during attack, and postattack. The considerations during sustained combat operations are also addressed.

2. Peacetime Preparedness

The basic element for maintaining adequate preparedness is a clear understanding of the threat and operational requirement, both overseas and in the US. To support these requirements, commanders' mission analyses must identify specific mission-essential NBC reconnaissance tasks for individuals and organizations that facilitate operations in NBC environments.

a. Preparedness in the US. Commanders of forces and facilities in the US must assess vulnerabilities that may compromise peacetime preparedness. The actions commanders take to reduce vulnerabilities depend on their assigned missions and supporting plans. Peacetime planning and supporting actions must include plans to use NBC detection capabilities, which minimize the vulnerability to NBC attacks and mitigate their effects. Commanders coordinate with civilian authorities and agencies to prevent, mitigate, and manage the consequences of deliberate or accidental NBC employment or similar TIM events in the US. Locations essential to deployment must have timely access to equipment, personnel, and units specializing in detecting and providing early warning of an NBC attack.

b. Preparedness in TOs. Peacetime preparedness for operations in NBC environments includes the measures taken by commanders in TO areas abroad, with appropriate emphasis on—

- Aerial ports of embarkation (APOEs), seaports of embarkation (SPOEs), aerial ports of debarkation (APODs), and seaports of debarkation (SPODs).
- Vulnerable, foreign military support personnel.
- Deployed US forces and facilities.
- Littoral operations.

The commands also undertake cooperative actions in peacetime with governments and armed forces of allies and potential coalition partners to sustain operations in NBC environments.

c. Peacetime Preparedness and Predeployment Actions. Actions include—

- Conducting NBC threat assessment.
- Evaluating force and unit status.
- Assessing training readiness.

- Ensuring coordinated planning.
- Conducting training.
- Taking medical protective measures.
- Verifying and exercising warning and reporting information networks.
- Planning and preparing NBC defense units, equipment, and supplies.
- Coordinating for host nation (HN) support as required.
- Verifying who is responsible for coordinating NBC defensive activities within an AO (e.g., what unit provides the base cluster commander, who is responsible for terrain management).

d. Peacetime Preparedness Actions.

(1) Assigning Responsibilities. Peacetime preparedness action includes assigning responsibilities for those personnel training in NBC monitoring, survey, and reconnaissance. These responsibilities include—

- Operating and maintaining NBC equipment applicable to the task.
- Recognizing attacks with NBC munitions and fully understanding unit procedures for implementing warnings and providing protection.
- Detecting and identifying contamination during NBC monitoring and survey operations.
- Monitoring personnel, food, drinking water, air, the environment, and equipment for NBC contamination and the effectiveness of decontamination measures.
- Collecting, packaging, and documenting samples of suspected biological contamination, establishing the chain of custody, and forwarding the samples as directed.
- Collecting samples of liquid and solid chemical agents.
- Marking NBC-contaminated areas, equipment, supplies, and stores with standard marking signs.
- Providing data for NBC reports.
- Organizing and conducting NBC monitoring and survey operations.
- Operating detection and survey equipment for recognizing and detecting hazards from CBR attacks.
- Checking for nonpotable water sources to assist in the selection of decontamination points. (PVNTMED personnel designate water sources for potable water.)
- Performing disease surveillance on and off the installation to identify a possible biological attack.

(2) Assessing Readiness. Peacetime preparedness actions include assessing readiness and reevaluating mission requirements. The following checklists provide an

NBC reconnaissance/detection guide that can be used during peacetime, sustained operations, or conflict termination.

- (a) Determine the following NBC and TIM detection requirements:
 - r What NBC and TIM detection capabilities and equipment are currently on site?
 - r Where are the NBC reconnaissance assets located?
 - r Who has access to these assets, and how do you contact them?
 - r What NBC and TIM detection equipment is projected to deploy to the site?
 - r What are the restrictions on bringing NBC detection assets into the country?
 - r Where are deploying NBC reconnaissance unit and detection equipment assets coming from?
 - r When are unit and equipment packages due in?
 - r Will sufficient NBC reconnaissance units and detection instruments be present to ensure total mission coverage (i.e., stationary sites, mobile reconnaissance teams, decontamination teams, instruments for contamination control area [CCA] and toxic-free area [TFA] operations, and instruments to place between contaminated and clean areas)?
 - r What is the readiness status of NBC reconnaissance assets?
- (b) Determine the following if HN support is available:
 - r What are the NBC detection equipment capabilities and limitations of the HN?
 - r How does the HN plan to use assigned NBC detection equipment assets?
 - r What integration of HN and unit plans must be accomplished in relation to stationary NBC detection equipment use to ensure maximum coverage?
 - r Does each decontamination team possess sufficient NBC detection equipment?
 - r How many people will be on each HN reconnaissance team?
 - r What is the HN concept of operations (CONOPS) for reconnaissance teams, and does it conflict with that of the US?
 - r What is the readiness status of HN NBC reconnaissance assets?
 - r What areas and routes will be accessible for US forces?
 - r What support (e.g., training, equipment) will HN reconnaissance assets require from US forces?

- r Do HN reconnaissance teams possess the types and amounts of NBC detection equipment to effectively implement the appropriate NBC reconnaissance CONOPS?
 - r What level of classified information, if any, can be shared with HN NBC personnel, and how will this affect combined operations?
 - r How can the HN be integrated into an NBC warning and reporting system?
- (c) Determine the following based on communications capabilities:
- r How will NBC contamination be reported (i.e., positive, negative, or by identification of specific agents, category, and concentration level)?
 - r How will reconnaissance teams be dispatched (automatically upon declaration of designated alarms or only when notified by command and control [C2])?
 - r What maintenance and supply support exists for NBC detection units and equipment?
 - r Are sufficient quantities of batteries with battery chargers available for NBC detection equipment?
 - r What communications capabilities and interoperability exist, and who will teams communicate with?
- (d) Determine the following if other service capabilities are available:
- r What other services have NBC specialists assigned?
 - r What roles and missions do the other services have in the area?
 - r Do the other services have assets available that you can use (e.g., biological detection through the Biological Integrated Detection System, enhanced chemical detection through the use of the Fox NBCRSs)?
 - r Do the other services possess sufficient personnel and equipment to fulfill their mission requirements in relation to how they directly impact your unit operations?

(3) Establishing NBC Response Sectors. Peacetime preparedness at fixed-site locations in CONUS or OCONUS (i.e., APOE, SPOE, APOD, or SPOD) includes assessment of their site mission capabilities and response actions in an NBC environment. Based on the large geographical area that many fixed sites occupy, commanders may consider establishing NBC response sectors to aid NBC reconnaissance actions. The value of NBC sectors can become particularly useful upon receipt of postattack NBC reconnaissance reports. When attacks are imminent, commanders should make the same initial alarm and MOPP declarations for the entire installation and any related response sectors in the immediate proximity of the installation.

(4) Determining Organization. Most military units can conduct NBC reconnaissance to help determine the presence or absence of NBC agents. Unit NBC

reconnaissance teams (from organic or supporting assets) provide the commander with critical information to support SA. Unit NBC reconnaissance teams are part of an integrated network of unit NBC centers and specialized teams. Additionally, designated unit personnel (i.e., shelter monitors) provide commanders with a rapid means of locating contamination and identifying and marking hazards.

(a) NBC reconnaissance teams are normally directed through the unit NBC center or unit control center. Before the attack, teams execute actions (such as pre-positioning M8/M9 detector paper on unit assets) and disperse and maintain assets (such as automatic chemical-agent alarms [ACAAs]).

(b) Subordinate unit NBC reconnaissance teams provide reports to the NBC center, and teams mark hazards and contamination as they are discovered. However, extensive marking can delay reconnaissance of the assigned area. Under these circumstances, teams would likely conduct a search to identify major hazards. If contamination is present, they complete an initial survey and report the results. Teams then return and properly mark hazards and contamination. Personnel not conducting mission-essential duties should remain protected until all hazards have been identified, located, reported, and marked.

(c) Unit NBC reconnaissance teams are organized, trained, and equipped by the unit to survey the postattack status of unit equipment, facilities, personnel, and areas of responsibility (AORs). The minimum size of a team is two people. One member maintains a constant watch for hazards, provides security, and calls for assistance if accidents or injuries occur. There is no maximum number of team members; however, team size should be kept to a minimum to reduce the number of people exposed to postattack hazards and still accomplish the mission. The use of large teams depends on the unit mission, weather, and need for additional security.

(d) NBC reconnaissance team equipment allowances vary depending on unit authorizations and whether vehicles and communications equipment are designated for team use. Leaders adjust actual team equipment needs to match the threat, area of coverage, terrain, or mission. Reconnaissance team equipment may be dedicated and stored in team kits, or teams may use equipment from shelter management or other unit team kits. *Table III-1*, page III-6, is a list of suggested equipment for a two-party survey team.

(5) Preparing an NBC Reconnaissance Team.

(a) Units prepare to provide reconnaissance for their specific areas. *Table III-2*, page III-6, outlines common actions that can be rehearsed for reconnaissance teams. Timely reporting allows the NBC center to assess the total status of mission resources and assign recovery forces where they are most effective.

(b) NBC reconnaissance teams are prepared to begin operations immediately after an attack or may delay operations to avoid or reduce exposure to NBC contamination fallout or unexploded ordnance (UXO) hazards. Specialized NBC reconnaissance teams may be directed to start operations immediately after the attack to provide commanders with a quick assessment of the status and the overall postattack situation. Commanders may also direct specialized teams to *auto roll* as soon as the attack is over. Unit NBC reconnaissance teams and individuals generally do not begin operations until directed by the NBC center. When preparing for postattack reconnaissance, teams will exercise caution to avoid crossing through cordoned and contaminated areas.

Table III-1. Suggested Equipment for a Two-Party Survey Team

Item	Quantity
Flashlight, high quality	2 each
Batteries, flashlight	Sufficient amount for 8 hours of use
Chemical light stick, white	10 each
Chemical light stick, red	10 each
NBC marking kit, signs	1 each
Survey tape, white	2 rolls
Communications device	1 each
M8 detector paper	5 booklets
M9 detector paper	2 rolls
Weapon	1 each (as required)
Hot-, cold-, wet-weather gear	2 sets
Magnifying glass	1 each
Radiac equipment, chemical detection device, DOD sampling kit	1 each
Handheld assay device	25 each

Table III-2. Common Team and Unit Actions

Preattack	
Assemble and inspect equipment.	Identify and inspect first aid kits.
Survey AORs.	Identify blackout actions if applicable.
Identify primary and alternate routes.	Implement cover, concealment, and deception actions.
Annotate map with key information.	Conduct operational checks for NBC detection equipment, including radiac equipment.
Identify facility power, gas, and fuel cutoffs if applicable.	Check medical items.
Pre-position M8/M9 detector paper.	
Postattack	
Survey predetermined routes.	Report enemy activity (SALUTE).
Find and report casualties, damage, and contamination.	Survey vehicles and equipment.
Mark hazards as necessary.	Maintain contact with the NBC center.
Report NBC detector alarms.	Request assistance from the NBC center.
Post, check, and report on M8/M9 detector paper.	Advise the NBC center on the ability to conduct the mission.
Transport injured personnel to casualty collection points. ¹	Conduct an NBC threat assessment.
¹ Team only.	

(c) Team preparation includes planning for site security when selecting locations for NBC detectors and M8 detector paper. This reduces the possibility that preselected and routinely checked sites could be mined or that teams could be targeted for ambush during routine operations. As a general rule, do not locate detection sites outside established perimeters unless they are coordinated with and approved by security forces.

(d) Planning actions also ensures that personnel within facilities, expedient bunkers, and defensive fighting positions pre-position M8/M9 detector paper in locations where they can observe the paper without physically leaving their protected positions. Place the M8 detector paper on a raised surface that is slightly canted toward the observation point. Use binoculars or a spotting scope during daylight to observe M8/M9 detector paper from the protected position or from beneath overhead cover. For nighttime operations, attach a rope or string to the observation stand or pad and pull it to an opening. Use only white light to read the M8/M9 detector paper. Do not use night vision devices (NVDs) or night vision rifle scopes because they do not show color changes.

3. Transition to Operations

There are multiple preparatory considerations that support the actions involved in the transition to sustained operations.

- a. NBC reconnaissance preparatory considerations can include the following:
 - **Intelligence.** Commanders and the NBC staff use IPB to direct NBC reconnaissance operations. They gain information that is critical to making decisions in defined areas and specific locations (i.e., assigning NBC reconnaissance elements to cover specific named areas of interest [NAIs]).
 - **Force organization and training.** Units train and exercise NBC reconnaissance capabilities as part of their integrated NBC warning and reporting network. Leaders understand NBC reconnaissance capabilities, and the staff prepares effective employment plans that maximize the probability of detection. Unit leaders assess team and overall unit performance and ensure the understanding of factors, such as the environmental impact on detections.
 - **Theater access maintenance.** Contingency plans that integrate NBC reconnaissance capabilities to help support unimpeded operations are prepared and exercised. Contingency planning ensures that required NBC reconnaissance assets are included on the time-phased force and deployment list (TPFDL). The TPFDL is also evaluated to ensure inclusion of technical escort and medical laboratory resources and NBC unit resources (e.g., C2 elements, control centers) as appropriate.
 - **Logistics support and sustainment.** Commander and staff planning sustains NBC reconnaissance capabilities, ranging from designating decontamination points for NBC reconnaissance assets to ensuring system level contracted logistics support (CLS).
 - **Physical environment.** Seasonal effects on terrain, weather, and sea conditions are carefully assessed before and during operations to determine the potential impact on NBC reconnaissance capabilities.

b. Many of the actions undertaken during peacetime preparedness will continue during the transition to operations. Detecting NBC agents is essential to maintaining operational capability. NBC detection equipment should be operated so that it results in timely automated warnings. NBC reconnaissance teams must be ready to begin operations immediately after an attack. For example, reconnaissance teams traveling

over a predefined route may begin physically checking and reporting the status of each detector on the installation. Other representative actions may include—

- Inventorying NBC detection assets and integrating resources with the host base, HN, and joint forces.
- Continuing the assessment of manpower and support requirements.
- Identifying shortages and overages to higher headquarters.
- Developing mission tasks and work schedules for NBC personnel and augmented support personnel.
- Establishing and evaluating the NBC detection array and the NBCRS.
- Activating the NBC detection, identification, and warning system(s) when required.
- Establishing primary and secondary C2 capabilities in the survival recovery center (SRC) and the damage control center (DCC).
- Identifying and training personnel for NBC reconnaissance teams. (Define the AOR for each team, and ensure that communications and verification procedures are established.)
- Identifying and establishing CCAs for NBC-protected facilities.
- Identifying potential CCAs and TFAs if collective protection is inadequate or nonexistent.
- Ensuring that all NBC reconnaissance team personnel have been issued serviceable PPE and that reserve stocks are protected from loss, damage, and possible contamination.
- Assisting unit personnel by checking their equipment for serviceability and ensuring that they inspect, maintain, and clean their assigned equipment.
- Evaluating installation contamination avoidance activities.
- Evaluating installation passive defense activities (e.g., dispersal, cover, concealment, deception).

4. During Attack and Postattack

An accurate assessment of the situation must be made during attack and postattack.

a. Based on the mission, enemy, terrain and weather, troops available, and civilian considerations (METT-TC), the following actions should be taken to accurately and rapidly determine the degree of NBC contamination so that warnings can be provided or forces can be allowed to reduce protection:

- Implement contamination avoidance measures, and take cover during attacks. Maintain SA, and report key observations as needed.
- Perform attack damage and hazard assessment.

- Survey the immediate area for casualties, UXO, damage, and indications of chemical use or fallout.
- Report findings and observations on weapon systems, munitions, and tactics used in the attack to the NBC center.
- Monitor the area to verify the presence, extent, and absence of NBC agents.
- Be alert for indications of biological-agent use (see *Chapter 7*).
- Recommend a protective posture that applies to the threat, or recommend further attack if contamination is absent. Conduct surveys to define and mark contaminated areas if contamination is present.
- Use the M291, M295, or another approved decontamination kit, as required, to decontaminate surfaces (vehicle access handles, equipment controls, bare metal, glass) before touching them.
- Plot contaminated areas, advise the NBC center on the agent persistency, and provide NBC reports and warnings (e.g., plot nuclear detonations and fallout, predict downwind hazards).
- Monitor for the arrival of fallout. If fallout arrives at the installation, implement exposure and radiological contamination controls, predict radiation intensities, and submit required reports.
- Evaluate craters to determine if a ground-bursting chemical weapon, conventional warhead, or airburst debris caused the crater.
- Identify vapor concentrations along designated routes.
- Collect, package, and mark soil, water, and vegetation samples that may be contaminated.
- Provide reconnaissance-related information to the NBC center. Report the—
 - Physical state of the agent (powder, liquid).
 - Apparent viscosity (neat sample or thickened agent).
 - Size of droplets.
 - Effect on vegetation, animals, and personnel.
- Check the placement of detectors and sector and area transition signs.
- Reposition vapor detectors between contaminated and uncontaminated areas or sectors as required, and replace the detectors if necessary.
- Search for residual hazards.
- Determine if designated open-air CCAs and TFAs are contaminated, and locate uncontaminated CCAs and TFAs.

b. Ensure that personnel know their individual postattack reconnaissance responsibilities. Critical mission-essential activities continue during postattack reconnaissance and non-mission-essential personnel use available protection (e.g., remain indoors) until hazards have been identified, located, and reported.

5. Sustained Combat Operations

During sustained combat operations, NBC reconnaissance assets are integrated into NBC reconnaissance efforts. NBC reconnaissance units are employed to confirm or deny the contamination of areas. The method used to employ NBC reconnaissance assets must be focused by IPB, CCIR, and IR.

a. Air Component Operations.

(1) NBC attacks have the potential to degrade air component operations. The lethality of NBC weapons and the operational tempo of air operations require timely and effective NBC detection and warning.

(2) AB NBC detection capabilities include chemical-agent monitors (CAMs); improved CAMs; ACAAs; M256-series kits; radiation detection, identification, and computation equipment; DOD sampling kits; and M8/M9 detector paper dispersed around flight line facilities, on equipment, and on personnel.

(3) To support NBC reconnaissance, the AB may divide into separate response sectors to help facilitate efficient and effective postattack reconnaissance. Specific measures are also taken to support NBC reconnaissance (preattack and postattack).

b. Navy Component Operations. An adversary may decide to employ NBC weapons against a port facility, and NBC planning indicates that an adversary could use a persistent chemical agent against a port facility (see *Figure III-1*). Based on that information, multiple NBC reconnaissance options are considered.

(1) Detection and Alarm. Due to the short distance between the line of dissemination and the docks and the confined, fixed-site nature of the port, even alarms provided by deployed, operating detectors would allow little opportunity to avoid contamination (e.g., the alarm would be raised at essentially the same time as the ships, personnel, and staged material are being enveloped in the agent cloud). However, an immediate alarm from NBC reconnaissance assets would—

- Preclude the possibility of other ships being unknowingly loaded with contaminated material.
- Allow early identification of treatment for affected personnel.
- Permit early use of contamination control to prevent the spread of the agent by vehicular and personnel traffic beyond port boundaries.

(2) Contamination Control. Determining and marking the contaminated zone is a necessary, time-consuming task. Useful search and survey instruments, such as CAM, will be used for marking the zone of contamination, estimating the downwind hazard, and controlling the area.

(3) Hazard Area Estimates. Planners use automated decision support tools (such as vapor, liquid, and solid tracking and the hazard prediction and assessment capability model) to indicate the potential area where the aerosol cloud would result in 50 percent incapacitation (due to liquid and aerosol contamination) of the exposed population. Weather data, the type of agent, and the length of the spray line are inputs used in the decision support tool.

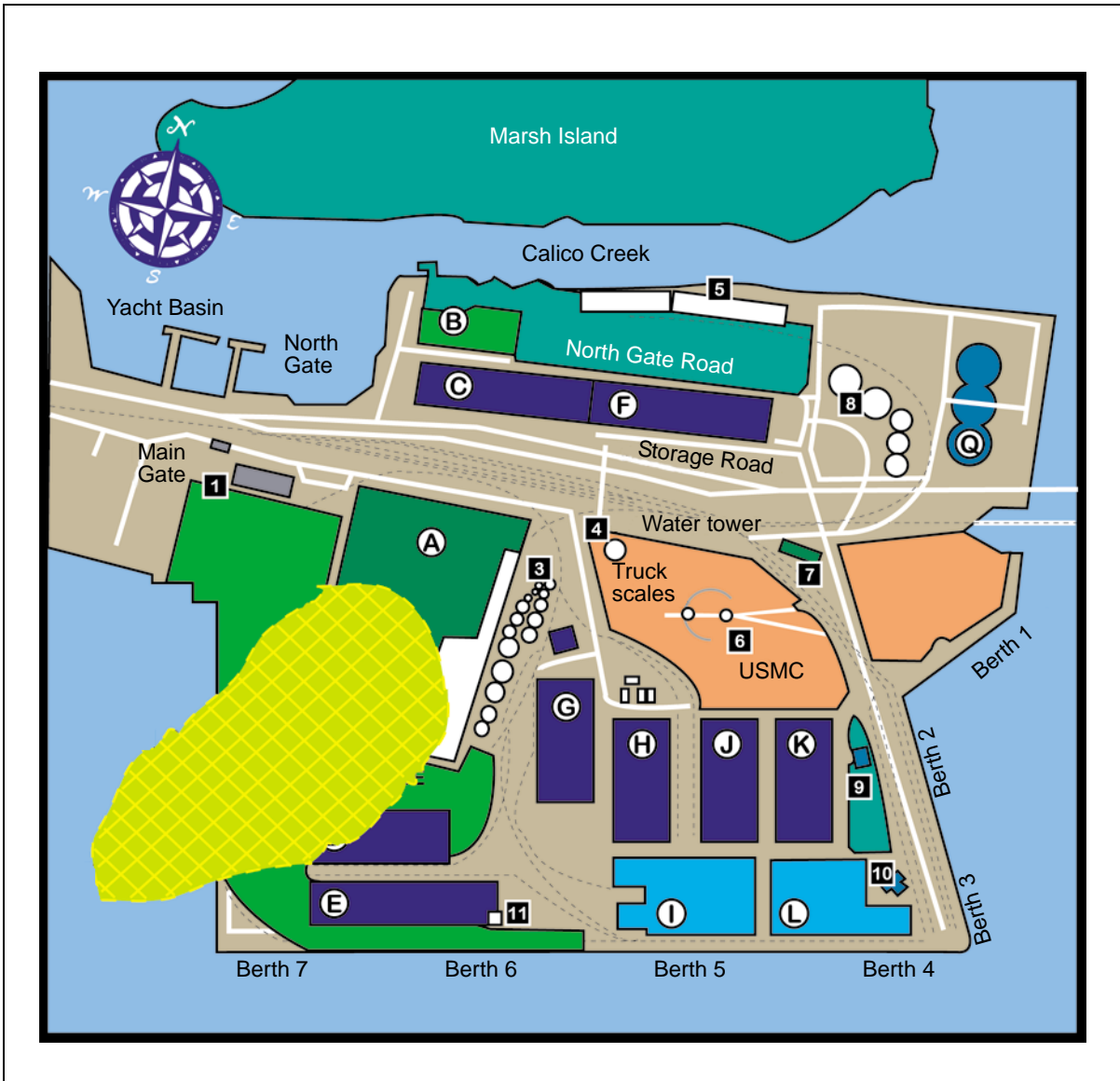

Figure III-1. Chemical-Agent Attack Over a Port Area

(4) Response Options. Response planning considers multiple COAs and how NBC reconnaissance information could support each COA. Once it has been determined that the area may have been the target of a chemical-agent attack, the commander could order a temporary halt in operations. Personnel would then take immediate action to protect themselves and avoid additional contamination. The port could be sealed to entry and exit to prevent contamination of additional personnel and equipment, and loading operations would cease. NBC reconnaissance teams would begin the task of mapping and cordoning off the contaminated area, and nonessential military and civilian personnel would be evacuated to a holding area. Based on assessments, the planning team also examines other COAs, such as using alternate port facilities or increasing dispersal of assets at the port.

c. Land Component, Offensive Operations. NBC reconnaissance operations support various missions, such as movements to contact, hasty and deliberate attacks,

exploitation and pursuit operations, and river crossing operations. The offensive is the commander's primary means for gaining the initiative against an enemy force. Offensive operations are characterized by momentum, the initiative of subordinate commanders, and confirmation of the presence or absence of contamination.

(1) Confirmation or Denial of Contaminated Areas. When the IPB identifies possible contaminated areas in the AO, NBC reconnaissance assets can confirm or deny the presence of contamination. Templated areas of possible contamination that could affect operations are designated as NAIs. These NAIs are included in the ISR plan. Supporting NBC reconnaissance elements are tasked in the ISR plan to observe selected NAIs. If NBC reconnaissance units conduct a physical survey of the NAI, the supporting unit may have to provide security. Detailed coordination with other reconnaissance assets is required to prevent fratricide and duplication of effort. However, if insufficient time is available to conduct a physical reconnaissance, a map reconnaissance will have to suffice.

(2) Confirmation of Contamination. To support land force combat operations, NBC reconnaissance elements are integrated into combat formations. They move behind or with the lead maneuver force. If the formation encounters contamination, the NBC reconnaissance elements can deploy to find clear routes around it. As they attempt to find a bypass route, the lead maneuver force provides security. Once the bypass route is located, the NBC reconnaissance elements are integrated back into the formation in case there are additional contaminated areas.

(3) Movements to Contact.

(a) Movement to contact is a type of offensive operation designed to develop the situation and gain or reestablish enemy contact. Commanders organize forces to provide all-around security, and contamination avoidance is critical to maintaining flexibility. Once units enter contaminated areas, the commander's freedom of action is degraded. NBC reconnaissance units support the commander's requirement to retain freedom of maneuver.

(b) IPB will identify the areas of greatest threat from NBC contamination, and the commander will task-organize supporting NBC reconnaissance units to meet the identified threat. If the commander has no such units, the task of conducting NBC reconnaissance falls to cavalry and scout units, in addition to their primary missions. The following operational factors are considered:

- Plan NBC reconnaissance operations to provide flexibility for the commander.
- Task-organize supporting NBC reconnaissance units based on IPB and METT-TC.
- Identify known or suspected areas of contamination.
- Prioritize NBC reconnaissance support to lead maneuver forces.
- Ensure that the advance guard force is NBC reconnaissance heavy.
- Coordinate for decontamination after the mission.

(c) In *Figure III-2*, an armored cavalry regiment (ACR) is performing a movement to contact. Because the IPB has identified the possibility of contamination in

the combat zone, each squadron is supported by an NBC reconnaissance unit/element. The squadron and regiment IPB indicates where the enemy may use persistent chemical agents. The unit will react to any contamination located by ground and air scout reconnaissance patrols.

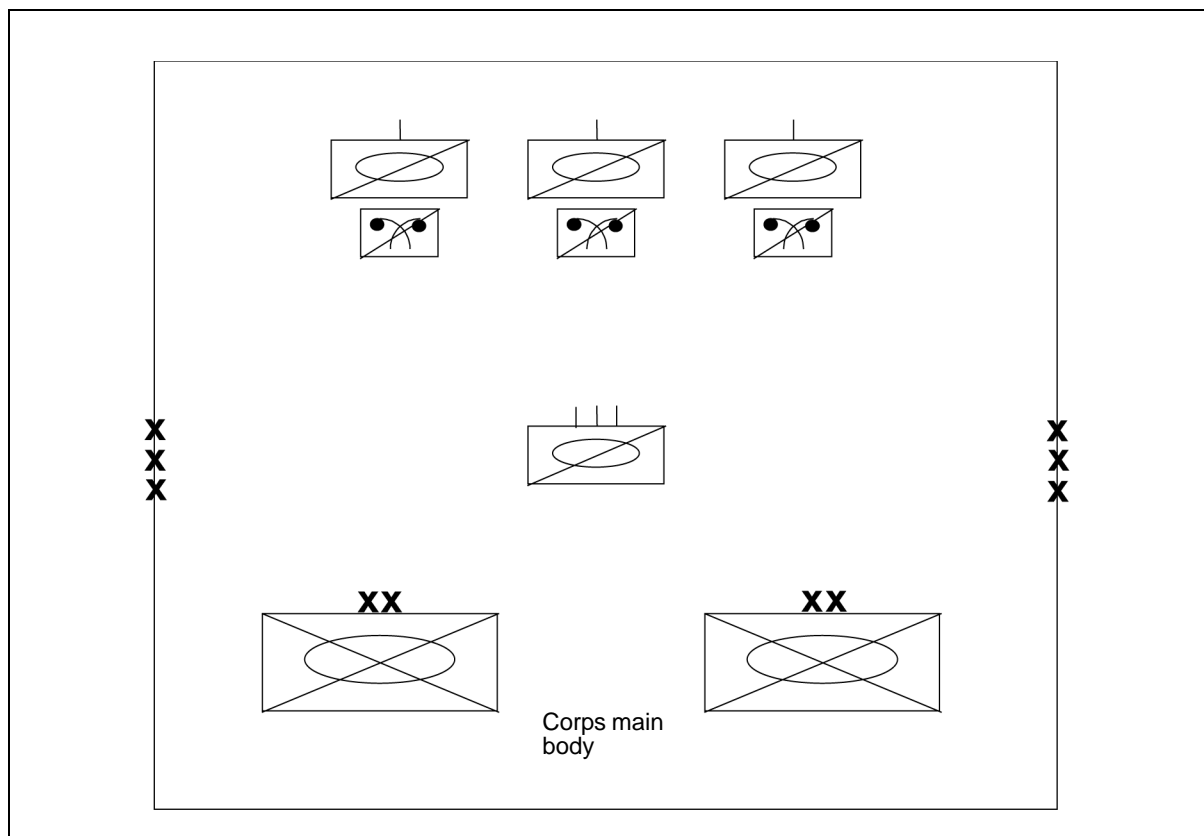

Figure III-2. Corps Movement to Contact With an ACR Covering Force

(d) *Figure III-3*, page III-14, shows a division movement to contact with a brigade advance guard followed by two brigades. The lead brigade receives an entire NBC reconnaissance platoon. By weighing the advance guard with NBC reconnaissance assets, the division facilitates flexibility. When the advance guard encounters contamination, bypass routes can be quickly identified and the division's main body can proceed forward at its planned speed. The platoon leader chooses to employ his unit in a section organization. When the lead combat force encounters contamination, the section can quickly locate a bypass route to facilitate the forward movement of the advance guard. One team will remain behind to survey the contaminated area and aid follow-on forces.

(4) Attacks.

(a) Attacks are offensive operations that destroy or defeat enemy forces, seize and secure terrain, or both. NBC reconnaissance is employed to enhance maneuver and agility of the attacking force. NBC reconnaissance units allow the force to avoid contaminated areas. The following operational factors are considered:

- Use NBC reconnaissance operations to provide flexibility and facilitate synchronization.

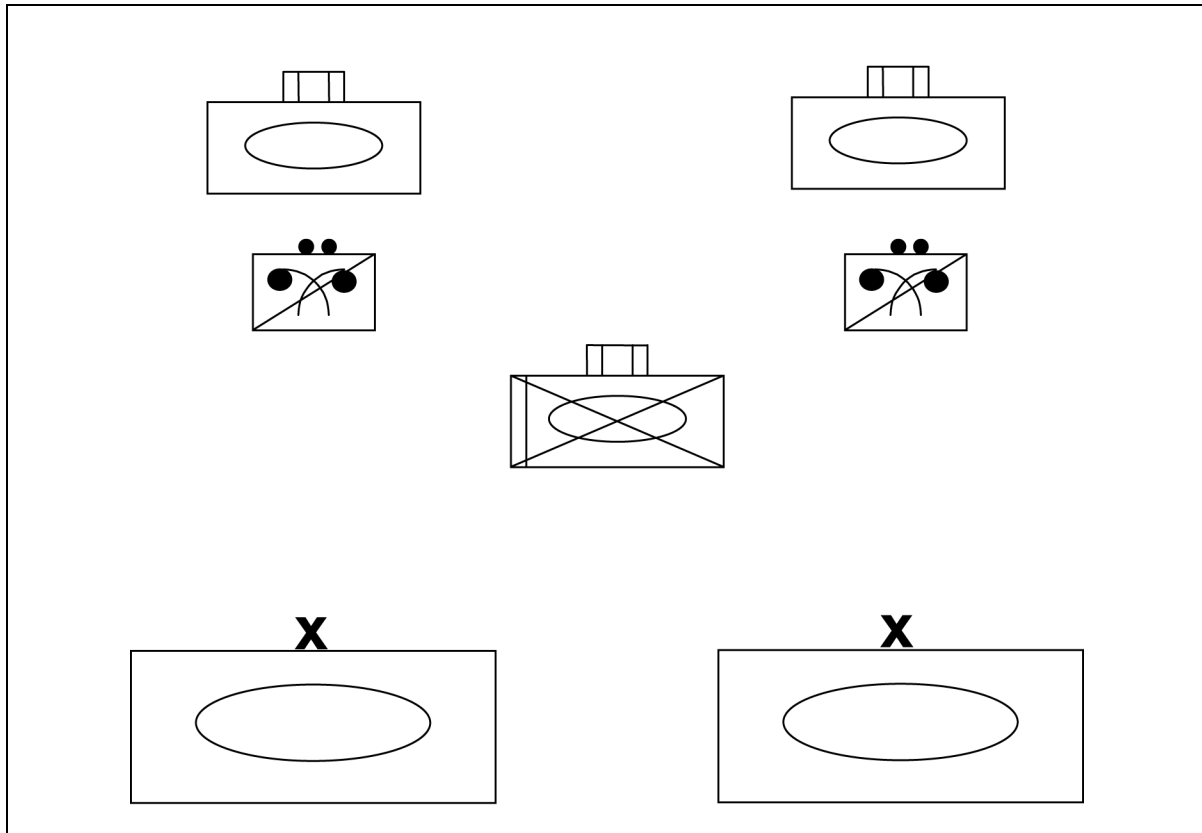

Figure III-3. Division Movement to Contact With a Brigade Advanced Guard

- Identify known or suspected areas of contamination.
- Focus NBC reconnaissance assets to retain freedom of maneuver.
- Give priority of NBC reconnaissance support to lead maneuver forces.
- Identify possible contaminated areas and possible bypass routes.

(b) *Figure III-4* shows a division conducting an attack. Elements of the supporting NBC reconnaissance unit are normally employed behind the lead element along the main axis of advance. This provides security for the unit and places it well forward to react to any contamination encountered by the lead TF. If contamination is encountered, the lead TF goes to MOPP 4 status and continues to attack and the NBC reconnaissance platoon finds bypasses around the contamination for the follow-on forces. A unit from the corps NBC company reinforces the division conducting the corps main attack by providing support along routes of reinforcement and main supply routes (MSRs). The corps NBC reconnaissance company employs its remaining assets in the same manner, but in support of the corps. The NBC reconnaissance platoon in the ACR responds to reports of contamination in its AO and in critical areas determined by the commander.

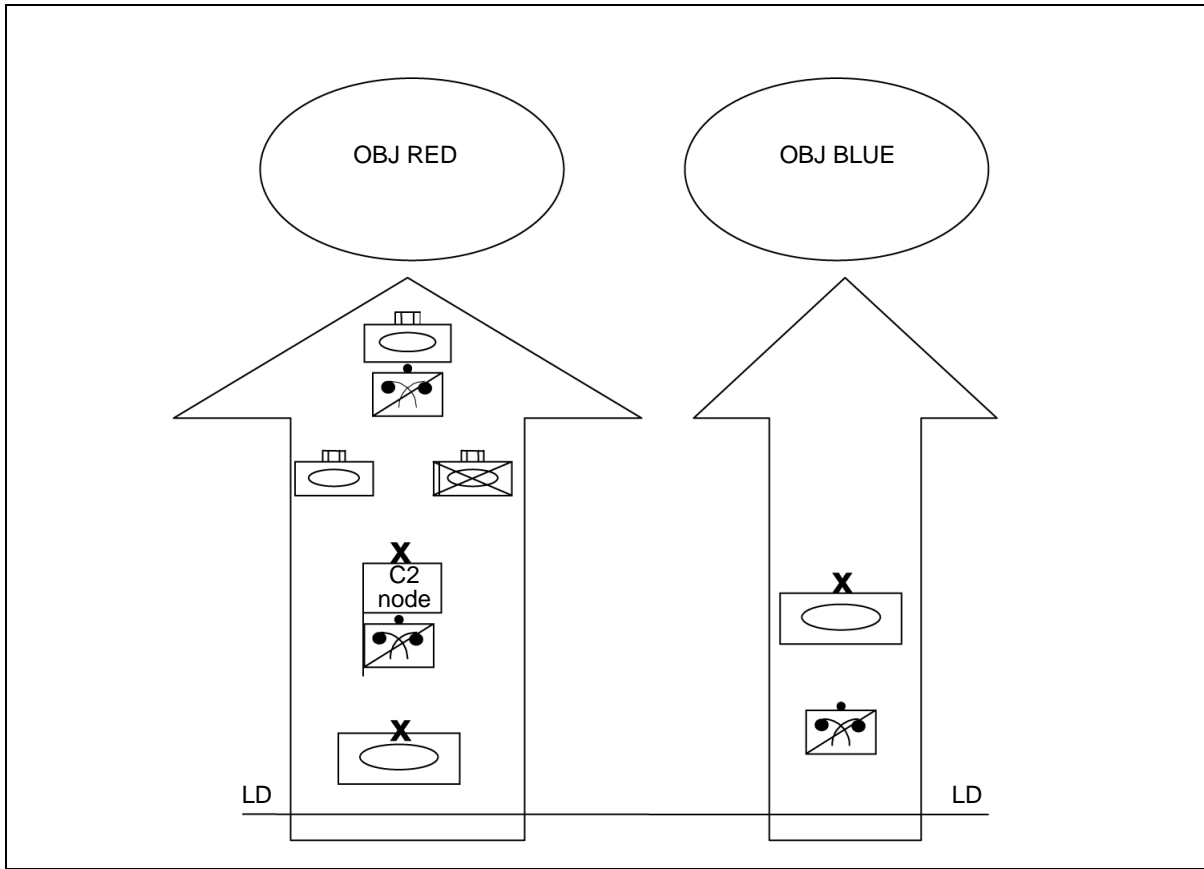

Figure III-4. Attack With Division as Corps Main Attack

(c) *Figure III-5*, page III-16, shows a battalion TF supported by an NBC reconnaissance squad that is attached to the TF scout platoon. The intelligence section and the NBC officer have templated a possible persistent chemical attack that could influence maneuver along the TF planned axis of advance. The NBC reconnaissance squad will confirm or deny the presence of contamination at the NAI. The main body of the scout platoon will cross the line of departure (LD) before the NBC reconnaissance squad. An armor platoon will be on standby to assist the NBC reconnaissance squad if it contacts enemy forces and cannot break contact. The scouts moving ahead of the NBC reconnaissance squad provide security for it.

(5) Exploitation and Pursuit Operations.

(a) Exploitation and pursuit operations usually follow a successful attack, and fleeing enemy forces may use chemical weapons more freely than an enemy executing a well-prepared defense. This will require the use of NBC reconnaissance units. The following operational factors are considered:

- Focus NBC reconnaissance operations to provide flexibility and speed to the commander.
- Ensure that NBC reconnaissance support is agile and flexible.
- Mark and report all identified areas of contamination, and control access to these areas.

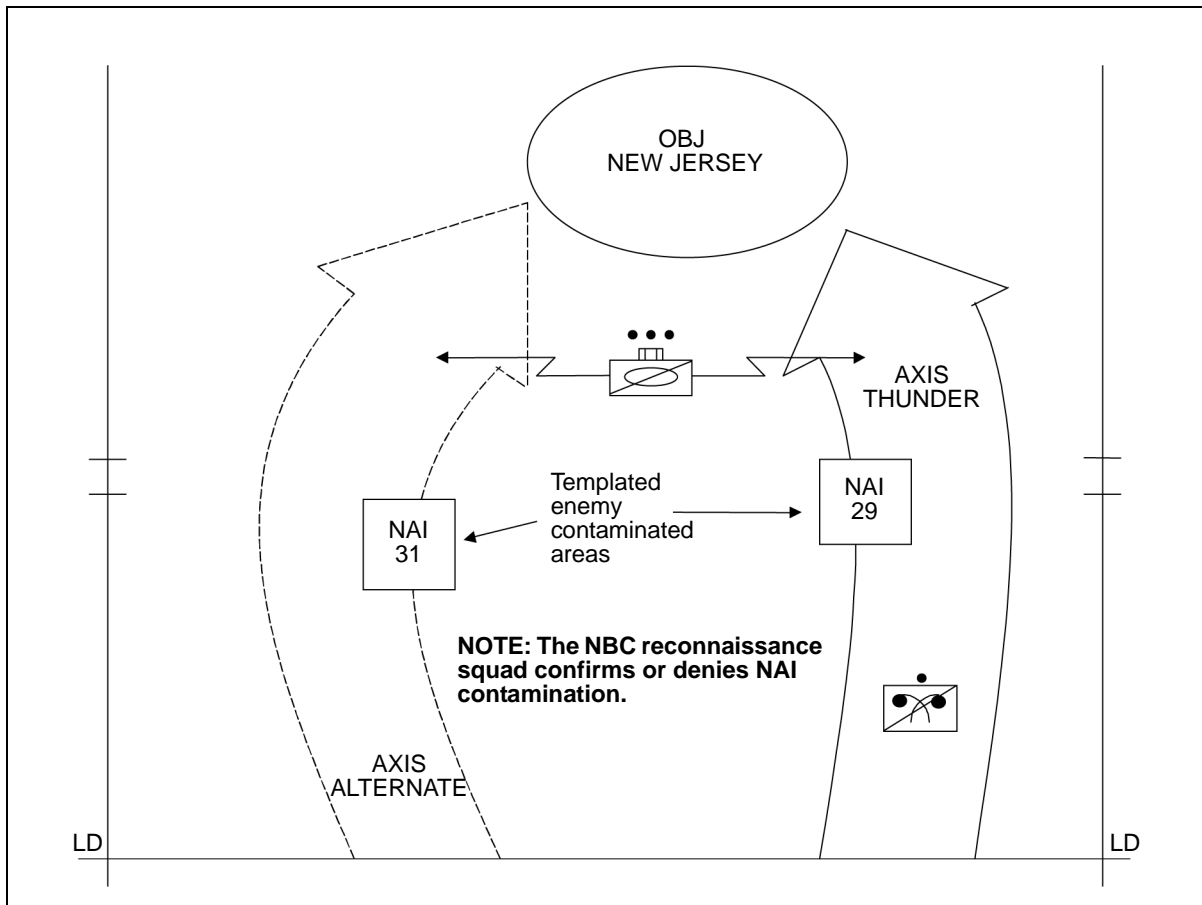

Figure III-5. NBC Reconnaissance Squad Supporting a Battalion TF

- Prepare to encounter enemy stockpiles of NBC weapons.
- Prepare to encounter the effects of destroying enemy NBC weapons stockpiles, facilities, and commercial chemical and nuclear facilities.
- Focus NBC reconnaissance assets to retain freedom of maneuver.
- Prioritize NBC reconnaissance support to lead maneuver forces.

(b) An adversary may use NBC weapons to slow or impede the pursuit force so that it can reorganize, reconstitute, and regain the initiative. For this reason, NBC reconnaissance assets can be placed just behind the lead TF to react to any contamination the pursuit force may encounter.

(6) River Crossing Operations.

(a) A river crossing may be conducted as part of an offensive action, and it presents a lucrative target for enemy NBC weapons. NBC reconnaissance units can be employed in a contamination avoidance role on the farside of the river to allow the momentum of the operation to continue. They are also prepared to respond to NBC attacks in the crossing areas. NBC reconnaissance elements need to be positioned to support the crossing sites and the routes to the crossing sites. They may also move with

the lead maneuver force across the river to find clear routes around contaminated areas on the farside. The following operational factors are considered:

- Focus NBC reconnaissance operations to provide flexibility and speed to the commander.
- Recognize the high probability of enemy NBC attacks.
- Focus NBC reconnaissance assets to retain freedom of maneuver in the crossing area.
- Prepare to shift NBC reconnaissance assets to the farside with the initial assault force.

(b) *Figure III-6* shows a regiment conducting a deliberate river crossing. The brigade is being supported by an NBC reconnaissance squad. The IPB has identified that the best time for the enemy to employ chemical weapons is when the bridges are across the river. This will slow the tempo of the crossing effort and allow enemy forces to reposition and possibly counterattack. The NBC reconnaissance unit has the primary mission of providing NBC reconnaissance on the bridging sites. If chemical weapons are used on a crossing site, the NBC reconnaissance unit will identify the agent and the extent of contamination. This information will allow the commander to make a decision to continue using the crossing site, shift all forces to the other crossing site, or initiate another crossing operation.

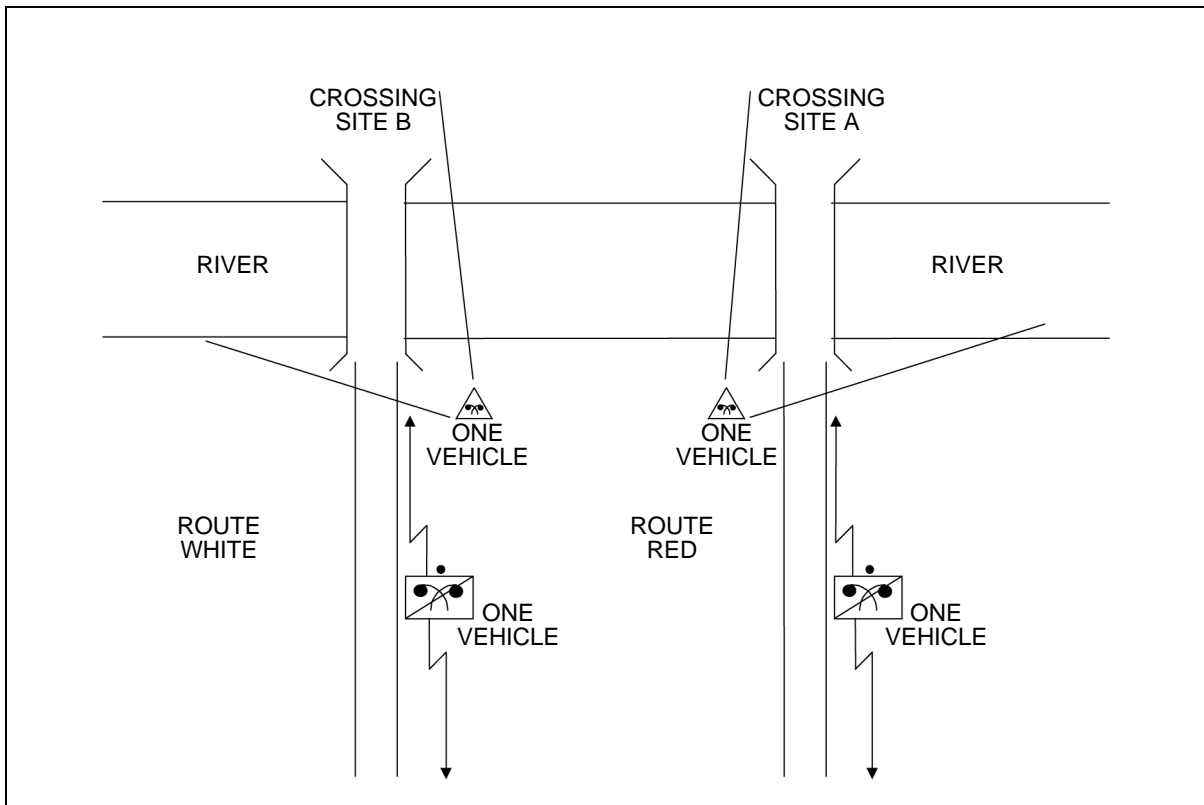

Figure III-6. NBC Reconnaissance Squad Supporting a River Crossing Operation

d. Land Component, Defensive Operations.

(1) The purpose of a defensive operation is to defeat enemy attacks. Defensive operations retain ground, gain time, deny the enemy access to an area, and damage or defeat attacking forces. NBC reconnaissance units are integrated throughout the depth of the battle area to provide flexibility to the security force commander and to enhance his agility. NBC reconnaissance units in the rear area help retain the freedom of maneuver and enhance the survivability of forces.

(2) The three types of defensive operations are mobile, area, and retrograde.

- **Mobile.** A mobile defense orients on the destruction of an enemy force by trading terrain to expose the enemy to a counterattacking mobile reserve.
- **Area.** An area defense focuses on denying the enemy access to designated terrain for a specified time, rather than focusing on the outright destruction of the enemy.
- **Retrograde.** A retrograde operation is a movement to the rear or away from the enemy.

(3) The main focus of NBC reconnaissance in the defense (*Figure III-7*) is to identify NBC hazards that could hinder maneuver and support forces and to decrease the survivability of the defending forces. By identifying and marking hazards, counterattacking or repositioning forces can avoid them. This allows the defender to gain time, concentrate forces elsewhere, control key or decisive terrain, and wear down enemy forces as a prelude to offensive operations. The overall goal is to improve the commander's ability to retain his initiative in operations where he could be facing a numerically superior force. The positioning of NBC reconnaissance units is critical for supporting defensive operations. For example, a division may use an assigned or attached NBC reconnaissance unit to support missions, such as—

- Performing route reconnaissance of MSRs.
- Confirming or denying NBC hazards in NAIs.
- Performing NBC reconnaissance as part of a quartering party.

(4) Close coordination with the supported unit is also necessary during defensive operations. NBC reconnaissance units operating forward of the supported unit's defensive positions must understand the unit's scheme for counterreconnaissance. This will reduce the possibility of fratricide. The NBC unit must coordinate all movements in the main defensive area to prevent losses to friendly minefields, obstacles, and counterreconnaissance efforts.

e. Land Component, Fixed-Site Operations.

NOTE: The NBC reconnaissance considerations addressed during fixed-site operations could impact all components.

(1) The ability to sustain combat operations in the joint rear area (JRA) is vital to operational success. If contaminated by attack, units identify clear areas and move along predesignated routes from contaminated areas in order.

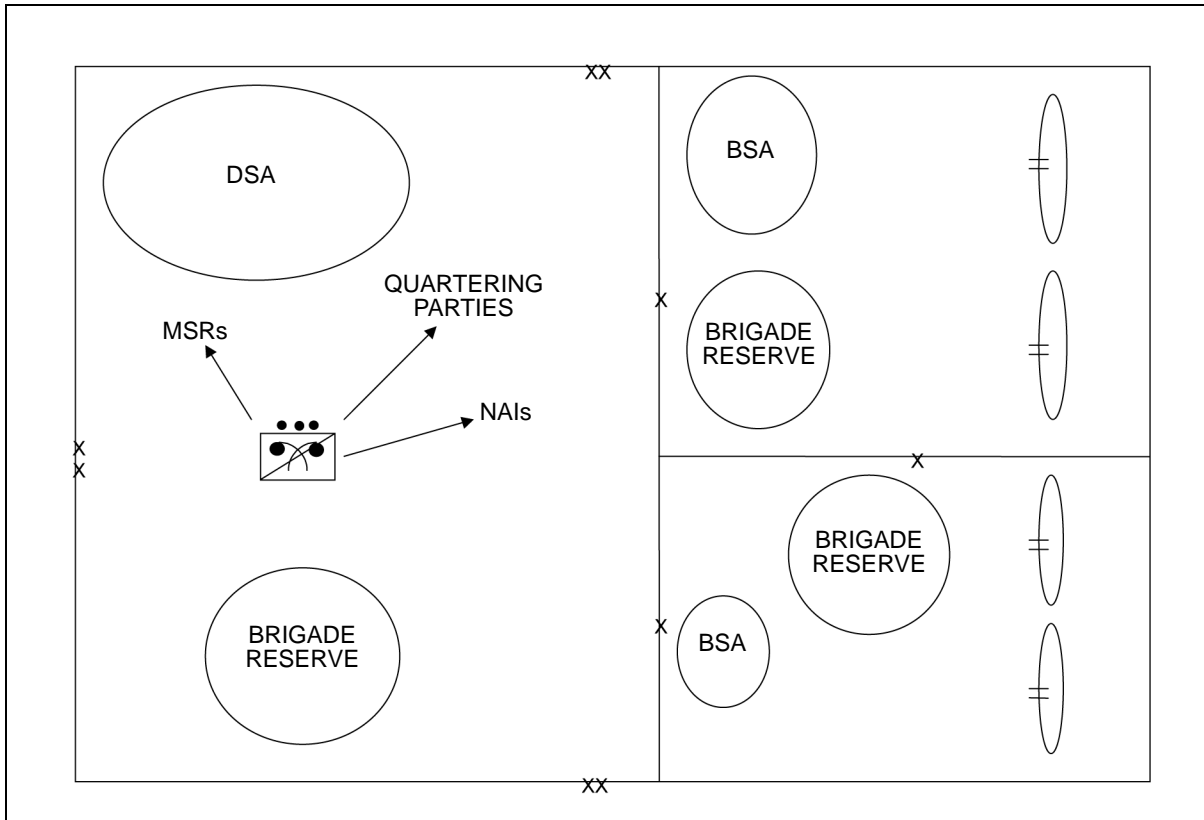

Figure III-7. NBC Reconnaissance Units Supporting a Defensive Operation

(2) Units in the JRA may fall within the range of adversary air and surface weapon delivery systems armed with NBC warheads; and an adversary may choose to use persistent agents on deep areas, fixed sites, MSRs, or flank areas. Industrial facilities subject to attack may also release TIM that could produce hazards to personnel.

(3) The areas of greatest vulnerability are large fixed sites (e.g., ports of debarkation [PODs]), staging and marshaling areas, hubs, bases, assembly areas, and MSRs adjacent to sites involved in early force buildup activities.

(4) NBC reconnaissance operations in the JRA are based on service and site requirements, but are coordinated with the joint rear area coordinator (JRAC) and base cluster commanders, when designated. One of the JRAC's responsibilities is NBC defense integration of reconnaissance assets. Component commanders will incorporate NBC reconnaissance plans into their area and base cluster defense plans. They will also position NBC reconnaissance assets to support current mission requirements and facilitate future operations according to directives and priorities of the joint force commander (JFC) and the area commander. Coordinated reconnaissance detection and marking are needed, and civilian workers should also be trained to conduct self-assessment activities to detect possible contamination in their work areas. However, a military unit trained and equipped to deal with NBC contamination will normally be necessary to support these surveys.

(5) APODs and en route fixed sites may also be targeted to disrupt or inhibit US military deployments. Because it is unlikely that all of the operational areas of an APOD will be contaminated at any one time, it is particularly important that the

commander know the location of hazard areas, the requirements for working and parking areas, and the availability of runways and taxiways.

(6) SPODs may also be attractive targets for NBC attack. NBC attacks may result in contamination of some operating surfaces, and the size of the contaminated area may be small compared to the size of the port. However, the capability to identify those areas and facilities within the port that escaped contamination is key to sustaining throughput operations.

(7) The vulnerability of MSRs to NBC attacks can also have an adverse impact if there are few major MSRs, limited alternative routes, and limited off-road capability. NBC reconnaissance units will be employed in rear areas at critical points, such as APODs and MSRs. NBC reconnaissance assets play a significant role by locating, marking, and finding bypasses around contaminated areas to ensure continuous support.

(8) In rear areas, NBC reconnaissance units also respond to reports of NBC attacks to determine the type and extent of contamination. NBC reconnaissance units may also be assigned NBC search and surveillance missions to observe designated areas for NBC attacks. MSRs and areas to be occupied by logistics and C2 facilities may also be checked for NBC hazards before their occupation (*Figure III-8*).

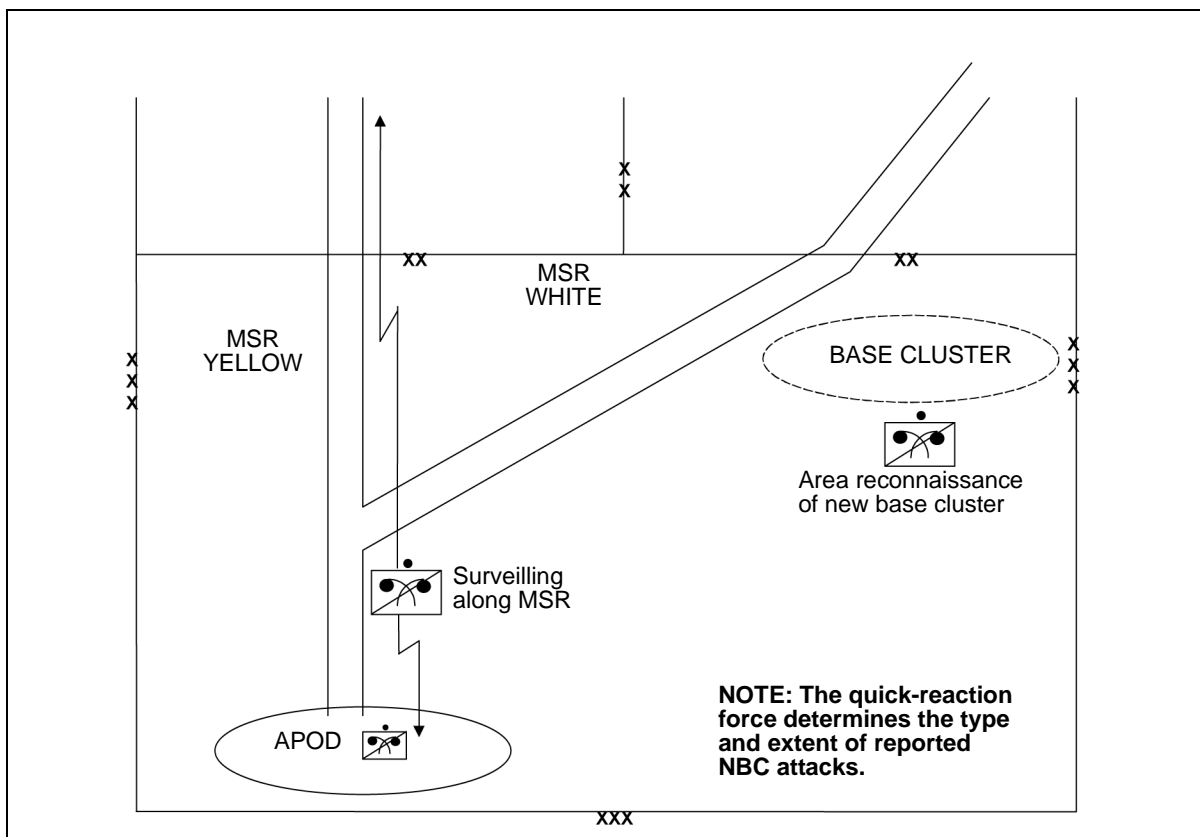

Figure III-8. NBC Reconnaissance Units Supporting Rear Area Operations

(9) The JRAC develops and coordinates missions for NBC reconnaissance units in the JRA. The NBC center associated with the JRAC commits NBC reconnaissance assets based on priorities that the commander establishes. NBC reconnaissance units provide support to the affected bases and base clusters, and those supporting the JRA must also expect to operate with other services and the HN (*Figure III-9*).

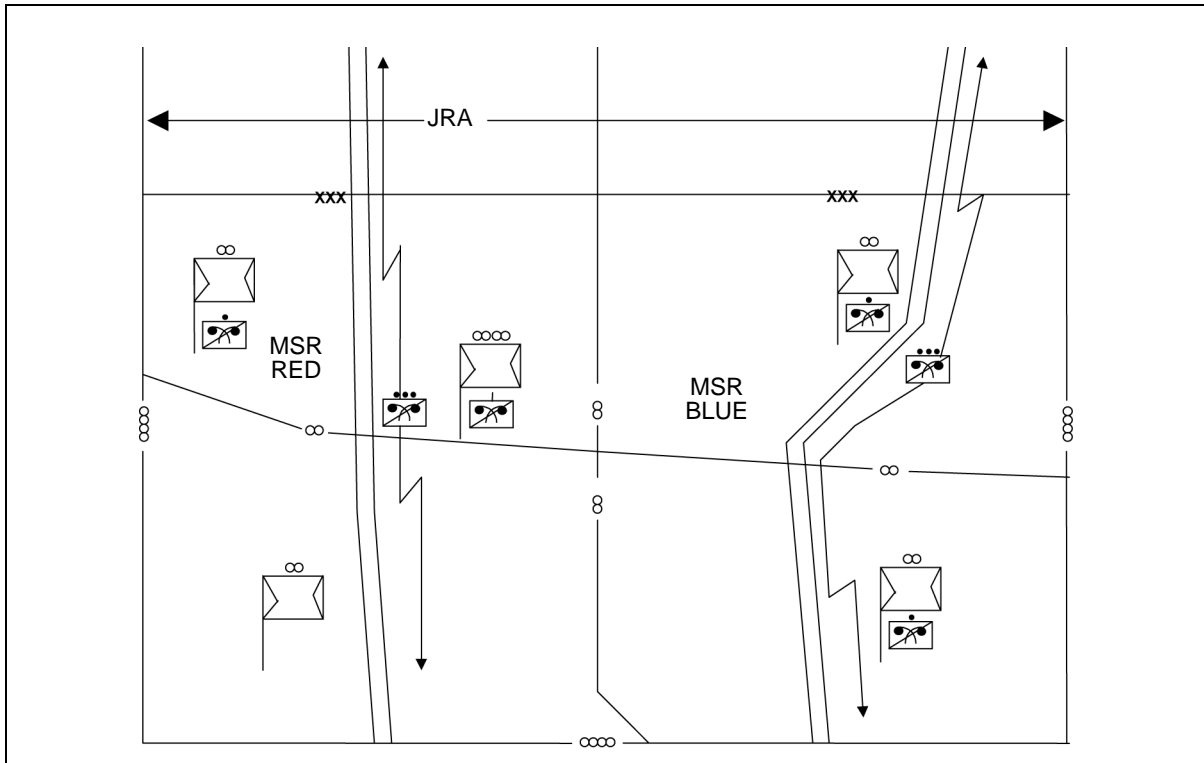

Figure III-9. NBC Reconnaissance Operations in the Corps Theater Rear Area

f. Forcible-Entry Operations.

(1) A forcible entry is an offensive operation for seizing and holding a military lodgment in the face of armed opposition. There are three types of forcible-entry operations—air, parachute, and amphibious assaults. The Army specializes in parachute and air assaults. The USMC specializes in amphibious assaults and usually conducts air assaults as part of an amphibious operation. Air and parachute assaults permit JFCs to introduce combat power very quickly.

(2) Forcible-entry operations are complex, and they are normally joint operations. Often, only hours separate alert and deployment. Operations are carefully planned and rehearsed at training and marshaling areas. Joint and service commanders carefully balance C2, combat, combat support (CS) (including NBC reconnaissance), and combat service support (CSS) assets to quickly obtain the maximum combat power.

(3) Enemies possess the motives and means to interrupt the deployment flow. Threats to deploying forces may include advanced conventional weaponry, NBC weapons, or TIM. NBC reconnaissance assets would be very useful at APODs and SPODs. They are particularly vulnerable targets since they are the entry points for forces and equipment. POD operations involve relatively soft targets. In addition to the

presence of military forces and material, HN support personnel, contractors, and civilians may be working there. Many of these lucrative targets are within the range of enemy forces. A successful attack on a POD can have a major impact on force projection momentum. Commanders at all levels focus attention on security actions (such as NBC reconnaissance) that can help reduce vulnerabilities. To avoid threats to entry operations, the force may operate through intermediate staging bases.

g. Nonlinear Operations. Nonlinear operations are now more common than ever. Operation Just Cause and the last 36 hours of Operation Desert Storm featured large-scale, nonlinear operations.

(1) In nonlinear operations, maneuver units may operate in noncontiguous areas throughout the AO. Even when operating in contiguous AOs, maneuver forces may orient on objectives without geographic reference to adjacent forces. Mobile NBC reconnaissance assets are essential to enable the identification of clean bypass routes so that the force can maintain the required mobility. Nonlinear operations typically focus on multiple decisive points. LOCs often diverge from lines of operation, and sustaining operations may depend on the use of NBC reconnaissance assets with standoff detection capabilities.

(2) Nonlinear and linear operations are not mutually exclusive. Depending on the perspective and the echelon, operations are often combined. For example, a corps may employ its forces in noncontiguous areas, operating simultaneously against multiple decisive points. A brigade combat team in the same corps, operating within an urban area, may employ units in a linear array.

6. Conflict Termination

Conflict termination generally results in the end of hostilities; however, the presence of NBC or TIM can still present a volatile situation. During conflict termination, the following tasks will likely integrate NBC reconnaissance capabilities:

- IPB.
- Force protection (FP).
- Decontamination and mitigation of residual hazards.
- Control and recovery of adversary NBC capabilities.
- Coordination with nonmilitary entities.
- Health service support (HSS).
- Accurate record keeping.
- Contaminated material retrograde.

a. IPB. Intelligence collection and analysis continue to be focused on adversary NBC capabilities and provide for surveillance of adversary NBC assets (e.g., known or suspected NBC capabilities that have yet to be captured or destroyed).

b. FP. Units maintain NBC detection capabilities to help deter and mitigate the possible effects of NBC attacks. An adversary's armed forces or terrorists may still seek to strike (CONUS/OCONUS) during the reduction in US force levels.

c. Decontamination and Mitigation of Residual Hazards. Commander maintenance of SA enables rapid identification of those areas that are contamination hazards. Containment and mitigation actions previously taken are assessed to determine whether follow-on actions (e.g., low-level monitoring, weathering, isolation, containerization) should be conducted. Operations may require the application of specialized NBC detection assets having detection capabilities that exceed (e.g., lower detection thresholds) those found in most military units. These activities may require intensive coordination and cooperation with multinational forces, HN civil authorities, and other US Government (USG) agencies that offer specialized capabilities and skills. The commander will determine when emergency or routine equipment retrograde procedures will be undertaken. This command decision entails accepting higher contamination risk when warranted by immediate (emergency) mission requirements.

d. Control and Recovery of Adversary NBC Capabilities. As a commander considers NBC-related objectives associated with disabling or destroying NBC capabilities, planning provides NBC detection capabilities to monitor and survey designated areas. Recovery, search, identification, and control plans include NBC specialists for monitoring and survey operations as required.

e. Coordination With Nonmilitary Entities. Nonmilitary international organizations, nongovernmental organizations (NGOs), and private volunteer organizations could play significant roles during conflict termination to help activities, such as NBC detection and management of contamination hazards. For example, these organizations could be a source of information on possible contaminated areas, local populace experiencing suspected agent symptoms, or other data that could support unit NBC defense IR.

f. HSS. During termination, HSS includes continuing medical surveillance, providing selected health and medical care, and monitoring individual exposure as part of the required record-keeping process.

g. Accurate Record Keeping. During conflict termination, the commander addresses two areas—documenting lessons learned and identifying *after-operation follow-up*. Summaries may be prepared that outline when, where, and how NBC attacks or TIM incidents occurred. Accurate record keeping also addresses the monitoring of incidents involving personnel for long-term health problems that could be operational-related.

h. Contaminated Material Retrograde.

(1) Goals for contaminated material retrograde from the theater are mission support, forces and resource protection from NBC hazards, and contamination control. To assist with requirements for contaminated material retrograde, the JRAC may organize a support TF to accomplish tasks from marking equipment to monitoring contamination. Personnel safety is of foremost concern during the retrograde of equipment with potential, residual, or low-level NBC contamination. Services and other responsible military agencies must develop and implement specific precautionary procedures for handling and transporting their equipment. Any equipment present in the attack or downwind hazard areas may possess residual contamination. NBC detectors (such as the improved CAM) with sensitivities that exceed those found in most military units may be required at specified sites in the JRA to monitor for residual contamination.

(2) Personnel assisting the JRAC with detection, monitoring, and preparation of equipment will require stringent personal protection and specialized detectors. These preparations may require continuous operations for weeks or months. As suspect equipment is consolidated for monitoring, decontamination, and weathering, security and buffer zones around the consolidation site provide additional contamination control measures to protect US and multinational forces and HN personnel. Ships requiring depot level chemical and radiological decontamination at a shipyard will proceed en route as operations permit.

(3) Air quality control and related legal requirements are additional considerations requiring legal advice and review before equipment retrograde. Once in CONUS, precautionary measures continue throughout the remaining equipment life cycle, including DOD control requirements, pre-maintenance monitoring, and other periodic monitoring.

Chapter IV

PLANNING

1. Background

NBC reconnaissance planning follows the MDMP, with increased emphasis on IPB and the development of PIR. The NBC reconnaissance plan provides guidance by assigning missions and priorities to answer the commander's PIR. The IPB and PIR determine what the commander wants or needs to know about the enemy (to include NBC capabilities), the enemy's purpose, and terrain and weather considerations. The IPB process also supports determining and assessing the capabilities of the unit or adjacent friendly units.

2. Levels

a. Tactical Planning. Tactical planning concentrates on NBC reconnaissance capabilities of organic, supporting, and adjacent units. It also focuses on the size and location of the battlespace within the AO. See *Appendixes B* and *C* for a standing operating procedure (SOP) outline and an NBC reconnaissance operations checklist, respectively, which are tools that support tactical planning.

b. Operational Planning. Operational planning focuses on NBC reconnaissance capabilities to support air, maritime, and ground operations. IPB evaluates the adversary's capabilities and assesses what detection assets may be required to mitigate identified vulnerabilities and capabilities. For example, adjusting the TPFDL may be necessary to add technical escort units (TEUs), theater area medical laboratories, Navy forward deployable PVNTMED units, or other biological detection units.

c. Strategic Planning. Strategic planning prioritizes and provides required assets (i.e., NBC reconnaissance units, detection equipment) to support missions within CONUS and OCONUS. Applicable strategic level intelligence information is also furnished to provide timely and effective IPB.

3. Concept

NBC reconnaissance planning balances multiple considerations, including the threat, the battlespace environment, available systems and resources, risk assessments, and the commander's guidance. By maximizing the effect of the overlapping factors contributing to NBC reconnaissance, a synergy is established. This synergy drives the effective probability of mission success, ensures that the operational concept is executable, and ensures that the NBC reconnaissance plan is logistically supportable. The concept of NBC reconnaissance is presented in *Figure IV-1*, page IV-2.

4. Military Decision-Making Process

The MDMP is a process that can result in the generation and approval of operation plans (OPLANs) and operation orders (OPORDs) to support NBC reconnaissance. The MDMP steps used to develop an NBC reconnaissance plan include—

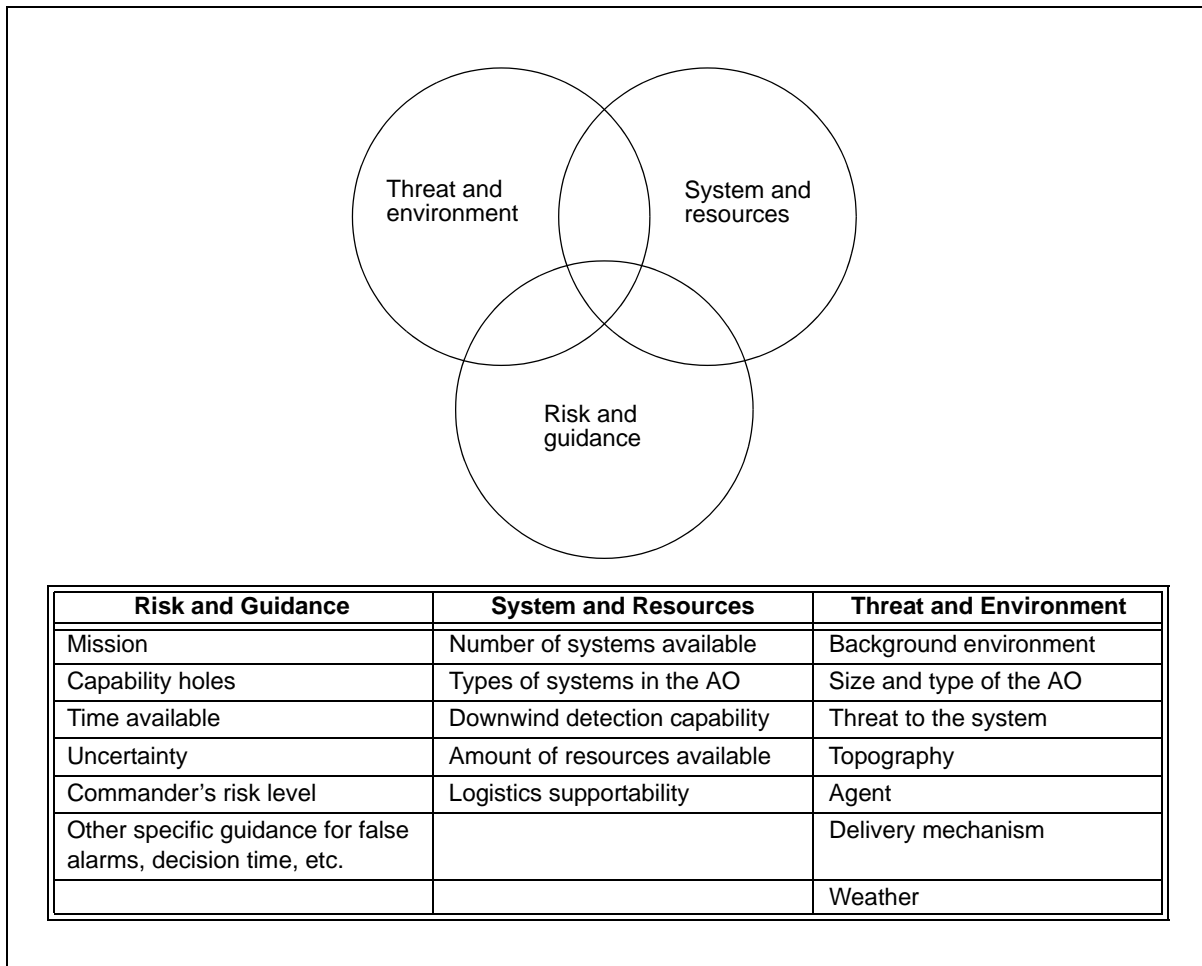

Figure IV-1. Concept of NBC Reconnaissance

- Mission receipt.
 - Mission analysis.
 - COA development.
 - COA analysis (war gaming).
 - COA comparison.
 - COA approval.
 - Orders preparation.
- a. **Mission Receipt.** During this phase of the MDMP, the commander issues initial guidance on the NBC reconnaissance. This is communicated to NBC reconnaissance assets through a warning order (WARNORD) issued by the operations section. The NBC staff provides input for the WARNORD.
 - b. **Mission Analysis.**
 - (1) During the mission analysis phase, the commander and the NBC staff—

- Analyze the higher headquarters order for NBC reconnaissance guidance.
- Conduct an initial NBC IPB (see *Appendix D*).
- Determine specified, implied, and essential tasks for NBC reconnaissance.
- Review available NBC reconnaissance assets.
- Determine constraints.
- Identify critical facts and assumptions.
- Conduct an NBC risk assessment and vulnerability analysis.
- Determine NBC-related CCIR.
- Develop the initial NBC reconnaissance annex.
- Plan the use of available time.
- Write the restated mission.
- Conduct a mission analysis briefing.
- Approve the restated mission.
- Develop the commander's intent for NBC reconnaissance.
- Issue the commander's guidance for NBC reconnaissance.
- Issue a WARNORD.
- Review the facts and assumptions.

(2) During mission analysis, the commander may identify NBC CCIR and PIR that are critical to SA. This could change his assessment of the battlespace and affect his plan (e.g., identifying contaminated movement routes, determining if the enemy has NBC weapons in range). It may also lead to the issuance of an NBC reconnaissance fragmentary order (FRAGORD) by the operations section for NBC reconnaissance assets to collect information to support NBC CCIR and PIR. For example, the FRAGORD may direct NBC reconnaissance assets to confirm or deny the presence of contamination.

(3) Based on the initial IPB and CCIR and PIR guidance from the commander, the staff (NBC, medical, and intelligence sections) identifies gaps in the available NBC intelligence. An initial NBC reconnaissance plan to acquire information based on available NBC reconnaissance assets is developed. The operations section approves the initial NBC reconnaissance annex ordering NBC reconnaissance assets to begin their collection effort. This initial NBC reconnaissance annex should contain, as a minimum—

- Location of the AO for NBC reconnaissance.
- Mission statement.
- Task organization.
- NBC reconnaissance objective.
- NBC PIR and IR and the initial NBC NAIs.

- LD and line of contact times.
- Routes to and through the AO and the instructions for the passage of lines.
- Communications, NBC warning and reporting system, and logistics support.
- Fire support measures.
- HSS.
- Sample evacuation plans (see *Appendix E*).
- Other NBC support required (i.e. decontamination, escort, medical laboratories).

(4) The NBC reconnaissance annex initiates NBC reconnaissance collection actions. As more information becomes available, it is incorporated into updates for the NBC reconnaissance annex of the OPORD. *Figure IV-2* shows the OPORD annex format and contains suggested items for inclusion. As NBC reconnaissance assets collect information and other NBC intelligence sources fill information gaps, the taskings to NBC reconnaissance assets are updated to reflect new or revised CCIR and PIR.

c. COA Development.

(1) After receiving guidance, the staff develops COAs for analysis and comparison. During this phase, the NBC staff further refines development of the NBC reconnaissance plan for support of each COA being developed. The annex also indicates what support is required for the NBC reconnaissance effort. The plan is adjusted based on any reports from NBC reconnaissance operations in progress. The NBC reconnaissance plan is integrated into the unit ISR plan to ensure visibility and unity of effort for each COA.

(2) During the development of COAs, the NBC staff (primary and additional duty personnel) is aware of the capabilities of the unit organic NBC reconnaissance assets and the supporting specialized NBC reconnaissance unit assets (see *Appendix F*). The following actions should be considered when preparing COAs for NBC reconnaissance operations, whether using supporting NBC reconnaissance assets or an organic unit:

- Identify AOIs for NBC ISR.
- Coordinate with organic, subordinate, and supporting NBC reconnaissance assets.
- Pre-position NBC reconnaissance assets to support requirements.
- Assess the time and distance factors associated with movement formations (see *Appendix G*) and surveillance techniques (see *Appendix H*) for conducting NBC reconnaissance.
- Orient the mission execution to provide timely notification of critical information to support tactical decisions.
- Orient the NBC reconnaissance on the presence or absence of NBC contamination in AOIs.

ANNEX X (NBC RECONNAISSANCE) TO OPORD _____

1. SITUATION.
 - a. CCIR (PIR, friendly force information requirements, and EEFI).
 - b. IPB outputs related to NBC reconnaissance (NAIs, TAIs, vulnerability, risk).
2. MISSION (search; survey; surveillance; sample; or route, zone, or area reconnaissance).
3. EXECUTION.
 - a. Scheme of support. State the overall NBC reconnaissance objective and plan, including tasks and purposes. Detail how NBC reconnaissance assets operate in relation to the rest of the force. State the method that NBC reconnaissance forces will use to get to the assigned area (passage through friendly forces, infiltration, penetration of enemy security zone, passage of lines). (Refer to the NBC reconnaissance overlay.)
 - b. Tasks to subordinate units. Each task to a subordinate NBC reconnaissance asset must include the following:
 - How the unit will get to its assigned area (routes, passage points).
 - The NBC reconnaissance objective for the unit.
 - Specific NBC collection tasks (PIR with indicators) and where to conduct reconnaissance (NAIs) as identified in the NBC reconnaissance plan matrix. State when to conduct the NBC reconnaissance operation and when the information is needed.
 - c. Coordinating instructions. Include the following:
 - MOPP level guidance.
 - Automatic masking criteria.
 - Troop safety criteria.
 - Locations of linkup points for decontamination sites.
 - Locations of medical facilities for treating NBC casualties.
 - Designated turn-in point and procedures for handling NBC samples.
 - Civilian and military facilities whose destruction could create significant NBC or TIM hazards.
 - Operational exposure guidance, if applicable.
 - Procedures for limiting EMP effects.
 - Identification of designated observer units.
 - Identification of procedures for providing support to local populations.
4. SERVICE SUPPORT. Include the following:
 - Decontamination support.
 - Medical support.
 - Prophylaxis and treatments.
 - Laboratory analysis for samples.
 - Medical evacuation.
 - Technical escort of samples.
 - CLS.
 - Maintenance support.
 - PPE, chemical defense equipment, and resupply after decontamination.
 - Aviation support (standoff detection and aerial surveys).
 - Mortuary affairs and disposition of contaminated remains.
5. COMMAND AND SIGNAL.
 - a. Command (centralized versus decentralized).
 - b. Signal.
 - Who to report collected NBC information to and by what means.
 - The retransmission plan to support the operation.
 - NBC warning and reporting system.

Figure IV-2. NBC Reconnaissance OPORD Annex

- Plan the resupply (logistics) activities to sustain NBC reconnaissance operations.
- Determine the possible locations for after-mission decontamination.
- Plan security to protect NBC reconnaissance assets.
- Determine the rules of engagement (ROE) to prevent fratricide.
- Plan to deploy and integrate automatic detection, identification, and warning systems with individual detection and identification equipment. Ensure maximum coverage of critical areas with automatic systems. Rely on manual systems to expand or back up the coverage.
- Use operational exposure guidance (OEG) to support radiological search and survey guidance (see *Appendix D*).
- Plan to use the data provided by the fielded detectors and the primary or additional NBC staff to determine the unit status. The actual presence or absence of contamination should be confirmed by multiple detection systems. The following indicators could be included in unit SOPs to determine the presence or absence of contamination:
 - Agent symptoms in personnel and wildlife. (Some chemical agents manifest themselves several hours after an attack; some biological agents manifest themselves several days or weeks after an attack.)
 - Tactics and weapon systems used in the attack.
 - The presence of suspicious clouds, vapors, powders, or liquids.
 - Intelligence data supporting the likely or actual use of CB agents in theater.
 - Reports from personnel, teams, and automatic systems.
- Plan to request specialized assets (such as NBC reconnaissance teams, damage assessment and response teams, and contamination control teams) to verify initial positive indications, identify agents, and survey unmonitored areas.
- Establish command or support relationships to ensure responsiveness and flexibility when using a supporting NBC reconnaissance unit.

d. COA Analysis (War Gaming). During this phase, the staff *war-games* the COAs they have developed. The staff evaluates each COA, revises the NBC reconnaissance plan, adjusts the CCIR and PIR, identifies missions for subordinate units, defines the task organization, prepares staff estimates and products, and develops matrices/sketches to support the COAs. Logistics considerations, the NBC warning and reporting system structure (e.g., decentralized or centralized reporting, communications resources designated for use), and sample evacuation plans for NBC reconnaissance are further developed and war-gamed for each COA.

e. COA Comparison. The COA comparison is conducted by establishing criteria, war-gaming results, and developing a decision matrix. At the end of this phase, a decision briefing is given.

f. COA Approval. After the decision briefing, the commander decides on the COA he believes to be the most advantageous. Once the commander has selected a COA, he may refine his intent statement, CCIR, and PIR to support the selected COA. He then issues any additional guidance on priorities for CS or CSS activities (particularly for NBC reconnaissance resources he needs to preserve his freedom of action), orders preparation, rehearsals, and mission execution.

g. Orders Preparation. Based on the commander's decision and final guidance on NBC reconnaissance, the NBC staff refines the COA and completes the NBC reconnaissance annex to the OPLAN. The NBC staff prepares its portion of the order to implement the selected COA by turning it into a clear, concise concept of NBC reconnaissance operations that supports the commander's intent. The COA sketch can become the basis for the NBC reconnaissance operation overlay. OPORDs and OPLANs provide all the necessary information that subordinates require for execution of the NBC reconnaissance plan, but without unnecessary constraints that would inhibit subordinate initiative. The NBC staff also assists subordinate staffs as needed with their NBC reconnaissance planning and coordination.

Chapter V

CAPABILITIES

1. Background

a. This chapter focuses on the NBC reconnaissance organizations, capabilities, and equipment. All service components possess organic NBC reconnaissance, and other organizations are available within each component to support specialized NBC reconnaissance requirements. *Appendix F* provides more information on unit level NBC reconnaissance equipment and service capabilities.

b. The armed forces of the US must be prepared to conduct prompt, sustained, and decisive combat operations in NBC environments. Each service and its functional components have the capability to operate in an NBC environment. Inherent in this effort is the need for up-to-date information on adversary NBC capability and employment. This information is obtained through NBC reconnaissance efforts.

c. NBC reconnaissance is a multiechelon process that begins at the national level and ranges down to include the alert watchfulness of each individual. Operationally, NBC reconnaissance focuses on providing key information to support the commander's SA. Tactically, NBC reconnaissance is a routine part of conventional land or maritime operations.

2. Equipment Capabilities

a. USAF, USN, USMC, and USA units have organic capabilities for conducting NBC reconnaissance. Most units can detect selected chemical-agent liquid and vapors and gamma and beta radiation. Capabilities available to most military units include—

- **ACAA.**
 - M8A1-series point alarm detects nerve-agent vapors.
 - M22 alarm detects nerve and blister agents.
 - M90 automatic agent detector detects nerve- and blister-agent vapors.
 - Maritime chemical-agent point detection system detects nerve agents.
 - Improved chemical-agent point detection system detects nerve and blister agents.
- **Improved CAM.** This point monitor detects nerve- and blister-agent vapors.
- **Chemical-agent detection paper.**
 - M8 detector paper detects liquid nerve (types G and V) and blister (type H) agents.
 - M9 detector paper provides nonspecific detection for nerve and blister agents.
- **M256A1 chemical-agent detector.** This portable, disposable detection kit detects nerve-, blood-, and blister-agent vapors.

- **Dosimeter.** This device provides a total absorbed dose for radiation exposure.
- **Radiac sets.** These devices (such as the AN/VDR-2, a portable radiac instrument) are used for area surveys and personnel monitoring.
- **M272 chemical-agent water testing kit.** The M272 detects cyanide, mustard, lewisite, and nerve agents when present in concentrations greater than the short-term or emergency limit.
- **NBCRS and NBC reconnaissance vehicle (NBCRV).** These systems can detect a wide variety of chemical agents and radiation. The NBCRS can conduct point biological-agent detection and point and standoff chemical detection.

b. NBC reconnaissance units can operate in CONUS and OCONUS during all phases of operations. They are integrated into the overall ISR plans; their efforts must be focused by the IPB and the commander's PIR and IR. Service NBC reconnaissance assets can provide additional or specialized capabilities that support requirements of other components.

NOTE: See Appendix F for details on special support units and assets for NBC reconnaissance.

3. United States Army

a. Allocation. The numbers, types, and locations of NBC units and headquarters depend on the operational situation. The allocation of some NBC assets is theater-dependent. Exact numbers of NBC units in a specific AO may vary because of the theater-specific differences in NBC support requirements. NBC support requirements are based on the priorities established by the commander. Those requirements must be identified in OPLANs to ensure that NBC support is incorporated into the TPFDL.

b. Division Area. Some infantry divisions still retain an organic NBC defense company. Most mechanized and armored divisions do not have an organic NBC defense company; however, they do retain NBC reconnaissance platoons. For additional NBC reconnaissance support, the division relies on corps augmentation. Light infantry divisions do not have an organic NBC company; they rely on corps augmentation for NBC reconnaissance. Separate brigades have an NBC platoon (smoke/decontamination/reconnaissance) in the brigade headquarters and headquarters company (HHC).

NOTE: Mechanized and armored divisions are in a transition period; their organic NBC defense companies are being moved to echelons above division.

c. Corps Area. The corps has an assigned NBC brigade, and the numbers and types of NBC units assigned to the brigade depend on the corps mission and its organization. This brigade is a mix of NBC reconnaissance, mechanized smoke, smoke/decontamination, reconnaissance/decontamination, and biological detection units beyond those that are organic to the division. It allows the corps commander to send additional resources where they are needed. The planning allocation for a corps NBC brigade, which includes NBC reconnaissance and C2 assets, is as follows:

- A brigade headquarters and headquarters detachment (HHD).
- One NBC reconnaissance company and one NBC reconnaissance/decontamination company per light ACR and SPOD.

- Two or more NBC battalion headquarters to provide C2 for assigned companies.
- One biological detection company, which operates directly under the NBC brigade.

d. Communications Zone (COMMZ). A JRA is not a safe haven from combat operations because enemy force capabilities may present a significant NBC threat. The COMMZ has assets (such as a biological point detection capability [i.e., portal shield]) to monitor for and identify biological agents (see *Appendix F*). The planning allocation for the COMMZ NBC brigade, which includes NBC reconnaissance and C2 capabilities, is as follows:

- A brigade HHD.
- Two or more NBC battalion headquarters to provide C2 for assigned companies.
- One biological detection company.
- One NBC reconnaissance company.
- One NBC reconnaissance/decontamination company (one per SPOD).

NOTE: See *Appendix J* for details on USA NBC reconnaissance tactics, techniques, and procedures (TTP).

4. United States Marine Corps

a. Individual Units. USMC unit capabilities are based on unit equipment and training in NBC detection, protection, and decontamination operations. USMC units have organic NBC personnel and equipment within each organization, down to the battalion and squadron levels. NBC personnel provide training and operational support for NBC defense. The personnel-intensive tasks (such as NBC reconnaissance operations) are performed by additional duty marines from within the unit. The USMC typically uses the same NBC defense equipment as other services. NBC reconnaissance teams consist of two or three marines, down to the company and squadron levels. These NBC reconnaissance teams can detect and locate most NBC hazards and provide unit commanders with information about where contamination may or may not be present. Collected data is forwarded to higher headquarters via communications nets (e.g., radio, digital nets, and the joint warning and reporting network). If more information is required, detailed surveys can be conducted.

b. Structured NBC Defense Units.

(1) NBC Reconnaissance Platoons. These platoons are equipped with the M93A1 or the joint-service, lightweight NBCRS. The M93A1 NBC reconnaissance platoons are currently located within each USMC division, are attached to the light armor reconnaissance battalion, and provide the commander with a mobile platform to conduct NBC reconnaissance. The joint-service, lightweight NBCRS is assigned to the Marine division and force service support groups to provide improved detection.

(a) In the forward combat area, the joint-service, lightweight NBCRS (light armored vehicle [LAV]) will be integrated into the overall ISR effort to confirm or deny contaminated areas in support of combat operations. It supports the forward-deployed combat elements through all phases of force projection and may be

employed with, or independent of, other LAVs required to support the scheme of maneuver.

(b) The joint-service, lightweight NBCRS (high-mobility, multipurpose wheeled vehicle [HMMWV]) will be used in the rear areas to monitor MSRs, logistics bases, airfields, ports, and key C2 centers for NBC hazards. It may be employed to support military operations other than war (MOOTW) when forces are operating near industrial areas that pose a TIM threat and in response to, or to mitigate, an NBC or TIM terrorist threat.

(2) Chemical-Biological Incident Response Force (CBIRF). Comprised of about 350 marines and sailors, the unit can provide NBC reconnaissance, personnel and casualty decontamination, medical support, and expert advice through the Electronic Reach-Back Advisory Group. This group is an organization chartered to assist with the development, training, and operations of the CBIRF; and it is comprised of nationally and internationally recognized civilian experts in science and medicine. The CBIRF has state-of-the-art monitoring and detection equipment for identifying, sampling, and analyzing NBC hazards, including TIM. It is self-contained, self-sufficient, and rapidly deployable worldwide. (*Appendix F* includes additional information on the CBIRF.)

5. United States Air Force

a. Reconnaissance Forces. USAF NBC reconnaissance forces are structured to support AB survivability and operations. Each AB civil engineering (CE) squadron contains a readiness flight (office symbol CEX). This flight is the focal point for nonmedical NBC defense. CE readiness flight personnel are NBC technicians. They are responsible for managing and supporting (nonmedical) NBC planning, training, and operations on the base. All other units on the base support NBC defensive operations, as necessary, with their own organic resources (primarily unit decontamination teams and postattack reconnaissance sweep teams). CE readiness flights establish and operate the base NBC detection grid (point and standoff detectors), conduct NBC reconnaissance missions on and near the AB, operate the NBC center, and perform NBC warning and reporting system functions.

(1) CE readiness flights and unit type codes (UTCs) have organic vehicles. They use equipment such as ACAAs, chemical point monitors, chemical detection kits, biological sampling kits, radiacs, and other NBC equipment. They deploy to contingency operating locations and are assigned to the CE organization at the forward location.

(2) USAF units may operate without support from ABs (such as air control [ground-based radar warning] squadrons), and they may have NBC detection equipment and a CE readiness technician organic to their unit.

(3) All deployable USAF units and personnel are trained to perform basic postattack reconnaissance in their immediate work area by using M8/M9 detector paper. Organic security forces may have M256A1 kits and improved CAMs issued to them by CE readiness flights.

b. Postattack Actions.

(1) The base SRC assesses initial reports from the base defense operations center (BDOC), control tower, and CE postattack reconnaissance teams to determine the

nature of the attack and identify obvious damage to the base. The SRC uses this information to determine when unit postattack reconnaissance team surveys begin.

(2) Base CE postattack reconnaissance teams begin surveys and report contamination, UXO, damage, fire, and other incidents as found. The SRC uses this information to determine what type of attack occurred and when unit postattack reconnaissance team surveys begin.

(3) The SRC identifies contamination hazards and directs MOPP levels and alarm conditions for base zones and sectors. Contamination marking and clear communication of the contaminated zones are critical to successful execution and contamination avoidance.

(4) Personnel remain under cover and conduct physical checks of the outside area and inside facilities for UXO, casualties, and facility or equipment damage. All positive results are reported to the unit control or work center.

(5) When directed by the unit control center or other authority, unit postattack reconnaissance teams begin sweeps over predesignated unit areas. Teams check pre-positioned M8 detector paper for signs of contamination and look for passive indicators, such as dead or dying wildlife. Teams also determine if sufficient uncontaminated assets remain to allow the use of only these assets, and they separate and properly mark contaminated assets from uncontaminated resources.

(6) Unit control centers and the SRC collect postattack reconnaissance information, determine the effect on operations, prioritize actions, and recommend COAs to the wing operations center (WOC) and the commander. The NBC cell plots any contamination that is found and identifies the type of agent. Medical NBC personnel perform a health risk assessment and team with CE NBC personnel to provide the SRC director, and subsequently the wing commander, with an overall risk assessment that includes NBC zones, sector alarm conditions, and MOPP levels and determines potential hazard duration. The SRC continually evaluates and adjusts protective measures as hazards decrease or if the wind direction shifts. CE and NBC personnel will advise on the use of MOPP variations to reduce thermal burden and maintain an appropriate level of protection.

(7) Bioenvironmental engineer personnel integrated into the postattack reconnaissance team conduct environmental sampling and surveillance to identify the extent and persistency of contamination in contaminated areas or formerly contaminated areas. With unit support, they also compile exposure information from dosimeters, individual sampling badges, and NBC defense cell data to assist in the medical-treatment process and document exposure.

(8) When directed to resume mission-critical operations or tasks, personnel continue to look for evidence of contamination, watch for hazard-marking signs or indications, and mark contaminated assets. When directed by the SRC unit control center, personnel replace contaminated M8/M9 detector paper and protective covers (e.g., plastic over vehicles and equipment).

6. United States Navy

a. Afloat. Shipboard CBR defense capabilities focus on the survivability of the unit and are conducted primarily by the shipboard damage control organization. Threat

analysis, hazard prediction, and message reports are the responsibility of the ship operation department. The primary advisor to the commanding officer (CO) for CBR defense actions is the damage control assistant. The damage control assistant is responsible for maintaining the ship CBR defense bill, which outlines NBC procedures and assigns personnel for NBC duties for the ship. The damage control organization includes personnel assigned as standoff detector operators, ventilation control personnel, on-station monitors, survey teams, decontamination teams, and personnel decontamination station operators.

b. Ashore. Within each disaster preparedness functional AOR, there are organized units assigned to perform specific tasks by the Navy shore activity commander. These units, called *disaster preparedness teams*, are composed of the smallest number of personnel required to perform the stated function with assigned equipment. Standard teams may include control and communication, security, engineering, fire fighting, and CBR defense. CBR defense teams support survey, decontamination, and contingency response.

NOTE: The Navy does not operate with specialized NBC organizations afloat or ashore.

Chapter VI

TASKS

1. Background

a. NBC reconnaissance is conducted to obtain information by visual observation or other methods and to confirm or deny the presence of NBC hazards or attacks. It may include gathering information on the enemy use of NBC weapons, associated hazards, or meteorological data for NBC hazard predictions. NBC reconnaissance also includes finding clean areas and detours around NBC-contaminated areas. Tasks may include search; survey; surveillance; sampling; and route, zone, and area reconnaissance.

b. The goal of NBC reconnaissance is to produce information that allows friendly force elements to avoid contaminated areas. It also provides technical intelligence concerning enemy offensive NBC capability and is part of the overall intelligence collection effort. It is performed during preparation for operations, during sustained combat operations, and after conflict resolution to provide information used by the commander to support IPB requirements.

NOTE: For detailed information, see *Appendix G* for search and survey movement techniques, *Appendix H* for surveillance techniques, and *Appendix I* for search and survey detection methods.

2. Search

a. Searches are initially conducted to find contamination. They are conducted on a continuous basis to detect hazards along routes, in areas, or in selected zones or sectors of interest. When the NBC reconnaissance unit encounters contamination, it uses a series of actions (critical tasks) to develop the situation. The unit—

- **Reports.** When the reconnaissance unit finds contamination, it stops and reports its presence. The team may use a size, activity, location, unit, time, and equipment (SALUTE) report or an NBC 1 or 4 initial report (see *Chapter VIII* and *Appendix K* for further information on NBC reporting). If enemy contact is expected, the NBC reconnaissance unit remains in a covered and concealed position to minimize exposure to the contamination.
- **Determines the agent type or the radiation intensity.** If possible, the NBC reconnaissance unit develops the situation by determining the agent type or the radiation intensity. Security elements move to covered and concealed positions to provide overwatch.
- **Performs follow-on tasks.** The unit conducts follow-on tasks (marking, bypassing, and sampling) as required.
- **Chooses a COA.** Once the leader has gathered enough information, he makes a decision and selects a COA. The COA should adhere to the commander's intent, be within the capability of the unit, and allow the unit to resume its mission as soon as possible (ASAP). COAs include

conducting an NBC survey to determine the exact boundaries of the contaminated area, searching and bypassing to facilitate the bypass, or bypassing the contaminated area to find the shortest, safest route across the contaminated area.

- **Implements the commander's decisions.** The commander acts on the information reported by the reconnaissance unit. The impact of the reported contamination is analyzed against the current and future operations. The commander may decide to alter the scheme of maneuver to avoid the contamination, or he may increase the protective posture.

b. Search techniques can use point or standoff capabilities to find contaminated areas. All search techniques require applied judgment based on METT-TC. The terrain and the enemy dictate which technique to use and the level of detail possible. More than one technique may be executed during a single mission. There are three search techniques that can be employed during reconnaissance operations to locate contaminated areas—zigzag, lane, and cloverleaf (see *Appendix G*). Each technique can be performed mounted or dismounted. The detection equipment varies based on the situation and the threat. Equipment and system operating instructions are found in applicable operator and crew service and technical publications.

3. Survey

a. After contamination is detected, survey techniques (*Figure VI-1*) determine the location and size of the contamination. This resource-intensive operation is typically conducted in rear areas to prevent units from unknowingly entering the contaminated area.

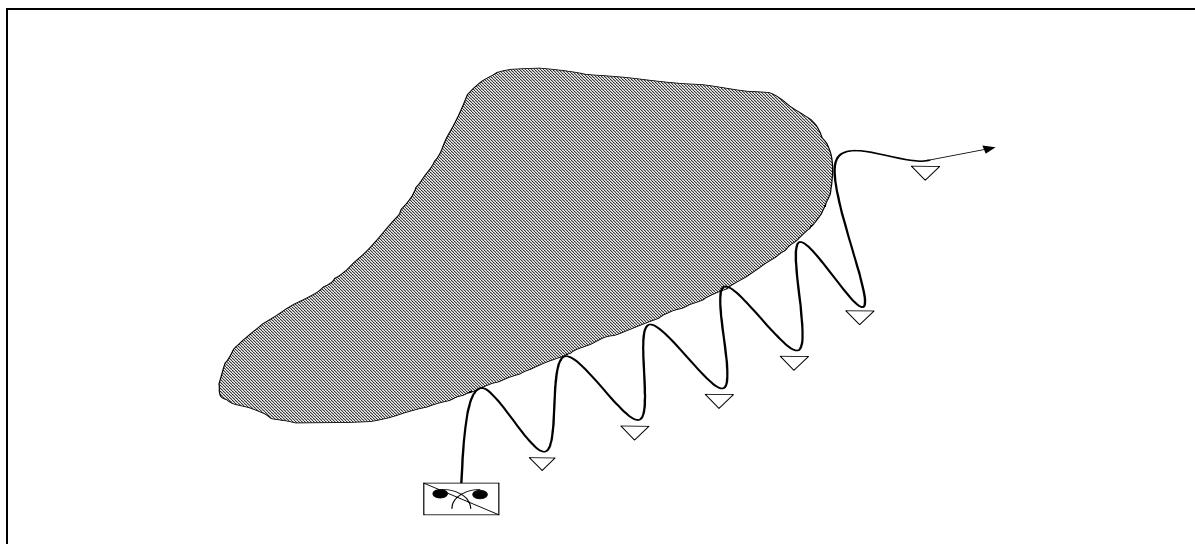

Figure VI-1. NBC Survey

- b. The following are critical tasks conducted during an NBC survey:
- Locate the general boundaries of the contaminated area.
 - Place warning markers at specified intervals around the contaminated area and at all entry points.

- Determine the intensity of the contamination.
- Report information via an NBC 4 report.

c. NBC surveys define the boundaries of contaminated areas. All survey techniques require applied judgment based on METT-TC. The mission, the terrain, and the enemy indicate the technique that should be used. There are three survey techniques that can be employed when the contamination is located—nearside-farside, box, and star (see *Appendix G*). The techniques are usually performed mounted to minimize the exposure of survey personnel to NBC hazards; however, they can be performed dismounted.

d. There are two types of surveys—complete and incomplete. A complete survey occurs when the entire extent of the contamination has been identified. An incomplete survey occurs when the entire extent of the contamination has not been identified, such as when an NBC reconnaissance unit must conduct a survey to find a bypass route. The detection equipment used to conduct surveys varies based on the situation and the threat. Equipment and system operating instructions are found in applicable operator and crew service and technical publications.

4. Surveillance

a. Surveillance (*Figure VI-2*, page VI-4) is the systematic observation of aerospace, surface and subsurface areas, places, persons, and things by visual, aural, electronic, or other means. All units perform a type of NBC surveillance. They monitor their areas to provide early warning by using detection systems, such as ACAAs. They can also be given the mission to perform NBC surveillance by observing specified areas (e.g., NAIs) for indications of an attack. NBC surveillance can be supported by several systems, such as the M21 remote sensing chemical-agent alarm; joint-service, lightweight, standoff chemical-agent detector; and biological point detector (biological integrated detection system). After observing the indications of an NBC attack, the reconnaissance element has the following options:

- Conduct an NBC survey to define the boundaries of the contamination.
- Locate and mark clear bypass routes.
- Terminate the mission, and move to the coordinated decontamination point.
- Continue the mission.

b. The following critical tasks are conducted during an NBC surveillance:

- Occupy OPs to overwatch the designated area.
- Report all indications of an NBC attack.

c. Specialized units (conventional and special operations) also support NBC surveillance with point or mobile, standoff LOS detectors to detect NBC agents. NBC surveillance capabilities are integrated to form a detection network. The network requires the following capabilities to maximize the probability of detection:

- Determine whether contamination is present in contact (liquid or solid) or vapor form.

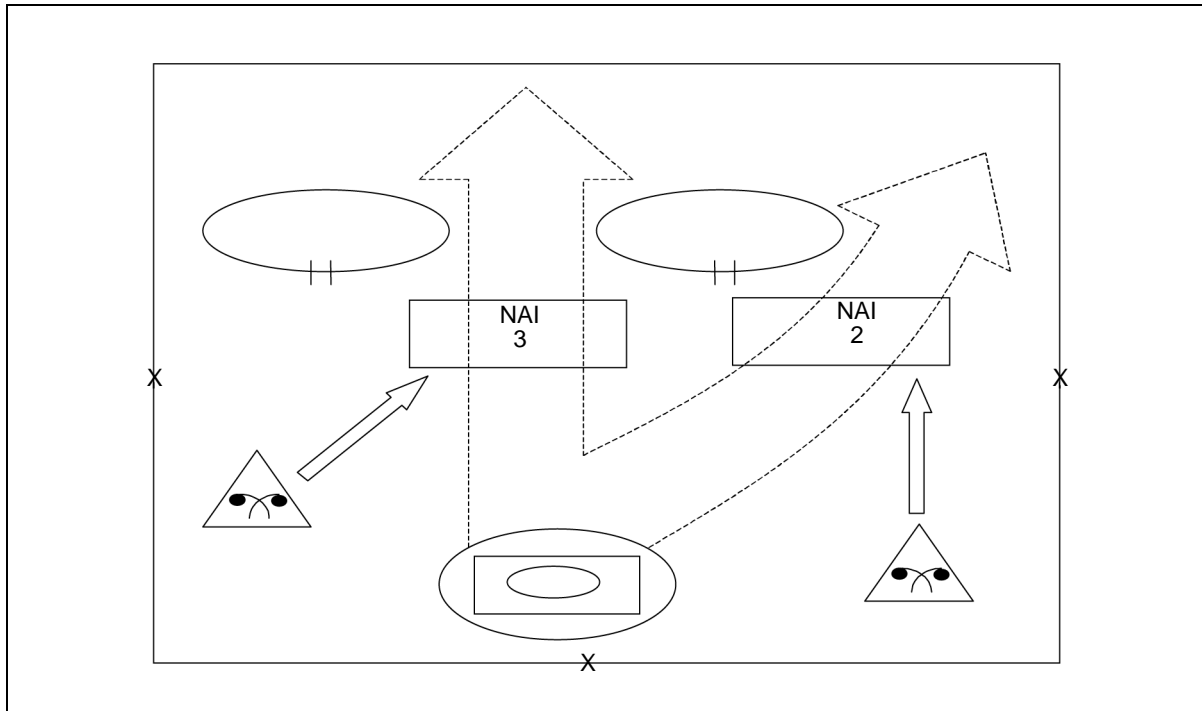

Figure VI-2. NBC Surveillance

- Detect and locate contamination from an attack that could impact on a unit location or upwind.
- Identify the type of agent, if possible, based on the available capability.
- Quantify the intensity of the hazard.
- Consolidate and communicate report information to the NBC center.
- Determine when the hazard has diminished to enough to allow MOPP level reduction.

NOTES:

1. See *Appendix L* for TTP on USA special operations NBC reconnaissance units.

2. See *Appendixes M* and *N* for TTP on joint-service, lightweight, standoff chemical-agent detectors and joint-service, lightweight NBCRS.

5. Sampling

a. Sampling is the process or technique of selecting, packaging, and documenting the collection of material. Sampling supports operational requirements and IR. The processing of samples includes verification that an attack has occurred (detect to verify) to support protection, prevention, and treatment decisions (detect to treat). The processing of the sample includes collection, handling, transferring, and chain of custody. Chain-of-custody and transfer procedures are established by each TO.

b. The following critical tasks are conducted during NBC sampling:

- Collect the sample.
- Prepare the sample documentation that describes the material.
- Maintain the chain of custody.
- Handle the sample properly.

NOTE: See *Appendix E* for detailed information on sampling.

6. Route Reconnaissance

a. Route reconnaissance (*Figure VI-3*) is a form of reconnaissance that focuses along a specific LOC, such as a road, railway, or cross-country mobility corridor. A route may encompass a single road, or it could be an axis of advance. Typically, a unit performs an NBC route reconnaissance as part of the overall operation.

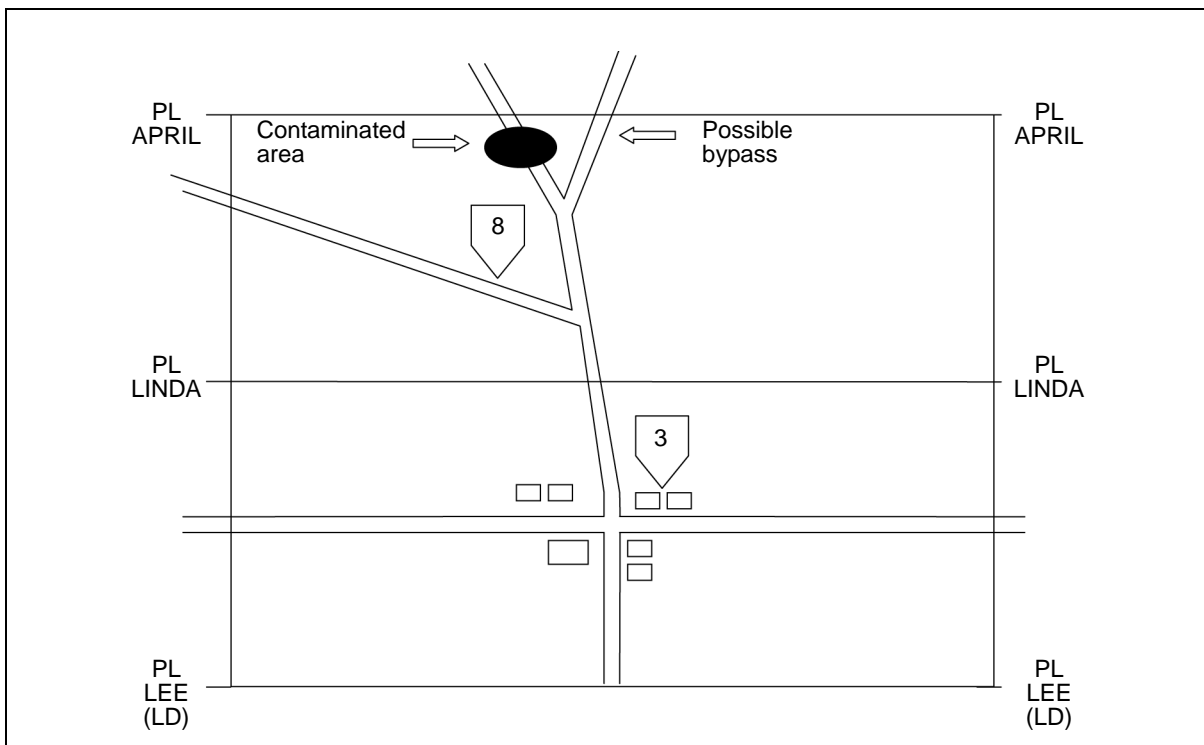

Figure VI-3. NBC Route Reconnaissance

b. When the commander's IPB indicates that there is a high likelihood of contamination along the route, a unit (particularly an NBC reconnaissance element) is given the specific mission to conduct an NBC route reconnaissance. The NBC route reconnaissance proceeds faster than an NBC zone reconnaissance. The size of the route and the time available dictate the size of the reconnaissance element. Once contamination is detected, the reconnaissance element has the following options:

- Conduct an NBC survey to define the boundaries of the contamination.
- Locate and mark clear bypass routes.

- Terminate the mission, and move to the coordinated decontamination point.
 - Continue the mission.
- c. Critical tasks must be accomplished during a route reconnaissance. The IPB and previous NBC reports indicate the possible locations of contamination. The following critical tasks are conducted during a route reconnaissance:
- Reconnoiter the route, and determine the location of any contamination.
 - Locate and mark bypass routes if contamination is encountered.
 - Report and mark all NBC hazards along the route.

7. Zone Reconnaissance

a. A zone reconnaissance (*Figure VI-4*) is a directed effort to obtain detailed information on NBC hazards within a specific zone. It is appropriate when previous knowledge of the area is limited and there are indications or reports of NBC hazards. Typically, a zone reconnaissance is performed to determine the suitability for large unit assembly areas or logistics bases. Previous reports or intelligence may indicate a high probability of past NBC attacks within the zone. A zone reconnaissance may include several area or route reconnaissance missions assigned to subordinate elements. Once contamination is detected, the reconnaissance element has the following options:

- Conduct an NBC survey to define the boundaries of the contamination.
- Locate and mark clean bypass routes.
- Terminate the mission, and move to the coordinated decontamination point.
- Continue the mission.

b. Unless specifically directed by the commander, critical tasks must be accomplished during a zone reconnaissance. The commander may direct the reconnaissance toward specific IR only, based on the time available and his intent. The following critical tasks are conducted during a zone reconnaissance:

- Reconnoiter all terrain within the zone for contamination.
- Locate all previously reported NBC attack areas, and determine if there is still a hazard.
- Locate all possible contamination within the zone.
- Check all water sources for contamination (e.g., conduct sampling and forward samples for testing).
- Verify the location of commercial TIM facilities, and check for possible contamination.
- Report all information.
- Mark contaminated areas.
- Locate routes to bypass contamination.

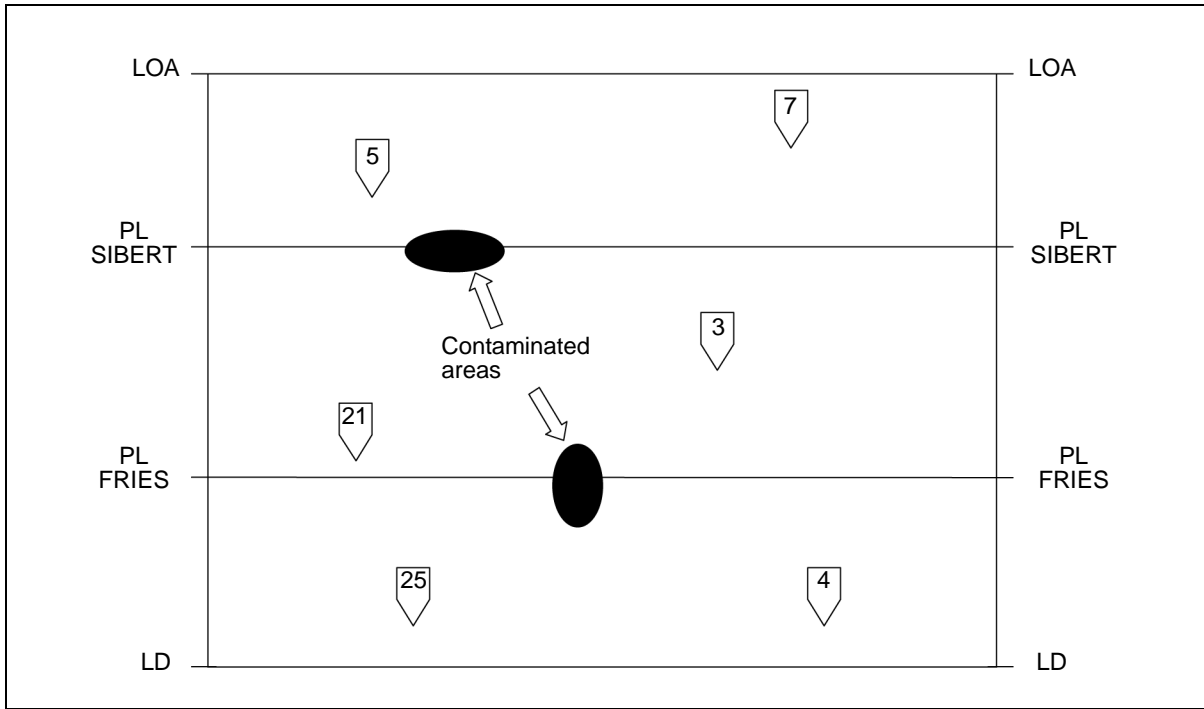

Figure VI-4. NBC Zone Reconnaissance

8. Area Reconnaissance

a. Area reconnaissance (*Figure VI-5*, page VI-8) focuses on obtaining detailed information about the terrain or enemy activity within a prescribed area. An area reconnaissance is a specialized form of zone reconnaissance, but it proceeds faster since the effort is focused on a specific piece of terrain. It may also be referred to as a *point reconnaissance* to obtain information of specific terrain features or facilities (e.g., an enemy storage facility). An area reconnaissance is typically assigned when employing a unit to reconnoiter a reported NBC attack area. Once contamination is detected, the reconnaissance element usually performs a survey to define the boundaries of the contamination. If contamination is found, the NBC reconnaissance unit has the following options:

- Conduct an NBC survey to determine the extent of the contamination.
 - Locate and mark all NBC hazards within the area.
 - Terminate the mission with permission of the headquarters controlling the mission.
 - Continue the mission.
- b. The following critical tasks are conducted during an area reconnaissance:
- Reconnoiter all terrain within the area.
 - Locate and mark all NBC hazards within the area.
 - Locate bypass routes around identified contaminated areas.
 - Report all information.

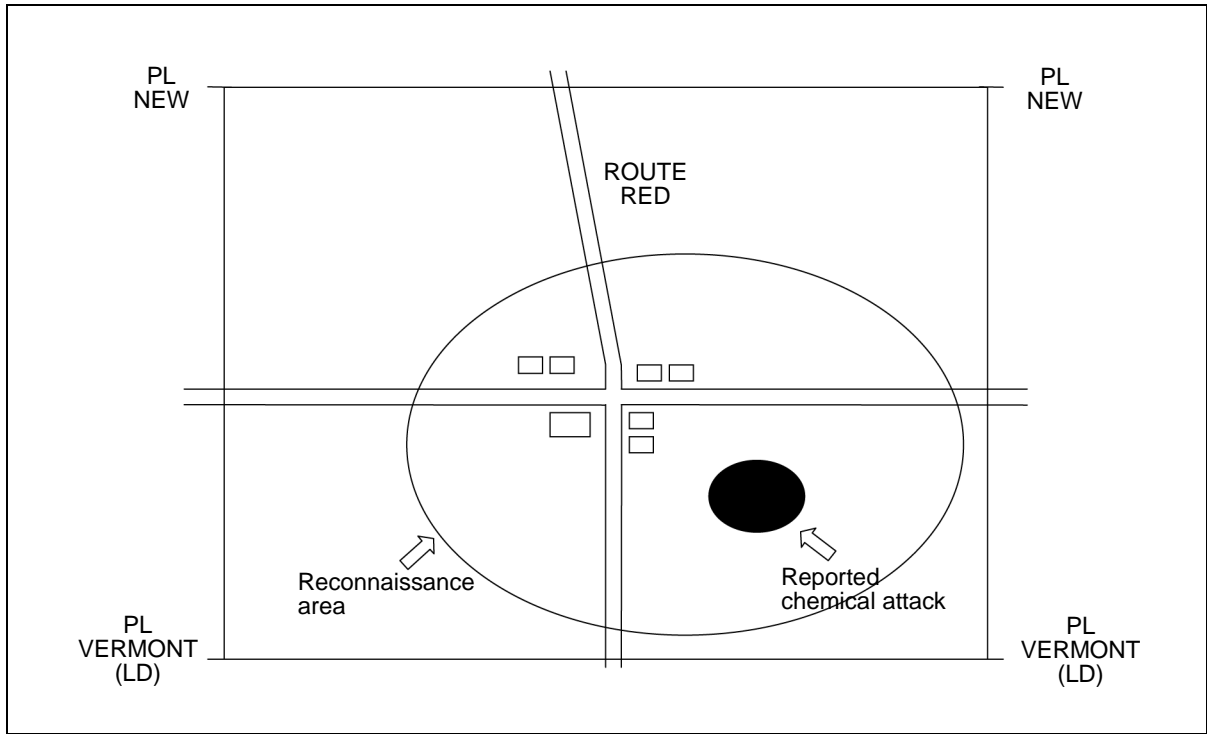

Figure VI-5. NBC Area Reconnaissance

Chapter VII

SAMPLING OPERATIONS

1. Background

Sampling is the process or technique of selecting, packaging, and documenting the collection of NBC material. Sampling represents a coordinated effort that occurs between the collection assets (e.g., weapons of mass destruction [WMD] civil-support team, biological detection unit, PVNTMED element), the escort unit who accepts the chain of custody of the sample from the collection asset, and the supporting medical laboratory that performs field confirmatory identification of samples. Further, a CCIR can be directly supported by information products from the sampling process. The decision to detect to protect and treat can be directly impacted by analysis results from the sampling process.

NOTE: *Appendix E* provides further detail on the sampling plan, sampling operations guidance, packaging and sampling procedures, and sample transfer point operations.

2. Agent Indicators

a. Typical indicators of the presence of NBC agents on the battlefield or at an incident site include—

- Activation of automatic agent detector alarms.
- Smoke, aerosol, or spray emanating from aircraft, vehicles, shells, or other munitions.
- Suspicious odors, liquids, films, or particulate matter that are not normally associated with high-explosive weapons.
- Casualties with signs and symptoms that display the presence of NBC agents, such as—
 - Many patients with the same illness.
 - Nonendemic infection.
 - Compressed epidemic curve.
 - Symptoms that are unusual for a patient's age.
 - Dead animals.
 - Multiple simultaneous outbreaks.

b. When suspicious events occur, the use of NBC agents against US, allied, or coalition forces must be verified. Evidence must be scientifically valid, and any samples must have a legal chain of custody from the point of collection to presentation. Available units may carry out a rapid, on-site search or survey using available medical or NBC detection equipment to determine the nature and extent of contamination to support the—

- Verification that an agent release has occurred.
- Verification of the viability and virulence of an agent.
- Identification of areas and surfaces that require decontamination.
- Determination of the handling and disposal procedures for expendable items.
- Verification of the decontamination completeness.

3. Sample Collection

a. Quality sample collection is especially critical for analyzing and identifying CB agents. In-theater agent identification is generally conducted by the supporting medical laboratories to support the commander's IR. Definitive identification is conducted only at selected CONUS laboratories (e.g., US Army Medical Research Institute of Infectious Diseases [USAMRIID]). They provide definitive identification and confirmation for the President and SecDef; specifically, biological-agent identification and BW levels that support critical IR—presumptive, field confirmatory, and definitive.

- **Presumptive.** This is the identification of a suspect biological agent by means of devices, materials, or technologies. It is based on detecting biological markers using a single methodology. The biological markers and methodologies used at this level, or the differentiation among a family of similar agents, may not be possible. Presumptive identification is equivalent to the Laboratory Response Network Level A and the USA Biological Integrated Detection System. Examples might include identification by sensor triggering, handheld devices (handheld assays), initial systems, or laboratory analysis employing one screening methodology (microscopic morphology, antibody/protein, or nucleic acid-based test).
- **Confirmatory.** This is the identification of a suspect biological agent by means of devices, materials, or technologies. It is based on detecting biological markers using two or more independent biological marker results. Examples might include the findings of the presumptive biological marker identification with the addition of a positive polymerase chain reaction or enzyme-linked immunosorbent assay. Field confirmatory identification can be conducted by forward-deployed or forward-positioned laboratories, such as the USAF biological augmentation team, theater area medical lab, or forward deployable PVNTMED unit.
- **Definitive.** This is the specific identification of a suspect biological agent as to genus and species, serological type, or toxin by means of devices, materials, or technologies. It is based on two or more independent biological marker results, using different methodologies available and highly skilled testing personnel, thus providing the highest levels of accuracy. Sample and specimen identification can be accomplished by nationally recognized laboratories, such as USAMRIID.

b. Exercise extreme care when taking samples containing CBR material. It may be necessary to take multiple samples. Careful storage, handling, and transporting are necessary to support accurate reporting of whether or not an attack occurred and what agent was used. For example, in many parts of the world, some biological agents are endemic to the natural environment. The detection of an endemic disease must not be mistaken for a biological attack. Quality control and safety are essential when taking samples. Some considerations include—

- **Biological samples.** Biological samples may include living microorganisms. Keeping the sample at the proper temperature during evacuation is essential to maintaining agent viability. Due to the perishability of some biological material, timeliness is also critical when transferring a biological sample. Quality packaging is a key factor to prevent spillage or breakage during transport.
- **Radiological samples.** Radiological samples present further challenges. Packaging and transporting samples require key radiation safety considerations (such as shielding distance and time) to minimize or preclude the occurrence of a hazard.
- **Chemical samples.** Chemical samples may include very toxic material. Packaging may be further complicated by the fact that munition fragments or other material (solid or liquid) may be included as part of the sample.

c. The following sample collection practices are common to all sampling procedures to ensure sample quality:

- Use properly sized and prepared containers with an airtight seal.
- Keep the empty containers in a clean bag or box.
- Open the sample container only to add the sample.
- Use the proper tools to collect samples.
- Ensure that sampling equipment is disposable or that enough clean spares are available to allow single use during a sampling mission.
- Properly decontaminate the sampling equipment between sample locations.
- Collect a sufficient number of samples for accurate laboratory analysis. Generally, collect as much of a sample as the container will safely allow.
- Mark and record the sample locations for quality control, and note if additional samples must be taken.
- Sequentially number and label the sample containers and collection forms.
- Complete the sampling form during the sample collection.
- Tape or seal the container cap after closing.
- Double-bag the samples.

d. If there is not enough time to conduct an elaborate, systematic sample collection procedure, devote the effort to collecting samples in a manner that minimizes sampling errors. The following are typical sampling errors:

- Taking too few samples.
- Taking samples of an incorrect size.
- Assuming a contaminated material is homogeneous when, in fact, the contamination occurred in a heterogeneous manner.
- Placing multiple samples in the same sample container.
- Taking improper background samples or not taking background samples.
- Taking samples with contaminated collection equipment (e.g., using the same sample collection instrument to collect more than one sample).
- Taking samples and not using appropriate PPE.
- Improperly documenting the collection of samples and incorrectly preparing shipping documents.
- Prioritizing sample evacuation operations not occurring.

e. Samples must be packaged and transported to a supporting laboratory. Avoid introducing false contamination (intentional or otherwise) before the analysis is conducted.

(1) The sample may first be transported to a supporting medical laboratory in theater (such as the theater area medical laboratory) where the sample may be *split*. However, personnel and time constraints may preclude sending a sample to the supporting medical laboratory for analysis. The medical laboratory analyzes the sample to provide in-theater field confirmation identification to support medical protective and preventive treatment recommendations. The rest of the sample is repackaged and sent to a designated CONUS laboratory for definitive identification and confirmation. Further, based on existing agreements, a portion of a sample may be analyzed by a supporting HN laboratory.

(2) If possible, transport actual or suspected biological samples that contain suspected materials at temperatures that preserve the sample (i.e., 1° to 4°C unless otherwise indicated). Do not freeze samples.

f. Trained personnel collect, package, transport, and analyze samples as rapidly as possible to ensure that timely information is provided. The sample must also be expeditiously handled based on its potential perishability, especially biological-agent samples.

NOTE: Generally, an unrefrigerated sample remains viable for about 6 hours and a refrigerated sample remains viable for 24 to 48 hours. A sample can be quick-frozen to -107°C, and a theater area medical laboratory can add a stabilizer to a sample to help maintain viability.

g. Precise records must be sent with each sample. These records are used to expedite the analysis and guide the analysts in the choice of instrumentation and procedures. The records may also be used as evidence at a later stage. Positive and negative control and an unbroken chain of custody must be maintained for the samples

due to their critical nature. See *Appendix E* for additional information on chain-of-custody guidance.

4. Responsibilities

a. Operational Theater Commander. The commander is responsible for sampling and identification. When operations involve a known or likely potential for contamination, commanders may consider the establishment of an integrated crisis action team from the staff (including operations, logistics, intelligence, medical, and NBC personnel) for managing sampling operations in an area that is subject to attack or contamination. (See *Figure VII-1*, page VII-6, for an outline of the sampling process.) When preparing a sampling plan, commanders should provide early guidance on the—

- Number of teams to be used and their taskings.
- FP guidance, such as the OEG and individual protection guidance.
- Allocation of operational resources. Missions may result in contamination of equipment, vehicles, and aircraft.
- Intended use of HN assets. The plan may require liaison with diplomats, fire fighters, police, medical personnel, and other HN assets.
- Media issues, such as rules for engaging the media regarding missions.
- Requirement for secure communications.
- Designation of logistical priorities, regarding handling and transporting samples and transporting sampling teams.
- Intended final disposition and ownership of materials collected.

(1) The commander may order a sample collection for the support of intelligence and operational requirements, which include—

- Verification that an attack has occurred.
- Identification of agents used.
- Delivery systems and their nation of origin.
- Determination of the level of CB warfare technology involved.

(2) Sample processing includes collection, handling, transferring, chain-of-custody, and administrative procedures. After laboratory analysis of the sample, medical, NBC, and intelligence personnel analyze the data to support multiple requirements (*Figure VII-2*, page VII-6).

(3) The nature and extent of a hazard may change as the mission continues and additional information is made available. The commander and the local military commander may need to adjust the nature and scope of the resources allocated to the mission. There will be a need for continual liaison and reassessment between operational commanders and unit staffs.

b. NBC Staff. The NBC staff develops and implements environmental sampling plans for NBC reconnaissance assets. The preparation of this plan should be coordinated with medical and intelligence sections to support the unity of effort for the commander's

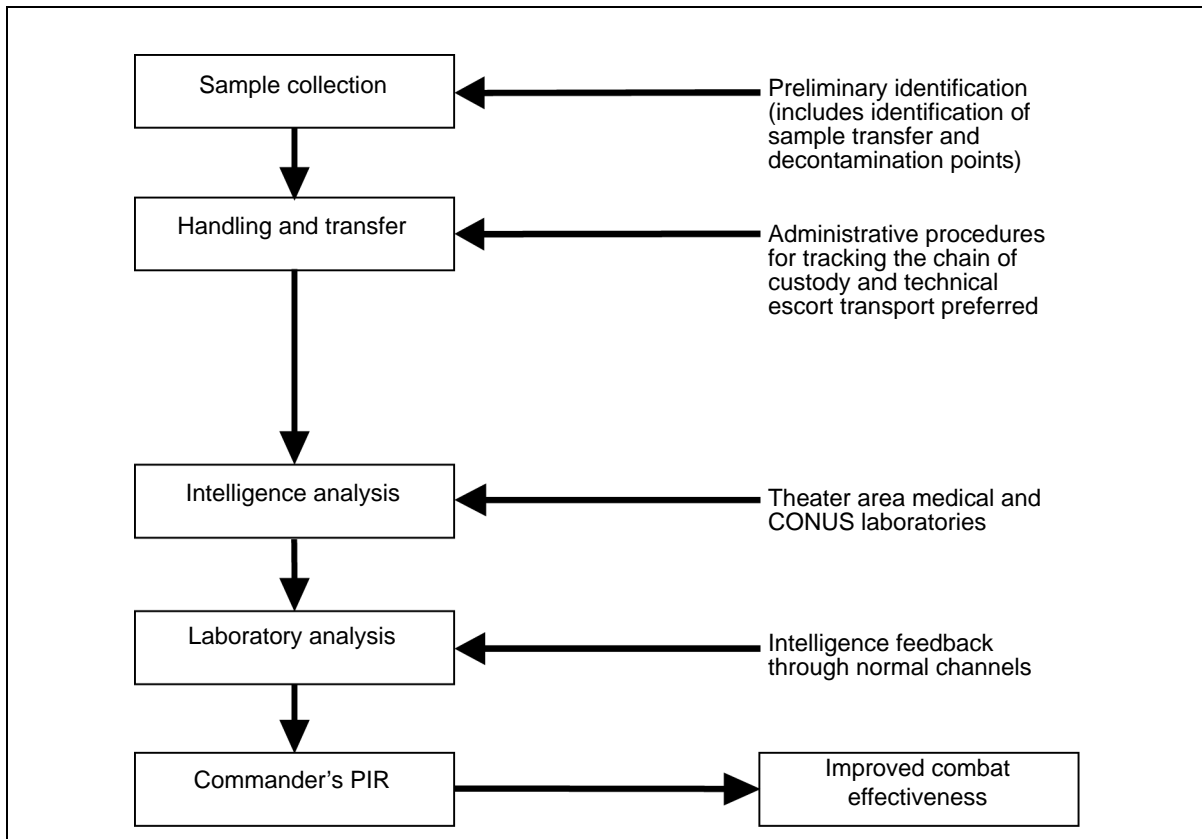

Figure VII-1. Sampling Process

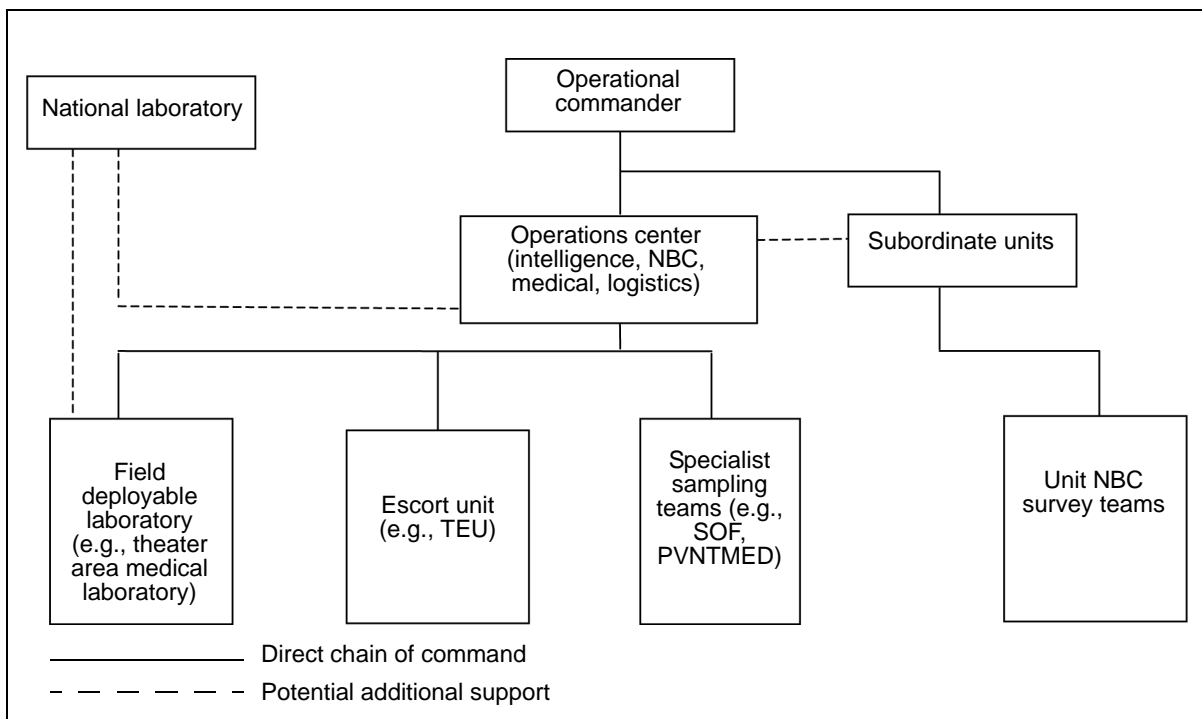

Figure VII-2. Suggested Operational Structure for a Sampling Mission

intelligence and IR. Depending on the type of mission and the resources available, the OPLAN should address the—

- Base structure, operations security (OPSEC), and logistics considerations.
- Augmentation to the staff with on-site military or civilian scientific advisors and the issuance of related WARNORDs to parent organizations within and outside the theater or organizations having an off-site technical reach-back capability to contact required subject matter experts (SMEs).
- Augmentation to the command with trained sampling teams and the issuance of related WARNORDs to parent organizations within and outside the theater.
- Need for air assets (e.g., aerial surveys, rapid transport of samples).

The NBC staff may also conduct, or acquire the results of, manual or computer-assisted modeling of potential area and downwind hazards. When practical, the modeling will be completed before the teams deploy.

c. Operational Commander.

(1) The commander may designate and allocate the necessary military assets to carry out the sampling missions. The commander's staff serves as the nerve center for sampling operations and will command, coordinate, and control all sampling operations.

(2) The commander's staff may receive reports from the following subordinate elements, depending on the nature and extent of the hazard:

- Specialist sampling and survey teams.
- Surgeons.
- Supporting medical laboratories.
- Sample control sites.
- Security forces.
- Escort units.

(3) The responsibilities of the unit staff may include—

- Supporting specialist sampling teams with transportation, interpreters, security, navigation and communications equipment, food, shelter, medical care, decontamination, and other functions needed to carry out the mission.
- Ensuring that sample chain-of-custody requirements are met.
- Establishing report protocols with the NBC staff and command.
- Maintaining reports.
- Coordinating the technical escort of samples.
- Establishing and manning a sample control site.
- Routinely updating the downwind modeling.

- Providing status reports to the operational commander and major subordinate units affected by sampling operations.
- Coordinating sample transport to regional and national identification laboratories for detailed analysis.
- Coordinating special storage, packaging, and handling requirements to ensure the integrity of samples and the safety of personnel escorting or handling the samples.

d. **Sample Control Site.** Samples generated from survey and sampling teams may be routed to a single sample control site (e.g., theater area medical laboratory) that supports incident operations. It is responsible for receiving samples, providing field confirmation identification, and preparing the sample for shipment to a CONUS laboratory.

e. **Technical Assistants.** These assistants are drawn from military/civilian national assets (on site or through technical reach-back). They will have detailed knowledge of the agents and sophisticated sampling procedures, and their expertise can be used for the—

- Conduct of risk management (RM).
- Definition of incident source terms.
- Result interpretation.
- Plume modeling and environmental transport simulation.
- Aerial reconnaissance.
- Specialized air sampling, including personal breathing zone sampling.
- Decontamination and waste management.
- Risk communication and public affairs (PA).
- Transportation of hazardous materials (HAZMAT).
- Medical management of casualties (surgeon).

f. **Unit NBC Reconnaissance Teams.**

(1) Unit reconnaissance teams conduct, record, and report surveys of known or suspected incidents. They provide prompt estimates of the severity and extent of hazards using an NBC warning and reporting message.

(2) The teams are responsible for collecting, documenting, and initially packaging any samples taken. Prior coordination with intelligence and medical units may be necessary for initial sampling operations. The teams must adhere to any special sampling tasks provided by the unit commander in the OPORD, and they must comply with FP guidance for the mission. Decontamination may be required for sampling operations and should be coordinated before beginning sampling missions.

g. **Specialist Sampling and Survey Teams.**

(1) Specialist teams may be used for sampling missions. They are responsible for conducting proper collection, documentation, custody, handling, packaging, transportation, and field analysis of environmental samples (e.g., soil, water, air, and some urban samples). These teams are composed of unit NBC survey and/or PVNTMED

personnel who have training in sampling procedures. These teams are expected to have specific knowledge of general sampling procedures.

(2) The teams bring sufficient sampling and survey equipment and a base load of supplies to perform their assigned missions. They are equipped to detect the presence of various agents and equipped and trained to take samples in the suspected attack area. The teams are qualified to take environmental samples only; they are not qualified to take medical specimens. They will immediately report significant safety hazards when such hazards are discovered.

h. Supporting Laboratories. National laboratories and deployable military medical laboratories will be identified to support sampling operations. These laboratories support field confirmation or definitive identification and confirmation.

5. Execution

a. The OPORD that supports sample planning considers multiple factors, including—

- The identification of vulnerable facilities in potential AOs, sites with large inventories of TIM, or sites with TIM sources (e.g., nuclear power plants, research reactors, nuclear fuel facilities, medical and industrial irradiators, nuclear waste dumps).
- Potential threat scenarios.
- The use of decision support tools to model potential threats.
- Likely transportation routes and staging areas.
- Critical resupply (transportation, self-contained breathing apparatus) areas.
- Specific logistics requirements.
- Identification of time estimates to accomplish the sampling.
- FP and ROE to ensure protection for the sampling team.
- Detailed maps of the AOR.
- Terrain and weather data.
- The impact of NBC environments on mission completion.
- The number of trained forces needed to adequately support a large-scale incident.

b. NBC reconnaissance units are responsible for collecting and initially packaging agent samples. PVNTMED personnel are responsible for environmental-health sampling and exposure surveillance. Medically trained sampling teams are responsible for collecting biomedical specimens. Technical intelligence and medical personnel may augment NBC reconnaissance teams for the collection of biomedical specimens.

- (1) Units designated to collect samples include—
- NBC reconnaissance.

- Technical intelligence.
- PVNTMED.
- Veterinarian.

(2) Designated sampling units train on packaging and transporting samples. Only authorized and trained elements can collect biomedical samples.

(3) The specific sample collection and processing performed by NBC reconnaissance units and sampling teams vary. Unit missions, capabilities, and authorized equipment cause differences in how samples are collected and processed. For example, the methods used to collect and process samples by biological detection assets (i.e., portal shield, Biological Integrated Detection System) will vary. The procedures used to collect and process samples are addressed in system level technical manuals (TMs) and technical orders (TOs), unit-specific TTP manuals, unit SOPs, and contingency plans.

c. The intelligence, medical, or NBC section may generate a mission requirement for sampling operations. The NBC section may also coordinate with the intelligence or medical section and recommend that other collection assets (e.g., scouts, PVNTMED) conduct NBC-related sampling operations. Sampling missions should be coordinated with the intelligence section. The mission is approved by the commander via the operations section.

(1) The NBC officer or NCO advises the commander on the proper use and employment of units capable of conducting NBC sampling operations, provides information, and recommends missions for the sampling units (except medical and veterinary). The NBC section generates the mission requirement for NBC sampling units and elements, and the NBC officer or NCO determines the best method for completing the requirement. The NBC officer or NCO uses the following considerations to determine which sampling assets are tasked:

- The intent of the IR.
- The location of the sampling target.
- The effect of sampling on current and future operations.
- Medical treatment facilities (MTFs).
- Support requirements (e.g., decontamination needs).
- Security requirements.
- Escort unit requirements (e.g., identifying other trained assets for sample escort if TEU assets are unavailable).

(2) Collected samples are packaged and transported to a sample transfer point, which may be the decontamination point. A qualified escort must accompany the suspected sample during the entire evacuation process to ensure safety and to maintain the chain of custody. Technical escort is preferred during the entire evacuation process, but may not always be practical because of the limited number of TEUs.

(3) After the supporting theater area medical laboratory withdraws an aliquot for testing, it turns the sample over to the escort for delivery to the CONUS laboratory for definitive identification. A technical escort accompanies the sample from

the POD to the CONUS receiving laboratory. The supporting theater laboratory reports its findings to the field commander for use in the MDMP.

d. The preparation of a sample collection order requires detailed coordination and careful execution. The most valuable and reliable intelligence data regarding contaminated areas is obtained from well-planned, coordinated sampling operations. See *Figure VII-3*, page VII-12, for factors that should be considered for inclusion in a collection annex to an OPORD or OPLAN.

(1) Land, air, or maritime forces (i.e., corps, air wing, or group) may require preparation of a sample collection OPORD. The OPORD may include provisions for—

- Identifying missions for deploying NBC reconnaissance units, sampling teams, TEUs, and theater area medical laboratories.
- Coordinating sampling team, escort, and medical assets to support sample evacuation.
- Outlining options for the retrograde of sample evacuation packages to CONUS for definitive identification and confirmation.
- Providing required resources (e.g., CSS requirements) for sampling, escort, transport, and medical procedures.
- Coordinating sample evacuation plans with other commands (e.g., USAF and USN medical laboratory activities) to support in-theater functions (such as laboratory analysis) and to ensure asset visibility throughout the evacuation process.
- Issuing directives (on order) for the evacuation of background and presumptive-identified samples.
- Establishing (in coordination with NBC reconnaissance and escort units) the locations of potential sample transfer points and the means (e.g., escort element and transport assets) by which sample evacuation packages will move from sample transfer points to intermediate points and to the final destination.
- Identifying alternate escort assets if TEU assets are unavailable.
- Directing NBC reconnaissance, escort, and medical laboratory assets to establish and maintain communications for coordination of sample pickup and delivery and for feedback (e.g., laboratory analysis results).
- Providing for the receipt of reports from the supporting theater area medical laboratory or the OCONUS laboratory on the results of the sample analysis.
- Coordinating and tracking the forwarding of samples to supporting medical laboratories outside the theater.
- Requesting other national or theater strategic sampling assets (not in the COCOM commander's chain of command) to provide feedback on the results of their efforts through applicable channels.

ANNEX M (SAMPLE COLLECTION) TO OPORD _____

1. SITUATION.
 - a. Enemy Forces.
 - Identify enemy NBC and TIM capabilities that may require collection and analysis (e.g., agent type).
 - Identify known and suspected locations that may require collection efforts.
 - Identify or project enemy activities that may require sampling.
 - b. Friendly Forces.
 - Identify or request assigned assets that can provide collection, escort, and laboratory analysis capabilities.
 - Identify the assets that are available at the next higher unit, including the higher leader's intent with regard to the use of the resources.
 - c. Terrain and Weather.
 - Identify the impact of terrain and weather on the time required to collect or transport the sample.
 - Identify the potential impact of weather on sample viability.
2. MISSION. Provide the mission(s) for NBC reconnaissance, escort, and medical laboratory assets that identifies who, what, when, where, and why.
3. EXECUTION.
 - a. Concept.
 - Identify the concept for integrated use of sampling, escort, and laboratory assets.
 - Identify the requirement for additional assets to support the execution concept.
 - Establish the priorities for unit support tasks.
 - Clearly state the missions or tasks for each unit involved.
 - b. Task Organization.
 - Identify the units that are available or required to conduct sampling, escort, and laboratory operations (e.g., NBC reconnaissance, laboratories, PVNTMED, SOF, other national strategic assets).
 - Identify the command or support relationships that should be established for supporting collection, escort, and medical assets.
 - c. Attachments and Detachments.
 - Identify or request attachments that can provide collection, escort, or laboratory analysis.
 - Identify the capabilities of other components, coalition forces, or the HN that may have to support collection, escort, or laboratory analysis.
 - d. Coordinating Operations.
 - Assess the time requirements to support the concept of operations (e.g., the time required to analyze samples, transport samples, and conduct sampling).
 - Identify the supporting assets from other components, coalition forces, or the HN.
 - Identify the role of other strategic collection assets, if applicable.
 - Identify the means to receive information from national or theater strategic collection or laboratory assets.
 - State the sampling-related CCIR.

Figure VII-3. Sample Collection OPORD Annex

- State the sampling RM control measures (e.g., protection guidance).
 - State the FP requirements (e.g., provide security for the sampling team).
 - Provide the movement plan (e.g., designate the sample transfer points, provide the means [ground or air] to move samples inter- and intratheater, provide the schedule [if applicable])
 - Identify cross-border requirements for sample movement, if required (e.g., there may be a prohibition against crossing international boundaries with samples).
4. SERVICE SUPPORT.
- Identify and provide support requirements for sampling, escort, or laboratory assets (e.g., life support, transportation).
 - Identify and provide resources to support decontamination.
5. COMMAND AND SIGNAL.
- a. Command.
- Establish command and support relationships.
 - Identify detect-to-treat decisions on the decision support template.
 - Identify who directs sample evacuation to supporting laboratories.
- b. Signal.
- Identify communications assets required to coordinate sampling, escort, and laboratory reporting.
 - Identify the information required to support reporting and coordination.
 - Indicate whether information exchange is permitted with the HN or coalition forces.

Figure VII-3. Sample Collection OPORD Annex (Continued)

- (2) The OPORD may also address—
- Deploying an advance party to coordinate sample evacuation activities with the supported unit, escort elements, and theater area medical laboratories.
 - Establishing (in coordination with supported and escort units) sample transfer points and route and local security for the movement of support crews to sample transfer points.
 - Coordinating for required support (e.g., FP, transportation, communications, life support, personnel accountability) from the supported unit.
 - Directing teams to rehearse sample evacuation procedures, including transporting simulated packages to sample transfer points.
 - Directing the collection of background samples at selected intervals.
 - Using the sample evacuation OPORD of the supported unit to prepare the supporting OPORD (e.g., sample transfer point locations and escort, security, and identification requirements).
 - Forwarding FRAGORD directives for the evacuation of samples.
 - Receiving the results of supporting medical laboratory analysis.
 - Coordinating and specifying sample transfer points (most appropriately the decontamination point for the reconnaissance mission team), sample couriers, special packaging and handling procedures, chain of custody, and diagnostic laboratory delivery

points in SOPs and OPLANs. Otherwise, the NBC center will have to coordinate and specify requirements between medical, intelligence, reconnaissance escort, and decontamination units not previously coordinated (along with any special requirements dictated by the situation).

- Ensuring the priority transport of samples to supporting laboratories.
- Maintaining a strict chain of custody. This allows samples to be traced to their origin and provides tamperproof evidence.
- Ensuring that the receiving laboratory (e.g., theater area or CONUS medical laboratory) knows the sample is coming.

(3) Operational considerations for locating and operating sample transfer points include locating possible upwind locations, using remote areas (consistent with local security conditions), and considering the distance and the time sensitivity associated with the sample transfer. Other operational considerations include the following:

- The escort team—
 - Approaches the sampling team from an upwind direction for sample transfer.
 - Establishes the sample transfer point outside the estimated hazard area if possible.
 - Executes the sample transfer after the CB cloud has dissipated.
- Unit leaders use MOPP analysis to determine the appropriate protective measures for team personnel. As a minimum, the support team conducts sample evacuation using appropriate respiratory and skin protection measures. Protective measures that the team can use include changing uniforms, showering, donning gloves, using respiratory protection devices (such as an appropriate high-efficiency particulate air filter respirator capable of providing protection against a BW aerosol), wearing masks, wearing eye protection, and conducting the sample transfer during daylight (e.g., ultraviolet radiation destroys most bacterial BW agents).
- Personnel maintain BW samples at 1° to 4°C and maintain an unbroken chain of custody.
- Sampling unit, escort, and medical elements conducting sample evacuation establish and maintain communications throughout the process.
- Personnel provide a FRAGORD to the sampling team to ensure that they are aware of sample transfer point location(s) and the route and time of the sample transfer.

6. Sampling Teams

a. Generally, NBC and PVNTMED personnel are tasked to take samples. In some circumstances (e.g. clandestine use of a new agent in rear areas), the sampling team is augmented with civilian sampling specialists or other personnel with appropriate expertise. During sampling, intelligence or medical personnel may assist NBC personnel. Such assistance should be incorporated into SOPs and OPLANs. Trained personnel ensure uniformity, viability, safety, and accountability in sampling procedures. Only trained medical personnel take biomedical samples. The standard sampling kit is the M34-series NBC agent sampling kit. This kit contains the material necessary to obtain small liquid and solid samples of CB agents or TIM. If the M34-series kit or a commercial kit is unavailable, a field-expedient kit can be assembled from like materials with the help of supporting medical units (see *Appendix E*). Many commercial sampling kits are also used to support NBC agent collection. These kits are primarily used by specialists who are assigned to units such as TEUs, WMD civil-support teams, and explosive ordnance disposal (EOD) detachments. The composition of the commercially available kits and the operating instructions are found in the operating manuals.

b. The size of a sampling team is two to four personnel. The primary objective of sampling is to acquire sufficient agent and degradation products for laboratory identification. Normally, an NBC reconnaissance team has already determined the location of the agent. If sample surveys are required, the size of the sampling team is increased to take into account the additional duties.

c. Sampling teams are augmented with personnel who are experts in related specialist areas, such as—

(1) A medical person who is familiar with medical and epidemiological effects of CB agents and who knows epidemiological or forensic medicine.

(2) An EOD expert who is specialized in CB weapons.

d. Sampling teams are briefed on the following NBC reconnaissance matters before they proceed to their mission:

- The area to be examined.
- Routine patrol instructions.
- Intelligence information that is pertinent to the mission, particularly reports on recent NBC attacks.
- Meteorological data (including the wind speed and direction) for the area to be sampled.

Chapter VIII

REPORTING AND MARKING

1. Background

a. NBC reconnaissance reports contribute vital information to a common operational picture (COP). This information supports the process of predicting, detecting, identifying, warning of, and reporting NBC attacks. The reports inform units of clean areas and possible contamination.

b. Specific line items for NBC reports are shown in *Appendix K*. Some line items of the NBC report must always be reported. Other line items are optional and should be reported if known.

2. Reporting

a. Standardization Agreement (STANAG) 2103 specifies standardized NBC report formats. The formats are based on a code letter system (line item letter) to shorten the length of the message being passed. The standardized reports are—

- **NBC 1.** Observer's report that gives basic data.
- **NBC 2.** Report for passing the evaluated data that is collected from NBC 1 reports.
- **NBC 3.** Report for the immediate warning of predicted contamination and hazard areas.
- **NBC 4.** Report for forwarding detection data, such as monitoring, survey or reconnaissance results. This report is used in two cases—if an attack is not observed and the first indication of contamination is by detection and to report measured contamination as a part of a survey or monitoring team.
- **NBC 5.** Report for passing information on areas of actual contamination. This report can include areas of possible contamination, but only if actual contamination coordinates are included in the report. The NBC 5 report consists of a series of grid coordinates, and it is prepared from information provided in the NBC 4 report. It is also used to transmit the decay rate of fallout. The NBC 5 report may be sent before or after the NBC 4 report has been received and may be revised and sent several times during the period of interest.
- **NBC 6.** Report for passing detailed information on NBC events. Battalion-size or equivalent organizations prepare the NBC 6 report when requested by higher headquarters to summarize information concerning CB attacks. The report provides intelligence information that is used to analyze future enemy intentions.

NOTE: The NBC 4, 5, and 6 reports would likely be used to support NBC reconnaissance missions.

- **SALUTE.** Any unit may provide a SALUTE report that includes information on contamination.
- **System-specific.** Sensor suites (i.e., joint-service, lightweight NBCRS; NBCRV; and M93A1 Fox) provide reports containing component and system level detection and identification results.

(1) To meet specific reporting requirements, units may preformat data collection requirements. Information that may be reported could include data on casualties; UXO; tactics employed by the enemy; NBC weapon indicators; and damage to equipment, facilities, vehicles, aircraft, or roads. During postattack reconnaissance, teams look for activated NBC detectors, M8/M9 detector paper results, operating or spent munition delivery systems or spray tanks, aerosol generators, submunitions, and bomblets. Teams should include the name, rank, unit, present location, and phone number (or another contact method) of the team for further information. Operations or control centers consolidate reports to provide a complete assessment report.

(2) NBC reconnaissance team members must relay the most precise information possible to their controlling headquarters. This information is used for detailed agent identification, MOPP analysis, persistency, and exposure control calculations. They supplement the basic line items of NBC reports by adding information in the applicable remarks section. Sample entries for the remarks section are as follows:

- **CAM/improved CAM.** Report the number of CAMs used at the same location, the type (open-air or concentrated) and height of monitoring, the type of agent, a description of the bar readings, and the time spent with the CAM in the monitoring mode.
- **M22 automatic, chemical-agent detector alarm.** Report the location of the M22 in relation to its environment and the type of agent detected.
- **M8 detector paper.** Report the specific color change, the time of the reading, and the percentage of paper covered by droplets.
- **M256A1.** Report the type (open-air or concentrated) and height of monitoring and the specific color change or lack of color change for each test spot.
- **Physical observance of droplets.** Describe observable droplets located on nonporous surfaces, such as a vehicle windshield. For example, a reconnaissance team might report, “We have amber-colored droplets on a vehicle windshield.”

b. NBC collection, reporting, and evaluation are crucial to the mission. Individual and unit reconnaissance teams report postattack information through operations or control centers by the fastest available means of communication. Each element that receives a report has two responsibilities—

- To provide the information to the next level in the chain of command or a designated agency.
- To provide the information to elements at risk within the unit or within the area affected by the hazards.

c. If normal communications fail, reports are submitted to the next higher level in the chain of command. The operations or control center uses postattack information to evaluate attacks, determine attack patterns and probable targets, and evaluate the effectiveness of passive defense measures. The tactical situation, the equipment available, and the unit mission also determine the method of transmitting reports.

(1) NBC reconnaissance reports are forwarded by the communications mode (e.g., radio, telephone, local area network [LAN], intercom, digital) specified in the applicable OPLAN, OPORD, or SOP. To reduce transmission time and make the communications asset available for other information traffic, reports should be preformatted, short, and concise.

(2) When operating in NBC collection and control center AOs, support units transmit NBC reports to the applicable operations center for that AO. Designated nuclear observers' reports are transmitted directly to the NBC control center from the subcollection center, bypassing the NBC collection center (*Figure VIII-1*).

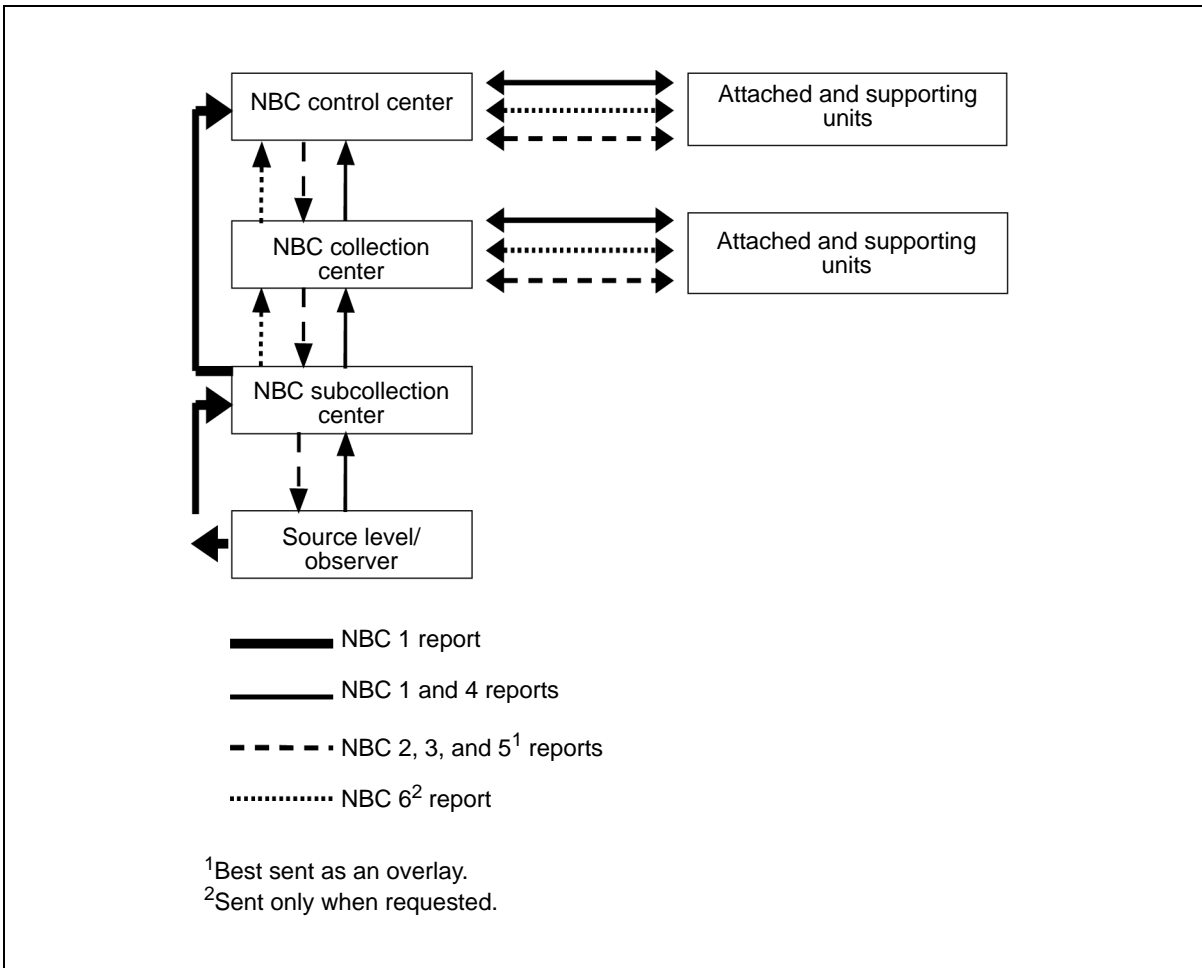

Figure VIII-1. NBC Report Flow

3. Marking

a. Introduction.

(1) Reconnaissance is used to detect contamination before direct movement into or through designated areas when—

- Contamination is unknown and units must move into or through an area or occupy it.
- Contamination is known and the boundaries must be identified.
- Uncontaminated route(s) through or around an area must be located and identified.

(2) Once an area is searched and contamination is located, the area is surveyed (if required) and marked and a report is submitted to the requesting headquarters. Marking a contaminated area or equipment designates a hazard. A more detailed survey determines the extent and intensity of the contamination. Markings warn individuals and units visually, identify routes through or around contamination to maximize operational maneuverability, and identify equipment that is hazardous to operators and maintenance personnel.

b. Contamination Marking.

(1) The NBC contamination marking set (*Figure VIII-2*) used by US forces contains all the material needed to mark contaminated areas. The marking set contains the following:

- Flag containers (each container holds 60 [20 white, 20 blue, and 20 yellow] NBC contamination marking flags).
- Mounting stakes (48 each to make poles and attach marking ribbon).
- A ribbon container (contains thirteen 20-meter rolls of marking ribbon for hanging flags between poles or other objects).
- Crayons for marking information on flags.

(2) Contamination marking signs are standardized in color, shape, and size (*Figure VIII-3*, page VIII-6). The primary (background) color of the marking sign indicates the general type of contamination. The secondary (foreground) color identifies the specific hazard. Contamination marking signs are annotated with important information that includes the following data fields:

- **Chemical.** Post the name of the agent, if known, and the date and time of detection.
- **Biological.** Post the name of the agent, if known, and the date and time of detection.
- **Radiological.** Post the dose rate, the date and time of the reading, and the date and time of the burst, if known.

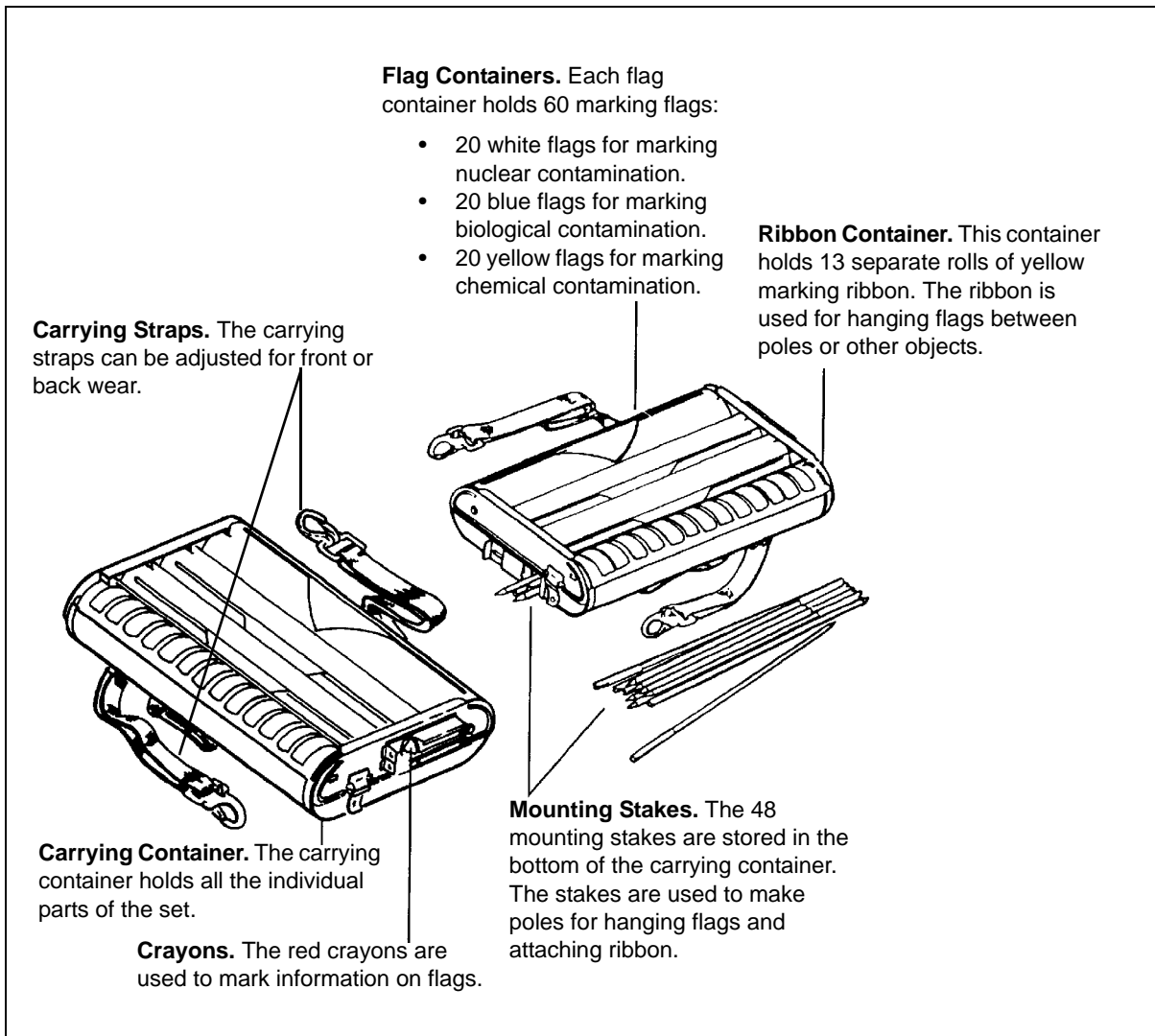

Figure VIII-2. NBC Contamination Marking Set

(3) Units follow major command (MACOM) or theater standards for marking hazards. When those standards are not provided or when standard markers are unavailable, units may use the expedient markers shown in *Figure VIII-4*, page VIII-7, to mark NBC hazards. Personnel use any suitable material to construct the markers to the approximate size and shape of the examples. Materials for expedient marking include locally produced marking signs, decals, tape, chalk, and paint.

c. NBC Contamination Marking Procedures.

(1) Place the contamination markers where they are most likely to be seen by approaching individuals and units. Individuals who locate the contamination will place markers at the point of detection. To prevent forces from missing posted markers and inadvertently entering contaminated areas, place adjacent marking signs at intervals of 25 to 100 meters, depending on the terrain. If marking contamination in open terrain (i.e., desert, plains, rolling hills), raise the markers to heights that permit approaching forces to view them at distances up to 200 meters. (*Figure VIII-5*, page VIII-7, shows a sample contamination bypass marker.)

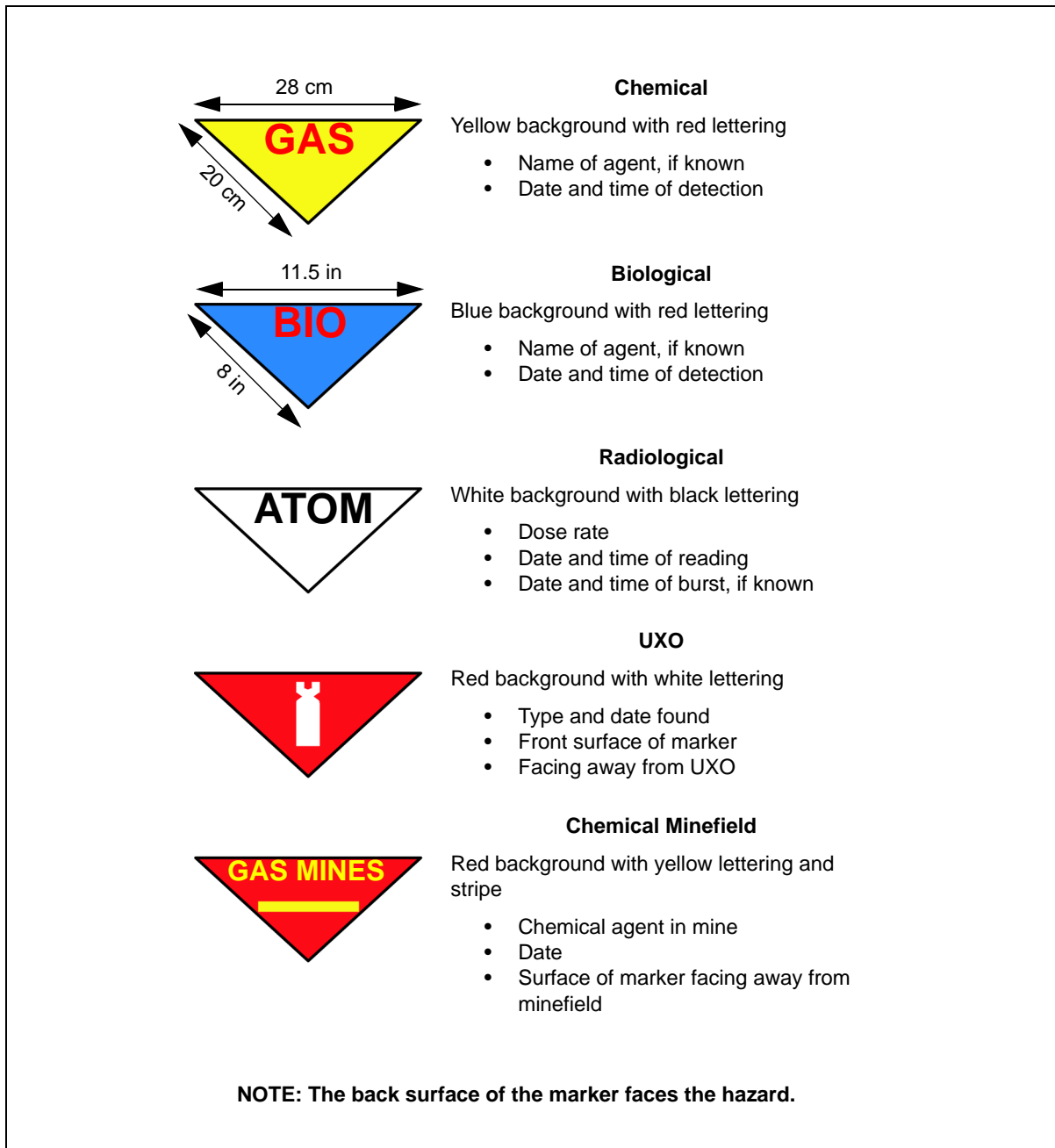

Figure VIII-3. Standard NBC Hazard Markers

(2) Mark contamination on all sides in rear areas to warn follow-on and support units of the hazard. These clear zones (safe lanes) provide greater freedom of movement by rear area forces through or around contamination.

(3) Mark buildings and other facilities that may be contaminated at critical points, such as entry points.

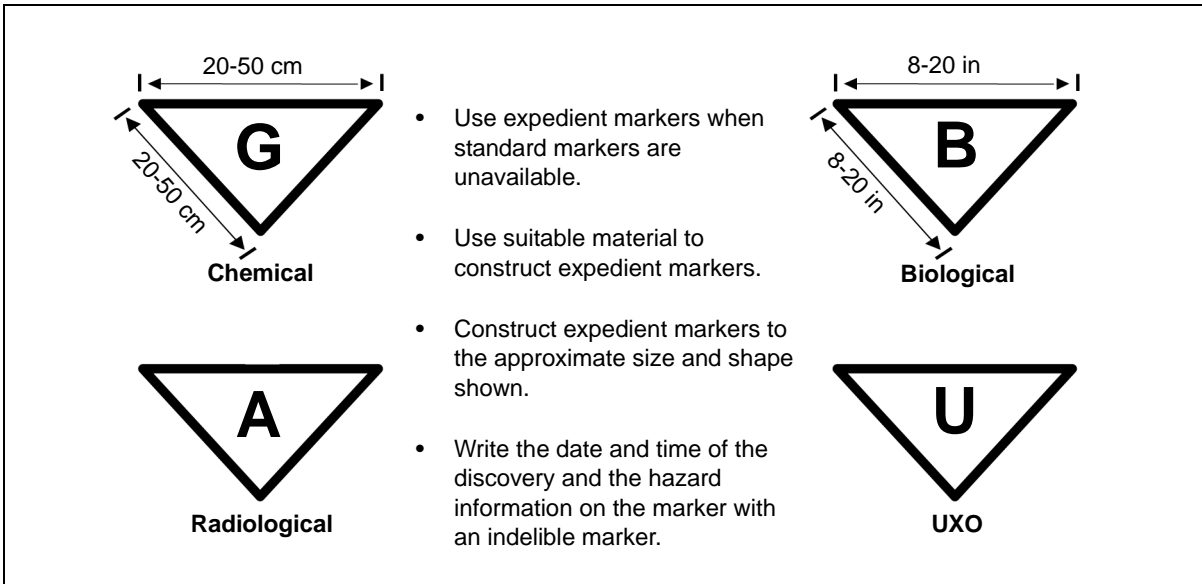

Figure VIII-4. Expedient NBC Hazard Markers

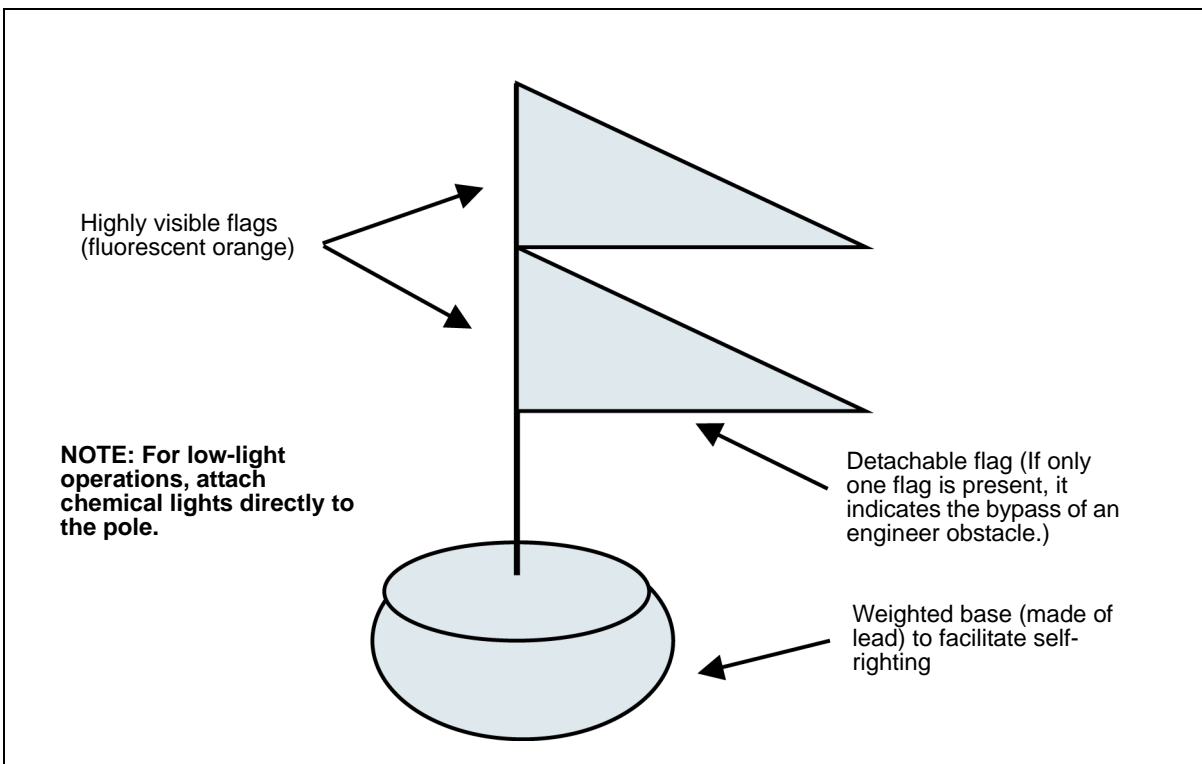

Figure VIII-5. Contamination Bypass Marker

(4) Mark materiel to protect personnel from accidental contamination. Place contamination markers on any unmarked equipment present in the NBC attack area. Personnel using equipment after decontamination must take precautions against vapor, particulate, and liquid contamination that may be trapped inside filters, assemblies, and joints. The contamination could pose a hazard while equipment is being used or maintained. (*Figure VIII-6* shows a sample hazard warning tag.)

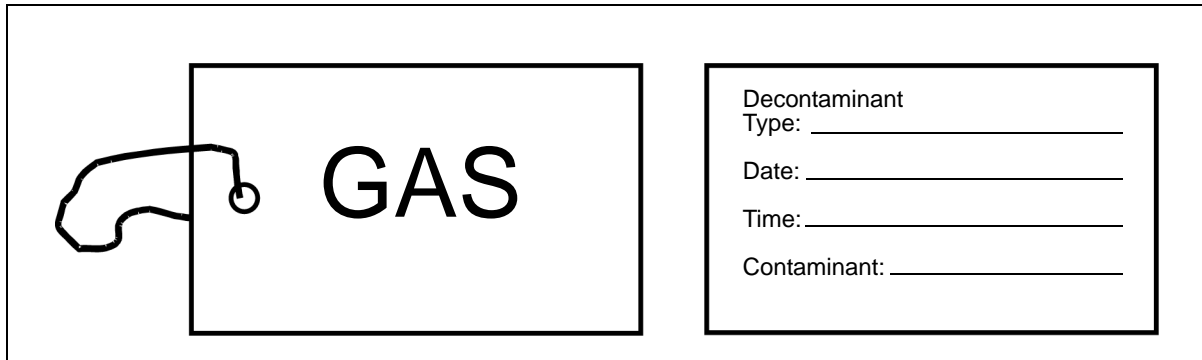

Figure VIII-6. NBC Hazard Warning Tag

Chapter IX

TOXIC INDUSTRIAL MATERIAL RECONNAISSANCE

1. Background

a. This chapter provides an overview of TIM reconnaissance operations. The procedures outlined in this chapter do not meet all peacetime HAZMAT safety and legal requirements; however, mission criticality, resource limitations, and enemy actions may make compliance with peacetime regulations impossible or impractical during military operations. The procedures in this chapter provide a means to balance mission accomplishment and team safety in a potentially hostile environment. These TTP do not constitute an automatic waiver for units to deviate from standard HAZMAT practices and regulations during military operations. Unit leadership (in coordination with NBC, medical, and legal staff representatives) must assess each situation according to certain factors, such as the controlling headquarters guidance, applicable laws and procedures, and risk assessments.

b. Due to the low toxicity and stability of TIM, incidental release from transport vehicles is expected to affect an area considerably smaller than the area affected by CW agent attacks. Releases from fixed facilities may be much larger and similar to CW agent attacks in size and downwind magnitude. A ready reference for information on TIM releases is the US Department of Transportation (DOT) *Emergency Response Guidebook*. It contains extensive cross-reference tables of dangerous TIM and includes exposure safety and contamination danger guidance.

2. Nature of the Problem

a. Sources. Virtually every nation in the world has some form of TIM production, storage facility, or distribution capability. Most of these TIM are used for peaceful purposes and are considered to be in one of the following categories:

- Agricultural (insecticides, herbicides, and fertilizers).
- Industrial (chemical and radiological materials used in manufacturing, fuels, processes, and cleaning materials).
- Production and research (material used in research and pharmaceuticals or produced in a facility).
- Radiological (material used in nuclear power plants or medical facilities and laboratories).

b. Prevalence. Given the prevalence of TIM throughout the world, specialized NBC or medical teams (e.g., PVNTMED elements) may be required to detect, identify, quantify, sample, mark, survey, and report TIM for deployed forces.

3. Risk Analysis

a. RM. Before deployment on a mission, leaders and the staff conduct risk analysis (RA). The process identifies and assesses the threat, develops controls, makes

risk decisions, implements controls, and follows up with supervision and continuance of the RM process.

b. Identification of the Threat. The IPB process provides information on the TIM threat. The information collected provides various data, such as the types of TIM that may be encountered, the possible TIM locations, and the types of industrial or research facilities that may be encountered during mission execution. A HN liaison (government official, factory worker, local citizen) may also be able to further characterize the nature of the threat in question.

c. Assessment of the Threat. The assessment determines the direct impact of each TIM on the operation. Technical reach-back may be required to support the assessment, and automated decision support tools also support the assessment process. The unit staff (medical, intelligence, NBC SMEs) conducts coordination to prepare an assessment that estimates the severity of the TIM threat and the probability of a TIM event and determines the risk level and the overall risk to mission accomplishment.

d. Precautionary Measures. Standard measures are developed to eliminate or reduce the risk. They include—

- Avoiding the risk and taking precautionary measures, such as selecting an alternate location for an operation and coordinating with fire service and HAZMAT teams.
- Delaying a COA to reduce the risk by delaying the task and waiting until additional resources (e.g., specialized PVNTMED or NBC detection units) become available.
- Transferring the risk by taking appropriate actions, such as using another unit that is better positioned or more survivable to accomplish the mission.
- Using physical or operational control (OPCON) measures, such as the use of barriers, signs, and boundaries.
- Developing a TIM hazard reconnaissance OPLAN.
- Coordinating with theater medical elements (e.g., PVNTMED) for assistance and follow-on technical support.
- Coordinating with TEU elements for follow-on technical support.
- Coordinating with structural engineer elements if the facility to be reconnoitered was damaged or destroyed or the vulnerability analysis indicates that it has been abandoned for a long time.
- Coordinating with the in-theater supporting medical laboratory for the delivery of samples collected during TIM reconnaissance operations.
- Reporting findings through command channels.

e. Implementation of Precautionary Measures. Assets are made available to implement specific measures. Implementation provides applicable plans or orders that may indicate various information, such as the TIM threat, operational measures (e.g., boundaries, AOs), or missions assigned to collection assets (e.g., medical or NBC reconnaissance elements). When friendly units are required to operate in an area where

a potential TIM hazard exists, the implementation of precautionary measures may also involve—

- Coordinating ERTs with the HN. These teams may be formed from US, coalition, or multinational assets.
- Identifying what and how much TIM material is present, the amount of contamination present, and the extent of possible future contamination in an accidental release of TIM materials
- Coordinating with higher headquarters and coalition, multinational, and HN assets to identify the availability of chemical accident/incident response and assistance teams (i.e., TEUs, PVNTMED units, or civilian agencies).
- Revising an accident/incident response plan.

f. Supervision and Review. Risks and precautionary measures are continuously reevaluated to assess their effectiveness, based on several factors, such as a change of mission.

4. Safety

a. Precautions. The reconnaissance of an area or facility contaminated with NBC agents or TIM requires the adherence to generally accepted safety precautions for personnel protection while conducting the reconnaissance. However, some significant differences to the procedures for conducting TIM reconnaissance include the following:

- The degree of protection required may be greater. TIM may be caustic, explosive, flammable, or radioactive. It may displace oxygen or be present in very high concentrations.
- Detection and identification may be more difficult. While detection and identification equipment and methods are available for toxic industrial chemicals (TICs), the number of possibilities makes knowing what type of protection to use and when to don protection more difficult.
- Leaders must pay greater attention to the potential for immediate and long-term hazards when conducting TIM reconnaissance.
- Military protective filters are optimized against CB warfare agents, but not against TIC. The charcoal filters contained in military protective equipment are designed to protect against field concentrations of toxic CB warfare agents. Military protective masks do not provide adequate protection against some organic vapors and should not be used in atmospheres with an oxygen content of less than 19.5 percent by volume. The use of a self-contained breathing apparatus is necessary, especially when the identification of the HAZMAT or its concentration has not been determined.
- Reconnaissance personnel must be aware of the risks when moving about in facilities where structural hazards or operating machinery are present. In addition, they should avoid areas where explosive vapors are present or where there is no oxygen.

Conducting reconnaissance of TIM hazards can be safe, hazardous, or dangerous, depending on the agent, its concentration and quantity, its condition, the level of protection, available equipment, and unit procedures.

b. Hazard Relationships.

(1) *Table IX-1* lists some HAZMAT and concentrations that are considered hazardous, yet safe, under controlled conditions or low concentrations. Note that for some chemicals (e.g., chlorine, ammonia), the initial effects indicating their presence (odor or irritation) will occur below the threshold limit value (TLV).

Table IX-1. Safe and Hazardous Concentrations of Selected Chemicals, in Parts Per Million

Chemical	Minimum Effects (1-Hour Exposure)	Threshold Limit Value		IDLH	LEL
		Time-Weighed Average	Short-Term Exposure Limit		
Chlorine	1	0.5	1	10	NA
Ammonia	25	25.0	35	300	150,000

NOTE: Wear Level A when there is a chance that liquids are present.

(2) Based on hazard relationships—

- Never try to identify TIM through the senses (i.e., smell, touch).
- Don respiratory protection or immediately evacuate the area at the first sign of contamination (e.g., explosive concentration, flammable atmosphere, odor, skin irritation, physical symptoms) until the type and degree of the hazard are determined.

(3) For those chemicals that have an explosive hazard and a concentration that is immediately dangerous to life or health (IDLH) far below the lower explosive limit (LEL), leave the area immediately if the explosive meter limit reads anything other than 0.

c. Visual Indications of Concentrations Above IDLH.

(1) The reconnaissance of an NAI with potential TIM hazards poses a challenging situation. A team may not necessarily know that there is a hazard until it is detected; but by the time the hazard is detected, the team may have been exposed to a hazardous concentration. It is always safest to approach any potentially hazardous site in Level A PPE (see *Table IX-2*).

(2) Other control measures depend on the RA. For example, a reconnaissance team may use a combination of distance, shielding, and time (i.e., delay entry) as potential control measures for a radiological hazard. A backup team in Level A, or at least one level higher PPE than the entry team (with a self-contained breathing apparatus), should be dressed and ready to rescue the entry team before they enter the hot zone. Additionally, emergency decontamination should be available on site before the team enters the hot zone. Once at the reconnaissance site, the team may be alerted to a possible IDLH hazard and need to don Level A PPE. Some visual indications include—

- A vapor cloud.
- A large, damaged or leaking container or vessel.

Table IX-2. Protection Levels

Level of Protection	Equipment		Protection Provided
	Recommended	Optional	
A	<p>Pressure demand, full-facepiece, self-contained breathing apparatus or pressure demand, supplied-air respirator with escape self-contained breathing apparatus</p> <p>Fully encapsulating chemical-resistant suit</p> <p>Inner chemical-resistant gloves</p> <p>Chemical-resistant safety boots/shoes</p> <p>Two-way radio communications</p>	<p>Cooling unit</p> <p>Coveralls</p> <p>Hard hat</p> <p>Disposable gloves and boot covers</p> <p>Long, cotton underwear</p>	<p>Level A provides the highest available level of respiratory, skin, and eye protection.</p>
B	<p>Pressure demand, full-facepiece, self-contained breathing apparatus or pressure demand, supplied-air respirator with escape self-contained breathing apparatus</p> <p>Chemical-resistant clothing (overalls and long-sleeved jacket; hooded, one- or two-piece, chemical splash suit; disposable, one-piece, chemical-resistant suit)</p> <p>Inner and outer chemical-resistant gloves</p> <p>Chemical-resistant safety boots/shoes</p> <p>Hard hat</p> <p>Two-way radio communications</p>	<p>Coveralls</p> <p>Disposable boot covers</p> <p>Face shield</p> <p>Long, cotton underwear</p>	<p>Level B provides the same level of respiratory protection as Level A, but less skin protection. It is the minimum level recommended for initial site entries until the hazards have been further identified.</p>
C	<p>Full-facepiece, air-purifying, canister-equipped respirator</p> <p>Chemical-resistant clothing (overalls and long-sleeved jacket or hooded, one- or two-piece, chemical splash suit)</p> <p>Inner and outer chemical-resistant gloves</p> <p>Chemical-resistant safety boots/shoes</p> <p>Hard hat</p> <p>Two-way radio communications</p>	<p>Coveralls</p> <p>Disposable boot covers</p> <p>Face shield</p> <p>Escape mask</p> <p>Long, cotton underwear</p>	<p>Level C provides the same level of skin protection as Level B, but a lower level of respiratory protection.</p>
D	<p>Coveralls</p> <p>Safety boots/shoes</p> <p>Safety glasses or chemical splash goggles</p> <p>Hard hat</p>	<p>Gloves</p> <p>Escape mask</p> <p>Face shield</p>	<p>Level D provides no respiratory protection and minimal skin protection.</p>

- Strong or irritating odors.
- Victims.
- Dead plants or animals.
- Confined spaces (vapor buildup, oxygen deficiency).
- Highly toxic chemicals.
- Energetic or explosive materials.

NOTE: The required level of protection will be established by the commander.

(3) General safety precautions include—

- Having a plan.
- Knowing the capabilities and limitations of the crew and measuring equipment.
- Being cautious; treating materials as hazardous until proven otherwise; and approaching a site upwind, up-terrain, and upstream.
- Keeping a safe distance.
- Not rushing to victims' aid without PPE.
- Not touching, eating, smelling, or tasting unknown material or HAZMAT.
- Not assuming that a vapor is harmless because it has no odor.
- Not driving or walking through spills or clouds.
- Not eating, drinking, or smoking in the reconnaissance area.
- Eliminating all ignition sources (flames, sparks, catalytic converters).
- Preparing teams to dress out in Level A.
- Dressing out the backup team in Level A PPE or at least one level higher than the entry team.
- Setting up on-site emergency decontamination.
- Ensuring that properly functioning detection equipment (such as radiac equipment) is available.
- Using the buddy system.
- Planning for decontamination.
- Minimizing the presence in TIC/TIM environments.

5. Organization and Equipment

NOTE: The organization (personnel and equipment) of each team depends on the unit missions and capabilities.

a. Organization.

(1) Within each specialized team equipped to conduct TIM hazard reconnaissance, personnel should be fully trained in HAZMAT operations. Their abilities should include—

- Conducting dismounted operations in environments that are potentially contaminated by TIM hazards.
- Selecting and using proper instrumentation to detect and identify common TIM hazards.
- Wearing and maintaining the appropriate PPE, including a self-contained breathing apparatus and a positive-pressure, fully encapsulated, personal protective suit.
- Providing medical expertise in sampling and health hazard protection guidance and assistance by augmenting NBC detection teams with medical personnel.

(2) Dismounted reconnaissance elements should be organized into at least two-person teams to ensure personnel safety using the buddy system. Both team members will remain together throughout the dismounted reconnaissance operations.

b. Equipment.

(1) Additional equipment must be provided for a team to safely detect, identify, mark, report, and sample TIM hazards. The equipment includes chemical detection tubes and an explosive/flammable/oxygen meter to detect, identify, and possibly quantify TIC hazardous vapors. Additionally, the team must have an operating radiac meter with them when approaching the reconnaissance area because radiation cannot be detected with the senses.

(2) Team members are provided PPE specifically designed to protect them from the effects of TIC hazards. Air-purifying respirators must not be worn when an oxygen-deficient atmosphere is suspected or present.

(3) Reconnaissance teams are also provided with a soil, liquid, and radiological sampling kit and sorbent tubes to sample TIM. The following specialized equipment may be used when conducting TIM detection operations:

- **PPE and support equipment.** Level A protection must be available when conducting specific reconnaissance operations. The complete PPE for conducting TIM reconnaissance operations consists of Level A protection.
- **Communications equipment.** Members of the team must be able to communicate with each other and the safety monitor during dismounted reconnaissance operations.
- **Explosive/flammable/oxygen meter.** Teams must avoid explosive/flammable gases by using an instrument that detects their

presence. The team should also mark and report areas that have low concentrations of oxygen that would be hazardous.

- **Personal air sampler.** Team members can wear an instrument on the outside of their PPE to collect gas, vapor, and aerosol samples for subsequent analysis by the theater area medical laboratory or other medical/PVNTMED personnel.
- **HAZMAT kit.** Team members must be able to detect and identify TIM.
- **M34-series sampling kit.** Team members can take soil, water, vegetation, biological, and radiological samples using the M34-series sampling kit. This kit can be augmented with pipettes to perform liquid sampling.
- **Radiac set.** The team should use a radiac set to detect alpha, X-ray, beta, and gamma radiation.
- **Marking tape.** The boundary of a TIM hazard can be shown with colored banner tape, color-coded traffic cones, or color-coded light sticks. The standard military NBC hazard marking system **should not** be employed because it could be misconstrued to indicate that the hazard is a CB warfare agent, against which specific safety precautions must be taken.
- **TIM references.** References such as the National Institute for Occupational Safety and Health (NIOSH) *Pocket Guide to Chemical Hazards*, DOT *Emergency Response Guidebook*, and Field Manual (FM) 8-500 are used to identify the parameters and characteristics of TIC, the PPE requirements, and the appropriate actions to take in the event of encountering one of the listed TICs.

6. Operations

a. Tasks. Whether the NBC reconnaissance is in a combat environment to detect the presence of chemical agents or in a peacetime environment to detect the presence of TIM, the basic tasks remain the same. They are as follows:

- The presence of TIM must be detected so that potentially affected units can be warned of its presence and avoid the area.
- The TIM must be identified so that the proper precautions can be taken if contact is unavoidable.
- The area of the TIM must be marked to alert personnel and to define the limits of the hazard for follow-on remediation.
- The existence and parameters of the TIM should be reported as quickly as possible so that decisions about addressing the hazard can be made.
- The TIM samples should be taken so that laboratory analysis can be made.

b. Reconnaissance Missions. TIM reconnaissance missions include—

- **Route reconnaissance.** Used to obtain information about a specific transportation avenue or route of march.
- **Area reconnaissance.** Used to obtain information about a specific area, terrain feature, or location.
- **Zone reconnaissance.** Used to obtain information within a specific zone defined by boundaries.
- **Search.** Used to determine the presence of a hazard along a route or within a specified area. After encountering HAZMAT, it should be identified and its concentration (chemical) or intensity (radiological) determined. The search technique may be used when conducting a route, area, or zone reconnaissance.
- **Survey.** Used to characterize the hazard, including the limits of contamination, the quantity of the contaminant, and the conditions of the site.
- **Sampling.** Employed after a search has determined the presence of an agent. Sampling takes place before, during, or after a survey has been completed. Samples represent the contamination on the ground, in the air, at a specific point, or in a liquid. They may also represent the cumulative exposure of personnel to TIM.

c. **Reconnaissance Patterns.** Search patterns locate contamination, and survey patterns define the boundaries of contamination. See *Chapter VI* and *Appendix I* for further information on searches.

d. **Prereconnaissance Coordination.** Before executing a TIM reconnaissance operation, command guidance should include the—

- Boundary of the route, area, or zone to be reconnoitered. The boundaries represent the limit of possible hazards to unprotected personnel and serve as the point for donning PPE. Without a defined boundary, the mission to search for TIM may become too large to execute.
- Levels of PPE required.
- Turn-back dose rate.
- Location of decontamination station.
- Location and nature of medical support available.
- C2 relationships.
- Communication protocols

e. **PPE.**

(1) The decision tree shown in *Figure IX-1*, page IX-10, may be used to determine the appropriate level of PPE as follows:

- **No known hazard.** When no known hazard is expected to exist, PPE is not initially required; however, Levels A and C PPE will be available in case a HAZMAT is encountered. (The determination that no known hazard is expected to exist will be made by the NBC element.)

- **Expected, unidentified hazard.** When a hazard is expected to exist, but further information is unknown, reconnaissance personnel will wear Level A PPE.
- **Expected, qualified hazard.** When a hazard below the IDLH level is expected to exist and there is sufficient information to qualify the nature of the hazard, the commander must authorize the wear of PPE lower than Level A.

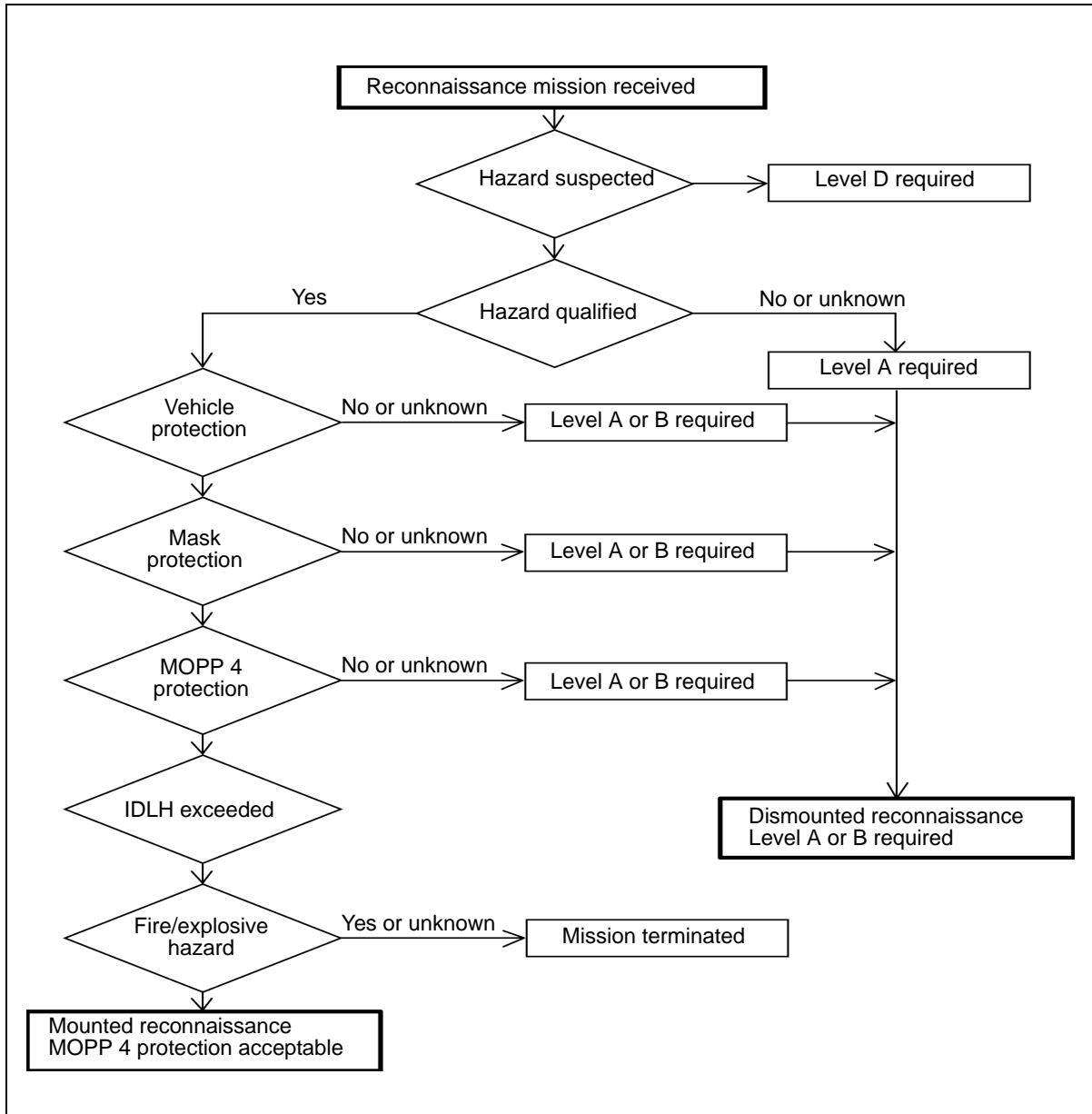

Figure IX-1. Levels of PPE

(2) If oxygen-deficient or explosive atmospheres, fire hazards, or high dose rate radiation fields are encountered, personnel should report the information and terminate the mission.

f. Searches. A search will begin at the limit of the possible hazard provided by the controlling headquarters and move in a pattern designated by the commander. When a hazard is detected, personnel complete the search mission and report the TIM and its location to the commander. During all searches, one surveyor continually monitors for the presence of oxygen-deficient and explosive atmospheres. If either of these conditions is present, the mission is terminated immediately. Additionally, one surveyor maintains a record of the TIM concentration. If the concentration exceeds the IDLH level, the search team exits the area immediately, dons Level A protection, and if necessary, conducts further operations.

(1) Dismounted Operations.

(a) Dismounted NBC reconnaissance search operations require more time and may be conducted downwind, upwind, or crosswind of the suspected area of contamination using the guidance provided in *Table IX-3*.

Table IX-3. Approach Selection Criteria

Approach	Selection Criteria
Upwind	Level A protection is required for the expected contamination. There is a large area of contamination. The air supply is the primary concern.
Downwind	Level C protection is adequate for the expected contamination. There is a small area of contamination. The air supply is of no concern.
Crosswind	Level C protection is adequate for the expected contamination. Less caution is required based on the expected concentration. There is a moderately sized area of contamination. The air supply is of no concern.

- Downwind (Figure IX-2, page IX-12.** The team remains mounted, if applicable, until reaching a point 100 meters downwind of the limit of the possible hazard (provided by the NBC center). At that point, the surveyors dismount, don the appropriate level of PPE, and initiate a search. An attempt to detect TIM should be made at 100- to 200-meter intervals along each leg of the search pattern. Using a downwind approach, the surveyors expose themselves to the minimum concentration of TIM before obtaining a qualitative detection of TIM. However, if the downwind hazard area is large (more than 600 meters), mobility restrictions imposed by the requirement to replace the self-contained breathing apparatus after 30 to 35 minutes will adversely affect the ability to perform a search of the entire downwind area. The mission is terminated after detecting TIM or upon reaching the location of the expected TIM release and detecting nothing.

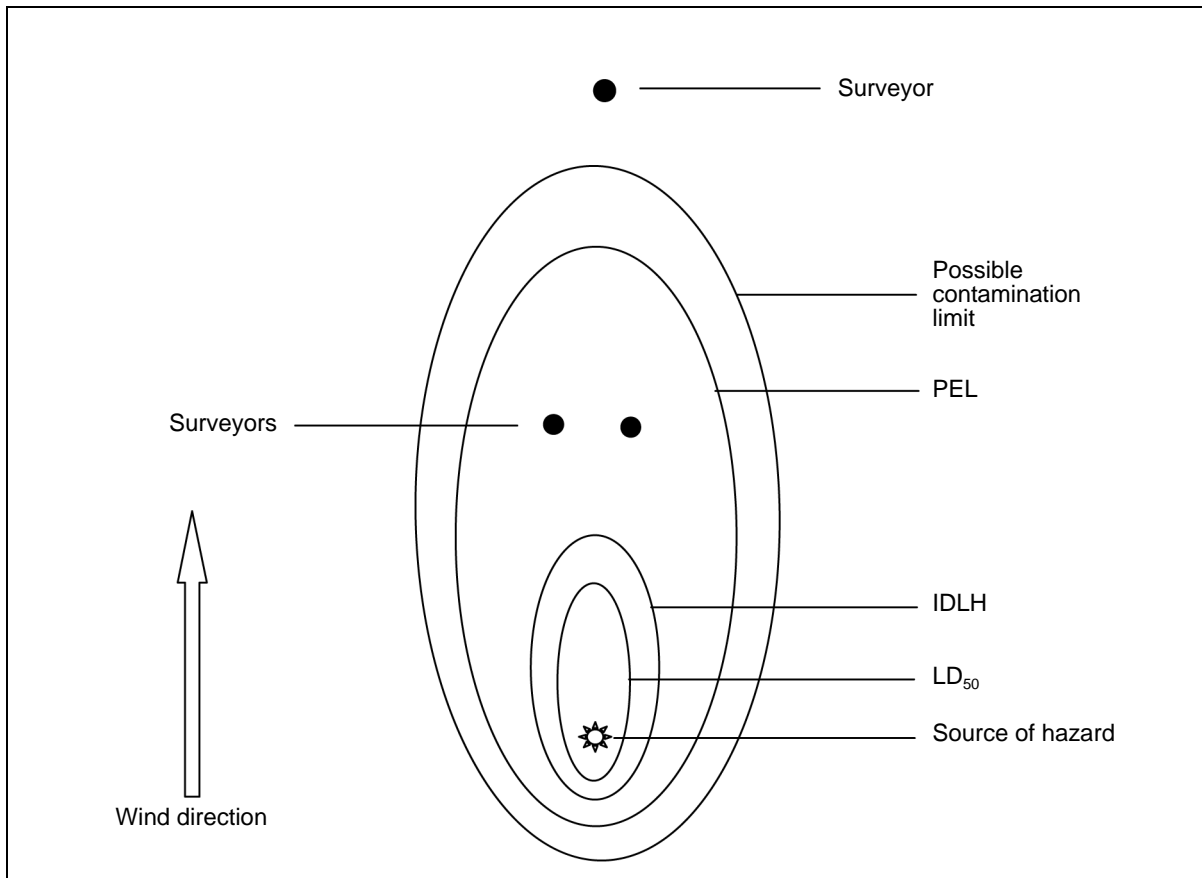

Figure IX-2. Downwind Search

- Upwind (Figure IX-3).** The team remains mounted, if applicable, until reaching a point 100 meters upwind of the limit of the possible hazard (provided by the NBC center). At that point, the surveyors dismount, don the appropriate level of PPE, and initiate a search. An attempt to detect TIM should be made at 100- to 200-meter intervals along each leg of the search pattern. Using an upwind approach, the surveyors will be initially closer to the center of the expected point of release (source) of the TIM. While they will be able to reach this point more easily, they will be at risk for greater contamination and exposure to the TIM, especially radiation. The mission is terminated after detecting TIM or upon reaching the expected source of the TIM and detecting nothing.

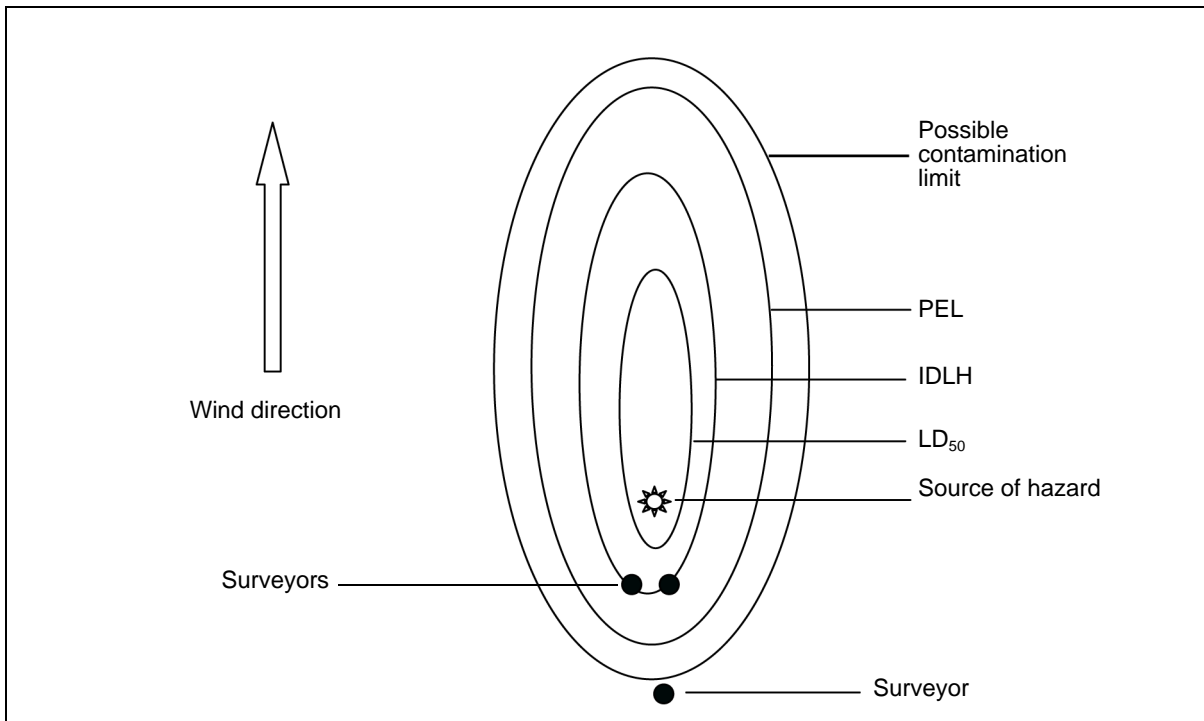

Figure IX-3. Upwind Search

- Crosswind (Figure IX-4, page IX-14).** The team remains mounted, if applicable, until reaching a point 100 meters from the limit of the possible hazard (provided by the NBC center). At that point, the surveyors dismount, don the appropriate level of PPE, and initiate a search. An attempt to detect TIM should be made at 100- to 200-meter intervals along each leg of the search pattern. Using a crosswind approach, the surveyors will be initially closer to the center of the expected point of release (source) of the TIM and will be at greater risk of encountering higher concentrations of the TIM. The mission is terminated after detecting TIM or upon reaching the expected source of the TIM and detecting nothing.

(b) Before conducting dismounted operations, a visual reconnaissance (with binoculars, if available) of the area should be accomplished from a safe distance. The area should be divided into sectors and the reconnaissance conducted in phases to minimize the burden of carrying all detection and identification equipment at once. The priority of effort should focus on conducting a visual inspection, performing an initial atmospheric assessment, taking and analyzing vapor samples, and using sampling kits to take liquid and solid samples as necessary.

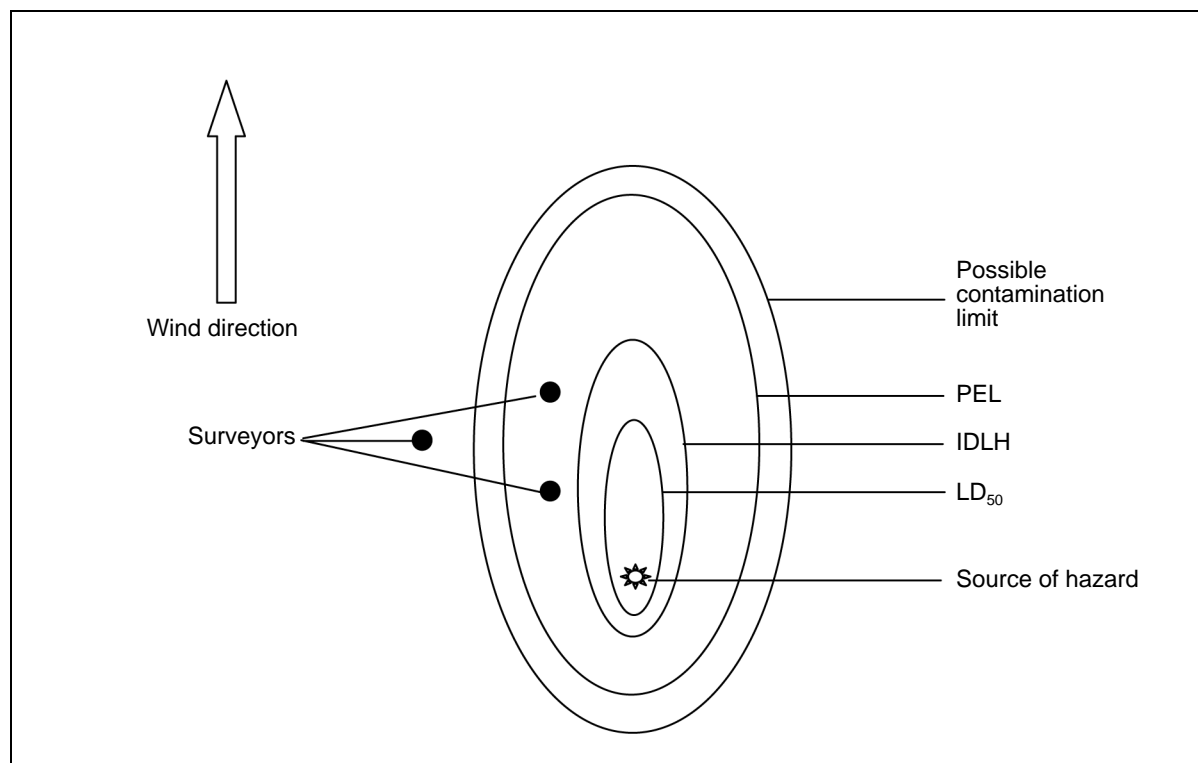

Figure IX-4. Crosswind Search

(c) After the initial detection, surveyors attempt to detect TIM at 200-meter intervals, proceeding in the direction of the expected source of contamination and using personal air samplers. Air samplers can be analyzed at a later time in a laboratory to determine if TIM may have been contacted. Radio communications and periodic communication checks should also be maintained.

WARNING
If any surveyor encounters difficulty (breach of PPE, malfunction of self-contained breathing apparatus), all surveyors should exit the area upwind as rapidly as possible.

(2) Mounted Operations.

(a) Mounted operations may be conducted when the presence of a TIM has been qualified, when TIM does not penetrate the collective protection of a vehicle, when TIM does not exceed the IDLH level, or when there is no indication that TIM is present. Mounted reconnaissance procedures differ slightly from those employed during combat operations.

(b) During mounted operations, the search begins 100 meters downwind of the limit of the possible contamination (provided by the NBC center). Surveyors should expect a very slow increase in contamination intensity (e.g., chemical and radiological) as the vehicle approaches the suspected point of TIM release. The mission is terminated upon contact with TIM.

(c) If unexpected TIM or TIM that exceeds the IDLH level is detected during a mounted search, the vehicle immediately exits the area via its entry route. Further search operations are conducted in the dismounted mode under the guidelines of searching for an expected, qualified or expected, unidentified hazard, depending on the information available.

g. Surveys. Surveyors move 100 meters downwind of the detection location and begin marking the area, employing the pattern directed by the commander. Upon completion, reports reflecting the boundary of the contamination (location of the contamination markers) are forwarded to the next higher authority. Surveys may be mounted or dismounted, based on the TIM identified and its concentration.

h. Samples. The team may be required to take air, soil, liquid, and wipe samples. The mission statement should specify if samples are required from only one location or from several locations within the contaminated area. All samples must be marked with the date and time the sample was taken, the sampling method, where the sample was taken, and the type of material contained in the sample.

7. Dos and Don'ts

Adhere to the following dos and don'ts during TIM operations:

- **Dos.**

- „ ALWAYS prepare a plan before conducting a reconnaissance of a potentially contaminated site.
- „ ALWAYS ensure that all members of the reconnaissance team understand the plan.
- „ ALWAYS ensure that emergency support elements (medical support) are ready to support the reconnaissance operation if needed.
- „ ALWAYS know the capabilities and limitations of the crew and equipment.
- „ ALWAYS treat material as hazardous until proven otherwise.
- „ ALWAYS have a safety monitor (in Level A PPE) available to assist the two-person reconnaissance team in case of an emergency.
- „ ALWAYS be alert for visual indications of possible safety hazards.
- „ ALWAYS evaluate the amount of personal protection required. If unsure, use Level A with self-contained breathing apparatus.
- „ ALWAYS analyze all available information.
- „ ALWAYS use a toxic gas detector when entering a potentially contaminated area.
- „ ALWAYS eliminate all ignition sources (e.g., flames, sparks, catalytic converters) in areas potentially contaminated with TIC.
- „ ALWAYS use the buddy system (have teams of two or more members).
- „ ALWAYS plan for decontamination.

- ALWAYS approach a potential radiological hazard with a properly operating radiac meter, and be alert for changes in the meter readings.
- **Don'ts.**
 - NEVER rush to the aid of victims without donning adequate PPE.
 - NEVER enter a confined space (tank, basement, well, sewer, closed rail car, or another area with inadequate ventilation) where the possibility of toxic gas or insufficient oxygen exists.
 - NEVER touch, eat, smell, or taste unknown materials.
 - NEVER open a sealed or closed bulk container to see what is inside or to take a sample.
 - NEVER drive or walk through unidentified spills or vapor clouds.
 - NEVER touch or attempt to move UXO.
 - NEVER conduct a TIM reconnaissance alone.

Appendix A

OPERATIONS IN SPECIAL ENVIRONMENTS

1. Background

Each of the following environments has a different influence on NBC reconnaissance operations:

- Mountain.
- Jungle.
- Desert.
- Arctic.
- Urban.
- Littoral.
- Subterranean.

2. Mountain Environment

a. Excluding extremely high, alpine type mountains, most mountain systems are characterized by—

- Heavy woods or jungle.
- Compartments and ridge systems.
- Limited LOCs, usually of poor quality.
- Highly variable weather conditions.

b. NBC reconnaissance elements concentrate on low terrain for persistent chemicals and on prominent terrain features for radiological hot spots produced by fallout. NBC attacks could be delivered aurally by munitions or ballistic missiles. Chemical agents are heavier than air and will settle in valleys and depressions. Subject to a mountain breeze, agents will move down and within the valley. Due to the general lack of cloud spreading, high dosages are difficult to obtain on crests and sides of ridges and hills. However, crosswinds on mobility corridors could possibly carry CB agents into an adjacent valley.

c. The thermal radiation produced by a nuclear weapon can make up 40 percent of the energy output of the weapon. This wave of heat can be affected by terrain and air density, producing differential heating. The thermal pulse produces fires in leaves, brush, and trees and creates avalanches and rock slides in appropriate areas. Contamination from the weapon and ground debris swept up in the fireball produced by a blast near or at the ground surface is strongly affected by local heating and sustained weather patterns, including winds and precipitation.

3. Jungle Environment

a. Jungle canopy and vegetation help shield the soldier from the most immediate danger from blast and thermal pulses. However, the same is not true for prompt radiation or the activation products that develop in the dense air and foliage of the jungle.

b. Tropical climates require the highest degree of individual discipline and conditioning to maintain effective NBC reconnaissance. Leaders must ensure that unit NBC defense equipment is maintained in a usable condition. Rapid mildew, dry rot, and rust can occur in jungle areas.

c. High, constant temperatures; heavy rainfall; and very high humidity dominate the climatic features of jungle areas. These features can increase the survivability of biological agents. In a thick jungle, there is usually little or no wind and the canopy blocks most of the sunlight from the ground, thus providing excellent conditions for threat use of biological agents.

d. The same canopy that provides some shielding from radiation may also enhance the blast effect by blowing down trees and creating projectiles. In addition, the lack of penetrating wind results in decreased downwind hazards. Rains can wash radiation into water collection areas and produce a hot spot.

e. The jungle canopy creates good overhead cover from aircraft spray. Persistent agents delivered by artillery or bombs that penetrate the canopy before being released can create a hazard in the immediate area of impact.

f. Due to hot, humid conditions prevalent in jungle environments, frequent work breaks and MOPP level reduction is necessary. Unfortunately, the jungle environment tends to make chemical agents more persistent and more effective in producing casualties.

4. Desert Environment

a. Deserts are semiarid and arid regions that contain a variety of soils in varying relief. They are characterized by—

- Extreme temperature ranges during a 24-hour period.
- Changing visibility conditions.
- Long periods of drought.
- Shortage of suitable groundwater.
- Large areas of excellent trafficability that are interspersed by ravines, bogs, and sand seas.
- The absence of pronounced terrain features.

b. Contamination found in a desert may become covered up and then suddenly reappear because of shifting sands. Once an area has been contaminated, it should be periodically monitored. Immediate radiation, blast, and thermal pulse in the desert environment is rapid and unattenuated by natural barriers or dense, moist air. Uniform heating of the environment produces a symmetrical pattern around the detonation point.

With weapons of lower output, weapon fragments and earth taken up in the fireball will not fall far from the detonation zone.

c. Extreme temperature ranges and soil compositions found in the desert complicate reconnaissance operations. The high temperatures during the day inhibit personnel movement in high MOPP levels and can cause malfunctions in equipment and detectors being used outside their usual operating ranges. The relative lack of cover and concealment in desert terrain makes security a problem during daylight operations. As a consequence, night may become the usual time for NBC reconnaissance operations, even though the lack of light complicates the reading of chemical detection paper and kits. Soil composition can adversely affect detection capabilities of an NBCRS since liquid contamination is absorbed by the soil. Further, the NBCRS must be operated with the air conditioner on in hot temperatures to prevent damage to onboard equipment. The system will operate effectively for 1 hour with the air conditioner turned off.

5. Arctic Environment

a. Arctic and subarctic regions comprise about 45 percent of North America and 65 percent of Europe. They are characterized by—

- Extreme cold and deep snow during the winter months.
- Spring breakup, which results in poor trafficability.
- Whiteout conditions, which effect depth perception and visibility and make flying and driving hazardous.
- Ice fog, causing clouds of ice crystals to cover personnel, vehicles, bivouac areas, and permanent facilities.

b. When temperatures fall below 0°C, reconnaissance elements may have difficulty operating and maintaining their equipment. Furthermore, toxic chemicals react differently at extremely low temperatures. For example, blister agents (such as distilled mustard, phosgene oxime, and mustard-lewisite mixture) become solids well above the freezing point of water. Persistent agents contained in munitions can become more persistent at low temperatures.

c. In cold weather, additional measures may be called for in applicable equipment TMs and TOs. For example, chemical detection and identification kits cannot detect solid agents. It may be necessary to take soil, snow, or vegetation samples from suspicious areas and warm them to detect and identify chemical agents.

6. Urban Environment

a. Urban areas often contain confined spaces (such as sewers, storm drains, subways, and basements) that present a hazard (i.e., an oxygen-deficient or explosive atmosphere, heavier-than-air chemical agents or compounds). Chemical agents tend to act differently in urban areas (collect in low areas, drift into buildings, and seep into piles of rubble). The persistency of chemical agents can also increase after settling in these areas. Monitoring and survey teams must thoroughly check areas before attempting to occupy or traverse them.

b. The stable environment of an urban area may increase the persistency of biological agents. Personal hygiene becomes very important. Leaders must establish and

consistently enforce sanitary and personal-hygiene measures, including immunizations. Leaders must ensure that all personnel eat safe food, drink safe water, and never assume that local food and water are safe.

c. Although not a terrain feature, the population density of an urban area must be considered. The potential exists of encountering a large number of contaminated, panicked, and injured personnel.

d. Urban areas can be susceptible to threat use of TIM as a weapon, especially if there is a sizable chemical industry, storage, or transportation (i.e., railroad switching yard, truck terminal, waterway, or canal) facility associated with the area. Units should be aware of this potential hazard and the types of TIM that they may encounter.

e. Urban areas can make hazard predictions less accurate. Shifting winds might contaminate buildings and the areas around them, but leave an adjacent area relatively free of contamination. Units should check areas (such as basements) that they plan to occupy, even if only for a short term.

f. Nuclear or radiological hazards produce difficult choices for operations in urban environments. Radiation may be masked or attenuated by barriers until a unit is too close to be considered safe. Fast-moving operations through an area containing radiological hazards often progress more quickly than some instruments can respond to the presence of radiation. Building surfaces may allow radiological hazards to radiate in place until they are moved by the wind or water. Buildings may also shield, scatter, or reflect radiation. Surface streets will likely absorb the direct thermal energies of the detonation, causing the streets to rupture and possibly igniting or sparking underground utilities. Building materials will become activated and may remain so for a long time following weapon detonation.

7. Littoral Environment

a. During operations in littoral areas, multiple considerations can impact NBC reconnaissance operations. For example, land and sea winds occur almost daily in tropical and midlatitude regions on the coast of islands and continents. They occur because the land cools and heats more rapidly than the adjacent water (i.e., winds blow toward the water in the morning and toward the land in the evening). Therefore, the commander must be concerned about an offshore vapor or aerosol point or line source release and provide NBC reconnaissance support from the AA.

b. To support port operations, planners must be aware of the impact of meteorological and fresh/salt water conditions on NBC reconnaissance assets that are used by land and maritime components. They must also consider the potential impact of interferences on NBC reconnaissance capabilities.

8. Subterranean Environment

a. Subterranean areas (such as caves) can present a hazard. Chemical agents tend to act differently in caves, collecting in the low areas. The persistency of chemical agents can also increase after settling in these areas. Monitoring and survey teams must be thoroughly prepared before checking these areas.

b. The stable environment of a subterranean area may also increase the persistency of biological agents. Leaders must be aware of a possible oxygen-deficient or explosive atmosphere, heavier-than-air chemical agents, or TIM.

Appendix B

STANDING OPERATING PROCEDURES

Figure B-1 shows a sample outline for an NBC reconnaissance unit NBC SOP.

- 1. COMMAND AND CONTROL.**
 - Teams organization and responsibilities.
 - Work-rest cycles (personnel scheduling rotations).
 - SRC operations.
 - NBC control center operations.
 - Unit control center operations.
 - Reports and reporting requirements.
 - CCA operations.
 - Hydration standards and feeding.
 - Safety.
 - Security.
 - Classified material protection.
 - Chain of custody.
 - Orders.
 - OEG.
- 2. COMMUNICATIONS.**
 - Security.
 - Equipment (phones, radios, sirens, public address systems with loud speakers, flags).
 - Procedures.
 - Alarm conditions.
 - Signals.
 - Call signs and procedures.
- 3. LOGISTICS.**
 - Security.
 - Safety.
 - Weapons.
 - Vehicles (load plans).
 - NBC equipment.
 - Resource dispersal and replenishment.

Figure B-1. SOP Outline

- Shelters, bunkers, revetments, defensive fighting positions.
- Road march.
- HSS (e.g., medical evacuation).
- Casualty collection points.

4. SECURITY.

- Operations.
- Physical protection and FP.
- Communications.
- Duress codes.
- Arming and weaponry.
- Active and perimeter defense.
- Base denial.
- Intelligence.
- RA.
- Site surveys.
- Hazards analysis.
- Vulnerability analysis.
- Preattack checklists.

5. OPERATIONS.

- Security.
- Safety.
- NBC survey.
- NBC zone, route, and area reconnaissances.
- Sampling operations.
- Codes.
- Active and passive indicators.
- Contamination avoidance and control (i.e., cross or bypass a contaminated area).
- Blackout procedures.
- Reports.
- UXO.
- Casualties.
- Contaminated area marking and identification.
- MOPP levels.
- First aid.
- Movement through and around contamination.
- Laws of armed conflict.
- Precombat checks.

Figure B-1. SOP Outline (Continued)

- Actions in assembly areas.
- Medical support (deploy with essential medical prevention and protection measures [e.g., pretreatments, barrier creams, prophylaxis] as directed by competent medical authority).
- Recovery operations.
- Consolidation and reorganization checklist.

6. APPENDIXES.

- Organizational clothing and individual equipment.
- Air defense.
- Fire support and call for fire.
- Safety.
- Operational terms.

Figure B-1. SOP Outline (Continued)

Appendix C

UNIT CHECKLIST

Figure C-1 is a sample NBC reconnaissance unit checklist.

1. Determine the minimum amount of information required to conduct the reconnaissance mission. This information can be extracted from the controlling headquarters OPORD.
 - r Enemy situation.
 - r Friendly situation.
 - r Supported unit mission.
 - r Supported commander's intent.
 - r C2.
 - r Mission.
 - r Logistics support.
 - r Signal.
 - r Security support.
 - r MOPP level, OEG, and correlation factor.
 - r Support unit.
2. Determine the type of reconnaissance missions or tasks to be conducted.
 - r Route.
 - r Zone.
 - r Area (may require checking a specific point within the assigned area).
 - r Survey.
 - r Search.
 - r Surveillance.
 - r Sampling.
3. Determine how many vehicles will be required for the mission.

Figure C-1. Sample Unit Checklist

4. Determine the required actions at the contaminated area.
 - r Identify or verify the presence of contamination.
 - r Mark the contamination.
 - r Report the contamination.
 - r Locate bypass routes (which sides).
 - r Find the shortest route across the area.
 - r Continue to place markers at selected intervals.
 - r Collect samples.
 - r Continue the mission.
 - r Remain and assist units in avoiding the contaminated area.
5. Analyze the reconnaissance mission.
 - r Type of search technique.
 - r Intervals for samples and readings.
 - r Mounted or dismounted.
6. Determine the type of search or survey technique that is required.
7. Assess the chain-of-custody requirements.
 - r Identify the sample transfer point location.
 - r Provide reports.
 - r Request information on who assumes custody.
 - r Request information on the coordination required with the supporting lab, if required.
8. Determine the logistics requirements.
 - r Decontamination point location.
 - r Routes for contaminated or uncontaminated vehicles.
 - r Signals to identify a vehicle as contaminated (e.g., lights on).
 - r Source for CSS (e.g., supply, maintenance, services).

Figure C-1. Sample Unit Checklist (Continued)

Appendix D

INTELLIGENCE PREPARATION OF THE BATTLESPACE

1. Background

This appendix provides planning considerations to support the integration of NBC reconnaissance through the four steps of the IPB process.

2. Define the Battlespace Environment

The battlespace environment is defined by—

- Identifying the limits of the command AO and battlespace. The AO is the geographical area where the commander is assigned the responsibility and authority to conduct military operations. The battlespace environment can extend back to CONUS and could be impacted by terrorist or nation state use of CBRN weapons.
- Identifying the limits of the AOI. The AOI is the geographical area from which information and intelligence are required to permit planning or successful conduct of the commander's operation. Sources of information may include other federal agencies (e.g., State Department, national level intelligence agencies) operating within the AOI who may have information that will help support the commander's overall SA.
- Identifying the amount of detail required and the amount feasible within the time available. The time available for completion of the IPB process may not permit the luxury of conducting each step in detail. For example, the NBC and medical staffs must realize the time sensitivity of critical information, such as the time from the exposure of personnel to a biological agent until the onset of symptoms.

3. Describe the Battlespace Effects on Threat and Friendly Capabilities

This is accomplished by analyzing the battlespace environment. The information supports the conduct of friendly vulnerability assessment (VA), and the evaluation begins with an analysis of the existing and projected conditions of the battlespace environment. During the evaluation, multiple considerations are evaluated. Planners identify characteristics of the battlespace that could affect friendly target vulnerability, influence the commander's decisions, or affect the COA available to US forces.

a. Terrain Analysis.

(1) The terrain analysis reduces the uncertainties regarding the effects of natural and man-made features on friendly NBC operations. It focuses on the military aspects of the terrain, including—

- **Observation and fields of fire.** Observation is the influence of terrain on reconnaissance, surveillance, and target acquisition

capabilities. A field of fire is the area which a weapon or a group of weapons may cover effectively with fire from a given position.

- **Cover and concealment.** Planners identify the cover and concealment that may be available to preclude possible targeting by an adversary.
- **Obstacles.** Planners identify the obstacles (natural and man-made) that may be used by an adversary with capabilities (such as persistent chemical agents) to impede or delay the advance of US forces.
- **Key terrain.** Key terrain is any feature or area that would offer a marked tactical advantage if an adversary seized it or gained control of it.
- **AA.** An AA is a route by which a force may reach key terrain or an objective. NAIs along an AA that an enemy may target with NBC weapons are also identified.

(2) The terrain analysis is conducted as follows:

- The terrain is evaluated through a map analysis supplemented by NBC reconnaissance.
- Terrain factor overlays are developed and analyzed, including the identification of contaminated areas.
- Combined-obstacle overlays are developed.
- AAs are identified and analyzed.
- AA overlays are developed.

(3) Terrain analysis examines the potential impact of factors on contaminants. Contamination hazards depend on the ground conditions encountered. For example, the surface and soil type affect how readily a chemical agent is absorbed into the soil. The type of surface also affects the persistency of chemical agents. Even though the actual operational environment is a combination of conditions, looking at the following general conditions separately will give an indication of what to expect:

- **Sand.** Sand is generally any surface that has a large amount of sand (such as a beach), and it normally has good drainage. When chemical agents are applied to this surface, they tend to be drawn into the subsurface, lowering the quantity of contamination available for liquid detection.
- **Soil.** Soil is generally any surface that contains quantities of clay and loam. Depending on the relative amount of each soil component, chemical agents react differently. Normally, some percentage of the agent is absorbed into the subsurface (until saturation).
- **Grass.** Grass is generally any surface covered with a layer of grass, from a few centimeters to a half meter in height. A portion of the chemical agent remains on the grass, while the rest is absorbed into the underlying soil. The chemical agent on the grass is available for liquid detection.

- **Mud.** Mud is generally any surface saturated with water, resulting in muddy conditions. The amount of persistent agent that can be absorbed by wet soil is inversely related to the water content of the soil (such as the more water, the less chemical agent absorbed). Under this condition, chemical agents remain on the surface longer, thus increasing the probability of detection.
- **Artificial surfaces.** Artificial surfaces (such as concrete and wood) are porous. Liquid agents are absorbed over time. The surface may initially present a contact hazard and later present a vapor hazard during agent off-gassing.

(4) The more absorbent the soil, the less liquid remains on the surface. This decreases the probability of detection by M8/M9 detector paper. The smoother and harder the surface, the higher the probability of detection with an NBCRS. When the NBCRS is detecting on rough surfaces, the sampling wheel tends to bounce, decreasing the probability of detection. On soft or porous surfaces, the ability of the NBCRS to detect contamination can be improved by stopping to lower the probe near the surface. The heated probe causes absorbed chemical agents to vaporize. The vaporized agent can then be analyzed by NBC reconnaissance assets.

b. **Weather Analysis.** Weather in the AO is analyzed to determine its effects on friendly and threat operations. The operational and tactical environments require that weather and terrain be considered simultaneously and developed as an integrated product. Weather and terrain can be graphically portrayed to indicate the possible impact of NBC weapons within an AO. For example, weather conditions influence the persistency of liquid contamination. Such contamination is detected in two ways—as a vapor (as it evaporates) or by physical contact. As wind speed and temperature increase, the evaporation of liquid contamination increases. This means that there are more vapors present to detect, thus increasing the probability of detection. The following factors should be considered when analyzing weather aspects:

- Wind speed and direction can impact the downwind travel and hazard areas associated with NBC agents.
- Atmospheric stability can play a key factor in the analysis of when an adversary may use NBC weapons.
- Temperature and humidity have a direct impact on the performance of personnel and equipment. Temperature extremes and humidity reduce the capabilities of personnel and equipment and may require the use of special personnel shelters or equipment.

c. **Other Analysis.** This includes all aspects of the battlefield environment that affect friendly or threat COAs not already incorporated into terrain and weather analyses.

4. Evaluate the Adversary

Threat evaluation is a detailed study of threat forces, their composition and organization, tactical doctrine, weapons, equipment, and supporting systems. Threat evaluation determines threat capabilities and limitations and how the threat would fight if not constrained by weather and terrain. Evaluate the adversary by—

- Identifying threat capabilities.
- Identifying gaps in the current intelligence holdings.
- Creating or updating threat models.
- Creating templates.

a. **Identifying Threat Capabilities.** Threat capabilities are broad COAs and supporting operations used by the threat to influence the accomplishment of the friendly mission. Planners use intelligence information to assess possible enemy offensive NBC capabilities and to assess the potential impact of agent use.

b. **Identifying Gaps in the Current Intelligence Holdings.** Planners describe the prioritization of gaps in the current holdings on enemy offensive NBC capabilities using the commander's initial IR. The early identification of gaps allows planners to initiate action to collect the NBC intelligence required to fill the gaps.

c. **Creating or Updating Threat Models.** Threat evaluation is performed by knowing the threat and using decision support tools that would portray how enemy NBC weapon use could impact the AO. The use of models and other automated decision tools provides a means to assess the potential footprint for an enemy attack. For example, the NBC and intelligence sections coordinate and determine how an adversary may use his capability to get the best spread of agent on the target. There are multiple factors to consider, including weapon fusing, direct or indirect delivery of the agent to the target, downwind hazard estimates, contamination deposition patterns, the TBM threat, radiological hazards, and TIM hazards.

(1) **Weapon Fusing.** Weapon fusing affects when a munition detonates. For example, if a munition detonates at ground level, it deposits most of the agent in the shell crater, minimizing the contaminated area. When munitions burst above the target, wind speed and direction directly influence the spread of the agent. As a munition bursts, the heavier droplets fall faster and the smaller ones drift downwind. The most heavily contaminated area is near the attack area. The chemical agent radiates in a bell shape in the direction of the wind, creating a contamination *footprint*. A unit conducting NBC reconnaissance has a higher probability of detecting contamination when traveling crosswind to the footprint. The higher the concentration of the agent, the higher the probability of detection. The concentration of the agent on the ground depends on the type of agent, the time since delivery, the delivery method, and the type of ground surfaces.

(2) **Delivery of the Agent.** Delivery of the agent may be direct or indirect. Indirect (off-target) delivery is generally upwind of the target area, and the resulting aerosol/vapor cloud or spray stream drifts onto the target. Direct or indirect types of attack can be delivered from a bursting munition or from a spray device. A radiological dispersal device (RDD) can also use a spray device. Munitions or spray tanks can be filled for dissemination as—

- A finely divided powder in aerosol suspension.
- Liquid splashes or droplets or as a finely divided liquid in aerosol suspension.
- A volatile liquid that quickly evaporates into a vapor when released as an aerosol (explosively or from a spray).

NOTE: Solid agents are unlikely to evaporate quickly enough to form a vapor, although frozen liquids will evaporate when the temperature rises.

(a) **Bursting Munition.** A bursting munition has a thin outside layer filled with an agent; the agent is dispersed by an air or ground burst. An airburst covers a large area; a ground burst impacts directly on the target. In a ground burst, the explosion drives some of the agent into the crater, where it can persist and remain a hazard (vapor, percutaneous, or ingestion). The types of munitions used are point source and multiple point source.

- **Point source.** A point source munition disseminates an agent from a single point. Delivery can be an air burst, a surface burst, or a penetrating round. A massive chemical bomb delivered by aircraft, missile, or artillery shell is an example of a point source delivery.
- **Multiple point source.** A number of point source munitions are distributed in an irregular pattern over a target area. Each point source munition spreads the agent as an aerosol or a vapor that merges with other aerosols and vapors downwind. Cluster bombs and multiple rocket launchers are examples of multiple point source delivery systems.

(b) **Spray Device.** Spray devices release chemicals from storage tanks or from containers carried by systems, such as aircraft, submarines, patrol boats, missiles, and other vehicles. The degree of dispersion is varied, thus influencing the duration of effectiveness. Spray device delivery is characterized as a *line source*, which simply means that it disseminates agents along a line of release. An aircraft spray system (internally or externally mounted) is an example of a line source delivery system.

(3) **Downwind Hazard Estimates.** Downwind hazards from biological weapons have a significantly larger potential area of effect than chemical weapons. If weather conditions are optimal, a downwind hazard can extend to a few hundred kilometers. The quantities required for BW are small compared to those required for chemical weapons, and BW agents can be disseminated crosswind with few, if any, indications of hostile intent. Key variables that affect the downwind hazard area include weather, terrain, the type of agent, particle size, and the type of delivery system.

(4) **Contamination Deposition Patterns.** Contamination deposition patterns could result from a bursting artillery attack (*Figure D-1*, page D-6). The sample surface contamination pattern provides the basis for some general conclusions as follows:

- Agent deposition generally radiates in a bell shape in the downwind direction.
- The heaviest concentrations usually occur closest to where the warhead functions.
- The deposition of the agent is uneven. Deposition concentrations generally decrease in crosswind directions from the downwind path of the agent.
- The contamination deposition footprint lessens over time, and the concentration levels decrease.

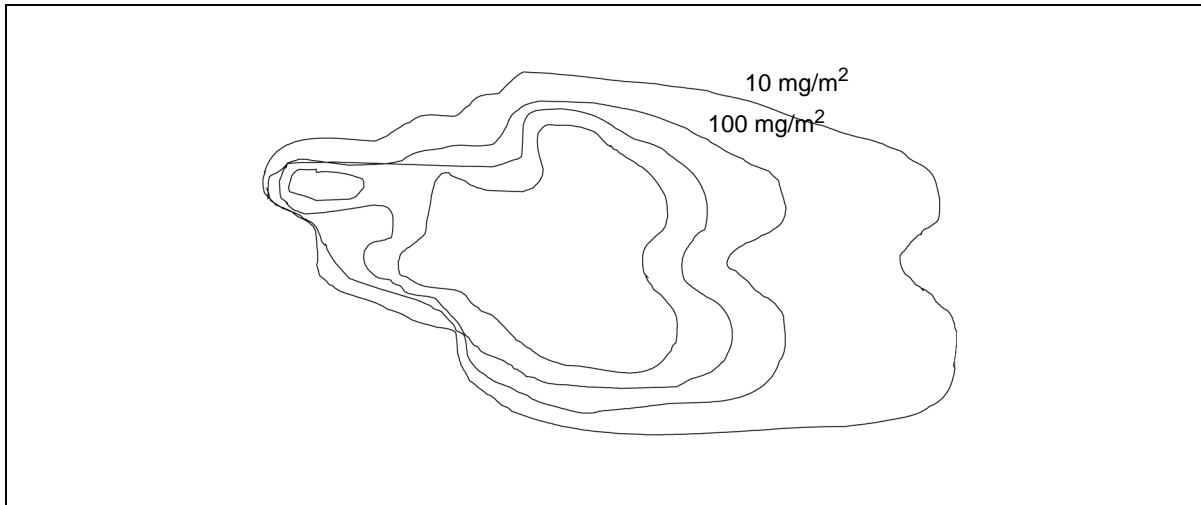

Figure D-1. Sample Contamination Footprint for a Liquid-Agent Artillery Attack

(5) TBM Threat.

(a) TBMs have unique characteristics that must be considered when planning defensive actions. For example, no other target system can put a warhead into the theater rear area or threaten neutral countries within a matter of minutes. Airburst warheads from a TBM provide effective area coverage and dispersion patterns for CB agents. When released at optimal burst heights, agents fall to the ground within 5 to 60 minutes (*Figure D-2*) in the direction of the prevailing wind.

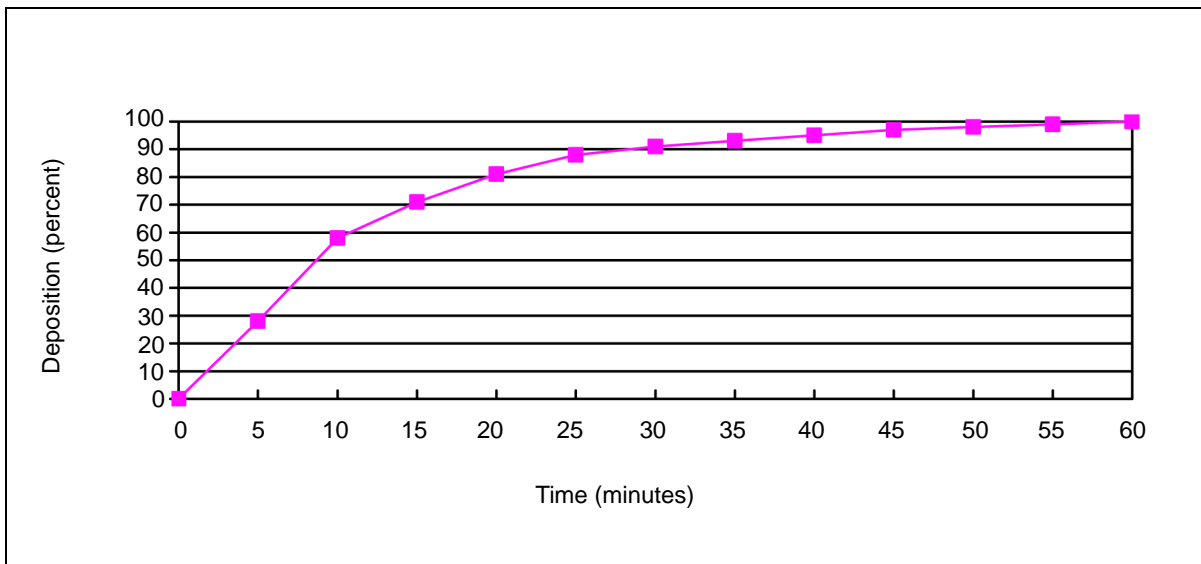

Figure D-2. Airburst Warhead Deposition Time (Notional)

(b) Large agent droplets or solids fall more quickly; small droplets fall further downwind at a slower rate. Similarly, the vapor released as these agents evaporate moves from the point of release toward the ground in a downwind direction.

(c) Secondary threats may also exist during and after some TBM attacks. TBMs may have warheads that do not separate from the missile body until the warhead functions or the missile hits the ground.

(d) In addition to the explosive, chemical, or biological hazards, the missile may impact a building or create a crater. When this happens, the impact site may contain hazards from the remaining missile fuel and oxidizer or from the facility or structure the missile hits (e.g., fuel, power lines, munitions). Depending on the quantity remaining, the residual fuel and oxidizer (red, fuming nitric acid) can cause M8 detector paper to falsely indicate the presence of chemical agents or to mask the presence of an agent.

(6) Radiological Hazards. Radiological hazards can include alpha, beta, and gamma radiation that must be considered when planning reconnaissance missions. The threat to US forces could include the radiological hazards from nuclear facilities, radiological dispersion, improvised nuclear devices, sealed sources, reactor fuel production, or luminescent military commodities.

(a) Nuclear Facilities. Nuclear facilities may release radioactive material to the environment as a result of an attack on the installation, sabotage, or an accident (e.g., Chernobyl). A damaged reactor can release large amounts of radioactive material, composed of many different radionuclides, over an extended period of time. Radioactive materials of concern include noble gases, halogens (radioiodines), mixed particulate fission products, and transuranics (e.g., uranium and plutonium). Consequently, forces downwind from an incident may face the possibility of external and internal exposure over a large affected area and for an extended period of time. The hazard posed by internal exposure to radiation is radionuclide-specific. Therefore, estimates of an effective dosage (i.e., the dosage from internally deposited nuclides) highly depend on the identification and quantification of the environmental contamination, particularly airborne contamination.

(b) Radiological Dispersion. Radiological materials are used in many industrial, research, and medical applications and are increasingly available. Dispersal falls into two categories—simple radiological dispersal and RDDs.

- **Simple radiological dispersal.** Simple radiological dispersal could be any dissemination of radioactive material other than that produced by a nuclear explosive device. It is specifically designed to cause damage, injury, or area denial by means of the radiation produced following dissemination. For example, an adversary could create a perceived or real health threat by securing a supply of radioactive material from a medical lab, an industry, or another site and dispersing the material into the public water supply or via an aircraft over a troop staging area.
- **RDD.** An RDD can be defined as any device (including a weapon or equipment) other than a nuclear explosive device that is specifically designed to disseminate radioactive materials to cause damage, injury, or area denial via the radiation produced by decaying radionuclides in the material. The use of the explosive or incendiary, mixed with radioactive materials, could create an incident in which the initial explosion would kill persons in the immediate vicinity of the device. The

radionuclide decay would continue to threaten first responders and others near the incident site.

(c) **Improvised Nuclear Devices.** A nuclear detonation is the sudden release of energy from nuclear fission or fusion. The prompt, initial radiation poses a severe external radiation hazard, while fallout poses serious external and internal radiation hazards. The radioactive material produced by a nuclear explosion is composed of the same fission products as those from a reactor accident and may also include activation products produced when neutrons from the fission interact with the surrounding environment. Plutonium and/or uranium not fissioned during the nuclear reaction will also be dispersed by the explosion. Because of the large amounts of energy released from a nuclear explosion, the plumes of fallout and airborne contamination can impact massive geographic regions.

(d) **Sealed Sources.** It is conceivable that personnel may enter areas where radioactive materials have been left (intentionally or unintentionally). Breakdown in normal control mechanisms, collateral damage caused by combat, or malicious use by adversaries able to acquire medical or industrial sources of radioactive material could result in significant radiation dosages to forces. Sealed sources, by definition, are designed to contain radioactive material inside (e.g., radioactive gases in glass vials, radioactive powders double-encapsulated in stainless steel, metal impregnated with radionuclides and then encapsulated). When such sources maintain their structural integrity, they pose an external exposure hazard from the penetrating radiation (neutrons or gamma rays). However, when the integrity of a source is compromised, the source can present a contamination problem and an internal hazard from the nonpenetrating radiation (beta or alpha particles). Commonly found, sealed sources that may pose a significant gamma radiation exposure hazard include iridium-192 industrial radiography sources, cobalt-60 medical teletherapy sources, and cesium-137 calibration irradiator sources.

(e) **Reactor Fuel Production.** Uranium is a naturally occurring, low-level radioactive metal that has many civilian and military applications. Natural uranium metal is processed by the nuclear-power industry to produce uranium enriched in the isotope uranium-235, which is then suitable for use as nuclear reactor fuel. The inadvertent release of reactor fuel (e.g., terrorist incident) could cause exposure to gamma and beta radiation.

(f) **Luminescent Military Commodities.** Tritium is widely used in the military to create self-luminescent displays on compasses, weapon sights, and other items. Tritium is also used in some nuclear devices. Generally, exposure to this nuclide is not a serious threat because tritium is a very low-energy beta emitter that disperses quickly in the environment if released. As a low-energy beta emitter, it is an internal exposure concern. Tritium detection requires special monitoring and sampling techniques.

(7) **TIM Hazards.** Given the prevalence of TIM throughout the world, a significant hazard to US forces exists. Area studies, intelligence estimates, and economic studies can also be used to indicate the type and level of TIM hazard in a specific AO. TIM hazards must be determined at the local level, based on local activities (industrial, agricultural). A TIM assessment of an area must include commercial transportation routes (highway and rail), chemical production and storage areas, pipelines, and temporary storage areas (such as ports, rail yards, and airfields). In the field, it is

common practice to ship hazardous, useful, and valuable materials in mismarked or unmarked containers, railcars, and drums. TIM releases should be considered in the following four categories:

- **Intentional release.** This is the intentional use of TIM against US or allied forces and/or civilians in the AO.
- **Collateral damage.** This is the unintentional release of TIM caused by friendly or enemy military action in the AO.
- **Accidental release.** This type of release dramatically increases if qualified, trained plant or storage operators flee an area.
- **Sabotage.** Sabotage may be carried out by individuals with a political agenda or by disgruntled employees at a facility. Although the intent of the sabotage may be to disrupt the production of a specific product, TIM releases may cause an unintentional hazard.

d. **Creating Templates.** This process converts the threat doctrine or patterns of operation to graphics (doctrinal templates). Doctrinal templates convert the threat order of battle (OB) data into graphics that show how the threat might use its offensive NBC capability according to doctrine and training, without the constraints of weather and terrain. A template includes a description of threat offensive NBC capabilities, tactics, and options. It also lists or describes the options available to the threat if the operation fails or if subsequent operations succeed. A template can identify high-value targets (HVTs), which are assets that the threat commander requires for successful mission completion.

5. Determine Adversary Courses of Action

a. Commanders determine the adversary COAs that will influence the accomplishment of the friendly mission. They—

- Identify the likely objectives of the threat and the desired end state.
- Identify the full set of COAs and associated NBC offensive capabilities available to the threat.
- Evaluate and prioritize each COA. Use judgment to rank the threat COAs in their likely order of adoption.
- Develop each COA in the amount of detail that time allows. To ensure completeness, integrate the following NBC considerations:
 - **What.** Identify the type of agent(s) that may be used to support adversary COAs.
 - **When.** Identify the time the adversary may use his offensive NBC capability.
 - **Where.** Identify the sectors or zones where NBC agents may be used.
 - **How.** Identify the method by which the threat will employ its offensive NBC capability.

- a. **Why.** Identify the objective or end state that the threat intends to accomplish.

b. For each COA, commanders develop the following products for follow-on analysis and comparison:

(1) **Situation Template.** The situation template is a doctrinal template with terrain and weather constraints applied. It is a graphic depiction of expected threat dispositions for each possible threat COA. It usually depicts the most critical point in the operation as agreed upon by the intelligence and operations officers.

(2) **Event Template.** The event template is a guide for NBC reconnaissance collection planning. The event template depicts the NAI where activity or the lack of activity may indicate which COA the threat has adopted.

(3) **Event Matrix.** The event matrix provides details on the type of NBC activity expected in each NAI, the times the NAI is expected to be active, and its relationship to other activities on the battlefield.

(4) **Decision Support Template.** The decision support template is a combined intelligence and operations estimate in graphic form. It indicates the points where a decision from the commander may be required, based on input from multiple sources, including NBC reconnaissance information.

Appendix E

SAMPLING

1. Background

Although a sample collected from an alleged attack area can be significant, it can become useless if the sample team does not record critical information about its collection. It can also become useless if the collector improperly packs the sample, it becomes too warm, or it breaks during shipment to an analysis center. Further, the sample can be a hazard if there is an incident (e.g., spillage) during shipment.

NOTES:

- 1. The term *sample* refers to nonhuman and nonanimal origin. The term *specimen* refers to human and animal origin.**
- 2. Always consider that chemical agents may have been used. Check for chemical agents before collecting a biological sample or specimen. Chemical agents can damage or destroy biological agents. Also, chemical agents not identified in the sample or specimen can pose a hazard to receiving laboratory personnel. Mark all samples that are potentially contaminated with chemical agents.**
- 3. Protect the collector from potential BW agents. At a minimum, respiratory protection and protective gloves must be worn. Additional care must be taken when collecting samples and specimens to prevent cross contamination. Gloves must be changed or decontaminated between sample collections, and gloves must be changed between specimen collections. In addition, sample and specimen containers and packaging should be decontaminated with 5 percent chlorine solution.**
- 4. Do not deliver samples to the clinical laboratory of an MTF for analysis. Deliver them to the supporting confirmatory laboratory for processing to prevent accidentally spreading a BW agent in the MTF.**

2. Plan

a. A sampling plan is essential to a successful sampling operation. The plan defines the strategies and methods to best fulfill the objectives of the investigation. Each sampling operation is unique; therefore, each operation requires a unique plan. In many cases, large amounts of material might not be available. The most important consideration is that the sample accurately reflects the scene and that it has not been contaminated by the collection or handling process.

b. The validity of the subsequent laboratory analysis and the extent to which it produces a valid snapshot of an incident scene depends on the degree with which sampling operations conform to the sampling plan objectives. In some circumstances (such as a terrorist incident), multiple samples may be drawn. In other cases (such as an unopened letter suspected of containing anthrax spores), a single sample will fulfill the

sampling objectives. The sampling plan must consider the expected results of the sampling operation as a guide. The sampling plan defines the—

- Purpose and scope of the operation, including the objectives, limitations, and pertinent background information.
- Sampling media, such as groundwater, surface water, soil, sediment, and waste.
- Sampling parameters, such as the expected contaminants or type of contaminants.
- Sampling scheme, consisting of the sample type, strategy, and number.
- Techniques to be used.
- Time schedule (how long the sampling mission will last).

3. Operations

a. Site Assessment. Before conducting any sampling, the sampling team should conduct a survey of the sampling site.

NOTE: If sufficient personnel are available, the site assessment may be conducted by a separate team or element.

(1) The sampling team should establish contamination control zones (hot, warm, and cold) and must decontaminate the outside of sample containers using a 5 percent chlorine solution. They should solicit information from victims, witnesses, and emergency response personnel, if available. Observations of the scene and the situation can assist the team in developing a sampling plan. Information on reported odors, tastes, and symptoms can provide preliminary information to help identify the type of material being encountered. For chemical agents, this information is particularly useful. Immediate symptoms (such as twitching, pupil dilation, lacrimation, and breathing difficulties) can point the team toward a chemical incident.

(2) The sampling team should mark and take note of safety hazards and any challenges that might affect the sampling operation. All potential forms of harm (thermal, radiological, asphyxiation, chemical, biological, etiological, mechanical, and structural) should be identified. Before entering any structure, the location and/or coordinates should be taken and entered on a diagram/sketch form. These could be map grid coordinates or global positioning system (GPS) coordinates, as appropriate.

(3) The sampling team should conduct first-entry monitoring of the sample site. TIM environment monitoring may be enhanced by available CB monitoring equipment, as required. For chemical environments, equipment might consist of M8 detector paper, Draeger tubes, M256 kits, improved CAM, or a combination thereof. For biological environments, the team may conduct tests using surface samplers and handheld assays, if available. Any hot spots should also be identified. The area should be marked so that the sampling team will know the location of the initial sampling.

(4) Using the diagram/sketch form and a tape measure, the reconnaissance team should sketch the layout of the area where sampling is to take place. Particular attention should be paid to determining potential sampling locations. The layout of the room/field should be documented with dimensions, measurements, and items that might be of interest. Relevant reference points, control areas, and hazards should be annotated

on the form. The diagram/sketch form can be used to brief the sampling team, which may use the form when conducting sampling operations.

(5) Digital and still photographs and videos may also be taken of the entire sampling area. The sampling team leader (TL) and team members should review the videos and photographs to develop a proper sampling plan that supports the overall objectives. Photographs should be logged into the photographic log.

(6) Upon completion of photography, filming, and surveying, the reconnaissance team should place documentation in a large, clear, sealed bag. Information should be facing outward so that it can be read. Equipment must also be bagged and decontaminated upon removal from the hot zone.

(7) After processing through decontamination, the reconnaissance leader should brief the commander and the sampling TL.

b. Sampling Team Roles. The size and composition of the sampling team may vary based on the size, type, and scope of the incident and the response. At a minimum, the team should consist of five personnel—a TL, a two-person sampling team, and a two-person backup sampling team.

(1) The TL—

- Develops a sampling plan that supports the overall operational objectives.
- Reviews the photographs and videos of the sampling site with the reconnaissance team.
- Prioritizes the sampling locations.
- Makes team assignments.
- Briefs the sampling team.
- Coordinates with the incident commander (IC) to control access to the sampling scene and ensure that it is secure.
- Coordinates with other agencies, as required.

(2) The sampling team—

- Consists of at least two personnel. One individual serves as the recorder, logging in all samples and videotaping or taking photographs of the entire sampling process. The second person conducts the actual sampling process. They buddy-check each other throughout the operation.
- Prepares all the items necessary to conduct sampling operations (such as labels, pens, decontamination equipment, and sampling kits).
- Uses the layered-glove method for sampling operations. The individual conducting the sampling wears at least two pairs of gloves. After taking a sample, he peels off the outer layer of gloves. The individual recording the operation hands over a fresh pair of outer gloves for taking the next sample.
- Avoids getting gloves contaminated during sampling operations.

c. **Sampling Kits.** Several commercially available sampling kits have been developed, and new kits are currently in development. Biological sampling kits are developed for application in a specific sampling situation or a variety of situations. The type of sampling kit available for use depends on the unit equipment authorizations.

d. **Sampling Considerations.** Sampling is a key step in determining the presence of TIM suspected of containing CB agents. The goal of sampling is to collect a series of samples of suspected material that are representative of the original source, thus permitting analysis at the incident site or an alternate location. An important factor to keep in mind during sampling operations for a potential criminal investigation is that non-law-enforcement emergency responders are not evidence gatherers. However, responders that follow the procedures documented herein can facilitate the process for law enforcement officials through proper sample collection, documentation, and tracking.

(1) **Types of Samples.** Samples consist of the following types:

- **Environment.** This sample is removed from common, natural materials, such as water, soil, or vegetation.
- **CBRN.** This sample could include CB warfare agents, radiological samples, and TIM.
- **Matrix.** The environmental medium sampled may contain a suspect analyte (e.g., groundwater, surface water, soil, sediments, waste, air). Matrices are commonly separated into three categories—liquid, solid, and vapor—referring to the physical state of the medium.
- **Background.** This sample is collected away from the source area (upwind or updrift) to isolate the effects of the source or site on the sampling process. Control samples ensure that the target compound in the sample is specific to the operation location and is not a result of cross contamination or naturally occurring background components.
- **Blank.** This is a collection item that is taken to the field for a collection mission, but it is not used. The blank sample is analyzed with the collected samples to ensure that specific materials identified in the samples were not present before the sampling operation.
- **Medical.** This specimen is taken from animals or humans suspected of being infected with a biological agent. The specimen may include blood, tissue, nasal secretions, vomitus, urine, or feces.

(2) **Sampling Approaches.** Grab sampling and composite sampling are two basic collection techniques in sampling operations. Grab sampling is when a single sample is removed at a single point in time from one location. This can be contrasted with composite sampling in which samples are taken at multiple locations at one time or at one location over a course of time and then combined together. Composite sampling produces an average value of a site when analyzed. It is commonly employed when analyzing environmental sites for pollutants or when screening large numbers of samples, such as during waste disposal operations.

(a) Most sampling operations are a series of discrete grab samples. Multiple grab samples carry an analytical cost burden, but composite sampling risks

dilution of the CB agent to below the detection limit of the analytical platforms. Furthermore, the probability of the samples being required as evidence in court proceedings makes grab sampling the preferred method for sampling operations.

(b) Once the sample collection type has been determined, the sampling team must consider whether there is a suspect substance to be sampled or whether the sampling is intended to confirm the successful decontamination of a site. The number of samples that must be taken and the number of personnel available to support the sampling operation are also key factors. Additionally, time constraints on when the objectives must be achieved are important. These are just a few of the issues that must be addressed in developing a sample strategy. There are three basic strategies for sampling a given target area:

- **Random.** Random, unsystematic sampling of the target or a portion of the target may be used when there is no known specific area of concentration or when there is concern, but a lack of definitive information, that drives site selection to a specific zone.
- **Systematic.** Systematic (or grid) sampling is an objective strategy where samples are taken at predetermined intervals. Regular patterns of samples can rely on a grid structure that is superimposed on the target area or some other type of persistent pattern that is applied to a zone. In some cases, the grid can literally be demarcated with string or stakes.
- **Judgmental.** Judgmental (or selective) sampling is a subjective strategy where sites are selected based on the assessment or determination of the sampling team. Often, judgmental sampling is employed to take a series of grab samples from the areas considered to be the most likely sites of contamination.

e. **Sampling Guidelines.** While specific sampling procedures vary depending on the matrix and the type of sampling kit, there are common guidelines that apply to any sampling operation. Safety is the foremost concern during any sampling operation. The sample site may be inherently dangerous and contaminated.

(1) Identify any hazards that could impact the sampling operation. Develop a plan for eliminating, minimizing, or avoiding the hazard.

(2) Ensure that all personnel involved in the operation are dressed in the appropriate level of PPE according to Occupational Safety and Health Administration regulations.

(3) Ensure that the sampling site is clear of secondary or additional devices before the sampling operation. However, remain vigilant for the possibility that these devices may be present. If any devices are found, remove them or render them safe before proceeding with any sampling operation.

(4) Do not conduct operations in a contaminated area without backup personnel present. They should be partially dressed in the appropriate PPE and prepared to enter the area as an emergency extraction team.

(5) Take the following steps to ensure that contamination is not spread:

- Establish hot, warm, and cold zones. Clearly mark the boundaries between the zones.
- Clearly identify ingress and egress points after the zones are established.
- Establish a decontamination area in the warm zone for personnel and equipment. Decontaminate all sampling team members and sample containers according to applicable guidelines (as defined by the sampling team).

(6) Place a disposable, impermeable sheet on a field table or the ground for the staging of sampling equipment and containers.

(7) Prepare prepackaged sampling tools in the cold zone. The goal is to maximize the amount of time the team is able to spend collecting samples in the hot zone by thoroughly preparing sampling gear in the cold zone.

(8) Collect critical samples and those that are most likely to be lost, destroyed, altered, or overlooked first; and then move them to the staging area.

(9) Ensure that sampling tools are precleaned, individually wrapped, and sterile. Do not reuse or recycle them. Use them to collect a single sample only.

CAUTION

Do not use alcohol wipes for biological samples because they can destroy the biological material collected.

(10) Avoid contaminating the outside of the primary container. Test the container for contamination if possible; for example, certain liquid military chemical agents can be detected with M8 detector paper. If the container becomes contaminated, repackage the entire sample in an uncontaminated container.

(11) Place the primary container into a secondary container for transport to the cold zone for packaging and shipping.

(12) Decontaminate secondary containers before removing them from the contaminated area.

f. Selecting the Sampling Location.

(1) The type of sampling (*Table E-1*) may vary based on the nature, source, type, and method of dissemination and the site location. Typically, the best locations for sampling are in areas where casualties have occurred, in areas with wilted or discolored plants, or near an abundance of dead animals (particularly fish and birds).

(2) Solid samples (such as powders, solids, paints, and metals) may be useful if they are collected at a crime scene, an impact area, a blast zone, an operating facility, or locations where runoff may collect. Look for areas that exhibit stains, powdering, or particulate matter on surfaces, vegetation, or the ground. Less preferred areas are those exposed to direct sunlight and high temperatures. Other than casualties, aerosols may leave little residue. Water and vegetation downwind of the sampling site and PPE (especially filters) may also provide useful samples.

Table E-1. Selecting the Sampling Location

Location	Potential Sample Collection Areas
Surface Sampling	
Office	Desk, bench, and tabletop Floor, concrete, and linoleum Exit door Interior door, cabinet, drawer, and cart handle Wall Baseboard molding Bookshelf Bookcase top and shelf Ceiling Chair arm Coat rack File cabinet Fire extinguisher Stair railing Stairwell tread Storage locker Telephone Window sill
Household	Floor Wall Appliance Window and window sill Mantle Television Countertop
Laboratory	Instrument washing area Instrument sterilization area Equipment surface (centrifuge, balance) Interior and exterior of incubator, storage cabinet, etc. Bench top Window and window sill
Ventilation System	Fan housing exterior Supply duct interior and exterior Air supply and return vent Fan interior Top of fan housing

Table E-1. Selecting the Sampling Location (Continued)

Location	Potential Sample Collection Areas
Vehicle Interior	Dashboard Window Seat Steering wheel
Potentially Exposed Personnel	Clothing Boot Skin Nasal cavity
Outdoors	Vehicle exterior Building exterior
Air Sampling	
Personal	Personal air monitor
Solid and Liquid Sampling	
Outdoors	Leaf Soil Loose powder Puddle of liquid Debris Surface film from confined body of water
Indoors	Loose powder Unlabeled container of solid or liquid Piece of material (carpet, curtain, clothing, etc.)

- g. Sampling Guidelines. Use the following guidelines when collecting samples:
- Take soil samples as close to the center of contamination as possible, ½ inch deep, and over a surface area of 3½ by 3½ inches. Samples may be taken near bodies of fallen victims.
 - Ensure that stone samples are no bigger than ¼ to ½ inch, and place them in a plastic freezer bag. The volume of stones should be approximately 200 to 300 milliliters.
 - Collect snow samples from the layer that is suspected of being exposed to the contaminant.
 - Do not collect vegetable, leaf, grass, or grain matter by hand. Pay particular attention to the discoloration or withering of the matter. Place each sample in a separate container.
 - Take samples from walls, vehicles, or other types of immovable objects by scraping the contaminated surface and placing the scrapings in a jar.

4. Documentation

a. A complete history of the circumstances surrounding the acquisition of each sample or specimen must be documented and provided to the analyzing agency. These documents should also accompany shipments to the confirmatory laboratory. Critical information includes the—

- **Meteorological conditions.** Describe the meteorological conditions at the time of sampling and at the time of the alleged attack.
- **Attack to collection time.** State the estimated length of time after the alleged attack when the sample or specimen was taken.
- **Circumstances of the acquisition.** Describe how the sample or specimen was obtained and indicate the source of the sample.
- **Physical description.** Describe the physical state (solid, liquid, powder, viscosity), color, approximate size, weight or volume, identity (i.e., military nomenclature, dirt, leaves), and dose rate (if radiologically contaminated).
- **Circumstances of the agent deposition.** Describe the type of delivery system; how the system or weapon functioned; how the agent acted on release; sounds heard during dissemination; a description of craters or shrapnel found associated with the burst; and colors of smoke, flames, or mist that may be associated with the attack.
- **Agent effects on vegetation.** Describe the general area (jungle, mountain, grassland) and changes in the vegetation after agent deposition (i.e., color change, wilting, drying, dead) in the main attack and fringe areas.
- **Agent effects on humans.** Describe how the agent affected personnel in the main attack area versus the fringe areas; the duration of agent effects; peculiar odors that may have been noticed in the area before, during, and after the attack; measures taken that alleviated or worsened the effects; and the approximate number of victims and survivors (include age and gender).
- **Agent effects on animals.** Describe the types of animals that were and were not affected by the attack and a description of how they were affected.
- **Grid coordinates.** Identify the location where the sample or specimen was taken.
- **Presumptive identification.** Identify the system that conducted the sample identification (if applicable).

b. See *Figure E-1*, page E-10, for a sample CW/BW report that serves to capture the critical data described earlier. The report allows the data collector to note and record relevant details associated with pre- and postcollection conditions. Do not consider the report to be all-inclusive.

1. Sample or Specimen Identification #: _____

2. Collection Date/Time: _____

3. Collector/Unit: _____

4. Type/Sample:
 ____environmental ____biomedical ____single ____multiple
 ____air ____surface ____solid ____liquid
 ____sampling method ____sampling medium

5. Purpose:
 ____attack ____CB alarm ____chemical detection
 ____illness/death ____reconnaissance ____other

6. Post Exposure:
 ____hours ____days
 ____weeks ____unknown

7. Location:
 ____town _____
 ____coordinates _____

a. Terrain:
 ____flat ____hills ____mountain ____desert ____jungle
 ____sparse ____trees ____grass ____shore ____river ____ocean

b. Weather:
 ____clear ____cloudy ____rain ____fog ____snow ____dust

c. Wind:
 ____light ____heavy ____gusty ____none

d. Odor:
 ____sweet ____fruity ____peppery ____floral ____irritating
 ____changing ____none

Figure E-1. Sample CW/BW Report

e. Temperature: _____
 _____ at time of attack _____ at time of sample collection

8. Comments: _____

9. Attack:

a. Date/Time: _____

b. Method:
 _____ artillery _____ rocket _____ aircraft bomb _____ aircraft spray _____ mortar
 _____ rocket-propelled grenade/grenade _____ other (describe) _____

c. Explosion:
 _____ air (height _____) _____ ground (size _____) _____ distance
 Description: _____

d. Consistency:
 _____ smoke _____ mist _____ dust _____ rain _____ gel _____ invisible
 Description: _____

10. Environmental Sample:
 _____ soil _____ water _____ vegetation _____ air _____ other
 Description: _____

11. Biomedical Specimen:
 _____ acute _____ convalescent _____ exposed, not ill _____ postmortem _____ control
 Explain: _____
 _____ blood _____ liver _____ lung _____ spleen _____ brain _____ skin _____ kidney
 _____ urine _____ other

12. Comments: _____

13. Casualty: service number _____ unit _____ sex: male female

Figure E-1. Sample CW/BW Report (Continued)

14. Signs/Symptoms: onset _____ duration _____

a. Head:

_____ fever _____ chills _____ headache _____ flushed face _____ dizziness

_____ unconsciousness _____ coma _____ hallucinations

b. Eyes:

_____ double vision _____ blurred vision _____ large pupils _____ pinpoint pupils

c. Nose:

_____ runny _____ bleeding

d. Throat:

_____ sore _____ dry _____ salivating _____ bloody sputum _____ hoarseness

_____ difficulty speaking

e. Respiration:

_____ difficulty breathing _____ wheezing (in/out) _____ chest pain/discomfort

_____ coughing _____ labored breathing

f. Heart:

_____ pounding or running _____ irregular heartbeat

g. Gastrointestinal:

_____ loss of appetite _____ nausea _____ frequent vomiting _____ vomiting with blood

_____ frequent diarrhea _____ diarrhea with blood

h. Urinary:

_____ bloody urine _____ unable to urinate

i. Musculoskeletal:

_____ neck pain _____ muscle tenderness _____ muscle trembling/twitching

_____ paralysis (describe) _____

_____ convulsions _____ tremors _____ muscle aches _____ back pain _____ joint pain

Figure E-1. Sample CW/BW Report (Continued)

j.	Skin:
	<input type="checkbox"/> rash <input type="checkbox"/> redness <input type="checkbox"/> itching <input type="checkbox"/> blisters <input type="checkbox"/> pain <input type="checkbox"/> numbness <input type="checkbox"/> profuse perspiration
15.	Comments: _____ _____
16.	Animals Affected: <input type="checkbox"/> yes <input type="checkbox"/> no Describe: _____
17.	Related Specimens: _____ Identification Number: _____ Description: _____
18.	Collector: _____ Signature: _____ Name: _____ Phone Number: _____ E-mail: _____
19.	Reviewer: _____ Signature: _____ Name: _____ Phone Number: _____ E-mail: _____

Figure E-1. Sample CW/BW Report (Continued)

5. Identification and Control

NOTE: The sample identification and control procedures for collection devices and systems will vary slightly from the procedures described below. However, maintaining an unbroken chain of custody and assigning a unique sample identification number are required.

a. Samples must be carefully controlled to be of greatest value. A sample package consists of a chain of custody that must be recorded on a sample or specimen custody document (*Figure E-2*, page E-14). The chain of custody is critical because it provides an

audit trail of when and where the sample was taken. The team assigns an identification number and affixes it to the sample or its container to aid in identification.

Sample or Specimen Custody Document				
1. Receiving Activity			2. Location	
3. Name, Grade, and Title of Person From Whom Received <input type="checkbox"/> Owner <input type="checkbox"/> Other			4. Address (Include Zip Code)	
5. Where Obtained			6. Date/Time Obtained	
7. Item #	8. Quantity	9. Description of Sample or Specimen		
Chain of Custody				
10. Item #	11. Date (yymmdd)	12. Released by	13. Received by	14. Purpose of Change of Custody
		Signature	Signature	
		Name, Grade, and Title	Name, Grade, and Title	
		Signature	Signature	
		Name, Grade, and Title	Name, Grade, and Title	
		Signature	Signature	
		Name, Grade, and Title	Name, Grade, and Title	
		Signature	Signature	
		Name, Grade, and Title	Name, Grade, and Title	

Figure E-2. Sample Chain-of-Custody Form

b. The document identifies when the sample was collected, who collected the sample, who maintained custody of the sample, and what was been done with the sample. When samples are transferred from one person to another, a custody transfer occurs. A custody transfer also occurs when supervision of the sample changes. All sample transfers or custody changes are documented. Use a Department of Defense (DD) Form 1911 (Material Courier Receipt) or another document (such as a DA Form 4137 [Evidence/Property Custody Document] or a Centers for Disease Control and Prevention [CDC] laboratory response network chain-of-custody form, as directed) for each shipment transported. The chain of custody must accompany the sample during transport from the point of collection to the final receiving location. Each time the sample is transferred to another individual, the receiving person must sign the document to show that they have received the sample. The chain-of-custody document provides answers to the following questions:

- When was the sample collected?
- How many samples were collected?
- Who maintained custody of the sample?
- What was done with the sample at each change of custody?

c. The instructions for completing the form in *Figure E-2* are as follows:

Block 1. Enter the unit designation.

Block 2. Enter the address, code, or coordinates of the collecting organization according to the SOP.

Block 3. Enter the name, grade, and title of the person from whom the sample was received.

Block 4. Enter the nearest large city, if applicable, and the country. Include the mailing address, Army post office (APO) or Fleet post office (FPO), and zip code.

Block 5. Enter the address, unit code, or coordinates of the location where the sample was collected according to the SOP.

Block 6. Enter the date-time group when the sample was obtained.

Block 7. Enter and itemize each package being evacuated.

Block 8. Enter the quantity of samples received.

Block 9. Enter descriptive information for items. The following are sample descriptions:

- **Sample vial package.** A sample vial containing less than 10 milliliters of the sample, wrapped with lab film, and sealed with tamper-resistant tape.
- **Sample bottle.** A sample bottle containing less than 50 milliliters of the sample, wrapped with lab film, and sealed with tamper-resistant tape.
- **Cold-weather sample.** A 50-milliliter conical tube containing a cold-weather filter, placed in less than 40 milliliters of collection fluid, wrapped with lab film, and sealed with tamper-resistant tape.

- **Supporting documents.** A sealed disk mailer containing one biological event log and one incident report, individually labeled.

NOTES: Close the entries in blocks 7, 8, and 9 with an initialed line and the words “nothing follows.” If the item description(s) will not fit in block 9, continue the description on a plain sheet of paper, remembering to close it with an initialed line and the words “nothing follows.”

Block 10. Enter the appropriate item number(s) from block 7 that are being transferred. If a separate action is done with only one of the items on the list, create a separate chain of custody form for that item and attach a copy of the original form.

Block 11. Enter the date of the transaction (yymmdd).

Block 12. Enter the name of the person currently responsible for the custody of the item.

Block 13. Enter the name of the person assuming responsibility for the item.

Block 14. Enter a brief, accurate explanation of why the custody of the article was transferred (e.g., released for evacuation).

d. To prevent confusion, use the sample identification number (*Figure E-3*) when referring to the sample or to information concerning its acquisition. A sample identification number contains the following information:

- **Country of acquisition.** This is a two-digit alphabetic code for the country from which the collector took the sample. A listing of country codes is shown in *Table E-2*. (See International Organization for Standardization [ISO] 3166-1 for more information.)
- **Date acquired.** This is a six-digit numerical code for the year, month, and day that the collector took the sample.
- **Sequence number.** This is a three-digit numerical code assigned by the team. It begins each collection day. The first sample collected is 001, the second 002, and so forth.
- **Identification.** This is a two- or three-digit alphabetic code for the sampler’s identity, and it must be protected. Use codes XA through XZ and then XXA through XXZ, if necessary. The NBC center operational level commander (e.g., COCOM commander, joint task force [JTF] commander, component commander) should assign two- and three-digit alphabetic codes to their units.

LA011020-002-XA		
LA	=	The collector took the sample in Laos.
011020	=	The sample was obtained on 20 October 2001.
002	=	This was the second sample taken on 20 October 2001.
XA	=	John Doe collected the sample; XA signifies his identity.

Figure E-3. Example of a Sample Identification Number

Table E-2. Country Codes

Country	Code
Afghanistan	AF
Albania	AL
Algeria	DZ
American Samoa	AS
Andorra	AD
Angola	AO
Anguilla	AI
Antarctica	AQ
Antigua and Barbuda	AG
Argentina	AR
Armenia	AM
Aruba	AW
Australia	AU
Austria	AT
Azerbaijan	AZ
Bahamas	BS
Bahrain	BH
Bangladesh	BD
Barbados	BB
Belarus	BY
Belgium	BE
Belize	BZ
Benin	BJ
Bermuda	BM
Bhutan	BT
Bolivia	BO
Bosnia and Herzegovina	BA
Botswana	BW
Bouvet Island	BV
Brazil	BR
British Indian Ocean Territory	IO
Brunei Darussalam	BN
Bulgaria	BG
Burkina Faso	BF
Burundi	BI
Cambodia	KH
Cameroon	CM
Canada	CA
Cape Verde	CV
Cayman Islands	KY
Central African Republic	CF
Chad	TD
Chile	CL

Table E-2. Country Codes (Continued)

Country	Code
China	CN
Christmas Island	CX
Cocos (Keeling) Islands	CC
Colombia	CO
Comoros	KM
Congo	CG
Congo, The Democratic Republic of the	CD
Cook Islands	CK
Costa Rica	CR
Cote D'ivoire	CI
Croatia	HR
Cuba	CU
Cyprus	CY
Czech Republic	CZ
Denmark	DK
Djibouti	DJ
Dominica	DM
Dominican Republic	DO
Ecuador	EC
Egypt	EG
El Salvador	SV
Equatorial Guinea	GQ
Eritrea	ER
Estonia	EE
Ethiopia	ET
Falkland Islands (Malvinas)	FK
Faroe Islands	FO
Fiji	FJ
Finland	FI
France	FR
French Guiana	GF
French Polynesia	PF
French Southern Territories	TF
Gabon	GA
Gambia	GM
Georgia	GE
Germany	DE
Ghana	GH
Gibraltar	GI
Greece	GR
Greenland	GL
Grenada	GD
Guadeloupe	GP

Table E-2. Country Codes (Continued)

Country	Code
Guam	GU
Guatemala	GT
Guinea	GN
Guinea-Bissau	GW
Guyana	GY
Haiti	HT
Heard Island and McDonald Islands	HM
Holy See (Vatican City State)	VA
Honduras	HN
Hong Kong	HK
Hungary	HU
Iceland	IS
India	IN
Indonesia	ID
Iran, Islamic Republic of	IR
Iraq	IQ
Ireland	IE
Israel	IL
Italy	IT
Jamaica	JM
Japan	JP
Jordan	JO
Kazakhstan	KZ
Kenya	KE
Kiribati	KI
Korea, Democratic People's Republic of	KP
Korea, Republic of	KR
Kuwait	KW
Kyrgyzstan	KG
Lao People's Democratic Republic	LA
Latvia	LV
Lebanon	LB
Lesotho	LS
Liberia	LR
Libyan Arab Jamahiriya	LY
Liechtenstein	LI
Lithuania	LT
Luxembourg	LU
Macao	MO
Macedonia, The Former Yugoslav Republic of	MK
Madagascar	MG
Malawi	MW
Malaysia	MY

Table E-2. Country Codes (Continued)

Country	Code
Maldives	MV
Mali	ML
Malta	MT
Marshall Islands	MH
Martinique	MQ
Mauritania	MR
Mauritius	MU
Mayotte	YT
Mexico	MX
Micronesia, Federated States of	FM
Moldova, Republic of	MD
Monaco	MC
Mongolia	MN
Montserrat	MS
Morocco	MA
Mozambique	MZ
Myanmar	MM
Namibia	NA
Nauru	NR
Nepal	NP
Netherlands	NL
Netherlands Antilles	AN
New Caledonia	NC
New Zealand	NZ
Nicaragua	NI
Niger	NE
Nigeria	NG
Niue	NU
Norfolk Island	NF
Northern Mariana Islands	MP
Norway	NO
Oman	OM
Pakistan	PK
Palau	PW
Palestinian Territory, Occupied	PS
Panama	PA
Papua New Guinea	PG
Paraguay	PY
Peru	PE
Philippines	PH
Pitcairn	PN
Poland	PL
Portugal	PT

Table E-2. Country Codes (Continued)

Country	Code
Puerto Rico	PR
Qatar	QA
Reunion	RE
Romania	RO
Russian Federation	RU
Rwanda	RW
Saint Helena	SH
Saint Kitts and Nevis	KN
Saint Lucia	LC
Saint Pierre and Miquelon	PM
Saint Vincent and the Grenadines	VC
Samoa	WS
San Marino	SM
Sao Tome and Principe	ST
Saudi Arabia	SA
Senegal	SN
Serbia and Montenegro	CS
Seychelles	SC
Sierra Leone	SL
Singapore	SG
Slovakia	SK
Slovenia	SI
Solomon Islands	SB
Somalia	SO
South Africa	ZA
South Georgia and the South Sandwich Islands	GS
Spain	ES
Sri Lanka	LK
Sudan	SD
Suriname	SR
Svalbard and Jan Mayen	SJ
Swaziland	SZ
Sweden	SE
Switzerland	CH
Syrian Arab Republic	SY
Taiwan, Province of China	TW
Tajikistan	TJ
Tanzania, United Republic of	TZ
Thailand	TH
Timor-Leste	TL
Togo	TG
Tokelau	TK
Tonga	TO

Table E-2. Country Codes (Continued)

Country	Code
Trinidad and Tobago	TT
Tunisia	TN
Turkey	TR
Turkmenistan	TM
Turks and Caicos Islands	TC
Tuvalu	TV
Uganda	UG
Ukraine	UA
United Arab Emirates	AE
United Kingdom	GB
United States	US
United States Minor Outlying Islands	UM
Uruguay	UY
Uzbekistan	UZ
Vanuatu	VU
Venezuela	VE
Viet Nam	VN
Virgin Islands, British	VG
Virgin Islands, US	VI
Wallis and Futuna	WF
Western Sahara	EH
Yemen	YE
Zambia	ZM
Zimbabwe	ZW

6. Reporting and Shipping

a. The collector must provide a formatted message for transmission as soon as possible to report the acquisition of the sample and the shipment of samples and specimens. The collector ensures that the acquisition message has been properly classified.

b. A complete background information history of circumstances (i.e., a completed CW/BW sample report and a chain-of-custody form) about the collection of each sample or specimen must be compiled. Critical background information is contained in the CW/BW sample report.

c. All suspect NBC samples and collected specimens are evacuated to a medical or confirmatory laboratory for analysis. Laboratories will prioritize sample or specimen analysis based on METT-TC factors. The numbers and types of samples and specimens analyzed are determined by the laboratory commander.

d. A message generally contains the following information:

- The sample or specimen identification number and shipment date, transportation mode, courier identification, air bill-of-lading number,

flight number, destination, and estimated time of arrival (if applicable). (The chain-of-custody form is used to maintain control of the sample.)

- Background information surrounding the sample or specimen, such as the circumstances surrounding its acquisition.
- The name of another country or agency that obtained the sample or specimen from the same event or area and is not shown on the message address.
- All the details that relate to the acquisition of the sample or specimen, despite how insignificant they may seem to the collector.

e. Designated samples and specimens are shipped by the fastest, safest means possible, preferably by a TEU, to the location designated by the controlling headquarters. The receiving laboratory is notified in advance of the sample shipment, and the receiving laboratory may provide special shipping instructions.

f. The designated sample courier controls the transport of samples and specimens to the designated location. Coordination is made with the receiving location (i.e., laboratory) before the actual delivery. Suspect CB samples and specimens are generally delivered to the supporting laboratory in the AO for in-theater analysis before they are transported out of the AO. The supporting laboratory withdraws an aliquot of each sample or specimen for analysis. The supporting laboratory provides a field confirmatory identification, and the CONUS-based laboratory provides a definitive identification.

NOTE: The CONUS-based reference laboratory is responsible for providing definitive identification and confirmation for national level decision making.

g. The controlling headquarters uses the following criteria to determine the final destination of each sample or specimen:

- Does the sample or specimen contain CBR material?
- Is the sample or specimen content completely unknown?
- What is the ability to get the sample to its destination within the required time frame?
- Does the sample contain an infectious substance?

h. In any case, the TEU must be notified in advance of shipment so that additional instructions or deviations from standard instructions can be given. The TEU controls the transport of samples and specimens to their final destination(s).

NOTES:

1. Do not ship suspected toxic samples or specimens or munitions systems to CONUS technical centers or intelligence agencies without coordination and prior approval by the recipient.

2. Coordinate with the supporting laboratory upon its arrival in the AOR. This coordination supports the material exchange of information.

7. Witness Interviews

a. Introduction.

(1) Interviewing an alleged victim or witness is an important phase of an investigation. Generally, if the mission requires interviews with alleged victims or interrogation of threat forces, the interview should be conducted by trained interrogation teams.

(2) Although sample collection is important, the interview process is an important phase of an investigation. Each collector must constantly be aware of how he may unconsciously influence a witness' testimony. Vocal tones, facial expressions, body language, and the manner in which he poses questions can affect testimony.

(3) Therefore, each collector must constantly monitor the interpreter and the interviewee. He must also monitor the type of questions used to ensure that they do not lead the witness toward a foregone conclusion. The following paragraphs cover, in detail, the rationale and techniques used for successful interviews, but they are only guidelines. *Figure E-4* shows a sample interview form.

b. Elements of Proper Interviewing.

(1) A collector using an interpreter should position himself so that he can monitor the witness and the interpreter and maintain control of the interview direction and speed. A tape recorder may be used to preserve the actual conversation so that it can be reviewed later.

(2) A key element to interviewing more than one person in a group of people is to ensure that each person is questioned alone. Questions should not lead to yes or no answers. If the witness does not understand the question, he may respond with yes to avoid displeasing the collector. This could result in a rapid, but inaccurate, interview.

(3) When conducting an interview—

- Ensure that it is conducted in a way that is as psychologically comfortable for the witness as possible.
- Do not become emotionally involved with the state of affairs or surroundings of a witness during an interview.
- Be aware that misinformation and propaganda may be presented. Testimony should describe scientific reality, not a social or political *truth*.
- Understand that many people do not have the education or the means to establish the scientific causality of an event. Because of this, the witness may identify the wrong factor as the cause of the event.
- Do not assume anything about information received surrounding an investigation. Misinformation of varying intensity and sophistication can come from any group of people.

c. Background Information. The interviewer uses information about a witness' social and environmental background to help establish his credibility and relationship to an alleged attack. The most important part of the background is establishing the correct names and aliases of the witness. In multicultural societies, individuals often use

CB Incident Interview

Date: _____ Interviewer: _____

Subject's Name: _____

Alias #1 _____ #2 _____

Age: _____ Sex: Male Female Year of Birth: _____

Nationality: _____

Subject's Address: _____

Identification Card #: _____

Delivery Methods

Type: _____ unknown _____ ground _____ air _____ artillery/rocket _____ mine
 _____ other (describe): _____

Height: _____(m)

Size: _____(m) (affected area)

Distance: _____(m)

Agent Characteristics

Odor: _____ none _____ sweet _____ fruity _____ irritating _____ peppery _____ floral
 _____ changing _____ unknown _____ other (describe): _____

Comments: _____

Consistency:

_____ smoke _____ mist _____ dust _____ rain _____ gel _____ dry
 _____ visible _____ invisible _____ other (describe): _____

Color: _____ Describe Development of Color: _____

Area Coverage: _____

Physical Dissemination/Coverage (Droplet Size and Distribution) (write or draw):

Symptoms:

Figure E-4. Sample CB Incident Interview Form

Individual Actions

During Attack: _____

After Attack: _____

Protective Measures: _____

Treatment Received: _____

Environmental Effects

Vegetation Change? Yes No

Describe: _____

Animals Affected? Yes No

Describe: _____

Others Affected

Name	Age	Symptoms	Resolution

Figure E-4. Sample CB Incident Interview Form (Continued)

different names that correspond to each society in which they exist. Because of the confusion that surrounds combat areas, a photograph of the witness can often aid in recontacting the witness. The next important element of background information involves defining the witness' military training and service.

d. Attack Data and Agent Characteristics.

(1) The description of how an alleged CB attack occurred is critical in determining whether or not an attack occurred. Often, the best way to proceed is by asking questions such as "What happened next?" or "What was it like?"

(2) Always ask questions that require the witness to describe or explain the situation. During questioning, do not assume that any specific event occurred. For example, instead of asking "What color was the agent?" ask "Was there a color associated with the event?"

(3) If the event involved a weapon, ensure that the questioning derives information on how the weapon functioned. Information that shows the witness' awareness of the difference between high-explosive (HE) and toxic-agent weapon functioning is important.

(4) A sketch may be drawn of the area, indicating north, the wind direction at the time of the attack, and the approximate scale. When applicable, include a description of topographic features; the location of trees, forests, and buildings; the disposition of personnel; the personnel affected; the points of impact of shells or other projectiles; the zone contaminated by the agent spread; the location of dead or wounded persons and animals; and other relevant information.

8. Handling and Packaging Materials

a. Characteristics. There are several physical and chemical characteristics that must be considered when selecting a suitable container for shipping and sampling. Important characteristics include the container material, size, shape, and sealing method. Generally, a container should be made of material that is chemically nonreactive with the sample and it should maintain physical integrity during normal handling and shipment. The container must have sufficient volume to contain enough samples for all analyses required of the sample and for several repeat analyses. It should have an opening that allows for easy filling and emptying of the container and that minimizes external contamination of the container. Finally, all containers should be new and unused. *Table E-3*, page E-28, recommends sample containers based on accepted analytical practices.

b. Precautions. To ensure an accurate analysis, it is critical that a sample does not become contaminated during the process of collection and transport. To avoid cross contamination, take the following precautions:

- Work from the suspect least contaminated site toward the suspect most contaminated site.
- Wear disposable gloves, and change them after taking each group of samples at one site (e.g., discard your gloves after collecting all soil samples).

Table E-3. Container Selection

Sample Type	Analysis Test Category	Container
Air	Chemical	Air filter
	Radiological	Swipes
Soil	Chemical	4-oz high-density polyethylene
	Biological	4-oz high-density polyethylene
	Radiological	4-oz high-density polyethylene
Water	Chemical	Low-density polyethylene
	Radiological	Low-density polyethylene
Vegetation	Chemical	4-oz high-density polyethylene
	Biological	4-oz high-density polyethylene
	Radiological	4-oz high-density polyethylene
Liquid agent	Chemical	Low-density polyethylene
	Biological	Low-density polyethylene
Dilute agent	Chemical	Low-density polyethylene

- Keep equipment away from dirt, dust, soil, and surfaces that are likely to be contaminated. Put the equipment on a clean, plastic sheet.
- Double-bag samples immediately after they are collected.
- Clean the sampling equipment after taking each group of samples and check for residual contamination, or use disposable sampling equipment.
- Clean and decontaminate sampling tools between sample collections. To avoid cross contamination, wipe the outside of all containers with a 5 percent chlorine solution.

c. **Collection Bags.** A leakproof, clear, plastic collection bag can be used as the initial container for samples, such as protective masks and filter canisters, individual antidote and decontamination kits, munition fragments, and other items that are too large to place in a specimen jar. It can also be used to package containers, which ensures a vapor barrier in case the container is broken in transit. It acts as an initial or secondary vapor barrier that prevents air from leaking in and toxic material from leaking out. The following are recommended procedures when using leakproof, clear, plastic collection bags:

Step 1. Verify that the item has a command designated sample or specimen number if you are packaging a sample or specimen container.

Step 2. Carefully place the sample or specimen in a bottom corner of the bag.

Step 3. Ensure that each layer of packaging is decontaminated using a 5 percent chlorine solution.

Step 4. Squeeze all the air out of the bag, and seal it.

d. **Jars and Tubes.** Glass specimen jars and polypropylene tubes can be used for collection; however, do not store biological samples in polypropylene containers because proteins and deoxyribonucleic acid (DNA) may adhere to them. Use glass containers to

hold small environmental samples or autopsy specimens. Use polypropylene tubes to hold medical specimens, such as blood and urine. Use glass containers instead of plastic ones because toxic agents may leach chemicals from plastics into a sample, introducing contamination and complicating analysis efforts.

e. Shipping Containers. Place samples and specimens into commercial, biohazard shipping containers for shipping.

f. Commercial-Air Shipment. When the samples must be transported on commercial aircraft, International Air Transport Association-approved sample transport containers must be used for shipment and delivery to the designated location.

g. Temperatures. Samples or specimens submitted for analysis must be properly packaged, labeled, and shipped to ensure that they arrive in an analytically acceptable condition. All samples should be maintained at 1° to 4°C. Ideally, samples should arrive at the laboratory within 6 hours of collection. The samples should be delivered to the CONUS laboratory within 24 to 48 hours. If the samples or specimens cannot be delivered to CONUS within this time, they should be flash-frozen to -165°C. Dry ice can be used if flash-freezing is not available. If the samples cannot be delivered to CONUS within 48 hours, the supporting laboratory should subculture the samples and specimens and send the subculture to the CONUS laboratory.

h. Insulation. Standard polyethylene or metal ice chests are the most easily procured items that can be used to ship CB samples and specimens. Even though an ice chest provides good insulation for samples or specimens and the coolant, place extra insulation and cushioning around the metal cans inside the ice chest. Plastic bubble wrap or foam rubber can be used with good results.

NOTE: Table E-4 lists materials that can be used to assemble a CB sample collection equipment kit.

Table E-4. CB Sample Collection Equipment

Description	Stock Number	Amount
Bag, plastic, recloseable		10 each
Blade, surgical, CS21, 150s	6515-01-009-5297	2 each
Bleach, 32-oz		1 bottle
Chest, ice		1 each
Combustible gas indicator that indicates the percentage of oxygen and volatility		1 each
Container, shipping, International Air Transport Association		1 each
Floor sweep (vermiculite)	8720-01-026-9419	2 bags
Gas meter capable of providing on-station analysis and detection capability for multiple gases, including industrial gases		1 each
Gas meter that detects vapor in ppm and indicates the presence of vapor and its strength		10 each
Gauze pads		1 box
Gloves, size 8-8½	8415-00-J02-2902	2 boxes
Gloves, size 9-9½	8415-00-634-4639	2 boxes

Table E-4. CB Sample Collection Equipment (Continued)

Description	Stock Number	Amount
Ice pack	CP TR-6345-20	6 each
Insulated bag, Type 1	AF 01-814-8	10 each
Insulated bag, Type 2	AF 01-814-10	10 each
Knife, pocket	5110-00-526-8740	1 each
Labels, paper, pressure-sensitive	7530-00-577-4376	20 each
Liquid sampler	W 51910 (50/box)	2 boxes
Marking pen, waterproof	AF 13-381	10 each
Matches, waterproof		20 each
Methanol, 32-oz		2 bottles
Microspatula with nonstick ends	AF 21-401-50A	2 each
Pad, cooling chemical	6530-00-133-4299	2 each
Pad, nonadherent	6510-00-111-0706	4 each
Paper, nonbleeding, plastic strip, pH testing	SW-S 65271	1 each
Parafilm with a dispenser	6640-01-185-3289	2 boxes
Personal air sampler	LSS G4980	1 each
Pipette, graduated, transfer type	AF 13-711-9A	10 each
Pipette, jumbo, transfer type	AF 13-711-7	1 each
Plastic bags	AF 01-812-6B (500/pack)	1 pack
Pliers, #47, 5-in	6520-00-543-5330	1 each
Pocket bubble metric kit	GL4981	2 each
Polypropylene scoop, 5 x 2 x 2 inches	ASP S1021-5	1 each
Razor, surgical prep	6515-00-926-2089	10 each
Sample bottle, 6-oz	CP J-6103-50	5 bottles
Sampling container (with lead shielding for radiation sample)		1 each
Scissors, universal type	AF 08-951-30	1 each
Screwdriver, flat tip, ¼-in	5120-00- 596-8653	1 each
Seals, tamper-resistant		100 each
Spoon spatula	AF 14-356-10	2 each
Stopcock, three-way	ASP S8965-2	1 each
Syringe, hypodermic, 50- or 60-ml	6515-00-168-6913	2 each
Tape, antiseizing	8030-00-889-3535	1 each
Tape, pressure-sensitive, adhesive, 2-in	7510-00-159-4450	1 each
Throat swab		1 box
Tongs	AF 15-202-5	1 each
Tube	EC ST-023	1 each
Tubing, laboratory, clear, R3602	AF 14-169-3B	1 box
Watch, wrist	6645-00-066-4279	2 each
Water, sterile, 32-oz		1 bottle
Whirl/pak bag, 6-oz	AF 01-812-6B	1 box

9. Techniques and Procedures

a. The collection of environmental samples is an integral part of investigating allegations pertaining to the first use of CB agents. The types of samples and specimens taken and the collection methods are influenced by guidance from the operational or tactical level commander on sampling requirements, the assignment of collection assets, and the prioritization of sampling efforts. During sampling operations, the commander establishes the required protective equipment to fit the situation.

b. NBC reconnaissance units collect samples under various circumstances. For example, a reconnaissance unit may collect samples in an area free of hostile forces or a special forces (SF) team may collect samples within the enemy AO or deep in the enemy rear area. Samples may include toxic-agent munitions, chemical products, air, water, soil, and vegetation. Expended equipment includes items such as M256A1 kits and M8/M9 detector paper. These items should be recovered, packaged, and shipped with the samples for analysis. Different information may be derived from each type of sample. *Table E-5* shows the recommended sizes of samples.

Table E-5. Recommended Sizes of Samples

Item	Size	Remarks
Chemical Samples		
Soil	10 cm x 5 cm x 1 cm	A larger area is more useful than a greater depth.
Liquid agent	50 ml	None
Diluted agent	10 ml	The depth depends on the water source and the agent surface tension.
Water	50 ml (maximum)	The depth depends on the water source and the agent surface tension.
Vegetation	Equivalent to 3 leaves or 3 handfuls of grass	The size depends on the amount of contamination. The best samples are found closest to the release point.
Biological Samples		
Soil	10 cm x 5 cm x 1 cm	A larger area is more useful than a greater depth.
Liquid	25 to 50 ml	A C18 Sep-Pak™ cannot be used with medical samples.
Vegetation	About the size of a soft drink can	The best samples are found closest to the release point.
Radiological Samples		
Water	2 l	This sample is obtained from surface or water discharges.
	1 l	This sample is obtained from drinking water.
Soil	2 kg (about 1 m x 1 m x 8 cm)	This is the gamma spectrometry plus the gross alpha or beta.
	100 g	This is the gross alpha or beta.
Vegetation	3 l, densely packed	None

c. Sampling techniques vary according to the circumstances under which the sampling team must work. Teams may be able to obtain *neat* chemical-agent samples from shipping, production, and storage containers. The return and recovery of any sample identification or test equipment previously used to identify the agents (such as M256 series kits, M8/M9 detector paper) are of great value to the laboratory conducting

analysis. Some of these items may be recovered, packaged, and shipped for analysis. The types of samples evacuated depends on the type of testing required and the laboratory conducting the analysis.

d. An adversary may use radiological agents to restrict the use of terrain. These agents could include high-activity, radioactive-level wastes from industrial operations; and teams could encounter high dosages when operating in these areas. The procedures for radiological-agent sampling are generally the same for CB sampling; however, CB sampling containers do not provide sufficient shielding to protect individuals who are carrying them.

e. If the primary radiological hazard is residual radioactive contamination, the sampling team could take very small quantities of low-activity environmental samples. Very small quantities of these samples could perhaps be safely contained in CB sample containers. The radiological hazard from these samples should be limited to alpha- and beta-emitting radionuclides.

NOTE: Radiological monitoring is conducted to ensure the safety of the sampling team from unwarranted radiation exposure. Do not use CB containers to transport special nuclear material or high-level waste from reactor operations. Do not use the sampling methods discussed in this appendix for high-activity radiological agents, nuclear waste, or special nuclear material. Use standard dosimetry techniques and equipment to monitor the radioactive dosage for each sampling team member. (See *Appendix I* for radiation search and survey detection methods.)

10. Chemical and Biological Sampling (Environment)

Control (or background) samples collected from clean samples as baseline data should be nearly identical to the samples collected near the attack area. The contaminated samples are compared to the baseline data, especially if unknown or nonstandard chemical and/or suspected biological agents were employed. The supporting laboratory uses the control samples to compare with a contaminated one. The reconnaissance team collects control samples of soil, water, and vegetation from areas about 500 meters upwind of the attack area. Control samples must be generically the same as those collected in the attack area. For example, if leaves from an apple tree in an attack area were collected as a suspect contaminated sample, the reconnaissance team should collect leaves from an apple tree outside the contaminated area as a control sample. If water is collected from a pond in the attack area, the reconnaissance team should collect water from a pond (not a moving stream) in a nearby clean area as a control sample. The size of the control sample should be about the same as the suspect contaminated sample (see *Table E-5*, page E-31).

NOTES:

- 1. Collect environmental samples as directed in the operator's manual or other publications for operating collection systems. During transportation, maintain the samples at 1° to 4°C.**
- 2. The CB sampling described in this section is provided as a guide. Specialized units may use more detailed procedures found in references such as Allied Engineering Publication (AEP) 10.**

3. Reconnaissance units collect samples under various circumstances. All expended material (such as M8/M9 detector paper and M256A1 kits) should be recovered, packaged, and shipped with the suspected samples for analysis.

a. Air and Vapor Samples. Air is a good sample matrix since it is a well-mixed medium. Air from a sample site contains a static concentration of contaminants. The concentration of contaminants depends on the flow rate of the contaminant into the environment, the wind speed, the physical state of the contaminant, the terrain contours, and the temperature as a variable. The sample should be taken within 1 to 2 meters of a contaminated surface or at the downwind edge of a contaminated area. The method should consist of pumping a given volume of air through sample tubes by hand or with an electric pump.

(1) When to Sample. Perform sampling as soon as possible after suspected CB contamination is encountered or when directed by higher headquarters.

(2) Where to Sample.

(a) The best places to obtain samples are as close to the emission source as possible; the chemical concentration is maximal at this point. The farther from the original point of release the more diluted the sample becomes from mixing with air, water, or environmental pollutants.

(b) Natural and man-made terrain features (such as hills, rows of buildings, and valleys) sometimes aid the collector by channeling emissions. When these features are close to a particular facility, use the downwind side for sample collection (if possible) because the emissions remain concentrated due to the channelizing effect. The collector determines the typical downwind location and collects environmental samples from that area.

(c) If the situation permits collection in a possibly contaminated location, use a detector kit (such as the M256A1 or M18A2) initially to decide if a possible vapor hazard exists from known chemical agents. Also, use the kit to test possible toxic-agent munitions. Take air samples with the M18A2 white strip tubes, and save them for laboratory analysis.

(d) Small air samplers also enable the collector to obtain vapor samples from alleged toxic-agent munitions at a safe distance, while EOD personnel render the munitions safe. If EOD personnel are not on the scene, the air sampler can be started but the collector should stand at a safe distance while the sampler is operating.

(3) How to Sample.

(a) Contaminants are sampled for later identification by using devices that draw air through filter material and selectively remove certain compounds. Persons sampling air should not use cologne, perfume, insect repellent, medical creams, or strong soaps before taking a sample. The fragrances in these products are volatile organic compounds that can be absorbed on the filter and skew analytical results. Smoke also severely interferes with the air sampling; therefore, avoid cigarette and campfire smoke and vehicle exhausts.

(b) A method for collecting air samples is with devices such as the PAS-1000 automatic air sampler in conjunction with a Tenax™ tube for a total of 3 to 4 minutes, when possible. Upon completion of sampling, place the Tenax tube in a sealable bag and seal the bag with pressure-sensitive or Teflon™ tape. Place the bag into a second

bag, and use any type of tape to secure it. Decontaminate each layer of packaging with a 5 percent chlorine solution. Place the bag in a cooler until the sample is transported to its destination.

b. **Water Samples.** Water samples are collected by PVNTMED/bioenvironmental engineer personnel for identification or verification of biological contamination. Liquid sampling involves collecting enough fluid to obtain good information about the contaminants. At least four samples should be taken—three samples of the suspected contamination and one control sample from a nearby uncontaminated area for reference.

(1) **When to Sample.** Sample fluid from a facility when intelligence or local reports suggest that a process of possible interest is ongoing. Collect water samples from allegedly contaminated field areas just after the start of a rainstorm when runoff is beginning. Natural surface drainage will concentrate any remnants of toxic compounds in depressions, streams, or ditches. Because of their large surface area and the potential for collecting runoff from an attack site, ponds, streams, reservoirs, or puddles in the immediate area of a suspected attack are potential sources of useful samples. The most desirable sample is a surface sample. The samples can be taken with a 50- to 100-milliliter pipette (or syringe) from the source surface. Use one pipette per sample, transfer the contents into a separate clean sample bottle (retaining any material suspended in the water), and close the bottle (airtight). A sample size of at least 50 milliliters is needed. In addition to water samples, surface scum and bottom sediment can also be sampled and forwarded for analysis. These samples can be collected by skimming or dredging.

(2) **Where to Sample.** Drains are ideal sites since contamination and dilution from other sources are minimized. For example, sample stream water in the slower moving parts of the stream. The turbulence and speed of rapidly flowing water often dilutes chemical concentration and affects contamination. If an oil stain-like fan, globules, organic materials, or unnatural-looking powder is visible on surface water, take surface samples of the material. Otherwise, take the sample from near the bottom of the stream. Most chemicals of interest are denser than water, so they usually sink to lower levels. However, high water temperatures promote decomposition and may cause the upper layers of water to harbor contaminants. For example, a blister agent (mustard) may float on the surface of the water due to surface tension, even though it is heavier than water. The reconnaissance team may also collect samples from stagnant pools of water if the pools of water are part of chemical waste areas, such as a landfill or a chemical disposal area. Chemicals may percolate into stagnant pools or dumps close to the site.

(3) **How to Sample.** Provide the analysis center with one C18 and one silica cartridge if the Sep-Pak is not available. Follow the manufacturer's instructions when collecting water samples using the Sep-Pak. Additionally, if it is believed that the threat has used CW agents during an attack, use the M272 chemical-agent water test kit for sampling.

c. **Soil Samples.** Soil is a good medium to sample for toxic organic compounds. It may contain large amounts of compounds of interest. For best results, it is critical that the collector sample at the precise site of compound deposition.

(1) **When to Sample.** Sample as soon as possible, when directed, or after the alleged incident.

(2) Where to Sample. Contamination may be recognized by discoloration or apparent deposition of material on the soil surface. Collect only discolored soil or deposited materials if possible.

(3) How to Sample. Wear MOPP gear, and avoid direct contact with the sample.

(a) If discoloration or deposits of material are evident, use a garden trowel, a wooden tongue depressor, or a similar item to carefully scrape up the soil. Scrape the top 2 to 5 centimeters of soil from areas that appear to be contaminated. If sampling chunks or clods of earth, select those that are no larger than 1 by 5 by 10 centimeters. Also, collect a control sample of the same soil type or texture from a nearby uncontaminated area.

(b) The collection container could be a glass bottle or jar or a leakproof, sealable bag. When using a glass bottle or jar as a container, seal the cap with pressure-sensitive tape and mark it for identification. When using leakproof, sealable bags, place each sample in a separate bag, push out the excess air, fold the open end two or three times, and wrap it with tape. Insert the bag into another bag, seal it, tape it, mark it for identification, and place a tamper-resistant seal across it. Ensure that each layer of packaging is decontaminated using a 5 percent chlorine solution.

d. Vegetation Samples. Vegetation provides an excellent means for collecting samples.

(1) When to Sample. Sample as soon as possible after the alleged incident.

(2) Where to Sample. Take vegetation samples near the center of the area, about 100 meters upwind of the area, and at several 100-meter intervals downwind of the area. If the collector can discern a contamination pattern in the area, he should report it.

(3) How to Sample. Make a visual survey of the area, don protective equipment (MOPP 4), and enter the area from an upwind direction. The minimum size sample of value is three leaves or three handfuls of grass. One leaf is of little value, but should be collected. Bark is acceptable, but not preferred.

(a) Collect vegetation samples that are different from normal. Select leaves that have wilted or appear to have been chemically burned.

(b) Collect vegetation that appears to have liquid or solid substances deposited on the surface (may appear as a shiny or moist area).

(c) Collect vegetation at several locations within the suspect contaminated area. Preferred sampling locations are horizontal surfaces. Use a cutting tool or another sharp object to cut several affected leaves or a handful of grass. Do not crush the sample. Place the sample in a sealable, leakproof, clear plastic or zipper-lock bag. Squeeze excess air out of the bag, and seal it. Fold the open end of the bag two or three times, and wrap it with tape. Mark the bag for identification. Take a control sample of similar material from an unaffected area. Seal, tape, and mark the control sample in the same manner as the actual sample. Ensure that each layer of packaging is decontaminated using a 5 percent chlorine solution. When it is possible to determine a probable center of attack in an area, collect vegetation samples near the center of the area, about 100 meters upwind of the area, and at several 100-meter intervals downwind of the area.

e. Other Solids.

(1) Stones. Collect stones of moderate size (0.5 to 2 centimeters), with a maximum volume of 200 to 300 milliliters. Place the samples in plastic-free bags in the same manner as soil samples.

(2) Snow. Collect the sample from the layer of snow believed to be exposed to a chemical attack. Collect it from a 10- by 10-centimeter area, 2 centimeters deep. New snow covering the exposed layer preserves the agents, but it should not be collected. Place the sample in a clean sample bottle, and close it with a lined lid. Clean the threads before closing the bottle to prevent melted snow from leaking out.

(3) Carbonized Material. Carbonized material is of value because of its ability to absorb toxic agents. Collect samples to a total volume of 200 to 300 milliliters. Place the samples in plastic-free bags in the same manner as soil samples.

(4) Nontransportable Solids. Samples from immovable objects (such as buildings, walls, paved surfaces, and vehicles) should be taken by scraping or rubbing the contaminated surface with dry, cotton wool/filter paper or cotton wool soaked in distilled water, acetone, or another suitable solvent. The samples should be carefully packaged in airtight containers.

(5) Miscellaneous. Fragments of munitions, canisters, respirator canisters from protective masks, and items of individual NBC PPE are also highly desirable sources of CB agent samples. Canisters are particularly useful since they trap low molecular weight agents and particulates. Cap the canisters and place them in a plastic-free bag or container. After expelling excess air, close the bag and seal it by taping. Remember that the location where a canister is found might not be the contaminated site, because the user may have moved it after being contaminated.

NOTE: Ensure that each layer of packaging is decontaminated using a 5 percent chlorine solution.

11. Medical Specimens

Trained medical technicians or physicians should collect medical specimens (human or animal) or be certified by the appropriate medical authority (e.g., special forces group [SFG] surgeon). Remember, the collector must have permission (authority) to collect medical specimens from the dead because of religious beliefs in many cultures. To obtain such specimens without permission may result in unnecessary mission complications. Ensure that all personnel handling or collecting medical specimens have received proper immunizations for their own protection; they must be inoculated according to the Surgeon General's guidance. Medical specimens collected during an investigation include blood, urine, sputum, nasal swabs, tissue specimens from living victims, and blood and urine specimens from unexposed persons (background control specimens).

NOTES:

1. Specific guidance for the collection of specimens is included in the Surgeon General's medical reference material.

2. See FM 4-02.7 for information on specimen collection and preservation.

12. Radiological-Agent Sampling

a. Background. Radiological sampling operations are important to determine if and where a threat uses a radiological agent. The collection of samples and background information must be as detailed and comprehensive as possible. Each sample must be processed and analyzed to provide data for analysis. Sample processing includes the collection of the sample, its handling and transfer, and the associated administrative procedures.

NOTE: The radiological sampling described in this section is provided as a guide. Specialized units may use more detailed procedures found in references such as AEP 49.

(1) The administrative procedures ensure a documented chain of custody and a detailed description of the collection procedure. After laboratory analysis of the sample, intelligence personnel analyze the data to produce intelligence to support operational requirements.

(2) A threat may scatter radiological agents as radionuclide dust or as pellets of radioactive materials. Radioactive dust will cover vegetation, soil, and water surfaces. Radioactive pellets will not cover vegetation surfaces like a dust, but will remain on the surface of the soil. Also, pellets will sink to the bottom of bodies of water. The team can take samples of vegetation, soil, or water to collect the pellets or dust.

(3) The team does a ground radiological search to locate the contamination. Since the purpose of a sampling mission is to collect radioactive samples, terminate the search after the radioactive area is found. The safety of the team is a constant concern for the commander. The contaminated area may emit high dose rates of radiation; therefore, the team monitors the radiation throughout the radiological sampling mission and does not exceed the commander's OEG.

(4) The team collects radiologically contaminated environmental samples. It chooses the environmental samples based on the measurements the collector makes with radiac meters. Ground contamination may vary significantly from place to place. Local dose rate averages are helpful in choosing a representative sampling location. Conduct soil sampling after the release has ended. Be aware of the commander's dose and turn-back dose rate guidance and of the hazards that may be encountered.

b. Surface Soil Sampling. Evaluate the levels of ground contamination from wet and dry depositions. Validate the plume modeling, and assess the external exposure and inhalation exposure from resuspended activity. Determine the ingestion exposure pathway.

Step 1.

- Receive an initial briefing and assignment from the command.
- Obtain the appropriate equipment.
- Check the instrument performance.
- Conduct radio and GPS checks when leaving for the assignment.

Step 2.

- Wrap the instruments in plastic to prevent contamination (except for the detector window if there is one).

- Preclean and bag or wrap the sample collection equipment.
- Set the alarm levels of direct-reading dosimeters and dose rate meters.
- Wear appropriate radiation protection equipment.
- Wear disposable latex or vinyl gloves, and change them between sample locations.

Step 3.

- Select sampling sites that permit easy resampling at a later date if necessary.
- Identify the position using a GPS reading, local landmarks, stakes, or other markers.
- Select an area that is relatively unvegetated and undisturbed since the radioactive release and well away from structures (e.g., approximately twice the height of nearby structures) to minimize the effects of wind currents on deposition. The number of sampling sites depends on the purpose of sampling and the information required from the particular analysis. Obtain this information during the mission prebrief.
- Take the sample in an area that is 450 to 900 square centimeters, and obtain a composite of 10 or more individual plugs or cores. If time is critical, collect only a single core. In general, collect the top 5 centimeters of the soil (e.g., topsoil) for analyses. The sampling pattern can include—
 - Laying out a 5-meter straight line, transacting the line at about 50-centimeter intervals, and taking at least 10 samples.
 - Measuring out two 1-square-meter areas that are spaced about 3 meters apart and collecting samples from the middle and the corners of each square.

NOTES:

1. A ground tarp can be used to place tools, instruments, and collected samples on to help prevent contamination of sampling equipment.

2. Before collecting soil samples in a suspected contaminated area, conduct a handheld gamma instrument survey to avoid hot spots and determine external exposure levels.

Step 4. Record the environmental conditions at each sampling location at the time of sample collection. These include the weather conditions and the ambient gamma dose rate.

Step 5. Use the following procedures when collecting a sample in moist or loamy soil:

- Select the sampling location and pattern. Don rubber gloves. Remove all vegetation to a height of 1 to 2 centimeters above the soil, and save the vegetation for analysis if desired.

- Use an indelible ink pen to mark the outside of the sampling tool to the desired depth.
- Press the sampling tool into the ground to the desired depth without twisting or disturbing the grass cover or surface soil. Force may be required to get the sampling tool into the ground. This may be accomplished by stepping on the top of the sampling tool or using a rubber mallet.
- Gently twist the sampling tool to cleanly remove the topsoil plug intact. If the plug cannot be removed intact, use another method of sampling, such as inserting the sampling tool in various places along the perimeter of a small circle until a plug is freed.
- Place the plug in a new sample collection container. If the plug does not come out of the sampling tool easily, use a long, flat-blade knife to remove it from the tool.
- Take at least 10 topsoil cores in the sampling pattern selected, and place them into the sample collection container.

Step 6. Use the following procedures when collecting a sample in dry, loose, and sandy soils:

- Select the sampling location and pattern. Don rubber gloves. Remove all vegetation to a height of 1 to 2 centimeters above the soil, and save the vegetation for analysis if desired.
- Press a 10- by 10- by 1-centimeter stamp into the desired location. Use a rubber mallet if necessary.
- Use the matching scoop to slide beneath the stamp, trapping the sample within the stamped area.
- Carefully transfer the sample to a clean, unused sample container.
- Repeat with the specified pattern to obtain 10 samples and composites.

Step 7. Seal the bags with tape. With an indelible ink pen, write the sample identification, location (GPS), date and time of the sample collection, and the collector's initials on the sampling container and the sample control form. Begin a chain-of-custody form if necessary.

Step 8. Clean the sampling tools in clean (distilled) water, and dry them before proceeding to the next sample collection point. Assess the tool for residual contamination using alpha/beta instruments.

Step 9. Repeat steps 3 through 8 for all necessary replicates, background samples, and other sampling locations.

Step 10. Visually inspect the sampling equipment, and replace or clean it if necessary. Use alpha/beta instruments to determine if the sampler remains contaminated.

Step 11. Complete a soil sampling form for each soil sample collected. Place the original forms in a sealed plastic bag, and transport them with the sample.

Step 12. Periodically survey the vehicle and personnel.

Step 13. Perform personnel and equipment monitoring (contamination check) during and after the mission.

c. Surface Water Sampling.

Step 1.

- Receive an initial briefing and assignment from the command.
- Obtain the appropriate equipment.
- Check the instrument performance.
- Conduct radio and GPS checks when leaving for the assignment.

Step 2.

- Wrap the instruments in plastic to prevent contamination (except for the detector window if there is one).
- Preclean and bag or wrap the sample collection equipment.
- Set the alarm levels of direct-reading dosimeters and dose rate meters.
- Wear appropriate radiation protection equipment.
- Wear disposable latex or vinyl gloves, and change them between sample locations.

Step 3.

- Collect 1 to 4 liters at each sampling location unless otherwise directed. Some typical locations include—
 - » Recreation areas.
 - » Public water supply intakes.
 - » Places where water is used (or obtained for use) by animals (e.g., cattle).
 - » Places where water is obtained to irrigate crops.
- Be aware of the following:
 - » The concentrations across a stream or river become more uniform proceeding downstream. Even so, the mixing can still be incomplete miles downstream of the release point—especially in large bodies of slow-moving water.
 - » Radionuclide concentrations in a river are more uniform downstream of turbulence (e.g., white water), meandering portions of the river, and after variations in depth and width.
 - » One sampling point at middepth in the center of the stream should suffice if the stream is relatively narrow and the water is well mixed. If the sample is collected from the bank rather than midstream, collect it from the bank on the outside of a bend where the flow is greatest.

- Composites are required in larger, poorly mixed rivers. This involves at least one vertical composite consisting of a sample collected just below the surface, a sample from middepth, and a sample collected just above the bottom.
- Lakes and ponds experience less mixing and have a greater tendency to stratify than streams and rivers. This stratification is primarily due to temperature. For best results, determine the water temperature profile and sample the different layers independently.
- A single vertical composite at the deepest point in a small impoundment or pond may be satisfactory. In a natural pond, this will usually be near the center. For a man-made body of water, the deepest point is close to a dam. Several vertical composites are required in lakes and large impoundments.

Step 4. Use the sampling form to record the environmental conditions at each sampling location at the time of the sample collection. Include the weather conditions, the ambient gamma dose rate, the water temperature, and the flow rate (if applicable).

Step 5. Don gloves and boots.

Step 6. Dip a bucket or another collection device into the water. Rinse the collection device and the sample container. If using a portable peristaltic pump, ensure that the line is clean before pumping. Pump long enough that the source of water has an opportunity to rinse the inside of the tube.

Step 7.

- Don waders.
- Submerge the sample container or collecting device into the water again.
- Allow the container to fill slowly and continuously.
- Avoid surface disturbance.
- Avoid collecting bottom sediment, vegetation, or small fish.
- Do not fill the sample containers to the very top.

Step 8. Follow the procedures below using a long-handled dipper or another scooping type collecting device:

- Open and slightly tilt the sample container.
- Slowly empty the sampler contents into the container using a new, clean funnel. Allow the sample stream to flow gently down the side of the bottle with minimal disturbance.
- Preserve the sample if directed.
- Cap the container tightly, and wipe down the exterior surface. Tape the cap closed, or seal it if specified.

- Use an indelible ink pen to write the sample identification, location, date and time of sample collection, and the collector's initials on the sampling container and the sample control form.

Step 9. Complete the necessary sampling forms, and begin a chain-of-custody form if required.

Step 10. Decontaminate the outside of the sampling containers and apparatus by rinsing them with clean (distilled) water. Wipe them down. Be alert for oil, grease, or any other type of surface scum that might stick to the sampling device.

Step 11. Repeat the above steps for all necessary replicates, background samples, and other sampling locations.

d. Vegetation and Pasture Sampling.

Step 1.

- Receive an initial briefing and assignment from the command.
- Obtain the appropriate equipment.
- Check the instrument performance.
- Conduct radio and GPS checks when leaving for the assignment.

Step 2.

- Wrap the instruments in plastic to prevent contamination (except for the detector window if there is one).
- Preclean and bag or wrap the sample collection equipment.
- Set the alarm levels of direct-reading dosimeters and dose rate meters.
- Wear appropriate radiation protection equipment.
- Wear disposable latex or vinyl gloves, and change them between sample locations.

Step 3.

- Collect all samples from areas that are unprotected from the wind and undisturbed since the release. The areas should be located in open level areas, away from walkways, roads, ditches, and trenches.
- Ensure that a sampling point near a building is at least twice the height of the building away from the building.
- Use a handheld gamma survey instrument to locate an area with relatively uniform levels. Avoid hot spots.
- Avoid sampling in waterlogged areas and areas that contain a large proportion of dead plant material.
- Try to take the sample from a defined area. A 1- by 1-meter area will often provide a sufficient vegetation sample. Unless directed otherwise, obtain at least 1 kilogram of material, expanding the defined area if necessary.

Step 4. Use the sampling form to record the environmental conditions at each sampling location at the time of the sample collection. Include the weather conditions and the ambient gamma dose rate.

Step 5. Use shears or another instrument to cut the sample down to 1 to 2 centimeters above the ground. Disposable scalpels limit cross contamination problems.

Step 6. Carefully fill a large, clean, unused polyethylene bag, taking care to minimize external contamination. Seal the container.

Step 7. Use an indelible ink pen to write the sample identification, location, date and time of sample collection, and the collector's initials on the sampling container and the sample control form.

Step 8. Complete the necessary sampling forms, and begin a chain-of-custody form if required.

Step 9. Decontaminate the outside of the sampling containers and tools by rinsing them with clean (distilled) water. Wipe them down. Double-bag the sample. Check the surfaces of the sampling equipment with alpha/beta instruments for residual contamination.

Step 10. Repeat steps 3 through 9 for all necessary replicates, background samples, and other sampling locations.

Step 11. Periodically survey the vehicle and personnel.

Step 12. Perform personnel and equipment monitoring (contamination check) during and after the mission.

e. Urban Sampling.

Step 1.

- Receive an initial briefing and assignment from the command.
- Obtain the appropriate equipment.
- Check the instrument performance.
- Conduct radio and GPS checks when leaving for the assignment.

Step 2.

- Wrap the instruments in plastic to prevent contamination (except for the detector window if there is one).
- Preclean and bag or wrap the sample collection equipment.
- Set the alarm levels of direct-reading dosimeters and dose rate meters.
- Wear appropriate radiation protection equipment.

Step 3. Use the sampling form to record the environmental conditions at each sampling location at the time of the sample collection. Include the weather conditions and the ambient gamma dose rate. Annotate the sampling location on an area map. If possible, take a digital or self-developing image of the area.

Step 4. Sample roof tiles.

- Select buildings with roofs that are easy to access.
- Obtain permission from the owner to take tiles that are still in place.
- Try to select tiles that are oriented at $\leq 45^\circ$ to the ground. Do not select tiles that are oriented vertically.
- Use appropriate, clean tools to remove four to eight tiles. One or two tiles will represent each sample.
- Transfer the tiles into a new, dry container.
- Wipe the external surfaces of the container, and double-bag it.
- Use an indelible ink pen to write the sample identification, location, date and time of sample collection, and the collector's initials on the sampling container and the sample control form. Record the sampling details, including the specific sample location and the exposed area.
- Place and seal all sample bags inside a large, thick, black plastic bag.

Step 5. Sample road dust.

- Select areas where dust is clearly visible.
- Use a new paintbrush to sweep the dust into a pile, and sweep it onto a small scoop. Avoid inhaling resuspended dust because the presence of alpha-emitting radionuclides could pose a serious radiological inhalation hazard. Use a new paintbrush for each new set of samples.
- Place the scoop in the sample container, and slowly tip the dust into the container.
- Wipe the external surfaces of the container, and double-bag it.
- Use an indelible ink pen to write the sample identification, location, date and time of sample collection, and the collector's initials on the sampling container and the sample control form. Record the sampling details, including the specific sample location and the exposed area.
- Place and seal all sample bags inside a large, thick, black plastic bag.

Step 6. Sample roof gutter dirt.

- Select buildings with roofs that are easy to access, and choose a site that is close to the gutter downpipe.
- Use a gloved hand to remove dirt from the bottom of the gutter, and place it in a sample container.
- Wipe the external surfaces of the container, and double-bag it.
- Use an indelible ink pen to write the sample identification, location, date and time of sample collection, and the collector's initials on the sampling container and the sample control form. Record the sampling details, including the specific sample location and the exposed area.

- Place and seal all sample bags inside a large, thick, black plastic bag.

Step 7. Sample improvised air filters.

NOTE: The system airflow rate is particularly important. By estimating the time of plume passage, the approximate concentration of radioactivity in the air can be estimated.

- Identify buildings or homes with ventilation systems that were operating and stationary during plume passage.
- Determine the airflow rate of the system or engine, if possible, and record it on an air sampling form.
- Remove the filter cover. Determine if significant contamination is present by surveying with a beta/gamma or alpha contamination probe. Record the net count rate on the surface of the filter, and record the details of the instrument used.
- Place the filters into a polyethylene bag, wipe the external surface, and label it. Double-bag the sample.
- Use an indelible ink pen to write the sample identification, location, date and time of sample collection, and the collector's initials on the sampling container and the sample control form. Record the sampling details, including the specific sample location and the exposed area.

Step 8. Periodically survey vehicles and personnel; and document the reading, time, and location.

Step 9. Perform personnel and equipment monitoring (contamination check) after the mission.

13. Background Samples

Take background samples that correspond to each type of contamination sample. Pack and transport the background samples in the same manner as the contaminated samples. Background samples must closely resemble those presumed to be contaminated. Seek vegetable matter that is identical to the contaminated sample, and select water from an area nearby that was not subjected to contamination. Clearly mark background and contaminated samples.

NOTE: The background samples will be analyzed at a supporting laboratory along with the actual suspected samples.

14. Transfer Operations

The sample procedures outlined below can be used by teams who are responsible for receiving a CB sample.

- a. Notification of Transfer.
 - (1) The escort unit liaison receives a report of the CB incident.
 - (2) The escort unit establishes direct communications with the TF/supported headquarters.

- (3) The escort unit reports to designated areas within the predetermined response time.
- (4) The escort unit liaison—
 - (a) Receives mission briefs from the medical staff, NBC cell, and liaison officer (LNO)/NCO.
 - (b) Determines the type of unit collecting samples.
 - (c) Identifies the location of collection and transfer points.
 - (d) Determines the method of movement (air, sea, or ground) to the sample transfer point.
 - **Air.** Identifies the pickup zone (PZ)/landing zone (LZ) locations, and ensures that the escort team has transportation to and from these locations.
 - **Sea.** Identifies the port or pickup/landing point locations, and ensures that the escort team has transportation to and from these locations.
 - **Ground.** Determines if coordination is required for vehicle decontamination after the samples are picked up, and coordinates as necessary.
 - (e) Coordinates for security along the escort route and at the sample transfer point.
 - (f) Issues a WARNORD/FRAGORD to the escort team.
- (5) The escort TL briefs the team on the mission.
- (6) The escort unit liaison coordinates with the theater area medical laboratory/supporting laboratories for receipt of the sample.
- (7) The escort unit liaison coordinates for assets to fly samples to CONUS if required.
- (8) The escort unit liaison coordinates with CONUS escort assets (i.e., TEU) to meet the receiving team at the APOD and transport the sample to the appropriate laboratory.
- (9) The escort unit liaison tracks the progress of the operation and updates the TF/supported headquarters.
 - b. Planning.
 - (1) The escort unit TL issues a WARNORD to the team.
 - (2) The escort unit TL—
 - (a) Conducts a mission analysis and begins troop-leading procedures.
 - (b) Identifies the force structure, type of mission (CB), and required equipment.
 - (c) Identifies the critical times in mission accomplishment and determines time constraints.

- (d) Identifies the location and routes of the proposed sample transfer site and linkup point. Briefs the team on alternate locations and routes.
- (e) Determines the size and number of samples that will be received by the laboratory and communicates that information to the laboratory.
- (f) Determines the nature of the suspected agent and the neutralization procedures as required (e.g., handheld assay strips).
- (g) Determines if the environment is permissive or nonpermissive.
- (h) Verifies the means of transportation to the transfer site (air, sea, or ground) with the liaison team.
- (i) Coordinates for the security element or plans to provide security if required.
- (j) Identifies the implied tasks necessary to accomplish the overall mission.
- (k) Identifies the location of the theater area medical laboratory and other supporting laboratories.
- (l) Identifies the quantity of samples.

NOTE: The escort team may need to provide a sample to HN, theater area medical, or CONUS laboratories for identification. The theater area medical laboratory will split the sample and analyze one portion of it to support the in-theater commander's requirements. The rest of the sample will be forwarded to CONUS laboratories for identification.

- (m) Verifies the communications plan with higher headquarters and supporting units and verifies the interoperability of communication procedures.
- (n) Coordinates for additional logistics support if needed (e.g., transportation, decontamination, security, classes of supply).
- (o) Coordinates with local medical units to ensure that they can accommodate chemically contaminated casualties.
- (p) Determines the wind direction to ensure that proposed sites are upwind of the known contaminated area/unit (in a clean location, if possible).

(3) The escort unit TL and the noncommissioned officer in charge (NCOIC) issue the OPORD.

(4) The escort unit TL back-briefs the LNO on the plan.

c. Preparation.

(1) The leaders supervise the escort team's performance of precombat inspections in preparation for the current mission. The escort team performs preventive maintenance on all equipment and vehicles according to the appropriate TM and loads the vehicles.

(2) The escort team conducts rehearsals with the supporting units, if possible, to include actions at the sample transfer point. For some missions, the escort team performs the entire mission (e.g., sampling through forwarding the sample to the supporting medical laboratory).

d. Site Setup/Linkup.

(1) The escort unit TL conducts the initial linkup with the sampling unit. The leader uses radio communications or physically meets the unit at a specific location and time. (Use near and far recognition symbols, if possible.) Upon establishing linkup, the team moves to the sample transfer area.

(2) The escort team sets up the sample transfer site and, based on the wind direction, establishes the site upwind of the known contaminated area/unit (in a clean location, if possible). The team also determines the placement of the hot line and establishes the sample transfer decontamination line.

(3) The escort team sets out the necessary equipment as follows:

(a) Biological.

- Packaging and wrapping equipment (zipper-lock bags, 6-milliliter bags).
- Refrigeration equipment (coolers, sample transfer cases, cold packs).
- Decontamination equipment (buckets, bleach, spray bottles).
- Miscellaneous equipment (clipboard, ink pens, tape, gloves, DD Form 1911).

(b) Chemical.

- Packaging and wrapping equipment (zipper-lock bags, 6-milliliter bags).
- Refrigeration equipment (coolers, sample transfer cases, cold packs).
- Decontamination equipment (buckets, spray bottles).
- Detection equipment.

e. Transfer. Transfer procedures will vary depending on the type of unit that collected the sample (i.e., biological detection system, NBCRS). The following sample procedures should be considered:

(1) The collection team moves to the linkup location on the contaminated side of the hot line (if the area is dirty).

(2) The collection team verifies the identity of escort team personnel obtaining the sample.

(3) The collection team delivers the sample in the configuration specified in the unit TTP manual or technical publication.

(4) An escort team member—

- Uses a spray bottle of bleach or places the sample container in a 5 percent chlorine solution to decontaminate the outside of the sample container.
- Places the container in another single or double zipper-lock bag.
- Completes the chain-of-custody paperwork.

- Verifies the serial numbers as appropriate.
- Ensures that the chain-of-custody document is complete and signs it.
- Places the sample and disks or printouts (if applicable) inside a refrigerated container.
- Places the sample in a sample transfer case.
- Sprays the outside of the sample transfer case with decontaminant.

NOTE: Keep refrigerated containers in a low ultraviolet light environment. Coordinate with the supporting medical laboratory for the best sample temperature during transportation.

(5) All personnel are decontaminated if necessary.

(6) The escort team closes out the site and evacuates the sample to the designated location.

NOTES:

1. During sample transfer with a contaminated Fox, the Fox may back up about 5 meters short of the hot line. Fox sample containers are located outside the vehicle in sample vial tubes. The Fox unit receives the sample receipt from the escort team and places the document in a zipper-lock bag in the sample container box on the outside of the Fox. The unit places a contamination marker in the clean area adjacent to where the sample transfer occurred.

2. In some instances, escort team personnel may be required to remove a surface sample wheel from an NBCRS and place it in a zipper-lock bag. A team member will carry the bag containing the wheel to the hot line, spray it with a 5 percent chlorine solution, and place it in a double zipper-lock bag.

f. Site Closeout.

(1) Escort team members close out the site on the hot side after they process through the decontamination line.

(2) Escort team members complete the decontamination process, mark the location of the site as contaminated (if required), and submit an NBC 4 report (if necessary).

(3) The escort unit TL provides a status report to the escort unit liaison.

(4) The escort team transfers the samples to the designated location.

g. Escort and Transfer.

(1) The escort team moves by ground or air to the designated location.

(2) The TL notifies the LNO that they are en route.

(3) The escort team identifies the number of samples taken and the suspected agent if known (use a code word).

(4) The escort team transfers the samples to the designated location operations center and is given a tracking number. The samples and any additional items (computer software, paperwork) are signed over on a chain-of-custody form.

(5) The TL notifies the LNO when the transfer is complete.

h. Receiving the Sample for CONUS Shipment.

(1) A CONUS escort team is notified that samples are being collected by a theater-based escort team.

(a) The liaison team determines the priority of movement for the samples to CONUS and determines when an aircraft will be available for evacuation.

(b) The escort team begins manifesting for departure.

(c) The liaison team coordinates for escort back to CONUS or requests an escort team from CONUS.

(2) The team prepares the samples for shipment to a CONUS location.

(a) The team begins repacking the samples in a proper transfer container. If an agent is of biological origin, the team ensures that it is kept at the appropriate temperature. The unit holding the samples maintains the chain-of-custody documents and ensures that copies of all previous chain-of-custody documents accompany the escort team.

(b) The team ensures that all additional paperwork, computer software, and a description of the samples accompany the samples to their final destination.

(c) The escort team moves the samples to the linkup point, manifests the samples (which includes preparing the shipper's declaration, properly marking the package, and briefing members of the aircrew), and boards the aircraft for return to CONUS.

i. Final Destination. The liaison team coordinates for escort personnel to meet the CONUS escort team at the designated location. Escort personnel pick up the team and drive them to the appropriate analysis laboratory. The team signs over all items to the appropriate laboratory.

15. Labeling and Documentation

Documentation is essential to the forensic quality of the sample because it provides detailed information regarding the sampling location, conditions, equipment, personnel, time, and other pertinent details. Anecdotal information should also be recorded when processing the sample. Strict adherence to documentation guidelines helps verify the integrity of the sample(s). Remember, a sample not documented is a sample not taken. Documentation must be as complete as possible before collecting each sample. The following sample documents provide formats that may be used to record basic data relating to sample collection. There is a variety of options available to ensure that essential documentation is prepared during sampling operations.

NOTE: The original documentation should accompany the sample throughout its life cycle. However, all agencies involved in handling and processing the samples should retain a copy of the appropriate paperwork covering their activities.

a. Sample Labels and Seals. Label, package, seal, and transport samples to a designated laboratory for analysis according to local forensic transport practices and state and federal regulations. Clearly label primary and secondary containers with identification information (*Figure E-5*). Seal the lid of the outermost container with tamper-resistant tape. Mark it with the sampler's name, the sample number, the date and time of sampling, and the place it was collected (*Figure E-6*).

Collector:
Sample Number:
Place of Collection:
Grid/GPS Coordinates (if available):
Date Sampled:
Time Sampled:
Field Information:

Figure E-5. Sample Label

Name and Address of Organization Collecting Samples: _____ _____
Person Collecting Samples: _____ (Signature)
Sample Number: _____
Date Collected: _____ Time Collected: _____
Place Collected: _____

Figure E-6. Sample Seal

b. Sample Evidence/Sample Log. Use an evidence/sample log (*Figure E-7*, page E-53) to maintain an accurate record of all samples taken. At a minimum, ensure that the log contains the unique identifier from the sample label (the sample number), a description of the sample, the sample location, the sample collector’s name, witness information, and the date and time of sample collection.

c. Sample Photographic Log. Maintain a photographic log (*Figure E-8*, page E-54) for all digital and still photographs taken, and assign a number to each photograph. The log documents the process of scene photography, including the technical and descriptive information concerning the photographic task.

NOTE: Videotaping the sampling process produces an additional burden on the need to adhere to proper sampling procedures. The videotape becomes admissible in court, and any mistakes that are documented during the sampling process can be used in any pending criminal investigation or prosecution.

d. Sample Diagram/Sketch Form. Use a diagram/sketch form (*Figure E-9*, page E-55) during the site assessment to depict the sampling site. Identify the location, date, and assessment team members; and provide a space for a sketch and any clarifying notes to aid in site assessment.

e. Sample Administrative/Logistics Form. The administrative/logistics form (*Figure E-10*, page E-56) documents the conditions of the sampling site and serves as a

running log of the activities that comprise the operation. Include a description of the weather and the temperature at the time of sampling.

f. Sample Recovery Log. The recovery log (*Figure E-11*, page E-57) can also serve as an evidence/sample log.

16. Packaging of Samples for Shipment

All samples must be packaged in three layers of containment to meet air transport regulations—the sample container, a primary container, and a secondary container. To meet these requirements—

- Use special transport media that complies with the United Nations (UN) handling regulations. It consists of a primary container, which is held in absorbent material within a secondary container. The secondary container is carried in an outer container. (Commercially manufactured packs specifically designed for the transport of dangerous pathogens and approved by the International Air Transport Association are widely available.)
- Double-wrap or -bag the primary container for less hazardous samples. Place the primary container in another bag (secondary container). Remove excess air pockets, and place the secondary container in an outer container packed with absorbent material. Place breakable containers in rigid containers to protect them from puncture or breakage.

a. Less Than 50 Milliliters. If the volume does not exceed 50 milliliters, place the material in a securely closed, watertight container (primary) and enclose it in another durable, watertight container (secondary). Several primary containers can be enclosed in a single secondary container if the total volume does not exceed 50 milliliters. Ensure that the space at the top, bottom, and sides between the primary and secondary containers contains enough nonparticulate absorbent material (e.g., paper towels) to absorb the contents of the primary container(s) in case of breakage or leakage. Enclose each secondary container in an outer shipping container (e.g., sample transfer case) that is constructed of corrugated fiberboard, cardboard, wood, or another material of equivalent strength.

b. More Than 50 Milliliters. If the volume is greater than 50 milliliters, ensure that packaging material complies with the requirements in paragraph 16a. In addition, place a shock-absorbent material, which is at least equal in volume to the absorbent material, between the primary and secondary containers and on the top, bottom, and sides between the secondary container and the outer shipping container. Ensure that single primary containers do not contain more than 1,000 milliliters of material. However, two or more primary containers whose combined volumes do not exceed 1,000 milliliters can be placed in a single, secondary container. No more than 4,000 milliliters of an etiologic agent can be enclosed within a single outer shipping container.

NOTES:

1. Wear eye protection, respiratory protection, and gloves when handling a sample.
2. See applicable system level TMs or TOs for specific instructions on packaging liquid samples, such as sample vials or bottles.

Location: _____	Personnel and Contact Information: _____ _____ _____ _____ _____
Date: _____	
Incident Identifier: _____	
Preparer/Assistants: _____	

Sample Identifier	Description	Sample Location	Time	Collected By	Photo (Yes or No)	Sample Kit	Packaging Method	Comments

Figure E-7. Sample Evidence/Sample Log

Page ____ of ____

Location: _____				Camera: _____		
Date: _____				Type of Film and Rating: _____		
Incident Identifier: _____				Remarks: _____		
Preparer/Assistants: _____				_____		
_____				_____		
_____				_____		
Photo Number	Roll and Frame Number	Description of Photographic Subject	Camera Settings and Lens Type	Distance	Use of Scale	Sketch (If Applicable)

Figure E-8. Sample Photographic Log

Location:	Date:	Incident Identifier:	Preparer/Assistants:
Sketch:		Notes:	

SAMPLE

Figure E-9. Sample Diagram/Sketch Form

Page ____ of ____

Location (Grid, GPS, Address): _____ _____ Mission/Case Number: _____ Preparer: _____ _____ Time and Date of Arrival: _____ Condition of Sampling Site (Secured/Unsecured): _____ _____ Lighting Conditions: _____ Weather Conditions: _____ Special Conditions, Safety Hazards or Conditions: _____ _____	Personnel Involved: _____ _____ _____ _____ Preliminary Survey (Note Observations): _____ _____ Final Survey: _____ _____ _____
---	---

Administrative Log	
Time	Pertinent Description/Information

Figure E-10. Sample Administrative/Logistics Form

Grid/GPS/Coordinate Location: _____	Sampling Team: _____
Time and Date: _____	_____
Mission/Case Number: _____	_____
Preparer/Assistants: _____	_____
_____	_____

Sample Number	Location of Sample	Description	Sampled By	Type	Lot Number	Photograph Number	Comments

Figure E-11. Sample Recovery Log

17. Transfer of Samples to a Laboratory or Lead Agency

a. Proper documentation of the sampling process is a key factor in the successful transfer of samples to a laboratory for analysis or to the lead agency in an investigation, particularly with respect to maintaining an accurate depiction of the chain of custody. In the event of litigation, the processes of sample collection, transfer, analysis, storage, and disposal are documented and comprise a chain of custody that may be used to trace the possession of the sample from the moment of collection through analysis and disposal. Chain of custody is a critical element of good field and laboratory practices.

b. The sampling TL—

- Signs and records the date and time of transfer on the chain-of-custody form to be included with each group of samples in each transportation container.
- Makes a copy of all documentation.
- Places the original chain-of-custody documentation in a sealed plastic bag.
- Seals the transportation containers with tamper-proof shipping tape.
- Transfers the transportation containers to the lead agency (in person, by hand) and documents the transfer on the chain-of-custody form.

c. If the chain is broken between the transfer of samples, implement a contingency plan. Determine the cause of the chain breakage and perform corrective actions to reconstruct the chain. Obtain affidavits (*Figure E-12*) from all field and laboratory personnel. An affidavit is a sworn statement that the person in question actually relinquished samples to the next individual in the transfer process. This process is greatly facilitated if copies of all forms are retained. Complete the transfer of samples, and attach the affidavits to the chain-of-custody documentation.

AFFIDAVIT

State of _____, County of _____

I do solemnly swear (or affirm) that, to the best of my knowledge, the environmental samples identified on the chain-of-custody form were transferred in a secure manner to the next party indicated on the chain-of-custody form. I also solemnly swear (or affirm) that, to the best of my knowledge, the samples were not damaged or tampered with during process or transfer.

In **WITNESS WHEREOF** I have hereunto set my hand and seal this ____ day of _____ 20__.

Typed Name and Position/Rank: _____

Agency: _____

Signature and Date: _____

Subscribed and sworn to (or affirmed) before me this ____ day of _____ 20__.

Witness Signature: _____

My commission expires: _____

Figure E-12. Sample Affidavit

Appendix F

ORGANIZATIONS AND EQUIPMENT

1. Background

This appendix provides information on service assets that have NBC reconnaissance capability. It also includes brief descriptions of chemical and radiological equipment that are generally available at unit level.

2. United States Army Capabilities

US Army NBC reconnaissance units are composed of teams, squads, sections, and platoons. One system (M93A1 Fox) and one crew is a team, two teams are a squad, and an ad hoc grouping of three or more systems teams is a section. Platoons range in size from three to eight teams with their vehicles.

a. Chemical Company (Smoke/Decontamination/Reconnaissance) (ACR). *Figure F-1* shows the organization of this company. It can be wheel- or track-equipped. An NBC reconnaissance platoon is organized with three squads, and each squad has two M93A1 Fox vehicles.

- **Allocation.** One company per ACR.
- **Mission.** To provide NBC warning and reporting staff support, NBC reconnaissance support, equipment decontamination, and/or smoke support to an ACR.
- **Capabilities.**
 - Conducts route, zone, and area NBC reconnaissance.
 - Conducts NBC surveys, surveillance, and sampling.
 - Provides ISR support, decontamination, and smoke support.

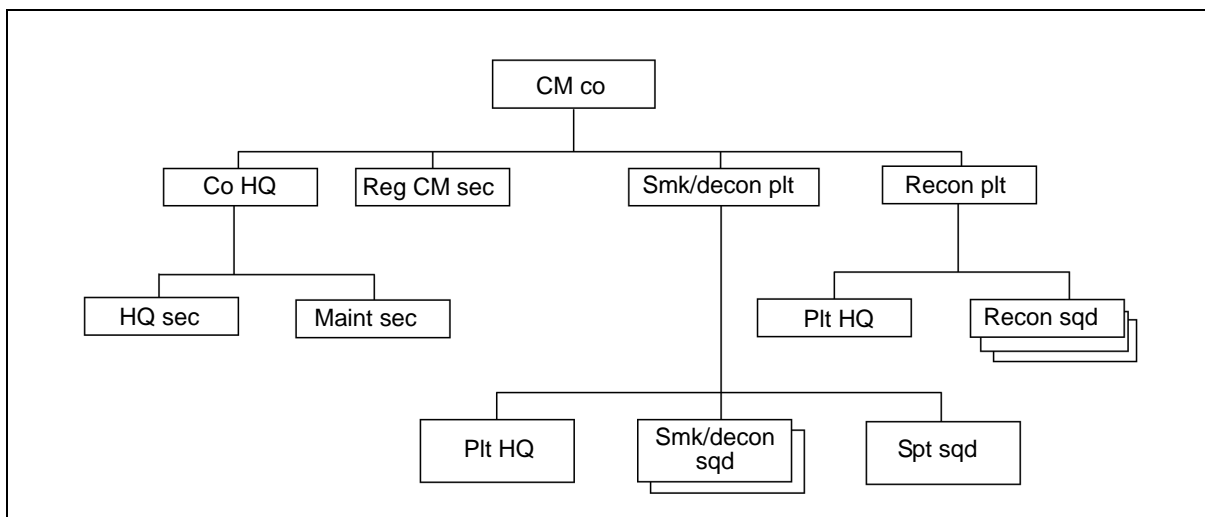

Figure F-1. Chemical Company (Smoke/Decontamination/Reconnaissance) (ACR)

b. Chemical Company (Reconnaissance/Decontamination) (ACR) (Light). *Figure F-2* shows the organization of this company. An NBC reconnaissance platoon is organized with two squads, and each squad has two M93A1 Fox vehicles.

- **Allocation.** One company per ACR (light).
- **Mission.** To provide NBC warning and reporting, NBC staff support, NBC reconnaissance support, and NBC decontamination support to an ACR (light).
- **Capabilities.**
 - Conducts route, zone, and area NBC reconnaissance.
 - Conducts NBC surveys, surveillance, and sampling.
 - Provides reconnaissance and decontamination support.

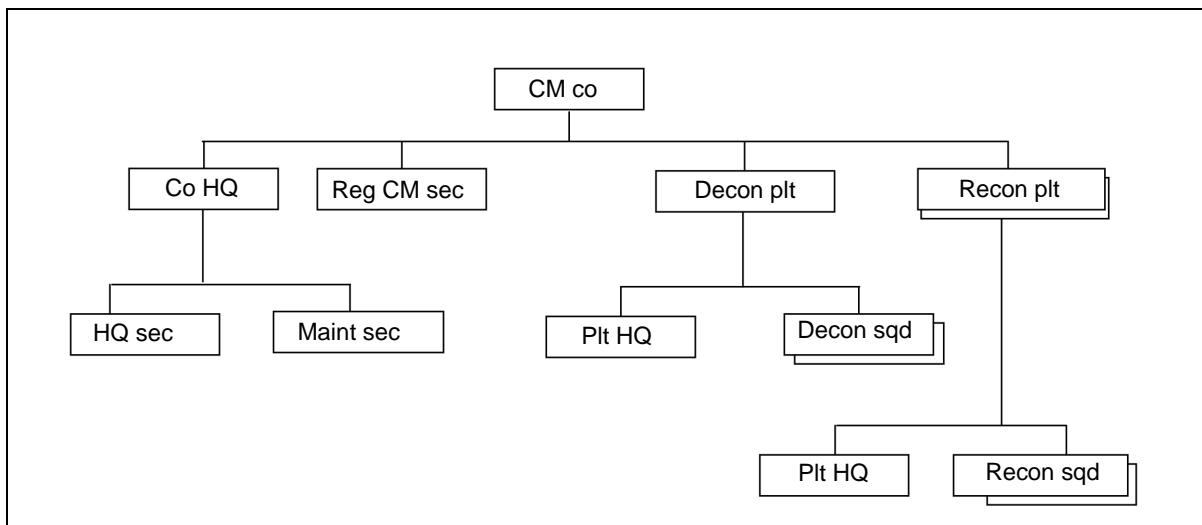

Figure F-2. Chemical Company (Reconnaissance/Decontamination) (ACR) (Light)

c. Chemical Detachment (Reconnaissance). *Figure F-3* shows the organization of this detachment. Each reconnaissance squad has two M93A1 Foxes.

- **Allocation.** One per Force XXI digitized division cavalry squadron.
- **Mission.** To provide NBC reconnaissance support for elements of a Force XXI digitized division.
- **Capabilities.** Conducts route, zone, and area NBC reconnaissance to determine the presence and extent of NBC contamination.

d. Chemical Company (Reconnaissance). *Figure F-4* shows the organization of this company. It has three platoons, each platoon has four squads, and each squad has two M93A1 Fox vehicles.

- **Allocation.** One company per corps/theater Army (TA) (assigned to the corps NBC battalion).
- **Mission.** To provide NBC reconnaissance support for elements of a corps/TA.

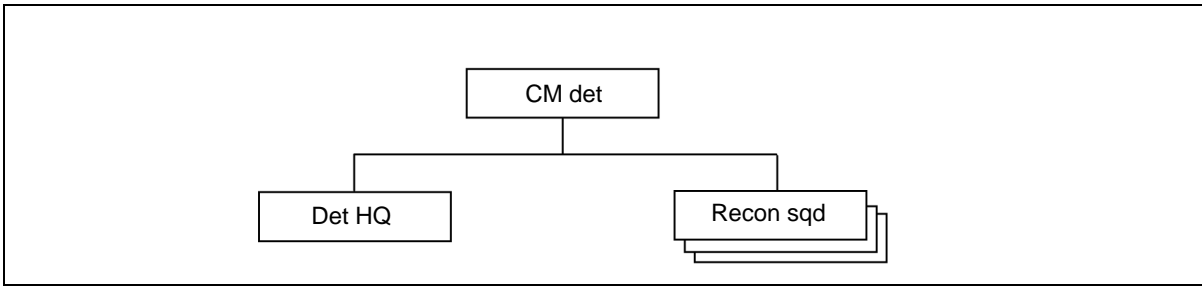

Figure F-3. Chemical Detachment (Reconnaissance)

- **Capabilities.**
 - Conducts route, zone, and area NBC reconnaissance to determine the presence and extent of NBC contamination.
 - Provides radiation monitoring and chemical-agent accident and incident control plan operations support.
 - Provides conventional route, zone, and area reconnaissance.

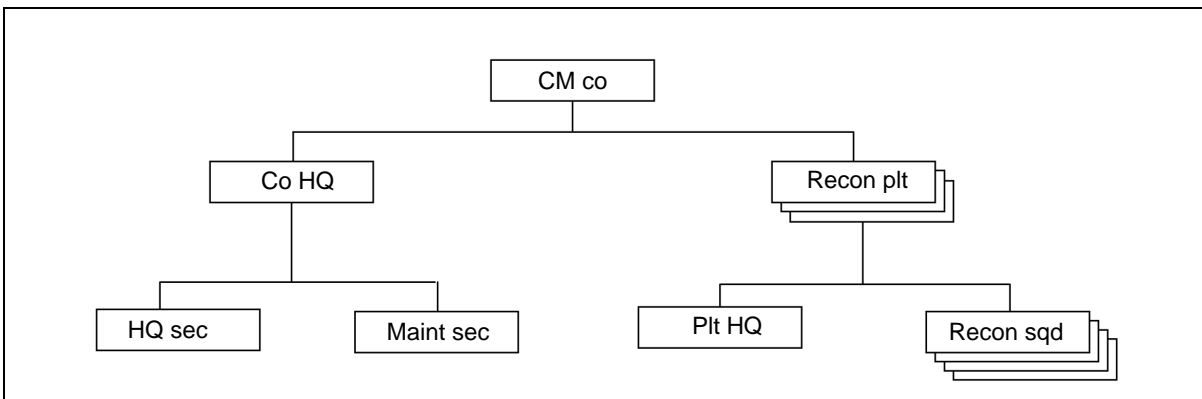
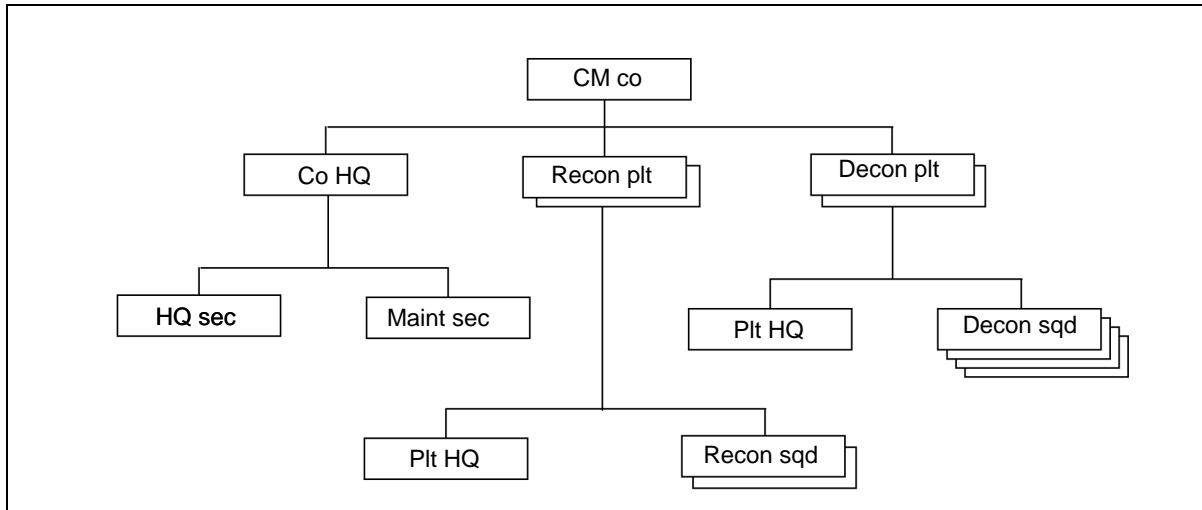

Figure F-4. Chemical Company (Reconnaissance)

e. Chemical Company (Reconnaissance/Decontamination) (Force XXI Digitized Division). *Figure F-5*, page F-4, shows the organization of this company. It has two reconnaissance platoons, each platoon has two squads, and each squad has two M93A1 Fox vehicles.

- **Allocation.** One per Force XXI digitized division (assigned to the corps NBC battalion).
- **Mission.** To provide NBC reconnaissance and equipment decontamination for Force XXI digitized divisions.
- **Capabilities.**
 - Performs NBC reconnaissance and decontamination missions simultaneously. The reconnaissance and decontamination elements are dedicated to their respective missions.
 - Conducts route, zone, and area NBC reconnaissance.
 - Operates in the division area.



**Figure F-5. Chemical Company (Reconnaissance/Decontamination)
(Force XXI Digitized Division)**

f. Chemical Company (Biological Detection). *Figure F-6* shows the organization of this company.

- **Allocation.** One company per corp, one per TA, and one per Force XXI digitized division (heavy).
- **Mission.** To provide early warning, detection, location, and identification of biological agents and BW.
- **Capabilities.**
 - Provides 5 platoons that operate up to 35 detection/identification teams. Each platoon consists of 7 teams.
 - Collects and identifies known or suspected samples of biological agents.
 - Collects and holds samples for later laboratory analysis.
 - Has limited chemical detection capabilities.
 - Sets up and is operational in less than 1 hour.
 - Provides 24-hour operations under all weather conditions.
 - Possesses navigational, meteorological, communication, and auxiliary power.

g. NBC Reconnaissance (LB) Team and Chemical Reconnaissance Detachment (CRD) (see *Appendix L*).

h. NBC Reconnaissance Platoon, Stryker Brigade Combat Team. *Figure F-7* shows the organization of this team. The platoon consists of three reconnaissance squads, and each squad has two NBCRVs.

- **Allocation.** Organic to the Stryker brigade combat team reconnaissance and surveillance target acquisition squadron.

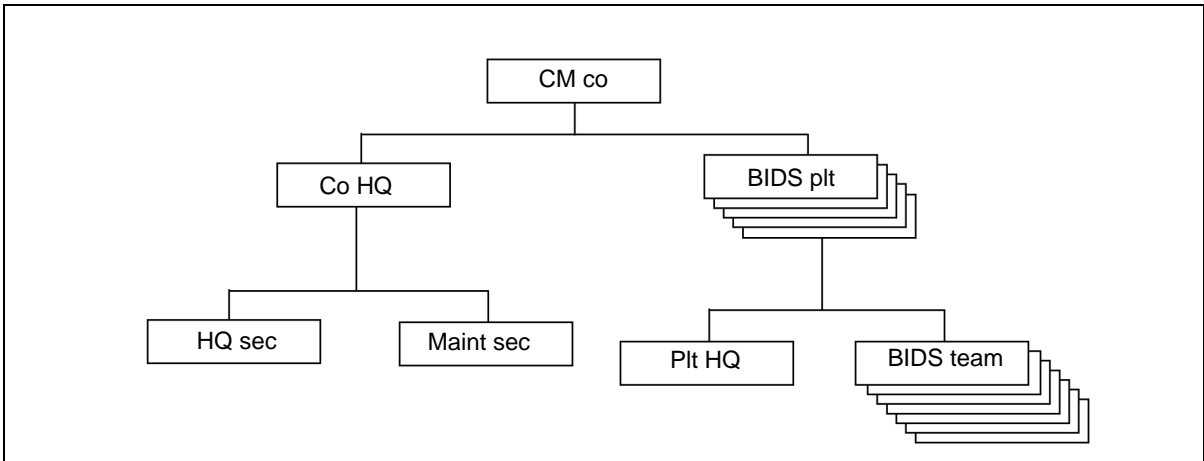

Figure F-6. Chemical Company (Biological Detection)

- **Mission.** To provide NBC reconnaissance support to the Stryker brigade combat team.
- **Capabilities.** Conducts route, zone, and area NBC reconnaissance.

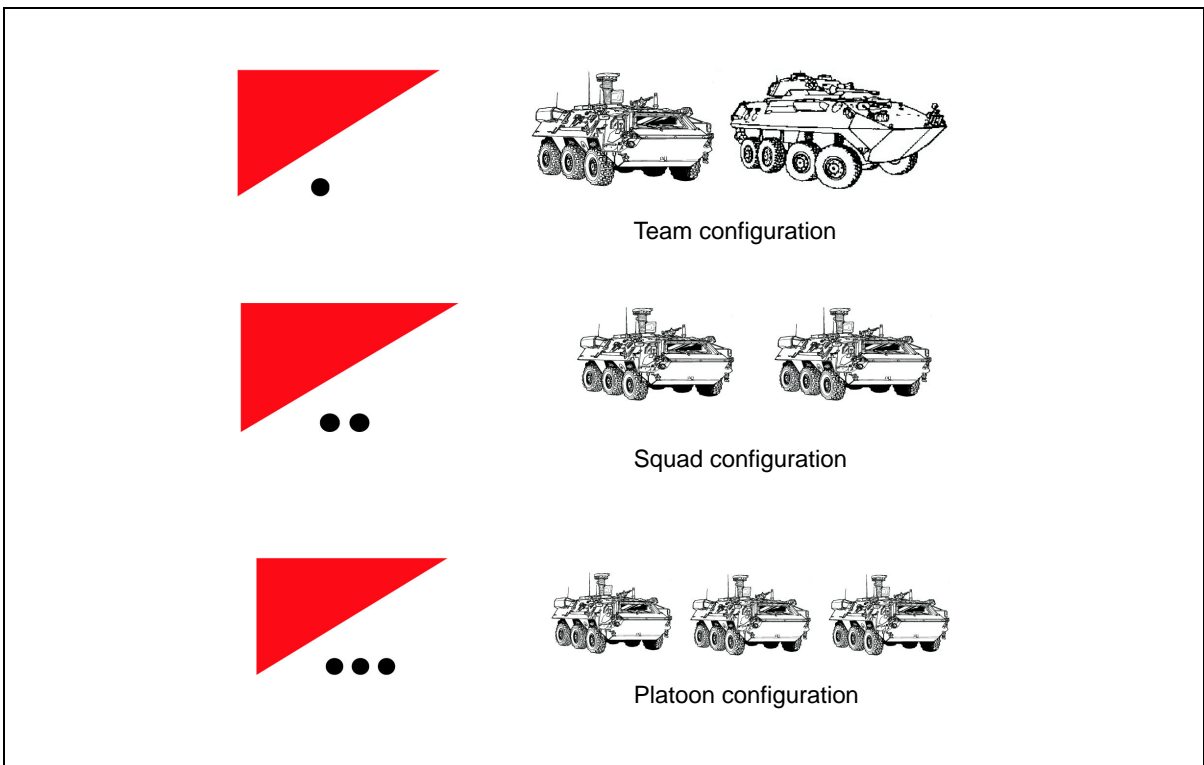

Figure F-7. NBC Reconnaissance Platoon, SBCT

i. Chemical Company (Heavy Division). *Figure F-8* shows the organization of this company.

- **Allocation.** One per armored or mechanized division. (These divisions are in a transition period, and their organic NBC defense company is being moved to echelons above division.)
- **Mission.** To provide NBC staff support, equipment decontamination, smoke support, and NBC reconnaissance for a heavy division.
- **Capabilities.**
 - „ Provides NBC staff services to the division headquarters.
 - „ Operates on a 24-hour basis.
 - „ Provides radiation monitoring and chemical detection capability in support of nuclear or chemical accident/incident control plan operations.
 - „ Conducts route, zone, and area NBC reconnaissance.
 - „ Conducts NBC surveys, surveillance, and sampling.

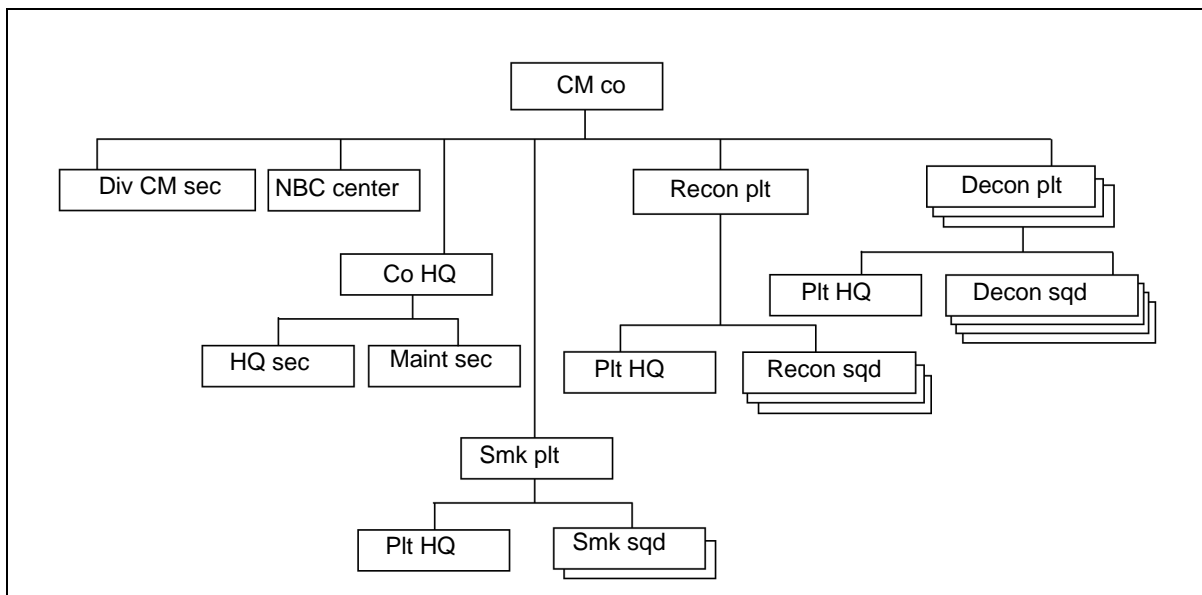

Figure F-8. Chemical Company (Heavy Division)

j. TEU. *Figure F-9* shows the organization of this unit.

- **Mission.** To provide worldwide, no-notice field sampling, identification, and verification of chemical agents and to monitor, recover, decontaminate, escort, and mitigate hazards associated with CB materials in compliance with international, federal, state, and local laws.
- **Capabilities.**
 - „ Provides technical escort of CB munitions and materials.

- Renders safe and/or disposes of weaponized CB munitions and materials.
- Conducts technical intelligence exploitation of foreign CB munitions and material.
- Provides CB response teams to government agencies, as required, to support national and international requirements.
- Conducts operations in hazardous environments.

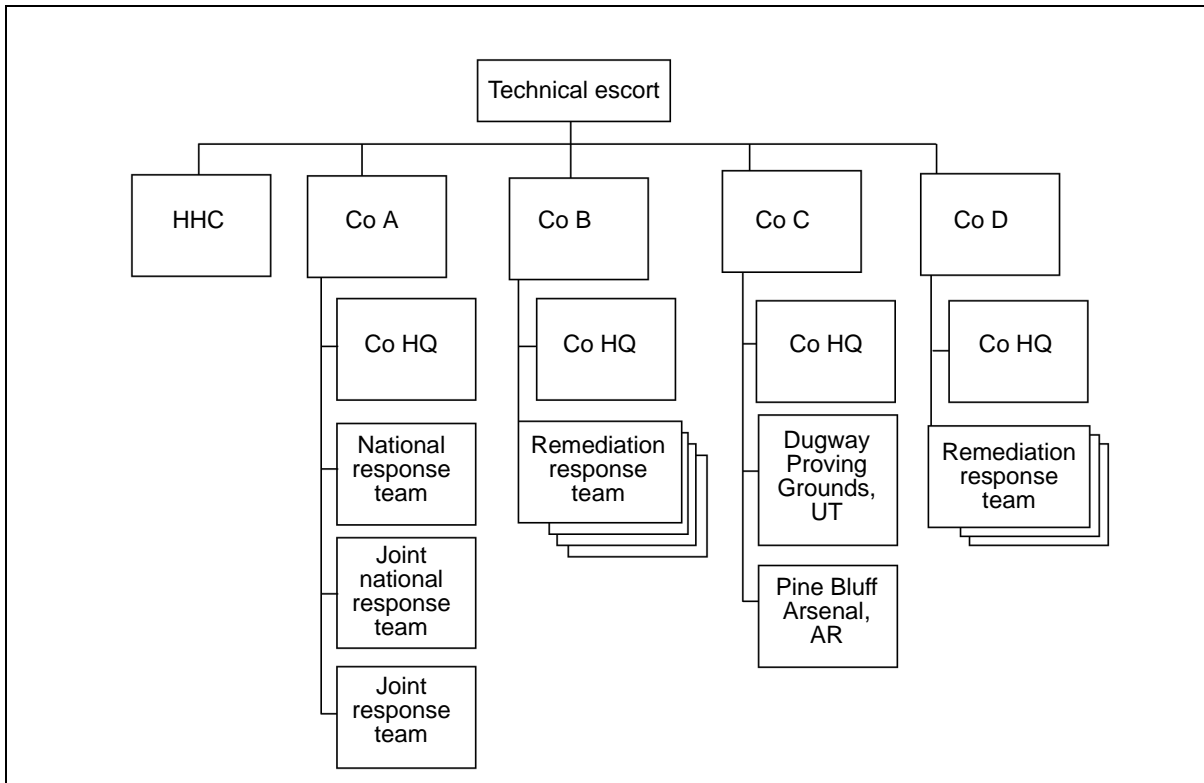

Figure F-9. TEU

k. EOD Unit. These units provide EOD support to defeat or mitigate the hazards from conventional, nuclear, or chemical military munitions and WMD. They—

- Identify and render safe foreign and US military munitions.
- Dispose of munitions encountered and render safe terrorist improvised explosive devices (IEDs).
- Respond to WMD incidents.
- Conduct training on military munitions and IEDs.

l. WMD Civil-Support Team. *Figure F-10*, page F-8, shows the organization of this team.

- **Allocation.** One per assigned region.
- **Mission.** To support civil authorities at a domestic chemical, biological, radiological, nuclear, and high-yield explosives (CBRNE) site by—

- n Identifying agents or substances.
- n Assessing current and projected consequences.
- n Advising on response measures.
- n Assisting with approximate requests for additional support.
- **Capabilities.**
 - n Supports local ICs and emergency responders.
 - n Detects unknown NBC agents.
 - n Surveys and conducts the modelling of the hazard.
 - n Advises the IC.

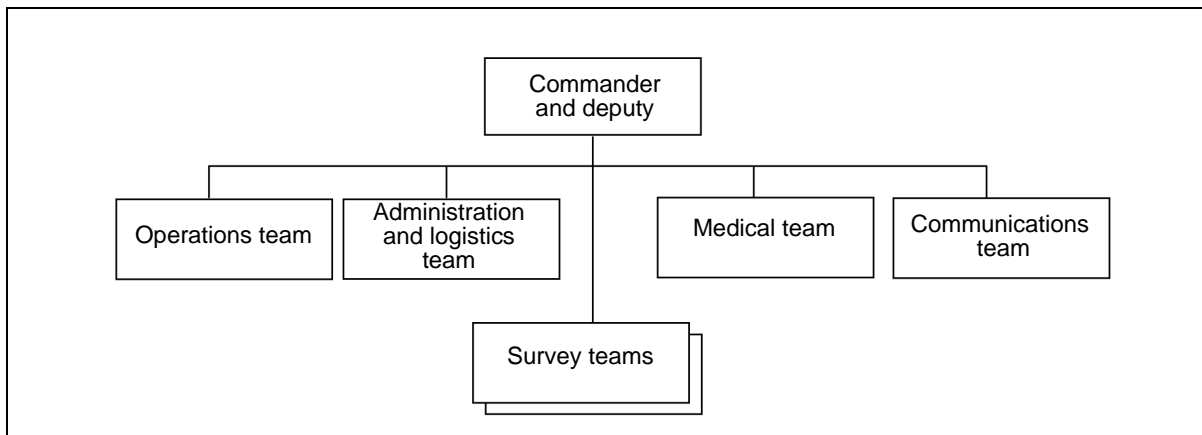

Figure F-10. WMD Civil-Support Team

- m. Soldier, Biological, and Chemical Command, Edgewood Chemical Biological Center.
 - **Mission.** The chemical support division serves as the Edgewood Chemical Biological Center point of contact for operations associated with chemical surety materiel-related remediation and restoration at formerly used defense sites. The chemical support division also manages and maintains support services and capabilities associated with materiel, facilities, and equipment vital to the Edgewood Chemical Biological Center’s mission. The chemical support division provides technical and program management support to DOD and other government agencies associated with processing chemical facilities, equipment, and ammunition.
 - **Capabilities.** The chemical support division provides a full range of chemical surety material-related air, water, and soil analysis in support of the Edgewood Chemical Biological Center, DOD, other governmental agency operations, and remediation efforts. The chemical support division also provides and maintains a repository of chemical-agent standard analytical reference materials in support of the DOD chemical defense mission. The chemical support division maintains specialized equipment to accomplish its assigned mission, such as the real-time analytical platform (a vehicle containing a fully functional chemical analysis

system). In its current configuration, the real-time analytical platform can automatically sample ambient air to detect the presence of specific CW agents (nerve and blister).

- n. Soldier, Biological, and Chemical Command, CB Rapid Response Team.
 - **Mission.** The CB rapid response team deploys (on order) in support of the lead federal agency (LFA). It also provides technical assistance to federal, state, and local officials in response to, and mitigation of, incidents.
 - **Capabilities.** The CB rapid response team assists in the detection, neutralization, containment, dismantlement, and disposal of articles containing (or suspected of containing) CB or related HAZMAT. It uses its organic capability to support mission-essential functions, such as sampling, monitoring, recovery, verification, and decontamination.

o. Special Medical Augmentation Response Team—Chemical and Biological (SMART-CB). SMART-CBs are organized and equipped to respond to NBC incidents and provide critical medical support activities. They are trained medical teams that can deploy rapidly in response to a CB incident (an accident involving the transport or storage of weapons, the release of CW or BW agents or radiological material, a leak of industrial chemicals or infectious or radioactive material).

- **Allocation.** One per each US Army regional medical command.
- **Mission.** To respond to NBC incidents and provide critical medical support.
- **Capabilities.**
 - n Provides medical advice and consultation to commanders and local medical and political authorities responding to a threat or incident.
 - n Advises on the protection of first responders and other health care personnel, casualty decontamination procedures, first aid (for nonmedical personnel), initial medical treatment, and casualty handling. The initial advice includes signs, symptoms, first aid (self-aid, buddy aid, and combat lifesaver aid), and initial treatment when an incident occurs.
 - n Assists in facilitating the procurement of needed resources. During an incident, all response personnel must first protect themselves from the agent or material and then provide assistance to victims.
 - n Conducts the initial response. Upon arriving at the incident site or AO, the team determines the types and numbers of other responders required. After the initial assessment, the SMART-CB may elect to use telemedicine reach-back or request domestic or foreign response assets organized at the national level.

NOTE: For additional information on SMARTs, see FM 8-42.

p. CBRN Installation Support Team. Incident response is initiated by the local installation and is supported, as needed, by the local community and state assets (as per applicable agreements), MACOM, DA, and federal resources. The CBRN installation support team (*Figure F-11*, page F-10) is an element of the immediate installation response and is tailored from on-call organic installation/community assets. In order to

sustain operations, installations must be augmented until additional capabilities are alerted, organized, and deployed to the incident site.

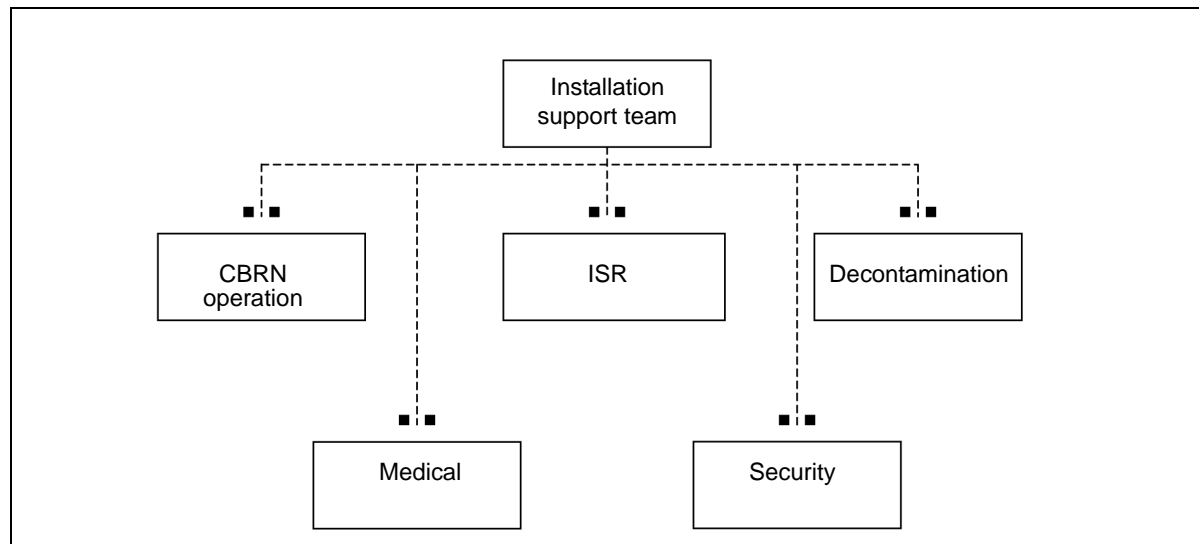

Figure F-11. CBRN Installation Support Team

- **Allocation.** The installation support team detects, identifies, locates, and marks CBR hazards (including TIC and TIM) throughout the installation. The team also enables the installation commander to warn military and civilian personnel of a hazard on and off the installation. Finally, the team conducts limited personnel and patient decontamination to minimize casualties, sustain operations, and prevent the spread of contamination. The installation support team reports directly to the installation commander or his representative and conducts operations in support of the installation antiterrorism (AT)/FP plan.
- **Mission.** On order, the installation support team performs CBR detection, warning, and reporting and limited decontamination operations at an installation to minimize casualties and limit the spread of contamination in support of the installation AT/FP plan. It conducts hand-off to a rapid response team or another designated augmentation support team and, if needed, provides augmentation.
- **Capabilities.**
 - „ Detects CBR hazards (including TIC and TIM) to provide limited early warning.
 - „ Performs presumptive identification of CBR hazards to identify the agent or material.
 - „ Locates CBR hazards.
 - „ Communicates directly with the installation commander, IC or designated representative, and installation emergency operations center (EOC) using secure voice communications.

- „ Calculates hazard predictions to warn military and civilian personnel of downwind hazards.
- „ Advises on evacuation routes.
- „ Marks contaminated areas to prevent casualties and the spread of contamination.
- „ Provides PVNTMED assistance and medical surveillance.
- „ Provides prompt, effective, emergency medical care on site to minimize mortality.
- „ Coordinates administrative and logistics support to sustain operations.
- „ Coordinates security support to prevent casualties and limit the spread of contamination.
- „ Conducts limited personnel and equipment decontamination to sustain operations and limit the spread of contamination.

3. United States Marine Corps Capabilities

a. Unit Defense Teams. Unit defense teams are not filled by NBC specialists, but are primarily formed at company level from assigned personnel. Company teams may be reinforced by the attachment of other company teams as directed by the senior commander. Thus, NBC reconnaissance/survey and surveillance/monitoring are accomplished at the company level.

- **Allocation.** Company teams are organized per the unit SOP.
- **Mission.** To provide NBC reconnaissance, survey, surveillance, monitoring, and decontamination as directed by the company commander or higher headquarters.
- **Reconnaissance/survey capabilities.**
 - „ Recognizes NBC attacks and understands unit procedures to implement warnings.
 - „ Detects CB agents and radiological hazards.
 - „ Operates and performs operator's maintenance on NBC detection and sampling equipment, such as the NBCRS.
 - „ Conducts NBC sampling surveys.
 - „ Collects samples of suspected contamination and forwards them to higher headquarters.
 - „ Marks contaminated areas, equipment, and supplies with standard marking signs.
 - „ Provides data for the compilation of NBC reports.
- **Surveillance/monitoring capabilities.**
 - „ Operates and performs operator's maintenance on NBC monitoring equipment.

- n Conducts NBC monitoring operations.
- n Monitors the effectiveness of decontamination measures.
- n Provides data for the completion of NBC reports.

b. **CBIRF.**

- **Allocation.** The CBIRF is assigned to the II Marine Expeditionary Force.
- **Mission.** To deploy domestically or overseas and provide FP/mitigation in the event of a WMD incident and to respond to no-notice WMD incidents with a rapid, deployable installation response force.
- **Capabilities.**
 - n Detects and identifies CB agents.
 - n Performs sampling and collection.
 - n Monitors concentration and exposure levels.
 - n Provides decontamination for first responders.
 - n Provides casualty decontamination on scene.
 - n Conducts victim searches in areas and confined spaces.
 - n Performs technical rescue and casualty extractions.
 - n Provides emergency medical care in contaminated areas.
 - n Provides casualty triage and stabilization.
 - n Transfers casualties to local medical systems.
 - n Provides casualty decontamination support.
 - n Provides a mobile laboratory.

c. NBC Reconnaissance Platoon. NBC reconnaissance assets (i.e., the M93A1 or the joint services light NBCRS) are integrated into ISR efforts to confirm or deny the presence of contaminated areas. NBC reconnaissance assets can be task-organized to support forward-deployed combat elements or be located in rear areas to monitor MSRs or C2 nodes.

4. United States Air Force Capabilities

a. NBC forces are structured to support AB survivability and operations. Each AB CE squadron contains a readiness flight (office symbol CEX). This flight is the focal point for nonmedical NBC defense. EOD, fire protection (HAZMAT team), also has key NBC or CBRNE capabilities. Bioenvironmental engineering personnel (United States Air Force specialty code [AFSC] 43E3 and 4BOX1) are medical assets that team with CE readiness to assess risks and recommend response actions. Bioenvironmental engineering is also responsible for monitoring the water supply. The senior bioenvironmental engineering member is the NBC medical defense officer.

(1) CE readiness personnel (AFSC 3E9X1) are NBC technicians who are responsible for managing and supporting all (nonmedical) NBC planning, training, and operations on the base. The number of personnel assigned to the flight depends on the

size, mission, and threat environment of the base. The flight chief is a CE officer or civilian equivalent, and the superintendent is a master sergeant or senior master sergeant. Typically, peacetime CONUS and OCONUS Air Force bases (AFBs) with combat (fighter, bomber) wings or CS (cargo, tanker) wings have six to twelve 3E9X1 personnel assigned. At CONUS support bases (training, depots), the readiness flight function may be contracted out or minimally manned and the NBC defense capability may be limited. Contingency AFBs in high-threat areas normally have fifteen to twenty-two 3E9X1 personnel. CE readiness personnel perform the following NBC defense functions:

- Conduct NBC defense training for all USAF personnel.
- Train unit NBC teams (contamination control, shelter management).
- Develop base NBC defense plans and procedures.
- Advise the commander on all nonmedical aspects of NBC defense.
- Establish and operate the base NBC detection grid (point and standoff detectors).
- Conduct NBC reconnaissance missions on and near AFBs.
- Establish personnel CCA.
- Operate the NBC control center and perform NBC warning and reporting system functions.
- Advise contamination control teams.
- Mark contaminated areas.
- Manage and direct NBC shelter operations (from SRC or NBC control center).

(2) The EOD flight is part of the CE squadron or detachment. EOD personnel receive specialized training in NBC agents and have some NBC detection equipment, including M18A2s. USAF EOD teams have Level A HAZMAT suits.

(3) The fire protection flight is part of the CE squadron or detachment. Most permanent AFBs have fully trained (technician and operation level) and equipped HAZMAT response teams. USAF HAZMAT technicians are trained on improved CAMs, M256A1s, and air data module 300 NBC detection equipment.

NOTE: Fire protection flights at contingency operating locations may not have fully staffed and equipped HAZMAT teams.

(4) Bioenvironmental engineering flights, assigned to the aeromedical squadron, are equipped with specialized equipment for detecting and measuring environmental hazards. They also have some standard NBC gear, including DOD biological sampling kits, improved CAMs, and air data module 300 NBC detection equipment. Bioenvironmental engineers are the installation HAZMAT, exposure assessment, and risk assessment experts. They deploy to contingency operation locations as a part of preventive aerospace medicine, global-reach lay-down, and medical NBC teams.

b. The NBC defense structure includes a defined C2 structure and concept of operations for wartime. The host wing commander sets alarm conditions, MOPP levels,

and FP conditions for the entire base. The SRC is the base command post element. It develops, recommends, implements (with wing approval), and tracks preattack, during-attack, and postattack passive defense activities on the base. CE readiness personnel are assigned to work in the SRC, and the SRC and the control center are often collocated. The NBC control center reports to the SRC, controls NBC reconnaissance teams, and monitors NBC detectors. The SRC broadcasts alarm conditions and MOPP changes to all units on base, activates the base siren, tracks casualties and damage to installation resources, and directs recovery efforts. The SRC tracks the location of all known postattack hazards on the base.

c. The next level below the SRC in the command structure is the unit control center. All major units on the base operate a unit control center during wartime, and all personnel and work centers on the base are subordinate to a unit control center. The unit control center provides rapid attack warnings to all assigned or attached unit personnel, monitors the status of unit activities, and maintains a log of unit actions. It also passes information to and from the SRC and directs and monitors the implementation of unit preattack, during-attack, and postattack actions. The unit control center maintains a base map (color-coded or marked to enable quick identification) with all unit postattack reconnaissance AORs, structures, shelters, bunkers, and primary operating areas. Checklists outline the tasks and responsible unit functions under each alarm condition. Following attacks (in coordination with the SRC), the unit control center directs unit teams to conduct postattack reconnaissance sweeps, reports postattack hazards to the SRC, and coordinates recovery actions.

d. The unit control center tracks the location of all known postattack hazards (including contamination and UXO) that may affect unit personnel or the mission. It advises unit personnel of hazard locations and directs the movement of unit assets away from hazard areas. If the base uses the NBC sector or zone concept, the unit control center tracks the alarm condition and the MOPP for the sectors and zones and controls the movement of unit resources into and out of contaminated areas.

e. Within the USAF, deployable teams are organized under UTCs that prescribe specific team support for a given contingency. Within this concept, trained individuals are deployed for assignment to teams when the need arises. USAF deployable teams are shown in *Table F-1*.

5. United States Navy Capabilities

a. Afloat. CBR defense is coordinated aboard each ship according to the specific CBR defense bill for that ship. The responsibility for CBR defense normally rests with the damage control officer, who organizes the CBR defense team. Personnel are assigned to teams to perform the following functions:

- **Detection.** Operates and maintains shipboard-mounted detection systems. Employs point detection and monitoring equipment.
- **Survey.** Conducts a CBR survey of the ship to determine the location and extent of contamination.
- **Contamination control.** Operates CCA as defined in the ship CBR defense bill.

Table F-1. USAF Deployable Teams

UTC	Identification	Description
FF9DA	NBC and Conventional Threat Response Core Team	Provides limited NBC and conventional defense-supporting activities that range from small-scale contingency operations to MTWs and responds to major accidents and natural disasters for ABs with up to 1,200 personnel. Capabilities include preliminary risk and vulnerability assessments, threat analysis, planning, detection, identification, warning, reporting, decontamination, CCA, disaster response equipment, technical data, roll-on/roll-off, and 463L pallets. Personnel deploy with PPE, clothing, weapons, and ammunition.
FF9DB	NBC and Conventional Threat Response Light Team	Provides minimal NBC and conventional defense-supporting activities that range from small-scale contingency operations to MTWs and responds to major accidents and natural disasters for ABs with up to 600 personnel. Capabilities include preliminary risk and vulnerability assessments, threat analysis, planning, detection, identification, warning, reporting, decontamination, CCA, disaster response equipment, technical data, roll-on/roll-off, and 463L pallets. Personnel deploy with PPE, clothing, weapons, and ammunition.
FF9DC	NBC and Conventional Threat Response Light Team	Provides additional technical expertise, support, and manpower to other UTCs in full-spectrum threat response to NBC and conventional defense, major accidents, and disaster response operations. Personnel skills include detection, identification, warning, reporting, decontamination, and contamination control operations. Provides additional manpower-supporting activities ranging from small-scale contingency operations to MTWs. Personnel deploy with PPE, clothing, weapons, and ammunition.
FF9DD	Theater/Joint Task NBC and Conventional C2 Support Team	Provides a full-spectrum threat response C2 element to support numbered USAF, air component, and JTF commanders for activities ranging from small-scale contingencies to MTWs. Provides situational analysis and advice on NBC and conventional issues to the supported commander and subordinate units, and provides support for major accident and natural disaster operations. Personnel deploy with PPE, clothing, weapons, and ammunition.
FF9DE	NBC and Conventional Response Contamination Control Team Equipment Set	Provides limited full-spectrum threat response contamination control capabilities for sustained operations in NBC and conventional environments. Provides contamination avoidance resources, such as decontamination apparatus and supplies, M295 decontamination kits, protective covers, decontaminants, and application devices. Requires manpower augmentation (10 personnel, any USAF) from the supported unit for setup, maintenance, and operation of contamination control equipment.
FF9DF	USAF Joint Services Light NBCRS	Provides personnel, equipment, and supplies to operate the light NBCRS. Provides a specialized vehicle equipped with a state-of-the-art suite of detectors and sensors, including mobile standoff and point vapor/aerosol, surface detection, identification, and quantification of hazards utilizing a three-person team that is task-qualified and certified to operate the system. Personnel deploy with PPE, clothing, weapons, and ammunition.

Table F-1. USAF Deployable Teams (Continued)

UTC	Identification	Description
FF9DG	CE Squadron NBC Collective-Protective Equipment Set	Provides NBC collective protection and sustainment for about 120 sortie generation personnel per day for up to 96 hours. Provides personnel with a toxic-free, rest-and-relief environment. Requires manpower augmentation (10 personnel) from the supported unit or one UTC FF9DJ for setup, operation, maintenance, and reconstitution.
FF9DH	CE Squadron Open-Air CCA Set	Provides standardized open-air CCA equipment to transition up to 1,200 personnel into a toxic-free, rest-and-relief environment. Requires manpower augmentation (10 personnel) from the supported unit for setup, maintenance, and operation.
FF9DJ	NBC and Conventional Response Personnel Sustainment Team	Provides a full-spectrum threat response manpower augmentation element (10 personnel, any USAF) to support sustained operations in NBC and conventional environments. Supports major accident and natural disaster operations and recovery. Team members are trained in contamination control, CCA operations, collective protection system operations, shelter team management, unit control center operations, and NBC detection equipment operations. Provides the deployed commander with a cadre of trained personnel to assist with the continuity of operations in all contingency environments. Personnel deploy with PPE, clothing, weapons, and ammunition in support of UTCs FF9DE, FF9DG, FF9DH, and FF9DI.
FF9DK	USAF Joint Services Light NBCRS Sustainment Team	Provides a three-person team that is task-qualified and certified to extend operations of UTC FF9DF for 24 hours. Personnel deploy with PPE, clothing, weapons, and ammunition.
FF9DL	CE Squadron Prime BEEF NBC Collective-Protective Equipment Set Heavy System	Provides NBC collective protection and sustainment for about 280 sortie generation personnel per day for up to 96 hours. Provides personnel with a toxic-free, rest-and-relief environment. Requires manpower augmentation (20 personnel) from the supported unit or two UTCs FF9DJ for setup, maintenance, operation, and reconstitution.
FF9DM	NBC and Conventional Threat Response Core Team	Provides NBC and conventional defense capability to respond to attacks, major accidents, and natural disasters in support of small-scale contingency operations (without augmentation) or MTWs for an AB with up to 1,200 personnel (with augmentation by UTC FF9DC). Capabilities include preliminary risk assessment, vulnerability assessment, threat analysis, planning, detection, identification, warning, reporting, decontamination, CCA, disaster response equipment, technical data, roll-on/roll-off, and 463L pallets. Personnel deploy with PPE, clothing, weapons, and ammunition.
FF9DN	Personal Air Monitor Team (UTC FFGL2/3/4)	Provides public health, occupational, environmental, and disease assessment, surveillance, and intervention at the employment location. Provides PVNTMED services for a deployed AB with up to 5,000 personnel. Provides personnel for medical support planning and input into the layout of sanitation facilities. Ensures the safety of the food and water supply. Provides limited clinical services. Deploys with the lead wing to help establish the base infrastructure or support lead mobility wing operations. Provides limited NBC defense capability to medical units.

Table F-1. USAF Deployable Teams (Continued)

UTC	Identification	Description
FF9DO	Medical NBC Team (UTC FFGL1)	Provides increased wing survivability through human health protection, supports medical facility operations, and works to prevent acute and chronic health hazards resulting from operations in an NBC threat environment. Conducts NBC surveillance. Advises commanders on NBC health effects, threat impact, protective-action posture, recovery activities, and human health risk assessments. Documents personnel exposure to NBC agents. Operates as part of the personal air monitor team (FF9DN). Interfaces with the biological augmentation, wartime medical decontamination, and CE readiness teams.
FF9DP	Biological Augmentation Team (UTC FFBAT)	Is a flexible, rapidly deployable, two-person laboratory team assigned to the deployed MTF. Expands theater force health protection by introducing the best-available, advanced microbiological diagnostic capabilities. Identifies naturally occurring and induced pathogens in clinical samples and other environmental media. Provides a preventive medicine capability. Provides diagnostic data to support the early warning of pathogen exposures. Assesses the extent and type of biological contamination in other substances (food, air, water, and soil).
FF9DQ	Wartime Medical Decontamination Team (UTC FFGLB)	Provides the capability to remove or neutralize NBC agents on casualties immediately before being admitted to the MTF. Can be deployed, assigned, or pre-positioned to support and enable USAF MTFs. Safely and effectively treats contaminated casualties without contaminating medical personnel, equipment, or facilities. Decontamination sites and facilities are constructed near the MTF. Personnel decontamination is accomplished by removing clothing and washing skin with soap or a chlorine solution. Conducts contamination control of medical personnel and assets as needed.
FF9DR	Theater Epidemiological Team (UTC FFHA1)	Provides theater level support to the USAF component command surgeon or the JTF surgeon. Provides medical, environmental, and occupational threat assessments; support for outbreak investigations; and recommendations for preventive countermeasures and needed surveillance systems. Coordinates with other medical and line force protection teams and federal and international agencies. Is collocated with the theater surgeon or the appropriate headquarters element.
FF9DS	Air Force Radiological Assessment Team (UTCs FFRA1/2/3)	Is a globally responsive, specialty asset team that provides field radiological support to the assigned theater medical authority. Identifies the radiological environment and recommends protective actions to ensure the health and safety of USAF and DOD personnel and the surrounding community. Provides expert guidance on the type and degree of radiological hazards that face deployed forces. Based on these assessments, makes recommendations to optimize FP in light of achieving mission objectives. Typical deployment scenarios include consequence management operations from Broken Arrows, Faded Giants, and terrorist use of radiological dispersion weapons or improvised nuclear devices and humanitarian assistance operations to countries that have experienced a nuclear exchange.

- **Decontamination.** Operates decontamination stations as designated by the damage control officer.
 - **Damage control training.** Provides CBR defense training to survey and decontamination teams and the ship crew.
- b. Ashore. Disaster preparedness teams are established by the naval shore activity commanding officer. CBR defense teams consist of the following assets:
- **CBR survey team.** Surveys assigned areas to determine CBR contamination locations and levels. Marks hazardous areas.
 - **Personnel decontamination team.** Conducts chemical and radiological decontamination of personnel who are not seriously injured.
 - **Facilities and area decontamination team.** Effects CBR decontamination of essential facilities and areas.
 - **Radiation monitor pool.** Provides radiation monitoring capability and equipment required for performing rescue, first aid, and firefighting.
 - **Dosimetry team.** Determines the radiation dosage of personnel by reading dosimeters and recording readings.
 - **Clothing decontamination team.** Retrieves contaminated clothing from personnel decontamination stations, determines its reusability, decontaminates it, and returns it to the clothing supply team.
 - **Nuclear accident team.** Provides assistance to the on-scene commander. Performs emergency actions that may be necessary to minimize the initial results of a nuclear accident or incident.
 - **Shelter management team.** Provides orderly administration of activities related to the comfort and welfare of inhabitants of an assigned shelter.
- c. Forward-Deployable, Preventive-Medicine Unit (FDPMU).
- (1) The FDPMU enhances force health protection (FHP) by—
 - Identifying and evaluating environmental health hazards, including CBR and physical agents.
 - Advising the operational commander on significant health risks.
 - Assessing the risk of adverse health outcomes.
 - Monitoring the health of deployed forces.
 - Recommending countermeasures and interventions needed to protect the health of the force.
 - (2) The FDPMU task-organizes from the Bureau of Medicine and Surgery assets, predominately the Navy Environmental Health Center and subordinate activities. A designated FDPMU can deploy to provide short-duration, specialized PVNTMED support; but with resupply, it can provide support for extended operations.
 - (3) FDPMU teams are functionally organized to provide the appropriate level of response and technical augmentation to military authorities. The FDPMU is composed

of the PVNTMED, disease vector, chemical, radiological, and microbiological components.

- **PVNTMED.**
 - „ Serves as the overall coordinating hub for the other components in providing theater level recommendations regarding FHP strategies.
 - „ Provides expert PVNTMED consultation to prevent or limit the impact of disease outbreaks through field sanitation expertise and assessment, epidemiological investigation of disease outbreaks, and theater surveillance data analysis.
 - „ Recommends interventions for the prevention and control of deployment-related occupational and environmental illnesses, injuries, and diseases.
 - „ Serves as the theater-wide potable water and food safety consultant.
- **Disease vector.**
 - „ Provides strategies and programs to protect deployed forces from vector-borne diseases, including surveillance and control of insects and animals that transmit diseases of military relevance.
 - „ Conducts surveillance operations for insect and animal vectors of human disease through the collection and identification of specimens that may be suspected of transmitting disease pathogens.
 - „ Determines the potential threat of vector-borne diseases in an AO.
 - „ Conducts pest control operations to control or minimize the threat of vector-borne disease transmission.
- **Chemical.**
 - „ Provides detection, identification, monitoring, and assessment of chemical agents and environmental hazards.
 - „ Acts as the theater-wide consultant and reference source for chemical and environmental agent-related health risk information.
 - „ Makes recommendations to eliminate or minimize personnel exposures to TIC and TIM.
 - „ Performs surveillance and exposure assessments of air, soil, and personnel.
 - „ Prepares and ships samples to reference laboratories.
 - „ Identifies potential health threats from the civilian infrastructure (refineries, chemical plants).

- **Radiological.**
 - Detects and quantifies radioactive materials.
 - Advises the on-scene commander.
 - Provides consultation in the establishment of an environmental dosimetry surveillance program and associated protective actions.
- **Microbiological.**
 - Detects, identifies, and analyzes naturally occurring infections and BW agents that may be encountered during deployments.
 - Provides laboratory diagnosis of military-relevant infectious diseases within the theater.
 - Serves as the local JTF commander's SME on matters regarding infectious diseases and BW agents.
 - Provides laboratory support for in-theater infectious disease outbreak investigations.
 - Processes and analyzes potentially dangerous infectious specimens, especially in the event of a known or suspected BW incident.

6. Unit Level Chemical and Radiological Detection Equipment

a. M8 Chemical-Agent Detector Paper. Personnel use M8 paper to detect liquid Types V and G nerve agents and Type H blister agents. M8 paper comes in a book of 25 perforated sheets. A color comparison chart is printed on the inside front cover for the identification of chemical agents. The sheets turn dark green (Type V), yellow (Type G), or red (Type H) upon contact with the agent. The paper must touch the agent, so personnel must use caution when taking a sample. M8 paper does not detect chemical agents in water or chemical vapors. Agent deposition on M8 paper is primarily composed of very small droplets (50 to 100 microns). Recognition is especially challenging, if not impossible, at night or in the presence of other interferences (such as smoke).

b. M9 Chemical-Agent Detector Paper. M9 paper is issued in a 7-ounce dispenser box that contains one 30-foot roll of 2-inch-wide detector paper and a plastic storage bag. It is primarily used on personnel and has a sticky backside, allowing personnel to place a long strip on their arm, leg, back, and other places expected to be exposed to potential hazards. M9 paper turns red to brown in color when liquid chemical agents are detected. Personnel should place strips of M9 paper so that it can be observed, ensuring that the flaps protrude long enough to be seen while masked or buttoned up inside tactical vehicles. Doors, hatches, and areas that troops come into frequent contact with should be considered *first choice* when applying M9 paper to tactical vehicles.

c. M256A1 Chemical-Agent Detector Kit. The M256A1 is used to support unmasking procedures and to detect and identify field concentrations of nerve, blister, and blood agents. The test takes 15 minutes to complete, and a color change indicates harmful chemical-agent concentrations. The M256A1 contains potentially carcinogenic reagents.

d. M8A1 ACAA. The M8A1 is positioned upwind from unit positions, and it provides early warning of nerve-agent vapors. This remote detector is connected by WD-1 communications wire to an M42 alarm unit. The M8A1 detects the nerve agent and sends an electronic signal to the M42, which provides a remote audible/visual signal (a visual signal is used when noise discipline is a concern). The M10A1 power supply provides direct current (DC) power to the detector from an alternating current (AC) (115- or 220-volt) source. The detector uses one BA 3517/U battery, and the alarm uses four BA 3030 or BB 3203/UF (D cell) batteries.

e. M90 Automatic Agent Detector. The M90 detects nerve and blister agent. It is currently in use by the USAF.

f. M21 Remote-Sensing, Chemical-Agent Alarm. The M21 is a standoff chemical detector that detects nerve and blister agents. In a stationary position, it scans a 60° arc. (See the unit staff chemical officer for range detection distances.)

g. M22 Automatic Chemical-Agent Detector Alarm. The M22 is positioned upwind from unit positions. It detects, identifies, and provides early warning of nerve- and blister-agent vapors. The M22 is connected by WD-1 communications wire to an M42 alarm unit. The M22 is replacing the M8A1 ACAA as a point detector. The M22 uses a nonrechargeable lithium battery (BA 5590/U) and an XM28 power supply kit (national stock number [NSN] 6665-01-438-6960).

h. CAM/Improved CAM. The CAM and improved CAM are handheld instruments that detect, identify, and provide relative vapor concentration readouts for Types G and V nerve agents and Type H blister agents. They are used for area reconnaissance, area surveillance, and decontamination monitoring. The improved CAM is more reliable and needs less maintenance than the CAM.

i. M272 Water Testing Kit. The M272 is a lightweight, easy-to-use kit that detects and identifies harmful amounts of chemical agents in raw and treated water sources.

j. M18A2 Chemical-Agent Detector Kit. The M18A2 uses detector tubes and paper tickets to detect and classify dangerous concentrations of lethal chemical agents in the air and on exposed surfaces.

k. MM1 Spectrometer. The MM1 is a field gas chromatograph/mass spectrometer system housed inside the M93A1 NBCRS. It detects and identifies all known chemical agents and some TIM. The information can be printed to a hard copy tape for later, more detailed analysis and a record of the detection.

l. Chemical-Agent Point Detection System. This system is an installed shipboard automatic vapor sensor that provides point detection of several nerve agents.

m. Improved Chemical-Agent Point Detection System. This system is an installed shipboard automatic vapor sensor that provides real-time detection of nerve and blister agents.

n. AN/KAS-1 CW Directional Detector. This is a semiportable system that is designed to detect nerve-agent vapor clouds at ranges up to 5 kilometers.

o. AN/VDR-2 Radiac Set. The AN/VDR-2 detects and measures the gamma radiation dose rate, measures the total dosage, and monitors the turn-back dose rate during radiological survey missions. It detects beta radiation, but does not measure it.

The AN/VDR-2 provides a means to conduct dismounted monitoring and surveying of personnel and equipment. It is a lightweight, electromagnetic pulse (EMP)-hardened, tactical dose rate meter that is composed of an IM-243 radiac meter, a DT-616 radiac probe, and a carrying pouch with a strap. It uses three 9-volt batteries or operates off 24-volt vehicle power.

NOTE: The dose rate is how much radiation one can expect to absorb in 1 hour, and the total dosage is how much total radiation one has absorbed.

p. AN/UDR-13 Radiac Set. The AN/UDR-13 measures gamma radiation and provides the total dosage and the dose rate. It is a compact, lightweight device and is replacing the IM-93/UD dosimeter.

q. IM-93/UD Dosimeter. The IM-93/UD measures the total dosage. It is worn as close to the body as possible and used to monitor the total dosage for a unit.

r. PP-1578A/PD Radiac Detector Charger. The PP-1578A/PD provides the electrical charge required to zero the IM-93/UD dosimeter. It is a small electrostatic-charge generator that is designed to serve all US and certain North Atlantic Treaty Organization (NATO) combat dosimeters.

s. DT-236 Dosimeter. The DT-236 is worn by personnel and provides the total dosage measurement. Personnel wearing the dosimeter cannot read it, because it requires the AN/PDR-75 to determine exposure levels. The AN/PDR-75 measures cumulative gamma and neutron radiation dosage. The DT-236 augments the IM-93/UD or AN/UDR-13; it is not designed to act as a stand-alone dosimeter. Dosimeters provide a picture of how much total radiation personnel have accumulated.

t. AN/PDR-75 Radiac Detector/DT-236 Reader. This device reads and displays accumulated neutron and gamma radiation total dosage recorded by the DT-236 dosimeter. It provides leaders and medical personnel with an indication of the total gamma and neutron dosage of exposed personnel. The set consists of radiac computer indicator (reader) CP 696/PDR-75, a two-piece battery box, and three power cables. It can be powered with a 12- or 24-volt lithium battery (BA 5590/U) or a 24-volt vehicle battery.

7. Chemical Detector Capabilities and Interferents

a. Chemical detectors detect and identify CW agents at different levels of sensitivity. *Table F-2* provides additional information on the capabilities of chemical detectors and monitors.

b. *Table F-3*, page F-24, provides information on selected chemical detectors and their sensitivities. However, they may react to materials other than CW agents and produce *false positives*. NBC reconnaissance personnel must be aware of this possibility.

c. *Table F-4*, page F-25, shows many of the interferents that may cause false positives.

NOTE: The use of insecticides around chemical detectors, alarms, and monitors and M8/M9 paper is not recommended.

d. The environment also plays a role in the ability of detectors to perform, and it sometimes complicates the issue when analyzing results. *Table F-5*, page F-26, shows how environmental conditions relate to the performance of detectors.

Table F-2. Chemical Detector and Monitor Capabilities

Detector or Monitor	Agent Form	Chemical Agent		Response Time ²
		Detection	Identification	
M8 Chemical-Agent Detector Paper	Liquid	Types G, V, and H	Types G, V, and H	Less than 30 seconds
M9 Chemical-Agent Detector Paper	Liquid	Types G, V, and H	None	Less than 30 seconds
M256A1 Chemical-Agent Detector Kit ¹	Vapor	Types G, VX, HD, L, CX, AC, and CK	Categorizes as nerve, blood, or blister	15 minutes
M8A1 ACAA	Vapor	Types GA, GB, GD, and VX	None	Less than 2 minutes
M90 Automatic Agent Detector	Vapor	Types GA, GB, GD, GF, VX, HD, L, AC, and CK	Categorizes as nerve, blood, or blister	4 to 5 seconds
M21 Remote-Sensing, Chemical-Agent Alarm	Vapor	Types GA, GB, GD, HD, and L	Nerve or blister	Less than 1 minute (scan cycle)
M22 Automatic Chemical-Agent Detector Alarm	Vapor	Types GA, GB, GD, GF, VX, H, and L	Categorizes as nerve or blister	30 seconds to 2 minutes
CAM/Improved CAM	Vapor	Types GA, GB, GD, VX, HD, and HN	Categorizes as nerve or mustard	Less than 1 minute
M272 Water Testing Kit	Liquid	Types G, VX, HD, L, and AC	Distinguishes between agents	20 minutes
M18A2 Chemical-Agent Detector Kit	Vapor	Types G, V, H, HD, HT, HL, CX, ED, PD, MD, AC, CK, and CG	Types G, V, H, HD, HT, HL, CX, ED, PD, MD, CK, AC, and CG	1 to 4 minutes
MM1 (NBCRS)	Liquid	All CW agents and some TIM	All known CW agents, some TIM	Less than 45 seconds
Chemical-Agent Point Detection System	Vapor	Types GA, GB, GD, GF, and VX	None	Within seconds under normal conditions after warm-up
Improved Chemical-Agent Point Detection System	Vapor	Types G, V, and H	Categorizes as nerve or blister	Less than 1 minute
AN/KAS-1 CW Directional Detector	Vapor	Types GA, GB, GD, GF, and VX	None	Based on operator skill and experience and vapor cloud density

¹The M256A1 contains a book of M8 detector paper.

²The response time may vary with the agent, the agent concentration, the temperature, and the droplet size.

Table F-3. Chemical Detector Limits and Miosis Levels

Detector	Type					
	GA	GB	GD	GF	VX	HD
M8 Chemical-Agent Detector Paper	0.2 ml	0.2 ml	0.2 ml	0.2 ml	0.2 ml	0.2 ml
M9 Chemical-Agent Detector Paper	110 µ	110 µ	110 µ	110 µ	100 µ	110 µ
M256A1 Chemical-Agent Detector Kit	0.005 mg/m	0.005 mg/m	0.005 mg/m	0.005 mg/m	0.02 mg/m	2 mg/m
M8A1 ACAA	0.1-0.2 mg/m	0.1-0.2 mg/m	0.1-0.2 mg/m	NA	0.4 mg/m	NA
M90 Automatic Agent Detector	0.04 mg/m	0.04 mg/m	0.04 mg/m	0.04 mg/m	0.04 mg/m	0.2 mg/m
M21 Remote-Sensing, Chemical-Agent Alarm	90 mg/m	90 mg/m	90 mg/m	NA	NA	1,500 mg/m
M22 Automatic Chemical-Agent Detector Alarm	0.1 mg/m	0.1 mg/m	0.1 mg/m	0.1 mg/m	0.04 mg/m	2.0 mg/m
CAM/Improved CAM	0.1 mg/m	0.1 mg/m	0.1 mg/m	NA	0.1 mg/m	0.1 mg/m
M272 Water Testing Kit	0.02 mg/l	0.02 mg/l	0.02 mg/l	0.02 mg/l	0.02 mg/l	2.0 mg/l
M18A2 Chemical-Agent Detector Kit	Not available	0.1 mg/m	Not available	Not available	0.1 mg/m	0.5 mg/m
MM1 (NBCRS)	0.1-1 µg/m	0.1-1 µg/m	0.1-1 µg/m	0.1-1 µg/m	0.1-1 µg/m	0.1-1 µg/m
Chemical-Agent Point Detection System	Not available	0.3 mg/m	0.3 mg/m	Not available	0.3 mg/m	NA
Improved Chemical-Agent Point Detection System	Not available	Not available	Not available	Not available	Not available	Not available
AN/KAS-1 CW Directional Detector	Not available	Not available	Not available	Not available	Not available	NA
Miosis Levels (Inhalation/Ocular, 2-Minute Exposure)	0.4 mg-min/m	0.4 mg-min/m	0.2 mg-min/m	0.2 mg-min/m	0.1 mg-min/m	NA

Table F-4. Interferents

Detector	Sources of False Readings
M8 Chemical-Agent Detector Paper	Antifreeze and petroleum-based products
M9 Chemical-Agent Detector Paper ¹	Antifreeze and petroleum-based products
M256A1 Chemical-Agent Detector Kit	HC smoke, decontaminants, and smoke from burning brush
M8A1 ACAA	Engine exhaust and rocket-propellant, screening, and signaling smoke
M90 Automatic Agent Detector	Diesel exhaust
M21 Remote-Sensing, Chemical-Agent Alarm	Sun in the field of view, insecticide, halon gas, and alcohol
M22 Automatic Chemical-Agent Detector Alarm	Brake fluid, signaling smoke, malathion, petroleum products (JP8), aqueous fire fighting foam (concentrated), oil-of-wintergreen muscle rub, and tear gas
CAM/Improved CAM	Perfume, diesel fuel additives, and paint fumes
M272 Water Testing Kit	Some battlefield substances
M18A2 Chemical-Agent Detector Kit	Some battlefield substances, including smoke and decontaminants
MM1 (NBCRS)	Petroleum-based hydrocarbons and some naturally occurring substances
Chemical-Agent Point Detection System	Some shipboard vapors at high concentrations
Improved Chemical-Agent Point Detection System	Paint vapors
AN/KAS-1 CW Directional Detector	Based on operator skill and experience

Table F-5. Environmental Conditions

Detector	Environmental Precautions	Remarks
M8 Chemical-Agent Detector Paper	Protect from rain. Be aware of delayed color change below 0°C.	It may take up to 2 minutes to change color below 0°C. This delayed reaction can cause personnel to mistakenly believe an item is clean when it is not.
M9 Chemical-Agent Detector Paper	Protect from rain. Do not operate below 0°C.	None
M256A1 Chemical-Agent Detector Kit	Do not place in direct sunlight. Protect from freezing. Do not store above 57°C.	Sunlight and high temperatures speed the evaporation of reagents.
M8A1 ACAA	Avoid high dust conditions.	None
M90 Automatic Agent Detector	None	None
M21 Remote-Sensing, Chemical-Agent Alarm	Avoid heavy rain, dust, snow, smoke—anything that can obscure energy.	None
M22 Automatic Chemical-Agent Detector Alarm	Operate between 6° and 52°C.	None
CAM/Improved CAM	Operate between 11° and 49°C.	None
M272 Water Testing Kit	Operate between 0° and 52°C (the optimal range is 10° and 41°C).	It takes more time to complete the test if the sample is not taken within the optimal temperature range.
M18A2 Chemical-Agent Detector Kit	None	None
MM1 (NBCRS)	None	None
Chemical-Agent Point Detection System	None	None
Improved Chemical-Agent Point Detection System	None	None
AN/KAS-1 CW Directional Detector	Based on operator skill and experience	None

8. Special-Purpose Equipment

a. **Samplers.** Samplers are used to collect biological particles from ambient air. The particles are then concentrated on a dry medium (filter pad) or in an aqueous solution (portable, biological aerosol sampler). The dry and wet samplers are portable, self-contained units that can sample at various intervals from 5 minutes to several hours. Multiple samplers can be used inside buildings to sample internal circulated air, or they can be used outside (upwind of unit locations or along a unit perimeter). After sampling, the operator can conduct the presumptive identification process with a handheld assay or a DOD biological sampling kit.

b. **Handheld Assay.** A handheld assay can be used with a sampler to support the presumptive identification process for biological agents. For example, the user or operator pipettes small amounts (e.g., 100 microliters) of liquid with agent-containing

particles into the individual sample wells for each agent strip on the handheld assay. If the handheld assay provides a presumptive identification for a biological agent, the results are reported to the commander.

c. DOD Biological Sampling Kit.

(1) This kit is a one-time-use item, and it supports the presumptive identification process for select biological agents. The kit includes a—

- Panel of up to eight handheld assays.
- Bottle of buffer solution.
- Packet of sterile cotton swabs.
- Set of laminated instruction cards.
- 10- by 10-centimeter cutout.

(2) Material from the sampler can be used with the DOD biological sampling kit when conducting the presumptive identification process, or the operator can use a cotton swab and the buffer solution to place the suspected substance (e.g., anthrax spores) in the liquid solution to conduct identification.

CAUTION

Never use the sampling kit as the sole basis for agent identification or for diagnostic purposes.

Appendix G

MOVEMENT FORMATIONS AND MOVEMENT, SURVEY, AND SEARCH TECHNIQUES

1. Background

An NBC reconnaissance unit uses standard movement formations and techniques to get to its assigned area. Once at the mission area, the unit selects the appropriate NBC survey and search techniques to perform its mission.

2. Movement Formations

a. Fundamentals. To survive on a battlefield and provide NBC reconnaissance, leaders must exercise C2, maximize the use of terrain, and apply the following fundamentals of movement:

- Move on covered and concealed routes.
- Do not move directly forward from covered and concealed positions.
- Avoid likely ambush sites and other danger areas.
- Enforce camouflage, noise, and light discipline.
- Maintain all-around security, including air guards.
- Use terrain for protection.
- Avoid possible kill zones.
- Maximize vehicle capabilities.

b. Control. Leaders place themselves where they can best exercise control. Their location is governed by the situation, the movement formation, the movement technique, and whether or not the unit is performing reconnaissance. The selection of the movement formation is based on METT-TC. The distance between vehicles varies according to the terrain and the enemy. Each vehicle crew is responsible for a different sector to provide all-round security while on the move. Leaders direct movement by using arm-and-hand signals. Radios should be used only as a backup means of communication.

c. Mounted Movement Formations. There are five formations for mounted movement—column, line, wedge, V, and echelon.

NOTE: The following illustrations show platoon movement formations; however, section and squad leaders can configure these mounted movement techniques for two, three, or four vehicles.

(1) Column. The column formation is used for road marches, for movement during limited visibility, and when passing through defiles or other restrictive terrain. The unit can deploy rapidly from the column formation into other formations, and the column formation simplifies control and provides good security. The staggered column formation (*Figure G-1*, page G-2) is used for rapid movement across open terrain. It affords all-round observation and fields of fire. The unit leader positions himself to best

control the unit. Vehicles should maintain 25- to 100-meter intervals and lateral dispersion. Each vehicle commander maintains observation of his designated sector. The exact distance between vehicles depends on METT-TC, weather conditions, and visibility.

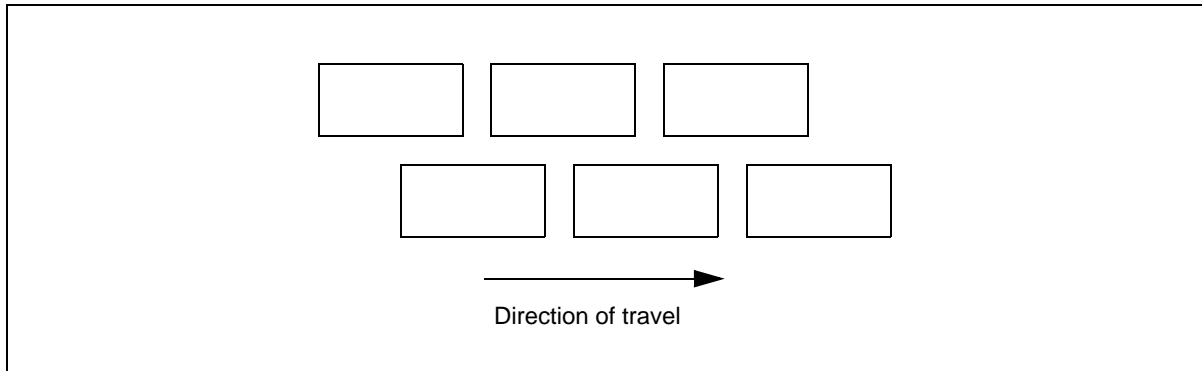

Figure G-1. Staggered Column Formation

(2) Line. The line formation is used for rapid movement when time is limited; however, it provides little flank security. This formation is primarily used when no enemy contact is expected and time is critical.

(3) Wedge. The wedge formation (*Figure G-2*) allows for security and facilitates C2. Vehicle dispersion and intervals depend on METT-TC and visibility. When spreading out in open, flat terrain, each vehicle operator must maintain visibility of the vehicle in front of him. Each vehicle commander maintains observation of a designated sector. This formation is used when enemy contact is possible, and it can be adapted to a column of wedges (*Figure G-3*). The wedge formation is one of the most frequently used unit movement formations, and it allows for optimum flexibility and security and good C2. It is best employed when traveling or traveling overwatch conditions are warranted.

(4) V. The V formation (*Figure G-4*, page G-4) affords good security, speed, and C2. The split V formation (*Figure G-5*, page G-4) can be used when two units are operating on different routes. These formations are used when contact is possible, but speed is desirable. The lead V element moves along covered and concealed routes for protection. The trail element moves at a variable speed, continually overwatching and providing security. The trail element must always maintain visual contact with the lead element and may stop periodically to observe.

(5) Echelon (Left and Right). The echelon formation (*Figure G-6*, page G-5) provides coverage of an area. It provides flexibility and speed, but does not provide sufficient security if enemy contact is possible or expected.

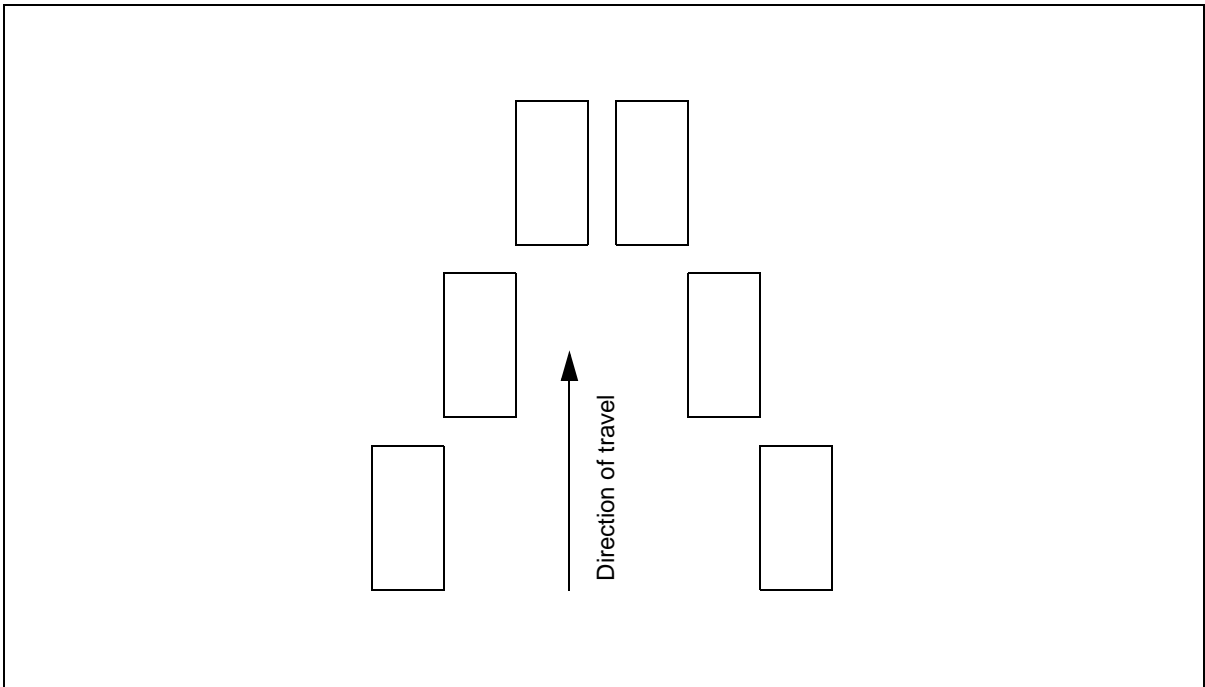

Figure G-2. Wedge Formation

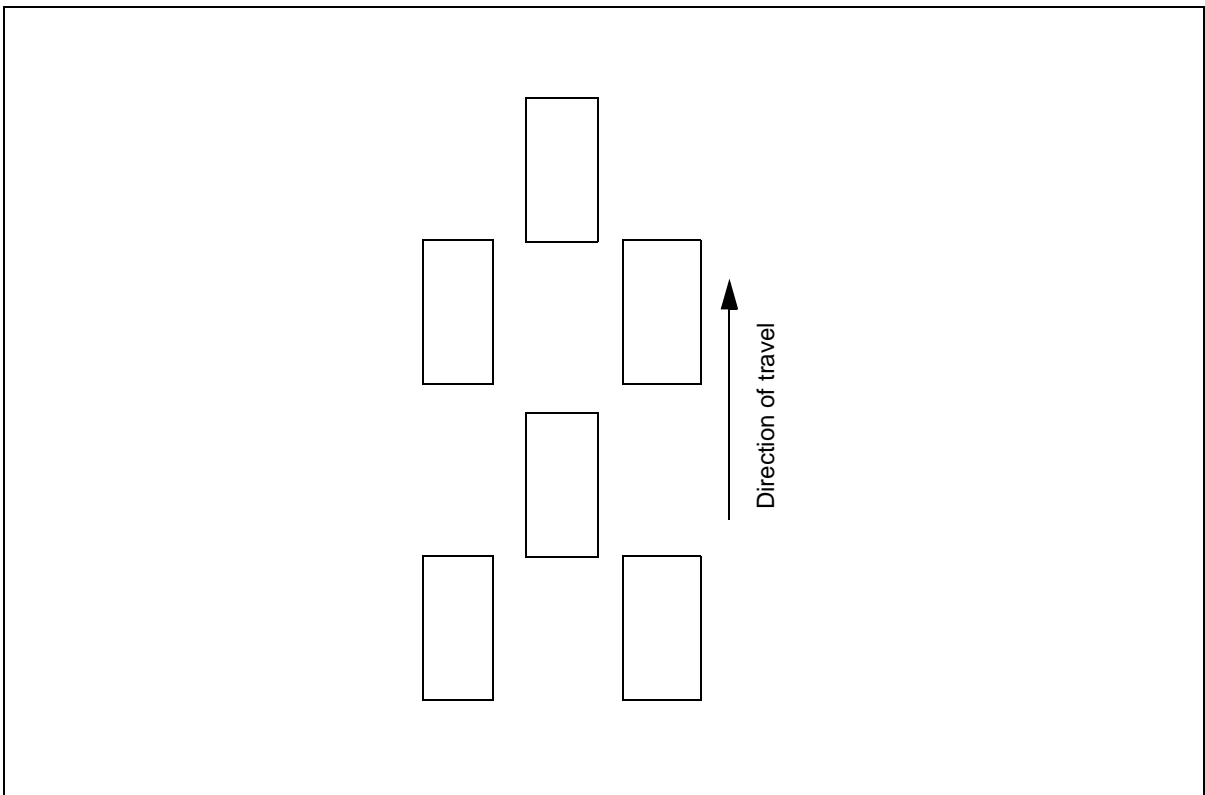

Figure G-3. Column-of-Wedges Formation

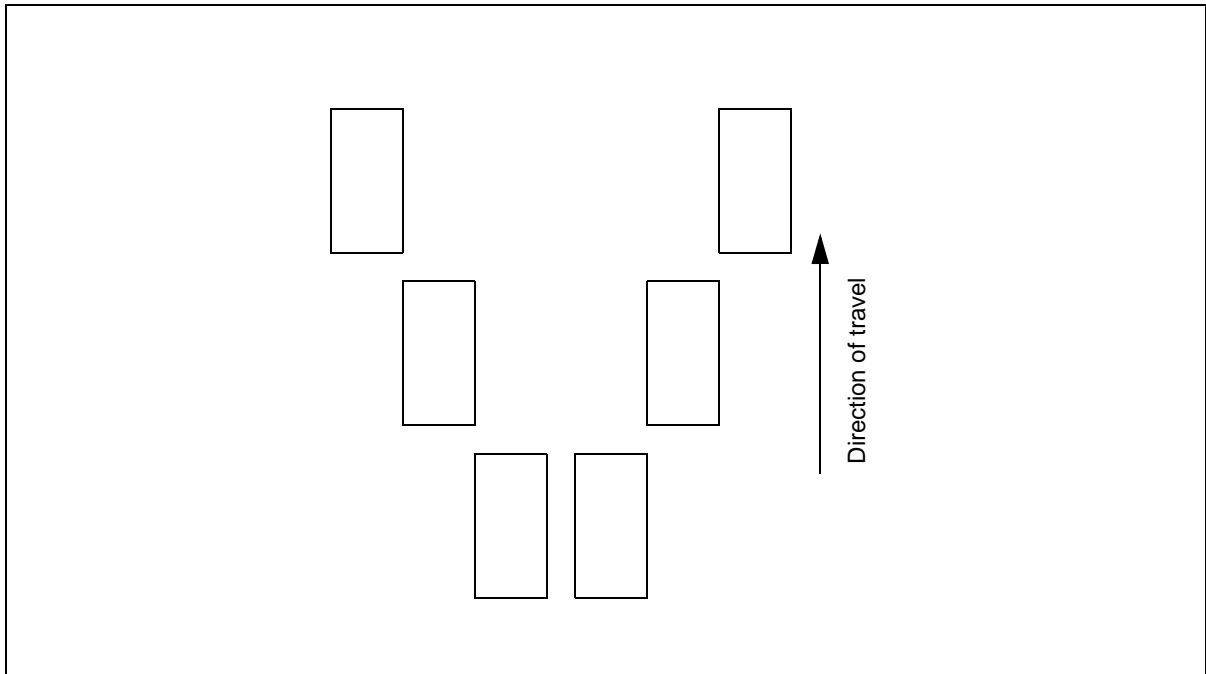

Figure G-4. V Formation

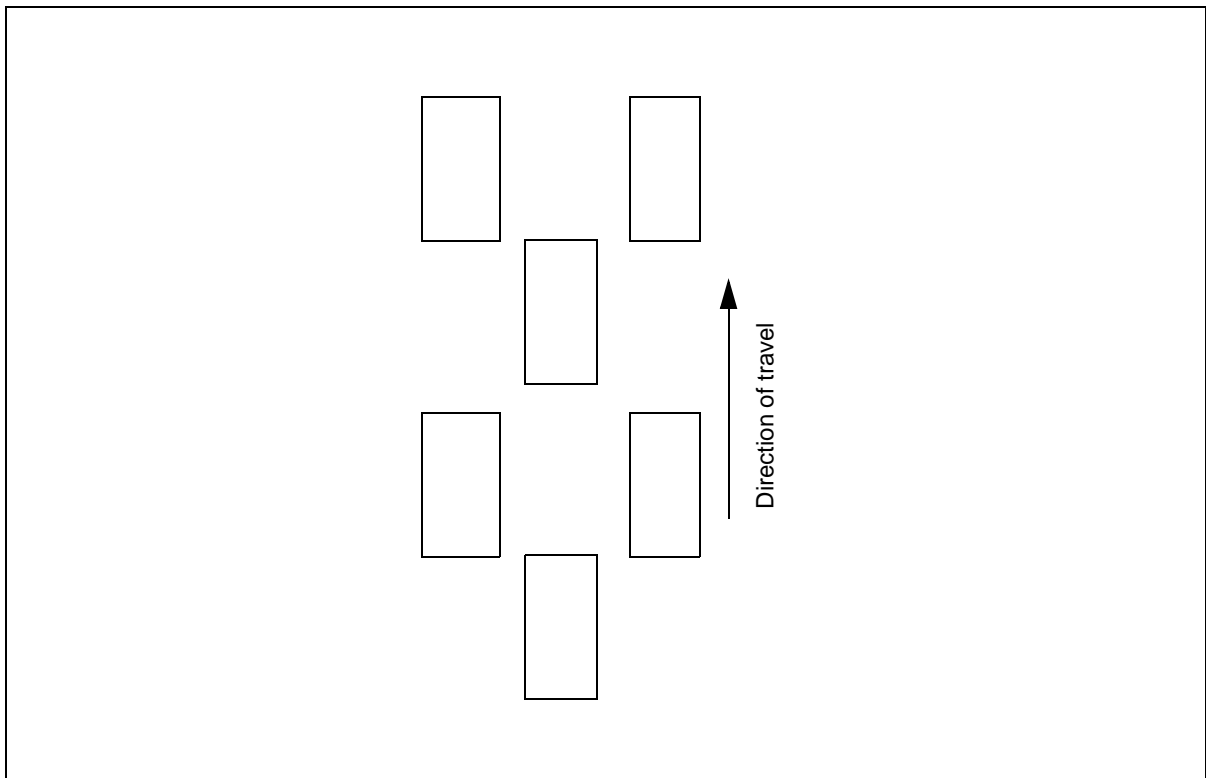

Figure G-5. Split V Formation

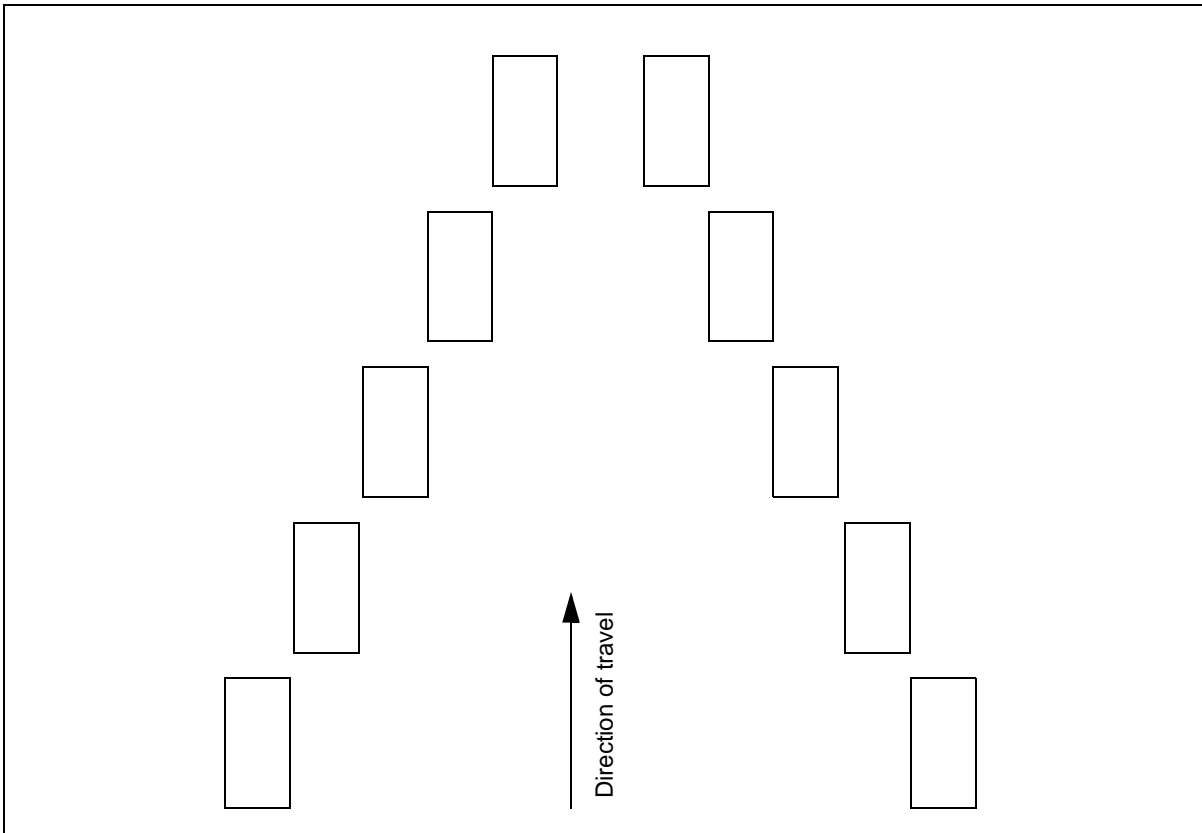

Figure G-6. Echelon (Left and Right) Formations

d. Stationary Formations. There are two security formations used when vehicles are not moving—herringbone and coil.

(1) Herringbone. The herringbone formation (*Figure G-7*, page G-6) is used to disperse the unit when they are traveling in a column formation. It may be used during air attacks or when the unit must stop during movement. It lets the unit move to covered and concealed positions from a road or an open area, and it establishes all-round security without requiring detailed instructions. Vehicles are repositioned as necessary to take advantage of the best cover, concealment, and fields of fire. Crew members dismount and establish security.

(2) Coil. The coil formation (*Figure G-8*, page G-6) provides 360° security and observation when the unit is stationary. It is useful for tactical refueling and resupply and when issuing unit orders. Security, including air guards and dismounted personnel, is posted. The coil formation is used—

- When visibility is limited, the unit leader forms the coil. When the coil is complete, all vehicles stop, adjust for cover and concealment, turn 90° outward, and post security.
- During daylight or whenever speed is essential, the unit leader signals vehicles to move into position and stop. Other vehicles move directly to their assigned positions (as stated in the unit SOP), seek cover and concealment, and post security.

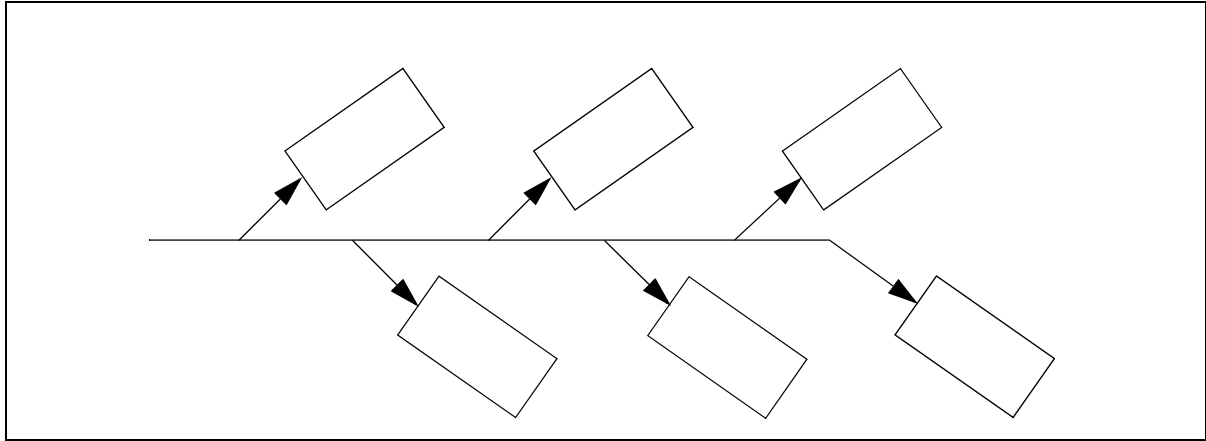

Figure G-7. Herringbone Formation

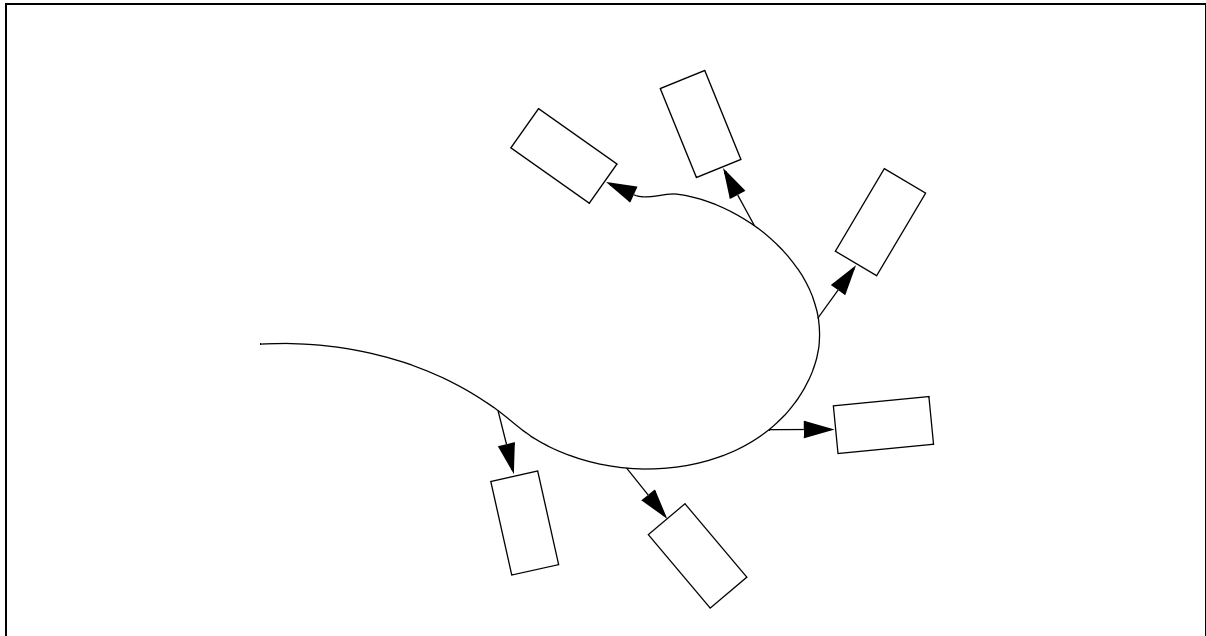

Figure G-8. Coil Formation

3. Movement Techniques

Movement techniques are used by units to traverse terrain. The likelihood of enemy contact determines which movement technique to use—traveling, traveling overwatch, or bounding overwatch (see *Table G-1*).

Table G-1. Movement Techniques

Enemy Contact	Recommended Movement
Not likely	Traveling
Likely (possible)	Traveling overwatch
Expected	Bounding overwatch

a. **Traveling.** The traveling technique is employed when speed is necessary and enemy contact is not likely. The unit moves in a column formation, with 50-meter intervals. Vehicles move continuously at a maximum safe speed. When the column stops, vehicles move into a herringbone formation. The unit moves along covered and concealed routes, automatically contracting and expanding based on terrain and visibility. Local security is maintained according to the unit SOP. Each vehicle posts an air guard. The unit leader locates where he can best exercise control.

b. **Traveling Overwatch.** The traveling overwatch technique is employed when enemy contact is likely (possible). The unit moves in a column formation, with 50-meter intervals and designated lead and trail elements. The trail element moves continuously, following covered and concealed routes. The lead element is approximately 50 to 100 meters ahead of the trail element, depending on terrain and vegetation. The trail element moves at varying speeds, stopping as required to overwatch the lead vehicle. Visual contact is maintained with the lead element at all times. The trail element overwatches at a distance that would allow it to fire or move to support the lead element if necessary. In wooded areas or restricted terrain, units reduce the speed and the intervals. In adverse weather conditions, the crew of the lead vehicle dismounts to verify route trafficability and the following vehicle(s) provides overwatch. The unit maintains local security according to the unit SOP.

c. **Bounding Overwatch.** The bounding overwatch technique is employed when enemy contact is expected. The staggered column formation, with 50- to 100-meter intervals between vehicles, is the standard movement formation. The lead element bounds forward, following a covered and concealed route. The bounding element may be a single vehicle or multiple vehicles. The overwatching element covers the progress of the bounding element from covered and concealed positions, offering observation and fields of fire against suspected enemy positions. Visual contact is maintained at all times. The length of a bound is based on terrain analysis and the ranges and fields of fire from the overwatching vehicles. When cresting a hill, entering an open area, exiting a defile, or moving through restrictive terrain, a crewman dismounts from the vehicle. He moves forward on foot to a point where he can observe all suspected and likely enemy firing positions. The unit maintains local security according to the unit SOP.

4. Survey Techniques

Survey techniques can be conducted by a mounted or dismounted team. Survey techniques used include nearside-farside, box, star, and bounce-and-bypass. The distances suggested for each technique vary depending on METT-TC.

a. **Nearside-Farside.**

(1) The nearside-farside survey technique is used by a reconnaissance element when a team enters the contaminated area. All vehicles or personnel in the reconnaissance element stop. Each team determines if it is in the contaminated area. If a team is in the contaminated area, it moves back along its original path for 200 meters and checks for contamination (see *Figure G-9*, page G-8). If it is out of the contaminated area, it emplaces appropriate warning markers. If it is still in the contaminated area, it moves back another 200 meters and checks for contamination. This process is repeated until it is clear of the contamination. Once the initial vehicle or individual has found the nearside boundary of contamination, it moves forward across the contaminated area, testing every 200 meters.

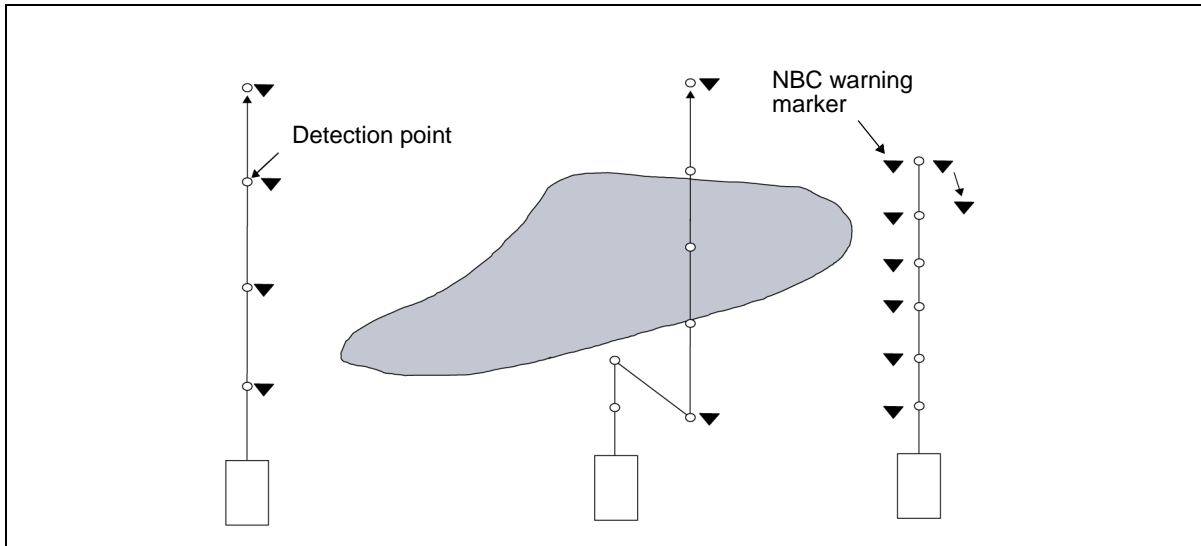

Figure G-9. Nearside-Farside Survey Technique

(2) When contamination is no longer detected, the team moves forward another 200 meters and checks again. If no contamination is detected, it places an NBC warning marker. Each team in the element executes this process to determine the nearside and farside boundaries of the contamination.

(3) It is possible that the left and right limits of the contamination are not identified, even though the left and right reconnaissance teams determined a nearside and a farside (see *Figure G-10*). In this case, the reconnaissance element can shift teams to the left and right to find the boundaries or it can execute a box survey technique. The lateral spacing between teams is important to quickly locate all boundaries of the contaminated area. Once the boundaries are located, clear bypass routes can be easily located.

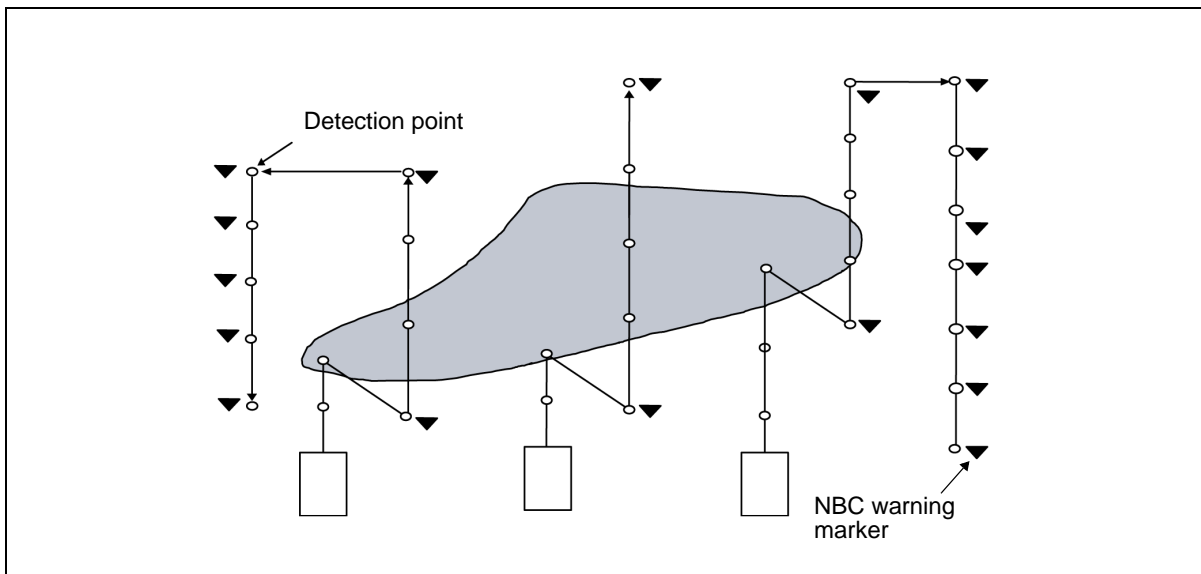

Figure G-10. Contamination Area Extending Past the Initial Right Limit of the Survey

b. Box.

(1) The box survey technique (*Figures G-11 through G-14*, pages G-10 and G-11) is used to determine the general dimensions (length and width) of a contaminated area. It is best employed by three teams, and the process starts once a team enters the contaminated area. All teams in the reconnaissance element stop and check for contamination in their immediate areas. The first team to report contamination becomes the base element. If any other teams in the element are located in the contaminated area, they must back out of the contamination. All teams in the element should orient on the base team. At least one team should be to the left and one team to the right of the base team.

(2) The base team moves forward and finds the farside of the contamination. The crew continues to check for contamination every 200 meters. When the crew fails to get a positive reading, they proceed another 200 meters and establish the initial farside line. The team to the right of the base team places an NBC warning marker to indicate the initial nearside line, moves forward 200 meters, and checks for contamination.

(3) The crew can find two things at this point—contamination or no contamination. If contamination is detected, the team turns 90° to the right, moves 200 meters, and checks again. If no contamination is found, the team moves forward 200 meters and checks again. This process of going straight or turning will continue in a box-like movement until the team has crossed the initial farside line; this is the initial right limit of the contamination. The movement of the team depends on the orientation of the contaminated area.

(4) Once the team has reached the initial farside line, the team moves toward the base team while checking for contamination. The team to the left of the base vehicle executes the same movement as the team to the right, except its first turn will be to the left. While this may sound complicated, it is not difficult to execute. The reconnaissance unit leader must receive continuous reports from the other teams on their findings—positive or negative. From these reports the NBC reconnaissance unit leader plots the findings to get a general idea of the contamination layout.

(5) Once the NBC reconnaissance unit leader is satisfied that the limits of the contamination have been determined, the unit locates the best route to bypass the contamination. Warning markers are erected around the contamination and along any trails leading into the contaminated area so that the bypass route is clearly marked.

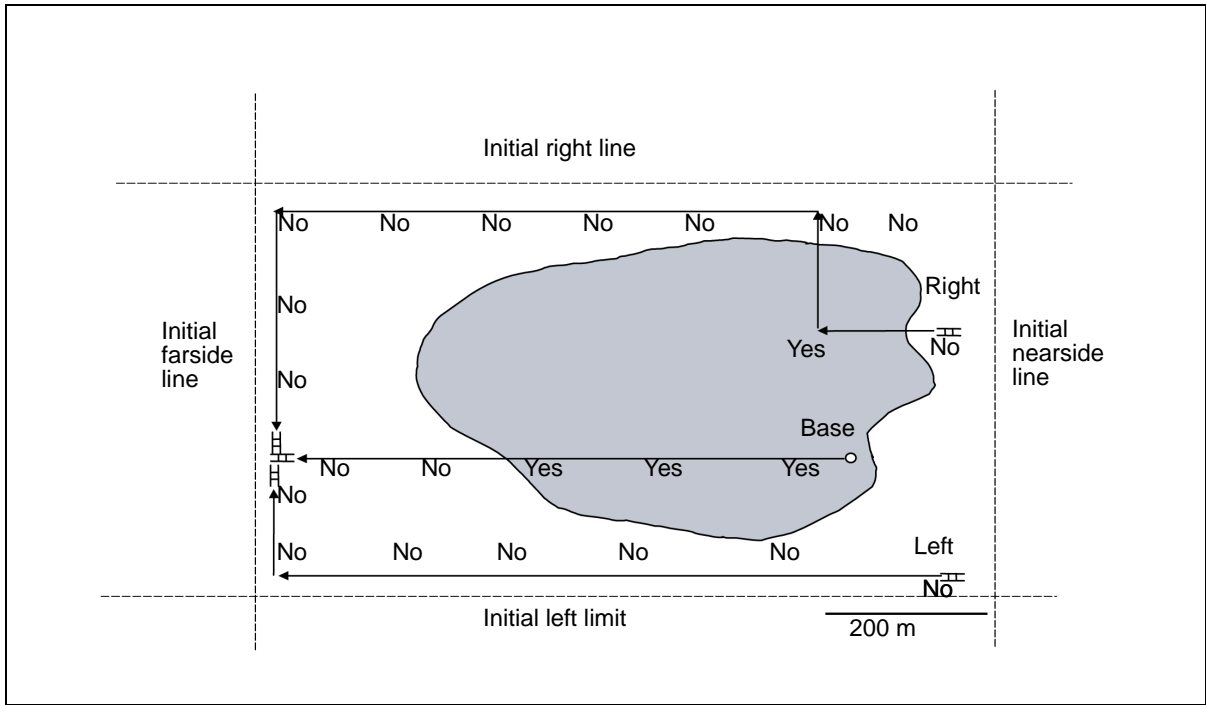

Figure G-11. Box Survey Technique on Orientation A

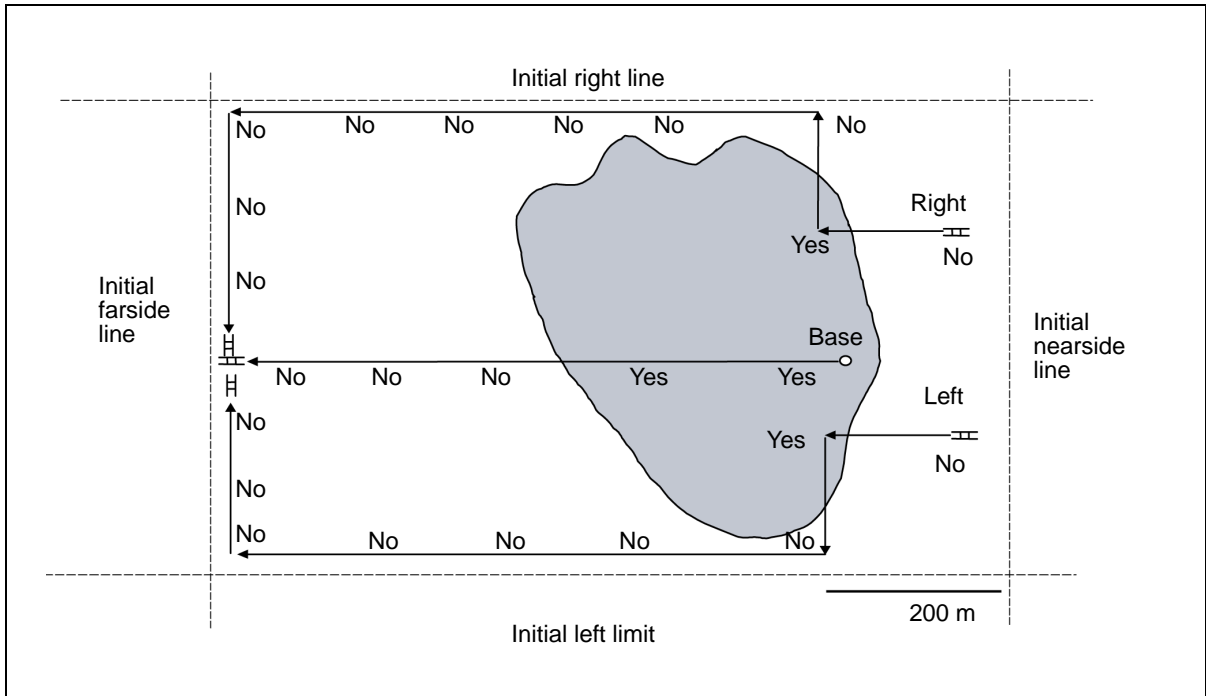

Figure G-12. Box Survey Technique on Orientation B

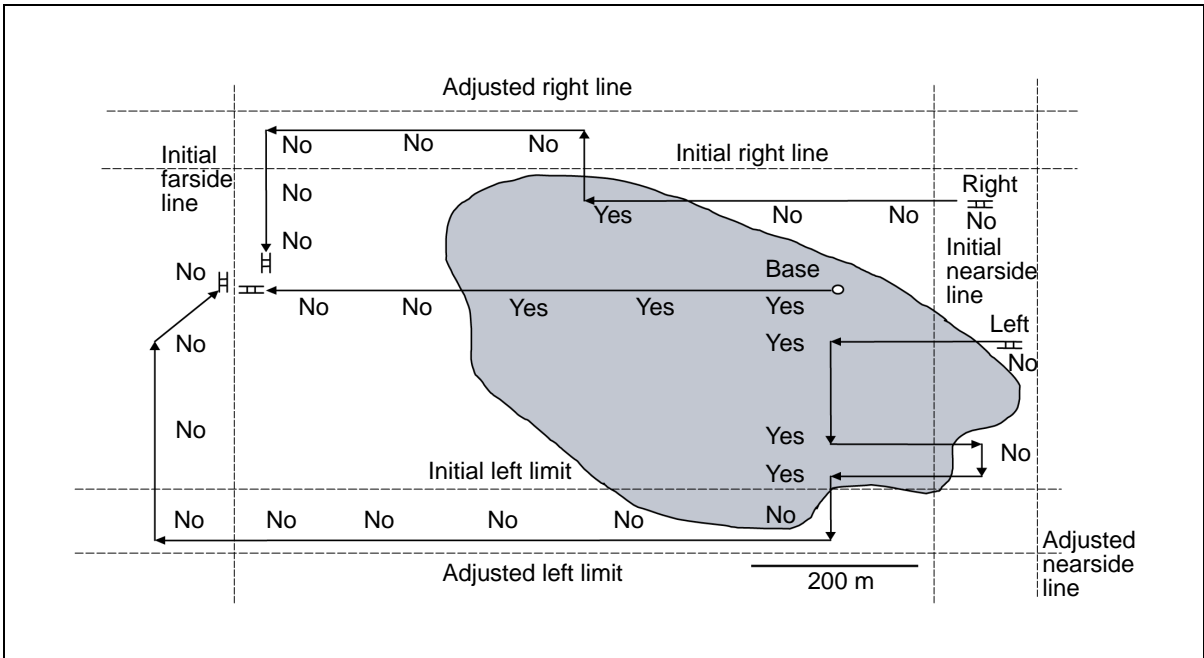

Figure G-13. Box Survey Technique on Orientation C

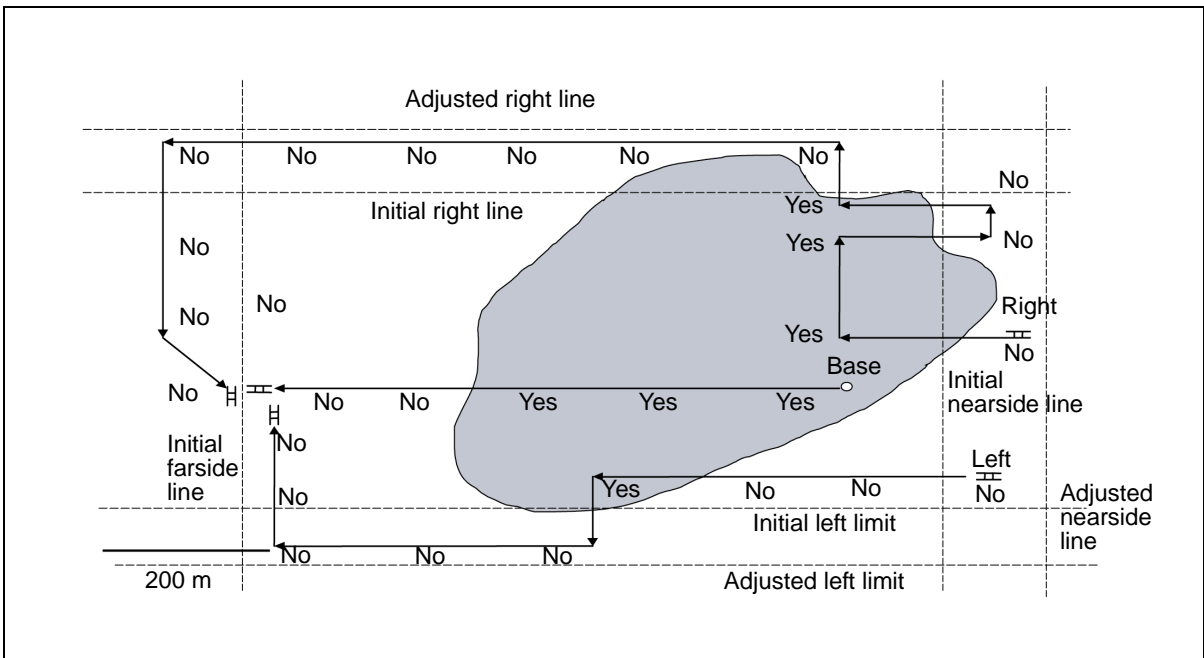

Figure G-14. Box Survey Technique on Orientation D

c. Star.

(1) The star survey technique (*Figures G-15 and G-16*) is a very quick way to determine the rough limits of a contaminated area. The team that encounters the contamination moves back from the contaminated area 200 meters from the last positive reading. This point is the base of the star. The team posts a warning marker and proceeds forward, detecting every 200 meters to find the farside. Once the team has detected no contamination, it proceeds for another 200 meters and checks again. If no contamination is detected, another warning marker is posted. This ends the first leg of the star.

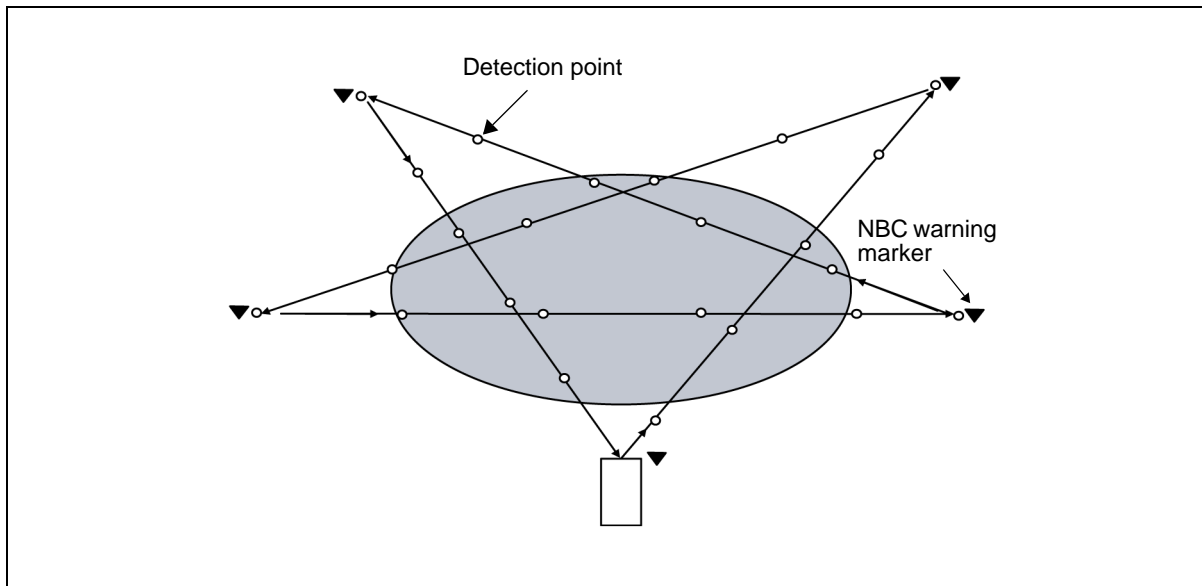

Figure G-15. Star Survey Technique

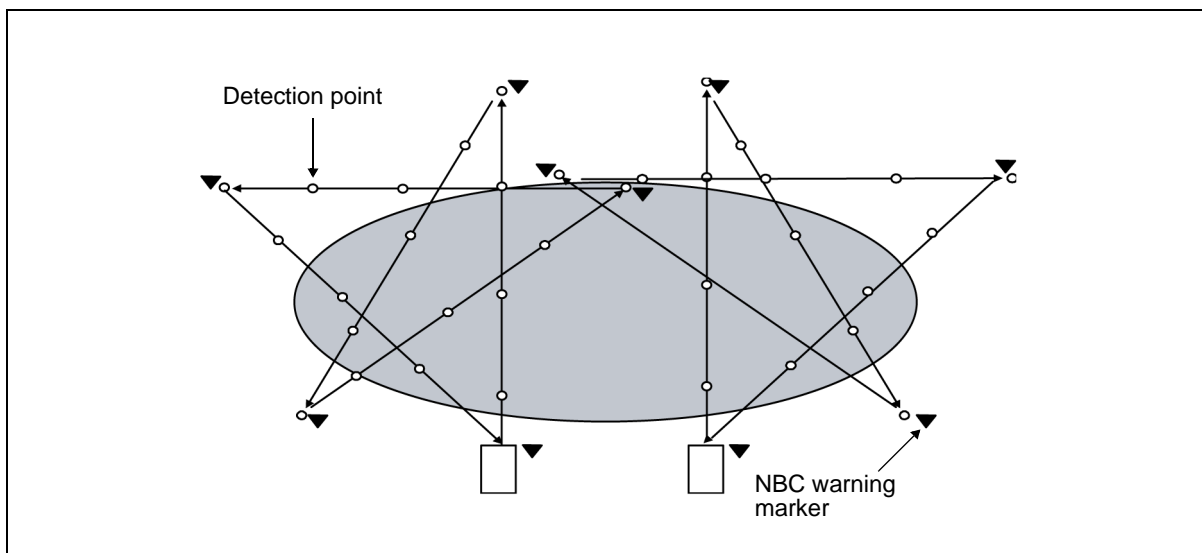

Figure G-16. Star Survey Technique With Two Vehicles

(2) The team turns about 135° and travels in that direction, detecting every 200 meters. If no contamination is detected on this leg, the team does not travel any longer than the length of the initial leg. The team repeats this process until it arrives at or near the base of the star. This technique can be used by two or more teams to obtain more detecting points, increasing the accuracy of the survey.

d. Bounce-and-Bypass. The bounce-and-bypass survey technique (*Figure G-17*) is used to locate the general boundaries of a contaminated area. The team places warning markers at specified intervals around the contaminated area and at all entry points. This technique can also be used to support a radiological survey. The team reports the intensity of radiation at the contamination boundary.

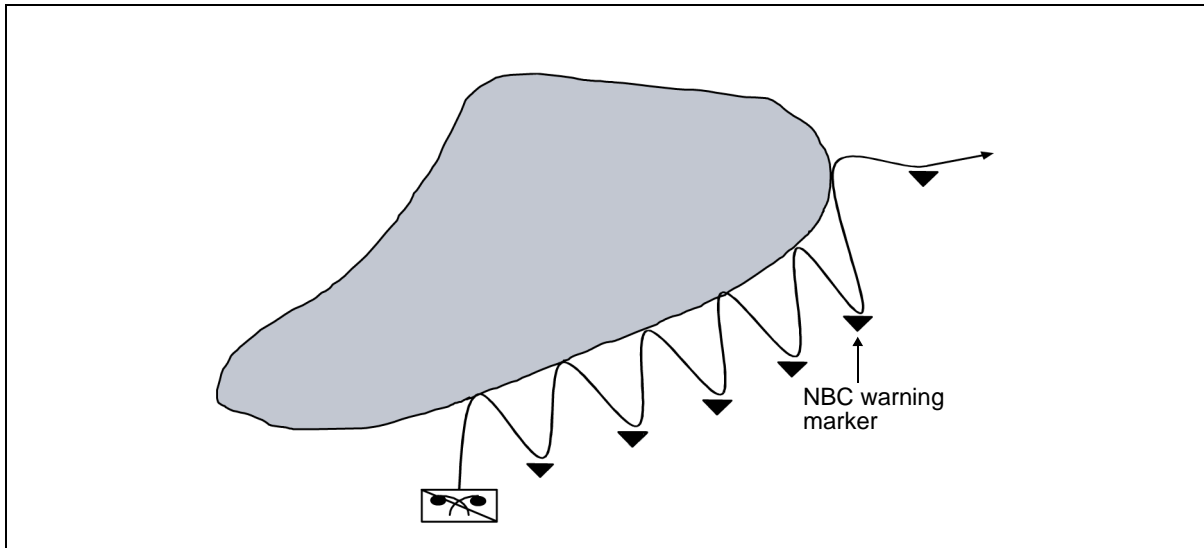

Figure G-17. Bounce-and-Bypass Survey Technique

5. Search Techniques

Search techniques can be conducted by a mounted or dismounted team. Search techniques include zigzag, lane, and cloverleaf. The distances suggested for each technique vary depending on METT-TC.

a. Zigzag.

(1) The zigzag search technique (*Figures G-18 and G-19*, page G-14) is used to locate contaminated areas during route, zone, or area reconnaissance missions. The reconnaissance element begins its search at the deployment (start) line, maintaining 200-meter intervals between vehicles. A team moves forward along a line that is oriented 45° from the start line. The team monitors identification equipment for indications of contamination. After the team has moved 500 meters along the first zig, it turns 90° and zags. After traveling 500 meters, it turns 90° for a second zig. **NOTE: Depending on the terrain, the distances could be larger or smaller.**

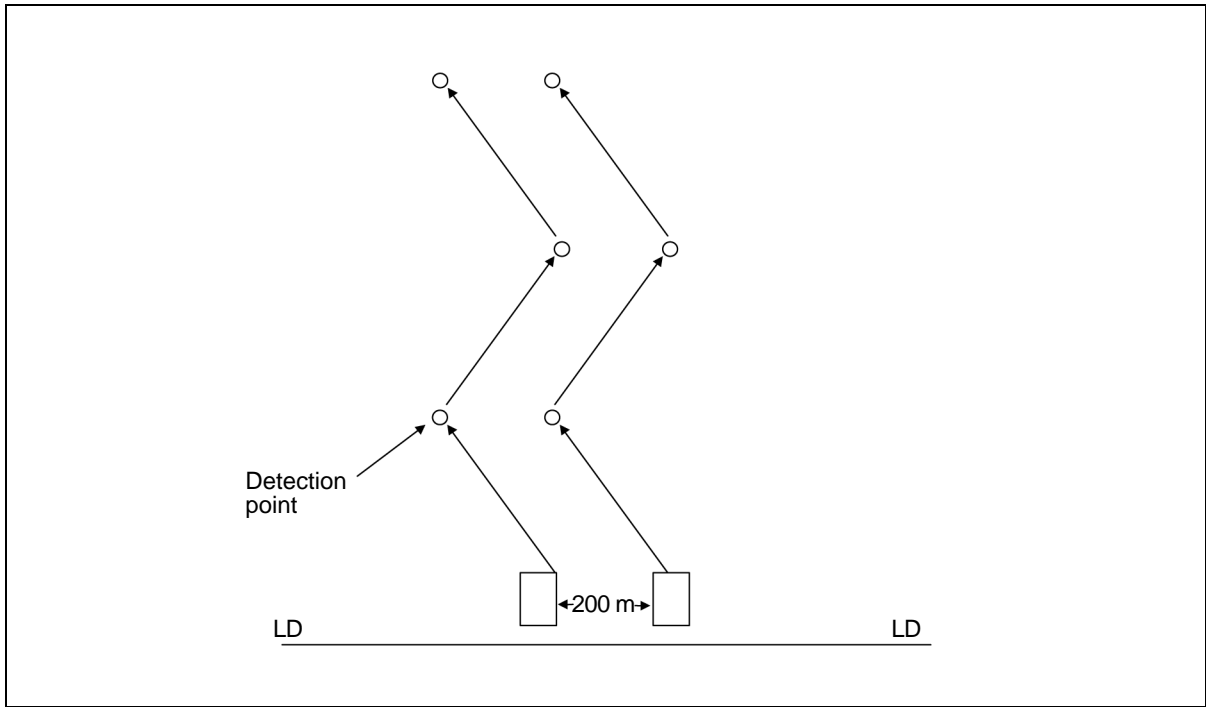

Figure G-18. Zigzag Search Technique

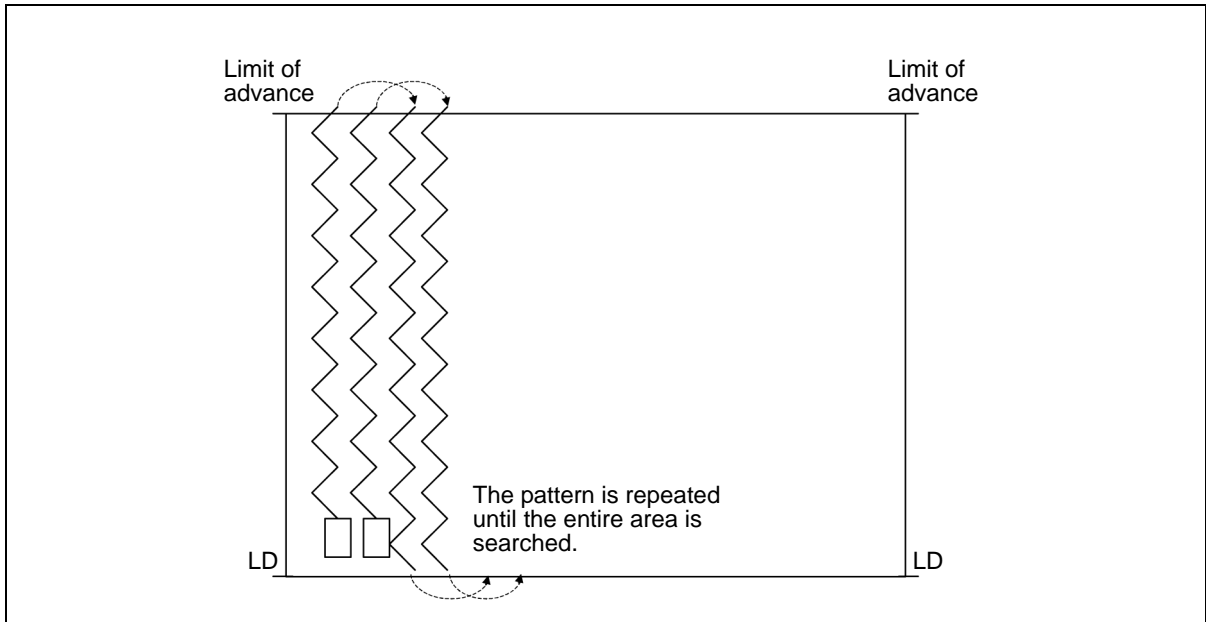

Figure G-19. Multiple Sweeps Using the Zigzag Search Technique

(2) The team continues to zigzag until the reconnaissance element has reached its limit of advance. If the entire mission area has been searched, the reconnaissance element reports the results of the reconnaissance. If the reconnaissance element did not search the entire mission area, it begins a new sweep. It repeats the process until contamination is detected or the entire mission area is searched. The zigzag technique has a higher probability of detecting contamination because the surface area not traversed by the reconnaissance element is less than that of other search techniques.

b. Lane.

(1) The lane search technique (*Figure G-20*) is used to locate contaminated areas. It is very similar to the zigzag technique, but is primarily used during route reconnaissance missions. It can also be used for area reconnaissance of long, narrow pieces of terrain, such as defiles. The reconnaissance element begins its search at the LD with an interval of less than 200 meters between vehicles (if more than one vehicle is used). For narrow routes, the reconnaissance element moves in a staggered column formation. Each team moves along a line until it reaches the limit of advance. Teams monitor the identification equipment for indications of contamination and take readings every 500 meters.

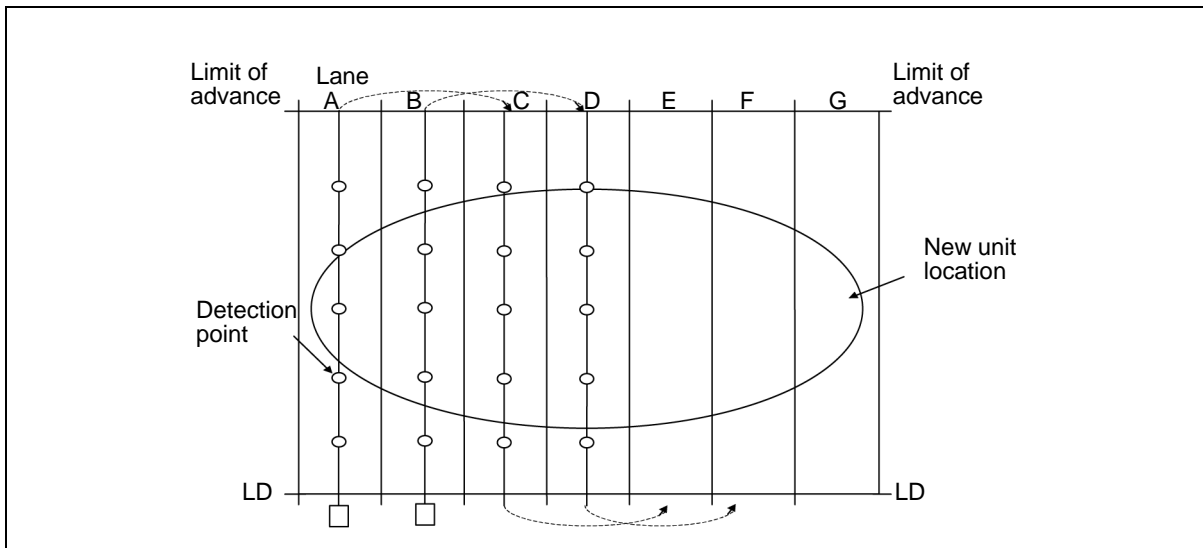

Figure G-20. Lane Search Technique

(2) When the reconnaissance element reaches the limit of advance and the entire mission area is searched, it reports that no contamination detected. If the element did not search the entire mission area, it begins a new sweep and repeats the process until contamination is detected or the entire mission area is searched.

c. Cloverleaf.

(1) The cloverleaf search technique (*Figure G-21*, page G-16) is used during mounted and dismounted operations. During dismounted operations, the team member dismounts from the vehicle and moves in a cloverleaf pattern. The vehicle is used as the center of the search, and each leaf extends 50 to 200 meters from the vehicle. This technique is not used in radiologically contaminated areas because of the lack of shielding. The CAM and the M256 kit are the primary detection tools that dismounted

personnel use to detect chemical contamination. They also use M8 and M9 detector paper.

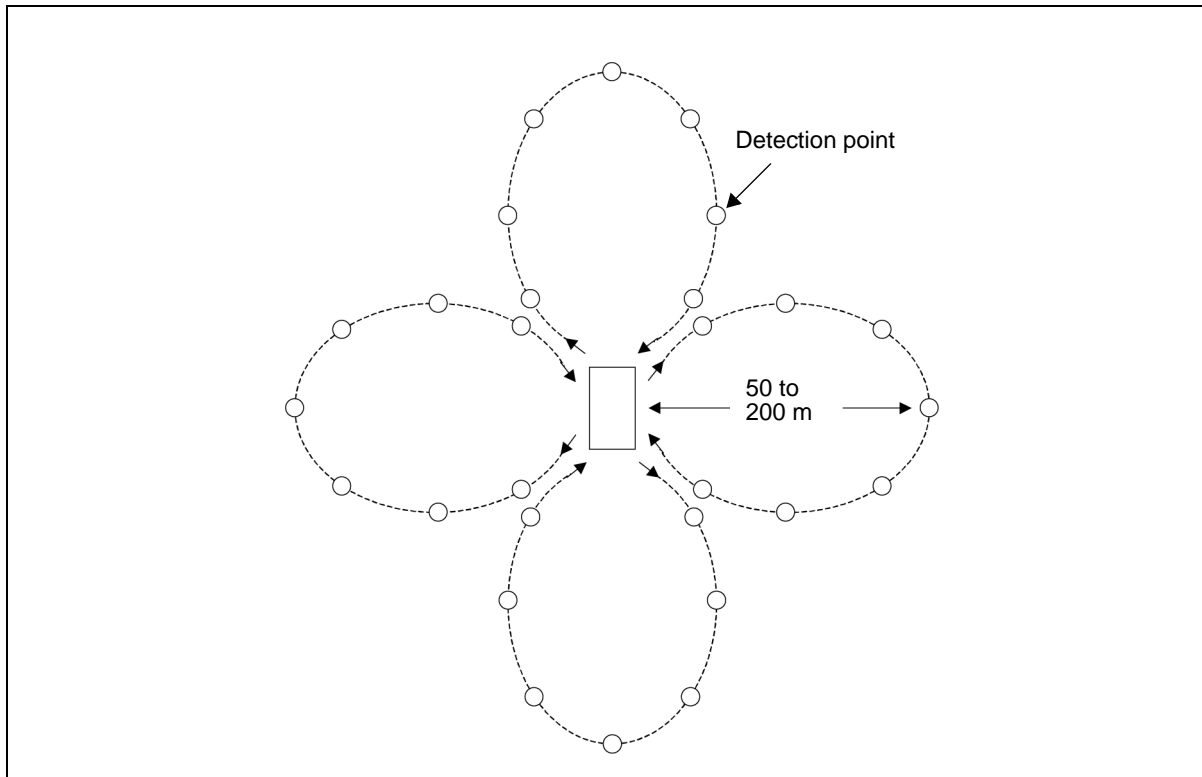

Figure G-21. Cloverleaf Search Technique

(2) This technique is primarily used in restricted terrain or to ensure that sites for high-value facilities (such as C2 centers) are free of contamination. The cloverleaf search technique is time-consuming; however, it provides detailed coverage and information about an area.

Appendix H

SURVEILLANCE TECHNIQUES

1. Background

a. Surveillance is the systematic observation of aerospace, surface, or subsurface areas, places, persons, or things by visual, aural, electronic, photographic, or other means. All units perform a type of NBC surveillance—monitoring. Units monitor their areas to provide early warning by using the ACAA. Units can also be given the mission to perform NBC surveillance by observing NAIs for indications of a chemical attack. Specialized units perform NBC surveillance with point or mobile standoff detectors and LOS detectors.

b. Surveillance also includes medical surveillance. Medical surveillance involves the ongoing, systematic collection of health data. This data is essential to the evaluation, planning, and implementation of public health practice and is closely aligned with the dissemination of data as required by higher authority.

2. Establishing an Automatic Chemical-Agent Alarm Detector Network (Monitoring)

a. ACAAs and detectors (e.g., M8, M22, and M90 series) are used in point, stationary roles. Chemical agents can be delivered directly on unit positions (on-target attacks) or upwind to drift over the unit position (off-target attacks). Detection methods differ for each type of attack.

- **On-target attacks.** On-target attacks produce immediate casualties by contaminating troops and equipment. A large amount of agent must be delivered in a very short time (within 30 seconds). Alarms may take several seconds to respond, and they do not detect all chemical agents. Therefore, a large percentage of personnel might be exposed to chemical agents before an alarm sounds. This means that personnel must recognize the delivery of the chemical agent, observe a color change in the detector paper, or recognize symptoms of chemical-agent poisoning.
- **Off-target attacks.** It is easier to protect against off-target attacks. Units use alarms to alert personnel that a chemical agent is about to drift over their position. Detector paper can also alert units that they are moving into a contaminated area. Personnel can then take protective action before being exposed to the agent.

b. Each unit and installation develops a plan for the deployment and integration of automatic chemical detection, identification, and warning systems with individual chemical detection systems. Plans must include the activation and use of an NBC warning and reporting system and local communications. Alerts may be achieved with radio communications, public-address systems, or flags. Manual systems are used for backup roles and to expand coverage. The current inventory of detectors sample for chemical vapors at the detector location. Manual systems provide an indication of a

chemical attack in 12 minutes or less (for specific agents). Postattack determination for the presence or absence of chemical agents may take 30 minutes or more.

(1) **Detector Assets.** NBC personnel determine how many detector assets are available. They assess how many detector systems are needed to provide coverage for the unit area or fixed site.

(2) **Detector Employment.** NBC personnel prepare a dispersal employment scheme for assigned automatic detectors, M256A1 kits, and M8 and M9 detector paper. The unit perimeter or installation is divided into sectors. Incident response maps can be overprinted with the sectors identified. The size and shape of the sector may vary based on what is located in the sector. A dice five pattern (a rectangle with five detectors, one in each corner and one in the center) can be used as the basic pattern (see *Figure H-1*). The dice five pattern can also be applied to the installation or unit area, placing available detectors evenly throughout the installation or perimeter. The prevailing winds for the fixed site should be taken into account. Detectors should always be concentrated on the upwind side. Identify critical functions and areas (C2 facilities; munitions sites; buildup and storage areas; aircraft locations; maintenance facilities; petroleum, oil, and lubricants [POL] resources; and cantonment and support areas). Predetermine M8 and M9 detector paper placement for unit monitoring. At fixed sites with limited assets and responsibility for small cantonment areas, use detection teams in the cantonment area in the dice five pattern and provide extended coverage of the perimeter as detectors become available. If detectors are not available, the unit should disperse any necessary sampling supplies or equipment or otherwise prepare to sample, preferably at the same designated detector sites.

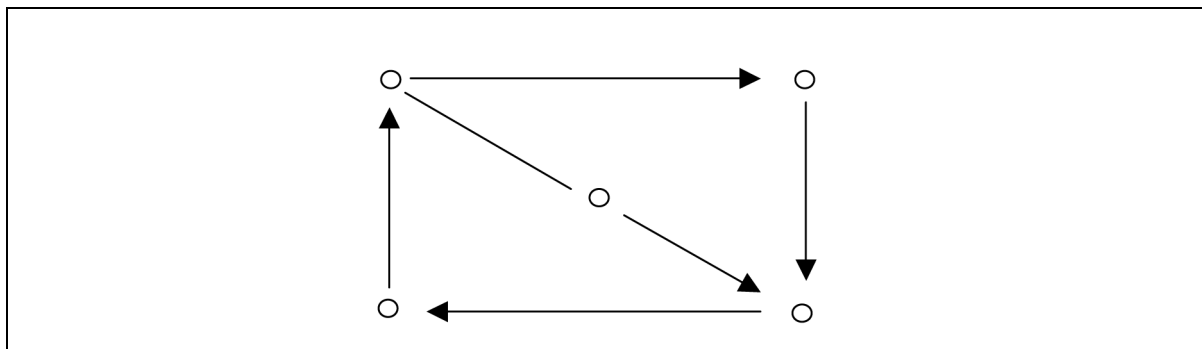

Figure H-1. Dice Five Pattern Detector Placement

(a) A unit emplaces alarms as soon as it arrives in the area it plans to occupy. If possible, detectors should be no more than 150 meters upwind from the farthest upwind unit position. This warns the personnel upwind and those farther downwind. The detector units should never be placed more than 400 meters from the alarm unit; otherwise, the signal may not be strong enough to sound the alarm. The optimum spacing of 300 meters between detectors reduces the risk that a chemical cloud will drift between detectors without sounding the alarm.

(b) The number of alarms needed to protect a unit depends on the unit size. The larger the unit front, the more detectors are needed to warn the unit. In this case, *front* means the upwind direction. Front could be the left or right flank or the forward or rear edge of the unit. *Table H-1* shows the number of detectors required for optimum alarm employment.

Table H-1. Number of Detectors Required

Unit Front Size (Meters)	Number of Detectors
1 to 36	1
37 to 372	2
373 to 708	3
709 to 1,044	4
1,045 to 1,380	5

(c) Chemical alarms are usually employed at unit level. Exact positions for the alarms must be determined based on wind speed, wind direction, terrain, and the tactical situation. The commander, with advice from the unit NBC NCO, chooses the actual positions. *Figure H-2* shows how a fixed emplacement might look. Note how the detectors are positioned and how these positions change when wind direction and unit position change. CW agent point vapor detectors (such as M8A1, M22, and M90) should be placed around a perimeter to provide rapid indication of vapor presence. Because the detector is a point source detector, ensure that enough detectors are placed in the upwind positions on the fixed site. Although the point vapor detector is capable of monitoring agent contamination at an extremely low concentration, do not employ it as a vapor monitor inside collective protection facilities unless a sufficient number of detectors are available to provide detection of chemical attacks.

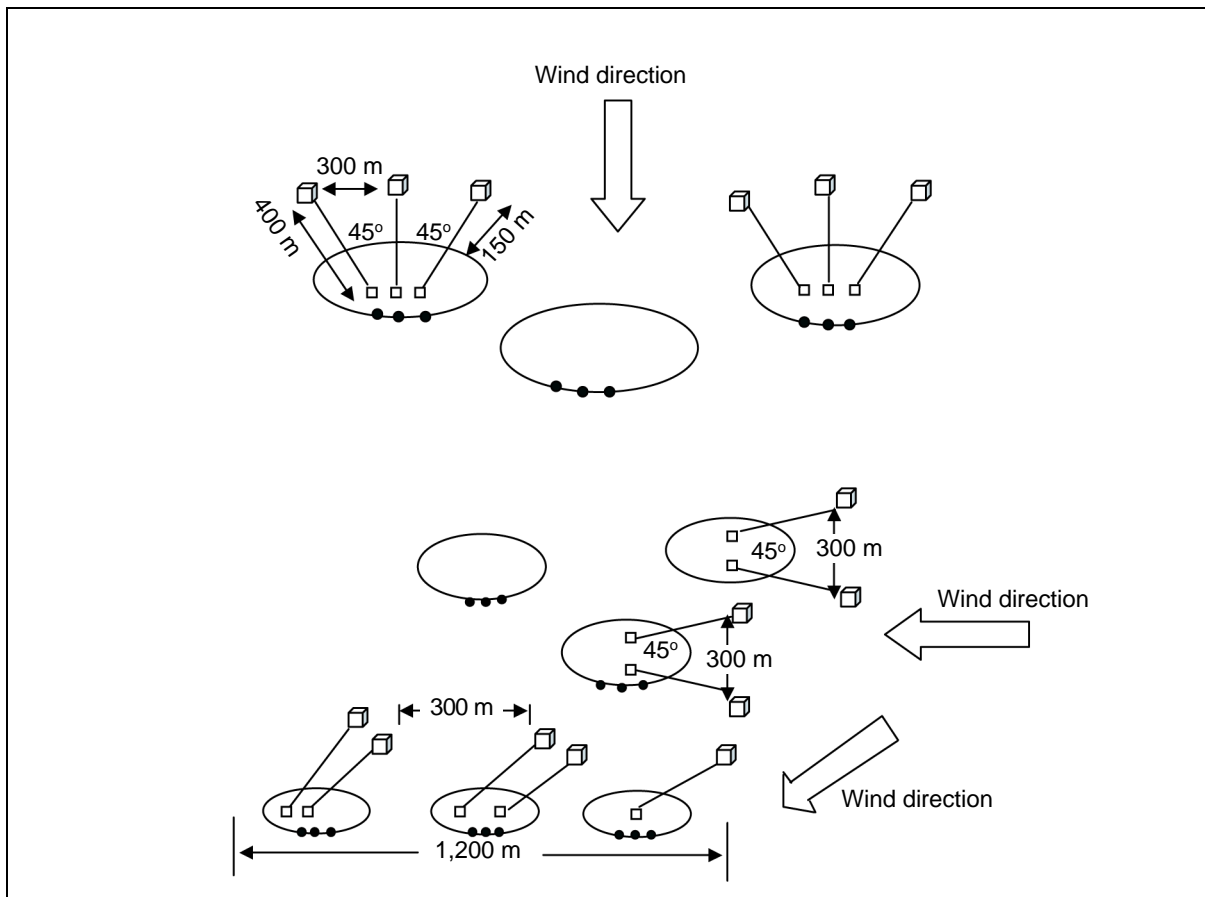

Figure H-2. Fixed Emplacement of ACAAs

NOTE: When emplacement is complete, show the alarm locations on a site diagram (i.e., grid map, range card). For night operations, a strip of engineer tape can be placed on the alarms to help locate them.

(d) A sample chemical detector deployment scheme for a fixed site (approximately 3,000 by 5,000 meters) uses 35 detectors in an overlapping dice five pattern. This pattern calls for 14 detectors to be placed on the perimeter of the base, 18 detectors placed on the interior of the base, and 3 mobile units to be deployed with chemical reconnaissance teams. This configuration allows for quick chemical detection with a high confidence level, regardless of wind direction and speed. The mobile units are used to verify single detector alarms and possible false alarms. Consider the following factors when establishing a detector array:

- The exact detector locations are not as important as ensuring that a sufficient number of detectors are staggered in upwind positions from where personnel may be working or sleeping.
- Detector spacing should be based on METT-TC to provide maximum coverage.
- Detectors should be no closer than 25 feet to any major structure to ensure maximum exposure to prevailing winds and limit interference caused by buildings (micrometeorological phenomenon).
- Detectors should be positioned at least 3 feet off the ground, but no more than 6 feet, to ensure maximum exposure to the contaminated environment.
- Detectors should be placed near personnel so that alarms can be heard and detector malfunctions reported. On the perimeter, detectors are ideally positioned next to defensive fighting positions.
- Commanders should rely on additional information when confirming an attack. When possible, do not rely on the results of a single detector to determine if contamination is present. Observe postattack data for the activation of additional detectors, M8 and M9 detector paper reaction, environmental indications, casualties, and other detection means to confirm a chemical attack.
- Everyone is issued M8 and M9 detector paper. It can be used after a suspected attack (blotting) to confirm chemical use.
- All personnel must be trained to check suspected surfaces with M8 and M9 detector paper before touching them. They must avoid marked-off areas (contamination and UXO).

(e) When emplacing alarms, the wire connecting the alarm and the detector must be protected from indirect fire. This can be done by burying the wire. It should be checked periodically (at least every 4 to 6 hours) to ensure that it has not been broken or cut.

NOTE: The M8-series alarm is designed to operate in a temperature range of -40° to 49°C. During Operations Desert Shield and Desert Storm in the Persian Gulf, deployed units experienced a high frequency of false alarms. This was due to a multitude of problems. However, the two principal causes were identified as high temperatures and high dust concentrations. The high-temperature problem was reduced by placing the alarm up off the ground on wood or boxes in a shaded area, natural or man-made (such as under camouflage netting). High dust concentrations required replacing filter paddles in the alarm more frequently (once every 1 to 2 hours of operation).

(f) An ACAA can be mounted on a vehicle; however, it does not provide detection while the vehicle is moving.

3. Observing Specified Areas (Named Areas of Interest)

NBC surveillance provides observation of a specific area for indications of an NBC attack. Based on IPB and vulnerability planning, these designated areas are typically NAIs. The commander prioritizes the use of available collection assets against designated NAIs; and teams monitor, watch, and listen to observe designated areas for indications of an attack. The primary means of surveillance may be from OPs. An OP is a position occupied to observe a designated area. The team reports any indication of an NBC attack or enemy activity. Another means of surveillance is conducting routine patrols through the AO. This is normally conducted in rear areas along MSRs and road networks.

a. **OP Site Selection.** The supported unit leader or the NBC reconnaissance unit leader selects the general location for the OP. The leader considers METT-TC factors, the intelligence collection plan, and the ISR plan when determining the general positioning of the OP site.

b. **Attack Indicators.** Agents can be disseminated by using overt or covert methods. Explosive delivery systems or spray tanks (such as artillery, rockets, and missiles detonating) have a distinctive visual signature during the day and at night. Aircraft spraying agents have distinctive flight patterns along with the signature of the liquid being released. While these indicators are not positive proof that an attack has occurred, there is an increased probability that it has. Depending on METT-TC, the NBC reconnaissance element occupying the OP can conduct a search of the NAI to confirm or deny the presence of contamination.

c. **Site Reconnaissance.** Reconnaissance is the first step in site selection. Begin with a map reconnaissance. Use the map reconnaissance to determine initial surveillance areas that support the employment tactic; and then select primary, alternate, and supplemental surveillance sites within each surveillance area. Some rules of thumb for the reconnaissance include—

- Reconnoiter the detection areas and potential sites firsthand, if possible.
- Coordinate with the terrain owner before conducting the reconnaissance.
- Ensure that the reconnaissance element includes the designated serial leaders.

4. Conducting Standoff Chemical-Agent, Line-of-Sight Detection (Monitoring)

Standoff LOS chemical detection capabilities from NBC reconnaissance units (equipped with an M93A1 NBCRS) provide a 5-kilometer range between the detector and the target area. This system provides a stationary capability to provide support for standoff monitoring of NAIs specified in ISR plans. Standoff detection can be conducted upwind, downwind, or crosswind.

a. Techniques.

(1) **Upwind Surveillance.** This technique reduces the likelihood that the NBC surveillance asset (NBCRS team) will be exposed when conducting surveillance. Surveillance asset efforts remain focused by IPB and the commander's PIR and IR.

(2) **Downwind Surveillance.** While this technique provides early warning, reconnaissance crews will likely be exposed to FP hazards or agent hazards. The application of this technique must weigh the potential threat against the risk. The IPB, RA, and vulnerability analysis must consider the cost factor and the likelihood and impact of reconnaissance vehicle and crew exposure.

(3) **Crosswind Surveillance.** When conventional or NBCRS teams conduct crosswind surveillance, they are positioned to observe NAIs unaffected by head or tail winds. This technique is recommended when contamination avoidance is foremost and observation and sensing can be achieved using standoff sensors and dismounts.

b. Capabilities.

(1) **M21 Remote-Sensing, Chemical-Agent Alarm.** The M21 detects nerve- and blister-agent vapor. It operates as a detector, and the alarm automatically scans a 60° arc. (See the unit staff chemical officer for range detection distances.) It is a passive infrared device that reacts audibly by horn and visually by illumination. It is mounted on an M93A1 NBCRS, or it can be manually emplaced by an M93 NBCRS crew. (See *Appendix J* for further information on M21 employment techniques.)

(2) **AN/KAS-1, CW Directional Detector.** The AN/KAS-1 is a shipboard, manually operated, passive sensor that detects nerve-agent vapor. It detects the infrared signature of nerve agents (GA, GD, GB, GF, and VX), but cannot discriminate between the agents. In addition, it cannot determine the range to the vapor cloud.

5. Establishing a Biological-Agent Detector Array (Monitoring)

Biological detection assets are employed as units, not as separate, stand-alone individual systems. The NBC staff prepares an employment plan that is based on the commander's concept of operation.

a. The biological detection array must maximize the probability of detection. The resultant employment plan can include an area array, a critical-node array, or both to provide an integrated (layer) network of detectors.

(1) **Area Array.** This tactic employs biological detection units over a large area to detect biological clouds upwind of the operational area of concern. The biodetection SME (e.g., biodetection platoon leader or company commander), in coordination with the battle staff of the supported unit (in particular, operations,

intelligence, medical, and NBC sections), determine the specific architecture of this array. The array is designed to address the threat, operational level NAIs, and unit dispositions. The area array maximizes the coverage and potential warning to the command. As the distance between the biological assets is increased, the risk of missing detections also increases.

(2) Critical-Node Array. This tactic is normally used in support of the most critical NAIs. When performing this mission, biological detection elements may be upwind or collocated with a critical asset (such as assembly areas, logistics bases, major airfields and ABs, naval bases, or ports) to detect or confirm attacks of BW on these facilities.

(a) Critical-node planning provides an integrated biological detection capability. A layered detection capability addresses the need for biological surveillance of outside ambient air and internal building air. The actual number of biological sampling or detection systems required varies depending on the size of the critical node. However, multiple systems (samplers or detectors) are required to provide monitoring support.

(b) Outside air surveillance detects the external release of a biological agent from an overt or covert release. Additionally, critical facilities may also be provided biological sampling or detection capabilities internal to the heating, ventilation, and air conditioning (HVAC) system based on the possible use of biological agents by an adversary.

b. Multiple biological detection capabilities can be used to support area or critical-node array employment. Biological detection assets that are well suited for this include the Biological Integrated Detection System for land forces and the Interim Biological-Agent Detection System for maritime forces. Additionally, multiple tactical systems are available to support critical-node biological detection. Critical-node (e.g., building) biological detection can also be supported by using samplers with handheld assays. Regardless of the availability of operational or tactical-level capabilities, the evaluated report information from these assets is critical to the operational and tactical commander's SA.

(1) Biological Integrated Detection System. The Biological Integrated Detection System is an operational-level war asset. It is configured to detect various characteristics that are indicators of a large-scale BW attack, and it provides a presumptive identification capability. The results of the identification process are reported, and biological samples are evacuated to preselected sample transfer points. This information, along with other intelligence and medical data, provides the commander with the capability to assess whether a large-scale biological attack has occurred. Since the identification of a biological agent is not specific enough to distinguish between various strains of an agent and the system cannot identify all biological agents, the identification is presumptive. The system automatically takes physical samples required for analysis by a medical laboratory.

(2) M99 Joint Portal Shield, Fixed-Site Biological Surveillance Systems. The M99 joint portal shield is an array of point detectors that provides a biodetection capability to detect and presumptively identify a BW attack through the use of networked sensors arrayed around a fixed site. The shelter encloses the sensor and its ancillary components and provides protection from the weather. The sensor regularly updates the command post computer through a radio modem and uses detection algorithms to determine if a rise in the local particulate count merits testing for BW

agents. The sensor presumptively identifies up to eight biological agents simultaneously. The networked sensors at a fixed site are separated (by distance) according to METT-TC factors; however, LOS must be maintained between sensors so that communications can be sent via the radio modem back to the command post computer.

(3) Interim Biological-Agent Detection System. The Interim Biological-Agent Detection System is an installed shipboard sensor that provides point detection of airborne BW agents on a nearly real-time basis. The number of these systems is limited, and they are cross-decked as directed by higher authority (one or more ships in a task group may have a system installed). The Interim Biological-Agent Detection System continuously samples outside air and detects changes in the amount of airborne particles in several size ranges. When a suspicious increase occurs in the number of particles of respirable size, the system prepares a sample for testing to presumptively identify selected biological agents. The intended replacement for the Interim Biological-Agent Detection System is the XM98 Detection System, Biological Agent: Joint Point, Ship. It consists of an XM98 basic biological suite unit, a power pack, and two external control subsystem assemblies.

(4) Joint Biological Point Detection System. This system includes the man-portable, XM96 detection system, biological agent, or the trailer-mounted, Joint Biological Point Detection System. The man-portable Joint Biological Point Detection System consists of a basic biological suite unit, an environmental control unit, and a power pack. The basic biological suite unit can be remotely operated, and it provides a presumptive identification and sampling capability for biological agents. The Joint Biological Point Detection System can also be remotely operated in a trailer-mounted configuration. Data relays are established for the man-portable or trailer-mounted configuration for transmitting information to a central location. Either configuration requires periodic servicing to replenish consumables and perform operator and organizational maintenance.

6. Conducting Biological-Agent Surveillance (Standoff Detection)

The Long-Range, Biological, Standoff Detection System is a JTF and echelons above corps (EAC) USA biological detection company asset that assists in providing early detection of a biological attack. It enhances SA and allows FP. The system is a key element of the biological surveillance plan for the joint force command and corps, and it is integrated into the commander's overall battlefield ISR plan.

a. Purpose. The Long-Range, Biological, Standoff Detection System employs a laser system mounted in a UH-60 helicopter to scan a designated AOI and find large, man-made aerosol clouds suspected of containing BW agents. It provides a long-range, nonspecific warning of an approaching particulate or aerosol cloud. Used under appropriate meteorological conditions and given other supporting battlefield intelligence, the data it provides can be used in the decision to give advance warning to units and to alert biological detection elements to go to a higher level of readiness. The system teams obtain data and use helicopter radios to submit incident data reports. The JTF or unit NBC officer analyzes the data, evaluates all available indicators (in coordination with the medical officer), ascertains if a biological attack has occurred, and determines the appropriate recommendations for the commander.

b. Functions. The four major functions include—

- **Surveillance.** The system scans the atmosphere within the NAI, looking for man-made clouds.
- **Detection.** The laser detects a range of particulates in the size and concentration expected of BW agent disseminations. This detection is generic in that it detects potential man-made aerosols.
- **Discrimination.** Discrimination is defined as the ability of the operator to determine if the detected aerosol cloud is man-made (smoke, BW agent) or natural (pollen, fog, rain).
- **Tracking.** Tracking is the repeated detection of an aerosol cloud. Once surveillance has detected a cloud, the operator can map the detectable size and shape of the aerosol cloud. As the aircraft makes multiple scans on the suspect aerosol, the operator tracks further cloud movement, direction, and speed.

c. Employment.

(1) The system provides the operational-level commander with a critical asset that complements other ground-based biodetection assets (i.e., Biological Integrated Detection System). Specifically, this asset is designed to classify an aerosol as man-made or natural. In accomplishing this function, employment roles could include—

- **Cue point detection.** The system provides information to the ground-based biodetectors to facilitate notification (cueing) of point detectors about an incoming man-made aerosol.
- **Detection probability.** The mobile, standoff capability enables the detection of man-made aerosols that may miss point detectors due to gaps in clouds or low agent concentrations upon arrival at the point detector.
- **Early warning.** The system may provide early warning of possible man-made aerosols that may threaten forces on the move.
- **Force economy.** The primary role of the system is to complement command point detector arrays. However, METT-TC considerations (i.e., large-area coverage requirements, limited availability of biodetection assets) may increase the viability of using the system in a force economy role to cover areas that exceed the point detector network coverage areas.

(2) The system is employed to detect and report suspected BW aerosols, at distances of 5 to 30 kilometers, under various atmospheric conditions. A clear LOS is required between the system and the aerosol. The system cannot reliably detect point source aerosols, but it can detect broken, long-line releases. It is operated above friendly territory and out of range of effective enemy fire.

d. Capabilities. The system can detect aerosol clouds and classify them as potentially man-made or naturally occurring. Depending on multiple METT-TC factors (i.e., available flight time, assigned mission), planners may direct the system crew to conduct the following actions:

- **Detection mapping of a man-made aerosol.** The system crew maps the left and right limits of the cloud and estimates the downwind cloud

drift (direction and speed). This technique requires 30 to 45 minutes and can support warning of specific areas.

- **Detection and tracking of an aerosol.** This technique estimates the downwind cloud drift (direction and speed) and classifies the aerosol (naturally occurring or man-made). However, it does not determine the left and right limits of the cloud. This technique requires about 15 minutes.
- **Detection and classification of an aerosol.** The system team detects the cloud and determines if it is naturally occurring or man-made. This technique requires about 5 minutes.

e. **Mission.** The system provides long-range biological information. It detects, ranges, and tracks large-area aerosols disseminated on the ground or in the air. Although the system is configured for aerial-based surveillance, it cannot be configured for use on other small or medium rotary-wing aircraft.

7. Conducting Medical Surveillance

Personnel presenting symptoms may be the first indication of an attack, but they may not occur until after a lengthy incubation period. Careful tracking of disease spikes is critical to an effective detection system.

a. Establishing an environmental baseline is important to help identify variances that may be attributable to a BW attack. MTFs and PVNTMED facilities routinely perform medical surveillance of disease incidence and of syndromes associated with biological agents. In CONUS, all daily Ambulatory Data System information from each MTF is extracted by the DOD Global Emerging Infections System and evaluated by the Electronic Surveillance System for the Early Notification of Community-Based Epidemics. The Air Force uses the Global Expeditionary Medical System for this purpose at deployed locations.

- b. The effectiveness of routine medical surveillance may be improved by—
- Reviewing local and regional endemic diseases.
 - Developing a baseline profile of the water and sampling food and water supplies periodically (frequently during high-threat periods).
 - Providing updates to personnel on symptoms associated with high-threat agents and ensuring that medical personnel are briefed to look for such symptoms. (This must be balanced against the potential for *worried well*, which associates symptoms of commonly occurring diseases or infections with a BW agent attack.)
 - Sharing information with surrounding hospitals and clinics.
 - Determining the accessibility of a regionally networked database that tracks spikes in certain disease symptoms and training personnel to use the information to provide early warning of a BW attack.

c. Medical surveillance is a technique designed to *detect to protect or treat*, not *detect to warn*. The following limitations pertain to medical surveillance TTP:

- Many BW-related diseases can result in vague, nonspecific symptoms during the early stages of illness. Classic, fully differentiated syndromes may not be apparent until late in the clinical course.
- Many medical personnel have little clinical experience in recognizing BW-related disease or infection. A diagnosis of initial cases is confounded by clinical presentations that mimic naturally acquired diseases.
- Affected personnel may not be familiar with symptoms caused by BW agents and may not seek early medical treatment.
- Relatively few hospitals and clinics have established, networked databases to track symptoms, identify symptom clusters, and rapidly identify medical situations characteristic of a BW attack.

Appendix I

RADIOLOGICAL SEARCH AND SURVEY DETECTION METHODS

1. Background

Radiological monitoring is conducted to determine the presence, distribution, type, and intensity of residual radiation. It is performed in a stationary position. The AN/VDR-2 and AN/UDR-13 radiac sets are used to support the monitoring process. The AN/UDR-13 measures gamma radiation dose rates. The AN/VDR-2 measures gamma radiation dose rates and can detect, but not measure, beta radiation.

2. Area Monitoring

Nuclear weapons or radiological agents may be employed at anytime on the battlefield. All units monitor for radiation upon initial deployment. Monitoring provides early warning and useful radiological information to units at all levels. There are two types of area monitoring—periodic and continuous.

a. **Periodic Monitoring.** Periodic monitoring consists of frequent checks of the unit area or ship for the arrival or presence of radiation. It assures the commanding officer that the unit area or ship is not contaminated. The direct or indirect technique (paragraph 3) can be used for periodic monitoring, and only one radiac meter is required. Periodic monitoring warns the unit if contamination arrives, and it is initiated—

- After the first use of a nuclear weapon in theater.
- When a unit is out of contact with higher headquarters.
- When ordered by higher headquarters.
- When continuous monitoring is terminated.
- At least once each hour to record readings. SOPs and ship bills dictate the frequency of readings and provide detailed information on monitoring procedures.

b. **Continuous Monitoring.** Continuous monitoring involves checking for radiation in the unit area. The indirect technique (paragraph 3b) is normally used. Continuous monitoring is initiated or required—

- When a nuclear detonation is observed, heard, or reported in the AO.
- When a nuclear report is received and the unit is in the predicted area of contamination.
- When a dose rate of 1 centigray per hour (cGyph) is recorded during periodic monitoring.
- When ordered by the commander.

NOTE: Periodic monitoring is resumed when the unshielded dose rate falls below 1 cGyph.

3. Monitoring Techniques

There are two types of monitoring techniques—direct and indirect.

a. Direct Monitoring.

(1) Direct monitoring is the simplest, most precise monitoring technique. The radiac meter is used to get an unshielded (outside) dose rate, and the highest reading observed on the radiac meter is recorded. Direct readings are used when conditions and OEG permit. The unshielded dose rate is determined by—

- Standing outside at least 10 meters away from buildings or other large structures or objects that may shield out a portion of the reading.
- Holding the radiac meter at waist level or 1 meter off the ground or deck.
- Rotating your body 360° while standing in one place.

(2) Direct monitoring is used—

- While monitoring for the initial detection or arrival of fallout.
- When in low dose rate areas.
- When determining unshielded (outside) ground dose rates for transmission or correlation factors.
- When verifying the contamination status of a new position.
- While moving through a contaminated area on foot.

b. Indirect Monitoring.

(1) Indirect monitoring is used by a unit to measure radiation levels when dose rates are high enough to be read inside a shielded location. It keeps exposure to a minimum because personnel remain inside shelters or vehicles. It is conducted as follows:

- Take dose rate readings inside the shelter or vehicle.
- Take at least one dose rate reading outside the shelter or vehicle to determine the correlation factor.
- Take the inside and outside dose rate readings after fallout and within 3 minutes of each other. To obtain the inside dose rate reading, stand in the center of the shelter, hold the radiac meter at waist level or 1 meter off the ground or deck, and rotate your body 360° while standing in one spot. Record the highest dose rate reading observed.
- Obtain both readings before determining the correlation factor.

(2) If the vehicle does not have a designated location for the survey meter, the monitor (positioned in the assistant driver's seat) should hold it in a vertical position. He should take the readings with the survey meter consistently located in the selected position.

(3) If the radiac meter is installed in a vehicle or a building, the user verifies that the correct attenuation factor was entered. If the correct attenuation factor was set, he reads the outside dosage directly off the instrument. If the attenuation factor was not set properly, he corrects the setting and retakes the reading.

4. Correlation Factors

Correlation factors are required to convert inside dose rate readings to outside dose rate readings. They are calculated using the following formula:

$$CF = \frac{OD}{ID}$$

where—

CF = Correlation factor

OD = Outside dose rate

ID = Inside dose rate

NOTE: Correlation factors are always greater than 1.00 and are rounded to the nearest hundredth.

a. Vehicle Correlation Factor.

(1) Data for the vehicle correlation factor is provided by the survey party, and it consists of a set of two readings taken at the same location. One reading is taken inside the vehicle or bay with the instrument correctly located. All subsequent inside readings must be taken with the survey meter in this same position. The other reading is taken immediately as a normal monitoring reading, at the same location, with the vehicle moved at least 10 meters away.

(2) One or two additional sets should be taken at different locations so that the NBC defense team can use an average vehicle correlation factor. Sites selected for vehicle correlation factor data should have foliage and surface conditions similar to the contaminated area. New correlation factor data must be obtained if ground surface conditions change or if there is a change in the survey meter or vehicle.

b. Air-Ground Correlation Factor. The air-ground correlation factor is the ratio of an outside ground reading to an inside air reading taken at the height of the survey. The air reading is taken directly above the ground reading. An air-ground correlation factor must be obtained for the survey information to be useful. The survey team must obtain new air-ground correlation factor data—

- When beginning each 2-, 3-, or 4-course leg.
- When changing the survey height.
- When a change in ground foliage occurs.
- When changing the aircraft.
- When changing the survey instrument or the batteries in the survey instrument.
- When a change in the average surface condition occurs.

5. Recording

The control center relies on monitoring reports to construct and update contamination overlays. These overlays are used by the entire command. The following forms are used to record monitoring data.

- Point technique form.
 - The form should contain self-explanatory block headings.
 - Any heading not applicable to the situation should be lined through.
 - Space should be allocated for the monitor to enter the correlation factor data.
 - The monitor does not calculate the correlation factor; it is done by the unit NBC defense team.
 - The remarks section should be used to provide any additional information of value to the NBC defense team.
 - The NBC defense team uses the remarks section to show the calculation of the correlation factor, normalizing factor calculations, the time of burst, and any additional information of value.
- Course leg technique form.
 - The form should contain self-explanatory block headings.
 - Any heading not applicable to the situation should be lined through.
 - Space should be allocated for the monitor to enter the correlation factor data.
 - The monitor does not calculate the correlation factor; it is done by the unit NBC defense team.
 - The NBC defense team uses the remarks section to show the calculation of the correlation factor, normalizing factor calculations, the time of burst, and any additional information of value.

6. Radiological Surveys

Radiological surveys are used to find the extent and intensity of radiological contamination. They require time and coordination, and team members and equipment must be diverted from primary missions. Because of these circumstances, surveys are conducted only when directed and when the intensity of contamination must be known. The NBC control center initiates all radiological surveys to ensure that the right amount of data is obtained at the right time. The survey team consists of a monitor and the necessary support and security personnel. The control center briefs the survey teams and controls their movements. The two types of radiological surveys are aerial and ground.

- a. Aerial Survey.
 - (1) Advantages.
 - A large area can be surveyed quickly.

- Personnel are exposed to a low dosage because of the distance the aircraft flies above the ground.
- Less equipment and personnel are required. A helicopter and a survey team can cover more terrain than 10 trucks with ground survey teams.
- Inaccessible areas can be surveyed.

(2) Techniques.

- **Point.** The point technique is used to determine ground dose rates at points of operational concern. The aircraft flies to and lands at specified points.
- **Course leg.** The pilot flies a straight line between two checkpoints; for example, from Point A (top of a hill) to Point B (top of another hill). The aircraft only lands to obtain the air-ground correlation factor data.
- **Route.** The pilot flies between two checkpoints, following the route of a predominant terrain feature (such as a road, riverbank, or railroad track) that connects the two checkpoints. The aircraft only lands to get the air-ground correlation factor data needed by the control center.

(3) Procedures. The control center team briefs the pilot and the survey team. All information concerning the mission (such as survey height, ground speed, routes, course legs, checkpoints) comes from the control center team. The TL and the instrument operator sit beside each other to aid in communications. The TL should be able to speak with the pilot. The following procedures are used:

(a) Point. The aircraft must land near the point of interest. The monitor dismounts, proceeds to the selected point, and takes the reading by using normal ground monitoring procedures. When high dose rates do not permit this procedure, aerial dose rates are taken using an air-ground correlation factor.

(b) Course Leg.

- The pilot maintains (as near as possible) a constant height aboveground, a constant ground speed, and a straight flight direction between the start and end checkpoints of each course leg.
- The pilot flies the aircraft on the proper course, over the start checkpoint, and on a straight path to the end checkpoint. Shortly before reaching the start checkpoint, he alerts the monitor and gives him the height aboveground.
- The monitor records the time and height aboveground. He rechecks and zeros the radiac meter before each course leg to assure proper operation.
- The pilot gives the mark command when the aircraft is directly over the start checkpoint.

- The monitor reads the survey meter, records the dose rate, and begins timing preselected time intervals.
- The monitor reads the survey meter and records the dose rate at each preselected time interval; for example, every 10 seconds.
- The pilot alerts the monitor again when the aircraft approaches the end checkpoint. He gives the mark command when the aircraft is directly over the end checkpoint.
- The monitor reads and records the final dose rate.

(c) Route. The procedures are identical to those for a course leg survey; however, a straight flight direction may or may not be required.

b. Ground Survey.

(1) Advantages.

- A ground survey is independent of weather conditions.
- A ground survey provides more accurate information than an aerial survey.
- An echelon can use regularly assigned personnel and equipment to perform a ground survey within its AOR.

(2) Disadvantages.

- Lacks the speed and flexibility of an aerial survey.
- Results in higher radiation dosages to personnel.
- Places a larger load on communications facilities.
- Diverts more personnel and equipment from the mission.

(3) Techniques.

- **Route.** The team takes dose rate readings inside the vehicle at selected intervals between checkpoints along a route.
- **Point.** The team travels to a point and takes one reading for that location.
- **Preselected dose rate.** The team looks for a given dose rate designated by the control center team. This technique is used for old contamination and neutron-induced radiation. For old contamination that is greater than the time of attack (H)+48, the team drives into an area until it finds 1 cGyph or a designated dose rate. A neutron-induced pattern is circular and decays much slower than fallout.

(4) Procedures. The control center team briefs the driver and the survey team. All information (such as the ground speed, routes or points to be surveyed, checkpoints concerning the mission) comes from the control center team. The TL sits behind the driver and watches the odometer. The monitor sits in a position, usually the front passenger's seat. This must be the same spot where the correlation factor data was taken.

- The driver tells the team when they are at the start point.

- The TL records the time and identifies the mark. If it is a point survey, the monitor can exit the vehicle and take an unshielded reading. If the correlation factor data has already been taken, the monitor can stay in the vehicle.
- The driver starts driving the route. The TL watches the odometer and gives the mark command at preset distance intervals; for example, every 0.3 mile.
- The monitor records the last reading and the TL records the ending time when the vehicle arrives at the end checkpoint.

NOTE: The survey data (*Figures I-1 and I-2, pages I-8 and I-9*) is delivered to the control center after the survey team is monitored for radiological contamination.

c. Equipment. The following equipment is required for radiological surveying:

- A radiac meter to measure dose rates.
- An individual radiation exposure meter for radiation exposure control.
- Forms for recording information collected during the survey. Local reproduction of survey forms should be authorized.
- A watch to determine the time when survey readings are taken. An aerial survey requires a stopwatch or a watch with a second hand.
- A vehicle with high radiation-shielding characteristics.
- Communications equipment for rapid reporting.
- Maps of the land to be surveyed.

d. Turn-Back Dose and Turn-Back Dose Rate. The control center team provides the TL with the turn-back dose and the turn-back dose rate.

(1) Turn-Back Dose. This is the maximum total dosage that the team is allowed. The TL monitors the total dosage for all personnel on the mission. When the turn-back dose is acquired, the team turns around, uses the same route, and returns to its unit for monitoring and, if necessary, decontamination.

(2) Turn-Back Dose Rate. This is the maximum dose rate that the team is allowed. The TL keeps track of the dose rate and brings his team back if the turn-back dose rate is detected. An area survey meter is used to detect the radiation level.

RADIOLOGICAL DATA SHEET MONITORING OR POINT TECHNIQUE				Date	Page No.	No. of Pages			
				10 January 2005	1	1			
Survey Party or Monitoring Unit Designation				Monitor (Print Name)					
Co B, 1-11 Inf				PFC I.M. Observer					
Map Used			Type of Vehicle or Other Shielding		Instrument Type				
Bierhofen 1:50,000			Foxhole		IM-174B/PD				
Reading No.	Location	Time	Dose Rate (cGyph)	Reading No.	Location	Time	Dose Rate (cGyph)		
1	AY123456	0600	0	16	AY123456	0945	7		
2	AY123456	0615	0	17	AY123456	1000	7		
3	AY123456	0630	0	18	AY123456	1015	7		
4	AY123456	0645	1	19	AY123456	1030	8		
5	AY123456	0700	0	20	AY123456	1045	8		
6	AY123456	0715	0	21	AY123456	1100	8		
7	AY123456	0730	0	22	AY123456	1115	8		
8	AY123456	0745	1	23	AY123456	1130	9		
9	AY123456	0800	1	24	AY123456	1145	9		
10	AY123456	0815	1	25	AY123456	1200	8		
11	AY123456	0830	2	26	AY123456	1215	8		
12	AY123456	0845	2	27	AY123456	1230	7		
13	AY123456	0900	3	28	AY123456	1245	7		
14	AY123456	0915	5	29	AY123456	1300	6		
15	AY123456	0930	7	30	AY123456	1315	6		
Remarks									
TOB 0555				$\frac{180}{9}$					
CF = 20									
Correlation Factor Data									
Location	Reading No.	Dose Rate (cGyph)		CF	Location	Reading No.	Dose Rate (cGyph)		CF
		Inside	Outside				Inside	Outside	
AY123456	24	9	180	20					

Figure I-1. Sample Survey Data (Monitoring or Point Technique)

RADIOLOGICAL DATA SHEET ROUTE OR COURSE LEG TECHNIQUE (Ground and Aerial Survey)					Date	Page No.	No. of Pages								
					20 July 2005	1	1								
Survey Party Designation				Monitor (Print Name)											
B-2-9				PFC Fares											
Map Used			Aircraft or Vehicle Type		Instrument Type										
Bierhofen 1:50,000			UH-60		AN/VDR-2										
Route or Course Leg Designation				CK-CE	CE-CB	CB-CD									
Time at Start of Leg or Route				0950Z	0955Z	1005Z									
Time Route Completed (Ground) or Survey Height (Air)				200 ft	200 ft	200 ft									
Distance or Time Interval Used				10 sec	10 sec	10 sec									
Remarks Time of Burst: 200730Z N = 1.2 CA-CE AGCF = 3.800 NF = 2.767 OCF = 10.515 CE-CB AGCF = 3.800 NF = 2.884 OCF = 10.559 CB-CD AGCF = 3.800 NF = 3.123 OCF = 11.867 Start and stop times are reported for each route or portion of a route completed at one time by the ground survey. If a route is done in pieces, use a separate column for each piece.					Reading No.	Dose Rate (cGyph)	Reading No.	Dose Rate (cGyph)	Reading No.	Dose Rate (cGyph)					
					1		1		1						
					2		2		2						
					3		3		3						
					4		4		4						
					5		5		5						
					6		6		6						
					7		7		7						
					8		8		8						
					9		9		9						
					10		10		10						
					11		11		11						
					12		12		12						
					Air-Ground or Vehicle Correlation Factor Data					13		13		13	
										14		14		14	
					Location	Height (Air Only)	Dose Rate (cGyph)		CF	15		15		15	
							Inside	Outside		16		16		16	
							17			17		17			
					BF	200 ft	5	18	3.8	18		18		18	
										19		19		19	
					20		20		20						

Figure I-2. Sample Survey Data (Route or Course Leg Technique)

e. Control Center Decisions. The following actions must be taken by the control center team before operations can begin:

- **Sequence.** Survey the areas that carry the most essential operational interest first.
- **Monitoring reports.** Check the monitoring reports that have been received first. It is better to use units already in the contaminated areas than to place more personnel at risk.
- **Height aboveground.** Determine if presurvey flights over course legs are needed to ensure clearance for the survey aircraft. Intelligence units or organizations can help by providing information on the area of concern. The optimum height is 200 feet aboveground, and the maximum height is 500 feet aboveground.

NOTE: Flight at these altitudes places the aircraft in an exposed position and should be avoided, especially near known threat activity. Survey altitudes should be as low as possible so that the aircraft is camouflaged with surrounding terrain and vegetation.

f. Correlation Factor Data. The control center team determines where to obtain correlation factor data. The location is based on the direction that the survey will be flown or driven. This goes hand in hand with the sequence. If more than one route or course leg is to be done, the mission is planned so that the pilot or driver can make an easy transition to each subsequent route or course leg. Pilots and, possibly, drivers should participate in this planning. The slower the aircraft air speed and the shorter the time between readings, the more accurate the results will be.

g. Mission Order. Use the five-paragraph OPORD format to brief the monitor and the survey team on their missions as shown in *Figure I-3*.

7. Radiological Monitoring (Search)

Radiological monitoring detects the presence of radiation and measures it with radiac instruments while moving. It is done before the main body of the unit encounters the hazard and is conducted to initially detect or determine the extent of the contamination. Regardless of the radiation source, monitoring concentrates on the location rather than the intensity of the dose rate. Thus, reconnaissance provides information about the size of a contaminated area and little else. Once plotted, reconnaissance data provides the minimum essential information needed to evaluate the impact the contamination will have on current operations, such as—

- The location of and details concerning uncontaminated (clean) areas that can be used to avoid a contaminated area. If total avoidance cannot be accomplished, reconnaissance may determine the route with the lowest dose rate.
- A hazard that might otherwise go undetected.
- The extent or size of a hazard.

a. Attack Indicators. When reconnoitering for a radiological hazard, the team surveys the surroundings for attack indicators, such as—

- Arrival and settling of dust-like particles.

1. SITUATION.
 - a. Operational situation. Briefly describe the operational situation because it concerns the survey. Include enemy forces, friendly forces, and planned actions.
 - b. Contamination situation. Present any factual information available about the contaminated area. Include the limits, dose rate, sources of contamination, terrain, and weather.
2. MISSION. Write a clear, concise statement of the task to be accomplished (who, what, when, where, and why).
3. EXECUTION.
 - a. Concept of operations.
 - b. Specific assignment for each team. In subsequent, separate, lettered subparagraphs (a, b, c), give the specific task for each survey party. Include the coordination elements required.
 - c. Coordinating instructions. In the last subparagraph of paragraph 3, include instructions applicable to two or more survey teams, such as—
 - Time of departure and return.
 - Routes and alternate routes to and from the contaminated area.
 - Coordination required.
 - Dosage danger limitations. If a radiac meter is used to check the turn-back dose or turn-back dose rate, enter the value as the alarm set point and check it before departure.
 - Actions to be taken upon reaching dosage limitations.
 - Marking of contaminated areas if and when it is required.
 - Debriefing information (where, when, and by whom).
 - Decontamination information, if required (when, where, and by whom).
4. ADMINISTRATION AND LOGISTICS. Include information on the required equipment and forms.
5. COMMAND AND SIGNAL.
 - a. Command. Include the location of the defense team.
 - b. Signal. Include the following information:
 - Procedures for reporting data.
 - Special instructions concerning signal operating instructions.
 - Call signs, code to be used, and reporting times.
 - Communications means (primary and alternate).

Figure I-3. Sample Mission Order Format

- Trees blown down.
- Scorching on one side of objects.
- Overturned objects.
- Evidence of treetop fires.
- Dead animals and birds.
- Rain or snow after an airburst occurs.

b. Limitations. Radiation presents a penetrating hazard, and the only complete protection from radiological contamination is completely avoiding the area. When radiological hazards are initially located, there may be no indication that the maximum

dose rate may be found. The process of determining the highest dose rate may be lethal to the team. The commander specifies the turn-back rate for each mission, and it must be low enough to permit additional contamination exposure.

c. Techniques.

(1) The most desirable information is the location of uncontaminated areas. Nuclear reconnaissance is rarely concerned with determining the dose rates inside contaminated areas. The monitoring team conducts radiological reconnaissance using the zigzag, lane, and star patterns shown in *Appendix G*.

(2) The location of the contamination perimeter (area or path) is of principal value and importance. Monitoring teams must be provided with the turn-back dose and the turn-back dose rate. The turn-back dose rate serves as the threshold for contamination. It may be specified in the unit SOP or provided in mission briefings.

(3) When monitoring teams discover contamination, they report its location and may also report dose rates and the time of detection. The NBC 4 nuclear report format can be used to report the data; however, most expeditious reporting requires only a simple statement that contamination is present at a specific location. When the NBC 4 nuclear report format is used, the word *contact* is used in the GENTEXT entry.

(4) Upon detecting contamination, the team records the reading and the time and location of the reading, renders a report to alert the main body or unit, and then withdraws to an uncontaminated area. The team flanks the contamination, repeating the in-and-out process within its assigned area, section, or zone.

d. Marking Areas. Monitoring teams mark the outer boundaries of the contamination unless otherwise directed. In some cases, this may provide information to the enemy about troop movements. Markers are erected only at logical points of entry, facing away from the contamination.

e. Washout.

(1) Washing out radiological fallout particles from the air can vastly effect monitoring operations. If the washout is caused by rain, the resulting contamination will collect in low areas, streams, ponds, and rivers and create hot spots. However, large bodies of water allow heavier fallout particles to settle and provide shielding. If snow causes the washout, the area will initially be evenly blanketed. Heavy snowfall may shield indications and readings of radiation levels, but it will eventually melt and the result will be the same as that caused by rain.

(2) A washout area can be larger or smaller than the fallout area when the same size of attack is employed as a surface burst. There is no satisfactory washout prediction system. Essentially, prediction involves determining when moisture will fall, how much moisture will fall, how large the particles will be, and what the form (rain, sleet, hail, snow) of the moisture will be. Washout can also cause a significant hot spot in an otherwise normal fallout pattern.

Appendix J

UNITED STATES ARMY NUCLEAR, BIOLOGICAL, AND CHEMICAL RECONNAISSANCE UNIT OPERATIONS

1. Background

This appendix addresses NBCRSs and NBC reconnaissance units. It discusses the different types of units and their functions and responsibilities, including unit planning, search, survey, surveillance, sampling, and employment.

2. Equipment

a. NBC reconnaissance supports the defense principle of contamination avoidance. The basic item of equipment used is the M93-series Fox NBCRS. It is being replaced by the Stryker NBCRV as part of the Stryker joint-service, lightweight NBCRS program.

b. NBCRS vehicles (Fox and Stryker) are capable of NBC detection, warning, and sampling. The sensor suites are integrated into high-speed, high-mobility, wheeled or armored vehicles and are capable of performing NBC reconnaissance on primary, secondary, and cross-country routes throughout the battlefield. NBCRS vehicles are not fighting vehicles. They are scarce resources that are vulnerable to damage and destruction from enemy fire, so they must be protected. They are designed to improve reconnaissance operations while on the move and provide a safe environment for the crew by using an overpressure system. NBCRS vehicles (Fox and Stryker)—

- Provide reduced response time and quick detection.
- Allow identification within seconds.
- Pinpoint contamination within minutes.
- Have quick marking capabilities.

c. *Tables J-1 and J-2*, page J-2, list the capabilities and limitations of M93 and M93A1 NBCRSs, respectively. *Table J-3*, page J-3, shows a comparison of the NBCRS and the NBCRV.

Table J-1. M93 Capabilities and Limitations

Capabilities	Limitations
Conducts NBC reconnaissance on the move.	The vehicle is not readily recognizable as friendly.
Conducts NBC reconnaissance without personnel exiting the vehicle.	The system requires specialized maintenance support.
Has an overpressure system that allows the crew to operate in an NBC-contaminated environment without masking.	The MM1 spectrometer requires 15 to 20 minutes for initial preparation before operation.
Detects and identifies 60 chemical agents.	The vehicle is not heavily armored.
Provides location data to better delineate contamination.	The MM1 cannot operate continuously.
Swims readily with little preparation.	The MM1 is not an effective chemical vapor detector.
Is air-conditioned to enhance crew working conditions and keep electronic equipment from overheating.	The system does not have standoff CB detection capability.
Allows contamination to be marked without exposing the crew.	The cooling system is undersized for some high-workload activities.
Stores data on unknown, suspected chemical agents.	The system is non-mission-capable without an operating air conditioner.
Keeps up with maneuver forces.	The system does not have biological detection or identification capability.
Has a built-in vehicle orientation system for navigation.	
Is mobile to allow large-area coverage.	
Has self-recovery capability.	
Retrieves and retains samples.	

Table J-2. M93A1 Capabilities and Limitations

Capabilities	Limitations
Conducts NBC reconnaissance and survey on the move.	The vehicle is not readily recognizable as friendly.
Conducts NBC reconnaissance without personnel exiting the vehicle.	The system requires specialized maintenance support.
Has an overpressure system that allows the crew to operate in an NBC-contaminated environment without masking.	The MM1 spectrometer requires 15 to 20 minutes for initial preparation before operation.
Detects and identifies 60 chemical agents.	The vehicle is not heavily armored.
Provides location data to better delineate contamination using the onboard navigation system, Force XXI battle command brigade and below, and enhanced position locating and reporting system.	The M21 remote-sensing, chemical-agent alarm cannot conduct standoff chemical surveillance on the move.
Swims readily with little preparation.	The MM1 cannot operate continuously.
Is air-conditioned to enhance crew working conditions and keep electronic equipment from overheating.	The MM1 is not an effective chemical vapor detector.
Allows contamination to be marked without exposing the crew.	The cooling system is undersized for some high-workload activities.
Stores data on unknown, suspected chemical agents.	The system does not have biological detection or identification capability.

Table J-2. M93A1 Capabilities and Limitations (Continued)

Capabilities	Limitations
Keeps up with maneuver forces.	The system will continue to operate without an operating air conditioner; however, the crew will not be able to continue for extended periods.
Has a built-in vehicle orientation system for navigation.	
Is mobile to allow large-area coverage.	
Has self-recovery capability.	
Has digital communications capability.	
Has standoff detection capability (M21).	
Has an automated, double-wheel system.	
Has computer integration of a detection suite that allows operation by a smaller crew (reduced from 4 to 3).	
Has a metrological sensor.	
Has a ground temperature sensor.	
Has an improved marking system.	
Has an improved overpressure system.	
Retrieves and retains samples.	

Table J-3. Comparison of the NBCRS and the NBCRV

		NBCRS	NBCRV
Capabilities	Armor	7.62-mm armor plate	14.5-mm armor plate
	Weapon	M240 machine gun (7.62-mm) on cupola	M2 machine gun (.50 caliber), remotely operated
Sensors	Liquid chemical agent	MMI	CB mass spectrometer II with improved interference rejection
	Stationary standoff chemical vapor	M21 (60° field of view)	Joint-service, lightweight, standoff chemical-agent detector (360° scan capability)
	Mobile standoff chemical vapor	None	Joint-service, lightweight, standoff chemical-agent detector (360° scan capability)
	Chemical vapor confirmation	None	Yes
	Biological detection/aerosol	None	Yes

3. Functions and Responsibilities

The NBC reconnaissance platoon performs five critical tasks—detect, identify, mark, report, and sample. Timely, accurate detection and warning are critical for battlefield success. The key people performing these tasks are the platoon leader, platoon sergeant, squad leader, vehicle commander, and vehicle crew.

- a. **Platoon Leader.** The platoon leader is responsible for platoon discipline and training and equipment maintenance. He obtains NBC intelligence for the supported

unit commander to support successful tactical operations. He also serves as a vehicle commander. The platoon leader assists the supported unit battle staff in preparing plans and missions for his platoon. He acts as the SME on the capabilities and limitations of the NBC reconnaissance platoon. This prevents his platoon from being tasked with missions that it does not have the equipment or training to perform.

b. Platoon Sergeant. The platoon sergeant is second in command and is responsible to the platoon leader for maintenance, logistics, and discipline. He ensures that training is conducted according to the platoon leader's guidance. He also serves as a vehicle commander.

c. Squad Leader. The squad leader has overall responsibility for the squad. While conducting NBC reconnaissance operations, he directs and controls the movement of the squad. He selects vehicle positions during movements, sets vehicles into position during occupations, and determines routes of movement. The squad leader communicates with the platoon leader and executes his commands. He supervises the preparation of the squad to conduct operations and is responsible for training the vehicle commanders in his squad.

d. Vehicle Commander. The vehicle commander is responsible for crew discipline and training, equipment maintenance, logistical monitoring and reporting, and tactical employment of his vehicle. He briefs the crew, controls vehicle movement, submits crew reports to the squad leader, and supervises the initial first aid and evacuation of wounded crew members. He is responsible for planning and conducting NBC reconnaissance missions when operating as a reconnaissance team. He is also responsible for controlling all onboard weapon systems.

e. Vehicle Crew. The vehicle crew consists of the following members:

- **M93.** A vehicle commander, a driver, and two surveyors (one is the MM1 operator).
- **M93A1.** A vehicle commander, a driver, and one surveyor (MM1 operator).

4. Types of Reconnaissance Units

NOTE: See Appendix F for information on NBC reconnaissance unit organization and capabilities.

a. NBCRS- and NBCRV-Equipped Units.

(1) There are several types of NBCRS- and NBCRV-equipped units. For example—

- The heavy division chemical company (currently in transition to division cavalry squadron) NBC reconnaissance platoon has six M93A1s.
- The corps NBC reconnaissance company platoon has eight M93A1s.
- The NBC reconnaissance platoon (ACR) (heavy) has six M93A1s.
- The NBC reconnaissance platoon (ACR) (light) has four M93A1s.
- The most recent NBC unit organization is the Stryker brigade combat team NBC reconnaissance platoon. It is located within the

reconnaissance, surveillance, and target acquisition (RSTA) squadron and has three M93A1s. (This is an in-lieu-of system until the Stryker NBCRV is fielded.)

(2) Although there are various types of NBC reconnaissance platoons, the basic building block or the most optimal employment method of NBC reconnaissance organizations is the squad configuration (two M93A1s), where the vehicles operate as a pair. All platoon variations generally follow the same doctrinal employment concept. The units conduct route, zone, and area NBC reconnaissance to determine the presence and extent of NBC contamination using the NBC reconnaissance techniques of search, survey, and surveillance. However, due to the new operating environment, flexibility and creativity are essential for the employment of NBC reconnaissance assets where a templated NBC threat is not as clearly defined (see *Chapter II*). In these instances, METT-TC drives the employment method and operating as a pair may not always be the preferred method for NBC reconnaissance missions.

(3) An NBCRS-equipped unit can be employed to operate as a pure element or decentralized, depending on METT-TC factors, to respond to asymmetrical threats over a large operating environment. The NBC reconnaissance platoon normally operates as one of three configurations—team, squad, or platoon—and supported units must be familiar with NBC reconnaissance unit capabilities. The task organization facilitates NBC ISR throughout the depth and width of the battlespace. This broadened ISR requirement is achievable by planning and conducting a comprehensive vulnerability and mission analysis and a coordinated IPB. Other potential NBC reconnaissance missions include environmental or industrial hazard surveillance and overwatching key fixed sites, such as airfields or ports. Regardless of the mission, NBCRSs and vehicles require a security element or wing man to provide conventional threat overwatch.

(a) Team. The team configuration is used when one NBCRS or vehicle operates by itself, without the support of another NBCRS or vehicle. For most NBC reconnaissance organizations, this is not the optimal employment method, but it is the normal configuration for the Stryker NBC reconnaissance platoon in the RSTA squadron. In the RSTA squadron, one NBCRS or vehicle is generally paired with a security element or wing man from the reconnaissance troop. This allows maximum coverage for NBC ISR missions in a 50- by 50-kilometer area that the Stryker brigade combat team may have to cover.

(b) Squad. The squad configuration is preferred for most NBC reconnaissance units. A squad consists of two NBCRSs or vehicles and is the most optimal organization under most conditions, including large-area reconnaissance, extended route reconnaissance, deliberate attacks, and defensive operations. NBC reconnaissance squads rely on a security element that can be provided by the supported unit. This configuration allows two NBCRSs or vehicles to complement each other with their sensors and maximize contamination avoidance and detect-to-warn principles. When operating as a pair, the squad can quickly find bypass routes around contamination to avoid the loss of maneuver force momentum or it can locate an uncontaminated route. The third NBCRS or vehicle can perform NBC surveillance operations oriented on NAIs developed during the process as an integral part of the overall intelligence collection effort, or it can provide overwatch on key fixed sites.

(c) Platoon. In the platoon configuration, all vehicles operate together in unison, no matter how many vehicles are in a platoon. For instance, the corps NBC

platoons and the heavy division chemical company NBC reconnaissance platoons could operate together. These types of combined missions may be necessary for large SPODs or APODs or in strategically located key areas where numerous vehicles are required. For the Stryker brigade combat team reconnaissance platoon, this means that the three vehicles are operating in unison. The platoon configuration is rarely formed in the Stryker brigade combat team because it provides little flexibility to the commander. However, it may be necessary for all types of platoons when large contaminated areas or locations require extensive marking or surveillance.

(4) NBCRS- or NBCRV-equipped units possess NBC collective protection; however, that capability is negated in an oxygen-deficient environment. Additionally, the use of NBC reconnaissance assets are prioritized because the size of the AO may present a challenge for the unit to provide full coverage. Any determined effort by an adversary to employ NBC capabilities requires that the NBC staff and reconnaissance units receive augmentation. Security for NBC reconnaissance assets is always a concern, and proper coordination and planning must occur to prevent fratricide.

b. Wheeled or Armored Vehicle-Equipped Reconnaissance Units. Some NBC reconnaissance units have been issued wheeled or armored vehicles (such as HMMWVs or armored personnel carriers [APCs]) pending the receipt of NBCRSs or vehicles. When using a wheeled or armored vehicle as a prime mover and as standard detection, identification, and sampling equipment, the following procedures may be used:

- The TL provides and orients the organic weapon on the sector of fire. He visually inspects the area for signs of contamination.
- The NBC specialist opens the door of the vehicle wide enough to take a reading with the NBC detection and identification equipment or to collect a suspect sample of CB contamination. He attaches M8 detector paper to a long handle or stake, reaches it out the door of the vehicle or over the side of the HMMWV, and touches the ground or vegetation.
- The TL may conduct periodic checks from an armored vehicle hatch position, using an M256A1 chemical detector kit. He places the expended tickets in a waterproof bag after writing the checkpoint number on the paper tab.
- The NBC specialist inspects the M8 detector paper for signs of contamination and informs the TL of the results. He seals positive M8 detector paper in a plastic bag and labels the bag with the date-time group (DTG), location (grid) where the sample was taken, and possible type of contamination. He places the sample bag inside a large, waterproof bag that holds all the samples collected during the mission.
- The NBC specialist places a CAM outside the door, approximately 1 meter aboveground, and checks for contamination. If contamination vapors are detected and there is no doubt as to the validity of the results, he uses an M256A1 chemical detector kit to verify the results and he bags all expended tickets.

NOTE: If a positive reading for chemical contamination is obtained, move back 100 to 200 meters from the position where the initial positive reading was detected and repeat the procedure until a negative reading is obtained.

- The NBC specialist exits the vehicle, if necessary, to check the area around the vehicle for contamination using M8 detector paper and the CAM or improved CAM.
- The NBC specialist collects samples of small dead animals, discolored leaves, soils, etc. as stated in the OPORD or orders from higher headquarters. He reports all findings to the TL, and the TL or driver records all findings on the appropriate forms.

5. Planning

NBC reconnaissance planning is critical, and there is seldom enough time to plan for every possible situation. There are, however, essential elements (such as the commander's intent and a complete mission statement) that must be included in all NBC reconnaissance plans. These elements provide a level of detail required to ensure total integration and utilization of NBC reconnaissance assets. The commander's intent for the mission must be clearly identified. The intent is what the commander wants the mission to accomplish when completed—a clear concise statement of who, what, when, where, and why NBC reconnaissance is needed to support the operation.

a. Initial Planning and Coordination.

(1) Plan and prepare for reconnaissance using troop-leading procedures and the situation estimate. Identify required actions to be performed at the objective, and then plan backward to the departure from friendly lines and forward to the reentry of friendly lines. The platoon or squad leader normally receives the OPORD in the supported unit tactical operations center (TOC), where communications are good and key personnel are available for questions and coordination. Mission coordination must be thorough and detailed since NBC reconnaissance platoons and squads act semi-independently, temporarily move beyond direct-fire support of the supported unit, and occasionally operate forward of friendly units.

(2) The platoon or squad leader normally coordinates directly with the supported unit staff. The NBC reconnaissance unit leader must continuously coordinate with the support unit staff throughout the planning and preparation phases. NBC reconnaissance leaders must coordinate directly with the unit conducting forward and rearward passage of lines and with other units operating in the AO and adjacent areas. Items to coordinate with the supported unit include—

- Changes and updates in the enemy and friendly situations.
- The best use of terrain for routes, rally points, and forward reconnaissance bases.
- Light and weather data.
- The security of the NBC reconnaissance element.
- The use and location of LZs.
- The departure and reentry of friendly lines.
- Fire support on the objective and along the planned routes, including alternate routes.
- Rehearsal areas and times.

- Special equipment requirements.
 - HSS, including medical evacuation.
 - Logistics support.
 - Signal plan call signs, frequencies, code words, pyrotechnics, challenges, and passwords.
 - Identification to reduce the incidence of fratricide.
- b. Plan Completion. Consider the following:
- **Essential and supporting tasks.** Ensure the assignment of all essential tasks to be performed on the objective, at danger areas, at security or surveillance locations, along routes, and during the passage of lines.
 - **Key travel and execution times.** Estimate the time requirements for moving to the objective, reconnoitering the objective, establishing security and surveillance, completing assigned tasks while on the objective, moving to and through friendly lines, and conducting operational debriefings.
 - **Primary and alternate routes.** Select primary and alternate routes to and from the objective.
 - **Signals.** Consider using special signals, including approved hand-and-arm signals, flares, voice, whistles, radios, and infrared equipment.
- c. Planning Components. Consider the following:
- **Missions.** Examine the mission. Ensure that plans cover ways to enhance the survivability and mobility of friendly forces, assist in the regeneration of combat power, and identify forward combat and rear areas.
 - **Available resources.** Ensure that plans identify—
 - „ Organic NBC unit assets.
 - „ Resources available from higher headquarters.
 - „ Materials and equipment available from the HN.
 - **Coordination.** Coordinate NBC unit planning with all staff elements, especially operations and logistics sections. The enemy NBC threat is critical and requires close coordination with the intelligence section. The employment of NBC reconnaissance elements should not duplicate the efforts of conventional reconnaissance assets. Careful deployment and coordination with adjacent and supported units and fire support elements will enhance chemical unit survivability. Friendly units must know the location and intent of all chemical units to avoid fratricide, and chemical unit operations must be logistically supportable.
 - **Simplicity.** Exclude unnecessary elements, and reduce essential elements to the simplest form.
 - **Organizational relationships.** Clearly define command and support relationships, and fix responsibilities.

- **Continuity.** Designate an alternate headquarters to assume responsibility when the primary headquarters is out of action.
- **Versatility.** Ensure that NBC units are able to react to unexpected situations.
- **Effective control.** Realize that NBC units will operate away from their parent units. Electronic and NBC warfare, along with the sheer size of the battlefield, will make communications difficult. Ensure that the plan establishes a C2 system and provides specific measures to adopt in the absence of direct communications links or control.
- **Decentralized execution.** Delegate authorities, yet keep necessary control.
- **Habitual relationships.** Be aware that it is beneficial to have the same chemical unit always supporting the same unit.

d. **Integrated NBC Reconnaissance Unit Reporting.** Integrated, automated capabilities can be used to report NBC information. The multipurpose, integrated chemical-agent detector—

- Automates the NBC warning and reporting system process throughout the battlespace.
- Automates the gathering of contamination data.
- Automatically formats and transmits reports.
- Sounds an alarm.
- Interfaces with the M43A1 chemical alarm, automatic chemical-agent detector and alarm, AN/VDR-2 radiac set, and other existing and developmental detectors.
- Interfaces, as required, with other vehicle subsystems, such as the GPS and M42 chemical alarm.
- Automatically formats and transmits NBC reports (chemical and nuclear) upon detection.
- Transmits audible “Gas, Gas, Gas” or “Fallout, Fallout, Fallout” warnings over the communications net upon chemical or nuclear detection. However, in order to receive this audible warning, the receiving system must be equipped with specific hardware.

6. Search and Survey

NOTE: The procedures outlined below are specific to the M93-series NBCRS.

a. Vehicle commanders must train their crews to follow certain procedures when conducting NBC search and survey techniques for NBC hazards, regardless of the MM1 mobile mass spectrometer method (*Table J-4*) used by the detection suite operator.

Table J-4. MM1 Methods

Number	Name	Description
1	Test/110	Confidence check/calibration
2	CW agent wheel/180	Search and survey
3	CW agent surface/120	Verification of alarm
4	CW agent air/180	Vapor detection only
5	N simulat wheel/180	Search and survey
6	N simulat surface/120	Verification of alarm
7	N simulat air/180	Vapor detection only

(1) The NBCRS operates in the air-high mode during movement from the assembly area to the start point. At the start point, the double-wheel sampling system operates and the MM1 is in the wheel-high position.

(2) For multiple missions, the lateral intervals between NBC reconnaissance teams are approximately 100 meters, based on METT-TC. If the MM1 operator detects a trace level reading of contamination, he notifies the vehicle commander. The vehicle commander directs the driver to stop the NBCRS, and he notifies the vehicle commander of the other team(s) that contamination is present. Next, the NBC reconnaissance team continues the process to identify the type and extent of the contamination. The other team(s) executes a search and survey pattern appropriate to the stated NBC reconnaissance mission and the situation. While the team is conducting a search and survey, the vehicle commanders of all NBCRS vehicles turn control of the vehicles over to their respective MM1 operators.

(3) For single NBCRS missions, the NBCRS team warns the supported force, backs out of the contamination, drops a marker, and executes a search and survey pattern appropriate to the stated NBC reconnaissance mission and situation. The team then continues with the supported unit or goes back to the perimeter to mark the contamination.

b. The following procedures provide a standardized method for NBCRS teams to verify detection results. The use of these procedures may vary based on METT-TC (e.g., initial or follow-up detection, available time, enemy situation).

(1) The MM1 operator performs the following steps:

Step 1. Change to method 3, and wait until the sampler line temperature drops to 120°C.

Step 2. Direct the surveyor to lower the probe to within 10, 5, and 1 centimeter of the ground and hold it at each depth until the temperature has dropped to 110°C.

Step 3. Watch the monitor until the maximum ion intensity (higher than 4) is displayed.

Step 4. Press the SPECTRUM/AMOUNT VS. TIME button, and direct the surveyor to put the probe back in its monitoring position.

Step 5. Press the PRINT button. The ion fragments will be printed by mass and weight.

Step 6. Assign the substance an extra substance number (61 to 68).

Step 7. Go to the LOGBOOK screen, move the cursor to the substance number, and enter the extra substance number (61 to 68).

Step 8. Change the monitor code to 1, and then go back to the LOGBOOK screen.

Step 9. Check the monitor list for the extra substance number (61 to 68), and press the AIR MONITOR button.

Step 10. Lower the probe to the surface, and hold it for 4 or 5 seconds to verify the extra substance against the original substance. Press the PRINT button when the extra substance and the agent detected appear together on the screen.

Step 11. Delete the item (extra substance or agent) that has the lowest reading. If the agent is unknown, leave the extra substance on the monitor list.

(2) The vehicle commander—

- Inserts the information into an NBC 4 report and transmits it to higher headquarters.
- Directs the driver to make a 180° turn and proceed 200 meters or until the MM1 shows normal readings.
- Directs the surveyor to drop a contamination marker at least 200 meters from the edge of the contamination.

(3) The MM1 operator records the marker and location number in the logbook. He also records the number of samples taken, if any.

(4) The search and identification team rejoins the other team to continue the mission.

c. There are seven search and survey patterns—zigzag, box, star, cloverleaf, lane, nearside/farside, and bounce-and-bypass (*Table J-5*, page J-12). As a general rule, the zigzag, lane, star, and bounce-and-bypass patterns are used with the search technique and the box, cloverleaf, and nearside/farside patterns are used with the survey technique.

(1) Contamination markers are positioned to mark the limits of a contaminated area (perimeter marking) or to mark a bypass route (bypass marking).

Table J-5. Search and Survey Patterns

Mission	Formation	Survey Pattern	Search Pattern
Route	Staggered column	Nearside/farside Cloverleaf Box	Bounce-and-bypass Lane Zigzag
Area	Line	Cloverleaf Box Nearside/farside	Lane Star
Zone	Line Wedge	Cloverleaf Box Nearside/farside	Bounce-and-bypass Lane Star
Point	Line	Cloverleaf Box Nearside/farside	Bounce-and-bypass Lane Star

Ensure that the markers are within LOS of each other. After the markers are dropped, periodically report their locations to higher headquarters via an NBC 4 report.

(2) NBC reconnaissance markers are not easily seen by heavy forces conducting rapid movements, so unit SOPs should prescribe far NBC warning marker procedures. VS17 recognition panels are excellent far NBC warning markers. Locally fabricated far NBC warning markers should be emplaced by unit scouts, engineers, or military police—not NBC reconnaissance teams. NBC reconnaissance teams are more likely to be contaminated and should not break the seal of their overpressure system to emplace far NBC warning markers. Far NBC warning markers are emplaced 100 to 200 meters back from the NBCRS markers and positioned to facilitate bypass by rapidly moving forces. Traffic control around contaminated areas can be enhanced by establishing traffic control points manned by unit personnel.

7. Surveillance

The M21 remote-sensing, chemical-agent alarm supports the avoidance of contamination by conducting standoff detection of chemical clouds. (See the unit staff chemical officer for range detection distances.) It can be used to augment point detectors, such as the M8- and M22-series alarms. There are two methods of employment—dismounted and mounted.

- **Dismounted.** In supporting defensive operations, the M21 can be dismounted on a tripod and powered by connecting a 65-foot cable to the vehicle slave receptacle. A pair of M21s should be employed so that their fields of view (FOVs) interlock with each other.
- **Mounted.** In supporting offensive operations, the detector is mounted on an NBCRS and used to provide forward-area surveillance. The NBCRS vehicle can bound from one surveillance location to another to help maneuver elements avoid chemical clouds and give the reconnaissance element an idea of where to look for ground contamination. When moving with a combat element, the NBCRS squad leapfrogs forward. One team should never be more than 3

kilometers forward of the other team. A pair of M21s should be employed so that their FOVs interlock with each other.

a. **Point Surveillance.** Point surveillance ensures that time-sensitive critical operations can be conducted without unwarned encounters with chemical clouds. It can be performed mounted or dismounted. Point surveillance missions are short in duration (usually less than 2 hours) and are usually oriented on key terrain features (chokepoints, bridges, barriers, road intersections).

b. **Area Surveillance.** Area surveillance provides greater detection capability in large areas and is used by an NBCRS squad, section, or platoon. Area surveillance can be performed mounted or dismounted. It requires detailed planning and can be oriented on the wind. The following are some examples of area surveillance:

- Scan AAs.
- Reconnoiter forward logistics areas.
- Provide hasty detection during halts and silent watches.
- Confirm or deny NBC reports from other sources.
- Keep a previously cleared area under surveillance until it is used to ensure that no chemical employment has occurred.
- Provide vapor detection in support of movement operations.

c. **Mission Planning.**

(1) To ensure success, an M21 mission must be planned to match the mission it is supporting. The commander's concept of the operation is the key to how the M21 can best support the mission. At the operator level, guidance is provided for employment on sites that require surveillance. It is the vehicle commander's responsibility to ensure that the M21 is employed to support the concept of the operation.

(2) A reconnaissance of potential sites is required to ensure that the required coverage can be provided. This may be a map reconnaissance or, in some cases, a physical reconnaissance. An overlay of the plan is probably going to be provided. Using a map, conduct a hasty map reconnaissance of the specified surveillance sites and assess their FOVs using the M21 template.

(a) **Map Reconnaissance.** This is the easiest method to use, but it is also the least accurate. Obtaining aerial photographs can help with the accuracy. A map reconnaissance is usually conducted to tentatively select employment sites. If adequate time is available, request an LOS analysis from the intelligence section or a summary of the NAIs from the supporting engineer unit or section. The intelligence section sometimes has tools that allow stereoscopic analysis of the terrain. If necessary, use the following techniques to conduct an unassisted map reconnaissance:

- Select a map with the highest possible resolution.
- Use an M21 template.
 - Select the scale.
 - Mark the site location.
 - Draw a line 5,000 meters long on the center, individual FOV.

- „ Draw seven vectors at 10°.
 - „ Number the vectors from left to right (1 through 7).
 - „ Intersect the vectors at 500-meter intervals.
 - „ Label the template.
- Locate potential employment sites.
- (Dismounted Only) Construct a range card when the M21 is in position.
 - „ Mark the grid reference lines.
 - „ Mark the site location with a “+.”
 - „ Draw seven vectors out to their maximum individual LOS.
 - „ Draw a small, perpendicular line at the end of each vector.
 - „ Label each vector line from left to right (1 through 7).
 - „ Record the distance along the side of each vector.
 - „ Record the marginal data (scale, M21 location, reference, and preparer).

(b) Physical Reconnaissance. This is the best method to determine the actual LOS available, but it depends on the tactical situation. Do an initial map reconnaissance to select tentative sites, and then do a physical reconnaissance. Ensure that the NBCRS has security provided by the supported unit when moving to the surveillance sites. Use a lensatic compass or the onboard navigation equipment to determine the azimuths for each potential individual FOV, and record the LOS available on the M21 template or, if used, a range card.

(3) If no surveillance sites have been specified, select general areas (six-digit grid coordinates) that will provide the proper coverage. Always consider the commander’s intent when selecting the locations. The scheme of maneuver, operational security, emplacement/recovery time (dismounted operations), mission requirements, and operational risks affect the selection of the M21 employment site. A good site will meet the following criteria:

- An LOS between the detector and the target area. Without an LOS, the detector cannot get the correct background readings.
- Radio and/or wire communications. Without communications to pass the alarm and detection data to affected units, the system is of little use.
- Routes for rapid displacement to the next employment site. Some missions will place the detector well forward, and rapid displacement is essential to providing continuous support.
- Security by combat elements. This is essential to ensure that the system remains combat-effective and is not destroyed or captured by enemy forces.
- Protection from direct and indirect fires and observation. Cover and concealment improve the survivability of the system.

- Ideal wind direction. When deployed in an area surveillance mission, the detector can be oriented toward the wind to warn of approaching chemical clouds.
- (4) It is normal to plan at least three different sites for each surveillance mission—primary, alternate, and different.

- **Primary.** This is the actual location of the detector, with orientation upon the target area. It is usually the best site of those initially selected.
- **Alternate.** This is another site with the same target area. It is usually identified as an alternative to the primary site in the event that the first site is compromised and or comes under enemy fire.
- **Different.** This is a different location that is used to view a different target. It may be necessary because of a change in the plan for a surveillance mission or a change in the wind direction.

NOTE: See *Appendix N* for information on NBCRV joint-service, lightweight, standoff chemical-agent detector surveillance techniques.

8. Sampling

a. Sampling operations are particularly important if a previously unknown agent is used or if the suspected use is the first use of a CB agent by a threat force. If the type of agent is unknown, the unit leader conducts an RA to provide safety for his unit (e.g., an unknown agent could potentially penetrate collective protection equipment). During the mission analysis for TIM reconnaissance, consider the availability of appropriate individual and collective protection. The collection of CB samples and the background information must be as detailed and comprehensive as possible. Each sample is processed and analyzed to provide data for intelligence analysts to use. The processing of CB samples includes collecting, handling, transferring, and maintaining the chain of custody.

b. Chemical samples are taken when directed by higher headquarters or when the sensor detects or identifies the presence of a chemical substance. Biological samples are taken when directed by higher headquarters. The NBCRS does not have biological detection capability, so take samples in an area where suspected contamination exists (look for dead animals and plants). Possible ground locations include low-lying areas, wet or damp terrain, and shady areas. Grassy terrain provides better quality samples than rocky terrain.

c. Plan sampling operations in advance, and use the following steps to take CB samples:

Step 1. Perform preventive-maintenance checks and services on all equipment.

Step 2. Remove sample bottles, and mark them with control numbers using a china or indelible marker (see *Appendix E*).

Step 3. Enter all sample bottle numbers in the crew logbook.

Step 4. Take at least two samples about 500 meters upwind of the sample area. These are known as *background samples* that are not contaminated. They are

used as comparison samples to ensure that a compound is not naturally found in the area.

Step 5. Enter the contaminated area, and identify the sample (dirt, vegetation).

Step 6. Mount the protective work glove into the work port.

Step 7. Insert your left arm into the work glove.

Step 8. Release the latch on the sample tray, and pull the tray out to the fully extended position.

Step 9. Remove the cap from the sample bottle.

Step 10. Grasp the gripper tongs by the handle and slide them out of the tray.

Step 11. Watch through the floor window, and use the tongs to grasp the sample and place it in a sample bottle.

Step 12. Replace the tongs on the tray.

Step 13. Replace the cap on the sample bottle.

Step 14. Transfer the samples to the proper organization (e.g., technical intelligence collection point).

NOTE: A soil sample should weigh about 10 grams, and a liquid sample should be 15 to 25 milliliters.

d. A sample collected from an area is significant, but it can become useless if proper steps are not taken to record critical information about its collection. See *Appendix E* for the proper procedures for recording the information.

e. After the NBCRS team takes the samples and arrives at the decontamination site, it conducts a sample change of custody at a site or grid coordinate established by the controlling headquarters. The controlling headquarters is responsible for getting personnel to the site to effect the transfer. Samples are passed through the glove port to receiving personnel, who are typically technical intelligence or escort teams. The following items should accompany the samples:

- Information contained in the crew's mission log.
- Printout from the MM1.
- Chain-of-custody form.

9. Unit Employment

NBC reconnaissance units are employed to enhance combat power. Combat power is the ability to fight; and it is achieved by combining maneuver, firepower, protection, and leadership.

a. Employment Guidelines.

(1) Task-organize NBC reconnaissance units based on the mission and the type of unit being supported (e.g., battalion, regiment). NBC reconnaissance units are concentrated and weighted with the main effort to help ensure success, but there are never enough units to handle all tasks. Concentrating NBC reconnaissance assets can

improve the speed of detection and the speed of locating bypasses for maneuver forces; however, a trade-off occurs in the amount of area that can be covered. Commanders should consider this as a choice when choosing between mass and economy of force.

(2) Integrate NBC reconnaissance units with fire and maneuver. The scheme of maneuver supports NBC reconnaissance plan preparation. NBC reconnaissance units enhance the effectiveness of fire and maneuver, can operate well forward in the combat zone, and require the protection offered by fire and maneuver.

(3) Ensure that current NBC reconnaissance unit operations promote future force operations. NBC units and staffs must anticipate future missions and reposition units, if necessary, while accomplishing the current mission.

(4) Do not hold NBC reconnaissance units in reserve. NBC reconnaissance units do not remain with forces that are not in the fight. They remain out of action only long enough to refit after a major action.

(5) Build a logistically sustainable force. Resources are always limited. NBC reconnaissance units cannot sustain themselves; they require support from other organizations. NBC reconnaissance, unit sustainment, and the supporting logistics structure, including CLS, must be planned in detail.

(6) Maintain effective battle command. Effective plans use all available NBC unit headquarters, align them with maneuver boundaries, and hand off operations smoothly between them.

b. Command and Support Relationships. NBC units can operate under two types of relationships—command and support. Command responsibility and authority are established through command relationships. Support relationships are established to define specific relationships and responsibilities between supporting and supported units. Command and logistics responsibilities and the authority to reorganize or reassign component elements of a supporting force remain with the higher headquarters or parent organization unless otherwise specified.

(1) Command. Chemical units can operate under four command relationships—organic, assigned, attached, and OPCON.

- **Organic.** An organic unit forms a part of another unit and is listed in the table of organization. It may be attached, placed under OPCON, or given a direct support (DS) mission to a subordinate element of the parent unit. An organic unit may also be retained in general support (GS) of the entire parent unit.
- **Assigned.** An assigned unit is placed under control of higher headquarters, usually above division level, on a relatively permanent basis. It may be attached, placed under OPCON, or given a DS mission to a subordinate element of the parent unit. An assigned unit may also be retained in GS of the entire parent unit.
- **Attached.** An attached unit is usually attached to a larger unit for an extended period of time. Unless otherwise specified in the order, the gaining unit is responsible for C2 and logistical support and the parent unit retains responsibility for personnel transfers and promotions.

- **OPCON.** The gaining commander can use an OPCON unit like an organic unit for mission accomplishment. This includes task-organizing subordinate forces, assigning tasks, and designating objectives. Unless otherwise specified in the order, the parent unit retains responsibility for logistical and administrative support.

(2) **Support.** A support relationship is established when NBC units are placed in DS of a force or when a commander elects to retain chemical units in GS of his command. Command responsibility is retained by the parent unit. Full logistics responsibility also rests with the parent unit unless the supported unit is directed to fulfill certain logistical functions, such as rations, POL, or medical support.

(a) **DS.** A DS unit provides dedicated support to a specific unit, usually for a single operation or for a short time. The supported unit commander has a high degree of control over the tasks performed by the supporting unit, without the responsibility for logistics or administration. The supporting unit takes task assignments and priorities from the supported unit and gives priority of support to it. The parent unit retains command authority and logistics and administration responsibilities. This relationship precludes further task organization.

(b) **GS.** A commander with organic, assigned, attached, or OPCON units may elect to retain any part of those assets in GS. They are retained in GS when higher headquarters requires greater flexibility and control. In this relationship, support is to the force as a whole, rather than to a particular subdivision of the force. The subordinate force commander requests support from the senior force commander, task by task, rather than from the supporting unit.

c. **Offensive Operations.** The main focus of NBC reconnaissance in the offense is the freedom of maneuver so that the commander can avoid contaminated areas. The IPB identifies likely and known areas of contamination. The NBCRS allows commanders to rapidly bypass contaminated areas and maintain the operating tempo (OPTEMPO). All NBC reconnaissance operations during the offensive tend to occur in sequential phases. The length and nature of each phase, and whether they even occur, varies from situation to situation. The four phases of support are planning, preparation, execution, and recovery.

- **Planning.** The NBC reconnaissance unit leader must understand the supported unit's mission, its concept of operations, and the commander's intent. The NBC reconnaissance unit leader then begins troop-leading procedures. To support a maneuver unit conducting offensive operations, he considers the—
 - Command and support relationship.
 - Location of enemy forces (known and templated).
 - Range of enemy weapon systems.
 - Location of enemy and friendly obstacles (known and templated).
 - Surface wind direction and speed.
 - Type of NBC weapon the enemy could employ.

The supported unit's battle staff (intelligence and chemical) can provide most of this information. The NBC reconnaissance unit conducts a

physical reconnaissance or, if necessary, a detailed map reconnaissance of the mission area. When possible, the NBC reconnaissance unit leader issues his order at a terrain vantage point overlooking the operational area; otherwise, he uses a sand table. Each vehicle commander should have a copy of the supported unit's operations overlay.

- **Preparation.** Preparation begins when the WARNORD is received, and it includes—
 - Conducting precombat checks.
 - Maintaining and inspecting equipment.
 - Distributing supplies.
 - Feeding soldiers.
 - Resting.
 - Checking the physical health of soldiers.
 - Camouflaging.

Next, the NBC reconnaissance unit leader issues the mission order and coordinates with the supported unit to ensure understanding of how the mission will be executed. The leader may be required to back-brief the supported unit and should attend rehearsals.

- **Execution.** The NBC reconnaissance unit begins movement with sufficient time to cross the LD in the designated order of march. The NBC reconnaissance unit leader monitors both units' internal net and the supported unit's net (usually the command net).
- **Recovery.** During the recovery phase, the NBC reconnaissance unit rearms, refuels, and refits as quickly as possible. If the NBC reconnaissance unit becomes contaminated during the mission, decontamination will be necessary. The level of decontamination required depends on the weather, type of contamination, and follow-on mission. The unit's main objective during this phase is to become fully mission-capable and ready for future operations.

(1) **Movement to Contact.** The purpose of a movement to contact is to make initial contact with the enemy or to regain lost contact. The supported force conducts a movement to contact in a way that risks the smallest part of the force, while the remainder is available to immediately respond when contact is made.

(a) The force conducting a movement to contact is normally organized into a forward security element, a security force, flank and rear guards, and a main body. The enemy can use persistent chemical agents to contaminate terrain, shape the battlefield, force friendly forces into engagement areas, and deny or restrict terrain from friendly use. Limited knowledge of the terrain and AO can result in the friendly force encountering contamination from previous battles.

(b) During a maneuver unit (i.e., divisional) movement to contact, an NBC reconnaissance platoon could provide one squad to each maneuver brigade. If the threat of encountering contamination is high, the platoon may form into sections. However, employment by a squad is the preferred means. For cavalry regiments

conducting a movement to contact, each ground cavalry squadron is supported by a squad.

(c) The squad should remain intact to avoid diluting its potential to rapidly detect NBC hazards. NBC reconnaissance teams typically operate apart from each other, but in mutual support. The squad can operate inside the supported unit's formation or as part of the flank security.

(d) When operating inside the formation, one NBCRS team or squad generally moves in the forward security element and the other team or squad moves with the security force. If the lead combat element encounters contamination, the lead NBCRS moves forward (on order) to locate a clean route around the contamination. The supported force selects the preferred direction (or bypass to the right or left) before conducting the operation. If a bypass route cannot be located in the preferred direction, the NBCRS team attempts to locate a bypass in the other direction.

(e) When the squad operates as part of the flank security, one NBCRS team moves on each flank. The teams may move continuously or by alternating bounds. When operating by alternating bounds, the stationary team overwatches using the M21 remote-sensing, chemical-agent alarm. If the overwatching team detects a chemical cloud, the supported force halts. The other NBCRS team moves forward and initiates a scan with the M21. By using triangulation, the location of the cloud can be determined. Once the relative position of the cloud is known, the NBC reconnaissance squad moves forward to determine if there is any liquid contaminant. The NBC reconnaissance squad must be supported by a direct-fire combat unit while it moves forward to reconnoiter for a liquid contaminant. If contamination is found, the squad tries to locate a bypass route. Upon contact with the enemy, the squad leader quickly determines the threat and the main effort of the supported force. He determines where and how he can provide support. NBCRS teams do not close with enemy forces.

(2) Attack. The adversary may use persistent chemical agents to slow or fix attacking forces. He will attempt to alter the OPTEMPO in his favor and will use chemical weapons to provide this ability. Persistent chemical agents can be used to protect exposed flanks. NBC reconnaissance units may be employed with the supported force to provide contamination avoidance forward. Squads are weighted to the main effort of the attack to provide early warning of possible contamination and find bypasses to maintain attack tempo. When possible, NBCRS teams stay under central control of the squad leader to allow coordination and synchronization.

(3) Exploitation. Exploitation is conducted to take advantage of success on the battlefield. It prevents the enemy from reconstituting an organized defense or conducting an organized withdrawal. Enemy forces may employ persistent chemical agents to deny or restrict key terrain. They may contaminate routes behind them in an attempt to break contact. NBC reconnaissance units may be employed with the exploitation force. Their main focus is to quickly find routes around contaminated areas so that the momentum of the exploitation is maintained.

(4) Pursuit. The purpose of a pursuit is to complete the destruction of an enemy while it is withdrawing. The enemy force is the main objective. The enemy may use chemical agents to break contact or slow pursuing forces. It may use persistent chemical agents to its rear and flanks. Nonpersistent chemical agents will be used directly on friendly forces to slow their advance. NBC reconnaissance units will move with direct pressure and enveloping forces to assist in their rapid movement. Areas of

contamination must be quickly bypassed. These areas must be accurately reported and marked so that follow-on forces can avoid them.

d. **Defensive Operations.** The main focus of NBC reconnaissance in the defense is to identify NBC hazards that could hinder maneuver and support forces and to decrease the survivability of defending forces. By identifying and marking hazards, counterattacking or repositioning forces can avoid them. This allows the defender to gain time, concentrate forces elsewhere, control key or decisive terrain, and wear down enemy forces as a prelude to offensive operations.

(1) **Planning.** When planning at the platoon level during defensive operations, the platoon leader considers the—

- Command and support relationships.
- Friendly scheme of maneuver.
- Supported unit commander's intent.
- Likely enemy COAs.
- Location of friendly obstacles.
- Weather (surface wind direction and speed).

(a) It is important that the NBC reconnaissance unit leader conduct a leader's reconnaissance. He should conduct a physical reconnaissance of the area and determine the location of friendly obstacles. This will prevent fratricide from friendly minefields and other obstacles.

(b) The NBC reconnaissance unit conducts precombat checks and inspections and readies all equipment and personnel for the upcoming mission. Orders must thoroughly cover the defensive operations and possible enemy COAs to reduce platoon reaction time. The NBC reconnaissance unit must know the—

- Location of friendly obstacles.
- Location of designated passage points and lanes.
- Recognition signals.
- Location of the counterreconnaissance screen.

(c) The need for close coordination with the supported unit remains the same during defensive operations. NBC reconnaissance units operating forward of the supported unit's defensive positions must understand the scheme for counterreconnaissance to reduce the possibility of fratricide. The NBC reconnaissance unit must coordinate all movements in the main defensive area to prevent losses to friendly minefields, obstacles, and counterreconnaissance efforts. The NBC reconnaissance unit leader should obtain a copy of the fire support overlay before departure or coordinate with the fire support officer to use the existing target information reference system to adjust fire.

(d) The NBC reconnaissance unit's mission will probably begin before defense execution. It may be part of the counterreconnaissance smoke operations during the supported unit's defense preparation. Throughout the defensive operation, the NBC reconnaissance unit must be aware of increased enemy reconnaissance operations. It

could encounter enemy reconnaissance elements during reconnaissance operations or while in the assembly area.

(e) The NBC reconnaissance unit must recover quickly to support possible follow-on offensive operations. It rearms, refuels, and refits as quickly as possible; and its main objective during this phase is to become fully mission-capable.

(2) **Covering Force.** The corps and division may establish a covering force as the first echelon of a two-echelon defense. The function of a covering force is to destroy the leading elements of the attacking force, cause the deployment of follow-on forces, and force the enemy to disclose its main effort. The enemy may use chemical weapons to force the withdrawal of the covering force or fix it in place. Persistent chemical agents are employed to contaminate the covering force, degrade the ability to operate, deny terrain or routes, and protect the flanks of attacking forces. An NBC reconnaissance unit assigned to a covering force positions itself to observe NAIs. The NAIs are selected during the IPB process as possible targets for enemy NBC attacks. If these areas are contaminated, they may affect the way the covering force executes the commander's intent. Additionally, the NBC reconnaissance unit must be in a position to quickly respond to reported NBC attacks throughout the covering force area.

(3) **Sector.** A defense sector is an area designated by boundaries that defines where a unit operates. Commanders often use sectors for maximum freedom to execute the defense using whatever techniques are necessary. The enemy uses NBC weapons in much the same manner as it does in a covering force. The enemy attempts to locate the reserve and destroy or slow its entry into the battle. NBC reconnaissance units are positioned in the defense sector to provide NBC reconnaissance support. A squad typically operates in support of a maneuver brigade. When a division is conducting a defensive operation, NBC reconnaissance squads are task-organized to the defending brigades and the division reserve. In defending brigades, the NBC reconnaissance squad is kept under brigade control. The squad is assigned a surveillance mission to observe NAIs and react to reports of NBC attacks. During the execution of a counterattack, the squad or a team may provide support to the counterattack force.

(4) **Battle Position.** A battle position is a general location and orientation of forces on the ground. Units defend from a battle position. The NBC reconnaissance unit leader uses IPB and the deployment support team to determine the likely enemy NBC threat. NBC reconnaissance teams are positioned to overwatch expected attack locations.

(5) **Strongpoint.** A unit is given a strongpoint defense mission when terrain retention is required to stop or redirect enemy formations. The NBC reconnaissance unit leader uses IPB and the deployment support team to determine the likely enemy NBC threat. NBC reconnaissance teams are positioned to overwatch expected attack locations.

Appendix K

MONITORING, RECONNAISSANCE, SURVEILLANCE, AND SURVEY REPORTS

1. Background

NBC contamination data is submitted by unit monitoring, reconnaissance, surveillance, and survey teams. The NBC 4 monitoring and survey report is used to pass NBC hazard information to the NBC control center. When more information is needed, the NBC control center coordinates with a team to collect and forward the necessary data.

2. Types of Reports

a. NBC reports start with a common message heading that consists of the NBC report number (1 through 6) and the event (NBC, release other than attack, or unknown). The heading is followed by sets that provide contamination data. The following NBC reports are commonly used:

- **NBC 1.** Observer's report that gives basic data.
- **NBC 2.** Report for passing the evaluated data that is collected from NBC 1 reports.
- **NBC 3.** Report for the immediate warning of predicted contamination and hazard areas.
- **NBC 4.** Report for forwarding detection data, such as monitoring, survey or reconnaissance results. This report is used in two cases—if an attack is not observed and the first indication of contamination is by detection and to report measured contamination as a part of a survey or monitoring team.
- **NBC 5.** Report for passing information on areas of actual contamination. This report can include areas of possible contamination, but only if actual contamination coordinates are included in the report. The NBC 5 report consists of a series of grid coordinates, and it is prepared from information provided in the NBC 4 report. It is also used to transmit the decay rate of fallout. The NBC 5 report may be sent before or after the NBC 4 report has been received and may be revised and sent several times during the period of interest.
- **NBC 6.** Report for passing detailed information on NBC events. Battalion-size or equivalent organizations prepare the NBC 6 report when requested by higher headquarters to summarize information concerning CB attacks. The report provides intelligence information that is used to analyze future enemy intentions.

b. NBC 3, 4, 5, and 6 reports are important tools for forwarding monitoring, survey, and reconnaissance data. *Figures K-1 through K-6*, pages K-2 through K-7, show the sets that are included in these reports.

Set	Description	Condition	Example/Remarks
ALFA	Strike serial number	M	ALFA/UK/A231/001/N//
DELTA	DTG of attack or detonation and attack end	M	DELTA/201405ZSEP1997//
FOXTROT	Location of attack or event	M	FOXTROT/32UNB058640/EE//
GOLF	Delivery and quantity information	O	GOLF/SUS/AIR/1/BOM/4//
HOTEL	Type of nuclear burst	O	HOTEL/SURF//
NOVEMBER	Estimated nuclear yield in kilotons	O	NOVEMBER/50//
PAPA BRAVO	Detailed fallout hazard prediction parameters	M	PAPAB/019KPH/33KM/5KM/272DGT/312DGT//
PAPA CHARLIE	Radar-determined external contour of radioactive cloud	O	PAPAC/32VNJ456280/32VNJ456119 32VNJ556182/32VNJ576200/ 32VNJ566217/32VNJ456280//
PAPA DELTA	Radar-determined downwind direction of radioactive cloud	O	PAPAD/030DGT//
XRAY BRAVO	Predicted contour information	O	This set can be repeated up to three times to describe three possible hazard areas corresponding to the time period from the chemical downwind message. A hazard area for a following time period will always include the previous hazard area.
YANKEE	Downwind direction and speed	O	YANKEE/27ODGT/015KPH//
ZULU	Actual weather conditions	O	ZULU/4/10C/7/5/1//
GENTEXT	General text	O	Include general remarks as appropriate.
M = Mandatory (information is always sent) O = Operational (information is sent based on availability) C = Conditional (information is tied to other message contents)			

Figure K-1. Sample NBC 3 Report (Nuclear)

Set	Description	Condition	Example/Remarks
ALFA	Strike serial number	M	ALFA/UK/A231/001/C//
DELTA	DTG of attack or detonation and attack end	M	DELTA/201405ZSEP1997/201420ZSEP1997//
FOXTROT	Location of attack or event	M	FOXTROT/32UNB058640/EE//
GOLF	Delivery and quantity information	O	GOLF/OBS/AIR/1/BML/-//
INDIA	Release information on CB agent attacks or releases other than attack	M	INDIA/AIR/NERV/P/ACD//
PAPA ALPHA	Predicted attack and hazard area	M	PAPAA/1KM/2-6DAY//
PAPA XRAY	Hazard area location for weather period	M	PAPAX/201600ZSEP1997/ 32VJ456280/32VJ456119/ 32VJ576200/32VJ566217/ 32VJ456280//
XRAY BRAVO	Predicted contour information	O	This set can be repeated up to 50 times to represent multiple contours.
YANKEE	Downwind direction and speed	O	YANKEE/27ODGT/015KPH//
ZULU	Actual weather conditions	O	ZULU/4/10C/7/5/1//
GENTEXT	General text	O	GENTEXT/NBCINFO/RECALCULATION BASED ON WEATHER CHANGE//
M = Mandatory (information is always sent) O = Operational (information is sent based on availability) C = Conditional (information is tied to other message contents)			

Figure K-2. Sample NBC 3 Report (CB)

Set	Description	Condition	Example/Remarks
ALFA	Strike serial number	M	ALFA/US/WEP/001/RN//
CHARLIE	DTG of report or observation and event end	M	DELTA/281405ZSEP1997//
FOXTROT	Location of attack or event	M	FOXTROT/32UNB058640/EE//
GOLF	Delivery and quantity information	O	GOLF/SUS/TPT/1/TNK/1//
INDIA	Release information on CB agent attacks or releases other than attack	M	INDIA/SURF/2978/-/ARD//
PAPA ROMEO	Predicted isolation and hazard area	M	PAPAR/1000M/5KM//
PAPA XRAY	Hazard area location for weather period	M	PAPAX/081200ZSEP1997/ 32VNJ456280/32VNJ456119/ 32VNJ576200/32/VNJ566217/ 32VNJ456280//
XRAY BRAVO	Predicted contour information	O	This set can be repeated up to 50 times to represent multiple contours.
YANKEE	Downwind direction and speed	O	YANKEE/27ODGT/015KPH//
ZULU	Actual weather conditions	O	ZULU/4/10C/7/5/1//
GENTEXT	General text	O	Include general remarks as appropriate.
M = Mandatory (information is always sent) O = Operational (information is sent based on availability) C = Conditional (information is tied to other message contents)			

Figure K-3. Sample NBC 3 Report (Release-Other-Than-Attack)

Set	Description	Condition	Example/Remarks
ALFA	Strike serial number	O	ALFA/US/WEP/001/RN//
INDIA	Release information on CB agent attacks or releases other than attack	O	INDIA/SURF/2978/-/SPEC//
QUEBEC ¹	Location of reading, sample, or detection and type of sample or detection	M	QUEBEC/32V/NJ481203/GAMMA/-//
ROMEO ¹	Level of contamination, dose rate trend, and decay rate trend	O	ROMEO/7CGH/DECR/DF//
SIERRA ¹	DTG of reading or initial detection of contamination	M	SIERRA/202300ZSEP1997//
TANGO ¹	Terrain, topography, and vegetation description	M	TANGO/URBAN/URBAN//
WHISKEY	Sensor information	O	WHISKEY/-/POS/NO/HIGH//
YANKEE ¹	Downwind direction and speed	O	YANKEE/27ODGT/015KPH//
ZULU ¹	Actual weather conditions	O	ZULU/4/10C/7/5/1//
GENTEXT	General text	O	Include general remarks as appropriate.
¹ Sets QUEBEC, ROMEO, SIERRA, and TANGO are a segment. With the exclusion of set ROMEO, this segment is mandatory. Sets YANKEE and ZULU are a second segment, which is operationally determined. These sets or segments can be repeated up to 20 times to describe multiple detection, monitoring, or survey points.			
M = Mandatory (information is always sent) O = Operational (information is sent based on availability) C = Conditional (information is tied to other message contents)			

Figure K-4. Sample NBC 4 Report (CB or Release-Other-Than-Attack)

Set	Description	Condition	Example/Remarks
ALFA	Strike serial number	O	ALFA/US/WEP/001/RN//
CHARLIE	DTG of report or observation and event end	O	CHARLIE/281530ZSEP1997//
INDIA	Release information on CB agent attacks or releases other than attack	M	INDIA/SURF/2978/-/SPEC//
OSCAR	Reference DTG for estimated contour lines	M	OSCAR/281830ZSEP1997//
XRAY ALPHA	Actual contour information	M	XRAYA/0.003CGH/334015N1064010W/ 334020N1064010W/ 334020N1064020W/ 334015N1064020W/ 334015N1064010W// This set can be repeated up to 50 times to represent multiple contours.
XRAY BRAVO	Predicted contour information	O	This set can be repeated up to 50 times to represent multiple contours.
YANKEE	Downwind direction and speed	O	YANKEE/27ODGT/015KPH//
ZULU	Actual weather conditions	O	ZULU/4/10C/7/5/1//
GENTEXT	General text	O	Include general remarks as appropriate.
M = Mandatory (information is always sent) O = Operational (information is sent based on availability) C = Conditional (information is tied to other message contents)			

Figure K-5. Sample NBC 5 Report (Release-Other-Than-Attack)

Set	Description	Condition	Example/Remarks
ALFA	Strike serial number	O	ALFA/US/WEP/001/RN//
CHARLIE	DTG of report or observation and event end	O	CHARLIE/281530ZSEP1997/ 281545ZSEP1997//
FOXTROT	Location of attack or event	O	FOXTROT/32UNB058640/EE//
INDIA	Release information on CB agent attacks or releases other than attack	O	INDIA/SURF/2978/-/SPEC/-//
QUEBEC	Location and type of reading or sample detection	O	QUEBEC/32VNJ481203/GAMMA//
SIERRA	DTG of reading	O	SIERRA/282300ZSEP1997//
GENTEXT	General text	M	GENTEXT/NBCINFO/HOSPITAL VEHICLE CARRYING RADIOACTIVE WASTE OVERTURNED ON ROUTE 25//
M = Mandatory (information is always sent)			
O = Operational (information is sent based on availability)			
C = Conditional (information is tied to other message contents)			

Figure K-6. Sample NBC 6 Report (Release-Other-Than-Attack)

3. Integrated, Automated Warning and Reporting

Integrated, automated capabilities (such as the multipurpose, integrated, chemical-agent detector and embedded common technical architecture) can be used to provide warning to combat and armored vehicles, tactical vans, and shelters. These systems automate the NBC warning and reporting system process throughout the battlespace. They automate the gathering of contamination data from fielded NBC detectors and sensors and automatically format and transmit reports.

4. Reporting

a. Information for Reporting Monitoring Data. Monitoring reports provide the location of the reading, the dose rate, and the DTG the reading was taken. The following information is provided:

- Line Quebec contains the location in military grid reference system (MGRS) latitude and longitude coordinates.
- Line Romeo contains the dose rate reading in cGyph. Only the outside (unshielded) dose rate is reported by the unit NBC defense team. Certain words that describe the circumstances surrounding the contamination are associated with the dose rate. The following words should be used in

conjunction with line Romeo, and more than one word can be used on a single report.

• Initial, peak, special, and contact (used by reconnaissance only).

• Series, summary, and verification.

• Increasing, decreasing, fallout, induced, and overlapping.

- Line Sierra contains the DTG, which is reported in Zulu time.
- Line Zulu Bravo is used to transmit correlation factor data.

b. **Formatting Instructions.** Only the unit NBC defense team places monitoring data to be sent to higher headquarters in the NBC 4 nuclear report format. Monitors do not originate or send the NBC 4 report to higher headquarters. The following information is provided:

- Lines Quebec, Romeo, and Sierra may be repeated as many times as necessary.
- An NBC 4 report is sent when locations and times change. It provides a specific picture of the contamination throughout the area.
- The control center provides guidance on the message precedence for an NBC 4 report. The guidance is based on whether the report is automatic or additional.
- Precedence is normally immediate, but it may be upgraded or downgraded depending on the urgency.
- Line Quebec should be encoded for OPSEC purposes.
- An NBC 4 report may contain lines other than Quebec, Romeo, Sierra, and Zulu Bravo at the discretion of the sender.

c. **Automatic Reports.** Automatic reports prevent overload of the communications network and ensure that only meaningful data is reported. The types of automatic reports are initial, peak, and special. Some other automatic reports may be specified by the control center or required by the intermediate commander for operational purposes.

(1) **Initial Report.** When the unit monitor records a dose rate of one or more cGyph outside, he notes the time, moves directly to the shelter, and reports the findings to the unit NBC defense team. The unit NBC defense team warns and alerts personnel of fallout and formats an NBC 4 nuclear report to send to the control center, using the word *initial* on line Romeo. The control center uses the initial report to confirm the fallout prediction. Initial report dose rates cannot be converted to H+1.

(2) **Peak Report.**

(a) While performing continuous monitoring, the unit monitor records dose rates according to the time intervals specified by the unit. While fallout is arriving, dose rates are recorded at 15-minute or directed intervals. The dose rate will steadily rise until it reaches a peak, and then it will begin to decrease. Once there is a constant decrease, the monitor—

- Takes inside and outside dose rate readings for the correlation factor calculation.

- Records the inside dose rate reading as the next reading in the sequence in the main body of the recording form and in the correlation factor data block.
- Completes the location and dose rate reading blocks.
- Obtains another outside dose rate reading at the same location within 3 minutes and immediately returns to the shelter.
- Records the highest outside dose rate reading in the correlation factor data block.
- Reports the inside and outside dose rate readings and when (time) and where (location) they were obtained to the NBC defense team via radio, wire nets, or in person.
- Does not calculate or apply the correlation factor to this data or use a standard report format to send the data.
- Resumes continuous monitoring and records dose rates at 30-minute or directed intervals after the peak dose rate is reported.
- Continues the procedures until the unit leaves the contaminated area, the radiation level drops to 1 cGyph, or the CO directs that periodic monitoring begin.

(b) The unit NBC defense team calculates the correlation factor and applies it to the highest dose rate recorded. The team then formats the NBC 4 nuclear report, using the word *peak* in line Romeo. Do not screen or delay a peak report because the information is extremely important to the control center.

(3) Special Report. Unit instructions may establish the requirement for special NBC 4 nuclear reports, which are evaluated by the control center. They invite command attention to areas or conditions of serious concern. The operational situation and unit radiation status determine the criteria for these reports.

d. Directed Reports. Selected units in the contaminated area will be directed to submit additional NBC 4 nuclear reports that are used by the control center to evaluate the radiological contamination hazard. There are three directed reports—series, summary, and verification.

(1) Series Report.

(a) A series report consists of dose rate readings taken at the same location at 30-minute intervals for 2½ hours, followed by hourly reports. A series report begins after a peak dose rate has been noted at the monitor's location. The monitor—

- Starts taking readings at the time of burst. (The instrument used to measure dose rates should be rezeroed before each reading.)
- Takes readings at the same location.
- Records readings on the designated service form.
- Reports each dose rate reading and the time it was taken to the NBC defense team.
- Continues the procedures until told to stop.

(b) The unit NBC defense team organizes the data into an NBC 4 nuclear report. Do not screen or delay a series report because the information is needed by the control center to determine the fallout decay rate and other calculations.

(2) Summary Report.

(a) A summary report shows the radiation distribution throughout a unit AOR and can be used to verify an overlay of shrinking contamination. The unit NBC defense team directs the monitor to take dose rate readings at several locations within the subunit or ship boundaries. The monitor records the location, dose rate, and time of readings and returns the recording form to the unit NBC defense team.

(b) The NBC defense team places the data into the proper report format, such as an NBC 4 nuclear report, using the word *summary* as a text entry in the NBC report line GENTEXT. The NBC defense team ensures that sufficient readings were taken to represent the situation across its area. The report is sent through intermediate headquarters (where additional data from other units is added if available) to the control center.

(3) Verification Report.

(a) A verification report is completed in response to a direct request from the control center and is passed to the control center without delay. It is used to recheck unusually high dose rates, a zero reading, or other abnormalities. A verification report is not a retransmission of previously reported readings, but a check of the actual condition of the area.

(b) Units tasked to provide a verification report receive specific instructions on the location of readings, why the report is being requested, and details about communications. The direct monitoring technique is used when possible.

(c) The monitor records data on the appropriate form and turns the form in to the unit NBC defense team when the mission is complete. The NBC defense team formats the information into the proper format, such as an NBC 4 report, using the word *verification* as a text entry in the NBC report line GENTEXT.

Appendix L

CHEMICAL SERVICES ORGANIZATIONS

NOTE: The NBC reconnaissance (LB) team organization (commonly referred to as the CRD in the SOF community) is undergoing an extensive force design update. It will increase from 5 to 14 personnel to better serve the requirements of geographic COCOM and SF commanders. This appendix addresses the mission and capabilities of the new and old organizations. CRDs reside in active and reserve components. The restructure will occur at different rates and times over the next several years, but the reserve component changes are expected in 2006.

1. Background

This appendix provides TTP for the LB team and CRD. It is a general guide and does not eliminate the requirement for well-written, practiced, mission-essential task list (METL)-driven SOPs. Users of this appendix can adapt their TTP to meet different situations that are caused by various METT-TC factors.

2. General

a. Where proliferation has occurred in regions of potential conflict, deterrence of an adversary's NBC weapons employment is a principal US national objective. The United States Special Operations Command (USSOCOM) must train and prepare forces to meet the requirements for planned, contingency, and unexpected (but plausible) operations in NBC environments in the geographic COCOM AOR. A CRD provides the geographic COCOM and SF commanders with an effective, deep NBC strategic reconnaissance capability to detect and assess WMDs in any environment.

b. This proliferation of NBC weapons places an increased reliance on intelligence collection efforts. The evidence from such efforts defines the threat capability to develop, produce, stockpile, and employ NBC weapons. US foreign policy decisions and initiatives depend heavily on the evidence of using (or preparing to use) NBC weapons in conflicts not directly involving the US.

c. SF are deployed worldwide across the spectrum of conflict in peace and in war. Since the 1960s, the US has dealt with a series of asymmetric threats, which have increased in lethality exponentially over time. The evolution of terrorism has shown trends over time that evolved conventional cold war threats into asymmetric threats. Foreign terrorism continues to be active against US targets overseas. This mandates allocating additional resources to combat asymmetrical threats and protect US national interests.

d. Emerging asymmetric threats (such as WMDs) challenge the safety of this nation and our coalition partners. In response to these emerging threats, US forces must be capable of conducting special NBC reconnaissance activities to provide SA and support to interagency or joint operations, foreign internal defensive operations, unconventional warfare, and counterterrorism (CT) and counterproliferation (CP) of WMD.

e. Once hostilities have started, a difficult requirement (which has national and international implications) is the confirmation of the first use of WMDs, particularly CB weapons. The use of NBC weapons against the US or our allies must be verified. Evidence, therefore, must be scientifically valid, and any samples must have a legal chain of custody from the point of collection to presentation (see *Appendix E*). The operational capabilities of the LB team and CRD help support these IR. Strategic and tactical intelligence focuses special NBC reconnaissance elements on specific areas of alleged threat NBC activities and also supports MDMP.

f. CRDs are assigned to existing SFGs. These SFGs are regionally oriented to each COCOM in various regions around the world. This alignment allows each CRD to conduct area studies of its assigned joint operations area (JOA). Active component CRDs are aligned with SFGs that have a high NBC threat; reserve component CRDs support SFGs with a lesser NBC threat. All CRDs, regardless of alignment, are capable of being task-organized under any joint special operations task force (JSOTF). Using a CRD in its targeted JOA increases its effectiveness.

3. Support to Special Operations Principal Missions

Based on the possibility of operating in a semipermissive or nonpermissive, contaminated NBC environment, SOF have organized, trained, and equipped special NBC reconnaissance teams to support these operations.

a. CP of WMDs. The application and use of NBC reconnaissance assets may include actions taken to seize, destroy, render safe, capture, or recover WMDs. Specific CP activities conducted by SOF are classified, and further discussion of CP is beyond the scope of this manual.

b. Foreign Internal Defense (FID). FID is participation by civilian and military agencies of a government in any of the action programs taken by another government to free and protect its society from subversion, lawlessness, and insurgency. The primary contribution of an LB team or CRD in this interagency activity could be to organize, train, advise, and assist HN military forces, paramilitary forces, and NBC reconnaissance resources. They can provide training that ranges from the use of chemical detection equipment to more sophisticated TIM detection and identification equipment.

c. Special Reconnaissance (SR). SR actions are conducted by SOF to obtain or verify (by visual observation or other collection methods) information concerning the capabilities, intentions, and activities of actual or potential enemies. SR includes special NBC reconnaissance; area assessment; environmental hydrographic, geological, and meteorological reconnaissance; coastal patrol and interdiction; target and threat assessment; and poststrike reconnaissance. In addition to SR, overt information collection may be conducted to determine the need for, or viability of, contemplated operations. Examples of SR missions include—

- Collecting critical information on NBC capabilities and intentions.
- Observing fauna, flora, and civilian or threat losses caused by friendly nuclear or chemical strikes.

- Conducting special NBC reconnaissance throughout the joint special operations area (JSOA) and areas near SOF operational and support center sites.
- Assessing and sampling NBC hazards at damaged enemy WMD facilities (production, stockpile, research, and development centers).
- Developing site characteristics, indicators, and profiles.
- Conducting battle damage assessment (BDA) of previously attacked sites.

d. **Direct Action.** Direct action may involve short-duration strikes and other small-scale offensive surgical actions by SOF or SO-capable units to seize, destroy, capture, recover, or inflict damage on designated personnel or material. Sample activities include raids, ambushes, direct assaults, standoff attacks, terminal guidance operations, precision destruction operations, and recovery operations (including noncombatant evacuation). When conducting direct actions against an adversary, SOF must consider the collateral effects of the strike. The collateral effects may cause NBC hazards that affect SOF operating in the area and the need to conduct NBC reconnaissance to determine the presence or absence of contamination. LB team or CRD tasks can include—

- Advising SOF on the hazards when the intended target or AO presents an NBC threat.
- Retrieving a sample after SOF have gained access to a site.
- Providing specific training to SOF in the collection or identification of NBC materials.
- Augmenting SOF conducting a WMD munitions seizure by providing technical information on munition and agent characteristics or providing actual hands-on preparation of seized munitions.
- Providing BDA of a direct action target after SOF interdict it.

e. **Unconventional Warfare (UW).** UW is a broad spectrum of military and paramilitary operations. It is normally of long duration and predominantly conducted by indigenous or surrogate forces who are organized, trained, equipped, supported, and directed in varying degrees by an external source. It includes guerrilla warfare and other direct, offensive, low-visibility covert or clandestine operations. UW also includes indirect activities, such as subversion, sabotage, intelligence activities, evasion, and escape. It is further complicated by the presence of NBC weapons. SOF NBC reconnaissance assets can assist indigenous forces with NBC reconnaissance training, intelligence, and communications. When SOF are conducting UW against an adversary with suspected NBC capability, SOF commanders use NBC reconnaissance assets to support vulnerability analysis, determine the risk involved, and determine the necessary active and passive defense measures.

4. Support to Special Operations Collateral Missions

LB team and CRD support to special operations principal missions are enduring and will change infrequently; however, special operations collateral missions will shift more readily because of the changing international environment. SOF are not manned, trained, or equipped for collateral missions. They conduct collateral missions using

inherent capabilities resident in the primary missions. Collateral missions are missions other than those that a force is primarily organized, trained, and equipped for and that the force can accomplish by virtue of its inherent capabilities.

a. Coalition Support. Coalition support may include training coalition partners on NBC reconnaissance tactics and techniques, assisting with communications interface to integrate coalition partners into the NBC warning and reporting structure, and establishing liaison.

b. Security Assistance. Security assistance consists of US programs that provide defense articles, military training, and other defense-related services by grant, loan, credit, or cash sales in furtherance of national policies and objectives. Security assistance tasks could include NBC vulnerability analysis and assessments and the development of mitigation techniques. The primary SOF role in security assistance is to provide mobile training teams (MTTs) and other forms of training assistance. Personnel conducting security assistance are prohibited by law from performing combatant duties. For additional information, see *Joint Tactics, Techniques, and Procedures for Foreign Internal Defense* and *Joint Tactics, Techniques, and Procedures for Foreign Humanitarian Assistance*.

c. Other Support. Support to other federal agencies may occur on a case-by-case basis. An example is supporting the Department of State (DOS) overseas during a WMD terrorist event against US facilities (e.g., consulate).

5. Five-Man LB Team

a. An LB team (*Figure L-1*) is a light, airborne, airmobile, five-man team. Each position has its own operations and functions and is identified and coded with a parachutist additional skill identifier. An LB team consists of the following positions:

- NBC officer.
 - Establishes policies and procedures.
 - Supervises and inspects operations.
 - Makes recommendations to the SFG and special forces operational detachment (SFOD) commanders.
 - Prepares OPORDs and OPLANs for employment of the detachment.
 - Keeps the commander or TL advised on the status of ongoing NBC operations.
 - Is particularly important in the verification and collection of CB agents, precursors, and industrial agents.
 - Is responsible for the direct supervision of missions that are intended as field verification and collection operations.
- Operations sergeant.
 - Has primary responsibility for team and individual training and readiness.
 - Prepares OPORDs.
 - Develops and analyzes the intelligence situation and mission profile.

- - Supervises team operations when operating in a split-team configuration.
- Chemical operations specialist.
 - Executes the missions planned by the NBC officer.
 - Conducts NBC reconnaissance and sample collection.
 - Operates NBC detection equipment, communications equipment, photographic equipment, CB sampling equipment, and weapons.
 - Trains and supervises nonchemical soldiers in the execution of NBC reconnaissance when required.
- Assistant chemical operations specialists (two).
 - Execute the missions planned by the NBC officer.
 - Operate detection and sampling equipment.

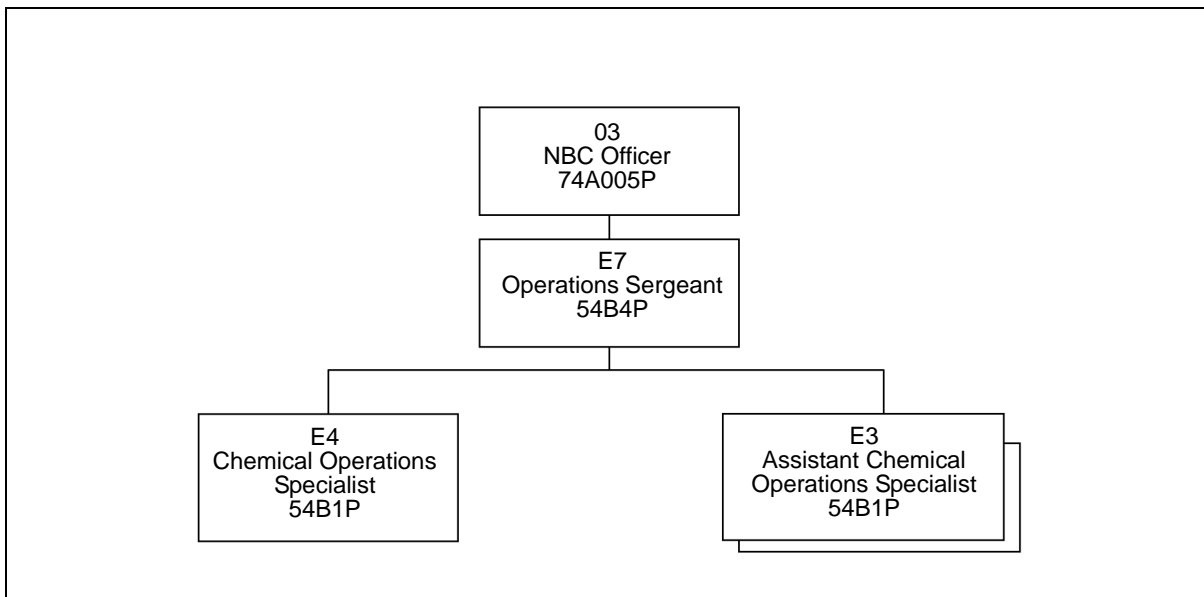

Figure L-1. LB Team

- b. A five-man LB team—
- Provides special NBC reconnaissance support to SOF who are supporting strategic, operational, or tactical objectives.
 - Can be attached to an SFOD as an augmenting technical team in a nonpermissive or semipermissive environment.
 - Can be deployed independently in a permissive environment.
 - Is an SFG commander's primary means of conducting special NBC reconnaissance operations. The current rank structure and organizational density within an LB team limits its ability to support the assigned SFG. It is primarily an augmentation team and, therefore, has operational limitations (security, medical support, language skills, communications).

- Supports NBC aspects of SR, UW, FID, and direct-action operations.
- Deploys on short notice, with minimal preparation, at any level of conflict.
- Conducts operations anytime and in all types of terrain and weather.
- Normally has the same regional orientation as the SFG.
- Can augment an SFOD with NBC material detection, collection, field identification, sampling, and packaging.
- Possesses specialized NBC protective equipment.
- Detects nuclear and chemical material.
- Conducts presumptive identification of biological material.
- Collects NBC samples.
- Is a specialized technical reconnaissance unit that supports SOF NBC requirements.
- Gives the SOF commander a unique, specialized detachment for special NBC reconnaissance.
- Can be attached to another SOF or to a conventional element for a specific mission.
- Can provide training to other personnel (e.g., SFOD-A personnel) on NBC skills to support mission requirements.
- Conducts collection and identification operations.
- Focuses on special NBC reconnaissance operations in areas that are not accessible to conventional reconnaissance elements.
- Rapidly deploys to areas of suspected NBC use.
- Conducts sampling and field identification.

c. The mission can require augmentation by the entire LB team, or the team can be split into two subelements. Each subelement should consist of at least two LB team members. In unique situations, depending on METT-TC, attaching only one LB team member may be required. The LB team commander, along with his supported element, tailors the level of support or effort required based on the mission requirements and limitations.

d. The supported commander (or leader), with input from the LB team commander, determines the configuration of each subelement according to METT-TC. Normally, the split-team configuration consists of two subelements. The LB team NBC officer takes the first subelement with one chemical operations specialist and one assistant chemical operations specialist. The operations sergeant takes the second subelement with the remaining personnel.

6. Special Forces Chemical Reconnaissance Detachment

a. A CRD is a light, airborne, airmobile, 14-man detachment (*Figure L-2*, page L-8). The headquarters plans and supports reconnaissance operations and provides C2 of subordinate elements. CRD-As conduct special NBC reconnaissance and survey operations in conjunction with SOF in all environments. Each position has its own operations and functions, and positions are identified and coded with additional skill identifiers (parachutist, ranger, and technical escort). A CRD team consists of the following positions:

- Commander.
 - Establishes policies and procedures.
 - Supervises CRD operations.
 - Makes recommendations to the SFG chemical staff, operations section, and commander.
 - Provides training guidance to CRD-As.
- Detachment sergeant.
 - Is responsible to the commander for CRD operations, maintenance, logistics, and discipline.
 - Ensures that training is conducted according to the commander's guidance.
 - Coordinates and provides required assets for current detachment operations, and anticipates requirements for future operations.
- CRD-As.
 - Operations NCOIC. (1) Supervises detachment operations. (2) Ensures detachment training and readiness. (3) Integrates into the planning process of the supported SFOD-A by helping develop and analyze the intelligence situation and mission profile.
 - Chemical operations sergeants. (1) Execute missions planned by the supported SOF element and CRD-A NCOIC. (2) Conduct NBC reconnaissance and sample collection. (3) Operate standard and SOF-unique NBC detection equipment, communications equipment, photographic equipment, CB sampling equipment, and weapons. (4) Train and supervise nonchemical soldiers in the execution of special NBC reconnaissance when required.

b. A CRD provides NBC reconnaissance for a deployed SFOD in all environments (permissive, semipermissive, and nonpermissive) in support of strategic, operational, and tactical objectives (*Figure L-3*, page L-8). It is employed in one of two modes—

- Unilaterally in a permissive environment.
- As augmentation or training support to an SFOD in a semipermissive or nonpermissive environment.

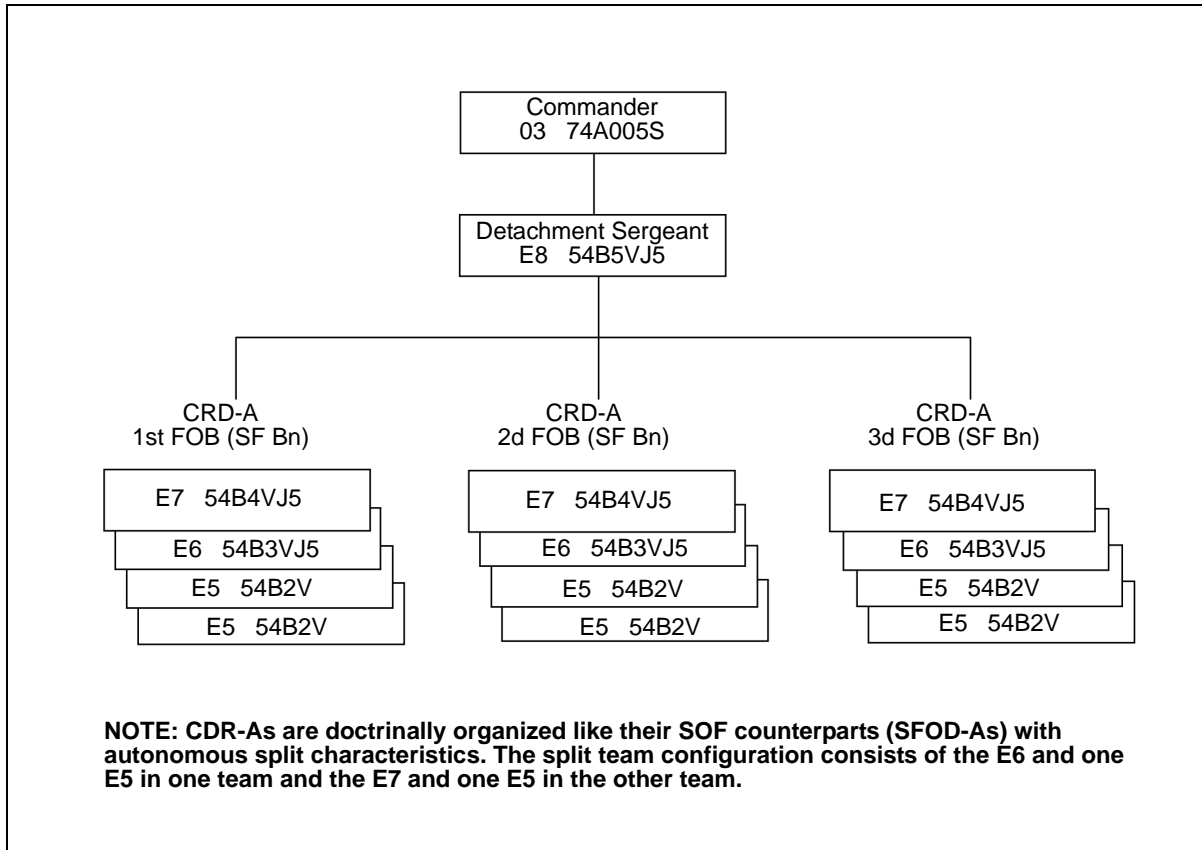

Figure L-2. CRD

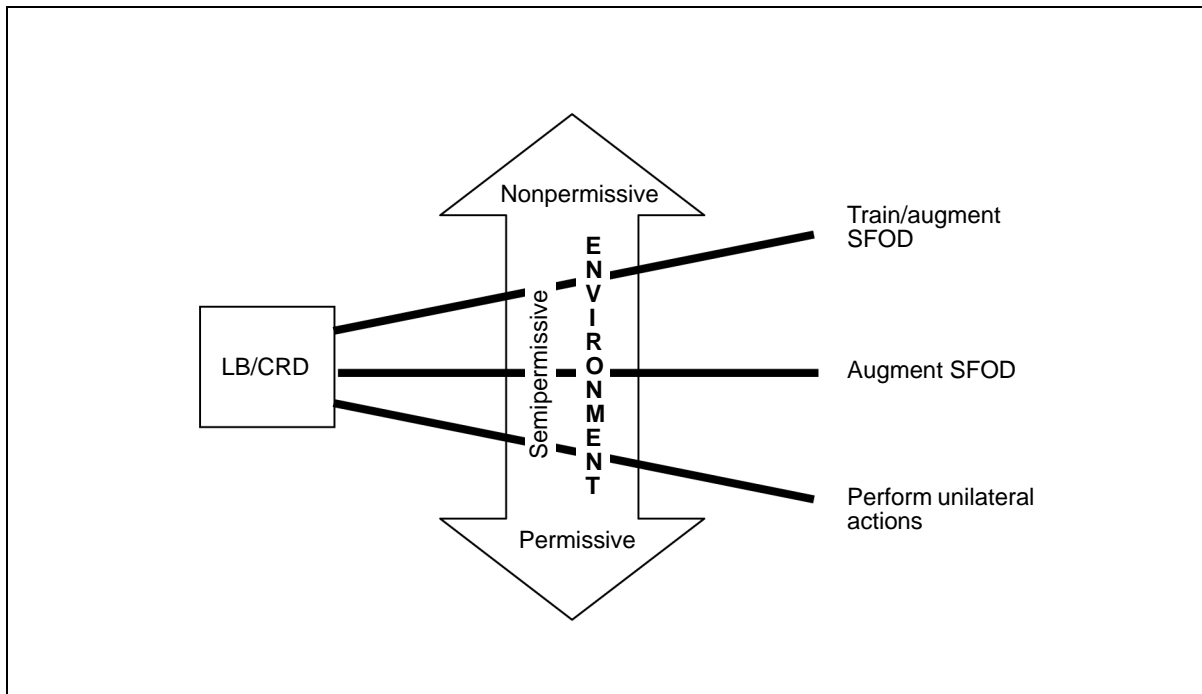

Figure L-3. LB Team/CRD Scope of Employment Within the Operational Environment

c. A CRD provides significantly increased SR activities, including SA, interagency and joint operations, FID, UW, and CT and CP of WMDs. It detects, samples, and presumptively identifies NBC agents.

d. The normal employment configuration of a CRD is to attach a CDR-A to each SF battalion (or forward operating base [FOB]) for a habitual relationship. In this configuration, the headquarters is located at the SFG headquarters or special forces operations base (SFOB) for planning purposes. Other configurations depend on METT-TC. For example, the entire CRD could work together as one organization, possibly for foreign consequence management missions or reconnaissance missions requiring rest plans. In addition, two CRD-As could be task-organized as the main effort, while leaving one SF battalion without a CRD asset. CRD employment is not limited to these options, but planners should strive to maintain a habitual relationship through training or operations.

e. CRD-As can conduct split-team operations when required. This operational doctrine allows them to quickly and efficiently conduct special NBC reconnaissance and surveys of several WMD targets within large special operations areas. CRD-A capabilities include—

- Operations in industrial chemical hazard environments for short durations.
- Support to foreign consequence management operations as directed by regional COCOMs.
- Technical escort in support of consequence management missions.

f. CRD equipment authorizations include common and SOF-unique items. They have the same equipment as their SOF counterparts (SFOD-As) to ensure their interoperability with them. *Table L-1*, page L-10, shows representative equipment authorizations; specific equipment allowances will vary based on the modified table of organization and equipment (MTOE).

7. Communications

The LB team and CRD must maintain secure communications—

- Internally with the FOB, SFOB, or advanced operations base (AOB) in a permissive environment.
- Externally with the supported unit (e.g., SFOD) in semipermissive and nonpermissive environments. The SFOD will dictate communications protocols.

8. Command and Staff Relationships

The SF unit commander has overall responsibility for the LB team and CRD. He provides his staff with his intent, and the staff plans accordingly. The SF unit staff has the following responsibilities:

- **Operations.** The LB team and CRD report to unit operations for planning, training, and budgeting guidance and coordination. This includes planning and employment considerations with the SFG or battalion chemical staff.

Table L-1. Representative CRD Equipment

Communications-Electronics	Detection
Cable, WD-1/TT	CAM
Digital camera (still, video, and audio capability)	CB sampling kit
Interrogator set, AN/PSX-1	Chemical-agent detector, M21
MINTERM, KY-99	Chemical-agent detector, M22
Monocular night device, AN/PVS-14	Radiac meter, AN/PDR-77
Multiband, intrateam radio	Radiac set, AN/UDR-13
Navigation set, GPS	Radiac set, AN/UDR-13
Night vision goggles, AN/PVS-7D	Mobility
Radio set, AN/PRC-126	Truck, utility, HMMWV
Radio set, AN/PRQ-7	FP
Radio set, AN/PSC-5	Adapter rail weapon, mounted, M5
Reeling cable, hand, RL-39	Bayonet system, XM9
Special mission radio, AN/PRC-137F	Carbine, 5.56-mm, M4
Transponder set, AN/PSC-12	Mask, M40, and standard PPE
	Pistol, 9-mm, M9
	Self-contained breathing apparatus (Level A)
	SOF-modified M4
NOTE: This equipment is likely to change or be upgraded due to the SOF rapid-acquisition cycle for government and commercial off-the-shelf equipment.	

- **Intelligence.** Unit intelligence provides all the intelligence needs to the LB team and CRD for planning and execution. Intelligence information includes the locations of enemy units and facilities, confirmed and suspected use of NBC warfare, and enemy intent to use NBC warfare. The intelligence staff also assumes control of special intelligence material and information during deployment and missions.
- **Group chemical staff.** The group chemical staff is the primary advisor to the SFG commander. It advises on CRD capabilities, limitations, and employment considerations and provides general training guidance.
- **Supply.** Unit supply assists with the acquisition, maintenance, and resupply of specialized pieces of equipment needed for operations.
- **Group support company.** The group support company provides administration, personnel services, and all classes of supply. The CRD is attached to the group support company.

9. Prepermission Activities

a. The keystone of SOF prepermission planning is the operational element that plans and executes the mission. The inherent qualities of special operations involve detailed planning and foresight. The intelligence preparation of the JSOA is critical when an operational area contains an NBC threat.

b. Training requirements are extensive. Each unit member possesses the skills necessary to conduct special NBC reconnaissance in permissive, semipermissive, and nonpermissive areas. Each unit member can operate authorized equipment for suspected

agent detection, identification, and sampling. Unit personnel operate for extended periods in full NBC PPE.

c. Additionally, CRD personnel have the technical escort additional skill identifier (J5) and are ranger-qualified. They can conduct technical reach-back to selected agencies and provide details on agent characteristics and threat WMD systems. They do this through requests for information, primarily during the planning phases of a mission. Requests for information may also be submitted during or after mission execution, if required.

d. *Figure L-3*, page L-8, shows the employment ranges from unilateral missions in permissive regions to augmentation in semipermissive or nonpermissive (denied) special operations areas. The COCOM may determine augmentation of an SOF unit with an LB team or CRD, or the SOF unit may determine a requirement for augmentation. The C2 relationships integrate the LB team or CRD into the normal SFOD C2 scheme. In all environments, the LB team or CRD can be attached or in OPCON to a SFOD, JSOTF, coalition JSOTF, SFOB, FOB, or AOB.

e. Once assigned to an SFG, a CRD soldier receives the required orientation, cross training, field craft, and survival training that enable the team to infiltrate and perform as a member in all environments. Training requirements demand a high level of physical fitness, airborne qualification, and a high degree of motivation. Unit personnel conduct specific, area-oriented SF training to enable them to integrate their operations into those of the SFOD.

f. In addition, the team conducts advanced technical training that enables it to carry out its unique tasks. The advanced technical training requires refresher training at regular intervals to sustain team proficiency. The group chemical officer and NCO monitor and assist in the technical, tactical, and professional development of CRD personnel.

g. LB team and CRD unit personnel require sufficient training in selected SF (18-series military occupational specialty [MOS]) tasks that allow them to function in a semipermissive or nonpermissive environment with an SFOD or other SOF element. The LB team and CRD also conduct training according to the SFG area orientation.

h. NBC technical training covers conventional and special NBC reconnaissance training, CB sampling techniques, detection techniques, field identification procedures, technical escort tasks, and NBC technical observation and evaluation skills. The team/detachment has the latest technical field equipment available from government agencies or commercial sources.

i. Every team member is qualified in special NBC reconnaissance TTP. For example, unit personnel are trained on the details of safe sampling and detection of known or suspected toxic materials and radiological agents, such as NBC contaminants and environmental samples of suspected contaminated air, soil, water, and vegetation. The training also includes procedures for taking background and control samples. Team/detachment personnel also train in confined-space and target entry techniques for civilian and military operations (TIM and NBC agents).

j. Team/detachment members help SFODs prepare a target analysis matrix, which is also known as a CARVER (criticality, accessibility, recuperability, vulnerability, effect, recognizability) report. They train SFODs on the skills required to conduct a technical evaluation, or they augment an SFOD and provide observation and

identification, as required, of preplanned objectives for inclusion in the CARVER report. Therefore, detachment/team members must be able to observe and evaluate the activities and resources at CB agent production and storage sites. Unit personnel gain the necessary information by going to and studying the various chemical weapons demilitarization facilities, chemical weapons storage sites, and CB defense research facilities and by conducting in-depth area studies of SFG target areas.

k. This paragraph identifies the various stages of a team/detachment mission. Since a team/detachment may augment an SFOD, the team/detachment NBC officer must integrate his mission planning cycle into the SFOD planning cycle. During mission planning, the CRD/CRD-A will be integrated into all aspects of the SFOD plan as appropriate (see *Table L-2*).

Table L-2. Sample Mission Tasking and Planning Process

Step 1. The SFG receives a mission from the JSOTF via a mission tasking.
Step 2. The SFG commander and his staff, including the chemical staff, conduct a brief mission analysis and further delegate the mission tasking to an FOB commander. The SFG attaches a CRD-A to the FOB if it is not already attached.
Step 3. The SFG gives the CRD a WARNORD of the mission and requirement for a CRD-A. The CRD commander determines which CRD-A will report to the FOB if it is not already attached.
Step 4. The FOB commander, his staff, and selected SFOD-A prepare a MICON and send it to the SFG commander for approval.
Step 5. The CRD-A reports to the FOB and its supported SFOD-A for mission planning. This planning is normally done in isolation.
Step 6. The SFOD-A and CRD-A determine the level of effort that is required by the CRD-A during mission planning. They plan and prepare to execute the mission.
Step 7. The SFG normally returns the MICON approval to the FOB during mission planning.
Step 8. The plan is briefed to the FOB and SFG commander during a "brief back" at the end of the mission planning. This is where the NBC staff, including the CRD commander can check the plan.
Step 9. Any remaining CRD-A members who took part in the mission planning phase remain in isolation until after mission completion if only portions of the CRD-A accompany the SFOD-A into the JOA. This ensures that OPSEC is maintained.

(1) Just as conventional units task-organize to perform specific missions, SF commanders also task-organize SFODs in response to mission requirements. SF mission taskings that require the capabilities of an LB team/CRD-A may need the assistance of only one or two NBC reconnaissance team members. SF commanders tailor their force to the mission requirements and constraints.

(2) When tasked to execute a specific mission, the LB team/CRD-A moves to the isolation facility. If the SFOD requires augmentation, the LB team/CRD-A links with the employed SFOD-A in the isolation facility. The LB team and the SFOD-A jointly complete existing plans or conduct deliberate mission planning. The LB team/CRD-A task organization is established. The combined team—

- Receives operational intelligence briefings.
- Refines the execution plan based on the actual situation.
- Conducts required specialized training.
- Requests and receives specialized mission-specific equipment.

- Rehearses the combined team activities.
- Resolves legal or policy issues concerning the mission.
- Commits the details of the mission to memory.
- Prepares a written OPORD.
- Prepares individual and team equipment for infiltration.
- Develops requirements for intelligence to send forward and monitors the progress for inclusion in planning.

(3) After the SFOD receives the mission statement, the SFOD commander and the LB team or CRD-A commander provide the supported commander with a short, informal mission concept (MICON) brief, which is forwarded to the tasking headquarters. The MICON brief ensures that the planning efforts meet the supported commander's intent. When the MICON is approved and the planning is complete, the SFOD-A and LB team or CRD-A commanders give the supported commander and his staff a mission back brief (*Table L-3*, page L-14). The SFOD-A and LB team or CRD-A modify their plan, if required, after the back brief. Finally, the LB team or CRD-A prepares accompanying supplies and equipment for infiltration.

1. There are multiple factors to consider as the LB team or CRD-A plans its mission. *Table L-4*, page L-15, is a checklist that contains sample considerations for the various phases of an assigned mission.

10. Mission Activities

a. Commanders may order the collection of material and environmental samples for support of intelligence and operational requirements, such as evidence that an attack has occurred, field identification of agents used, degradation of products or delivery systems, and the agent nation of origin. Sampling operations are particularly important if a threat uses a previously unknown agent or a CB agent first. Therefore, the collection of samples and background information must be as detailed and comprehensive as possible. CRDs may use photographs to help make the background information comprehensive.

b. Threats may also use radiological agents to restrict the use of terrain and to cause delayed casualties. Further, residual radiation can potentially cause high dosages for those who operate in the contaminated area. The team may collect samples to verify use and identify radionuclides.

c. Special NBC reconnaissance tasks include conducting sampling operations, providing NBC-related technical evaluation and observation, and providing advice and training on special NBC reconnaissance skills. The data from sampling operations supports the IPB process and directly relates to ongoing and future operations. Real-time data transmission and sampling supports—

- Collecting and providing baseline bioenvironmental samples for background levels of indigenous biological material in a given area.
- Collecting and identifying suspect CB samples (chemical, biological, biomedical, environmental [soil, air, liquids, vegetation]) and anatomical samples from animals or suspect contaminated animal specimens.

Table L-3. Outline for a Mission Back Brief

Responsibility	Item to Brief
Commander or NCOIC	Purpose
	Mission
	Higher commander's intent
	Detachment commander's intent
	Responsibilities
Operations Sergeant	Concept of operations
	ROE
	Infiltration plan (if different than the SFOD-A plan or if only into the target area from the objective rally point) <ul style="list-style-type: none"> • Point of no return • Contingency plan • Primary and alternate points of entry • Contingency plan at entry points • Assembly plan
	Primary and alternate points of entry
	Disposition of excess items <ul style="list-style-type: none"> • Contact points (primary, alternate, and contingency) • Movement plans
	Actions from points of entry to the contact site
	Actions from the contact site to the operational area <ul style="list-style-type: none"> • Security plans • Actions at the objective
	Specific duties of the technical team, the sample recovery team, and other specialized teams <ul style="list-style-type: none"> • Withdrawal • Linkup or exfiltration plan (primary, alternate, and contingency) • Training plan
	Tentative plan to train indigenous force
	Program of instruction (individual, collective, and leader)
Supply Sergeant	Supplies and equipment
	Special mission equipment issued to the LB team
	Cross-load plan
CRD/LB Commander or NCOIC	Closing statement
	Readiness posture of team
	Unresolved issues and concerns
	Questions
NOTE: This outline is for LB team and CRD topics and activities. The format must be coordinated with the SFOD-A briefer.	

Table L-4. Checklist for Mission Considerations

Prelaunch	
r	Receive pretreatments and prophylaxis.
r	Prehydrate during planning phase (most likely you will not be able to stay hydrated during operations).
r	Bring additional food and water for en route time, return trips, and possible delays.
r	Bring additional ground ensembles and masks.
r	Consider weather conditions (humidity [for persistent agents], wind direction, and temperature) and the time of day that may effect NBC use while en route and at the site.
r	Be prepared to wear some sort of undergarment to allow for bodily functions.
r	Ensure that necessary medical pretreatments, barrier creams, prophylaxis, decontamination kits, and professional gear are accessible after donning PPE.
r	Coordinate the disposition of contaminated equipment after the mission.
r	Coordinate decontamination line procedures for everyone involved.
En Route	
r	Ensure time for detector warm-up and purging.
r	Conduct background checks.
r	Establish mission support sites.
r	Avoid known areas of NBC use (upwind) if possible.
Infiltration/Exfiltration	
r	Determine if the location is contaminated.
r	Decontaminate personnel and equipment as soon as possible (threat may dictate otherwise).
On Site	
r	Report the status.
r	Coordinate security.
r	Conduct sample preparation and packaging.
r	Initiate sample chain of custody.
r	Maintain documentation (photos, logs, locations, weather, background).
r	Perform protection and documentation actions.
r	Maintain a low signature.
Recovery	
r	Determine if the element is returning with a known contaminant.
r	Check detectors.
r	Coordinate the recovery location with all units arriving at the same location.
r	Coordinate decontamination lines and standard life support procedures with all units at the arrival location.
r	Maintain sample chain of custody.

- Collecting radiological samples, such as radioactive dust particles, pellets, or industrial waste spread throughout an area.
- Providing preliminary identification of chemically contaminated samples and presumptive identification of biological samples.

NOTE: See Appendix E for an overview of CBR sampling operations.

d. The LB team/CRD may augment an SFOD conducting a unilateral collection mission, such as technical observations to support surveillance of known or suspected NBC facilities in hostile areas where the threat precludes the use of other human

intelligence means. The LB team/CRD provides NBC technical training to an SFOD if mission requirements prevent augmentation.

11. Postmission Activities

a. Information gathering is the goal of NBC reconnaissance operations. After completing special NBC reconnaissance mission tasks, the team/detachment quickly exfiltrates to an isolation facility or other secure area for postmission activities. Postmission activities include a debriefing, after-action report (AAR), reconstitution, recovery, stand-down, and regeneration. Command emphasis is essential to the success of postmission activities.

b. The team/detachment has SOPs for postmission debriefings, which ensures that all the needed information is provided. If the LB team/CRD is part of an SFOD, its debriefing is integrated into the operational detachment debriefing. A debriefing has two primary purposes—

- To review the information developed by the team at mission completion. This allows the team to expand on what it has already reported, adding details to fill in the gaps.
- To review the total operation, from planning through extraction. This allows the team to pinpoint what worked, what did not work, and how to make it better.

c. The deploying headquarters should conduct a debriefing immediately after extraction to cover what has to be disseminated immediately. Within 2 hours of extraction, the deploying headquarters should begin a detailed debriefing of the SFOD and CRD-A/CRD. Intelligence personnel should direct the debriefing, if possible. The deploying headquarters operations section should have tracking maps, the team mission profile folder, the team journal, team messages, and debriefing formats on hand. The team should complete a written debriefing in the format provided by the deploying headquarters before starting the formal debriefing. The communications NCO should debrief radio-telephone operators. Aircrews and drivers should be debriefed after an insertion or extraction. One copy of the debriefing should go to higher headquarters, and a copy should be included in the unit historical records.

d. After the debriefing, the detachment commander (with the assistance of other members of the LB team/CRD) prepares the AAR. The AAR states the “who, what, where, when, and how” of the operation. It is a permanent record of major team activities, from isolation to debriefing. As such, it is an extremely important template on which past missions may be compared and future missions planned. If the LB team/CRD was part of an SFOD mission, the AAR should be integrated into the operational detachment AAR. Whether the LB team/CRD conducted missions as part of an operational detachment or unilaterally, the AAR is submitted to unit operations and forwarded through command channels to the commander not later than 48 hours after the LB team/CRD has been debriefed. The intelligence officer at each echelon maintains copies of the LB team/CRD AAR.

e. Follow-on missions may be conducted, but are normally an exception. The LB team/CRD may perform follow-on missions under the following conditions:

- The follow-on mission—

- - Becomes a new, separate mission.
 - Allows for additional planning time.
 - Does not compromise the main mission.
 - Does not go beyond the capability of the LB team/CRD.
- The LB teams/CRD have trained for the follow-on mission and have the mission-specific equipment required.
- The LB team/CRD, when going into isolation, understands that there may be a “be-prepared-to” follow-on mission at the time they receive the mission letter/briefing.
- Follow-on mission supply pallets and door bundles should be constructed for possible future missions prior to infiltration.

Appendix M

ADVANCED STANDOFF CHEMICAL DETECTOR

1. Background

CAUTION

Standoff chemical detectors may not detect low levels of TIM and should not be relied on as an indication that an area is clear.

a. Advanced standoff chemical detectors rapidly detect and identify the presence of CW vapors. (See the unit staff chemical officer for range detection distances.) They contain several improvements over the M21 remote-sensing, chemical-agent alarm. Advanced standoff chemical detectors—

- Detect nerve-, blister-, and blood-agent vapors and can be programmed to detect a wide variety of other chemical vapors, including some TICs.
- Provide 360° coverage.
- Will work on the move at speeds up to 56 kilometers per hour (kph).
- Employ a passive infrared system that detects the presence or absence of chemical agents by completing a spectral analysis of target chemicals.

b. Some detectors can operate from a tripod-mounted platform or be integrated into mobile reconnaissance platforms, where the results can be communicated to local and remote personnel via C2 systems. The tripod-mounted variant is intended to operate in the operational field environment at static, designated locations and ground fixed-site locations near or around ABs and ports. With integration into a mobile reconnaissance platform, detectors can also be positioned in a covered and concealed location with maximum LOS to designated key terrain. *Figure M-1*, page M-2, provides information on performance parameters.

c. Advanced standoff chemical detectors have the following constraints:

- **Networking for remote operation.** A detector can be networked to provide remote operation. Multiple alerts and information are displayed on a single screen, allowing the operator to easily triangulate the actual hazard location. This can only be done when an effective communications network exists.
- **Locating the hazard.** A detector reports the direction of a hazard based on the relative bearing from the scanner position. It reports the right and left limits, elevation, and declination of a hazard, but does not provide the distance from the scanner or the depth of the cloud.
- **Tracking the hazard.** A detector reports the movement of a hazard as scans are updated in the search mode. Each detection and subsequent alert is treated as a separate event. Tracking the cloud is only provided when triangulation is available. Additionally, the detector may not detect low-level emissions, such as something leaking from a container.

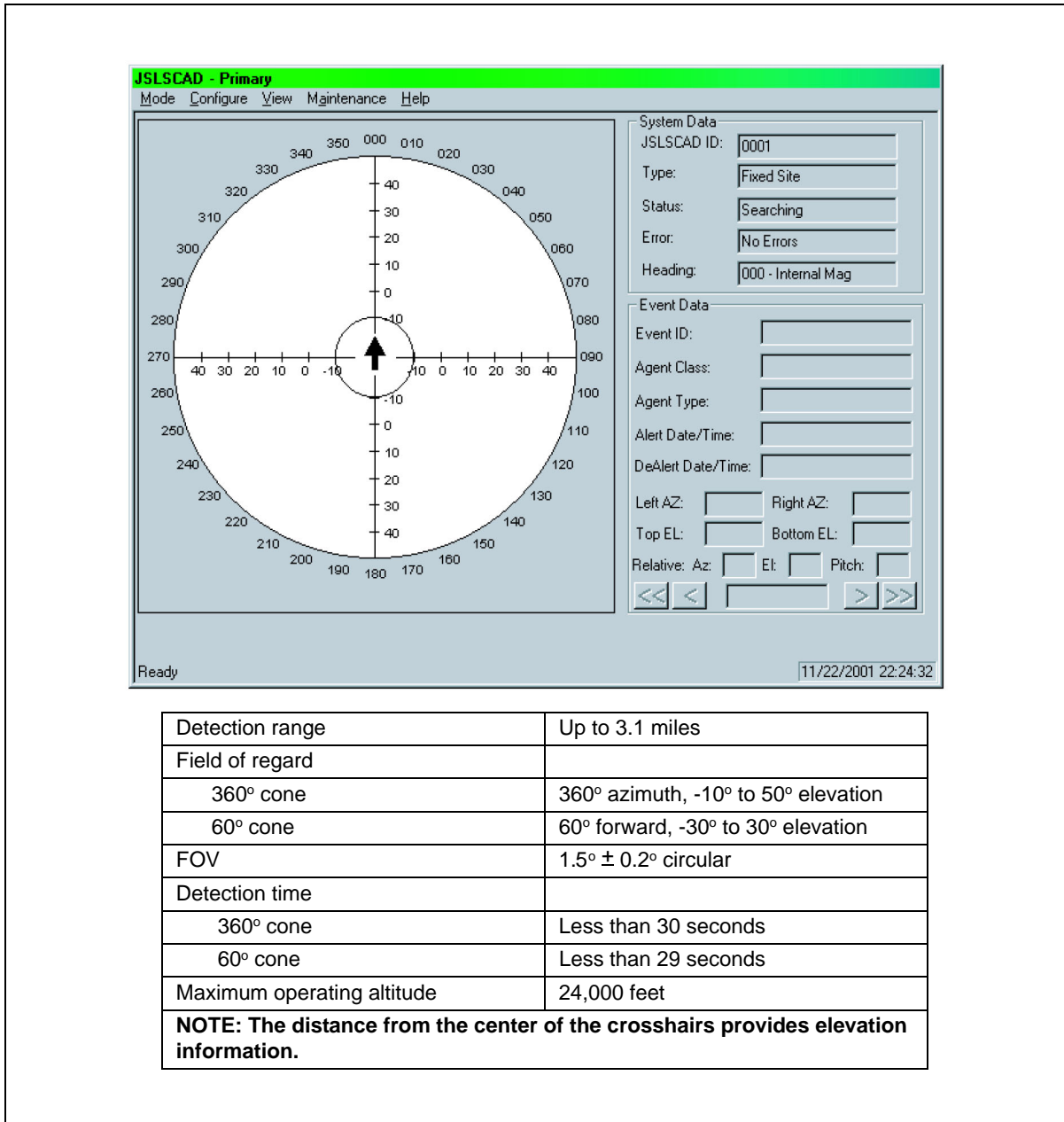

Figure M-1. Advanced Standoff Chemical Detector Performance Parameters

- Detecting cloud formations.** A detector is designed to detect clouds containing selected CW agents in vapor form. The operator must be aware of how the weather impacts the system. For example, a cold or frozen agent may not produce enough vapor to be detected, rain may interfere with detection, and detection of some agents (e.g., blood agents) may only occur within 5 kilometers due to agent volatility.

2. Concept of Operations

Advanced standoff chemical detectors allow war-fighting commanders to monitor the battlespace for CW agents. During periods of increased tension, detectors will be deployed at fixed sites, as mobile detection systems on and around fixed sites (such as main and collocated operating bases), or in support of maneuver units. They will be positioned to maximize detection in designated areas, and they can also be used in an overlapping FOV to provide triangulation and tracking of a cloud. Advanced standoff chemical detectors—

- Monitor AAs and egress routes.
- Search areas between friendly and enemy forces.
- Monitor bridges, road junctions, and other point targets.
- Monitor barriers, such as minefields, obstacles, and chokepoints.
- Cue and vector NBCRVs to or around suspected hazard areas.
- Provide advance detection and warning (i.e., area surveillance or unit defense) of hazards to units located adjacent to favorable terrain (i.e., having adequate LOS).

a. Operation Modes. Advanced standoff chemical detectors can be operated in two modes—vehicle-mounted and tripod-mounted.

(1) Vehicle-Mounted. The detector is integrated into a mobile reconnaissance platform. NBCRVs equipped with an advanced standoff chemical detector should be positioned with maximum LOS to designated key terrain.

(2) Tripod-Mounted. The detector is powered by an auxiliary power unit that is serviced and refueled as needed. The detectors may be interfaced with a warning and reporting network to transmit detection information to an operations center. After the detector is positioned, a terrain sketch is prepared to indicate the LOS. The information is then correlated with terrain data at the operations center to provide cloud location information. The operations center periodically interrogates the detector to ensure that the system is functioning properly. Every effort should be made to maximize the FOV of the standoff detector. Mounting it on a building roof or another elevated structure is encouraged to improve visibility. Standoff detectors have a declination angle of 10°, so ensure that they are not so far off the ground that coverage is limited in critical areas.

b. Mobile Employment.

(1) Where possible, advanced standoff chemical detectors will be employed in pairs (two reconnaissance teams) so that one team can use the detector in an overwatch position while the other team is moving. The detector is powered up while the vehicle is moving so that scans can be made at short halts without the need for instrument warm-up. The detector can be moved by the reconnaissance vehicle at a maximum speed of 56 kph. The detector moves in 1,000-meter intervals and stops for about 2½ minutes to gather data at each point. If it indicates the presence of vapor hazard, the reconnaissance

team uses remaining onboard detectors to determine the extent and type of contamination present.

CAUTION

The maximum speed (56 kph) may exceed the safe speed of the vehicle over certain types of terrain. Never plan a reconnaissance to exceed the maximum safe speed of the vehicle for the terrain being traversed.

(2) Advanced standoff chemical detectors are used on mobile reconnaissance platforms to conduct reconnaissance in the following roles:

- Identifying potential routes that contain a vapor hazard.
- Providing overwatch for vapor hazards while other mobile reconnaissance platforms search for liquid hazards.
- Searching an area that units want to use (e.g., assembly area) to determine the presence of vapor hazards.
- Performing a secondary role to provide warning of off-target vapor attacks at fixed sites that have suitable conditions for employment.

(3) In determining the exact location of vapor hazards, there are different types of chemical agents (such as GB and thickened GD, VX, and HD) that produce varying amounts of vapor, depending on agent characteristics and weather conditions. Additionally, standoff chemical detection provides only the direction of the hazard, not distance information. To determine the actual location of a hazard, the unit can use various techniques.

(a) Single System. A single reconnaissance platform (*Figure M-2*) can take information from multiple detections and perform the map resections on all detections. This method can be effective when the wind speed is less than 10 kph for a point release.

(b) Multiple Systems. Information from multiple reconnaissance systems (*Figure M-3*) can be combined. Using the direction of the left and right limits, a resection is performed on a map indicating the location of the hazard. This is the preferred method, especially when wind speeds are in excess of 10 kph, which creates a moving hazard. This method effectively locates point releases, such as a surface-to-surface missile system (SCUD) impact or a limited artillery strike, but is less effective against a line release.

(c) Cueing and Vectoring. A reconnaissance system can follow the direction provided by the detector, vectoring in on the location. Other onboard sensors (such as the automatic, chemical-agent detector and alarm or the CB mass spectrometer) will alarm when contact with the hazard occurs. This is the least preferred method since it is the most time-consuming and provides very little useful information. It provides leading-edge information for one point only and may not be a true representation of the larger picture. Cloud locations can quickly change, and the detector operator may have difficulty detecting movement when he is in contact with the cloud. Cueing and vectoring may be used to locate off-gassing from ground contamination, allowing a reconnaissance platform to begin a survey and determine the limits of the ground contamination.

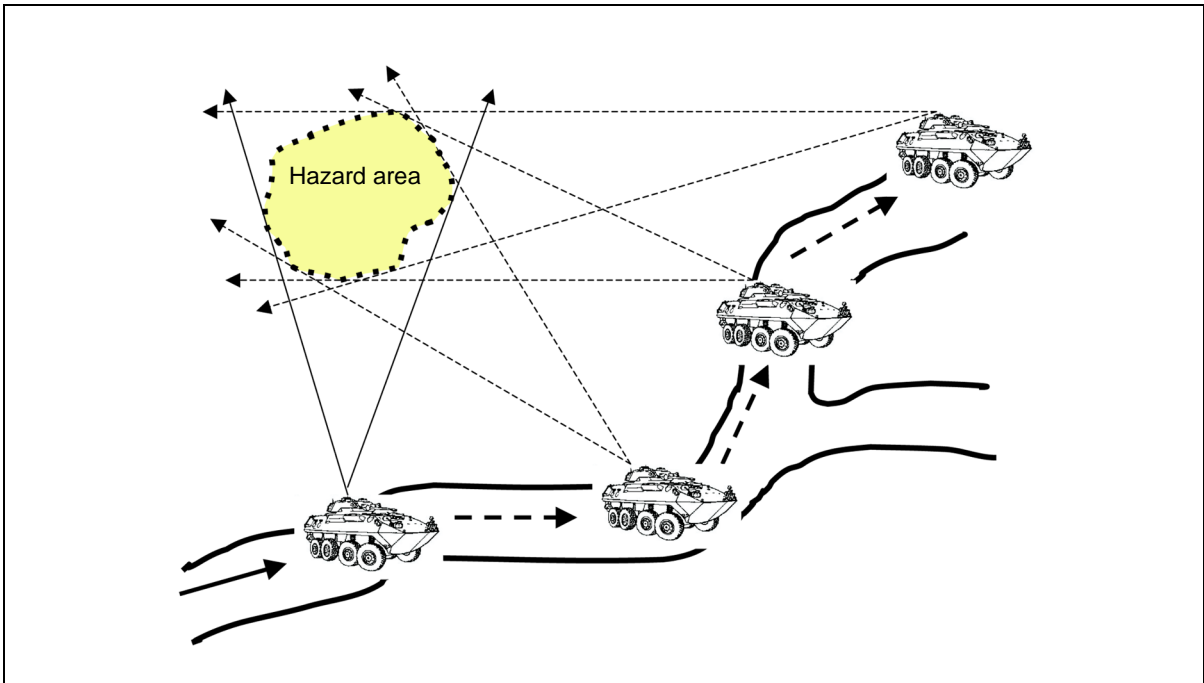

Figure M-2. Single-System Detection Technique

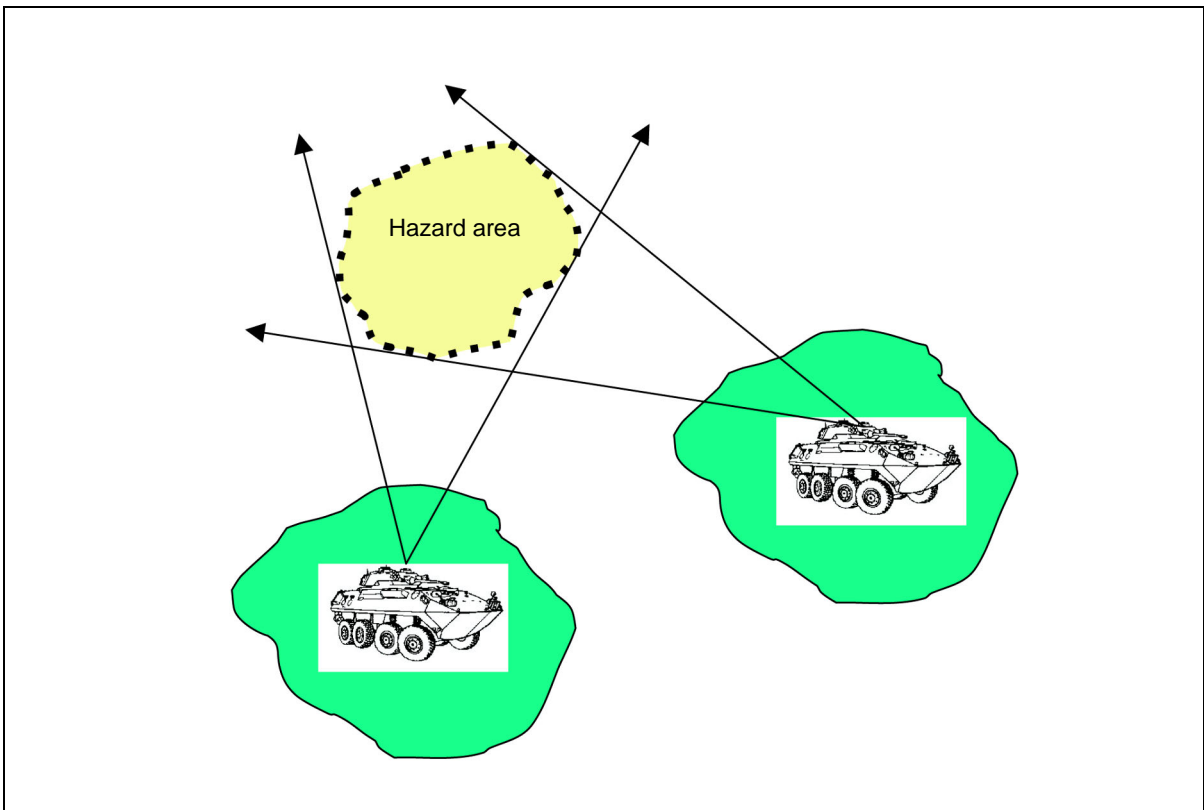

Figure M-3. Multiple-System Detection Technique

c. Reporting Information. The unit should use an NBC 1 report to transmit standoff detection of a chemical agent. Current and future standoff detectors should provide the agent type, the right and left limits of vapors, and the elevation and declination of vapors. Existing standoff detectors do not provide the distance to the cloud, which means that the specific location of the hazard is unknown. Near-term detectors may provide the distance to the initial edge of the hazard, but they will not provide the total depth.

d. Fixed-Site Tactical Employment.

(1) The tripod-mounted, advanced standoff chemical detector can be employed as a networked or stand-alone detector. As a point detector, it indicates the onset or arrival of chemical agents. Employment of the detector should ensure good visibility of upwind areas of operating forces to detect attacks and allow the commander sufficient time to take immediate action.

(2) Advanced standoff chemical detectors may be employed at airfields, forward facilities, logistics bases, rear area CPs and headquarters (fixed sites), and port facilities. They may also be used to detect chemical agents and provide early warning around MSRs and other LOCs.

(3) The distance between detectors is based on the terrain and the threat. The distance between the fixed site and the detector is based on the terrain, the size of the area to be covered, the radio transmission range, the desired warning time, and METT-TC.

(4) Fixed-site installation of detectors should exploit available terrain and infrastructure to the maximum extent possible. Buildings and other high ground should be exploited to improve visibility and limit uncovered areas hidden behind other structures. Power converters may be used to capitalize on the electrical or generator power available.

(5) At least three detectors are required to conduct a reliable map resection and provide the cloud location (*Figure M-4*). If only two systems are used or if all three systems are placed in a straight line, the cloud location cannot be determined in many situations.

(6) Information provided by an advanced standoff chemical detector is used by the NBC center, cell, or SRC staff to help determine the status of the installation before, during, and after an attack. The detector provides detection and warning information, and the input supports recommendations on appropriate modifications to FP and MOPP levels. The advanced standoff chemical detector provides near real-time stationary and on-the-move detection of chemical agents. The operator display unit provides a visual display for the detection. The data fields provide the azimuth to the cloud, the cloud height, the date and time of detection, and the type of agent detected (*Figure M-5*).

e. TICs. TICs confront personnel from fixed-site storage and production facilities and from mobile sources, such as pipelines and tanker trucks. The ability to detect significant releases of TICs at a distance, especially those with the ability to penetrate protective masks, is very valuable. Standoff chemical detectors detect a very limited number of TICs. The *fingerprint* or *spectra* required for detecting a specific chemical can be individually loaded onto a system as needed. If it suspected that a facility contains TICs that a standoff chemical detector has been programmed to detect, reconnaissance

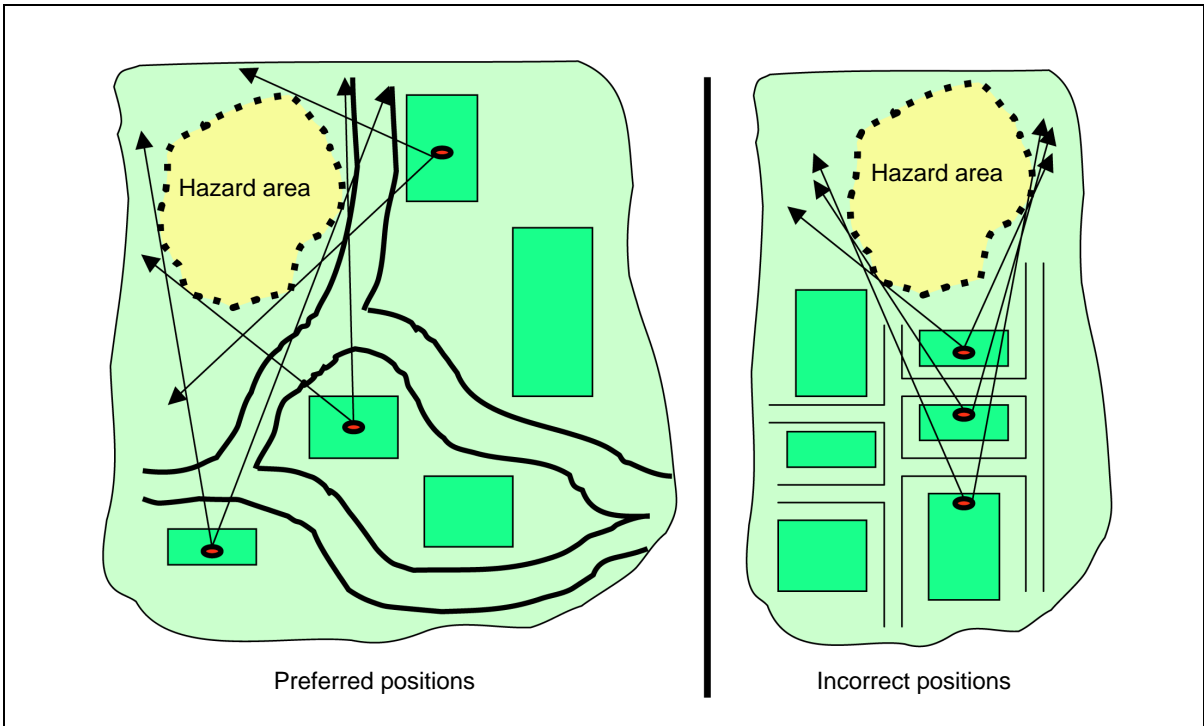

Figure M-4. Positioning Detectors at Fixed-Site Locations

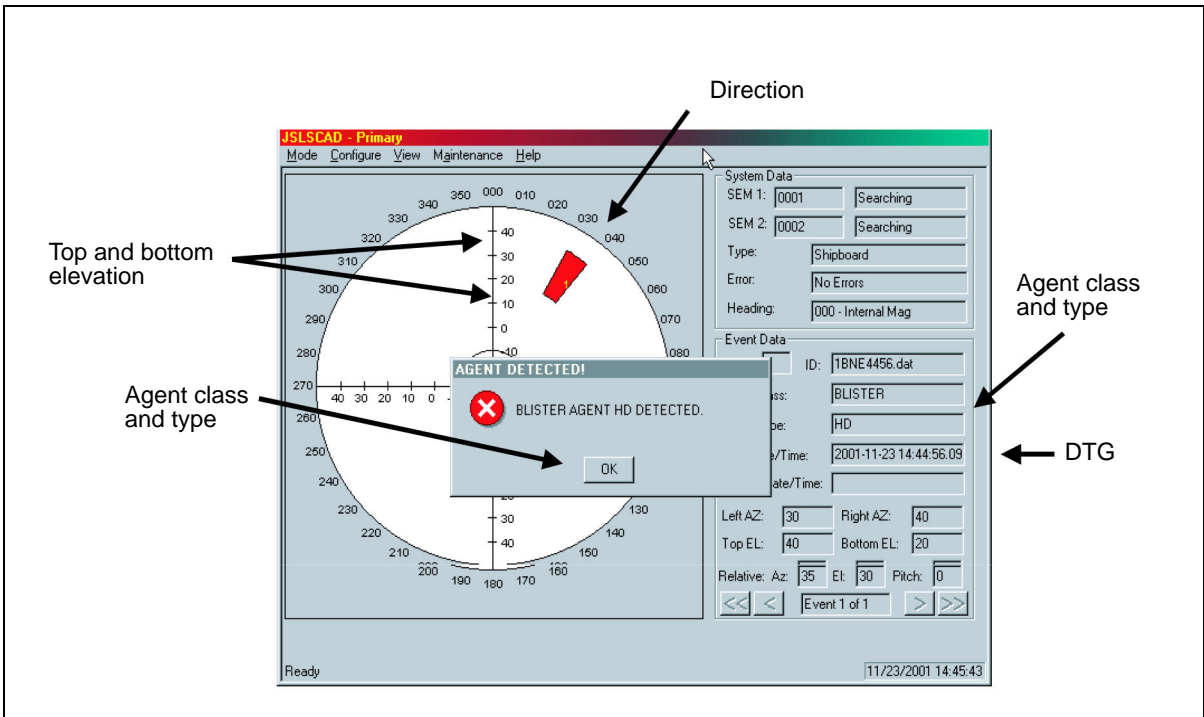

Figure M-5. Operator Display Unit Indicating Detection of a Blister Agent

can be performed from a mobile platform or the facility can be monitored from a static location.

CAUTION

Standoff chemical detectors do not determine if an area is low in oxygen (depleted oxygen environment). Use extra caution when dealing with enclosed areas or very large amounts of chemicals.

3. Air Base Fixed-Site Employment

a. Introduction.

(1) Because of their passive nature, advanced standoff chemical detectors cannot provide the specific location, tracking (movement), or distance to the leading or trailing edge of the detected cloud. To maximize the effectiveness and provide this information, triangulation with two or more detectors can be used. To perform triangulation, the fields of the detectors must cross or overlap. The basic detection grid could require four detectors to provide coverage for a small installation (about 1,500 by 2,500 meters). A larger installation (3,000 by 500 meters) would require about six to provide coverage.

(2) Installation size is only one factor in determining the required number of detectors. FOV is another factor that could effect the number of detectors required. Standoff detectors must be positioned so that they have an unobstructed FOV. This may require elevating the detector scanner or sensor electronics module to a height that provides a clear view of the horizon. Tall or large structures (such as dormitories, hangars, and fuel tanks) can obstruct the FOV. Terrain features (such as mountains, hills, and valleys) may also obstruct the FOV. These factors must be considered when locating the detector so that blind areas are minimized and the overlapping of detectors is maximized to ensure adequate coverage of the fixed site through point or area surveillance.

(a) Point Surveillance. Point surveillance is conducted for a specific period of time and oriented or focused on key terrain located on or off the installation or base property. For example, the detector would be focused into the wind or toward an area of concern. The detector defaults at 360° and can be adjusted to focus on specific areas of concern, thereby reducing the reaction time to agent threats.

(b) Area Surveillance. Area surveillance provides warning to friendly units, allowing them to avoid contaminated areas before they pose a hazard to resources. It may be conducted while positioned around the AB perimeter. On-the-move area surveillance can be conducted if a mobile reconnaissance platform is available.

b. Vehicle-Mounted Employment.

(1) Single System. A single system provides a 5-kilometer LOS (10-kilometer diameter) circular ring of coverage around an employed site. In this situation, the system should be located as close as possible to the center of the AB with an unobstructed field of regard. The information provided by a single system is based on the location of the detector and limited to the relative azimuth, elevation, and pitch of the cloud.

(2) **Multiple Systems.** Multiple systems, configured with an overlapping field of regard, provide the ability to gather cloud location and tracking information when the data is plotted on a grid map. Vehicle-mounted detectors are positioned strategically around the AB as close to the perimeter as possible. For example, three systems could be placed upwind of the base airfield, and a fourth system could be positioned strategically on the base. Four systems provide a sensor perimeter (scanning diameter) for each system and provide an outer perimeter (overall diameter) for the combined field of regard. As the individual fields of regard bisect, the detection event data from individual systems can be analyzed to provide triangulation. Triangulation occurs when the fields of regard of two or more scanners bisect or overlap. Triangulation is not performed by the system software or computer interface; it must be performed manually by plotting the detection information from each detector on an installation or area map. The process of establishing a triangulated pattern is accomplished by separating two or more detectors by approximately 1,000 meters and focusing the field of regard so that they cross.

c. **Tripod-Mounted Employment.**

(1) A tripod-mounted system can be used in and around fixed-site installations to optimize the sensor FOV and to overcome obstructions from buildings and equipment. Key definitions that must be understood for fixed-site elevation include—

- **Sensor height.** Sensor height is the elevation at which the sensor is placed on the ground, building, or equipment to provide an unimpeded field of regard or clear LOS.
- **Ground intersect.** Ground intersect is the distance from the system that the lower tangent of 10° will intersect the ground. The ground intersect is representative of the distance from the detector that will not be viewable in the field of regard. Always consider the ground intersect when elevating the system.

(2) To execute fixed-site elevation of advanced standoff chemical detectors, assess the following factors:

- **Survey.** Examine the perimeter of the installation to determine potential limiting factors. This includes determining the presence of topographical or structural blockages. Survey off-site areas up to 5 kilometers away to ensure that an unobstructed field of regard is provided to each detector.
- **Site preparation.** Prepare each detector position or site according to the paragraph 2d. Include mounting brackets or tripods needed to affix the detector to the site.
- **Elevation.** Consider using the roofs of existing buildings or structures to elevate the system.

(3) The operator display unit provides detection information based on a single detector. Triangulation is the plane formed when connecting data from two or more detectors. To conduct triangulation, determine the location of each detector and plot the locations on an installation or area grid map. The location can be determined by measuring from the detector to two known points, such as buildings or other structures. A GPS can also be used to determine the exact detector location.

4. Aerospace Configuration

Advanced standoff chemical detectors can be operated with low or mid-level aerial platforms (such as unmanned aerial vehicles) and with aircraft (such as MH-53J/M, AC-130H/U, MC-130E/H/P variants, and CV-22). These aircraft are usually tasked for insertion, extraction, direct action, BDA, low-level refueling, or combat search and rescue and are typically employed without additional airborne support assets. The threat to aircraft from chemical contamination is greatest at low altitudes (below 1,000 feet above ground level) and while operating into and out of airfields. Downward-looking aerial application of standoff detection has the added value of determining cloud location.

5. Maritime Configuration

Information obtained from the advanced standoff chemical detector can be used by the commander for contamination avoidance maneuvers. Onboard ship, the detectors replace the AN/KAS-1 CW directional detectors. The joint-service, lightweight, standoff chemical-agent detector will be used on ships, on boats, on rotary-wing aircraft, and in various expeditionary (beach reconnaissance) and base applications.

a. Surface Combatants, Command Ships, Aircraft Carriers, and Amphibious Ships. These ships have two detectors with overlapping fields of regard to assure improved coverage. The operator display unit is located on the bridge and in the combat information center. The detectors are primarily operated from the combat information center, allowing remote control and visual display of information (agent type and location) via the operator display unit. The operating system passively and continuously scans the field of regard (total search area of 360° azimuth, -10°/+50° vertical). Upon detection of a chemical agent, the detector provides a local chemical-agent warning and directional data. The information provided by the detector is evaluated with intelligence, radar, electronic-warfare sensors, lookouts, and other sensors and available information to determine and correlate threat bearings displayed on the operator display unit. The officer of the deck or the tactical action officer take evasive maneuvering actions, increase protective levels, reconfigure ventilation systems, and activate countermeasure washdown systems as appropriate.

b. Mine/Countermine Ships. These vessels may have one or two sensors to provide coverage.

c. Amphibious Readiness Groups. Each deployed assault craft unit detachment with landing craft units is equipped with two detectors, but they are not permanently mounted. They are available for use if intelligence sources indicate the possibility of contamination on the objective beach. Landing craft units are equipped with mounting brackets and are the primary platform for beach reconnaissance missions.

d. Aircraft. The standard manned aerial configuration consists of a forward-looking sensor module mounted on an exterior hard point of the aircraft. The module interfaces with the operator display unit via a direct connection and associated power cable. The operator display unit is mounted inside the aircraft, away from the cockpit area. The detector scans a 60°, forward-looking cone and provides early warning of contamination and hazard areas that allows appropriate and timely aircrew responses. If a positive reaction is noted, a chemical-agent warning is provided locally to the aircrew chief via the operator display unit.

e. Selected Naval Installations. Advanced standoff chemical detectors will be deployed at various points around the facility according to terrain in order to provide overlapping detection areas that provide the facility 360° coverage.

f. Ashore Expeditionary Forces. Naval construction battalions, naval beach groups, naval beach masters, and amphibious construction battalions deploy joint-service, lightweight, standoff chemical-agent detectors to provide detection while operating in forward-deployed and expeditionary areas where there is an indication of the potential use of chemical agents.

g. Naval Special Warfare (NSW). Advanced standoff chemical detectors installed on NSW watercraft receive one sensor with a forward-looking field of regard. The sensor has about 180° azimuth extent and is capable of high-speed operations (0 to 60 knots). The remaining detectors assigned to NSW teams and combat support teams are portable and tripod-mounted.

h. Medical. Advanced standoff chemical detectors are used by fleet hospitals. They are employed on a four-point system to achieve overlapping 360° coverage. Forward-deployed preventive medical units also receive detectors to use in stand-alone medical facilities in high-threat areas.

WARNING

The decision to sound an alarm and further disseminate the word that a chemical attack has taken place must occur within seconds. Use NBC 1 reports to pass the alarm and alert the NBC control center or the SRC that an attack has occurred.

The commander must rapidly gather detection, intelligence, medical, and other pertinent information to determine the next COA. False alarms must be confirmed as rapidly as possible to get personnel out of MOPP and to restore full operational capability.

The NBC control center or the SRC will confirm and validate the attack through the evaluation of reports.

Appendix N

JOINT-SERVICE, LIGHTWEIGHT NUCLEAR, BIOLOGICAL, AND CHEMICAL RECONNAISSANCE SYSTEM AND STRYKER NUCLEAR, BIOLOGICAL, AND CHEMICAL RECONNAISSANCE VEHICLE

1. Background

The joint-service, lightweight NBCRS and the Stryker NBCRV provide the commander with the capability to conduct NBC reconnaissance in his AO (e.g., fixed site, port, airfield, maneuver unit). They have comparable detection suites on different vehicles. For example, the Stryker NBCRV is a Stryker wheeled, armored vehicle and the joint-service, lightweight NBCRS is an armored LAV or HMMWV variant.

2. Description

- a. The joint-service, lightweight NBCRS and the Stryker NBCRV—
 - Are deployed as mobile detection systems on and around fixed sites (main operating bases, collocated operating bases, and bare bases).
 - Are deployed in support of land forces.
 - Are deployed to perform NBC reconnaissance tasks as described in *Chapter VI*.
 - Perform nuclear and chemical detection on the move, at speeds up to 45 kph (depending on METT-TC).
 - Perform stationary NBC surveillance missions, such as biological detection.

NOTE: The biological detection capability can only be used in a stationary surveillance role. Taking into account METT-TC and the most recent enemy intelligence, systems and vehicles are positioned to maximize the probability of detection in a designated area.

- Can conduct NBC point detection and standoff chemical detection through air and surface sampling.
 - Warn of NBC agent detection.
 - Identify specific BW and CW agents.
 - Measure or detect radiation.
 - Take samples for lab analysis.
 - Are used to supplement other CB detectors on the battlefield.
- b. Once an area is searched and contamination is confirmed, the area is marked with the appropriate NBC markers. NBC warning reports with meteorological and

location data are forwarded to the supporting NBC control center or SRC, using digital or voice means to update the situation for commanders.

c. Operators perform NBC reconnaissance operations in an environmentally controlled atmosphere that is protected from all known CB warfare agents, nuclear particulates, and most TIM. The information received from the detectors is automatically prepared for electronic transmission through the NBC warning and reporting system.

d. The joint-service, lightweight NBCRS has its own electrical power source to provide support to the system. During stationary operations, it can operate from standard external power sources. The Stryker NBCRV has a NATO power adapter and can also operate from an external power source.

3. Employment

a. Capabilities. The joint-service, lightweight NBCRS and the Stryker NBCRV provide—

- Stationary, mobile, and standoff chemical (liquid and vapor) detection.
- Stationary and mobile radiation detection.
- Stationary biological detection

They are tactical assets, and commanders plan for their use to support war requirements at the tactical and operational levels. Multiple systems are required to establish an area or critical-node array, and they provide another asset that can be used for point biological detection. When conducting point biological detection operations, they cannot conduct mobile chemical or radiological detection, but can still conduct stationary monitoring.

(1) Tactical Level. They can provide tremendous coverage of an AO (i.e., provide large-area coverage, conduct several search or survey missions) in support of chemical and radiological detection. There is a tremendous benefit through the use of their reconnaissance capabilities, and they provide critical information to the commander. The joint-service, lightweight NBCRS and the Stryker NBCRV are important, low-density assets. Task-organizing them to support AB, brigade, and regimental missions increases the overall combat power of the tactical-level commander (i.e., avoid contamination, maintain OPTEMPO).

(2) Operational Level. As part of an operational-level biological detector array, the control of these detection assets could likely revert to an operational-level war commander (e.g., JTF), because centralized reporting is generally conducted to help determine if a biological attack occurred. Additionally, the operational-level commander should have access to other resources (i.e., Biological Integrated Detection System) whose primary mission is to conduct point BW detection. Further, there may be specific METT-TC situations when the joint-service, lightweight NBCRS and the Stryker NBCRV are used as point biological detectors. For example, during FP early-entry operations, they may be used to support biological detection if other BW detection assets are not available. They can also use their chemical point and standoff capabilities during a biological surveillance mission. When additional forces with BW detection capabilities arrive, the joint-service, lightweight NBCRS and the Stryker NBCRV would likely resume support for other NBC reconnaissance operation, such as search or survey.

b. **Operational Differences.** There are also some operational differences between the joint-service, lightweight NBCRS and the Stryker NBCRV that leaders must consider during the employment of NBC reconnaissance capabilities. Selected differences include the following:

- **Radiological detection.** The Stryker NBCRV uses an AN/UDR-13 and AN/VDR-2. The joint-service, lightweight NBCRS uses an AN/VDR-2. The AF joint-service, lightweight NBCRS uses an AN/VDR-2 and ADM-300.
- **Chemical vapor sampling.** The Stryker NBCRV has a chemical vapor sampling system to confirm vapor detection. The joint-service, lightweight NBCRS does not have a similar capability.
- **Vehicle variants.** The Stryker NBCRV and the joint-service, lightweight NBCRS (LAV) are wheeled, armored vehicles. Commanders will likely task-organize them to support combat forces (i.e., maneuver elements). The joint-service, lightweight NBCRS (HMMWV) will likely be task-organized to support fixed-site NBC reconnaissance operations or other areas of the battlespace that will enhance system survivability.
- **Armament.** The Stryker NBCRV has a remotely operated weapon capability. The joint-service, lightweight NBCRS (LAV) weapon cannot be remotely operated. The joint-service, lightweight NBCRS (HMMWV) does not have weapon capability.

c. **ABs, Ports, and Fixed Sites.**

(1) Both detection assets can be deployed at ABs, ports, and fixed sites as outlined by base support plans. Key nodes (such as the NBC control center) monitor the units on the base and receive data reports via radio links. The commander combines the information with that from other deployed detectors at fixed sites to make decisions and take appropriate actions.

(2) The detection assets will normally be assigned specific sectors at a fixed site, such as an AB. Each fixed site should have a plan to receive and place the assets. The assets will be used as directed via the wing operations center, SRC, or NBC cell based on the threat and any vulnerability in the fixed detector array.

d. **Land Forces.** When deployed with forward combat units, both detection assets are integrated into the overall ISR effort to provide early warning and confirm contaminated or uncontaminated areas in support of combat operations.

(1) **Offensive Operations.** Movement to contact, attack, exploitation, and pursuit are all offensive operations that need to maintain momentum. The detection assets support these operations by deploying with or immediately behind forward forces to quickly mark and identify routes around contaminated areas.

(2) **Defensive Operations.** Two patterns of defensive operations are mobile defense and area defense. The detection assets can be deployed with forward security forces and reserve counterattack forces to mark and provide bypass routes. Other missions include monitoring MSRs, troop concentrations, APODs, and SPODs.

4. Tasks

a. The joint-service, lightweight NBCRS and the Stryker NBCRV warn units of contamination, report the location of hazards, mark areas of contamination, locate clean bypass routes, and collect and transport samples of NBC material for later analysis. They accomplish these functions by performing the following tasks:

- **Search.** See *Appendix G* for information on search techniques.
- **Survey.** See *Appendixes G* and *I* for information on survey techniques.
- **Surveillance.** See *Appendix H* for information on surveillance techniques and procedures (i.e., observing NAIs, establishing a biological detection array). See *Appendix M* for information on advanced chemical standoff detector employment.
- **Sampling.** See *Appendix E* for information on sampling techniques.

b. Both detection assets use onboard detectors (e.g., M22) to detect and identify NBC agents, allowing commanders to take appropriate defensive measures. Once contamination has been located, physical markers are dropped to locate the extent of the hazard area. The assets also capture, contain, and provide samples for confirmatory analysis using the sampling arm and external storage vials. *Figure N-1* shows the main-menu screen of the Stryker NBCRV; it provides feedback on NBC detection suite results.

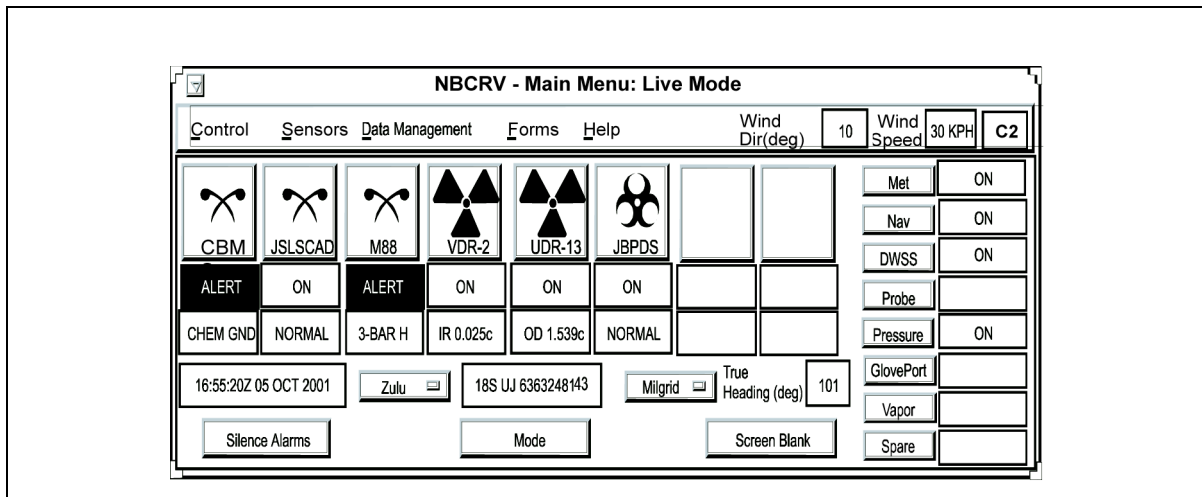

Figure N-1. Stryker NBCRV Main-Menu Sample Screen

(1) CB Mass Spectrometer. The spectrometer provides point and mobile detection and identification of chemical agents (e.g., ground contamination and vapor). The data input is received and displayed on the main-menu screen.

(2) Joint Biological Point Detection System. This system provides point detection and identification of biological agents.

NOTE: The Joint Biological Point Detection System will not be placed in the standby mode while on the move.

(3) Joint-Service, Lightweight, Chemical-Agent Detector. This detector provides point and mobile standoff detection of chemical agents. (See *Appendix M* for further information.)

(4) M88 Chemical-Agent Sensor. This sensor provides point and mobile detection of G-series nerve and blister agents. It provides agent concentration, when and where the agent was first detected, and when and where the agent was last detected. Information from the M88 is fed to the main-menu screen of the Stryker NBCRV.

(5) Radiation Detectors.

(a) AN/VDR-2 Radiac Meter. It provides the radiation dose rate and the total accumulated dosage inside and outside the vehicle in near real time. Information from the AN/VDR-2 is fed to the main-menu screen of the Stryker NBCRV. The ADM-300 radiac meter provides similar capabilities for the AF variant of the joint-service, lightweight NBCRS.

(b) AN/UDR-13 Radiac Meter. It provides the radiation dose rate and the total accumulated dosage inside and outside the vehicle. It also measures prompt gamma and neutron dosages from a nuclear event and gamma dosages and dose rates from a nuclear fallout. Information from the AN/UDR-13 is fed to the main-menu screen of the Stryker NBCRV.

5. Task Organization

The joint-service, lightweight NBCRS and the Stryker NBCRV are subject to established command and support relationships according to applicable OPLANs and OPORDs. For example, at USAF installations, the installation commander will likely maintain control of these assets through the NBC control center located in the SRC. For further detail on these relationships, see applicable service publications.

6. Communications

The joint-service, lightweight NBCRS and the Stryker NBCRV require interface with installation level and/or unit communications to support connectivity to the supported unit. Short- or long-range vehicle radios (AN/VRC-90A/D/F) will be used. These assets can communicate digitally with the Enhanced Position Locating and Reporting System or through voice communication with the Single-Channel, Ground-to-Air Radio System.

REFERENCES

Department of Defense

- DD Form 1911, *Material Courier Receipt*, May 1982.
- DODD 2000.12, *DOD Antiterrorism (AT) Program*, 18 August 1999.
- DODD 3025.1M, *Manual for Civil Emergencies*, June 1994 (U).
- DODD 3025.12, *Military Assistance for Civil Disturbances (MACDIS)*, 4 February 1994 (U).
- DODD 3025.15, *Military Assistance to Civil Authorities*, 18 February 1997.
- DODD 3150.8, *DOD Response to Radiological Accidents*, 13 June 1996.
- DODD 3150.8M, *Nuclear Weapon Accident Response Procedures (NARP)*, December 1999.
- DODD 5100.77, *DOD Law of War Program*, 9 December 1998.
- DODD 5240.1, *DOD Intelligence Activities*, 25 April 1988 (U).
- DODD 5525.5, *DOD Cooperation with Civilian Law Enforcement Officials*, 15 January 1986.

Joint

- CJCSI 3125.01, *Military Assistance to Domestic Consequence Management Operations in Response to a Chemical, Biological, Nuclear, or High-Yield Explosive Situation*, 3 August 2001.
- CJCSM 3150.03B, *Joint Reporting Structure Event and Incident Reports*, 23 July 2003.
- CJCSM 3500.04C, *Universal Joint Task List*, 1 July 2002.
- Joint Service Chemical and Biological Defense Fact Sheets, August 1998.
- Joint Service Chemical and Biological Defense Program FY 00-02 Overview.
- Joint Service Nuclear, Biological, and Chemical Defense Concept, September 1997.
- JP 1, *Joint Warfare of the Armed Forces of the United States*, 14 November 2000.
- JP 1-01, *Joint Doctrine Development System*, 5 July 2000.
- JP 1-02, *Department of Defense Dictionary of Military and Associated Terms*, 12 April 2001.
- JP 2-01.3, *Joint Tactics, Techniques, and Procedures for Joint Intelligence Preparation of the Battlespace*, 24 May 2000.
- JP 3-0, *Doctrine for Joint Operations*, 10 September 2001.
- JP 3-01, *Joint Doctrine for Countering Air and Missile Threats*, 19 October 1999.
- JP 3-01.5, *Doctrine for Joint Theater Missile Defense*, 22 February 1996.

JP 3-07, *Joint Doctrine for Military Operations Other Than War*, 16 June 1995.

JP 3-07.1, *Joint Tactics, Techniques, and Procedures for Foreign Internal Defense (FID)*, 26 June 1996.

JP 3-07.2, *Joint Tactics, Techniques, and Procedures for Antiterrorism*, 17 March 1998.

JP 3-07.6, *Joint Tactics, Techniques, and Procedures for Foreign Humanitarian Assistance*, 15 August 2001.

JP 3-10, *Joint Doctrine for Rear Area Operations*, 28 May 1996.

JP 3-10.1, *Joint Tactics, Techniques, and Procedures for Base Defense*, 23 July 1996.

JP 3-11, *Joint Doctrine for Operations in Nuclear, Biological, and Chemical (NBC) Environments*, 11 July 2000.

JP 3-33, *Joint Force Capabilities*, 13 October 1999.

JP 4-0, *Doctrine for Logistic Support of Joint Operations*, 6 April 2000.

JP 4-02, *Doctrine for Health Service Support in Joint Operations*, 30 July 2001.

JP 5-0, *Doctrine for Planning Joint Operations*, 13 April 1995.

JP 5-00.2, *Joint Task Force (JTF) Planning Guidance and Procedures*, 13 January 1999.

JP 6-0, *Doctrine for Command, Control, Communications, and Computer (C4) Systems Support to Joint Operations*, 30 May 1995.

Multiservice

FM 3-3/FMFM 11-17, *Chemical and Biological Contamination Avoidance*, 16 November 1992.

FM 3-3-1/FMFM 11-18, *Nuclear Contamination Avoidance*, 9 September 1994.

FM 3-5/MCWP 3-37.3, *NBC Decontamination*, 28 July 2000.

FM 3-6/AFM 105-7/FMFM 7-11H, *Field Behavior of NBC Agents (Including Smoke and Incendiaries)*, 3 November 1986.

FM 3-9/NAVFAC P-467/AFR 355-7, *Potential Military Chemical/Biological Agents and Compounds*, 12 December 1990.

FM 3-11/MCWP 3-37.1/NWP 3-11/AFTTP(I) 3-2.42, *Multiservice Tactics, Techniques, and Procedures for Nuclear, Biological, and Chemical Defense Operations*, 10 March 2003.

FM 3-11.4/MCWP 3-37.2/NTTP 3-11.27/AFTTP(I) 3-2.46, *Multiservice Tactics, Techniques, and Procedures for Nuclear, Biological, and Chemical (NBC) Protection*. 2 June 2003.

FM 3-11.34/MCRP 3-37.5/NWP 3-11.23/AFTTP(I) 3-2.33, *Multiservice Procedures for Nuclear, Biological, and Chemical (NBC) Defense of Theater Fixed Sites, Ports, and Airfields*, 29 September 2000.

FM 3-90/FMFM 11-20, *Tactics*, 4 July 2001.

FM 4-25.11/NTRP 4-02.1/AFMAN 44-163, *First Aid*, 23 December 2002.

FM 6-02.85/MCRP 3-40.2A/NTTP 3-13.1.16/AFTTP(I) 3-2.22, *JTF IM Multiservice Tactics, Techniques, and Procedures for Joint Task Force Information Management*, 10 September 2003.

FM 8-9/NAVMED P-5059/AFJMAN 44-151V1V2V3, *NATO Handbook on the Medical Aspects of NBC Defense Operations AMEDP-6(B) Part I - Nuclear Part II - Biological Part III - Chemical*, 1 February 1996.

FM 8-284/NTRP 4-02.23 (NAVMED P-5042)/AFMAN(I) 44-156/MCRP 4-11.1C, *Treatment of Biological Warfare Agent Casualties*, 17 July 2000.

FM 8-285/NAVMED P-5041/AFJMAN 44-149/FMFM 11-11, *Treatment of Chemical-Agent Casualties and Conventional Military Chemical Injuries*, 22 December 1995.

Army

Chemical and Biological Information Analysis Center (CBIAC), *Worldwide Chemical-Agent Detection Handbook*, 3 October 1995.

DA Form 12-99-R, *Initial Distribution Requirements for Publications*, 1 April 1996.

DA Form 2028, *Recommended Changes to Publications and Blank Forms*, 1 February 1974.

DA Form 4137, *Evidence/Property Custody Document*, 1 July 1976.

DA Pamphlet 50-6, *Chemical Accident or Incident Response and Assistance (CAIRA)*, 26 March 2003.

DA Pamphlet 385-61, *Toxic Chemical-Agent Safety Standards*, 27 March 2002.

FM 3-0, *Operations*, 14 June 2001.

FM 3-6, *Field Behavior of NBC Agents (Including Smoke and Incendiaries)*, 3 November 1986.

FM 3-7, *NBC Field Handbook*, 29 September 1994.

FM 3-14, *Nuclear, Biological, and Chemical (NBC) Vulnerability Analysis*, 12 November 1997.

FM 3-19, *NBC Reconnaissance*, 19 November 1993.

FM 3-101, *Chemical Staffs and Units*, 19 November 1993.

FM 3-101-6, *Biological Defense Operations, Corps/Company Tactics, Techniques and Procedures*, 25 March 1999.

FM 4-02, *Force Health Protection in a Global Environment*, 13 February 2003.

FM 4-02.33, *Control of Communicable Diseases Manual, Edition 17*, 31 December 1999.

FM 4-02.7, *Health Service Support in a Nuclear, Biological, and Chemical Environment Tactics, Techniques, and Procedures*, 1 October 2002.

FM 8-42, *Combat Health Support in Stability Operations and Support Operations*, 27 October 1997.

FM 8-500, *Hazardous Materials Injuries, A Manual for Pre-Hospital Care (4th Edition)*, 17 January 1997.

FM 100-30, *Nuclear Operations*, 29 October 1996.

FM 100-6, *Information Operations*, 27 August 1996.

FM 100-7, *Decisive Force: The Army in Theater Operations*, 31 May 1995.

FM 101-5, *Staff Organization and Operations*, 31 May 1997.

FM 21-10, *Field Hygiene and Sanitation*, 21 June 2000.

STP 8-91W15SM-TG, *MOS 91W, Health Care Specialist*, 10 October 2001.

TC 3-4, *Chemical Battle Staff Handbook*, 3 October 1995.

TRADOC Pamphlet 525-63, *Operations Concept for Biological Defense*, 1 December 1994.

US Army Chemical School, *Army Chemical Review*, January 1997.

US Army Chemical School, *Army Chemical Review, NBC Operations in Bosnia*, July 1996.

US Army Chemical School, *Chemical Vision 2010*, 3 February 1999.

US Army Chemical School, *Concept for Biological Detection Future*, 18 September 1996.

US Army Chemical School, *Theater Missile Defense, Joint Project Optic Cobra 1996, After Action Report*, 1996.

US Army Chemical School, *TOE Summary Book*, 1 June 2000.

US Army Maneuver Support Center, *Force Development BR DCD*, 15 October 2001.

US Army Medical Research Institute of Infectious Diseases (USAMRIID), *Medical Management of Biological Casualties Handbook, Fourth Edition*, February 2001.

USAMRICD, *Medical Management of Biological Casualties Handbook*, February 2001.

USAMRICD, *Medical Management of Chemical Casualties*, August 1999.

Air Force

AFDD-1, *Air Force Basic Doctrine*, September 1997.

AFH 32-4014V1, *USAF Operations in a Chemical and Biological (CB) Warfare Environment, Planning and Analysis, Volume 1*, 1 March 1998.

AFH 32-4014V2, *USAF Operations in a Chemical and Biological (CB) Warfare Environment, CB Hazards, Volume 2*, 1 December 1997.

AFH 32-4014V3, *USAF Operations in a Chemical and Biological (CB) Warfare Environment, Defense Equipment, Volume 3*, 1 February 1998.

AFI 10-2501, *Full Spectrum Threat Response (FSTR) Planning and Operations*, 24 December 2002.

AFI 33-360, Volume 1, *Publications Management Program*, 6 May 2002.

AFI 33-360, Volume 2, *Content Management Program–Information Management Tool (CMP-IMT)*, 11 September 2003.

AFMAN 10-2602, *NBC Defense Operations and Standards*, 29 May 2003.

AFMAN 32-4004, *Emergency Response Operations*, 1 December 1995.

AFMAN 32-4005, *Personnel Protection and Attack Actions*, 30 October 2001.

AFPAM 32-4019, *Chemical-Biological Warfare Commander's Guide*, 1 April 1998.

AFPD 10-2, *Readiness*, 1 March 1997.

AFPD 32-40, *Disaster Preparedness*, 1 May 1997.

US Air Force Engineering Support Activity, *Chemical and Biological Defense Concept of Operations*, January 1998.

US Air Force Institute for National Security Studies, *Countering the Proliferation and Use of Weapons of Mass Destruction*, 1998.

Marine Corps

MCWP 3-37, *Marine Air-Ground Task Force (MAGTF) Nuclear, Biological, and Chemical Defense Operations*, 21 September 1998.

MCWP 5-1, *Marine Corps Planning Process*, 5 January 2000.

Navy

Naval Doctrine Command, US Navy, *Executive Summary, Multinational Maritime Operations*, 1996.

Naval Doctrine Publication 1, *Naval Warfare*, Washington, DC: Department of the Navy, 28 March 1994.

Naval Doctrine Publication 2, *Naval Intelligence*, Washington, DC: Department of the Navy, 30 September 1994.

Naval Doctrine Publication 4, *Naval Logistics*, 20 February 2001.

NAVSUP Publication 409. *MILSTRIP/MILSTRAP Desk Guide*, 9 May 2003.

Navy Warfare Publication 3-20.31 (Revision A), *Surface Ship Survivability*, June 1998.

OPNAV P-86-1-95, *US Navy CBR Defense/US Marine Corps NBC Defense Handbook*, April 1995.

US Navy Detachment, Fort Leonard Wood, MO, *Trainee Guide, Disaster Preparedness Operations Specialist*, June 1998.

NATO Standardization Agreements (STANAG) and Publications

STANAG 2002, *Warning Signs for the Marking of Contaminated or Dangerous Land Areas, Complete Equipments, Supplies, and Stores, Edition 8*, 29 January 1999.

STANAG 2083, *Commander's Guide on Nuclear Radiation Exposure of Groups, Edition 5*, 19 September 1986.

STANAG 2103, *Reporting Nuclear Detonations, Biological and Chemical Attacks, and Predicting and Warning of Associated Hazards and Hazard Areas {ATP-45(B)}*, Edition 8, 31 August 2000.

STANAG 2112, *Nuclear, Biological, and Chemical Reconnaissance, Edition 4*, 6 March 1998.

STANAG 2353, *Evaluation of NBC Defence Capability, Edition 5*, 6 March 2000.

Other Sources

AEP 10, *Sampling and Identification of CB Agents*.

AEP 49, *Sampling and Identification of Radiological Agents*.

Army Medical Research Institute of Chemical Defense, *Medical Management of Chemical Casualties Handbook, Chemical Casualty Care Division, USAMRICD, Third Edition*, July 2000.

Defense Intelligence Agency Manual 58-13, *Defense Human Resources Intelligence Collection Procedures (SECRET/NOFOR)*.

DOT, *2000 Emergency Response Guidebook, A Guide for First Responders During the Initial Phase of a Dangerous Goods/Hazardous Materials Incident*.

DOT Regulation 49 CFR 173.196.

DHHS (NIOSH) Publication 2001-145, *NIOSH Pocket Guide to Chemical Hazards and Other Databases (with IDLH Documentation)*, August 2001.

FEMA, *Federal Radiological Emergency Response Plan (FRERP)*, CFR 50, Federal Register 46542, May 1996 (U).

FEMA, *Federal Response Plan (Unclassified)*, April 1999.

Guide to Understanding the Threat From Toxic Industrial Chemical, U.S., U.K., C.A., Memorandum of Understanding, August 1995.

IC 2003-1 to AFMAN 32-4017, *Civil Engineer Readiness Technician Manual for Nuclear, Biological, and Chemical Defense*, 29 May 2003.

IATA, *Dangerous Goods Regulation (DGR)*, 1 January 2002.

IATA, Packaging Instruction 602, 2001.

IATA, Packaging Instruction 650, 2001.

IATA, Packaging Instruction 904, 2001.

International Civil Aviation Organization Technical Instructions (ICAOTI) on the Safe Transport of Dangerous Goods by Air, 1999-2000 Edition.

ISO 3166-1, *Codes for the Representation of Names of Countries and Their Subdivisions - Part 1: Country Codes*, 1997.

Memorandum, Under Secretary of Defense, Military and Veterans Health Coordinating Board and Presidential Review Directive (PRD-S), 7 December 1999.

Nancy R. Brietich, et al., *Worldwide Chemical Detection Equipment Handbook*, CBIAC, October 1995.

National Defense University, Center for Counter-Proliferation Research—*Deterrence and Defense in a Nuclear, Biological, and Chemical Environment*, Robert B. Joseph and John F. Reichart, 1999.

Office of Special Assistant for Gulf War Illness, *Lessons Learned Implementation*, 18 November 1999.

Presidential Decision Directive (PDD)/National Security Council (NSC) 39, *US Government Policy on Counterterrorism*, 21 June 1995.

Sharon Reutter, *Soldier, Biological, and Chemical Command, Review and Recommendations for Human Toxicity Estimates for FM 3-11.9*.

USACHPPM TG 230, *Chemical Exposure Guidelines for Deployed Military Personnel*, January 2002.

GLOSSARY

PART I—ABBREVIATIONS AND ACRONYMS

μ	micron(s)
μg	microgram
A	
AA	avenue of approach
AAR	after-action report
AB	air base
AC	alternating current
ACAA	automatic chemical-agent alarm
ACR	armored cavalry regiment
AEP	allied engineering publication
AFB	Air Force base
AFDD	Air Force doctrine document
AFH	Air Force handbook
AFI	Air Force instruction
AFJMAN	Air Force joint manual
AFM	Air Force manual
AFMAN	Air Force manual
AFPAM	Air Force pamphlet
AFPD	Air Force policy directive
AFR	Air Force regulation
AFSC	Air Force specialty code
AFTTP(I)	Air Force tactics, techniques, and procedures (interservice)
AGCF	air-ground correlation factor
AL	Alabama
AO	area of operations

AOB	advanced operations base
AOI	area of interest
AOR	area of responsibility
APC	armored personnel carrier
APO	Army post office
APOD	aerial port of debarkation
APOE	aerial port of embarkation
AR	Arkansas
AR	Army regulation
ASAP	as soon as possible
AT	antiterrorism
ATP	allied tactical publication
ATTN	attention
AZ	azimuth
B	
BDA	battle damage assessment
BDOC	base defense operations center
BEEF	base engineer emergency force
BIDS	Biological Integrated Detection System
bn	battalion
BSA	brigade support area
BW	biological warfare
C	
C	Celsius
C2	command and control
CAM	chemical-agent monitor
CARVER	criticality, accessibility, recuperability, vulnerability, effect, recognizability
CB	chemical and biological
CBIAC	Chemical and Biological Information Analysis Center

CBIRF	chemical-biological incident response force
CBR	chemical, biological, and radiological
CBRN	chemical, biological, radiological, and nuclear
CBRNE	chemical, biological, radiological, nuclear, and high-yield explosives
CCA	contamination control area
CCIR	commander's critical information requirements
CDC	Centers for Disease Control and Prevention
CE	civil engineering
CF	correlation factor
CG	commanding general
cGyph	centigray per hour
CJCSI	Chairman of the Joint Chiefs of Staff instruction
CJCSM	Chairman of the Joint Chiefs of Staff manual
CLS	contracted logistics support
cm	centimeter(s)
CM	chemical
co	company
CO	commanding officer
COA	course of action
COCOM	combatant command
COMM	commercial
COMMZ	communications zone
CONOPS	concept of operations
CONUS	continental United States
COP	common operational picture
CP	counterproliferation
CRD	chemical reconnaissance detachment
CS	combat support
CSS	combat service support
CT	counterterrorism

CW	chemical warfare
D	
DA	Department of the Army
DC	District of Columbia
DC	direct current
DCC	damage control center
dd	date
DD	Department of Defense
decon	decontamination
deg	degrees
det	detachment
DHHS	Department of Health and Human Services
dir	direction
div	division
DNA	deoxyribonucleic acid
DOD	Department of Defense
DODD	Department of Defense directive
DOS	Department of State
DOT	Department of Transportation
DS	direct support
DSA	division support area
DSN	Defense Switched Network
DTG	date-time group
E	
EAC	echelons above corps
EEFI	essential elements of friendly information
EL	elevation
e-mail	electronic mail
EMP	electromagnetic pulse

EOC	emergency operations center
EOD	explosive ordnance disposal
ERT	emergency response team
F	
F	Fahrenheit
FDPMU	forward-deployable, preventive-medicine unit
FEMA	Federal Emergency Management Agency
FHP	force health protection
FID	foreign internal defense
FL	Florida
FM	field manual
FMFM	Fleet Marine Force manual
FOB	forwarding operating base
FOV	field of view
FP	force protection
FPO	Fleet post office
FRAGORD	fragmentary order
ft	foot, feet
FY	fiscal year
g	gram(s)
G	
gal	gallon(s)
GENTEXT	general text
GPS	global positioning system
GS	general support
H	
H	time of attack
HAZMAT	hazardous materials
HE	high explosive

HC	hexachloroethane
HHC	headquarters and headquarters company
HHD	headquarters and headquarters detachment
HMMWV	high-mobility, multipurpose wheeled vehicle
HN	host nation
HQ	headquarters
HSS	health service support
HVAC	heating, ventilation, and air conditioning
HVT	high-value target
I	
IATA	International Air Transport Association
IC	incident commander
IC	interim change
ID	identification
IDLH	immediately dangerous to life or health
IED	improvised explosive device
in	inch(es)
inf	infantry
IPB	intelligence preparation of the battlespace
IR	information requirements
ISO	International Organization for Standardization
ISR	intelligence, surveillance, and reconnaissance
J	
J5	plans directorate of a joint staff
JBPDS	Joint Biological Point Detection System
JFC	joint force commander
JOA	joint operations area
JP	joint publication
JRA	joint rear area

JRAC	joint rear area coordinator
JSLSCAD	joint-service, lightweight, standoff chemical-agent detector
JSOA	joint special operations area
JSOTF	joint special operations task force
JTF	joint task force
K	
kg	kilogram(s)
kph	kilometers per hour
L	
l	liter(s)
LAN	local area network
LAV	light armored vehicle
lb	pound(s)
LD	line of departure
LD₅₀	lethal concentration for 50 percent of exposed, unprotected population
LEL	lower explosive limit
LFA	lead federal agency
LNO	liaison officer
LOA	limit of advance
LOC	line of communications
LOS	line of sight
LZ	landing zone
M	
m	meter(s)
MACOM	major command
maint	maintenance
MANSCEN	Maneuver Support Center

MCCDC	Marine Corps Combat Development Command
MCP or MC2P	Marine Corps planning process
MCRP	Marine Corps reference publication
MCWP	Marine Corps warfighting publication
MD	Maryland
MDMP	military decision-making process
METL	mission-essential task list
METT-T	(USMC) mission, enemy, terrain and weather, troops available, and time
METT-TC	mission, enemy, terrain and weather, troops available, and civilian considerations
mg	milligram(s)
mg/m²	milligrams per square meter
MGRS	military grid reference system
MICON	mission concept
MILSTRIP	military standard requisitioning and issue procedure
min	minute(s)
ml	milliliter(s)
mm	millimeter(s)
mm	month
MO	Missouri
MOOTW	military operations other than war
MOPP	mission-oriented protective posture
MOS	military occupational specialty
MSR	main supply route
MTF	medical treatment facility
MTOE	modified table of organization and equipment
MTT	mobile training team
MTTP	multiservice tactics, techniques, and procedures
MTW	major theater war
N	

N	decay rate
NA	not applicable
NAI	named area of interest
NATO	North Atlantic Treaty Organization
NAVFAC	Naval Facilities Engineering Command
NAVMED	Naval Medical Command
NAVSUP	Naval Supply Systems Command
NBC	nuclear, biological, and chemical
NBCRS	nuclear, biological, and chemical reconnaissance system
NBCRV	nuclear, biological, and chemical reconnaissance vehicle
NCO	noncommissioned officer
NCOIC	noncommissioned officer in charge
NF	normalization factor
NGO	nongovernmental organization
NIOSH	National Institute for Occupational Safety and Health
No.	number
NSN	national stock number
NSW	Naval Special Warfare
NTRP	Navy Tactical Reference Publication
NTTP	Navy tactics, techniques, and procedures
NVD	night vision device
NWDC	Navy Warfare Development Command
NWP	Naval warfare publication
O	
OB	order of battle
OBJ	objective
OCF	outside correlation factor
OCONUS	outside the continental United States
Oct	October
OD	operational detachment

OEG	operational exposure guidance
OP	observation post
OPCON	operational control
OPLAN	operation plan
OPNAV	Office of the Chief of Naval Operations
OPORD	operation order
OPR	office of primary responsibility
ops	operations
OPSEC	operations security
OPTEMPO	operating tempo
oz	ounce(s)
P	
PA	public affairs
PCN	publication control number
PEL	permissible exposure limit
PFC	private first class
PIR	priority intelligence requirements
PL	phase line
plt	platoon
POD	port of debarkation
POL	petroleum, oil, and lubricants
PPE	personal protective equipment
ppm	pounds per minute
PVNTMED	preventive medicine
PZ	pickup zone
R	
RA	risk analysis
RDD	radiological dispersal device
recon	reconnaissance

reg	regimental
RI	Rhode Island
RM	risk management
ROE	rules of engagement
RSTA	reconnaissance, surveillance, and target acquisition
S	
SA	situational awareness
SALUTE	size, activity, location, unit, time, and equipment
SCUD	surface-to-surface missile system
sec	section
SecDef	Secretary of Defense
SEM	sensor electronics module
SF	special forces
SFG	special forces group
SFOB	special forces operations base
SFOD	special forces operational detachment
SMART-CB	special medical augmentation response team—chemical and biological
SME	subject matter expert
smk	smoke
SOF	special operations forces
SOP	standing operating procedure
SPOD	seaport of debarkation
SPOE	seaport of embarkation
spt	support
sq	square
sqd	squad
SR	special reconnaissance
SRC	survival recovery center
STANAG	standardization agreement (NATO)

STP	soldier training publication
T	
TA	theater Army
TAI	target area of interest
TBM	theater ballistic missile
TC	training circular
TEU	technical escort unit
TF	task force
TFA	toxic-free area
TG	training guide
TIC	toxic industrial chemical
TIM	toxic industrial material
TL	team leader
TLV	threshold limit value
TM	technical manual
TO	technical order
TO	theater of operations
TOB	time of burst
TOC	tactical operations center
TOE	table(s) of organization and equipment
TPFDL	time-phased force and deployment list
TRADOC	United States Army Training and Doctrine Command
TSP	training support package
TTP	tactics, techniques, and procedures
TX	Texas
U	
U	unclassified
UN	United Nations
US	United States

USA	United States Army
USACHPPM	United States Army Health Promotion and Preventive Medicine
USACMLS	United States Army Chemical School
USAF	United States Air Force
USAMRICD	United States Army Medical Research Institute of Chemical Defense
USAMRIID	United States Army Medical Research Institute of Infectious Diseases
USG	US Government
USMC	United States Marine Corps
USN	United States Navy
USSOCOM	United States Special Operations Command
USSTRATCOM	United States Strategic Command
UT	Utah
UTC	unit type code
UW	unconventional warfare
UXO	unexploded ordnance
V	
VA	Virginia
VA	vulnerability assessment
W	
WARNORD	warning order
WMD	weapons of mass destruction
WOC	wing operations center
Y	
yy	year
Z	
Z	Zulu

PART II—TERMS AND DEFINITIONS

aerosol. A liquid or solid composed of finely divided particles suspended in a gaseous medium. Examples of common aerosols are mist, fog, and smoke. (JP 1-02)

area assessment. The commander's prescribed collection of specific information that commences upon employment and is a continuous operation. It confirms, corrects, refutes, or adds to previous intelligence acquired from area studies and other sources prior to employment. (JP 1-02)

area of interest. The area of concern to the commander, including the area of influence, areas adjacent thereto, and extending into enemy territory to the objectives of current or planned operations. This area also includes areas occupied by enemy forces who could jeopardize the accomplishment of the mission. Also called **AOI**. (JP 1-02)

area of operations. An operational area defined by the joint force commander for land and naval forces. Areas of operation do not typically encompass the entire operational area of the joint force commander, but should be large enough for component commanders to accomplish their missions and protect their forces. Also called **AO**. (JP 1-02)

area of responsibility. The geographical area associated with a combatant command within which a combatant commander has authority to plan and conduct operations. Also called **AOR**. (JP 1-02)

armored personnel carrier. A lightly armored, highly mobile, full-tracked vehicle, amphibious and air-droppable, used primarily for transporting personnel and their individual equipment during tactical operations. Production modifications or application of special kits permit use as a mortar carrier, command post, flame thrower, antiaircraft artillery chassis, or limited recovery vehicle. Also called **APC**. (JP 1-02)

assault craft unit. A permanently commissioned naval organization, subordinate to the commander, naval beach group, that contains landing craft and crews necessary to provide lighterage required in an amphibious operation. Also called **ACU**. (JP 1-02)

assembly area. 1. An area in which a command is assembled preparatory to further action. 2. In a supply installation, the gross area used for collecting and combining components into complete units, kits, or assemblies. (JP 1-02)

avenue of approach. An air or ground route of an attacking force of a given size leading to its objective or to key terrain in its path. Also called **AA**. (JP 1-02)

avoidance. Individual and/or unit measures taken to avoid or minimize nuclear, biological, and chemical (NBC) attacks and reduce the effects of NBC hazards. (JP 1-02)

axis of advance. A line of advance assigned for purposes of control; often a road or a group of roads, or a designated series of locations, extending in the direction of the enemy. (JP 1-02)

battle damage assessment. The timely and accurate estimate of damage resulting from the application of military force, either lethal or non-lethal, against a predetermined objective. Battle damage assessment can be applied to the employment of all types of weapon systems (air, ground, naval, and special forces weapon systems) throughout the range of military operations. Battle damage assessment is primarily an intelligence responsibility with required inputs and coordination from the operators. Battle damage assessment is composed of physical damage assessment, functional damage assessment, and target system assessment. Also called **BDA**. (JP 1-02)

battlespace. The environment, factors, and conditions that must be understood to successfully apply combat power, protect the force, or complete the mission. This includes the air, land, sea, space, and the included enemy and friendly forces; facilities; weather; terrain, the electromagnetic spectrum; and the information environment within the operational areas and areas of interest. (JP 1-02)

biological agent. A microorganism that causes disease in personnel, plants, or animals or causes the deterioration of materiel. (JP 1-02)

biological defense. The methods, plans, and procedures involved in establishing and executing defensive measures against attacks using biological agents. (JP 1-02)

biological operation. Employment of biological agents to produce casualties in personnel or animals or damage to plants. (JP 1-02)

biological threat. A threat that consists of biological material planned to be deployed to produce casualties in personnel or animals or damage plants. (JP 1-02)

biological weapon. An item of materiel, which projects, disperses, or disseminates a biological agent including arthropod vectors. (JP 1-02)

blister agent. A chemical agent which injures the eyes and lungs and burns or blisters the skin. Also called vesicant agent. (JP 1-02)

boundary. A line that delineates surface areas for the purpose of facilitating coordination and deconfliction of operations between adjacent units, formations, or areas. (JP 1-02)

casualty. Any person who is lost to the organization by having been declared dead, duty status – whereabouts unknown, missing, ill, or injured. (JP 1-02)

chain of command. The succession of commanding officers from a superior to a subordinate through which command is exercised. (JP 1-02)

chemical agent. Any toxic chemical intended for use in military operations. (JP 1-02)

chemical defense. The methods, plans, and procedures involved in establishing and executing defensive measures against attack utilizing chemical agents. (JP 1-02)

chemical dose. The amount of chemical agent, expressed in milligrams, that is taken or absorbed by the body. (JP 1-02)

chemical environment. Conditions found in an area resulting from direct or persisting effects of chemical weapons. (JP 1-02)

chemical monitoring. The continued or periodic process of determining whether or not a chemical agent is present. (JP 1-02)

chemical operation. Employment of chemical agents to kill, injure, or incapacitate for a significant period time, man or animals, and deny or hinder the use of areas, facilities, or materiel; or defense against such employment. (JP 1-02)

chemical survey. The directed effort to determine the nature and degree of chemical hazard in an area and to delineate the perimeter of the hazard. (JP 1-02)

chemical warfare. All aspects of military operations involving the employment of lethal and incapacitating munitions/agents and the warning and protective measures associated with such offense operations. Since riot control agents and herbicides are not considered to be chemical warfare agents, those two items will be referred to separately or under the broader term "chemical," which will be used to include all types of chemical munitions/agents collectively. (JP 1-02)

chemical weapon. Together or separately, (a) a toxic chemical and its precursors, except when intended for a purpose not prohibited under the Chemical Weapons Convention; (b) a munition or device, specifically designed to cause death or other harm through toxic properties of those chemicals specified in (a), above, which would be released as a result of the employment of such munition or device; (c) any equipment specifically designed for use directly in connection with the employment of munitions or devices specified in (b), above. (JP 1-02)

combat information center. The agency in a ship or aircraft manned and equipped to collect, display, evaluate, and disseminate tactical information for the use of the embarked flag officer, commanding officer, and certain control agencies. Certain control, assistance, and coordination functions may be delegated by command to the combat information center. Also called **CIC**. (JP 1-02)

combat search and rescue. A specific task performed by rescue forces to effect the recovery of distressed personnel during war or military operations other than war. Also called **CSAR**. (JP 1-02)

combat service support. The essential capabilities, functions, activities, and tasks necessary to sustain all elements of operating forces in theater at all levels of war. Within the national and theater logistic systems, it includes but is not limited to that support rendered by service forces in ensuring the aspects of supply, maintenance, transportation, health services, and other services required by aviation and ground combat troops to permit those units to accomplish their missions in combat. Combat service support encompasses those activities at all levels of war that produce sustainment to all operating forces on the battlefield. Also called **CSS**. (JP 1-02)

combat support. Fire support and operational assistance provided to combat elements. Also called **CS**. (JP 1-02)

combatant command (command authority). Nontransferable command authority established by title 10 (“Armed Forces”), United States Code, section 164, exercised only by commanders of unified or specified combatant commands unless otherwise directed by the President or the Secretary of Defense. Combatant command (command authority) cannot be delegated and is the authority of a combatant commander to perform those functions of command over assigned forces involving organizing and employing commands and forces, assigning tasks, designating objectives, and giving authoritative direction over all aspects of military operations, joint training, and logistics necessary to accomplish the missions assigned to the command. Combatant command (command authority) should be exercised through the commanders of subordinate organizations. Normally this authority is exercised through subordinate joint force commanders and Service and/or functional component commanders. Combatant command (command authority) provides full authority to organize and employ commands and forces as the combatant commander considers necessary to accomplish assigned missions. Operational control is inherent in combatant command (command authority). Also called **COCOM**. (JP 1-02)

command and control. The exercise of authority and direction by a properly designated commander over assigned and attached forces in the accomplishment of the mission. Command and control functions are performed through an arrangement of personnel, equipment, communications, facilities, and procedures employed by a commander in planning, directing, coordinating and controlling forces and operations in the accomplishment of a mission. Also called **C2**. (JP 1-02)

commander’s critical information requirements. A comprehensive list of information requirements identified by the commander as being critical in facilitating timely information management and the decision-making process that affect successful mission accomplishment. The two key subcomponents are critical friendly force information and priority intelligence requirements. Also called **CCIR**. (JP 1-02)

common operational picture. A single identical display of relevant information shared by more than one command. A common operational picture facilitates collaborative planning and assists all echelons to achieve situational awareness. Also called **COP**. (JP 1-02)

communications zone. Rear part of a theater of war or theater of operations (behind but contiguous to the combat zone) which contains the lines of communications, establishments for supply and evacuation, and other agencies required for the immediate support and maintenance of the field forces. Also called **COMMZ**. (JP 1-02)

concept of operations. A verbal or graphic statement, in broad outline, of a commander’s assumptions or intent in regard to an operation or series of operations. The concept of operations frequently is embodied in campaign plans and operation plans; in the latter case, particularly when the plans cover a series of connected operations to be carried out simultaneously or in succession. The concept is designed to give an overall picture of the operation. It is included primarily for additional clarity of purpose. Also called **CONOPS**. (JP 1-02)

contamination control. Procedures to avoid, reduce, remove, or render harmless (temporarily or permanently) nuclear, biological, and chemical contamination for the purpose of maintaining or enhancing the efficient conduct of military operations. (JP 1-02)

contamination. 1. The deposit, absorption or adsorption of radioactive material, or of biological or chemical agents on and by structures, areas, personnel, or objects. 2. Food and/or water made unfit for consumption by humans or animals because of the presence of environmental chemicals, radioactive elements, bacteria, or organisms, the by-product of the growth of bacteria or organisms, the decomposing material (to include the food substance itself) or waste in the food or water. (JP 1-02)

continental United States. United States territory, including the adjacent territorial waters, located within North America between Canada and Mexico. Also called **CONUS**. (JP 1-02)

contingency plan. A plan for major contingencies that can reasonably be anticipated in the principal geographic subareas of the command. (JP 1-02)

contracted logistic support. Support in which maintenance operations for a particular military system are performed exclusively by contract support personnel. Also called **CLS**. (JP 1-02)

course of action. 1. Any sequence of activities that an individual or unit may follow. 2. A possible plan open to an individual or commander that would accomplish, or is related to the accomplishment of the mission. 3. The scheme adopted to accomplish a job or mission. 4. A line of conduct in an engagement. 5. A product of the Joint Operation Planning and Execution System concept development phase. Also called **COA**. (JP 1-02)

date-time group. The date and time, expressed in digits and time zone suffix, at which the message was prepared for transmission. (Expressed as six digits followed by the time zone suffix; first pair of digits denotes the date, second pair the hours, third pair the minutes, followed by a three-letter month abbreviation and two-digit year abbreviation.) Also called **DTG**. (JP 1-02)

debarkation. The unloading of troops, equipment, or supplies from a ship or aircraft. (JP 1-02)

decision support template. A graphic record of wargaming. The decision support template depicts decision points, timelines associated with movement of forces and the flow of the operation, and other key items of information required to execute a specific friendly course of action. Also called **DST**. (JP 1-02)

decontamination. The process of making any person, object, or area safe by absorbing, destroying, neutralizing, making harmless, or removing chemical or biological agents, or by removing radioactive material clinging to or around it. (JP 1-02)

deliberate attack. A type of offensive action characterized by preplanned coordinated employment of firepower and maneuver to close with and destroy or capture the enemy. (JP 1-02)

detection. 1. In tactical operations, the perception of an object of possible military interest but unconfirmed by recognition. 2. In surveillance, the determination and transmission by a surveillance system that an event has occurred. 3. In arms control, the step in the process of ascertaining the occurrence of a violation of an arms control agreement. 4. In nuclear, biological, and chemical (NBC) environments, the act of locating NBC hazards by use of NBC detectors or monitoring and/or survey teams. (JP 1-02)

direct action. Short-duration strikes and other small-scale offensive actions by special operations forces or special operations-capable units to seize, destroy, capture, recover, or inflict damage on designated personnel or materiel. In the conduct of these operations, special operations forces or special operations-capable units may employ raid, ambush, or direct assault tactics; emplace mines and other munitions; conduct standoff attacks by fire from air, ground, or maritime platforms; provide terminal guidance for precision-guided munitions; conduct independent sabotage; and conduct anti-ship operations. Also called **DA**. (JP 1-02)

direct support. A mission requiring a force to support another specific force and authorizing it to answer directly to the supported force's request for assistance. Also called **DS**. (JP 1-02)

doctrine. Fundamental principles by which the military forces or elements thereof guide their actions in support of national objectives. It is authoritative but requires judgment in application. (JP 1-02)

essential elements of friendly information. Key questions likely to be asked by adversary officials and intelligence systems about specific friendly intentions, capabilities, and activities, so they can obtain answers critical to their operational effectiveness. Also called **EEFI**. (JP 1-02)

explosive ordnance disposal. The detection, identification, on-site evaluation, rendering safe, recovery, and final disposal of unexploded explosive ordnance. It may also include explosive ordnance which has become hazardous by damage or deterioration. Also called **EOD**. (JP 1-02)

fire support officer. Senior field artillery officer assigned to Army maneuver battalions and brigades. Advises commander on fire-support matters. Also called **FSO**. (JP 1-02)

foreign internal defense. Participation by civilian and military agencies of a government to free and protect its society from subversion, lawlessness, and insurgency. Also called **FID**. (JP 1-02)

forward operations base. In special operations, a base usually located in friendly territory or afloat that is established to extend command and control or communications or to provide support for training and tactical operations. Facilities may be established for temporary or longer duration operations and may include an airfield or an unimproved airstrip, an anchorage, or a pier. A forward operations base may be the location of special operations component headquarters or a smaller unit that is controlled and/or supported by a main operations base. Also called **FOB**. (JP 1-02)

general support. 1. That support which is given to the supported force as a whole and not to any particular subdivision thereof. 2. **(DOD only)** A tactical artillery mission. Also called **GS**. (JP 1-02)

global positioning system. A satellite constellation that provides highly accurate position, velocity, and time navigation information to users. Also called **GPS**. (JP 1-02)

hazard. A condition with the potential to cause injury, illness or death of personnel; damage to or loss of equipment or property, or mission degradation. (JP 1-02)

health service support. All services performed, provided, or arranged by the Services to promote, improve, conserve, or restore the mental or physical well-being of personnel. These services include but are not limited to the management of health services resources, such as manpower, monies, and facilities; preventive and curative health measures; evacuation of the wounded, injured, or sick; selection of the medically fit and disposition of the medically unfit; blood management; medical supply, equipment, and maintenance thereof; combat stress control; and medical, dental, veterinary, laboratory, optometric, medical food, and medical intelligence services. Also called **HSS**. (JP 1-02)

high-value target. A target the enemy commander requires for the successful completion of the mission. The loss of high-value targets would be expected to seriously degrade important enemy functions throughout the friendly commander's area of interest. Also called **HVT**. (JP 1-02)

host nation. A nation that receives the forces and/or supplies of allied nations, coalition partners, and/or NATO organizations to be located on, to operate in, or to transit through its territory. Also called **HN**. (JP 1-02)

host-nation support. Civil and/or military assistance rendered by a nation to foreign forces within its territory during peacetime, crises or emergencies, or war based on agreements mutually concluded between nations. Also called **HNS**. (JP 1-02)

identification. 1. The process of determining the friendly or hostile character of an unknown detected contact. 2. In arms control, the process of determining which nation is responsible for the detected violations of any arms control measure. 3. In ground combat operations, discrimination between recognizable objects as being friendly or enemy, or the name that belongs to the object as a member of a class. Also called **ID**. (JP 1-02)

improvised explosive device. A device placed or fabricated in an improvised manner incorporating destructive, lethal, noxious, pyrotechnic, or incendiary chemicals and designed to destroy, incapacitate, harass, or distract. It may incorporate military stores, but is normally devised from nonmilitary components. Also called **IED**. (JP 1-02)

individual protection. Actions taken by individuals to survive and continue the mission under nuclear, biological, and chemical conditions. (JP 1-02)

individual protective equipment. In nuclear, biological, and chemical warfare, the personal clothing and equipment required to protect an individual from biological and chemical hazards and some nuclear effects. (JP 1-02)

industrial chemicals. Chemicals developed or manufactured for use in industrial operations or research by industry, government, or academia. These chemicals are not primarily manufactured for the specific purpose of producing human casualties or rendering equipment, facilities, or areas dangerous for human use. Hydrogen cyanide, Cyanogen chloride, phosgene, and chloropicrin are industrial chemicals that also can be military chemical agents. (JP 1-02)

information requirements. Those items of information regarding the enemy and his environment which need to be collected and processed in order to meet the intelligence requirements of a commander. (JP 1-02)

intelligence preparation of the battlespace. An analytical methodology employed to reduce uncertainties concerning the enemy, environment, and terrain for all types of operations. Intelligence preparation of the battlespace builds an extensive database for each potential area in which a unit may be required to operate. The database is then analyzed in detail to determine the impact of the enemy, environment, and terrain on operations and presents it in graphic form. Intelligence preparation of the battlespace is a continuing process. Also called **IPB**. (JP 1-02)

intelligence requirement. 1. Any subject, general or specific, upon which there is a need for the collection of information, or the production of intelligence. 2. A requirement for intelligence to fill a gap in the command's knowledge or understanding of the battlespace or threat forces. (JP 1-02)

intelligence. 1. The product resulting from the collection, processing, integration, analysis, evaluation, and interpretation of available information concerning foreign countries or areas. 2. Information and knowledge about an adversary obtained through observation, investigation, analysis, or understanding. (JP 1-02)

interoperability. 1. The ability of systems, units, or forces to provide services to and accept services from other systems, units, or forces and to use the services so exchanged to enable them to operate effectively together. 2. (**DOD only**) The condition achieved among communications-electronics systems or items of communications-electronics equipment when information or services can be exchanged directly and satisfactorily between them and/or their users. The degree of interoperability should be defined when referring to specific cases. (JP 1-02)

joint force commander. A general term applied to a combatant commander, subunified commander, or joint task force commander authorized to exercise combatant command (command authority) or operational control over a joint force. Also called **JFC**. (JP 1-02)

joint operations area. An area of land, sea, and airspace, defined by a geographic combatant commander or subordinate unified commander, in which a joint force commander (normally a joint task force commander) conducts military operations to accomplish a specific mission. Joint operations areas are particularly useful when operations are limited in scope and geographic area or when operations are to be conducted on the boundaries between theaters. Also called **JOA**. (JP 1-02)

joint rear area coordinator. The officer with responsibility for coordinating the overall security of the joint rear area in accordance with joint force commander directives and priorities in order to assist in providing a secure environment to facilitate sustainment, host-nation support, infrastructure development, and movements of the joint force. The joint rear area coordinator also coordinates intelligence support and ensures that area management is practiced with due consideration for security requirements. Also called **JRAC**. (JP 1-02)

joint rear area. A specific land area within a joint force commander's operational area designated to facilitate protection and operation of installations and forces supporting the joint force. Also called **JRA**. (JP 1-02)

joint special operations area. A restricted area of land, sea, and airspace assigned by a joint force commander to the commander of a joint special operations force to conduct special operations activities. The commander of joint special operations forces may further assign a specific area or sector within the joint special operations area to a subordinate commander for mission execution. The scope and duration of the special operations forces' mission, friendly and hostile situation, and politico-military considerations all influence the number, composition, and sequencing of special operations forces deployed into a joint special operations area. It may be limited in size to accommodate a discrete direct action mission or may be extensive enough to allow a continuing broad range of unconventional warfare operations. Also called **JSOA**. (JP 1-02)

joint special operations task force. A joint task force composed of special operations units from more than one Service, formed to carry out a specific special operation or prosecute special operations in support of a theater campaign or other operations. The joint special operations task force may have conventional non-special operations units assigned or attached to support the conduct of specific missions. Also called **JSOTF**. (JP 1-02)

liaison. That contact or intercommunication maintained between elements of military forces or other agencies to ensure mutual understanding and unity of purpose and action. (JP 1-02)

line of communications. A route, either land, water, and/or air, that connects an operating military force with a base of operations and along which supplies and military forces move. Also called **LOC**. (JP 1-02)

line of departure. 1. In land warfare, a line designated to coordinate the departure of attack elements. 2. In amphibious warfare, a suitably marked offshore coordinating line to assist assault craft to land on designated beaches at scheduled times. Also called **LD**. (JP 1-02)

logistic support. Logistic support encompasses the logistic services, materiel, and transportation required to support the continental United States-based and worldwide deployed forces. (JP 1-02)

logistics. The science of planning and carrying out the movement and maintenance of forces. In its most comprehensive sense, those aspects of military operations that deal with: a. design and development, acquisition, storage, movement, distribution, maintenance, evacuation, and disposition of materiel; b. movement, evacuation, and hospitalization of personnel; c. acquisition or construction, maintenance, operation, and disposition of facilities; d. acquisition or furnishing of services. (JP 1-02)

main supply route. The route or routes designated within an operational area upon which the bulk of traffic flows in support of military operations. Also called **MSR**. (JP 1-02)

maritime environment. The oceans, seas, bays estuaries, islands, coastal areas, and the airspace above these, including the littorals. (JP 1-02)

mean lethal dose. 1. The amount of nuclear irradiation of the whole body which would be fatal to 50 percent of the exposed personnel in a given period of time. 2. The dose of chemical agent that would kill 50 percent of exposed, unprotected, and untreated personnel. (JP 1-02)

median incapacitating dose. The amount or quantity of chemical agent which when introduced into the body will incapacitate 50 percent of exposed, unprotected personnel. (JP 1-02)

medical treatment facility. A facility established for the purpose of furnishing medical and/or dental care to eligible individuals. (JP 1-02)

military operations other than war. Operations that encompass the use of military capabilities across the range of military operations short of war. These military actions can be applied to complement any combination of the other instruments of national power and occur before, during, and after war. Also called **MOOTW**. (JP 1-02)

military standard requisitioning and issue procedure. A uniform procedure established by the Department of Defense for use within the Department of Defense to govern requisition and issue of materiel within standardized priorities. Also called **MILSTRIP**. (JP 1-02)

mission-oriented protective posture gear. Military term for individual protective equipment including suit, boots, gloves, mask with hood, first aid treatments, and decontamination kits issued to soldiers. Also called **MOPP gear**. (JP 1-02)

mission-oriented protective posture. A flexible system of protection against nuclear, biological, and chemical contamination. This posture requires personnel to wear only that protective clothing and equipment (mission-oriented protective posture gear) appropriate to the threat level, work rate imposed by the mission, temperature, and humidity. Also called **MOPP**. (JP 1-02)

mobile training team. A team consisting of one or more US military or civilian personnel sent on temporary duty, often to a foreign nation, to give instruction. The mission of the team is to train indigenous personnel to operate, maintain, and employ weapons and support systems, or to develop a self-training capability in a particular skill. The National Command Authorities may direct a team to train either military or civilian indigenous personnel, depending upon host-nation requests. Also called **MTT**. (JP 1-02)

monitoring. 1. The act of listening, carrying out surveillance on, and/or recording the emissions of one's own or allied forces for the purposes of maintaining and improving procedural standards and security, or for reference, as applicable. 2. The act of listening, carrying out surveillance on, and/or recording of enemy emissions for intelligence purposes. 3. The act of detecting the presence of radiation and the measurement thereof with radiation measuring instruments. Also called radiological monitoring. (JP 1-02)

movement to contact. A form of the offense designed to develop the situation and to establish or regain contact. (JP 1-02)

multiservice tactics, techniques, and procedures. Actions and methods that describe how the forces of two or more services will be employed in joint operations. It is ratified by two or more services and is promulgated in publications that identify the participating services, e.g., Army-Navy MTTP. MTTP increase interoperability among service war-fighting, staff, and support elements and, therefore, often require rapid development to maximize war-fighting effectiveness. MTTP supplement joint doctrine and JTTP, generally providing an increased level of detail. As such, it often requires frequent revision.

munition. A complete device charged with explosives, propellants, pyrotechnics, initiating composition, or nuclear, biological, or chemical material for use in military operations, including demolitions. Certain suitably modified munitions can be used for training, ceremonial, or nonoperational purposes. Also called ammunition. (JP 1-02)

named area of interest. The geographical area where information that will satisfy a specific information requirement can be collected. Named areas of interest are usually selected to capture indications of adversary courses of action, but also may be related to conditions of the battlespace. Also called **NAI**. (JP 1-02)

neat sample. An ideal sample medium for collection and laboratory analysis.

nerve agent. A potentially lethal chemical agent which interferes with the transmission of nerve impulses. (JP 1-02)

nongovernmental organizations. Transitional organizations of private citizens that maintain a consultative status with the Economic and Social Council of the United Nations. Nongovernmental organizations may be professional associations, foundations, multinational businesses, or simply groups with a common interest in humanitarian assistance activities (development and relief). "Nongovernmental organizations" is a term normally used by non-United States organizations. Also called **NGOs**. (JP 1-02)

nonpersistent agent. A chemical agent that when released dissipates and/or loses its ability to cause casualties after 10 to 15 minutes. (JP 1-02)

nuclear defense. The methods, plans, and procedures involved in establishing and exercising defensive measures against the effects of an attack by nuclear weapons or radiological warfare agents. It encompasses both the training for, and the implementation, of these methods, plans and procedures. (JP 1-02)

nuclear, biological, and chemical defense. Defensive measures that enable friendly forces to survive, fight, and win against enemy use of nuclear, biological, or chemical (NBC) weapons and agents. US forces apply NBC defensive measures before and during integrated warfare. In integrated warfare, opposing forces employ nonconventional weapons along with conventional weapons (NBC weapons are nonconventional). (JP 1-02)

nuclear, biological, and chemical environment. Environments in which there is deliberate or accidental employment, or threat of employment, of nuclear, biological, or chemical weapons; deliberate or accidental attacks or contamination with toxic industrial materials, including toxic industrial chemicals; or deliberate or accidental attacks or contamination with radiological (radioactive) materials. (JP 1-02)

nuclear, biological, and chemical-capable nation. A nation that has the capability to produce and employ one or more types of nuclear, biological, and chemical weapons across the full range of military operations and at any level of war in order to achieve political and military objectives. (JP 1-02)

objective. 1. The clearly defined, decisive, and attainable goals towards which every military operation should be directed. 2. The specific target of the action taken (for example, a definite terrain feature, the seizure or holding of which is essential to the commander's plan, or an enemy force or capability without regard to terrain features). (JP 1-02)

observation post. A position from which military observations are made, or fire directed and adjusted, and which possesses appropriate communications; may be airborne. Also called **OP**. (JP 1-02)

obstacle. Any obstruction designed or employed to disrupt, fix, turn, or block the movement of an opposing force, and to impose additional losses in personnel, time, and equipment on the opposing force. Obstacles can be natural, man-made, or a combination of both. (JP 1-02)

operation order. A directed issued by a commander to subordinate commanders for the purpose of effecting the coordinated execution of an operation. Also called **OPORD**. (JP 1-02)

operational control. Command authority that may be exercised by commanders at any echelon at or below the level of combatant command. Operational control is inherent in combatant command (command authority) and may be delegated within the command. When forces are transferred between combatant commands, the command relationship the gaining commander will exercise (and the losing commander will relinquish) over these forces must be specified by the Secretary of Defense. Operational control is the authority to perform those functions of command over subordinate forces involving organizing and employing commands and forces, assigning tasks, designating objectives, and giving authoritative direction necessary to accomplish the mission. Operational control includes authoritative direction necessary to accomplish the mission. Operational control should be exercised through the commanders of subordinate organizations. Normally this is exercised through subordinate joint force commanders and Service and/or functional component commanders. Operational control normally provides full authority to organize commands and forces and to employ those forces as the commander in operational control considers necessary to accomplish assigned missions; it does not, in and of itself, include authoritative direction for logistics or matters of administration, discipline, internal organization, or unit training. Also called **OPCON**. (JP 1-02)

order of battle. The identification, strength, command structure, and disposition of the personnel, units, and equipment of any military force. Also called **OB**. (JP 1-02)

ordnance. Explosives, chemicals, pyrotechnics, and similar stores, e.g., bombs, guns and ammunition, flares, smoke, or napalm. (JP 1-02)

persistency. In biological or chemical warfare, the characteristics of an agent which pertains to the duration of its effectiveness under determined conditions after its dispersal. (JP 1-02)

persistent agent. A chemical agent that, when released, remains able to cause casualties for more than 24 hours to several days or weeks. (JP 1-02)

pig or piglette. A heavy-duty, metal container that is designed to contain small sample containers for transport to the laboratory.

preventive medicine. The anticipation, communication, prediction, identification, prevention, education, risk assessment, and control of communicable diseases, illnesses and exposure to endemic, occupational, and environmental threats. These threats include nonbattle injuries, combat stress responses, weapons of mass destruction, and other threats to the health and readiness of military personnel. Communicable diseases include anthropod-, vector-, food-, waste-, and waterborne diseases. Preventative medicine measures include field sanitation, medical surveillance, pest and vector control, disease risk assessment, environmental and occupational health surveillance, waste (human, hazardous, and medical) disposal, food safety inspection, and potable water surveillance. Also called **PVNTMED**. (JP 1-02)

priority intelligence requirements. Those intelligence requirements for which a commander has an anticipated and stated priority in the task of planning and decision making. Also called **PIRs**. (JP 1-02)

proliferation (nuclear weapons). The process by which one nation after another comes into possession of, or into the right to determine the use of, nuclear weapons; each nation becomes potentially able to launch a nuclear attack upon another nation. (JP 1-02)

protection. 1. Measures taken to keep nuclear, biological, and chemical hazards from having an adverse effect on personnel, equipment, or critical assets and facilities. Protection consists of five groups of activities: hardening of positions, protecting personnel, assuming mission-oriented protective posture, using physical defense measures, and reacting to attack. 2. In space usage, active and passive defensive measures to ensure that United States and friendly space systems perform as designed by seeking to overcome an adversary's attempts to negate them and to minimize damage if negation is attempted. (JP 1-02)

protective clothing. Clothing especially designed, fabricated, or treated to protect personnel against hazards caused by extreme changes in physical environment, dangerous working conditions, or enemy action. (JP 1-02)

protective mask. A protective ensemble designed to protect the wearer's face and eyes and prevent the breathing of air contaminated with chemical and/or biological agents. (JP 1-02)

reconnaissance. A mission undertaken to obtain, by visual observation or other detection methods, information about the activities and resources of an enemy or potential enemy, or to secure data concerning the meteorological, hydrographic, or geographic characteristics of a particular area. Also called **RECON**. (JP 1-02)

request for information. 1. Any specific time-sensitive ad hoc requirement for intelligence information or products to support an ongoing crisis or operation not necessarily related to standing requirements or scheduled intelligence production. A request for information can be initiated to respond to operational requirements and will be validated in accordance with the theater command's procedures. 2. The National Security Agency/Central Security Service uses this term to state ad hoc signals intelligence requirements. Also called **RFI**. (JP 1-02)

risk assessment. The identification and assessment of hazards (first two steps of risk management process). (JP 1-02)

risk management. The process of identifying, assessing, and controlling risks arising from operational factors and making decisions that balance risk cost with mission benefits. Also called **RM**. (JP 1-02)

rules of engagement. Directives issued by competent military authority that delineate the circumstances and limitations under which United States forces will initiate and/or continue combat engagement with other forces encountered. Also called **ROE**. (JP 1-02)

search. 1. An operation to locate an enemy force known or believed to be at sea. 2. A systematic reconnaissance of a defined area, so that all parts of the area have passed within visibility. 3. To distribute gunfire over an area in depth by successive changes in gun elevation. (JP 1-02)

security. 1. Measures taken by a military unit, activity, or installation to protect itself against all acts designed to, or which may impair its effectiveness. 2. A condition that results from the establishment and maintenance of protective measures that ensure a state of inviolability from hostile acts or influences. 3. With respect to classified matter, the condition that prevents unauthorized persons from having access to official information that is safeguarded in the interests of national security. (JP 1-02)

smoke screen. A cloud of smoke used to conceal ground maneuver, obstacle breaching, recovery operations, and amphibious assault operations as well as key assembly areas, supply routes, and logistic facilities. (JP 1-02)

special reconnaissance. Reconnaissance and surveillance actions conducted by special operations forces to obtain or verify, by visual observation or other collection methods, information concerning the capabilities, intentions, and activities of an actual or potential enemy or to secure data concerning the meteorological, hydrographic, or geographic characteristics of a particular area. It includes target acquisition, area assessment, and post-strike reconnaissance. Also called **SR**. (JP 1-02)

subordinate command. A command consisting of the commander and all those individuals, units, detachments, organizations, or installations that have been placed under the command by the authority establishing the subordinate command. (JP 1-02)

surveillance. The systematic observation of aerospace, surface, or subsurface areas, places, persons, or things, by visual, aural, electronic, photographic or other means. (JP 1-02)

survey. The directed effort to determine the location and the nature of a chemical, biological, and radiological hazard in an area. (JP 1-02)

tactical control. Command authority over assigned or attached forces or commands or military capability or forces made available for tasking, that is limited to the detailed direction and control of movements or maneuvers within the operational area necessary to accomplish missions or tasks assigned. Tactical control is inherent in operational control. Tactical control may be delegated to, and exercised at any level at or below the level of combatant command. When forces are transferred between combatant commands, the command relationship the gaining commander will exercise (and the losing command will relinquish) over these forces must be specified by the Secretary of Defense. Tactical control provides sufficient authority for controlling and directing the application of force or tactical use of combat support assets within the assigned mission or task. Also called **TACON**. (JP 1-02)

tactical operations center. A physical groupment of those elements of a general and special staff concerned with the current tactical operations and the tactical support thereof. Also called **TOC**. (JP 1-02)

tactics. 1. The employment of units in combat. 2. The ordered arrangement and maneuver of units in relation to each other and/or the enemy in order to use their potentialities. (JP 1-02)

task force. 1. A temporary grouping of units, under one commander, formed for the purpose of carrying out a specific operation or mission. 2. A semi-permanent organization of units, under one commander, formed for the purpose of carrying out a continuing specific task. 3. A component of a fleet organized by the commander of a task fleet or higher authority for the accomplishment of a specific task or tasks. Also called **TF**. (JP 1-02)

terrorism. The calculated use of unlawful violence or threat of unlawful violence to inculcate fear; intended to coerce or to intimidate governments or societies in the pursuit of goals that are generally political, religious or ideological. (JP 1-02)

toxic chemical. Any chemical which, through its chemical action on life processes, can cause death, temporary incapacitation, or permanent harm to humans or animals. This includes all such chemicals, regardless of their origin or of their method of production, and regardless of whether they are produced in facilities, in munitions, or elsewhere. (JP 1-02)

toxic industrial biological. Biological materials (bacteria, viruses, and toxins) found in medical research, pharmaceutical, or other manufacturing processes that are toxic to humans and animals, or cause damage to plants. Also known as **TIB**. (FM 4-02.7)

toxic industrial chemical. Chemical compounds used or produced in industrial processes that are toxic to humans and animals, or cause damage to plants. **EXAMPLES** include fuels, solvents, heavy metals, and chemicals used in manufacturing processes. Also known as **TIC**. (FM 4-02.7)

toxic industrial material. Toxic industrial materials may be toxic industrial chemical (TIC), toxic industrial biological (TIB) and toxic industrial radiological (TIR) materials. Also known as **TIM**. (FM 4-02.7)

toxic industrial radiological. Radiation-emitting materials used in research, power generation, medical treatment, and other non-weapon developmental activities that are harmful to humans and animals if released outside their controlled environment. Also known as **TIR**. (FM 4-02.7)

unconventional warfare. A broad spectrum of military and paramilitary operations, normally of long duration, predominantly conducted by indigenous or surrogate forces who are organized, trained, equipped, supported, and directed in varying degrees by an external source. It includes guerrilla warfare and other direct offensive, low visibility, covert, or clandestine operations, as well as the indirect activities of subversion, sabotage, intelligence activities, and evasion and escape. Also called **UW**. (JP 1-02)

warning order. 1. A preliminary notice of an order or action which is to follow. 2. **(DOD only)** A crisis action planning directive issued by the Chairman of the Joint Chiefs of Staff that initiates the development and evaluation of courses of action by a supported commander and requests that a commander's estimate be submitted. 3. **(DOD only)** A planning directive that describes the situation, allocates forces and resources, establishes command relationships, provides other initial planning guidance, and initiates subordinate unit mission planning. (JP 1-02)

weapons of mass destruction. Weapons that are capable of a high order of destruction and/or of being used in such a manner as to destroy large numbers of people. Weapons of mass destruction can be high explosives or nuclear, biological, chemical, and radiological weapons, but exclude the means of transporting or propelling the weapon where such means is a separable and divisible part of the weapon. Also called **WMD**. (JP 1-02)

INDEX

A

AAs II-3
aerial survey I-4
agent indicators VII-1
air environment II-4
air samples E-33
airfields II-4
air-ground correlation factor I-3
all clear I-4
anchorages II-4
APOD III-1
APOE III-1
arctic environment A-3
area array H-6
area defense III-18
area monitoring I-1
area reconnaissance I-1, VI-7, IX-9
attack indicators I-10
attacks III-13
automatic reports K-8

B

background samples E-45
battlespace environment D-1
biological detection assets H-6
biological samples VII-3
bounce-and-bypass survey technique G-13
bounding overwatch technique G-7
box survey technique G-9
bursting munition D-5

C

capabilities I-2
chain of custody E-13
chemical detectors F-22
chemical samples VII-3
choke points II-3
civil control II-5
civil/infrastructure environment II-4
cloverleaf search technique G-15
coalition support L-4
COAs
 adversary D-9
 development of IV-4
coil formation G-5
collateral effects II-4

collateral missions L-3
collection equipment E-29
column formation G-1
commander's decisions VI-2
communications L-9
confirmation I-4
confirmatory identification VII-2
conflict termination III-22
connectivity I-2
contaminated material retrograde III-23
continuous monitoring I-1
control E-13
correlation factors I-3, I-10
country codes E-16
CRD L-7
critical-node array H-7
crosswind search IX-13
CW/BW report E-9

D

decision support template D-10
defensive operations III-18, J-21
definitive identification VII-2
deposition pattern D-5
desert environment A-2
detection I-1
detector employment H-2
dewarning I-4
direct action L-3
direct monitoring I-2
directed report K-9
dismounted
 operations IX-11
 surveillance J-12
documentation E-9, E-50
downwind hazard D-5
downwind search IX-11
during attack III-8

E

echelon formation G-2
environmental hazards II-4
equipment IX-7, J-1
equipment, capabilities of V-1
escort E-49

event
 matrix D-10
 template D-10
expected, qualified hazard IX-10
expected, unidentified hazard IX-10
exploitation III-15

F

FID L-2
fixed-site operations III-18
force organization III-7
forcible-entry operations III-21
functions J-3

G

ground survey I-6

H

handling E-27
hazard relationships IX-4
health hazards II-4
herringbone formation G-5

I

identification I-1, E-13
improvised nuclear device D-8
indirect monitoring I-2
industry II-5
infrastructure II-5
initial report K-8
intelligence III-7
interview form E-24

J

jungle environment A-2

K

key terrain II-3

L

labeling E-50
land environment II-3
lane search technique G-15
LB team L-4
lightweight NBCRS N-1
line formation G-2
littoral environment A-4
logistics support III-7
luminescent military commodities D-8

M

maneuver spaces II-3
man-made infrastructures II-4
maritime environment II-3
marking I-1, VIII-4, I-12
 procedures VIII-5
 signs VIII-4
MDMP IV-1
medical samples E-36
medical surveillance I-4, H-10
mission I-1, L-13
 analysis IV-2
 receipt IV-2
mobile defense III-18
monitoring techniques I-2
mountain environment A-1
mounted
 operations IX-14
 surveillance J-12
movement
 formations G-1
 techniques G-6
movement to contact III-12
multiple point sources D-5

N

NAIs H-5
natural harbors II-4
NBC reports VIII-1, K-1
NBCRS N-1
NBCRV N-1
nearside-farside survey technique G-7
network monitoring H-1
no known hazard IX-9
nonlinear operations III-22
nuclear facilities D-7

O

observation II-3
obstacles II-3
offensive operations III-11, J-18
operational commander VII-7
operational level I-4, N-2
operational planning IV-1
OPORD VII-9
orders preparation IV-7
organization III-4, IX-7, N-5
organizations, chemical service L-1

P

- packaging E-52
- packaging materials E-27
- pasture sampling E-42
- peacetime preparedness III-1, III-2
- peak report K-8
- periodic monitoring I-1
- physical environment III-7
- planning J-7
- point reconnaissance I-1
- point source D-5
- postattack III-8
- postmission L-16
- PPE levels IX-9
- precautionary measures IX-2
- premission L-10
- preparation III-5
- prereconnaissance IX-9
- presumptive identification VII-2
- principles I-2
- protection I-4
- pursuit operations III-15

R

- RA IX-1
- radiological
 - detection equipment F-20
 - dispersion D-7
 - hazards D-7
 - monitoring I-10
 - samples VII-3
 - sampling E-37
 - surveys I-4
- reactor fuel production D-8
- readiness III-2
- reconnaissance annex IV-4
- reconnaissance team VII-8
- recording I-4
- relationships
 - command and staff L-9
 - command and support J-17
- reliability I-2
- reporting I-1, VIII-1, E-22, K-7
- reports VI-1, VIII-1, K-1
- response III-11
- response sector III-4
- responsibilities VII-5, J-3
- retrograde operations III-18

- river crossing III-16
- route reconnaissance I-1, VI-5, IX-9

S

- safety IX-3
- SALUTE report VIII-2
- sample IX-15
 - collection VII-2
 - control site VII-8
 - identification number E-16
- sampling I-1, VI-4, VII-1, IX-9, E-1, J-15
 - approaches E-4
 - considerations E-4
 - environment E-32
 - guidelines E-5, E-8
 - kits E-4
 - location E-6
 - plan E-1
- sampling team VII-15, E-2
- sealed source D-8
- search I-1, VI-1, IX-9, IX-11, J-10
 - patterns IX-9
 - techniques G-13
- security assistance L-4
- series report K-9
- shipping E-22
- site
 - assessment E-2
 - closeout E-49
 - setup/linkup E-48
- situation template D-10
- situational awareness I-3
- soil samples E-34
- SOP outline B-1
- space environment II-4
- special operations L-2
- special report K-9
- specialist teams VII-8
- special-purpose equipment F-26
- SPOD III-1
- SPOE III-1
- spray device D-5
- SR L-2
- staff VII-5
- standoff chemical detectors M-1
 - aerospace configuration M-10
 - fixed-site employment M-8
 - maritime configuration M-10
- standoff detection II-4, H-6, H-8
- star survey technique G-12

strategic level I-4
strategic planning IV-1
Stryker NBCRV N-1
subterranean environment A-4
suitability I-2
summary report K-10
surface contamination I-5
surface soil samples E-37
surface water samples E-40
surveillance I-1, VI-3, H-1, J-12
survey I-1, VI-2, IX-9, IX-15, J-10
survey techniques G-7
survivability I-2
sustainment III-7

T

tactical level I-4, N-2
tactical planning IV-1
tasks N-4
TBM D-6
templates D-9
terrain analysis D-1
theater access III-7
threat
 environment II-1
 evaluation D-3
TIM
 hazards II-2, D-8
 operations, dos and don'ts IX-15
 reconnaissance IX-1
timeliness I-2
transfer
 operations E-45
 procedures E-48
transition III-7
traveling overwatch technique G-7
traveling technique G-7
treatment I-4
tripod-mounted detector M-3
turn-back dose I-7
turn-back dose rate I-7

U

unit checklist C-1
unit employment J-16
units, types of J-4
upwind search IX-12
urban environment A-3
urban sampling E-43
USA

 capabilities V-2
 organizations and equipment F-1
USAF
 capabilities V-4
 organizations and equipment F-12
USMC
 capabilities V-3
 organizations and equipment F-11
USN
 capabilities V-5
 organizations and equipment F-14
UW L-3

V

V formation G-2
vapor samples E-33
vegetation samples E-35, E-42
vehicle correlation factor I-3
vehicle-mounted detector M-3
verification I-4
verification report K-10

W

war gaming IV-6
warning I-3, K-7
warning tag VIII-8
washout I-12
water samples E-34
weather II-5
weather analysis D-3
wedge formation G-2
witness interviews E-24

Z

zigzag search technique G-13
zone reconnaissance I-2, VI-6, IX-9

**FM 3-11.19
MCWP 3-37.4
NTTP 3-11.29
AFTTP(I) 3-2.44**

30 JULY 2004

By Order of the Secretary of the Army:

PETER J. SCHOOMAKER
General, United States Army
Chief of Staff

Official:



JOEL B. HUDSON
Administrative Assistant to the
Secretary of the Army
0418201

DISTRIBUTION:

Active Army, Army National Guard, and U.S. Army Reserve: To be distributed in accordance with the initial distribution number 115094, requirements for FM 3-11.19.

By Order of the Secretary of the Air Force:

DAVID F. MACGHEE, JR.
Major General, USAF
Commander
Headquarters Air Force Doctrine Center

Air Force Distribution: F

Marine Corps PCN: 143 000146 00

