

MCWP 3-15.5 (formerly FMFM 2-11)

MAGTF Antiarmor Operations



U.S. Marine Corps

PCN 143 000119 00

MCCDC (C 42)
27 Nov 2002

E R R A T U M

to

MCWP 3-15.5

ANTIARMOR OPERATIONS

1. For administrative purposes, FMFM 2-11 is reidentified as MCWP 3-15.5.

143 000119 80

DEPARTMENT OF THE NAVY
Headquarters United States Marine Corps
Washington, DC 20380-0001

9 June 1992

FOREWORD

1. PURPOSE

Fleet Marine Force Manual (FMFM) 2-11, *MAGTF Antiarmor Operations*, sets forth the doctrine, tactics, techniques, and procedures to be employed by a MAGTF commander and subordinate commanders in defensive operations against a mechanized force.

2. SCOPE

FMFM 2-11 provides guidance for the MAGTF commander, his staff, and his subordinate commanders in conducting combat operations against an enemy armor force. FMFM 2-11 sets forth a framework for employing the MAGTF's transitional capabilities against modern armor forces.

3. SUPERSESSION

FMFM 2-11 supersedes the defensive doctrine in FMFM 9-1, *Tank Employment/Countermechanized Operations*.

4. CHANGES

Recommendations for improving this manual are invited from commands as well as directly from individuals. Forward suggestions using the User Suggestion Form format to—

COMMANDING GENERAL
DOCTRINE DIVISION (C 42)
MARINE CORPS COMBAT DEVELOPMENT COMMAND
2042 BROADWAY STREET SUITE 210
QUANTICO, VIRGINIA 22134-5021

5. CERTIFICATION

Reviewed and approved this date.

BY DIRECTION OF THE COMMANDANT OF THE MARINE CORPS



M. R. STEELE
Colonel, U. S. Marine Corps
Acting Director, MAGTF Warfighting Center
Marine Corps Combat Development Command
Quantico, Virginia

DISTRIBUTION: 139 000141 00

USER SUGGESTION FORM

From:

To: COMMANDING GENERAL, DOCTRINE DIVISION (C 42), MARINE CORPS COMBAT DEVELOPMENT
COMMAND, 2042 BROADWAY STREET SUITE 210, QUANTICO, VIRGINIA 22134-5021

Subj: RECOMMENDATIONS CONCERNING FMFM 2-11, *MAGTF ANTIARMOR OPERATIONS*

1. In accordance with the Foreword to FMFM 2-11, which invites individuals to submit suggestions concerning this FMFM directly to the above addressee, the following unclassified recommendation is forwarded:

<u>Page</u>	<u>Article/Paragraph No.</u>	<u>Line No.</u>	<u>Figure/Table No.</u>	
Nature of Change:	<input type="checkbox"/> Add	<input type="checkbox"/> Delete	<input type="checkbox"/> Change	<input type="checkbox"/> Correct

2. Proposed new verbatim text: (Verbatim, double-spaced; continue on additional pages as necessary.)

3. Justification/source: (Need not be double-spaced.)

NOTE: Only one recommendation per page.

Record of Changes

Change No.	Date of Change	Date of Entry	Organization	Signature

MAGTF Antiarmor Operations

Table of Contents

	Page
List of Illustrations	ix
Chapter 1. Introduction	
1001 The MAGTF vs. Enemy Armored Formations	1-1
1002 Scope	1-1
1003 Marine Corps' Warfighting Concept in Antiarmor Operations	1-2
1004 Engagement Area Model	1-3
Chapter 2. The Threat	
Section I. Threat Offensive Doctrine	
2101 Threat Offensive Philosophy	2-1
2102 Types of Offensive Action	2-2
2103 Tactical Formations and Movements	2-2
2104 Forms of Maneuver	2-3
Section II. Threat Armor	
2201 Armor Improvements	2-6
2202 Threat Armored Vehicles	2-6
2203 Armor Vulnerability	2-16
2204 Lightly Armored Vehicles	2-16
Chapter 3. MAGTF Antiarmor Weapons and Techniques	
Section I. Antiarmor Weapon Systems	
3101 Weapons Systems	3-1
3102 Strength and Weaknesses of Antiarmor Weapons Systems	3-10
Section II. Antiarmor Techniques	
3201 Methods of Engagement	3-12
3202 Engagement Area	3-15
3203 Weapon Positioning	3-16
3204 Fire Control	3-21
3205 Tank Killer Teams	3-29

Chapter 4. Antiarmor in the Defense

Section I. Defensive Doctrine

4101	Fundamentals of the Defense	4-1
4102	Organization of the Defense	4-2
4103	Distribution of Forces	4-3
4104	Defensive Positions and Sectors	4-4
4105	Types of Defense	4-4
4106	Offensive Action in the Defense	4-5

Section II. Organization of a MAGTF Antiarmor Defense

4201	MAGTF Air and LAI Operations	4-9
4202	Division	4-9
4203	Regiment	4-10
4204	Battalion	4-12
4205	Company	4-16
4206	Maneuvering and Battle Positions	4-16
4207	Reverse Slope Defense	4-20
4208	Perimeter Defense	4-22
4209	Urban Terrain and Antiarmor Operations	4-23
4210	Combat Service Support	4-26
4211	Defense Control Measures	4-26

Section III. Delay Against Mechanized Forces

4301	Fundamentals of the Delay	4-28
4302	Techniques for Delaying	4-28
4303	Employment of Delaying Forces	4-30
4304	Employment of the Reserve	4-31
4305	Planning and Conducting a Delay Operation	4-31

Section IV. Fire Support and the Engagement Area

4401	Definition	4-34
4402	Offensive Air Support	4-34
4403	Indirect Fire Support	4-36
4404	Fire Support Planning	4-37

Section V. Engineering Operations and the Engagement Area

4501	Definitions	4-39
4502	Survivability	4-39
4503	Countermobility	4-41
4504	Existing Obstacles	4-43
4505	Reinforcing Obstacles	4-43
4506	Obstacle Employment Principles	4-46

		Page
Section VI. Intelligence		
4601	Surveillance, Reconnaissance, and Intelligence Group	4-49
4602	Fundamentals of Intelligence	4-49
4603	Types of Intelligence	4-49
4604	Organization of the Battlefield	4-49
4605	Intelligence Preparation of the Battlefield	4-51
Section VII. Electronic Warfare		
4701	Definitions	4-52
4702	Planning Considerations	4-52
Chapter 5. Antiarmor Exercise		
5001	General Situation	5-1
5002	Special Situation #1	5-1
5003	Special Situation #2	5-3
5004	Special Situation #3	5-3
5005	Special Situation #4	5-3
5006	Special Situation #5	5-4
5007	Special Situation #6	5-4
5008	Special Situation #7	5-5
Appendixes:		
A	Antiarmor Close Combat Course	A-1
B	Recommended Professional Reading List	B-1
C	Glossary	C-1
D	References	D-1
Index		Index 1

List of Illustrations

Figure		Page
1-1	Doctrinal Spectrum.	1-2
1-2	Engagement Area Model.	1-4
2-1	Commitment of Forces.	2-2
2-2	March Formation – Battalion.	2-2
2-3	Battalion Prebattle Formations.	2-3
2-4	Deployment of a Battalion and Company.	2-4
2-5	Forms of Maneuver.	2-5
2-6	T-80.	2-6
2-7	T-72.	2-7
2-8	T-64.	2-7
2-9	T-62.	2-8
2-10	T-54/55.	2-8
2-11	PT-76 (Light Amphibious Tank).	2-9
2-12	BMD.	2-9
2-13	BMP.	2-10
2-14	BTR-60PB.	2-10
2-15	BTR-40P2 ATGM Carrier.	2-11
2-16	BTR-40P2 (BRDM-2).	2-11
2-17	BTR-40 (4 × 4) Without Armament.	2-12
2-18	AMX-30 MBT (France).	2-12
2-19	Leopard 2 MBT (Germany).	2-13
2-20	Merkava MBT (Israel).	2-13
2-21	Centurion Mk 10 MBT (Great Britain).	2-14
2-22	AMX-13 Light Tank (France).	2-14
2-23	Marder ICV Infantry Combat Vehicle (Germany).	2-15
2-24	OTO Melara C13 APC (Italy).	2-15
2-25	Tank Deadspace.	2-17
2-26	Armor Vulnerability.	2-18
3-1	M1A1 Tank.	3-1
3-2	M60A1 Tank.	3-2
3-3	LAV 25 AT.	3-2
3-4	LAV 25.	3-3
3-5	TOW (HMMWV).	3-3
3-6	AH-1W COBRA Attack Helicopter.	3-4
3-7	M47 Dragon.	3-4
3-8	Shoulder-Launched Multipurpose Assault Weapon (SMAW).	3-5
3-9	M72A2 Light Antiarmor Weapon (LAW).	3-5
3-10	AT4.	3-6

Figure		Page
3-11	MK-19 Machine Gun.	3-6
3-12	M-2 Browning Machine Gun (Caliber .50 HB).	3-7
3-13	Copperhead.	3-7
3-14	Family of Scatterable Mines.	3-8
3-15	Dual-Purpose Improved Conventional Munitions 155 mm M-198.	3-8
3-16	F/A-18 Hornet.	3-9
3-17	AV-8B Harrier.	3-9
3-18	A-6 Intruder.	3-9
3-19	A-4 Skyhawk.	3-10
3-20	HAW-MAW-LAW.	3-12
3-21	HAW-MAW-LAW Achieving Depth.	3-13
3-22	Massed-Surprise Fire.	3-14
3-23	Engagement Methods.	3-14
3-24	Front and Flank Combination Engagement.	3-15
3-25	Location of Engagement Areas.	3-16
3-26	Engagement Area (Combination).	3-16
3-27	Concealment Using Natural Terrain.	3-17
3-28	Overhead Protection.	3-17
3-29	Hide Position.	3-18
3-30	Turret Defilade.	3-18
3-31	Hull Defilade.	3-18
3-32	Inadequate Dispersion.	3-19
3-33	Lateral and In-Depth Dispersion.	3-19
3-34	Mutual Support Between Weapons.	3-20
3-35	Standoff Range.	3-20
3-36	Flank Shot.	3-21
3-37	Sector of Fire.	3-21
3-38	Overlapping Sectons of Fire.	3-22
3-39	Target Reference Point.	3-23
3-40	Trigger Point.	3-24
3-41	Sample TOW Section Fire Command.	3-25
3-42	Frontal Fire Pattern.	3-25
3-43	Cross Fire Pattern.	3-26
3-44	Depth Fire Pattern.	3-26
3-45	Kill Window.	3-27
3-46	Positions.	3-27
3-47	Range Card.	3-28
3-48	Platoon Fire Plan.	3-29
4-1	Organization of the Defense.	4-2
4-2	Defensive Concepts.	4-5
4-3	Defense Spectrum.	4-6
4-4	Counterattacks.	4-7
4-5	Stay Behind Forces.	4-8
4-6	Marine Expeditionary Force/Division Screen.	4-10
4-7	Division Main Battle Area.	4-10

Figure		Page
4-8	Sectors.	4-11
4-9	Battle Positions/Sectors.	4-12
4-10	Strongpoint/Battle Positions.	4-12
4-11	Defend in Sector.	4-13
4-12	Sector/Battle Positions/Strongpoint.	4-14
4-13	Battalion Battle Position.	4-15
4-14	Battalion Strongpoint.	4-15
4-15	Execution Matrix.	4-18
4-16	Completed Execution Matrix/Overlay.	4-19
4-17	Military Topography.	4-20
4-18	Reverse Slope Defense.	4-21
4-19	Weapons Positions.	4-22
4-20	Perimeter Defense.	4-23
4-21	HUB Phenomenon.	4-23
4-22	Mechanized Force in Built-Up Area.	4-24
4-23	Battalion Defense.	4-25
4-24	Battle Position.	4-26
4-25	Delay From Successive Positions.	4-29
4-26	Delay From Alternate Position.	4-30
4-27	Calculation Table.	4-38
4-28	Target Group.	4-38
4-29	Target Series.	4-38
4-30	Strongpoints.	4-40
4-31	Obstacle Zone.	4-42
4-32	Obstacle Belts.	4-42
4-33	Armored Unit Approaches Obstacle.	4-44
4-34	Constructed Obstacle.	4-45
4-35	FASCAM.	4-46
4-36	Obstacle/Weapon Integration.	4-47
4-37	Supporting the Maneuver Commander's Plan.	4-47
4-38	MAGTF Intelligence Organizations.	4-50
4-39	Organization of the Battlefield.	4-51
5-1	General Situation.	5-2
5-2	Situation #1.	5-2
5-3	1st Marine Regiment Defensive Position.	5-4
5-4	1st Bn 5th Marines in Built-Up Area.	5-5
A-1	Training Area Antiarmor Close Combat Course.	A-1

Chapter 1

Introduction

The Marine Corps is an expeditionary force that must be *light* enough to be strategically projected yet *heavy* enough to defeat potential adversaries possessing large armored formations. The expeditionary nature of the Marine Corps limits the number of armor assets available to the Marine Air-Ground Task Force (MAGTF), while many of our potential enemies continue to expand and upgrade their armor forces. This dilemma requires that the MAGTF commander adopt a style of warfighting which allows him to win without armor parity. The MAGTF defeats enemy armor through the use of combined arms and the execution of maneuver warfare as prescribed in FMFM 1, *Warfighting*.

1001. The MAGTF vs. Enemy Armored Formations

A MAGTF may confront two types of armor threat. The first is the small group of tanks operating in direct support of enemy infantry. The second type is the large armored force which is the enemy's arm of decision and its primary means of influencing the battle. The destruction of this large armored force is the subject of this manual.

Destroying small groups of tanks is an action that occurs primarily at the small-unit level of war. The destruction of enemy armored formations is primarily a tactical action composed of the many technical actions available to the MAGTF commander. The defeat of large armored formations is *not* the result of a series of successful, random actions at the platoon and squad level, in which small units utilize supporting arms on an as-required basis. Success against large armored formations requires the proper planning, coordination, and execution from the MAGTF commander down through his subordinate commanders and staffs. This MAGTF focus will ensure the fullest use of combined arms.

When a MAGTF confronts a modern land army, the development of a *countermechanized plan* as a separate and distinct part of the operations order—relegated to an annex—is not valid. This approach views enemy armor as an aberration in primarily an infantry-intensive environment. The assumption of large numbers of enemy armor must be integrated and reflected throughout the operations order. While adjustments are made according to mission, enemy, terrain and weather, troops and support available, and time available, the MAGTF should assume an antiarmor posture as a rule, not an exception.

1002. Scope

This manual sets forth the basic concepts of antiarmor operations for the MAGTF commander, subordinate commanders, and his staff. This manual provides general guidance (doctrine and tactics) and specific guidance (techniques and procedures) to commanders and their staffs. It is important to understand the difference between these types of guidance and their applicability. Guidance on the

conduct of combat operations varies from the very general to the very specific. Usually, the more general the guidance, the more widely applicable it is; and the more specific the guidance, the fewer the situations where it applies. The most general guidance is called doctrine, while the most specific guidance is called procedures. Tactics and techniques fall between doctrine and procedures, with tactics being more general than techniques. (See fig. 1-1.)

There are no clear divisions between these different levels of guidance. The interdependence of these levels is equally difficult to quantify. For example, a change in tactics may or may not require a change in procedures. The guidance in this manual includes doctrine, tactics, techniques, and procedures.

a. Doctrine. FMFM 2-11 provides the doctrinal foundation for employment of antiarmor operations by the MAGTF commander. FMFM 2-11 also provides the Threat doctrine for antiarmor operations. Doctrine is the fundamental principles by which the military forces or elements thereof guide their actions in support of national objectives. It is authoritative but requires judgment in application. (Joint Pub 1-02) Doctrine is a collection of words which describe how military organizations function and how military operations are conducted. Each principle has (1) a word or phrase for a name and (2) a definition which explains or describes the principle. The definition may include a list of functions or a list of parts. Doctrine is important because words are the tools for thinking, teaching, and giving directions. An

example is the primacy of the combined arms concept over individual arms in achieving success.

b. Tactics. This manual covers the tactical actions that a commander must take to destroy enemy armor formations. Tactics is 1. The employment of units in combat. 2. The ordered arrangement and maneuver of units in relation to each other and/or to the enemy in order to use their full potentialities. (Joint Pub 1-02) An example is the use of a *spoiling attack* to keep an attacking force off balance.

c. Techniques. Techniques are methods of accomplishing a goal or mission. An example is engaging enemy armored formations at the maximum effective range of friendly antiarmor weapon systems.

d. Procedures. Procedures are a series of standardized steps, a particular way of doing something. An example is the formulation of an antiarmor weapon range card.

1003. Marine Corps' Warfighting Concept in Antiarmor Operations

The MAGTF defines the Marine Corps' posture toward combat. When the MAGTF is fighting

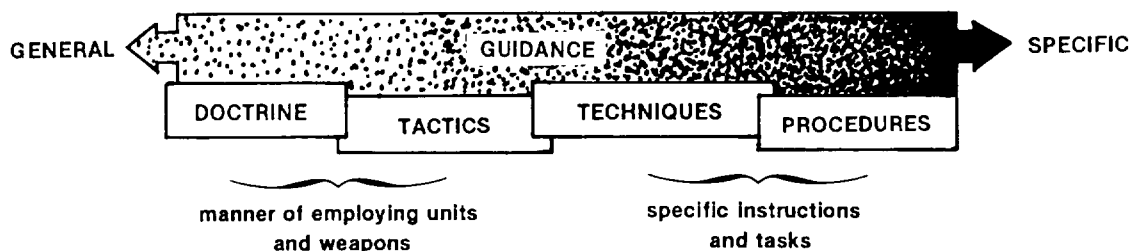

Figure 1-1. Doctrinal Spectrum.

against armored formations, the fact that it is an air-ground team can be used to present the enemy with a dilemma. To effectively strike our ground forces, the enemy must mass his armor. However, massing his armor presents a lucrative target to our ground attack aircraft. Conversely, to avoid being attacked by Marine air, enemy armored commanders will seek to operate in forests, built-up areas, and other close terrain. However, this terrain is precisely the kind of place where our ground forces can most effectively attack armored vehicles.

a. The MAGTF's Transitional Capability. The MAGTF commander views his force's transitional capability as a combat multiplier, allowing the MAGTF to simultaneously confront the enemy with a variety of modes of fighting:

- Light armor (LAI).
- Mechanized (AAV).
- Dismounted (foot).
- Motorized (truck).
- Helicopterborne (helicopter).

b. Definitions. The following definitions are provided to assist the reader in developing a basic understanding of antiarmor doctrine and operations.

(1) Mechanized Force. A mechanized force is a task-organized, ground combat force of combined arms built around an infantry or tank unit, reinforced with substantial assault amphibious assets. A Marine mechanized force normally is supported by air, artillery, light armor, antitank, engineer, reconnaissance, motor transport, and other combat support and combat service support units. References to mechanized or armored units/forces include but are not restricted to tracked vehicles.

The terms armor and mechanized are often used interchangeably. Additionally, the terms antiarmor, antimech, or countermech mean the same thing.

(2) Mechanized Operation. A mechanized operation is a tactical operation designed to maximize the ground mobility, protection, shock action, and firepower of the force to concentrate combat power rapidly against the enemy. Combat power is generated by the massed employment of tanks and enhancing the mobility of other forces through the use of assault amphibious vehicles (AAVs), or armored personnel carriers (APCs) and infantry fighting vehicles (IFVs), and other ground mobility means.

(3) Mechanized Infantry. This term refers to a task-organized force of Marine infantry mounted in AAVs which are employed in conjunction with tanks. In general, this term is a reference to any infantry (friendly or enemy) that are riding in APCs or IFVs. Note, that in most of the world's land armies the APC or IFV is organic to the infantry units.

(4) Light Armored Infantry (LAI). This term refers to the LAI battalion. The infantry personnel which are organic to the LAI battalion are called scout infantry. Scout infantry are not employed in the same manner as infantry or mechanized infantry. Scout infantry are trained and organized for employment in support of light armored vehicles. In consonance with the LAI battalion's mission, scout infantry normally avoid decisive close combat.

1004. Engagement Area Model

In addition to the preceding model depicting different levels of guidance, the reader should also be

cognizant of another conceptual model that addresses the technical aspects of antiarmor operations within the framework of the engagement area (EA), weapon engagement and positioning, and unit positioning. This model, which will be referred to as the EA model, will assist the reader in

understanding a unit's antiarmor posture within the broader context of the MAGTF's primary mission. *The EA model is the frame of reference for the discussion of antiarmor operations.* (See fig. 1-2.) This concept will be defined in the forthcoming chapters. See chapter 3, par. 3202.

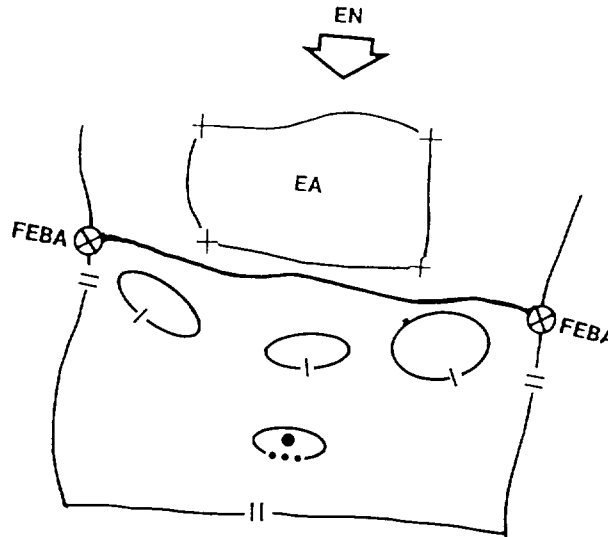

Figure 1-2. Engagement Area Model.

against armored formations, the fact that it is an air-ground team can be used to present the enemy with a dilemma. To effectively strike our ground forces, the enemy must mass his armor. However, massing his armor presents a lucrative target to our ground attack aircraft. Conversely, to avoid being attacked by Marine air, enemy armored commanders will seek to operate in forests, built-up areas, and other close terrain. However, this terrain is precisely the kind of place where our ground forces can most effectively attack armored vehicles.

a. The MAGTF's Transitional Capability. The MAGTF commander views his force's transitional capability as a combat multiplier, allowing the MAGTF to simultaneously confront the enemy with a variety of modes of fighting:

- Light armor (LAI).
- Mechanized (AAV).
- Dismounted (foot).
- Motorized (truck).
- Helicopterborne (helicopter).

b. Definitions. The following definitions are provided to assist the reader in developing a basic understanding of antiarmor doctrine and operations.

(1) Mechanized Force. A mechanized force is a task-organized, ground combat force of combined arms built around an infantry or tank unit, reinforced with substantial assault amphibious assets. A Marine mechanized force normally is supported by air, artillery, light armor, antitank, engineer, reconnaissance, motor transport, and other combat support and combat service support units. References to mechanized or armored units/forces include but are not restricted to tracked vehicles.

The terms armor and mechanized are often used interchangeably. Additionally, the terms antiarmor, antimech, or countermech mean the same thing.

(2) Mechanized Operation. A mechanized operation is a tactical operation designed to maximize the ground mobility, protection, shock action, and firepower of the force to concentrate combat power rapidly against the enemy. Combat power is generated by the massed employment of tanks and enhancing the mobility of other forces through the use of assault amphibious vehicles (AAVs), or armored personnel carriers (APCs) and infantry fighting vehicles (IFVs), and other ground mobility means.

(3) Mechanized Infantry. This term refers to a task-organized force of Marine infantry mounted in AAVs which are employed in conjunction with tanks. In general, this term is a reference to any infantry (friendly or enemy) that are riding in APCs or IFVs. Note, that in most of the world's land armies the APC or IFV is organic to the infantry units.

(4) Light Armored Infantry (LAI). This term refers to the LAI battalion. The infantry personnel which are organic to the LAI battalion are called scout infantry. Scout infantry are not employed in the same manner as infantry or mechanized infantry. Scout infantry are trained and organized for employment in support of light armored vehicles. In consonance with the LAI battalion's mission, scout infantry normally avoid decisive close combat.

1004. Engagement Area Model

In addition to the preceding model depicting different levels of guidance, the reader should also be

cognizant of another conceptual model that addresses the technical aspects of antiarmor operations within the framework of the engagement area (EA), weapon engagement and positioning, and unit positioning. This model, which will be referred to as the EA model, will assist the reader in

understanding a unit's antiarmor posture within the broader context of the MAGTF's primary mission. *The EA model is the frame of reference for the discussion of antiarmor operations.* (See fig. 1-2.) This concept will be defined in the forthcoming chapters. See chapter 3, par. 3202.

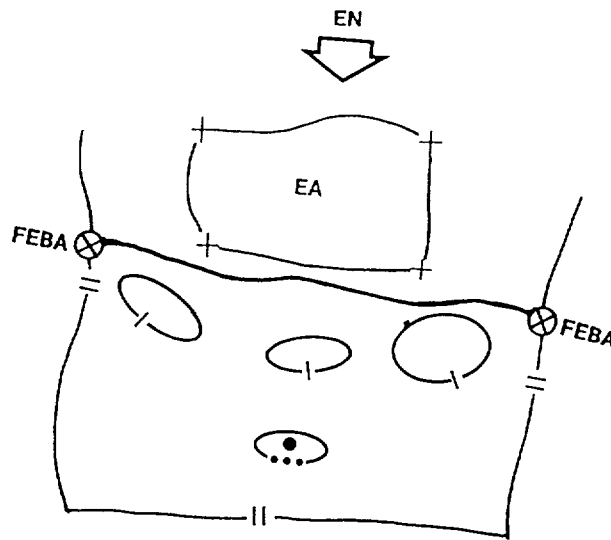

Figure 1-2. Engagement Area Model.

Chapter 2

The Threat

This chapter addresses offensive mechanized doctrine and armored vehicles used by potential adversaries. Many Third World countries were trained and equipped by the Soviet Union to the extent that Soviet offensive capability remains a useful yardstick by which to measure the MAGTF's capability against potential land armies. However, this chapter presents a generic enemy doctrine that is influenced by but not solely restricted to Soviet doctrine. *While many of our potential enemies are not 100 percent combined arms armies, some possess the capability to concentrate battalion- or regimental-sized armored formations against MAGTF defenses. Armor equipment presented in the second section includes vehicles manufactured by traditional allies.* Future weapon sales and shifting alliances could result in *friendly* equipment opposing a MAGTF. Because of these uncertainties, a basic understanding of mechanized doctrine and weapons capabilities is essential for successful antiarmor operations.

Section I. Threat Offensive Doctrine

2101. Threat Offensive Philosophy

Threat forces consider the offense the basic form of combat action. Threat forces plan on overwhelming the enemy with numbers coupled with speed and firepower at critical times during the battle. They also assume that there will be high losses early in the battle that are ultimately justified by the short duration of combat resulting from this mass-speed combination.

Offensive action will normally begin with simultaneous artillery and air attacks combined with tank and mechanized infantry formations to break through the enemy's tactical (division and below) defense. The mechanized formations then drive rapidly and forcefully into the depth of the enemy's operational rear to gain success. The assumption is that a disorganized, demoralized, and isolated enemy would be unable to reestablish an effective and coordinated defense. (FM 100-2-1)

Threat forces attempt to maintain a rapid tempo of operations by echeloning their formations. Echeloning occurs at the operational and tactical level. (See fig. 2-1.)

Planners desire an aggregate ratio of combat power of approximately 3:1 for conducting an attack. This 3:1 ratio refers to more than just cumulative numbers of first echelon troops and weapons relative to enemy troops and weapons in a given sector. When the attack begins, his actual strength advantage at the FEBA could be as small as 2:1. The remainder of the force may not be readily visible to defending enemy units. (FM 100-2-1)

A combined-arms army will emphasize some or all of the following concepts:

- Rapid concentration and dispersal of combat power on the battlefield.

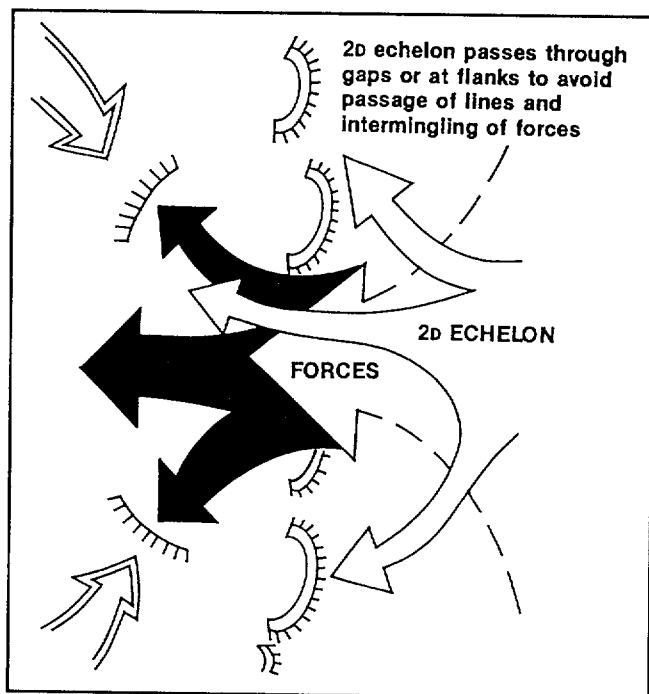

Figure 2-1. Commitment of Forces.

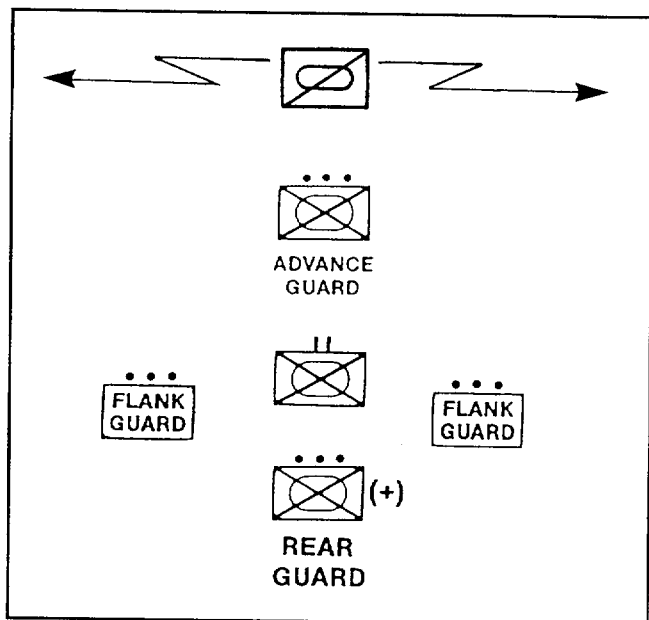

Figure 2-2. March Formation – Battalion.

- Attacking on multiple axes.
- Exploitation of weak points in an enemy defense.
- Flexibility and speed in shifting combat power.
- Surprise.
- Speed.
- Independent action by commanders.
- Attacking deep into the enemy's rear.

2102. Types of Offensive Action

Offensive actions are divided into three subcategories which focus on enemy actions and disposition.

- Attack against a defending enemy.
- Meeting engagement (enemy is also on offense).
- Pursuit (enemy is withdrawing).

2103. Tactical Formations and Movements

Threat forces emphasize rapid column movement in the *march formation* and successive deployment into the *prebattle formation* and the *attack formation*. These formations are designed for a rapid transition into combat while maintaining maximum security, speed, and firepower.

a. March Formation. A march is an organized troop movement conducted in column formation on roads or cross country. It is planned and conducted with expectation of contact. A regiment is normally assigned two routes and a battalion one route. See figure 2-2 for a battalion march formation. A march formation consists of the following elements:

- Reconnaissance.
- Advance guard.
- Flank security.
- Main force.
- Rear security element.

MARCH RATES

Average March Rates for Mixed Columns

Day, on roads	20 - 30 km/h
Night, on roads	15 - 20 km/h
Cross Country	5 - 10 km/h

The march is completed when the unit enters a new assembly area or when it enters prebattle formation or combat.

b. Prebattle Formation. The enemy will shift from a march formation to lateral deployment only when combat is imminent. The next successive lateral deployment out of the march formation is normally into a prebattle formation (also known as *approach march formation*). (See fig. 2-3.) The unit advances dispersed laterally and in depth. This formation is used when approaching the battlefield, moving into the enemy's rear, and attacking an enemy that has been severely degraded by artillery preparatory fires. A battalion advances with its companies deployed on line, in a wedge,

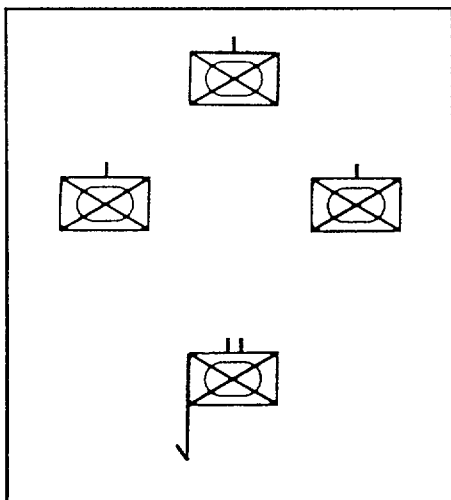

Figure 2-3. Battalion Prebattle Formations.

or an echelon. Each company moves in march column within the formation.

c. Attack Formation. The attack formation is assumed immediately before combat (1,000 meters from objective). (See fig. 2-4.) Platoons disperse laterally into line formations. A battalion may attack with all three companies on line.

As depicted, tanks on line normally precede APCs or IFVs. If troops dismount, they normally follow closely behind the tanks. APCs or IFVs normally follow between 100 to 400 meters behind the tanks. While the enemy may attempt to overrun the position mounted, any defensive position must be prepared to engage dismounted enemy infantry with tanks and IFVs firing in support.

2104. Forms of Maneuver

Soviet forces use three basic forms of maneuver: the frontal attack, flank attack, and envelopment. The flank attack and envelopment are normally done in conjunction with a frontal attack. (See fig. 2-5.)

a. Frontal Attack. The frontal attack was previously the most frequently employed form of maneuver. However, it is now the least preferred form of maneuver.

b. Flank Attack. Flank attacks are conducted through gaps or breaches through enemy formations and are normally a shallow attack against the enemy's flank or rear. Fire support is coordinated between forces simultaneously conducting frontal and flank attacks.

c. Envelopment. Envelopment is a deeper attack designed to get the enemy to fight in a new direction. It does not require coordination of fires with a force simultaneously conducting a frontal attack. It is the most desired form of maneuver because it exploits enemy gaps and allows attacks to the full depth of the enemy defense.

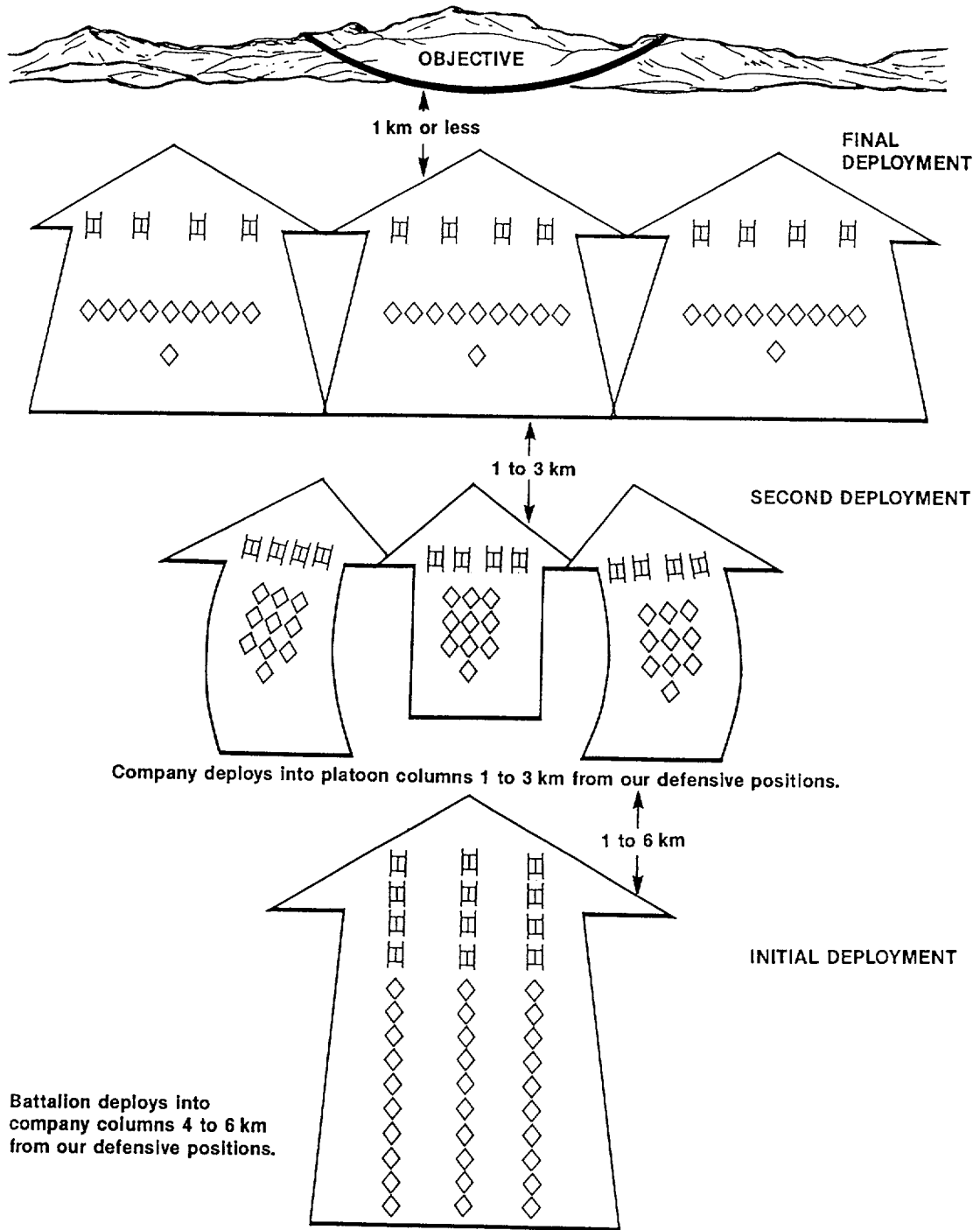
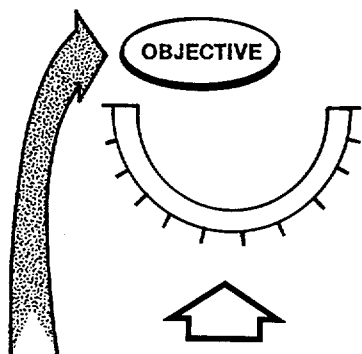

Figure 2-4. Deployment of a Battalion and Company.

Combination of Frontal and Flank Attacks



Envelopment With Frontal Attack

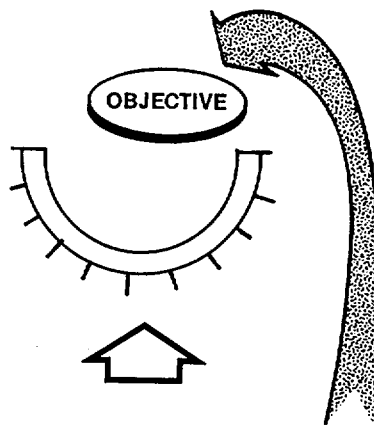

Figure 2-5. Forms of Maneuver.

Section II. Threat Armor

2201. Armor Improvements

During the 1980's, the M-1 Abrams, Leopard 2, and T-72 and T-80 model tanks were introduced with state-of-the-art armor protection. The emergence in NATO and the Warsaw Pact of increasingly sophisticated armor—composite and *reactive*—resulted in the degradation of high explosive (HE) shaped-charge antiarmor weapons (antitank guided missile and hand-held infantry weapons) and kinetic energy rounds (the tank cannon's primary armor defeating projectile).

Reactive armor is applied to the existing armor hull and turret. *Reactive* armor is simply explosive charges attached to the front and sides of armored vehicles that explode when hit, thereby negating the effects of shaped charge-type rounds. Composite armor is plating made of layered steel and ceramic with empty air spaces. Composite and *reactive* armor, either separately or in combination, severely decrease the probability of hit/kill (P_H/P_K) for frontal shots. *Reactive* armor can be easily and cheaply applied to upgrade existing T-54/55 and T-62 models, all plentiful in the Third World. Additionally, the T-72 and T-80 tanks with composite armor are being exported in greater numbers.

The Marine commander must be aware of the technical capabilities of his current antiarmor weapons systems relative to the type of tank he may encounter. Previously, a commander only considered the *size* of the tank force. He must now be equally concerned with the *type* of tanks he is fighting. A force of T-80 tanks presents a much greater challenge than a force of T-54 tanks without reactive and/or composite armor. Conceivably, the type of enemy tank force could alter tactics and techniques at every level of command from squad to division. Later sections will present technical and tactical options in the defense that account for differences in the *size* and *type* of enemy armored forces.

2202. Threat Armored Vehicles

The following identification guide is provided to assist the reader in understanding the individual characteristics of specific mechanized weapons. The reader should remember that many of these systems are found in Third World forces. Even equipment manufactured by U.S. Allies might confront us.

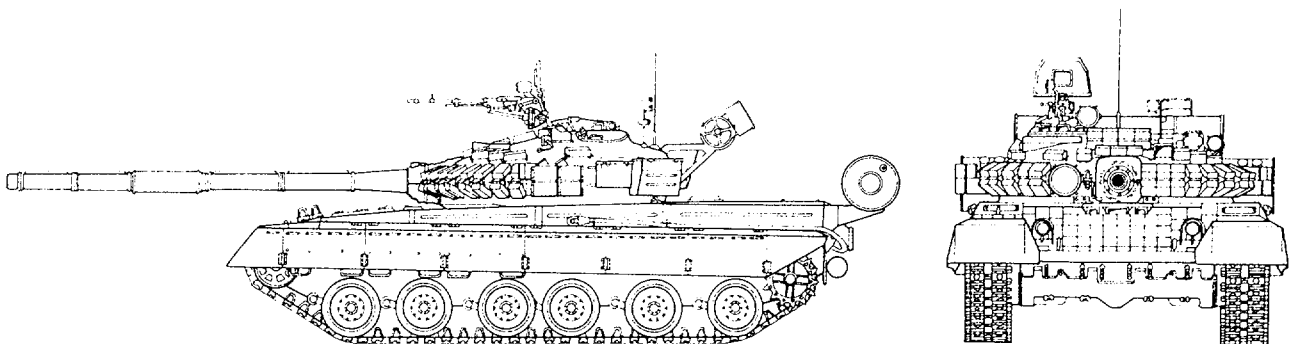

Crew	3
Weight	42 tons
Armament	125 mm smoothbore tank gun (also fires ATGM) Maximum effective range 50% P_H 2,000 m 7.62 Coaxial MG-maximum effective range 1,000 m 12.7mm Turret MG-maximum effective range 1,500 m
Basic Load	40 rounds main gun

Figure 2-6. T-80.

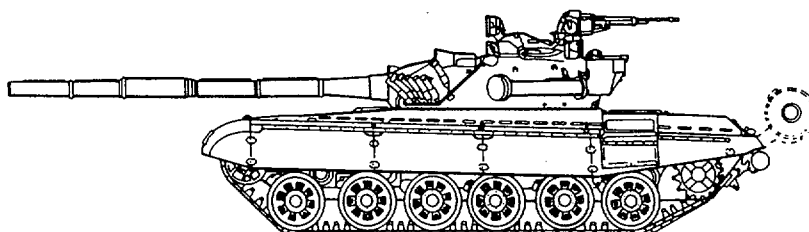

Crew	3
Weight	41 tons
Armament	125 mm smoothbore tank gun Maximum effective range 50% P _h 2,000 m 7.62 Coax MG-maximum effective range 1,000 m 12.7 mm Turret MG-maximum effective range 1,500 m
Basic Load	40 rounds main gun

Figure 2-7. T-72.

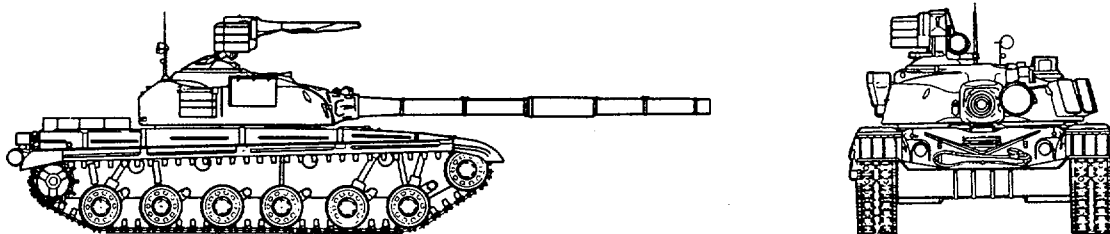

Crew	3
Weight	38 tons
Armament	125 mm smoothbore tank gun Maximum effective range 50% P _h 2,000 m 7.62 Coax MG-maximum effective range 1,000 m 12.7mm Turret MG-maximum effective range 1,500 m
Basic Load	40 rounds main gun

Figure 2-8. T-64.

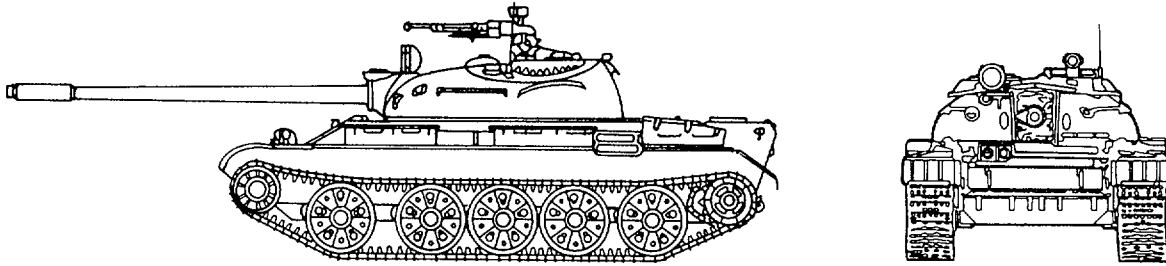

Crew	4
Weight	37.5 tons
Armament	115 mm smoothbore tank gun Maximum effective range 50% P _h 1,600 m 7.62 Coax MG-maximum effective range 1,000 m 12.7 mm Turret MG-maximum effective range 1,500 m
Basic Load	40 rounds main gun

Figure 2-9. T-62.

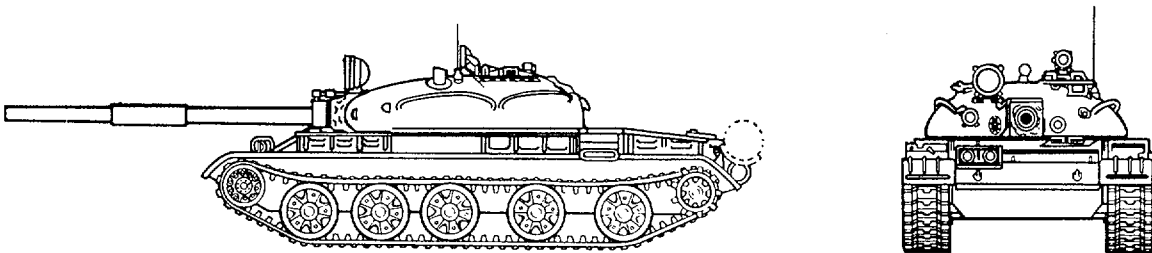

Crew	4
Weight	36 tons
Armament	100 mm rifled tank gun Maximum effective range 50% P _h 1,500 m 7.62 Coax MG-maximum effective range 1,000 m 12.7 mm Turret MG-maximum effective range 1,500 m
Basic Load	34 (T-54), 43(T-55)

Figure 2-10. T-54/55.

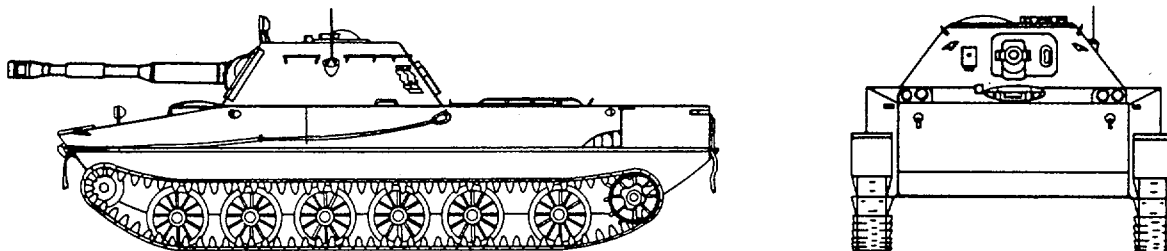

Crew	3
Weight	14 tons
Armament	76 mm tank gun Maximum effective range 50% P _h 650 m 7.62 Coax MG-maximum effective range 1,000 m
Basic Load	40 rounds main gun

Figure 2-11. PT-76 (Light Amphibious Tank).

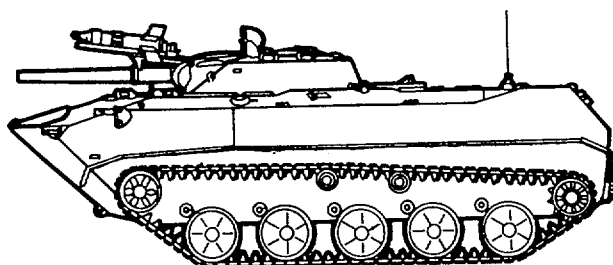

Crew	3, 5 passengers
Weight	7.5 tons
Armament	73 mm AT gun Maximum effective range 50% P _h 800 m AT-3 Sagger range 3,000 m 7.62 1/coax, 2/bow MG-maximum effective range 1,000 m
Basic Load	40 AT rounds and 3 ATGMs
Amphibious and Airdroppable	

Figure 2-12. BMD.

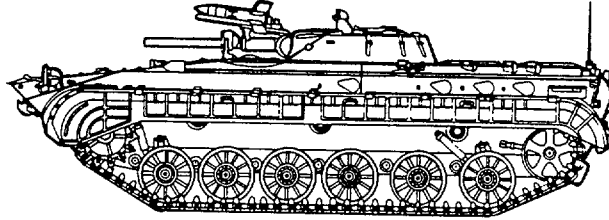

Crew	3, 8 passengers
Weight	13.5 tons
Armament	73 mm AT gun Maximum effective range 50% P _h 800 m AT-3 Sagger range 3,000 m
Basic Load	7.62 Coax MG-maximum effective range 1,000 m 40 AT rounds and 4 ATGMs
Amphibious	

Figure 2-13. BMP.

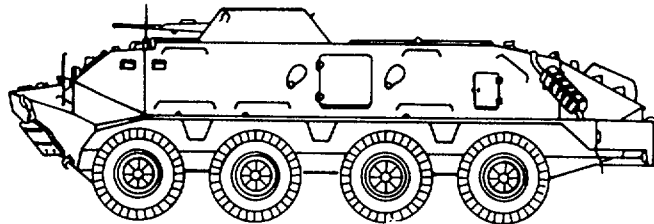

Crew	3, 8 passengers
Weight	10.2 tons
Armament	14.5 mm Turret MG 7.62 Coax MG-maximum effective range 1,000 m
Amphibious	

Figure 2-14. BTR-60PB.

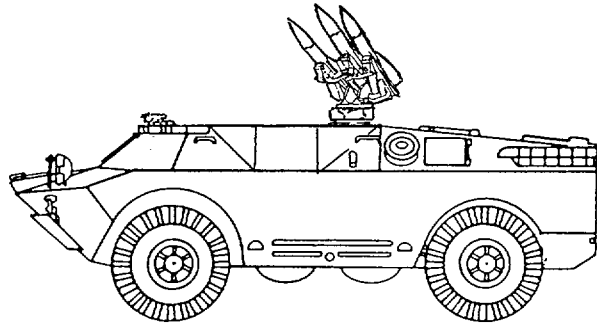

Crew	3
Weight	7 tons
Armament	AT-5 Spandrel AT-5 range 4,000 m
Basic Load	14 ATGMs

Figure 2-15. BTR-40P2 ATGM Carrier.

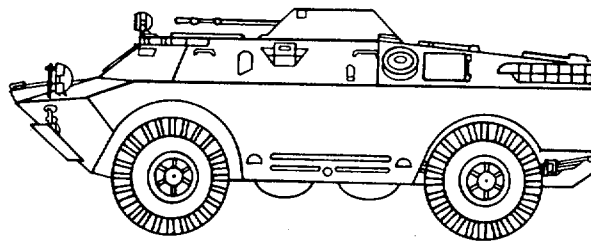

Crew	2-5 depending on mission
Weight	7 tons
Armament	14.5 mm Turret MG 7.62 Coax MG-maximum effective range 1,000 m
Amphibious Recon Vehicle	

Figure 2-16. BTR-40P2 (BRDM-2).

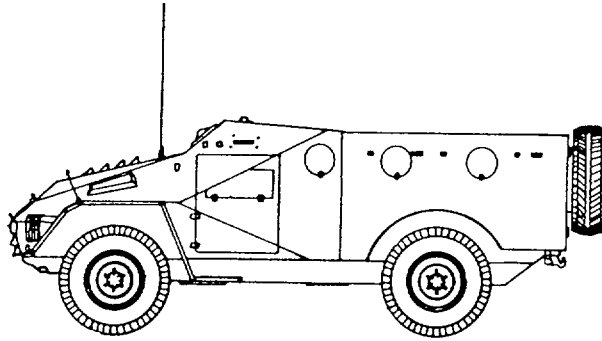

Crew	2 + 8
Weight	5,600 Kg

Figure 2-17. BTR-40 (4 × 4) Without Armament.

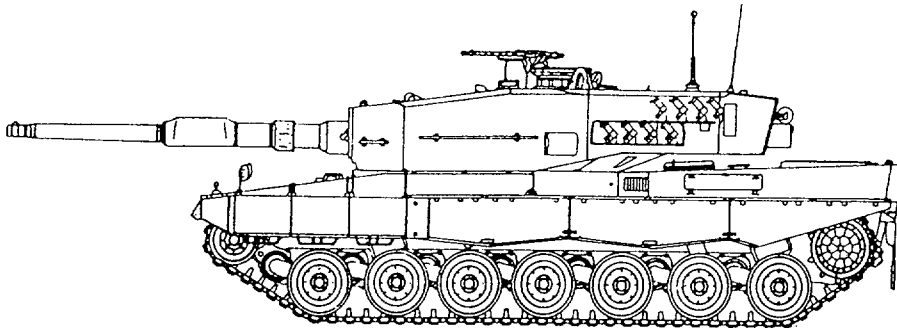

Crew	3
Weight	18 tons
Armament	105 mm main gun, 20 mm cannon, 7.62 mm MG
Basic Load	47 rounds main gun

Figure 2-18. AMX-30 MBT (France).

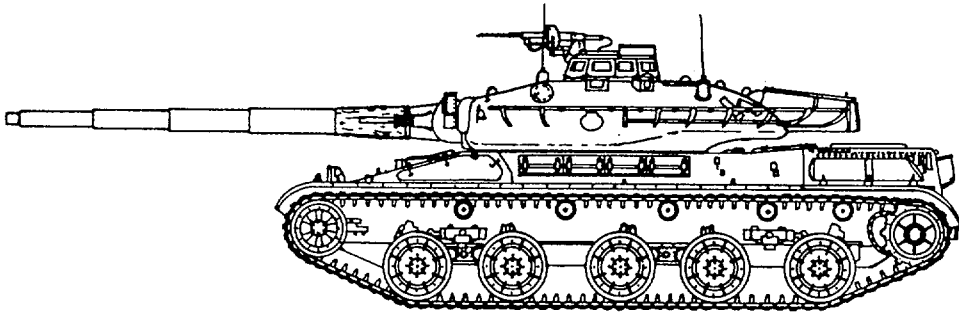

Crew	4
Weight	44.3 tons
Armament	120 mm main gun, 7.62 mm MG (coax), and 7.62 mm (loader)
Basic Load	42 rounds main gun

Figure 2-19. Leopard 2 MBT (Germany).

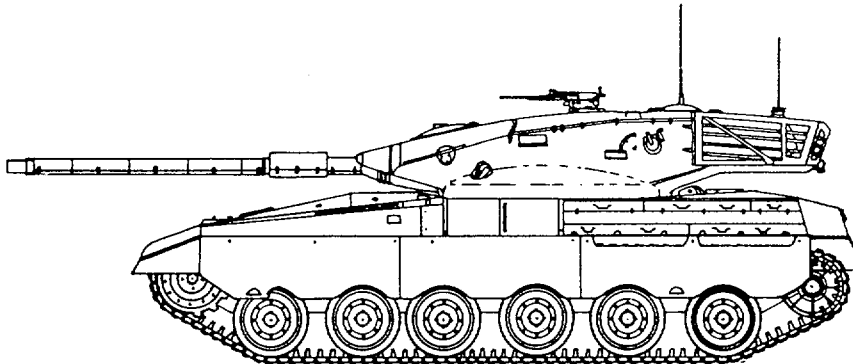

Crew	4
Weight	60,000 Kg
Armament	105 mm main gun, 7.62 mm MG (coax), and two 7.62 mm MG turret
Basic Load	62 rounds main gun

Figure 2-20. Merkava MBT (Israel).

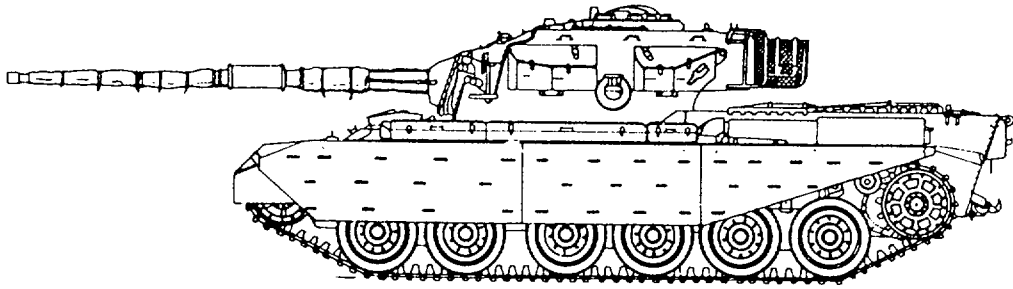

Crew	4
Weight	55,000 Kg
Armament	120 mm main gun, 7.62 mm MG (coax), and 7.62 mm MG turret
Basic Load	40 rounds main gun

Figure 2-21. Centurion Mk 10 MBT (Great Britain).

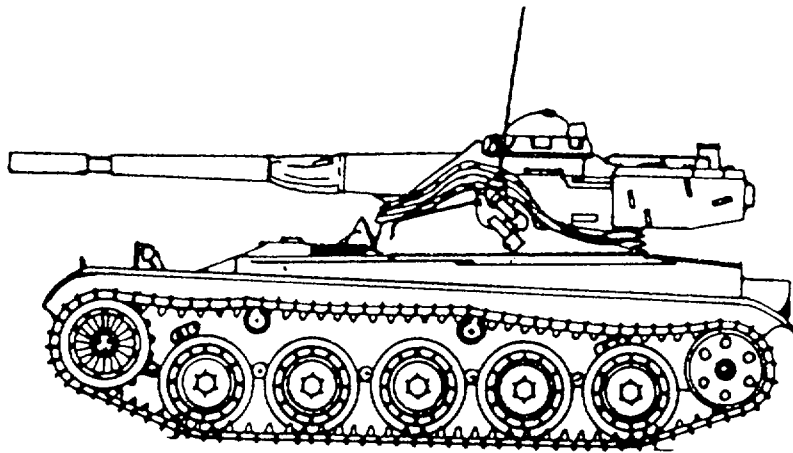

Crew	3
Weight	15,000 Kg
Armament	90 mm main gun, 7.62 mm MG (coax), and 7.62 mm MG turret
Basic Load	32 rounds main gun

Figure 2-22. AMX-13 Light Tank (France).

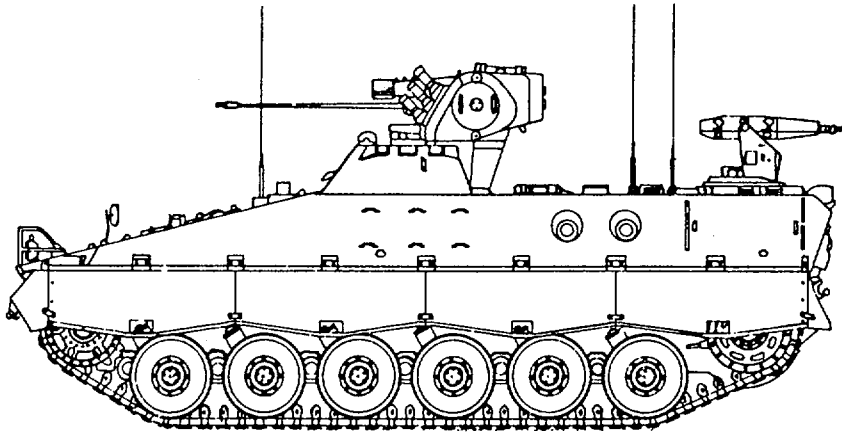

Crew	9
Weight	30,000 Kg
Armament	20 mm cannon, 7.62 mm MG
Basic Load	1,200 rounds 20 mm

Figure 2-23. Marder ICV Infantry Combat Vehicle (Germany).

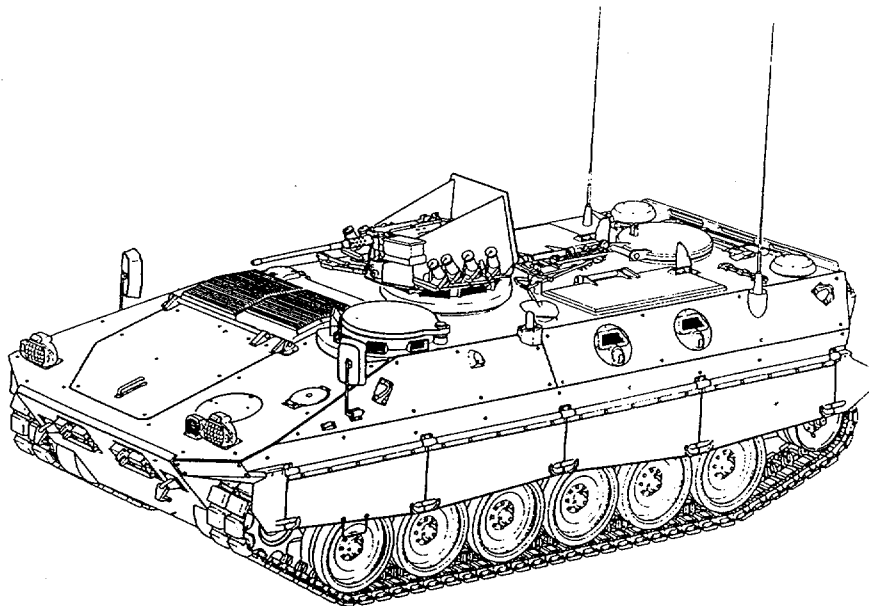

Crew	12
Weight	14,650 Kg
Armament	12.7 mm MG
Basic Load	800 rounds 12.7 mm

Figure 2-24. OTO Melara C13 APC (Italy).

2203. Armor Vulnerability

The tank is the backbone of a mechanized force. At some point in any antiarmor defense, the tank must be engaged and destroyed. Regardless of the type of armament and armor-homogenous steel – composite or reactive – there are inherent strengths and weaknesses common to all tanks and other armored vehicles by virtue of design. An understanding of the tank and other armored vehicles' vulnerabilities is prerequisite for the selection and positioning of antiarmor weapons and, ultimately, the destruction of the enemy armored force.

a. Deadspace. *Visual deadspace* refers to the areas surrounding a tank that the tank crewman cannot see due to the design of the tank and/or the location of the turret in relation to the hull. Any discussion of visual deadspace involves the issue if and when an enemy tank crew *buttons-up*. Generally, a tank commander will only button up if forced by air-burst artillery (friendly or enemy) and then for only the duration of the artillery fire. The tank is not *blind* when unbuttoned, but it still lacks *constant* 360-degree visibility. *Weapon deadspace* refers to areas surrounding the tank that cannot be fired upon with the tanks armament due to the elevation and depression of the guns. The combination of deadspace and the size of the target renders the tank especially vulnerable in close-in terrain. (See figs. 2-25 and 2-26.)

b. Armor Protection. It is impossible to provide armor of sufficient thickness throughout a tank to protect it completely from armor-defeating ammunition. The greatest degree of protection on a tank and other armored vehicles is on the front of the hull and the turret; the least protection is on the rear, sides, top, and undercarriage. This general rule applies to all types or models of armored vehicles. A flank or rear shot provides the highest P_h and P_k . The necessity of flank and rear shots is further underscored by the advent of composite (spaced) and *reactive* armor found on many threat tanks.

c. Engine Compartment. The engine compartment is a particularly vulnerable area. A tank can be stopped by using simple incendiary devices, such as a thermite grenade or napalm. It is unnecessary to destroy the entire engine. Sufficient damage to any critical component will prevent the engine from running. A disabled tank is still a stationary pillbox but is much easier to destroy.

d. Suspension System. The suspension system (including the track) is a susceptible area. Mines or log cribs may immobilize a tank. It should be pointed out that destruction of road wheels or support rollers may slow down or hinder tank movement; however, in most instances, loss of one or two road wheels or support rollers will not stop a tank.

e. Fuel System. Many threat tanks use both internal and external auxiliary fuel tanks. The auxiliary tanks, which are approximately the size of 55-gallon drums, are mounted on the side and rear of the tank. Though normally jettisoned prior to contact, if caught in an ambush, these fuel tanks make the tank considerably more vulnerable.

2204. Lightly Armored Vehicles

Although main battle tanks are the most dangerous armored vehicles on the battlefield, they are not the most numerous. All armies that have tanks (and many that do not) field lighter armored vehicles with significantly less protection. As a general rule, this means that these lighter vehicles are vulnerable to a wider variety of weapons than tanks and are thus easier to defeat. For example, the armored sides of these vehicles can be pierced by heavy machine gun (.50 caliber) fire. The sides of some lightly armored vehicles can be penetrated by even smaller caliber bullets. As is the case with tanks, each model has its own particular vulnerabilities.

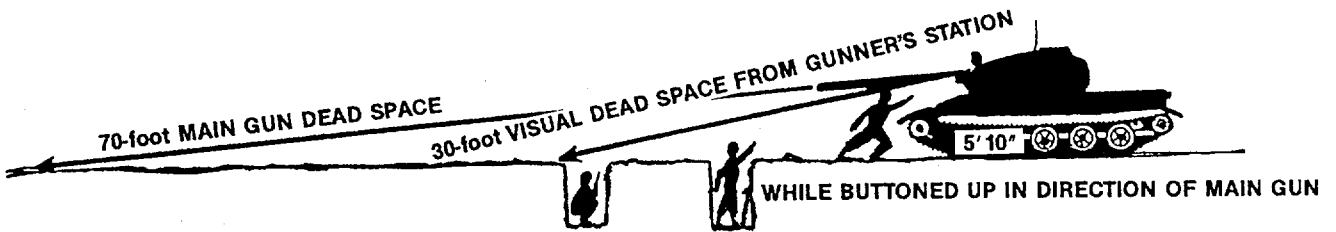
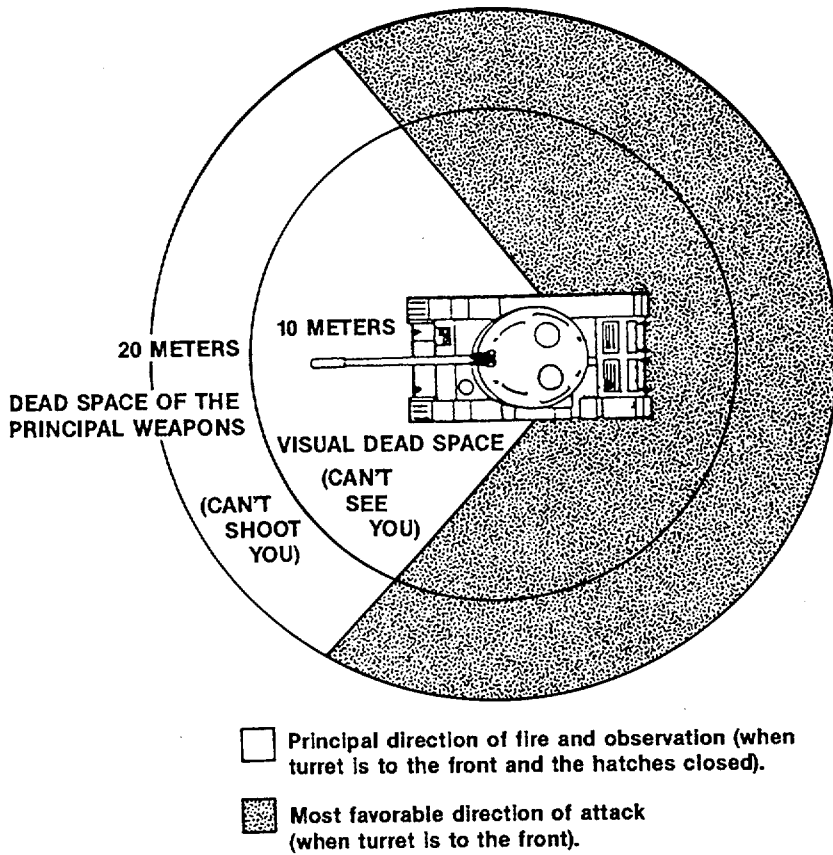

Figure 2-25. Tank Deadspace.

a. Armored Personnel Carriers. These *battle taxis* serve to carry from six to twenty infantrymen from one point on the battlefield to another. When armed with light (approximately 7.62 mm or .30 caliber) or heavy (12.7 mm, 14.5 mm, or .50 caliber) machine guns, empty APCs can provide a base of fire for the maneuver of their dismounted infantry.

While the APC protects its occupants against shell fragments and other small projectiles, it also puts them at greater risk from mines, antitank rockets and missiles, and direct hits from artillery. This is due to the infantry being compressed together in a small space and because armor has a tendency to contain (and thus greatly increase the effect of) the explosion of a rocket, mine, or shell.

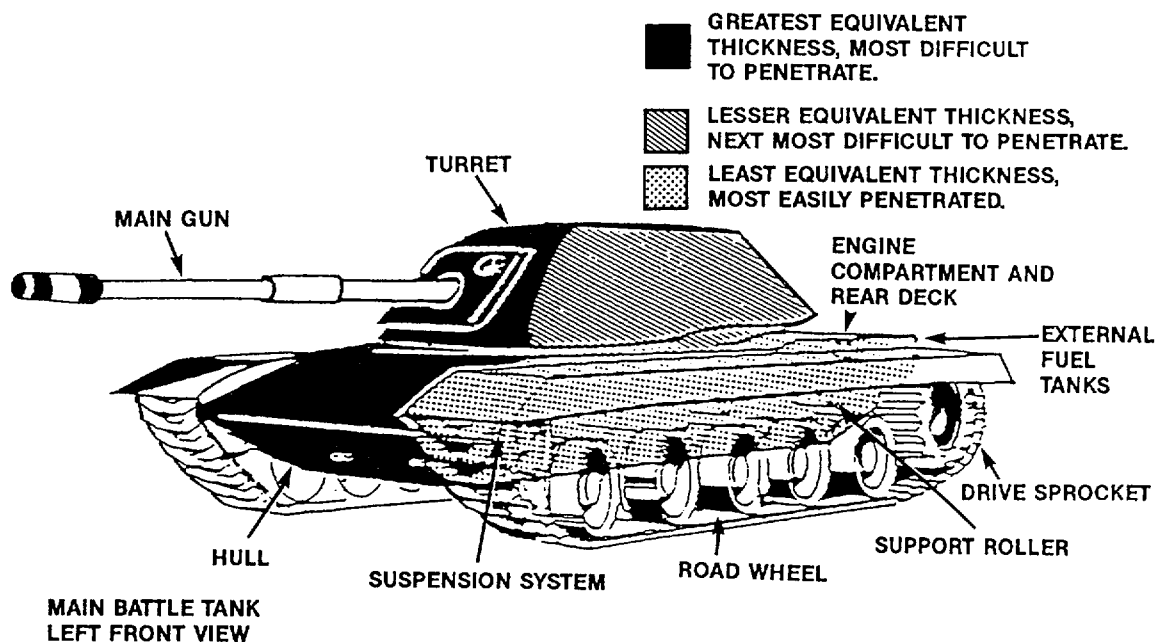

Figure 2-26. Armor Vulnerability.

Because of these dangers, troops will often ride on the outside of the APC. This, in turn, makes them more vulnerable to small arms and indirect fire.

b. Fire Support Vehicle (FSV). FSVs are armored personnel carriers that have been modified to carry a 25 mm to 105 mm gun. Their purpose is to provide a base of fire for the maneuver of infantry or other lightly armored vehicles, to attack bunkers and other point targets, and to combat other lightly armored vehicles.

Because of their thin armor relative to tanks and the fact that their guns are rarely able to penetrate the frontal armor or modern main battle tanks, FSVs cannot effectively fight against tanks in terrain favoring tanks. However, since their weapons can often fire through or destroy much of the cover found in urban areas, FSVs are dangerous opponents in city fighting.

While FSV have roughly the same vulnerability as tanks in regard to dead space of weapons, they are vulnerable to a wider variety of weapon systems.

c. Infantry Fighting Vehicles. Conceptually, these vehicles are a hybrid between FSVs and APCs. The Soviet BMP and the U.S. Army's Bradley Fighting Vehicle are two examples. IFVs carry a small caliber (25-35 mm) high velocity or medium caliber (approx. 75 mm) low velocity gun as well as a small squad (four to eight men) of infantry. Some IFVs are also equipped with anti-tank guided missiles.

Although they tend to have marginally better armor protection, IFVs have the same vulnerabilities as APCs. Their main guns have the same vulnerabilities due to dead spots.

d. Reconnaissance Vehicles. These tend to be smaller and even less well protected than other types of lightly armored vehicles. Some, in fact, are little more than modified scout cars. Armed with a machine gun or a light (25-35 mm) cannon, they are dangerous to infantry in the open and to other lightly armored vehicles. They are very vulnerable in forests, urban areas, and other close terrain.

e. Specialized Vehicles. The chassis of APCs and tanks are often used as the basis for a variety

of specialized vehicles. These can be used as mobile command posts, artillery observer vehicles, electronic warfare vehicles, mortar carriers, antitank guided missile carriers, anti-aircraft weapons carriers, or long-range missile carriers. Although many carry machine guns for local defense, these vehicles were not intended to engage in close combat and thus are very vulnerable to ground forces. Vehicles carrying anti-aircraft guns provide a notable exception to this general rule. Because of the high firepower of the anti-aircraft guns, these vehicles are often very effective as fire support vehicles.

Chapter 3

MAGTF Antiarmor Weapons and Techniques

Antiarmor operations involve more than tanks and TOWs (tube launched, optically tracked, wire command link, guided missile systems). The MAGTF possesses a vast array of weapons systems with antiarmor capabilities. While later chapters will address the proper integration of these weapons systems, it is imperative that the reader understand as precisely as possible the capability of each weapon system against a tank or other types of armored vehicles. Since improvement of weapon capabilities and armor is on-going and information is often classified, the reader should consult the unit S-2 for timely updates on the subject matter.

Section I. Antiarmor Weapons Systems

3101. Weapons Systems

The antiarmor capabilities of the following weapons systems will be the only items addressed in this section.

The M1A1 and the M60A1 tanks are both presented due to the transition phase-in period of the M1A1 Abrams tank.

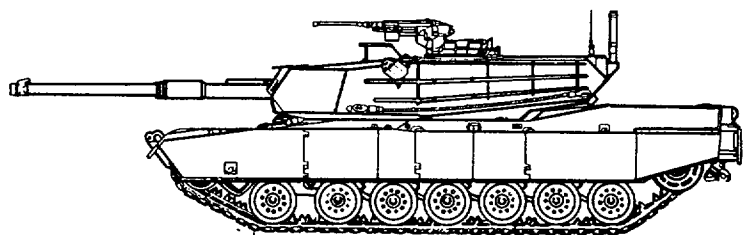
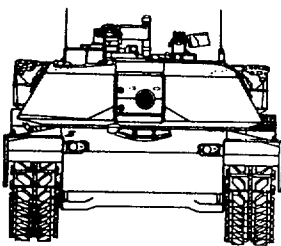

Crew	4
Weight	67.59 tons
Armament	120 mm smoothbore tank gun Maximum effective range 50% Ph 2,800 m .50 cal M2 MG tank commanders Maximum effective range 1,830 m 7.62 mm Coax MG and 7.62 mm Coax MG Loaders Maximum effective range 900 m
Basic Load	44 rounds main gun

Figure 3-1. M1A1 Tank.

The M1A1 main battle tank (MBT) is powered by a gas turbine engine rated at 1,500 hp, with a 23.8 hp/ton ratio. This MBT has a maximum speed of 42 mi/h and a cruising range of 275 miles. The M1A1 has a laser range finder, optical day sight, and a thermal imaging night sight. With the fording

kit, it is capable of moving in water at turret roof depth. The M1A1 fires only the Sabot (kinetic energy round) and the high explosive antitank (HEAT) (high explosive [HE] shaped charge). Unlike the M60A1, it does not fire HE, Beehive-T, or white phosphorous rounds.

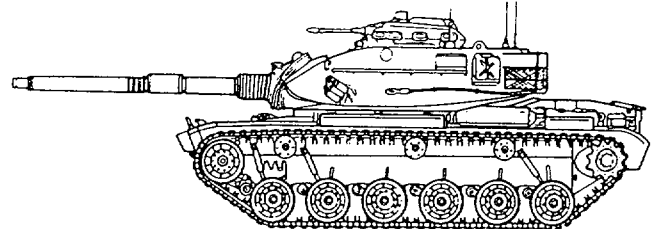
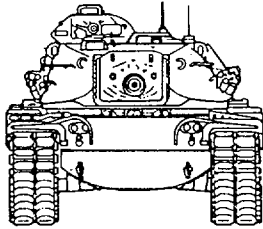

Crew	4
Weight	56.7 tons
Armament	105 mm rifled tank gun Maximum effective range 50% P _h 1,500 .50 cal M85 MG tank commanders Maximum effective range 1,100 m 7.62 mm Coax MG Maximum effective range 900 m
Basic Load	63 rounds main gun

Figure 3-2. M60A1 Tank.

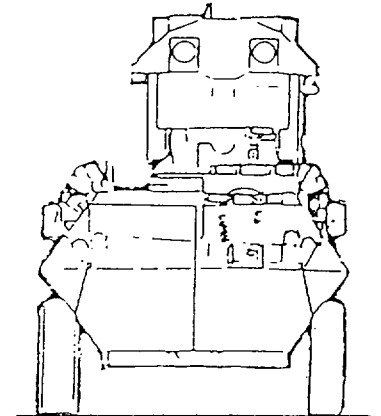
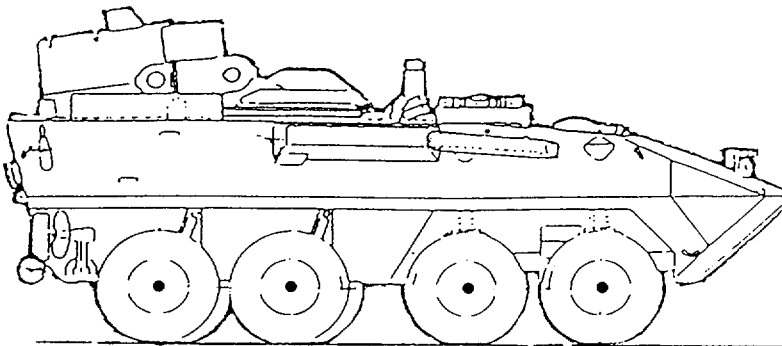

Crew	4
Weight	12.6 tons
Armament	TOW ATGM launcher, Maximum effective range 3,750 m
Basic Load	12 TOW missiles (2 ready, 10 stowed)
Top Speed	60+ mi/h

Figure 3-3. LAV 25 AT.

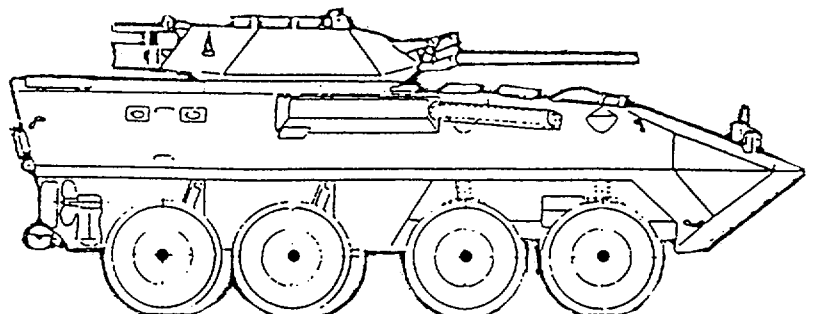

Crew	4, 4-6 passengers
Weight	12.2 tons
Armament	25 mm M242 chain gun Maximum effective range 2,000 m (approx.) 2-M240 7.62 mm MG coax and pintle-mounted Maximum effective range 900 m
Top Speed	60+ mph

Figure 3-4. LAV 25.

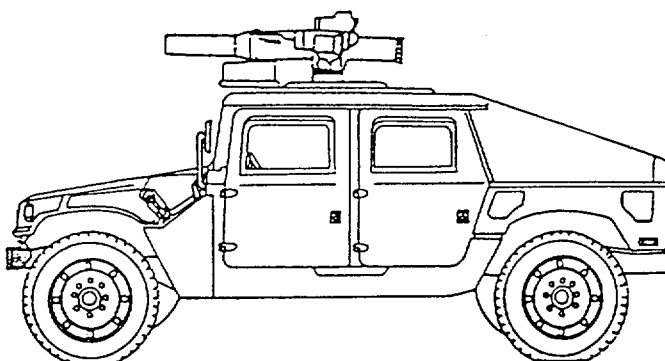

Crew	3
Weight	8,194 lb. w/equipment and crew TOW maximum range 3,750 m/21.5 sec (200 m per sec)
Basic Load	6 missiles

NOTE: TOW gunners normally require approximately 150 to 300 m of missile flight to gain control of the missile.

Figure 3-5. TOW (HMMWV).

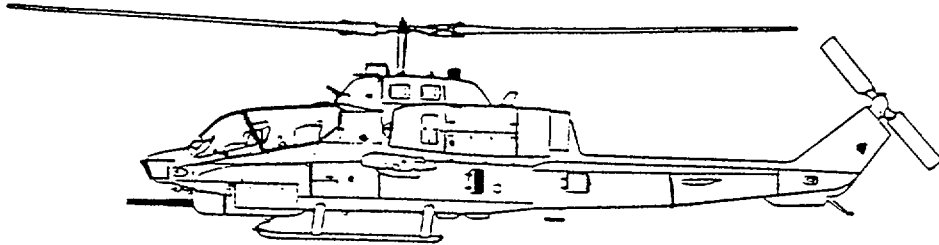

Armament	TOW or Hellfire (laser designated) Maximum range TOW 3,750 m/21.5 seconds Hellfire excess of 5,000 m
Basic Load	8 TOW or 8 Hellfire (combination of 4 TOW/4 Hellfire)

Figure 3-6. AH-1W COBRA Attack Helicopter.

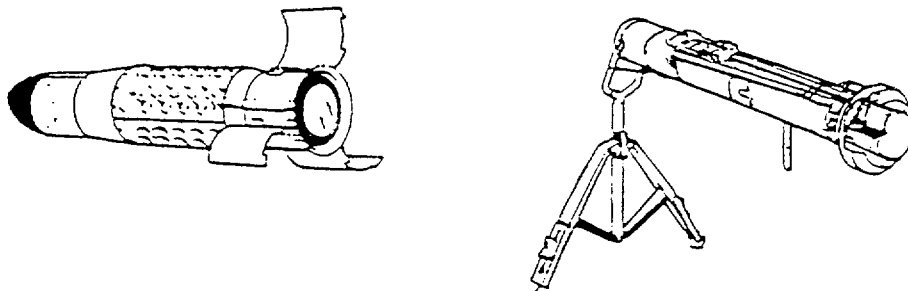

Team	2
Weight	29.56 lb (round with tracker)
Max Rg	1,000 m/11 sec (100 m per sec)

NOTE: Dragon gunners will normally require approximately 200 m of missile flight to gain control of the missile.

Figure 3-7. M47 Dragon.

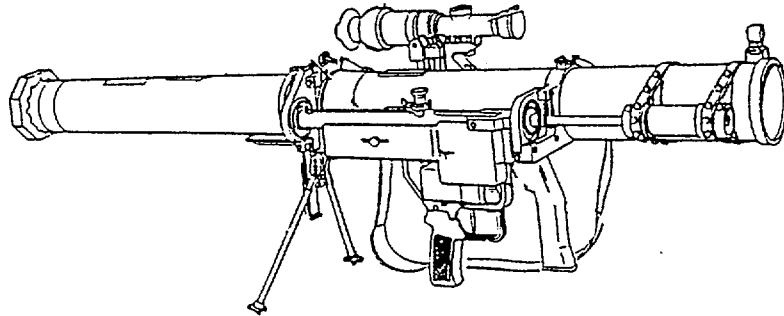

Team	1
Weight	29.20 lb
Warhead	83 mm High Explosive Dual Purpose (HEDP) 83 mm High Explosive Antiaircraft (HEAA)
Maximum eff rg	250 m stationary

Figure 3-8. Shoulder-Launched Multipurpose Assault Weapon (SMAW).

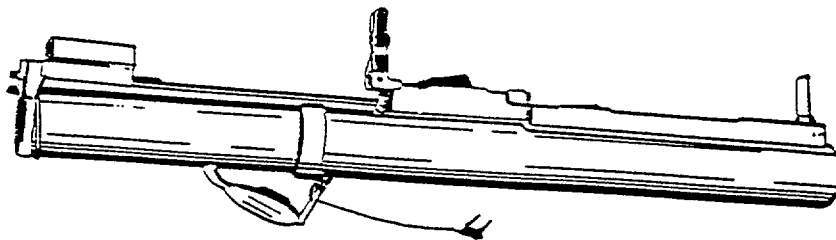

Team	1 or 2
Weight	5.1 lb
Warhead	66 mm HEAT
Maximum eff rg	50% P _h /P _k 200 m stationary 150 m moving

Figure 3-9. M72A2 Light Antiaircraft Weapon (LAW).

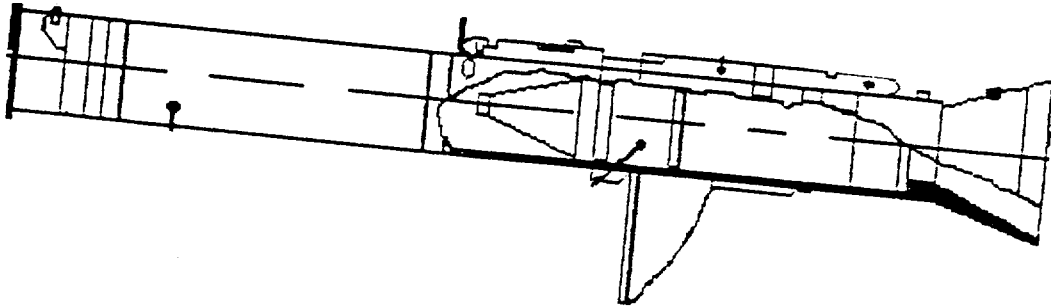

Team	1 or 2
Weight	14.6 lb
Warhead	84 mm HEAT
Maximum eff rg	50% P _H /P _K 300 m stationary 250 m moving (approx.)

The M72A2 LAW and its replacement – the AT4 – are both considered munitions.

Figure 3-10. AT4.

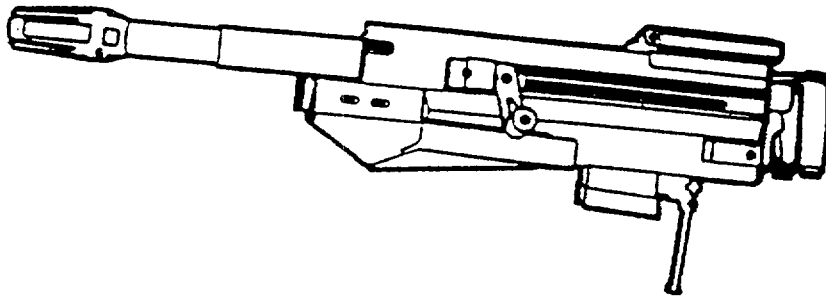

Team	2
Weight	72.5 lb
Maximum eff rg	1,500 m
Warhead	40 mm HEDP grenade

The MK 19 MG is mounted on the AAV, HMMWV, and ground-mounted on a tripod.

Figure 3-11. MK-19 Machine Gun.

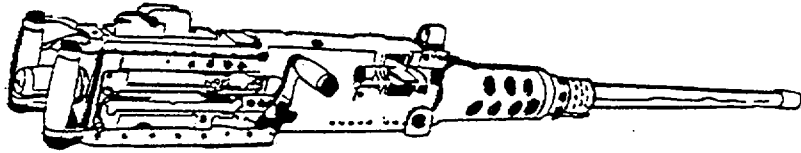

Crew/Team	1-4 (cupola, ring mount, or tripod)
Weight	128 lb (MG + tripod)
Maximum eff rg	50% P _H from tripod—1000 m against armor. cupola—800 m against armor.
Tracer burnout	2,200m

Figure 3-12. M-2 Browning Machine Gun (Caliber .50 HB).

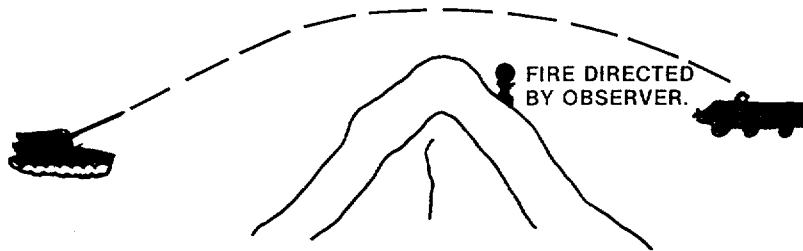

The Copperhead is a 155 mm cannon launched antitank laser-guided projectile. It has a maximum range of 16,800 m and a minimum range of 3,000 m. It must be terminally guided by the modular universal laser equipment (MULE) laser designator.

Figure 3-13. Copperhead.

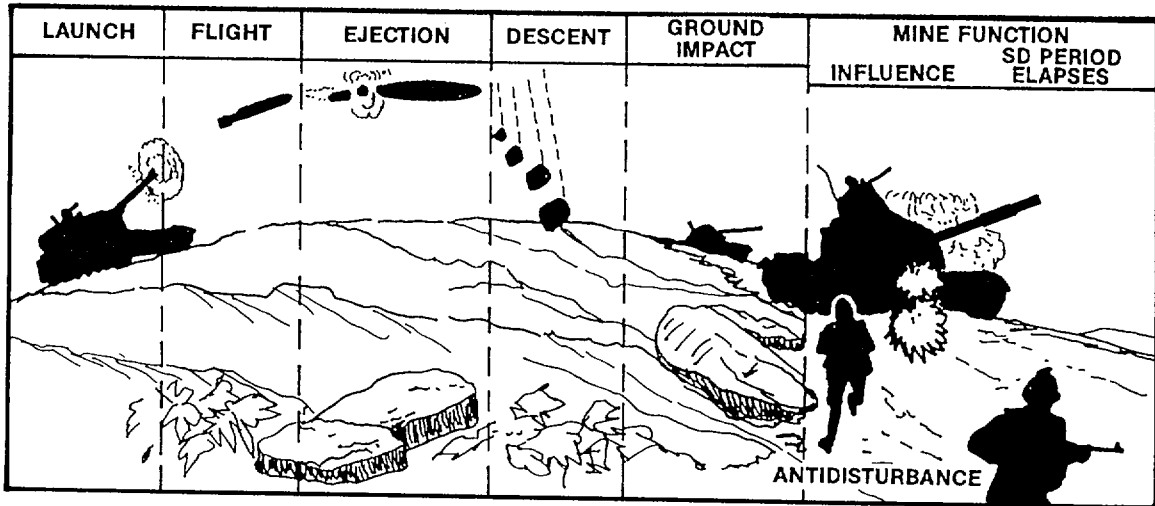

Family of scatterable mines (FASCAM) is both artillery and air-delivered. Remote antiarmor mine system (RAAMS) is a type of artillery delivered scatterable mines. RAAMS projectiles are 155 mm and contain nine antiarmor mines with self-destruct times of less than and greater than 24 hours. The GATOR (CBU 78/B) is an air-delivered mine. The GATOR consists of 60 submunitions—15 antiarmor and 45 antipersonnel.

Figure 3-14. Family of Scatterable Mines.

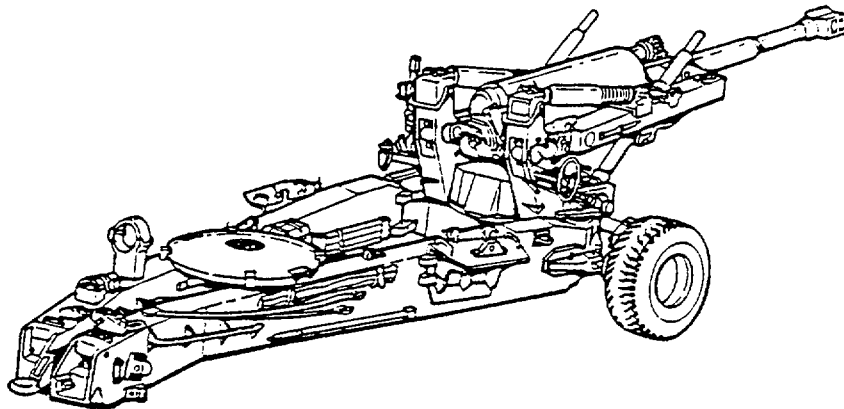

The M483A1 dual-purpose improved conventional munitions (DPICM) round is fired from the M-198, with a range of 17,500 m. This round contains antipersonnel, antimateriel, dual-purpose grenades. A shaped charge jet is expelled downward through the body of the grenade, while the rest of the grenade bursts into a large number of small fragments, expelled outward with high velocity. The jet is capable of penetrating approximately 2.75 inches of homogenous armor plate. Each projectile contains 88 shaped-charge grenades. An armor piercing projectile and an improved conventional munitions (ICM) projectile are fired by the 16-inch naval gun.

Figure 3-15. Dual-Purpose Improved Conventional Munitions 155 mm M-198.

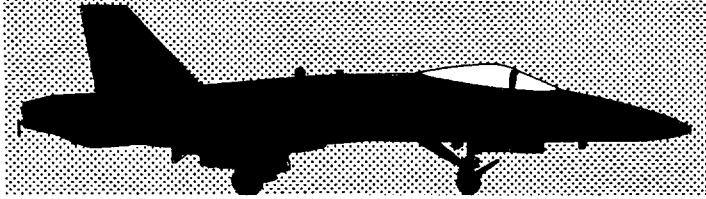

The F/A-18 is an all-weather, strike fighter capable of both intercept/destruction of enemy aircraft and close air support (CAS). Armament includes a 20 mm gun, bombs, missiles (Sidewinders and Sparrows), and rockets.

Figure 3-16. F/A-18 Hornet.

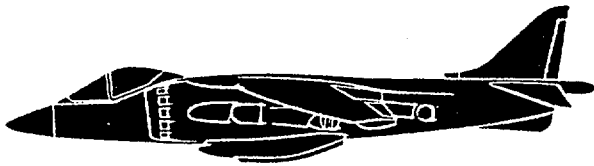

The AV-8B is a vertical/short takeoff and landing (V/STOL) fighter that provides CAS. Armament includes a 25 mm gun, missiles, bombs, and rockets.

Figure 3-17. AV-8B Harrier.



The A-6 is an all-weather, medium attack aircraft. Armament includes bombs and missiles.

Figure 3-18. A-6 Intruder.

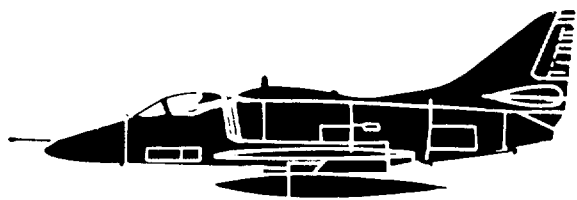

The A-4 is a light attack and CAS aircraft. Armament includes two 20 mm guns, bombs, and missiles. The A-4 is currently found in some United States Marine Corps Reserve units.

Figure 3-19. A-4 Skyhawk.

For a detailed discussion of weapon capabilities and employment of artillery, naval gunfire (NGF), and air-delivered ordnance, refer to MWP 22-2/FMFM 1-7, *Supporting Arms in Amphibious Operations*, FMFM 6-9, *Marine Artillery Support (under development)*, and FMFM 5-40, *Offensive Air Support (under development)*.

3102. Strength and Weaknesses of Antiarmor Weapons Systems

There is no single *best* weapons system for every situation. The choice of a single system or a mix of systems is mission, enemy, terrain and weather, troops and support available, and time available (METT-T) dependent. For a detailed study of a specific weapons system, the reader should refer to the appropriate FMFM or TM. The following general comments address different families of weapons systems from a technical perspective.

a. Tank. The tank is the best weapon within its maximum effective range to engage another tank from the front. The M1A1 tank's 120 mm gun is capable of penetrating the front slope of MBTs. The tank cannon is capable of a rapid rate of fire. A crew can acquire a target and fire 2 main gun rounds in 12 seconds. The tank is the most difficult antiarmor weapon to suppress with artillery fire. Its mobility and armor protection allows a more active defensive posture. The tank's M-2 MG can engage light armor.

The tanks structural weaknesses were previously discussed. Clearly, close-in terrain and the size of

the tank contribute to its vulnerability. The tank — individually or concentrated — presents a lucrative target for air. The tank's heat signature makes it susceptible to thermal imagery sights. The tanks weight and width restrict individual positioning options more than any other ground antiarmor weapon system.

b. ATGM. The TOW and Dragon possess high hit probability from the moment the gunner acquires control out to their maximum effective ranges. Both systems are man-portable. The TOW is found equipped on the light armored vehicle (LAV), high mobility multipurpose wheeled vehicle (HMMWV), and the AH-1W helicopter. The TOW can be ground-mounted on a tripod.

The gunner and the weapon are vulnerable to enemy fire, both direct and indirect, during target acquisition and tracking. Firing is marked by a distinctive signature. ATGMs have a slow rate of fire relative to tank cannons and relative to the speed of enemy armor in the assault. ATGM travel time to target is much slower than tank cannons, though the ability of tank crews to dodge ATGMs is probably overrated. Vegetation, firing over water, and lack of armor protection severely restrict ATGMs that are ground- or vehicle-mounted. While the TOW is capable of defeating most tanks from the front, the Dragon is restricted to flank shots, except for LAVs.

c. LAV 25/ LAV AT. The LAV vehicle is exceedingly fast but is lightly armored. Its security role in the defense requires speed and a *limited*

capability to engage enemy armor. The TOW capabilities have already been discussed. The 25 mm gun is capable of destroying light armor, particularly from the flank. Both variants are helicopter transportable. Both systems are fired with the gunner inside the vehicle, allowing for marginal protection from air burst artillery and small arms.

d. Light Antiarmor Weapons. The M72A2 LAW and the AT4 are both considered munitions, lightweight and easy to carry. They are both capable of penetrating Soviet T-62 (no reactive armor) and earlier models from the flanks. They are designed for close-in fighting. LAWs are fire-and-forget systems that expose the firer for the briefest possible time.

Range limitations and tracking of a moving target present difficulties, resulting in the firer well within the range of enemy weapons systems.

The MK-153 SMAW is a *bunker buster* that is capable of penetrating 1 inch of homogenous steel, making it effective against lightly armored vehicles.

e. Machine Guns. The MK-19 and the M-2 .50 cal MG are not primary armor defeating weapons. However, these weapons can engage light armored vehicles from the flanks and may be used in concert with other primary armored defeating weapons to provide synergy to the ambush.

f. AH-1W Helicopter. This helicopter fires either the TOW or Hellfire (laser designated) missiles.

The TOW requires exposure to track the missile to the target, making this system vulnerable to ground fire. However, the mobility of the AH-1W and the missile angle of impact against tank armor make it a formidable tank killing system. Time on station is a limiting factor in antiarmor operations.

g. Fixed-Wing Aircraft. Marine fixed-wing aircraft possess a variety of weapons systems and munitions capable of defeating enemy armor. However, vulnerability to ground weapons systems may require extensive suppression of enemy air defense (SEAD) fire. Time on station is a severe limitation. While clearly capable of destroying individual armored vehicles once detected, the best use of fixed-wing aircraft is against unsuspecting armored columns or second echelon units not fully deployed for combat.

h. Artillery. The 155 mm M-198 fires Copperhead and DPICM projectiles. The Copperhead projectile is clearly capable of defeating enemy tanks, but requires laser designation. Additionally, the availability of the rounds may be limited. The DPICM rounds are most effective against light armor, not MBTs. As with fixed-wing aircraft, a larger number of armor kills are likely against armored columns or second echelon units. Enemy counterbattery fire is a consideration when employing friendly artillery. Artillery in a direct fire role should only be used for self-protection. 105 mm artillery does not possess direct hit antiarmor capability sufficient to consider this size round an antiarmor munition.

Section II. Antiarmor Techniques

The following discussion considers antiarmor operations from a perspective of weapon(s) employment. The introduction of the engagement area (EA) model establishes the basic framework for posturing weapons/units in the defense against an armored force. The EA is a concept that assists commanders in focusing their planning, coordination, and allocation of resources toward the goal of defeating enemy armor.

3201. Methods of Engagement

There are two general methods of antiarmor engagement – HAW-MAW-LAW and massed-surprise fire. These two methods of engagement are not types of defense per se. Rather, they define the range relative to a weapon's maximum effective range at which friendly antiarmor weapons engage enemy armor. In practice, a defense usually employs techniques reflecting both methods of engagement.

a. HAW-MAW-LAW. HAW-MAW-LAW refers to heavy antiarmor weapons (TOWs and tanks),

medium antiarmor weapons (Dragons), and light antiarmor weapons (LAWs and AT-4s). The HAW-MAW-LAW concept embodies two ideas: the categorization of weapons and the employment of those weapons. These weapons are categorized by range, not weight. (See fig. 3-20.)

(1) Employment of HAW-MAW-LAW. HAW-MAW-LAW is a concept in which friendly antiarmor weapons engage enemy targets at their maximum effective ranges. The concept has evolved to include engaging with air, artillery, and NGF at their maximum effective ranges. The idea is to destroy enemy armor as far

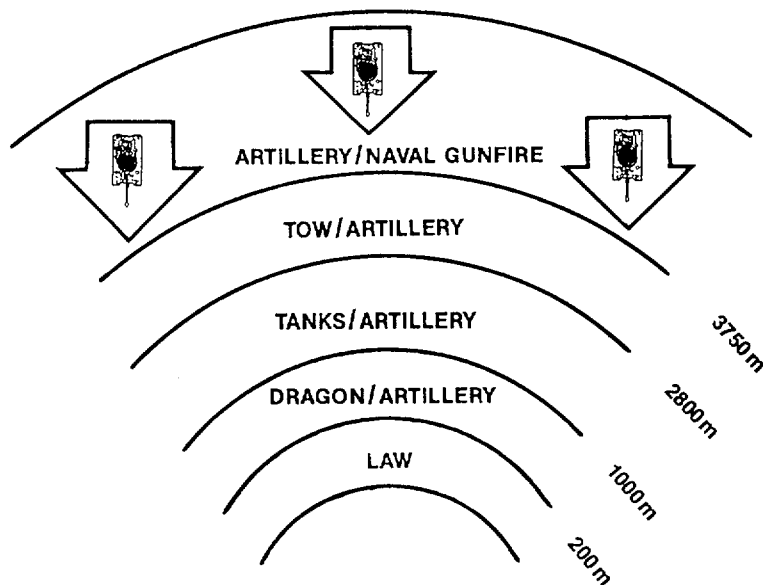

Figure 3-20. HAW-MAW-LAW.

forward of the friendly positions as possible. This method of engagement is normally employed against large armored formations.

(2) Disadvantages and Advantages of Employing HAW-MAW-LAW. The major disadvantage of HAW-MAW-LAW is the likelihood of early detection of friendly positions and consequently longer exposure to enemy direct and indirect fire. Secondly, flank shots may be more difficult to obtain at longer ranges. The advantage is that friendly weapons engage enemy armor for a longer period of time, normally allowing for more kills forward of the friendly positions. FMFM 9-1, *Tank Employment/*

Countermechanized Operations (which was superseded by this manual), referred to the HAW-MAW-LAW concept as concentric and ever-increasing volumes of fire. (See fig. 3-21.)

b. Massed-Surprise Fires. This method of engagement visualizes all direct fire weapons engaging the enemy force *simultaneously*. This method will result in more initial kills on first engagement, but at a much closer range. However, the mass and momentum may still carry the force into friendly positions. This method is ideal in the ambush of individual or small armor units. (See fig. 3-22.)

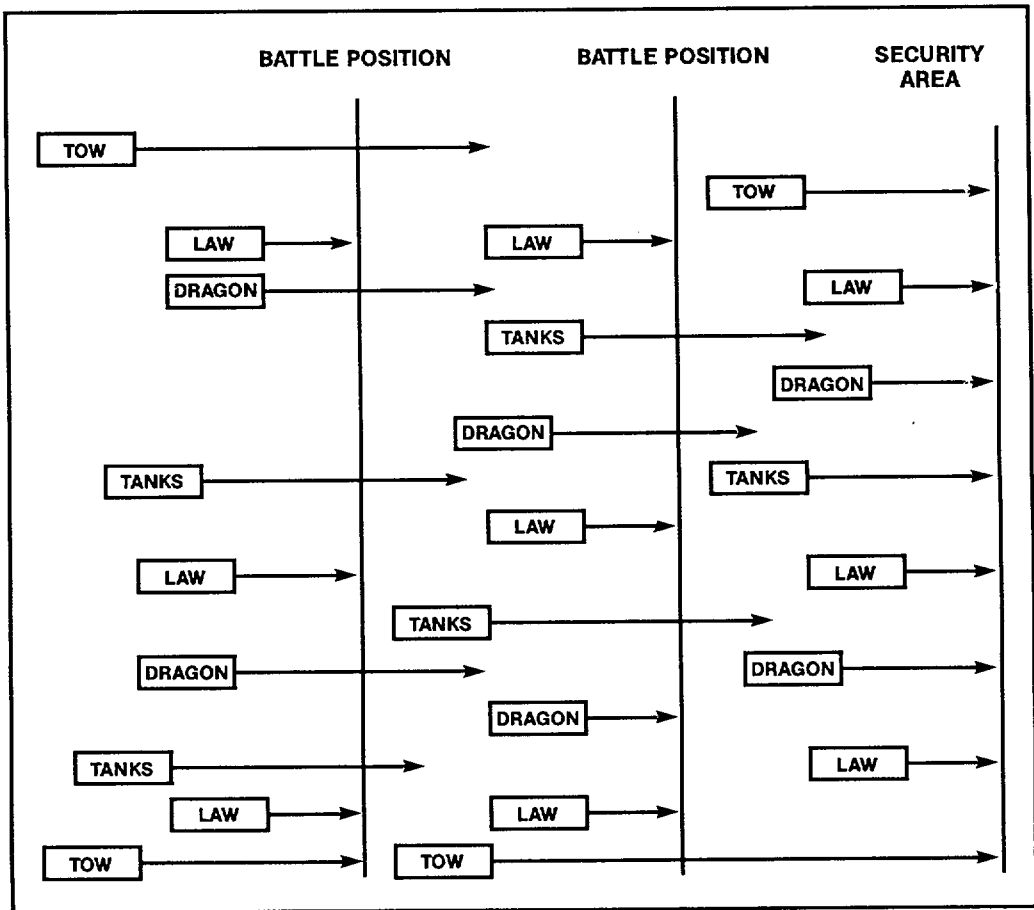

Figure 3-21. HAW-MAW-LAW Achieving Depth.

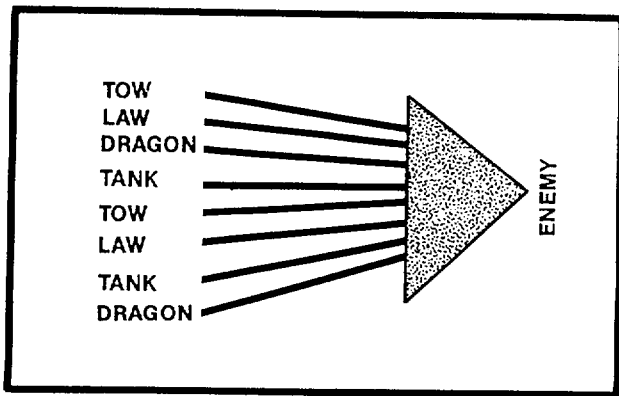

Figure 3-22. Massed-Surprise Fire.

c. Engagement Considerations. In principle, choosing the method of engagement would appear to depend solely on the size of the enemy armored force; e.g., HAW-MAW-LAW would be employed against a large force and massed-surprise fire would be employed against a smaller force. However, other factors should be considered in addition to the size of the enemy force. Other factors to be considered are terrain, point of aim, and positioning to counteract enemy artillery fire.

(1) **Terrain.** Terrain often limits the engagement ranges of antiarmor weapons. Studies of

the '73 Arab-Israeli War show the average tank-to-tank kill in the Golan Heights was between 350 by 500 meters; in the Sinai Desert, it was 500 by 800 meters. The maximum effective range of the tanks involved was approximately 1,500 meters. Studies of Central Europe indicate that 55 percent of the ground is considered close terrain. The following ranges can be expected in any Central European scenario:

Beyond 2,500 m 6% of all line-of-sight distances

Beyond 2,000 m 10% of all line-of-sight distances

Beyond 1,500 m 17% of all line-of-sight distances

Beyond 1,000 m 45% of all line-of-sight distances

Beyond 500 m 67% of all line-of-sight distances

(2) **Point of Aim.** The MAW and LAW systems will require flank shots to be effective against later model Soviet MBTs. In theory, these systems can achieve flank shots by firing across the front of a linear defense immediately facing and running perpendicular to the enemy force. However, the effect is decreased engagement range, regardless that each weapon may be firing at its maximum range. (See fig. 3-23.)

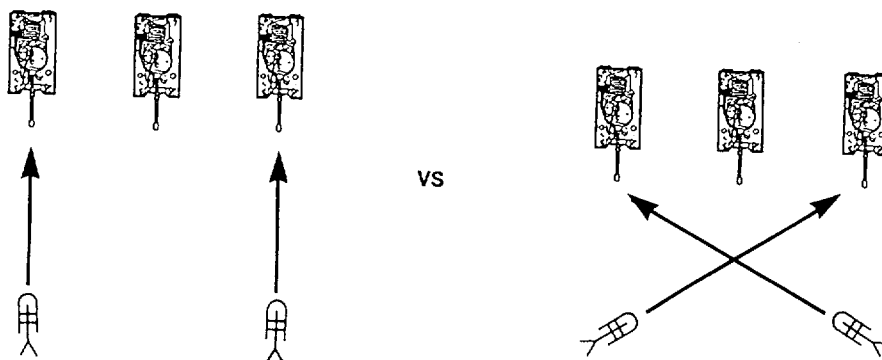

Figure 3-23. Engagement Methods.

Another positioning alternative to accommodating MAW-LAW flank shots is to position these systems forward or rearward of the HAW systems. This alternative may utilize either method of engagement. (See fig. 3-24.)

(3) Positioning to Counteract Enemy Artillery Fire. The Marine Corps, having limited tank assets, relies more on ATGMs than a land army. ATGMs are particularly susceptible to artillery suppression. To counteract this artillery, commanders may be forced to disperse weapon systems—laterally and in depth—greater distances than otherwise referred. Depending on the factors of METT-T, this could result in either method of engagement being employed or a combination of both methods.

3202. Engagement Area

EA is a designated area along a likely enemy avenue(s) of approach where the commander intends to destroy an enemy force through massed, converging fires. The EA is the key to organizing the antiarmor defense. The commander analyzes the terrain and determines the likely enemy avenues of approach. At this point, he determines the location of the EA(s). (See fig. 3-25.) The EA serves as a basis for the positioning of forces and the allocation of supporting arms and obstacles. The EA concept is sometimes referred to as *armor kill zone* or *fire sack* (Soviet Army).

The concept of the EA area—forward of the forward edge of the battle area (FEBA), within the battle

area, or a combination of both—is dependent on METT-T. This concept contains principles applicable to every tactical level. However, there is one significant aspect of METT-T that remains constant in a given engagement—the capability of the antiarmor weapon systems relative to the enemy armored force. Put simply, where do you position the weapon to get the proper angle of fire to destroy the enemy vehicle?

EAs may be forward of the FEBA or within the battle area. The EA should be where enemy armored formations are vulnerable to antiarmor fires, such as open areas or choke points. Ideally, these areas can be covered from a number of directions by a large number of antiarmor weapons. An EA may be identified by prominent terrain features around the area or by a target reference point (TRP) at the corners of the area. The area may be further subdivided into sectors.

In most cases, an EA forward of the FEBA is associated with a relatively linear position (the defense may have a number of subsequent battle positions) employing the HAW-MAW-LAW method of engagement. The location of the EA is based on the assumption that the majority of antiarmor weapons systems can achieve kills against enemy armor from the front or oblique angles, thereby preventing enemy armor penetration.

An EA within the battle area, regardless of the method of engagement, attempts to maximize flank shots at the expense of enemy penetration of the

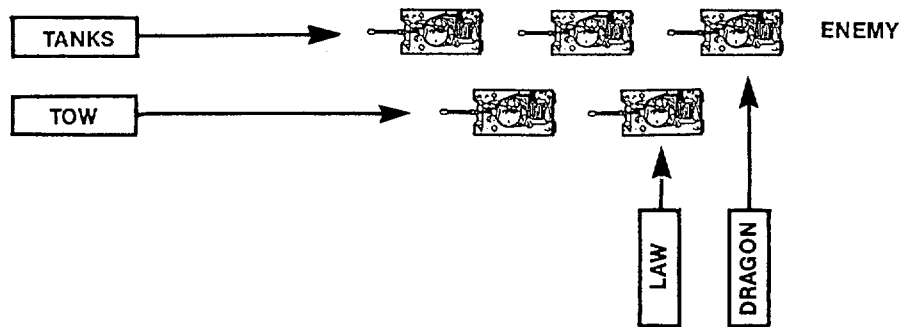

Figure 3-24. Front and Flank Combination Engagement.

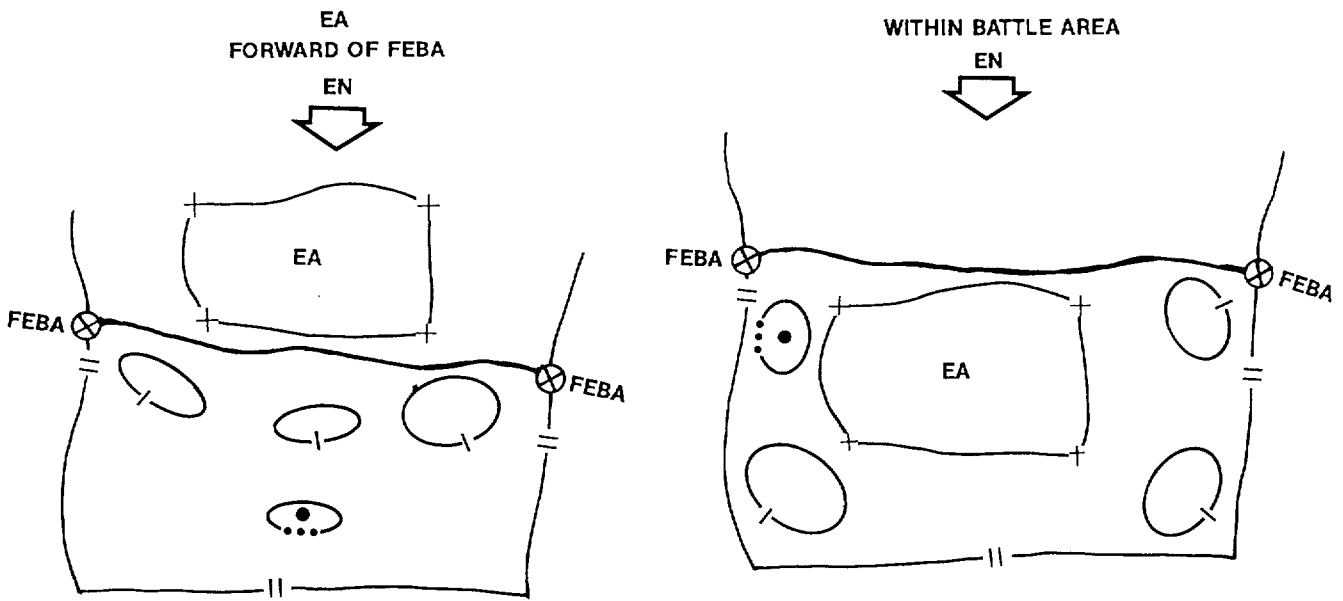

Figure 3-25. Location of Engagement Areas.

FEBA. While this type EA might appear the least preferred, it may be the most common, considering weapon capabilities compared to enemy armor.

A defense may contain both type of EAs, with a particular EA oriented toward a type of armor (See fig. 3-26.) For example, an EA forward of the FEBA might be employed against BMPs, allowing the leading tanks to penetrate the FEBA. The enemy tanks may be channeled into smaller kill zones within the battle area and destroyed by MAWs and LAWs or by a counter-attacking tank force.

The following discussion will focus on weapon positions, not unit positions, even though their governing principles are often the same. Unit positions will be considered in the broader context of the defense in later sections.

3203. Weapon Positioning

The concept of the ambush guides antiarmor weapon positioning. The position of the antiarmor weapon should provide protection and effect surprise while allowing the weapon to fire a lethal shot. The position should exploit the advantages of the weapon system while minimizing its vulnerabilities.

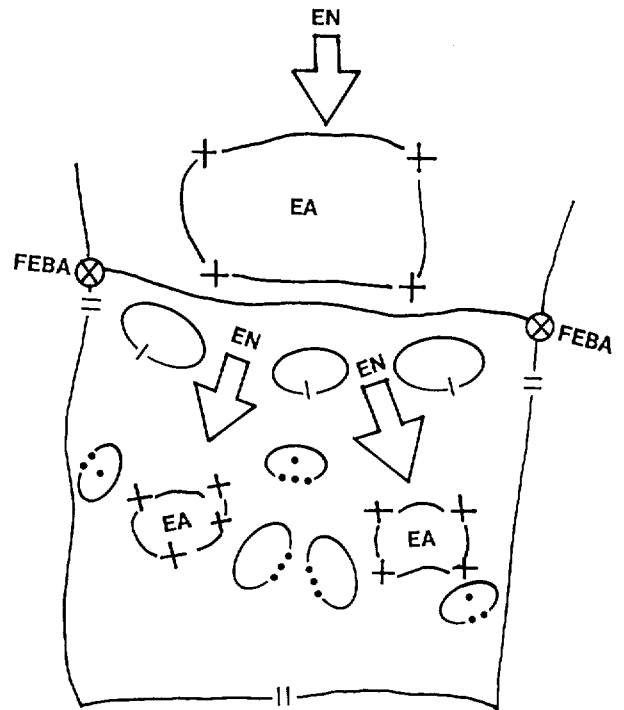
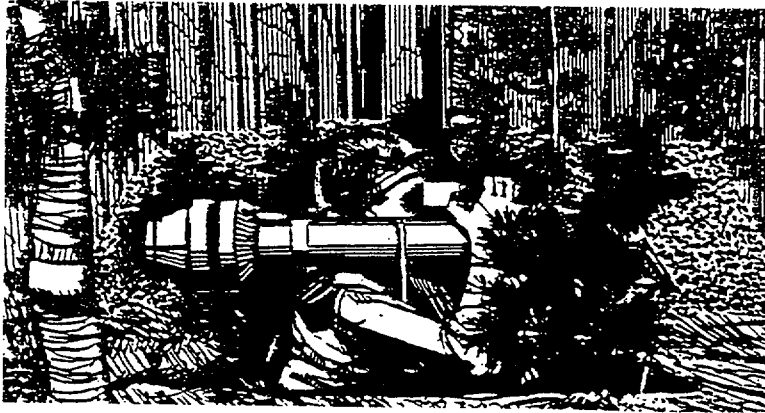

Figure 3-26. Engagement Area (Combination).

a. Cover and Concealment. Cover is protection from enemy fire; concealment is protection from enemy sight. Within the time allotted for preparation, every effort should be directed toward improving these aspects of a weapon position. See

figures 3-27 and 3-28 for examples of cover and concealment. There are three types of protection afforded ground mobile antiarmor weapons — hide position, turret defilade, and hull defilade. (See figs. 3-29 through 3-31.)



Movement of personnel in and around the position and failure to conceal from overhead observation are the most consistently neglected aspects of concealment for both ground-mounted and mobile antiarmor weapons systems. Movement of personnel should be minimized. Vehicles should utilize their camouflage nets whenever possible. Noise and light discipline should be enforced.

Figure 3-27. Concealment Using Natural Terrain.



Ground mounted weapon systems, possessing no armor protection, should also develop overhead protection to counter enemy artillery bursts.

Figure 3-28. Overhead Protection.

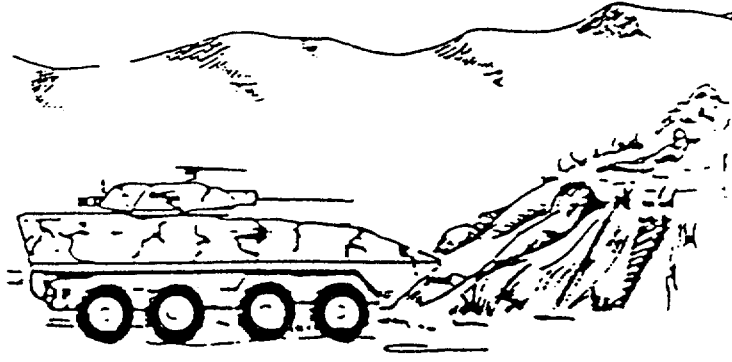

A vehicle is in the hide position when no part of the vehicle or commander is exposed to the front.

Figure 3-29. Hide Position.

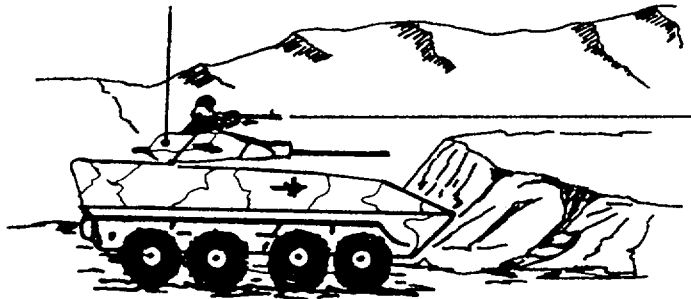

A tank or LAV is in turret defilade (also referred to as turret-down) when the entire vehicle is in defilade (behind cover), but the commander can still observe to the front from the turret.

Figure 3-30. Turret Defilade.

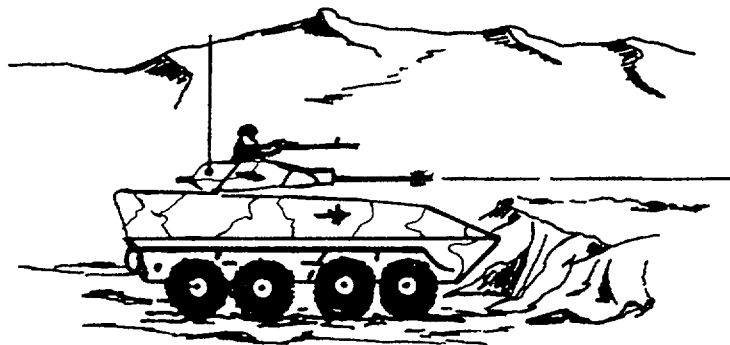

Hull defilade (also referred to as hull-down) is when the turret is the lowest part of the vehicle exposed. This position allows the vehicle to fire its primary weapon while still protecting its hull or body.

Figure 3-31. Hull Defilade.

b. Dispersion. Dispersion is the most effective passive measure a commander can utilize to negate the effects of threat artillery. Weapons should be dispersed both laterally and in depth so a single volley from an artillery battery would not prevent coverage of a given sector. The following examples in figures 3-32 and 3-33 depict the principle of dispersion. The enemy artillery battery is depicted firing an open sheaf.

principle of mutual support is applicable to positioning and fire control. Individual weapons and vehicles are never employed separately. However, antiarmor weapons like tanks and TOWs may be dispersed a considerable distance apart and still be able to cover the same sector. The other aspect of mutual support is protection against dismounted attack. Where required, antiarmor weapons should be positioned in the vicinity of accompanying infantry. (See fig. 3-34.)

c. Mutual Support. Mutual support is that support which units render each other against an enemy, because of their assigned tasks, their position relative to each other and to the enemy, and their inherent capabilities. (Joint Pub 1-02) The

d. Standoff Range. The standoff range is the distance that a weapon's maximum effective range exceeds that of an opposing weapon's maximum effective range. The advantage of the standoff

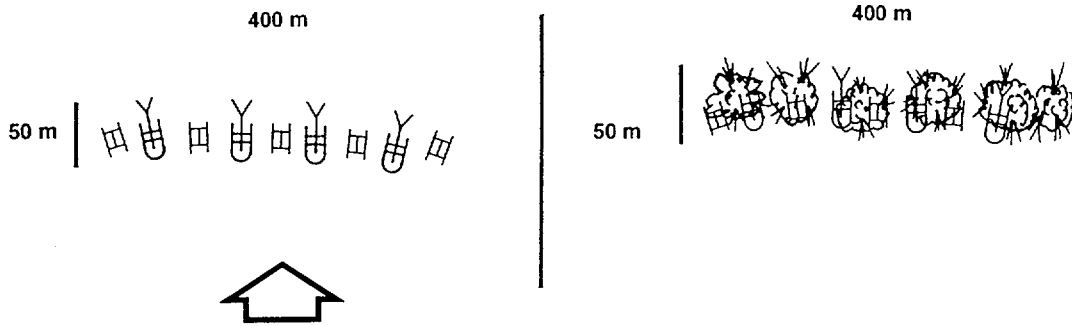

Figure 3-32. Inadequate Dispersion.

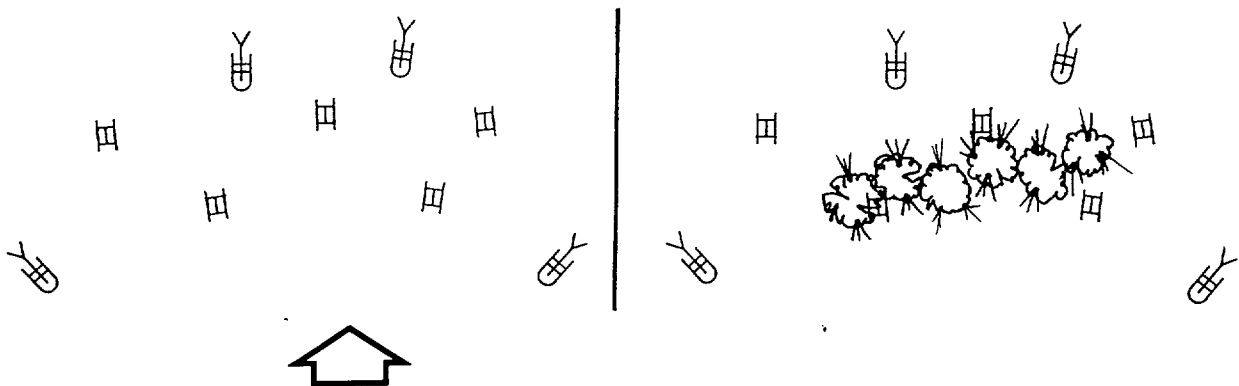

Figure 3-33. Lateral and In-Depth Dispersion.

range is its accuracy. For example, a TOW's maximum effective range of 3,750 meters exceeds a tank's maximum effective range of 2,000 meters by 1,750 meters. Therefore, a TOW system may be employed to maximize its *standoff* range by engaging the tank well beyond the tank's range. (See fig. 3-35.)

e. Flank Shots. The traditional approach of seeking flank shots is a method by which personnel position antiarmor weapons systems on the

flanks of the assaulting enemy force and it is not always feasible. (See fig. 3-36.) MAW and LAW systems require flank shots to be effective, since their chemical energy warheads are significantly degraded by composite and/or reactive armor (especially on the front slope of the tank). *The requirement for flank shots against enemy MBTs and defensive dispositions that facilitate these flank shots define the existing parameters for the Marine Corp's antiarmor posture.* Ideally, the disposition of the HAW systems would provide flank shots.

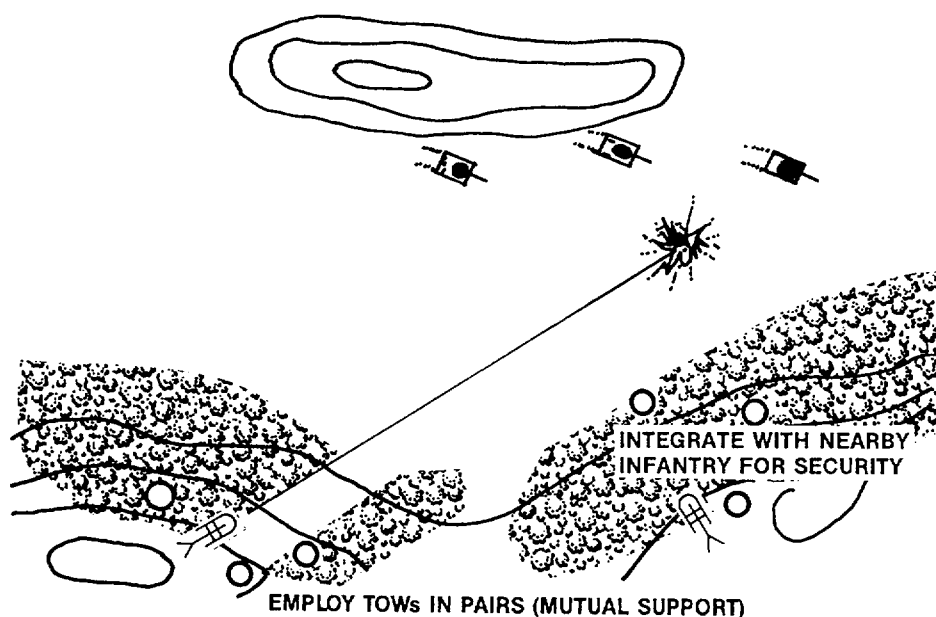

Figure 3-34. Mutual Support Between Weapons.

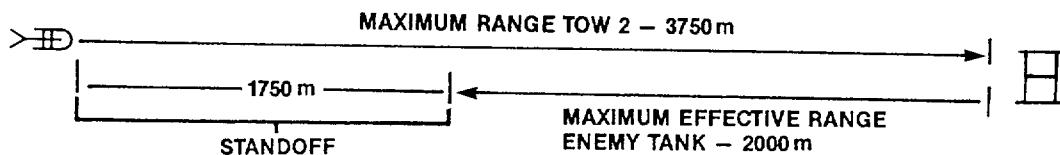

Figure 3-35. Standoff Range.

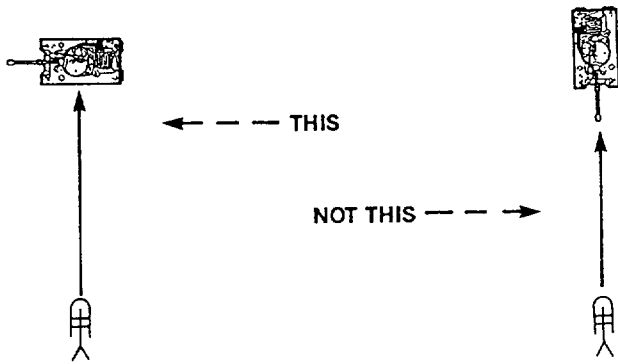

Figure 3-36. Flank Shot.

- Fire first. The weapon that fires first has a 5 to 1 advantage.
- Engage one target with one weapon. Avoid overkill.
- Establish *simple* and *complete* fire control procedures.
- Centralize the control of antiarmor fires.
- Centralize and mass artillery fire.
- Designate the responsibility for an EA to one individual (battalion or company commander).

Fire control and distribution measures must be simple and understood. The following paragraphs discuss the most commonly used measures for controlling the fires of antiarmor weapons.

3204. Fire Control

The first step the commander exercises in fire control is the designation of the EA. The EA provides the framework for all subsequent considerations of fire control. The following principles are the basis for effective fire control procedures:

- Use each weapon in its best role.
- Engage the enemy as rapidly as possible to minimize friendly exposure.
- Expose only those weapons needed to fire.
- Distribute fires to ensure complete coverage of enemy targets.
- Engage the most dangerous threats first.
- Maximize coordination of artillery and natural/manmade obstacles with direct fires.

a. Sector of Fire. A sector of fire is an area which is required to be covered by fire by an individual, by a weapon, or a unit. (Joint Pub 1-02) Sectors of fire ensure adequate distribution of massed fires within the EA. Sectors of fire are normally delineated by boundaries formed by natural terrain features that allow, whenever possible, ease of identification. The sector of fire may extend from the weapon to a distant boundary, or it may be an enclosed area located some distance from the weapon or unit. (See fig. 3-37.)

Normally, a specific type of weapon(s) will have a sector of fire. The sector of fire may overlap with another type of weapon's sector of fire. In this case, engagement criteria might further define each weapons role. (See fig. 3-38.)

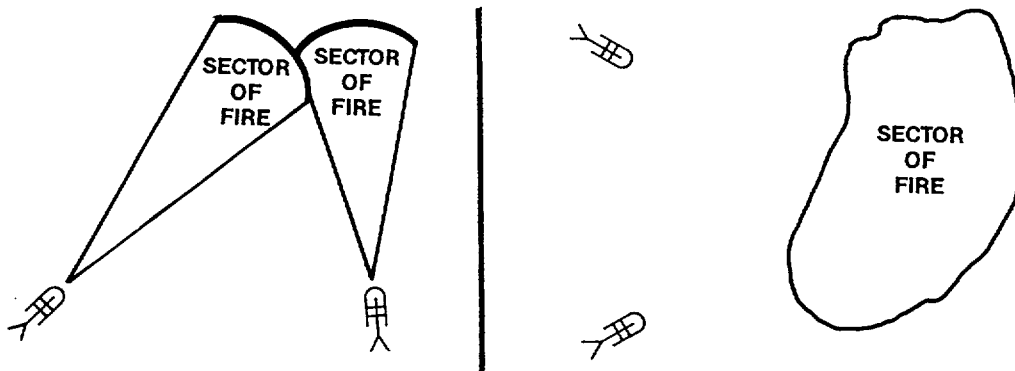

Figure 3-37. Sector of Fire.

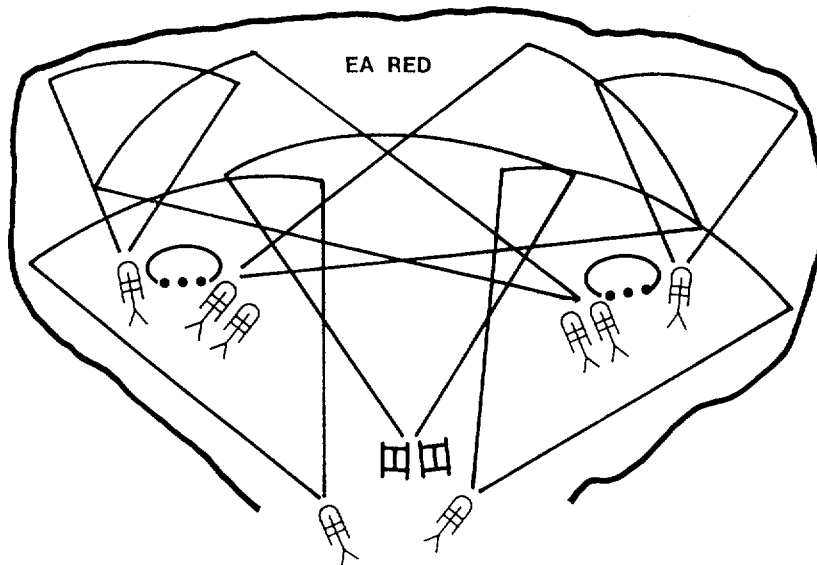

Figure 3-38. Overlapping Sections of Fire.

The terrain and the number and type of weapons available dictate how sectors of fire are assigned. They should be assigned so that an EA is completely covered by the appropriate fire. Mutual support is enhanced by assigning *primary* and *secondary* sectors of fire. One unit's (weapon) secondary sector of fire may correspond to another unit's (weapon) primary sector of fire. Fire may be shifted to the secondary sector, on order, when there are no targets in the primary sector. In consonance with sectors of fire, primary, supplementary, and alternate positions are normally planned for each weapon system.

b. Target Reference Point. A TRP is an easily recognizable point on the ground (either natural or manmade) used for identifying enemy targets or controlling fires. (FM 101-5-1) A TRP is used for controlling the fires of more than one direct fire weapon or tactical unit firing into the sector. It may be used to *distribute* or *converge* the fires of antiarmor weapons. TRPs are designated by using the standard target symbol and, once designated, may constitute an indirect fire target. If

designated an indirect fire target, the fire support coordinator (FSC) will provide the target numbering. (See fig. 3-39.)

c. Priority of Engagement. Priority of engagement is a sequence of targets that establishes the precedence (not the order of accomplishment) in which the targets should be attacked. This term relates primarily to direct fire antiarmor weapons. It is sometimes referred to as priority of targets. It is somewhat similar to the artillery term — target precedence. The regimental commander normally provides general guidance to his subordinate units on priority of engagement. It may have to be amplified at each succeeding subordinate tactical level in accordance with the antiarmor capability of each subordinate tactical echelon.

Priority of engagement is general guidance provided to a unit. Priority of engagement is also specific guidance provided to an antiarmor weapon squad or crew. Different weapons systems within a unit may have different priorities of engagement due to differing capabilities or the tactical scheme.

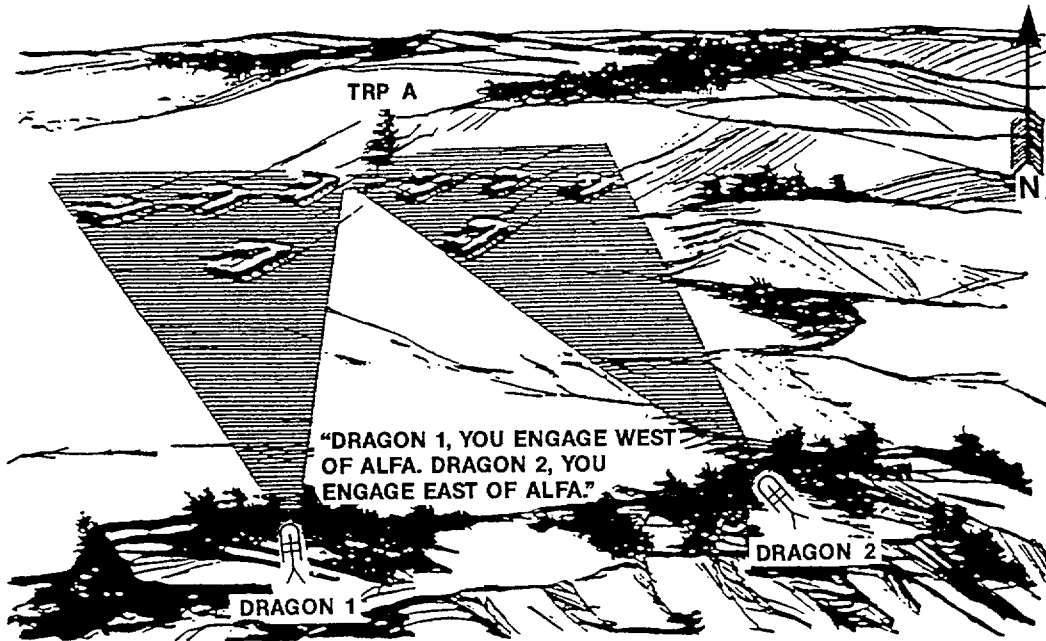

Figure 3-39. Target Reference Point.

A LAW team will normally have different priorities than an M1A1 tank. Engagement priorities are useful when there are overlapping sectors of fire or when communication is lost.

In addition to engagement priorities based on types of vehicles, the level of danger to the antiarmor weapon system must be considered. There are three categories of danger to the individual gunner that may modify the priority of engagement. *The categories are most dangerous, dangerous, and least dangerous.* The *most dangerous* category denotes an enemy weapon that can engage, is engaging, or is preparing to engage a friendly weapon. If two or more of them are present, engage the closest one first. The *dangerous* category signifies an enemy weapon that could engage a friendly weapon but has not seen it yet. The *least dangerous* indicates an enemy weapon which cannot engage or is not powerful enough to destroy a friendly weapon.

d. Methods of Initiating Engagement. There are two methods of initiating engagement—*on-order fire control* and *event-oriented fire control*. Either one may be used with the HAW-MAW-LAW or Massed Surprise fire method of engagement.

The first method, *on-order fire control*, is used when the commander gives the command for his elements to begin engaging the enemy. This method assumes that there are reliable communications and that the commander is in a position to see his entire EA or sector. The second method, *event-oriented fire control*, is the guidance that each gunner is given about what enemy action or event is to occur before he fires; e.g., the event could be when the first enemy tank crosses the trigger line or when a specific number of enemy armored vehicles cross the trigger line.

There are two fire control measures that are related to the methods of initiating engagement—

maximum engagement line and trigger point. The *maximum engagement line* is a constructed line within which targets can be engaged. It is never more than 3,750 meters (TOWs maximum range) down range. This line will normally be the range limit of the sector of fire. The *trigger point*, sometimes referred to as trigger line, is a location on the ground where the enemy comes within the effective range of a given weapon system. This line is where weapons systems fire on the enemy. The firing may be on-order or event-oriented. The trigger point is selected with consideration given to reaction time of the firing unit, time of flight of the projectile, and the rate of march of the enemy. (FMFM 6-18, *Techniques and Procedures for Fire Support Coordination*) (See fig. 3-40.)

The maximum engagement line and the trigger point may coincide. The dimensions are normally designated by TRPs.

e. Fire Commands/Fire Patterns. Fire commands and fire patterns are methods of fire

control that allow squads, sections, and platoons to engage enemy armor in the most economical and efficient manner. They may be incorporated in on-order or event-oriented initiated engagements. To be effective, fire commands and fire patterns should be rehearsed.

(1) Fire Commands. Fire commands are clear and concise fire commands that contribute to speed and accuracy in engaging armor formations. Fire commands will vary slightly, depending on the type of antiarmor weapon system. However, all initial fire commands contain the following five items as shown in figure 3-41.

Subsequent fire commands include those commands used to adjust, shift, and cease fire. They normally include only those elements necessary to accomplish these actions.

(2) Fire Patterns. Fire patterns are standard techniques for the distribution of antiarmor fires on multiple targets. Fire patterns are

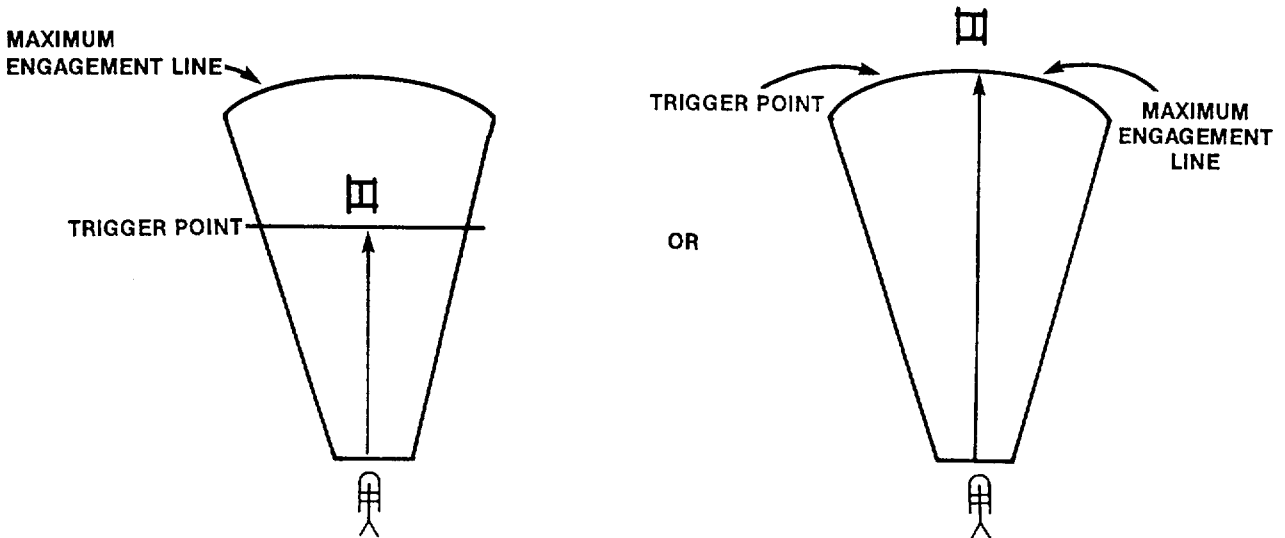

Figure 3-40. Trigger Point.

ALERT	"BRAVO Six Four, This is BRAVO Six One.
TARGET DESCRIPTION	Five Tanks
TARGET LOCATION	West of TRP Zero Zero Six
FIRE CONTROL METHOD (optional)	Depth
EXECUTION	At My Command, FIRE."

Figure 3-41. Sample TOW Section Fire Command.

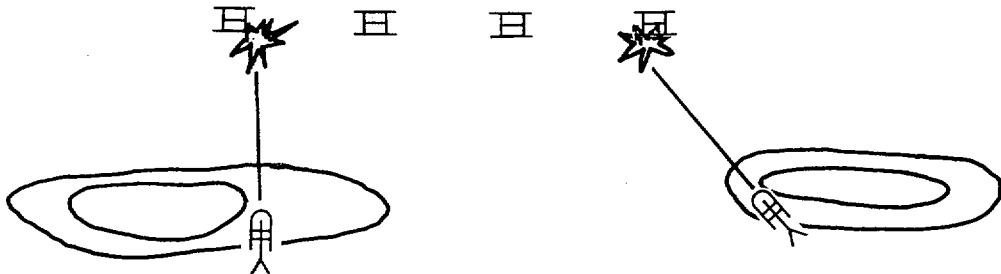

Figure 3-42. Frontal Fire Pattern.

announced as part of a platoon or section fire command. Fire patterns are normally used by tank and LAI platoons and TOW and Dragon sections. There are three basic fire patterns: frontal, cross, and depth. (See figs. 3-42 through 3-44.)

(a) Frontal Fire Pattern. The frontal fire pattern is most effective against an enemy armor column. This angle allows for flank shots and the gunners are not in the general observation area of the armor vehicle crew. The frontal fire pattern is least effective against an armor force deployed on line and assaulting directly toward the antiarmor weapons.

(b) Cross Fire Pattern. The cross fire pattern is used when enemy vehicles are deployed on line and assaulting directly toward the antiarmor weapons. This fire pattern requires that each weapon engage a target on the opposite flank. As targets are destroyed, fire is shifted toward the center of the formation. Cross fire creates flank shots and oblique shots. It requires good communication. The cross fire pattern decreases the time each gunner has to engage multiple targets compared to the frontal fire pattern, since the gunner is not engaging the enemy at the maximum effective range of his weapon relative to the FEBA.

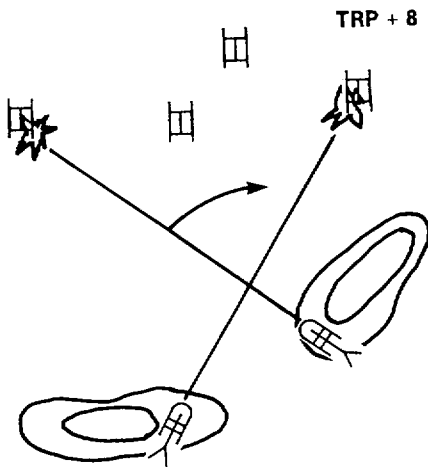

Figure 3-43. Cross Fire Pattern.

(c) **Depth Fire Pattern.** The depth fire pattern is employed when targets are exposed in depth. One section engages the nearest targets while the other section engages the farthest targets. As targets are destroyed, fires shift toward the center. This is especially effective against armored units in column or march formations. Like the cross fire pattern, depth fire may begin by event-oriented initiation, but requires good communication for subsequent control.

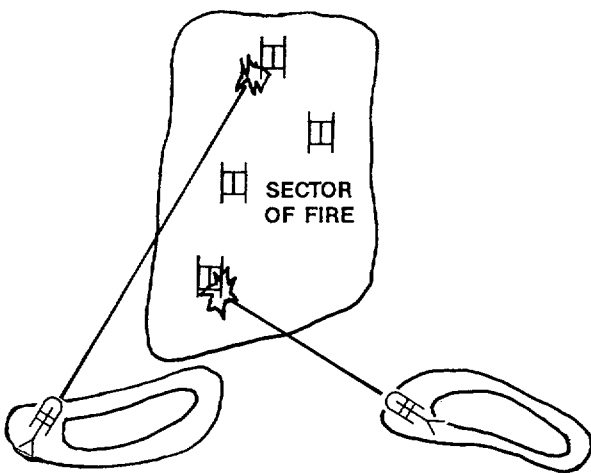

Figure 3-44. Depth Fire Pattern.

f. Kill Windows. The kill window is an exposed area between two covered areas that allows an ATGM gunner sufficient time to engage a target that is moving from one covered area to another across the exposed area. The TOW and Dragon require the gunner to track the target after firing until time of impact. The gunner must be aware of the time it takes the missile to reach various ranges after he fires (TOW—200 meters per second, Dragon—100 meters per second). The gunner should assume *worst case* conditions—the enemy vehicle moving at its top speed, approximately 10 meters per second. (See fig. 3-45.)

g. Primary, Alternate, and Supplementary Positions. Primary, alternate, and supplementary positions all contribute to effective fire control. For review, an alternate position has the same mission but different position than the primary position. A supplementary position is both a different position and a different mission. Where feasible, all antiarmor weapons should be assigned primary, alternate, and supplementary positions. Covered and concealed routes between positions are essential to ensure rapid displacement and to prevent detection of movement. (See fig. 3-46.)

h. Range Cards. A range card is an oriented sketch prepared for a *weapon* position. Two copies of the range card are made. One copy is retained by the crew and the other is forwarded to the next higher command. (See fig. 3-47.)

At a minimum, the range card should contain the following elements:

- Weapon positions (primary, supplementary, and alternate).
- Sectors of fire.
- Maximum engagement line.
- Range and azimuth to TRPs.
- Deadspace.
- Magnetic north.
- Unit designation, time, and date.
- Trigger point (if used).

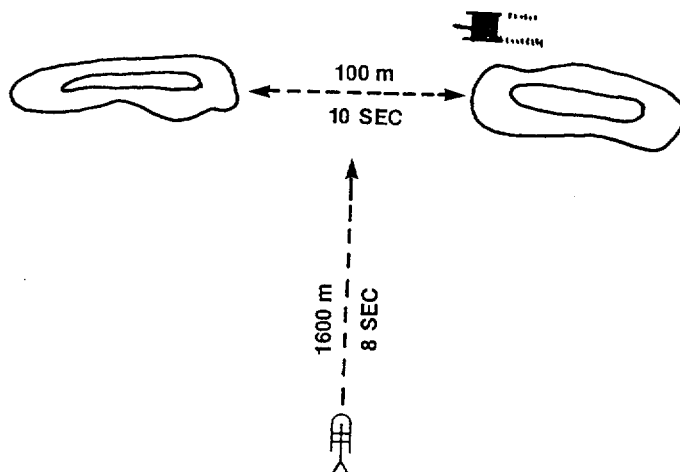

A kill window allows for sufficient engagement time. However, if the distance the enemy crossed was only 70 m, the TOW gunner would be unable to engage the target.

Figure 3-45. Kill Window.

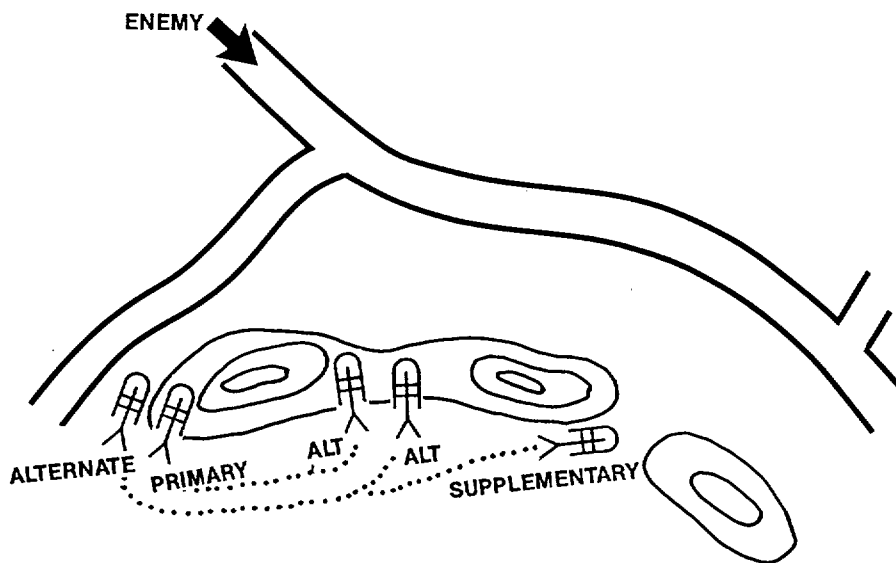

Figure 3-46. Positions.

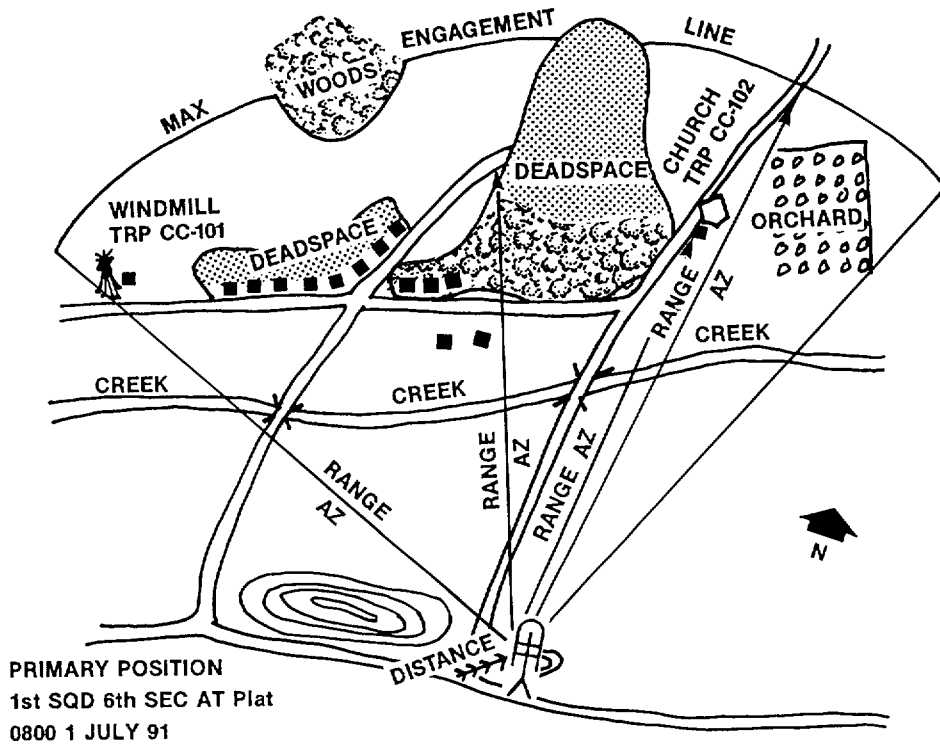

Figure 3-47. Range Card.

i. Platoon/Section Sector Sketch. A sector sketch is an oriented sketch prepared for a unit position. The sector sketch is a consolidation of the individual weapon range cards. Two copies of the sector sketch are made. One copy is retained by the preparer and the other is forwarded to the next higher command. Once the sector sketches are consolidated by the company commander and indirect fire targets are assigned, the sector sketch becomes the completed platoon fire plan sketch. Figure 3-48 is an example of a tank platoon sector sketch that has been developed into a platoon fire plan.

A platoon sector sketch normally depicts the following items:

- Engagement area.
- Main terrain features and ranges to them.

- Primary and secondary sectors of fire.
- Maximum engagement lines.
- Trigger line (if used).
- Target reference points.
- Dead space.
- Obstacles.
- Indirect fire targets (sketch becomes the fire plan).

The reader should recognize that the fire control measures presented in this section are to be integrated with those more familiar control measures such as phase lines, check points, and the fire support control measures discussed in previous sections. Disengagement criteria—a critical fire control measure in the defense—will be discussed in a later section.

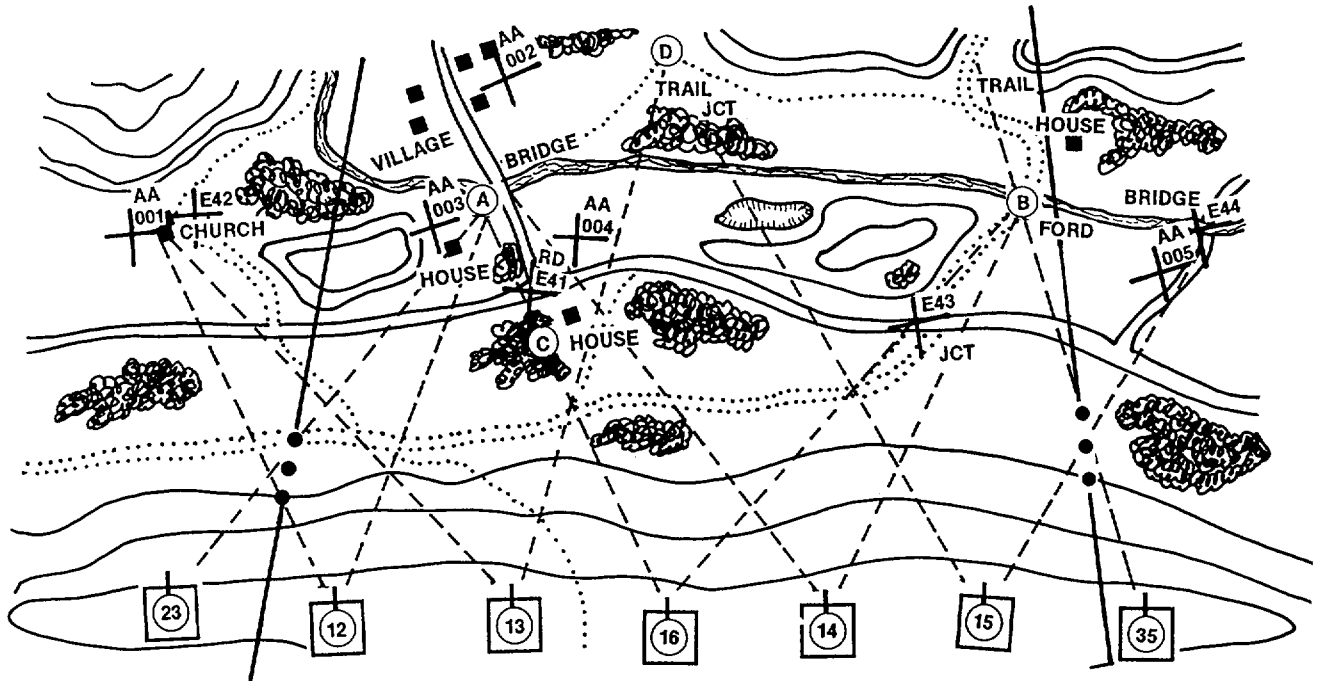

Figure 3-48. Platoon Fire Plan.

3205. Tank Killer Teams

Tank killer teams, sometimes referred to as armor killer teams, are normally squad-sized, task-organized units with independent missions and armed with MAWs and LAWs. Tank killer teams destroy enemy armor without becoming decisively engaged. They are also used to call for and adjust indirect fires and to report on enemy movement. Tank killer teams may use helicopters or vehicles for mobility. Their primary technique of engagement is the ambush with massed-surprise fire.

The roles assigned tank killer teams include but are not limited to the following missions:

- Employed in deadspace forward of the FEBA to canalize the enemy into EAs.
- Employed at night near the FEBA along primary or secondary avenues of approach as an economy of force measure.
- Employed in gaps between positions that cannot be covered by direct antiarmor fires.

Chapter 4

Antiarmor in the Defense

This chapter will discuss *unit* positioning. The preceding chapter addressed *weapon* positioning. Certain principles apply to both unit and weapon(s) positioning and are repeated (e.g., mutual support). While the MAGTF commander is ever cognizant of weapon positioning factors, unit positioning represents the focus of planning at the higher levels of command. Unit positioning will be discussed within the framework of basic defensive doctrine in which a major portion of the battlefield is organized into three areas: the security area, the main battle area, and the rear area. The antiarmor defense actually begins well forward of the security area with MAGTF air assets engaging advancing enemy armor. As enemy armor continues into the security area and main battle area, it encounters ever-increasing resistance from MAGTF assets in predetermined engagement areas.

Success against large armored formations is the result of the proper focus and coherent planning beginning with the MAGTF commander down through his subordinate commanders and staffs. This MAGTF perspective helps to ensure the proper integration of assets to achieve the combined arms effect.

Unless otherwise stated, at no time should the reader view a given technique or tactic as restricted to a certain style of warfare (e.g., mechanized infantry, light armored infantry, dismounted infantry, etc.) or specific type of terrain.

Section I. Defensive Doctrine

4101. Fundamentals of the Defense

The fundamentals of the defense, which are discussed in detail in the FMFM 6 series, are general rules evolved from logical and time-proven application of the principles of war to the defense.

- Preparation.
- Offensive Action.
- Defense in Depth.
- Concentration.
- Use of Terrain.
- Surprise.
- Flexibility.
- Mutual Support.
- Knowledge of the Enemy.

4102. Organization of the Defense

The defensive sector is organized into three echelons: the security area, main battle area, and rear area. (See fig. 4-1.)

a. Security Area. *The forward of the three echelons of a defensive sector.* It is the area forward of the FEBA out to the forward positions initially assigned to the security forces. The ground combat element commander may extend the lateral boundaries of subordinate units forward of the FEBA, giving them responsibility for the security area within sector to the forward limit of their boundaries, or he may assign a security force to operate across the entire ground combat element frontage. (FMFRP 0-14) In NATO, the security area is called the covering force area (CFA). Forces in the security area are assigned screen, guard, or covering force missions. Normally, a commander will have reconnaissance/security elements 30 miles forward of the main body for every hour of warning time desired. LAI and air units normally conduct the majority of operations in the security area.

See paragraph 4201 for discussion of MAGTF air and LAI operations.

The establishment of security forces by a higher headquarters does not relieve any commander of the responsibility for the security of his own position. Local security provides warning against immediate ground attack.

b. Main Battle Area. The main battle area (MBA) is the area extending from the FEBA to the rear boundaries of its forward subordinate units. The commander organizes the MBA by assigning defensive sectors, battle positions, or strongpoints to subordinate units. Regiments normally defend in sector. Battalion task forces and company teams may be assigned defensive sectors, battle positions, or strongpoints. Platoons defend as part of a company or from positions within a company sector. The preponderance of antiarmor weapons are found in the MBA.

c. Rear Area. For any particular command, the area extending forward from its rear boundary to the rear of the area of responsibility of

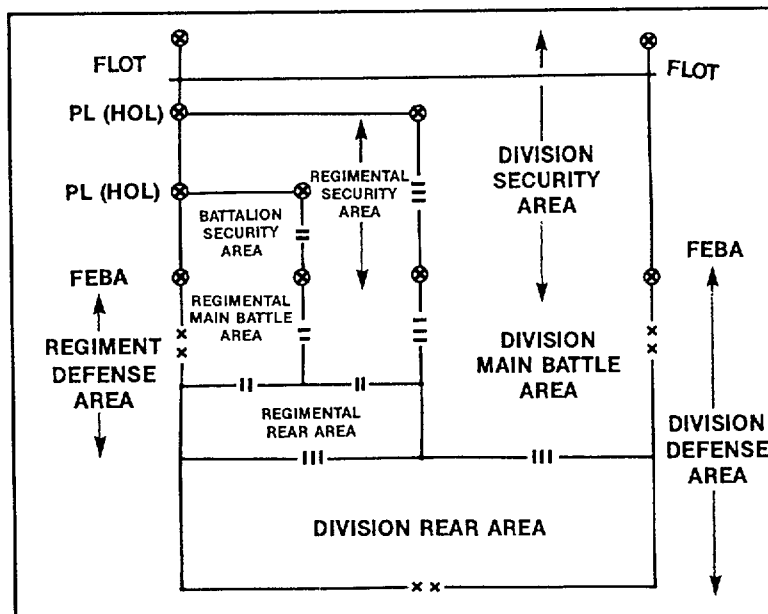

Figure 4-1. Organization of the Defense.

the next lower level of command. This area is provided primarily for the performance of combat service support functions. (Joint Pub 1-02) Normally, some TOW and Dragon weapons are allocated for rear area security against a breakthrough by enemy armor.

In addition to the three echelons of the defense, the following control measures contribute to the organization of the defense.

(1) Forward Edge of the Battle Area. The FEBA is the foremost limits of a series of areas in which ground combat units are deployed, excluding the areas in which the covering or screening forces are operating, designated to coordinate fire support, the positioning of forces, or the maneuver of units. (Joint Pub 1-02)

(2) Forward Line of Own Troops (FLOT). The FLOT is a line which indicates the most forward positions of friendly forces in any kind of military operation at a specific time. (Joint Pub 1-02) The FLOT normally identifies the forward location of covering and screening forces. However, in deep operations such as a turning movement by helicopterborne forces, the designation of the FLOT may not extend to include those forces.

(3) Handover Line (HOL). The HOL is a control feature, preferably following easily defined terrain features, at which responsibility for the conduct of combat operations is passed from one force to another. (Joint Pub 1-02) The HOL may be used by security forces delaying back toward the FEBA. At some point, the security forces do a *battle hand-off* to the stationary unit, passing control of all supporting arms and responsibility for the security area to the stationary force. The HOL is designated by higher headquarters. The commanders of the security area and the MBA coordinate the exact location and may recommend changes to higher headquarters.

4103. Distribution of Forces

The commander organizes his forces into three basic echelons: security forces, main battle forces, and reserves.

a. Security Forces. Security forces are employed in the security area to provide early warning, to delay the enemy, and to deceive the enemy as to the true location of the MBA. Security forces may be assigned missions to screen, guard, or cover. The use of a security force does not preclude the requirement for all other elements of the force to provide their own local security. LAI and mechanized forces are well suited for security missions because of their long-range weapons and mobility. Deep air support (DAS), CAS, and close-in fire support (CIFS) should be planned with ground forces in the security area. Particularly important is the use of Cobra helicopters with LAI units.

b. Main Battle Forces. Main battle forces are employed to engage the enemy and slow, stop, canalize, or disorganize his attack. They occupy positions within the MBA oriented on the main avenues of approach into the sector. Positions are organized in depth and should be mutually supporting. They need not be positioned on the FEBA, but should be able to engage the enemy effectively at or beyond it.

While the firepower of a mechanized force is an asset in any location, assignment to the FEBA may restrict a mechanized forces' tactical mobility. When a mechanized force is operating independently, it may be required to establish a defense and a portion of the force would have to be assigned to the MBA. When this occurs, units task-organized with tanks are not normally assigned to the MBA. However, any mechanized units assigned to the MBA should be given large defensive sectors and freedom of maneuver within their sector.

c. Reserves. Reserves are employed to limit enemy penetrations or counterattack to destroy or eject the enemy. They are normally held in covered positions in the rear area until employed. Mechanized forces are well suited for assignment to the reserve because of their mobility and combat power. Consideration for constituting the reserve should be given to utilizing LAI units withdrawing through the FEBA following their security operations. The allocation of resources between the FEBA and the reserve and the time to commit the reserve may be the most difficult decisions made in the defense.

4104. Defensive Positions and Sectors

Types of defensive positions are primarily defined, not by the physical organization of the ground, but the mission assigned the unit occupying the ground. While allowing for similarities, the following definitions are provided to eliminate some of the confusion that has accompanied previous doctrinal changes in the defense.

a. Battle Position. *A defensive location oriented on the most likely avenue of approach from which a unit may defend or attack.* Such units can be as large as reinforced battalions and as small as platoons. The unit assigned to the battle position is located within the general outline of the battle position, but other forces may operate outside the battle position to provide early detection of enemy forces and all-around security. (FMFRP 0-14) Battle positions are mutually supporting and are placed on terrain that dominates the armor avenues of approach.

b. Blocking Position. A defensive position so sited as to deny the enemy access to a given area or to prevent his advance in a given direction. (Joint Pub 1-02)

c. Delay Position. A position taken to slow up the advance of the enemy without being decisively engaged. (AR 310-25)

d. Strongpoint. A key point in a defensive position, usually strongly fortified and heavily armed with automatic weapons, around which other positions are grouped for its protection. (Joint Pub 1-02) A strongpoint is a heavily fortified, all around defensive position which cannot be overrun by tanks and which can be reduced by enemy infantry only after the expenditure of much time and overwhelming forces. It is normally occupied by a battalion or company. A strongpoint is established only after the commander determines that the position must be retained at all costs. It requires a considerable engineer effort and detailed fire support planning. Restated, a strongpoint is a type of blocking position with an unusually high degree of preparation.

Subsequent battle or delay positions are planned with either event-oriented or on-order criteria for disengagement. Movement off a blocking position or a strongpoint position is almost always on order.

e. Sector. An area designated by boundaries within which a unit operates, and for which it is responsible. (Joint Pub 1-02) Sectors may be assigned from division to squads. They may be used in conjunction with battle positions, blocking positions, delay positions, and strongpoints. Sectors may be used in the security area and MBA. Sector boundaries never split an avenue of approach. Defense in sector is the least restrictive mission.

4105. Types of Defense

There are two basic types of defense with many variations. In actual practice, an antiarmor defense is likely to include characteristics of both types.

a. Position Defense. The type of defense in which the bulk of the defending force is disposed in selected tactical localities where the decisive battle is to be fought. Principle reliance is placed on the ability of the forces in the defended localities to maintain their positions and to control the terrain between them. The reserve is used to add depth, to block, or restore the battle position by

counterattack. (Joint Pub 1-02) The position defense focuses on the retention of terrain by absorbing the enemy into a series of interlocked positions from which he can be destroyed, largely by fire. Position defense is the DOD/NATO term for what was formerly referred to as the area defense.

b. Mobile Defense. Defense of an area or position in which maneuver is used with organization of fire and utilization of terrain to seize initiative from the enemy. (Joint Pub 1-02) The mobile defense requires depth and focuses on the destruction of the enemy by permitting him to advance into a position that exposes him to counterattack by a strong mobile reserve. Normally, the mobile defense requires a large amount of air support to be used by the MAGTF against an attacking armor force.

Figure 4-2 depicts the fundamental difference in principle between the position and mobile defense regarding distribution of forces.

The position defense is normally used to retain terrain while the mobile defense is used to destroy the enemy force. Clearly, the position defense weights its forces forward while the mobile defense weights its forces toward its reserve or

counterattack force. In the position defense, the reserve is normally used to reestablish the FEBA following penetration by the enemy. In the mobile defense, the reserve or counterattack force is used to destroy the enemy. The division is normally the smallest size force that can conduct a mobile defense.

Conceptually, these two defenses define the extreme types of defense. They are traditional concepts that provide a context in which to discuss defense. However, actual defenses will normally include aspects of both position and mobile defense. Figure 4-3 depicts the spectrum of the defense and the weighting of techniques toward one extreme or the other.

4106. Offensive Action in the Defense

Offensive action in the defense allows the commander to regain the initiative and shape the battle. This may be achieved by actual physical destruction of an enemy unit or by disrupting the tempo of his operations. The *turning movement*, *counterattack*, *spoiling attack*, and *hide forces* are four of the commander's offensive options in the defense.

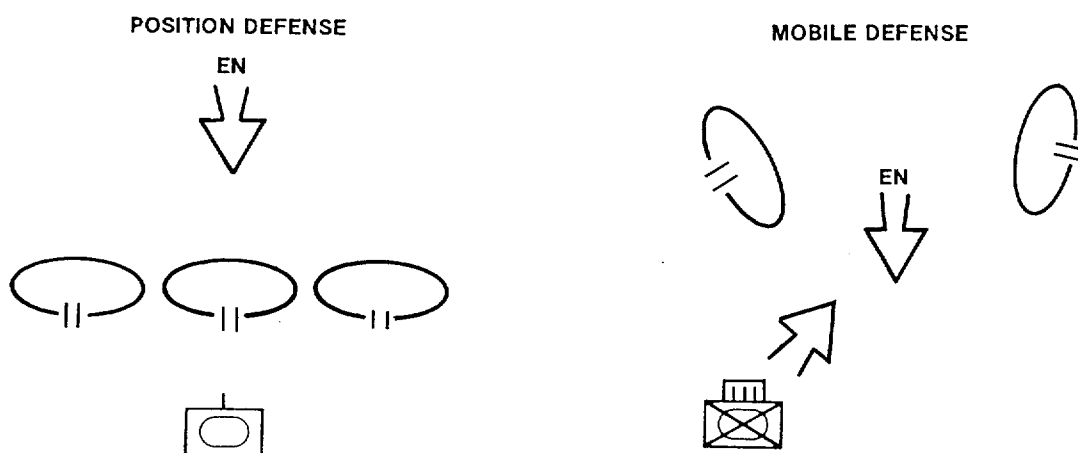

Figure 4-2. Defensive Concepts.

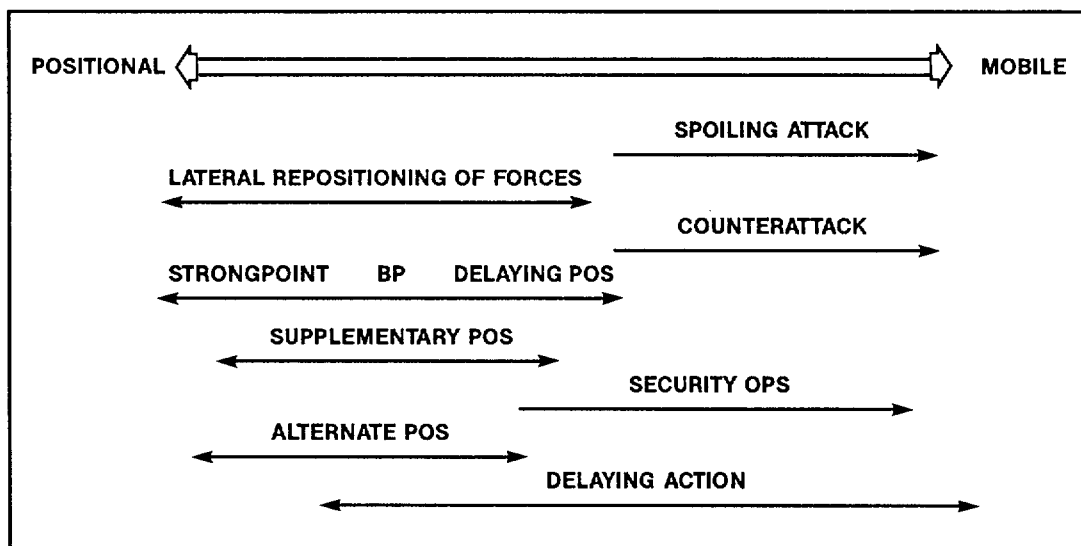

Figure 4-3. Defense Spectrum.

a. Turning Movement. A turning movement is a variation of the envelopment in which the attacking force passes around or over the enemy's principal defensive positions to secure objectives deep in the enemy's rear to force the enemy to abandon his position or divert major forces to meet the threat. (Joint Pub 1-02) A turning movement is an example of the deep battle. A turning movement would normally be directed by the MAGTF commander. It would likely involve helicopterborne and mechanized task forces that would ultimately result in a link-up well beyond the division's FLOT.

b. Counterattack. A counterattack is an attack by part or all of a defending force against an enemy attacking force, for such specific purposes as regaining ground lost or cutting off or destroying enemy advance units, and with the general objective of denying to the enemy the attainment of his purpose in attacking. In sustained defensive operations, it is undertaken to restore the battle position and is directed at limited objectives. (Joint Pub 1-02) The counterattack is the decisive element of defensive action. The counterattack is the commander's primary means of breaking the enemy attack or of regaining the initiative. Once launched, the counterattack becomes the main

effort. Success depends largely on surprise, speed, and boldness of execution. (See fig. 4-4.)

Counterattacks are conducted like other attacks. Counterattacks may be conducted forward of or within the MBA. Ideally, a counterattack is executed based on a plan with a designated EA or objective. However, a counterattack may be launched from a frag order. Timing and coordination with other elements of the defense is imperative. Counterattacks are conducted by the reserve or by uncommitted or lightly committed main battle forces. Mechanized forces are employed in the counterattack, whenever possible, due to their firepower and tactical mobility.

c. Spoiling Attack. A spoiling attack is a tactical maneuver employed to seriously impair a hostile attack while the enemy is in the process of forming or assembling for an attack. (Joint Pub 1-02) It is a preemptive, limited objective attack aimed at preventing, disrupting, or delaying the enemy's ability to launch an attack. A spoiling attack may be either a hasty or deliberate attack, depending on the time for preparation. It may be conducted like a raid with a planned withdrawal.

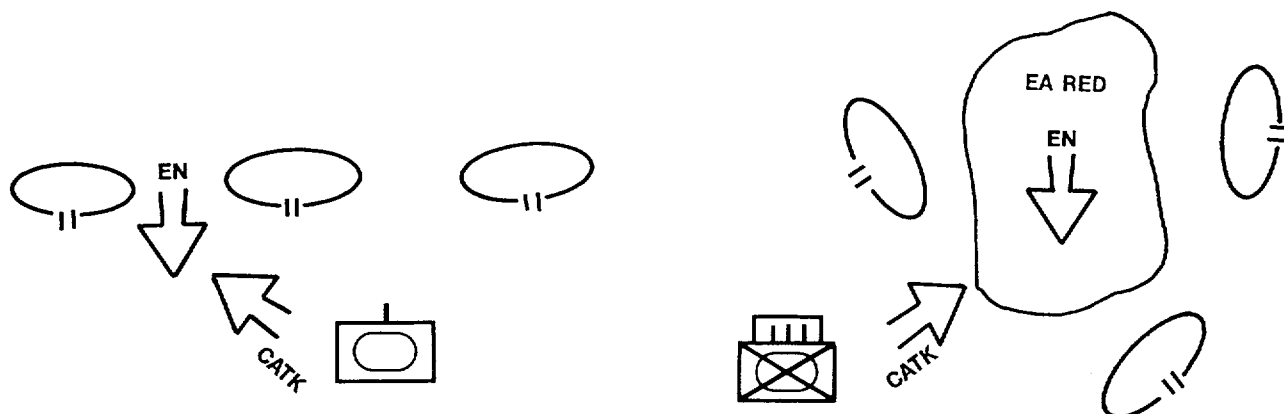

Figure 4-4. Counterattacks.

Like the counterattack, the circumstances in which it is conducted normally preclude full exploitation. Like the counterattack, a spoiling attack is normally conducted by all or a part of the reserve. This may require another reserve force to be temporarily formed.

d. Stay Behind Forces. Stay behind forces are mobile units that counterattacks or harasses enemy combat forces from the rear, or attacks and/or ambushes enemy command and control, combat support (CS), and combat service support (CSS) elements. Stay behind forces may be as large as a mechanized battalion task force or as small as an infantry tank killer team. *The concept of stay behind forces involves considerable risk.*

Regardless of the mission assigned, the success of the mission at some point will depend upon being bypassed by the enemy and eventually being able to disrupt the tempo of the enemy mechanized forces.

A stay behind unit may be initially positioned in the security area or within the MBA. A stay behind force may be required to conduct a breakout and linkup or exfiltrate back through friendly positions. Sufficient CS and CSS assets are allocated as required.

Figure 4-5 depicts a tank company firing on a second echelon mechanized battalion. A return route through friendly positions is planned. A scout section is providing a screen forward.

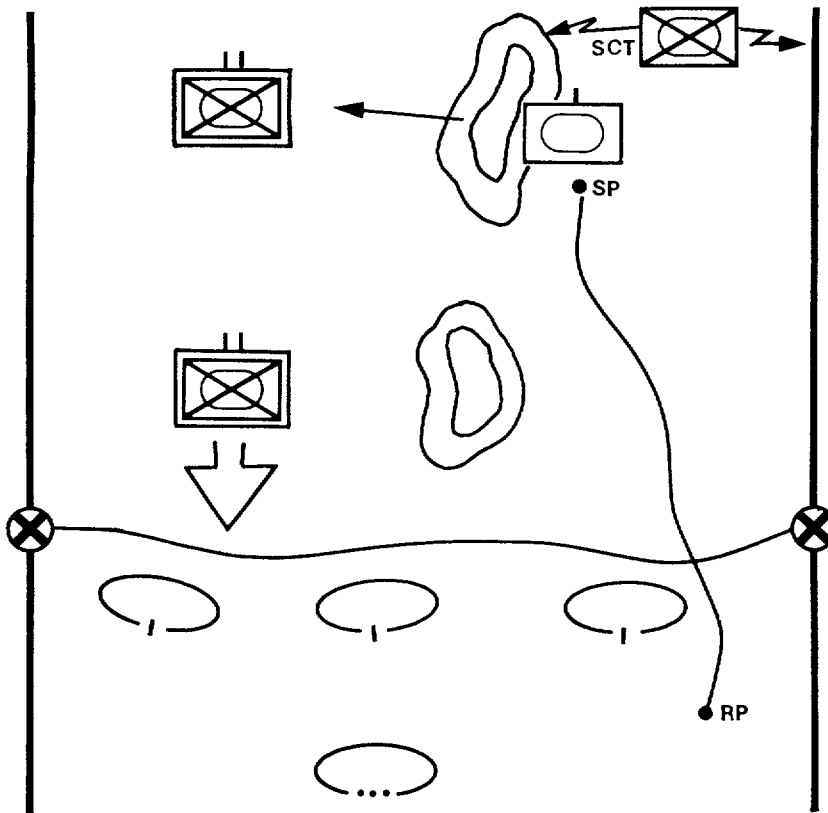

Figure 4-5. Stay Behind Forces.

Section II. Organization of a MAGTF Antiarmor Defense

4201. MAGTF Air and LAI Operations

Air assets define the farthestmost reach of the MAGTF when fighting the *deep battle*. The MAGTF commander may direct fixed-wing and attack helicopter operations forward of the security area against enemy armor. The idea is to attack the enemy either in predetermined or hastily established EAs while the enemy armor is not fully deployed. This presents a better array of targets for air attack. This concept is also used against enemy second echelon units while the first echelon units are being engaged by friendly ground units. As enemy armor enters the security area, it is engaged by LAI units supported by air and other supporting arms. LAI units may be reinforced with mechanized assets.

LAI battalion is a mobility asset that exemplifies the principle of economy of force. Its principal tasks are *reconnaissance, security, and limited offensive operations*. Control of LAI battalion by the MAGTF commander is normally exercised through the ground combat element (GCE) commander; however, the MAGTF commander can assume direct operational control of the battalion. An LAI unit may be combined with aviation combat element (ACE) assets to form a task-organized force well forward of the GCE elements.

4202. Division

The division will normally assign sectors within the MBA to its regiments. The division commander may further designate specific battle positions or strong-point positions that are critical to the overall defensive effort. If the division is conducting a mobile defense, a division level EA may be designated. This EA would normally accommodate an enemy MRR. Avenues of approach at division level are those that will accommodate a minimum of a fully deployed MRB. Likewise, the division commander should visualize his defense in terms of battalion positions when assigning regimental sectors. If the division is conducting basically a position defense, the designation of EAs are delegated to the regiments.

a. Security Area. Security forces are assigned screening, guard, or covering force missions in the security area. A security force is normally task-organized and may include dedicated artillery, air defense, engineers, and attack helicopters in its task-organization. The security area is normally the area where the advancing enemy armor is first engaged by friendly forces.

A *screening* element has the primary task to observe and report information. The *guard* protects the main force from attack, direct fire, and ground observation, by fighting to gain time, while also observing and reporting information. The mission to screen is included in a guard mission. A *covering force* is a force which operates apart from the main body for the purpose of intercepting, engaging, delaying, and deceiving the enemy before he can attack the main force. A mission to screen is included in the covering force mission. It differs from a guard force in that it is organized to operate independently, is organized with its own artillery, and may include offensive action characterized by limited counterattacks or spoiling attacks.

A covering force mission against a Soviet-type mechanized force would normally require a mechanized regiment- or battalion-sized task force reinforced with appropriate CS and CSS units. The covering force mission requires the capability to engage and delay the enemy and force MRR units to deploy.

LAI units and mechanized task forces are well suited for operations in the security area. The division would normally employ the LAI battalion in a screen or guard mission. LAI units have the capability to destroy enemy reconnaissance units and combat recon patrols. The LAI battalion would normally have to be reinforced with mechanized units and/or air assets to perform a guard or covering mission.

Units operating in the security area normally assume another mission following displacement through friendly lines. These missions include but

are not limited to the reserve, rear area security, and flank security. (See fig. 4-6.)

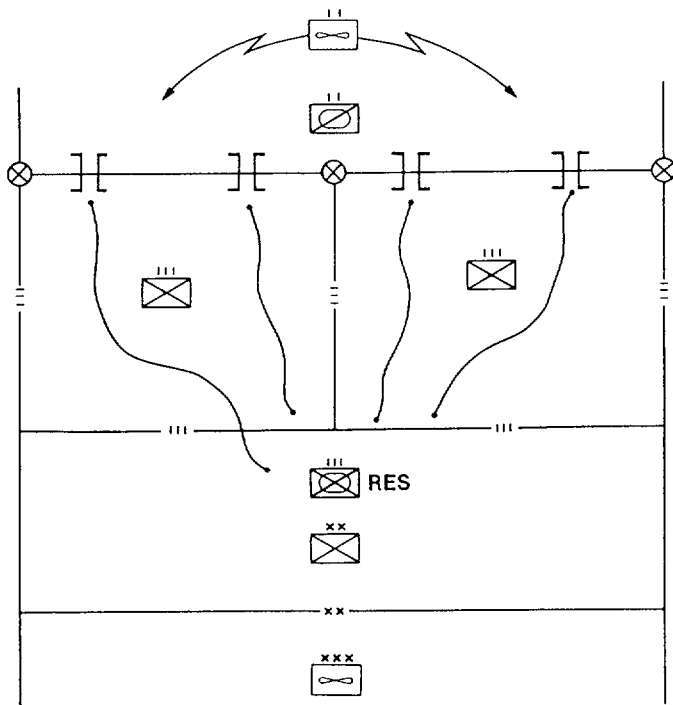

Figure 4-6. Marine Expeditionary Force/ Division Screen.

b. Main Battle Area. The division's MBA is normally organized into regimental sectors. (See

fig. 4-7.) Battle positions or strongpoints may be designated by the division commander within the regimental sectors. *The TOW, Dragon, and LAW weapons are the primary antiarmor weapons within the regimental sectors.* Normally, a mechanized unit would not be assigned to the MBA because it's mobility and firepower make it far better suited for a reserve mission. However, when a mechanized unit is assigned to the MBA, the majority of the tank units will be detached and assigned to the reserve.

The division controls movement of its regiments within the MBA by the use of phase lines. However, maximum latitude is normally granted regiments between phase lines. This allows regiments to maneuver their units between positions.

c. Rear Area. In addition to normal security requirements, the rear area may require an antiarmor capability located in its immediate vicinity. This requirement is normally met by incorporating TOW or Dragon assets into the local rear area security. The division reserve is used to prevent major armored attacks into the rear area.

4203. Regiment

A regiment may be required to establish a defense incorporating a security area, MBA, and rear area within a division sector. Regiments may use either

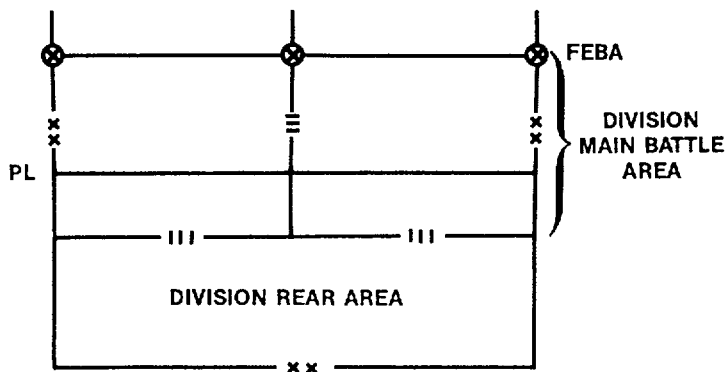

Figure 4-7. Division Main Battle Area.

a mobile or position defense depending upon availability of assets. In both the position or mobile defense, the overall scheme of maneuver makes the greatest possible use of maneuver and offensive action. A regiment can conduct counterattacks, spoiling attacks, and establish hide forces if it possesses sufficient mobility and firepower assets.

a. Organization of the Defense. The security area will normally be under task-organized forces designated by and reporting to the division. It may include some forces from the regiment that would revert to regimental control after moving through the HOL. However, the regiment is responsible for the area between the HOL and the FEBA and may desire to position some forces in this area.

The regiment organizes the MBA by assigning to subordinate battalion—sectors, battle positions, strongpoints, or a combination of all three. As a general rule, the regiment will assign mechanized forces to the reserve to maximize their tactical mobility.

(1) Sectors. Sectors are the least restrictive measure assigned by the regiment to the battalions. This method allows more freedom to maneuver and decentralized fire planning. Normally, battalion commanders have total freedom to position or maneuver within their sector. Like the division, the regiment utilizes phase lines within the sectors to control movement (See fig. 4-8.)

(2) Battle Positions. Battle positions (BPs) are used when the regimental commander desires greater control over the maneuvering and positioning of his battalion task forces. If the regimental commander designates the BPs, the battalion moves from this position only on-order or based on clear criteria established by the regimental commander. Figure 4-9 depicts a combination of battle positions and sectors. BPs are normally numbered.

(3) Strongpoint. If the regimental commander determines that certain terrain is critical to the defense, he will normally designate a strongpoint position. (See fig. 4-10.)

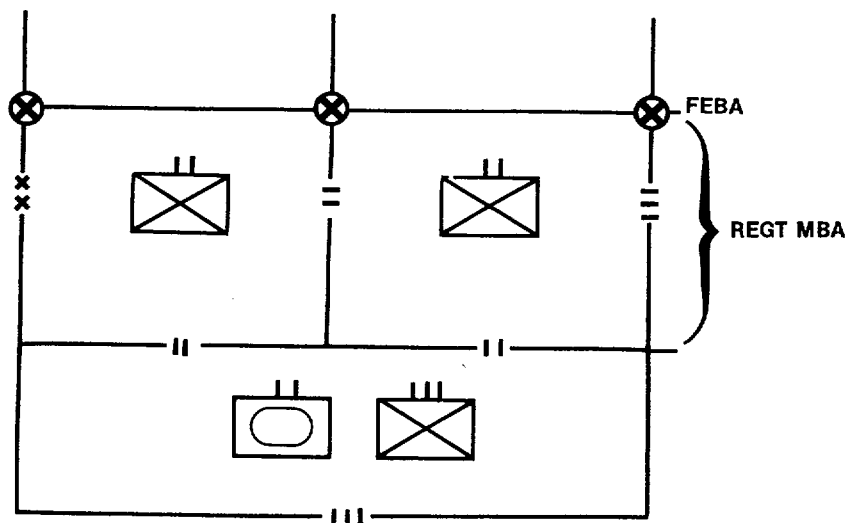

Figure 4-8. Sectors.

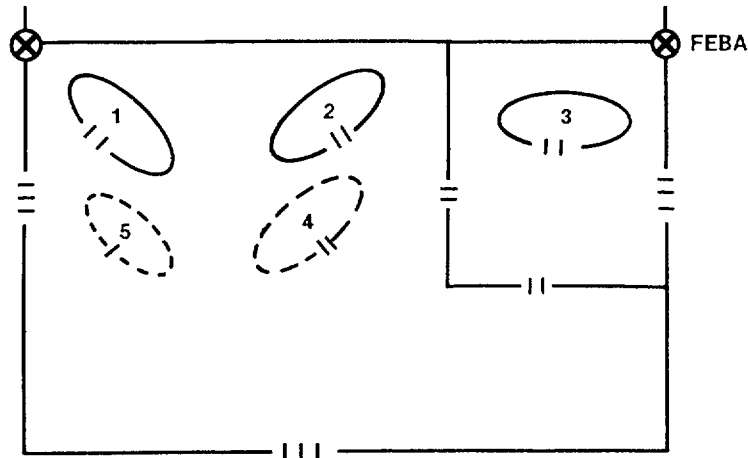

Figure 4-9. Battle Positions/Sectors.

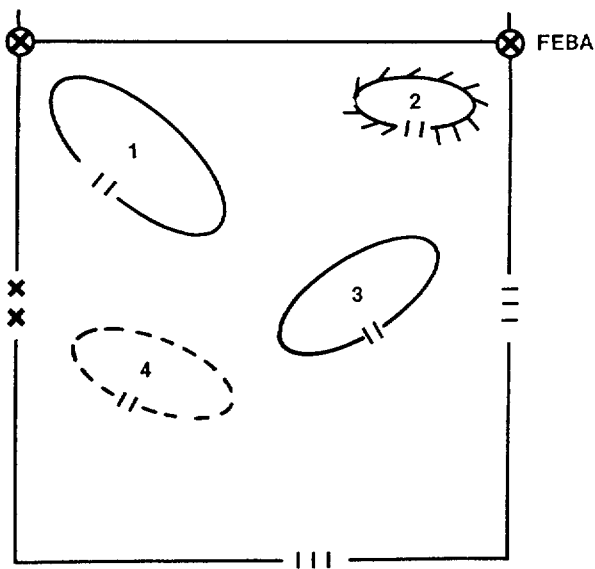

Figure 4-10. Strongpoint/Battle Positions.

b. Reserve Force. A regiment may designate a reserve, or else require the battalions to obtain permission before employing their reserves. When establishing a reserve, the guiding principle is to utilize mechanized forces and attack helicopters when available.

c. Rear Area Operations. A regiment will normally assign TOW sections and Dragon squads to support its rear area against any armor penetrations. LAI units may be assigned to the regiment and be utilized in the rear area following completion of their security role in the security area.

4204. Battalion

a. Security Area. In the security area, a mechanized battalion may participate as part of the covering force, or it may be assigned a guard mission. This section will address an infantry battalion defending in the MBA as part of a regiment.

b. Types of Defense. A battalion will normally defend using three basic types of defense – defend in sector, defend from a battle position, and defend a strongpoint. A battalion will normally form at least a platoon-sized reserve of mech and/or TOW forces, if available. The following graph summarizes the factors that a commander considers in selecting a battle position or a sector.

FACTOR	BATTLE POSITIONS	SECTOR
Avenues of Approach	Well Defined, En can be canalized	Multiple Avenues
Terrain	Dominates avenues of approach	No dominating terrain
Area of Operations	Narrow	Wide
Mutual Support between Companies	Achievable	Not Achievable
Higher commander's ability to control	Good	Degraded

c. Defend In Sector. Defense in sector is the most common defense mission in antiarmor operations. Company sectors are oriented on battalion avenues of approach (platoons size or larger).

Defend in sector is the least restrictive mission. Figure 4-11 depicts a battalion with three company teams in sector and a tank company in reserve.

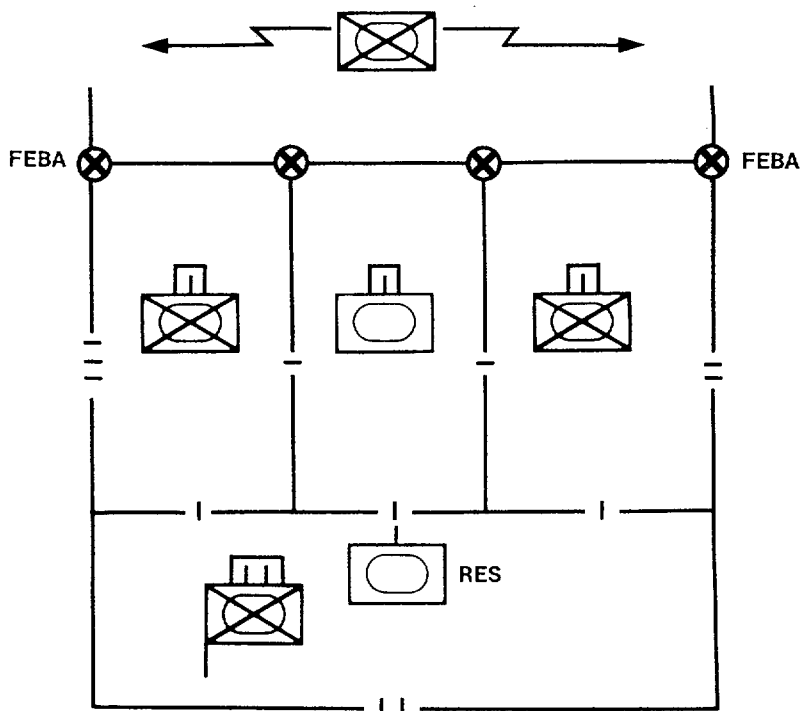

Figure 4-11. Defend in Sector.

The battalion commander may choose to employ companies in battle positions. This technique restricts maneuver and complicates flank coordination by the companies, but it gives greater control of the overall defense to the battalion commander. The use of on-order battle positions provides flexibility and depth to the defensive plan. However, the battalion must have sufficient mobility assets to ensure quick movement between positions. Figure 4-12 illustrates a defense incorporating battle positions, strongpoints, and sectors.

d. Defense of a Battle Position. A battalion may be assigned a battalion-sized battle position. A unit assigned a battle position occupies the general area of the position. Security forces may operate well forward to the flanks of battle positions for early detection of the enemy and for all-around

security. Units can maneuver in and outside of the battle position as necessary to adjust fires or to seize opportunities for offensive action in compliance with the commander's intent. Figure 4-13 illustrates a battalion battle position with company battle positions.

e. Defense of a Strongpoint. A strongpoint may be battalion size to platoon size. Battalion strongpoints can be established in isolation when tied to restrictive terrain on their flanks or on armor high speed avenues of approach tied to defensive positions of units on the flanks of the strongpoints. Strongpoints may be on the FEBA or in depth in the MBA. Defense in depth is achieved through multiple positions within the strongpoint. All positions within a strongpoint must be mutually supporting. Mechanized forces are rarely assigned to strongpoints. Infantry with

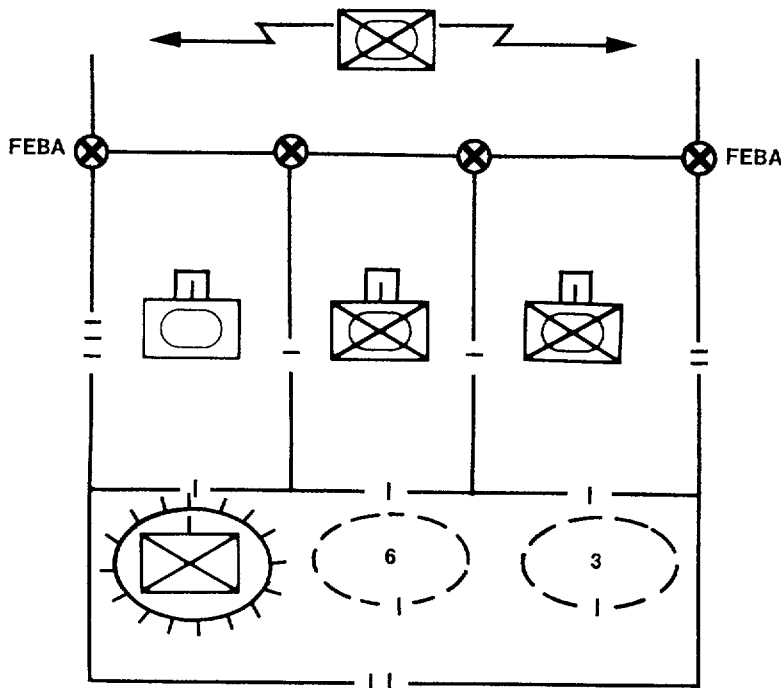

Figure 4-12. Sector/Battle Positions/Strongpoint.

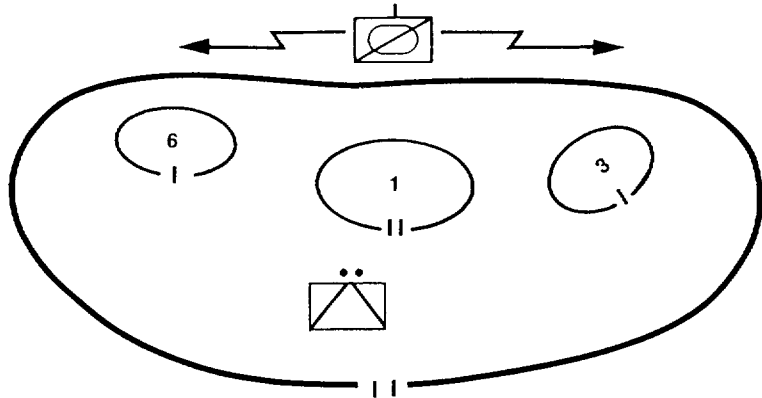

Figure 4-13. Battalion Battle Position.

TOWs and Dragons and sufficient engineer support organize strongpoint positions. (See fig. 4-14.)

f. Reserve Operations. A battalion may operate as a reserve force for a regiment. The reserve possesses mobility and firepower necessary to

engage enemy armor. The reserve may be assigned one of the following missions:

- Counterattack.
- Spoiling attack.
- Reinforce.
- Rear operations.

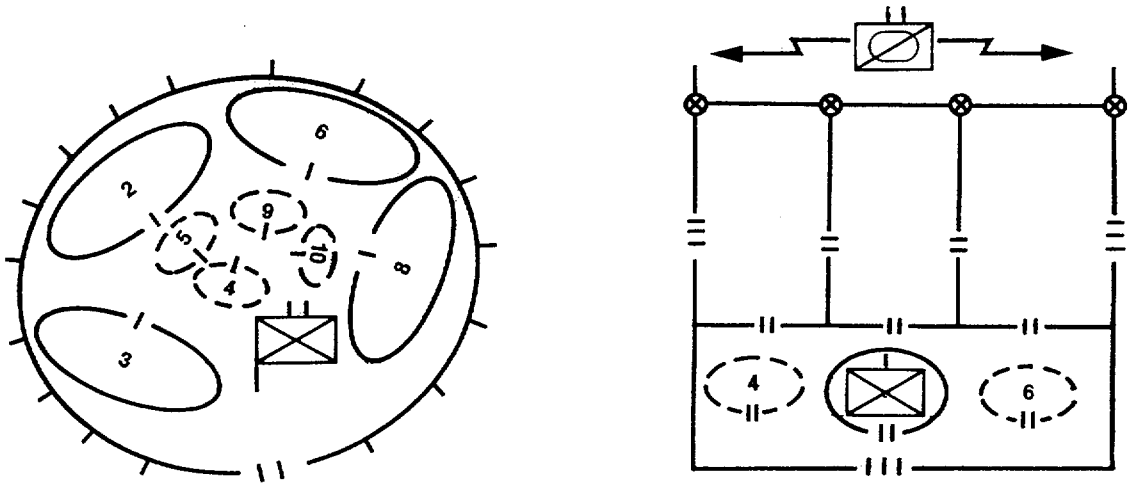

Figure 4-14. Battalion Strongpoint.

4205. Company

The company may function in the security area, MBA, or rear area. Normally, it fights as part of a larger organization.

a. Main Battle Area. The company should only be assigned a defensive sector when there is a single enemy avenue of approach along a corridor and little ability for the enemy to move laterally cross compartment. Normally the company is assigned a battle position which covers one or more EAs. This enables the task force commander to mass the fires of several company teams or other maneuver units on a single or series of EAs. It also allows the task force commander to maneuver a company to other battle positions.

b. Company Reserve. A company defending in sector may establish a reserve while a company defending from a battle position normally does not. The reserve may be positioned in the MBA area or rear area. It may be assigned a battle position blocking the most likely location for an enemy penetration. Ideally this position cannot be observed by enemy forces and provides covered, concealed, high speed routes to execute planned counterattack and reinforcement missions.

c. Team Battle Positions. The company commander may assign battle positions to his subordinate platoons. Considerations for assignment of subordinate platoons are shown below.

(1) **Dismounted Infantry.** Dismounted infantry are assigned a battle position which protects tanks, AAVs, and themselves from dismounted assault. The position normally is not collocated with tanks. The position should be well prepared with overhead protection when possible. The position may be part of a strong point. Small clusters of buildings may provide much of the advantage of a strong point and should

be considered as an infantry platoon position if it supports other elements of the team.

(2) **AAVs.** AAVs attached to the platoon may be collocated with the infantry or established on a nearby battle position under control of the AAV unit commander. Their weapon stations support the infantry unit.

(3) **Tank Platoons.** Tank platoons are positioned to cover EAs with both close and long-range fires. Tanks also mutually support dismounted infantry.

(4) **TOW/Dragons.** ATGMs attached or collocated with a company team should position themselves with infantry nearby for protection against dismounted assault. ATGMs may be positioned to fire short or long range, depending on the method of engagement.

d. Reserve Operations. A mechanized company may be designated a reserve for a regimental- or battalion-sized force. This reserve may be assigned missions similar to a battalion in the reserve.

e. Rear Area. A company will normally be assigned a sector as part of a battalion operation in the rear area.

4206. Maneuvering and Battle Positions

The battalion commander takes advantage of the mobility and long-range fires of his unit by shifting fires of a given unit to a different EA or by maneuvering his force to alternate or supplementary battle positions. The enemy can be expected to mass direct fires on a battle position once it is identified, in addition to suppressing it with considerable indirect fire or obscuring it with smoke. The enemy can be expected to continue to maneuver once engaged.

Second echelon forces may attack from a different direction. If the battalion possesses sufficient mobility, the commander should prepare for all of these contingencies by preparing alternate and supplementary battle positions for company teams and TOW sections. Movement to alternate and supplementary company team and TOW unit battle positions are normally controlled by the battalion commander in accordance with his scheme of maneuver. Care should be taken not to maneuver several units simultaneously, reducing the direct fire pressure on the enemy in an EA.

a. Types of Positions

(1) Alternate Positions for Companies. Alternate positions are normally at least 500 meters from the original position and still cover the same EA. This is the likely minimal distance where the effects of enemy indirect fires can be overcome. Several alternate positions may be planned for each company team. Movement to alternate positions will also disorient attacking enemy forces and help confuse enemy commanders of noncommitted units as to the strength and location of friendly forces.

(2) Supplementary Positions for Companies. Supplementary positions for companies cover different EAs. The supplementary position need not be any specific distance unless the force is under direct attack or suppressive fire.

(3) Alternate and Supplementary Positions Within Company Battle Positions. Alternate and supplementary positions may be planned for platoons. They serve the same functions as stated above. However, the battle position is rarely large enough to allow movements of extended distance.

b. Levels of Preparation. Battalion and company commanders will normally assign a level of preparation for battle positions. The subordinate tactical commander may raise the level of preparation but may not lower it. There are three

levels of preparation: *occupy*, *prepare*, and *reconnoiter*.

(1) Occupy. A unit occupies the position it will initially defend. This position is fully prepared and reconnoitered before the defense is initiated. The unit will have this position completed and occupied and will be ready to fight not later than the time specified in the mission statement.

(2) Prepare. The unit will take all actions necessary to prepare the position for the unit's mission. The troops must generally accomplish the following tasks:

- Physically sight each weapon in its fighting positions (primary, supplementary, and alternate).
- Establish fire control measures to include fire plan sketches, position stakes, and possibly TRP markers for tanks and ATGMs.
- Camouflage fighting positions.
- Clear fields of fire.
- Construct fighting positions to improve available cover and concealment.
- Recon and prepare routes between weapon positions.
- Coordinate with higher, adjacent, and supporting units. Coordinate the locations of companies and platoons, boundaries, and fire control measures.
- Conduct rehearsals.

(3) Reconnoiter. A unit instructed to reconnoiter a position will send one or more representatives to conduct a physical reconnaissance of that position. The recon party should determine the following:

- What fighting positions are available in and around the battle position.
- What covered and concealed routes are available to enter and leave the fighting positions from the rear and to allow maneuver between

primary, alternate, and supplementary positions.

- What fields of fire are available to each fighting position.

c. Execution Matrix. Various matrixes can be developed for the offense and the defense. CSS, artillery, and communication matrixes are just a few of the examples. This discussion will focus on an execution matrix for the defense. (See figs. 4-15 and 4-16.) An execution matrix is a simple tool that helps commanders and subordinates in three ways:

- The matrix helps the commander keep track of the plan and visualize various phases of the plan during the planning stage.
- The matrix makes it easier to brief the plan and aids subordinates in understanding the plan.
- The matrix aids in the conduct of the operation. As enemy action forces require adjustment to plans, a matrix is a useful tool to keep track of the situation.

The matrix essentially contains the bulk of the significant information contained in paragraph 3 of the operation order. In a clear and concise manner, it outlines exactly where units are, where

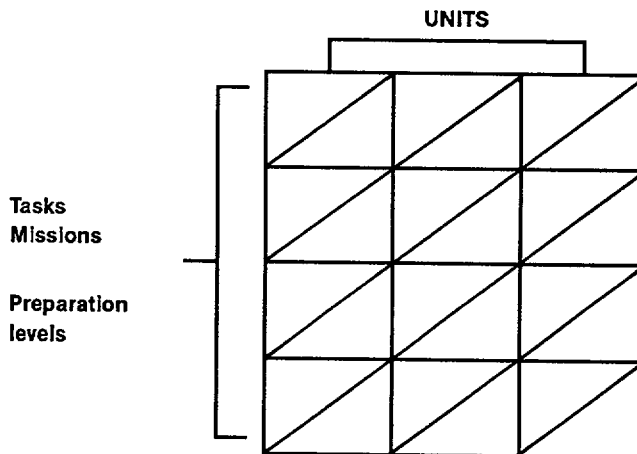
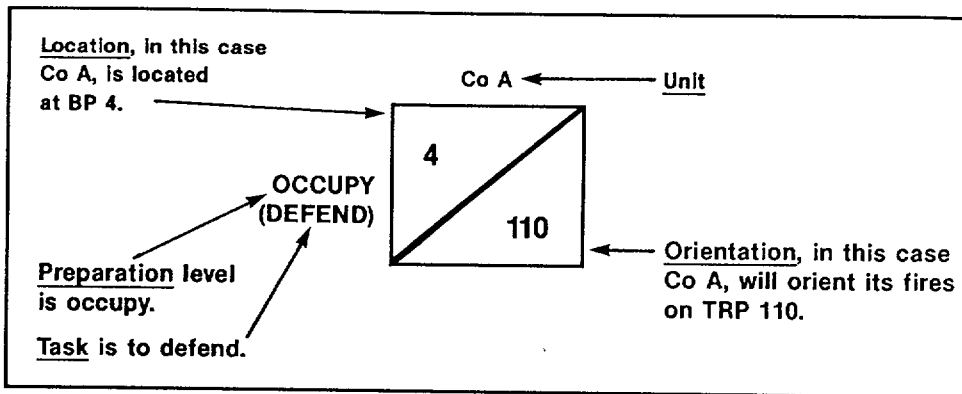

Figure 4-15. Execution Matrix.

	Co A	Co B	Co C	TANK Co	MORTARS
OCCUPY (DEFEND) (DELAY)	11 114	STRONG POINT 12 NH EA JIM	13 EA JOE	17 (DELAY) 118-119	FIRING POSITION 1 (FP1) 105-108 PRIORITY TO TANK Co
PREPARE (DELAY)				18 EA JACK	FP1 EA JACK PRIORITY TO TANK Co
PREPARE (DEFEND)	14 NH EA JIM		15 NH EA JIM	19 RESERVE	FP2 EA JIM PRIORITY TO B Co
RECON (DEFEND)	16 112				
COUNTER-ATTACK	11 114		13 EA JOE	ROUTE BLUE TO BP 18 EA JACK	FP1 EA JACK PRIORITY TO TANK Co

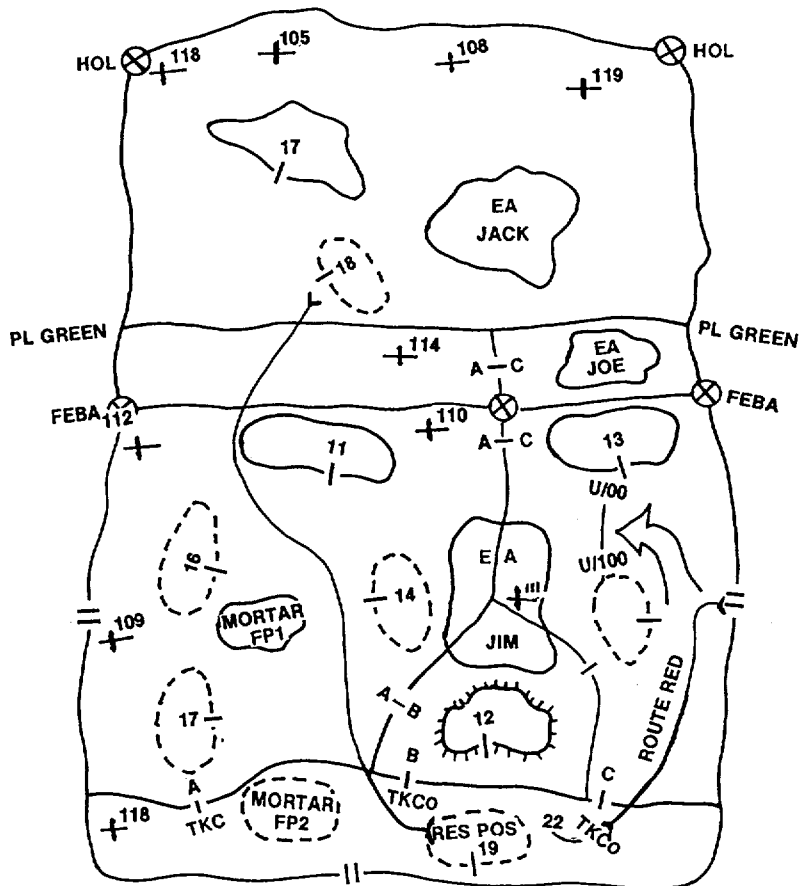

Figure 4-16. Completed Execution Matrix/Overlay.

the units are expected to go if necessary, and what they are to do after arriving there. Each commander can recopy the matrix on his own map and update as necessary. The matrix graphically portrays the commander's intent.

d. Contents of the Matrix. There is no set formula for the size and shape of the matrix or for exactly what information goes into the matrix. Some general guidelines are provided as follows:

- Tasks/missions and preparation levels for positions are normally placed on the left side of the matrix.
- Maneuver units and supporting units are placed at the top of the matrix.
- The number of boxes is dependent upon the number of units and the number of tasks included in the plan.
- The individual boxes are divided diagonally. The top left half of the box denotes the battle position or location of the unit, and the bottom right half denotes where the unit is to orient their fires.

4207. Reverse Slope Defense

A reverse slope is any slope which descends away from the enemy. (Joint Pub 1-02) (See fig. 4-17.)

A reverse slope defense is a variation of the position defense. A reverse slope defense is organized so that the main defensive positions are masked from enemy observation and direct fire by a topographical crest. A reverse slope aids the defender in bringing massed surprise fires to bear against an attacking enemy. While the crest is not occupied in strength, control of the crest by fire and employment of obstacles is the key to the success of a reverse slope defense.

The reverse slope defense can be especially effective against mechanized forces. (See fig. 4-18.) The intent is to isolate the enemy's lead units from follow-on forces. It establishes an EA into which the enemy moves directly after reaching the crest of a hill or ridgeline. The result is surprise, isolation, and defeat of a manageable portion of the attacker's force. Restated, the topographical crest marks the farthest limit of the EA.

A battalion rarely conducts a reverse slope defense along its entire front; however, there may be situations where subordinate units and weapon systems may be employed on the reverse slope.

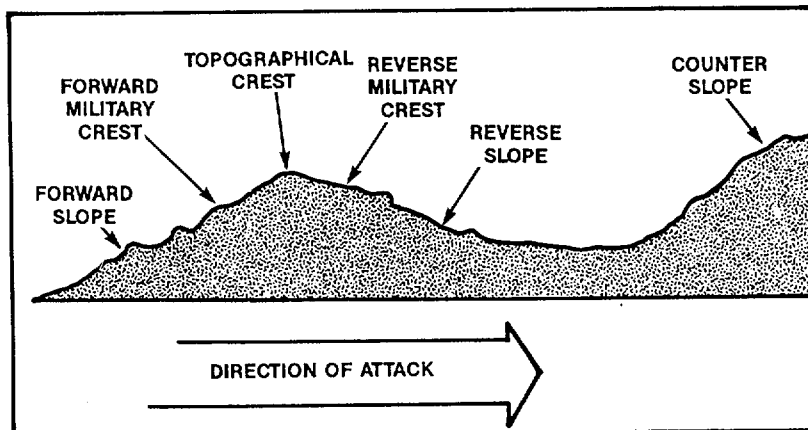

Figure 4-17. Military Topography.

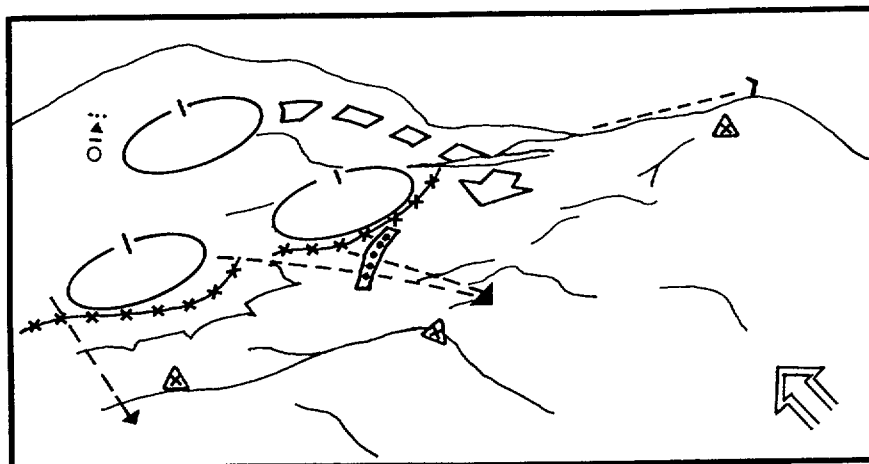

Figure 4-18. Reverse Slope Defense.

a. Tactical Considerations. The commander may choose to conduct a reverse slope defense—

- When the forward slope is untenable due to the density or accuracy of enemy fires.
- When the crest and forward slope offer little cover or concealment.
- When the forward slope has been lost or not yet seized.
- When units on the flanks can adequately cover the forward slope.
- When terrain on the reverse slope offers better fields of fire than terrain on the forward slope.
- To avoid an unfavorable salient or reentrant in the forward friendly disposition.
- To vary his tactical pattern, in order to deceive or surprise.
- When forced to assume a hasty defense while in contact with or proximity to the enemy.

b. Advantages. A reverse slope defense has the following advantages:

- A crest forward of the main defensive positions limits enemy observation, reducing the effectiveness of indirect fires and aviation, and degrades his direct fire weapons.
- The defender may be able to bring massed surprise fires to bear on the enemy as he crests the high ground.
- Units on the reverse slope have more freedom of movement until the crest is lost.
- The defense may deceive the enemy as to the true location and organization of the main defensive positions, saving the main positions from artillery preparation fires.

c. Disadvantages. A reverse slope defense has the following disadvantages:

- Once the security elements withdraw, the enemy can advance largely unimpeded until he has crested the high ground in front of the main defensive positions.
- Once cresting the high ground, the enemy has the advantage of attacking downhill.
- Difficulty in maintaining observation of the enemy.

- Obstacles in the forward slope may not be effectively covered by fire.
- The effective range of direct-fire weapons may be limited. Normally, the HAW-MAW-LAW technique cannot be utilized and stand-off range of HAWs and MAWs are sacrificed.

d. Weapons Positions. Figure 4-19 depicts a likely array of weapons' positions.

Fire support planning should place special emphasis on denying the enemy occupation and use of the topographical crest. While the main defensive positions are located on the reverse slope, the commander should establish security detachments on the forward slope. The plan for the counterattack should include clearing or regaining the crest from the enemy. Once successful, a reverse slope defense may have limited value a second time because the element of surprise is lost.

4208. Perimeter Defense

A perimeter defense is a defense without an exposed flank, consisting of forces deployed along the perimeter of the defended area. (Joint Pub 1-02) It is a position defense in which the defending unit is disposed to meet attacks from all directions

simultaneously. The term perimeter defense is usually applied to battalions and smaller units. (See fig. 4-20.) The general form of a perimeter is also used when the battalion task force or company team must prepare and defend from a strongpoint.

a. Tactical Considerations. The commander may establish a perimeter defense when—

- Operating independently.
- Isolated from friendly units by enemy action.
- Required to hold or protect an area such as a bridge or airfield.

b. Organization. A perimeter defense employs the bulk of combat power on the perimeter while maintaining an adequate reserve. However, a perimeter defense inherently lacks depth and restricts a defending mechanized unit from maneuvering and maximizing its firepower and mobility. This makes a perimeter defense especially vulnerable to an armor attack. The tactical commander minimizes these vulnerabilities by—

- Placing security as far out as possible.
- Orienting antiarmor weapons on EAs.
- Constituting a mechanized reserve.

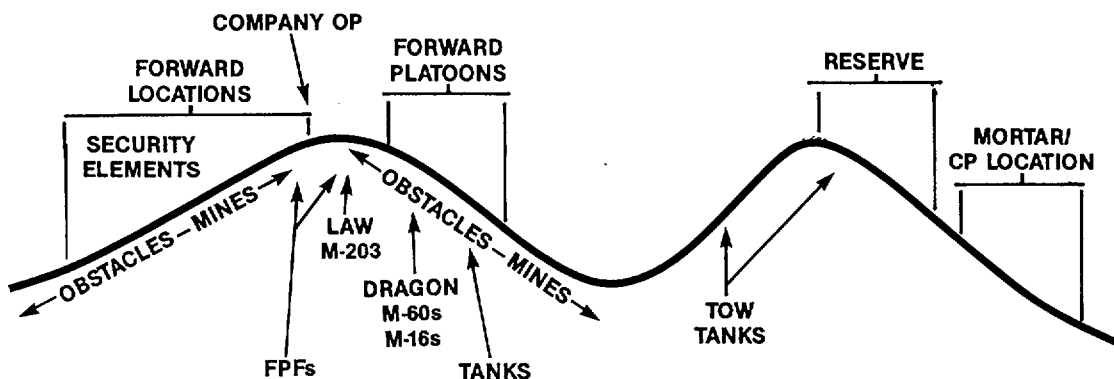

Figure 4-19. Weapons Positions.

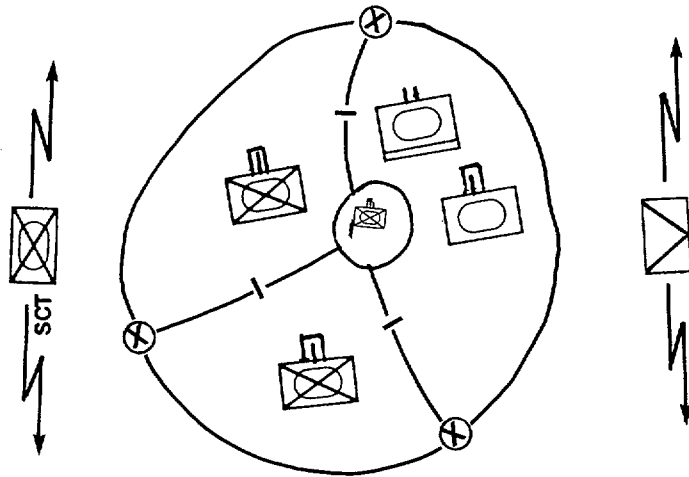

Figure 4-20. Perimeter Defense.

A battalion normally establishes a perimeter 2- to 4-kilometers in diameter. The perimeter is divided into company sectors with boundaries and coordinating points. Security elements and patrols (mounted and dismounted) are employed outside of the perimeter. The reserve defends a portion of the second line of defense behind the perimeter elements and counterattacks against an enemy penetration to restore the FEBA. Organic or attached CS and CSS elements are

normally placed in the center of the perimeter for protection.

4209. Urban Terrain and Antiarmor Operations

Central to any urban pattern is the hub or built-up area. Although it may vary in size from village to major urban complex, the effects of a hub remain constant. (See fig. 4-21.) Urban areas give the defender

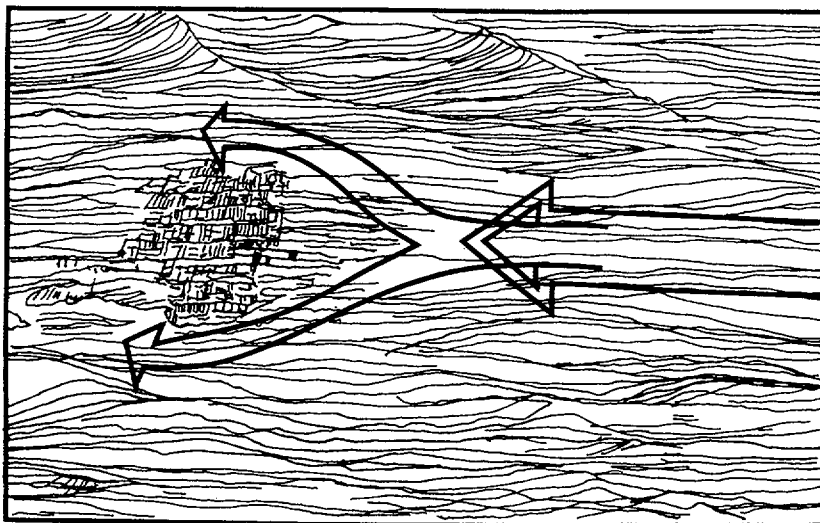

Figure 4-21. HUB Phenomenon.

a great advantage, similar to that of a strong point. An attacking mechanized force will normally try to bypass an urban area because fighting within an urban area is primarily a dismounted infantry battle. Threat mechanized units normally lack sufficient troop density and their artillery, and armored firepower and mobility are seriously degraded. Urban operations are slow moving, requiring high expenditures of ammunition, and create high casualty rates. It consists of decentralized actions with inherent difficulties in command, control, and communications.

For the MAGTF, the hub may serve as the pivot or anchor for its defense or as an element of a defense in depth. As shown, the hub is an obstacle which blocks the attacker's advance. Where adjacent natural terrain permits, a hub will normally be bypassed. This requires a change in direction of

advance and may reduce offensive momentum and cohesion. As the attacker slides off the leading edge of the hub and begins his bypass operation, his vulnerability to flank attacks and ambushes along the new axis of advance increases.

a. Organization of the Defense. Commanders at each level must decide how best to integrate manmade features into their overall scheme. If the retention of a built-up area is required, the defense may assume the characteristics of a position defense organized in depth and supported by strong mobile forces.

A division would normally employ its mechanized forces outside of the built-up area in reserve or counterattack roles against the enemy's flank. (See fig. 4-22.)

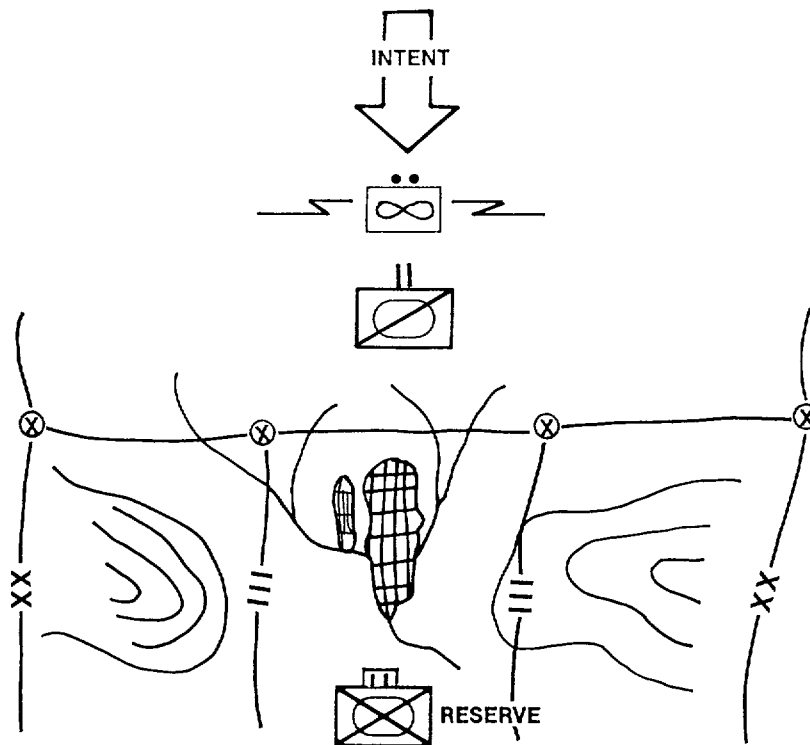

Figure 4-22. Mechanized Force in Built-Up Area.

The security area is established well forward of the built-up area. The MBA may contain the built-up area if it is critical to the defense of the urban area. When this situation occurs, it is important to initiate the defense of the urban area as far forward as possible to facilitate the defense of the built-up area and to avoid protracted fighting in the cities. Accordingly, EAs are established forward, to the flanks, and within (if possible). The division will normally assign the regiments sectors and may designate certain strongpoints. The regiments and battalions may assign subordinate units either sectors, strongpoints, or battle positions or a combination of the three. The functions and organization of the rear area are not significantly changed in an urban environment.

The principles discussed for a division and regiment also apply to a mechanized battalion. The battalion may assign its companies sectors, strongpoints, or battle positions or a combination of the three. Figure 4-23 demonstrates a battalion-sized unit integrating the built-up area into its defense. Note, an EA is positioned forward and a smaller EA is established

on the flank to take advantage of the *hub phenomenon*.

Figure 4-24 illustrates a battalion task force in the defense with company sectors and platoon battle positions.

See FMFM 7-15, *Military Operations in Urban Terrain (MOUT)* for further discussion of the defense within the built-up area.

b. Employment of Tanks. Tanks are best employed defending outside the urban area. When they are used within the built-up area, they are normally employed by section to support strongpoints. When possible, positions should be selected that provide use of their long-range fire. Additional concealment and protection from enemy anti-armor weapons should be sought by selecting positions behind walls or by driving inside structurally sound buildings. Tanks should always be employed with infantry for close in protection when fighting in a built-up area.

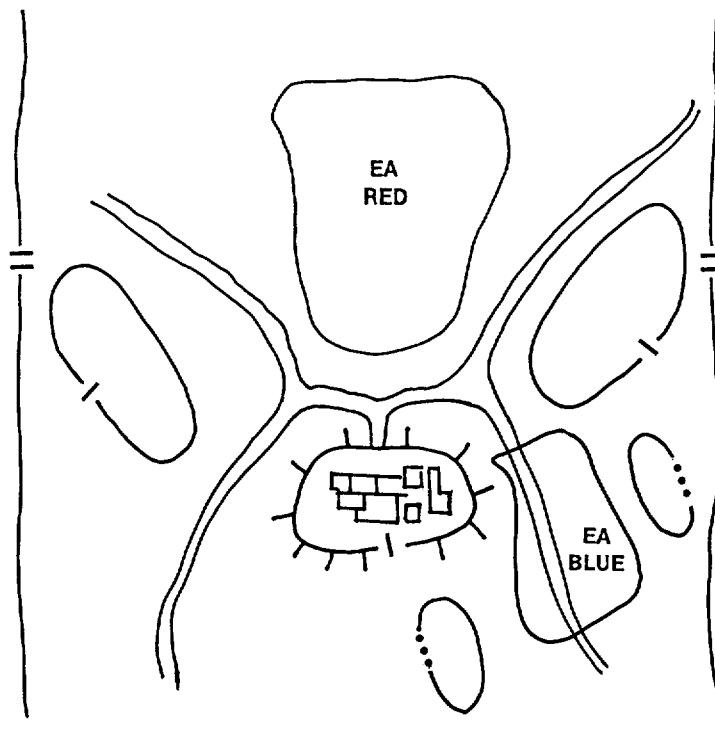

Figure 4-23. Battalion Defense.

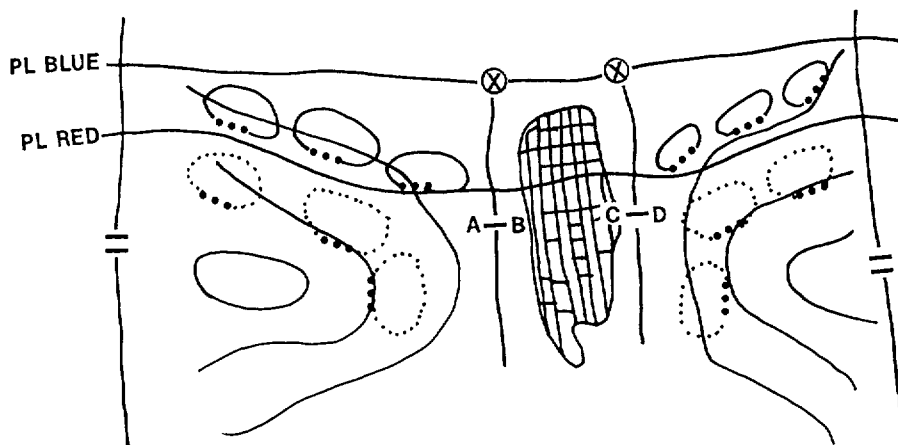

Figure 4-24. Battle Position.

c. Employment of AAVs. AAVs used in the defense of an urban area are normally employed by section. They may conduct all of the functions shown in the offense. When they are used for fire support, positions should be selected which provide long-range fires. Like tanks, they should utilize buildings and walls for increased protection against antiarmor fires.

d. Employment of TOWs and Dragons. TOWs and Dragons have more utility in the defense than they do in the offense. There is more time to select and prepare positions to overcome obstacles which may interfere with the flight of the missile. Their fires should be restricted to armored targets. Positions should be selected which provide longer range fire. Both TOWs and Dragons can be fired from enclosed areas providing it is a sturdy, ventilated structure and has a ceiling height of at least 7 feet and floor size of at least 6 by 10 meters for TOWs and 4.5 by 5 meters for Dragons.

4210. Combat Service Support

Logistics support must be coordinated during the planning and execution phases of each defensive operation. The combat and field trains are located as far to the rear as possible but close enough to be responsive to maneuver units. All CSS activities must look beyond the defense to support opportunities for

maneuver units during the transition to the offense. At each tactical level, the commander and the operations officer must coordinate with the G-4 (S-4) to ensure a given operation is supportable.

4211. Defense Control Measures

There are three types of control measures that are utilized in the defense—indirect fire, direct fire, and maneuver.

a. Indirect Fire Control Measures. See FMFM 6-18, *Techniques and Procedures for Fire Support Coordination*, for review.

- Coordinated fire line.
- Fire support coordination line (FSCL).
- Restrictive fire line.
- Boundaries.
- Airspace coordination area.
- Free fire area.
- No fire area.
- Restrictive fire area.
- Target reference point.

b. Direct Fire Control Measures. See chapter 3 for review.

- Engagement area.
- HAW-MAW-LAW and massed fire methods of engagement.
- Target reference point.
- Fire commands.
- Fire patterns.
- Sector of fire.
- Trigger point.
- Maximum engagement line.
- Priority of engagement.

c. Maneuver Control Measures. FM 101-5-1, *Operational Terms and Symbols*, provides detailed discussion on these control measures.

- Handover line.
- Forward line of own troops.

- Battle position.
- Strongpoints.
- Delay position.
- Blocking position.
- Disengagement criteria.
- Sectors.
- Coordinating points.
- Phase lines.
- Contact points.
- Checkpoints.
- Passage points.
- Passage lanes.
- Routes.
- Main supply routes.
- Assembly area.

Section III. Delay Against Mechanized Forces

A delaying operation is an operation in which a force under pressure trades space for time by slowing down the enemy's momentum and inflicting maximum damage on the enemy without, in principle, becoming decisively engaged. (Joint Pub 1-02) A unit is decisively engaged when it is no longer able to influence the action by fire and maneuver. The delaying force must have mobility roughly equal to the enemy force.

Delaying operations are conducted—

- When a force's strength is insufficient to defend or attack.
- To attrit the enemy.
- To draw the enemy into an unfavorable situation like a mobile defense.
- When the enemy intent is not clear and the commander desires time and intelligence.
- By the security element to protect and to provide early warning for the main force.
- By the security force to deceive the enemy as to the location of the MBA.
- To allow time to reestablish the defense or to prepare for offensive action.

4301. Fundamentals of the Delay

The fundamentals of the delay are essentially the same as those for the defense. A delay differs in that decisive engagement is avoided if at all possible. Special consideration is given to the following fundamentals:

a. Centralized Control and Decentralized Execution. Each commander must have freedom of maneuver against the enemy while the rearward movement of units must be coordinated by a higher headquarters to prevent gaps through which the enemy can bypass or envelope friendly units.

b. Maximum Use of Terrain and Obstacles. Terrain that provides long-range fires and covered withdrawal routes are utilized for delay positions. Engagement areas are selected that make maximum use of natural obstacles. Other obstacles are emplaced to canalize and delay the enemy and positioned to support the disengagement.

c. Force the Enemy to Deploy and Maneuver. Repeatedly forcing the enemy to deploy into assault formations and to maneuver will delay his advance.

d. Maintain Contact With the Enemy. This prevents the enemy from advancing unimpeded and keeps the friendly unit commander aware of their location.

e. Avoid Decisive Engagement. Units decisively engaged lose their freedom of maneuver and cannot continue to delay.

4302. Techniques for Delaying

A delaying force will normally be assigned sectors in which to delay and the initial delay positions. Additionally, phase lines may be imposed by the higher tactical headquarters to control the timing of

the delay. This process could begin at MEF or division level and be repeated at the regimental and battalion levels.

a. Delay Missions. There are two basic types of delay missions that may be assigned to a regiment or battalion.

(1) Delay in Sector. This is the least restrictive mission. There is usually no requirement to hold key or decisive terrain.

(2) Delay in Sector (Forward of a Specified Line for a Specified Time). This is a high-risk mission that requires preventing enemy forces from reaching a specified area earlier than the specified time or event, regardless of the cost. The task force commander normally limits the maneuver from delay position to delay position, or restricts crossing a particular phase line based on a specific time or event.

b. Methods of Delay. Units conducting a delaying operation can delay from successive positions

or from alternate positions or a combination of both. The technique selected will be dependent on the width of the assigned sector, the nature of the terrain, and the forces available.

(1) Delay From Successive Positions. This is a technique for delaying in which all the delaying unit's main battle forces are positioned forward in a single echelon. (See fig. 4-25.) Units delay continuously on and between battle positions throughout their sectors, fighting rearward from one position to the next, holding each as long as possible or for a specified time. The force may retain a small reserve.

(2) Delay From Alternate Positions. This is a technique in which a unit delays in sector with two subunits deployed in depth. (See fig. 4-26.) While the first subunit is fighting, the second occupies the next succeeding position to the rear and prepares to assume the fight.

The first subunit delays back to the second position, disengages and passes through or around the second subunit. It then prepares to resume the action from a third position further to the rear, while the second subunit takes up the fight.

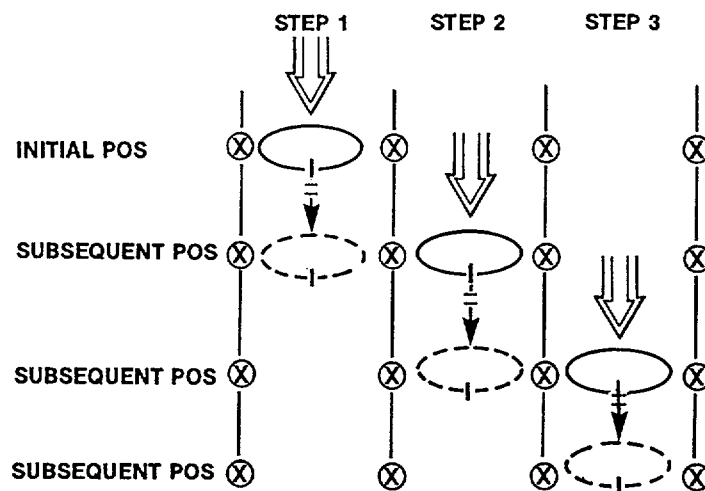

Figure 4-25. Delay From Successive Positions.

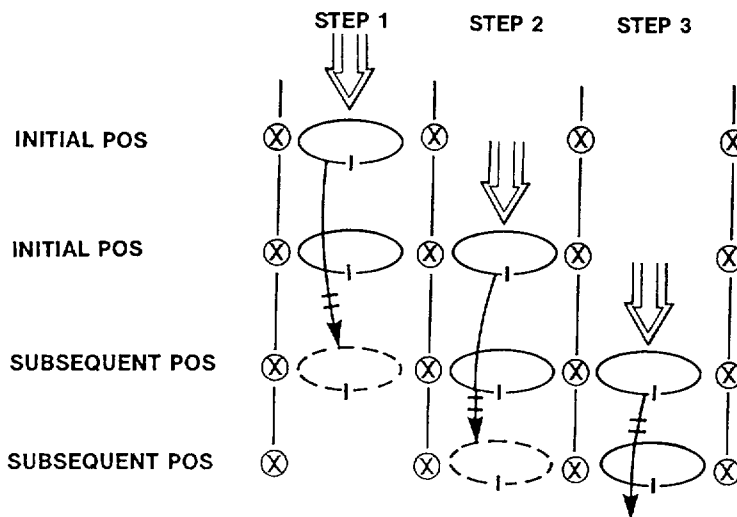

Figure 4-26. Delay From Alternate Position.

4303. Employment of Delaying Forces

LAI and mechanized forces are ideally suited for delay operations because of their long-range weapons and mobility. Helicopterborne and truck-mounted forces may conduct a delay in restrictive terrain that prohibits the enemy force from enveloping the delaying force. For example, mountainous terrain with restricted avenues of approach.

A mechanized regiment or the LAI Bn properly reinforced could conduct a delay as a covering force within the division security area or as an independent unit or as part of a larger force within the MBA. A mechanized battalion could conduct a delay as an independent unit or as part of a larger force.

Most operations within the security area involve those principles normally associated with the delay. Indeed, the actions of companies and platoons moving within the MBA to other battle positions are often indistinguishable from classic delay maneuvers.

Chapter 2 describes enemy offensive doctrine. Following the enemy's reconnaissance, he will lead with an advance guard battalion, which is led by an advance guard consisting of a combat recon patrol and a forward security element, both organized around tank units. When these units are engaged, the main body of either the advance guard or a regiment will attempt to envelope friendly forces. If their

bypass is successful, their second echelon forces will attempt to destroy the bypassed units. Conversely, the enemy could fix with his lead echelon and bypass with the second. Either way, delaying commanders at every level must optimize the capabilities of their forces to avoid decisive engagement or encirclement by the enemy.

a. Reconnaissance Units. Reconnaissance units may be employed as stay behind forces to observe the enemy and engage concentrations of enemy forces with supporting arms. When positioned along avenues of approach, consideration should be given to planning FASCAM targets which may delay second echelon enemy forces at critical times. Reconnaissance units may also be withdrawn from forward positions and placed along the flanks to provide early warning of enemy forces attempting to envelope or flank friendly delay positions. Again, reconnaissance elements can control supporting arms at critical times to disrupt the enemy.

b. LAI Units. LAI units are normally initially employed as part of the security force. Subsequently, they may be employed as stay behind forces to attack specific enemy combat support or service support units in order to disrupt his attack. LAI units may also be employed for flank security

or as a reserve. LAI units also possess the speed and mobility to conduct raids deep into the enemy's rear areas.

c. Mechanized Infantry. Mech-pure units and mechanized platoons normally do not engage enemy armored forces from a delay position where decisive engagement is not desired. Their weapons do not have sufficient range to avoid decisive engagement. Their primary mission at delay positions is to provide local security. Mechanized infantry normally displaces prior to engagement by other forces. Retention of infantry on the position after the engagement begins may result in unnecessary casualties. The infantry should displace to the final delay positions where they prepare positions in the event decisive engagement is required. Exception to the above general guidelines apply where the infantry possess ATGMs.

d. TOWs. TOW units may be employed in sections with mechanized infantry units providing local security. TOWs are employed by unit to mass their fires. These TOW units occupy delay positions and engage enemy at long range before losing their standoff advantage. The standoff advantage ends at approximately 2,000 meters, the range at which enemy tanks firing HE rounds can achieve effective fire against the TOWs. Remember, TOW squads and sections represent a highly mobile economy of force asset that may be employed anywhere from the security area to the rear area.

e. Tanks. During a delay, tanks are employed as the primary weapon to engage enemy tanks which lead the enemy advance guard and main body forces. Their high rate of fire, armor protection against enemy artillery and mobility, make tanks best suited for this mission. Tanks may also be retained in a reserve to extricate forces which have been decisively engaged or to conduct counterattacks.

f. Engineers. Engineers are normally employed in general or direct support of the delaying force with a priority of tasks assigned. Available

mechanized infantry units may be utilized to assist the engineers. There are two primary tasks which the engineers will be required to accomplish: counter-mobility and mobility. Both tasks may be critical in a delay operation. Obstacles are positioned to canalize the enemy into EAs and to delay the enemy during disengagement from a delay position. Equal consideration should be given to preparing or improving withdrawal routes for the delay forces.

4304. Employment of the Reserve

The establishment and employment of a reserve is highly desirable. Normally, a reserve is not maintained at the company level. The composition of reserve forces and the tasks they may be required to accomplish are shown below:

- *Contain penetrations.* Infantry units prepared to accept decisive engagement, TOW units, and tank units can accomplish this task.
- *Counterattack.* Counterattack to reduce penetrations, take advantage of an exposed enemy flank, or to extricate a decisively engaged enemy unit. Tank units are best suited for this mission.
- *Conduct a spoiling attack.* A reserve force may conduct an attack disrupting the enemy's tempo and cohesion, forcing the early deployment of following forces and supporting arms.

4305. Planning and Conducting a Delay Operation

a. Time Factors. Planning a delay operation against a mechanized force differs from other forces in that greater consideration must be given to time-distance factors and the enemy's ability to use restrictive terrain. When encountering a delay position, the enemy may attempt to fix the delaying force with his lead element and bypass or to envelop the delaying force with his second echelon utilizing wooded areas or other types of

restricted terrain. The mechanized commander must anticipate this tactic and analyze the time and distance required by the enemy to execute such a plan. A similar time-distance analysis is required of the delaying force's ability to disengage and move to a new delay position. These analyses will enable the commander to hold a position as long as possible without becoming decisively engaged or cut off.

b. Disengagement. Disengagement is the act of physically breaking contact with the enemy. A unit has disengaged when the enemy can neither observe or engage the unit with direct fire. Basic considerations for disengaging are shown below:

- Battle positions should be sited to facilitate disengagement.
- Disengagement should be conducted quickly to conceal the intention from the enemy and to effect a clean break before the enemy can react.
- Disengagement is conducted before decisive engagement. Detailed study and use of terrain is required.
- The sequence subordinate units will withdraw is planned in detail.
- When possible, units disengage by echelon.
- Disengagements may include rearward passages of lines.
- Heavy volumes of direct and indirect fires are used to assist the disengagement.
- Withdrawal routes (primary and alternate) to the next position should be clearly marked and unobstructed.

Disengagement criteria may be established for units and individual type of weapons. *Disengagement break lines* are locally imposed locations forward of the battle position that key a unit or a type of weapon system to move based on the presence of certain numbers or types of enemy vehicles. For example, six tanks reaching a certain distance from a battle position may key a TOW section to move.

Normally, the order of weapon system disengagement will be defined in the company commander's operations order. TOWs normally initiate the engagement and leave first due to their vulnerability to indirect fire. Mechanized infantry is next followed lastly by tanks. In periods of reduced visibility, enemy infantry activity may increase requiring your armor to displace first.

Control measures used in the delay are as follows:

- Phase lines of all higher commands.
- Supplemental phase lines.
- Checkpoints.
- Delay positions (sometimes called battle positions).
- Sectors.
- EAs and TRPs.
- Contact points.
- Passage points.
- Assembly areas, MSR, and logistics release points.
- Coordinating points.
- Routes and lanes.
- Trigger points and disengagement break lines (company level).

c. Conduct. The delay is conducted as aggressively as possible by commanders at each level of command. The commander must centrally control the operation but allow decentralized execution by his subordinates. They should be allowed as much freedom of maneuver as possible. The following actions are taken to conduct a delay.

- (1) All but essential personnel and material are withdrawn early to facilitate movement during the operation.
- (2) Reconnaissance elements are forward to provide timely information on the enemy.

(3) The initial delaying positions will normally be the only positions that can be organized, prepared, and occupied deliberately. Subsequent positions will normally be hastily prepared and occupied.

(4) The HAW-MAW-LAW method of engagement is normally used against the approaching enemy.

(5) Each position is defended until it is threatened with decisive engagement.

(6) When maximum delay has been achieved, movement to the next position begins.

(7) If decisive engagement of a unit occurs, the commander may take all of the following actions:

- Allocate priority of all fire support to the threatened unit.

- Direct adjacent units to engage enemy targets forward of the threatened unit.
- Reinforce the unit.
- Conduct a counterattack to disengage.

(8) The reserve may be a designated unit or the least engaged unit. Reserve missions are—

- Reinforcing.
- Assisting in disengagement.
- Providing overwatch.
- Assuming another unit's mission.
- Counterattack.
- Blocking.
- Spoiling attack.

(9) The delay must end with a planned operation such as a defense, a withdrawal, or an attack.

Section IV. Fire Support and the Engagement Area

The battlefield is a continuum extending from the farthest range of the MAGTF's assets to the MAGTF's rear area. The MAGTF confronts approaching armored columns with a variety of lethal combinations or *packages* of weapons systems. The MAGTF commander views the EA as a focal point at which enemy armor units are attacked and destroyed or disrupted. While an EA is ideally arrayed to utilize direct and indirect fire weapons systems in concert, EAs well forward of the FEBA may involve only aircraft or aircraft and long-range indirect fire weapons. EAs may be quickly established to account for fleeting opportunities. For example, an EA may be hastily established 100 to 200 kilometers forward of the FEBA in response to an immediately identified enemy armored column with aircraft and LAI as the only MAGTF assets utilized.

This chapter will address aircraft and indirect fire weapons systems in an antiarmor defense. The focus remains on the engagement of enemy armored columns and support units, *not* piecemealed armor assets supporting dismounted infantry operations.

4401. Definition

Fire support is the assistance to elements of the MAGTF engaged with the enemy rendered by other firing units, including (but not limited to) artillery, mortars, naval surface fire support, and close air support. (FMFM 2-7) The mission of fire support is to delay, disrupt, or destroy enemy forces in support of the scheme of maneuver.

Fire support is selective and focused—it is always considered within the context of maneuver—either immediate or eventual maneuver. Conversely, maneuver is dependent on fire support. Maneuver and fire support are concurrent, not sequential pre-occupations of the commander.

4402. Offensive Air Support

Offensive air support (OAS) is air operations conducted against enemy installations, facilities, and personnel to directly assist the attainment of MAGTF objectives by destruction of enemy resources or the isolation of his military force. (FMFM 5-40) Offensive air support is one of the six functions of Marine aviation. Offensive air support is applicable to the offense or defense. OAS is used to *destroy or neutralize* the enemy.

a. Types of OAS. OAS may be subdivided by categorizing operations according to the degree of coordination required with the supported ground unit. These categories are close-in fire support, CAS, and DAS.

(f) Close-In Fire Support. Air action unique to attack helicopters against hostile targets which are normally in closer proximity to friendly forces. CIFS requires detailed integration with the fire and movement of friendly forces. (FMFM 5-40) Attack helicopter operations include but are not restricted to CIFS missions.

Although attack helicopters do not perform CAS, their inherent characteristics and ability to integrate closely with the ground commander allow them to work alone or in conjunction with CAS aircraft. The attack helicopter occupies a niche between ground weapon systems and CAS aircraft allowing the MAGTF to cover gaps in the capabilities of assigned forces. In many situations such as poor weather or intense jamming and during fast moving, fluid battles, the attack helicopter may be the only type of OAS available.

Attack helicopters may be used to attack specific targets at specific locations or they may be assigned missions similar to a maneuver element.

When given a mission of flank or forward security or as a reaction force, attack helicopters primary importance rests with its mobility, not its fire support capabilities. In this instance, commanders should avoid overly restricting attack helicopters in a formal fire support plan.

Attack helicopters may support a mechanized task force or LAI units that are conducting security operations forward or to the flanks of a defensive position. Attack helicopters are ideal for supporting spoiling or counterattacks. Attack helicopters may be used in a delay to engage the enemy once the ground element has disengaged.

Detailed information on CIFS can be found in FMFM 5-41, *Close Air Support and Close-In Fire Support*.

(2) Close Air Support. Air action against hostile targets which are in close proximity to friendly forces and which require detailed integration of each air mission with the fire and movement of those forces. (Joint Pub 1-02)

CAS missions are normally flown short of the FSCL. CAS is closely integrated with other supporting arms and the fire and movement of the MAGTF. To preserve this integration, the commander of the supported ground unit requests and/or approves *all* CAS missions in his area of responsibility.

CAS is restricted to those aircraft missions which actually deliver ordnance on enemy targets. Detailed information on CAS can be found in FMFM 5-41.

(3) Deep Air Support. Air action against enemy targets at such a distance from friendly forces that detailed integration of each mission with fire and movement of friendly forces is not required. DAS missions are/can be flown on either side of the FSCL; the lack of a requirement for close coordination with the fire and maneuver of friendly forces is the qualifying factor. (FMFRP 0-14)

DAS differs from CAS and CIFS because it does not require close integration with friendly forces. Air interdiction and armed reconnaissance are DAS tasks.

(a) Air Interdiction. Air operations conducted to destroy, neutralize, or delay the enemy's military potential before it can be brought to bear effectively against friendly forces, at such distance from friendly forces that detailed integration of each air mission with the fire and movement of friendly forces is not required. (Joint Pub 1-02)

(b) Armed Reconnaissance. A mission with the primary purpose of locating and attacking targets of opportunity; i.e., enemy materiel, personnel, and facilities, in assigned general areas along assigned ground communication routes, and not for the purpose of attacking specific briefed targets. (Joint Pub 1-02) Aircraft conducting armed reconnaissance ordinarily operate at low altitudes making them easy targets for modern air defense weapons. Accordingly, armed reconnaissance missions require a low threat environment.

b. Types of Missions. CIFS and CAS are executed as either preplanned air support or *immediate* air support, as determined by the degree of prearrangement. *Preplanned* air support is air support in accordance with a program, planned in advance of operations. (Joint Pub 1-02) *Immediate air* support is air support to meet specific requests which arise during the course of a battle and which by their nature cannot be planned in advance. (Joint Pub 1-02) Both preplanned and immediate air support are executed in response to specific requests. Detailed information on the types of missions can be found in FMFM 5-41.

Fixed-wing aircraft are most effective against armored columns not fully deployed for combat. When ground units are engaging enemy armor with direct fire weapons, fixed-wing aircraft are often diverted to attack second echelon or

reinforcing units. Planning should allow for shifting air assets from one EA to another in a rapid manner.

c. SEAD Fires. SEAD fires should precede air strikes. SEAD fires consist of delivering accurate fire on hostile air defense artillery weapons. The purpose of SEAD is to minimize the loss or damage to friendly aircraft during planned air strikes by neutralizing these weapons. SEAD fire is placed on the weapon location immediately before and during the time friendly aircraft are over their target.

d. LAI and Aviation. Attack helicopter and fixed-wing assets provide increased flexibility and firepower for a unit defending against enemy armor. At the tactical and operational levels, a combination of LAI and ACE assets provide the supported commander with a unit capable of exceptional speed, range, and lethality. The concept of a MAGTF security force composed of LAI and ACE assets is discussed in FMFM 6-30, *LAI Employment* (under development). This force, operating well forward of the GCE, allows the MAGTF commander to see and shape the battlefield. LAI and ACE assets can engage enemy armor at the farthest possible point from friendly positions.

The introduction of LAI/ACE assets capable of deep operations provides the MAGTF commander with one more transitional capability to influence the action, but poses additional coordination problems. To ensure unity of effort among the diverse units operating in the MAGTF's area of influence, the MAGTF commander should assign the primary responsibility for the coordination of operations in this area to a subordinate.

While activities in the MAGTF area of influence are the responsibility of the MAGTF commander, the assignment of a *deep battle coordinator* allows timely decisions to be made based on the MAGTF commander's intent. The ACE commander is well suited for this task. The ACE commander possesses the requisite means for integrating the activities of both air and ground elements for

exploiting opportunities in this area. Accordingly, it may be necessary for the MAGTF commander to assign LAI assets to the ACE commander. Likewise, the ACE as commander may find it beneficial to designate the LAI unit commander as a mission commander and subordinate aviation assets to him.

4403. Indirect Fire Support

Fire support assets and priority of fires are allocated based on the most dangerous enemy avenues of approach (EAs are established here). They are normally suballocated to units on those approaches and shifted as the battle develops. Priority of fires is initially given to the forward security elements (e.g., LAI or mechanized units) and then shifted to the units on the FEBA when the security elements pass through the HOL. The allocation of fire support may be constantly shifted based on the factors of METT-T. It is no longer SOP that each infantry regiment will have an artillery battalion in DS. For example, an infantry regiment designated the main effort may have two or more artillery battalions providing support.

a. Uses of Indirect Fire Support. Indirect fires should be integrated with direct fire weapons to ensure the maximum benefit of combined arms. Indirect fire support includes but is not limited to the following uses:

- Disrupts, slows, and disorganizes the enemy and forces him to button-up at long range.
- Is employed against enemy overwatch or base of fire elements.
- Provides illumination for target acquisition at night.
- Covers disengagement, movements, and counterattacks.
- Destroys dismounted infantry with close-in barrage fire.
- Provides smoke for obscuration.
- Provides smoke at the rear of an assaulting unit to provide contrast for easier target acquisition.

- Delivers FASCAM on enemy armor avenues of approach.
- Kills armor with DPICM (against light armor) and Copperhead (any armor).
- Delivers counterbattery fire.
- Provides SEAD.

b. Fire Support Means. A basic understanding of the employment of each indirect fire support weapons system is imperative for the proper use of combined arms.

(1) Artillery. Artillery is positioned to provide close, deep, and counterfire support in coordination with maneuver forces. The intent is to disrupt and weaken the enemy's offensive action and to provide windows of opportunity for friendly offensive action. Control of fire support assets is more centralized for defensive operations against an enemy armored force. Artillery and other indirect fire support means must be massed against armor to be effective.

(2) Naval Gunfire. NGF ships can deliver a large volume of high velocity projectiles within a short period. NGF can deliver suppression (there is no immediate suppression mission for NGF), neutralization, and destruction fires. NGF's direct accuracy, high muzzle velocity, and flat trajectory provide effective, penetrative, and destructive power on targets which present an appreciable vertical surface. Positions and identifiable terrain features should be used to support the hasty attack.

(3) Mortars. Mortars at the battalion and company level are normally deployed to support secondary avenues of approach. They provide responsive smoke to support the maneuver of company teams and platoons between battle positions. During night operations, mortars assume a greater role since there is a requirement for illumination and the threat of a dismounted infantry attack is greater.

4404. Fire Support Planning

The fire support plan defines the way artillery, mortars, NGF, attack helicopters, and fixed-wing attack aircraft will be used to complement the scheme of maneuver, and it provides instructions for executing those fires. It may include air defense assets. It ranks targets in priority order, matches them with the available fire support systems, eliminates duplication of targets, and allows fires to be executed quickly without specific direction from the commander once the battle starts.

A fire support plan is developed before any operation and continues throughout the operation based on enemy contact and continuous intelligence gathering efforts. There is continuous interaction between the commander, staff, and his fire support agencies. The plan is constantly refined as the operation continues.

a. Time-Distance Factors. Fire support planning against armor is similar to other operations EXCEPT the movement, tempo, and distances covered are greater than those encountered against enemy dismounted infantry. Additionally, the target effects for a given type munition is less on enemy armor than on dismounted troops. These differences must be considered at the outset of the planning process. Figure 4-27 provides some basic speed/time considerations for fire support planning.

This table provides the time required to travel 1 kilometer or 1 mile while using specified march speeds. The travel times are calculated based on rates of march (miles/kilometers in one hour) and include time for scheduled short halts and time lost due to road and traffic conditions.

b. Targeting Considerations. Targets and targeting are discussed in detail in FMFM 2-7. Multiple armor targets call for special considerations. When fires are desired on several targets, groups and series of targets may be established.

ARTILLERY—TIME OF IMPACT

30 sec
3 min

Priority Target
Target Location by Grid

TIME DISTANCE TABLE

Speed Kilometers/Miles per Hour	Rate of March Miles/Kilometers Per Hour	Minutes to Travel 1 Kilometer
10 mi/h 16 km/h	8 mi/h 12 km/h	5
15 mi/h 24 km/h	12 mi/h 20 km/h	3
20 mi/h 32 km/h	16 mi/h 25 km/h	2.4
25 mi/h 40 km/h	20 mi/h 32 km/h	1.84
30 mi/h 48 km/h	25 mi/h 40 km/h	1.5
35 mi/h 56 km/h	30 mi/h 46 km/h	1.3
40 mi/h 65 km/h	35 mi/h 53 km/h	1.13

Figure 4-27. Calculation Table.

(1) **Groups.** A group of targets consists of two or more targets on which simultaneous fires are desired. In the defense, a group of targets can be used to destroy enemy stopped at minefields or to destroy vehicles waiting to cross rivers or bridges. Individual targets in the group can be selected based on how the commander thinks the enemy would form at these activities. (See fig. 4-28.)

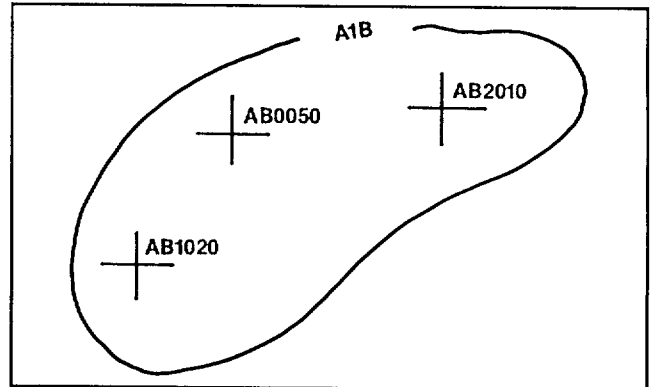

Figure 4-28. Target Group.

(2) **Series.** A series of targets is a number of targets or groups of targets planned to be fired in a predetermined sequence. In the defense, the series allows for fires which are tied to speed; but, in this case, it is the speed at which the enemy will attack. A series of linear targets may be planned to destroy the enemy attack echelons. Attack of linear targets 1,000 meters apart (3 minutes at 20 kilometers per hour) will keep fire continuously falling on the enemy. (See fig. 4-29.)

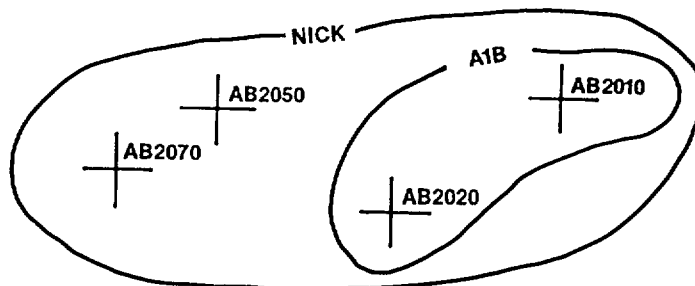

Figure 4-29. Target Series.

Section V. Engineering Operations and the Engagement Area

Engineers conduct a wide variety of tasks in support of the MAGTF. Tasks range from close CS to general engineering support. Essentially the same occupational specialties and equipment are resident in all FMF engineer units. Each unit's mission requires various skills, skill levels, and equipment items. The degree to which these skills and equipment are blended determines the capabilities possessed by individual engineer units. The primary differences between engineer units are the actual table of organization, table of equipment, and specific missions.

The four functional areas of engineer effort are mobility, countermobility, survivability, and general engineering. While all four functional areas may be applicable to antiarmor operations, survivability and countermobility are the primary engineering tasks associated with the EA. As the reader will observe, these tasks are often interrelated.

For an in-depth discussion of the following subjects, see FMFM 13, *MAGTF Engineer Operations*, FM 5-100, *Engineer Combat Operations*, and FM 5-102, *Countermobility*.

4501. Definitions

The following definitions will assist the reader in understanding the four functional areas.

Obstacle. Any natural or manmade obstruction that canalizes, delays, restricts, or diverts movement of a force. The effectiveness of an obstacle is enhanced considerably when covered by fire. Obstacles can include abatis, antitank ditches, blown bridges, built-up areas, minefields, rivers, road craters, terrain, and wire. (FMFRP 0-14) There are two categories of obstacles—existing and reinforcing.

a. Existing Obstacles. Existing obstacles are already present on the battlefield and not placed there through military effort. They may be natural such as lakes or mountains, or they can be cultural such as towns or railroad embankments. (FM 5-102)

b. Reinforcing Obstacles. Reinforcing obstacles are placed on the battlefield through military effort and are designed to strengthen the existing terrain to slow, stop, or canalize the enemy. They

include a road crater, a log crib, or a minefield. Scatterable mines are reinforcing obstacles emplaced by various delivery systems such as artillery or aircraft. (FM 5-102)

4502. Survivability

Survivability is the ability of personnel, equipment, and facilities to continue to operate within the wide range of conditions faced in a hostile environment. It includes all aspects of protecting personnel, weapons, and supplies. In order for the MAGTF to survive, it must be able to reduce exposure to threat acquisition, targeting, and engagement. Engineering operations play a key role in survivability in the areas of constructing fortifications, protective obstacles, strongpoints, and sustainment.

a. Fortifications. Engineers construct fighting positions for combat vehicles, direct fire weapons systems, artillery, and air defense. Fortifications provide protection and build confidence in Marines so that they will be able to use their weapons and fight effectively where they otherwise could not survive.

b. Protective Obstacles. Like final protective fires, protective obstacles provide the force with a combat *edge* during the enemy's final assault that may make the difference between success and failure. Protective obstacles also are used to impose a delay on an attacker. This action allows the defender time to break contact and displace to another battle position. Antipersonnel and anti-tank mines are used to limit the ability of the assaulting force to close with the defender. They are sited according to terrain and are covered by defending fires. These *hasty* minefields are installed adjacent to a battle position and are removed when the position is no longer occupied. These are the only obstacles that can be employed outside of designated obstacle zones and belts.

c. Strongpoints. Strongpoints are heavily fortified battle positions which cannot be overrun quickly or bypassed easily by enemy forces. They consist of an integrated series of exceptionally well protected fighting positions, connected by covered

routes, and reinforced with extensive protective obstacles. They are designed to withstand artillery fire strikes, plus mounted and dismounted assaults. The enemy can reduce them only by expending much time and overwhelming force.

In an antiarmor defense utilizing battle positions or sectors, engineer effort is first directed toward structuring the EA and only later to the preparation of unit positions. Establishing strongpoints requires extensive engineer effort preparing the position first and only then turning to the EA. As a rule of thumb, a minimally effective strongpoint requires one day of effort from an engineer organization the size of the defending force. For example, a company strongpoint requires assistance by an engineer company for one day to construct a minimally satisfactory position.

Figure 4-30 depicts two company-sized strongpoints overlooking a platoon battle position. Note that the minefield is a protective obstacle that slows the enemy's advance long enough to allow the friendly platoon to delay from its position.

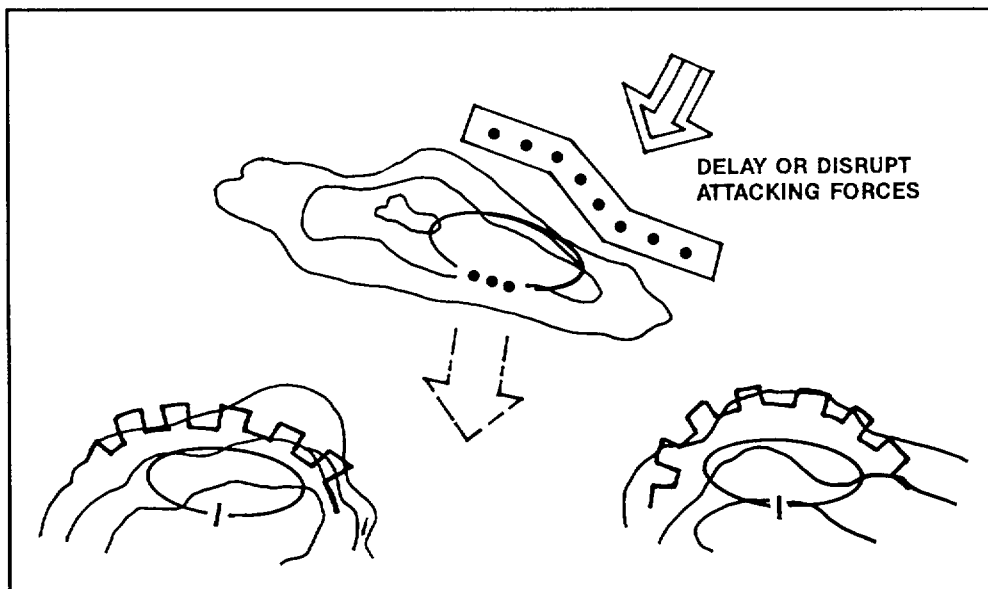

Figure 4-30. Strongpoints.

4503. Countermobility

Countermobility is the construction of obstacles and emplacement of minefields to delay, disrupt, and destroy the enemy by reinforcement of the terrain. The primary purpose of countermobility operations is to slow or divert the enemy, to increase time for target acquisition, and to increase weapon effectiveness. (FMFRP 0-14)

The intent of countermobility operations is to attack the enemy's ability to execute his plan by disrupting his combat formations, interfering with his command and control, and confusing his commanders to create a vulnerability that friendly forces can exploit. The secondary intent is to destroy or disable his vehicles. This is accomplished with an integrated system of obstacles and fires.

a. Obstacle Functions. Individual obstacles are designed to produce one of four primary obstacle functions—disrupt, turn, fix, or block. (FM 5-100)

(1) Disrupt. These obstacles disrupt march formations, break up operation timing, exhaust breaching assets, and cause separation between forward combat elements and wheeled supply vehicles. Obstacles also are used to disrupt assault formations, attacking the low-level command and control while the attacker is under direct fire.

(2) Turn. Turning obstacles move and manipulate the enemy to the force's advantage by enticing or forcing him to move in a desired direction, by splitting his formation, by canalizing him, or by exposing his flank.

(3) Fix. Fixing obstacles slow and hold the enemy in a specific area so that he can be killed with fires, or to generate the time necessary for the force to break contact and disengage.

(4) Block. Obstacles never, by themselves, serve to block an enemy force. Blocking obstacles are complex, employed in depth, and integrated with fires to prevent the enemy from

proceeding along a certain avenue of approach (or to proceed only at unacceptable cost). Blocking obstacles serve as a limit, beyond which the enemy will not be allowed to go.

b. Obstacle Planning and Control. Obstacles are an integral part of the maneuver commander's plan designed to cause specific effects on the attacking force in accordance with the commander's intent. Obstacles are planned and sited to support the tactical plan by physically manipulating the enemy in a way that is critical to the commander's concept. They are a means to shape the battlefield. Integrated obstacle plans ensure that every obstacle supports the entire operation from the MAGTF level down through the battalion.

Necessary control of the obstacle planning process is accomplished by graphically designating obstacle zones, obstacle belts, and obstacle restricted areas; designating critical directed obstacles; and reserving certain obstacles for execution only on order of a specific higher headquarters. Obstacle graphic control measures include obstacle zones, obstacle belts, obstacle restricted areas, and reserved obstacles. (FM 5-100)

(1) Obstacle Zones. Normally designated at the Division level to define where lower echelons are allowed to employ tactical obstacles. As tactical obstacles are only allowed within designated obstacle zones, division-level maneuver is unrestricted by friendly obstacles outside of the zones. A division plan may not provide obstacle zones to a regiment as the division commander intends to allow the regiment maximum flexibility. (See fig. 4-31.)

(2) Obstacle Belts. Obstacle belts are normally designated at the regimental level to further limit obstacle employment areas and focus the defense within the regiment. These belts consist of a system of obstacles designed to perform one of the four primary obstacle functions. This allows regimental maneuver within the obstacle zone in areas outside of the obstacle belts. (See fig. 4-32.)

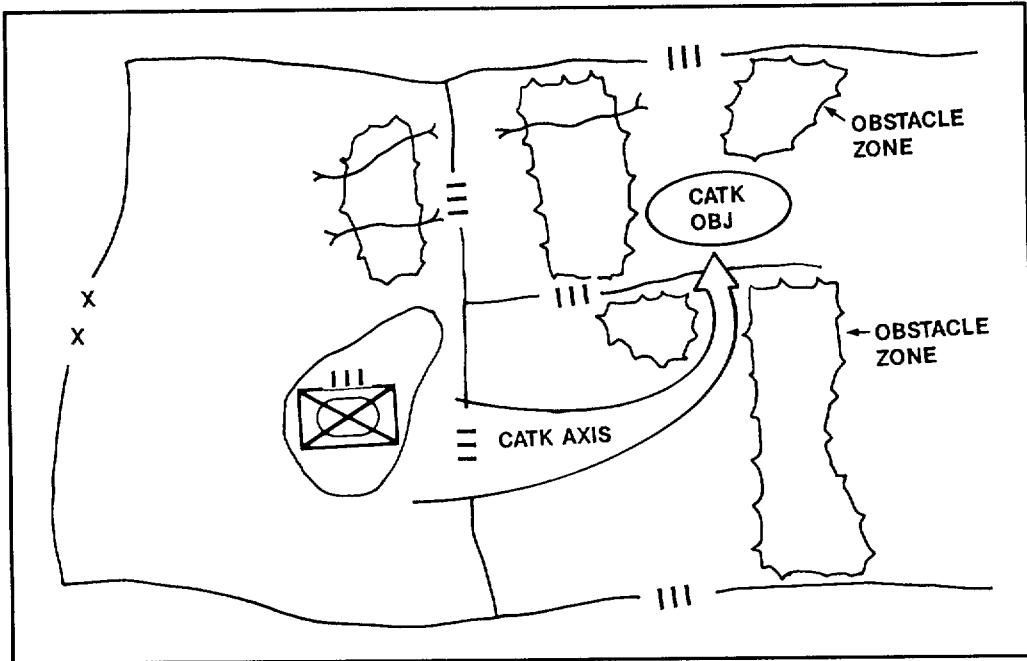

Figure 4-31. Obstacle Zone.

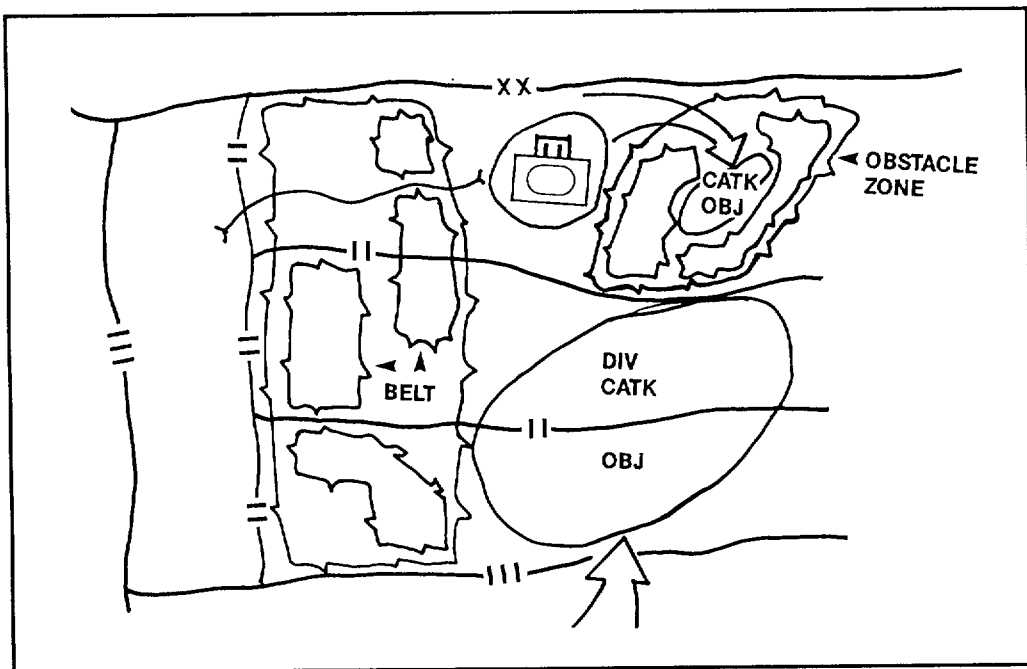

Figure 4-32. Obstacle Belts.

(3) **Obstacle Restricted Areas.** Obstacle restricted areas are used to limit the type or number of obstacles within an area. The actual restrictions are described in the body of the operations order.

(4) **Reserved Obstacles.** Certain obstacles may be reserved, which restricts the lower level commander's authority to execute them. Reserved obstacles allow critical, planned movement on the battlefield (e.g., counterattack) before their creation.

4504. Existing Obstacles

All ground movement, friendly or enemy, is governed by the existing obstacles inherent in the terrain whether they are natural or cultural. The battlefield commander can control the enemy's movement to a considerable extent by skillfully using the existing obstacle areas of the terrain and by strengthening and extending these through the creation of reinforcing obstacles. This section will address some specific types of existing obstacles.

a. Drainage Features. Drainage or surface water features include rivers, streams, canals, lakes, ponds, marshes, swamps, and bogs. Such features are obstacles whenever the water becomes deep or turbulent or the wetness makes soil conditions degrade cross-country movement. A river over 150 meters wide and over 1 or 2 meters deep is a major obstacle; however, the presence of bridges and fords may limit its obstacle value. Most tanks can ford water 3 to 5 feet deep. A truck can ford about 3 feet of water. Generally, most APCs and IFVs have riverine capability and only have trafficability problems with steep banks.

b. Soil. Soil trafficability, especially when considered in conjunction with climatic conditions, is a very important factor in evaluating cross-country movement. Normally, soil trafficability affects wheeled support vehicles more than armored vehicles. A tank has a very low ground pressure,

normally 8 to 12 pounds per square inch, which allows it to move on soft soil easier than trucks. (See fig. 4-33.)

c. Slope. Slope is the inclined surface of a hill, mountain, ridge, or any other part of the earth's land surface. Short vertical slopes, or *steps* higher than 1 foot will slow wheeled vehicles, 4-foot *steps* will stop most armored vehicles. In evaluating terrain for cross-country movement, slopes of 45 percent (about 24 degrees) is commonly used as the reasonable upper limit for tanks and 30 percent (about 17 degrees) for trucks.

d. Vegetation. Forest vegetation is the primary concern in cross-country vehicular movement. Forests with trees 20 to 25 centimeters (8 to 10 inches) in diameter are tank obstacles, and 5 centimeters (2 inches) stands will stop most wheeled vehicles.

e. Cultural Features. Cultural features are the works of man such as stone walls, hedgerows, dikes, canals, embankments, cuts, fills, and built-up areas. The obstacle value of a cultural feature depends on its size or extent, location, and construction. The natural obstacle value of built-up areas can be readily reinforced, and those which are properly located to control approaches or key terrain can be developed into formidable strongpoints.

Though the previous terrain considerations have focused on the tank as a measure of an individual obstacles value, the primary concern by MAGTF commanders and their subordinates is the effect of terrain on a combined arms formation, not individual tanks.

4505. Reinforcing Obstacles

There are a multiple number of reinforcing obstacles that the commander can use to knit together, strengthen, and extend the existing obstacles. These options allow the commander to change the military

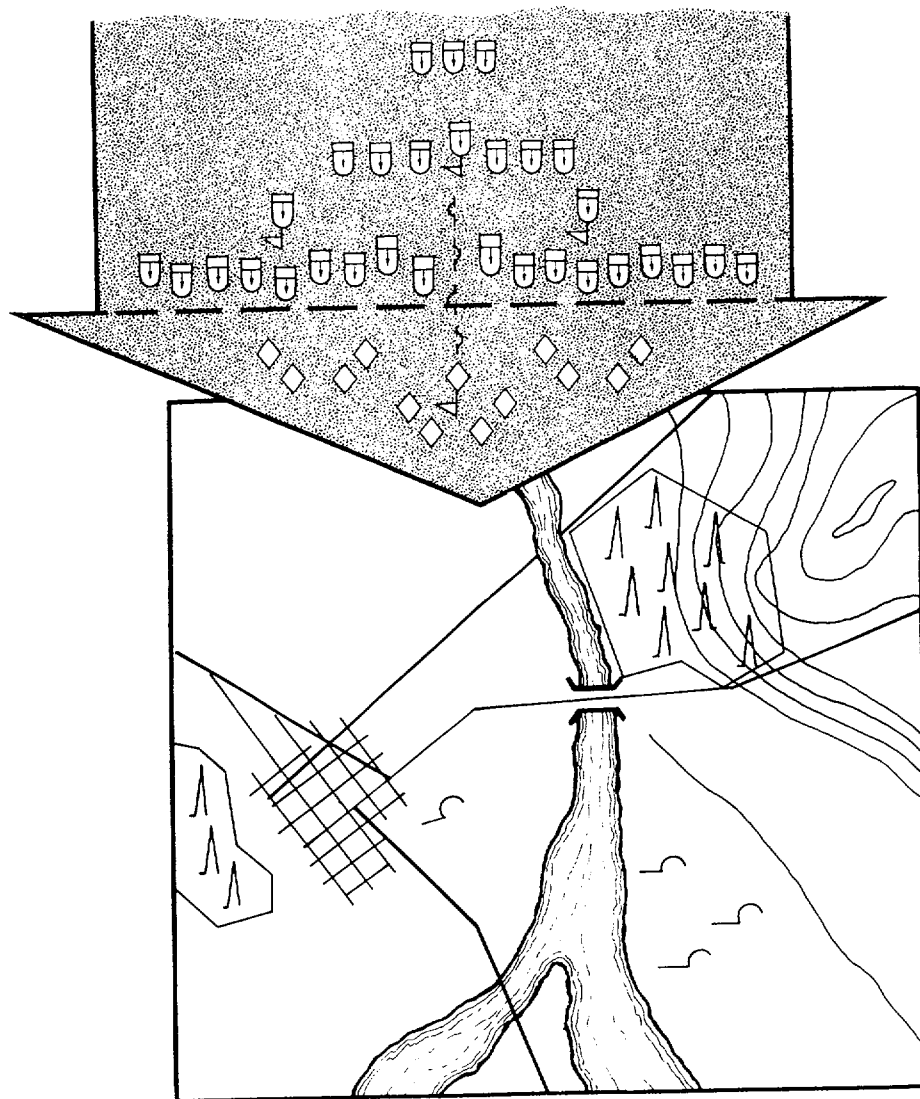

Figure 4-33. Armored Unit Approaches Obstacle.

characteristics of the terrain to fit his tactical plans and to disrupt those of his enemy. Reinforcing obstacles can be broadly categorized as the following:

- Demolition obstacles.
- Constructed obstacles.
- Land mines.
- Contamination.
- Expedient obstacles.

These categories are not mutually exclusive—some obstacles appear in more than one category and some (such as mines) are commonly used to strengthen others.

a. Demolition Obstacles. These are obstacles created by the detonation of explosives, including nuclear explosives. Demolition obstacles include:

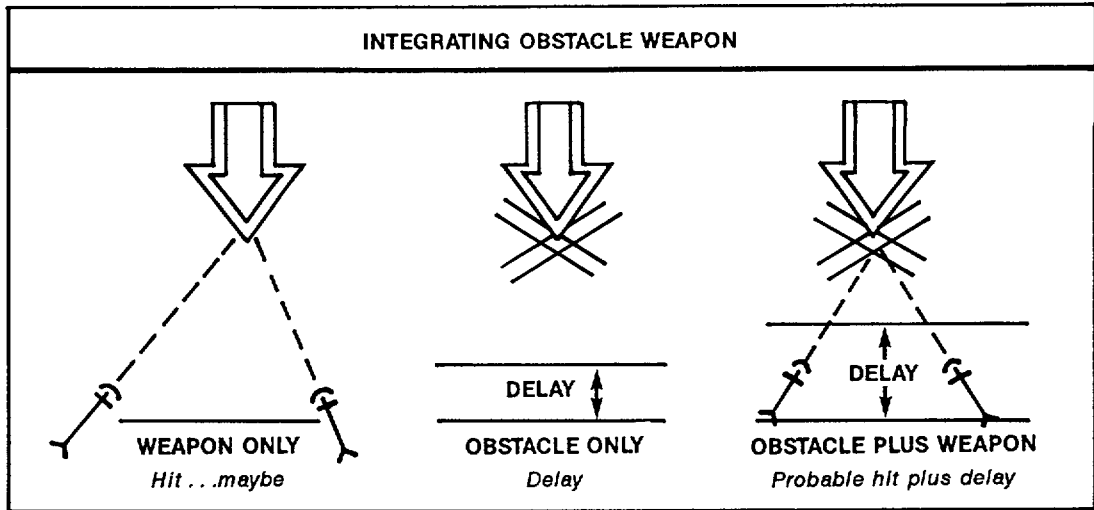

Figure 4-36. Obstacle/Weapon Integration.

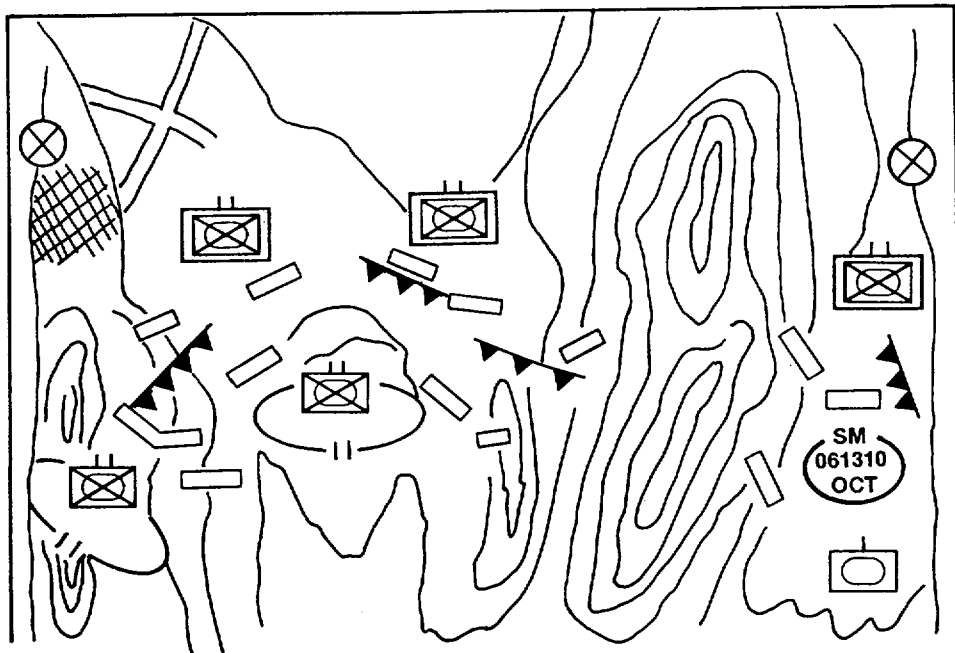

Figure 4-37. Supporting the Maneuver Commander's Plan.

are closed. For example, destruction of a major highway through a wooded area is largely ineffective if any nearby road or opening that offers a ready bypass route is left open.

d. Reinforcing Obstacles Are Employed in Depth. A series of simple obstacles arranged one behind the other along a probable axis of advance is far more effective than one large, elaborate obstacle. Obstacles must be far enough apart that each will require a new deployment of the enemy's counterobstacle forces and equipment.

e. Reinforcing Obstacles Are Employed for Surprise. A defender can retain a degree of initiative even when defending by using obstacles so as to obtain surprise. Scatterable mines permit rapid mining anywhere in the battle area, confronting the attacker with a completely new situation almost instantly. Also, sudden detonation of concealed obstacles in front of the attacking enemy or within his formations produces surprise.

Section VI. Intelligence

The key to the MAGTF defeating an enemy armored force is the correct and timely application of its mobility and firepower against the enemy. This requires sound and timely intelligence. Intelligence is the product resulting from the collection, processing, integration, analysis, evaluation, and interpretation of available information concerning foreign countries or areas. (Joint Pub 1-02) Combat commanders are primarily concerned with combat intelligence, which is the knowledge of the enemy, weather, and geographical features required in the planning and conduct of combat operations. Figure 4-38 illustrates the MAGTF's intelligence organizations.

4601. Surveillance, Reconnaissance, and Intelligence Group

The surveillance, reconnaissance, and intelligence group (SRIG) is part of the command element of the Marine expeditionary force (MEF). The SRIG greatly enhances the MAGTF's intelligence capability. The elements of a SRIG are:

- Headquarters company.
- Radio battalion.
- Communication battalion.
- Force reconnaissance company.
- Air/naval gunfire liaison company (ANGLICO).
- Unmanned aerial vehicle (UAV) company.
- Intelligence company.
 - Four counterintelligence (CI) teams.
 - Sensor control and management platoon (SCAMP).
 - Photo imagery interpretation unit (PIIU).
 - Interrogation platoon.
 - Tactical deception platoon.
 - Topographical platoon.
 - Surveillance and reconnaissance center (SARC).
 - MAGTF All-Source Fusion Center (MAFC).

Note: Marine expeditionary brigades (MEBs) and Marine expeditionary units (MEUs) have SRIG detachments.

4602. Fundamentals of Intelligence

The fundamentals of intelligence shown below are discussed in detail in FMFM 3-21, *MAGTF Intelligence Operations*.

- Centralized control.
- Timeliness.
- Systematic exploitation.
- Objectivity.
- Accessibility.
- Responsiveness.
- Source protection.
- Continuous review.

4603. Types of Intelligence

The types of intelligence shown below are discussed in detail in FMFM 3-21.

- Basic intelligence.
- Combat intelligence.
- Target intelligence.
- Counterintelligence.

4604. Organization of the Battlefield

From the commanders perspective, the battlefield is organized into three roughly concentric areas: the

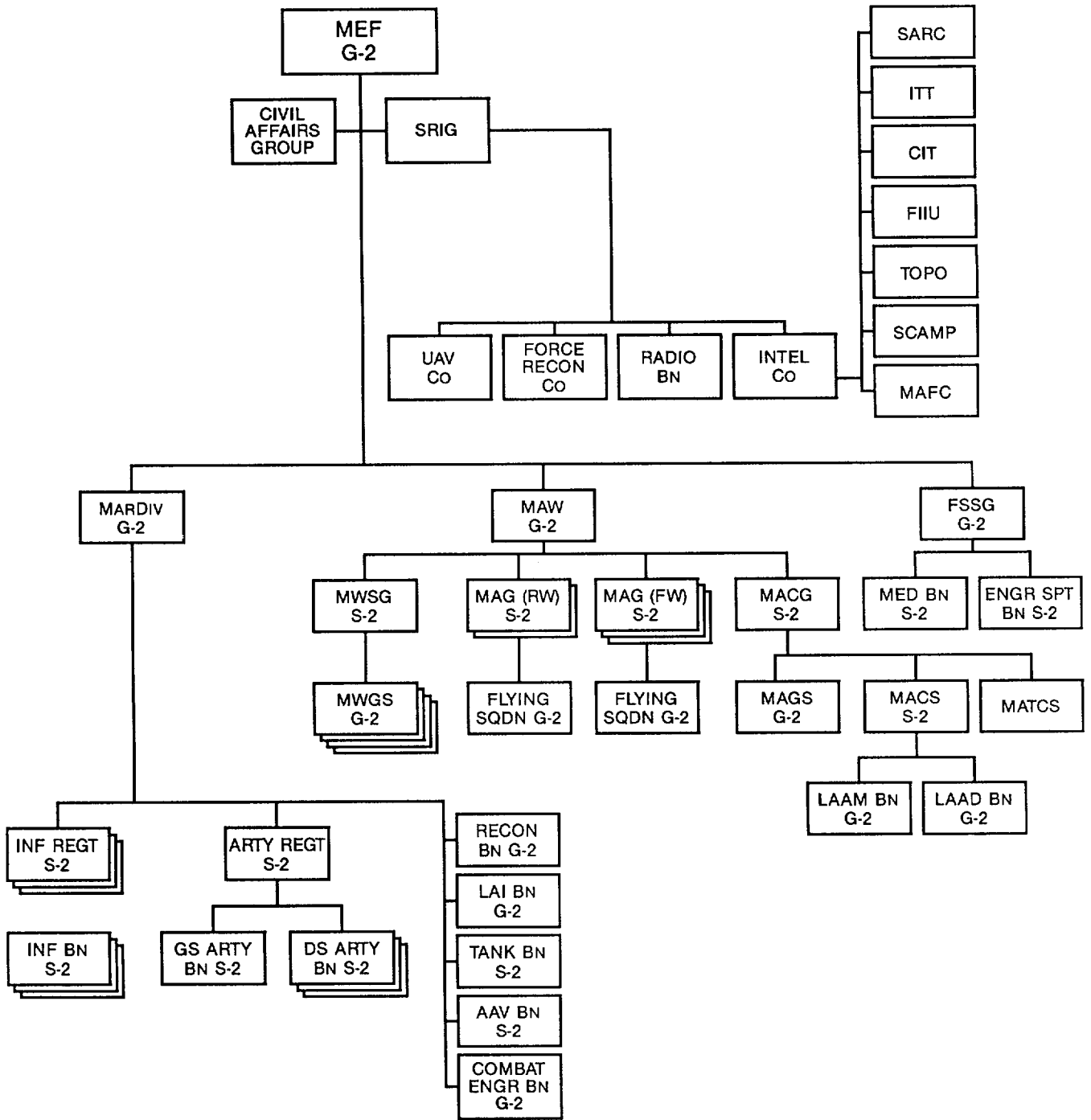

Figure 4-38. MAGTF Intelligence Organizations.

area of responsibility, the area of influence, and the area of interest. In a highly fluid environment with mobile forces (motorized/mechanized), these areas are normally larger than in dismounted operations. (See fig. 4-39.)

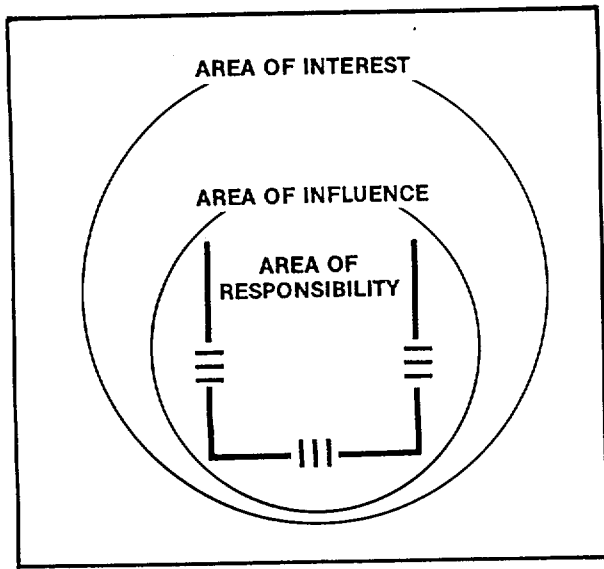

Figure 4-39. Organization of the Battlefield.

a. Area of Responsibility. A defined area of land in which responsibility is specifically assigned to the commander of the area for the development and maintenance of installations, control of movement and the conduct of tactical operations involving troops under his control along with parallel authority to exercise these functions. (Joint Pub 1-02)

b. Area of Influence. The area of influence is a geographical area wherein a commander is directly capable of influencing operations, by maneuver or fire support systems, normally under his command or control. (Joint Pub 1-02) It is not an assigned area, rather it is based on capabilities. For the MAGTF commander it is the range of

his aviation. For an LAI or mechanized infantry commander, it is normally the range of his artillery.

c. Area of Interest. The area of interest is that area of concern to the commander, including the area of influence and areas adjacent to it and extending into enemy territory to the objectives of current or planned operations. This area also includes areas occupied by enemy forces who could jeopardize the accomplishment of the mission. (Joint Pub 1-02) The size of the area depends on the situation and is based solely on the concerns of the commander.

4605. Intelligence Preparation of the Battlefield

Intelligence preparation of the battlefield (IPB) is a systematic approach to analysis of the enemy, weather, and terrain. It begins in peacetime contingency planning and continues during operations. IPB becomes the foundation for intelligence production in combat and initially can show gaps in the intelligence data base. It provides the basis for the collection plan and a guide for effective employment of collection, reconnaissance, and surveillance resources. Detailed discussion of IPB is shown in FMFM 3-21.

a. Characteristics. The IPB integrates enemy doctrine with the weather and terrain, the mission, and the specific battlefield environment, continually applying the data to tactical situations. Graphics are basic to the IPB analysis and consist of annotated military maps, multilayered overlays, gridded photographs, microfilm, large scale map substitutes, and templating techniques.

b. Terrain Analysis. The terrain analysis focuses on the military aspects of terrain. Overlays are produced which show line of sight (fields of fire), cover, concealment, obstacles, key terrain, avenues of approach, and mobility corridors.

Section VII. Electronic Warfare

Deploying electronic warfare assets far forward with LAI and other forward units provides the MAGTF commander with an increased capability to target and attack enemy electronic systems. The mobile electronics warfare support system (MEWSS), which is organic to the radio battalion of the SRIG, is an electronic warfare system which is mounted in an LAV. This system can be employed with LAI and other highly mobile units without impeding the mobility of the unit.

4701. Definitions

Electronic Warfare—Military action involving the use of electromagnetic energy to determine, exploit, reduce, or prevent hostile use of the electromagnetic spectrum through damage, destruction, and disruption while retaining friendly use of electromagnetic spectrum. Also called **EW**. There are three divisions within electronic warfare:

a. **electronic countermeasures**—That division of electronic warfare involving actions taken to prevent or reduce an enemy's effective use of the electromagnetic spectrum. Also called **ECM**. Electronic countermeasures include:

- (1) **electronic jamming**—The deliberate radiation, reradiation, or reflection of electromagnetic energy for the purpose of destroying, damaging, or disrupting enemy use of the electromagnetic spectrum.
- (2) **electronic deception**—The deliberate radiation, reradiation, alteration, suppression, absorption, denial, enhancement, or reflection of electromagnetic energy in a manner intended to convey misleading information and to deny valid information to an enemy or to enemy electronics-dependent weapons. Among the types of electronic deception are: (a) **manipulative electronic deception**—Actions to eliminate revealing, or convey misleading, electronic telltale indicators that may be used by hostile forces. (b) **simulative electronic deception**—Actions to represent friendly notional or actual capabilities to mislead hostile forces. (c) **imitative electronic deception**—The introduction of

electromagnetic energy into enemy systems that imitates enemy emissions.

- b. **electronic counter-countermeasures**. That division of electronic warfare involving actions taken to ensure friendly effective use of the electromagnetic spectrum despite the enemy's use of electronic warfare. Also called **ECCM**.
- c. **electronic warfare support measures**—That division of electronic warfare involving actions taken under direct control of an operational commander to search for, intercept, identify, and locate sources of radiated electromagnetic energy for the purpose of immediate threat recognition. Thus, electronic warfare support measures (ESM) provide a source of information required for immediate decisions involving electronic countermeasures (ECM), electronic counter-countermeasures (ECCM), avoidance, targeting, and other tactical employment of forces. Electronic warfare support data can be used to produce signals intelligence (SIGINT), both communications intelligence (COMINT) and electronics intelligence (ELINT).

4702. Planning Considerations

Electronic warfare, to be effective, should be centrally orchestrated and controlled by the MAGTF commander. The principle of centralized control and decentralized execution applies. Centralized control is necessary to ensure that the actions of one MAGTF organization do not interfere with the actions of another MAGTF unit. For example, one unit could begin jamming an enemy radio net which was yielding

valuable intelligence for another unit. In this instance, centralized control permits the requirement to neutralize the enemy's command and control system by one unit is weighed against the value of the intelligence the radio net is yielding to the MAGTF as a whole.

Electronic countermeasures and electronic warfare support measures are performed by MAGTF units as a result of specific taskings from the MAGTF commander. These taskings, if given, appear in the operations order given to a unit by higher headquarters. If a unit discovers that the enemy is using a radio frequency, this information is reported to higher headquarters through intelligence channels.

Electronic counter-countermeasures are practiced by all MAGTF units. These measures include such actions as daily changes in frequencies and unit call signs, use of encrypting devices, authentication procedures, and use of frequency hopping radios. ECCM measures are

normally prescribed in the MAGTF, GCE, ACE, CSSE, and SRIG communications plan.

Employment of MEWSS with an LAI unit does not automatically imply that the LAI unit commander has total freedom to employ the MEWSS. The MEWSS's activities will normally be controlled by the radio battalion, who will employ the system in accordance with the MAGTF commander's guidance. The specific tasks which the LAI unit commander can use the MEWSS to accomplish will be prescribed in the operations order given to the LAI unit by higher headquarters.

Employment of the MEWSS in SEAD operations must be closely coordinated with ACE attack aircraft and EW platforms, as well as with LAI and other fire support coordination agencies. This close coordination will reduce the potential for one unit's activities interfering with the activities of another and thus produce the maximum degradation of enemy air defense systems.

Chapter 5

Antiarmor Exercise

The following exercise is intended to demonstrate antiarmor capabilities of the MAGTF. The area of operations roughly approximates the Twentynine Palms, California desert terrain.

5001. General Situation

I MEF was directed to defend in zone the Kumri oil fields against possible enemy armor attacks. The GCE is composed of the following major units:

1ST MarDiv

- 1st Marines
- 5th Marines
- 7th Marines (rein)
 - 3rd Tk Bn (+)
 - 3rd AA Bn
- 11th Marines
- 1st Cbt Engr Bn
- 1st LAI Bn
- 1st Recon Bn

The enemy is a MRD with three MRRs (30 tanks per), one independent tank battalion (40 tanks), and two artillery battalions (total 36 gun tubes).

5002. Special Situation #1

The GCE commander has two regiments forward defending in zone in relatively static positions and the LAI Bn in the security area. The 7th Marines—a mechanized regiment—possesses the entire tank force (44 tanks) and three AAV companies. The 7th Marines is the designated reserve. (See fig. 5-1.)

Without knowing the GCE mission statement, would you consider the GCE to be in a mobile or position defense? (See chapter 4, par. 4105.)

The GCE commander will probably initially assign priority of fires to which major unit? (See chapter 4, par. 4403.)

The LAI Bn is approximately 30 kilometers forward of all friendly troops (including recon elements). The graphic control measure that would indicate the LAI Bn's location on a GCE or MEF overlay is called: FEBA, FLOT, or CFL? (See chapter 4, par. 4102.)

The LAI Bn may be assigned one of three missions in the security area—screen, guard, or cover. If assigned a guard or cover mission, LAI Bn would require reinforcement. What are some options available to reinforce the LAI Bn? (See chapter 4, par. 4201.)

The LAI Bn, when conducting security operations in the defense, will probably plan what type of operation to implement its mission statement? If the LAI Bn eventually returns through friendly lines while under enemy pressure, what control measure will it utilize to facilitate the transfer of responsibility for the security area and control of supporting arms to the units on the FEBA? (See chapter 4, secs. I and II.)

What options are available for flank security of the GCE? Does the use of LAI units in the security area relieve the regimental commanders of the responsibility of the area immediately forward of their positions? (See chapter 4, par. 4103 and sec. III.)

The GCE commander has directed that LAI Bn assume a guard mission forward of the FEBA and requested attack helicopters be placed OPCON to

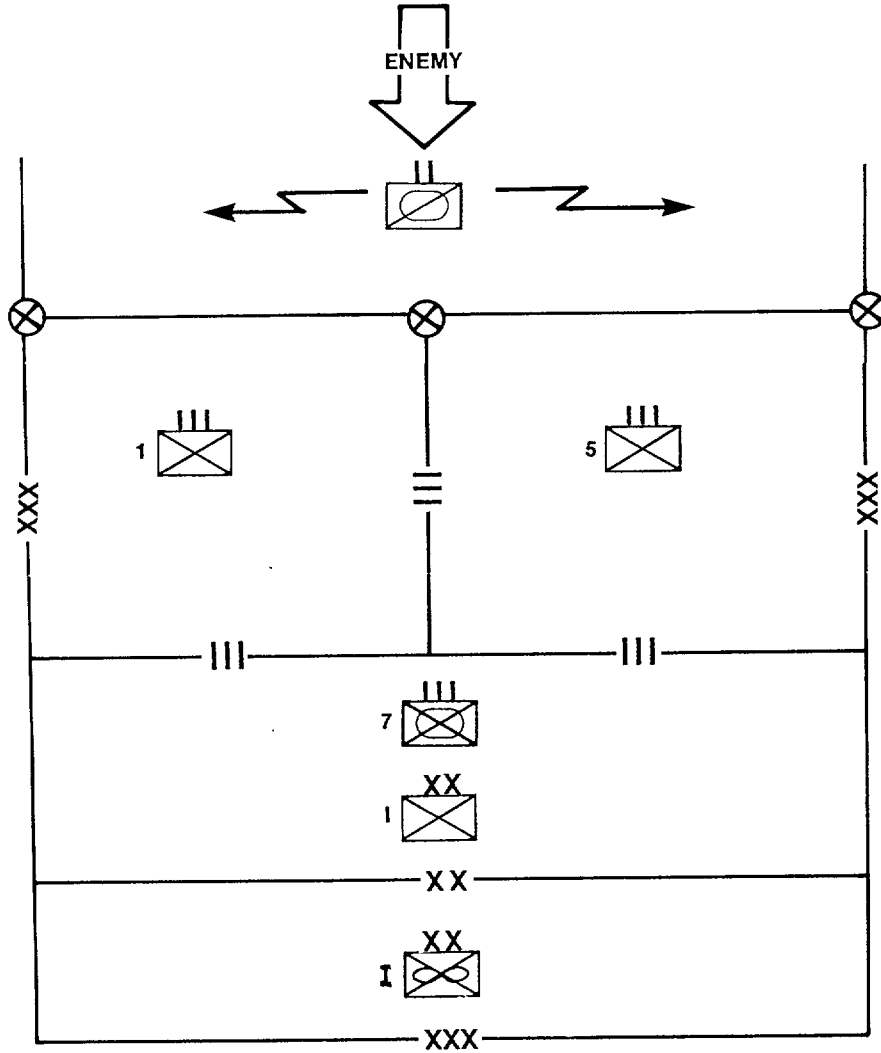

Figure 5-1. General Situation.

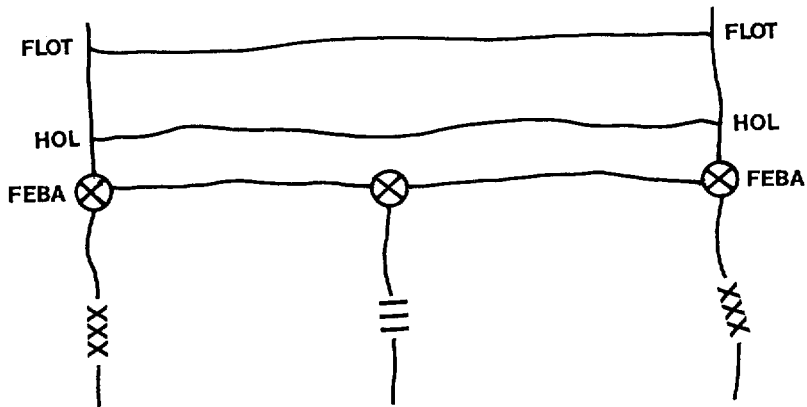

Figure 5-2. Situation #1.

LAI Bn. LAI Bn has been designated as the GCE's main effort with priority of fires. LAI Bn has planned a delay in sector in successive positions. The GCE commander designated a HOL about 3 kilometers forward of the FEBA. The HOL will also define LAI Bn's final delay position. Regimental commanders designated security elements of TOW and Scout jeeps to provide immediate security out to the HOL. (See fig. 5-2.)

5003. Special Situation #2

The MAGTF commander desires to attack the enemy as far forward as possible with as much firepower as possible. What are some options that the MAGTF commander has to fight the *deep battle*? Is it necessary to use major GCE elements when attacking the enemy well forward of the FEBA? (See chapter 4, sec. IV.)

Who is the MAGTF commander likely to assign as *deep battle coordinator*? What organizations are likely to plan EAs deep into enemy territory? (See chapter 4, secs. IV and V.)

Is enemy armor most vulnerable to air strikes in a column or when it is fully deployed in an assault formation? (See chapter 2.)

The MAGTF commander has designated the ACE commander to establish EAs well forward of the FLOT. These EAs will be used by fixed-wing aircraft in DAS missions. SRIG and the ACE coordinated the insertion of force recon personnel and ground sensors at some of the designated EA sites.

5004. Special Situation #3

The LAI Bn anticipates first encountering the MRD's reconnaissance followed by its advanced guard of FSE. The main force of MRRs will follow. The enemy tanks are the T-72 model with spaced and reactive armor. See chapter 2. The LAI Bn, supported by attack helicopters, believes it can destroy the reconnaissance and FSE units prior to moving through the HOL.

What weapons found in the LAI Bn and on the attack helicopters are effective against enemy armor? (See chapter 3.)

During the initial delay against the reconnaissance and FSE elements, the LAI Bn plans on ambushing most of the enemy armor at ranges of 600 meters or closer. What is this engagement technique called? Against larger enemy armor formations with many T-72's, the LAI units will likely use what engagement technique to force the enemy to deploy as early as possible?

The EAs established during a delay operation will likely be forward or inside of the initial delay positions? (See chapter 4, sec. III.)

The TOW missile has a *standoff* range versus an enemy tank, terrain permitting. Which technique of engagement maximizes this attribute? (See chapter 3, sec. III.)

Considering that the T-72s are more heavily armored than the LAV antitanks (ATs) and that the LAI Bn is conducting a delay, what disengagement criteria would be appropriate for LAI units? (See chapter 4, sec. III.)

Once the LAI Bn has crossed the HOL, what other missions might it be assigned? Missions for the attack helicopters? (See chapter 4, par. 4103 and sec. IV.)

5005. Special Situation #4

The GCE assigned sectors to its regiments, thereby allowing each regiment to develop its own EAs. The GCE commander visualized his defense in terms of battalion positions and enemy avenues of approach accommodating a fully deployed MRB.

What are the primary antiarmor weapons within the regimental sectors? (See chapter 4, par. 4202.)

What are two offensive missions that may be assigned the mechanized regiment in reserve? (See chapter 4, par. 4108.)

What offensive mission may be assigned LAVs that have been bypassed forward of the HOL? (See chapter 4, par. 4108.)

Neither 1st Marines or 5th Marines has tanks or LAIs. Both regiments are relying primarily on organic TOW, Dragon, and LAW assets in the antiarmor role. As the GCE operations officer, you decide that each regiment needs a mobile reserve of some size. Which antiarmor weapon systems could fulfill the role of a mobile reserve? (See chapter 3.)

5006. Special Situation #5

1st and 5th Marine Regiments have each been reinforced with a tank platoon, a TOW platoon, and an AAV platoon. An engineer company is in direct support. See figure 5-3 for depiction of 1st Marine Regiment defensive positions.

Judging by the array of unit positions in figure 5-3, is the EA located within or forward of the FEBA?

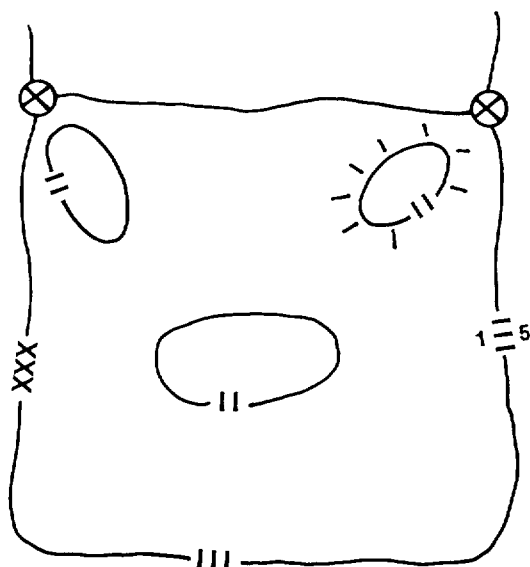

Figure 5-3. 1st Marine Regiment Defensive Position.

At what distance away from the FEBA would an attacking Soviet type battalion desire to deploy into its assault formation? (See chapter 2.)

Which position would you expect to get the priority of engineer support? (See chapter 4, sec. V.)

The reserve for the regiment would most likely be an infantry company, a mech-heavy team, or a TOW section? (See chapter 4, par. 4203.)

The reserve is located in the regimental security area, main battle area, or rear area? (See chapter 4, sec. I.)

At the regimental level, an avenue of approach is defined as an area that can accommodate what size unit? (See chapter 4, sec. I.)

Assuming the enemy tanks are T-72s with reactive armor, we would expect this regiment to engage the tanks with its Dragons and LAWs from the flanks or the front? (See chapter 4.)

Considering the wide frontages and the open desert terrain, we would expect the TOWs to utilize which method of engagement—HAW-MAW-LAW or massed fire technique? (See chapter 4.)

Which technique—HAW-MAW-LAW or massed fire—offers the likelihood of most first round kills? Gives away the friendly position the earliest? Minimizes enemy artillery? Provides most kills forward of the FEBA? (See chapter 4.)

5007. Special Situation #6

1st Bn 5th Marines is defending in sector with company sectors and platoon battle positions. This battalion has integrated a small village into its defense. (See fig. 5-4.)

The alternate platoon positions are normally a minimum of how many meters from the primary positions? Why? (See chapter 4, par. 4206.)

The small town functions as a battle position, sector, or strongpoint? Is it a cultural or reinforcing obstacle? (See chapter 4, secs. II and V.)

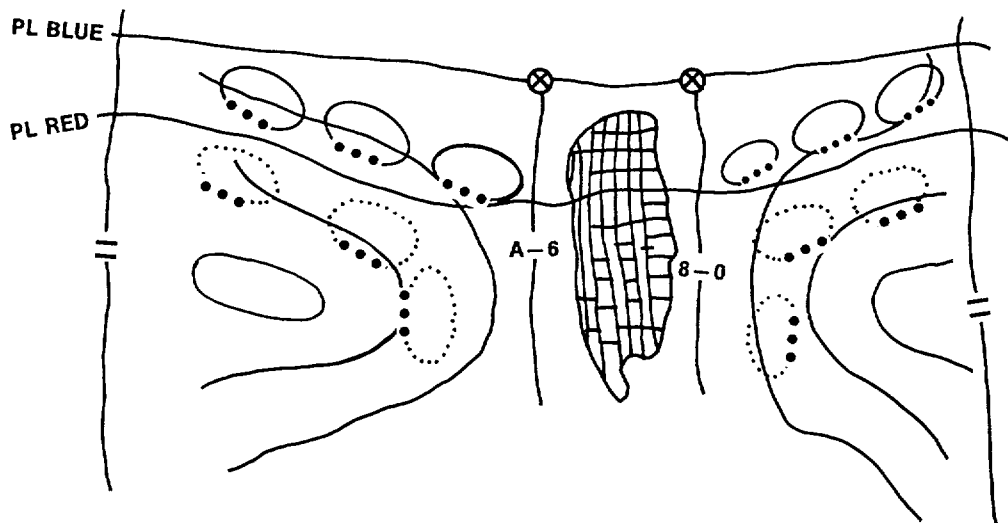

Figure 5-4. 1st Bn 5th Marines in Built-Up Area.

5008. Special Situation #7

What is the MEF organization that is likely to be responsible for directing and interpreting the intelligence data? (See chapter 4, sec. VI.)

What antiarmor resources does the GCE possess that may be used as an economy of force measure in protecting the rear area against an armor attack? What internal measures could the rear area establish to defend against an armor attack? (See chapter 4, sec. I.)

The MRD is primarily an armored unit. The MAGTF is a more balanced unit. What inherent advantages does a MAGTF possess over a unit

normally dedicated to one type or style of fighting? Night fighting probably favors which side? (See chapter 1.)

The enemy is constantly repositioning his tank reserves. What capability of the MAGTF is he probably trying to negate? (See chapter 4, sec. IV.)

Is it feasible to think of disrupting the enemy's forward forces by action in the enemy's rear? (See chapter 1.)

A turning movement would most likely involve what type MAGTF forces? (See chapter 4, par. 4108.)

Appendix A

Antiarmor Close Combat Course

This appendix contains a sample design from an antiarmor close combat course. It was taken from FM 23-3, *Tactics, Techniques, and Concepts of Antiarmor Warfare*. The size of the required area is dependent upon the number of stations included. As a minimum, an area 200 meters by 200 meters is required. An area this size will permit the training of an entire company at the same time. (See fig. A-1.)

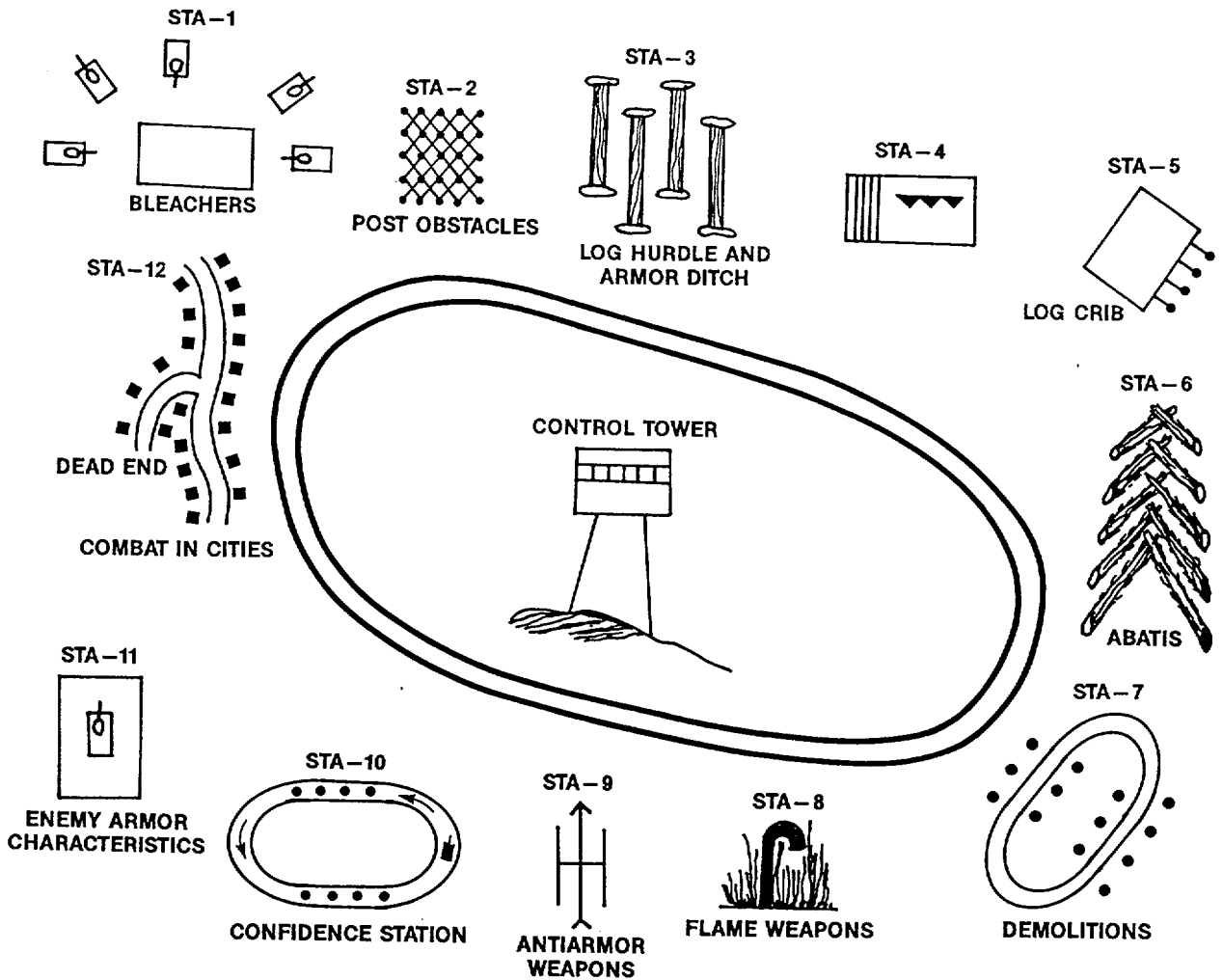

Figure A-1. Training Area Antiarmor Close Combat Course.

A brief description of each station—

Station 1—Introduction to Course

Station 1 provides a brief introduction of the entire course. Characteristics and limitations of armored vehicles are discussed and demonstrated, to include vision deadspace, weapons deadspace, and vulnerable areas of tanks and APCs. The differences in fields of view between U.S. and enemy tanks should be pointed out at this time. Tracing tape on two tanks illustrates vision and weapons deadspace. Students are allowed to enter the tanks to observe firsthand the feeling of protection experienced by tank crew members when buttoned up. After this station, students are broken down into 11 groups and are rotated in a county fair manner throughout the remainder of the course.

Station 2—Post Obstacles

Station 2 provides an explanation and demonstration of the construction of post obstacles to stop, impede, or canalize the movement of armored vehicles.

Station 3—Log Hurdles and Armor Ditch

Station 3 furnishes an explanation and demonstration of the construction of log hurdles and an armor ditch to stop, impede, or canalize the movement of armored vehicles.

Station 4—Antiarmor Minefield

Station 4 presents an explanation of how a small antiarmor minefield is emplaced. Practical work follows the explanation.

Station 5—Log Crib

Station 5 provides an explanation and demonstration of the construction of log crib obstacles.

Station 6—Abatis

Station 6 provides an explanation and demonstration of the construction of log abatis to stop or canalize the movement of armored vehicles.

Station 7—Demolitions

Station 7 supplies an explanation and demonstration of the use of demolitions to destroy or damage tanks. Students are required to employ dummy sled charges, Daisy Chain mines, saddle charges, and projectile charges against moving tanks.

Station 8—Flame Weapons

Station 8 furnishes an explanation and demonstration of the use of flame weapons against armored vehicles. Weapons demonstrated include the Molotov cocktail and fire bomb. Students are shown how to improvise flame weapons using material found on the battlefield. Students are permitted to throw live or dummy Molotov cocktails depending on safety regulations and the students' status of training.

Station 9—Antiarmor Weapons

Station 9 presents an explanation and demonstration of those antiarmor weapons assigned or attached to infantry units. Students are shown those areas of armored vehicles each weapon is most effective against.

Station 10—Confidence Station

Station 10 presents an explanation and demonstration of the construction of individual fighting positions for protection against tanks. Students are required to occupy prepared individual positions while tanks are driven over them.

Station 11—Characteristics of Enemy Armor

Station 11 furnishes an explanation and demonstration of the characteristics of enemy armored vehicles displayed. The use of mockups or large size armor flash cards will assist in the identification of vehicle vulnerabilities and visual deadspace.

Station 12—Combat in Cities

Station 12 provides an explanation and demonstration of combat against armored vehicles in cities. This station should include permanently constructed block houses for student practical work, but instruction can be presented using sand tables and mockups.

Appendix B

Recommended Professional Reading List

Badri, Magdoub, Zohdy	The Ramadan War, 1973
Caidin, Martin	The Tigers are Burning
Caputo, Phillip	A Rumor of War
Catton, Bruce	A Stillness at Appomatox
Crisp	Brazen Chariots
Del Vecchio, John M.	The 13th Valley
Earle	Makers of Modern Strategy
Guderian, Heinz	Panzer Leader
Harmon, Ernest H.	Combat Commander
Herzog, Chaim	War of Atonement
Keegan, John	The Face of Battle
Liddell, Hart	Strategy
Lind, William	Maneuver Warfare Handbook
Luttwak, Edward	The Israeli Army
MacDonald, Charles P.	Company Commander
Marshall, Samuel	L. A. Men Against Fire: The Problem of Battle Command in Future War
Patton, George S.	War as I Knew It
Phillips	Roots of Strategy
Robinett	Armor Command
Rommel, Erwin	Attacks
Sun Tzu	The Art of War
Taylor, Robert L.	Military Leadership: In Pursuit of Excellence
Tuchman, Barbara	The Guns of August
Von Mellenthin, Friedrich W.	Panzer Battles: A Study of the Employment of Armor in the Second World War
Wouk, Herman	War and Remembrance
DA PAM 20-201	Military Improvisation (Balck)
DA PAM 20-230	Russian Combat Methods (Balck)

Appendix C

Glossary

Section I. Abbreviations and Acronyms

AAV	assault amphibious vehicle	FSCL	fire support coordination line
ACA	airspace coordination area	FSE	forward security element
ACE	aviation combat element	FSV	fire support vehicle
ANGLICO	air/naval gunfire liaison company	GCE	ground combat element
APC	armored personnel carrier	HAW	heavy antiarmor weapon
AT	antitank	HE	high explosive
ATGM	antitank guided missile	HEAA	high explosive anti-aircraft
Bn	battalion	HEAT	high explosive antitank
BP	battle position	HEDP	high explosive dual purpose
CAS	close air support	HMMWV	high mobility multipurpose wheeled vehicle
CFA	covering force area	HOL	handover line
CFL	coordinated fire line	ICM	improved conventional munition
CI	counterintelligence	IFV	infantry fighting vehicles
CIFS	close-in fire support	IPB	intelligence preparation of the battlefield
COMINT	communications intelligence	LAI	light armored infantry
CS	combat support	LAV	light armored vehicle
CSS	combat service support	LAW	light antiarmor weapon
DAS	deep air support	LC	line of contact
DPICM	dual-purpose improved conventional munitions	LD	line of departure (ground operations)
EA	engagement area	MAFC	MAGTF All-Source Fusion Center
ECCM	electronic counter-countermeasures	MAGTF	Marine Air-Ground Task Force
ECM	electronic countermeasures	MATCS	Marine air traffic control squadron
ELINT	electronics intelligence	MAW	medium antiarmor weapon
ESM	electronic warfare support measures	MBA	main battle area
EW	electronic warfare	MBT	main battle tank
FASCAM	family of scatterable mines	MEB	Marine expeditionary brigade
FEBA	forward edge of the battle area	MEF	Marine expeditionary force
FFA	free fire area	METT-T	mission, enemy, terrain and weather, troops and support available — time available
FLOT	forward line of own troops		
FSC	fire support coordinator		

MEU	Marine expeditionary unit	SARC	surveillance and reconnaissance center
MEWSS.....	mobile electronics warfare support system	SCAMP	sensor control and management platoon
MG	machine gun	SEAD	suppression of enemy air defense
MRB.....	motorized rifle battalion	SIGINT.....	signals intelligence
MRD	motorized rifle division	SMAW.....	shoulder-launched multipurpose assault weapon
MRR.....	motorized rifle regiment	SRIG	surveillance, reconnaissance, and intelligence group
MSR	main supply route		
MULE	modular universal laser equipment		
NFA.....	no-fire area	TOW	tube launched, optically tracked, wire command link, guided missile system
NGF	naval gunfire		
OAS.....	offensive air support	TRP	target reference point
OPCON.....	operational control		
P_h	probability of hit	UAV.....	unmanned aerial vehicle
PIIU	photo imagery interpretation unit	USMCR	United State Marine Corps Reserve
P_k	probability of kill		
PL	phase line	V/STOL.....	vertical/short takeoff and landing
RAAMS.....	remote antiarmor mine system		
RFA.....	restrictive fire area		
RFL	restrictive fire line		

Section II. Definitions

A

advance guard—Detachment sent ahead of the main force to insure its uninterrupted advance; to protect the main body against surprise; to facilitate the advance by removing obstacles, and repairing roads and bridges; and to cover the deployment of the main body if it is committed to action. (Joint Pub 1-02)

ambush—A surprise attack by fire from concealed positions on a moving or temporarily halted enemy. (FM 101-5-1)

approach march—Advance of a combat unit when direct contact with the enemy is imminent. Troops are fully or partially deployed. The approach march ends when ground contact with the enemy is made or when the attack position is occupied. (Joint Pub 1-02)

area of influence—The area of influence is a geographical area wherein a commander is directly capable of influencing operations, by maneuver or fire support systems, normally under his command or control. (Joint Pub 1-02)

area of interest—That area of concern to the commander, including the area of influence, areas adjacent thereto, and extending into enemy territory to the objectives of current or planned operations. This area also includes areas occupied by enemy forces who could jeopardize the accomplishment of the mission. (Joint Pub 1-02)

area of responsibility—A defined area of land in which responsibility is specifically assigned to the commander of the area for the development and maintenance of installations, control of movement and the conduct of tactical operations involving troops under his control along with parallel authority to exercise these functions. (Joint Pub 1-02)

armor kill zone—See engagement area.

avenue of approach—An air or ground route of an attacking force of a given size leading to its objective or to key terrain in its path. (FM 101-5-1)

axis of advance—A general route of advance assigned for control purposes, extending in the direction of the enemy.

B

barrier—A coordinated series of obstacles designed or employed to canalize, direct, restrict, delay or stop the movement of an opposing force, and to impose additional losses in personnel, time and equipment on the opposing force. (Joint Pub 1-02)

barrier plan—The part of the operation order or plan that deals with the use of barriers, closely integrated with the scheme of maneuver and the fire support plan, to lend maximum support to the accomplishment of the assigned mission. (Various)

battle position—A defensive location oriented on the most likely enemy avenue of approach from which a unit may defend or attack. Such units can be as large as reinforced battalions and as small as platoons. The unit assigned to the BP is located within the general outline of the BP, but other forces may operate outside the BP to provide early detection of enemy forces and all-around security. (Various)

blocking position—A defensive position so sited as to deny the enemy access to a given area or to prevent his advance in a given direction. (Joint Pub 1-02)

boundary—In land warfare, a line by which areas of responsibility between adjacent units/formations are defined. (Joint Pub 1-02)

breach—The employment of any means available to break through or secure a passage through an enemy defense, obstacle, minefield, or fortification. (FM 101-5-1)

breakthrough—A rupturing of the enemy's forward defenses that occurs as a result of a penetration. A breakthrough permits the passage of an exploitation force. (FM 101-5-1)

bypass—Maneuvering around an obstacle, position, or enemy force to maintain the momentum of advance. Previously unreported obstacles are reported to higher HQ. Bypassed enemy forces are reported to higher HQ. (FM 101-5-1)

C

canalize—To restrict operations to a narrow zone by use of existing or reinforcing obstacles or by direct or indirect fires. (FM 101-5-1)

close air support—Air action against hostile targets which are in close proximity to friendly forces and which require detailed integration of each air mission with the fire and movement of those forces. (Joint Pub 1-02)

close-in fire support—Attack by attack helicopters of hostile targets which are normally in close proximity to friendly ground forces. (FMFM 5-1)

combat intelligence—That knowledge of the enemy, weather, and geographical features required by a commander in planning and conducting combat operations. It is derived from the analysis of information on the enemy's capabilities, intentions, vulnerabilities, and the environment. (JCS Pub 1-02)

combat service support area—A designated area from which combat service support elements provide logistic support to the ground combat element. (Various)

commander's intent—Commander's vision of the battle—how he expects to fight and what he expects to accomplish. (FM 101-5-1)

concealment—The protection from observation or surveillance. (FM 101-5-1)

contact point—A designated, easily identifiable terrain feature where two or more units are required to make contact. (Various)

coordinating point—A control measure that indicates a specific location for the coordination of fires and maneuver between adjacent units. Usually indicated whenever a boundary crosses the FEBA, COP, or GOP trace, and can be indicated where phase lines intersect boundaries. Physical contact between units is required at coordinating points during NATO operations. (Various)

counterattack—Attack by part or all of a defending force against an enemy attacking force, for such specific purposes as regaining ground lost or cutting off or destroying enemy advance units, and with the general objective of denying to the enemy the attainment of his purpose in attacking. In sustained defensive operations, it is undertaken to restore the battle position and is directed at limited objectives. (Joint Pub 1-02)

cover—1. Protection from the effects of fire. 2. A security mission assigned to a tactically self-contained unit operating beyond the support of friendly artillery positioned with the main body. Includes all tasks assigned to screening and guard forces as well as the requirement to develop the situation early, deceive, disorganize and destroy the enemy. (Various)

covering force—A force operating apart from the main force for the purpose of intercepting, engaging, delaying, disorganizing, and deceiving the enemy before he can attack the force covered. (Joint Pub 1-02)

D

dead space—An area within the maximum range of a weapon, radar, observer, which cannot be covered by fire or observation from a particular position because of intervening obstacles, the nature of the ground, or the characteristics of the trajectory, or the limitations of the pointing capabilities of the weapons. (Joint Pub 1-02)

decisive engagement—An engagement in which a unit is considered fully committed and cannot maneuver or extricate itself. In the absence of outside assistance, the action must be fought to a conclusion and either won or lost with the forces at hand. (FM 101-5-1)

deep air support—Air action against enemy hostile targets at such distance from friendly forces that detailed coordination with the fire and movement of friendly forces is not required. DAS missions are normally flown beyond the FSCL (FMFM 5-1)

defense—A coordinated effort by a force to defeat an attacker and prevent him from achieving his objectives. (FM 101-5-1)

defense in depth—The siting of mutually supporting defense positions designed to absorb and progressively weaken attack, prevent initial observations of the whole position by the enemy, and to allow the commander to maneuver his reserve. (Joint Pub 1-02)

defensive operations—Operations conducted with the immediate purpose of causing an enemy attack to fail. Defensive operations also may achieve one or more of the following: gain time, concentrate forces elsewhere, wear down enemy forces as a prelude to offensive operations, and retain tactical, strategic or political objectives. (FM 101-5-1)

defilade—1. Protection from hostile observation and fire provided by an obstacle such as a hill, ridge, or bank. 2. To shield from enemy fire or observation by using natural or artificial obstacles. (FM 101-5-1)

delay position—A position taken to slow up the advance of the enemy without becoming decisively engaged. (AR 310-35)

delaying operation—An operation in which a force under pressure trades space for time by slowing down the enemy's momentum and inflicting maximum damage on the enemy without, in principle, becoming decisively engaged. (Joint Pub 1-02)

deliberate attack—A type of offensive action characterized by preplanned coordinated employment of firepower and maneuver to close with and destroy or capture the enemy. (Joint Pub 1-02)

deliberate defense—A defense normally organized when out of contact with the enemy or when contact with the enemy is not imminent and time for organization is available. It normally includes an extensive fortified zone incorporating pillboxes, forts, and communications systems. (Joint Pub 1-02)

direction of attack—A specific direction or route that the main attack or the main body of the force will follow. The unit is restricted, required to attack as indicated, and is not normally allowed to bypass the enemy or maneuver off the assigned route. Used to ensure control in low visibility or when exact placement of forces is crucial, such as during night attacks, counterattacks, and supporting attacks. (Various)

displace—To leave one position and take another. forces may be displaced laterally to concentrate combat power in threatened areas. (FM 101-5-1)

E

echelon—1. A subdivision of a headquarters; i.e., forward echelon, rear echelon. 2. Separate level of command. As compared to a regiment, a division is a higher echelon, a battalion is a lower echelon. 3. A fraction of a command in the direction of depth, to which a principal combat mission is assigned; i.e., attack echelon, support echelon, reserve echelon. (Joint Pub 1-02)

engagement area—An area in which the commander intends to trap and destroy an enemy force with the massed fires of all available weapons. Engagement areas are routinely identified by a target reference point in the center of the trap area or by prominent terrain features around the area. Although engagement areas may also be divided into sectors of fire, it is important to understand that defensive systems are not designed around engagement areas, but rather around avenues of approach. Engagement areas and sectors of fire are not intended to restrict fires or cause operations to become static or fixed; they are used only as a tool to concentrate fires and to optimize their effects. (FM 101-5-1)

envelopment—An offensive maneuver in which the main attacking force passes around or over the enemy's principal defensive positions to attack those positions from the rear or to secure objectives to the enemy's rear.

evacuation—1. The process of moving any person who is wounded, injured, or ill to and/or between medical treatment facilities. 2. The clearance of personnel, animals, or materiel from a given locality. (Joint Pub 1-02)

exploitation— 1. Taking full advantage of success in battle and following up initial gains. 2. An offensive operation that usually follows a successful attack and is designed to disorganize the enemy in depth. (Joint Pub 1-02) (Parts 1 and 3 of a 3-part definition)

F

field of fire— The area which a weapon or a group of weapons may cover effectively with fire from a given position. (Joint Pub 1-02)

final protective fire— An immediately available preplanned barrier of direct and indirect fire designed to provide close protection to friendly positions and installations by impeding enemy movement into defensive areas. (FM 101-5-1)

fire and maneuver— A base of fire made up of one or more elements engages the enemy forces on the objective, while the other element(s) maneuvers to an advantageous position from which to close with and destroy the enemy. (Various)

fire and movement— A technique primarily used in the assault wherein a unit or element advances by bounds or rushes, with subelements alternately moving and providing covering fire for other moving subelements. May be done by individuals (personnel or vehicles) or units (such as fire teams or squads). Usually, fire and movement is used only when under effective fire from the enemy, because it is relatively slow and difficult to control. (Various)

fire mission— Specific assignment given to a fire unit as part of a definite plan. (Joint Pub 1-02)

fire plan— A tactical plan for using the weapons of a unit or formation so that their fire will be coordinated. (Joint Pub 1-02)

fire support— Assistance to elements of the ground forces engaged with the enemy rendered by other firing units, including (but not limited to) as artillery, mortars, naval gunfire, and close air support. (Various)

fire support coordination— The planning and executing of fire so that targets are adequately covered by a suitable weapon or group of weapons. (Joint Pub 1-02)

fix— Actions taken to prevent the enemy from moving any part of his forces from a specific location and/or for a specific period of time by holding or surrounding them to prevent their withdrawal for use elsewhere. (FM 101-5-1)

fortified area— A defensive system that contains numerous strongpoints disposed in depth and width in such a manner as to be mutually supporting. (Various)

forward edge of the battle area— The foremost limits of a series of areas in which ground combat units are deployed, excluding the areas in which the covering or screening forces are operating, designated to coordinate fire support, the positioning of forces, or the maneuver of units. (Joint Pub 1-02)

forward line of own troops— A line which indicates the most forward positions of friendly forces in any kind of military operation at a specific time. (JCS Pub 1-02)

forward slope— Any slope which descends towards the enemy. (Joint Pub 1-02)

frontage— The width of the front plus that distance beyond the flanks covered by observation and fire by a unit in combat. (FM 101-5-1)

frontal attack— An offensive maneuver in which the main action is directed against the front of the enemy forces, and over the most direct approaches. (FM 101-5-1)

G

gap— 1. Any break or breach in the continuity of tactical dispositions or formations beyond effective small arms coverage. 2. A portion of a minefield of specified width, in which no mines have been laid, to enable a friendly force to pass through the minefield in tactical formation. (FM 101-5-1)

group of targets— Two or more targets on which fire is desired simultaneously. A group of targets is designated by a letter/number combination or a nickname. (Joint Pub 1-02)

guard— A security element whose primary task is to protect the main force by fighting to gain time, while also observing and reporting information. (Joint Pub 1-02)

H

handover line—A control feature, preferably following easily defined terrain features, at which responsibility for the conduct of combat operations is passed from one force to another. (Joint Pub 1-02)

hasty attack—An offensive operation for which a unit has not made extensive preparations. It is conducted with the resources immediately available in order to maintain momentum, exploit an opportunity, or to take advantage of the enemy situation. (Various)

hasty breach—The rapid creation of a route through a minefield, barrier or fortification by an expedient method in order to maintain the momentum of the attack. (Various)

hasty defense—A defense normally organized while in contact with the enemy or when contact is imminent and time available for the organization is limited. It is characterized by improvement of the natural defensive strength of the terrain by utilization of fighting holes, emplacements, and obstacles. (Joint Pub 1-02)

hide—The positioning of a vehicle, individual, or unit so that no part is exposed to observation or direct fire. (FM 101-5-1)

I

indirect fire—High-trajectory fire delivered on a target which cannot be seen by the firing unit. (Various)

infiltration—1. The movement through or into an area or territory occupied by either friendly or enemy troops or organizations. The movement is made, either by small groups or by individuals, at extended or irregular intervals. When used in connection with the enemy, it implies that contact is avoided.
2. When used in conjunction with a tactical vehicular march, vehicles are dispatched individually or in small groups at irregular intervals to reduce density and prevent undue massing of vehicles. (FM 101-5-1)

insertion—1. Placement of troops and equipment into an operational area in air assault operations.
2. The placement of observation posts, patrols or raiding parties by helicopter, parachute, watercraft, or

other means. Stealth is normally a primary goal of an insertion. (Various)

intelligence—The product resulting from the collection, evaluation, analysis, integration, and interpretation of all available information concerning an enemy force, foreign nations, or areas of operations and which is immediately or potentially significant to military planning and operations. (FM 101-5-1)

interdict—To prevent or hinder, by any means, enemy use of an area or route.

interval—The space between adjacent individuals, ground vehicles, or units in a formation that are placed side by side, measured abreast. (Joint Pub 1-02)

K

key terrain—Any locality, or area, the seizure or retention of which affords a marked advantage to either combatant. (Joint Pub 1-02)

kill window—An exposed area between two covered areas traveled by the enemy that allows a friendly gunner sufficient time to engage the enemy.

L

liaison—That contact or intercommunication maintained between elements of military forces to ensure mutual understanding and unity of purpose and action. (Joint Pub 1-02)

local security—Those security elements established in the proximity of a unit to prevent surprise by the enemy. (FM 101-5-1)

M

main attack—The principal attack or effort into which the commander throws the full weight of the offensive power at his disposal. An attack directed against the chief objective of the campaign or battle. (Joint Pub 1-02)

main battle area—For any command, the area extending from the forward edge of the battle area to the rear boundaries of its forward subordinate units. (Various)

main body—The principal part of a tactical command or formation. It does not include detached elements of the command such as advance guards, flank guards, covering forces, etc. (FM 101-5-1)

main effort—The most important task to be accomplished by the force. It is assigned by the commander to a specifically designated subordinate unit. The commander ensures the success of the main effort by providing it the preponderance of support and by alerting reserves to rapidly reinforce the main effort or, if necessary, to assume the main effort. (Various)

main supply route—The route or routes designated within an area of operations upon which the bulk of traffic flows in support of military operations. (Joint Pub 1-02)

maneuver—1. A movement to place ships or aircraft in a position of advantage over the enemy. 2. Employment of forces on the battlefield through movement in combination with fire—or fire potential—to achieve a position of advantage in respect to the enemy in order to accomplish the mission. (Joint Pub 1-02) (Parts 1 and 4 of a 4-part definition.)

maximum engagement line—A line that depicts the farthest distance away from a position that a target can be engaged. Normally depicted as the range limit of the sector of fire. Also see trigger line.

meeting engagement—A combat action that occurs when a moving force, incompletely deployed for battle, engages an enemy at an unexpected time and place. (Joint Pub 1-02)

military crest—An area on the forward slope of a hill or ridge from which maximum observation covering the slope down to the base of the hill or ridge can be obtained. (FM 101-5-1)

military operations on urbanized terrain—All military actions planned and conducted on a topographical complex and its adjacent natural terrain where man-made construction is the dominant feature. It includes combat-in-cities, which is that portion of MOUT involving house-to-house and street-by-street fighting in towns and cities. (FM 101-5-1)

mission—The task, together with the purpose, which clearly indicates the action to be taken and the reason therefor. (Joint Pub 1-02) (Part 1 of a 3-part definition.)

mission-type order—1. Order issued to a lower unit that includes the accomplishment of the total mission assigned to the higher HQ. 2. Order to a unit to perform a mission without specifying how it is to be accomplished. (Joint Pub 1-02)

mobility—A quality or capability of military forces which permits them to move from place to place while retaining the ability to fulfill their primary mission. (Joint Pub 1-02)

movement to contact—An offensive operation designed to gain or reestablish contact with the enemy. Also known as advance to contact.

mutual support—That support which units render each other against an enemy, because of their assigned tasks, their position relative to each other and to the enemy, and their inherent capabilities. (Joint Pub 1-02)

N

neutralize—1. To render ineffective or unusable. 2. To render safe mines, bombs, missiles, and boobytraps. 3. To make harmless anything contaminated with a chemical agent. (FM 101-5-1)

O

objective—The physical object of the action taken, for example, a definite terrain feature, area, or enemy force, the seizure, holding, or destruction of which is essential to the commander's plan. (Various)

observation post—A position from which military observations are made, or fire directed and adjusted, and which possesses appropriate communications; may be airborne. (Joint Pub 1-02)

obstacle—Any natural or manmade obstruction that canalizes, delays, restricts, or diverts movement of a force. The effectiveness of an obstacle is enhanced considerably when covered by fire. Obstacles can include abatis, antitank ditches, blown

bridges, built-up areas, minefields, rivers, road craters, terrain, and wire. Existing obstacles are natural or cultural restrictions to movement that are part of the terrain when battle planning begins. Reinforcing obstacles are specifically constructed, emplaced, or detonated to tie together, strengthen, and extend existing obstacles. (FM 101-5-1)

on-call target—In artillery and naval gunfire support, a planned target other than a scheduled target on which fire is delivered when requested. (Joint Pub 1-02)

organization of the ground—The development of a defensive position by strengthening the natural defenses of the terrain and by assignment of the occupying troops to specific localities. (Joint Pub 1-02)

overwatch—1. A tactical technique in which one element is positioned to support the movement of another element with immediate direct fire. 2. The tactical role of an element positioned to support the movement of another element with immediate direct fire. (FM 101-5-1)

P

passage of lines—Passing one unit through the positions of another, as when elements of a covering force withdraw through the FEBA, or when an exploiting force moves through the elements of the force that conducted the initial attack. A passage may be designated as a forward or rearward passage of lines. (FM 101-5-1)

passage point—A place where units will pass through one another either in an advance or withdrawal. It is located where the commander desires subordinate units to physically execute a passage of lines. (FM 101-5-1)

patrol—A detachment of ground, sea, or air forces sent out for the purpose of gathering information or carrying out a destructive, harassing, mopping-up, or security mission. (Joint Pub 1-02)

patrol—A mission given to a detachment sent out by a larger unit for gathering information or for conducting combat operations. (FM 101-5-1)

penetration—In land operations, a form of offensive which seeks to break through the enemy's defense and disrupt the defensive system. (Joint Pub 1-02)

phase line—A line used for control and coordination of military operations. It is usually a recognizable terrain feature extending across the zone of action. Units normally report crossing PLs, but do not halt unless specifically directed. PLs often are used to prescribe the timing of delay operations. (FM 101-5-1)

point of departure—A specific place where a unit will cross the LD. (Various)

position—1. A location or area occupied by a military unit. 2. The location of a weapon, unit, or individual from which fire is delivered upon a target. **primary position**: a position which provides the best means to accomplish the assigned mission. **alternate position**: a position to be occupied when the primary position becomes untenable or unsuitable for carrying out its task. The alternate position is located so that the individual can continue to fulfill his original task. **supplementary position**: a position which provides the best means to accomplish a task that cannot be accomplished from the primary or alternate position. (FM 101-5-1)

preparation fire—Fire delivered on a target preparatory to an assault. (Joint Pub 1-02)

principal direction of fire—The direction of fire assigned or designated as the main direction in which a weapon will be oriented. It is selected based on the enemy, mission, terrain, and weapons capability. (FM 101-5-1)

priority of engagement—A sequence of targets that establishes the precedence (not the order of accomplishment) in which the targets should be attacked.

protective minefield—In land mine warfare, a minefield employed to assist a unit in its local, close-in protection. (Joint Pub 1-02)

pursuit—An offensive operation designed to catch or cut off a hostile force attempting to escape, with the aim of destroying it. (Joint Pub 1-02)

R

raid—An operation, usually small-scale, involving a swift penetration of hostile territory to secure information, confuse the enemy, or to destroy his installations. It ends with a planned withdrawal upon completion of the assigned mission. (Joint Pub 1-02)

rally point—An easily identifiable point on the ground at which units can reassemble and reorganize if they become dispersed. (FM 101-5-1)

rear area—For any particular command, the area extending forward from its rear boundary to the rear of the area of responsibility of the next lower level of command. (Joint Pub 1-02)

rear guard—Security detachment that protects the rear of a column from hostile forces. During a withdrawal, it delays the enemy by armed resistance, destroying bridges, and blocking roads. (Joint Pub 1-02)

reconnaissance—A mission undertaken to obtain, by visual observation or other detection methods, information about the activities and resources of an enemy or potential enemy; or to secure data concerning the meteorological, hydrographic, or geographic characteristics of a particular area. (Joint Pub 1-02)

relief in place—An operation in which, by direction of higher authority, all or part of a unit is replaced in an area by the incoming unit. The responsibilities of the replaced elements for the mission and the assigned zone of operations are transferred to the incoming unit. The incoming unit continues the operation as ordered. (Joint Pub 1-02)

reserve—Portion of a body of troops which is kept to the rear or withheld from action at the beginning of an engagement, available for a decisive movement. (Joint Pub 1-02)

rest and refit—A period during a tactical operation in which a part or all of a unit disengages from direct confrontation with the enemy in order to perform maintenance and resupply.

retirement—An operation in which a force out of contact moves away from the enemy. (Joint Pub 1-02)

retrograde movement—Any movement of a command to the rear, or away from the enemy. It may be forced by the enemy or may be made voluntarily. Such movements may be classified as withdrawal, retirement, or delaying action. (Joint Pub 1-02)

reverse slope—Any slope which descends away from the enemy. (Joint Pub 1-02)

S

scatterable mine—A mine laid without regard to classical pattern that is designed to be delivered by aircraft, artillery, missile, ground dispenser, or by hand. (Joint Pub 1-02)

scheduled target—In artillery and naval gunfire support, a planned target on which fire is to be delivered at a specific time. (Joint Pub 1-02)

scheme of maneuver—The tactical plan to be executed by a force in order to seize assigned objectives. (Joint Pub 1-02)

screen—A security element whose primary task is to observe, identify and report information, and which only fights in self-protection.

sector—An area designated by boundaries within which a unit operates and for which it is responsible. Normally, sectors are used in defensive operations. (FM 101-5-1)

sector of fire—An area which is required to be covered by fire by an individual, a weapon, or a unit. (Joint Pub 1-02)

security force—The detachment deployed (between the main body and the enemy) (to the front, flanks, or rear of the main body) tasked with the protection of the main body. May be assigned a screening, guard, or covering mission. (Various)

series of targets—A number of targets and/or groups of targets fired in a predetermined sequence in support of a scheme of maneuver. (Various)

signal intelligence—The product resulting from the collection, evaluation, analysis, integration, and

interpretation of all information derived from communications intelligence, electronic intelligence, and telemetry intelligence. (FM 101-5-1)

signature—The visible or audible effects produced when a weapon is fired or a piece of equipment operated, such as noise, smoke, flame, heat, or debris; also, an electronic emission subject to detection and traceable to the equipment producing it. (Various)

spoiling attack—A tactical maneuver employed to seriously impair a hostile attack while the enemy is in the process of forming or assembling for an attack. Usually employed by armored units in defense by an attack on enemy assembly positions in front of a main line of resistance or battle position. (Joint Pub 1-02)

standoff range—The distance that a weapon's maximum effective range exceeds that of another type weapon's maximum is referred to as the standoff range.

stay behind force—A force which is left in position to conduct a specified mission when the remainder of the force withdraws or retires from the area. (Joint Pub 1-02) Also known as hide forces.

strongpoint—A key point in a defensive position, usually strongly fortified and heavily armed with automatic weapons, around which other positions are grouped for its protection. (Joint Pub 1-02)

successive positions—Defensive fighting positions located one after another on the battlefield. A force can conduct a delaying action from successive delay positions. (FM 101-5-1)

suppression of enemy air defenses—That activity which neutralizes, destroys or temporarily degrades enemy air defenses in a specific area by physical attack and/or electronic warfare. (Joint Pub 1-02)

suppressive fire—Fires on or about a weapons system to degrade its performance below the level needed to fulfill its mission objectives, during the conduct of the fire mission. (Joint Pub 1-02)

T

tactical area of responsibility—A defined area of land for which responsibility is specifically assigned to the commander of the area as a measure for control of assigned forces and coordination of support. (Joint Pub 1-02)

tactics—1. The employment of units in combat. 2. The ordered arrangement and maneuver of units in relation to each other and/or to the enemy in order to utilize their full potentialities. (Joint Pub 1-02)

target reference point—An easily recognizable point on the ground (either natural or manmade) used for identifying enemy targets or controlling fires. (FM 101-5-1)

trigger point—Sometimes referred to as trigger line. An identifiable point on the ground used to time the delivery of fire with a moving target (i.e., to initiate fire on the enemy). A firing unit is given a command to fire as the target passes over or near the trigger point. The trigger point is selected in consideration of range, reaction time of the firing unit, time of flight of the projectile, and the rate of march of the enemy. It may coincide with the Maximum Engagement Line. (FMFM 6-18)

turning movement—A variation of the envelopment in which the attacking force passes around or over the enemy's principal defensive positions to secure objectives deep in the enemy's rear to force the enemy to abandon his position or divert major forces to meet the threat. (Joint Pub 1-02)

W

withdrawal operation—A planned operation in which a force in contact disengages from an enemy force. (Joint Pub 1-02)

Z

zone of action—A tactical subdivision of a larger area, the responsibility for which is assigned to a tactical unit; generally applied to offensive action. (Joint Pub 1-02)

Appendix D

References

1. Joint Publications

Joint Pub 1-02	Department of Defense Dictionary of Military and Associated Terms
Joint Pub 3-02	Joint Doctrine for Amphibious Operations
Joint Pub 3-02.1	Joint Doctrine for Landing Force Operations

2. Allied Tactical Publication

ATP-35(A)	Land Force Tactical Doctrine
-----------	------------------------------

3. Fleet Marine Force Manuals

FMFM 1	Warfighting
FMFM 1-2	Campaigning
FMFM 1-3	Tactics
FMFM 2	The MAGTF: A Combined-Arms Team (Coordinating Draft)
FMFM 2-1	Intelligence
FMFM 2-7	Fire Support in MAGTF Operations
FMFM 3-1	Command and Staff Action
FMFM 3-21	MAGTF Intelligence Operations
FMFM 3-30	Communications
FMFM 3-31	MAGTF Communications
FMFM 4	Combat Service Support
FMFM 4-1	Combat Service Support Operations (under development)
FMFM 5-1	Organization and Functions of Marine Aviation
FMFM 5-40	Offensive Air Support (under development)
FMFM 5-41	Close Air Support and Close-In Fire Support (under development)
FMFM 5-42	Deep Air Support (under development)
FMFM 5-50	Antiair Warfare (under development)
FMFM 5-52	Employment of Forward Area Air Defense Battery
FMFM 6-1	Marine Division
FMFM 6-2	Marine Infantry Regiment
FMFM 6-3	Marine Infantry Battalion
FMFM 6-4	Marine Infantry Company and Platoon
FMFM 6-8	Supporting Arms Observer, Spotter, and Controller
FMFM 6-9	Marine Artillery Support (under development)
FMFM 6-11	Mechanized Operations (under development)
FMFM 6-18	Techniques and Procedures for Fire Support Coordination
FMFM 6-21	Tactical Fundamental of Helicopterborne Operations

FMFM 6-30	Light Armored Infantry Employment (under development)
FMFM 6-31	Light Armored Infantry Battalion (under development)
FMFM 7-15	Military Operations in Urban Terrain (under development)
FMFM 9-2	Amphibious Vehicles (To be issued as FMFM 6-12, Amphibious Vehicle Employment)
FMFM 11-1	Nuclear, Chemical, and Defensive Biological Operations (to be issued as FMFM 11, MAGTF Nuclear, Chemical, and Defensive Biological Operations)

4. Fleet Marine Force Reference Publications

FMFRP 0-14	Marine Corps Supplement to the DOD Dictionary of Military and Associated Terms
FMFRP 7-24	Commander's Guide to Cold Weather Operations

5. Field Manuals

FM 5-101	Mobility
FM 5-102	Countermobility
FM 6-20	Fire Support in Combined Arms Operations
FM 17-95	Cavalry Operations
FM 34-3	Intelligence Analysis
FM 71-1	Tank and Mechanized Infantry Company Team
FM 71-2	The Tank and Mechanized Infantry Battalion Task Force
FM 71-3	Armored and Mechanized Infantry Brigade
FM 90-3	Desert Operations (How to Fight)
FM 90-5	Jungle Operations (How to Fight)
FM 90-6	Mountain Operations
FM 90-10	Military Operations on Urbanized Terrain (MOUT) (How to Fight)
FM 90-13	River Crossing Operations (How to Fight)
FM 100-2-1	Soviet Army Operations and Tactics
FM 100-2-3	The Soviet Army Troops Organization and Equipment
FM 100-5	Operations
FM 100-5-1	Operational Terms and Symbols
FM 101-10-1	Staff Officers Field Manual—Organizational, Technical, and Logistical Data, Volume 1

6. Training Circular

TC 7-24	Antiarmor Tactics and Techniques for Mechanized Infantry
---------	--

Index

	Paragraph	Page
A		
Air employment	4201	4-9
LAI support	4402d	4-36
Offensive air support	4402	4-34
Close air support	4402a(2)	4-35
Close-in fire support	4402a(1)	4-34
Deep air support	4402a(3)	4-35
Aircraft:		
A-4 Skyhawk	Fig. 3-19	3-10
A-6 Intruder	Fig. 3-18	3-9
AH-1W Cobra attack helicopter	Fig. 3-6	3-4
AV-8B Harrier	Fig. 3-17	3-9
F/A-18 Hornet	Fig. 3-17	3-9
Antiarmor weapons, strengths and weaknesses	3102	3-10
Area defense. (<i>See</i> Position defense.)		
Armor, enemy. (<i>See</i> Threat forces.)		
Artillery:		
Copperhead	Fig. 3-13	3-7
FASCM	Fig. 3-14	3-8
M-198, 155 mm	Fig. 3-15	3-8
B		
Battalion	4204	4-12
Defense, types of	4204b	4-12
Battle position	4204d	4-14
Defend in sector	4204c	4-13
Reserves	4204f	4-15
Strongpoint	4204e	4-14
Security area	4204a	4-12
Battle position	4104a, 4203a(2), Fig. 4-24	4-4, 4-11, 4-26
Battlefield, organization of	4604, Fig. 4-39	4-49, 4-51
Blocking position	4104b	4-4
C		
Combat service support	4210	4-26
Company positions	4206	4-16
Counterattack	4106b	4-6
Counter mobility. (<i>See</i> Obstacles.)	4503	4-41

	Paragraph	Page
D		
Defense:		
Division sectors	4202	4-9
Fundamentals	4101	4-1
Mobile defense	4105b	4-5
Offensive action in the defense	4106	4-5
Organization of defensive area	4102	4-2
Perimeter defense	4208	4-22
Position defense	4105a	4-5
Regimental sectors	4203	4-10
Reverse slope defense	4207	4-20
Urban terrain	4209	4-23
Defensive positions. (See Positions.)		
Delay:		
Employment of delaying forces	4303	4-30
Fundamentals	4301	4-28
Methods	4302b	4-29
Missions	4302a	4-29
Techniques	4302	4-28
Delay position	4104c	4-4
Disengagement break lines	4305b	4-32
Criteria	4305b	4-32
Distribution of forces	4103	4-3
Doctrine	1002a	1-2
Dragon, M47	Fig. 3-7, 4209d	3-4, 4-26
Dual-purpose improved conventional munitions	Fig. 3-15	3-8
E		
Electronic warfare	4701	4-52
Enemy. (See Threat forces.)		
Engagement area	1004, 3202, 4401	1-3, 3-15, 4-34
Engineers	4303f, 4501	4-31, 4-39
F		
Fire control measures:		
Engagement area. (See Engagement Area.)		
Fire commands	3204e(1)	3-24
Fire patterns	3204e(2)	3-24—3-26
Indirect	4211a	4-26
Kill windows	3204f	3-26
Maximum engagement line	3204d	3-24
Positions	3204g	3-26
Range cards	3204h, Fig. 3-47	3-26, 3-28
Sector sketch	3204i	3-28
Target reference point	3204b	3-22
Trigger point	3204d	3-24

	Paragraph	Page
S		
SEAD	4402c	4-36
Sectors. (See Defense.)		
Sectors of fire	3204a	3-21
Security:		
Covering force	4202a	4-9
Guard force	4202a	4-9
LAI units	4202a	4-9
Mechanized task forces	4202a	4-9
Screening element	4202a	4-9
Security area	4102a, 4204a	4-2, 4-12
SMAW	Fig. 3-8	3-5
Spoiling attack	4106c	4-6
SRIG. (See Intelligence.)		
Standoff range	3203b	3-19
Stay behind forces	4106d	4-7
Strongpoints. (See Positions, defensive.)		
T		
Tank. (See Mechanized forces.)		
M1A1	Fig. 3-1	3-1
M60A1	Fig. 3-2	3-2
Tank killer teams	3205	3-29
Threat forces:		
Armor vehicles	Figs. 2-6—2-24	2-6—2-15
Armor vulnerability	2203	2-16
Formations	2103	2-2, 2-3
Forms of maneuver	2104	2-3
Lightly armored vehicles	2204	2-16
Offensive action, types of	2102	2-2
Offensive philosophy	2101	2-1
TOW (HMMWV)	4209d, 4303d	4-26, 4-31
Turning movement	4106a	4-6
V		
Vehicle positions	Figs. 3-29—3-31	3-18
W		
Weapon positioning	3203	3-16
Cover and concealment	3203a	3-17
Dispersion	3203b	3-19
Flank shots	3201c(2), 3203e	3-14, 3-20
Mutual support	3203c	3-19
Standoff range	3203d	3-19

	Paragraph	Page
Mechanized – Continued		
Infantry	1003b(3), 4303c	1-3, 4-31
Operation	1003b(2)	1-3
Methods of engagement	3201	3-12
HAW-MAW-LAW	3201a	3-12
Massed-surprise fires	3201b	3-13
Mines:		
FASCM	Fig. 3-14, 4505c	3-8, 4-45
Land	4505c	4-45
Mobile defense	4105b	4-5
Mortars	4403b(3)	4-37
MOUT	4209a	4-25
N		
Naval gunfire	4403b(2)	4-37
O		
Obstacles:		
Belts and zones	4503b	4-41
Countermobility	4503	4-41
Demolition	4505a	4-44
Existing	4501a, 4505	4-39, 4-4
Functions	4503a	4-41
Protective	4502b	4-40
Reinforcing	4501b, 4505	4-39, 4-4
P		
Position defense	4105a	4-4
Positions, defensive	4104	4-4
Battle position	4104a, 4204d	4-4, 4-14
Blocking position	4104b	4-4
Company position	4206a	4-17
Delay position	4104c	4-4
Levels of preparation	4206b	4-17
Strongpoint	4104d, 4204e,	4-4, 4-14,
	4502c	4-40
Priority of engagement	3204c	3-22
R		
Rear area	4102c, 4202c	4-2, 4-10
Regimental defense	4203a	4-11
Reserves	4103c, 4203b,	4-4, 4-12,
	4204f, 4304,	4-15, 4-31
	4305c(8)	4-33

	Paragraph	Page
Fire control principles	3204	3-21
Initiating engagement	3204d	3-23
Fire support:		
Indirect fire support	4403a	4-36
Means	4403b	4-37
Offensive air support	4402	4-34
Planning	4404	4-37
Flank shots. (See Weapon positioning.)		
Fortifications	4502a	4-39
Forward edge of the battle area	4102c(1)	4-3
Forward line of own troops	4102c(2)	4-3
H		
Handover line	4102c(3), 4203a	4-3, 4-11
HAW-MAW-LAW	3201a, 4305c(4)	3-12, 4-33
Helicopter, AH-1W Cobra attack	Fig. 3-6	3-4
I		
Intelligence:		
Fundamentals	4602	4-49
IPB	4605	4-51
Organizations	Fig. 4-38	4-50
SRIG	4601	4-49
Types	4603	4-49
L		
LAW:		
AT4	Fig. 3-10	3-6
M72A2	Fig. 3-9	3-5
Light armored infantry	1003b(4)	1-3
Employment	4201, 4303b, 4302d	4-9, 4-30, 4-36
Light armored vehicle:		
LAV 25	Fig. 3-4	3-3
LAV 25 AT	Fig. 3-3	3-2
M		
Machine gun:		
M-2	Fig. 3-12	3-7
MK-19	Fig. 3-11	3-6
Main battle area	4102b, 4202b	4-2, 4-10
Massed-surprise fires	3201b	3-13
Matrix, execution	4206c, Fig. 4-15	4-18
Mechanized:		
Force	1003b(1), Fig.4-22, 4303	1-3, 4-24, 4-30