

FM 7-8

INFANTRY RIFLE PLATOON AND SQUAD

**HEADQUARTERS
DEPARTMENT OF THE ARMY**

**DISTRIBUTION RESTRICTION –
Approved for public release; distribution is unlimited.**

C1, fm 7-8
1 March 2001

By Order of the Secretary of the Army:

ERIC K. SHINSEKI
General, United States Army
Chief of Staff



JOEL B. HUDSON
Administrative Assistant to the
Secretary of the Army
0104302

DISTRIBUTION:

Active Army, Army National Guard, and U.S. Army Reserve: To be distributed in accordance with the initial distribution number 110782, requirements for FM 7-8.

INFANTRY RIFLE PLATOON AND SQUAD

Contents

	Page
Preface	vi
Chapter 1. DOCTRINE	
Section I. Fundamentals	1-1
1-1. Mission	1-1
1-2. Combat Power	1-2
1-3. Leader Skills	1-3
1-4. Soldier Skills	1-4
1-5. Training	1-4
Section II. Platoon Operations	1-4
1-6. Movement	1-5
1-7. Offense	1-6
1-8. Defense	1-10
1-9. Security	1-19
Chapter 2. OPERATIONS	
Section I. Command and Control	2-1
2-1. Mission Tactics	2-1
2-2. Troop-Leading Procedure	2-3
2-3. Operation Order Format	2-10

DISTRIBUTION RESTRICTION—Approved for public release; distribution is unlimited.

*This publication supersedes FM 7-8, 31 December 1980; FM 7-70, 10 September 1986.

	Page
Section II. Security	2-24
2-4. Security During Movement	2-24
2-5. Security in the Offense	2-25
2-6. Security in the Defense	2-26
Section III. Movement	2-27
2-7. Fire Team Formations	2-27
2-8. Squad Formations	2-29
2-9. Platoon Formations	2-31
2-10. Movement Techniques	2-38
2-11. Actions at Danger Areas	2-47
Section IV. Offense	2-54
2-12. Movement to Contact	2-54
2-13. Deliberate Attack	2-56
2-14. Attacks During Limited Visibility	2-60
Section V. Defense	2-66
2-15. Conduct of the Defense	2-66
2-16. Security	2-72
2-17. Command Post and Communications	2-72
2-18. Weapons Emplacement	2-72
2-19. Range Cards	2-76
2-20. Types of Positions	2-79
2-21. Squad Positions	2-80
2-22. Platoon Positions	2-80
2-23. Sector Sketches	2-80
2-24. Fire Control Measures	2-82
2-25. Priority of Work	2-84
2-26. Coordination	2-85
2-27. Fighting Positions	2-86
Section VI. Other Operations	2-97
2-28. Withdrawal	2-97
2-29. Delay	2-101
2-30. Retirement	2-102
2-31. Linkup	2-102
2-32. Stay-Behind Operations	2-102
2-33. Relief in Place	2-103
Section VII. Fire Support	2-105
2-32. Offensive Fire Support Planning	2-105
2-33. Defensive Fire Support Planning	2-105
2-34. Techniques of Indirect Fire Control	2-106

	page
Section VIII. Combat Service Support	2-109
2-35. Planning of Combat Service Support	2-109
2-36. Resupply Operations	2-109
2-37. Resupply Techniques	2-110
2-38. Aerial Resupply	2-112
2-39. Maintenance	2-113
2-40. Transportation	2-113
2-41. Soldier's Load	2-113
2-42. Personnel Service Support	2-114
2-43. Health Services Support	2-119
Section IX. Armored Vehicle Support	2-124
2-44. Combined Operations With Armored Vehicles	2-124
2-45. Considerations	2-125
2-46. Communicating With Tanks	2-126
2-47. Infantry Riding on Armored Vehicles	2-127
Section X. Obstacles	2-129
2-48. Employing Obstacles	2-129
2-49. Types of Obstacles 2	-130
2-50. Enemy Obstacles	2-142
2-51. Breaching and Clearing Obstacles	2-143
Section XI. Nuclear, Biological, and Chemical Operations	2-147
2-52. Operating in a Nuclear Environment	2-147
2-53. Operating in a Chemical and Biological Environment	2-149
Section XII. Observation Posts	2-153
2-54. Considerations	2-153
2-55. Actions at the Observation Post	2-155
2-56. Squad-Sized Observation Post	2-155
2-57. Visual Terrain Search	2-155
Section XIII. Techniques of Fire	2-157
2-58. Fire Distribution	2-157
2-59. Fire Control	2-158
2-60. Methods of Engagement With LAW and AT4	2-159
Section XIV. Limited Visibility Techniques	2-160
2-61. Night Vision	2-160
2-62. Dark Adaptation	2-162

	page
2-63. Planning the Use of Night	
Vision/Sensor Assets	2-163
2-64. Night Operation Tips and Techniques	2-163
Chapter 3. PATROLLING	
Section I. Planning Considerations	3-1
3-1. Organization 3	-1
3-2. Initial Planning and Coordination	3-2
3-3. Completion of the Plan	3-3
3-4. Departure From Friendly Lines	3-5
3-5. Rally Points	3-6
3-6. Leader's Reconnaissance of the Objective	3-9
3-7. Reentry of Friendly Lines	3-9
3-8. Debriefing	3-10
Section II. Reconnaissance Patrol	3-11
3-9. Organization	3-11
3-10. Tasks to Subordinate Units	3-11
3-11. Area Reconnaissance	3-11
3-12. Zone Reconnaissance	3-12
3-13. Route Reconnaissance	3-17
Section III. Combat Patrol	3-19
3-14. Organization	3-19
3-15. Tasks to Subordinate Units	3-19
3-16. Leader's Reconnaissance of the Objective	3-20
3-17. Ambush	3-20
3-18. Hasty Ambush	3-22
3-19. Deliberate Ambush	3-24
3-20. Point Ambush	3-25
3-21. Area Ambush	3-27
3-22. Antiarmor Ambush	3-28
3-23. Raid	3-30
Section IV. Tracking Patrol	3-30
3-24. Considerations	3-30
3-25. Organization	3-30
3-26. Tasks to Subordinates	3-31
3-27. Training	3-31
3-28. Intelligence	3-31
3-29. Trail Signs	3-32

	page
Section V. Patrol Bases	3-37
3-30. Site Selection	3-37
3-31. Planning Considerations	3-37
3-32. Patrol Base Occupation	3-38
3-33. Patrol Base Activities	3-40
Chapter 4. BATTLE DRILLS	
4-1. Definition	4-1
4-3. Format	4-2
Battle Drill 1. Platoon Attack	4-2
Battle Drill 1A. Squad Attack	4-8
Battle Drill 2. React to Contact	4-12
Battle Drill 3. Break Contact	4-14
Battle Drill 4. React to Ambush	4-16
Battle Drill 5. Knock Out Bunkers	4-18
Battle Drill 6. Enter Building/Clear Room	4-22
Battle Drill 7. Enter/Clear a Trench	4-27
Battle Drill 8. Conduct Initial Breach of a Mined Wire Obstacle	4-33
Chapter 5. INFANTRY PLATOON STANDING OPERATING PROCEDURE	5-1
Chapter 6. URBAN OPERATIONS	6-1
Appendix A. ORGANIZATION	A-1
Appendix B. INFANTRY PLATOON REFERENCE GUIDE	B-1
Glossary	Glossary-1
References	References-1
Index	Index-1

PREFACE

This manual provides doctrine, tactics, techniques and procedures on how infantry rifle platoons and squads fight. Infantry rifle platoons and squads include infantry, airborne, air assault, ranger, and light infantry platoons and squads. This manual supersedes FM 7-8, Infantry Platoon and Squad dated April 1981, as well as FM 7-70, The Light Infantry platoon and Squad dated September 1986, and is aligned with the Army's AirLand Battle doctrine. It is not intended to be a stand-alone publication. An understanding of FM 7-10, The Infantry Rifle Company, and FM 7-20, The Infantry Battalion, is essential.

The primary audiences for this manual are the infantry rifle platoon leader platoon sergeant, and squad and fire team leaders; instructors in TRADOC schools; and writers of infantry training literature. Secondary audiences include other infantry leaders and staff officers, service schools, and ROTC and military academy instructors.

This manual is organized with separate chapters covering doctrine, tactics, techniques and procedures, and includes a tactical standing operating procedure. This manual is designed to fit in the cargo pocket of the leader's Battle Dress Uniform. It should be used in the field as a guide to training and combat operations. It is written with a heavy bias toward the tactics, techniques, and procedures that make infantry soldiers successful in battle. Leaders must use the tactics, techniques, and procedures, but they must not lose sight of the simple doctrinal principles outlined in Chapter 1, Doctrine. Additionally, infantry leaders should use this manual in developing an estimate of the situation and an analysis of mission, enemy, terrain, and troops and time available. This analysis leads to an effective plan and to successful execution of the assigned mission.

Tough, realistic training is the key to successful execution. The specifics of how to train the infantry platoon and squad are explained in ARTEP 7-8-MTP. This manual provides the tasks, conditions, and standards for training, and outline how to integrate individual, leader, and soldier tasks. Use these manuals to train.

The terms **doctrine, tactics, techniques, procedures, drills, and tactical standing operating procedure** have come to be used almost interchangeably over the years. This manual is written in closer adherence to the established Army definition of these important terms:

Doctrine. The fundamental PRINCIPLES by which military forces or elements thereof guide their actions in support of national objectives. It is authoritative but requires judgement in application. (JOINT Pub 1-02.)

Tactics. 1. The EMPLOYMENT of units in combat. 2. The ordered ARRANGEMENT and MANEUVER of units in relation to each other and/or to the enemy in order to utilize their full potential. (JOINT Pub 1-02.)

Techniques. The general and detailed METHODS used by troops or commanders to perform assigned missions and functions, specifically, the methods of using equipment and personnel. Techniques describe A WAY, not the only way. (AR 310-25, The Army Dictionary)

Procedures. A standard detailed COURSE OF ACTION that describes how to perform a task. Procedures prescribe THE WAY of accomplishing tasks. (TRADOC Reg 11-7, Armywide Doctrinal and Training Literature Program)

Drills. Drills provide small units standard procedures essential for building strong, aggressive units. They provide standardized actions that link soldier and collective tasks at platoon level and below. There are two types of drills that apply to all type units—battle drills and crew drills.

Battle Drill. A collective action rapidly executed without applying a deliberate decision-making process. Battle drills are further defined in Chapter 4.

Crew Drill. A collective action that the crew of a weapon or piece of equipment must perform to use the weapon or equipment. This manual does not discuss crew drills. (FM 25-101.)

Tactical SOP. A set of instructions covering those features of operations which lend themselves to a DEFINITE or STANDARDIZED PROCEDURE without loss of effectiveness. The procedure is applicable unless ordered otherwise. (JOINT Pub 1-02.)

The proponent for this publication is the United States Army Infantry School. Send comments and recommendations on DA Form 2028 directly to: Commandant, US Army Infantry School, ATTN: ATSH-ATD, Fort Benning, GA 31905-5410.

This publication implements the following international agreement:
STANAG 2003, Patrol Reports.

Unless this publication states otherwise, masculine nouns and pronouns do not refer exclusively to men.

CHAPTER 1

DOCTRINE

The US Army's basic fighting doctrine is called AirLand Battle. It reflects time proven fundamentals, the structure of modern warfare, and the experience of combat. AirLand Battle doctrine provides a specific mission for infantry forces.

Section I. FUNDAMENTALS

Among the infantry's basic fundamentals are the principles of war, the elements of combat power, and the tenets of AirLand Battle. These fundamentals have application at the platoon and squad level. This section provides the mission of the infantry and the doctrine principles basic to the infantry rifle platoon and squad. These principles form the basis for platoon and squad tactics, techniques, procedures, and drills. This section also discusses the elements of combat power and the skills required of leaders and soldiers at the small-unit level.

1-1. MISSION

The mission of the infantry is to close with the enemy by means of fire and maneuver to defeat or capture him, or to repel his assault by fire, close combat, and counterattack.

a. Despite any technological advantages that our armed forces might have over an enemy, only close combat between ground forces gains the decision in battle. Infantry rifle forces (infantry, airborne, air assault, light, and ranger) have a key role in close combat situations. They—

- Attack over approaches that are not feasible for heavy forces.
- Make initial penetrations in difficult terrain for exploitations by armor and mechanized infantry.
- Retain existing obstacles and difficult terrain as pivots for operational and tactical maneuver.
- Seize or secure forested and built-up areas.
- Control restrictive routes for use by other forces.

- Operate primarily at night or during other periods of natural or induced limited visibility.
- Follow and support exploiting heavy forces when augmented with transportation.
- Conduct rear area operations, capitalizing on air mobility.

b. Success in battle hinges on the actions of platoons and squads in close combat; on their ability to react to contact, employ suppressive fires, maneuver to a vulnerable flank, and fight through to defeat, destroy, or capture the enemy. The successful actions of small units relies on the ability of leaders and soldiers to use terrain to good advantage; to operate their weapons with accuracy and deadly effect; to out think, out move, and out fight the enemy.

c. Infantry file platoons and squads normally operate as part of a larger force. They benefit from the support of other infantry units, armor, artillery, mortars, close air, air defense, and engineer assets. They also provide their own suppressive fires either to repel enemy assaults or to support their own maneuver.

1-2. COMBAT POWER

The doctrine that guides infantry forces is based on the four elements of combat power: maneuver, firepower, protection, and leadership.

a. **Maneuver.** Maneuver is the movement of forces supported by fire to achieve a position of advantage from which to destroy or threaten destruction of the enemy. Infantry forces move to gain a position of advantage over the enemy and to hold that advantage. They maneuver to attack enemy flanks, rear areas, logistics points, and command posts. In the defense, they maneuver to counterattack a flank of the enemy attack. Maneuver, properly supported by fires, allows the infantry to close with the enemy and gain a decision in combat.

b. **Firepower.** Firepower is the capacity of a unit to deliver effective fires on a target. Firepower kills or suppresses the enemy in his positions, deceives the enemy, and supports maneuver. Without effective supporting fires the infantry cannot maneuver. Before attempting to maneuver, units must establish a base of fire. A base of fire is placed on an enemy force or position to reduce or eliminate the enemy's ability to interfere with friendly maneuver elements. Leaders must know how to control, mass, and combine fire with maneuver. They must identify the most critical targets quickly, direct fires onto them, and ensure that the volume of fires is sufficient to keep the enemy from returning fire effectively, and the unit from expending ammunition needlessly.

c. **Protection.** Protection is the conservation of the fighting potential of a force so that it can be applied at the decisive time and place. Units

must never permit the enemy to acquire an unexpected advantage. Platoons and squads take active and passive measures to protect themselves from surprise, observation, detection, interference, espionage, sabotage, or annoyance. Protection includes two basic considerations: care of the soldier and his equipment, and action to counter enemy combat power.

(1) The first consideration involves sustainment techniques necessary to maintain the platoon and squads as an effective fighting force. It includes keeping soldiers healthy to maintain fighting morale through personal hygiene, physical conditioning, and rest plans. It also includes keeping equipment in good working condition, and providing and protecting supplies. It means managing the soldier's load so that he carries only what is needed and is fit to fight when required.

(2) The second involves security, dispersion, cover, camouflage, deception, and suppression of enemy weapons. Ultimately, the infantryman must remain undetected to survive. Once found, the infantryman becomes vulnerable to all the fires of the enemy and he must either fight to break contact or to close with and finish the enemy. The infantry always wants to set the time and place of battle, and must protect itself so that it can do so with maximum combat power and the important element of surprise.

d. **Leadership.** Military leadership is a process by which a soldier influences others to accomplish the mission. Leaders coordinate the other three elements of combat power. Their competent and confident leadership results in effective unit action. The right leadership gives purpose, direction, and motivation in combat. Leaders must know their profession, their soldiers, and the tools of war. Only this kind of leader can direct soldiers to do difficult tasks under dangerous and stressful conditions.

1-3. LEADER SKILLS

Infantry platoon and squad leaders must be tacticians. They cannot rely on a book to solve tactical problems. They must understand and use initiative in accomplishing the mission. This means that they must know how to analyze the situation quickly and make decisions rapidly in light of the commander's intent. They must be prepared to take independent action if necessary. The art of making sound decisions quickly lies in the knowledge of tactics, the estimate process, and platoon and squad techniques and procedures. The skills required of infantry leaders include physical toughness, technical knowledge, mental agility, and a firm grasp of how to motivate soldiers to fight on in the face of adversity.

1-4. SOLDIER SKILLS

Soldiers with sharply honed skills form the building blocks of combat effective squads and platoons. They must maintain a high state of physical fitness. They must be experts in the use of their primary weapons. They must be proficient in infantry skills (land navigation, camouflage, individual movement techniques, survival techniques, and so forth). Finally, they must know and practice their roles as members of fire teams, squads, and platoons.

1-5. TRAINING

Infantry units must train properly for combat. Training must conform to Army doctrine. Doctrinal manuals provide leaders correct procedures and principles to conduct training properly. Leaders and soldiers must understand standardized doctrinal principles found in applicable publications. They should refer to ARTEP 7-8-MTP to find the specific conditions and standards for the techniques and procedures discussed in this manual. Training must require unit leaders to use their initiative and make decisions quickly. The training environment must be realistic and stressful. Training must challenge soldiers to master all infantry tasks, individual and collective, and it must constantly remind them of their mission, their heritage, and the physical and mental toughness that is required of them. Platoon training must also promote the cohesion of the unit so that, when all else fails, units continue to fight.

Section II. PLATOON OPERATIONS

This section describes the three basic tactical operations undertaken by infantry platoons and squads—movement, offense, and defense. It also discusses the requirement for security which is inherent in all platoon operations. Infantry tactics build on the following five principles:

1. Squads and platoons fight through enemy contact at the lowest possible level.
2. Squads in contact must establish effective suppressive fire before they or other squads can maneuver. If the squad cannot move under its own fires, the platoon must attempt to gain suppressive fires and then maneuver against the enemy position.
3. Platoons and squads will fight as organized with fire teams and squads retaining their integrity. Even buddy teams slay the same. The team leader and the automatic

rifleman form one buddy team, and the grenadier (M203) and a rifleman form the other buddy team.

4. Success depends upon all soldiers understanding what the platoon is trying to do and the specific steps necessary to accomplish the mission.
5. The platoon leader never waits for the squad in contact to develop the situation. Anytime a fire team makes contact, the platoon also begins taking action. That way the platoon can quickly provide additional support, maneuver to take up the assault, or follow-up on the success of the squad that made contact.

1-6. MOVEMENT

Movement refers to the shifting of forces on the battlefield. The key to moving successfully involves selecting the best combination of formations and movement techniques in each situation. Leaders consider the factors of mission, enemy, terrain, and troops and time available (METT-T) in selecting the best route and the appropriate formation and movement technique. The leader's selection must allow moving squads to-

- Maintain cohesion.
- Maintain momentum.
- Provide maximum protection.
- Make contact in a manner that allows them to transition smoothly to offensive or defensive action.

a. **Formations.** Formations are arrangements of units and of soldiers in relation to each other. Platoons and squads use formations for control, security, and flexibility.

(1) **Control.** Every squad and soldier has a standard position. Soldiers can see their team leaders. Fire team leaders can see their squad leaders. Leaders control their units using arm-and-hand signals.

(2) **Security.** Formations also provide 360-degree security and allow units to give the weight of their firepower to the flanks or front in anticipation of enemy contact.

(3) **Flexibility.** Formations do not demand parade ground precision. Platoons and squads must retain the flexibility needed to vary their formations to the situation. The use of formations allows soldiers to execute battle drills more quickly and gives them the assurance that their leaders and buddy team members are in their expected positions and performing the right tasks.

b. **Movement Techniques.** Movement techniques describe the position of squads and fire teams in relation to each other during movement.

Platoons and squads use three movement techniques: traveling, traveling overwatch, and bounding overwatch.

(1) Like formations, movement [techniques provide varying degrees of control security, and flexibility.

(2) Movement techniques differ from formations in two ways:

(a) Formations are relatively fixed; movement techniques are not. The distance between moving units or the distance that a squad bounds away from an overwatching squad varies based on factors of METT-T.

(b) Formations allow the platoon to weight its maximum firepower in a desired direction; movement techniques allow squads to make contact with the enemy with the smallest element possible. This allows leaders to establish a base of fire, initiate suppressive fires, and attempt to maneuver without first having to disengage or be reinforced.

(3) Leaders base their selection of a particular movement technique on the likelihood of enemy contact and the requirement for speed.

c. **Other Considerations.** In planning tactical movement, leaders should also consider the requirements for—

- Reconnaissance.
- Dispersion.
- Security.
- Cover and concealment.
- Speed.
- Observation and fields of fire.
- Maneuver space.
- Command and control.

1-7. OFFENSE

Units undertake offensive operations to destroy the enemy and his will to fight; to seize terrain; to learn enemy strength and disposition; or to deceive, divert, or fix the enemy. Infantry platoons and squads normally conduct offensive operations as part of a larger force. However, they can perform some offensive operations independently. The company commander's application of combat power at the decisive point determines the outcome of the battle. Offensive operations are characterized by flexibility, surprise, concentration, speed, and audacity. Offensive operations include movements to contact, attacks, raids, reconnaissance and security operations, and ambushes.

a. **Movement to Contact.** A movement to contact is an offensive action that seeks (to gain or regain contact with the enemy. Usually, a unit moving to contact lacks detailed information about the enemy. Upon making contact, a unit identifies the enemy strengths and weaknesses as it develops the situation. A platoon conducts a movement to contact as

part of a company. Considerations for planning and conducting movements to contact include—

- Make enemy contact with the smallest element possible.
- Prevent detection of elements not in contact until they are in the assault.
- Maintain 360-degree security at all times.
- Report all information quickly and accurately.
- Maintain contact once it is gained.
- Generate combat power rapidly upon contact.
- Fight through at the lowest level possible.

b. **Infiltration.** Infiltration is a form of maneuver in the offense. It is a means of reaching the enemy's rear without fighting through prepared defenses. Infantry platoons infiltrate to move into or through an area without being seen or heard. An infiltration is not an end in itself but a means to an end.

(1) Platoons infiltrate—

- To gather information.
- To attack enemy positions from the rear.
- To conduct raids or ambushes in enemy rear areas.
- To capture prisoners.
- To seize key terrain in support of other operations.
- To aid a main attack.

(2) An infiltration has five phases.

(a) **Patrol.** Find gaps, weak areas in enemy defenses and enemy positions.

(b) **Prepare.** Make plans, give orders, coordinate with forward and flank units, and rehearse.

(c) **Infiltrate.** Use the specified infiltration method. Avoid contact. Ignore ineffective enemy fire. The three methods of infiltration are—

1. Multiple lanes. When many gaps exist and the terrain can support a large number of lanes, each squad uses its own lane.
2. Single lane—staggered squads. Units move along a single lane at staggered times. This method can be used when few gaps exist or when the ground restricts the number of lanes.
3. Single lane—one squad. A single gap exists on which the whole squad can move at the same time.

(d) **Consolidate.** Do this in the enemy rear or along a final linkup point; then, move to an assault position or an objective rally point to continue the mission.

(e) **Execute.** Carry out the assigned mission. The mission can be destroy enemy forces or equipment, seize key terrain or an area, capture prisoners, or gather information.

c. **Types of Attack.** An attack is an offensive action characterized by movement supported by fire. There are two types of attack: hasty and deliberate. They are distinguished chiefly by the time available for preparation. Additionally, special-purpose attacks include raids and ambushes. Successful attack depends on concentrating the maximum possible shock and violence against the enemy force. Infantry forces combine shock and violence with surprise. The objective is to shatter the enemy's nerve, ruin his synchronization, unravel his plan, and destroy his unit's cohesion and the willingness of his soldiers to fight. A successful attack combines a scheme of maneuver with a coordinated plan of direct and indirect fire support. The focus of an attacking platoon's fire and maneuver is a weak point, a vulnerable flank, or the rear of an enemy. Once he has identified the point of attack, the leader establishes a base of fire to kill, fix, or suppress the enemy at that point. He then maneuvers the rest of his force to a position from which it can assault.

(1) **Hasty attack.** A hasty attack is conducted with the forces immediately available to maintain momentum or to take advantage of the enemy situation. It does not normally allow for extensive preparation.

(2) **Deliberate attack.** A deliberate attack is carefully planned and coordinated. More time is available to perform thorough reconnaissance, evaluation of all available intelligence and relative combat strength, analysis of various courses of action, and other factors affecting the situation. It is generally conducted against a well-organized defense when a hasty attack is not possible or has been conducted and failed.

(3) **Raid.** A raid is an operation involving a swift penetration of hostile territory to secure information, to confuse the enemy, or to destroy his installations. It ends with a planned withdrawal after completion of the assigned mission.

(4) **Ambush.** An ambush is a surprise attack by fire from concealed positions on a moving or temporarily halted enemy unit. It combines the advantages and characteristics of the offense with those of the defense.

d. **Initiative in the Attack.** Seizing and retaining the initiative involves more than just achieving tactical surprise. It involves a process of planning and preparing for combat operations, finding the enemy first, avoiding detection, fixing the enemy, locating or creating a weakness, and maneuvering to exploit that weakness with a quick and violent assault.

(1) **Plan and prepare.** Leaders use the troop-leading procedure to make sure that all necessary steps are taken to prepare for an operation. Leaders use the estimate of the situation to analyze the factors of METT-T

and to determine the best course of action and to ensure that leaders, soldiers, and their equipment can perform the tasks necessary to accomplish the mission.

(2) **Find the enemy.** Platoon leaders find the enemy by knowing how he fights, by analyzing the terrain in light of this knowledge, and by actively reconnoitering to locate him.

(3) **Avoid detection.** Platoons avoid detection by moving along the least expected, generally the most difficult, route. They use the terrain to mask their movements. They use proper camouflage techniques and move with stealth. This allows platoons to capitalize on surprise. All of this requires imagination in leaders and stamina in all soldiers.

(4) **Fix the enemy.** Platoons and squads fix enemy forces by employing suppressive fires that kill exposed enemy soldiers and destroy their weapons. As a minimum, they render the volume and accuracy of the enemy's fire ineffective.

(5) **Find or create a weakness.** Leaders look for vulnerable flanks, gaps in lines, or lulls in enemy fire. When they cannot readily find a weakness, they create one with suppressive fire and the surprise effect of its suddenly coming from an unexpected direction.

(6) **Maneuver to exploit the weakness.** Leaders must exploit this weakness by moving to the best covered and concealed position and then assaulting to destroy, defeat, or capture the enemy.

(7) **Consolidate and reorganize.** Finally, platoons and squads must quickly consolidate the position to defend it against an enemy counter-attack. Units then reorganize themselves and prepare to continue the mission.

e, **Control Measures.** Leaders use graphic control measures to regulate or direct the platoon's movement, positions, and fire.

(1) Control measures are not intended to restrict the exercise of initiative (the function of command). Leaders use control measures to clarify their intent, focus the platoon or squad effort, and ensure synchronization. Each control measure should have a specific purpose that contributes to mission accomplishment. If a control measure fails the purpose test, leaders should not use it.

(2) Control measures can be drawn on a map, overlay, sketch, or a terrain model. Leaders should strive to keep control measures easily identifiable and simple. Graphic control measures in the offense include assembly area, attack position, line of departure, boundaries, route, release point, start point, axis of advance, direction of attack, phase line, checkpoint, assault position, objective, contact point, link-up point, infiltration lane, probable line of deployment, and limit of

advance. FM 101-5-1 discusses these control measures in detail and provides examples of their use.

f. **Attacks During Limited Visibility.** Attacks during limited visibility achieve surprise, avoid heavy losses, cause panic in a weak and disorganized enemy, exploit success, maintain momentum, and keep pressure on the enemy. Platoons and squads attack whenever possible during limited visibility. Darkness, fog, heavy rain, falling snow, and the smoke and dust of combat create limited visibility conditions that allow infantry platoons and squads to move undetected.

(1) **Fundamentals.** The fundamentals for a daylight attack apply to limited visibility attacks. Limited visibility attacks require-

- Well-trained squads.
- Natural light sufficient to employ night vision devices.
- A simple concept with sufficient control measures.
- Detailed, successful reconnaissance of the objective, routes, passage points, support-by-fire positions, and other key locations.

(2) **Considerations** Leaders must consider the increased difficulty during limited visibility operations in performing the following:

- Controlling the movement of individuals and squads.
- Identifying targets and controlling direct and indirect fires.
- Navigating and moving.
- Identifying friendly and enemy soldiers.
- Locating, treating, and evacuating casualties.
- Locating and bypassing or breaching enemy obstacles.

1-8. DEFENSE

This paragraph describes the characteristics of defensive operations, the role of the commander's concept in focusing the efforts of platoons and squads in the defense, and other considerations for planning defensive operations. Defensive operations are characterized by preparation, disruption, concentration, and flexibility. Platoons and squads normally defend as part of a larger force to disrupt, disorganize, delay, or defeat an attacking enemy, deny an area to an enemy, or protect a flank. They may also defend as a part of a larger unit in a retrograde operation. The challenge to the defender is to retain the initiative, that is, to keep the enemy reacting and unable to execute his own plan.

a. **Initiative in the Defense.** Since the enemy decides the time and place of the attack, leaders seize and retain the initiative in the defense through careful planning, preparation, coordination, and rehearsal. Leaders plan and establish the defense to find the enemy first, without being found; fix the enemy with obstacles and fires; locate or create a

weakness in the enemy's attack plan; and maneuver to exploit that weakness with quick violent counterattack.

(1) **Plan and prepare.** Leaders use the troop-leading procedure to make sure that all necessary steps are taken to prepare for an operation. They analyze the factors of METT-T to determine the best course of action. In the defense, they determine where best to kill the enemy with fires. They position key weapons to concentrate fires into that area, tie in fires with obstacles, position the remaining platoon and squad weapons to support and protect the key weapons, and reconnoiter and rehearse counterattacks.

(2) **Find the enemy.** Platoon leaders find the enemy by knowing how he fights, by analyzing the terrain in light of this knowledge, by positioning OPs along likely avenues of approach, and by actively patrolling to locate him.

(3) **Avoid detection.** Platoons avoid detection by securing their defensive positions or sectors early and continuously, by positioning squads and weapons away from natural lines of drift or obvious terrain features, and by employing effective camouflage and noise and light discipline.

(4) **Fix the enemy.** Platoons use a combination of tactical obstacles and direct and indirect fires to disrupt the enemy attack and fix the enemy in a place where the platoon can destroy him with fires.

(5) **Find or create a weakness.** Platoons create a weakness by destroying the enemy's command and control nodes, by isolating an attacking or assaulting enemy formation from its support, by causing mounted forces to dismount and thereby slowing the attack and making the enemy vehicles more vulnerable, by use of night vision devices to gain a visibility advantage, or by the effective use of illumination to blind or expose the enemy during his attack.

(6) **Maneuver to exploit the weakness.** Having created a weakness, platoons must exploit it with counterattacks against the flank or rear of the enemy attack by fire or maneuver. Platoons must carefully coordinate and rehearse all counterattacks to ensure the proper synchronization in lifting and shifting of direct and indirect fires. They must also consider the threat of follow-on enemy forces against their counterattack.

(7) **Reorganize.** Platoons and squads must be able to reorganize quickly to continue the defense against follow-on forces.

b. **Defense on a Reverse Slope.** An infantry company or platoon can organize a defense on the reverse slope of a hill (Figure 1-1, page 1-12). This defense is on the part of the hill or ridge that is masked by the crest from enemy direct fire and ground observation. The platoon must control the crest by fire.

- (1) The advantages of defending from a reverse slope are—
- Enemy ground observation of the position is masked.
 - There is more freedom of movement in the position due to the enemy's lack of ground observation.
 - Enemy direct-fire weapons cannot hit the position.
 - Enemy indirect fire is less effective due to the lack of enemy ground observation.
 - The defender gains surprise.
 - If the enemy attacks over the crest, he will isolate himself from his supporting element(s).

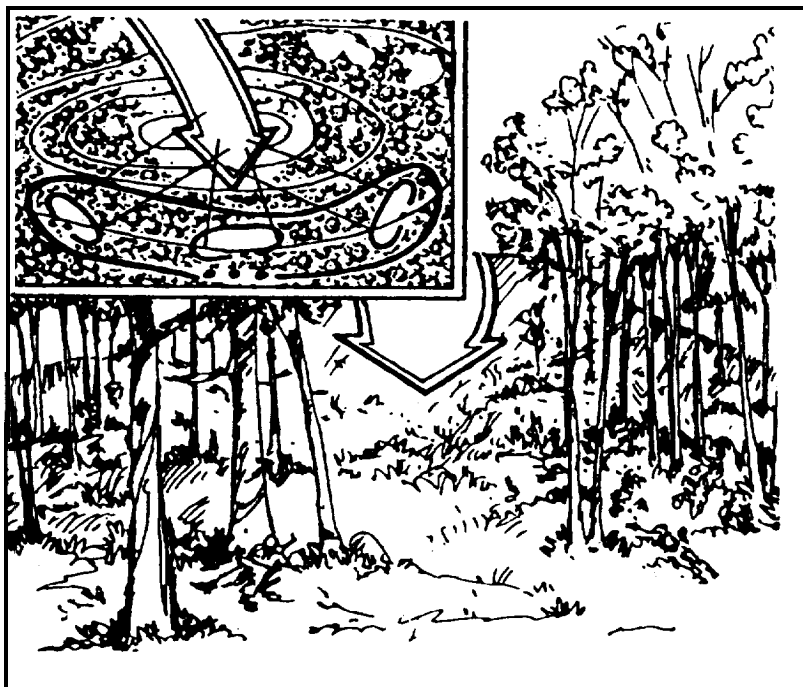

Figure 1-1. Defending from the reverse slope.

- (2) The disadvantages of defending from a reverse slope may include the following:
- It is more difficult to observe the enemy. Soldiers can see no farther forward than the crest, making it difficult to determine just where the enemy is as he advances. This is especially true during limited visibility conditions. OPs must be placed well forward of the crest for early warning and long-range observation.
 - Moving out of the position under pressure may be more difficult.

- Fields of fire are normally short. Grazing fire maybe less than 600 meters.
- Obstacles on the forward slope can only be covered with indirect fire or by units on the flanks-unless some weapons are initially placed forward.
- If the enemy gets to the crest, he can assault down the hill. This may give him a psychological advantage.
- If enough OPs are not put out or if they are not put in the right positions, the enemy may suddenly appear at close range without enough warning.

(3) The forward platoons are from 200 to 500 meters from the crest of the hills where they can have the best fields of fire and still have the advantages of the reverse slope.

(4) If it places them in supporting distance, the overmatching platoon is positioned on the forward slope of the next high ground to the rear (counterslope). Tasks assigned to the overmatching platoon include—

- Protect the flanks and rear of the forward positions.
- Reinforce the fires of the forward elements.
- Ǻ Block penetrations of the forward positions.
- Ǻ Cover the withdrawal of forward units.
- Counterattack.

(5) Platoon leaders plan indirect fire FPFs on or short of the crest of the hill to deny that area to the enemy and to help breakup his assault as he crosses the crest.

(6) Platoons position OPs on, or just forward of the crest to watch the entire platoon sector of fire. The OPs can vary in size from two soldiers to a squad reinforced with machine guns and antiarmor weapons.

(7) Leaders place obstacles below the crest of the hill on the friendly side. Tied in with an FPF, this can be effective in stopping or slowing an assault.

(8) The conduct of the defense from a reverse slope is the same as from a forward slope. However, the OPs forward of the position not only warn of the enemy's advance but also delay, deceive, and disorganize him by fire. OPs withdraw before they become engaged by the enemy. If machine guns are with the OPs, they withdraw first so they can occupy their primary fighting positions before the enemy reaches the crest. As the OPs withdraw, indirect fire is placed on the forward slope and on the crest of the hill to slow the enemy's advance. Soldiers in primary positions hold their fire until the enemy crosses the crest. As the enemy moves over the crest of the hill, the defenders hit him with all available fire.

(9) When the enemy assaults across the crest and is defeated, he will try to turn, bypass, or envelop the defense. To counter this, the overwatch element orients its fires to the flanks of the forward slope. Also, the defense must have appropriate supplementary positions and obstacles, as well as security elements, to warn if the enemy tries to envelop or bypass the position. Against armored, motorized, or road-bound attack, commanders and leaders should position antiarmor weapons and machine guns so their primary sectors are to the flanks of the reverse slope.

c. **Perimeter Defense.** The major advantage of the perimeter defense (Figure 1-2) is the preparedness of the platoon to defend against an attack from any direction. The main disadvantage is that combat power is not concentrated at first against an enemy avenue of approach. A perimeter defense differs from other defenses in that—

- The trace of the platoon is circular or triangular rather than linear.
- Unoccupied areas between squads are smaller.
- The flanks of the squads are bent back to conform to the plan.
- The bulk of combat power is on the perimeter.
- The reserve is centrally located.

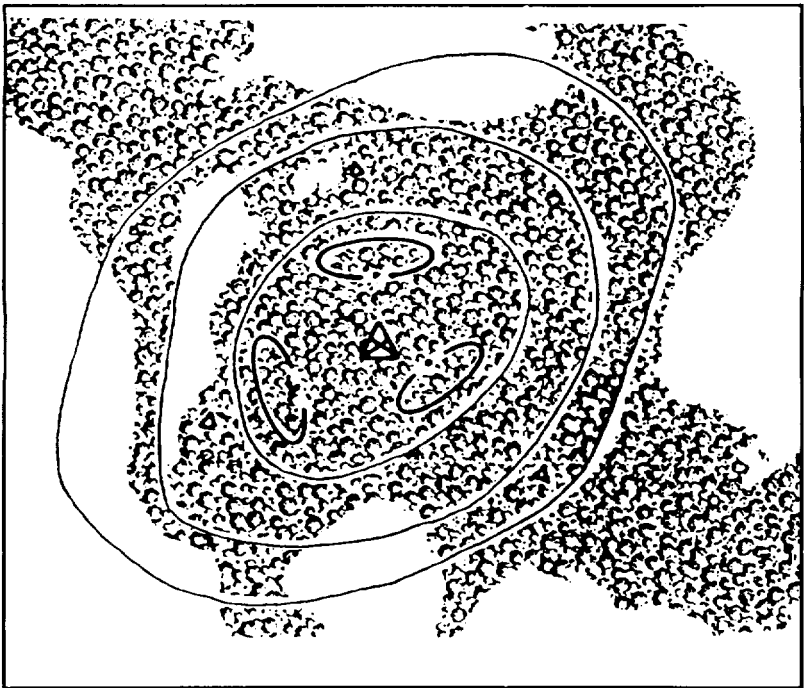

Figure 1-2. Perimeter defense.

d. **Defense in Sector.** Defense in sector maximizes the combat abilities of the infantry. It allows the platoon to fight throughout the depth of the sector using dispersed small-unit tactics.

(1) The platoon is usually assigned a sector within the company sector (Figure 1-3). The platoon leader may in turn assign sectors to individual squads to permit maximum freedom of action for the squad to defend. The platoon leader must remember that the squad has no way to call for fire support other than through the platoon net. FOs may be attached, or as a minimum leaders must be prepared to assist in calls for supporting fires.

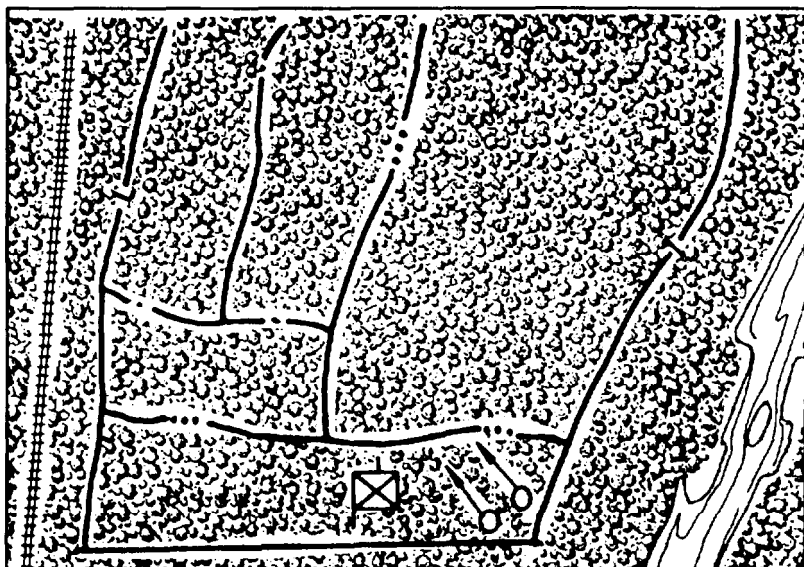

Figure 1-3 Assigned sectors.

(2) Each squad conducts detailed reconnaissance of its sector and identifies all likely enemy avenues of approach, choke points, kill zones, obstacles, patrol bases, and cache sites. They also identify all tentative positions.

(3) The platoon leader confirms the selected tentative sites and incorporates them into his concept (Figure 1-4, page 1-16). He designates initial positions and the sequence in which successive positions are to be occupied. He gives each squad specific guidance concerning contingency plans, rally points, and other coordinating instructions.

(4) Squads then prepare the defense in the sequence designated by the platoon leader. They initially prepare the primary position and then

a hasty supplementary position, and then they select the alternate position. Squads improve (he positions as time permits.

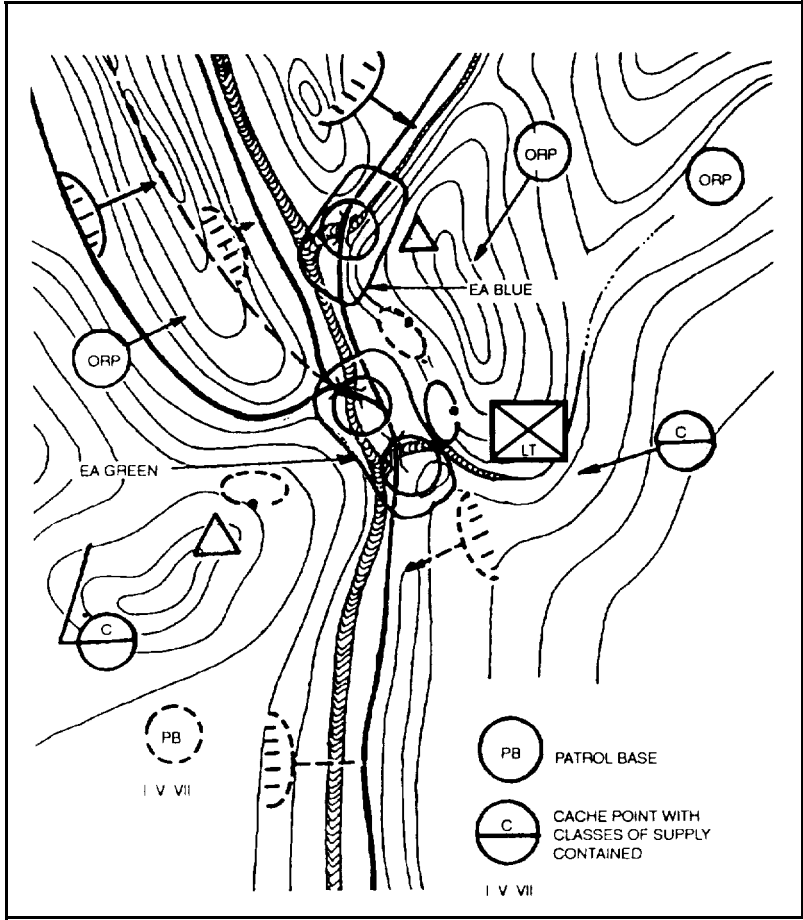

Figure 1-4. Concept of the operation for a defense in a sector.

(5) When Security warns of approaching enemy, the squad occupies its primary positions and prepares to engage the enemy. As the enemy moves into the choke point or kill zone, the squad initiates an ambush. It engages the enemy targets only as long as squads do not become decisively engaged. Squads then move to their next position and repeat the same process. The leader must plan the disengagement Supporting positions, the use of smoke, and rehearsals are key to effective disengagements.

Depending on METT-T factors, the entire battle maybe fought this way. Some variations of this technique include the following:

(a) Allowing the enemy to exhaust himself reacting to numerous ambushes, then conduct a violent counterattack along previously rehearsed routes to complete the destruction of the enemy. The platoon leader can do (his by retaining direct control over a large portion of the platoon and committing it at the decisive moment. An alternative is to use prearranged signals to consolidate the platoon at a rally point; then to conduct the counterattack.

(b) Having the forward ambush teams hold their fire until the lead elements of the enemy formation hit another ambush deeper in the sector. Then ambush the the next enemy element as it passes through the kill zone. This technique destroys the cohesion of the enemy and is especially effective if the ambush eliminates the command group of the enemy unit.

(c) Planning indirect fires to cause more enemy casualties at ambush sites along a well-defined route.

(6) Casualty evacuation and resupply of ammunition and water are particularly difficult when defending this way.

e. Mutually Supporting Battle Positions. Platoons and squads use this technique to concentrate firepower into a given engagement area. This technique prevents the attacker from focusing on the entire defensive scheme.

(1) Leaders must ensure that the position is organized in depth, that all likely avenues of approach arc covered by fire, and that all positions have interlocking fires. Each position must be supported by another position that can deliver fires into the flank or rear of the enemy attacking it. Leaders must include obstacles in the fire plan to slow and stop the enemy in the engagement area-to include extensive use of mines. Squads patrol forward of the BP to provide security. They harass the enemy to disorganize and confuse him as to the location of the main defenses.

NOTE: Fighting positions are not located on likely avenues of approach.

(2) The positioning of squads, organization of the engagement area, and fire control measures arc critical to the succcss of this technique. Leaders position their squads in relation to the avenue of approach. Platoon leaders use essential control measures to mass fires against the enemy within their sectors.

(3) variations of this technique include—

- Opening fire at the some time and withdrawing on command.
- Opening fire one element at a time. As the enemy orients on each element firing at them and begins to maneuver

against it, other elements open fire and the original element withdraws once it is no longer receiving enemy fire. It either moves to a new position or to a rally point.

- Maneuvering to prevent the enemy from withdrawing or reinforcing.
- Designating more than one engagement area. Leaders use supplementary and on-order positions and secondary sectors of fire to mass fire into engagement areas as required.

f. **Control Measures.** Leaders use control measures to assign responsibilities, coordinate fires and maneuver, control combat operations, and clarify their concept of the operation. Additionally, control measures ensure the distribution of fires throughout the platoon's area of responsibility and the initial positioning and subsequent maneuver of squads.

(1) Graphic control measures used in the defense include sectors, battle positions, boundaries, contact points, coordination points, forward edge of the battle area (FEBA), strongpoints, target reference points (TRP), assembly areas, phase lines, passage points and lanes, release points, and engagement areas. FM 101- 5-1 discusses these control measures in detail and provides examples of their use.

(2) Fire commands and control measures for individual and key weapons also constitute a type of control measure available to leaders. Weapons control measures include range cards, sectors of fire, principle direction of fire, final protective line, final protective fires, and target reference points. Most of these appear on the range card. Chapter 2 describes the requirements for weapons range cards and provides examples. In addition, antiarmor gunners, machine gun [cures, fire teams, squads, and platoons can be given engagement priorities and fire commands.

g. **Obstacles.** Obstacles give strength to a defense when properly employed. Platoons and squads incorporate existing and reinforcing obstacles into their defense and construct other obstacles systems with mines and wire.

(1) **Considerations.** Leaders must integrate their obstacle plans with direct and indirect fire plans and with their scheme of maneuver. Platoons and squads always cover obstacles by fire and observation. They protect obstacles with antipersonnel mines, trip flares, and warning devices. They camouflage wire or hide it in natural terrain features. Chapter 2 discusses the techniques of obstacle employment most common to infantry platoons and squads.

(2) **Classification.** Wire obstacles have three classifications based on their use and location. Priority for emplacement normally goes to tactical

wire. Additionally, leaders can organize their obstacles so that one obstacle can serve both tactical and protective functions.

(a) *Tactical.* Platoons site tactical wire parallel to and along the friendly side of the FPLs of their major weapons. Tactical wire holds the enemy where he can be killed or wounded by automatic rifle fire, Claymores, hand grenades, and machine gun fire.

(b) *Protective.* Squads locate protective wire to prevent surprise assaults from points close to the defense area. It normally lies just outside of hand-grenade range and well within both day and night observation.

(c) *Supplementary.* Platoons and squads use supplementary wire to disguise the exact line of tactical wire and to give continuity to the company obstacle plan.

1-9. SECURITY

Security includes any measure taken by platoons and squads against actions that may reduce their effectiveness. It involves avoiding detection by the enemy or deceiving the enemy about friendly positions and intentions. It also includes finding the enemy and knowing as much about his positions and intentions as possible. Security allows units to retain freedom of action and is an important part of maintaining the initiative. The requirement for security is an inherent part of all platoon operations. Platoons and squads secure themselves when they move, attack, and defend. As part of a larger formation, they may undertake security operations that involve patrolling; establishing squad-sized OPs on a screen line; or executing advance, flank, or rear guard missions for the main body in a movement to contact.

a. **Security During Movement.** Platoons and squads enhance security during movement by—

- Using the proper movement formation and technique.
- Moving as fast as the situation will allow. This may degrade the enemy's ability to detect the platoon or squad and the effectiveness of his fires once detected.
- Moving along terrain that offers cover and concealment.
- Enforcing noise and light discipline.
- Using proper camouflage techniques.

b. **Security in the Offense.** Security in the offense includes reconnaissance and security missions to locate the enemy and protect friendly forces from surprise while leaving them free to deploy when contact is made with the enemy. All platoons and squads are responsible for their own local security. They may also be given specific reconnaissance and security tasks as part of the company or battalion plan. Platoons and squads conduct patrols, establish OPs, and move using appropriate

movement formations and techniques to accomplish both reconnaissance and security tasks.

c. **Security in the Defense.** In the defense, platoons and squads use both active and passive measures to enhance security. Platoons also add to their security by actions taken to deny enemy reconnaissance elements accurate information on friendly positions. This includes the destruction of enemy reconnaissance elements and the use of deception measures.

(1) Active measures include—

- The use of OPs and patrols.
- The establishment of specific levels of alert within the platoon. The level can be adjusted based on the METT-T situation.
- Establishment of stand-to times. The platoon's SOP should detail the platoon's activities for stand-to.

(2) Passive measures include camouflage; movement control; noise and light discipline; proper radiotelephone procedures; and ground sensors, night vision devices, and antiarmor weapons' day and nightsights.

CHAPTER 2

OPERATIONS

This chapter provides techniques and procedures used by infantry platoons and squads. These techniques are used throughout the planning and execution phases of platoon and squad tactical operations.

Section I. COMMAND AND CONTROL

This section discusses mission tactics, troop-leading procedure, combat orders, and techniques for preparing a platoon to fight. These topics pertain to all combat operations. Their application requires time. With more time, leaders can plan and prepare in depth. With less time, they must rely on previously rehearsed actions, battle drills, and standing operating procedures.

2-1. MISSION TACTICS

Mission tactics is the term used to describe the exercise of command authority by a leader. Mission tactics places the relationship of command, control, and communications in proper perspective by emphasizing the predominance of command. This emphasis on command, rather than control, provides for initiative, the acceptance of risk, and the rapid seizure of opportunities on the battlefield. Mission tactics can be viewed as freedom of action for the leader to execute his mission in the way he sees fit, rather than being told how to do it. Mission tactics reinforced by the knowledge of the higher commander's intent and focused on a main effort establishes the necessary basis for small-unit leadership.

a. The philosophy of mission tactics extends throughout all levels of command. Leaders must be provided the maximum freedom to command and have imposed on them only the control necessary to synchronize mission accomplishment. Sometimes leaders must issue specific instructions. Normally, this is necessary when the unit's actions must be synchronized with other actions. Mission tactics, as a command philosophy, recognizes the many tools available to the leader, but emphasizes that there is no substitute for the personal element of command.

b. Execution of mission tactics requires initiative, resourcefulness, and imagination. Initiative must be driven by the commander's intent, not

merely by a desire for independent action. Leaders must be resourceful enough to adapt to situations as they are, not as they were expected to be.

c. Platoon and squad leaders also must effectively control their subordinates. Control restricts command. Generally, increased control leads to less application of command. Not all control is bad or counter-productive. For example, common doctrine is a form of control in that all leaders expect their subordinates to understand and apply the tenets of doctrine. Another common source of control is the use of graphics for operation overlays. While optional and situationally -dependent, these are restrictive and must be reviewed by the leader before implementation. Each control measure must have a specific purpose that contributes to mission accomplishment. If it does not pass this purpose test, it unnecessarily restricts freedom of action and should not be used.

d. Control is necessary to synchronize the actions of elements participating in an operation. The more complex the operation, the greater the amount of control needed. The challenge to leaders is to provide the minimal amount of control required and still allow for decentralized decision making in each situation.

(1) Mission tactics requires that leaders learn how to think rather than what to think. It recognizes that the subordinate is often the only person at the point of decision who can make an informed decision. Guided by the commander's intent, the mission, and the concept of the operation, the leader can make the right decision.

(2) At platoon and squad level useful forms of control include common doctrine, mission, concept of the operation, time, and control measures.

(a) Doctrine, especially the form of battle drills and unit SOPs that prescribe a way of performing a task, provides an element of control. By limiting the ways in which a task is performed to standard, battle drills and unit SOPs provide a common basis for action: allow for quick, practiced response; decrease the probability for confusion and loss of cohesion; and reduce the number of decisions to the essential minimum.

(b) The mission statement of the platoon is also a form of control. Its purpose provides the basis for decision and allows freedom of action. Its task provides a basis for establishing the main effort and focuses all other actions toward mission accomplishment.

(c) The concept of the operation identifies the main and supporting efforts for the higher unit and describes how a commander sees the execution of the operation. This allows the maximum possible freedom of action for the subordinate leader tasked with executing the main effort. Leaders executing the supporting effort will have less freedom of action because they must key their actions on the main effort. The concept of

the operation also details the control of fires and other combat multipliers which must be synchronized and focused on the main effort.

(d) Leaders use time to control units or individuals by establishing specifically when a task should begin or be complete. Control using time is especially critical when the platoon's actions must be synchronized with other units or supporting elements.

(c) Another source of control is the use of control measures. These include instructions to subordinate units, fire commands, and the use of operational graphics in overlays. While normally optional and situationally-dependent, control measures are potentially restrictive and must be reviewed by leaders before incorporating them into their plans. To ensure the proper amount of control, each control measure must have a specific purpose that contributes to mission accomplishment. If it does not pass (his test, it unnecessarily restricts freedom of action and should not be used.

e. Platoon and squad leaders use mission tactics to accomplish the mission. They give orders and instructions that communicate the higher commander's intent; the mission (task and purpose) of the unit; and the concept of the operation, to include control measures. They also use mission tactics to ensure that subordinates understand that they are expected to use initiative in making decisions when the situation is no longer what it was expected to be.

2-2 TROOP-LEADING PROCEDURE

Troop leading is the process a leader goes through to prepare his unit to accomplish a tactical mission. It begins when he is alerted for a mission. It starts again when he receives a change or a new mission. The troop-leading procedure comprises the steps listed below. Steps 3 through 8 may not follow a rigid sequence. Many of them may be accomplished concurrently. In combat, rarely will leaders have enough time to go through each step in detail. Leaders must use the procedure as outlined, if only in abbreviated form, to ensure that nothing is left out of planning and preparation, and that their soldiers understand the platoon's and squad's mission and prepare adequately. They continuously update their estimates throughout the preparation phase and adjust their plans as appropriate.

STEP 1. Receive the mission.

STEP 2. Issue a warning order.

STEP 3. Make a tentative plan.

**STEP 4. Start necessary
movement.**

STEP 5. Reconnoiter.

STEP 6. Complete the plan.

STEP 7. Issue the complete order.

STEP 8. Supervise.

a. **STEP 1. Receive the Mission.** The leader may receive the mission in a warning order, an operation order (OPORD), or a fragmentary order (FRAGO). He immediately begins to analyze it using the factors of METT-T

- What is the **MISSION**?
- What is known about the **ENEMY**?
- How will **TERRAIN** and weather affect the operation?
- What **TROOPS** are available?
- How much **TIME** is available?

(1) The leader should use no more than one third of the available time for his own planning and for issuing his operation order. The remaining two thirds is for subordinates to plan and prepare for the operation. Leaders should also consider other factors such as available daylight and travel time to and from orders and rehearsals. In the offense, the leader has one third of the time from his receipt of the mission to the unit's LD time. In the defense, he has one third of the time from mission receipt to the time the squad or platoon must be prepared to defend.

(2) In scheduling preparation activities, the leader should work backwards from the LD or defend time. This is reverse planning. He must allow enough time for the completion of each task.

b. **STEP 2. Issue a Warning Order.** The leader provides initial instructions in a warning order. The warning order contains enough information to begin preparation as soon as possible. Platoon SOPs should prescribe who will attend all warning orders and the actions they must take upon receipt: for example, drawing ammunition, rations and water, and checking communications equipment. The warning order has no specific format. One technique is to use the five-paragraph OPORD format. The leader issues the warning order with all the information he has available at the time. He provides updates as often as necessary. The leader never waits for information to fill a format. A sample warning order is in Figure 2-1. If available, the following information may be included in a warning order.

- The mission or nature of the operation.
- Who is participating in the operation.
- Time of the operation.
- Time and place for issuance of the operation order.

FORMAT	ANNOTATED FORMAT	EXAMPLE, ORAL (ATTACK)
SITUATION	Brief description of the enemy and friendly situations. Point out key locations on the ground, map, or sketch. Attachments and detachments to the squad/platoon.	<p>"This is a warning order. Hold your questions until I finish.</p> <p>"The scouts have identified a motorized rifle platoon with at least two BTRs defending Hill 876, vic GL123456. They are digging in and it looks like they plan to defend the road junction at GL126463. The rest of the enemy company is further to the west, around Hill 899.</p> <p>"Captain Williams just issued a warning order for the company to prepare for an infiltration at 0200 11 July to seize Hill 876 in order to provide suppressive fires for the battalion's main attack on Hill 899.</p> <p>"There are no attachments or detachments.</p> <p>"3d Plt attacks 11 0200 Jul 91 to seize Hill 876 (GL123456) in order to provide fires on Hill 899 in support of the battalion's attack.</p> <p>"We will be one of the two assault platoons along with 2d Plt. 1st Plt will be the base of fire along with the company mortars and Dragons.</p>
MISSION	Concise statement of the task and purpose (who, what, when, where, and why). If not all information is known, state which parts of the mission statement are tentative.	
EXECUTION	Brief statement of the tentative concept of the operation.	

Figure 2-1. Example of platoon warning order.

FORMAT	ANNOTATED FORMAT	EXAMPLE, ORAL (ATTACK)
EXECUTION (continued)	<p>Time schedule: Earliest time of move. Time and place of OPOD. Probable execution time. Inspection times and items to be inspected different from SOP Rehearsal time, location, and actions to be rehearsed.</p>	<p>"Time schedule is as follows: LD time is 0200. The earliest we will have to move is 2330. After 2330, we have to be ready to move within 10 minutes of the order to do so. My final inspection will be at 2300, here at the CP. We have a company rehearsal for team leaders on up, at 1600 at the company CP. We will meet here at 1530 and move together. I want a platoon rehearsal for team leaders, squad leaders, the aidman, the FO, and of course, SFC Fowler (the PSG) here at our CP at 1330. We will do a full platoon rehearsal at 2100 so we can do it at least once in the dark. Platoon rehearsals will be for actions at the objective. Squads rehearse breaching and react to contact drills on your own. My OPOD will be here at the platoon CP at 1030.</p> <p>Tasks to subordinate key personnel: Platoon sergeant Squad leaders RATELO Aidman Attachments To soldiers helping prepare OPOD. As needed to others.</p>

Figure 2-1. Example of platoon warning order (continued).

FORMAT	ANNOTATED FORMAT	EXAMPLE, ORAL (ATTACK)
SERVICE SUPPORT	Additional general instructions. CSS tasks to be accomplished that are different from the TACSOP.	"Each squad will carry four AT4s to use against the BTRs or any bunkers we find.
COMMAND AND SIGNAL	Location of CP succession of command (if not SOP). SOI in effect. Signals/code words.	"No change to platoon organization. The platoon CP will stay here. SOI we have is still in effect.
		"The time is now 0620. What are your questions?"

Figure 2-1. Example of platoon warning order (continued).

c. **STEP 3. Make a Tentative Plan.** The leader develops an estimate of the situation to use as the basis for his tentative plan. The estimate is the military decision making process. It consists of five steps: detailed mission analysis, situation analysis and course of action development, analysis of each course of action, comparison of each course of action, and decision. The decision represents the tentative plan. The leader updates the estimate continuously and refines his plan accordingly. He uses this plan as the start point for coordination, reconnaissance, task organization (if required), and movement instructions. He works through this problem solving sequence in as much detail as time available allows. As the basis of his estimate, the leader considers the factors of METT-T:

(1) **Mission.** The leader considers his mission as given to him by his commander. He analyzes it in light of the commander's intent two command levels higher, and derives the essential tasks his unit must perform in order to accomplish the mission.

(2) **Enemy.** The leader considers the type, size, organization, tactics, and equipment of the enemy he expects to encounter. He identifies their greatest threat to his mission find their greatest vulnerability.

(3) **Terrain.** The leader considers the effect of terrain and weather on enemy and friendly forces using the guidelines below (OCOKA):

(a) **Observation and fields of fire.** The leader considers ground that allows him observation of the enemy throughout his area of operation. He considers fields of fire in terms of the characteristics of the weapons available to him; for example, maximum effective range, the requirement for grazing fire, and the arming range and time of flight for antiarmor weapons.

(b) **Cover and concealment.** The leader looks for terrain that will protect him from direct and indirect fires (cover) and from aerial and ground observation (concealment)

(c) **Obstacles.** In the attack, the leader considers the effect of restrictive terrain on his ability to maneuver. In the defense, he considers how he will tie in his obstacles to the terrain to disrupt, turn, fix, or block an enemy force and protect his own forces from enemy assault.

(d) **Key terrain.** Key terrain is any locality or area whose seizure or retention affords a marked advantage to either combatant. The leader considers key terrain in his selection of objectives, support positions, and routes in the offense, and on the positioning of his unit in the defense.

(c) **Avenues of approach.** An avenue of approach is an air or ground route of an attacking force of a given size leading to its objective or key terrain in its path. In the offense, the leader identifies the avenue of approach that affords him the greatest protection and places him at the enemy's most vulnerable spot. In the defense, the leader positions his key

weapons along the avenue of approach most likely to be used by the enemy.

(f) **Weather.** In considering the effects of weather, the leader is most interested in visibility and trafficability.

(4) **Troops available.** The leader considers the strength of subordinate units, the characteristics of his weapon systems, and the Capabilities of attached elements as he assigns tasks to subordinate units.

(5) **Time available.** The leader refines his allocation of time based on the tentative plan and any changes to the situation.

d. **STEP 4. Start Necessary Movement.** The platoon may need to begin movement while the leader is still planning or forward reconnoitering. The platoon sergeant or a squad leader may bring the platoon forward, usually under the control of the company executive officer or first sergeant. This step could occur at any time during the troop-leading procedure.

e. **STEP 5. Reconnoiter.** If time allows, the leader makes a personal reconnaissance to verify his terrain analysis, adjust his plan, confirm the usability of routes, and time any critical movements. When time does not allow, the leader must make a map reconnaissance. The leader must consider the risk inherent in conducting reconnaissance forward of friendly lines. Sometimes the leader must rely on others (for example, scouts) to conduct the reconnaissance if the risk of contact with the enemy is high.

f. **STEP 6. Complete the Plan.** The leader completes his plan based on the reconnaissance and any changes in the situation. He should review his mission, as he received it from his commander, to ensure that his plan meets the requirements of the mission and stays within the framework of the commander's intent.

g. **STEP 7. Issue the Complete Order.** Platoon and squad leaders normally issue oral operations orders.

(1) To aid subordinates in understanding the concept for the mission, leaders should issue the order within sight of the objective or on the defensive terrain. When this is not possible, they should use a terrain model or sketch.

(2) Leaders must ensure that subordinates understand the mission, the commander's intent, the concept of the operation, and their assigned tasks. Leaders may require subordinates to repeat all or part of the order or demonstrate on the model or sketch, their understanding of the operation. They should also quiz their soldiers to ensure that **all** soldiers understand the mission. Chapter 5 provides a list of questions that leaders can ask to determine if the soldiers understand the mission.

h. **STEP 8. Supervise.** The leader supervises the unit's preparation for combat by conducting rehearsals and inspections.

(1) **Rehearsals.** The leader uses rehearsals to—

- Practice essential tasks (improve performance).
- Reveal weaknesses or problems in the plan.
- Coordinate the actions of subordinate elements.
- Improve soldier understanding of the concept of the operation (foster confidence in soldiers).

(a) Rehearsals include the practice of having squad leaders brief their planned actions in execution sequence to the platoon leader.

(b) The leader should conduct rehearsals on terrain that resembles the actual ground, and in similar light conditions.

(c) The platoon may begin rehearsals of battle drills and other SOP items before the receipt of the operation order. Once the order has been issued, it can rehearse mission specific tasks.

(d) Some important tasks to rehearse include—

- Actions on the objective.
- Assaulting a trench, bunker, or building.
- Actions at the assault position.
- Breaching obstacles (mine and wire).
- Using special weapons or demolitions.
- Actions on unexpected enemy contact.

(2) **Inspections.** Squad leaders should conduct initial inspections shortly after receipt of the warning order. The platoon sergeant spot checks Throughout the unit's preparation for combat. The platoon leader and platoon sergeant make a final inspection. They should inspect—

- Weapons and ammunition.
- Uniforms and equipment.
- Mission-essential equipment.
- Soldier's understanding of the mission and their specific responsibilities.
- Communications.
- Rations and water.
- Camouflage.
- Deficiencies noted during earlier inspections.

2-3. OPERATION ORDER FORMAT

An operation order (OPORD) is a directive issued by the leader to his subordinate leaders in order to effect the coordinated execution of a specific operation.

a. The leader briefs his OPORD orally from notes that follow the five-paragraph format below (Figure 2-2).

FORMAT	ANNOTATED FORMAT	EXAMPLE, ORAL (ATTACK)	EXAMPLE, ORAL (DEFEND)
TASK ORGANIZATION	Task Organization: Explain how the unit is organized for the operation. If there is no change to previous task organization, indicate "no change."	"Task organization is 1st Squad with two of the platoon's machine guns, 2d Squad, 3d Squad."	"Task organization is 1st Squad, 2d Squad with one machine gun team, 3d Squad with one machine gun team."
1. SITUATION	1. SITUATION: Provide information essential to the subordinate leader's understanding of the situation.	"Situation:	"Situation:
a. Enemy Forces.	<p>a. Enemy Forces. Refer to the overlay or sketch. Include pertinent intelligence provided by higher HQ and other facts and assumptions about the enemy. This analysis is stated as conclusions and addressed—</p> <ul style="list-style-type: none"> (1) Disposition, composition, and strength. (2) Capabilities. A listing of what the enemy is able to do and how well. (3) Most probable course of action. 	"Enemy forces: The scouts have confirmed a full strength motorized rifle squad on our portion of the company objective. They are dug in and expected to fight hard to retain this terrain. Their approximate positions and orientation are as reflected on the terrain model."	"Enemy forces: An enemy light battalion about 85% strength is expected to be traveling SSW paralleling the east side of Comanche Road on the night of 12 June as the supporting effort of a regiment attack. We anticipate their scouts to reconnoiter any time after 1200, 12 June."

Figure 2-2. Example operation order.

FORMAT	ANNOTATED FORMAT	EXAMPLE; ORAL (ATTACK)	EXAMPLE; ORAL (DEFEND)
<p>b. Friendly Forces.</p>	<p>b. Friendly Forces. Provide information that subordinates need to accomplish their tasks.</p> <p>(1) Higher unit. A verbal time statement of the higher unit commander's mission and concept of the operation statement from paragraph 3a.</p>	<p>"Friendly forces: Company C seizes OBJ FOX, vicinity of GL162827 to prevent enemy from concentrating combat power against the battalion main effort, Company A on OBJ COW. The CO's intent is to isolate the northern portion of the objective preventing the MRP main effort from concentrating against our breach in the south. He wants to execute the breach and pass through the main attack as quickly as possible. This will prevent enemy from affecting the battalion attack.</p>	<p>"Friendly forces: Company A defends NLT 121000Jun91 to destroy the enemy, vicinity of GL123456 (EA FOX) and GL127439 (EA PUP) to prevent the envelopment of Company B, the battalion main effort. The CO's intent is to occupy the BP with one platoon forward destroying any reconnaissance elements. Two platoons will concentrate fires in EA FOX. The main effort destroys vehicles in forward half of EA FOX. One platoon will disrupt enemy forces preventing envelopment of our main effort. Once reconnaissance elements are destroyed, that platoon will suppress enemy forces in EA PUP. Battalion obstacles will force enemy into EA PUP and FOX.</p>
<p>(2) Left unit's mission.</p>	<p>"On our left, 1st Platoon fix enemy on OBJ FOX to allow 2d Platoon to establish a breach.</p>	<p>"On our left, Company B defends the high ground to the west, vicinity of GL111461.</p>	

Figure 2-2. Example operation order (continued).

FORMAT	ANNOTATED FORMAT	EXAMPLE, ORAL (ATTACK)	EXAMPLE, ORAL (DEFEND)
	<p>(3) Right unit's mission.</p> <p>(4) Forward unit's mission.</p> <p>(5) Mission of the unit in reserve or following.</p> <p>(6) Units in support or reinforcing the higher unit.</p>	<p>"On our right, 2d Platoon establish a breach, vicinity of GL163826 to allow main attack to clear OBJ FOX.</p> <p>"To our rear, Company mortars suppress enemy on OBJ FOX to screen breaching effort.</p>	<p>"On our right, 2d Platoon, company main effort, defends BP 1 to destroy enemy in EA FOX.</p> <p>"Scout Plt screens forward of our company BP. They will withdraw through 2d Platoon.</p>
c. Attachments and Detachments.	<p>c. Attachments and Detachments. When not shown under Task Organization, list here or in an annex, units attached or detached from the platoon, together with the effective times.</p>	<p>"Attachments and detachments: The platoon has three Dragons attached, which will remain under platoon control until seizure of objective.</p>	<p>"Attachments and detachments: none.</p>
2. MISSION	<p>2. MISSION: Provide a clear, concise statement of the task to be accomplished and the purpose for doing it (WHO, WHAT, WHEN, WHERE, AND WHY). The leader derives the mission from his mission analysis.</p>	<p>"Mission: 3d Platoon attacks 140200Jun91 to seize western edge of Hill 652 (OBJ CAT), vicinity of GL170834 preventing disruption of battalion main attack.</p>	<p>"Mission: 1st Platoon defends Hill 202 (BP 2) NLT 121000Jun91 to destroy enemy in EA FOX vicinity of GL123456 to prevent the envelopment of 2d Platoon.</p>

Figure 2-2. Example operation order (continued).

FORMAT	ANNOTATED FORMAT	EXAMPLE, ORAL (ATTACK)	EXAMPLE, ORAL (DEFEND)
<p>3. EXECUTION Intent.</p>	<p>3. EXECUTION: Intent. Give the stated vision that defines the purpose of the operation and the relationship among the force, the enemy, and the terrain.</p>	<p>"Execution: "Concept of the operation: My intent is to penetrate OBJ CAT from the northeast. Then, we will move through the breach site. One squad will suppress the trench line allowing main attack to maneuver and enter the trench. Once the foothold is established, we will clear the trench line from east to west. Key to this mission is speed in establishing the foothold (decisive point) and providing suppressive fires allowing main attack access to trench line. This should keep them busy and keep them from disrupting the battalion main attack.</p>	<p>"Execution: "Concept of operation: My intent is to occupy BP 2 with two squads forward and one in depth. We will destroy forces in EA FOX and prevent envelopment of main effort. One squad destroys lead element forces, vicinity of minefield forcing them to move into EA FOX. We will then destroy him as he enters this area (decisive point). We cannot envelop 2d Platoon.</p>
<p>a. Concept of the operation.</p>	<p>Refer to the operation overlay and concept sketch. Explain, in general terms, how the platoon, as a whole, will accomplish the mission. Identify the most important task for the platoon (mission-essential task) and any other essential tasks. If applicable, designate the decisive point, form of maneuver of defensive techniques, and any other significant factors or principles. Limit this paragraph to six sentences.</p>		

Figure 2-2. Example operation order (continued).

FORMAT	ANNOTATED FORMAT	EXAMPLE, ORAL (ATTACK)	EXAMPLE, ORAL (DEFEND)
(1) Maneuver.	<p>(1) Maneuver. Address all squads and attachments by name, giving each of them an essential task. Designate the platoon's main effort; that is, who will accomplish the most important task. All other tasks must relate to the main effort. Give mission statements for each subordinate element.</p>	<p>"Maneuver: 1st Squad suppress trench line to allow 2d Squad to enter the trench line. 2d Squad, the main effort, clears trench line preventing disruption of battalion attack. 3d Squad establishes foothold in trench line allowing 2d Squad to enter trench line.</p>	<p>"Maneuver: 1st Squad destroy lead element to cause the enemy to deploy. 2d Squad, main effort, destroy the enemy in EA FOX to prevent the envelopment of 2d Platoon. 3d Squad blocks enemy forces attempting to envelop 2d Squad. Once the enemy crosses Comanche Road, all elements should be firing.</p>
(2) Fires.	<p>(2) Fires. Refer to the fire support overlay and target list. Describe the concept of fire support to synchronize and complement the scheme of maneuver. If applicable, address priority of fires (include changes), priority targets (who controls fires on them), and any restrictive control measures on the use of fires.</p>	<p>"Fires: Purpose of fires is to screen observation of breaching operation. 1st Squad has priority of 60-mm mortar fire. During consolidation, 3d Squad will have priority of fires. Battalion will fire a three-minute preparatory fire on OBJ COW to disrupt enemy command and control.</p>	<p>"Fires: Priority of fires is to 3d Squad initially, priority shifts to 2d Squad during the enemy's assault.</p>

Figure 2-2. Example operation order (continued).

FORMAT	ANNOTATED FORMAT	EXAMPLE, ORAL (ATTACK)	EXAMPLE, ORAL (DEFEND)
	<p>(3) Additional combat support assets (engineer, ADA). State the concept of employment of any combat support attachments or who gets priority of their use, how they are to be used (priority of effort), and how they will be controlled and by whom. (Do not include information that belongs in the Coordinating Instructions subparagraph.)</p>	<p>"Tasks to maneuver units: 1st Squad, shift fires to contact point 1, allowing 2d Platoon a clear approach into the trench line. "2d Squad, prepare satchel charges for bunkers. "3d Squad, be prepared to assist main attack.</p>	<p>"Tasks to maneuver units: 1st Squad occupy and prepare BP 2A, prepare your supplementary position here (point out on terrain model), to prevent flank attack. Prepare OP1 and construct obstacle 1. "2d Squad occupy and prepare BP 2B, construct obstacle 2, and provide one man to company to assist in establishing this minefield. Have that man report to the 1SG at the company CP GL119445, at 1400 today. "3d Squad occupy and prepare BP 2C, prepare OP 2, and construct obstacle 3.</p>
<p>b. Tasks to Maneuver Units.</p>	<p>Specify tasks, other than those listed in paragraph 3a(1), and the purpose of each, for squads and attachments. List each in separate numbered subparagraphs. Address the reserve last. State any priority of sequence.</p>		

Figure 2-2. Example operation order (Continued).

FORMAT	ANNOTATED FORMAT	EXAMPLE, ORAL (ATTACK)	EXAMPLE, ORAL (DEFEND)
<p>c. Tasks to Combat Support Units.</p>	<p>A platoon may receive an attachment of CS units; for example, an engineer squad. List tasks to CS units in subparagraphs in the order they appear in the task organization. List only those specific tasks that must be accomplished by these units not specified elsewhere.</p>	<p>"Tasks to combat support units: Mortars will occupy firing position, vicinity of GL167828 NLT 150425R Jun91.</p>	
<p>d. Coordinating Instructions.</p>	<p>Coordinating Instructions. List the details of coordination and control applicable to two or more units in the platoon. Items that may be addressed include— Priority intelligence requirements, intelligence requirements, and reporting tasks. Mission-oriented protective posture level (see Section XI). Troop safety and operational exposure guidance (see Section XI).</p>	<p>"Coordinating Instructions: Order of march for Company C is 1st Platoon, CP 2d Platoon, Mortars, 3d Platoon. "Order of march for the platoon is 1st Squad, HQ, 2d Squad, 3d Squad. Movement formation is platoon file, traveling. "LD time 142300RJun91. Depart the AA at 142130 Jun91. "MOPPI in effect. "Platoon rehearsal for key leaders, 1300. Company rehearsal, 1400. "Consolidation is IAW terrain model.</p>	<p>"Coordinating Instructions: All squads responsible for constructing protective and tactical (FPL) wire obstacles directly to their front. The PSG will coordinate that effort. "ADA weapons status: TIGHT. "Priority of work per platoon TACSOP. "Security: 20% until 112000Jun91 50% until defend time</p>

Figure 2-2. Example operation order (continued).

FORMAT	ANNOTATED FORMAT	EXAMPLE, ORAL (ATTACK)	EXAMPLE, ORAL (DEFEND)
	<p>Engagement and disengagement criteria and instructions. Fire distribution and control measures. Consolidation and reorganization instructions (other than SOP items). Reporting requirements; for example, crossing PLs or check points. Terrorism and counterterrorism instructions. Specified tasks that pertain to more than one squad or element. Rules of engagement. Order of march and other movement instructions (consider an annex).</p>	<p>"Timing: 1300 Plt rehearsal 1400 Co rehearsal 1700 Inspection 1730 Chow 1830 Rest 2100 Night rehearsal 0045 Stand-to 0115 Final inspection 0200 LD time 0515 Assault time</p>	<p>"Timing: 10 Jun 1700 Chow 11 Jun 0515 Stand-to 0700 Chow 1000 Inspection 1700 Chow 12 Jun 0515 Stand-to 0700 Chow 0900 Final inspection of positions 1000 defend time continue to improve positions as required.</p>
<p>4. SERVICE SUPPORT</p>	<p>4. SERVICE SUPPORT. Include CSS instructions and arrangements supporting the operation that are of primary interest to the platoon. Include changes to established SOPs or a previously issued order. Paragraph 4 is often prepared and issued by the PSG.</p>	<p>"Service support:</p>	<p>"Service support:</p>

Figure 2-2. Example operation order (continued).

FORMAT	ANNOTATED FORMAT	EXAMPLE, ORAL (ATTACK)	EXAMPLE, ORAL (DEFEND)
a. General.	Reference the SOPs that govern the sustainment operations of the unit. Provide current and proposed company trains locations, casualty and damaged equipment collection points, and routes to and from them.	"Company trains will be located at trail intersection, vicinity of GL161823 after seizure of OBJ FOX.	"Company trains located just west of the road intersection, vicinity of GL118440.
b. Material and Services.	(1) Supply.	Include information on all classes of supply of interest to the platoon. When applicable,	"Class I, T-MRE-T until defend time, then MRE-MRE-MRE.
(2) Transportation.	list constraints and limitations, specific operating hours, distribution methods or schedules and other information which alters the standard manner in which supplies are managed, controlled, handled, or distributed.		"Class IV, preconfigured loads will arrive at our position 1000 this morning. PSG, have a six-man detail ready to assist in off-loading.
(3) Services.	(3) Services. Include information or instructions that prescribe the type of service available, designation, and location of the facility and schedule for service.		

Figure 2-2. Example operation order (continued).

FORMAT	ANNOTATED FORMAT	EXAMPLE, ORAL (ATTACK)	EXAMPLE, ORAL (DEFEND)
(4) Maintenance.	(4) Maintenance. Include any information that differs from the established SOP on maintenance of weapons and equipment.		
(5) Medical Evacuation.	(5) Medical evacuation. Identify procedures for evacuation of wounded if they differ from the SOP.	"Company casualty collection points are located along the infiltration lane. Platoon CCP after seizure of OBJ CAT will be directly behind the BTR position.	"The platoon CCP will be located here. The company has been allocated one ambulance. PSG, find a route from the company trains to our location for that ambulance to get to us, as well as a litter evacuation route.
d. Personnel.	d. Personnel. Identify the EPW collection point and any additional instructions on EPW handling not covered in the SOP.	"Company expects to receive some replacements late 15 Jun. We should receive two 11B10s. "EPW collection point will be behind 1st Squad on the objective.	"The Chaplain will hold a non-denominational service at the company CP at 2000 today. Squad leaders report the number of men wishing to attend to the PSG by 1400. PSG, get that information to the 1SG.
e. Miscellaneous.	e. Miscellaneous. Include instructions for the destruction of supplies and any other information not covered elsewhere.		

Figure 2-2. Example operation order (continued).

FORMAT	ANNOTATED FORMAT	EXAMPLE, ORAL (ATTACK)	EXAMPLE, ORAL (DEFEND)
<p>5. COMMAND AND SIGNAL.</p> <p>a. Command.</p>	<p>a. Command.</p> <p>(1) Location of the higher unit commander and CP</p> <p>(2) Location of the platoon leader or CP.</p> <p>(3) Location of the PSG or alternate CP.</p> <p>(4) Succession of command (if different from the SOP).</p>	<p>"Command: Commander will follow us. He will set up CP in the vicinity of the trench line.</p> <p>"I will follow 1st Squad during movement and will assault with 2d Squad. PSG will follow 2d Squad, then move to the support-by-fire position with 1st Squad.</p>	<p>"Command: Commander will be located with main effort.</p> <p>"The platoon CP and the alternate are located here and here (point out on terrain model).</p>
<p>b. Signal.</p>	<p>b. Signal.</p> <p>(1) SOI index in effect.</p> <p>(2) Listening silence, if applicable.</p> <p>(3) Methods of communication in priority.</p> <p>(4) Emergency signals, visual signals.</p> <p>(5) Code words.</p>	<p>"Signal: The number combination password is seven.</p> <p>"The time is now 1007. What are your questions?"</p>	<p>"Signal: Company cease fire signal is two green star clusters followed by one red.</p> <p>"Code word for execution EA FOX with machine gun fire is GOLDSTRIKE and for all weapons firing is BLACKSMITH.</p> <p>"Running password for returning patrols and OPs is MOOSEBREATH followed by the number of soldiers returning.</p> <p>"The time is now 0912. What are your questions?"</p>

Figure 2-2. Example operation order (continued).

b. The leader uses a fragmentary order (FRGO) to change an existing order. He normally uses the OPORD format, but addresses only those elements that have changed. The leader should make his instructions brief, simple, clear, and specific.

c. Annexes provide the instructions for conducting specific operations (such as air assault, boat and truck movement, stream crossings, establishing patrol bases, and airborne insertions), if they are so detailed that a platoon SOP is insufficient for a particular situation. The format is the same as the five-paragraph OPORD.

d. An operation overlay is a tracing of graphic control measures on a map. It shows boundaries, unit positions, routes, objectives, and other control measures. It helps to clarify the operation order. Platoons normally trace their overlays from the company operations map. Squad leaders transfer control measures on to their maps as needed. The subordinate's need for higher unit graphics must be balanced against the risk of the enemy obtaining this information.

c. When possible, the leader uses the actual terrain or a terrain model to brief his OPORD. He may also use concept sketches—large, rough drawings of the objective areas—to show the flow of events and actions clearly.

(1) **Concept sketch.** The sketch shows the locations and positions of objectives, control measures, and key terrain in relation to each other. It is not necessarily drawn to scale.

(2) **Terrain model.** A terrain model is a three-dimensional scale model of the terrain (Figure 2-3). It is effective for briefing and discussing the actions on the objective. It may depict the entire mission area. However, for offense missions, priority should be given to building a model of the objective area.

(a) It should be built oriented to the ground (north on the model is north on the ground) and should show the main terrain features in the area.

(b) The next step after orienting the model to the ground is the construction of grid squares. The leader should identify the grid squares that the model will show. These ensure a more accurate model.

(c) The terrain model should depict key terrain, friendly control measures, and enemy dispositions.

(d) Materiel for constructing the model includes string, yarn (various colors), chalk (colored), 3x5 cards, target markers, or unit markers.

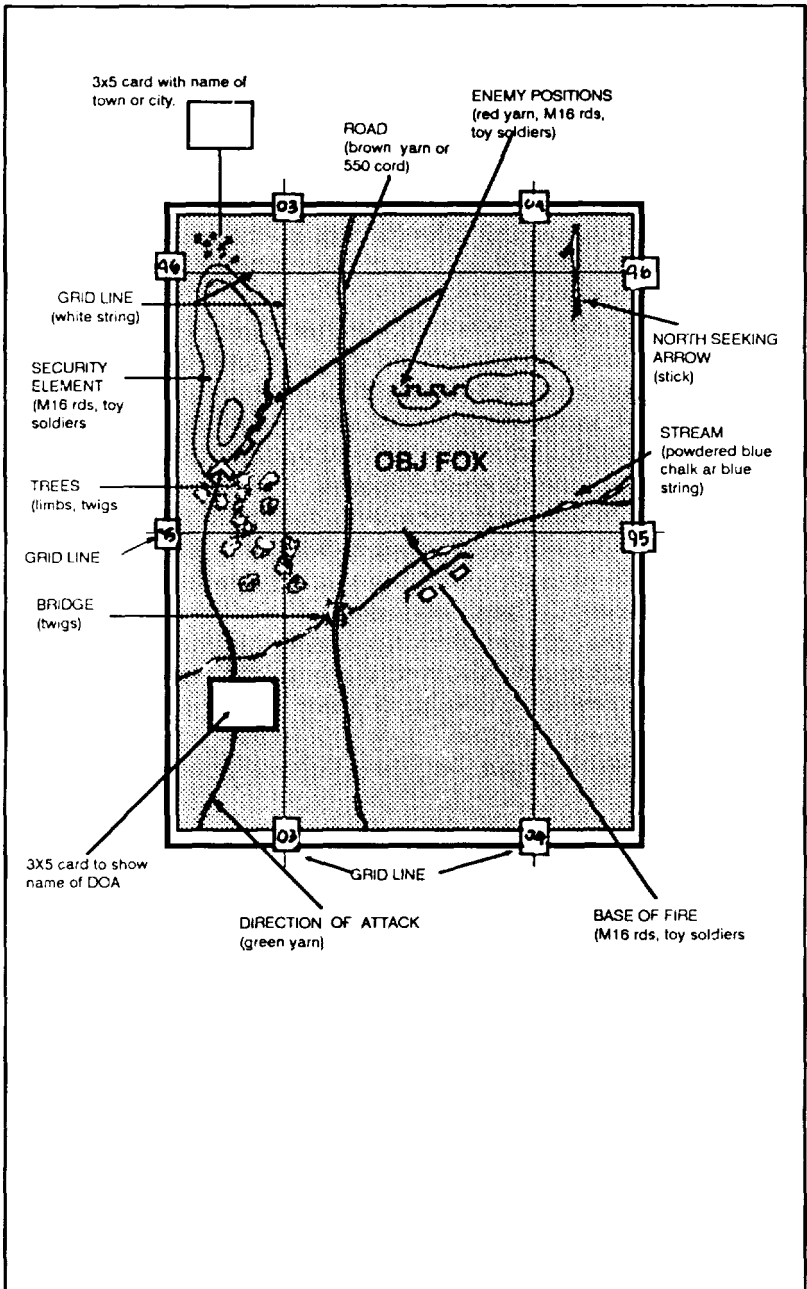

Figure 2-3. Terrain model techniques.

Section II. SECURITY

This section discusses techniques used by platoons and squads to provide security for themselves and for larger formations during movements and offensive and defensive operations.

2-4. SECURITY DURING MOVEMENT

Security during movement includes the actions that units take to secure themselves and the tasks given to units to provide security for a larger force.

a. Platoons and squads enhance their own security during movement through the use of covered and concealed terrain; the use of the appropriate movement formation and technique; the actions taken to secure danger areas during crossing; the enforcement of noise, light, and radiotelephone discipline; and the use of proper individual camouflage techniques.

(1) **Terrain.** In planning a movement, leaders consider the terrain from the aspect OCOKA as discussed in Section I. Leaders look for terrain that avoids obstacles, provides protection from direct and indirect fires and from ground and aerial observation, avoids key terrain that may be occupied by the enemy, allows freedom to maneuver, and avoids natural lines of drift or obvious terrain features. If key terrain cannot be avoided, leaders plan to reconnoiter it before moving through. When operating as an advance or flank guard for a larger force, platoons and squads may be tasked to occupy key terrain for a short time while the main body bypasses it.

(2) **Formations and movement techniques.** Formations and movement techniques provide security by—

- Positioning each soldier so that he can observe and fire into a specific sector that overlaps with other sectors.
- Placing a small element forward to allow the platoon to make contact with only the lead element and give the remainder of the platoon freedom to maneuver.
- Providing overwatch for a portion of the platoon.

In selecting formations and movement techniques leaders must consider other requirements such as speed and control as well as security. Section III provides a matrix to help leaders in determining the best formation and technique based on METT-T.

(3) **Security at danger areas.** Paragraph 2-11 describes actions taken by platoons and squads to secure danger areas before crossing them.

(4) **Camouflage, noise, light, and radiotelephone discipline.** Leaders must ensure that camouflage used by their soldiers is appropriate to the

terrain and season. Platoon SOPs specify elements of noise, light, and radiotelephone discipline. (See Chapter 5.)

b. Platoons and squads may operate as the advance, flank, or rear guard for larger units. They employ the same techniques described above to move as securely as possible. Section IV describes the techniques used by platoons executing a guard mission in a movement to contact.

c. During short halts, soldiers spread out and assume prone positions behind cover. They watch the same sectors that were assigned to them for the movement. Leaders establish OPs, and orient machine guns and antiarmor weapons along likely enemy approaches. Soldiers remain alert and keep movement to a minimum. During limited visibility, leaders incorporate the use of night vision devices.

d. During long halts, the platoon establishes a perimeter defense (See Chapter 1). The platoon leader ensures that the platoon halts on defensible terrain. He establishes the defense using the same considerations discussed in Section V.

e. For additional security during halts, the platoon leader may establish a squad-sized ambush. He must provide a specific location and instructions concerning the initiation and conduct of the ambush and the link-up of the squad with the platoon.

2-5. SECURITY IN THE OFFENSE

Security in the offense includes actions taken by platoons and squads to find the enemy, to avoid detection or prevent the detection of the larger body, and to protect the unit during the assault on the objective.

a. **Movement to Contact.** Platoons and squads execute guard or screening missions as part of a larger force in a movement to contact. (See Section III.)

b. **Reconnaissance Patrols.** Reconnaissance patrols are conducted before executing offensive operations to find the enemy and determine his strength and dispositions. Chapter 3 discusses techniques for platoons and squads conducting reconnaissance patrols.

c. **Hasty and Deliberate Attacks.** Platoons and squads use the same security techniques for movement discussed above while moving from assembly areas to the objective. The base-of-fire and maneuver elements of the platoon must provide their own security while executing their specific tasks.

(1) **Base-of-fire element.** The platoon sergeant or leader controlling the base-of-fire element should designate soldiers on the flanks of the position to provide observation and, if necessary, fires to the flanks while the element engages the enemy on the objective. The base-of-fire element also provides security to its rear.

(2) **Maneuver element.** The maneuver element must secure its own flanks and rear as it assaults across the objective. Platoon leaders should consider designating assaulting buddy teams to observe the flanks and rear. When clearing trenches, the platoon should be alert against local counterattacks along cleared portions of the trench behind the lead fire team. The base-of-fire element provides security for the maneuver element by engaging any counterattacking or reinforcing forces if it can do so without endangering the maneuver element with its own fires.

d. **Consolidation.** Platoons and squads move quickly to establish security during the consolidation of an objective. They do this by establishing OPs along likely approaches and by establishing overlapping sectors of fire to create all-round security. (See Section V.)

2-6. SECURITY IN THE DEFENSE

Security in the defense includes active and passive measures taken to avoid detection or deceive the enemy and to deny enemy reconnaissance elements accurate information on friendly positions.

a. **Terrain.** Leaders consider the terrain in terms of OCOKA as they plan for security in the defense. They look for terrain that will protect them from enemy observation and fires and, at the same time, provide observation and fires into the area where they intend to destroy the enemy or defeat his attack. When necessary leaders use defensive techniques, such as reverse slope or perimeter defense, to improve the security of the defensive position. Leaders plan protective obstacles to the flanks and rear of their positions and tie them in with supplementary fires. Leaders consider adjacent key terrain that threatens the security of their positions. They secure this terrain by posting OPs and by covering it with direct and indirect fires. Finally, leaders establish OPs along the most likely enemy approaches into the position or sector to provide early warning.

b. **Observation Posts.** Each platoon should post at least one OP. The platoon leader designates the general location for the OP and the routes to and from the OP. The squad leader establishing the OP selects the specific site. Section XII provides a detailed discussion of the techniques used by platoons and squads in establishing and manning OPs. When a platoon performs a screen mission for a larger force in a defense, it may establish squid-sized OPs that are well dispersed. The squads conduct patrolling missions between these OPs to establish the screen.

c. **Patrols.** Platoons should actively patrol the area to their front and flanks while in a defensive operation. These patrols should include observation of dead space, gaps between units, open flanks, and gaps or lanes in tactical and protective wire. Patrols may also be used to establish and relieve OPs. The platoon leader must ensure that all patrols not

initiated by his higher headquarters are coordinated with them. Chapter 3 provides detailed discussion of patrolling techniques for platoons and squads.

d. **Passive Measures.** Platoons may be directed to cover specific areas of its sector with night vision devices, thermal sights, or early warning devices. These systems should be incorporated into the platoon sector sketch. Passive measures also include camouflage; movement control; and noise, light, and radiotelephone discipline.

e. **Deceptive Measures.** Deceptive measures includes actions that platoons and squads may take to mislead the enemy and induce him to do something counter to his interests. Platoons may employ deceptive measures for local security such as dummy positions or supplemental wire.

f. **Deception Operations.** Platoons may conduct deception operations as part of a larger force. These operations may include demonstrations, feints, displays, or ruses. In most instances platoons execute missions as normal but on a limited scale (feint), or to present a false picture to the enemy.

Section III. MOVEMENT

This section discusses formations, movement techniques, and actions during movement for infantry platoons and squads.

2-7. FIRE TEAM FORMATIONS

Formation are arrangements of elements and soldiers in relation to each other. Squads use formations for control flexibility and security. Leaders choose formations based on their analysis of the factors of METT-T. Figure 2-6, page 2-29, compares formations. Leaders are up front in formations. This allows the fire team leader to lead by example, "Follow me and do as I do." All soldiers in the team must be able to see their leader.

a. **Wedge.** The wedge is the basic formation for the fire team. The interval between soldiers in the wedge formation is normally 10 meters. The wedge expands and contracts depending on the terrain. When rough terrain, poor visibility, or other factors make control of the wedge difficult, fire teams modify the wedge. The normal interval is reduced so that all team members can still see their team leader and the team leaders can still see their squad leader. The sides of the wedge can contract to the point where the wedge resembles a single file. When moving in less rugged terrain, where control is easier, soldiers expand or resume their original positions. (Figure 2-4).

b. **File.** When the terrain precludes use of the wedge, fire teams use the file formation (Figure 2-5).

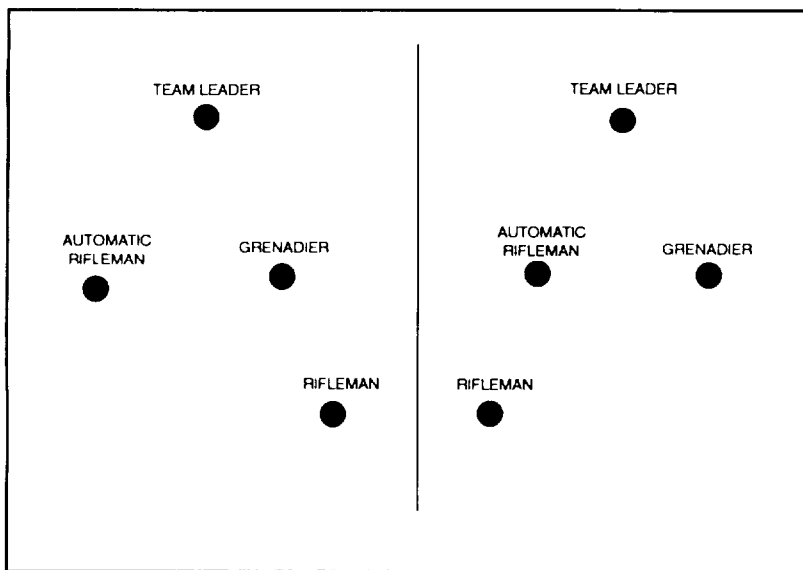

Figure 2-4. Fire team wedge.

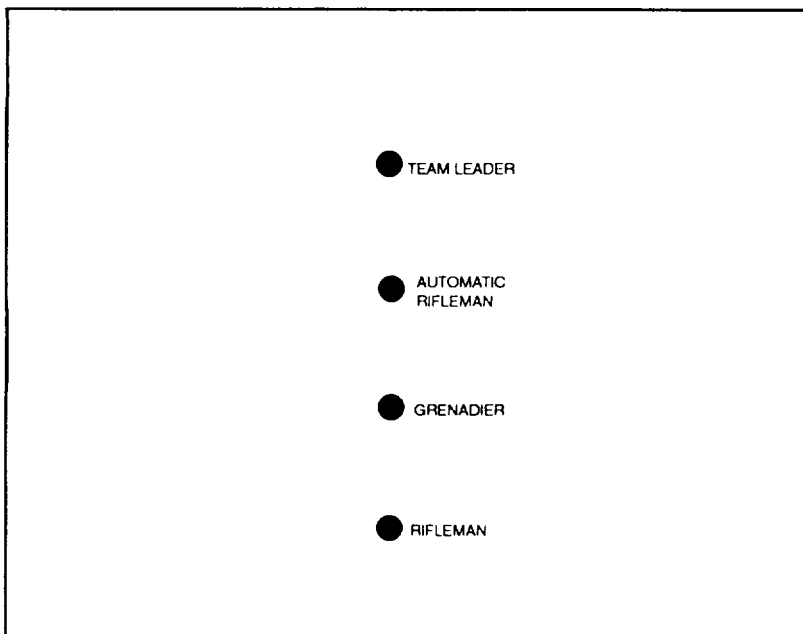

Figure 2-5. Fire team file.

MOVEMENT FORMATION	WHEN NORMALLY USED	CHARACTERISTICS			
		CONTROL	FLEXIBILITY	FIRE CAPABILITIES/ RESTRICTIONS	SECURITY
FIRE TEAM WEDGE	BASIC FIRE TEAM FORMATION	EASY	GOOD	ALLOWS IMMEDIATE FIRES IN ALL DIRECTIONS.	GOOD
FIRE TEAM FILE	CLOSE TERRAIN DENSE VEGETATION, LIMITED VISIBILITY CONDITIONS.	EASIEST	LESS FLEXIBLE THAN THE WEDGE.	ALLOWS IMMEDIATE FIRES TO THE FLANKS. MASK MOST FIRES TO THE REAR.	LEAST

Figure 2-6. Comparison of fire team formations.

2-8. SQUAD FORMATIONS

Squad formations describe the relationships between fire teams in the squad. They include the squad column and squad line. A comparison of the formations is in Figure 2-10, page 2-31.

a. **Squad Column.** The squad column is the squad's most common formation. It provides good dispersion laterally and in depth without sacrificing control, and facilitates maneuver. The lead fire team is the base fire team. When the squad moves independently or as the rear element of the platoon, the rifleman in the (rail fire team provides rear security (Figure 2-7).

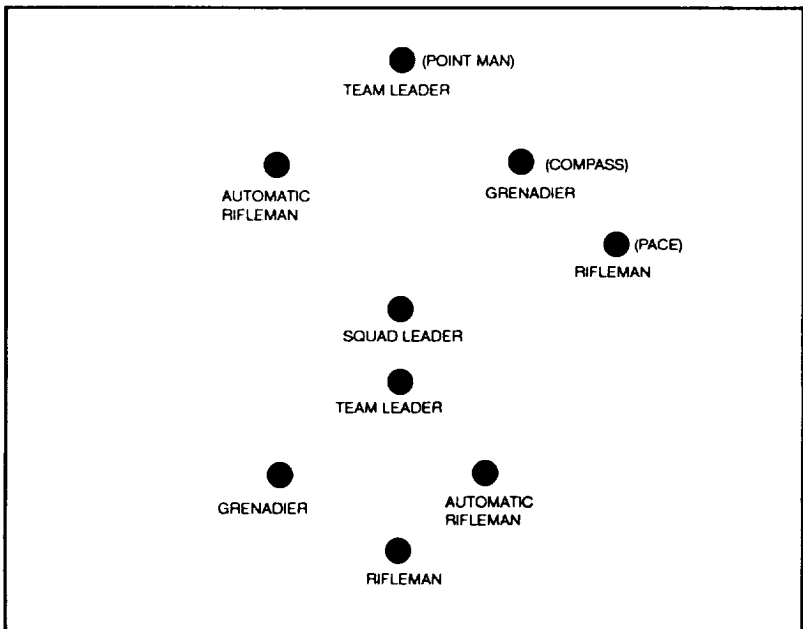

Figure 2-7. Squad column with fire teams in column.

b. **Squad Line.** The squad line provides maximum firepower to the front (Figure 2-8). When a squad is acting as the base squad, the fire team on the right is the base fire team.

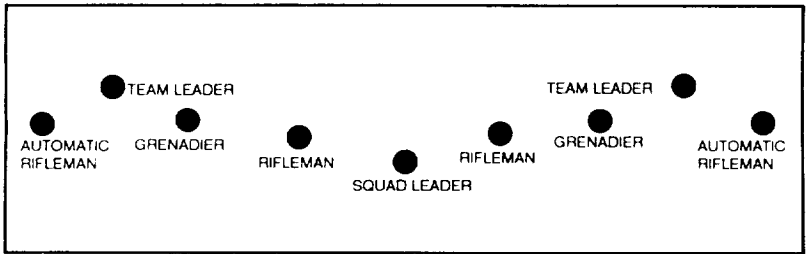

Figure 2-8. Squad Line.

c. **Squad File.** When not (raveling in a column or line, squads travel in file. The squad file has the same characteristics as the fire team file. If the squad leader desires to increase his control over the formation, exert greater morale presence by leading from the front, and be immediately available to make key decisions, he will move forward to the first or second position. Additional control over the rear of the formation can be provided by moving a team leader to the last position. (Figure 2-9.)

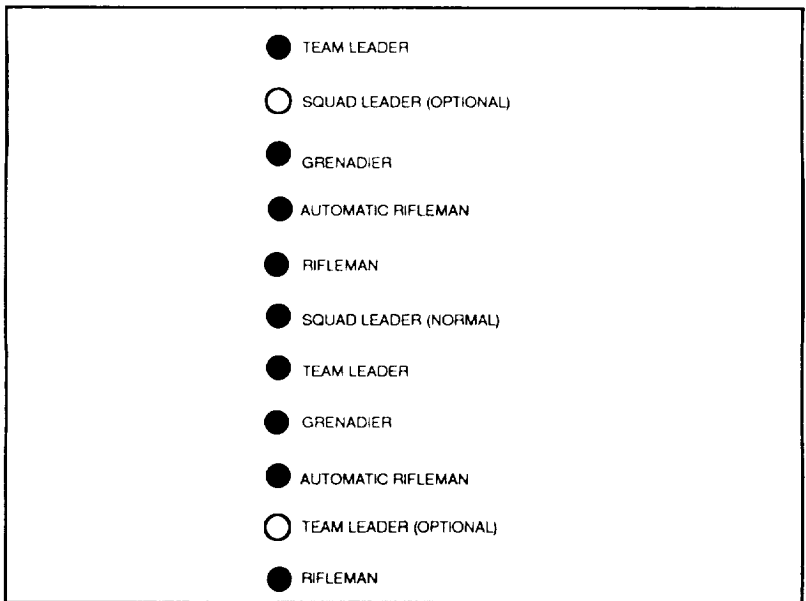

Figure 2-9. Squad file.

MOVEMENT FORMATION	WHEN NORMALLY USED	CHARACTERISTICS			
		CONTROL	FLEXIBILITY	FIRE CAPABILITIES/ RESTRICTIONS	SECURITY
SQUAD COLUMN	SQUAD PRIMARY FORMATION.	GOOD	FACILITATES MANEUVER, GOOD DISPERSION Laterally AND IN DEPTH.	ALLOWS LARGE VOLUME OF FIRE TO THE FLANK— LIMITED VOLUME TO THE FRONT.	ALL-ROUND
SQUAD LINE	WHEN MAXIMUM FIRE POWER IS REQUIRED TO THE FRONT.	NOT AS GOOD AS SQUAD COLUMN.	LIMITED MANEUVER CAPABILITY (BOTH FIRE TEAMS COMMITTED).	ALLOWS MAXIMUM IMMEDIATE FIRE TO THE FRONT.	GOOD TO THE FRONT, LITTLE TO THE FLANKS AND REAR.
SQUAD FILE	CLOSE TERRAIN VEGETATION, LIMITED VISIBILITY CONDITIONS.	EASIEST	MOST DIFFICULT FORMATION FROM WHICH TO MANEUVER.	ALLOWS IMMEDIATE FIRE TO THE FLANK MASKS MOST FIRE TO THE FRONT AND REAR.	LEAST

Figure 2-10. Comparison of squad formations.

2-9. PLATOON FORMATIONS

Platoon formations include the platoon column, the platoon line (squads on line or in column), the platoon vee and the platoon wedge. The leader should weigh these carefully to select the best formation based on his mission and on METT-T analysis. A comparison of the formations is in Figure 2-17, page 2-37.

a. **Platoon Column.** This formation is the platoon's primary movement formation (Figure 2-11). It provides good dispersion both laterally and in depth, and simplifies control. The lead squad is the base squad.

NOTE: METT-T will determine where crew-served weapons move in the formation. They normally move with the platoon leader so he can quickly establish a base of fire.

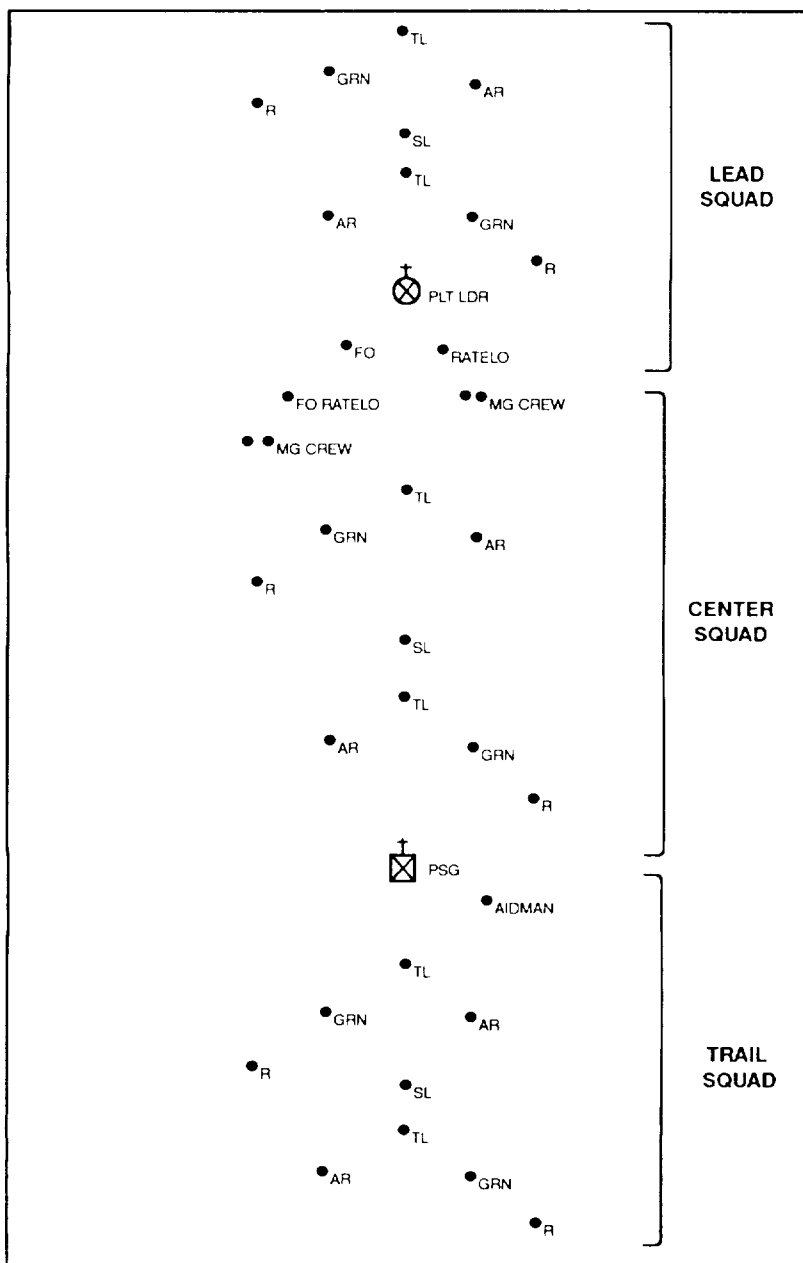

Figure 2-11. Platoon column.

b. **Platoon-Line, Squads-on-Line.** This formation allows the delivery of maximum fire to the front but little fire to the flanks (Figure 2-12). This formation is hard to control, and it does not lend itself well to rapid movement. When two or more platoons are attacking, the company commander chooses one of them as the base platoon. The base platoon's center squad is its base squad. When the platoon is not acting as the base platoon, its base squad is its flank squad nearest the base platoon. The machine guns can move with the platoon, or they can support by fire from a support position (not shown). This is the basic platoon assault formation.

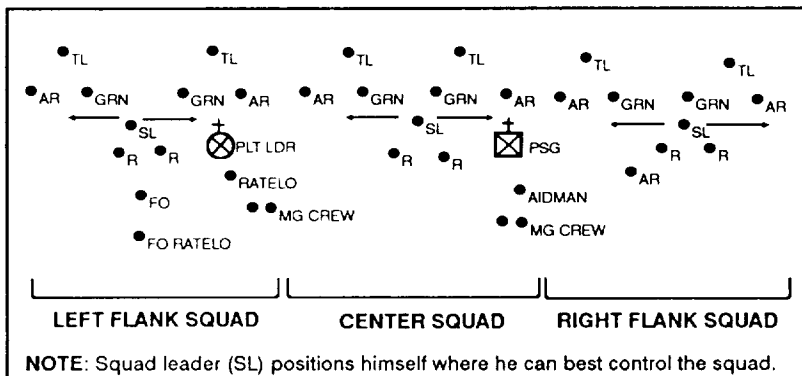

Figure 2-12. Platoon-line, squads-on-line.

c. **Platoon-Line, Squads-in-Column.** The platoon leader can use this formation when he does not want to deploy all personnel on line, and when he wants the squads to react to unexpected contact (Figure 2-13). This formation is easier to control, and it lends itself better to rapid

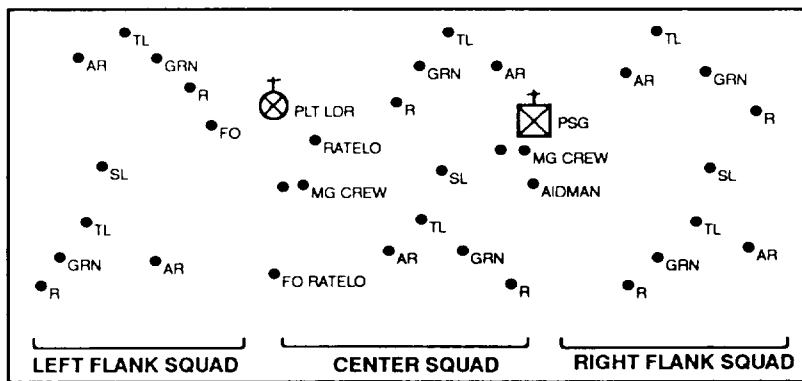

Figure 2-13. Platoon-line, squads-in-column.

movement than the platoon-line or squads-on-line formation; however, it is harder to control than and does not facilitate rapid movement as well as a platoon column. When two or more platoons are moving, the company commander chooses one of them as the base platoon. The base platoon's center squad is its base squad. When the platoon is not the base platoon, its base squad is its flank squad nearest the base platoon.

d. **Platoon Vee.** This formation has two squads up front to provide a heavy volume of fire on contact (Figure 2- 14). It also has one squad in the rear that can either overwatch or trail the other squads. This formation is hard to control; movement is slow The platoon leader designates one of the front squads to be the platoon's base squad.

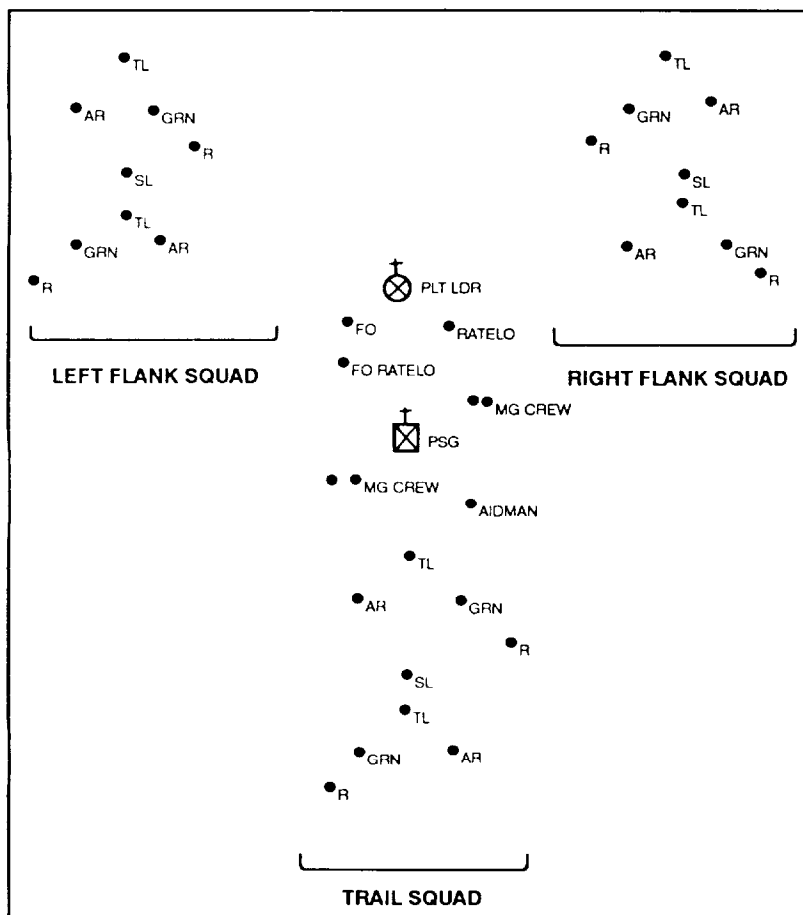

Figure 2-14. Platoon vee.

e. **Platoon Wedge.** This formation has two squads in the rear that can overwatch or trail the lead squad (Figure 2-15). It provides a large volume of fire to the front or flanks. It allows the platoon leader to make contact with a squad and still have one or two squads to maneuver. The lead squad is the base squad.

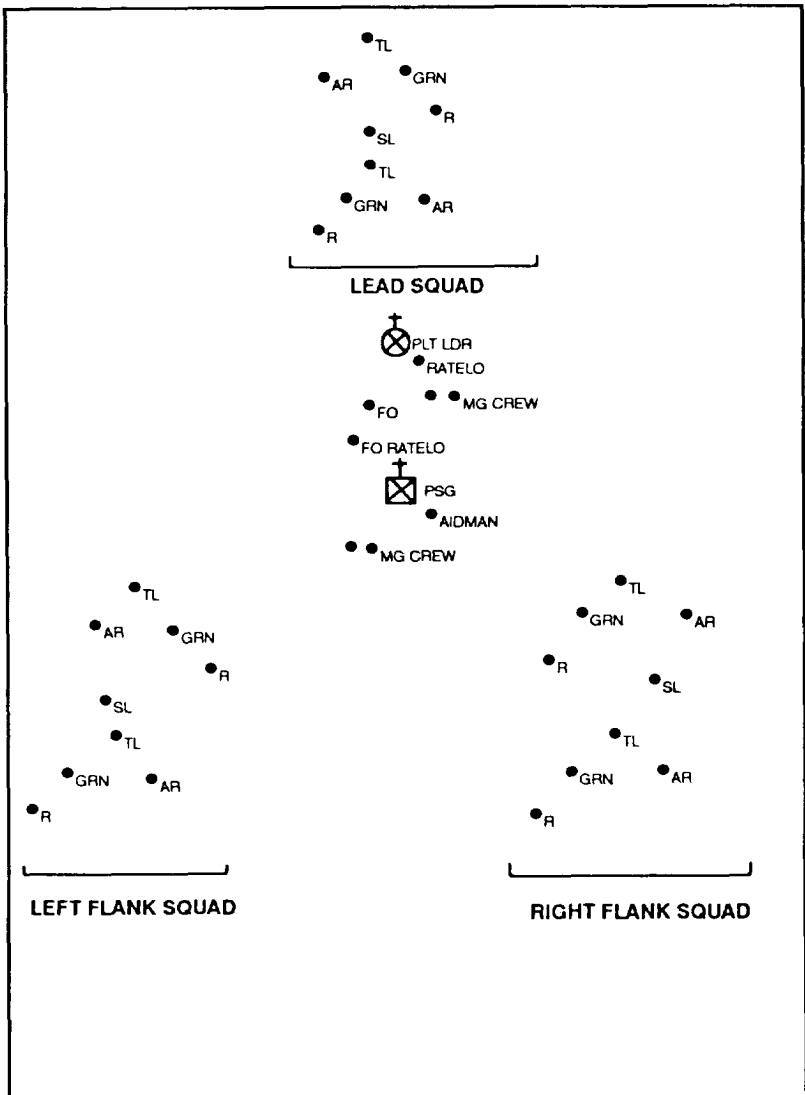

Figure 2-15. Platoon wedge.

f. Platoon File. This formation may be set up in several methods. One method is to have three-squad files follow one another using one of the movement techniques. Another method is to have a single platoon file with a front security element (point) and flank security elements. This formation is used when visibility is poor due to terrain, vegetation, or light conditions. (Figure 2-16.) The distance between soldiers is less than normal to allow communication by passing messages up and down the file. The platoon file has the same characteristics as the fire team and squad files.

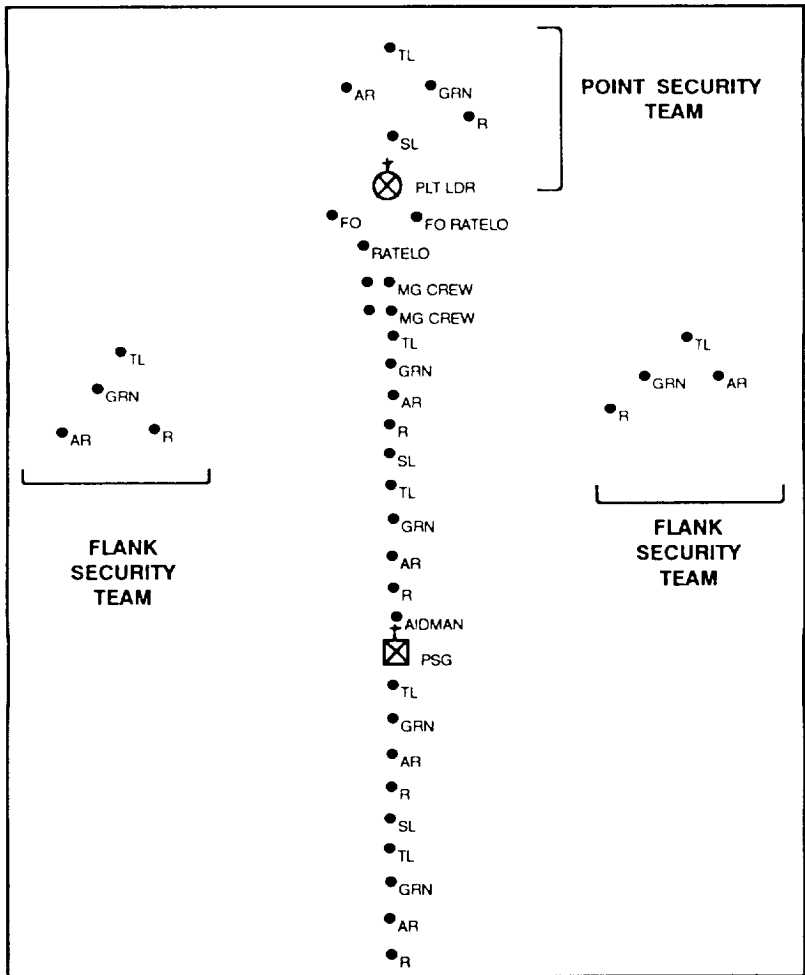

Figure 2-16. Platoon file.

MOVEMENT FORMATION	WHEN NORMALLY USED	CHARACTERISTICS			
		CONTROL	FLEXIBILITY	FIRE CAPABILITY RESTRICTIONS	MOVEMENT
PLATOON COLUMN	PLATOON PRIMARY MOVEMENT FORMATION	GOOD FOR MANEUVER (FIRE AND MOVEMENT)	PROVIDES GOOD DISPERSION LATERALLY AND IN DEPTH	ALLOWS LIMITED FIREPOWER TO THE FRONT AND REAR—HIGH VOLUME TO THE FLANKS	GOOD
PLATOON LINE, SQUADS ON LINE	WHEN THE LEADER WANTS ALL SOLDIERS FORWARD FOR MAXIMUM FIRE. POWER TO THE FRONT AND THE ENEMY SITUATION IS KNOWN	DIFFICULT	MINIMAL	ALLOWS MAXIMUM FIREPOWER TO THE FRONT—LITTLE TO FLANKS AND REAR	SLOW
PLATOON LINE, SQUADS IN COLUMN	MAY BE USED WHEN THE LEADER DOES NOT WANT EVERYONE ON LINE; BUT LEADER WANTS TO BE PREPARED FOR CONTACT: WHEN CROSSING THE LD WHEN LD IS NEAR THE OBJECTIVE	EASIER THAN PLATOON LINE. SQUADS ON LINE BUT MORE DIFFICULT THAN PLATOON COLUMN	GREATER THAN PLATOON COLUMN; SQUADS ON LINE BUT LESS THAN PLATOON LINE: SQUADS ON LINE	GOOD TO THE FRONT AND REAR, NOT AS GOOD AS PLATOON COLUMN; BETTER THAN PLATOON LINE	SLOWER THAN PLATOON COLUMN, BUT FASTER THAN PLATOON LINE SQUADS ON LINE
PLATOON VEE	WHEN ENEMY SITUATION IS VAGUE, BUT CONTACT IS EXPECTED FROM THE FRONT	DIFFICULT	PROVIDES TWO SQUADS UP FRONT FOR IMMEDIATE FIREPOWER AND ONE SQUAD TO THE REAR FOR MOVEMENT (FIRE AND MOVEMENT) UPON CONTACT FROM THE FLANK	IMMEDIATE HEAVY VOLUME OF FIREPOWER TO THE FRONT OR FLANKS	SLOW
PLATOON WEDGE	WHEN ENEMY SITUATION IS VAGUE, BUT CONTACT IS NOT EXPECTED	DIFFICULT BUT BETTER THAN PLATOON VEE AND PLATOON LINE, SQUADS ON LINE	ENABLES LEADER TO MAKE CONTACT WITH A SMALL ELEMENT AND STILL HAVE TWO SQUADS TO MANEUVER	PROVIDES HEAVY VOLUME OF FIREPOWER TO THE FRONT OR FLANKS	SLOW, FASTER THAN PLATOON VEE
PLATOON FILE	WHEN VISIBILITY IS POOR DUE TO TERRAIN OR LIGHT	EASIEST	MOST DIFFICULT FORMATION FROM WHICH TO MANEUVER	ALLOWS IMMEDIATE FIRES TO THE FLANKS, MASK MOST FIRES TO FRONT AND REAR	FASTEST

Figure 2-17. Comparison of platoon formations.

2-10. MOVEMENT TECHNIQUES

A movement technique is the manner a platoon uses to traverse terrain. There are three movement techniques: traveling, traveling overwatch, and bounding overwatch. The selection of a movement technique is based on the likelihood of enemy contact and the need for speed. Factors to consider for each technique are control, dispersion, speed, and security (Figure 2-18). Movement techniques are not fixed formations. They refer to the distances between soldiers, teams, and squads that vary based on mission, enemy, terrain, visibility, and any other factor that affects control. Soldiers must be able to see their fire team leader. The squad leader must be able to see his fire team leaders. The platoon leader should be able to see his lead squad leader. Leaders control movement with arm-and-hand signals. They use radios only when needed. Any of the three movement techniques (traveling, traveling overwatch, bounding overwatch) can be used with any formation.

MOVEMENT TECHNIQUES	WHEN NORMALLY USED	CHARACTERISTICS			
		CONTROL	DISPERSION	SPEED	SECURITY
TRAVELING	CONTACT NOT LIKELY	MORE	LESS	FASTEST	LEAST
TRAVELING OVERWATCH	CONTACT POSSIBLE	LESS	MORE	SLOWER	MORE
BOUNDING OVERWATCH	CONTACT EXPECTED	MOST	MOST	SLOWEST	MOST

Figure 2-18. Movement techniques and characteristics.

a. **Techniques of Squad Movement.** The platoon leader determines and directs which movement technique the squad will use.

(1) **Traveling.** Traveling is used when contact with the enemy is not likely and speed is needed (Figure 2-19).

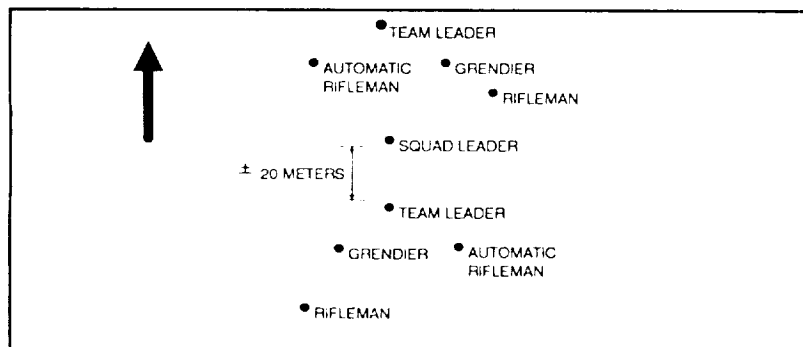

Figure 2-19. Squad traveling.

(2) **Traveling overwatch.** Traveling overwatch is used when contact is possible (Figure 2-20). Attached weapons move near the squad leader and under his control so he can employ them quickly.

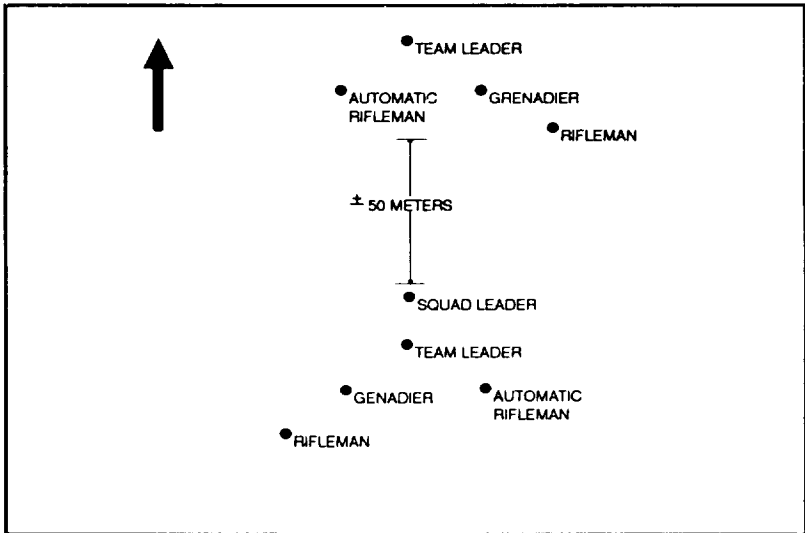

Figure 2-20. Squad traveling overwatch.

(3) **Bounding overwatch.** Bounding overwatch is used when contact is expected, when the squad leader feels the enemy is near (movement, noise, reflection, trash, fresh tracks, or even a hunch), or when a large open danger area must be crossed.

(a) The lead fire team overwatches first. Soldiers scan for enemy positions. The squad leader usually stays with the overwatch team. (Figure 2-21).

(b) The trail fire team bounds and signals the squad leader when his team completes its bound and is prepared to overwatch the movement of the other team.

(c) Both team leaders must know if successive or alternate bounds will be used and which team the squad leader will be with. The overwatching team leader must know the route and destination of the bounding team. The bounding team leader must know his team's destination and route, possible enemy locations, and actions to take when he arrives there. He must also know where the overwatching team will be, and how he will receive his instructions. The cover and concealment on the bounding team's route dictates how its soldiers move.

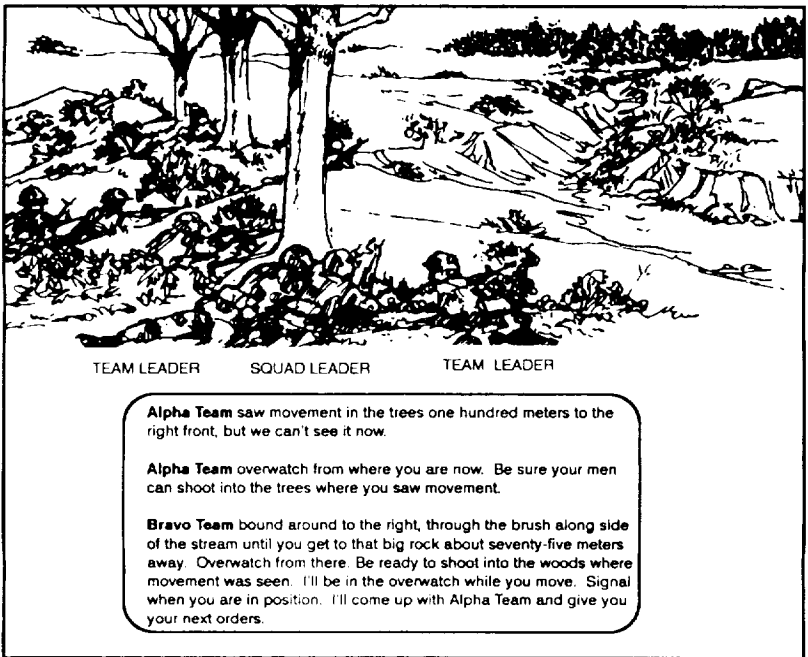

Figure 2-21. Example of squad leader's order to bound.

(d) Teams can bound successively or alternately. Successive bounds are easier to control; alternate bounds can be faster. (Figure 2-22.)

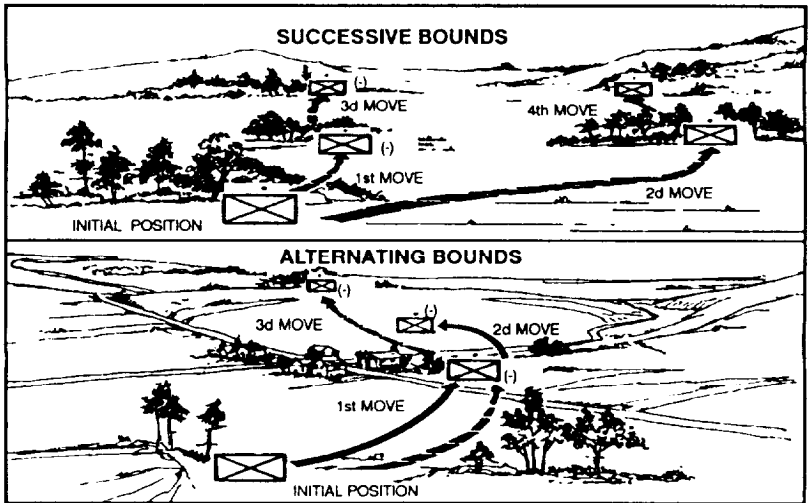

Figure 2-22. Squad successive and alternate bounds.

b. **Techniques of Platoon Movement.** The platoon leader determines and directs which movement technique the platoon will use.

(1) **Traveling.** Traveling is used when enemy contact is not likely and speed is needed (Figure 2-23).

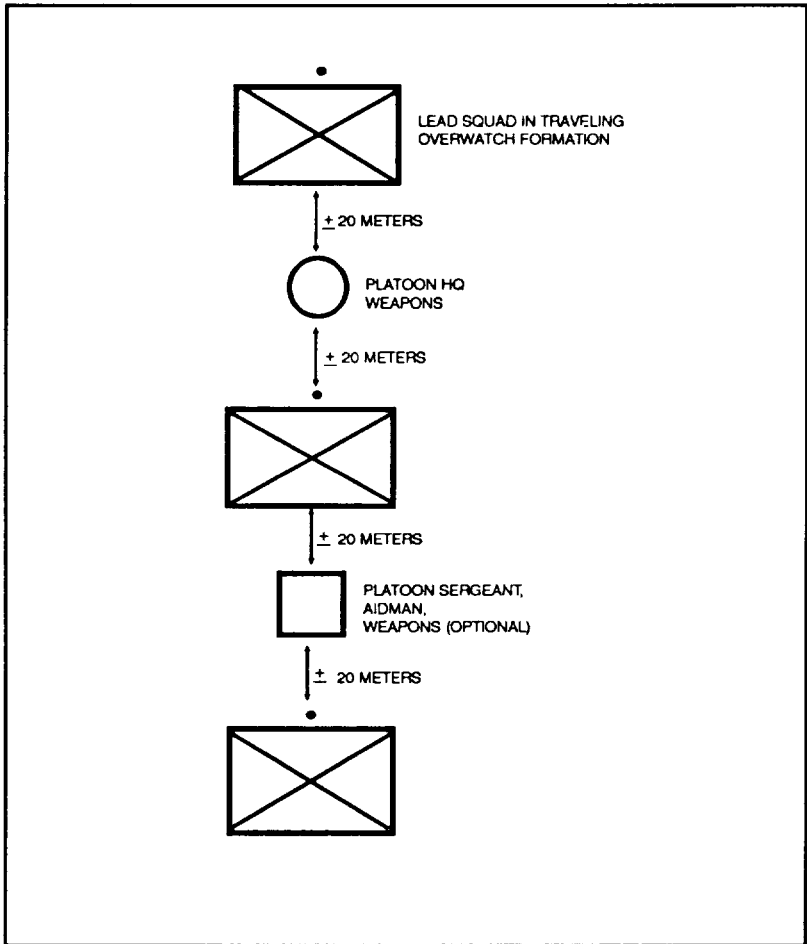

Figure 2-23. Platoon traveling.

(2) **Traveling overwatch.** Traveling overwatch is used when contact is possible but speed is needed (Figure 2-24). The platoon leader moves where he can best control the platoon. The platoon sergeant travels with the trailing squad, though he is free to move throughout the formation to

enforce security, noise and light discipline, and distances. between squads. The lead squad uses traveling overwatch, and the trailing squads use traveling.

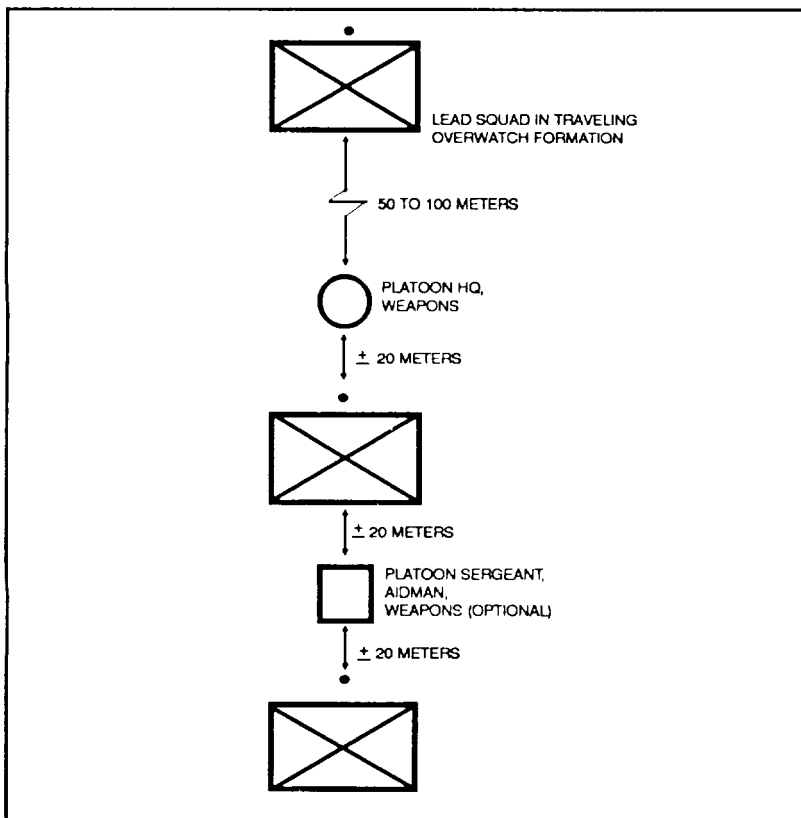

Figure 2-24. Platoon traveling overwatch.

(3) **Bounding overwatch.** Bounding overwatch is used when contact is expected (Figure 2-25). Platoons conduct bounding overwatch using successive or alternate bounds.

(a) **One squad bounding.** One squad bounds forward to a chosen position, then it becomes the overwatching element unless contact is made en route. The bounding squad can use either traveling overwatch, bounding overmatch, or individual movement techniques (low and high crawl, and short rushes by tire team or pairs).

(b) **One squad overwatching.** One squad overwatches the bounding squad from covered positions from which it can see and suppress likely enemy positions. Soldiers use sunning techniques to view their assigned

sector. The platoon leader remains with the overwatching squad. Normally, the platoon's machine guns are located with the overwatching squad also.

(c) *One squad awaiting orders.* One squad is uncommitted and ready for employment as directed by the platoon leader. The platoon sergeant and the leader of the squad awaiting orders position themselves close to the platoon leader.

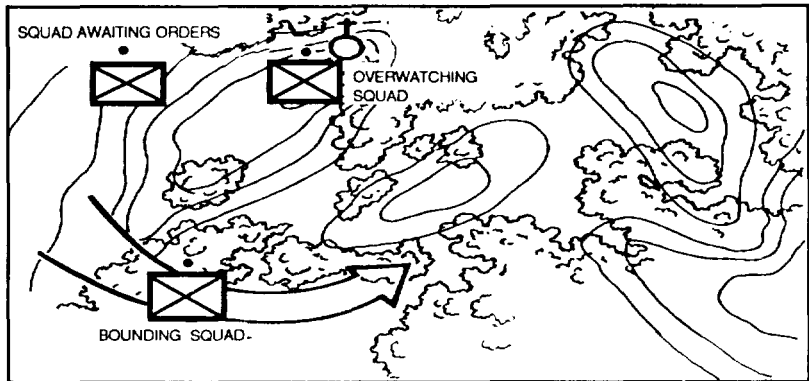

Figure 2-25. Platoon bounding overwatch

(d) *Considerations.* When deciding where to have his bounding squad go, a platoon leader considers—

- The requirements of the mission.
- Where the enemy is likely to be.
- The routes to the next overwatch position.
- The ability of an overwatching element's weapons to cover the bound.
- The responsiveness of the rest of the platoon.
- The fields of fire at the next overwatch position.

(e) *Instructions.* Before a bound, the platoon leader gives an order to his squad leaders from the overwatch position (Figure 2-26). He tells and shows them the following:

- The direction or location of the enemy (if known).
- The positions of the overwatching squad.
- The next overwatch position.
- The route of the bounding squad.
- What to do after the bounding squad reaches the next position.
- What signal the bounding squad will use to announce it is prepared to overwatch.
- How the squad will receive their next orders.

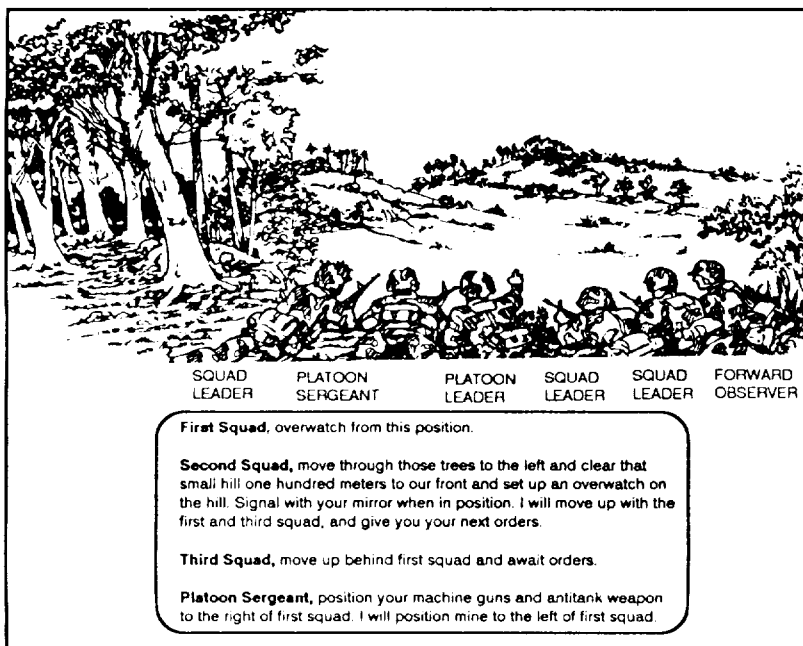

Figure 2-26. Example of platoon leader's order for bounding overwatch.

(f) *Machine guns.* The machine guns are normally employed in one of two ways:

- Attach both guns to the overwatch squad(s).
- One machine gun with the overwatch squad and the other with the bounding squad. This technique requires the guns to move between squads as they leave the overwatch to join the bounding squad.

c. **Individual Movement Techniques.** Individual movement techniques include the high and low crawl and short rushes (three to five seconds) from one covered position to another. (See FM 21-75.)

d. **Other Movement Situations.** The platoon can use other formations for movement.

(1) **Movement with armored vehicles.** For a detailed discussion of working with armored vehicles, see Section IX.

(2) **Movement by water.** The platoon avoids crossing water obstacles when possible. Leaders should identify weak or nonswimmers and pair them with a good swimmer in their squad.

(a) When platoons or squads must move into, through, or out of rivers, lakes, streams, or other bodies of water, they treat the water

obstacle as a danger area. While on the water, the platoon is exposed and vulnerable. To offset the disadvantages, the platoon—

- Moves during limited visibility.
- Disperses.
- Camouflages thoroughly.
- Moves near the shore to reduce the chances of detection.

(b) When moving in more than one boat, the platoon—

- Maintains tactical integrity and self-sufficiency.
- Cross loads key soldiers and equipment.
- Makes sure that the radio is with the leader.

(c) If boats are not available, several other techniques can be used such as—

- Swimming.
- Poncho rafts.
- Air mattresses.
- Waterproof bags.
- A 7/16-inch rope used as a semisubmersible one-rope bridge or safety line.
- Water wings (made from a set of trousers).

(3) **Tactical marches.** Platoons conduct two types of tactical marches with the company. They are foot marches and motor marches.

(a) *Foot marches.* See FM 21-18.

(b) *Motor marches.* The platoon conducts motor marches like any other tactical movement. Special requirements may include—

- Protection. Sandbagging the bottom of the truck to protect the soldiers from mines.
- Observation. Removing bows and canvas to allow 360-degree observation and rapid dismount.
- Inspection. Inspecting vehicle and driver to ensure they are ready. Checking fuel level and driver's knowledge of the route, speed, and distance between vehicles.
- Loading. The platoon should load vehicles keeping fire team, squad, and platoon integrity. For example, fire teams and squads intact on the same vehicle and platoons in the same serial. Additionally, key leaders, weapons, and equipment should be cross loaded.
- Rehearsals. Rehearsing immediate action to enemy contact (near and far ambush, air attack) ensuring the driver knows what to do.
- Air guards. Posting air guards for each vehicle.

(4) **Movement during limited visibility conditions.** At night or when visibility is poor, a platoon must be able to function the same as during

day. It must be able to control, navigate, maintain security, move, and stalk at night or during limited visibility.

(a) *Control*. When visibility is poor, the following methods aid in control:

- Selected personnel use of night vision devices.
- Leaders move closer to the front.
- The platoon reduces speed.
- Each soldier uses two small strips of luminous tape on the rear of his helmet to allow the soldier behind him to see.
- Leaders reduce the interval between soldiers and between units to make sure they can see each other.
- Leaders conduct headcounts at regular intervals and after each halt to ensure personnel accountability.

(b) *Navigation*. To assist in navigation during limited visibility, leaders use—

- Terrain association (general direction of travel coupled with recognition of prominent map and ground features).
- Dead reckoning (compass direction and specific distances or legs). At the end of each leg, leaders should verify their location.
- Movement routes that parallel identifiable terrain features.
- Guides or marked routes.
- GSRs to vector units to the proper location.
- Position-location devices.

(c) *Security*. For stealth and security in night moves, squads and platoons—

- Designate a point man to maintain alertness, the lead team leader to navigate, and a pace man to count the distance traveled. Alternate compass and pace men are designated.
- Allow no smoking, no lights, and no noise.
- Use radio-listening silence.
- Camouflage soldiers and equipment.
- Use terrain to avoid detection by enemy surveillance or night vision devices.
- Make frequent listening halts.
- Mask the sounds of movement with artillery tires.

(d) *Night walking*. Proficiency in night walking is gained through practice. A soldier walking at night looks ahead, then slowly lifting his right foot, he cases it forward about 6 inches to the front of the left foot. While easing his foot forward and keeping his toes pointed downward, the soldier feels for twigs and trip wires. He slowly places his foot on the

ground. Confident of solid, quiet footing, the soldier slowly moves his weight forward, hesitates, then repeats the process with the other foot. This technique is slow and time-consuming.

(e) *Stalking*. Soldiers stalk to get as close as they can to an enemy sentry, patrol, or base. This is best described as a slow, crouching night walk. The soldier watches the enemy continuously. When close to the enemy, the soldier squints to help conceal light reflected by his eyes. He breathes slowly through his nose. If the enemy looks in his direction, the soldier freezes. He takes advantage of the background to blend with shadows and to prevent glare or contrast. Soldiers move during distractions such as gusts of wind, vehicle movement, loud talking, or nearby weapons fire.

2-11. ACTIONS AT DANGER AREAS

A danger area is any place on a route where the leader's estimate process tells him that his platoon might be exposed to enemy observation, fire, or both. Platoons try to avoid danger areas. If a platoon must cross a danger area, it does so with great caution and as quickly as possible.

a. **Types of Danger Areas.** The following are some examples of danger areas and crossing procedures.

(1) *Open areas*. Conceal the platoon on the nearside and observe the area. Post security to give early warning. Send an element across to clear the far side. When cleared, cross the remainder of the platoon at the shortest exposed distance and as quickly as possible.

(2) *Roads and trails*. Cross roads or trails at or near a bend, a narrow spot, or on low ground.

(3) *Villages*. Pass villages on the downwind side and well away from them. Avoid animals, especially dogs, which might reveal the presence of the platoon.

(4) *Enemy positions*. Pass on the downwind side (the enemy might have scout dogs). Be alert for trip wires and warning devices.

(5) *Minefields*. Bypass minefields if at all possible—even if it requires changing the route by a great distance. Clear a path through minefields only if necessary.

(6) *Streams*. Select a narrow spot in the stream that offers concealment on both banks. Observe the far side carefully. Emplace near and far-side security for early warning. Clear the far side, then cross rapidly but quietly.

(7) *Wire obstacles*. Avoid wire obstacles (the enemy covers obstacles with observation and fire).

b. Crossing of Danger Areas. When the platoon crosses a danger area independently or as the lead element of a larger force, it must—

- Designate near- and far-side rally points.
- Secure the near side (right, left flanks, and rear security).
- Reconnoiter and secure the far side.
- Execute crossing the danger area.

(1) The platoon leader or squad leader decides how the unit will cross based on the time he has, the size of the unit, the size of the danger area, the fields of fire into the area, and the amount of security he can post. A small unit may cross all at once, in buddy teams, or one soldier at a time. A large unit normally crosses its elements one at a time. As each element crosses, it moves to an overwatch position or to the far-side rally point until told to continue movement.

(2) To maintain momentum, mailing platoons normally cross the danger area without conducting their own reconnaissance or establishing far-side security. The lead platoon conducts reconnaissance and maintains far-side security for the whole force.

NOTE: The secured area must be large enough to allow the full deployment of the remainder of the unit.

c. Crossing of linear Danger Areas (Platoon). The platoon crosses the danger area in the formation and location specified by the platoon leader. On the far side of the danger area, platoon personnel and equipment are accounted for. The platoon continues the mission. (Figure 2-27.)

(1) When the lead team signals "danger area" (relayed throughout the platoon), the platoon halts.

(2) The platoon leader moves forward, confirms the danger area, and determines what technique the platoon will use to cross. The platoon sergeant also moves forward to the platoon leader.

(3) The platoon leader informs all squad leaders of the situation and the near-side and far-side rally points.

(4) The platoon sergeant directs positioning of the near-side security (usually conducted by the trail squad). These two security teams may follow him forward when the platoon halts and a danger area signal is passed back.

(5) The platoon leader reconnoiters the danger area and selects the crossing point that provides the best cover and concealment.

(6) Near-side security observes to the flanks and overmatches the crossing.

(7) When the near-side security is in place, the platoon leader directs the far-side security team to cross the danger area.

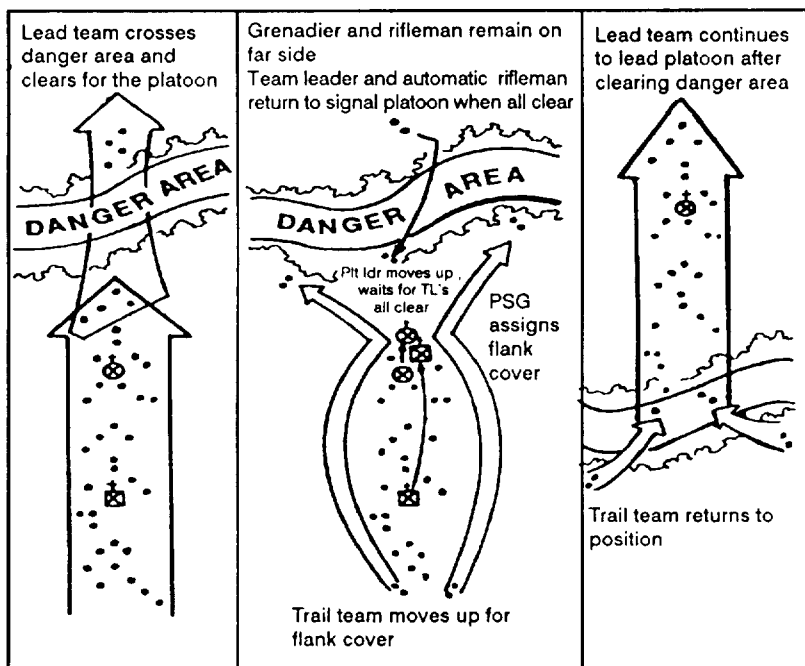

Figure 2-27. Crossing a danger area.

- (8) The far-side security team clears the far side.
- (9) The far-side security team leader establishes an OP forward of the cleared area.
- (10) The far-side security team signals to the squad leader that the area is clear. The squad leader relays the message to the platoon leader.
- (11) The platoon leader selects the method the platoon will use to cross the danger area.
- (12) The platoon quickly and quietly crosses the danger area.
- (13) Once across the danger area, the main body begins moving slowly on the required azimuth.
- (14) The near-side security element, controlled by the platoon sergeant, crosses the danger area where the platoon crossed. They may attempt to cover any tracks left by the platoon.
- (15) The platoon sergeant ensures everyone crosses and sends up the report.
- (16) The platoon leader ensures accountability and resumes movement at normal speed.

NOTE: The same principles stated above are used when crossing a smaller unit across a danger area.

d. **Crossing of Large Open Areas.** This is an area so large (hat the platoon cannot bypass due to the time to accomplish the mission (Figure 2- 28). A combination of (raveling overwatch and bounding overwatch is used to cross the open area. The traveling overwatch technique is used to save time. At any point in the open area where contact may be expected or once the squad or platoon comes within range of small-arms fire of the far side (about 250 meters), the squad or platoon moves using the bounding overwatch technique. Once beyond the open area, the squad or platoon reforms and continues the mission.

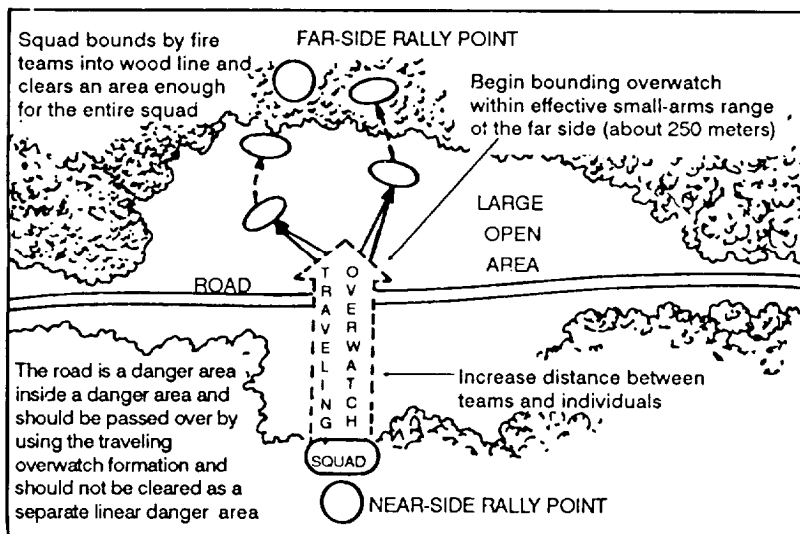

Figure 2-28. Crossing large open area.

e. **Crossing of Small Open Areas.** This is an open area small enough so that it may be bypassed in the time allowed for the mission. Two techniques can be used:

(1) **Detour bypass method.** By the use of 90-degree turns to the right or left, the squad or platoon moves around the open area until the far side is reached, then continues the mission. The pace count of the offset and return legs is not added to the distance of the planned route.

(2) **Contouring around the open area.** The leader designates a rally point on the far side with the movement azimuth, decides which side of the open area to contour around (after considering the distance, terrain, cover and concealment), and moves around the open area. He uses the wood line and vegetation for cover and concealment. When the squad or platoon arrives at the rally point on the far side, the leader reassumes the azimuth to the objective area and continues the mission (Figure 2-29).

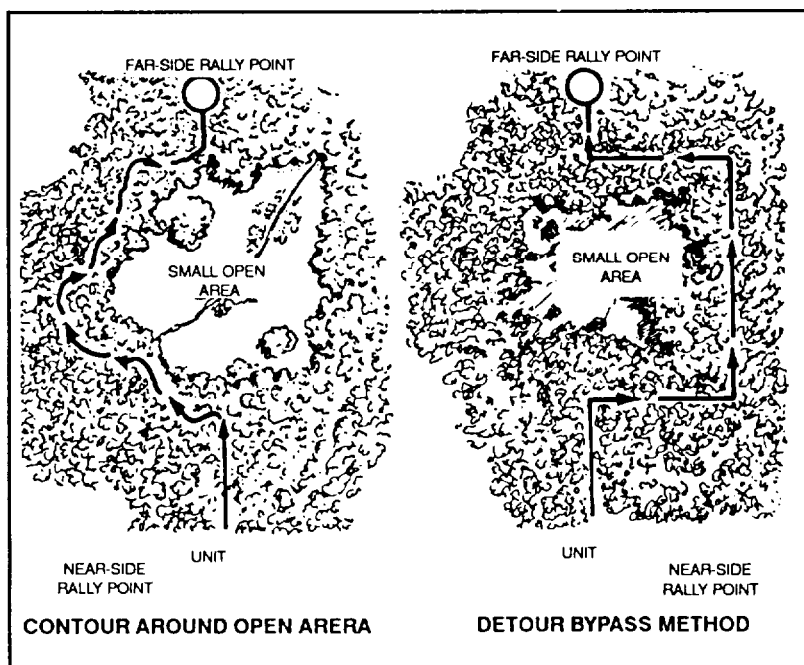

Figure 2-29. Crossing a small open area.

f. **Enemy Contact at Danger Areas.** If the platoon makes enemy contact in or around the danger area, see Figure 2-30 for contact on far side, Figure 2-31 for contact on a road or trail, or Figure 2-32 for contact on near side.

NOTE: Squads react to contact the same as platoons.

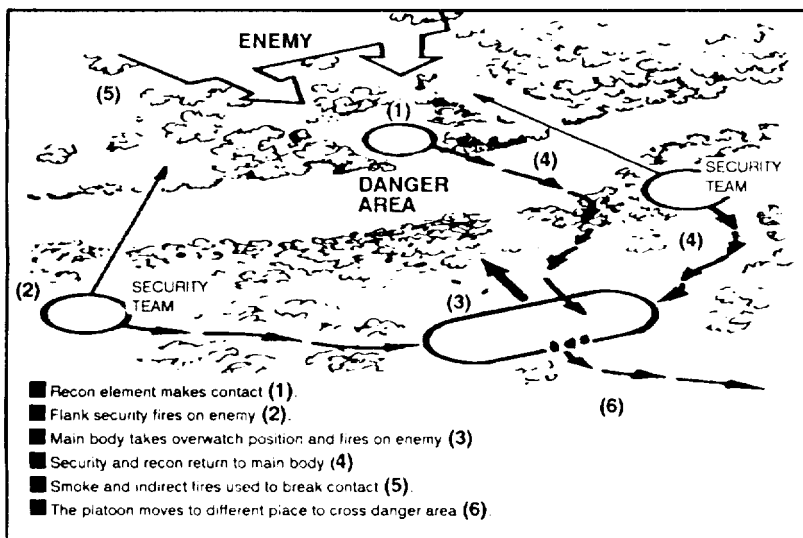

Figure 2-30. Enemy contact on far side.

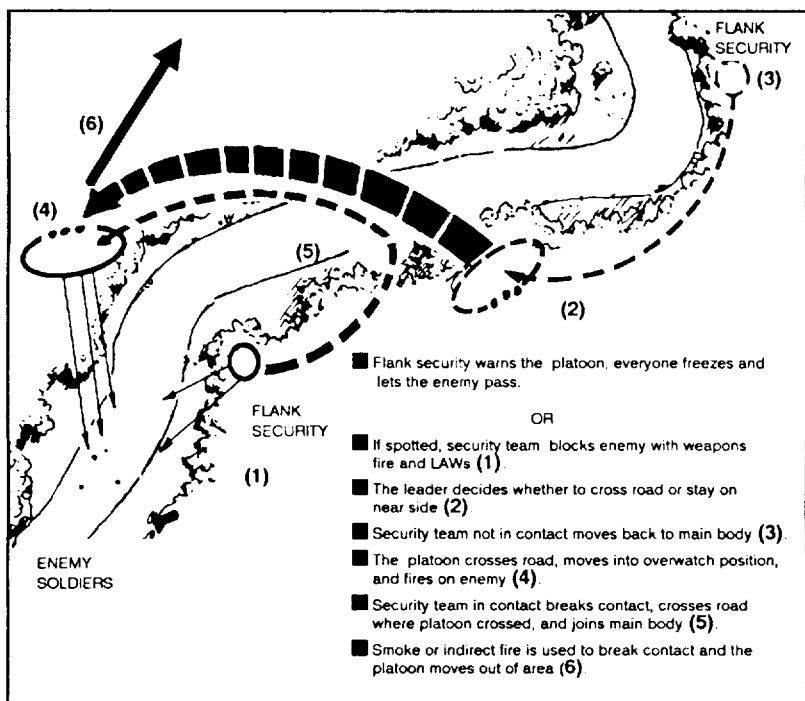

Figure 2-31. Enemy contact on road or trail.

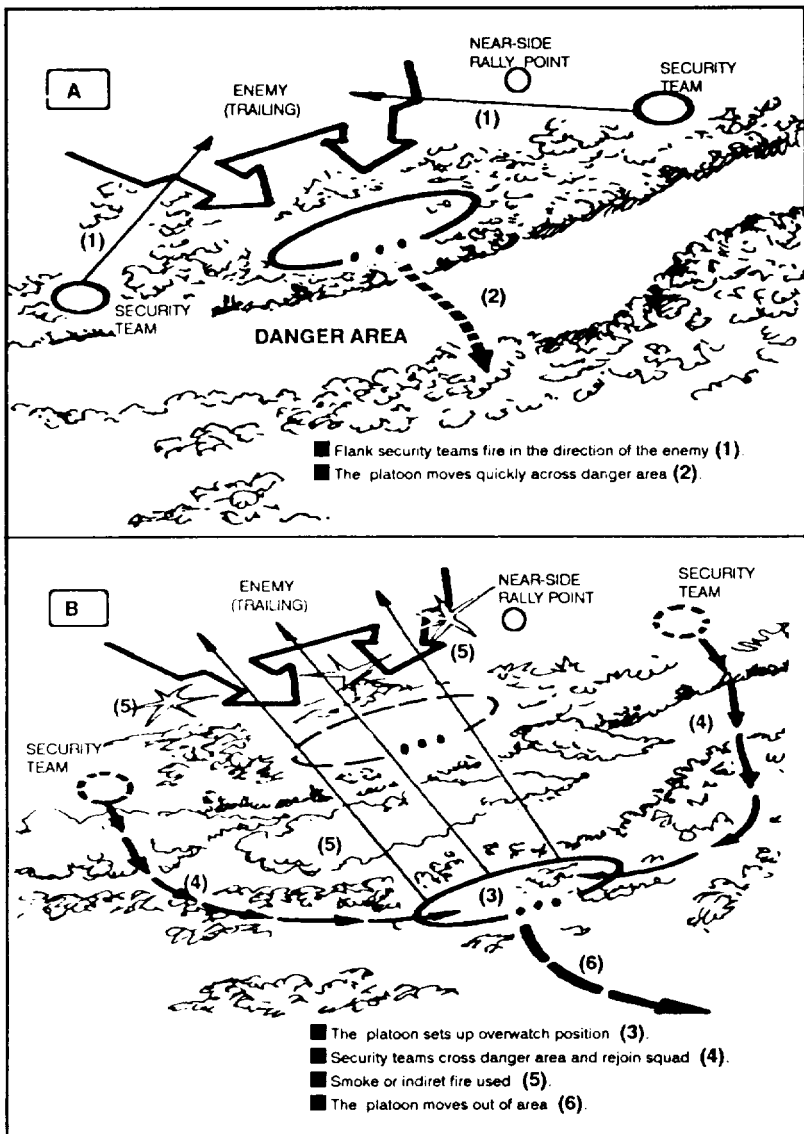

Figure 2-32. Enemy contact on near side.

Section IV. OFFENSE

This section provides techniques and procedures for offensive missions. It includes movement to contact, deliberate attack, and consolidation and reorganization on the objective.

2-12. MOVEMENT TO CONTACT

Infantry units use two techniques for conducting a movement to contact—search and attack or approach march. The platoon leader selects the technique based on the expected enemy situation. Search and attack is used when the enemy is dispersed, when the enemy is expected to avoid contact or quickly disengage and withdraw, or to deny him movement in an area. The approach march maybe used when the enemy is expected to deploy using relatively fixed offensive or defensive formations.

a. **Search and Attack Technique.** The search and attack technique involves the use of multiple squads and fire teams coordinating their actions to make contact with the enemy. Platoons attempt to find the enemy, and then fix and finish him. They combine patrolling techniques with the requirement to conduct hasty or deliberate attacks once the enemy has been found. Planning considerations include—

- The factors of METT-T.
- The requirement for decentralized execution. (The platoon leader coordinates the actions of squads.)
- The requirement for mutual support. (The platoon leader must be able to respond to contact with his other squads not in contact.)
- The length of operations. (The plan may need to address continuous operations.)
- The soldier's load. (Search and attack requires stealth.)
- Resupply and MEDEVAC.
- The positioning of key leaders and personnel.
- The employment of key weapons.
- The requirement for patrol bases.
- The concept for entering the zone of action.
- The concept for linkups. (All leaders must know how they will linkup once contact is made.)

b. **Approach March Technique.** The concept behind the approach march is to make contact with the smallest element, allowing the commander the flexibility of maneuvering or bypassing the enemy force. As part of a larger unit using the approach march technique, platoons may act as the advance, flank, or rear guard. They may also receive on-order missions as part of the main body.

(1) *Advance guard.* As the advance guard, the platoon finds the enemy and locates gaps, flanks, and weaknesses in his defense. The advance guard attempts to make contact on ground of its own choosing, to gain the advantage of surprise, and to develop the situation (either fight through or support the assault of all or part of the main body). The advance guard operates within the range of the main body's indirect fire support weapons.

(a) One rifle squad leads the advance guard.

(b) The platoon uses appropriate formations and movement techniques. (See Figure 2-33.)

(c) The leader rotates the lead squad as necessary to keep soldier fresh.

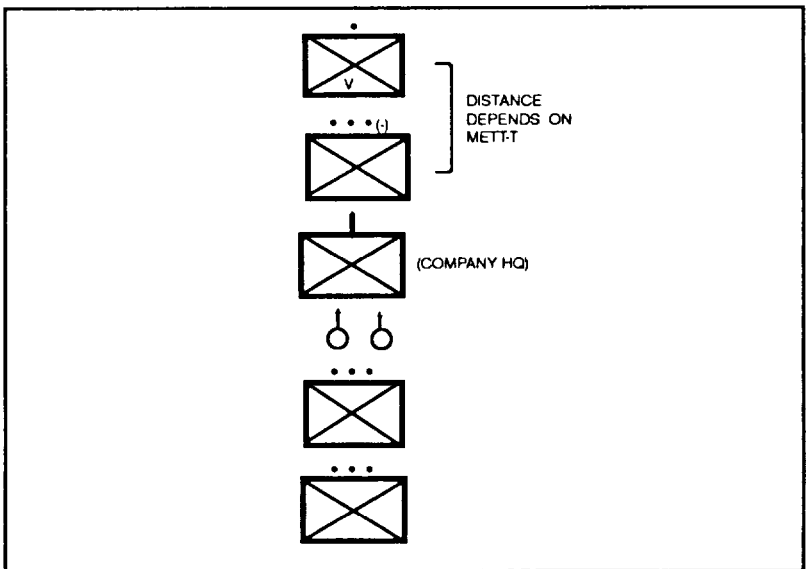

Figure 2-33. Lead element, using traveling overwatch.

(2) *Flank or rear guard.* The entire platoon may act as the flank or rear guard for a battalion conducting a movement to contact using this technique. The platoon—

- Moves using the appropriate formation and movement technique. It must maintain the same momentum as the main body.
- Provides early warning.
- Destroys enemy reconnaissance units.
- Prevents direct fires or observation of the main body.

(3) **Main body.** When moving as part of the main body, platoons may be tasked to assault, bypass, or fix an enemy force; or seize, secure, or clear an assigned area. The platoon may also be detailed to provide squads as flank guards, stay-behind ambushes, rear security, or additional security (o the front. These squads may come under the direct control of the company commander. Platoons and squads use appropriate formations and movement techniques, assault techniques, and ambush techniques.

2-13. DELIBERATE ATTACK

Platoons and squads conduct deliberate attacks as part of a larger force.

a. **Planning Considerations.** The leader uses the troop-leading procedure and the estimate of the situation to develop his plan (see Section I).

(1) The platoon can expect to be a base-of-fire element or an assault element. If the platoon receives the mission to conduct a supporting attack for the company, or to attack a separate objective, the platoon leader should constitute a base-of-fire element and an assault element. The platoon leader's decision to employ his squads depends on the ability to achieve suppressive fires against the objective, the need for firepower in the assault, and the requirement for a reserve to retain the freedom to maneuver. If the platoon is the company main effort, the platoon leader can retain less of his platoon as a reserve. If the platoon is the supporting effort, the platoon leader may require up to a squad as a reserve. The platoon leader may employ his squads in one of the following ways:

(a) Two squads and one or both machine guns as the base-of-fire element and one squad (with the remaining machine gun) as the assault element.

(b) One squad and one or both machine guns as the base-of-fire element and two squads (with the remaining machine gun) as the assault element.

(c) One squad and one or both machine guns as the base-of-fire element, one squad as the assault element, and one squad (with the remaining machine gun) to follow and support the assault element. This method generally supports the organization of the platoon for breaching obstacles during the assault.

(2) Additionally, if the company commander's concept calls for decentralized execution, the platoon leader must consider his objective, a vulnerable flank or exploitable weakness, routes, movement and fire control measures, and formations and movement techniques. The platoon leader considers these along with the factors of METT-T and the commander's intent to develop a scheme of maneuver and a fire support plan.

b. **Movement to the Objective.** Platoons and squads use the appropriate formations and movement techniques to avoid contact and achieve

surprise (see Section III). The platoon must remain undetected. If detected early, the platoon concentrates direct and indirect fires, establishes a base of fire, and maneuvers to regain the initiative.

(1) ***Movement from the assembly area to the line of departure.*** The platoon moves forward from the assembly area under company control. When the platoon leader is already forward with the company commander, the platoon sergeant moves the platoon forward. Machine guns and antiarmor weapons can precede the rest of the platoon by moving to an overwatch position on or near the LD. Leaders time the move from the assembly area during reconnaissance or rehearsals to ensure that the lead squad crosses the LD on time and at the right place. The platoon attempts to cross the LD without halting in an attack position. If the platoon must halt in the attack position, it deploys into the initial attack formation, posts security, and takes care of last-minute coordination. Whether or not the platoon halts in the attack position, it must deploy into the attack formation and fix bayonets before crossing the LD.

(2) ***Movement from the line of departure to the assault position or support position.*** The platoon moves using the appropriate technique. If it has its own support and assault elements, it may move them together for security, or along separate routes to their respective positions, for speed. The base-of-fire element must be in place and ready before the assault element continues beyond the assault position.

(a) The platoon leader's plan must address actions on chance contact. The lead squad executes the battle drill to react to contact (see Chapter 4, Battle Drill 2). The platoon leader makes an assessment and reports. The company commander may direct the platoon to fight through, fix, and bypass the enemy, or establish a hasty defense.

(b) If the platoon encounters an obstacle that it cannot bypass, it attempts a breach (see Section X and Chapter 4, Battle Drill 8).

(c) If the company concept calls for decentralized execution, the platoon leader must consider when to initiate his supporting fires.

- **Surprise.** If the attack is not detected, the base-of-fire element may hold fires until the assault element approaches the assault position. This will enhance surprise. The base-of-fire element may initiate fires early to keep the enemy's attention off the assault element as it moves to a flanking or rear position.
- **Suppression.** The leader must consider the length of time needed to suppress the enemy position and destroy as many of his weapons and bunkers as possible before the assault.

(3) ***Movement from the assault position to the objective.*** The assault position is normally the last covered and concealed position before reaching the objective.

(a) As it passes through the assault position, the platoon deploys into its assault formation; that is, its squads and fire teams deploy to place the bulk of their firepower to the front as they assault the objective. A platoon sometimes must halt to complete its deployment and to ensure synchronization so that all squads assault at the designated time.

NOTE: Platoons should avoid halting in the assault position, because it is dangerous and may cause the loss of momentum.

(b) The assaulting squads move from the assault position and onto the objective. The platoon must be prepared to breach the enemy's protective obstacles.

(c) As the platoon moves beyond the obstacle, supporting fires should begin lifting and shifting away from the objective. Both direct and indirect fires shift to suppress areas adjacent to the objective, to destroy enemy forces retreating, or to prevent enemy reinforcement of the objective.

c. **Assaulting the Objective.** As the platoon or its assault element moves onto the objective, it must increase the volume and accuracy of fires. Squad leaders assign specific targets or objectives for their fire teams. Only when these discreet fires keep the enemy suppressed can the rest of the unit maneuver. As the assault element gets closer to the enemy, there is more emphasis on suppression and less on maneuver. Ultimately, all but one fire team may be suppressing to allow that one fire team to break in to the enemy position. Throughout the assault, soldiers use proper individual movement techniques, and fire teams retain their basic shallow wedge formation. The platoon does not get "on-line" to sweep across the objective.

d. **Consolidation and Reorganization.** Once enemy resistance on the objective has ceased, the platoon must quickly take steps to consolidate and prepare to defend against a counterattack.

(1) **Consolidation techniques.** Platoons use either the clock technique or the terrain feature technique in consolidating on the objective.

NOTE: All-round security is critical. The enemy might counterattack from any direction. The platoon leader must evaluate the terrain thoroughly.

(a) **Clock technique.** In using this method, the platoon leader designates either a compass direction or the direction of attack as 12 o'clock. He then uses clock positions to identify the left and right boundaries for squads. The platoon leader positions key weapons along the most likely avenue of approach based on his assessment of the terrain. (See Figure 2-34.)

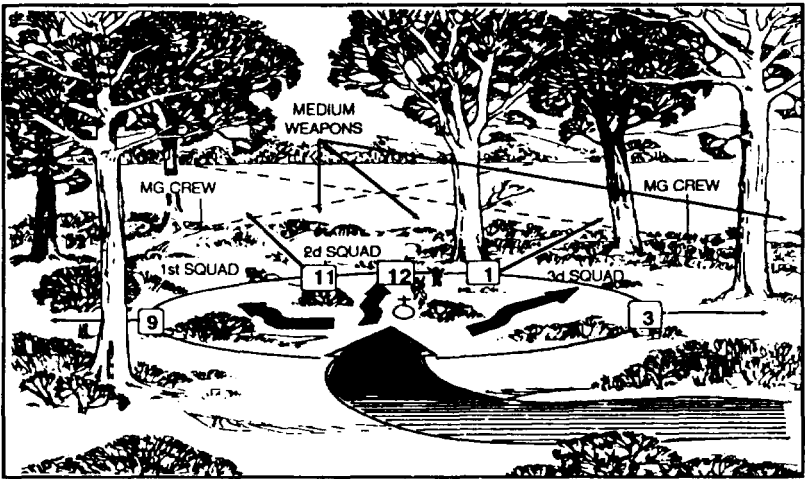

Figure 2-34. Clock technique.

(b) *Terrain feature technique.* In a similar manner, the platoon leader identifies obvious terrain features as the left and right limits for squads. In both techniques, he ensures that squad sectors of fire overlap each other and provide mutual support for adjacent units. (Figure 2-35.)

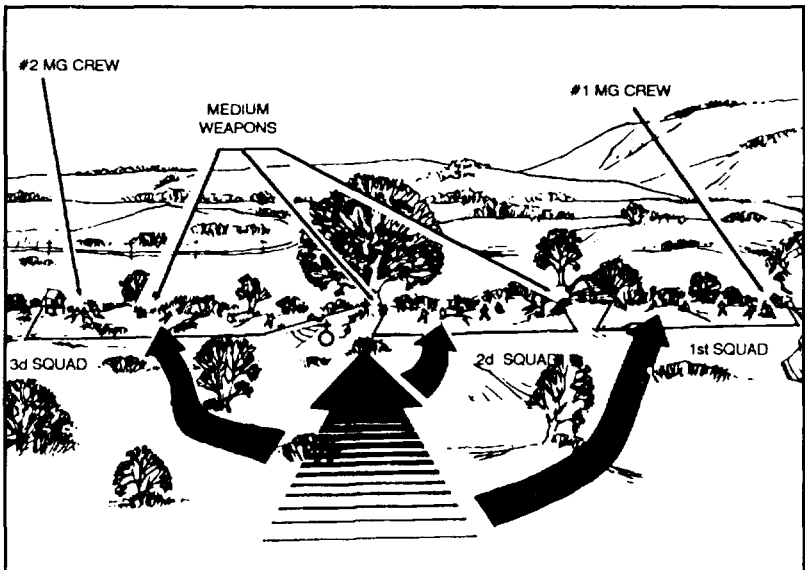

Figure 2-35. Terrain feature technique.

(2) **Reorganization.** Once platoons have consolidated on the objective, they begin to reorganize. Platoons reorganize to continue the attack. Reorganization involves—

- Reestablishing command and control.
- Remanning key weapons, redistributing ammunition and equipment.
- Clearing the objective of casualties and EPWs
- Assessing and reporting the platoon status of personnel, ammunition, supplies, and essential equipment.

2-14. ATTACKS DURING LIMITED VISIBILITY

Attacks during limited visibility achieve surprise, avoid heavy losses, cause panic in a weak and disorganized enemy, exploit success and maintain momentum, and keep pressure on the enemy. Limited visibility operations are one of the main missions of infantry forces. Whenever possible, US infantry will use limited visibility to conduct attacks.

a. **Planning.** The planning considerations for daylight attacks are the same as for limited visibility attacks. However, limited visibility attacks require additional control measures to prevent fratricide and keep the attack focused on the objective. Leaders may use boundaries, restrictive fire lines, and limits of advance to assist in control.

b. **Reconnaissance.** Reconnaissance is key to successful night attacks. It should be conducted during daylight down to the lowest level possible. The platoon should reconnoiter the routes on which they will move, the positions that they will occupy, and the assigned objective. The need for detailed information about the enemy must be balanced against the risk of being detected and the loss of surprise.

(1) The reconnaissance plan should also establish surveillance on the objective in case the enemy repositions units and weapons or prepares additional obstacles. Surveillance and security forces should also secure critical locations, such as assault and support positions, LD and PLD, routes, and RPs, to protect the platoon from enemy ambushes and spoiling attacks. These security forces may become part of the isolation element during the attack.

(2) When reconnaissance does not succeed due to lack of time, the platoon leader requests a delay in the attack time to allow for further reconnaissance. If this is not possible, an illuminated and supported attack should be considered. A night attack with marginal information of the enemy's defense is risky and difficult to conduct.

c. **Use of Guides.** During limited visibility attacks, the platoon may use guides to provide better control while moving into the assault position and onto the probable line of deployment (PLD).

(1) The company may organize a patrol to place platoon guides from the LD to subsequent RPs, at the entrance to the assault positions and at points along the PDL.

(2) Guides must be fully briefed on the plan and on their specific duties. They must rehearse their actions, to include—

- Reconnaissance of their assigned routes and release points.
- Pick-up and release of their assigned units. They must be able to identify the leader of the element they will guide (or the lead soldier of that element). They must also know and rehearse recognition signals.

(3) Platoons must rehearse their actions in the same order of march and sequence that they intend to use during the attack in order to make the pick-up and release of guides go smoothly.

d. **Fire Control Techniques.** Fire control techniques for limited visibility include the following.

(1) **Tracer fire.** Leaders in the assault element fire all tracers; their soldiers fire where the leader's tracers impact. The support element positions a machine gun on a tripod on the flank nearest the assault force. This weapon fires a burst of tracers every 15 seconds to indicate the near limit of the supporting fires. All other weapons in the support element keep their fires on the appropriate side of this tracer. The assault force signals to shift fires to the next position or to a set distance. If required, these rounds can be adjusted over the assault element to preclude fratricide.

(2) **Luminous tape or chemical lights.** Leaders mark assault personnel to prevent fratricide. The enemy must not be able to see the marking. Two techniques are to place tape on the back of the helmet or to use small infrared chemical lights (if the enemy has no NVDs). The support element must know where the lead assault element is. If the individual soldier markings do not suffice, large chemical lights (infrared or visible) are used. These lights are placed on the ground or thrown in front of the assault element. When clearing a trench line, soldiers may put chemical lights on a stick and move them with the lead element to ensure the support element shifts fires.

(3) **Weapon control restrictions.** To reduce the risk to the assault element, the leader may assign weapon control restrictions.

(a) The squad on the right in the assault might be given weapons free to the right flank because no friendly soldiers are there. However, weapons tight or hold on the left means that another friendly unit is located there.

(b) No automatic weapons will be fired by the assault force on the objective. This ensures that all automatic weapons are enemy.

(4) **Other techniques.** To increase control during the assault, the leader may use the following.

- No flares, grenades, or smoke used on the objective.
- Only certain personnel with NVDs can engage targets on the objective.
- A magnetic azimuth for maintaining direction.
- Mortar or artillery rounds to orient attacking units.
- Guides.
- A base squad or fire team to pace and guide others.
- Reduced intervals between soldiers and squads.
- Luminous tape on armbands or helmets.

e. **Mortar, Artillery, and Antiarmor Fires.** Mortar, artillery, and antiarmor fires are planned as in a daylight attack. They are not fired, however, unless the platoon is detected or is ready to assault. Some weapons may fire before the attack and maintain a pattern to deceive the enemy or to help cover noise made by the platoon's movement. This is not done if it will disclose the attack.

(1) Indirect fire is hard to adjust when visibility is poor. If doubt exists as to the exact friendly locations, indirect fire is directed first at enemy positions beyond the objective and then moved onto the objective. Illuminating rounds that are fired to burn on the ground can be used to mark objectives. This helps the platoon orient on the objective but also may adversely affect NVDs.

(2) Smoke is planned to further reduce the enemy's visibility, particularly if he has NVDs. The smoke is laid close to or on enemy positions so it does not restrict friendly movement or hinder the breaching of obstacles. Employing smoke on the objective during the assault may make it hard for assaulting soldiers to find enemy fighting positions. If enough thermal sights are available, smoke on the objective may provide a decisive advantage for a well-trained platoon.

(3) Illumination is always planned for limited visibility attacks, giving the leader the option of calling for it. Battalion commanders normally control the use of illumination but may authorize the company commander to do so. If the commander decides to use illumination, illumination should not be called for until the assault is initiated or the attack is detected. It should be placed on several locations over a wide area to confuse the enemy as to the exact place of the attack. Also, it should be placed beyond the objective to help assaulting soldiers see and fire at withdrawing or counterattacking enemy soldiers.

(4) Illumination may also be required if the enemy uses illumination to disrupt the effect of the NVDs. Once used, illumination must be continuous because attacking soldiers will have temporarily lost their

normal night vision. Any interruption in illumination may also reduce the effect of suppressive fire when the attackers need it most. Squad leaders must not use hand flares before the commander has decided to illuminate the objective.

(5) Thermal sights (AN/TAS-5) may be employed strictly for observation if there are no targets for the Dragons to engage. Positioned outside the objective area, these sights can provide current information. They may be used to assist the support element in controlling their fires or to provide the assault element with reports of enemy movements on the objective.

(6) When only a few NVDs are available, they must be employed at the most critical locations. These locations can be with the key soldiers in the breach element, key leaders in the assault element, other members of the assault element and key leaders and weapons in the support element.

f. Consolidation and Reorganization. After seizing the objective, the platoon consolidates and reorganizes. Consolidation and reorganization are the same as for a daylight attack with the following exceptions:

(1) The consolidation plan should be as simple as possible. In reorganizing, the platoon should avoid changes to task organization.

(2) Squad positions should be closer to case control and to improve mutual support. Position distances should be adjusted as visibility improves.

(3) Locating and evacuating casualties and EPWs takes longer. EPWs may have to be moved to the rear of the objective and held there until visibility improves.

g. Communication. Communication at night calls for the leader to use different methods than during daylight. For instance, arm-and-hand signals used during the day might not be visible at night. Other types of signals are used to pass information, identify locations, control formations, or begin activity. The key to tactical communications is simplicity, understanding, and practice. Signals should be an integral part of the platoon SOP. They should be as simple as possible to avoid confusion. Leaders should also ensure that every soldier understands and practices each basic signal and its alternate if the need arises. A technique to assist leaders and the RATELO with communication at night is to attach a large patch of luminous tape to the handset, or carry it in their pockets. Leaders and the RATELO can write target numbers, call signs, frequencies, code words, checkpoints, and so forth on it with a black grease pencil. This is easy to read at night and quickly removed if needed.

(1) The most common signals relate to the senses—sound, feel, and sight. Audio signals include radio, telephones, messengers, and grating or clicking of objects together. Messengers should carry written messages to avoid confusion and misunderstanding. When this is not possible,

leaders ensure that the messenger understands the message—have him repeat it word for word.

(2) Control at night involves some oral communication but spoken in a whisper. The radio and telephone might not be suitable at night. If either is used, the leader must be careful. Noise travels farther at night; including radio sounds, messages being passed, and the telephone ringing. These violate noise discipline and can be avoided or reduced by planned signals or clicks. Headphones reduce the amount of noise from telephones and radios. If headphones are not available, soldiers use the radio selector switch in the ON rather than SQUELCH ON position and adjust the volume so that only a faint rushing sound can be heard.

(3) Rocks and other objects can be used to send audible signals. They can be tapped or scraped together or against a tree or rifle stock to pass a message. These signals must be rehearsed. For each signal there must be a reply to show receipt of the signal. Other audible signals are whistles, bells, sirens, clackers or “crickets,” and horns. The device or method chosen depends on simplicity and security.

(4) Leaders can use a variety of visual signals as alternatives to audio signals. The signals can be active or passive. Visual signals must be noticeable and identifiable. These signals can be used to identify a critical trail junction, to begin an attack, to mark caches, or to report that a danger area is clear. For example, white powder can be used to show direction at a confusing trail intersection. Star clusters can signal to lift or shift support fires for an attack or raid. Chemical lights can signal a unit cache. The exposed dial of a compass can signal all clear when crossing a danger area. The possibilities are endless, but the leader must ensure that each soldier understands every signal. Some signals are—

- VS-17 panels.
- Sticks showing direction.
- Light-colored paint.
- Tape.
- Rock formations.
- Markings in the ground.
- Foot or talcum powder.
- Luminous tape.
- Flares.
- Flashlights.
- Illumination rounds (grenade launcher, mortar, artillery).
- Chemical lights.
- Infrared strobe lights.
- AN/PVS-5 night vision device.

- Burning fuel (saturated sand in a can).
- Luminous compass dial.

(5) Wire is a means of maintaining communications during the attack. The wire net should link the squad leaders, platoon leaders, and the company commander. At times, a security patrol can lay the wire before the attack. If not, the wire can be laid as the units move. The laying of wire before an attack could lead to discovery of the attack if the wire is not properly hidden, or if it is laid too far in advance. The wire net can be used to communicate while moving.

(a) *Platoon net.* Wire is laid from the platoon RP to the squad RP and to each squad leader's position on the PLD.

(b) *Assault wire.* Assault wire can be used as a guide from the company RP to the platoon and squad RPs.

(c) *Radios.* Squad radios can be used for backup communications.

h. Target Detection. The ability to detect targets at night depends on patience, alertness, attention to detail, and practice. Nature provides an endless array of patterns. However, man disturbs them or alters them so that they are detectable. Sensing the enemy at night requires leaders and soldiers to be patient, confident, and calm.

(1) Stealthy night movement and successful target engagement depend on knowing how the enemy attacks, defends, and uses terrain. Studying his techniques and established patterns helps in detecting targets.

(2) Patience and confidence are musts for effective target sensing at night. While moving through an area, soldiers must think "patterns." They must look calmly and methodically through the area, not focusing on the surface alone but on patterns—noticing straight lines, strange patterns, and light variations.

(3) Soldiers must look for sentries or positions at the entrances to draws, overlooking bridges and obstacles and on the military crests of prominent terrain (the spots used for best observation). They look for supporting positions, keeping in mind range distances for supporting weapons, NVDs, and LOS needs. Then soldiers search for enemy positions and other signs of enemy activity.

Section V. DEFENSE

Paragraph 3b of the platoon SOP (Chapter 5) provides a suggested sequence of tasks for establishing a defensive position. This section follows that sequence in describing techniques used in the planning and preparation phases of defensive operations.

2-15. CONDUCT OF THE DEFENSE

This paragraph provides a pattern of preparation, decision, and execution for platoons and squads. This pattern links the leader's critical decision points to a standard sequence of actions that a platoon takes in defensive operations. (Figure 2-36, page 2-71.) The standard sequence of actions are—

- Prepare for Combat.
- Move to Defensive Positions.
- Establish Defensive Positions.
- Locate the Enemy.
- Initiate Contact/Actions on Enemy Contact.
- Fight the Defense.
- Reorganize.

a. **Prepare for Combat.** The platoon leader receives the company warning or operation order.

(1) The platoon leader quickly issues a warning order.

(2) The platoon leader begins making a tentative plan based on his estimate of the situation and an analysis of METT-T.

(3) When possible the platoon leader (and squad leaders) reconnoiters the defensive position and the route(s) to it. The leader's reconnaissance party should always include a security team (minimum of two soldiers). The leader's reconnaissance—

(a) Maintains security.

(b) Checks for enemy positions, or signs of past enemy activities, obstacles, booby traps, and NBC contamination.

(c) Confirms/adjusts squad positions and sectors of fire from those in the tentative plan. (Normally the platoon leader assigns and adjusts machine guns and antiarmor positions.) The platoon leader revises his plan as necessary based on a further assessment of METT-T.

(d) As the reconnaissance party returns to the platoon, the platoon leader posts guides along the route to maintain security and help the platoon move into the position.

(4) Based on his reconnaissance, and any additional information, the platoon leader completes and issues his plan.

(5) All squad leaders check (the platoon sergeant spot checks) weapons, communications equipment and accessories for missing items (squad and individual) and serviceability.

(6) The platoon sergeant makes sure that the platoon has ammunition, food, water, and medical supplies on hand, in quantities prescribed by the platoon leader. (Squads and platoons should plan to prestock an additional basic load of ammunition on the defensive position.)

(7) All soldiers camouflage themselves and their equipment to blend with the terrain.

(8) The platoon rehearses critical tasks first.

(a) The platoon leader makes final inspection of weapons (test fires weapons, if possible), equipment (include communications checks), and personnel (include camouflage). The platoon sergeant closely monitors the soldiers' load to ensure that standard items are packed in accordance with the platoon SOP and that it is not excessive.

(b) If an advance party is used, the platoon leader, platoon sergeant, and advance party leader (normally a squad leader) review advance party activities and redistribute equipment to the advance party (for example, tripods, stakes). (See Chapter 5.)

(9) If not already moving, the platoon leader initiates the movement of his platoon.

b. Move to Defensive Positions. The platoon applies fundamentals of movement:

(1) Move on covered and concealed routes.

(2) Avoid likely ambush sites.

(3) Enforce camouflage, noise, and light discipline.

(4) Maintain all-round security, to include air guards.

(5) Use formations and movement techniques based on METT-T.

c. Establish Defensive Positions. The platoon halts short of the defensive position in a covered and concealed position, and establishes local security.

(1) The platoon leader and squad leaders and a security team (minimum of two soldiers) move forward to link up with the security team on the position.

(a) The squad leaders return to the platoon and move their squads forward.

(b) The platoon occupies the designated position. Guides control the movement of the platoon into position.

(2) As the platoon occupies its position, the platoon leader ensures that all tasks are performed in the stated priority of work. Additionally, the platoon leader—

- Walks forward of positions, if possible to check camouflage and confirm dead space. The most important aspect of infantry fighting positions is that they cannot be observed by the enemy until it is too late.

- Checks on wire and mine teams. The platoon leader ensures that protective wire is outside of hand-grenade range from the fighting positions and tactical wire lies along the friendly side of the final protective line (FPL).
- Briefs the platoon sergeant on the logistics plan (include resupply and casualty evacuation routes).
- Issues finalized platoon order and checks soldier knowledge and understanding. (All soldiers must be aware of friendly units forward of the position [for example, patrols, scouts] and their return routes. They must also know the signals or conditions to initiate, shift, fire final protective, and cease fires, and to reposition to alternate and supplementary positions.)

(3) The platoon improves the position continuously.

d. **Locate the Enemy.** The platoon establishes and maintains OPs and conducts security patrols as directed by the company commander. Patrols, OPs, and individual soldiers look and listen. They use night surveillance devices, binoculars, and PEWS to detect the enemy approach.

e. **Action on Enemy Contact.** Once the enemy is detected, the platoon leader—

- Alerts the squad leaders, platoon sergeant, and his forward observer.
- Reports the situation to the company commander.
- Calls in OPs. (The squad leader or platoon leader may decide to leave the OPs in place if the soldiers manning them can provide effective flanking fires, their positions afford them adequate protection, and or their return will compromise the platoon's position.)
- Calls for and adjusts indirect fire when the enemy is at maximum range.
- Initiates the long-range direct fires of his platoon on command from the company commander.

Leaders and individual soldiers return to their positions and prepare to fire on command from the platoon leader.

f. **Fight the Defense.** The platoon leader determines if the platoon can destroy the enemy from its assigned positions.

(1) If the answer is YES, the platoon continues to tight the defense.

(a) The platoon leader, or FO, continues to call for indirect fires as the enemy approaches. The platoon normally begins engaging the enemy at maximum effective range. It attempts to mass fires and initiate them simultaneously to achieve surprise. Long-range fires tied-in with obstacles should disrupt his formations; channelize him toward engagement areas; prevent, or severely limit his ability to observe the location of

friendly positions; and destroy him as he attempts to breach tactical obstacles.

(b) Leaders control fires using standard commands, pyrotechnics, and other prearranged signals. The platoon increases the intensity of fires as the enemy closes within range of additional weapons. Squad leaders work to achieve a sustained rate of fire from their positions by having buddy teams fire their weapons so that both are not reloading them at the same time.

(c) In controlling and distributing fires, the platoon and squad leaders consider—

- The range to the enemy.
- Priority targets (what to fire at, when to fire, and why).
- Nearest or most dangerous targets.
- Shifting to concentrate fires on their own or as directed by higher headquarters.
- Ability of the platoon to engage dismounted enemy with enfilading, grazing fires.
- Ability of the platoon's antiarmor weapon to achieve flank shots against enemy vehicles.

(d) As the enemy closes on the platoon's protective wire, the platoon leader initiates final protective fires (FPF) (the following actions occur simultaneously):

- Machine guns and automatic weapons fire along interlocking principle direction of fire (PDF), or final protective lines (FPL) as previously designated and planned. Other weapons fire at designated principle direction of fires. M203 grenade launchers engage enemy in dead space or against enemy attempts to breach protective wire.
- The platoon continues to fight with Claymores and hand grenades.
- If applicable, the platoon leader requests indirect final protective fires (FPF) if they have been assigned in support of his positions.

(e) The platoon continues to defend until the enemy is repelled, or the platoon is ordered to disengage.

(2) If the answer is NO, the platoon leader—

(a) Reports the situation to the company commander.

(b) Continues to engage the enemy or repositions the platoon (or squads of the platoon) only when directed by the company commander to—

- Continue fires into the platoon sector (engagement area).
- Occupy supplementary positions.

- Reinforce other parts of the company.
- Counterattack locally to retake lost fighting positions.
- Withdraw from an untenable position using fire and movement to break contact. (The platoon leader does not move his platoon out of position if it will destroy the integrity of the company defense. All movements and actions to reposition squads and platoons must be thoroughly rehearsed.)

NOTE: In any movement out of a defensive position, the platoon **MUST** employ all direct and indirect fire means available to suppress the enemy long enough for the unit to move.

g. Consolidate and Reorganize.

- (1) The platoon—
 - Reestablishes security.
 - Remans key weapons.
 - Provides first aid and prepares wounded soldiers for MEDEVAC.
 - Repairs damaged obstacles and replaces mines (Claymore) and booby traps.
 - Redistributes ammunition and supplies.
 - Relocates selected weapons to alternate positions if leaders believe that the enemy may have pinpointed them during the attack. Adjusts other positions to maintain mutual support.
 - Reestablishes communications.
 - Reoccupies and repairs positions, and prepares for renewed enemy attack.
- (2) Squad and team leaders provide ammunition, casualty, and equipment (ACE) reports to the platoon leader.
- (3) The platoon leader—
 - Reestablishes the platoon chain of command.
 - Consolidates squad ACE and provides ACE report to the company commander.
- (4) The platoon sergeant coordinates for resupply and supervises the execution of the casualty and EPW evacuation plan.
- (5) The platoon continues to improve positions. The platoon quickly reestablishes OPs and resumes patrolling as directed.

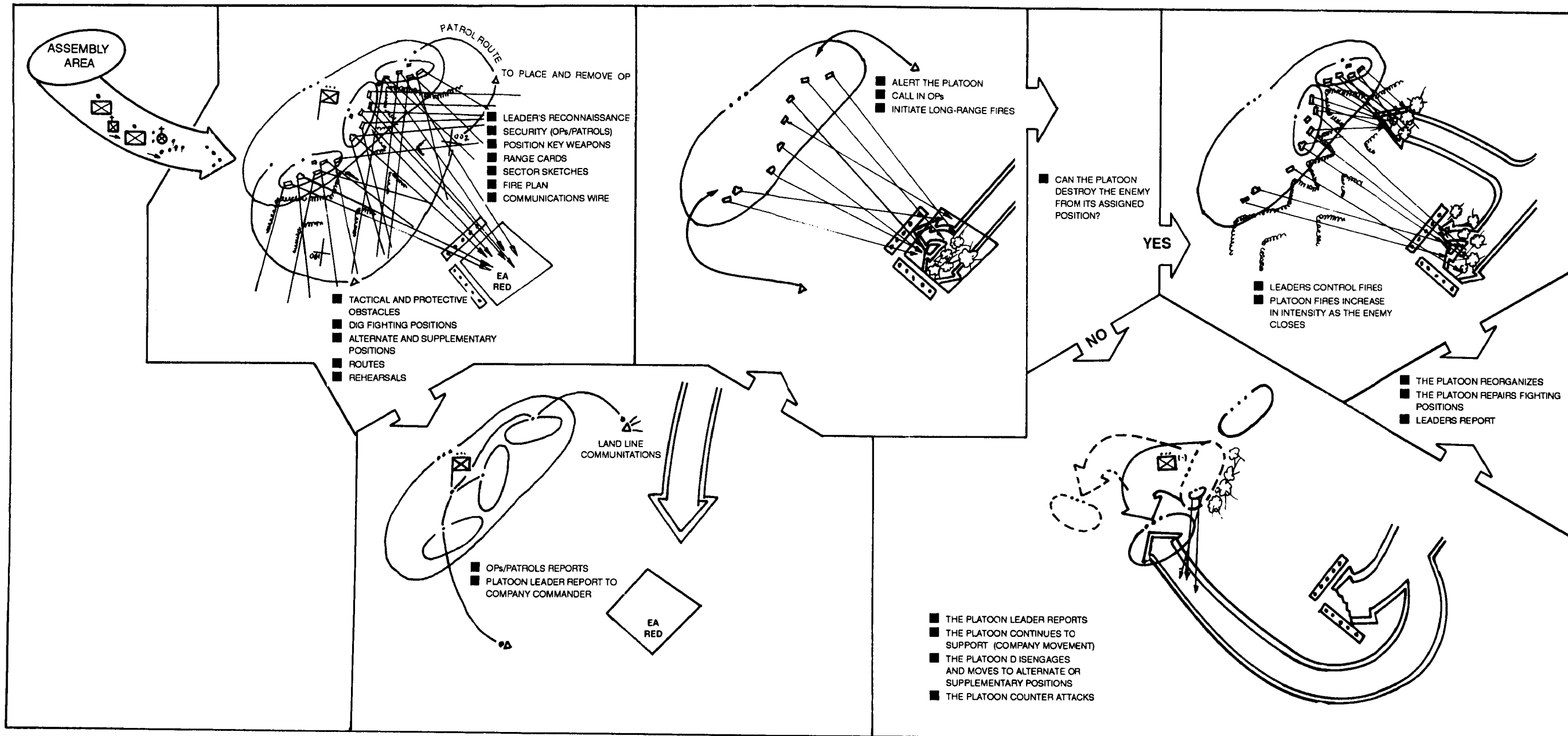

Figure 2-36. Platoon defend.

2-16. SECURITY

In the defense, infantry platoons attempt to surprise the enemy and initiate contact in such a way that his plan is disrupted. To capitalize on the element of surprise, infantry in defensive positions must remain undetected. A compromised position will either be bypassed or assaulted with overwhelming odds. Infantry platoons must conceal the location and preparation of their positions. They do this through the use of camouflage techniques and a strict adherence to noise and light discipline. Platoons must also provide their own security from the arrival of the leader's reconnaissance party through the execution of the defense. Platoons provide their own security through patrolling; the use of observation posts; and by detailing a percentage of the platoon to man hasty positions, while the remainder of the platoon prepares the defense. (Chapter 3 provides detailed information on patrolling techniques. Section XII discusses techniques for establishing observation posts. Securing the position during preparation can be an SOP item.)

2-17. COMMAND POST AND COMMUNICATIONS

A platoon leader sets up his CP where he can best see and control his platoon. The FO and the platoon RATELO occupy the platoon CP with the platoon leader. If the leader cannot see and control all of the platoon from one place, he sets up the CP where he can see and control the main effort. He then sets up an alternate CP where the platoon sergeant can control the rest of the platoon. The aidman normally locates with the PSG. The alternate CP bunker, with overhead cover, maybe large enough to hold additional ammunition and casualties. The EPW collection point is normally near the alternate CP Excess supplies, barrier material, equipment; and KIAs are camouflaged near the alternate CP The platoon CP ties into the company wire net with a field telephone (if in the TOE) and into the company radio net with a radio. The alternate CP ties into the platoon CP with wire. The platoon has its own platoon radio and wire nets. (Figure 2-37.)

2-18. WEAPONS EMPLACEMENT

The success of the defense depends on the positioning of soldiers and weapons. To position their weapons effectively, all leaders must know the characteristics, capabilities, and limitations of their weapons, the effects of terrain, and the tactics used by the enemy. Leaders should position weapons where they have protection; avoid detection; and surprise the enemy with accurate, lethal fires. In order to position the weapon, the leader must know where he wants to destroy the enemy and what effect he wants the weapon to achieve. Additionally, the platoon leader must consider whether his primary threat will be armored vehicles or dismounted infantry. When the platoon must fight armored vehicles,

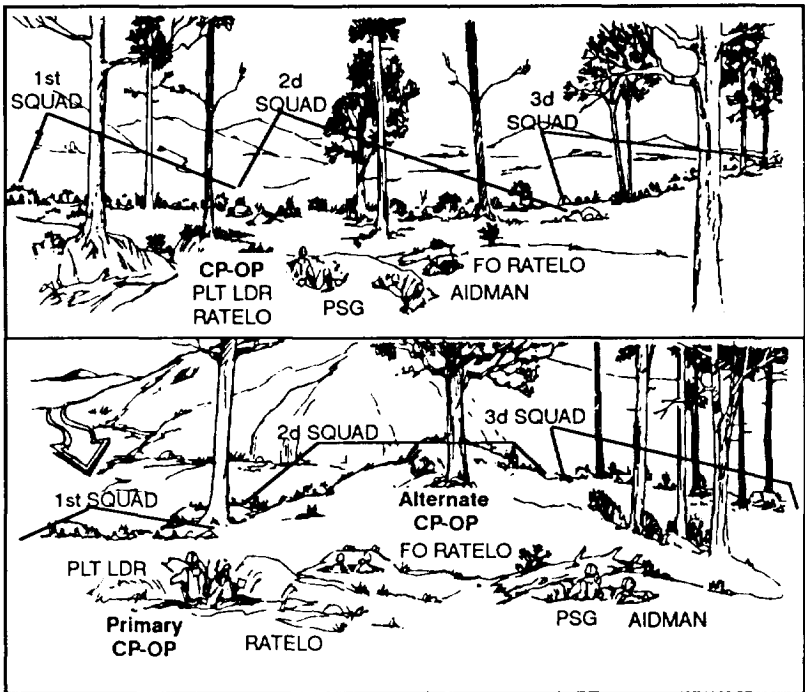

Figure 2-37. Command post-observation post.

the platoon leader positions antiarmor weapons along the most likely armored avenue of approach first. When the primary threat is from dismounted infantry, the the platoon leader should position his machine guns on the most likely dismounted avenue of approach first. The platoon leader must consider both mounted and dismounted avenues of approach. His plan should address both; one as a contingency of the other. Squad leaders position all other weapons to support these key weapons, cover dead space, and provide security.

a. **Machine Guns.** M60 (7.62-mm) and M249 (5.56-mm) machine guns are the platoon's primary weapons against a dismounted enemy. They provide a high volume of lethal, accurate fires to break up enemy assaults. They also provide limited effects against lightly armored vehicles and cause vehicle crews to button-up and operate with reduced effectiveness. Leaders position machine guns to—

- Concentrate fires where they want to kill the enemy.
- Fire across the platoon front.
- Cover obstacles by fire.
- Tie-in with adjacent units.

(1) The following definitions apply to the employment of machine guns.

(a) **Grazing fire** Grazing fire occurs when the center of the cone of fire dots not rise more than 1 meter (about waist high) above the ground. When firing over level or uniformly sloping terrain, a maximum of 600 meters of grazing fire can be obtained.

(b) **Dead space.** Dead space is an area within the maximum effective range of a weapon, surveillance device, or observer that cannot be covered by fire and observation from a given position because of intervening obstacles, the nature of the ground, the characteristics of the trajectory, or the limitations of the pointing capabilities of the systems. The platoon covers dead space with another direct fire weapon, M203 fire, indirect fires, or mines (commaml-detonated Claymores). Additionally, the platoon leader should attempt to tic-in obstacles (wire and mines) and fires to cover dead space. He may also position OPs to observe dead space for another position.

(c) **Final protective line.** A final protective line (FPL) is a predetermined line along which grazing fire is placed to stop an enemy assault. Where terrain allows, the platoon leader assigns a machine gun an FPL. Once in position, one soldier from the machine gun team walks the FPL to identify both dead space and grazing fire along its length. (Figure 2-38.)

(d) **Principle direction of fire.** A principle direction of fire (PDF) is a priority direction of fire assigned to cover an area which provides good fields of fire or has a likely avenue of approach. It is also used to provide mutual support to an adjacent unit. Guns are laid on the PDF if an FPL cannot be assigned due to terrain. If a PDF is assigned and other targets are not being engaged, guns are laid on the PDF.

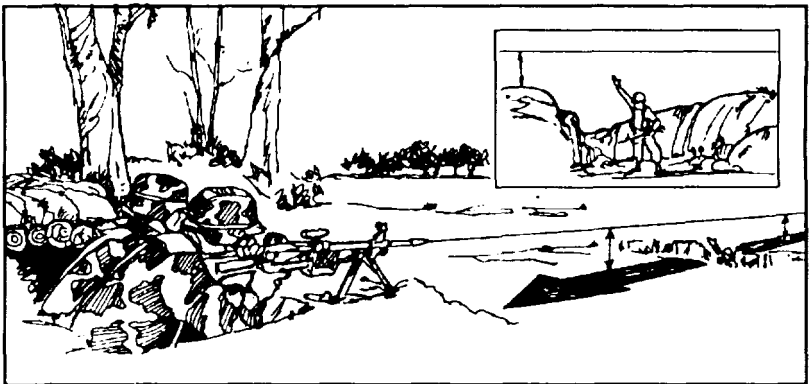

Figure 2-38. Finding dead space along an FPL.

(2) Each gun is given a primary and secondary sector of fire. Their sectors of fire should overlap each other and those of adjacent platoons. A gunner fires in his secondary sector only if there are no targets in his primary sector, or when ordered to do so. Each gun's primary sector includes an FPL or a PDF. The gun is laid on the FPL or PDF unless engaging other targets. When FPFs are called for, the gunner shifts to and engages on the FPL or PDF.

b. **Antiarmor Weapons.** The MAW is normally the antiarmor weapon that supports a rifle squad or platoon. In some units these weapons are organic to the platoon. At times, the platoon may be supported by TOWS. During planning, the leader considers the enemy vehicle threat, then positions antiarmor weapons accordingly to cover armor avenues of approach (Figure 2-39). He also considers the fields of fire, the tracking time, and the minimum arming ranges of each weapon. The platoon leader selects a primary position and a sector of fire for each antiarmor weapon. He also picks supplementary positions for them. The antiarmor leader selects alternate positions. Each position should allow flank fire and have cover and concealment. The leader can integrate the MAW thermal sight into his limited visibility security and observation plan.



Figure 2-39. Antiarmor weapon position.

c. **Grenade Launchers.** The M203 is the squad leader's indirect fire weapon. He positions it to cover dead space in the squad's sector, especially the dead space for the machine guns. The M203 gunner is also assigned a sector to cover with rifle fire. The high-explosive, dual-purpose (HEDP) round is very effective against lightly armored vehicles such as the BMP-1 and the BTR.

d. **Rifles.** The leader assigns positions and sectors of fire to each rifleman in the squad. Normally, he positions the riflemen to support the

machine guns and antiarmor weapons. They are also positioned to cover obstacles, provide security, cover gaps between units, or provide observation.

2-19. RANGE CARDS

A range card is a record of the firing data required to engage predetermined targets within a sector of fire during good and limited visibility. Every direct-fire weapon gunner must prepare a range card (DA Form 5517-R, Standard Range Card). Two copies of the range card are prepared. One copy stays at the position and the other is sent to platoon headquarters. Range cards are prepared for primary, alternate, and supplementary positions. Range cards are prepared immediately up arrival in a position, regardless of the length of stay, and updated as necessary. The range card is prepared in accordance with the FM for the specific weapon. The range card has two sections—a sector sketch section and a data section. A blank form for local reproduction on 8 1/2- by 11-inch paper is at the back of this manual. General preparation instructions are as follows. See Figure 2-40 for examples of completed DA Form 5517-R for a machine gun and Dragon.

a. The marginal information at the top of the card is listed as follows.

(1) **SQD, PLT CO.** The squad, platoon, and company designations are listed. Units higher than company are not listed.

(2) **MAGNETIC NORTH.** The range card is oriented with the terrain and the direction of magnetic north arrow is drawn.

b. The gunner's sector of fire is drawn in the sector sketch section. It is not drawn to scale, but the data referring to the targets must be accurate.

(1) The weapon symbol is drawn in the center of the small circle.

(2) Left and right limits are drawn from the position. A circled "L" and "R" are placed at the end of the appropriate limit lines.

(3) The value of each circle is determined by using a terrain feature farthest from the position that is within the weapon's capability. The distance to the terrain is determined and rounded off to the next even hundredth, if necessary. The maximum number of circles that will divide evenly into the distance is determined and divided. The result is the value for each circle. The terrain feature is then drawn on the appropriate circle.

(4) All TRPs and reference points are drawn in the sector. They are numbered consecutively and circled.

(5) Dead space is drawn in the sector.

(6) A maximum engagement line is drawn on range cards for antiarmor weapons.

(7) The weapon reference point is numbered last. The location is given a six-digit grid coordinate. When there is no terrain feature to be designated, the location is shown as an eight-digit grid coordinate.

STANDARD RANGE CARD
For use of this form see FM 7-8. This proposition is UNCLASSIFIED.

SO: 1
PL: 1
CO: B

MAGNETIC NORTH

DEAD SPACE

AIMING DISTANCE

DATA SECTION

POSITION IDENTIFICATION: _____ DATE: 10 JULY

WEAPON: MG EACH CIRCLE EQUALS: 150 METERS

NO	DIRECTION/DEFLECTION	ELEVATION	RANGE	AMMO	DESCRIPTION
1	/	+50/3	600		FPL
2	R275	+50/45	900		LOVE TREE
3	L150	0/28	525		TRAIL JUNCTION

REMARKS: 0-4
0 TW15/L7

DA FORM 5517-R, JAN 88

Primary sector with FPL.

STANDARD RANGE CARD
For use of this form see FM 7-8. This proposition is UNCLASSIFIED.

SO: 1B
PL: 1
CO: B

MAGNETIC NORTH

AIMING DISTANCE

DATA SECTION

POSITION IDENTIFICATION: 00451038 DATE: 4 JULY

WEAPON: MG EACH CIRCLE EQUALS: _____ METERS

NO	DIRECTION/DEFLECTION	ELEVATION	RANGE	AMMO	DESCRIPTION
1	L035	0/24	400		PDF(WOODS/R)
2	R375	-50/15	625		BARN
3	L175	-50/40	725		HEDGE ROW

REMARKS: 0 TW17/R0 0 TW 3/L3 0 TW7/R3

DA FORM 5517-R, JAN 88

Primary sector with PDF.

Figure 2-40. Example of completed DA Form 5517-R.

Maximum engagement line for Dragon.

STANDARD RANGE CARD
The use of this form and the R.A. The instrument is limited.

BLU 1
PL 2
CO B

DRAWING THE WORK IN

This is used for all types of direct fire weapons

DATA SECTION

POSITION IDENTIFICATION: PRIMARY DATE: 30 FEB 92

WEAPON: DRAGON EACH CIRCLE EQUALS: 100 METERS

NO.	DIRECTION/DEFLECTION	ELEVATION	RANGE	AMMO	DESCRIPTION
1	300°		1000M		LL
2	05°		1000M		RC
3	330°		705M		TRP AT CHURCH
4	0°		560M		TRP A? HILL TOP
5	270°		300M		GAP HILL TOP

REMARKS

DA FORM 5517-R, JAN 88 Edition of 1988 will be used unless otherwise noted

Figure 2-40. Example of completed Form 5517-R (continued).

c. The data section is filled in as follows.

(1) POSITION IDENTIFICATION. The position is identified as primary alternate, or supplementary.

(2) DATE. The date and time the range card was completed is entered.

(3) WEAPON. The weapon block indicates the weapons used.

(4) EACH CIRCLE EQUALS _____ METERS. Write in the distance in meters between circles.

(5) NO. Starting with left and right limits TRPs and reference points are listed in numerical order.

(6) DIRECTION/DEFLECTION. The direction is listed in degrees. The deflection is listed in mils.

(7) ELEVATION. The elevation is listed in mils.

(8) RANGE. The distance in meters from the position [to the left and right limits and TRPs and reference points.

(9) AMMO. The type of ammunition used is listed.

(10) DESCRIPTION. The name of the object is listed for example, farmhouse, wood line, hilltop.

(11) REMARKS. The weapon reference point data and any additional information is listed.

2-20. TYPES OF POSITIONS

Defensive positions may be classified as primary, alternate, or supplementary. All positions should provide observation and fields of fire within the weapon's or platoon's assigned sector. They should take advantage of natural cover and concealment even before soldiers begin to camouflage them. Soldiers improve their ability to reposition by using covered routes, communications trenches; by employing smoke; or by planning and rehearsing the repositioning by fire and maneuver. (Figure 2-41.)

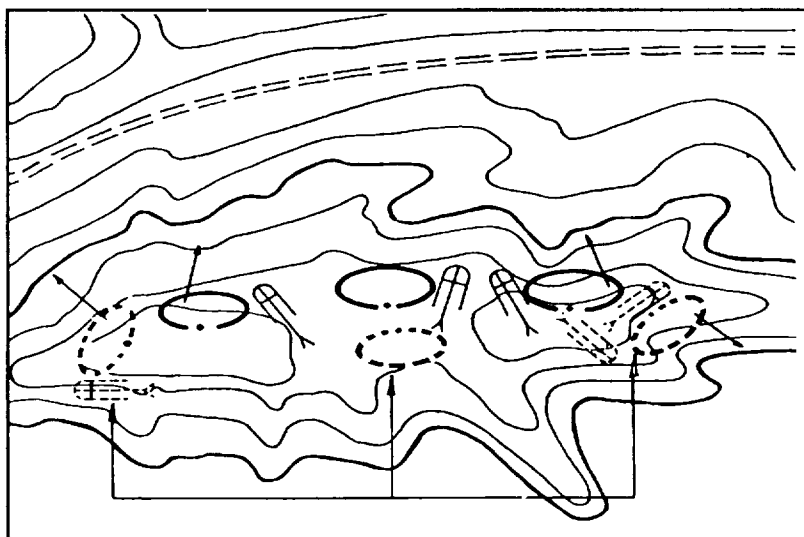

Figure 2-41. Relationship of defensive positions.

a. **Primary.** A primary position provides soldier, weapon crew, or unit the best mean to accomplish the assigned mission.

b. **Alternate.** Alternate positions allow soldiers, weapon crews, or units to cover the same sector of fire covered from the primary position. Soldiers occupy alternate positions when the primary position becomes untenable or unsuitable for carrying out their tasks. Soldiers may occupy alternate positions before an attack to rest and or perform maintenance, or to add the element of surprise to their defense

c. **Supplementary.** Supplementary positions provide the best means to accomplish a task that cannot be accomplished from the primary or alternate positions. Platoon leaders normally locate supplementary positions to

cover additional enemy avenues of approach and to protect the flanks and rear of the platoon position.

2-21. SQUAD POSITIONS

As a guideline, a squad can physically occupy a front of about 100 meters. From this position, it can defend 200 to 250 meters of frontage. The frontage distance between two-man fighting positions should be about 20 meters (allowing for a “lazy W” configuration on the ground; this would put fighting positions about 25 meters apart physically). Every position should be observed and supported by the fires of at least two other positions. One-man fighting positions may be located closer together to occupy the same platoon frontage. The distance between fighting positions depends on the leader's analysis of the factors of METT-T. In determining the best distance between fighting positions, the squad leader must consider—

- The requirement to cover the squad's assigned sector by fire.
- The need for security; that is, prevent infiltrations of the squad position.
- The requirement to prevent the enemy from using hand grenades effectively to assault adjacent positions, should he gain a fighting position.

2-22. PLATOON POSITIONS

The platoon leader assigns primary positions and sectors of fire to his machine guns and antiarmor weapons. He must personally check the lay of each weapon. He assigns primary positions and sectors of fire to his squads. The squad leader normally assigns the alternate positions for the squad and has them approved by the platoon leader. Each squad's sector must cover its own sector of fire and overlap into that of the adjacent squad. Flank squad sectors should overlap those of adjacent platoons. The platoon leader also assigns supplementary positions if required. The platoon leader may choose to position his squads in depth to gain or enhance mutual support.

2-23. SECTOR SKETCHES

Leaders prepare sector sketches based on their defensive plan. They use the range card for each crew-served weapon (prepared by the gunners).

a. **Squad Sector Sketch.** Each squad leader prepares a sector sketch to help him plan his defense and to help him control fire (Figure 2-42). The squad leader prepares two copies of the sector sketch. He gives one copy to the platoon leader and keeps the second copy at his position. The SOP should state how soon after occupying

the position the leader must forward the sketch. The sketch shows the following:

- Squad and platoon identification.
- Date/time group.
- Magnetic north.
- The main terrain features in his sector of fire and the ranges to them.
- Each primary fighting position.
- Alternate and supplementary positions.
- The primary and secondary sectors of fire of each position.
- Maximum engagement line.
- Machine gun FPLs or PDF.
- Dragon positions with sectors of fire.
- The type of weapon in each position.
- Observation posts and the squad leader's position.
- Dead space to include coverage by grenade launchers.
- Location of NVDs.
- Obstacles, mines, and booby traps.

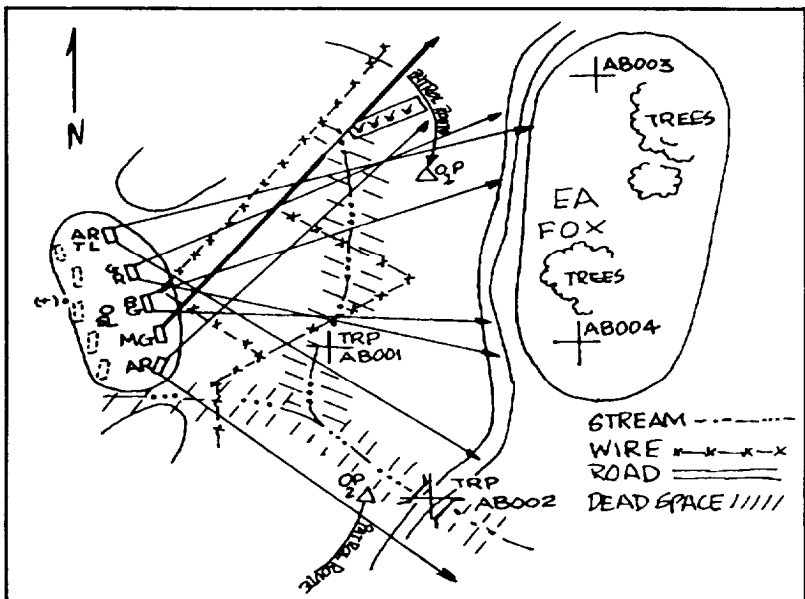

Figure 2-42. Squad sector sketch.

b. **Platoon Sector Sketch.** The platoon leader check range cards and squad sector sketches. If he finds gaps or other flaws in his fire plan, he adjusts the weapons or sectors as needed. If he finds any dead space, he takes steps to cover it with mines, grenade launcher fire, or indirect fire. He then makes two copies of his platoon sector sketch (one for his use; the other for the company commander) (Figure 2-43). His sketch shows the following:

- Squad sectors of fire.
- Machine gun and antiarmor weapon positions and their sectors of fires, to include FPLs and PDFs of the automatic rifles/machine guns and TRPs for the antiarmor weapons.
- Maximum engagement lines for antiarmor weapons.
- Mines (Claymores) and obstacles.
- Indirect fire planned in the platoon's sector of fire (targets and FPF).
- OPs and patrol routes, if any.
- Platoon CP
- Platoon/company identification.
- Dote/time group.
- Magnetic north.
- Location of casualty collection point.
- Location of NVDs/thermal sights that are part of the limited visibility security plan.
- Adjustments during limited visibility to maintain coverage of assigned TRPs.

2-24. FIRE CONTROL MEASURES

Normally, antiarmor fires (except LAWS) are part of the battalion or company fire plan. One leader controls all antiarmor weapons firing from a single position or into a single engagement area. Platoon leaders normally control the fires of machine guns. Squad leaders and team leaders control, automatic rifles, grenade launchers, and rifle fire. Platoon and squad leaders use the following fire control measures to ensure the proper concentration and distribution of fires.

a. **Sectors.** Leaders use sectors of fire to assign responsibility and ensure distribution of fires across the platoon and squad front. Sectors should always overlap with adjacent sectors.

b. **Engagement Areas.** Leaders use engagement areas to concentrate all available fires into an area where they intend to kill the enemy. When conducting ambushes, units refer to the engagement areas as a **KILL ZONE**.

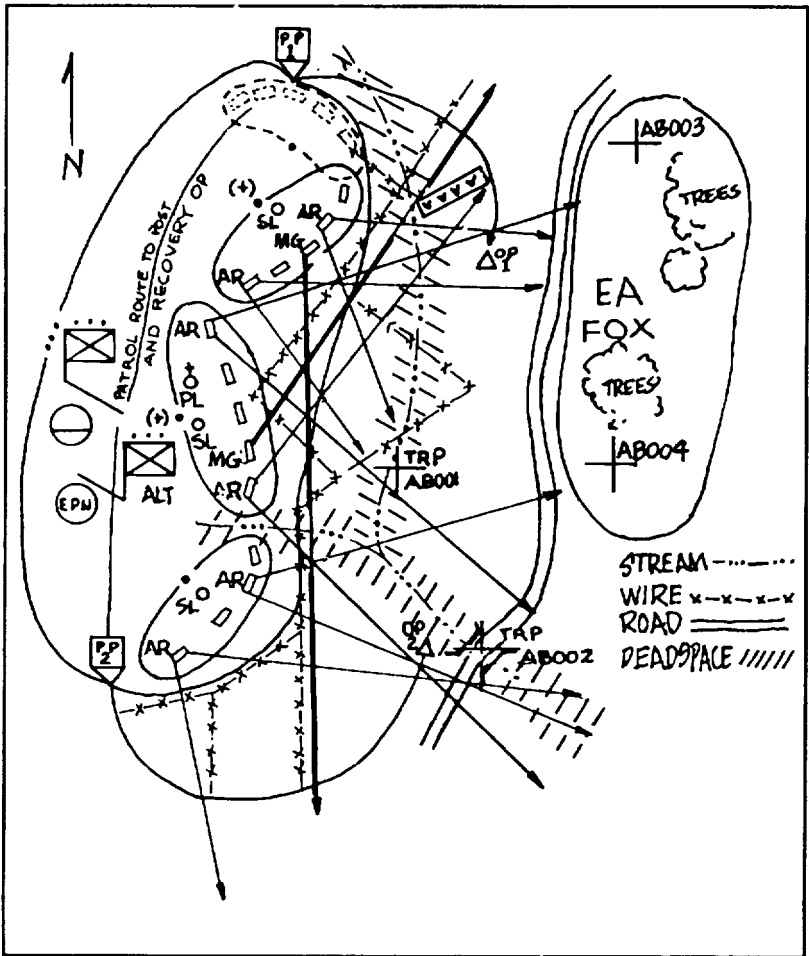

Figure 2-43. Example of a platoon sector sketch.

c. **Fire Patterns.** These include front, cross, and depth fires. These patterns describe the relationship between the weapons and the targets. The intent is to ensure that weapons do not waste ammunition firing on the same target, while other targets remain unengaged.

d. **Engagement Priorities.** These designate the priority for engaging key targets to include leaders, RATELOs crew-served weapons, and engineers. The following is an example of a engagement priority.

(1) **MAW gunners fire—**

- At the most threatening armored vehicle.
- At armor in the kill zone or primary sector.

- At armor in the secondary sector.
 - At armored vehicles beyond 200 meters.
- (2) **Machine gun gunner fire**—
- The FPL or PDF, if signaled to do so.
 - At groups of five or more in the primary sector (from farthest to closest).
 - At crew-served automatic weapons.
 - At groups of five or more in the secondary sector.
 - At unarmored vehicles.
- (3) **Automatic riflemen fire**—
- Along the FPL, if signaled to do so.
 - At groups of five or more in the primary sector (closest to farthest).
 - At soldiers in the primary sector.
- (4) **Grenadiers fire**—
- At light armored vehicles in sector.
 - At groups of three or more in sector.
 - At groups of three or more in secondary sector.
 - At individual soldiers in sector, using M16 rifles.
 - At dead space in sector (if occupied by the enemy).
 - At other targets as directed by squad or team leader (illumination or smoke on order).
- (5) **Riflemen fire**—
- In their primary and secondary sectors.
 - Nearest to farthest, starting on flank and working toward the center —
 - At leaders.
 - At RATELOs.
 - At individual soldiers.
- (6) **LAW gunners fire**—
- In two-soldier volleys on direction of the team or squad leaders.
 - At nearby threatening vehicle.

e. **Rate of Fire.** Some weapon system FMs specify rates of fire by name-others do not. The doctrinal terms should be used when possible; others are addressed by SOP.

2-25. PRIORITY OF WORK

The platoon's priority of work is a list of tasks that the leader uses to control what gets done by whom and in what order in the preparation of the defense. These tasks are normally prescribed in the SOP. An example of priority of work tasks by duty position is in Chapter 5. The leader adjusts the priority of work based on his consideration of the

factors of METT-T and on his and the higher commander's intent. The platoon's normal priority of work is—

- Establish local security
- Position antiarmor weapons, machine guns, and squads and assign sectors of fire.
- Position other assets attached to the platoon.
- Establish the CP and wire communications.
- Designate FPLs and FPFs.
- Clear fields of fire and prepare range cards and sector sketches.
- Coordinate with adjacent units—left, right, forward, and to the rear.
- Prepare primary fighting positions.
- Emplace obstacles and mines.
- Mark or improve marking for TRPs and other fire control measures.
- Improve primary fighting positions such as overhead cover.
- Prepare alternate positions, then supplementary positions.
- Establish a sleep and rest plan.
- Reconnoiter routes.
- Rehearse engagements, disengagements, and any counterattack plans.
- Adjust positions or control measures as required.
- Stockpile ammunition, food, and water.
- Dig trenches to connect positions.
- Continue to improve positions.

2-26. COORDINATION

Coordination between adjacent platoons/squads is normally from left to right and from front to rear. Information exchanged includes the following:

- Location(s) of leaders.
- Location of primary, alternate, and supplementary positions and sectors of fire of machine guns, antiarmor weapons, and subunits.
- Route to alternate and supplementary positions.
- Location of dead space between platoons and squads and how to cover it.
- Location of OPs and withdrawal routes back to the platoon's or squad's position.
- Location and types of obstacles and how to cover them
- Patrols to be conducted to include their size, type, times of departure and return, and routes.

- Location, activities, and presage plan for scouts and other units forward of the platoon's position.
- Signals for fire and cease fire and any other signals that may be observed
- Engagement and disengagement criteria.

2-27. FIGHTING POSITIONS

This paragraph discusses techniques for the construction of infantry fighting positions. Infantrymen use hasty; one-, two-, and three-soldier; machine gun; medium and light antitank; and 90-mm recoilless rifle positions. Soldiers must construct fighting positions that protect them and allow them to fire into their assigned sectors.

a. **Protection.** Fighting positions protect soldiers by providing **cover** through sturdy construction, and by providing **concealment** through positioning and proper camouflage. The enemy must not be able to identify the position until it is too late and he has been effectively engaged. When possible, soldiers should site positions in nonobvious places, behind natural cover, and in an easy to camouflage location. **The most important step in preparing fighting position is to make sure that it cannot be seen.** In constructing fighting positions, soldiers should always—

- Dig the positions armpit deep.
- Fill sandbags about 75 percent full.
- Revet excavations in sandy soil.
- Check stabilization of wall bases.
- Inspect and test the position daily, after heavy rain, and after receiving direct or indirect fires.
- Maintain, repair, and improve positions as required.
- Use proper materiel. Use it correctly.

NOTE: In sandy soil, vehicles should not be driven within 6 feet of the positions.

b. **Siting to Engage the Enemy.** Soldiers must be able to engage the enemy within their assigned sectors of fire. They should be able to fire out to the maximum effective range of their weapons with maximum grazing fire and minimal dead space. Soldiers and leaders must be able to identify the best location for their positions that meet this criteria. Leaders must also ensure that fighting positions provide interlocking fires. This allows them to cover the platoon's sector from multiple positions and provides a basis for final protective fires.

c. **Prepare by Stages.** Leaders must ensure that their soldiers understand when and how to prepare fighting positions based on the situation. Soldiers normally prepare hasty fighting positions everytime the platoon halts (except for short security halts), and only half of the platoon digs in

while the other half maintains security. Soldiers prepare positions in stages and require a leader to inspect the position before moving on to the next stage. See the following example.

EXAMPLE

STAGE 1. The leader checks the fields of fire from the prone position and has the soldier emplace sector stakes (Figure 2-44).

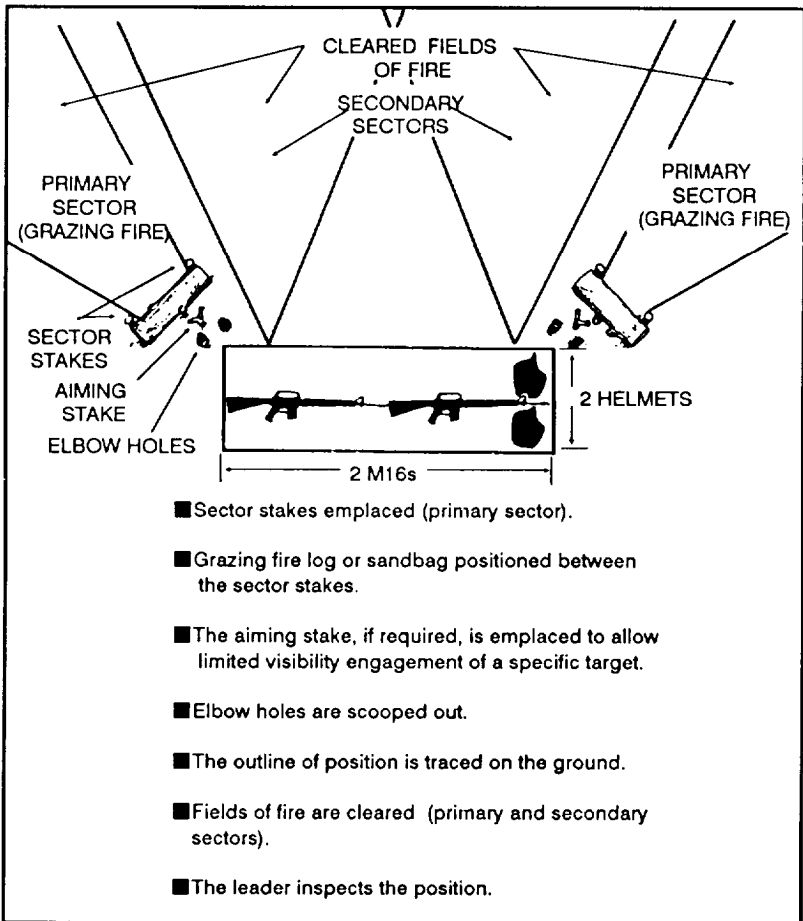

Figure 2-44. Stage 1, preparations of a fighting position.

STAGE 2. The retaining walls for the parapets are prepared at this stage. These ensure that there is at least one helmet distance from the edge of the hole to the beginning of the front, flank, and rear cover (Figure 2-45).

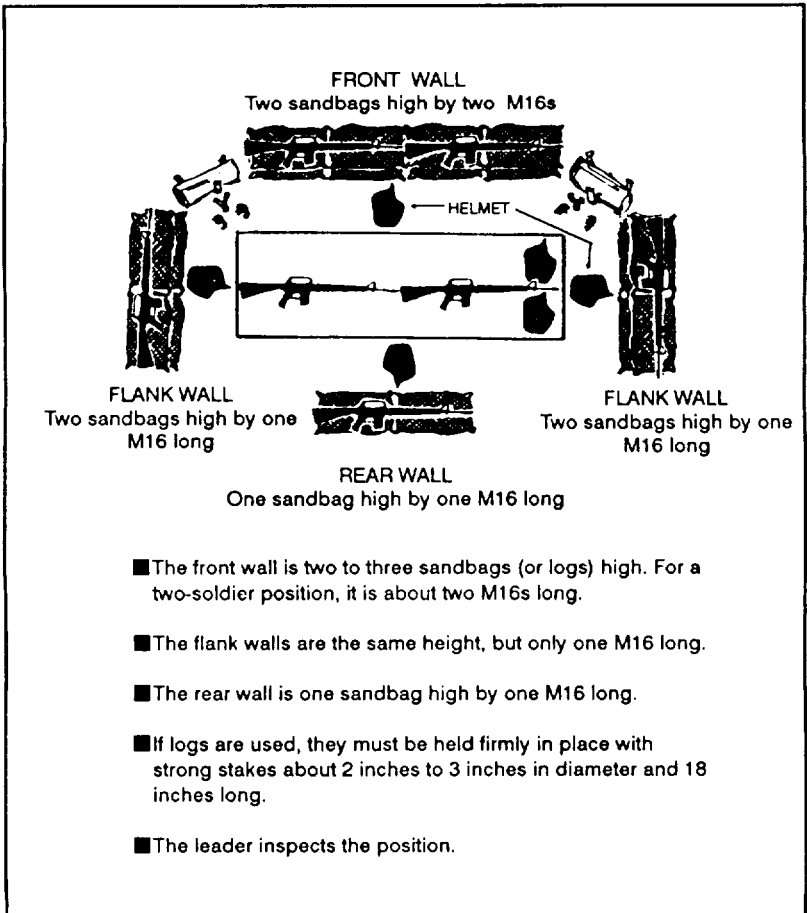

Figure 2-45. Stage 2, preparation of a fighting position.

STAGE 3. During stage 3, the position is dug and the dirt is thrown forward of the parapet retaining walls and then packed down hard (Figure 2-46).

STAGE 4. The overhead cover is prepared (Figure 2-47). Camouflage should blend with surrounding terrain. At a distance of 35 meters, the position should not be detectable.

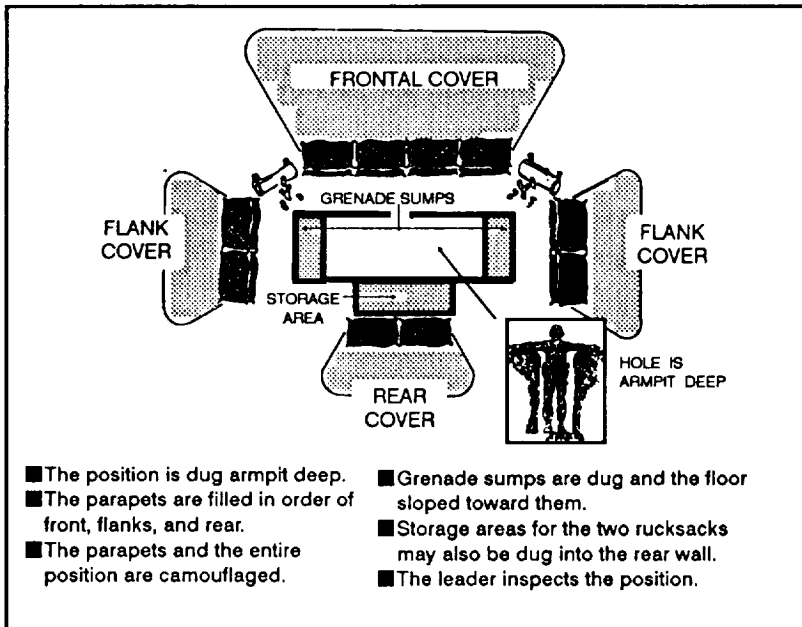

Figure 2-46. Stage 3, preparation of fighting position.

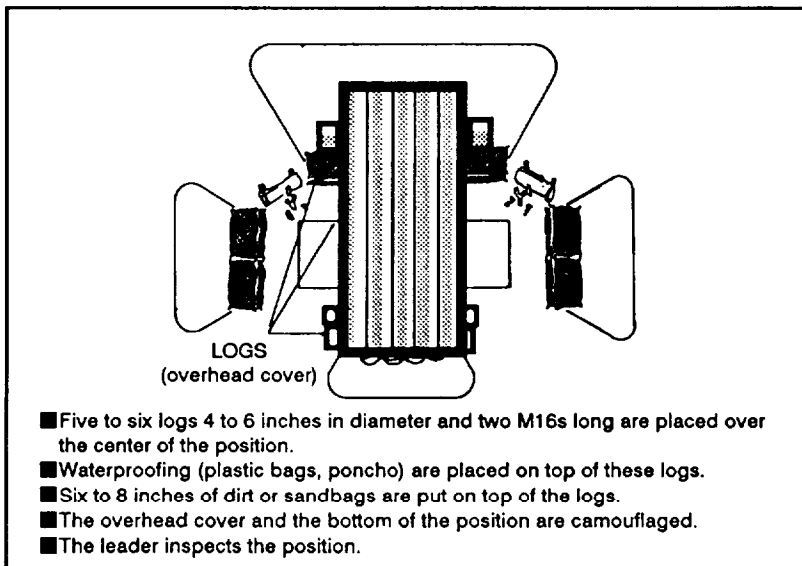

Figure 2-47. Stage 4, preparation of a fighting position.

d. **Types of Fighting Positions.** There are many different types of fighting positions. The number of personnel, types of weapons, the time available, and the terrain are the main factors that dictate the type of position.

(1) **Hasty fighting position.** Soldiers prepare this type of position when there is little or no time to prepare fighting positions (Figure 2-48). They locate it behind whatever cover is available. It should give frontal protection



Figure 2-48. Hasty fighting position.

from direct fire while allowing fire to the front and oblique. A hasty position may consist simply of a rucksack placed beside a tree or large rock. For protection from indirect fire, a hasty fighting position should be in a small depression or hole at least 18 inches deep. The term hasty position does not mean there is no digging. Even if there are only a few minutes, a prone shelter can be scraped out or dug to provide some protection. This type of position is well suited for ambushes or for protection of an overwatching element during raids and attacks. Hasty positions can also be the first step in construction of more elaborate positions.



Figure 2-49. One-soldier fighting position.

from direct fire while allowing fire to the front and oblique. A hasty position may consist simply of a rucksack placed beside a tree or large rock. For protection from indirect fire, a hasty fighting position should be in a small depression or hole at least 18 inches deep. The term hasty position does not mean there is no digging. Even if there are only a few minutes, a prone shelter can be scraped out or

(2) **One-soldier fighting position.** This type of position allows choices in the use of cover; the hole only needs to be large enough for one soldier and his gear. It does not have the security of a two-soldier position. The one-soldier fighting position must allow a soldier to fire to the front or to the oblique from behind frontal cover. (Figure 2-49.)

(3) **Two-soldier fighting position.** A two-soldier fighting position can be prepared in close terrain. It can be used where grazing fire and mutual support extend no farther than to an adjacent position. It can be used to cover dead space just in front of the position. One or both ends of the hole are extended around the sides of the frontal cover. Changing a hole this way lets both soldiers see better and have greater sectors of fire to the front. Also, during rest or eating periods, one soldier can watch the entire sector while the other sleeps or eats. If they receive fire from their front, they can move back to gain the protection of the frontal cover. By moving about 1 meter, the soldiers can continue to find and hit targets to the front during lulls in enemy fire. This type of position requires more digging and is harder to camouflage. It is also a better target for enemy hand grenades (Figure 2-50.)



Figure 2-50. Two-soldier fighting position.

(4) **Three-soldier fighting position.** A three-soldier position has several advantages over the other types of positions. There is a leader in each position, which makes command and control easier. It supports continuous, secure operations better than other positions. One soldier can provide security one can do priority work; and one can rest, eat, or perform maintenance. This allows the priority of work to be completed more quickly than in a one-soldier or two-soldier position. It allows the platoon to maintain combat power and security without either shifting personnel or leaving positions unmanned. It provides 360-degree observation and fire. It is more difficult for the enemy to destroy this type position. To do so, the enemy must kill or suppress three soldiers.

(a) When using three-soldier positions, the leader must consider the following.

- Either the distance between positions must be increased or the size of the squad's sector reduced. The choice depends mainly on visibility and fields of fire.
- Because the squad leader is in a fighting position that will most likely be engaged during the battle, he cannot exert personal control over the other two positions. The squad leader keeps control over the battle by—
 - Clearly communicating plans and intent to his squad to include control measures and fire plans.
 - Using prearranged signals like flares, whistles, or tracers.
 - Positioning key weapons in his fighting position.
 - Placing his fighting position so that it covers key or decisive terrain.
 - Placing his fighting position where his team might be able to act as a reserve.

(b) The three-soldier emplacement is the T-position. This basic design can be changed by adding or deleting berms, changing the orientation of the T, or shifting the position of the third soldier to form an L instead of a T. (Figure 2-51.)

- The first layout of the position is oriented to fire on expected enemy avenues of approach from any direction(s).
- Berms are added based on METT-T factors. They cannot block observation or fire into assigned primary or alternate sectors. Berms should be designed to support overhead constructions.
- Logs of sufficient diameter (4 to 6 inches) or long pickets are used to support overhead cover for the position. They are placed a minimum of 1 foot back from the edge of the hole, or one-fourth the depth of the hole, whichever is greater.
- The position is completed when natural camouflage materials are added to hide the position and strengthen it.

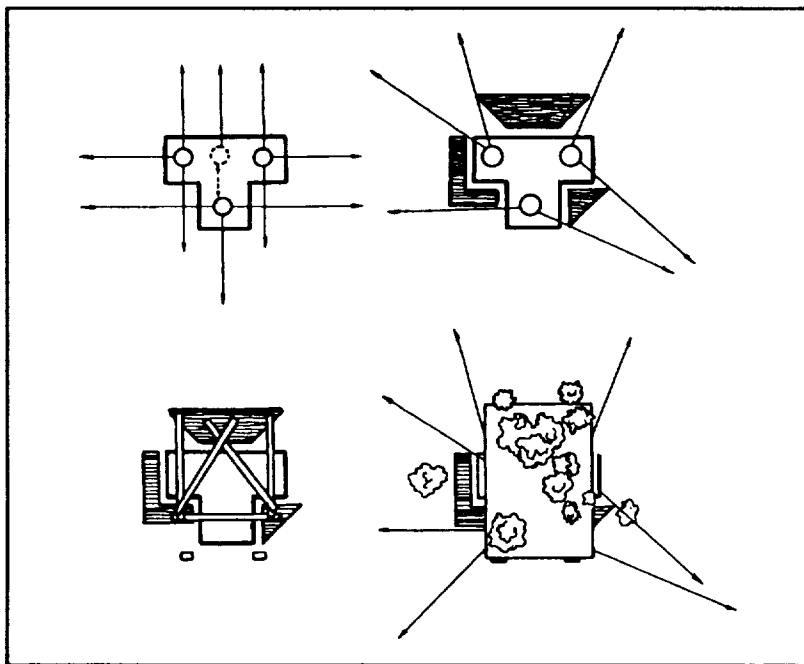

Figure 2-51. Three-soldier T-position.

(5) **Machine gun position.** The primary sector of fire is usually to the oblique so that the gun can fire across the platoon's front. The tripod is used on the side that covers the primary sector of fire. The biped legs are used on the side that covers the secondary sector of fire. When changing from primary to secondary sectors, the gunner moves only the machine gun. Occasionally, a sector of fire that allows firing directly to the front is assigned, but this can reduce the frontal cover for the crew when firing to the oblique. (Figure 2-52.)

(a) After the platoon leader positions the machine gun, he marks the position of the tripod legs and the limits of the sectors of fire. The crew then traces the outline of the hole and the frontal cover (if it must be improved).

(b) The crew digs the firing platforms first to lessen their exposure in case they have to fire before they complete the position. The platforms must not be so low that the gun cannot be traversed across its entire sector of fire. This reduces the profile of the gunner when he is firing and reduces the height of the frontal cover.

(c) After digging the firing platforms, the crew digs the hole. They first place the dirt where frontal cover is needed. They dig the hole deep enough to protect them and still let the gunner fire the gun with comfort,

usually about armpit deep. When the frontal cover is high and thick enough the crew uses the rest of the dirt to build flank and rear cover.

(d) Trench-shaped grenade sumps arc dug at various points so that either soldier can kick a grenade into one if needed.

(c) In some positions, a machine gun might not have a secondary sector of fire; so, only half of the position is dug.

(f) Overhead cover for a machine gun position is built the same as for a two-soldier position.

(g) When there is a three-soldier crew for a machine gun, the ammunition bearer digs a one-soldier fighting position to the flank. From his position, the ammunition bearer can see and fire to the front and to the oblique. Usually, the ammunition bearer is on the same side as the FPL or PDF. This allows him to see and fire his rifle into the machine gun's secondary sector, and to see the gunner and assistant gunner. The ammunition bearer's position is connected to the gun position by a crawl trench.



Figure 2-52. Machine gun position.

(6) *Dragon position* The Dragon can be employed from hasty or completed positions. (Figure 2-53.) However, some changes arc required.

DANGER

Dragon backblast and muzzle blast must be considered to avoid injuring personnel. When a Dragon is fired from a completed position, the muzzle end of the launcher must extend 6 inches beyond the front of the hole. The rear of the launcher must extend out over the rear of the hole.

(a) As the missile leaves the launcher, the stabilizing fins unfold. During firing, the gunner must keep the weapon at least 6 inches above the ground to allow room for the fins. The hole is only waist deep to allow the gunner to move while tracking a target. Because of the height of the Dragon gunner above ground level, the frontal cover should be high enough to hide his head and, if possible, the backblast of the Dragon. A hole is dug in front of the position for the biped legs.

(b) There will be times when the Dragon can be fired only in one direction. The position is adjusted to have cover and concealment from all other directions.

(c) When the Dragon is fired in only one direction, it should be to the oblique. This protects the position from frontal fire and allows engagement of the target from the flank. Both ends of the launcher must extend out over the edges of the hole.

(d) Overhead cover must be built on the flanks. Cover must be large enough for the gunner, the tracker, and the missiles. Overhead cover that allows fire from underneath it can be built if the backblast area is clear. However, overhead cover must be well camouflaged.

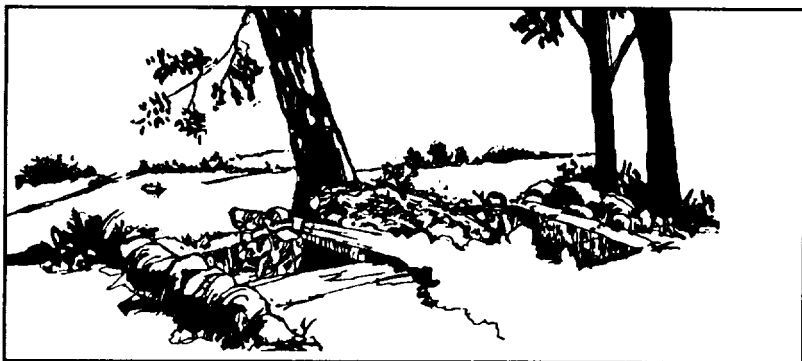

Figure 2-53. Dragon position.

(c) Selecting and preparing alternate positions for a Dragon have a high priority since the Dragon is an important weapon and is easy to detect. When preparing an alternate position, a covered route to it should be selected and improved so the gunner can move to it under fire.

(7) *90-mm recoilless rifle and ranger antiarmor weapon system position.* Positions for the 90-mm RCLR and the 84-mm RAAWS are built like Dragon positions, except they are larger. Since two soldiers are needed to operate the weapons, the hole must be a slightly longer if the gunner must fire to the right side of the frontal cover. The assistant gunner can

then work from the right side of the weapon (Figure 2-54). (Alternate positions, similar to the Dragon maybe prepared.)



Figure 2-54. RAAWS position.

DANGER

When the LAW, AT4, 90-mm RCLR, OR Flash is used from an infantry fighting position, care must be taken to ensure that no injuries result. **SOLDIERS MUST BE CLEAR OF THE BACKBLAST AREA.** No other fighting positions are located in the backblast area. The gunner must ensure there is nothing (walls, trees, or other objects) to the rear of the weapon to deflect the backblast.

(8) *Light antitank weapon, AT4, and Flash positions.* The LAW, the AT4, and the Flash can be fired from infantry fighting positions. If the LAW, AT4, or Flash is to be fired from a two-soldier position, the gunner must ensure that the other soldier is not in the backblast area. The front edge of a fighting position is a good elbow rest to help the gunner steady the weapon and to gain accuracy. The LAW or Flash gunner leans against the front or side wall of the hole for greater stability when firing. When firing the AT4, the gunner leans against the rear wall—his elbows are not supported. (Figure 2-55.)

e. **Trenches.** When there is time and help, trenches should be dug to connect fighting positions so soldiers can move by covered routes. The depth of a trench depends on the type of help and equipment available. Without engineer help, crawl trenches (about 3 feet deep by 2 feet wide)

are usually dug. The trench should zigzag so the enemy will not be able to fire down a long section of it (Figure 2-56).



Figure 2-55. Light antitank weapon position.

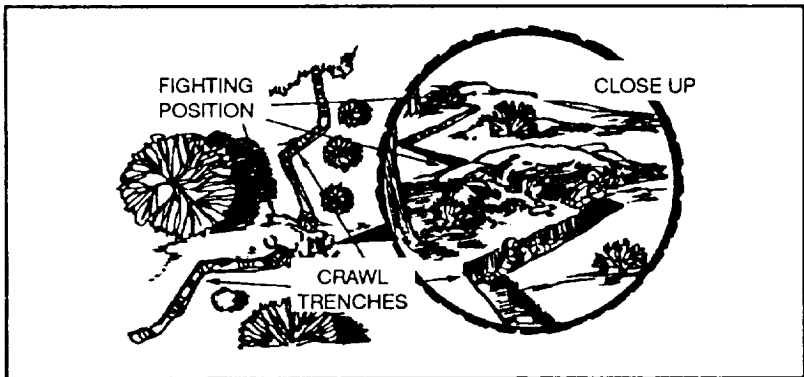

Figure 2-56. Trenches.

Section VI. OTHER OPERATIONS

Other tactical operations include retrograde (withdrawal, delay, and retirement and special operations (linkup, stay-behind, relief in place, and passage of lines). Squads or platoons conduct these operations as part of a larger force. A retrograde operation is an organized movement to the rear or away from the enemy.

2-28. WITHDRAWAL

In a withdrawal, a unit disengages from the enemy and repositions for another mission. Units withdraw either not under pressure or under pressure.

a. **Methods of disengagement.** Platoons have the basic methods of disengaging from the enemy. They can thin their lines, or they can move out by either fire team or squad.

(1) *Disengagement by thinning the lines.* Squad and team leaders begin the disengagement by directing soldiers to move rearward in buddy teams. Each buddy team covers the move of the other as they move back in turn (Figure 2-57). Smoke must be used to provide concealment if the soldiers are moving across open areas.



Figure 2-57. Disengagement by thinning the lines.

(2) *Disengagement by fire teams.* If enemy fire is so light that thinning the lines is not needed or if after having moved back far enough, thinning the lines is no longer needed squads can move back by fire teams. One team fires while the other one moves, alternating roles (Figure 2-58).

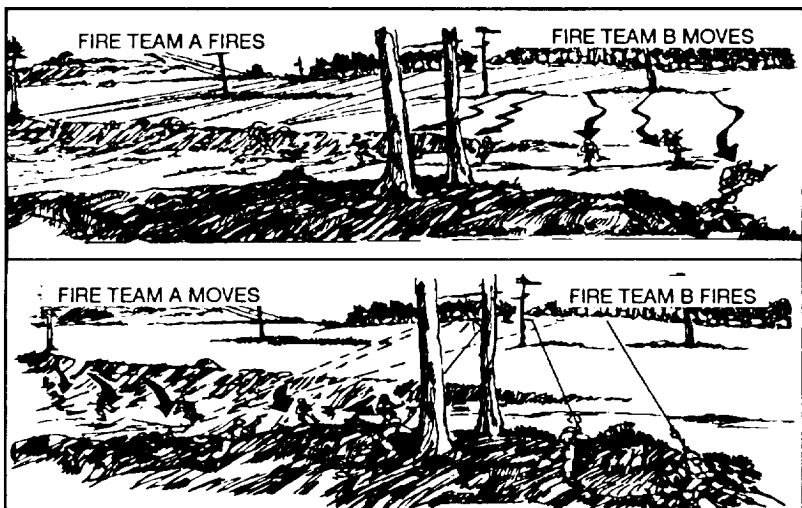

Figure 2-58. Disengagement by fire teams.

(3) *Disengagement by squads.* If enemy fire is so light that maneuver by fire teams is not needed or if squads have moved back to a point where it is no longer needed to move back by fire teams or by thinning the lines, the platoon moves back by squads. The platoon leader has each squad move back in turn, covered by the fire of the others (Figure 2-59).



Figure 2-59. Disengagement by squads.

b. **Withdrawal not under pressure.** In this type of withdrawal, platoons normally serve as the detachment left in contact (DLIC) or as part of the DLIC. (Figure 2-60). As the DLIC, the platoon performs the following.

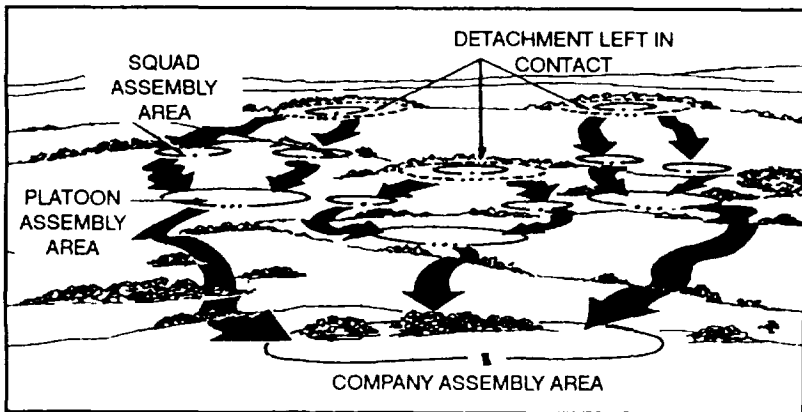

Figure 2-60. Withdrawal not under pressure.

- (1) Repositions squads and weapons to cover the company's withdrawal (Figure 2-61).
- (2) Repositions a squad in each of the other platoon positions to cover the most dangerous avenue of approach into the position.
- (3) continues the normal operating patterns of the company.
- (4) Covers the company withdrawal by fire if the company is attacked during withdrawal.
- (5) Withdraws once the company is at its next position.



Figure 2-61. Repositioning of squads.

c. **Withdrawal under pressure.** If it is not possible to prepare and position the security force, the platoon conducts a fighting withdrawal. The platoon disengages from the enemy by maneuvering to the rear. Soldiers, fire teams, or squads not in contact are withdrawn first so they can provide suppressive fires to allow the soldier, team, or squad in contact to withdraw. (Figure 2-62.)

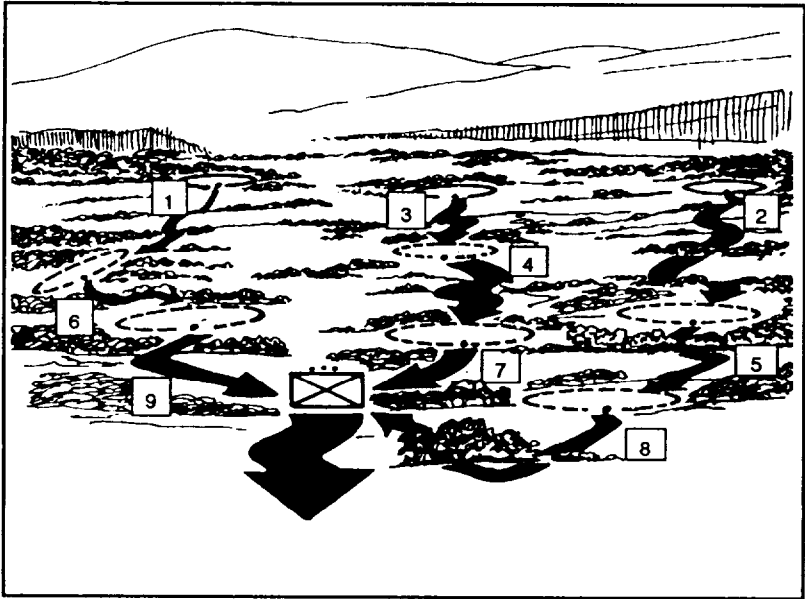

Figure 2-62. Bounding overwatch to the rear.

2-29. DELAY

In a delay, the platoon forces the enemy to slow its movement by forcing him to repeatedly deploy for the attack. Before the enemy assault, the delaying force withdraws to new positions.

a. The squads and platoons disengage from the enemy as described in a withdrawal under pressure. Once disengaged, a platoon moves directly to its next position and defends again.

b. The squads and platoons slow the advance of the enemy by shaking his morale, causing casualties and equipment losses. It can employ—

- Ambushes.
- Snipers.
- Obstacles.
- Minefields (to include phony minefields).
- Artillery and mortar fire.

2-30. RETIREMENT

Platoons and squads retire as members of larger units using standard movement techniques. A force that is not engaged with the enemy moves to the rear in an organized manner. Retirements usually involve tactical road marches.

2-31. LINKUP

A linkup is a meeting of friendly ground forces. Linkups depend on control, detailed planning, and stealth. Linkup procedure begins as the unit moves to the linkup point. The steps of this procedure are:

- a. If using radio communications, the platoon reports its location using phase lines, checkpoints, or other control measures.
- b. The first squad at the site stops and sets up a linkup rally point about 300 meters from the linkup point.
- c. The first squad sends a security team to find the exact location of the linkup point.
- d. The security team clears the immediate area around the linkup point. It then marks the linkup point with the coordinated recognition signal. The team moves to a covered and concealed position and observes the linkup point and immediate area around it.
- e. The next unit approaching the site repeats steps one through three. When its security team arrives at the site and spots the coordinated linkup point recognition signal, it gives the far recognition signal.
- f. The first security team responds, and the second team advances to the first team's location. The teams exchange near recognition signals.
- g. If entire units must link up, the second team returns to its unit's rally point and brings the unit forward to the linkup point. The first security team guides the entire second unit to the linkup rally point. Both teams are integrated into the security perimeter.
- h. When more than two units use the same linkup point, the first unit leaves a security team at the linkup point. They repeat the linkup procedure as other units arrive.

2-32. STAY-BEHIND OPERATIONS

Stay-behind operations can be used as a part of defensive or delay missions. In the defense once the enemy's combat units have passed, his weakest point (CS and CSS units) can be attacked.

a. **Types.** The two types of stay-behind operations are unplanned and deliberate.

(1) **Unplanned.** An unplanned stay-behind operation is one in which a platoon finds itself cut off from other friendly elements for an indefinite time without specific planning or targets.

(2) **Deliberate.** A deliberate stay-behind operation is one in which a platoon plans to operate in an enemy-controlled area as a separate and cohesive element for a certain amount of time, or until a specified event occurs. This requires extensive planning. Squads and platoons conduct this type of stay-behind operation only as part of larger units.

b. **Planning.** The troop-leading procedure applies to stay-behind operations. Planners must pay strict attention to the following:

(1) **Task organization.** The stay-behind unit includes only the soldiers and equipment needed for the mission. It needs only minimal logistics support and can provide its own security. It must be able (to hide easily and move through restrictive terrain.

(2) **Reconnaissance.** This is most important in a stay-behind operation. Reporting tasks and information requirements can include suitable sites for patrol bases, OPs, caches, water sources, dismounted and mounted avenues of approach, kill zones, engagement areas, and covered and concealed approach routes.

(3) **Combat service support.** Because the stay-behind unit will not be in physical contact with its supporting unit, supplies of rations, ammunition, radio batteries, water, and medical supplies are cached. Provisions for casualty and EPW evacuation depend on the company and battalion plans.

(4) **Deception plan.** Most stay-behind operations are setup covertly. The enemy must be misled during this effort to cause him to act in a manner favorable to the unit's plan of action. COMSEC is a special concern; radio transmissions must be brief and encoded.

(5) **Concept of the operation.** Units usually operate in small groups in their own areas. The actual concept, however, depends on the commander's intent.

2-33. RELIEF IN PLACE

A relief in place is an operation in which a platoon is replaced in combat by another platoon. The incoming platoon assumes responsibility for the combat mission and the assigned sector or zone of action of the outgoing platoon. Normally platoons conduct reliefs in place as part of a larger unit.

a. **Coordination.** Platoon responsibility is usually limited to the detailed coordination between key personnel and their counterparts. Leaders must coordinate the following items as a minimum.

(1) **Reconnaissance.** Leaders must reconnoiter different routes into and out of the position; assembly areas; logistics points; primary, alternate, and supplementary positions; obstacles; immediate terrain; and when possible, patrol routes and OP locations.

(2) **Plans and tasks.** The outgoing leader must provide copies of the platoon sector sketch, fire plan, range cards for all weapons, barrier plan, minefield records, counterattack plans, and plans for any other tasks that the platoon may have been tasked to perform as a part of the defense.

(3) **Relief plan.** Both leaders must know which method and sequence of relief has been prescribed in the higher unit order, and how they will execute the plan. They must—

- Know if their platoons will execute the relief by squads or as a complete platoon (method). Platoons may also execute the relief by occupying adjacent terrain, or terrain in depth rather than by relieving soldiers in position.
- Know the order of relief for platoons within the company (sequence); include the relief of OPs by patrol.
- Coordinate the use of guides, signals, challenge and password, and passage of responsibility for the mission and control of the platoon (normally when the majority of the incoming platoon is in place).

(4) **Exchange of equipment.** Leaders coordinate the exchange of tripods for crew-served weapons, phones or switchboards, and emplaced munitions (if included in the relief order). Platoons do not exchange radios or molar equipment (if attached).

(5) **Exchange of supplies.** Leaders identify numbers and types of supplies to be left behind and their location, to include: sensors, construction materiel, wire, and any supplies that might slow down the movement of the outgoing platoon.

b. **Execution.** During the execution both platoon leaders should collocate at the outgoing unit's CP. The leader of the outgoing platoon remains responsible for the defense of the area until the majority of the incoming platoon is in position. If the enemy attacks during the relief, the leader who has responsibility for the position at the time is in control. The other leader assists with assets under his control as directed. Squad leaders physically walk soldiers to positions and trade them out on a one-for-one basis. They allow time for outgoing soldiers to brief their reliefs on their positions, range cards, and other pertinent information. All leaders report completion of their portion of the relief as soon as possible.

Section VII. FIRE SUPPORT

Infantry platoons plan indirect fires to suppress, isolate, obscure, neutralize, destroy, deceive, or disrupt enemy forces. The fire planning process is used to plan indirect fires in support of offensive and defensive operations. Normally, battalions and companies conduct fire support planning and send a target list to the platoons. Platoon leaders and their FOs review the indirect fire plan to determine the need for additional targets in their area of responsibility. If a need exists for additional targets, the platoon leader requests those targets be included in the company fire plan through fire support channels. The platoon leader, however, does not wait to receive the company fire plan. He begins fire planning as soon as possible and integrates his fire plan into the company fire plan through fire support channels.

2-32. OFFENSIVE FIRE SUPPORT PLANNING

The offensive fire support plan is developed at the same time as the scheme of maneuver. The FO integrates the indirect fires, based on the platoon leader's guidance, to support the platoon's maneuver throughout the operation.

a. Fires are planned to support all phases of the attack. Fires are planned in front of, on, and behind the objective. Fires planned in front and on the objective support the approach, deployment, and assault of the attacking force. Fires planned beyond the objective support the consolidation and disrupt reinforcing and counterattacking forces. Fires are planned on all known or suspected enemy locations. Indirect fires are also planned on likely avenues of approach or on prominent terrain features.

b. The platoon uses smoke or white phosphorus to screen itself when moving across danger areas, when breaching obstacles, or to obscure known or suspected enemy positions.

2-33. DEFENSIVE FIRE SUPPORT PLANNING

The platoon leader and the FO plan indirect fire to support the defensive scheme of maneuver. Fire support considerations at platoon and squad level include final protective fires (FPF) and effect of smoke and illumination on defending forces.

a. Fires are planned on all likely enemy positions and on areas the enemy may use in the attack, such as OPs, support positions, avenues of approach, assault positions, dead space, flanks, and defiles. Fires are also planned in front of, on top of, and behind friendly positions to stop likely penetrations or to support a counterattack.

b. Final protective fire is a barrier of fire planned on the most dangerous enemy avenue of approach to provide immediate close protection for defending soldiers. The purpose of an FPF is to support the defeat of the enemy's close assault against a defensive position. Therefore, it must be integrated with the platoon direct fire plan and obstacle plan. Once called for, FPFs are fired continuously. For this reason, the company commander often retains the control of FPFs. FPFs must not be called for until the enemy is in close assault of the defensive position. All platoon weapons fire along their final protective line or principle direction of fire while the FPF is being fired.

c. Defending units use smoke sparingly. Most often defending platoons use smoke to screen their movement out of a position.

d. Illumination provides artificial lighting to the defending force. Illumination should be employed on top of or behind the attacking force instead of on top of the defending force. Platoons use flares, M203 illumination rounds, and mortar and artillery illumination rounds. Flares provide early warning of the enemy approach and help to pin point his location. Grenade launcher illumination rounds provide flexible and immediate illumination, while mortars and artillery provide sustained illumination. The company commander normally retains the control of illumination in the defense.

2-34. TECHNIQUES OF INDIRECT FIRE CONTROL

The positioning of the FO and the proper procedures used to call for fire is critical in order to receive immediate indirect fire.

a. **Forward Observer Positioning.** The platoon leader and FO should always be together during execution. This ensures close synchronization of the scheme of maneuver and plan of fire support. The platoon leader is responsible for both, but concentrates on maneuver and direct fires. The FO is the platoon leader's principle assistant in managing indirect fires. They eat, sleep, and fight together. Each has separate requirements to communicate with higher headquarters, but will do so almost always from the same location. The platoon leaders and FO identify primary and alternate positions to ensure continuous observation during limited visibility conditions. The FO verifies and rehearses FM radio communications as the tactical situation permits. Squad leaders may be designated to observe targets and call for fire, or they can be designated as an alternate FO to the platoon FO.

(1) The platoon leader must ensure that the FO knows the overall concept of the operation to include the following:

(a) The location and description of the targets to engage.

(b) The terminal effects required (destroy, delay, disrupt, suppress) and the purpose.

(c) The communication means, radio net, call signs, and fire direction center to use.

(d) When or under what circumstances to engage targets.

(e) The relative priority of targets.

(f) The method of engagement and method of control to be used in the call for fire.

(2) If the platoon leader and the FO cannot see the targets and trigger lines or TRPs under the visibility conditions expected at the time the target is to be fired, they immediately notify the company. The company commander and fire support team (FIST) evaluate the situation and notify higher headquarters. The planning headquarters then plans a new target at a location that meets the commander's purpose for fire support.

b. Call for Fire. A call for fire is a message prepared by an observer. It has all the information needed to deliver indirect fires on the target. Any soldier in the platoon can request indirect fire support by use of the call for fire.

(1) Calls for fire must include—

(a) Observer identification and warning order.

- Adjust fire.
- Fire for effect.
- Suppress.
- Immediate suppression (target identification).

(b) Target location methods.

- Grid.
- Polar.
- Shift from a known point.

(c) Target description. Give a brief description of the target using the acronym "SNAP."

- Size/shape.
- Nature/nomenclature.
- Activity.
- Protection/posture.

(2) A call for fire may also include the following information (optional elements):

(a) Method of engagement. The method of engagement consists of the type of adjustments, danger close, trajectory, ammunition, and distribution.

(b) Method of fire and control.

- At my command.
- Cannot observe.
- Time on target.
- Continuous illumination.
- Coordinated illumination.

- Cease loading.
- Check firing.
- Continuous fire.
- Repeat.

(c) Refinement and end of mission.

- Correct any adjustments.
- Record as target.
- Report battle damage assessment.

(3) Examples of call for fire follow:

(a) Grid.

- "_____ this is _____ adjust fire/fire for effect, over. "
- "Grid _____, over. "
- "(Target description) _____, over."

NOTE 1. Determine a six-digit grid for the target.

NOTE 2. Determine a grid direction to the target and send after the call for fire but before any subsequent corrections.

(b) Polar.

- "_____ this is _____ adjust fire/fire for effect, polar, over."
- "Direction _____, Distance _____, Up/Down _____ over."
- "(Target description) _____, over."

NOTE 1. Determine the grid direction to the target.

NOTE 2. Determine a distance from the observer to the target.

NOTE 3. Determine if any significant vertical interval exists.

NOTE 4. Fire direction center must have OP location.

(c) Shift from a known point.

- "_____ this is _____ adjust fire/fire for effect, shift (target number/registration point number), over."
- "Direction _____, Right/Left _____, Add/Drop _____ Up/Down _____, over."
- "(Target description) _____, over."

NOTE 1. Determine the grid direction to the target.

NOTE 2. Determine a lateral shift to the target from the known point.

NOTE 3. Determine the range shift from the known point to the target

NOTE 4. Fire direction center must have known point location and target number.

Section VIII. COMBAT SERVICE SUPPORT

CSS operations at platoon level are a vital part of infantry operations. They consist of logistical and personnel functions. CSS is integrated into the tactical planning process from the starting phases of operations. Well-planned and executed CSS is a large part of mission accomplishment and success of combat operations. Like CS, CSS is a combat multiplier. Soldiers well supplied with food, water, ammunition, shelter, and medical care are more successful in accomplishing their missions than those who are not.

2-35. PLANNING OF COMBAT SERVICE SUPPORT

The company headquarters plans, coordinates, and executes CSS functions for the company. The platoon leader is responsible for CSS, just as he is for everything that relates to his platoon. He constantly stays abreast of the platoon's CSS status and, along with the platoon sergeant, plans and executes CSS. The platoon sergeant, however, carries the bulk of this load. He consolidates information from the squad leaders, requests support from the XO or ISG, and assigns responsibilities to squads. Squad leaders plan and implement CSS operations for their squads, and they can delegate some functions to their team leaders. SOPs address additional responsibilities and duties in detail. They should standardize as many of the routine and recurring CSS operations as possible.

2-36. RESUPPLY OPERATIONS

Squad leaders must know the supply status for each member of the squad. As materials and supplies are used, squad leaders request resupply through the platoon sergeant. Platoon and squad SOPs should establish levels of depletion for specified items of supply (for example, water, ammunition). All soldiers and leaders should report supply status once that level is reached. The platoon sergeant combines requests from all squads and forwards them to the ISG or XO. There is no administrative/logistic net for the platoon. Logistics reports, when required, are sent on to the commander. Most resupply requests take a lot of time to transmit—line numbers should be used to save time. When operating on a nonsecure net, the platoon sergeant should encode all requests. The request is filled then or during the next resupply operation, depending on urgency. One of the most critical resupply functions is water. Even in cold areas, all personnel must drink at least two quarts of water a day to maintain efficiency. Water can be resupplied either by collecting and filling empty canteens or by distributing water cans to the platoons.

a. When water is not scarce, leaders must urge soldiers to drink water even when not thirsty. This is due to the body's thirst mechanism, which does not keep pace with the loss of water through normal daily activity. The rate at which dehydration occurs will depend on the weather conditions and the level of physical exertion.

b. If water is in short supply, soldiers must use water sparingly for hygiene purposes. When in short supply, water should not be used to heat MREs. Water used for coffee or tea may also be counterproductive because both increase the flow of urine. However, soups are an efficient means of providing both water and nutrition when water is scarce, particularly in cold weather when heated food is desirable. A centralized heating point can be used to conserve water yet provide warmed MREs.

c. In most environments, water is available from natural sources. Soldiers should be trained to find, treat (chemically or using field expedients), and use natural water sources. The use of iodine tablets is the most common and easiest method to treat water. (Iodine tablets that are not uniformly grey in color or no longer have a firm consistency should not be used.) (See FM 21-10 and FM 21-76 for more information.)

2-37. RESUPPLY TECHNIQUES

Platoon resupply is mainly a "push" system. The platoon receives a standard package of supplies based on past usage factors and planning estimates. The following discusses the three platoon and squad resupply techniques. Whatever resupply technique they select, leaders must ensure security. This involves security at the resupply point and rotating personnel to ensure continuous manning of crew-served weapons and OPs, leader availability, and unit preparedness in case of enemy attack. Platoons use backhauling to remove residue, casualties, damaged equipment, or excess ammunition to the rear. During each resupply operation, the platoon must plan for backhauling of excess items. Backhauling can be by manpack, vehicles or aircraft. Effective backhauling lessens the platoon's need to bury, camouflage, or otherwise dispose of unneeded material.

a. **In-Position Technique.** The company brings forward supplies, equipment, or both to individual fighting positions (Figure 2-63). This technique—

- Is used when an immediate need exists.
- Is used to resupply single classes of supply during contact or when Contact is imminent.
- Enables leaders to keep squad members in their fighting positions.

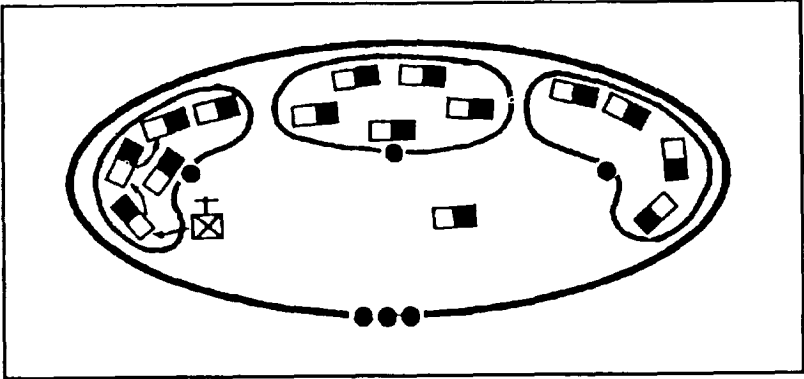

Figure 2-63. In-position technique.

NOTE: If vehicles cannot move near platoon positions, platoon members may need to help the resupply personnel move supplies and equipment forward.

b. **Service Station Technique.** To use this technique, soldiers must leave their fighting positions (Figure 2-64). Selected soldiers move to a company resupply point to the rear of the platoon position, conduct resupply, and return to their fighting position. This technique is used when contact is not likely, and for one or several classes of supplies.

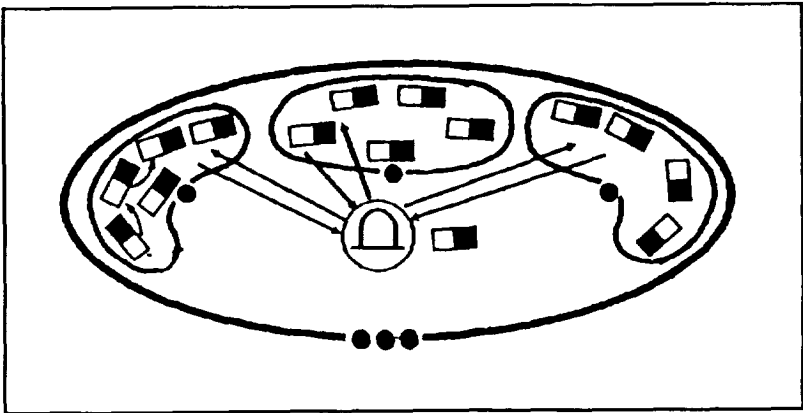

Figure 2-64. Service station technique.

NOTE: The platoon order should state the sequence for moving squads or portions of squads out of position. Companies may vary the technique by establishing a resupply point for each platoon and moving the supplies to that point.

c. **Pre-Position Technique.** In this technique, the company pre-positions supplies and equipment along a route to or at a platoon's destination. The company then directs the platoons to the sites. Though this method is used often during defensive operations to position supplies and equipment in subsequent BPs (Figure 2-65), it can be equally effective in other operations as a cache. A cache is a pre-positioned and concealed supply point that—

- Can be set up for a specific mission or contingency.
- Can be used effectively by platoons and squads to reduce the soldier's load.
- Can be either above or below ground.

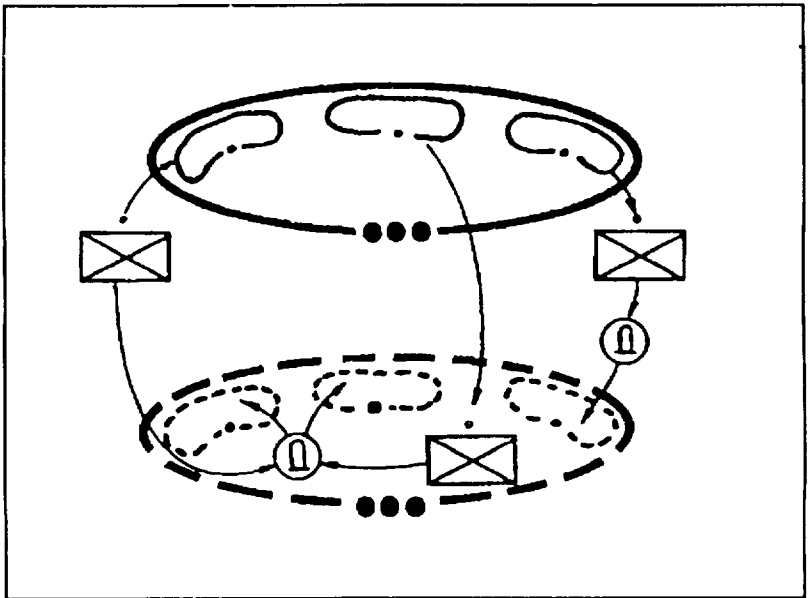

Figure 2-65. Pre-position technique.

NOTE: An above-ground cache is easier to use but more likely to be found by the enemy, civilities, or animals.

2-38. AERIAL RESUPPLY

Aerial resupply is often used to get supplies and equipment to the platoon. Rotary-wing aircraft are usually more precise in delivering supplies than fixed-wing aircraft. Rotary-wing aircraft deliver supplies and equipment to an LZ. Fixed-wing aircraft deliver to DZs. The platoon must secure the LZ or DZ. This helps protect the aircraft and ensure that the platoon receives the supplies. The platoon leader uses

the estimate process to find the best way to move to and secure the LZ or DZ, and to receive the supplies.

2-39. MAINTENANCE

Proper maintenance is the key to keeping equipment and materiel in good condition. It includes inspecting, testing, servicing, repairing, requisitioning, recovering and evacuating.

a. The platoon leader is responsible for the maintenance practices within his unit. He must coordinate his platoon's maintenance efforts with the XO to ensure that the platoon is acting IAW the company maintenance effort. The platoon sergeant coordinates and supervises the platoon's maintenance efforts. The squad leader is responsible for the maintenance of his squad's equipment.

b. Platoon communications equipment that needs repair is turned in to the company communications chief. Platoon weapons and other equipment are recovered to the platoon or the company collection points during battle, or turned in to the supply sergeant during resupply operations.

c. All soldiers must understand how to maintain their individual and squad weapons and equipment IAW the related technical manuals. The platoon leader, platoon sergeant, and squad leaders must understand maintenance for each piece of equipment in the platoon. The platoon SOP should specify maintenance periods (at least once a day in the field) and standards for equipment and who inspects which items (usually the squad leader, with spot-checks by the platoon sergeant and platoon leader).

2-40. TRANSPORTATION

Since the infantry platoon leader has no organic transportation, he requests transportation support through the first sergeant or XO. They in turn, request it from the battalion S4 or S3 Air if it involves helicopters. Whenever possible, rucksacks and excess equipment should be transported by vehicle, unless there is a specific reason not to.

2-41. SOLDIER'S LOAD

The soldier's load is a main concern of the leader. How much is carried, how far, and in what configuration are important mission considerations. Leaders must learn to prepare for the most likely contingencies based on available intelligence—they cannot be prepared for all possible operations. See FM 7-10 and FM 21-18 for detailed discussions on load planning, calculating, and management techniques used to assist leaders and soldiers in organizing tactical loads to ensure safety and combat effectiveness are discussed in Chapter 5.

2-42. PERSONNEL SERVICE SUPPORT

The main platoon combat personnel service support functions are strength accounting and casualty reporting. The platoon leader and NCOs are also responsible for handling EPWs and for the programs to counter the impact of stress and continuous operations. Platoon leaders coordinate personnel service support provided by the battalion S1, PAC, and chaplain through the company headquarters.

a. **Strength Accounting.** Leaders in the platoon use battle rosters to keep up-to-date records of their soldiers. They provide strength figures to the company at specific intervals. During combat, they provide hasty strength reports upon request or when important strength changes occur.

b. **Casualty Reporting.** During lulls in the battle, platoons give by-name or roster number (SOP dependent) casualty information to the company headquarters. Soldiers with direct knowledge of an incident must complete a DA Form 1155 (Figure 2-66). This form is used to report KIAs who were not recovered and missing or captured soldiers. DA Form 1156 is used to report those soldiers who have been killed and recovered and soldiers who have been wounded (Figure 2-67). The platoon leader or platoon sergeant reviews these forms for accuracy, then forwards them to the company headquarters.

c. **Services.** Services include mail, financial matters, awards and decorations, leaves and passes, command information, religious activities, legal assistance, welfare, rest and relaxation, and any other services related to the welfare and morale of the soldiers. Many services are standard procedure. The platoon leader must ensure that these services are available to the platoon. The first sergeant requests services for the platoon.

d. **Enemy Prisoners of War.** Soldiers must handle EPWs IAW international law and treat them humanely; they must not abuse them physically or mentally. EPWs must be allowed to keep their personal protective equipment. The senior officer or NCO present is responsible for their care. If a platoon cannot evacuate EPWs in a reasonable time, they must give EPWs food, water, and first aid. Soldiers should not give EPWs comfort items such as cigarettes or candy.

(1) EPWs who receive favors and those who are mistreated make poor interrogation subjects. Use the five S's in handling EPW.

(a) **Search the EPW.** One soldier should guard the EPW while another searches. The soldier searching should not get between the EPW and the guard. Position the EPW spread-eagled against a tree or wall or have him get on the ground in a push-up position with his knees touching the ground. Search him and search all his gear and clothing. Take his weapons and papers, except identification papers. Give the EPW a written receipt for any personal property and documents taken.

WITNESS STATEMENT ON CASUALTY INCIDENT (AR 600-10)		CHECK APPLICABLE BOX	
		<input type="checkbox"/> Killed in Action/Dead (remains not recovered) <input type="checkbox"/> Wounded in Action/Injured <input checked="" type="checkbox"/> Missing in Action/Missing <input type="checkbox"/> Captured	
1. LAST NAME, FIRST NAME MI (of casualty)	2. SSN	3. RANK	4. SEX
FOE, ROBERT	-	SP4	M
5. ORGANIZATION	6. DATE OF DEATH OR WHEN LAST SEEN		
C BATTERY 3/21ST FA	2030, 12 NOV 82		
7. GEOGRAPHICAL LOCATION OF INCIDENT (include grid coordinates and nearby town)	8. OTHER PERSONS WHO MAY HAVE WITNESSED THIS INCIDENT OR HAVE FURTHER INFORMATION		
A/B 122 344 FULDA, FRG	1SG SMITH C BATTERY 3/21ST FA		
9. CIRCUMSTANCES SURROUNDING INCIDENT (if known, include cause of death or condition when last seen, or how identified)			
SP4 FOE WAS THE RADIO OPERATOR FOR 2LT JONES, WHO WAS ATTACHED TO OUR PLATOON FOR A MISSION.			
(continued on back)			
DA FORM 1155		REPLACES EDITION OF 1 JUN 66, WHICH WILL BE ISSUED AND USED UNTIL EXHAUSTED.	
9. CIRCUMSTANCES SURROUNDING INCIDENT (Continued)			
HE WENT ON PATROL WITH 2LT JONES ON 12 NOV 82. HE LEFT OUR LINES AT 2030. NEITHER ONE RETURNED. THEY DIDN'T ANSWER THE RADIO. FIRING WAS HEARD FORWARD OF OUR POSITION ABOUT 2300 HOURS.			
10. NAME OF PERSON MAKING STATEMENT	11. RANK	12. SSN	
Q. T. WILLIAMS	PSG	000-00-0000	
13. UNIT	14. DATE	15. SIGNATURE	
C BATTERY 3/21ST FA	13 NOV 82	Q. T. Williams	

Figure 2-66. Witness statement.

CASUALTY FEEDER REPORT (AR 600-10)		CONTROL NO.	CHECK APPLICABLE BOX <input checked="" type="checkbox"/> HOSTILE ACTION <input type="checkbox"/> NON-HOSTILE ACTION
1. LAST NAME - FIRST NAME - MIDDLE INITIAL RAMIREZ, RICHARD			
2. SERVICE NO. 000-00-0000	3. GRADE E5	4. HOUR AND DATE OF INCIDENT 20 2200 Z OCT 89	
5. UNIT 1ST PLT B Co 5-87 INF	6. GEOGRAPHICAL LOCATION (nearby town) AND GRID COORDINATES BAMBERG		
7. TYPE OF CASUALTY (Check applicable box(es))			
<input type="checkbox"/> KILLED IN ACTION	<input type="checkbox"/> MISSING IN ACTION	<input checked="" type="checkbox"/> WOUNDED OR INJURED IN ACTION	
<input type="checkbox"/> DIED OF WOUNDS OR INJURIES	<input type="checkbox"/> CAPTURED	<input type="checkbox"/> LIGHTLY WOUNDED OR INJURED IN ACTION *	
<input type="checkbox"/> DIED NOT AS RESULT OF HOSTILE ACTION	<input type="checkbox"/> DETAINED	<input type="checkbox"/> SERIOUSLY WOUNDED OR INJURED IN ACTION *	
800. RECOVERED <input type="checkbox"/> YES <input type="checkbox"/> NO	<input type="checkbox"/> INTERNEED	<input type="checkbox"/> SERIOUSLY INJURED NOT AS RESULT OF HOSTILE ACTION	
900. BODY IDENTIFIED <input type="checkbox"/> YES <input type="checkbox"/> NO	<input type="checkbox"/> MISSING	<input type="checkbox"/> LIGHTLY INJURED NOT AS RESULT OF HOSTILE ACTION	
EVACUATED TO BN AID STATION			
* To be indicated by medical personnel only.			
DA FORM 1156, 1 Jun 66		REPLACES EDITION OF 1 MAY 61 WHICH WILL BE ISSUED AND USED UNTIL EXHAUSTED	
8. WITNESSES WHO SAW INCIDENT OR IDENTIFIED REMAINS (Name, grade, service number and unit) JEFF RHEINWALD E6 000-00-0000, SGT PLT, 7-6 INF JIMBO KELLER E4 000-00-0000, SGT PLT, 7-6 INF			
9. REMARKS (Additional circumstances, any religious ministrations performed, etc.)			
10. FOR USE BY CO. OR MED OFF (only for casualties not the result of hostile action)		AUTHENTICATED BY (CO or Med Off)	VERIFIED BY (Pers Off)
LINE OF DUTY () YES () NO () UNDETM			
UNIT 1ST PLT B Co, 5-87 INF	GRADE E7	SERVICE NO 000-00-0000	
DATE 20 OCT 89	SIGNATURE OF PERSON PREPARING REPORT Dora Conrad Kunklighter III		

D GPO : 1981 346-118

Figure 2-67. Casualty report.

(b) *Segregate* all EPWs into groups of males and females and sub-groups of officers, NCOs, enlisted soldiers, civilians, and politicians. This keeps the leaders from promoting escape efforts. Keep groups segregated as they move to the rear.

(c) *Silence* EPWs. Do not let EPWs talk to each other. This keeps them from planning an escape and from cautioning each other on security. Report anything an EPW says or tries to say to another EPW.

(d) *Speed* EPWs to the rear. Platoons turn EPWs over to the company where they are assembled and moved to the rear for questioning by qualified intelligence soldiers.

(c) *Safeguard* EPWs when taking them to the rear. Make sure they arrive safely. Watch out for escape attempts. Do not let them bunch up, spread too far out, or start diversions, such as fist fights, that create a chance for escape. At the same time, do not allow anyone to abuse them.

(2) If an EPW is wounded and cannot be evacuated through normal channels, he is treated by an aidman and evacuated through medical channels. The EPW must be guarded by other than medical soldiers.

(3) Before evacuating an EPW, tag him with a minimal EPW tag and equipment/document tag (Figures 2-68 and 2-69) or a complete tag (Figures 2-70). The tag should be perforated into three parts and made of durable material. It should measure about 10 centimeters by 10 centimeters for each part. It should be pierced at the top and bottom, and reinforced for security for ease of attachment. (See STANAG 2044.)

DATE /TIME CAPTURE	170900JAN92
PLACE OF CAPTURE	AB168291
CAPTURING UNIT	2/41C
CIRCUMSTANCES OF CAPTURE (how it happened)	ATTEMPTING TO PROBE DEFENSIVE POSITION

Figure 2-68. Minimal EPW tag.

TYPE DOCUMENT/EQUIPMENT	AK 47
DATE/TIME CAPTURED	170900JAN92
PLACE OF CAPTURE (grid coordinates)	AB168291
CAPTURING UNIT	2/41C
CIRCUMSTANCES OF CAPTURE (how it happened)	ATTEMPTING TO PROBE DEFENSIVE POSITION
PW FROM WHOM TAKEN	HECTOR ARGUELLO

Figure 2-69. Minimal document/equipment tag.

<p>ATTACH TO PW 123456 A</p> <p>DATE OF CAPTURE _____ () <u>170900Z JAN 92</u></p> <p>NAME () <u>HECTOR ARGUELLO</u></p> <p>SERIAL NUMBER () <u>NONE</u></p> <p>RANK () <u>SERGEANT</u></p> <p>UNIT () <u>UNKNOWN</u></p> <p>LOCATION OF CAPTURE () _____</p> <p>CAPTURING UNIT () <u>214/C</u></p> <p>SPECIAL CIRCUMSTANCES OF CAPTURE () _____ <u>ATTEMPTING TO</u> <u>PROBE DEFENSIVE</u> <u>POSITION</u></p> <p>WEAPONS DOCUMENTS () _____ <u>AK 47</u></p> <hr/> <p>FORWARD UNIT 123456 B</p> <p>() _____</p> <p>DATE OF CAPTURE _____</p> <p>() _____</p> <p>NAME () _____</p> <p>SERIAL NUMBER () _____</p> <p>RANK () _____</p> <p>DATE OF CAPTURE () _____</p> <p>UNIT () _____</p> <p>LOCATION OF CAPTURE () _____</p> <p>CAPTURING UNIT () _____</p> <p>SPECIAL CIRCUMSTANCES OF CAPTURE () _____</p> <p>_____</p> <p>WEAPONS DOCUMENT () _____</p> <p>_____</p> <hr/> <p>ATTACH TO ITEM 123456 C</p> <p>() _____</p> <p>DATE OF CAPTURE _____</p> <p>() _____</p> <p>NAME () _____</p> <p>SERIAL NUMBER () _____</p> <p>RANK () _____</p> <p>DATE OF BURTH () _____</p> <p>UNIT () _____</p> <p>LOCATION OF CAPTURE () _____</p> <p>DESCRIPTION OF WEAPONS/DOCUMENTS () _____</p> <p>_____</p> <p>DOCUMENTS AND WEAPON CARD</p> <p>() _____ () _____</p>	<p style="text-align: center;">PW</p> <p style="text-align: center;">DO NOT REMOVE THIS PART FROM PW</p> <p style="text-align: center;">DISARM AND SEARCH THOROUGHLY () _____ REPORT IMMEDIATELY () _____ SEGREGATE BY CATEGORY () _____ SAFEGUARD FROM DANGER () _____</p> <p style="text-align: center;">BACK OF PART A</p> <p>NOTE: See STANAG 2044 for reproducible copy.</p> <p>On the back of the lower part should be written in red letters: ATTACH TO CAPTURED WEAPONS AND/OR DOCUMENTS.</p> <p>Total tag should measure approximately 30 x 10 centimeters.</p>
---	---

Figure 2-70. EPW and document/equipment tag.

c. **Captured Enemy Documents.** Enemy documents are a valuable source of information; they must be processed as quickly as possible. Documents can be official or personal. When a platoon captures documents in the custody of an EPW, the platoon leader or the senior leader at the capture site is responsible for preliminary screening and for reporting the capture of enemy documents to his next higher leader. That leader is responsible for ensuring that the documents are properly tagged. The leader ensures that the documents accompany the EPW to the point of turnover to the company.

f. **Captured Enemy Equipment and Associated Technical Documents.** Equipment and documents (operator's manuals, TMs, and soon) are a valuable source of information. They must be kept together and guarded throughout the capture and evacuation process to prevent looting, misuse, or destruction. Equipment and documents must be tagged. Captured enemy medical equipment and supplies will not be used on US casualties. It should be turned in for use on wounded EPWs.

2-43. HEALTH SERVICES SUPPORT

Platoon health services support consists of the prevention, treatment, and evacuation of casualties. Prevention is emphasized; soldiers can lose their combat effectiveness because of nonbattle injuries or disease. Understanding and applying the principles of field hygiene and sanitation, preventing weather-related injuries, and considering the soldier's overall condition can eliminate many casualties. (See FMs 21-10 and 21-11.)

a. The SOP should address casualty evacuation procedures in detail. It must clearly state that personal protective equipment remains with and is evacuated with the casualty. The casualty's weapon and equipment is retained by the platoon, redistributed as appropriate (ammunition, food, water, special equipment) or evacuated to the field trains by backhaul at the next LOGPAC. Machine guns, M203s, and other special weapons are never evacuated but are reassigned to their soldiers.

(1) The platoon SOP must include the following:

- Duties and responsibilities of key personnel in planning and executing casualty evacuation.
- Priorities of evacuation.
- Provisions for retrieving and safeguarding weapons, ammunition, and equipment.

(2) Paragraph 4 of the OPORD must provide the following:

- Location of casualty collection points (battalion, company, platoon).
- Procedures and responsibilities for medical evacuation.
- Planned use of nonmedical transportation assets for evacuation.

- Procedures for treating and evacuating EPWs and civilian casualties.
- Communication nets for evacuation requests.
- A time when the evacuation mission will begin and the nonmedical soldiers can aid in collection and evacuation. This prevents combat power from being diverted from the mission.

b. Leaders must be prepared to treat and evacuate casualties. They must understand the plan for casualty evacuation and immediately begin to execute it once casualties occur. The platoon aidman is trained to assess, to triage, and to begin treatment of casualties. If he becomes a casualty, both the the combat lifesavers and the leaders in the platoon must be prepared m evaluate, treat. and evacuate casualties. treatment of serious casualties means stabilizing the soldier until he can be evacuated to the battalion aid station The company and battalion casualty evacuation plans should assume responsibility for the casualties as far forward as possible. Ambulances (ground and air) should pick up the casualties as far forward as possible and the tactical situation permits. Any vehicles in the AO can be used to transport casualties.

c. At least one soldier in each squad must be trained as a combat lifesaver to help the aidman treat and evacuate casualties The lifesavers are part of the platoon aid and litter team(s). They provide initial treatment until medical personnel can treat casualties, **but only after their primary infantry duties are complete.** They can also help in triage, treatment, or both for soldiers after medical personnel arrive, if the tactical and medical situations allow. The platoon sergeant supervises this effort.

d. Treatment of casualties normally' begins at the conclusion of the engagement, during the reorganization of the platoon. Casualties are treated where they fall (or under nearby cover and concealment) by the casualty himself, a buddy, an aidman, or a combat lifesaver. They are then evacuated by improvised or lightweight litters to the platoon casualty collection point. This point is chosen by the platoon leader in the OPOD or by the platoon sergeant as needed on site. When selecting the evacuation point, the leader must consider cover and concealment, security, space in which to treat casualties, route access, and air access. KIA arc not collected in or near the casualty collection or evacuation points. As the casualties are collected, they are triaged (sorted) and separated for treatment. The goal is to accomplish the greatest good for the greatest number. The casualty treatment categories arc immediate, delayed, minimal, and expectant.

- (1) **Immediate—to save Life or limb.**
 - (a) Airway obstruction.

(b) Respiratory and cardiorespiratory failure (cardiorespiratory failure is not considered an “immediate” condition on the battlefield; it is classified as expectant).

(c) Massive external bleeding.

(d) Shock.

(e) Sucking chest wound, if respiratory distress is evident.

(f) Second or third degree burns of the face and neck, or perineum (musing shock or respiratory distress).

(g) After casualty with life- or limb-threatening conditions has been initially treated, no further treatment will be given until other “immediate” casualties have been treated.

(2) Delayed-Less Risk by Treatment Being Delayed.

(a) Open chest wound.

(b) Penetrating abdomen wound.

(c) Severe eye injury.

(d) Avascular limb without apparent blood supply.

(c) Other open wounds.

(f) Fractures.

(g) Second and third degree burns not involving the face and neck or perineum.

(3) Minimal-Can Be Self Aid or Buddy Aid. Patients in this category are not evacuated to a medical treatment facility.

(a) Minor lacerations.

(b) Contusions.

(c) Sprains.

(d) Minor combat stress problems.

(e) Partial thickness burns (under 20 percent).

(4) Expectant-Little Hope of Recovery. This category should be used only if resources are limited.

(a) Massive head injury with signs of impending death.

(b) Burns on more than 85 percent of the body surface area.

NOTE: Casualties with minor injuries can assist with recording treatment, emergency care, and defense of the area.

c. The platoon can use any of several evacuation methods. (See FM 8-10-4.)

(1) Dedicated medical evacuation assets can evacuate the casualties directly to the BAS from the point of injury or planned patient-collection points.

NOTE: If casualties are evacuated by MEDEVAC, they are taken to the medical facility that can give the proper level of care to the most

serious casualty onboard. usually at least the medical clearing station in the brigade support area.

(2) The casualties can be moved by vehicle or litter to the company casualty collection point for evacuation. The OPORD should state how and when this should be done. Medical platoon ambulances attached to the company then move the casualties to the rear.

(3) The platoon sergeant can direct platoon aid and litter teams to carry the casualties to the rear.

(4) Casualties with minor wounds can either walk by themselves or help carry the more seriously wounded soldiers.

(5) In rough terrain (or on patrols), casualties can be evacuated to the BAS by aid and litter teams, carried until transportation can reach the platoon or cached and picked up later.

(6) Dead soldiers should be evacuated by backhaul on supply vehicles—not in ambulances or MEDEVAC helicopters,

f. The information in Figure 2-71 is essential in the format shown when requesting MEDEVAC.

LINE	ITEM	EXPLANATION	WHERE/HOW OBTAINED	WHO NORMALLY PROVIDES	REASON
1	Location of Pickup Site.	Encrypt the grid coordinates of the pickup site. When using the DRYAD Numeral Cipher, the same "SET" line will be used to encrypt the grid zone letters and the coordinates. To preclude misunderstanding, a statement is made that grid zone letters are included in the message (unless SOP specifies its use at all times).	From Map	Unit Leader(s)	Required so evacuation vehicle knows where to pick up patient. Also, so that the unit coordinating the evacuation mission can plan the route for the evacuation vehicle (if the evacuation vehicle must pick up from more than one location).
2	Radio Frequency, Call Sign, and Suffix.	Encrypt the frequency of the radio at pickup site, not a relay frequency. The call sign (and suffix if used) of person to be contacted at pickup site may be transmitted in the clear.	From SOP	RATELO	Required so that evacuation vehicle can contact requesting unit while en route (obtain additional information or change in situation or directions).

Figure 2-71. MEDEVAC request preparation.

LINE	ITEM	EXPLANATION	WHERE/HOW OBTAINED	WHO NORMALLY PROVIDES	REASON
3	Number of Patients by Precedence	Report only applicable information and encrypt the brevity codes. A - URGENT. B - URGENT SURGICAL. C - PRIORITY. D - ROUTINE. E - CONVENIENCE. IF two or more categories must be reported in the same request, insert the word "BREAK" between each category.	From Evaluation of Patient(s)	Aidman or Senior Person Present	Required by unit controlling the evacuation vehicles to assist in prioritizing mission.
4	Special Equipment Required	Encrypt the applicable brevity codes. A - None. B - Hoist. C - Extraction equipment. D - Ventilator.	From Evaluation of patient/ Situation	Aidman or Senior Person Present	Required so that the equipment can be placed on board the evacuation vehicle prior to the start of the mission.
5	Number of Patients	Report only applicable information and encrypt the brevity code. if requesting MEDEVAC for both types, insert the word "BREAK" between the litter entry and ambulatory entry L + number of patient-litter. A + number of patient-ambulatory.	From Evaluation of Patient(s)	Aidman or Senior Person Present	Required so that the appropriate number of evacuation vehicles may be dispatched to the pickup site. They should be configured to carry the patients requiring evacuation.
6	Security of Pickup Site (Wartime)	N - No enemy troops in area. P - possible enemy troops in area (approach with caution). E - Enemy troops in area (approach with caution). X - Enemy troops in area (armed escort required).	From Evaluation of Situation	Unit Leader	Required to assist the evacuation crew in addressing the situation and determining if assistance is required. More definitive guidance can be furnished the evacuation vehicle while it is in route (specific location of enemy to assist an aircraft planning its approach.
6	Number and Type of Wound, Injury, or Illness (Peace-time)	Specific information regarding patient wounds by type (gunshot or shrapnel). Report serious bleeding, along with patient blood type, if known.	From Evaluation of Patient	Aidman or Senior Person Present	Required to assist evacuation personnel in determining treatment and special equipment needed.

Figure 2-71. MEDEVAC request preparation (continued).

LINE	ITEM	EXPLANATION	WHERE/HOW OBTAINED	WHO NORMALLY PROVIDES	REASON
7	Method of Marking Pickup Site	Encrypt the brevity codes. A - Panels. B - Pyrotechnic signal. C - Smoke signal. D - None. E - Other.	Based on Situation and Availability of Materials	Aidman or Senior Person Present	Required to assist the evacuation crew in identifying the specific location of the pick up. Note that the color of the panels or smoke should not be transmitted until the evacuation vehicle contacts the unit (just prior to its arrival). For security, the crew should identify the color and the unit verify it.
8	Patient Nationality and Status	The number of patients in each category need not be transmitted. Encrypt only the applicable brevity codes. A - US military. B - US civilian. C - Non-US military. D - Non-US civilian. E - EPW.	From Evaluation of Patient	Aidman or Senior Person Present	Required to assist in planning for destination facilities and need for guards. Unit requesting support should ensure that there is an English speaking representative at the pickup site.
9	NBC Contamination (Wartime)	Include this line only when applicable. Encrypt the applicable brevity codes. N - Nuclear. B - Biological. C - Chemical.	From Situation	Aidman or Senior Person Present	Required to assist in planning for the mission. (Determine which evacuation vehicle will accomplish the mission and when it will be accomplished.)
9	Terrain Description (Peacetime)	Include details of terrain features in and around proposed landing site. if possible, describe relationship of site to prominent terrain feature (lake, mountain, tower).	From Area Survey	Personnel at Site	Required to allow evacuation personnel to assist route/avenue of approach into area. Of particular importance if hoist operation is required.

Figure 2-71. MEDEVAC request preparation (continued).

Section IX. ARMORED VEHICLE SUPPORT

Armored and mechanized forces often support infantry units in combat operations. The fundamentals and principles stated previously in this manual for tactical operations still apply. This section discusses tactics and techniques used by infantry units working with armored vehicles. It is based on an infantry platoon working with an armored vehicle platoon or two-vehicle section. (Figures 2-72 and 2-73.)

2-44. COMBINED OPERATIONS WITH ARMORED VEHICLES

Leaders must know what heavy and light forces can do for each other. In operations in which light forces predominate, airborne, air assault, or

other light infantry lead the combined arms attack, all other arms support the infantry.

a. Infantrymen help heavy forces by finding and breaching or marking antitank obstacles. Infantry provides security for armored vehicles. They detect and destroy or suppress antitank weapons. They designate targets for tanks to destroy by main gun fire and continue to assist by spotting the impact of tank rounds for the gunner.

b. Heavy forces help infantry by leading them in open terrain and providing them a protected, fast moving assault weapons system. They suppress and destroy enemy weapons, bunkers, and tanks by fire and maneuver. They also provide transport when the enemy situation permits.

2-45. CONSIDERATIONS

Commanders use the estimate of the situation to determine the mix of armored and infantry forces, and the command relationship (attached or OPCON).

a. Tanks. Tank platoons use the wingman concept; the platoon leader's tank and his wingman, and the platoon sergeant's tank with his wingman. They operate as a four-vehicle platoon. (Figure 2-72) The TOE for a tank platoon does not break the organization down any further than the platoon. However, tanks and infantry must work closely. In most operations where they work together, infantrymen must establish direct contact with individual tanks. They will not have time to designate target or direct fires through the platoon chain of command. Infantrymen and tankers must know how to communicate by radio, phone, and visual signals.

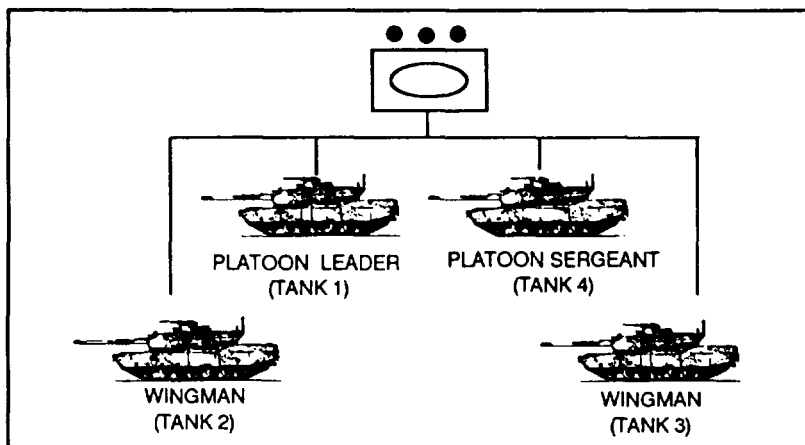

Figure 2-72. Tank platoon.

b. **Mechanized Infantry.** Mechanized infantry combines the protection, firepower, and mobility of armored forces, with the close combat capability of infantry forces. Infantry adds security and close combat capability to mechanized forces while gaining from their mobility and firepower. Infantry may work together with mechanized forces or may operate in synchronization with them to clear a way through obstacles before an armored attack, hold a strongpoint while mechanized infantry maneuvers around it, or conduct MOUT missions. (Figure 2-73.)

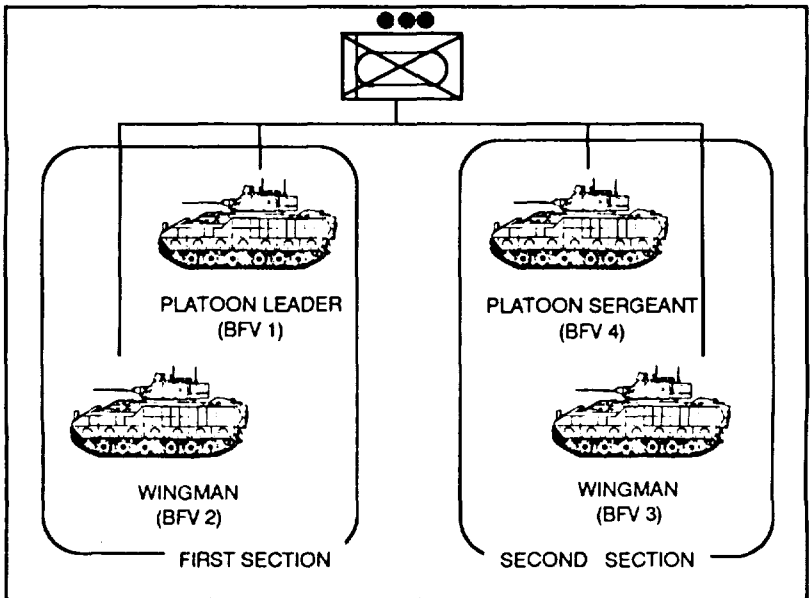

Figure 2-73. M2 platoon.

2-46. COMMUNICATING WITH TANKS

Before an operation, infantry and tank platoon leaders must coordinate communications means and signals. This should include the use of radios; phones; and visual signals such as arm-and-hand, panel, lights, flags, and pyrotechnics. Most tanks (except the M1) have an external phone on the rear for infantrymen to use. On the M1, the infantryman can run communication wire to the tank commander through the turret. This wire can be hooked into the tank's communication system. Leaders must be confident that tanks and infantry will be able to move and shoot without confusion.

2-47. INFANTRY RIDING ON ARMORED VEHICLES

Soldiers ride on the outside of armored vehicles routinely. So long as tanks and infantry are moving in the same direction and contact is not likely, soldiers should always ride on tanks.

a. **Guidelines for Riding on all Armored Vehicles.** The following must be considered before soldiers mount or ride on an armored vehicle.

(1) When mounting an armored vehicle, soldiers must always approach the vehicle from the front to get permission from the vehicle commander to mount. They then mount the side of the vehicle away from the coaxial machine gun and in view of the driver.

(2) If the vehicle has a stabilization system, squad leaders ensure it is OFF before giving the okay for the vehicle to move.

(3) The infantry must dismount as soon as possible when tanks come under fire or when targets appear that require the tank gunner to traverse the turret quickly to fire.

(4) All soldiers must be alert for obstacles that can cause the tank to turn suddenly and for trees that can knock riders off the tank.

b. **Guidelines for Riding on Specific Armored Vehicles.** The following information applies to specific vehicles.

(1) **M1.** The M1 tank is not designed to carry riders easily. Riders must NOT move to the rear deck. Engine operating temperatures make this area unsafe for riders. (Figure 2-74.)

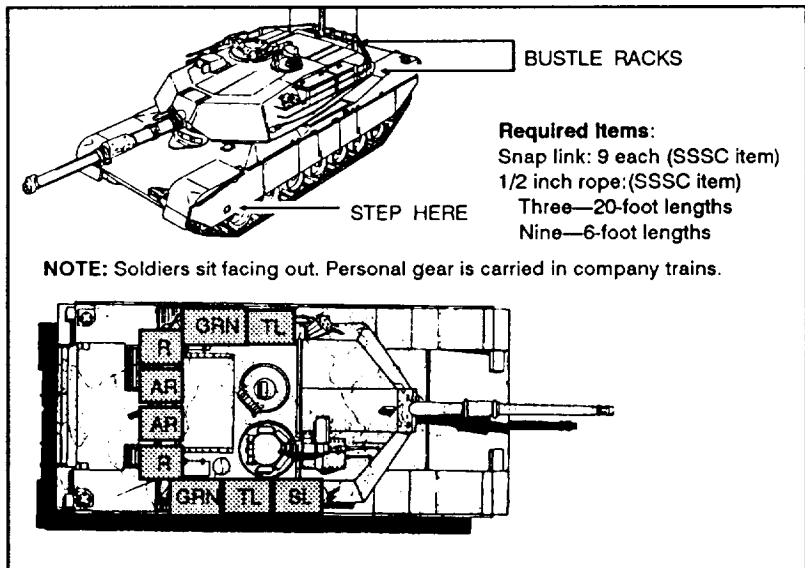

Figure 2-74. Mounting and riding arrangements on an M1.

(a) One infantry squad can ride on the turret. The soldiers must mount in such a way that their legs cannot become entangled between the turret and the hull by an unexpected turret movement. Rope maybe used as a field-expedient in fantry rail to provide secure handholds.

(b) Everyone must be to the rear of the smoke grenade launchers. This automatically keeps everyone clear of the coaxial machine gun and laser range finder.

(c) The infantry must always be prepared for sudden turret movement.

(d) Leaders should caution solders about sitting on the turret blow-out panels, because 250 pounds of pressure will prevent the panels from working properly. If there is an explosion in the ammunition rack, these panels blow outward to lessen the blast effect in the crew compartment.

(e) If enemy contact is made, the tank should stop in a covered and concealed position, and allow the infantry time to dismount and move away from the tank. This action needs to be practiced before movement.

(f) The infantry should not ride with anything more than their battle gear. Personal gear should be transported elsewhere.

(2) **M60.** The procedures for mounting infantry on M60-series tanks (Figure 2-75) are as follows:

(a) One infantry squad can ride on the turret or on the back deck clear of the turret. Tine problem of sudden turret movement is not as great as with M1-series tanks, but the soldiers must still be prepared for it.

(b) Everyone must be to the rear of smoke grenade launchers.

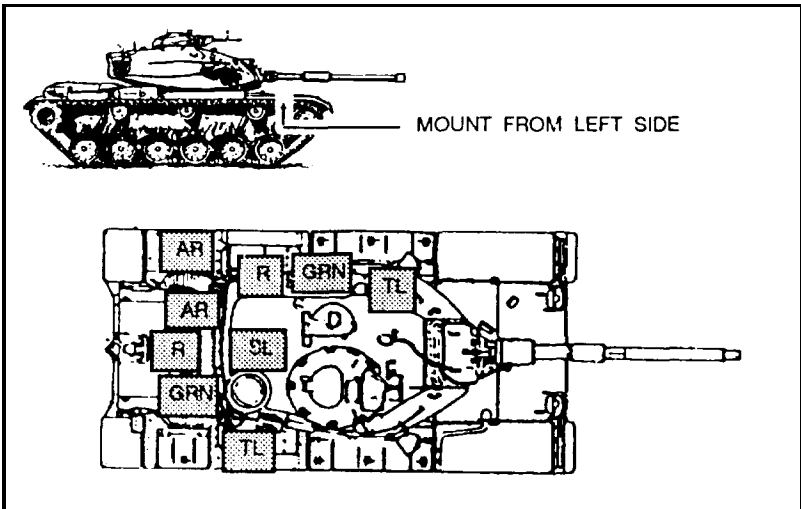

Figure 2-75. Riding arrangement on the M60.

(b) Everyone must be to the rear of smoke grenade launchers.

(c) If enemy contact is made, the tank should stop in a covered and concealed position, and allow the infantry time to dismount and move away from the tank. This action needs to be practiced before movement.

(d) Even on the M60-series, there is not enough room for the infantry to ride with anything more than battle gear.

Section X. OBSTACLES

An obstacle is any natural or man-made obstruction that turns, frees, disrupts, or blocks the movement of a force. The platoon must know how to employ obstacles and how to breach and clear obstacles. See FM 5-34 and FM 5-102 for additional information concerning obstacles.

2-48. EMPLOYING OBSTACLES

Obstacles are used in all operations, but are most useful in the defense. Obstacles are normally constructed by engineers with help from the platoon. There will be times when the unit must build obstacles without engineer help. In such cases, the leader should seek engineer advice on the technical aspects. Leaders must always consider what materials are needed and how long the obstacle will take to construct.

In the offense, the platoon/squad uses obstacles to—

- Aid in flank security.
- Limit enemy counterattack.
- Isolate objectives.
- Cut off enemy reinforcement or routes of withdrawal.

In the defense, the platoon/squad uses obstacles to—

- Slow the enemy's advance to give the platoon/squad more time to mass fires on him.
- Protect defending units.
- Canalize the enemy into places where he can more easily be engaged.
- Separate the enemy's tanks from his infantry.
- Strengthen areas that are lightly defended.

a. **Functions.** Obstacles perform one of four tactical functions—disrupt, turn, fix, or block.

(1) **Disrupt.** These obstacles are used to disrupt assault formations, attacking the low-level command and control while the attacker is under direct fire.

(2) **Turn.** Turning obstacles move and manipulate the enemy to the force's advantage by enticing or forcing him to move in a desired direction, by splitting his formation, by canalizing him, or by exposing his flank.

(3) **Fix.** Fixing obstacles slow and hold the enemy in a specific area so that he can be killed with fires, or the obstacles generate the time necessary for the force to break contact and disengage.

(4) **Block.** Blocking obstacles are complex, employed in depth, and integrated with fires to prevent the enemy from proceeding along a certain avenue of approach. Blocking obstacles serve as a limit, beyond which the enemy will not be allowed to go.

b. **Principles of Employment.** When employing obstacles, the leader considers the following principles.

(1) **Support the tactical plan.** Obstacles supplement combat power, decrease the mobility of the enemy, and provide security for the platoon. While considering enemy avenues of approach, he also considers his own movement requirements, such as routes for resupply, withdrawal, counterattacks, patrols, and observation posts.

(2) **Tie in.** He ties in his reinforcing obstacles with existing obstacles. He must also tie in the obstacle plan with his plans for fire support.

(3) **Covered by observation and fire.** He ensures that all obstacles are covered by observation and fire. This reduces the enemy's ability to remove or breach the obstacles and increases the possibilities of placing fire on the enemy when he encounters the obstacles.

(4) **Constructed in depth.** He emplaces obstacles so that each new obstacle encountered by the enemy attrites the enemy force and causes a desired and controlled reaction. Proper use of obstacles in depth wears the enemy down and significantly increases the overall desired effect.

(5) **Employed for surprise.** An obvious pattern of obstacles would divulge locations of units and weapons. Friendly forces must avoid readily discernible, repetitive patterns.

2-49. TYPES OF OBSTACLES

There are two types of obstacles—existing and reinforcing.

a. **Existing Obstacles.** Existing obstacles are those natural or cultural restrictions to movement that are part of the terrain when battle planning begins. The location and characteristics of natural or cultural obstacles have a direct relationship to the plan of operations and the positioning of forces. Existing obstacles should be easily converted into more effective obstacles, they should be in defilade from enemy observation, they should be where friendly observation and fires can prevent enemy breaching, and they should be difficult to bypass. Existing obstacles include the following.

(1) **Steep slopes.** Varying degrees of incline are required to stop different types of vehicles. Tanks can negotiate slopes as steep as 60 percent. Craters, mines, abatis, and induced landslides increase the obstacle value of slopes.

(2) **Escarments.** Vertical (or near-vertical) cuts and walls over 1 1/2 meters high cannot be crossed by vehicles without some type of breach. Thick rock walls, railroad embankments, and steep fills along highways are examples of escarpments.

(3) **Ravines, gullies, and ditches.** Generally, ravines, gullies, and ditches are obstacles to wheeled vehicles. If over 5 meters wide, these obstacles are usually effective against tracked vehicles.

(4) **Rivers, streams, and canals.** The major obstacle value of rivers, streams, and canals is that they must be crossed by special means: deepwater fording or surface or aerial means. The ease of crossing by deepwater fording and surface means is determined by the width and depth of the water obstacle, the water velocity, and the condition of the banks and bottom.

(5) **Swamps and marshes.** Swamps and marshes, where firm ground is lacking or is a meter or so below water level, are effective obstacles against all types of vehicles. They also severely restrict the mobility of infantry.

(6) **Snow.** Even on otherwise trafficable terrain, snow 1 meter deep becomes a major obstacle to personnel and vehicles.

(7) **Trees.** Heavy stands of trees that are 8 inches or more in diameter, spaced less than 20 feet apart, will eventually build up into an obstacle if tracked vehicles attempt to push them over and force their way through.

(8) **Built-up area.** The obstacle value of a built-up area depends on its size, location, and construction. The natural obstacle value of built-up areas can be increased by cratering streets; demolishing walls; overturning or derailling street or railroad cars; and constructing roadblocks from steel rails, beams, and rubble. When reinforced with mines and barbed wire, such obstacles protect against armored, mechanized, and infantry forces.

b. Reinforcing Obstacles. Reinforcing obstacles are those specifically constructed, emplaced, or detonated to tie together, strengthen, and extend existing obstacles. Careful evaluation of the terrain, to determine its existing obstructing or canalizing effect, is required to achieve maximum use of reinforcing obstacles. Installation time and manpower are usually the two most important factors. Infantry soldiers provide the most readily available source of manpower. Reinforcing obstacles include the following.

(1) **Road craters.** Road craters are effective obstacles on roads or trails if the areas on the flanks of the crater arc tied into steep slopes or mined areas.

(2) **Abatis.** An abatis is an obstacle created by cutting down trees so that their tops are crisscrossed and pointing toward the expected enemy direction. It is most effective for stopping vehicles in a forest. This obstacle may be reinforced with mines and booby traps.

(3) **Ditches.** Ditches across roads and trails arc effective obstacles. Large ditches in open areas require engineer equipment.

(4) **Log hurdles.** Log hurdles act as “speed bumps” on roads. They are easily installed and are most effective when used in conjunction with other obstacles.

(5) **Log cribs.** A log crib is constructed of logs, dirt, and rocks. The logs are used to make rectangular or triangular cribs, which arc filled with dirt and rock. These are used to block narrow roads and defiles. Unless substantially built, log cribs will not stop tanks.

(6) **Log posts.** Log posts embedded in the road and employed in depth can effectively stop tracked vehicles. If they arc not high enough to be pushed out of the way, posts can cause a tracked vehicle to throw a track if it tries to climb over. If employed with wire and mines, they can also slow infantry.

(7) **Rubble.** Rubble from selected masonry structures and buildings in a built-up area will limit movement through an area and provide fortified fighting positions.

(8) **Wire entanglements.** Wire entanglements impede the movement of infantry and, in some cases, tracked and wheeled vehicles. The materials used in constructing wire entanglements are relatively lightweight (compared to other obstacles) and inexpensive, considering the protection they afford.

(a) **Triple standard concertina fence.** The most common wire entanglement a platoon or squad may build is the triple standard concertina fence. It is built of either barbed wire concertina or barbed tape concertina. There is no difference in building methods. (Figure 2-76.) The material and labor requirements for a 300-meter triple standard concertina fence arc—

- Long pickets—160
- Short pickets—
- Barbed wire, 400-meter reels—3
- Rolls of concertina—59
- Staples—317
- Man-hours to erect—30

First lay out and install pickets from left to right (facing the enemy). Put the long pickets five paces apart, and the short (anchor) pickets two paces from the end of the long pickets. The enemy and friendly picket rows are offset and arc placed 3 feet apart. Now layout rolls of concertina. Place a roll in front of the third picket on the enemy side, and two rolls to the rear of the third picket on the friendly side. Repeat this step every fourth picket thereafter. Install the front row concertina and horizontal wire. Place the concertina over the pickets. Install the rear row of concertina and horizontal wire. Install the top row of concertina and join the rear horizontal wire.

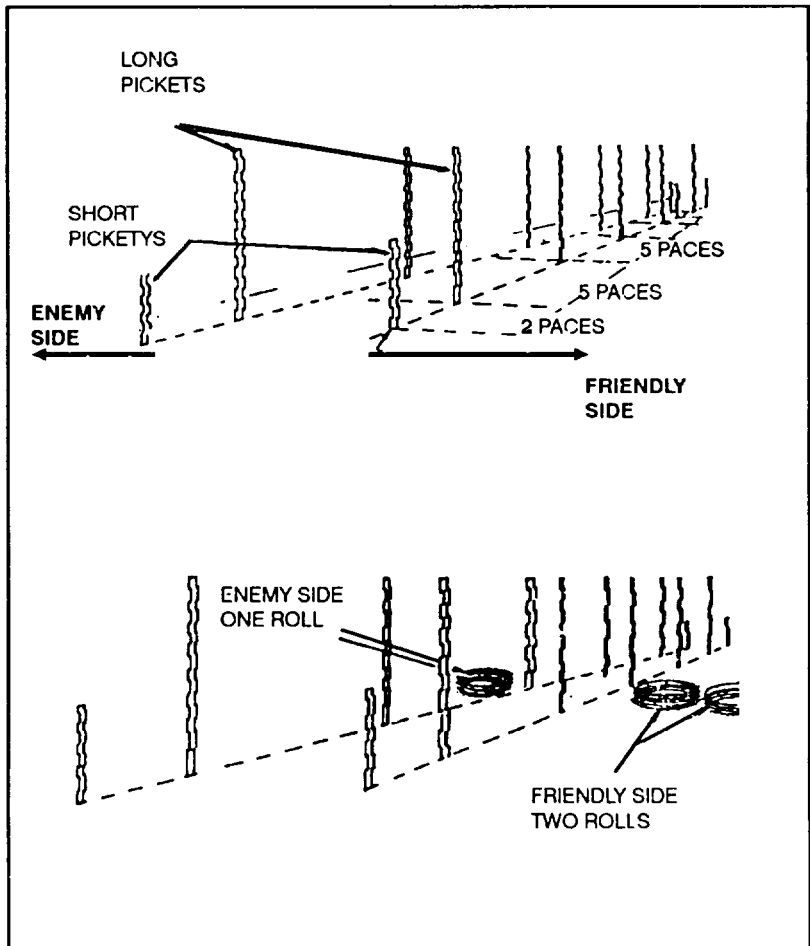

Figure 2-76. Concertina fence.

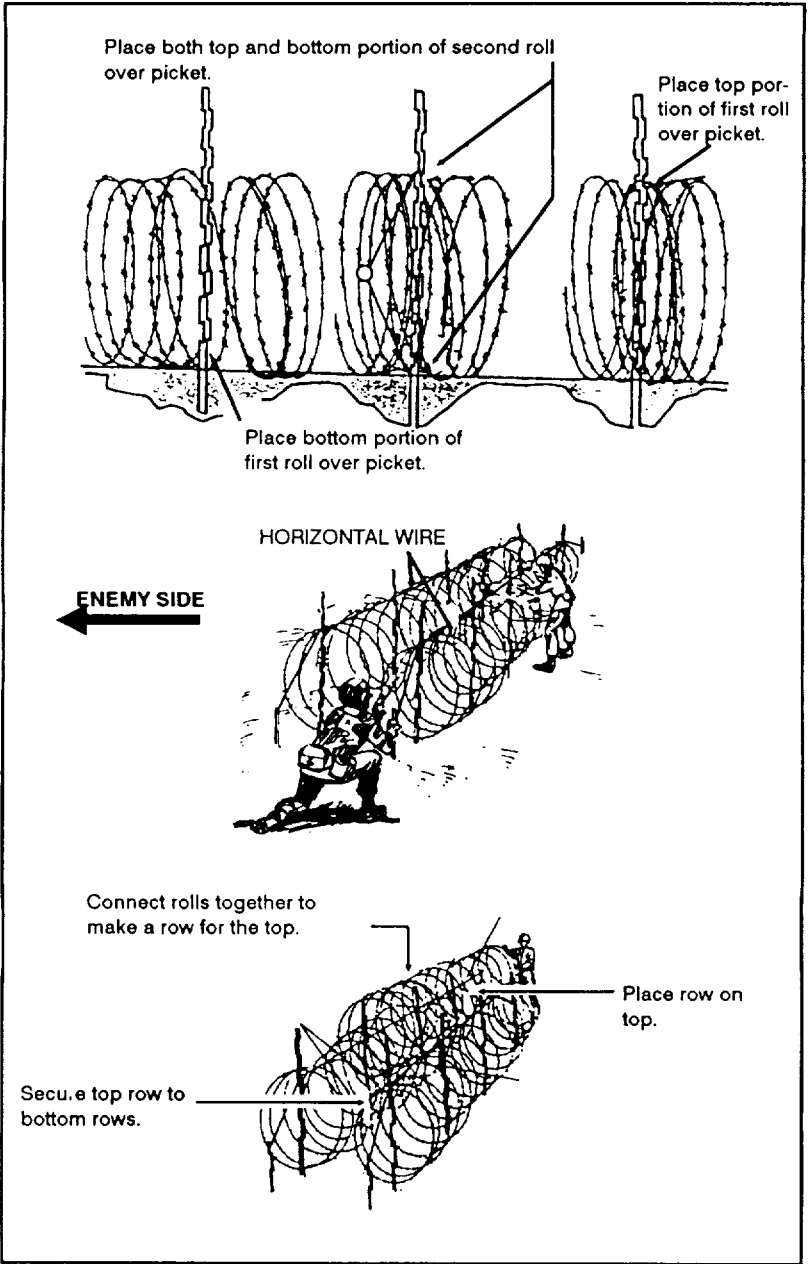

Figure 2-76. Concertina fence (continued).

(b) *Concertina roadblock.* The concertina roadblock is placed across roadways and designed to block wheeled or tracked vehicles. The roadblock is constructed of 11 concertina rolls or coils placed together, about 10 meters in depth, reinforced with long pickets five paces apart. The rolls or coils should not be tautly bound, thus allowing them to be dragged and tangled around axles, or tank road wheels and sprockets. Additionally, wire is placed horizontally on top of the concertina rolls or coils. (Figure 2-77.)

NOTE: Place three long pickets five paces apart per coil and place horizontal wire on top of coil.

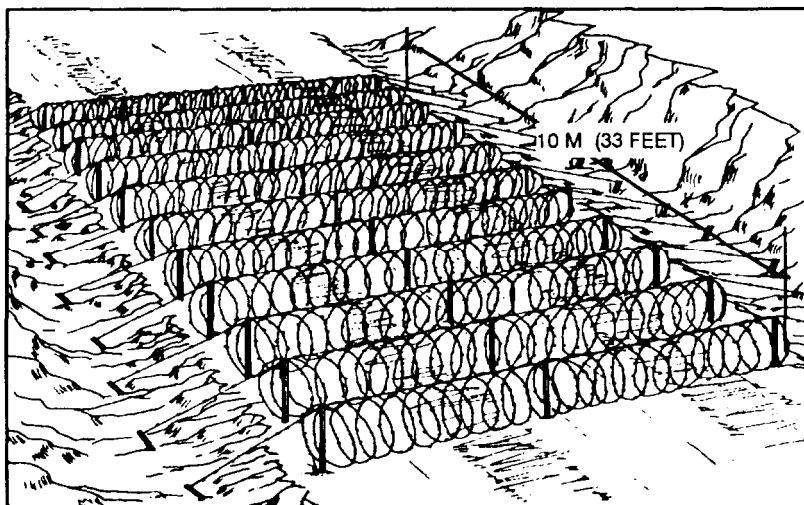

Figure 2-77. Concertina roadblock.

(c) *Tanglefoot.* Tanglefoot is used where concealment is essential and to prevent the enemy from crawling between fences and in front of emplacements. The obstacle should be employed in a minimum width of 32 feet. The pickets should be placed at irregular intervals of 2 1/2 feet to 10 feet, and the height of the barbed wire should vary between 9 to 30 inches. Tanglefoot should be sited in scrub, if possible, using bushes as supports for part of the wire. On open ground, short pickets should be used.

(9) *Mines.* Mines are one of the most effective tank and personnel killers on the battlefield. Minefield that an infantry platoon or squad most commonly emplace are the hasty protective, point, and phony.

(a) *Hasty protective minefield.* In the defense, platoons and squads lay hasty protective minefields to supplement weapons, prevent surprise,

and give early warning of enemy advance. A platoon can install hasty protective minefields, but only with permission from the company commander. Hasty protective minefields are reported to the company commander and recorded on DA Form 1355-1-R. The leader puts the minefield across likely avenues of approach, within range of and covered by his organic weapons. If time permits, the mines should be buried to increase effectiveness, but they may be laid on top of the ground in a random pattern. The minefield should be recorded before the mines are armed. The leader installing the minefield should warn adjacent platoons and tell the company commander of the minefield's location. When the platoon leaves the area (except when forced to withdraw by the enemy), it must remove the minefield or transfer the responsibility for the minefield to the relieving platoon leader. Only metallic mines are used in hasty protective minefields. Booby traps are not used in hasty protective minefields; they delay removal of the mines. The employing platoon must make sure that the minefield can be kept under observation and covered by fire at all times. The following example describes how to lay a hasty protective minefield.

EXAMPLE

After requesting and receiving permission to lay the minefield, the platoon leader and squad leaders reconnoiter to determine exactly where to place the mines. The leaders find a need to use antitank mines to block enemy vehicles at the bridge and the ford. The leaders decide that antipersonnel mines are needed to protect the antitank mines and to cover the likely avenues of approach of enemy infantry (Figure 2-78).

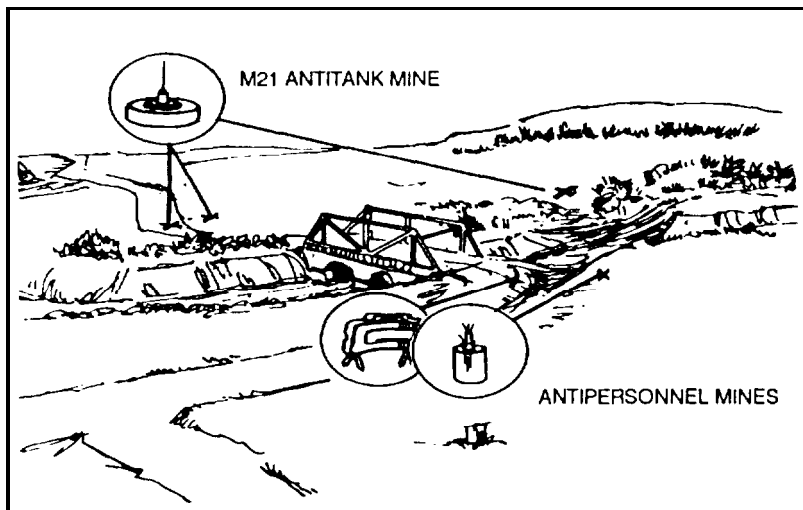

Figure 2-78. Antipersonnel and antitank mines in a hasty protective minefield.

While the soldiers are placing the mines, the platoon leader finds an easily identifiable reference point in front of the platoon's position. The platoon leader records the minefield using a reference point (Figure 2-79). The row of mines closest to the enemy is designated A and the succeeding rows are B, C, and so on.

The ends of a row are shown by two markers. They are labeled with the letter of the row and number 1 for the right end of the row and number 2 for the left end of the row. The rows are numbered from right to left, facing the enemy. The marker can be a steel picket or wooden stake with a nail or a can attached so that it can be found with a metallic mine detector.

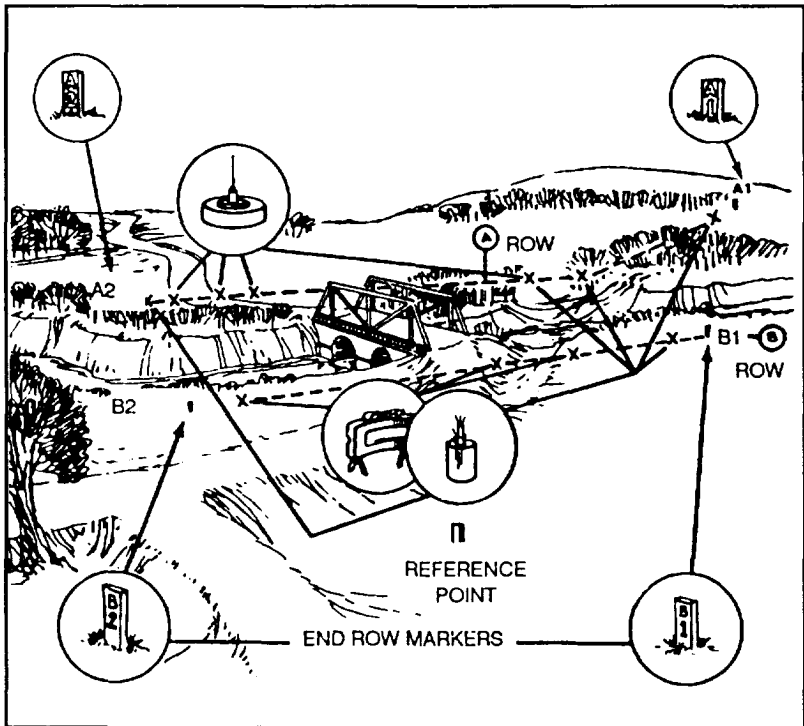

Figure 2-79. Leader visualizes hasty protective minefield.

From the concrete post, the platoon leader measures the magnetic azimuth in degrees and paces the distance to a point between 15 and 25 paces to the right of the first mine on the friendly side of the minefield. (Figure 2-80.) This point, B-1, marks the beginning of the second row.

The platoon leader places a marker at B-1 and records the azimuth and distance from the concrete post to B-1 on DA Form 1355-1-R.

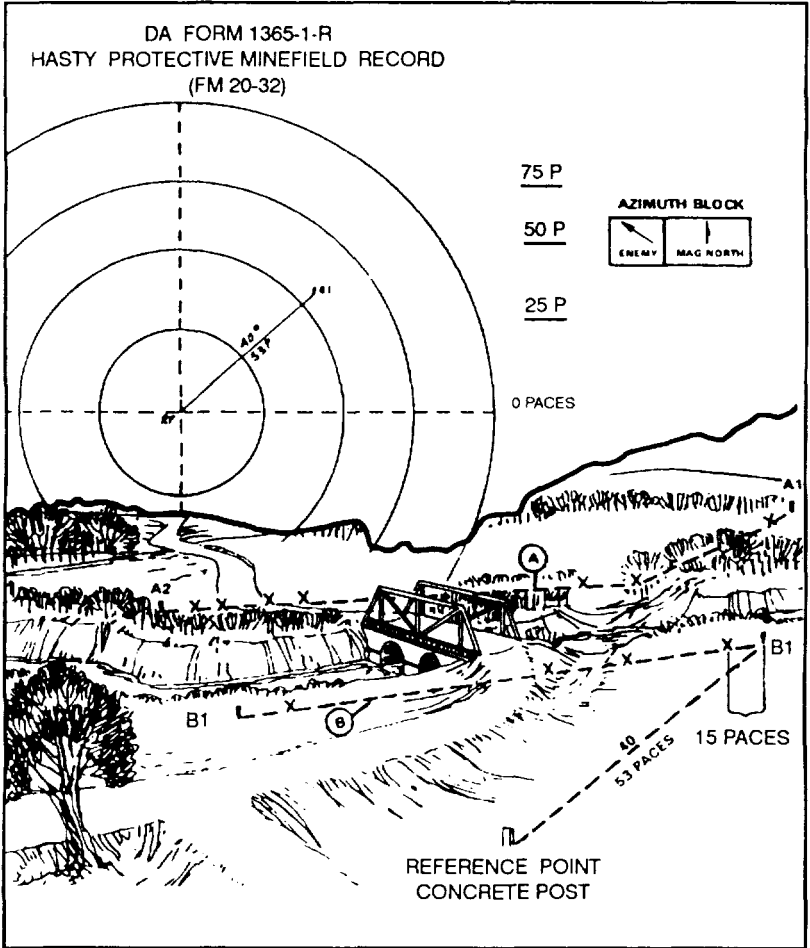

Figure 2-80. Marking and recording a minefield.

Next, from B-1 the platoon leader measures the azimuth and distance to a point 15 to 25 paces from the first mine in row A. He places a marker at this point and records it as A-1. The platoon leader then measures the distance and azimuth from A-1 to the first mine in row A and records the location of the mine. He then measures the distance and azimuth from the first mine to the second, and so on until all mine locations have been

recorded as shown. The platoon leader gives each mine a number to identify it in the tabular block of DA Form 1355-1-R. When the last mine location in row A is recorded, the platoon leader measures an azimuth and distance from the last mine to another arbitrary point between 15 and 25 paces beyond the last mine. He places a marker here and calls it A-2. The platoon leader follows the same procedure with row B.

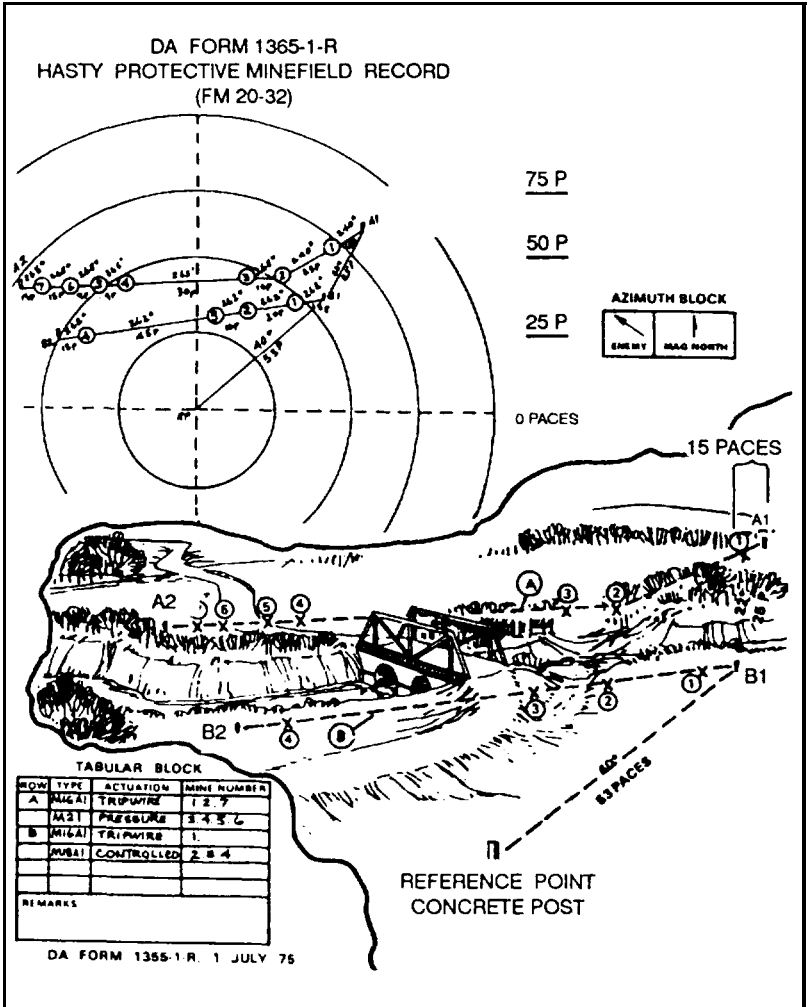

Figure 2-80. Marking and recording minefield (continued).

When the platoon leader finishes recording and marking the rows, he measures the distance and azimuth from the reference point to B-2 to A-2, and records them. If antitank mines are being used, it is recommended that they be used at the A-2/B-2 markers, because their large size facilitates retrieval.

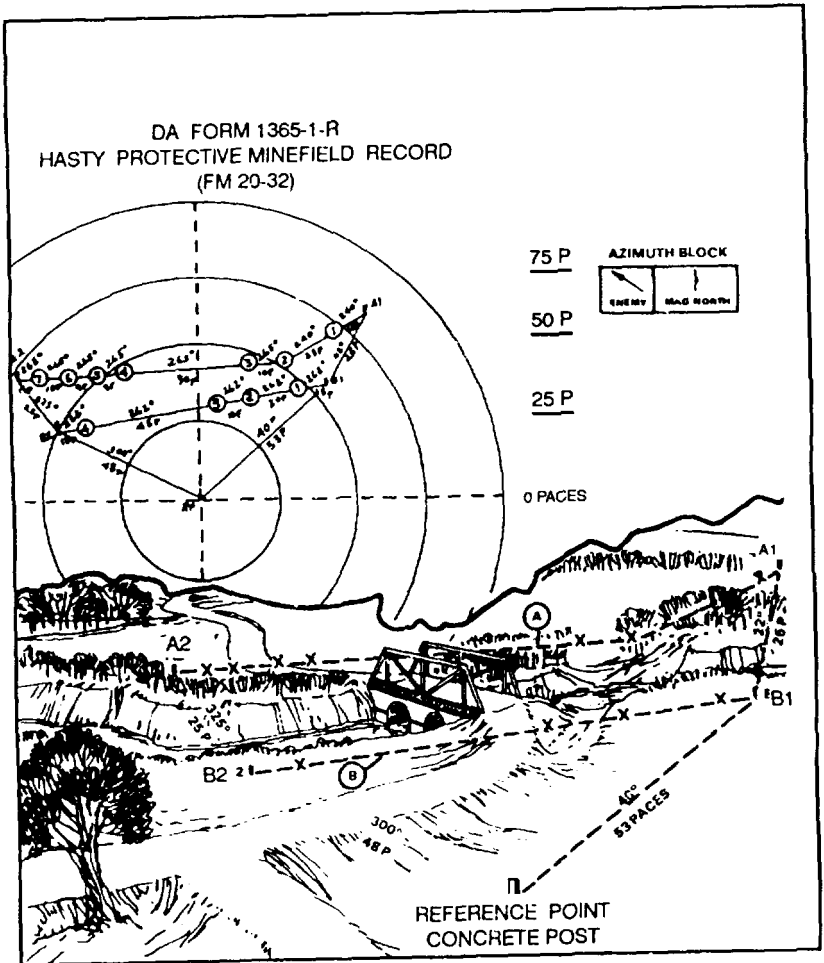

Figure 2-80. Marking and recording minefield (continued).

The platoon leader now ties in the reference point with a permanent landmark that he found on the map. He measures the distance and the azimuth from this landmark to the reference point. The landmark might

be used to help others locate the minefield should it be abandoned. Finally, he completes the form by filling in the tabular and identification blocks.

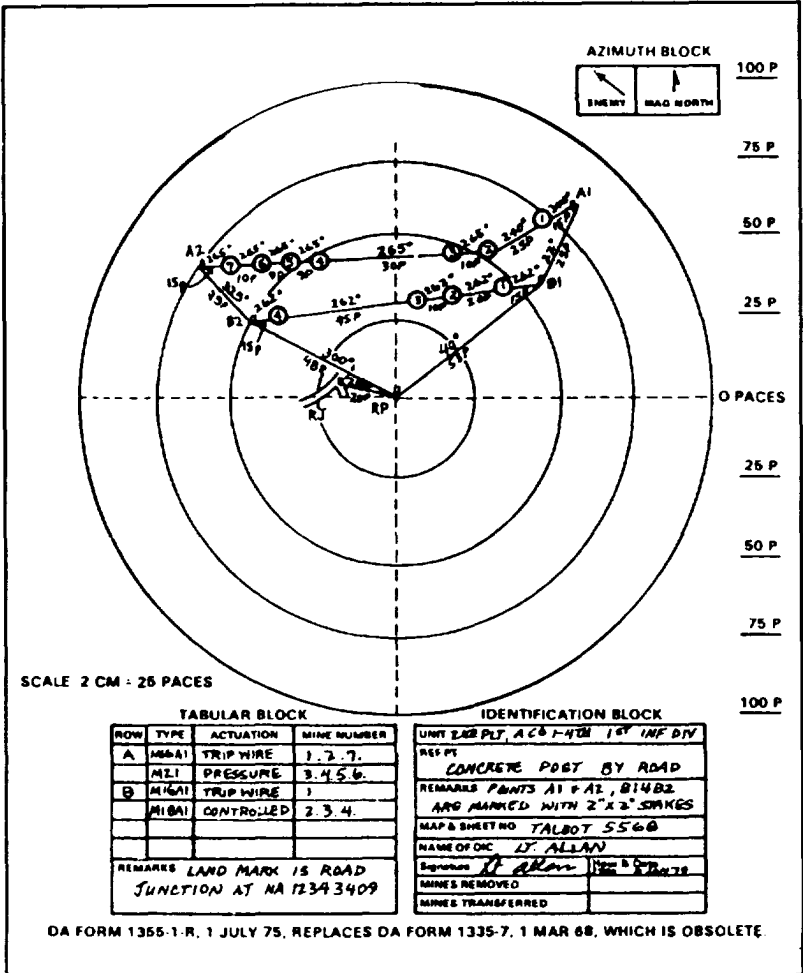

Figure 2-80. Marking and recording minefield (continued).

While the platoon leader is tying in the landmark, the soldiers arm the mines nearest the enemy first (row A). The platoon leader reports that the minefield is completed and keeps DA Form 1355-1-R. If the minefield is transferred to another platoon, the gaining platoon leader signs

and dates the mines transferred block and accepts the form from the previous leader. When the minefield is removed, the form is destroyed. If the minefield is left unattended or abandoned unexpectedly, the form must be forwarded to the company commander. The company commander forwards it to battalion to be transferred to more permanent records.

When retrieving the mines, the soldiers start at the reference point and move to B-1, using the azimuth and distances as recorded. They then move from B-1 to the first mine in row B. However, if B-1 is destroyed, they move from the reference point to B-2 using that azimuth and distance. They will now have to shoot the back azimuth from B-2 to the last mine. The stakes at A-1, B-1, A-2, and B-2 are necessary because it is safer to find a stake when traversing long distances than to find a live mine.

(b) *Point minefields*. Point minefield disorganize enemy forces and hinder their use of key areas. Point minefield are of irregular size and shape, and include all types of antitank and antipersonnel mines, and antihandling devices. They should be used to add to the effect of existing and reinforcing obstacles, or to rapidly block an enemy counterattack along a flank avenue of approach.

(c) *Phony minefields*. Phony minefields, used to degrade enemy mobility and preserve friendly mobility, are used to simulate live minefields and deceive the enemy. They are used when lack of time, personnel, or material prevents use of actual mines. Phony minefield may be used as gaps in live minefields. To be effective, a phony minefield must look like a live minefield by either burying metallic objects or making the ground look as though objects are buried.

2-50. ENEMY OBSTACLES

Platoons bypass and breach enemy obstacles. The decision to bypass or breach is based on the mission, the situation, and the assets available.

a. **Bypassing**. Obstacles are bypassed if at all possible. When bypassing an obstacle, the leader reports its type and location to higher headquarters. The leader must be alert for enemy contact when bypassing, because the enemy normally covers the bypass routes by fire.

b. **Breaching**. A breach is the employment of any means available to break through or secure a passage through an enemy obstacle. There are four types of breaches:

1. In-stride.
2. Deliberate.
3. Assault.
4. Covert.

For more information, see FM 90-13-1.

2-51. BREACHING AND CLEARING OBSTACLES

Leaders must know the techniques used to overcome reinforced obstacles. Some obstacles may not restrict infantry units, but will restrict vehicular movement. The platoon may have to clear obstacles to help vehicles go forward. The platoon may not be able to keep the enemy from knowing that it is going to breach, but may keep the enemy from knowing where and when it will breach. The platoon breaches different obstacles using different techniques, types of equipment, and explosives. Equipment and explosives may include rocket-propelled line charges, mine detectors, bangalore torpedoes, grappling hooks, direct fire weapons, and hand-emplaced explosives. Platoons breach all obstacles using the same fundamentals (SOSR):

- Suppress the enemy to allow the breach element to create a breach.
- Obscure the breach site from enemy observation.
- Secure the breach site, execute the breach, and secure the far side.
- Reduce the obstacle to facilitate movement of follow-on forces.

a. **Minefield.** The objective of a minefield breach is to clear a path or lane through a mined area for friendly forces to continue their mission. The selection of lane locations should take advantage of cover and concealment, overwatching fires, and the commander's scheme of maneuver. Breaching a minefield where it is first encountered before considering other possible sites is not recommended.

DANGER _____
Chemical mines are not blown in place.

(1) **Step 1. Suppress the Enemy.** The enemy covering the obstacle must be suppressed.

(2) **Step 2. Obscure with Smoke.** Smoke is used to obscure the obstacle area and conceal friendly soldiers.

(3) **Step 3. Probe and Mark Mines.** A footpath or lane is probed and the mines are marked. The preferred way to clear a lane through a minefield is to use a rocket-propelled line charge or bangalore torpedo.

(Figure 2-81.) The only way to clear a minefield without special equipment is to probe with a pointed nonmetallic object. One squad probes while the platoon (-)overmatches. (Figure 2-82.)

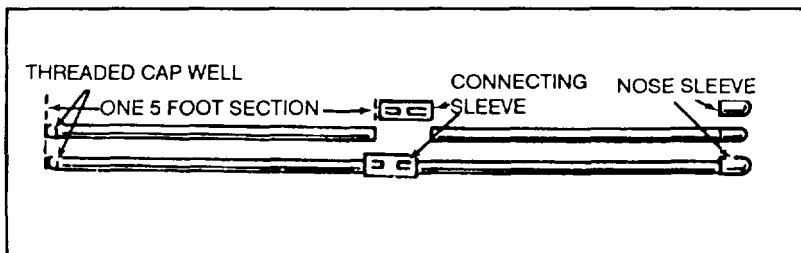

Figure 2-81. Bangalore torpedo.

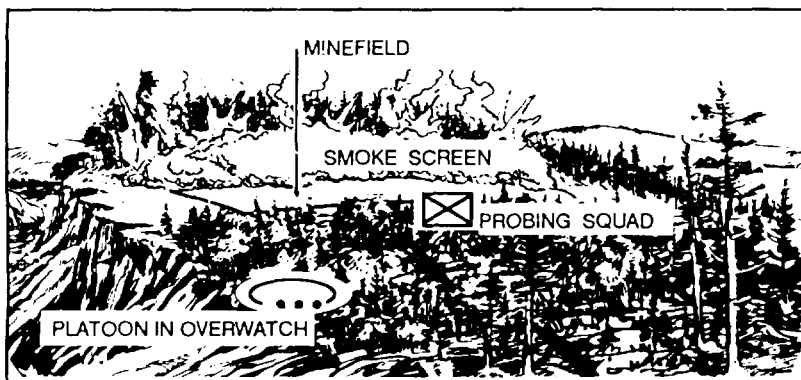

Figure 2-82. Platoon (-) overwatches probing squad.

(a) The squad probing the footpath or lane through the minefield uses two probers—one in front, clearing a lane wide enough to crawl through and one prober clearing 10 meters behind and slightly to one side so that their lanes overlap.

(b) Two other soldiers crawl along behind to secure the probers, to carry additional supplies, or to take a prober's job if one becomes a casualty. The probers should be rotated often to keep them from getting tired or careless, or both. (Figure 2-83.)

(c) The probers wear their protective vests, Kevlar helmets, and carry their NBC masks. They roll up their sleeves and remove rings and watches. LBE, rucksacks, weapons, and other metallic equipment are carried by other members of the breach force. They stay close to the ground in a prone position. They use sight and touch to detect trip wires, fuzes, or pressure prongs. The probers look and feel forward. They use a

slender, nonmetallic object to probe every 2 inches across a 1-meter front. They push probe gently into ground at an angle less than 45 degrees.

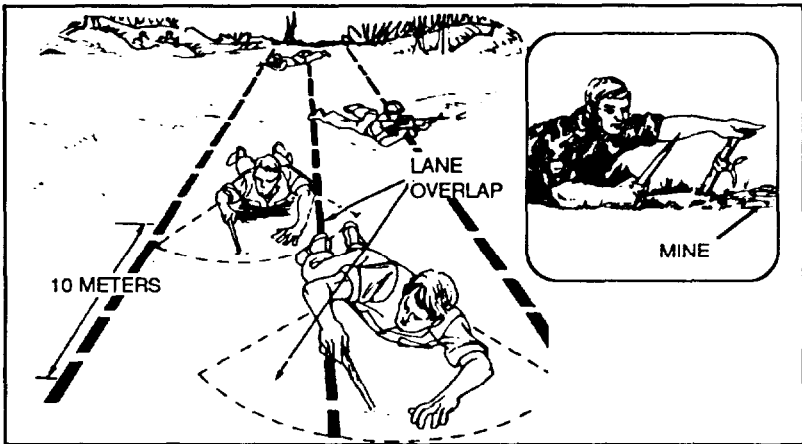

Figure 2-83. Probing for mine.

DANGER

When intelligence indicates the probability of magnetically-influenced fuzes, soldiers must not wear metallic items.

NOTE: If in a contaminated environment, probers must maintain protective posture.

(d) If the probe meets resistance and does not go into the ground freely, the prober picks the soil away with the tip of the probe and removes the loose dirt by hand. If it is a mine, they remove enough soil to see what type of mine it is. They mark its location without attempting to remove or disarm the mine.

DANGER

If the probe is pushed straight down, its tip can detonate a pressure fuze.

NOTE: If a soldier is injured in a minefield, all other soldiers freeze. The nearest soldier probes his way to the injured soldier, applies first aid, and carries him out-carefully moving back through the probed lane.

(4) **Step 4. Secure the Far Side.** As soon as the breaching element has probed a lane, it or another element secures the far side. Infantry forces should secure the far side of an obstacle as quickly as possible. This helps keep the enemy from attacking or placing fires on the breach site. When breaching an obstacle for vehicles, if the infantry can bypass on foot, leaders should designate an element to bypass the obstacle and secure the far side while breaching effort is on-going. That element should have machine guns; light and or medium antiarmor weapons; and a map, compass, and a pair of binoculars or a thermal sight to call for and adjust fires.

(5) **Step 5. Reduce the obstacles.** Marked mines are destroyed with explosives or grappling hooks. Metallic mines must be destroyed before moving soldiers through the lane.

(6) **Step 6. Mark Cleared Lane.** The squad marks the cleared lane.

(7) **Step 7. Move Unit Through the Obstacle.** The leader moves the unit through the obstacle.

b. Tank Ditches. SOSR is applied in breaching tank ditches. Infantry can reduce tank ditches by bringing down the sides of the ditch with D-handled shovels, helmets, or explosives. An armored combat earth mover, tank with blades, or combat engineer vehicle should be used to reduce the obstacle quickly. (Figure 2-84)



Figure 2-84. Clearing a tank ditch.

c. **Craters. SOSR is applied.** A crater is reduced using the same steps as a tank ditch.

d. **Wire. SOSR is applied.** If vehicles are available, they should be used to pull wire entanglements off assault paths, detonating antipersonnel mines in the process. Another method is for soldiers to prepare and emplace material over the wire to make an assault footpath. The assaulting unit must first clear the wire of antipersonnel mines before laying material onto the wire. Another method is to cut through the wire obstacle as described below, after suppressing the enemy and obscuring their visibility.

(1) **Clear a Lane Through the Wire.** Wire cutters, bangalore torpedoes, or explosives are used to remove the wire. The clearing squad checks for and marks mines and booby traps. One squad breaches while the platoon (-) overwatches. Tank fire (HEP), combat engineer vehicle fire, and massed indirect and direct fire can help breach the wire, if available.

(2) **Secure the Far Side.** As soon as the clearing squad has cleared a lane, it secures the far side.

(3) **Reduce the Obstacle.** Marked mines are destroyed with explosives or grappling hooks.

(4) **Mark Cleared Lane.** The cleared lane is marked.

Section XI. NUCLEAR, BIOLOGICAL, AND CHEMICAL OPERATIONS

Nuclear, biological, and chemical weapons cause casualties, destroy or disable equipment, restrict the use of terrain, and disrupt operations. They are used separately or in combination with conventional weapons. The platoon must be able to fight on an NBC-contaminated battlefield. Soldiers must train to standard on NBC tasks IAW STP 21-1-SMCT, STP 21-24-SMCT; FM 3-100; AR 350-42; and DA Pam 350-38.

2-52. OPERATING IN A NUCLEAR ENVIRONMENT

Information about possible enemy use of nuclear weapons is forwarded to companies and smaller units through the chain of command by the quickest and most secure means. The communication to these units need contain only—

- A proword signaling that the message is a nuclear strike warning.
- A brief message, IAW SOP, that directs the unit either to take specific protective actions or to evacuate the area.

a. **Alarm for Nuclear Hazard.** As soon as a soldier using a monitoring device detects a nuclear hazard, he should warn others. The alarm must be passed swiftly throughout the platoon.

(1) **FALLOUT is the standard (shouted) alarm.** It is also used when the platoon moves into an area contaminated by residual radiation.

(2) **ALL CLEAR is used to signal that the danger no longer exists.** This signal is first given by the company commander or a platoon leader and then repeated by each soldier when he hears it.

b. **Nuclear Protective Measures.** Many basic infantry skills and tasks contribute to the squad's/platoon's nuclear preparedness.

(1) A soldier protects himself against many nuclear effects by taking cover in a fighting position, culvert, or ditch, or behind a hill. In most cases, a fighting position with overhead cover provides the best protection.

(2) Soldiers react to an unexpected nuclear attack.

c. **Procedures Following a Nuclear Detonation.** The following actions should be taken automatically and without order right after the shock wave from a nuclear detonation passes.

(1) **Leaders.**

- Reestablish the chain of command and communication.
- Reestablish security and report to higher headquarters—situation reports and initial NBC 1 report.

(2) **Soldiers.**

- Check for injuries and give emergency first aid.
- Check radios for proper operations and reestablish communications if required.
- Give an immediate status report to higher.
- Take actions to repair fighting positions.
- Start continuous monitoring with radiacmeters.
- Continue the mission.

d. **Radiological Monitoring.** Radiological monitoring is the detection (presence and intensity) of residual radiation by the use of radiacmeters. Monitoring is essential down to squad level to prevent overexposure to radiation. The IM-174 or AN/VDR-2 series radiacmeters are the instruments used for area monitoring and survey. The IM-93 or DT236 dosimeters are the instruments used to measure total dose radiation received by soldiers. The two types of monitoring techniques are periodic and continuous. Platoons will return to periodic monitoring when ordered by higher or when the radiacmeter reading falls below 1 cGy per hour.

(1) Periodic monitoring is frequent checks of the platoon area for radiation. During periodic monitoring, the platoon takes a reading with

the IM-174 at least once each hour. SOPs may require more frequent readings and detailed information when monitoring.

(2) Continuous monitoring is the continuous surveillance for radiation in the unit area or position. The platoon begins monitoring when—

- A nuclear detonation is observed or reported.
- An NBC-3 nuclear report is received from higher headquarters.
- A dose rate of 1 centigray (cGy) per hour is recorded during periodic monitoring. Centigray (cGy) is a unit of absorbed dose of radiation formerly called a rad.
- Ordered by higher.

2-53. OPERATING IN A CHEMICAL AND BIOLOGICAL ENVIRONMENT

Threat forces have both chemical and biological weapons that can be used separately, together, or with nuclear and conventional weapons. Regardless of how these weapons are used, the platoon must be able to survive to be able to continue its combat mission.

a. **Characteristics of Chemical Agents.** Chemical agents are used to cause casualties, degrade performance, slow maneuver, restrict terrain, and disrupt support. They can cover large areas and may be placed on a target as a vapor, liquid, or aerosol. Chemical agents can be disseminated by artillery, mortars, rockets, missiles, aircraft spray, bombs, and landmines. See Figure 2-85 for additional information on characteristics of chemical weapons.

b. **Characteristics of Biological Agents.** Biological agents are disease-producing germs. These agents may be dispersed as aerosols by generators, explosives, bomblets, missiles, and aircraft. Harmful germs may also be spread by the release of infected insects, such as flies, mosquitoes, fleas, and ticks.

c. **Alarms for Chemical Hazard or Attack.** Soldiers must immediately stop breathing, mask, and give vocal or visual signals when chemical agent symptoms are displayed or when the M8A1 alarm sounds.

(1) Standard alarms include the vocal signal GAS, prescribed arm-and-hand signals, automatic chemical-agent alarms, rapid and continuous beating on any metal object that produces a loud noise, a succession of short blasts on a vehicle horn or any other similar device, or a broken warbling siren sound (for example, 10 seconds on, 10 seconds off). (Figure 2-86.)

(2) The vocal ALL CLEAR signals that the danger no longer exists. It is given by leaders (company commander or platoon leader) after prescribed unmasking procedures have been completed.

Type of Agent	Sym- bol	Means of ID	Symptoms in Man	Effects on Man	Rate of Action	Normally Disseminated	Protection Required	Decontamination
Nerve	GA GB GD	M256, M18A2, M19 M8/M9 paper, M8A1 alarm	Difficulty breathing, sweating, drooling, nausea, vomiting, convulsion, and dim vision.	Incapacitate at low concentrations; kills if inhaled or absorbed through the skin or eyes.	Very rapid by inhalation, slower through skin	Aerosol or vapor	Protective mask and protective clothing	STB slurry; household bleach; 10% solution of lye or washing soda; DS2 steam and ammonia in confined area; hot soapy water; M258-series kit.
	V							
Blood	AC CK	M256, M18A2 M19	Rapid breathing, convulsions, and coma.	Kills if high concentrations are inhaled	Rapid	Aerosol or vapor	Protective mask	None needed in field.
Bluster	HD HN	M256, M18A2, M19, M8/M9 paper	No early symptoms, Searing of eyes and stinging of skin.	Blusters skin and respiratory tract; can cause temporary blindness. Some agents sting and form wheals on the skin.	Bluster delayed hours to days; eye effects more rapid. Mustard lewisite, and phosgene oxime very rapid.	Liquid or droplets	Protective mask and protective clothing	STB, DS2, household bleach, M258-series kit. Try lye, fire; wash with soap and water.
	HL L							

Figure 2-85. Chemical-agent characteristics.

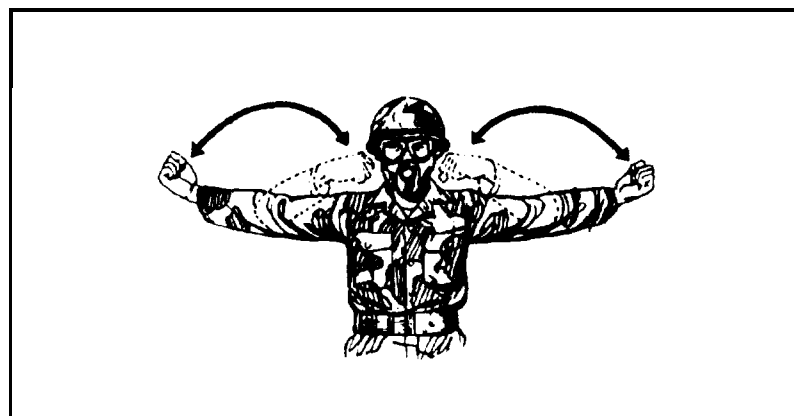

Figure 2-86. Standard alarm signal.

d. **Protective Measures in Chemical and Biological Warfare.** Art attack can occur without warning. Soldiers must know exactly what to do and how to do it without hesitation. Their lives depend on it.

(1) **Chemical attack.** A soldier's main protection against a chemical attack is his protective mask. The mask protects against inhaling chemical agents. If an attack is imminent or if chemicals have already been employed, soldiers should mask when—

- Chemical alarms or detection kits signal the presence of chemical agents.
- Any artillery, mortar, rocket, or aircraft attack with other than HE munitions occur on or near their position.
- Smoke or mist of an unknown source appears in the area. A chemical attack is suspected for any other reason, such as enemy soldiers seen wearing protective masks and clothing, or presence of dead animals or people with no outward sign of injury.
- The platoon must enter an area known to be or suspected of being contaminated by a chemical or biological agent.
- For no obvious reason, soldiers have any of the following symptoms:
 - A runny nose.
 - A feeling of choking or tightness in the chest or throat.
 - Blurred vision or trouble focusing.
 - Difficulty in or increased rate of breathing.

(2) **Biological attack.** Information on the enemy's use of biological agents is passed from higher to lower. The best local defense against biological warfare is strict enforcement of all preventive medicine (prescribed immunizations) and field sanitation measures plus high standards of personal hygiene. Soldiers should eat and drink only from approved sources.

c. **Individual Actions Before a Chemical Attack.** If a platoon learns that it is subject to an imminent chemical attack or downwind vapor hazard, each soldier should take the following precautionary measures:

- Place the chcnlictil-agent alarm into operation.
- Assume MOPP level 2, 3, or 4 (depending on the situation).
- Attach M8/M9 paper to personnel and vehicles.
- Cover as much equipment as possible.
- Ensure decontamination equipment is accessible.
- Be prepared to move from the location on order.

f. **Individual Actions During a Chemical Attack.** Actions are IAW Battle Drill 5, Chapter 4.

g. **Individual Actions After a Chemical Attack.** Soldiers check for casualties, give first aid, identify the agent, send NBC-1 or NBC-4 report,

request permission to move, schedule decontamination operations, and mark area to warn friendly soldiers.

h. Conditions for Unmasking. The senior person present follows these procedures:

(1) **Procedures with detector kit.** The M256 chemical-agent detector kit is used to test for the presence of chemical agents. This takes about 15 minutes. If there is no evidence of agents, one or two soldiers unmask for 5 minutes, then remask. They are observed for chemical-agent symptoms for 10 minutes in a shady area. (A shady area is used because light causes contraction of the pupils, which could be interpreted as a nerve-agent symptom.) If no symptoms appear, the squad/platoon contacts higher headquarters for permission to unmask. Once permission is granted, the rest of the soldiers can safely unmask.

(2) **Procedures without detector kit.** The following is an emergency field expedient when friendly elements have been masked for a long time, when there are no remaining signs of chemical agent use, and when the platoon has no detector kit. One or two soldiers are selected to hold deep breaths, break the seals of their masks, and keep their eyes wide open for 15 seconds. They then clear their masks, reseal them, and wait for 10 minutes. If symptoms do not appear after 10 minutes, the same soldiers again break their seals, take two or three breaths, and clear and reseal their masks. After another 10-minute wait, if symptoms have not developed, the same soldiers unmask for 5 minutes and then remask. After 10 more minutes, if symptoms have not appeared, the rest of the group can safely unmask once permission is granted from higher headquarters. They should all remain alert for the appearance of any chemical symptoms. This procedure takes about 35 minutes.

i. Mission-Oriented Protection Posture. Once chemical agents have been employed or while the threat of enemy chemical attack exists, the unit commander decides whether to keep all or only some of the soldiers masked and in chemical-protective clothing. The MOPP level directed by the unit commander specifies what equipment to wear and what precautionary measures to use. (Figure 2-86.) There is also a mask-only category of MOPP. The mask-only command may be given if no liquid hazard or mustard agent vapor is present. These levels apply in all cases to the soldiers inside or outside vehicles. Leaders should take every opportunity to train their soldiers in all levels of MOPP using simulated NBC conditions. There is a significant loss of effectiveness caused by operation in MOPP 4. When soldiers are using full NBC protective equipment, judgment is degraded, communications are less effective, and information flow is reduced.

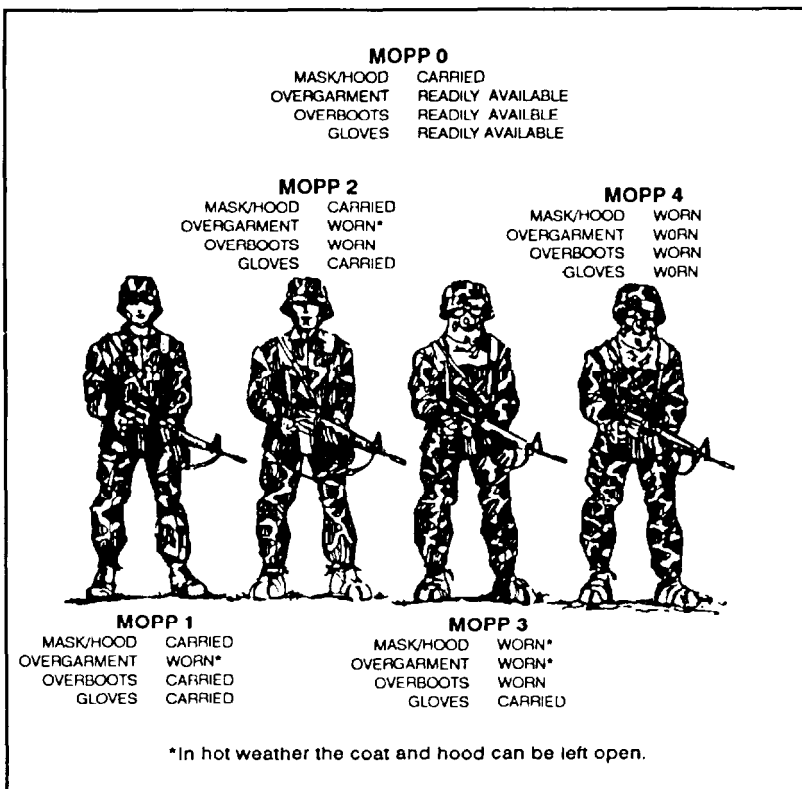

Figure 2-87. MOPP and protective equipment.

Section XII. OBSERVATION POSTS

Observation posts are positions where soldiers watch and listen for enemy activity in an assigned area. OPs provide security and intelligence for the platoon. Platoons establish and maintain OPs as the company commander directs (normally one per platoon).

2-54. CONSIDERATIONS

When planning an OP the platoon leader must consider the following.

a. **Siting.** Normally the platoon leader identifies the general location and the squad leader selects the actual site for the OP.

(1) OPs must be sited to allow observation of the designated area.

(2) OPs should also be sited to take advantage of natural cover and concealment to provide protection for the soldiers manning it.

(3) OPs should be located within small-arms range of the platoon positions.

b. **Observation.** When he identifies the general location for the OP, the platoon leader must also indicate the area to be observed and any specific instructions covering what soldiers are to look for or be especially alert to. The area observed may be a sector, one or more avenues of approach (normally one per OP), a named area of interest (NAI), or a target reference point (TRP). OPs should also require minimal repositioning for limited visibility.

c. **Cover and Concealment.** Sometimes the requirement for fields of observation may make it difficult to achieve cover and concealment. Some techniques include—

- Avoid obvious terrain such as hilltops.
- Avoid easily identifiable terrain features such as water towers, church steeples, tallest buildings, lone buildings or trees, or isolated groves.
- Avoid routes or positions that skyline soldiers.
- Select a covered and concealed route to and from the OP.

d. **Communications.** Soldiers must be able to report what they see and hear. Wire is the primary means of communications between the OP and the platoon. If possible, the OP should have radio communications as a backup. An additional soldier may be added as a messenger if no other means of communication is available. The SOP should specify how often OPs make routine communications checks. When the platoon loses wire communications with the OP, the leader always details at least two soldiers to check and repair the line—one for security, one for repair. Soldiers checking for breaks in wire should always approach the OP with caution in case the enemy has captured and occupied it.

e. **Manning.** At least two soldiers must man each OP. A fire team may man the OP if it will remain in place or not be relieved for long periods. All soldiers prepare fighting positions at the OP for protection and concealment. Additionally, each soldier must have a prepared position to return to in the platoon position.

f. **Additional Instructions.** In addition to the intelligence and security reporting requirements, the squad leader also briefs the soldiers manning the OP on the challenge and password, the running password, when to engage and when not to engage the enemy, conditions when the OP can withdraw, when to expect relief, and contingency plans for loss of communications.

g. **Equipment.** Special equipment for the OP includes binoculars, maps, a compass, night vision devices (goggles or an antiarmor thermal

sight), trip flares and other alert devices, a field phone, paper and pencil, and a watch.

2-55. ACTIONS AT THE OBSERVATION POST

Once the squad leader has positioned and briefed the soldiers at the OP site, one soldier always observes and records while the remainder perform(s) the actions listed below:

- Establish security. Install trip flares and noise-making devices.
- Prepare positions to include range cards. Record data for use in requesting and adjusting fire; for example, azimuths and ranges to TRPs.
- Make communications checks or report as required.
- Rotate duty as the observer every 20 to 30 minutes. An observer's efficiency quickly decreases after that time.
- Brief relieving soldiers on any information or special instructions before departing the OP! The frequency of reliefs for OPs depends on the physical condition of the soldiers, weather conditions, morale, the number of soldiers available for relief, and the requirements of the next operation. As a guide, OPs should be relieved every two to four hours.
- Withdraw as directed or to avoid capture. Soldiers manning the OP advise the platoon leader that they are returning and request support (direct or indirect) if needed. Leaders must alert all soldiers in the platoon when reliefs move to or from the OP, and when it withdraws.

2-56. SQUAD-SIZED OBSERVATION POST

A squad may occupy one OP to add security and combat power when the platoon has a mission to screen the flank of a larger force or to secure a large area. The squad-sized OP allows the platoon to observe from OPs and to conduct patrols between them. Leaders use the same considerations listed above in planning and siting squad-sized OPs. The squad leader spreads his soldiers out in two- or three-soldier positions. Each position acts as an OP to observe an assigned sector.

2-57. VISUAL TERRAIN SEARCH

A visual terrain search involves the two steps discussed below. (See Section XIV for a detailed discussion of night vision.) Observation posts report all information quickly, accurately, and completely. They make sure that the report answers the questions WHO, WHAT, WHERE, and WHEN. It is best to use the SALUTE format when reporting information.

a. **Step 1.** The observer makes an overall search of the entire area for obvious targets, unnatural colors, outlines, or movement. To do this quickly, he raises his eyes from just in front of his position to the greatest range he wants to observe. If the sector is wide, he observes it in sections. (Figure 2-88.)

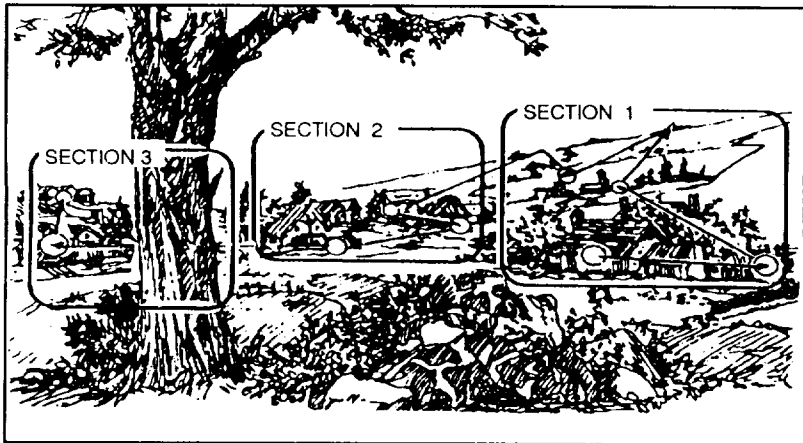

Figure 2-88. Overall search.

b. **Step 2.** He observes overlapping 50-meter wide strips, alternating from left to right and right to left until he has observed the entire area. (Figure 2-89.) When he sees a suspicious spot, he searches it well.



Figure 2-89. Overlapping 50-meter search

Section XIII. TECHNIQUES OF FIRE

Leaders must know fire distribution, fire control, and methods of engaging targets with antiarmor weapons.

2-58. FIRE DISTRIBUTION

Leaders must distribute the fires of their organic weapons to destroy or suppress enemy positions. There are two ways to distribute fire on a target—point fire and area fire.

a. **Point Fire.** This is fire directed at one point; for example, an entire team or squad fires at one bunker. (Figure 2-90.)



Figure 2-90. Point fire.

b. **Area Fire.** This type of fire covers an area laterally and in depth. (Figure 2-91.) If a squad leader wants fire on a wood line, he can shoot tracers to mark the center of the target. Soldiers on his left fire to the left of the tracers; soldiers on his right fire to the right.



Figure 2-91. Area fire.

2-59. FIRE CONTROL

Leaders must decide which fire control method or combination of methods will work in each tactical situation. They must ensure the fires of their units are effective.

a. **Methods of Fire Control.**

(1) **Sound signals.** This includes both voice and devices such as whistles and horns. Sound signals are good only for short distances. Their range and reliability are reduced by battle noise, weather, terrain, and vegetation.

(2) **Trigger points/lines.** The leader can prearrange for soldiers to start firing once the enemy reaches a certain point or terrain feature. When this method of fire control is used, the soldiers do not have to wait for an order to start firing. Prearranged fire can also be cued to friendly actions.

(3) **Visual signals.** The leader can give a visual signal when he wants the soldiers to begin, cease, or shift fire as soon as they see or hear the signal. Platoons can also use visual signals triggered by the enemy.

(4) **Time.** The platoon maybe directed to begin, shift, and cease firing at a set time.

(5) **Techniques of fire.**

(a) **Search-fire-check.**

- Step 1. Soldiers search their sectors for enemy targets.
- Step 2. Soldiers fire at any targets (appropriate for their weapon) that appear in their sectors.
- Step 3. While searching their sectors, soldiers look to their leaders for specific orders.

(b) **Return-fire.** This technique tells each soldier in the platoon what to do in use the platoon makes unexpected contact with the enemy.

(c) **Rate-of-fire.** This technique tells each soldier how fast to fire at the enemy. The rate of fire varies among weapons, but the principle is to fire at a maximum rate when first engaging a target and then slow the rate to a point that suppresses the target and conserves ammunition.

NOTE: Buddy teams fire their weapons at varied rates so that they do not run out of ammunition at the same time.

b. **Fire Commands.** Leaders use fire commands to direct the fires. A fire command has the following six parts:

(1) **Alert.** In this part of the command, the leader alerts the soldiers to receive further instruction. He can alert the soldiers by name or unit designation, by some type of visual or sound signal, by personal contact, or by any other practical way.

(2) **Direction.** In this part of the fire command, the leader tells the soldiers the general direction to the target. In some cases, it pinpoints a target. There are three ways to give the direction to the target.

(a) The leader points with his armor rifle.

(b) The leader fires tracer ammunition at a target.

(c) The leader uses either TRPs or easily recognized man-made objects or terrain features. He gives the general direction just before he gives the references point.

(3) **Description.** In this part of the fire command, the leader describes the target briefly but accurately. The formation of enemy soldiers is always given.

(4) **Range.** In this part of the fire command, the leader tells the soldiers the range to the target in meters.

(5) **Method of fire.** In this part of the fire command, the leader tells the soldiers which weapons to fire. He can also tell the type and amount of ammunition to fire, and the rate of fire.

(6) **Communal to fire.** In this part of the fire command, the leader tells soldiers when to fire. He can use an oral command, a sound, or a visual signal. When he wants to control the exact moment of fire, he says, AT MY COMMAND (then pauses until ready to commence firing). When he wants to start firing upon completion of the fire command, he just says FIRE.

c. **Subsequent Fire Commands.** These commands adjust or change information given in the initial fire command. Only the elements that change are given.

d. **Termination of Fire.** Fire is terminated by the command or signal for CEASE FIRE, END OF MISSION.

2-60. METHODS OF ENGAGEMENT WITH LAW AND AT4

The four methods of engaging targets with both the LAW and the AT4 are single, sequence, pair, and volley firing.

3. **Single Firing.** In single firing, one soldier engages a target with one LAW or AT4—there are no follow-on shots. This method is mostly for use at short ranges (50 meters or less with the LAW, 200 meters or less with the AT4). The single-firing method can be effective at greater ranges (out to 200 meters with the LAW, out to 300 meters with the AT4) when the exact range to the target is known.

b. **Sequence Firing.** In sequence firing, one firer armed with two or more LAWs or AT4s engage a single target. The firer—

- Inspects and prepares the weapons for firing and lays them side by side.
- Fires and observes the impact of the round.

- If he hits the target, continues to fire follow-on rounds until the target is destroyed or until ordered to cease fire.
- If he misses, applies burst-on-target corrections with follow-on rounds until the target is hit. He then fires until he destroys the target or until ordered to cease fire.

c. **Pair Firing.** In pair firing, two or more firers each armed with two or more LAWs or AT4s engage the same target. They exchange in formation throughout the target engagement.

(1) The first firer who sees the target identifies it, announces the estimated range and the lead he will use, and fires.

(2) The second firer observes the firing, announces a revised estimate of range and lead (if appropriate), and fires.

(3) The firers continue exchanging range and lead information until the target is hit.

(4) Once the range and lead have been determined, both firers, on command, engage the target until it is destroyed or until ordered to cease fire.

d. **Volley Firing.** In volley firing, more than one firer engages the same target using one or more LAWs and AT4s. Volley firing should be used when the range to the target has been determined. This method is desirable because more rounds are fired at a given time, thus increasing the probability of hitting/killing the target. (FM 23-33 and FM 23-25.)

Section XIV. LIMITED VISIBILITY TECHNIQUES

The infantry fights at night to take advantage of limited visibility. The use of NVDs and scanning techniques aids the infantryman in operating during all limited visibility conditions. This section provides techniques for improving and maintaining night vision, and techniques for attacks during limited visibility.

2-61. NIGHT VISION

Darkness affects the senses of sight, hearing, and smell. Sharpening these senses requires training. Soldiers must know how their eyes function at night to best use them.

a. **Night Vision Scanning.** Dark adaptation is only the first step toward making the greatest use of night vision. Scanning enables soldiers to overcome many of the physiological limitations of their eyes. It can also reduce confusing visual illusions. This technique involves looking from right to left or left to right using a slow, regular scanning movement (Figure 2-92). At night, it is essential to avoid looking directly at a faintly visible object when trying to confirm its presence.

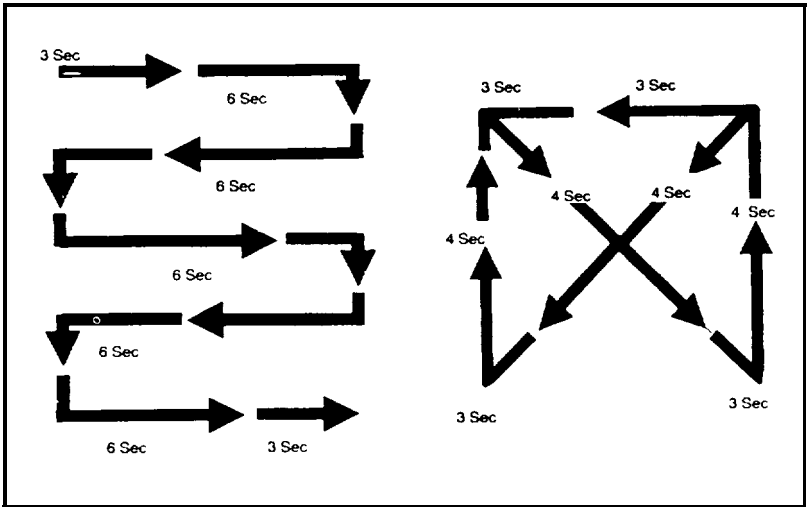

Figure 2-92. Typical scanning pattern.

b. **Use of Off-Center Vision.** The technique of viewing an object using central vision is ineffective at night. This is due to the night blind spot that exists during low illumination. Soldiers must learn to use off-center vision. This technique requires viewing an object by looking 10 degrees above, below, or to either side of it rather than directly at it (Figure 2-93).

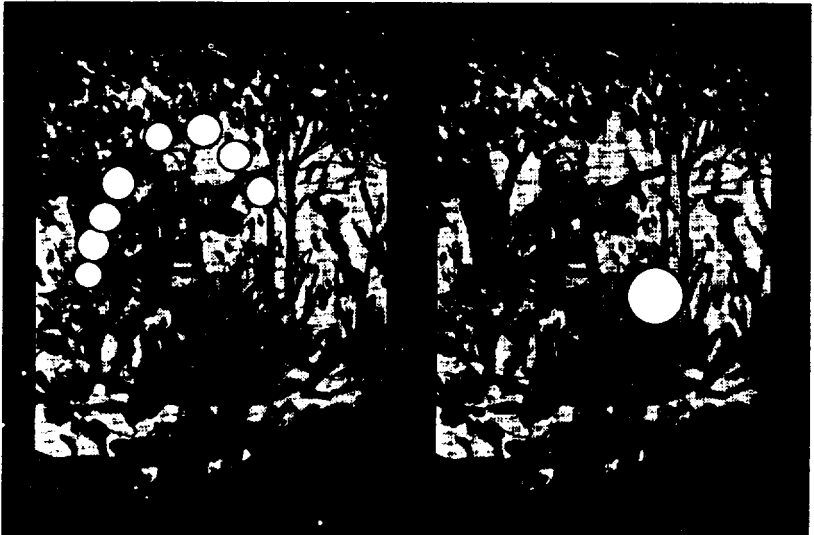

Figure 2-93. Off-center viewing technique.

c. **Countering of the Bleach-Out Effect.** Even when soldiers practice off-center viewing, the image of an object bleaches out and becomes a solid tone when viewed longer than two to three seconds. By shifting his eyes from one off-center point to another, the soldier can continue to pick up the object in his peripheral field of vision.

d. **Shape or Silhouette.** Visual sharpness is greatly reduced at night; therefore, objects must be recognized by their shape or outline. Knowing the design of structures common to the area of operations enhances success with this technique.

2-62. DARK ADAPTATION

Dark adaptation is the process by which the human body increases the eyes' sensitivity to low levels of light.

a. Soldiers adapt to darkness at varying degrees and rates. During the first 30 minutes in the dark, eye sensitivity increases about 10,000 times, but not much after that.

b. Dark adaptation is affected by exposure to bright light such as matches, flashlights, flares, or vehicle headlights. Full recovery from these exposures can take up to 45 minutes.

c. Using night vision goggles impedes adaptation. However, if a soldier adapts to the dark before donning the goggles, he gains full dark adaptation within 2 minutes when they are removed.

d. Soldiers must know that color perception decreases at night. They may be able to distinguish light and dark colors depending on the intensity of reflected light.

c. Visual acuity is also reduced. Since visual sharpness at night is one-seventh of what it is during the day, soldiers can see only large, bulky objects. This means that object identification at night is based on generalized contours and outlines. Depth perception is also affected.

CAUTION

Although night vision devices can help the soldier see at night, they degrade the other senses. Ability to hear, smell, and feel decreases because of the concentration required to use NVDs effectively. Leaders should prepare for night operations by using all the senses. On certain operations, this may require that some soldiers not use NVDs.

2-63. PLANNING THE USE OF NIGHT VISION/SENSOR ASSETS

Leaders must develop a night vision plan that interlocks sectors of NVD employment much like that planned for interlocking weapon fire sectors. Often, using NVDs requires repositioning to ensure full coverage of an area. Thermal sights should be kept on a wide field of view until engagement or sector coverage will have gaps. To best use weapons with image intensification nightsights, some NVDs should be used forward of the firing positions to aid in target identification. Night OPs using NVDs can provide target identification for direct-fire weapons and then, with the use of tracers, quickly direct fire onto targets. Use of a three-soldier element at squad level during movement can enhance enemy detection and destruction.

- One soldier uses unsupported night-adapted vision.
- One soldier uses the AN/P VS-7.
- One soldier uses the AN/PVS-4 mounted on the M 16 rifle.

2-64. NIGHT OPERATION TIPS AND TECHNIQUES

To the infantryman, the dark of night is a helper. It offers advantages to the soldier familiar with operating during darkness, but to those not familiar with darkness, the known appears to become the unknown.

a. Land Navigation.

(1) Routes may be marked with chemical lights, flashlights, or cans filled with diesel-soaked dirt and set alight. Special precautions must be taken to ensure that markers are shielded from enemy observation.

(2) Luminous panels can be used to identify vehicles, road guards, and turning points. Panels are arranged in various patterns for different unit identification.

b. Equipment.

(1) The first rule of night operations: do not ignore the night capability of devices not usually considered night operations equipment; for example:

- Binoculars, direct-fire scope, or any image-magnifying optical equipment will also enhance night vision because they focus more light in the eye than the unaided eye can gather.
- The lensatic compass has luminous markings and detents that allow it to be set for night navigation without using a light.

(2) Ground surveillance radars are effective when oriented along the direction of attack to report and correct deviations for the attacking force. GSRs are also effective when employed in combination with thermal sight equipment to overwatch movement of attacking forces.

(3) At ranges of less than 800 meters, operators tend to underestimate range by as much as 25 percent. Range estimation errors can be reduced by

teaching operators to relate targets to terrain features at ranges determined by daylight reconnaissance and map study.

(4) Rough triangulation from two or more night observation posts is useful in reducing range estimation errors.

(5) For moving targets, a ground surveillance radar can provide effective target location information.

(6) Seismic, magnetic, and electromagnetic sensors can detect the presence of personnel or vehicles; however, these systems cannot discriminate between types of vehicles or between civilians and enemy. For this reason, night observation devices must be used in combination with sensors.

(7) Long-range systems and devices are employed at the maximum range that terrain and operator expertise will allow to permit early identification of advancing targets.

(8) Proper use of infrared aiming devices, such as the AN/PAQ-4(A), can greatly enhance a platoon's night fighting capability. Care must be taken to ensure that the devices are properly mounted and zeroed to the weapon. Indiscriminated or unsupervised use can result in compromising a platoon's position, whether in offense or defense. Proper use of scatter shields can significantly reduce this risk of early detection. These devices may be particularly effective in a MOUT environment.

c. Illumination.

(1) Flares should be dropped at irregular intervals beyond and on line with the objective to provide orientation. This technique compromises surprise, however, and should be used only in emergency situations or when a subunit becomes so disoriented it hampers mission success.

(2) Areas other than the attack areas may be illuminated to mislead the enemy.

d. Smoke Obscurants.

(1) White phosphorus smoke can be fired on the objective as a heading reference.

(2) Smoke is as effective at night as in the day in reducing visibility. Except for thermal imagery devices, electro-optical night observation devices cannot penetrate heavy smoke.

e. Security.

(1) Noise signatures are reduced as much as possible.

(2) Rock-filled cans suspended on barrier wire or across approach routes into defensive positions can provide intrusion warning.

(3) Blue light is much more difficult to see at night than red light. Unlike red light, however it does not hamper night vision.

(4) Command posts and trains have problems with security at night because of their high noise signature from generators. The noise may be

masked by placing generators in pits and surrounding them with bales of hay or vehicles. Placing generators in wooded or built-up areas not only helps dampen the noise, but scatters it as well, making it harder to pinpoint the noise source.

f. **Engineer.** Engineer missions do not change during darkness, but employment may. For a night attack, the engineers move forward with infantry to begin breaching operations under cover of darkness; they must mark their breaches, however, so the main body can find them with a minimum of trouble. Chemical lights or fluorescent tape on stakes is a good technique. The first unit to move through the breach sends back guides to meet other units and guide them through the enemy obstacle system.

g. **Maneuver.**

(1) All night maneuvers are kept simple. Complex operations at night may not work.

(2) Animals of all types—cows, monkeys, wild boars, horses, dogs, buffalo—have been used successfully by other armies throughout history to probe enemy defenses and cause the defender to reveal gun positions, minefields, barriers, and wire.

(3) Commanders should consider occupying alternate or supplementary positions after dark so that the attacker's artillery fires and assault will be directed against an unoccupied area.

(4) Consideration should be given to relocating reserves after dark, since the enemy may prefer to use artillery rather than maneuver to breakup counterattacks.

(5) Reserve units whose position has been detected in the daytime should be moved, if at all possible.

h. **Personnel.**

(1) Apprehension rises significantly during darkness, and it becomes more difficult to get soldiers to cat, especially if combat is anticipated. They must then contend with the natural "low" that occurs between 0300 and 0600 hours.

(2) Sleep deprivation has numerous effects on the body, and commanders should be aware of this during planning.

(3) When planning night operations, consideration must be given to the method that will be used to mark locations where casualties are to be collected so they can be found by medical personnel and evacuated. Collecting casualties at the assault position or objective rally point is a technique that can speed evacuation.

(4) The commander of a unit that is to conduct a night attack must give thought to his litter teams, especially how he will man them.

(5) Aidmen must reconnoiter the routes from casualty collection points to the battalion aid station during daylight and again during darkness. This is especially critical during a night defense.

i. Combat Service Support.

(1) Leaders should plan for a significant increase in consumption of batteries, flashlights, and illumination rounds (including tracers) when planning for night operations.

(2) If aerial resupply is to be used, a method to guide the aircraft into position is required. A directional light source, such as a strobe light or a chemical light on a helmet, may be used.

(3) Ammunition prestock efforts require careful planning if they are to be effective. Prestock locations must be clearly identified and marked so they can be found during darkness, even by a unit other than the one that installed the prestock.

CHAPTER 3

PATROLLING

This chapter implements STANAG 2003

Patrols are missions to gather information or to conduct combat operations. Infantry platoons and squads conduct three types of patrols: reconnaissance, combat and tracking. This chapter describes the planning considerations used in preparation for patrols, conduct of patrols, and establishment of and actions taken in a patrol base.

Section I. PLANNING CONSIDERATIONS

This section provides the planning considerations common to most patrols, the required tasks that guide the platoon and squad leader in organizing patrols, the initial planning and coordination requirements, and the coordination requirements for the departure and reentry of friendly lines.

3-1. ORGANIZATION

To accomplish the patrolling mission, a platoon or squad must perform specific tasks; for example, secure itself, danger area crossings, or rally points; reconnoiter the patrol objective; breach, support, or assault. As with other missions, the leader tasks elements of his platoon in accordance with his estimate of the situation. He identifies those tasks the platoon must perform and decides which elements will perform them. Where possible, in assigning tasks, the leader should maintain squad and fire team integrity. The chain of command continues to lead its elements during a patrol. The terms "element" and "team" refer to the squads, fire teams, or buddy teams that perform the tasks as described. Squads and fire teams may perform more than one task in an assigned Sequence others may perform only one task. The leader must plan carefully to ensure that he has identified and assigned all required tasks in the most efficient way. Elements and teams for platoons conducting patrols include the common and specific elements for each type of patrol. The following elements are common to all patrols.

a. **Headquarters Element.** The headquarters consists of the platoon leader, RATELO, platoon sergeant, FO, and FO RATELO. It may consist of any attachments that the platoon leader decides that he or the platoon sergeant must control directly.

b. **Aid and Litter Team.** Aid and litter teams are responsible for treating and evacuating casualties.

c. **Enemy Prisoner of War Team.** EPW teams are responsible for controlling enemy prisoners IAW the five S's and the leader's guidance.

d. **Surveillance Team.** The surveillance team keeps watch on the objective from the time that the leader's reconnaissance ends until the unit deploys for actions on the objective. They then join their element.

e. **En Route Recorder.** The en route recorder records all information collected during the mission.

f. **Compass Man.** The compass man assists in navigation by ensuring the lead fire team leader remains on course at all times. Instructions to the compass man must include an initial azimuth with subsequent azimuths provided as necessary. The compass man should preset his compass on the initial azimuth before moving out, especially if the move will be during limited visibility conditions. The platoon or squad leader should also designate an alternate compass man.

g. **Pace Man.** The pace man maintains an accurate pace at all times. The platoon or squad leader should designate how often the pace man is to report the pace to him. The pace man should also report the pace at the end of each leg. The leader should also designate an alternate pace man.

3-2. INITIAL PLANNING AND COORDINATION

Leaders plan and prepare for patrols using the troop-leading procedure and (he estimate of the situation. Leaders identify required actions on the objective, then plan backward to the departure from friendly lines and forward to the reentry of friendly lines. They normally receive the OPOD in the bat talion or company CP where communications are good and key personnel are available. Because patrols act independently, move beyond the direct-fire support of the parent unit, and operate forward of friendly units, coordination must be thorough and detailed. Leaders normally coordinate directly with the battalion staff. They coordinate continuously throughout the planning and preparation phases. They use checklists to preclude omitting any items vital to the accomplishment of the mission.

a. Items coordinated between the leader and the battalion staff or company commander include—

- Changes or updates in the enemy situation.
- Best use of terrain for routes, rally points, and patrol bases.

- Light and weather data.
- Changes in the friendly situation.
- The attachment of soldiers with special skills or equipment; for example, engineers, sniper teams, scout dog teams, FOs, or interpreters.
- Use and location of landing zones.
- Departure and reentry of friendly lines.
- Fire support on the objective and along the planned routes, including alternate routes.
- Rehearsal areas and times. The terrain for the rehearsal should be similar to that at the objective, to include buildings and fortifications if necessary. Coordination for rehearsals includes security of the area, use of blanks, pyrotechnics, and live ammunition.
- Special equipment requirements.
- Transportation support, including transportation to and from the rehearsal site.
- Signal plan-call signs frequencies, code words, pyrotechnics, and challenge and password.

b. The leader coordinates with the unit through which his platoon or squad will conduct its forward and rearward passage of lines. (See paragraph 3-4 for specific items for coordination.)

c. The platoon leader also coordinates patrol activities with the leaders of other units that will be patrolling in adjacent areas at the same time.

3-3. COMPLETION OF THE PLAN

As the platoon leader completes his plan, he considers the following.

a. **Essential and Supporting Tasks.** The leader ensures that he has assigned all essential tasks to be performed on the objective, at rally points, at danger areas, at security or surveillance locations, along the route(s), and at passage lanes.

b. **Key Travel and Execution Times.** The leader estimates time requirements for movement to the objective, leader's reconnaissance of the objective, establishment of security and surveillance, compaction of all assigned tasks on the objective, movement to an objective rally point to debrief the platoon, and return to and through friendly lines.

c. **Primary and Alternate Routes.** The leader selects primary and alternate routes to and from the objective (Figure 3-1). The return routes should differ from the routes to the objective.

d. **Signals.** The leader should consider the use of special signals. These include arm-and-hand signals, flares, voice, whistles, radios, and

infrared equipment. All signals must be rehearsed so that all soldiers know what they mean.

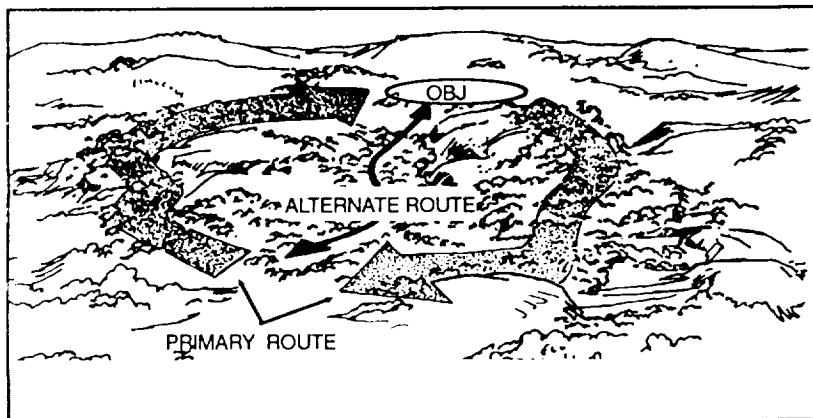

Figure 3-1. Primary and alternate routes.

e. **Challenge and Password Forward of Friendly Lines.** The challenge and password from the SOI must not be used beyond the FEBA.

(1) The platoon can use the odd-number system. The leader specifies an odd number. The challenge can be any number less than the specified number. The password will be the number that must be added to it to equal the specified number.

(2) The platoon leader can also designate a running password. This code word alerts a unit that friendly soldiers are approaching in a less than organized manner and possibly under pressure. This may be used to get soldiers quickly through a compromised passage of friendly lines. The running password is followed by the number of soldiers approaching ("Moosebreath five"). This prevents the enemy from joining a group in an attempt to penetrate a friendly unit.

f. **Location of Leaders.** The leader considers where he and the platoon sergeant and other key leaders should be located for each phase of the patrol mission. The platoon sergeant is normally with the following elements for each type of patrol:

- On a raid or ambush, he normally controls the support element.
- On an area reconnaissance, he normally stays in the ORP.
- On a zone reconnaissance, he normally moves with the reconnaissance element that sets up the link-up point.

g. **Actions on Enemy Contact.** Unless required by the mission, the platoon avoids enemy contact. The leader's plan must address actions on

chance contact at each phase of the patrol mission. The platoon's ability to continue the mission will depend on how early contact is made, whether the platoon is able to break contact successfully (so that its subsequent direction of movement is undetected), and whether the platoon receives any casualties as a result of the contact.

(1) The plan must address the handling of seriously wounded soldiers and KIAs.

(2) The plan must address the handling of prisoners who are captured as a result of chance contact and are not part of the planned mission.

h. Contingency Plans. The leader leaves for many reasons throughout the planning, coordination, preparation, and execution of his patrol mission. Each time the leader departs without radio or wire communications, he must issue a five-point contingency plan. The contingency plan includes—

- Where the leader is going.
- Who he is taking with him.
- The amount of time he plans to be gone.
- The actions taken if the leader does not return.
- The unit's and the leader's actions on chance contact while the leader is gone.

3-4. DEPARTURE FROM FRIENDLY LINES

The departure from friendly lines must be thoroughly planned and coordinated.

a. Coordination. The platoon leader must coordinate with the commander of the forward unit and the leaders of other units that will be patrolling in the same or adjacent areas. The coordination includes S01 information, signal plan, fire plan, running password, procedures for departure and reentry lines, dismount points, initial rally points, departure and reentry points, and information about the enemy.

(1) The platoon leader provides the forward unit leader with the unit identification, the size of the patrol, the departure and return times, and the area of operation.

(2) The forward unit leader provides the platoon leader with the following:

- Additional information on terrain.
- Known or suspected enemy positions.
- Likely enemy ambush sites.
- Latest enemy activity.
- Detailed information on friendly positions and obstacle locations. This includes the location of OPs.
- Friendly unit fire plan.

- Support that the unit can provide; for example, fire support, litter teams, guides, communications, and reaction force.

b. **Planning.** In his plan for the departure of friendly lines, the leader should consider the following sequence of actions:

- Making contact with friendly guides at the contact point.
- Moving to the coordinated initial rally point.
- Completing final coordination.
- Moving to and through the passage point.*
- Establishing a security-listening halt beyond the friendly unit's final protective fires.

*The platoon should remain in single file. The platoon sergeant follows directly behind the guide so that he can count each soldier that passes through the passage point. He gives the count to the guide, tells him how long to wait at the passage point (or when to return), and confirms the running password. If the platoon makes contact after it is past the departure point, it fights through. Soldiers return to the departure point only if they become disorganized. They then reoccupy the initial rally point and the leader reports to higher headquarters.

3-5. RALLY POINTS

The leader considers the use and locations of rally points. A rally point is a place designated by the leader where the platoon moves to reassemble and reorganize if it becomes dispersed.

a. **Selection of Rally Points.** The leader physically reconnoiters routes to select rally points whenever possible. He selects tentative points if he can only conduct a map reconnaissance. He confirms them by actual inspection as the platoon moves through them. Rally points must—

- Be easy to find.
- Have cover and concealment.
- Be away from natural lines of drift.
- Be defendable for short periods.

b. **Types of Rally Points.** The most common types of rally points are initial, en route, objective, reentry, and near-and far-side rally points. Soldiers must know which rally point to move to at each phase of the patrol mission. They should know what actions are required there and how long they are to wait at each rally point before moving to another.

(1) **Initial rally point** An initial rally point is a place inside of friendly lines where a unit may assemble and reorganize if it makes enemy contact during the departure of friendly lines or before reaching the first en route rally point. It is normally selected by the commander of the friendly unit.

(2) **En route rally point.** The leader designates en route rally points every 100 to 400 meters (based on the terrain, vegetation, and visibility). When the leader designates a new en route rally point, the previously designated one goes into effect. This precludes uncertainty over which one soldiers should move to if contact is made immediately after the leader designates a new rally point. There are three ways to designate a rally point:

(a) Physically occupy them for a short period. This is the preferred method.

(b) Pass by at a distance and designate using arm-and-hand signals.

(c) Walk through and designate using arm-and-hand signals.

(3) **Objective rally point.** The objective rally point (ORP) is a point out of sight, sound, and small-arms range of the objective area. It is normally located in the direction that the platoon plans to move after completing its actions on the objective. The ORP is tentative until the objective is pinpointed. (Figure 3-3, page 3-8.) Actions at or from the ORP include—

- Reconnoitering the objective.
- Issuing a FRAGO.
- Disseminating information from reconnaissance if contact was not made.
- Making final preparations before continuing operations; for example, recamouflaging; preparing demolitions; lining up rucksacks for quick recovery; preparing EPW bindings, first aid kits, and litters; and inspecting weapons.
- Accounting for soldiers and equipment after actions at the objective are complete.
- Reestablishing the chain of command after actions at the objective are complete.

(a) **Occupation of an ORP by a squad.** In planning the occupation of an ORP, the squad leader considers the following sequence:

- Halt beyond sight, sound, and small-arms weapons range of the tentative ORP (200 to 400 meters in good visibility; 100 to 200 meters in limited visibility).
- Position security.
- Move forward with a compass man and one member of each fire team to confirm the location of the ORP and determine its suitability. Issue a five-point contingency plan before departure.
- Position the Team A soldier at 12 o'clock, and the Team B soldier at 6 o'clock in the ORP. Issue them a contingency plan and return with the compass man.

- Lead the squad into the ORP, position Team A from 9 to 3 o'clock and Team B from 3 to 9 o'clock.

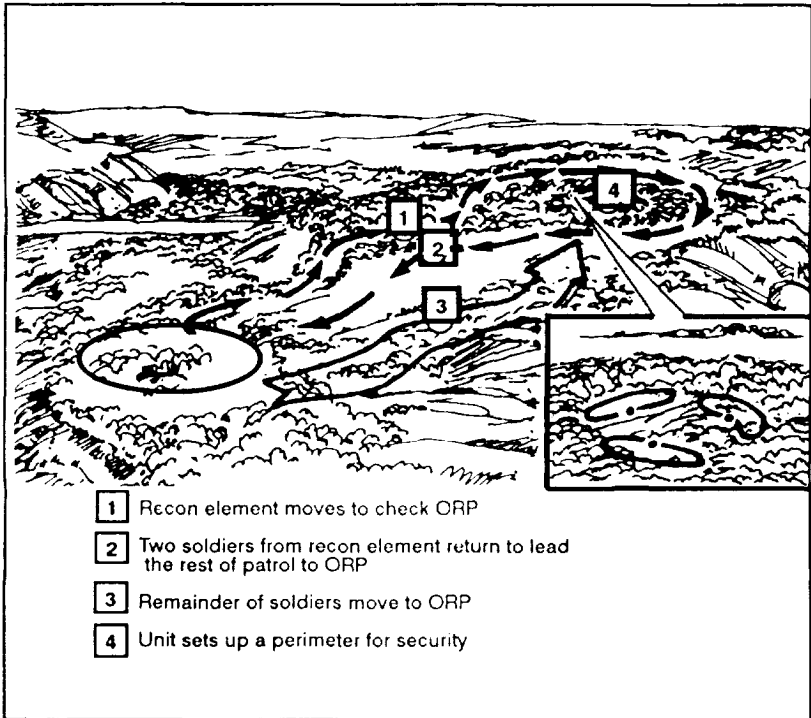

Figure 3-2. Objective rally point.

NOTE: The squad may also occupy the ORP by force. This requires more precise navigation, but eliminates separating the squad.

(c) *Occupation of an ORP by a platoon.* The platoon leader should consider the same sequence in planning the occupation of an ORP. He brings a soldier from each squad on his reconnaissance of the ORP and positions them at the 10, 2, and 6 o'clock positions. The first squad in the order of march establishes the base leg (10 to 2 o'clock). The trailing squads occupy from 2 to 6 o'clock and 6 to 10 o'clock, respectively.

(4) *Reentry rally point.* The reentry rally point is located out of sight, sound, and small-arms weapons range of the friendly unit through which the platoon will return. This also means that the RRP should be outside the final protective fires of the friendly unit. The platoon occupies the RRP as a security perimeter.

(5) *Near-and far-side rally points.* These rally points are on the near and far side of danger areas. If the platoon makes contact while crossing the danger area and control is lost, soldiers on either side move to the rally point nearest them. They establish security, reestablish the chain of command, determine their personnel and equipment status, and continue the patrol mission, link up at the ORP, or complete their last instructions.

3-6. LEADER'S RECONNAISSANCE OF THE OBJECTIVE

The plan must include a leader's reconnaissance of the objective once the platoon or squad establishes the ORF. During his reconnaissance, the leader pinpoints the objective; selects security, support, and assault positions for his squads and fire teams; and adjusts his plan based on his observation of the objective. Each type of patrol requires different tasks during the leader's reconnaissance. The platoon leader will take different elements with him. The leader must plan time to return to the ORP, complete his plan, disseminate information, issue orders and instructions, and allow his squads to make any additional preparations.

3-7. REENTRY OF FRIENDLY LINES

The platoon leader's initial planning and coordination must include the reentry of friendly lines. The platoon leader should consider the following sequence.

WARNING

Reentry of friendly lines at night is dangerous and should only be attempted when it is essential to the success of the patrol.

- a. The platoon halts in the RRP and establishes security.
- b. The platoon leader radios the codeword advising the friendly unit of its location and that it is ready to return. The friendly unit must acknowledge the message and confirm that guides are waiting before the platoon moves from the RRP.

(1) If radio communications are not possible, the platoon leader, RATELO, and a two-man (buddy team) security element move forward and attempt to contact an OP using the challenge and password. The OP notifies the friendly unit that the platoon is ready to return and requests a guide.

(2) If the platoon leader cannot find an OP, he moves with the RATELO and security element to locate the coordinated reentry point.

He must move straight toward (and away from) friendly lines, never parallel to them. All lateral movement should be outside of small-arms weapons range.

NOTE: The platoon leader should only attempt this procedure during daylight. At night he should use other backup signals to make contact with friendly units. The preferred method is to wait until daylight if contact with the friendly unit cannot be made as planned.

c. Once the friendly unit acknowledges the return of the platoon, the platoon leader issues a five-point contingency plan and moves with his RATELO and a two-man (buddy team) security element on a determined azimuth and pace to the reentry point.

d. The platoon leader uses far and near recognition signals to establish contact with the guide.

c. The platoon leader signals the platoon forward (radio) or returns and leads it to the reentry point. He may post the security element with the guide at the enemy side of the reentry point.

f. The platoon sergeant counts and identifies each soldier as he passes through the reentry point.

g. The guide leads the platoon to the assembly area.

h. The platoon leader reports to the command post of the friendly unit. He tells the commander everything of tactical value concerning the friendly unit's area of responsibility.

i. The platoon leader rejoins the platoon in the assembly area and leads it to a secure area for debriefing.

3-8. DEBRIEFING

Immediately after the platoon or squad returns, personnel from higher headquarters conduct a thorough debrief. This may include all members of the platoon or the leaders, RATELOs, and any attached personnel. Normally the debriefing is oral. Sometimes a written report is required. NATO forces use the patrol report form specified by STANAG 2003. Information on the written report should include-

- Size and composition of the platoon conducting the patrol.
- Mission of the platoon (type of patrol, location, purpose).
- Departure and return times.
- Routes. Use check points, grid coordinates for each leg or include an overlay.
- Detailed description of terrain and enemy positions that were identified.
- Results of any contact with the enemy.

- Personnel status at the conclusion of the patrol mission, including the disposition of casualties.
- Conclusions or recommendations.

Section II. RECONNAISSANCE PATROL

The three types of reconnaissance patrols are area, zone, and route. Reconnaissance patrols provide timely and accurate information on the enemy and terrain. They confirm the leader's plan before it is executed. The commander must inform the leader of the specific information requirements for each mission.

3-9. ORGANIZATION

Besides the common elements, reconnaissance patrols have a reconnaissance team and a reconnaissance and security team.

a. **Reconnaissance Team.** Reconnaissance teams reconnoiter the objective area once the security teams are in position. Normally these are two-man teams (buddy teams) to reduce the possibility of detection.

b. **Reconnaissance and Security Team.** R&S teams are normally used in a zone reconnaissance, but may be useful in any situation when it is impractical to separate the responsibilities for reconnaissance and security.

3-10. TASKS TO SUBORDINATE UNITS

Normally the platoon headquarters element controls the platoon on a reconnaissance patrol mission.

a. The platoon leader must consider the requirements for reconnaissance and security in assigning tasks to his squads or fire teams. He may separate the tasks so that one or more squads conduct the reconnaissance while other squads or fire teams provide security at various locations. Or, he may assign reconnaissance and security (R&S) tasks to each squad or team. When a fire team conducts a reconnaissance patrol it operates as a single R&S team.

b. In assigning tasks, the leader must also consider the size and number of reconnaissance objectives, the requirement to secure the ORP and other points, and the time allowed for conducting the mission.

3-11. AREA RECONNAISSANCE

An area reconnaissance is conducted to obtain information about a specified location and the area around it. The location may be given as a grid coordinate or an objective on an overlay. In an area reconnaissance, the platoon or squad uses surveillance or vantage-points around the objective from which to observe it and the surrounding area. In planning

for an area reconnaissance mission, the platoon leader considers the following sequence of actions.

a. The leader may include a surveillance team in his reconnaissance of the objective from the ORP. He positions it while on the reconnaissance. The subordinate leader responsible for security establishes security at the ORP and positions other security teams as required on likely enemy avenues of approach into the objective area.

b. If required the leader positions other surveillance elements about the objective. He may move them on one route, posting them as they move, or he may direct them to move on separate routes to their assigned locations.

c. After observing the objective for a specified time, all elements return to the ORP and report their observations to the leader or the recorder. Once all information is collected, it is disseminated to every soldier.

3-12. ZONE RECONNAISSANCE

A zone reconnaissance is conducted to obtain information on enemy, terrain, and routes within a specified zone. Zone reconnaissance techniques include the use of moving elements, stationary teams, or a series of area reconnaissance actions.

a. **Moving Elements.** The leader plans the use of squads or fire teams moving along multiple routes to cover the entire zone. Methods for planning the movement of multiple elements through a zone include the fan, the box, converging routes, and successive sectors.

(1) **Fan method.** The leader first selects a series of ORPs throughout the zone. The platoon establishes security at the first ORP. Each R&S team moves from the ORP along a different fan-shaped route that overlaps with others to ensure reconnaissance of the entire area. The leader maintains a reserve at the ORP. When all R&S teams have returned to the ORP, the platoon collects and disseminates all information to every soldier before moving on to the next ORP. (Figure 3-3.)

(2) **Box method.** The leader sends his R&S teams from the ORP along routes that form a boxed-in area. He sends other teams along routes through the area within the box. All teams meet at a link-up point at the far side of the box from the ORP. (Figure 3-4.)

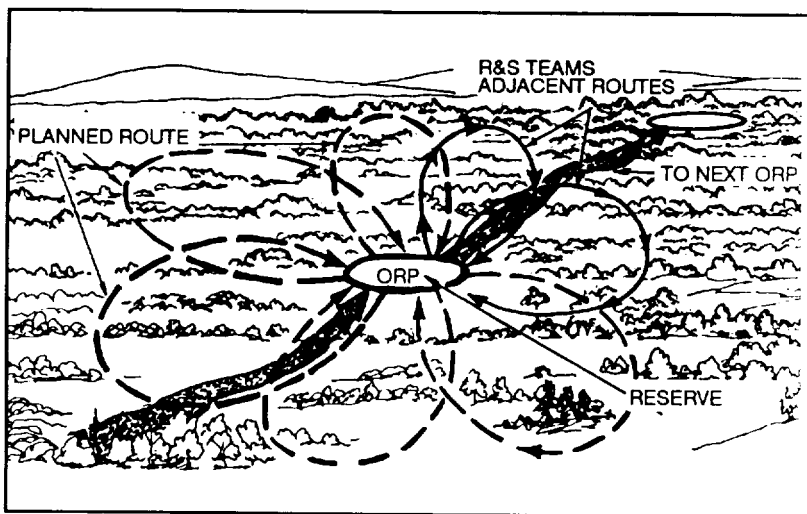

Figure 3-3. Fan method

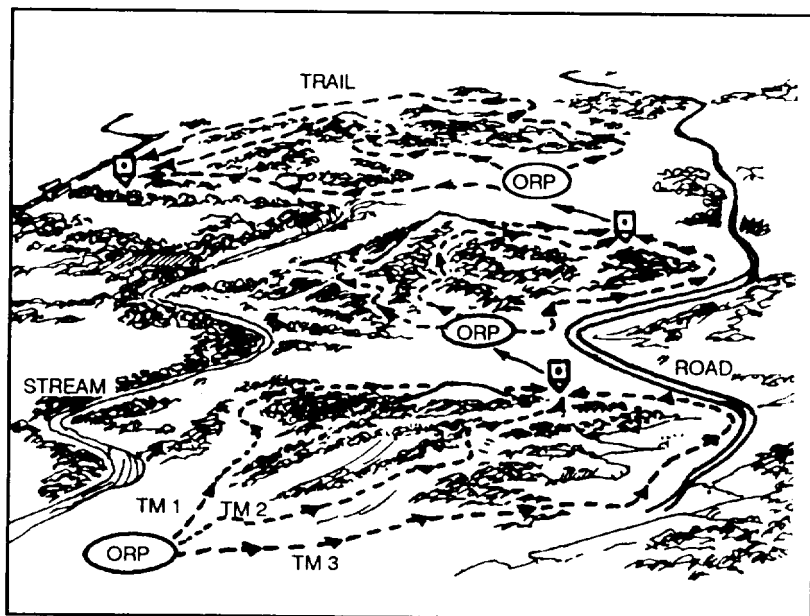

Figure 3-4. Box method.

(3) *Coverging routes method.* The leader selects routes from the ORP through the zone to a link-up point at the far side of the zone from the ORP. Each R&S team moves along a specified route and uses the fan method to reconnoiter the area between routes. The leader designates a time for all teams to link-up. (Figure 3-5.)

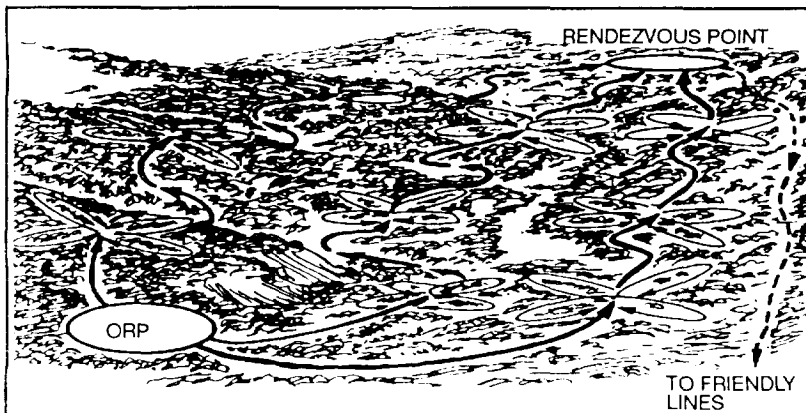

Figure 3-5. Coverging routes method.

(4) *Successive sector method.* The leader may divide the zone into a writs of sectors. Within each sector, the platoon uses the converging routes method to reconnoiter to an intermediate link-up point where it collects and disseminates the information gathered to that point before reconnoitering the next sector. (Figure 3-6.)

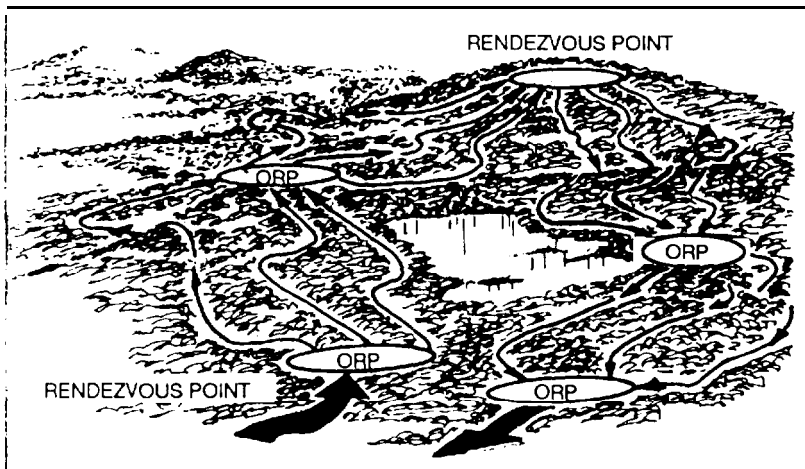

Figure 3-6. Successive sector method.

b. **Stationary Teams.** Using this technique, the leader positions surveillance teams in locations where they can collectively observe the entire zone for long-term, continuous information gathering (Figure 3-7). He must consider sustainment requirements when developing his soldier's load plan.

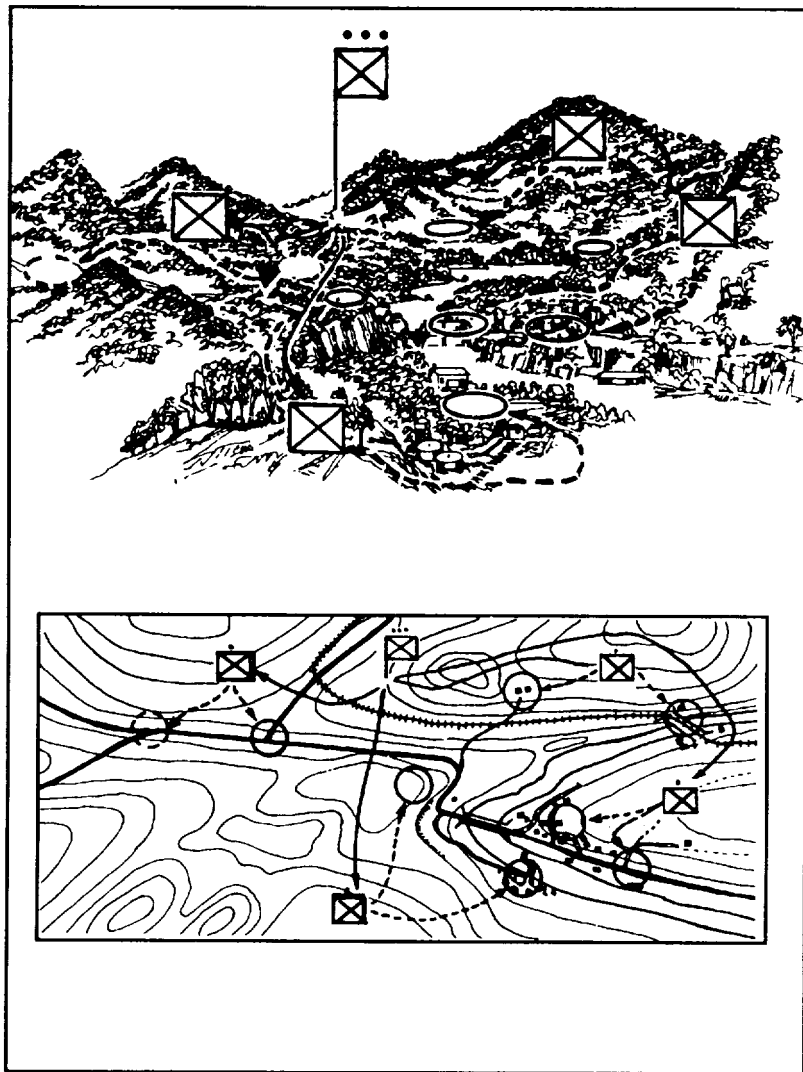

Figure 3-7. Zone reconnaissance using stationary surveillance.

c. **Multiple Area Reconnaissance.** The leader tasks each of his squads to conduct a series of area reconnaissance actions along a specified route. (Figure 3-8.)

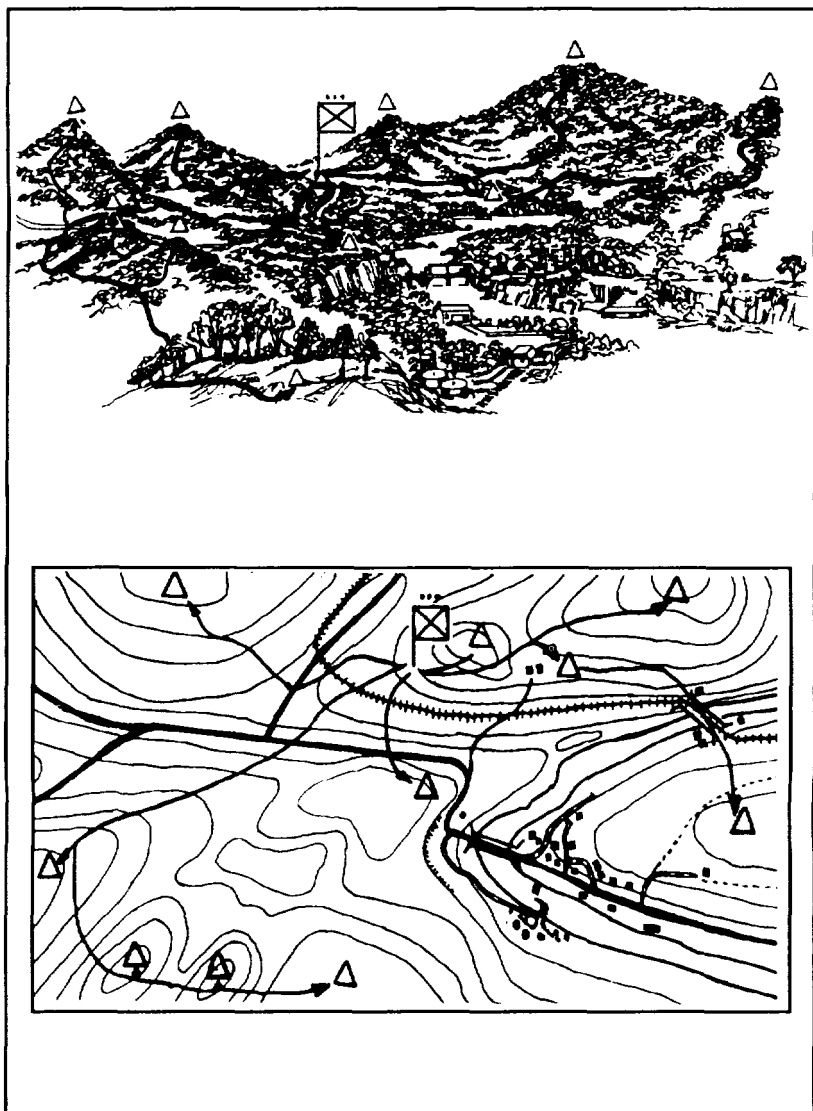

Figure 3-8. Zone reconnaissance using multiple area reconnaissance.

3-13. ROUTE RECONNAISSANCE

A route reconnaissance is conducted to obtain detailed information about one route and all the adjacent terrain or to locate sites for emplacing obstacles. A route reconnaissance is oriented on a road; a narrow axis, such as an infiltration lane; or a general direction of attack. Normally engineers are attached to the infantry unit for a complete route reconnaissance. Infantry can conduct a hasty route reconnaissance without engineer support. A route reconnaissance results in detailed information about trafficability, enemy activity, NBC contamination, and aspects of adjacent terrain from both the enemy and friendly viewpoint. In planning a route reconnaissance the leader considers the following.

a. The preferred method for conducting a route reconnaissance is the fan method described above. The leader must ensure that the fans are extensive enough to reconnoiter intersecting routes beyond direct-fire range of the main route. (Figure 3-9.)

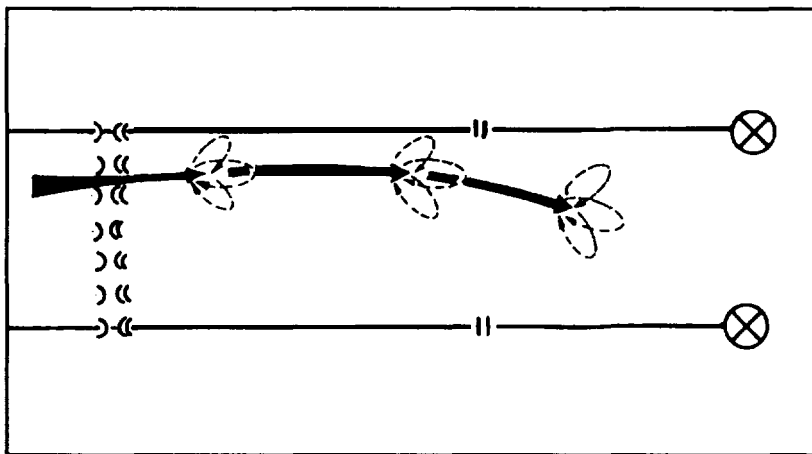

Figure 3-9. Route reconnaissance using fans.

b. The platoon should use a different return route.

c. If all or part of the proposed route is a road, the leader must treat the road as a danger area. The platoon moves parallel to the road using a covered and concealed route. When required, reconnaissance and security teams move close to the road to reconnoiter key areas.

d. The leader should submit the patrol report in an overlay format LAW FM 5-34 or GTA 5-2-5 (Figure 3-10, page 3-18).

Section III. COMBAT PATROL

Combat patrols are conducted to destroy or capture enemy soldiers or equipment; destroy installations, facilities, or key points; or harass enemy forces. They also provide security for larger units. The two types of combat patrol missions are ambush and raid.

3-14. ORGANIZATION

Besides the common elements, combat patrols also have the following elements and teams.

a. **Assault Element.** The assault element seizes and secures the objective and protects special teams as they complete their assigned actions on the objective.

b. **Security Element.** The security element provides security at danger areas, secures the ORP, isolates the objective, and supports the withdrawal of the rest of the platoon once it completes its assigned actions on the objective. The security element may have separate security teams, each with an assigned task or sequence of tasks.

c. **Support Element.** The support element provides direct fire support and may control indirect fires for the platoon.

d. **Breach Element.** The breach element breaches the enemy's obstacles when required.

e. **Demolition Team.** Demolition teams are responsible for preparing and exploding the charges to destroy equipment, vehicles, or facilities on the objective.

f. **Search Team.** The assault element may comprise two-man (buddy teams) or four-man (tire team) search teams to search bunkers, buildings, or tunnels on the objective. These teams may search the objective or kill zone for casualties, documents, or equipment.

3-15. TASKS TO SUBORDINATE UNITS

Normally the platoon headquarters element controls the platoon on a combat patrol mission. The platoon leader must make every attempt to maintain squad and fire team integrity as he assigns tasks to subordinate units.

a. The platoon leader must consider the requirements for assaulting the objective, supporting the assault by fire, and securing the platoon throughout the mission.

(1) For the assault on the objective, the leader must consider the required actions on the objective, the size of the objective, and the known or presumed strength and disposition of the enemy on and near the objective.

(2) The leader must consider the weapons available, and the type and volume of fires required to provide fire support for the assault on the objective.

(3) The leader must consider the requirement to secure the platoon at points along the route, at danger areas, at the ORP, along enemy avenues of approach into the objective, and elsewhere during the mission.

b. The leader must assign additional tasks to his squads for demolition, search of enemy killed and captured, guarding of EPWs, treatment and evacuation (litter teams) of friendly casualties, and other tasks required for successful completion of the patrol mission.

c. The platoon leader must determine who will control any attachments of skilled personnel or special equipment.

3-16. LEADER'S RECONNAISSANCE OF THE OBJECTIVE

In a combat patrol, the leader has additional considerations for the conduct of his reconnaissance of the objective from the ORR. He is normally the assault element leader. He should also take the support element leader, the security element leader, and a surveillance team (a two-man team from the assault element).

a. The leader should designate a release point halfway between the ORP and the objective. Squads and fire teams separate at the release point and move to their assigned positions. The release point should have wire communications with the ORP and be set up so that other elements can tie into a hot loop there.

b. The platoon leader should confirm the location the objective and determine that it is suitable for the assault or ambush. He notes the terrain and identifies where he can place mines or Claymores to cover dead space. He notes any other features of the objective that may cause him to alter his plan.

c. If the objective is the kill zone for an ambush, the leader's reconnaissance party should not cross the objective, to do so will leave tracks that may compromise the mission.

d. The platoon leader should confirm the suitability of the assault and support positions and routes from them back to the ORP.

e. The platoon leader should post the surveillance team and issue a five-point contingency plan before returning to the ORP.

3-17. AMBUSH

An ambush is a surprise attack from a concealed position on a moving or temporarily halted target. Antiarmor ambushes are established when the mission is to destroy enemy armored or mechanized forces. Ambushes are classified by category-hasty or deliberate; type-point or area; and

formation — linear or L-shaped. The leader uses a combination of category, type, and formation in developing his ambush plan.

a. **Planning.** The key planning considerations include—

- Covering the entire kill zone by fire.
- Using existing or reinforcing obstacles (Claymores and other mines) to keep the enemy in the kill zone.
- Protecting the assault and support elements with mines, Claymores, or explosives.
- Using security elements or teams to isolate the kill zone.
- Assaulting into the kill zone to search dead and wounded, assemble prisoners, and collect equipment. (The assault element must be able to move quickly through its own protective obstacles.)
- Timing the actions of all elements of the platoon to preclude loss of surprise.
- Using only one squad to conduct the entire ambush and rotating squads over time from the ORP. This technique is useful when the ambush must be manned for a long time.

b. **Formations.** The leader considers the linear or L-shaped formations in planning an ambush.

(1) **Linear.** In an ambush using a linear formation, the assault and support elements deploy parallel to the enemy's route (Figure 3-11). This positions both elements on the long axis of the kill zone and subjects the enemy to flanking fire. This formation can be used in close terrain that restricts the enemy's ability to maneuver against the platoon, or in open

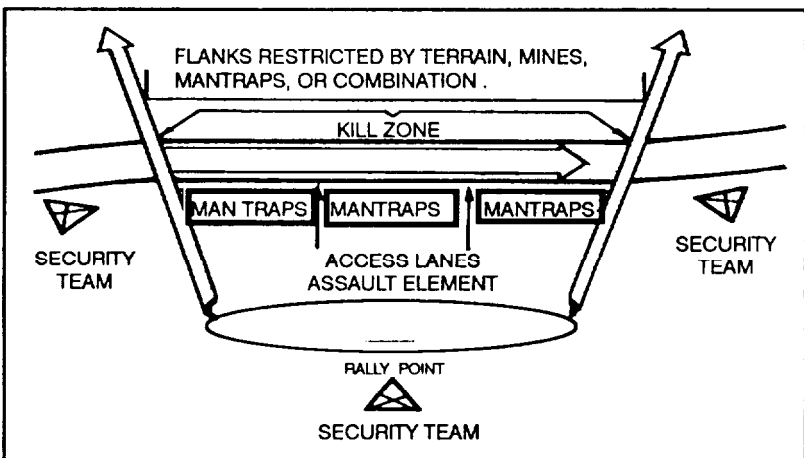

Figure 3-11. Linear ambush formation.

terrain provided a means of keeping the enemy in the kill zone can be effected.

(2) *L-shaped*. In an L-shaped ambush, the assault element forms the long leg parallel to the enemy's direction of movement along the kill zone. The support element forms the short leg at one end of and at right angles to the assault element. This provides both flanking (long leg) and enfilading fires (short leg) against the enemy. The L-shaped ambush can be used at a sharp bend in a trail, road, or stream. It should not be used where the short leg would have to cross a straight road or trail. (Figure 3-12.)

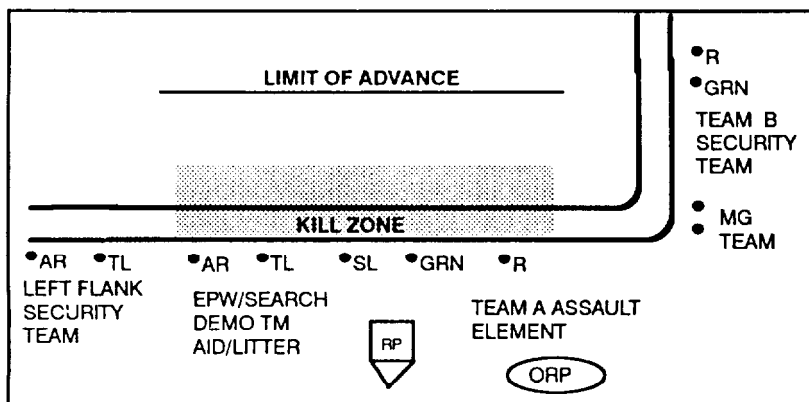

Figure 3-12. L-shaped ambush formation.

3-18. HASTY AMBUSH

A platoon or squad conducts a hasty ambush when it makes visual contact with an enemy force and has time to establish an ambush without being detected. The actions for a hasty ambush must be well rehearsed so that soldiers know what to do on the leader's signal. They must also know what action to take if detected before they are ready to initiate the ambush. The conduct of a hasty ambush is discussed below. In planning and rehearsing a hasty ambush the platoon leader should consider the following sequence of actions:

- a. Using visual signals, any soldier alerts the platoon that an enemy force is in sight. The soldier continues to monitor the location and activities of the enemy force until he is relieved by his team or squad leader.
- b. The platoon or squad halts and remains motionless.
- c. The leader determines the best nearby location for a hasty ambush. He uses arm-and-hand signals to direct soldiers to covered and concealed positions. The leader designates the location and extent of the kill zone.

d. Security elements move out to cover each flank and the rear. The leader directs the security elements to move a given distance, set up, and rejoin the platoon on order or, after the ambush (the sound of firing ceases). At squad level, the two outside buddy teams normally provide flank security as well as fires into the kill zone (Figure 3-13). At platoon level, fire teams make up the security elements (Figure 3-14, page 3-24).

e. Soldiers move quickly to covered and concealed positions, normally 5 to 10 meters apart. Soldiers ensure that they have good observation and fields of fire into the kill zone.

f. The leader initiates the ambush when the majority of the enemy force enters the kill zone. (If time and terrain permit, the squad or platoon may place out Claymores and use them to initiate the ambush.)

NOTE: If the enemy detects a soldier, the soldier initiates the ambush by firing his weapon and alerting the rest of the platoon, saying ENEMY RIGHT (LEFT or FRONT).

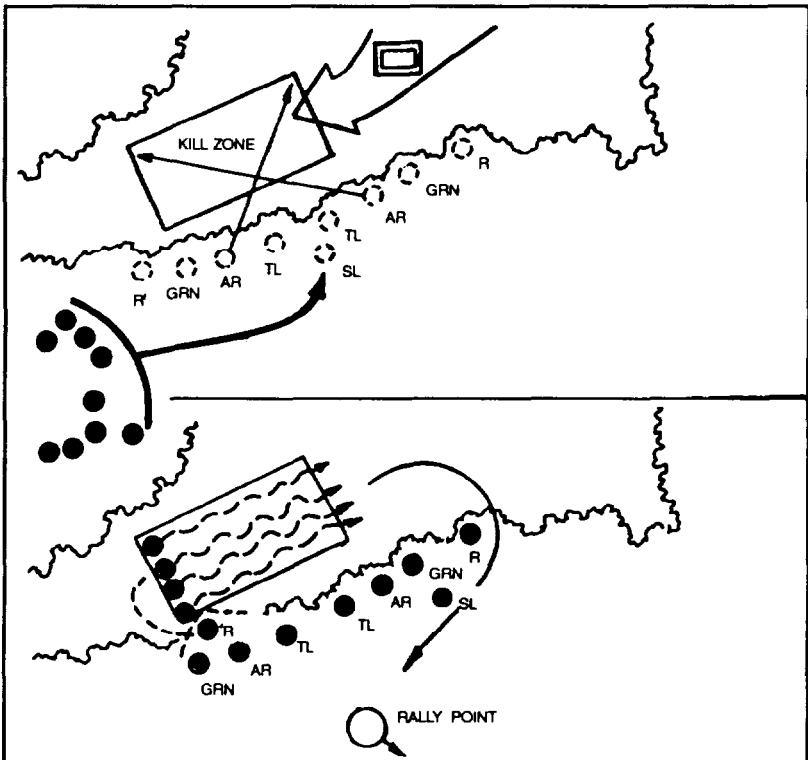

Figure 3-13. Squad hasty ambush.

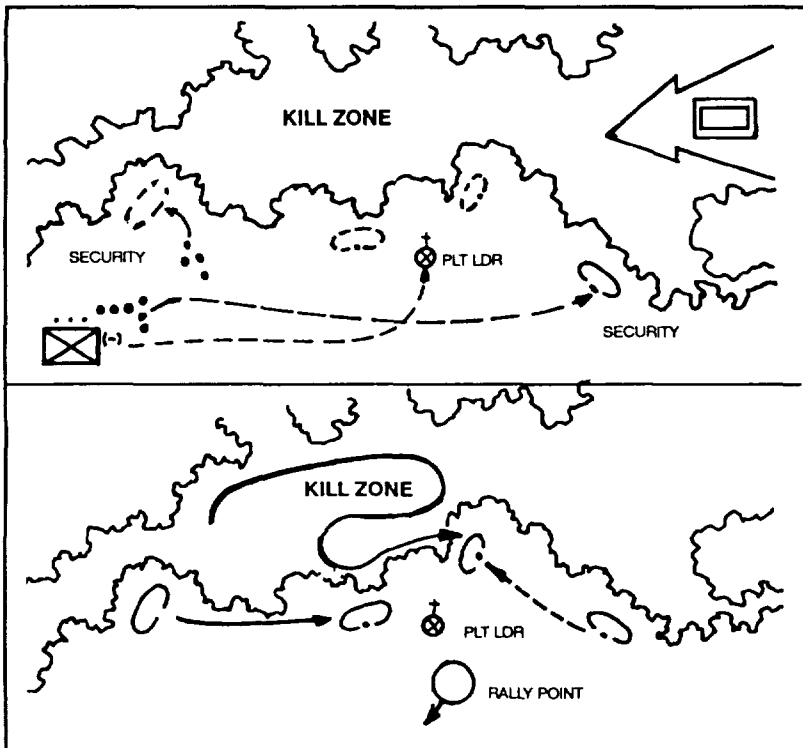

Figure 3-14. Platoon hasty ambush.

g. Leaders control the rate and distribution of fires. The leader orders cease fire when the enemy force is destroyed or ceases to resist. Directs the assault element to move into the kill zone and conduct a hasty search of the enemy soldiers. All other soldiers remain in place to provide security.

h. The security elements rejoin the platoon after the assault element has cleared through the kill zone. The platoon withdraws from the ambush site using a covered and concealed route. The platoon returns to the ORP in effect, collects and disseminates all information, reorganizes as necessary and continues the mission.

3-19. DELIBERATE AMBUSH

A deliberate ambush is conducted against a specific target at a predetermined location. The leader requires detailed information in planning a deliberate ambush:

- Size and composition of the targeted enemy unit.
- Weapons and equipment available to the enemy.

- The enemy's route and direction of movement.
- Times that the targeted unit will reach or pass specified points along the route.

3-20. POINT AMBUSH

In a point ambush, soldiers deploy to attack an enemy in a single kill zone. The platoon leader should consider the following sequence of actions when planning a deliberate point ambush:

a. The security or surveillance team(s) should be positioned first. The support element should be in position before the assault element moves forward of the release point. The support element must overwatch the movement of the assault element into position.

b. The platoon leader is the leader of the assault element. He must check each soldier once they establish the assault position. He signals the surveillance team to rejoin the assault element.

(1) Actions of the assault element should include-

- Identify individual sectors of fire as assigned by the platoon leader. Emplace aiming stakes.
- Emplace Claymores and other protective devices.
- Emplace Claymores, mines, or other explosives in dead space within the kill zone.
- Camouflage positions.
- Take weapons off SAFE. Moving the selection lever on the weapon causes a metallic click that could compromise the ambush if soldiers wait until the enemy is in the kill zone. This must be the last action performed by all soldiers before waiting to initiate the ambush.

(2) Actions of the support element include-

- Identify sectors of fire for all weapons, especially machine guns. Emplace limiting stakes to prevent friendly fires from hitting the assault element in an L-shaped ambush.
- Emplace Claymores and other protective devices.

c. Instructions to security teams must include how to notify the platoon leader of the enemy's approach into the kill zone (SALUTE report). The security element must also keep the platoon leader informed if any enemy forces are following the lead force.

d. The platoon leader must determine how large an element his ambush can engage successfully. He must be prepared to let units pass that are too large. He must report to higher headquarters any units that pass his ambush unengaged.

c. The platoon leader initiates the ambush. He may use a command detonated Claymore. He must also plan a backup method for initiating

the ambush should the primary means fail. This should also be a casualty-producing device such as a machine gun. This information must be passed out to all soldiers and practiced during rehearsals.

f. Soldiers must have a means of engaging the enemy in the kill zone during periods of limited visibility if it becomes necessary to initiate the ambush then. Use of tracers must be weighed against how it might help the enemy to identify friendly positions. The platoon leader may use handheld or indirect illumination flares.

g. The platoon leader should include indirect fire support as a part of his plan. Indirect fires can cover the flanks of the kill zone to help isolate it. They can also help the platoon to disengage if the ambush is compromised or the platoon must depart the ambush site under pressure.

h. The platoon leader must have a good plan to signal the advance of the assault element into the kill zone to begin its search and collection activities. Smoke may not be visible to the support element. All soldiers must know and practice relaying this signal during rehearsals.

i. The assault element must be prepared to move across the kill zone using individual movement techniques if there is any return fire once they begin to search. Otherwise the assault element moves across by bounding fire teams. Other actions in the kill zone include the following.

(1) Collect and secure all EPWs and move them out of the kill zone before searching bodies. Establish a location for EPWs and enemy wounded who will not be taken back that provides them cover, yet allows them to be found easily by their units.

(2) Search from one side to the other and mark bodies that have been searched to ensure the area is thoroughly covered.

(3) Use the two-man search technique.

(a) As the search team approaches a dead enemy soldier, one man guards while the other man searches. First, he kicks the enemy weapon away. Second, he rolls the body over (if on the stomach) by laying on top and when given the go ahead by the guard (who is positioned at the enemy's head), the searcher rolls the body over on him. This done for protection in case the enemy soldier has a grenade with the pin pulled underneath him.

(b) The searchers then conduct a systematic search of the dead soldier from head to toe removing all papers and anything new (different type rank, shoulder boards, different unit patch, pistol, weapon, or NVD). They note if the enemy has a fresh or shabby haircut and the condition of his uniform and boots. They take note of the radio frequency, SOI, and maps. Once the body has been thoroughly searched, the search team will continue in this manner until all enemy personnel in and near the kill zone

have been searched. Enemy bodies should be marked (for example, fold arms over chest) to avoid duplication.

(4) Identify and collect equipment to be carried back. Prepare it for transport. (Clear all weapons and place them on SAFE.)

(5) Identify and collect remaining equipment for destruction. The demolition team prepares dual-primed explosives (C4 with two M60 fuse lighters and time fuse) and awaits the signal to initiate. This is normally the last action performed before departing the objective and may signal the security elements to return to the ORP.

(6) Treat friendly wounded first, then enemy wounded, time permitting.

j. The flank security teams may also place out antiarmor mines after the ambush has been initiated if the enemy is known to have armor capability. If a flank security team makes contact, it fights as long as possible without becoming decisively engaged. It uses a prearranged signal to let the platoon leader know it is breaking contact. The platoon leader may direct a portion of the support element to assist the security team in breaking contact.

k. The platoon leader must plan the withdrawal from the ambush site:

(1) Elements normally withdraw in the reverse order that they established their positions.

(2) The elements may return first to the release point, then to the ORP, depending on the distance between elements.

(3) The security element at the ORP must be alert to assist the platoon's return to the ORP. It maintains security for the ORP while the rest of the platoon prepares to leave.

1. Actions back at the ORP include accountability of personnel and equipment and recovery of rucksacks and other equipment left at the ORP during the ambush.

3-21. AREA AMBUSH

In an area ambush, soldiers deploy in two or more related point ambushes. The platoon leader should consider the following sequence of actions when planning a deliberate area ambush.

a. A platoon is the smallest unit to conduct an area ambush. Platoons conduct area ambushes where enemy movement is largely restricted to trails or streams (Figure 3-15, page 3-28).

b. The platoon leader should select one principal ambush site around which he organizes outlying ambushes. These secondary sites are located along the enemy's most likely approach to and escape from the

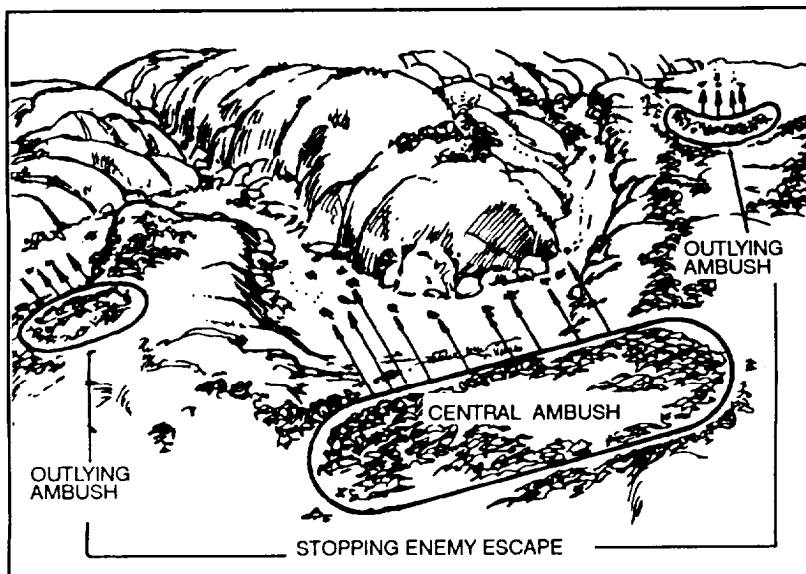

Figure 3-15. Area ambush.

principal ambush site. Squad-sized elements are normally responsible for each ambush site. They establish an area ambush as described above.

c. The platoon leader must determine the best employment of his machine guns. He normally positions them both with the support element of the principal site.

d. Squads responsible for outlying ambushes do not initiate their ambushes until after the principal one is initiated. They then engage to prevent enemy forces from escaping or reinforcing.

3-22. ANTIARMOR AMBUSH

Platoons and squads conduct antiarmor ambushes to destroy one or two armored vehicles. If a squad is given the mission to conduct an antiarmor ambush, it should have a MAW team attached to it. (Figure 3-16). The leader considers the following when planning an antiarmor ambush.

a. The armor-killer team is built around the MAW team. The leader must consider additional weapons available to supplement its fires. These are normally LAWs or AT4s. The leader must carefully position all antiarmor weapons to ensure the best shot (rear, flank, or top). The remainder of the platoon must function as support and security elements in the same way that they do for other combat patrols.

b. In a squad antiarmor ambush, the platoon leader selects the general site for the ambush. The squad leader must find a site that restricts

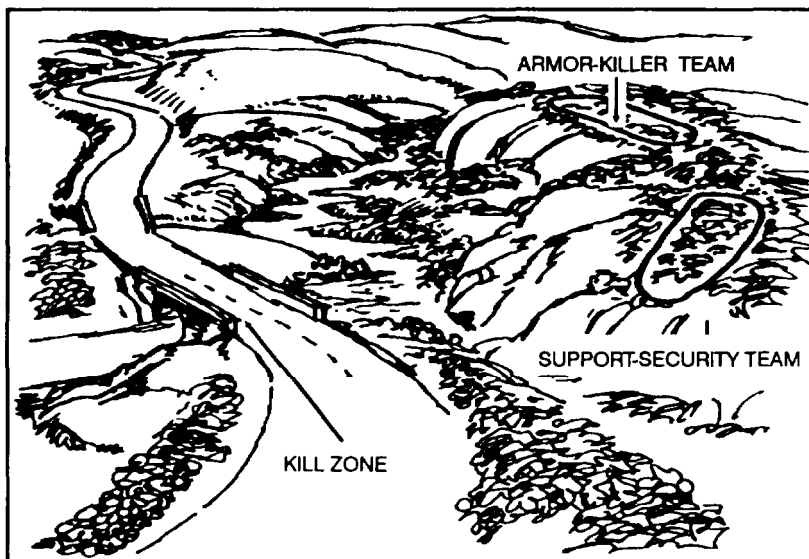

Figure 3-16. Antiarmor ambush.

the movement of armored vehicles out of the kill zone. The leader should attempt to place his elements so that an obstacle is between them and the kill zone.

c. Security elements must consider dismounted avenues of approach into the ambush site.

d. The leader should consider the method for initiating the antiarmor ambush. The preferred method is to use a command-detonated antiarmor mine placed in the kill zone. The MAW can be used to initiate the ambush, but its signature and slow rate of fire make it less desirable.

e. The armor-killer team attempts to kill the first and last vehicles in the column, if possible. All other weapons open fire once the ambush has begun. If the kill zone is within range of light antiarmor weapons, each soldier fires one during the ambush.

f. The leader must consider how the presence of dismounted enemy with the tanks will affect the success of his ambush. The leader's choices include—

- Initiate the ambush as planned.
- Withdraw without initiating the ambush.
- Initiate the ambush using only automatic weapons.
without tiring antiarmor weapons.

g. Because of the speed with which other armored forces can reinforce the enemy in the ambush site, the leader should plan to keep the

engagement short, and the withdrawal quick. The platoon will not clear through the kill zone as in other ambushes.

3-23. RAID

A raid is a combat operation to attack a position or installation followed by a planned withdrawal. Squads do not execute raids. The sequence of platoon actions for a raid is similar to those for an ambush. Additionally, the assault element of the platoon may have to conduct a breach of an obstacle. It may have additional tasks to perform on the objective; for example, demolition of freed facilities.

Section IV. TRACKING PATROL

A platoon or squad may receive the mission to follow the trail of a specific enemy unit. Soldiers look for signs left by the enemy. They gather information about the enemy unit, the route, and the surrounding terrain as they track.

3-24. CONSIDERATIONS

The key considerations for conducting a tracking patrol include—

- The soldiers move stealthily. The soldiers must be well-disciplined and well-trained in tracking techniques.
- When the platoon receives the mission to conduct a tracking patrol, it assigns the task of tracking to only one squad. The remaining squads and attachments provide security.
- The configuration of the platoon must provide security for the tracking team to the front and flanks as it follows the trail. The formation of a squad conducting a tracking patrol is in Figure 3-17. Separate elements of the squad must move as dispersed from each other as terrain and vegetation allows, and still maintain visual contact. Normally, the lead fire team is responsible for point security, tracking, and navigation.

3-25. ORGANIZATION

Besides the common elements, tracking patrols have a security team and a tracking team.

- a. Security Team. The security teams provide security for the squad leader, RATELO, and pace man and also provide rear and flank security.
- b. Tracking Team. The tracking team reads signs and follows the track of a specific enemy unit.

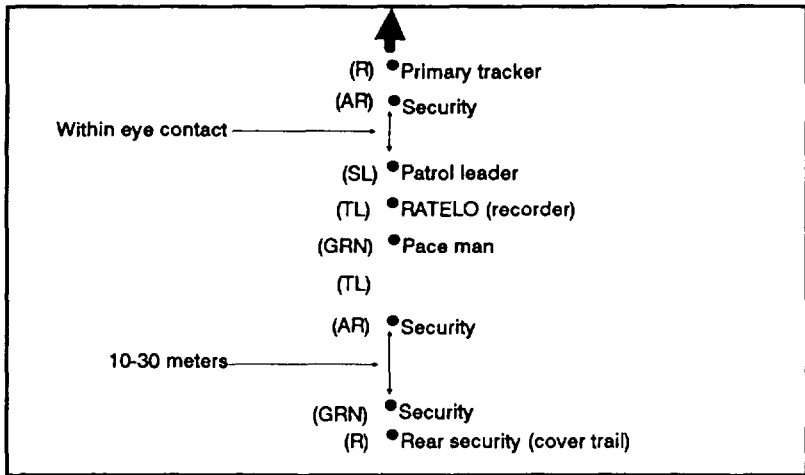

Figure 3-17. Tracking organization and formation.

3-26. TASKS TO SUBORDINATES

The most important consideration in assigning duties is the requirement to put the soldier best trained in tracking as the primary tracker. The squad leader attempts to maintain tire team and, if possible, buddy team integrity. He assigns the following duties to his soldiers.

a. **Patrol Leader.** The squad leader is the patrol leader and the main navigator. He has overall responsibility for mission accomplishment.

b. **Primary Tracker.** This soldier's only task is to follow the main trail of the main body of the unit being tracked.

c. **Security Man.** This soldier provides security for the primary tracker. When possible, he is the primary tracker's buddy team member.

c. **Security Team.** One buddy team provides security for the squad leader, the pace man, and RATELO.

d. **Rear Security Team.** One buddy team provides rear security for the squad.

3-27. TRAINING

Training is essential to develop and maintain the necessary tracking skills. Once deployed into an area of operation, training continues so the platoon can learn about local soil, climate, vegetation, animals, vehicles, footwear, and other factors. The primary tracker can prepare a tracking book showing specific signs and how they weather or change over time.

3-28. INTELLIGENCE

Specific intelligence about enemy habits, equipment, garment, footwear, diet, or tactics is important. For example, reports might show that the

enemy wears sandals like the natives in the area. However, the units being tracked show signs of one soldier wearing boots with an unfamiliar tread. This could mean that the unit has a trained cadre, a foreign advisor, or a prisoner with it. Any specific information about the enemy is also helpful. If possible, soldiers should interview someone who has seen them.

3-29. TRAIL SIGNS

Men, machines, and animals leave signs of their presence as they move through an area. These signs can be as subtle as an odor, or as obvious as a well-worn path. All soldiers can read obvious signs such as roads, worn trails, or tracks in sand or snow. However, attention to detail, common sense, staying alert, logic, and knowledge of the environment and enemy habits allow soldiers to obtain better information from signs they find in the battle area.

a. **Finding the Trail.** Finding the trail is the first task of the tracking team. The tracking team can reconnoiter around a known location of enemy activity when the trail cannot be found in the immediate area. There are two ways they can hunt for the trail:

(1) **From a known location.** Often there is a specific area or location where the enemy has been seen. From here, the tracking team can locate and follow the enemy's trail.

(2) **Cutting trail.** This occurs when the route of a friendly unit crosses a trail left by another group (Figure 3-18). It can be by chance or the team can deliberately choose a route that cuts across one or more probable enemy routes.

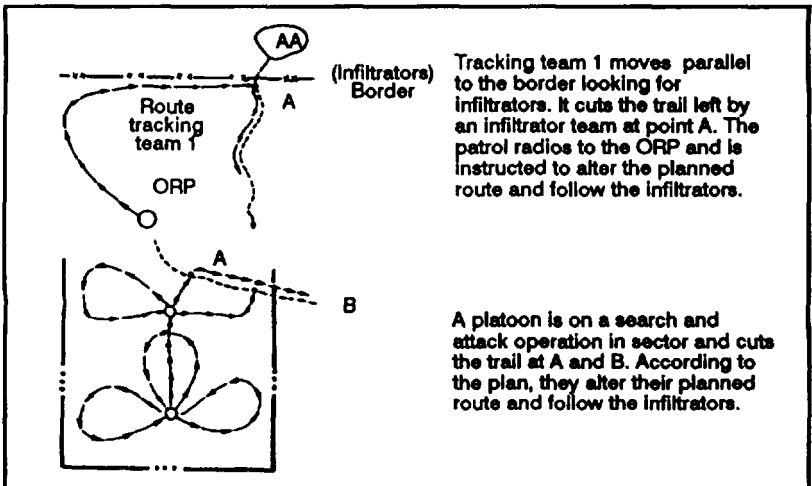

Figure 3-18. Cutting enemy trails.

(2) *Employing common countertracking techniques.* Once the enemy realizes he is being followed, he will try to evade or attack the tracking team (Figure 3-20).

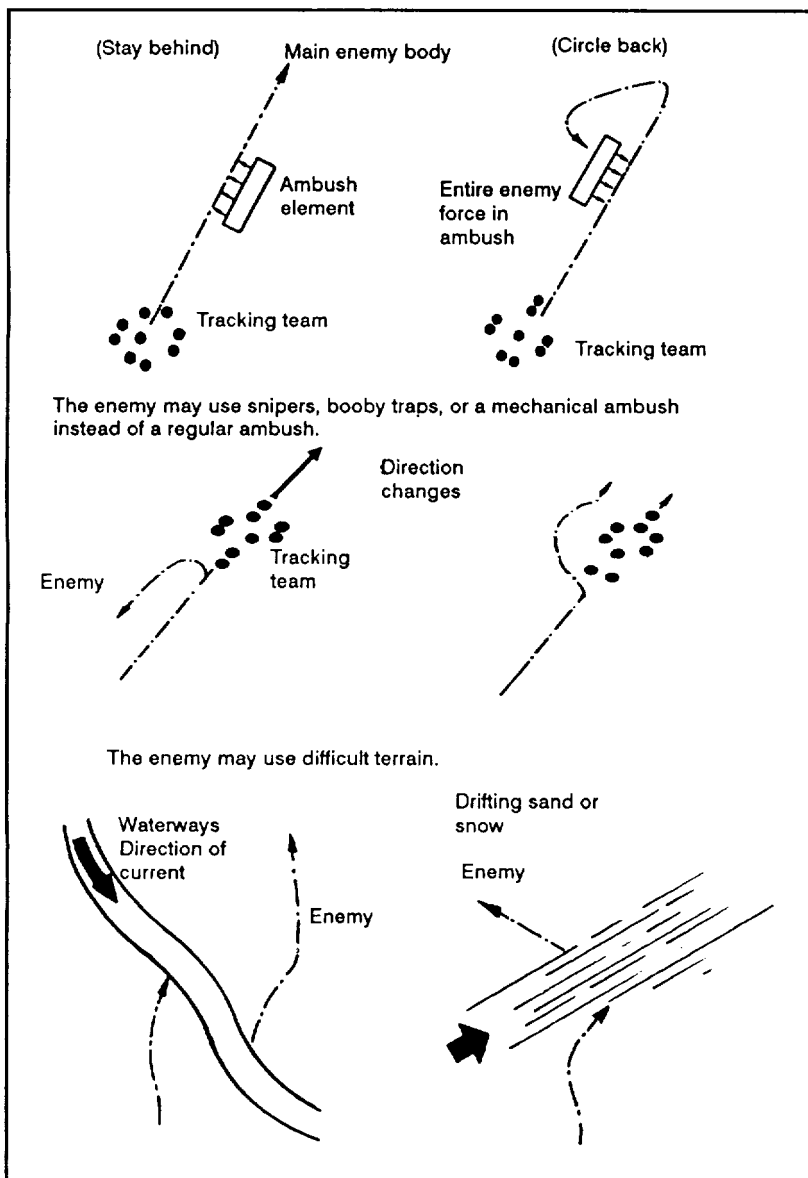
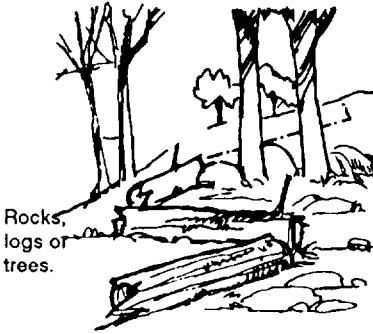
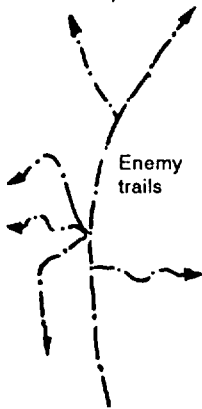

Figure 3-20. Countertracking techniques.



This technique is even more likely to be applied to wide areas where deadfall or rocks predominate; for example, a rock ledge or a blown down area in a large forest.

Sudden dispersal



Gradual dispersal

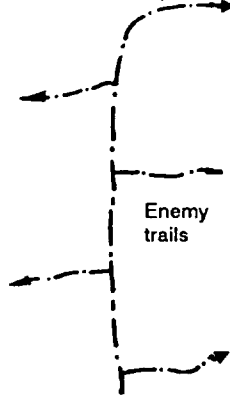

In many cases the enemy will walk backward retracing their footsteps before leaving the trail.

Back tracking

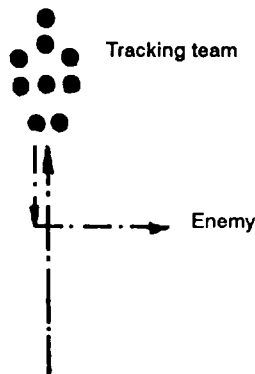

Figure 3-20. Countertracking techniques (continued).

c. **Multiple Patrols.** Two or more tracking teams can be used to track the same enemy unit.

EXAMPLE

1st Squad is tracking the enemy (Figure 3-21). The squad leader informs platoon headquarters (at the ORP) by radio and tells them the estimated size, composition, rate of march, and direction of travel of the enemy. The platoon leader directs 2d Squad on a route that will cut the enemy's trail.

2d Squad marks where they cut the trail (Point A) and begins tracking. The mark is by prearranged signal. It can be a stake driven into the ground, several stacked rocks, or a twist of grass tied up and bent at an angle.

1st Squad continues to follow the trail until it reaches the mark left by 2d Squad. This ensures that the enemy unit is still together and that 2d Squad has found the correct trail. The leader of 1st Squad then requests further orders from the ORP.

When 2d Squad confirms the enemy unit's direction, speed, and estimated distance, 2d Squad gives this information to the ORP. The platoon leader directs 3d Squad (which is patrolling in sector) to set up an ambush along the probable enemy avenue of approach.

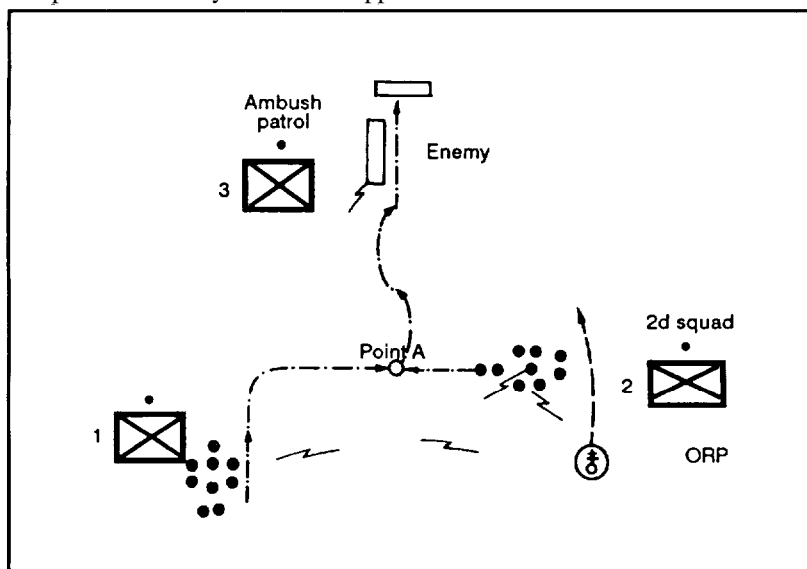

Figure 3-21. Multiple tracking teams.

Section V. PATROL BASES

A patrol base is a position set up when a squad or platoon conducting a patrol halts for an extended period. Patrol bases should be occupied no longer than 24 hours, except in an emergency. The platoon or squad never uses the same patrol base twice. Platoons and squads use patrol bases—

- To stop all movement to avoid detection.
- To hide during a long, detailed reconnaissance of an objective area.
- To eat, clean weapons and equipment, and rest.
- To plan and issue orders.
- To reorganize after infiltrating an enemy area.
- To have a base from which to conduct several consecutive or concurrent operations such as ambush, raid, reconnaissance, or security.

3-30. SITE SELECTION

The leader selects the tentative site from a map or by aerial reconnaissance. The site's suitability must be confirmed; it must be secured before occupation. Plans to establish a patrol base must include selecting an alternate patrol base site. The alternate site is used if the first site is unsuitable or if the patrol must unexpectedly evacuate the first patrol base.

3-31. PLANNING CONSIDERATIONS

Leaders planning for a patrol base must consider the mission and passive and active security measures.

a. **Mission.** A patrol base must be located so it allows the unit to accomplish its mission.

b. **Security Measures.** Security measures involve the following.

(1) The leader selects—

- Terrain that the enemy would probably consider of little tactical value.
- Terrain that is off main lines of drift.
- Difficult terrain that would impede foot movement such as an area of dense vegetation, preferably bushes and trees that spread close to the ground.
- Terrain near a source of water.
- Terrain that can be defended for a short period and that offers good cover and concealment.

- (2) The leader plans for—
- Observation posts.
 - Communication with observation posts.
 - Defense of the patrol base.
 - Withdrawal from the patrol base to include withdrawal routes and a rally point, or rendezvous point or alternate patrol base.
 - A security system to make sure that specific soldiers are awake at all times.
 - **Enforcement** of camouflage, noise, and light discipline.
 - The conduct of required activities with minimum movement and noise.
- (3) The leader avoids-
- Known or suspected enemy positions.
 - Built-up areas.
 - Ridges and hilltops, except as needed for maintaining communication.
 - Roads and trails.
 - Small valleys.

3-32. PATROL BASE OCCUPATION

A patrol base is established using the following steps.

a. The patrol base is reconnoitered and established the same as an ORP or RRP, except that the platoon will enter at a 90-degree turn (Figure 3-22.)

NOTE: This action is METT-T dependent; if there is nothing to be gained by doing this step, then the unit does not do it (for-example, flat desert terrain).

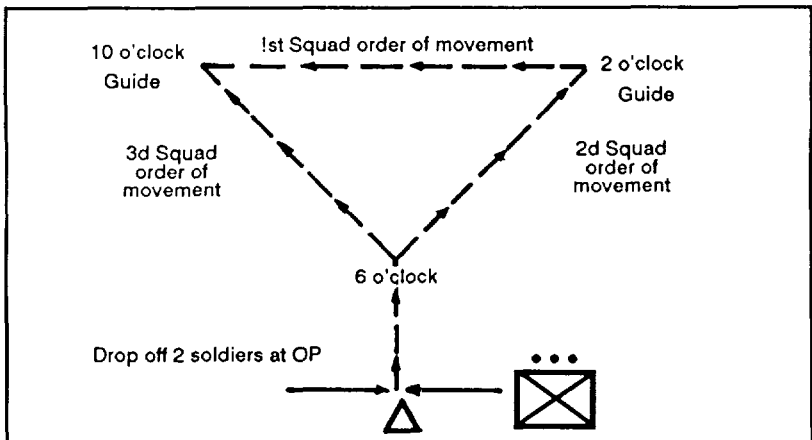

Figure 3-22. Occupation of the patrol base.

b. The platoon leader leaves a two-man OP at the turn. The platoon sergeant and the last fire team will get rid of any tracks from the turn into the patrol base.

c. The platoon moves into the patrol base as depicted in Figure 3-22. (Squads will occupy a cigar-shaped perimeter.)

d. All squad leaders move to the left flank of their squad sector.

e. The platoon leader and support element or weapons squad leader start at 6 o'clock and move in a clockwise manner adjusting the perimeter (meeting each squad leader at his squad's left flank). If the platoon leader and support element leader find a better location for one of the machine guns, they reposition it.

f. After the platoon leader has checked each squad's sector, the squad leader and another squad member report to the CP as an R&S team.

g. The platoon leader issues the three R&S teams a contingency plan and remind them that they are looking for the enemy, water, built-up areas or human habitat, roads and trails, and any possible rally points. (Squads occupying patrol base on their own do not send out R&S teams at night.)

h. The R&S team departs from the left flank of their squad's sector and moves out a given distance, as stated by the platoon leader in his instructions. The team moves in a clockwise direction and reenters the patrol base at the right flank of their squad's sector. The R&S team, if at all possible, should prepare a sketch of the squad's front and report to the CP.

NOTE 1: The distance the R&S team moves away from the squad's sector will vary depending on the terrain and vegetation (anywhere from 200 to 400 meters). All members of the platoon are on 100 percent alert during this time. The R&S team is of little value at night without the use of night vision devices. The RATELO must be able to establish communications with higher headquarters using a directional antenna.

NOTE 2: If the platoon leader feels that the platoon may have been tracked, he may elect to maintain 100 percent security and wait awhile in total silence before sending out the R&S teams.

i. Once all squad leaders (R&S teams) have completed their reconnaissance, they report back to the platoon leader at the CP.

j. The platoon leader gathers the information from his three R&S teams and determines if the platoon is going to be able to use the location as a patrol base.

3-33. PATROL BASE ACTIVITIES

If the platoon leader determines that he will be able to use the location as a patrol base, he gives the following information to his platoon sergeant and squad leaders. Platoon leader also disseminates other information such as daily challenge and password, frequencies, call signs. Squad leaders return to their squads, give out information, and begin the priorities of work as stated by the platoon leader. The patrol base must be sterilized upon departure.

a. **Security.** Only one point of entry and exit is used. Noise and light discipline are maintained at all times. Everyone is challenged. Squad leaders supervise the placement of aiming stakes and ensure Claymores are put out. Each squad establishes an OP and may quietly dig hasty fighting positions. Squad leaders prepare and turn in sector sketches to include range cards.

b. **Alert Plan.** The platoon leader states the alert posture (for example, 50 percent or 33 percent) and the stand-to time for day and night. He sets up the plan to ensure positions are checked periodically, OPs are relieved periodically, and ensure that at least one leader is up at all times.

c. **Withdrawal Plan.** Platoon leader designates which signal to use if contact is made (for example, colored star cluster), the order of withdrawal if forced out (for example, squads not in contact will move first), and the rendezvous point for the platoon (if the platoon is not to link up at an alternate patrol base).

d. **Maintenance Plan.** Platoon leader ensures that machine guns, other weapon systems, communication equipment, NVDs are not broken down at the same time for maintenance. Redistribute ammunition.

NOTE: Weapons are not disassembled at night.

e. **Sanitation and Personal Hygiene Plan.** The platoon sergeant ensures the platoon slit trench is dug and marked at night with a chemical light inside the trench. Squad leaders designate squad urine areas. All soldiers accomplish the following daily: shave; brush teeth; wash face, hands, armpits, groin, and feet; and darken (polish) boots. Soldiers ensure that no trash is left behind.

f. **Mess Plan.** No more than half of the platoon eats at one time.

g. **Water Resupply.** Platoon sergeant organizes a watering party. They carry canteens in an empty rucksack.

NOTE: Squads have the same requirements with their squad patrol base as platoons.

CHAPTER 4

BATTLE DRILLS

Infantry battle drills describe how platoons and squads apply fire and maneuver to commonly encountered situations. They require leaders to make decisions rapidly and to issue brief oral orders quickly.

4-1. DEFINITION

FM 25-101 defines a battle drill as “a collective action rapidly executed without applying a deliberate decision-making process.”

a. Characteristics of a battle drill are—

- They require minimal leader orders to accomplish and are standard throughout the Army.
- Sequential actions are vital to success in combat or critical to preserving life.
- They apply to platoon or smaller units.
- They are trained responses to enemy actions or leader’s orders.
- They represent mental steps followed for offensive and defensive actions in training and combat.

b. A platoons ability to accomplish its mission often depends on soldiers and leaders to execute key actions quickly. All soldiers and their leaders must know their immediate reaction to enemy contact as well as follow-up actions. Drills are limited to situations requiring instantaneous response; therefore, soldiers must execute drills instinctively. This results from continual practice. Drills provide small units with standard procedures essential for building strength and aggressiveness.

- They identify key actions that leaders and soldiers must perform quickly.
- They provide for a smooth transition from one activity to another; for example, from movement to offensive action to defensive action.
- They provide standardized actions that link soldier and collective tasks at platoon level and below. (Soldiers perform individual tasks to CTT or SDT standard.)
- They require the full understanding of each individual and leader, and continual practice.

4-2. FORMAT

The format for drills discussed in this chapter includes the title, the SITUATION that would cue the unit or the leader into initiating the drill, the REQUIRED ACTIONS in sequence, and supporting illustrations. Where applicable drills are cross-referenced with material in other chapters, or other drills, or both. Training standards for battle drills are in the mission training plan (MTP).

BATTLE DRILL I. PLATOON ATTACK

SITUATION: The platoon is moving as part of a larger force conducting a movement to contact or a hasty or deliberate attack.

REQUIRED ACTIONS: (Figure 4-2 see foldout on page 4-7.)

STEP 1. Action on Enemy Contact.

a. **The platoon initiates contact.** The platoon leader plans when and how his base-of-fire element initiates contact with the enemy to establish a base of fire. This element must be in position and briefed before it initiates contact. If the platoon has not been detected, STEPS 1 and 2 consist of positioning the support element and identifying the enemy's positions.

b. **The enemy initiates contact.** If the enemy initiates contact, the platoon takes the following actions:

- (1) The squad in contact reacts to contact (Battle Drill 2). It attempts to achieve suppressive fires with one fire team and maneuvers the other team to attack the enemy in the flank. The squad leader notifies the platoon leader of his action.
- (2) The platoon leader, his RATELO, the platoon FO, the squad leader of the next squad, and one machine gun team move forward to link up with the squad leader of the squad in contact.
- (3) The squad leader of the trail squad moves to the front of his lead fire team.
- (4) The platoon sergeant moves forward with the second machine gun team and links up with the platoon leader. If directed, he assumes control of the base-of-fire element and positions the machine guns to add suppressive fires against the enemy.
- (5) The platoon leader assesses the situation. He follows the success of the squad's flank attack by leading the trail squads along the covered and concealed route taken by the assaulting fire team of the squad in contact.
- (6) If the squad in contact cannot achieve suppressive fire, the squad leader reports to the platoon leader.

- (a) The squad in contact establishes a base of fire. The squad leader deploys his squad to provide effective, sustained fires on the enemy position. The squad leader reports his final position to the platoon leader.
- (b) The remaining squads (not in contact) take up covered and concealed positions in place and observe to the flanks and rear of the platoon.
- (c) The platoon leader moves forward with his RATELO, the platoon FO, the squad leader of the nearest squad, and one machine gun team.

STEP 2. Locate the Enemy.

- a. The squad leader of the squad in contact reports the enemy size and location, and any other information to the platoon leader. The platoon leader completes the squad leader's assessment of the situation.
- b. The squad continues to engage the enemy's position.
- c. The platoon sergeant moves forward with the second machine gun team and links up with the platoon leader.

STEP 3. Suppress the Enemy.

- a. The platoon leader determines if the squad in contact can gain suppressive fire against the enemy based on the volume and accuracy of the enemy's return fire.
 - (1) If the answer is **YES**, he directs the squad (with one or both machine guns) to continue suppressing the enemy
 - (a) The squad in contact destroys or suppresses enemy weapons that are firing most effectively against it; normally crew-served weapons.
 - (b) The squad in contact places screening smoke (M203) to prevent the enemy from seeing the maneuver element.
 - (2) If the answer is **NO**, the platoon leader deploys another squad and the second machine gun team to suppress the enemy position. (The platoon leader may direct the platoon sergeant to position this squad and one or both machine gun teams in a better support-by-fire position.)
- b. The platoon leader again determines if the platoon can gain suppressive fires against the enemy.
 - (1) If the answer is **YES**, he continues to suppress the enemy with the two squads and two machine guns.
 - (a) The platoon sergeant assumes control of the base-of-fire element (squad in contact, the machine gun teams, and any other squads designated by the platoon leader).

- (b) The machine gun team takes up a covered and concealed position and suppresses the enemy position.
 - (c) The platoon FO calls for and adjusts fires based on the platoon leader's directions. (The platoon leader does not wait for indirect fires before continuing with his actions.)
- (2) If the answer is still **NO**, the platoon leader deploys the last squad to provide flank and rear security and to guide the rest of the company forward as necessary, and reports the situation to the company commander. Normally the platoon will become the base-of-fire element for the company and may deploy the last squad to add suppressive fires. The platoon continues to suppress or fix the enemy with direct and indirect fire, and responds to orders from the company commander.

STEP 4. Attack.

If the squad(s) in contact together with the machine gun(s) can suppress the enemy, the platoon leader determines if the remaining squad(s) not in contact can maneuver. He makes the following assessment:

- Location of enemy positions and obstacles.
- Size of enemy force engaging the squad. (The number of enemy automatic weapons, the presence of any vehicles, and the employment of indirect fires are indicators of enemy strength.)
- Vulnerable flank.
- Covered and concealed flanking route to the enemy position.

a. If the answer is **YES**, the platoon leader maneuvers the squad(s) into the assault:

- (1) Once the platoon leader has ensured that the base-of-fire element is in position and providing suppressive fires, he leads the assaulting squad(s) to the assault position.
- (2) Once in position, the platoon leader gives the prearranged signal for the base-of-fire element to lift or shift direct fires to the opposite flank of the enemy position. (The assault element **MUST** pickup and maintain effective fires throughout the assault. Handover of responsibility for direct fires from the base-of-fire element to the assault element is critical.)
- (3) The platoon FO shifts indirect fires to isolate the enemy position.
- (4) The assaulting squad(s) fight through enemy positions using fire and maneuver. The platoon leader controls the movement of his squads. He assigns specific objectives for each squad and designates the main effort or base maneuver element. (The base-of-fire element must be able to identify the near flank of the assaulting squad(s).)

(5) In the assault, the squad leader determines the way in which he will move the elements of his squad based on the volume and accuracy of enemy fire against his squad and the amount of cover afforded by the terrain. (Figure 4-1.) In all cases, each soldier uses individual movement techniques as appropriate.

(a) The squad leader designates one fire team to support the movement of the other team by fires.

(b) The squad leader designates a distance or direction for the team to move. He accompanies one of the fire teams.

(c) Soldiers must maintain contact with team members and leaders.

(d) Soldiers time their firing and reloading in order to sustain their rate of fire.

(e) The moving fire team proceeds to the next covered position. Teams use the wedge formation when assaulting. Soldiers move in rushes or by crawling.

(f) The squad leader directs the next team to move.

(g) If necessary, the team leader directs soldiers to bound forward as individuals within buddy teams. Soldiers coordinate their movement and fires with each other within the buddy team. They maintain contact with their team leader.

(h) Soldiers fire from covered positions. They select the next covered position before moving. They either rush forward (no more than 5 seconds), or use high or low crawl techniques based on terrain and enemy fires.

b. If the answer is **NO**, or the assaulting squad(s) cannot continue to move, the platoon leader deploys the squad(s) to suppress the enemy and reports to the company commander. The platoon continues suppressing enemy positions and responds to the orders of the company commander.

STEP 5. Consolidate and Reorganize.

a. **Consolidate.** Once the assaulting squad(s) has seized the enemy position, the platoon leader establishes local security. (The platoon must prepare to defeat an enemy counterattack. The platoon is most vulnerable at the conclusion of the assault.)

(1) The platoon leader signals for the base-of-fire element to move up into designated positions.

(2) The platoon leader assigns sectors of fire for each squad.

(3) The platoon leader positions keys weapons to cover the most dangerous avenue(s) of approach.

(4) The platoon sergeant begins coordination for ammunition resupply.

- (5) Soldiers take up hasty defensive positions.
- (6) The platoon leader and his FO develop a quick fire plan.
- (7) The squads place out OPs to warn of enemy counterattacks.

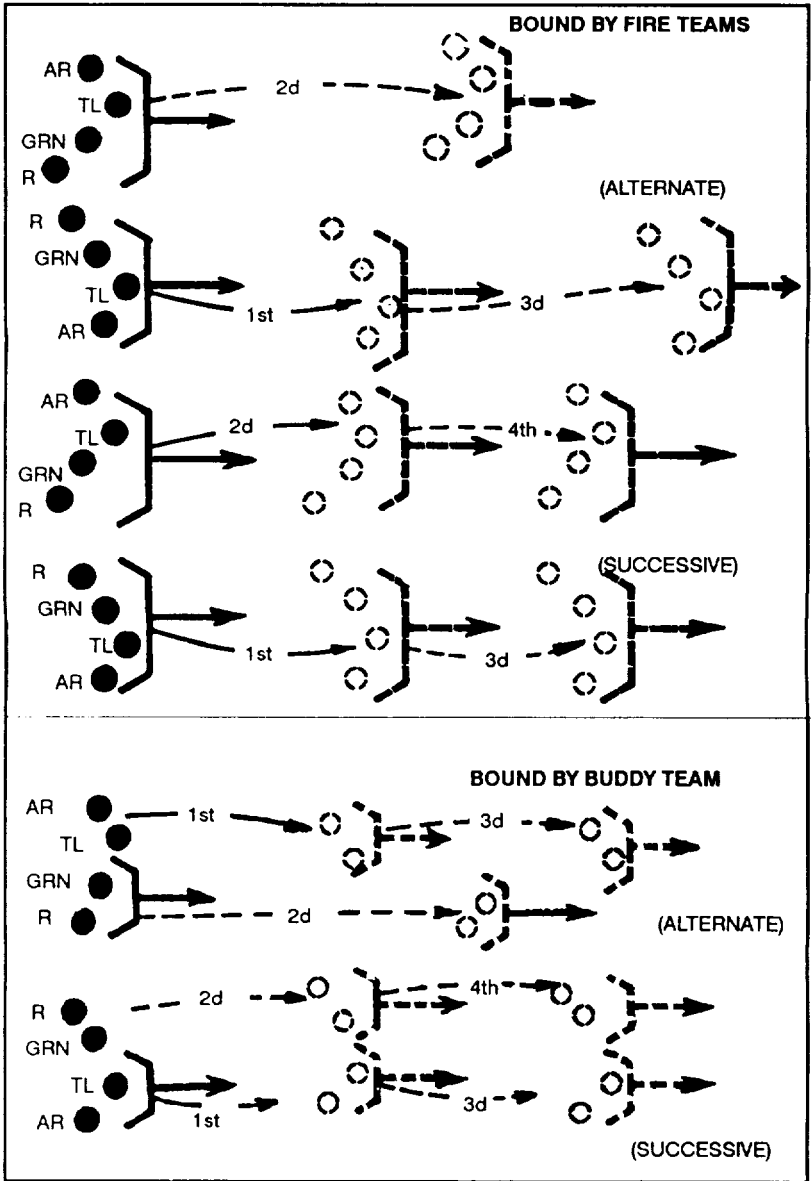

Figure 4-1. Movement to assault.

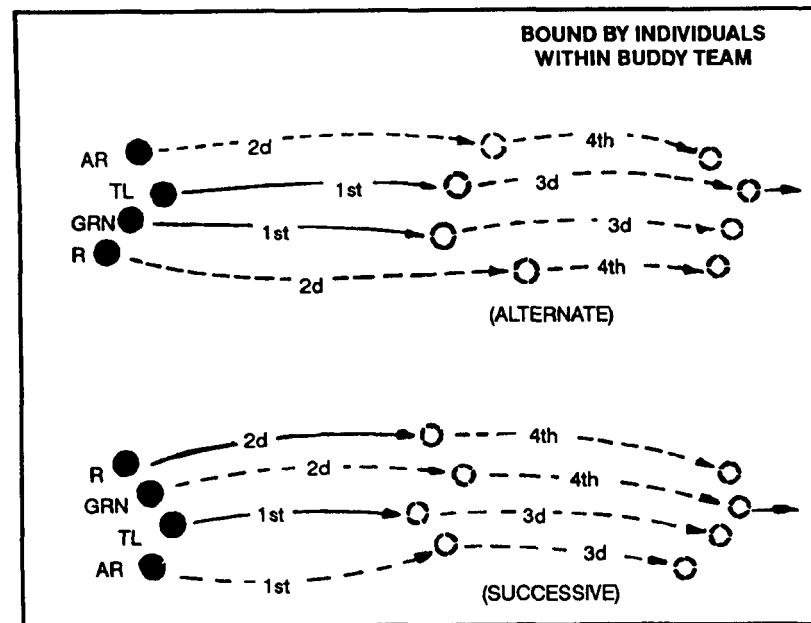

Figure 4-1. Movement in the assault (continued).

b. Reorganize.

(1) The platoon performs the following tasks (only after it completes the consolidation of the objective):

- (a) Reestablish the chain of command.
- (b) Redistribute and resupply ammunition.
- (c) Man crew-served weapons first.
- (d) Redistribute critical equipment (radios, NBC, NVDs).
- (e) Treat casualties and evacuate wounded.
- (f) Fill vacancies in key positions.
- (g) Search, silence, segregate, safeguard, and speed EPWs to collection points.
- (h) Collect and report enemy information and materiel.

(2) Squad leaders provide ammunition, casualty, and equipment (ACE) reports to the platoon leader.

(3) The platoon leader consolidates ACE reports and passes them to the company commander (or XO).

(4) The platoon continues the mission after receiving guidance from the company commander. The company follows the success of the platoon's flanking attack.

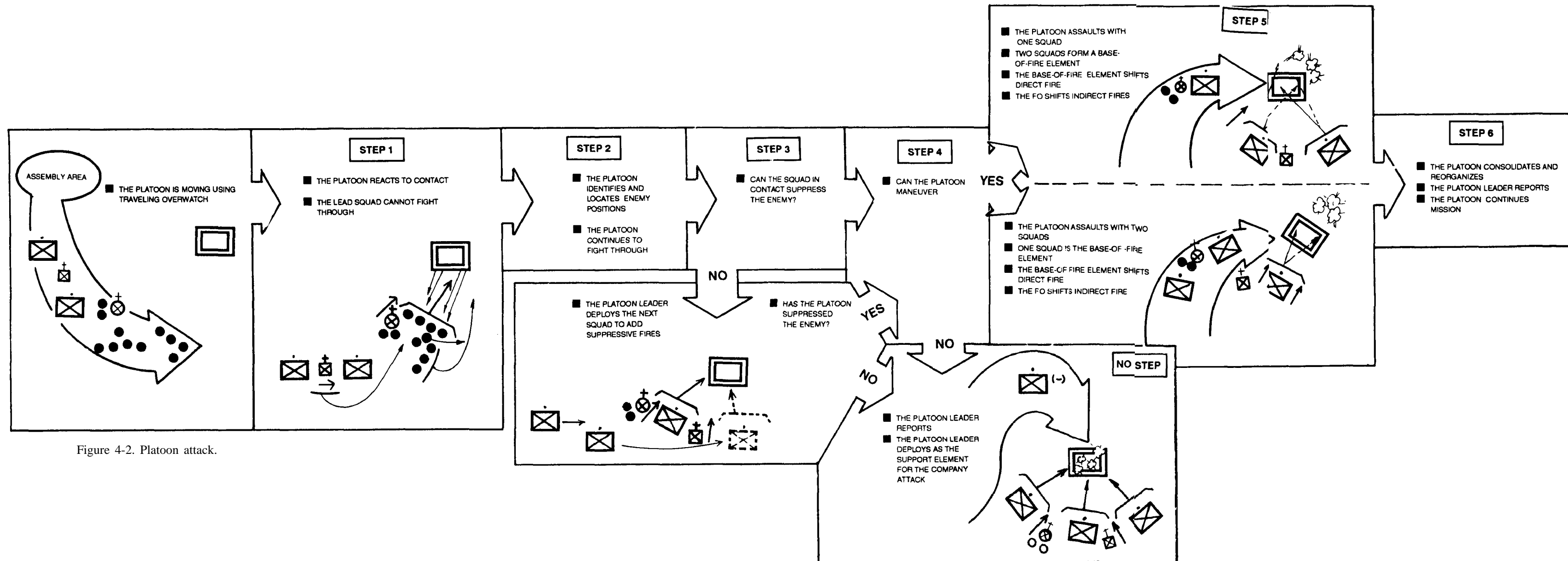

Figure 4-2. Platoon attack.

BATTLE DRILL 1A. SQUAD ATTACK

SITUATION: The squad is moving as part of the platoon conducting a movement to contact or a hasty or deliberate attack.

REQUIRED ACTIONS: (Figure 4-3):

STEP 1. Action on Enemy Contact.

a. Soldiers receiving fire take up nearest positions that afford protection from enemy fire (cover) and observation (concealment).

b. The fire team in contact immediately returns heavy volume of suppressive fire in the direction of the enemy.

(1) Soldiers in the fire team in contact move to positions (bound or crawl) from which they can fire their weapons, position themselves to ensure that they have observation, fields of fire, cover, and concealment. They continue to fire and report known or suspected enemy positions to the fire team leader.

(2) The team leader directs fires using tracers or standard fire commands.

(3) The fire team not in contact takes covered and concealed positions in place and observes to the flanks and rear of the squad.

(4) The squad leader reports contact to the platoon leader and moves toward the fire team in contact.

STEP 2. Locate the Enemy.

a. Using sight and sound, the fire team in contact acquires known or suspected enemy positions.

b. The fire team in contact begins to place well-aimed fire on suspected enemy positions.

c. The squad leader moves to a position where he can observe the enemy and assess the situation.

d. The squad leader requests, through the platoon leader, for immediate suppression indirect fires (normally 60-mm mortars).

e. The squad leader reports the enemy size and location, and any other information to the platoon leader. (As the platoon leader comes forward, he completes the squad leader's assessment of the situation.)

STEP 3. Suppress the Enemy.

The squad leader determines if the fire team in contact can gain suppressive fire based on the volume and accuracy of the enemy fire.

a. If the answer is YES, the fire team leader continues to suppress the enemy:

- (1) The fire team destroys or suppresses enemy crew-served weapons first.
- (2) The fire team places smoke (M203) on the enemy position to obscure it.
- (3) The fire team leader continues to control fires using tracers or standard fire commands. Fires must be well-aimed and continue at a sustained rate with no lulls.
- (4) Buddy teams fire their weapons so that both are not reloading their weapons at the same time.

b. If the answer is **NO**, the squad leader then deploys the fire team not in contact to establish a support-by-tire position. He reports the situation to the platoon leader. Normally, the squad will become the base-of-fire element for the platoon. The squad continues to suppress the enemy and responds to orders from the platoon leader. (The platoon leader, his RATELO, the platoon FO, one machine gun team, and the squad leader of the next squad, as well as the platoon sergeant and the other machine gun team, are already moving forward IAW Battle Drill 1, Platoon Attack.)

STEP 4. Attack.

If the fire team in contact can suppress the enemy, the squad leader determines if the fire team not in contact can maneuver. He makes the following assessment:

- Location of enemy position(s) and obstacles.
- Size of enemy force engaging the squad. (The number of enemy automatic weapons, the presence of any vehicles, and the employment of indirect fires are indicators of enemy strength.)
- Vulnerable flank.
- Covered and concealed flanking route to the enemy position.

a. If the answer is **YES**, the squad leader maneuvers the fire team in the assault:

- (1) The squad leader directs the fire team in contact to support the movement of the other fire team. He then leads or directs the assaulting fire team leader to maneuver his fire team along a route that places the fire team in a position to assault the enemy. (The assaulting fire team must pick up and maintain fire superiority throughout the assault. Handover of responsibility for direct fires from the supporting fire team to the assaulting fire team is critical.)
- (2) Once in position, the squad leader gives the prearranged signal for the supporting fire team to lift fires or shift fires to the opposite flank of the enemy position.

(3) **The assaulting fire team fights through enemy positions using fire and movement.** (The supporting fire team must be able to identify the near flank of the assaulting fire team.)

(a) The team leader selects the route that allows him to reach his objective, while providing the best available cover and concealment for his team. The team leader then leads his team, from up front, in a shallow wedge throughout the attack.

(b) Fire team members conduct individual movement techniques as individuals or buddy teams, while maintaining their relative position in the assault formation. At the end of each move, soldiers take up covered and concealed positions and resume firing.

b. If the answer is **NO** or the assaulting fire team cannot continue to move, the squad leader deploys the assaulting fire team to add its fires against the enemy, reports to the platoon leader and requests instructions. The squad continues suppressing enemy positions and responds to the orders of the platoon leader.

STEP 5. Consolidate and Reorganize.

a. Once the assaulting fire team has seized the enemy position, the squad leader establishes local security. (The squad leader must quickly prepare to defeat any enemy counterattack. At the conclusion of the assault, the squad is most vulnerable.)

(1) The squad leader signals for the supporting fire team to move up into a designated position.

(2) The squad leader assigns sectors of fire for both fire teams.

(3) The squad leader positions key weapons.

(4) All soldiers take up hasty defensive positions.

(5) The squad leader develops an initial fire support plan against an enemy counterattack. (As the platoon moves up, he hands the plan to the platoon leader for further development.)

(6) The squad leader posts an OP to warn of enemy activity.

b. The squad performs the following tasks:

(1) Reestablish the chain of command.

(2) Redistribute and resupply ammunition.

(3) Man crew-served weapons first.

(4) Redistribute critical equipment (for example, radios, NBC, NVDs).

(5) Treat casualties and evacuate wounded.

(6) Fill vacancies in key positions.

(7) Search, silence, segregate, safeguard, and speed EPWs to collection points.

(8) Collect and report enemy information and materiel.

- c. Team leaders provide ammunition, casualty, and equipment (ACE) reports to the squad leader.
- d. The squad leader consolidates the ACE report and passes it to the platoon leader (or platoon sergeant).
- e. The squad continues the mission after receiving instructions from the platoon leader. (The platoon follows the success of the squad's flanking attack with the remaining squads as part of the platoon attack.)
- f. The squad leader reports the situation to the platoon leader.

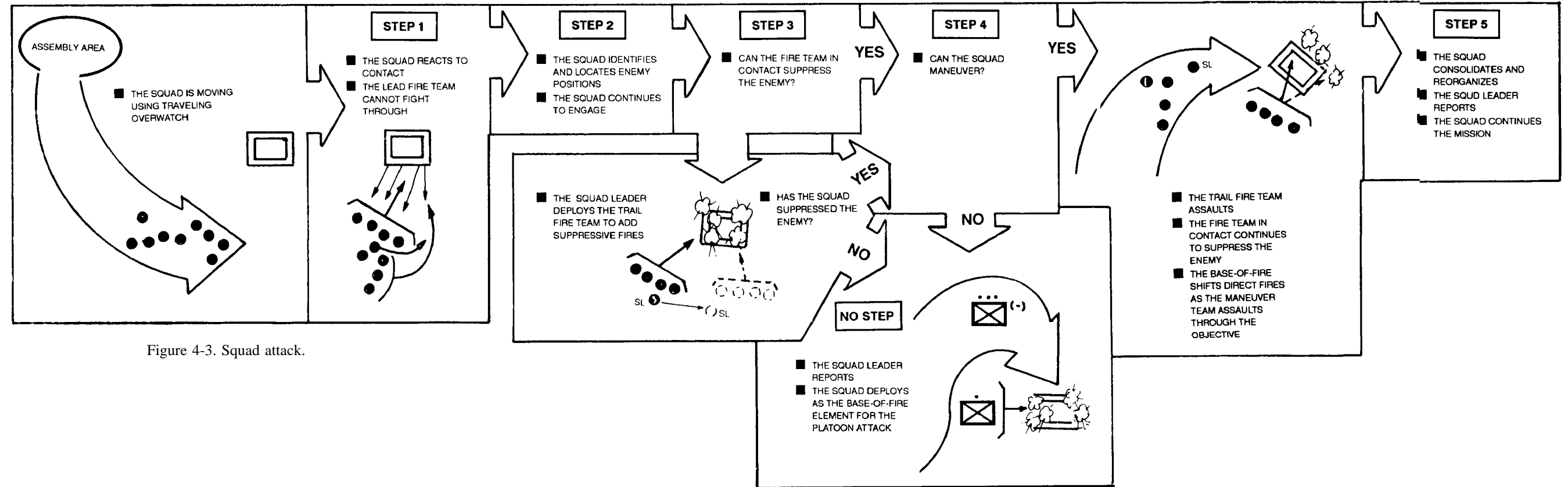

Figure 4-3. Squad attack.

BATTLE DRILL 2. REACT TO CONTACT

SITUATION: A squad or platoon receives fires from enemy individual or crew-served weapons.

REQUIRED ACTIONS: (Figure 4-4.)

1. Soldiers immediately take up the nearest covered positions and return fire in the direction of contact.

2. Team/squad leaders locate and engage known or suspected enemy positions with well-aimed fire, and pass information to the squad/platoon leader.

3. Fire team leaders control fire using standard fire commands (initial and supplemental) containing the following elements:

- Alert.
- Direction.
- Description of target.
- Range.
- Method of fire (manipulation, and rate of fire).
- Command to commence firing.

4. Soldiers maintain contact with the soldiers on their left and right.

5. Soldiers maintain contact with their team leaders and report the location of enemy positions.

6. Leaders check the status of their personnel.

7. The team/squad leaders maintain contact with the squad/platoon leader.

8. The squad/platoon leader—

a. Moves up to the fire team/squad in contact and links up with its leader. (The platoon leader brings his RATELO, platoon FO, the squad leader of the nearest squad, and one machine gun team. The squad leader of the trail squad moves to the front of his lead fire team. The platoon sergeant also moves forward with the second machine gun team and links up with the platoon leader, ready to assume control of the base-of-fire element.)

b. Determines whether or not his squad/platoon must move out of an engagement area.

c. Determines whether or not he can gain and maintain suppressive fires with his element already in contact (based on the volume and accuracy of enemy fires against the element in contact).

d. Makes an assessment of the situation. He identifies—

- The location of the enemy position and obstacles.
- The size of the enemy force. (The number of enemy automatic weapons, the presence

of any vehicles, and the employment of indirect fires are indicators of the enemy strength.)

- Vulnerable flanks.
- Covered and concealed flanking routes to the enemy position.

e. Determines the next course of action (for example, fire and movement, assault, breach, knock out bunker, enter and clear a building or trench).

f. Reports the situation to the platoon leader/company commander and begins to maneuver.

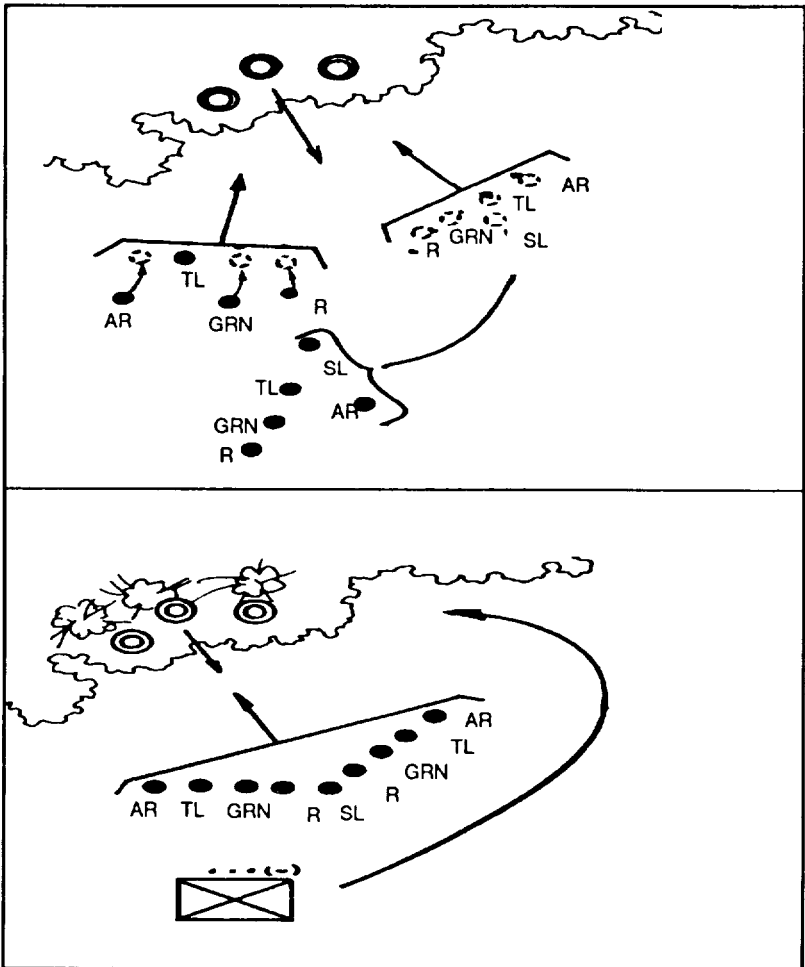

Figure 4-4. React to contact.

g. Calls for and adjusts indirect fire (mortars or artillery). (Squad leaders relay requests through the platoon leader.)

9. Team leaders lead their teams by example; for example, "Follow me, do as I do."

10. Leaders relay all commands and signals from the platoon chain of command.

BATTLE DRILL 3. BREAK CONTACT

SITUATION: The squad/platoon is under enemy fire and must break contact.

REQUIRED ACTIONS: (Figure 4-5.)

1. The squad/platoon leader directs one fire team/squad in contact to support the disengagement of the remainder of the unit.

2. The squad/platoon leader orders a distance and direction, or a terrain feature, or last objective rally point for the movement of the first fire team/squad.

3. The base of fire (fire team/squad) continues to suppress the enemy.

4. The moving element uses fragmentation, concussion, and smoke grenades to mask its movement.

5. The moving element takes up the designated position and engages the enemy position.

6. The platoon leader directs the base-of-fire element to move to its next location. (Based on the terrain and the volume and accuracy of the enemy's fire, the moving fire team/squad may need to use fire and movement techniques.)

7. The squad/platoon continues to bound away from the enemy until (the squad/platoon must continue to suppress the enemy as it breaks contact)-

- It breaks contact.
- It passes through a higher level support-by-fire position.
- Its fire teams/squads are in the assigned position to conduct the next mission.

8. The leader should consider changing the direction of movement once contact is broken. This will reduce the ability of the enemy to place effective indirect fires on the unit.

9. If the squad or platoon becomes disrupted, soldiers stay together and move to the last designated rally point.

10. Squad/platoon leaders account for soldiers, report, reorganize as necessary and continue the mission.

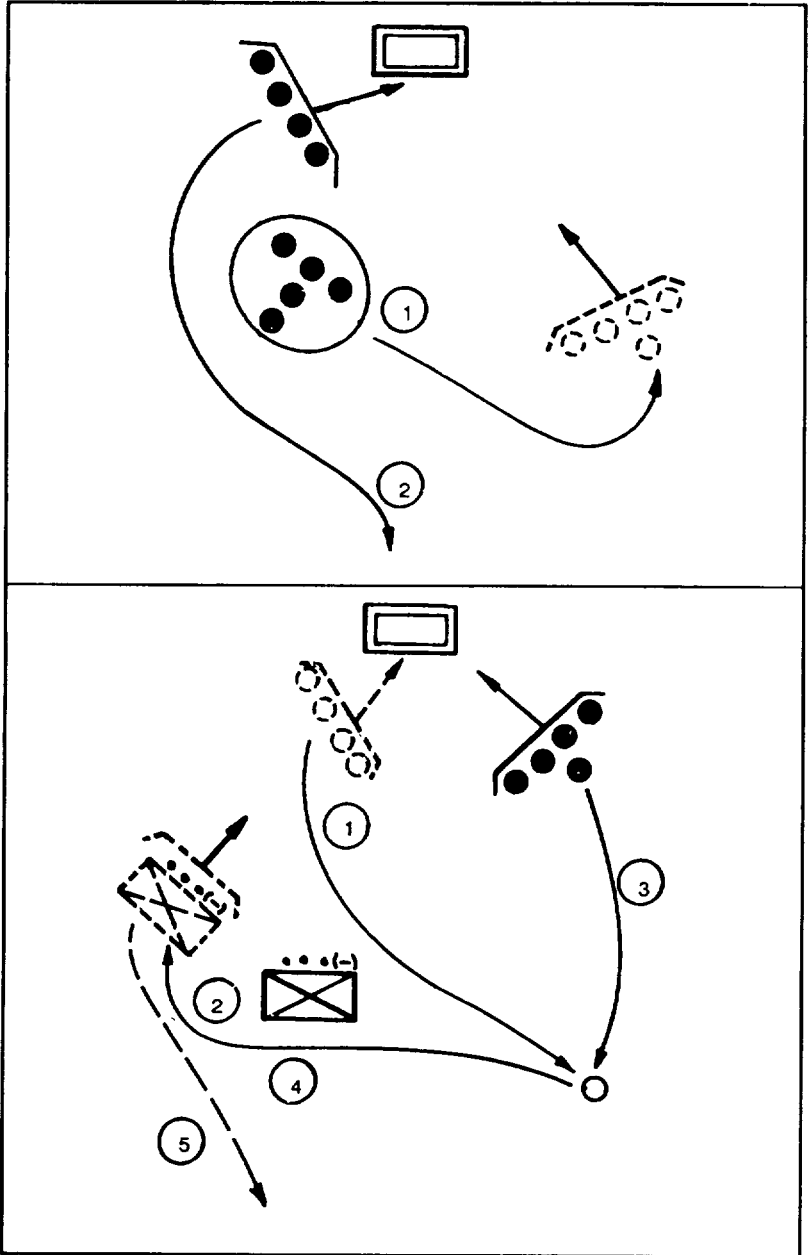

Figure 4-5. Break contact.

BATTLE DRILL 4. RACT TO AMBUSH

SITUATION: If the squad/platoon enters a kill zone and the enemy initiates an ambush with a casualty-producing device and a high volume of fire, the unit takes the following actions.

REQUIRED ACTIONS: (Figure 4-6.)

1. In a near ambush (within hand-grenade range), soldiers receiving fire immediately return fire, take up covered positions, and throw fragmentation concussion, and smoke grenades.

a. Immediately after the grenades detonate, soldiers in the kill zone assault through the ambush using fire and movement.

b. Soldiers not in the kill zone immediately—

- Identify enemy positions.
- Initiate immediate suppressive fires against the enemy.
- Take up covered positions.
- Shift fires as the soldiers in the kill zone assault through the ambush.

2. In a far ambush (beyond hand-grenade range). soldiers receiving fire immediately return fire, take up covered positions, and suppress the enemy by—

- Destroying or suppressing enemy crew-served weapons first.
- Obscuring the enemy position with smoke (M203).
- Sustaining suppressive fires.

a. Soldiers (teams/squads) not receiving fires move by a covered and concealed route to a vulnerable flank of the enemy position and assault using fire and movement techniques.

b. Soldiers in the kill zone continue suppressive fires and shift fires as the assaulting team/squad fights through the enemy position.

3. The platoon FO calls for and adjusts indirect fires as directed by the platoon leader. On order, he lifts fires or shifts them to isolate the enemy position, or to attack them with indirect fires as they retreat.

4. The squad/platoon leader reports, reorganizes as necessary, and continues the mission.

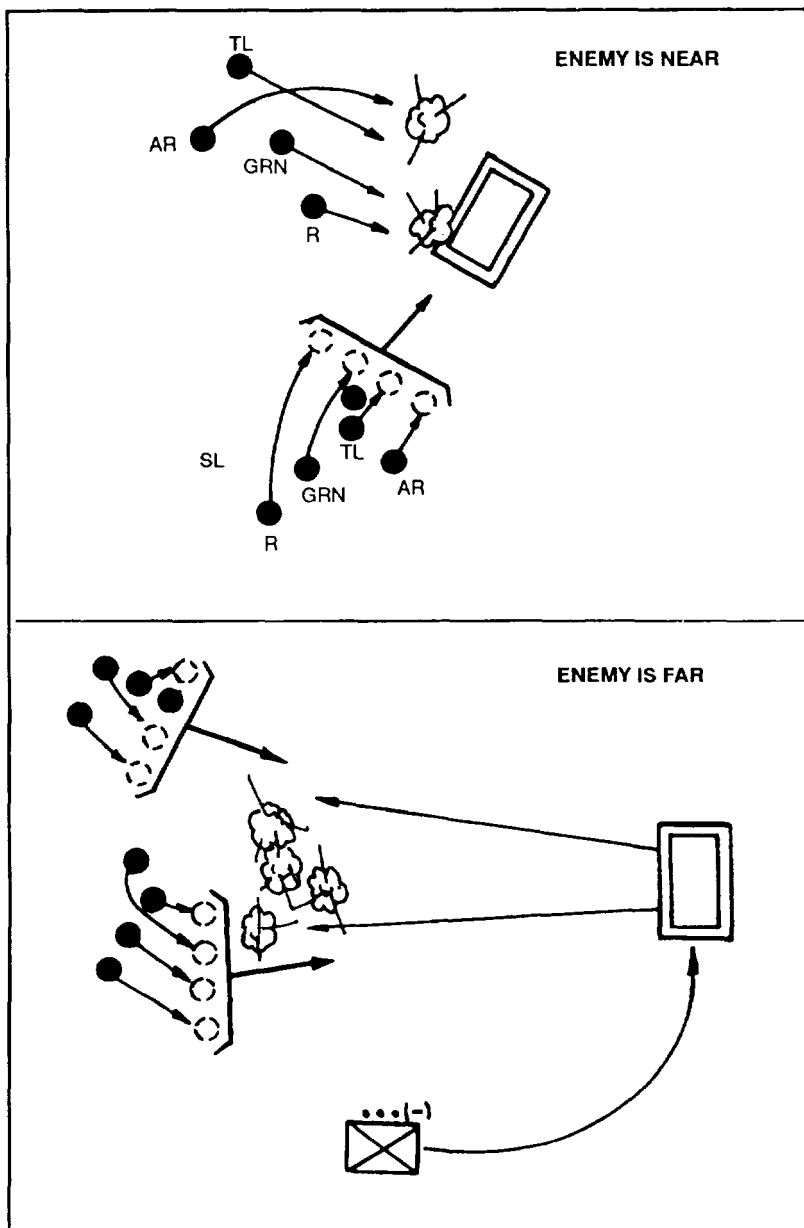

Figure 4-6. React to ambush.

BATTLE DRILL 5. KNOCK OUT BUNKERS

SITUATION: The platoon identifies enemy in bunkers while moving as a part of a larger force.

REQUIRED ACTIONS: (Figures 4-7 and 4-8.)

1. The platoon initiates contact:
 - a. The squad in contact establishes a base of fire.
 - b. The platoon leader, his RATELO, platoon FO, and one machine gun team move forward to link up with the squad leader of the squad in contact.
 - c. The platoon sergeant moves forward with the second machine gun team and assumes control of the base-of-fire element.
 - d. The base-of-fire element—
 - (1) Destroys or suppresses enemy crew-served weapons first.
 - (2) Obscures the enemy position with smoke (M203).
 - (3) Sustains suppressive fires at the lowest possible level.
 - e. The platoon FO calls for and adjusts indirect fires as directed by the platoon sergeant.
2. The platoon leader determines that he can maneuver by identifying—
 - a. The enemy bunkers, other supporting positions, and any obstacles.
 - b. The size of the enemy force engaging the platoon. (The number of enemy automatic weapons, the presence of any vehicles, and the employment of indirect fires arc indicators of enemy strength.)
 - c. A vulnerable flank of at least one bunker.
 - d. A covered and concealed flanking route to the flank of the bunker.
3. The platoon leader determines which bunker is to be assaulted first and directs one squad (not in contact) to knock it out.
4. If necessary, the platoon sergeant repositions a squad, fire team, or machine gun team to isolate the bunker as well as to continue suppressive fires.
5. The assaulting squad, with the platoon leader and his RATELO, move along the covered and concealed route and take action to knock out the bunker.
 - a. The squad leader moves with the assaulting fire team along the covered and concealed route to the flank of the bunker.
 - (1) The assaulting fire team approaches the bunker from its blind side and does not mask the fires of the base-of-fire element.
 - (2) Soldiers constantly watch for other bunkers or enemy positions in support of it.

b. Upon reaching the last covered and concealed position—

(1) The fire team leader and the automatic rifleman remain in place and add their fires to suppressing the bunker (includes the use of LAW/AT4s).

(2) The squad leader positions himself where he can best control his teams. On the squad leader's signal, the base-of-fire element lifts fires or shifts fires to the opposite side of the bunker from the assaulting fire team's approach.

(3) The grenadier and rifleman continue forward to the blind side of the bunker. One soldier takes up a covered position near the exit, while one soldier cooks off (two seconds maximum) a grenade, shouts FRAG OUT, and throws it through an aperture.

(4) After the grenade detonates, the soldier covering the exit enters the bunker, firing short bursts, to destroy the enemy. The soldier who throws the grenade should not be the first one to clear the bunker.

c. The squad leader inspects the bunker to ensure that it has been destroyed. He reports, reorganizes as needed, and continues the mission. The platoon follows the success of the attack against the bunker and continues the attack of other bunkers.

6. The platoon leader repositions base-of-fire squads as necessary to continue to isolate and suppress the remaining bunkers, and maintain suppressive fires.

7. The platoon leader either redesignates one of the base-of-fire squads to move up and knock out the next bunker; or, directs the assaulting squad to continue and knock out the next bunker.

NOTE: The platoon leader must consider the condition of his assaulting squad(s) (ammunition and exhaustion) and rotate squads as necessary.

a. On the platoon leader's signal, the base-of-fire element lifts fires or shifts fires to the opposite side of the bunker from which the squad is assaulting.

b. At the same time, the platoon FO shifts indirect fires to isolate enemy positions.

8. The assaulting squad takes action to knock out the next bunker (see paragraph 5, above).

9. The platoon leader reports, reorganizes as necessary, and continues the mission. The company follows up the success of the platoon attack and continues to assault enemy positions.

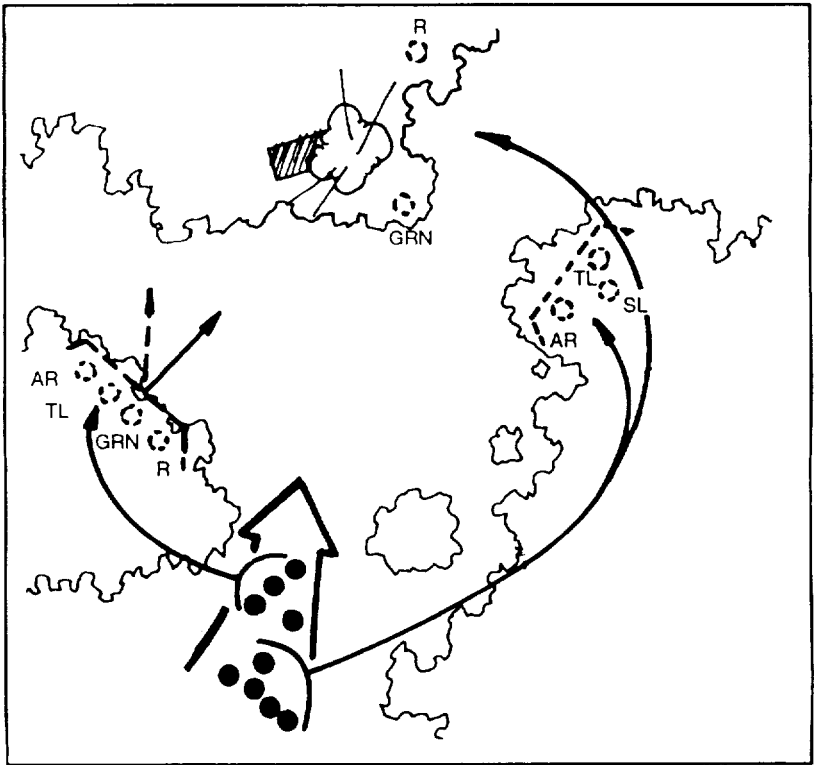

Figure 4-7. Knock out bunker (squad).

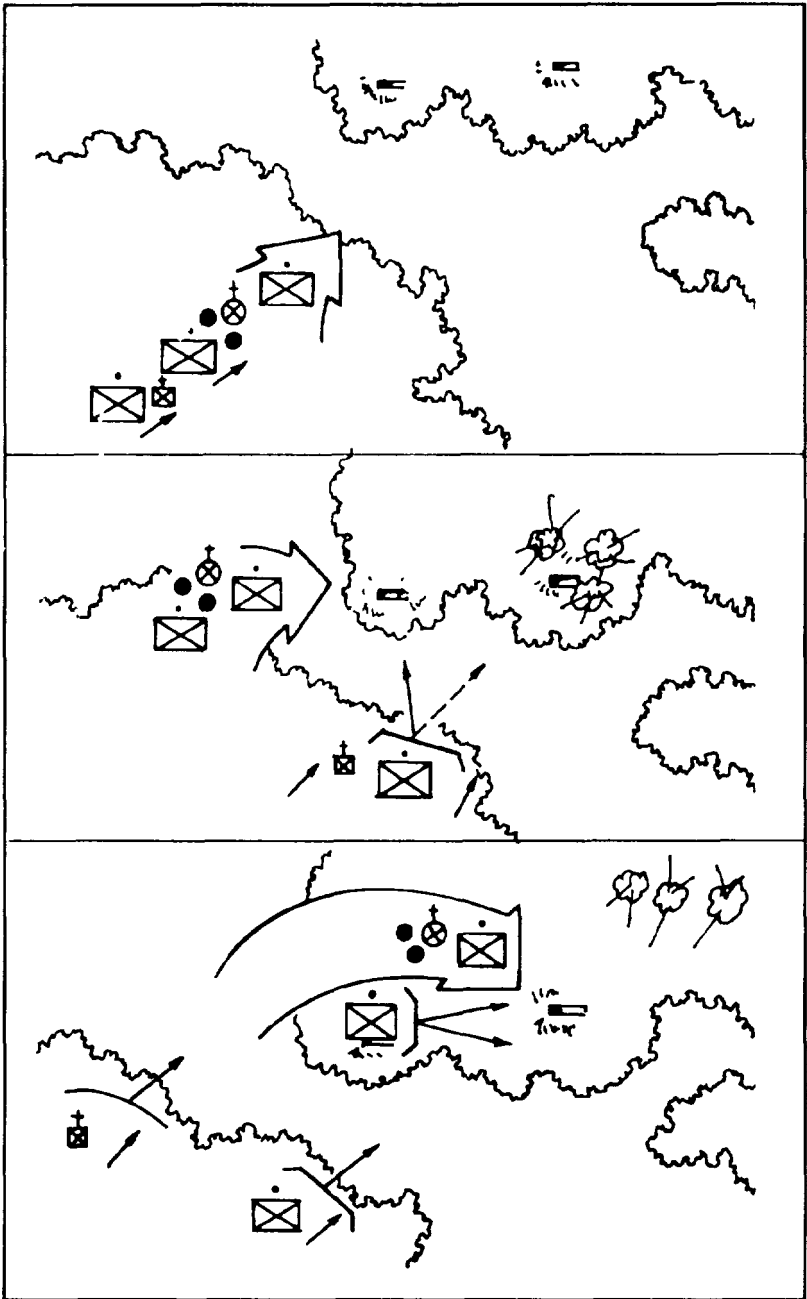

Figure 4-8. Knock out bunkers (platoon).

BATTLE DRILL 6. ENTER BUILDING/CLEAR ROOM

SITUATION: Operating as part of a larger force, the squad is moving and identifies an enemy force in a building.

REQUIRED ACTIONS: (Figures 4-9 and 4-10.)

NOTE: The discussion that follows assumes that the infantry squad is supported only by the platoon's organic weapons. The preferred method of entering a building is to use a tank main gun round; direct-fire artillery round; or TOW, Dragon, or Hellfire missile to clear the first room. Additionally, some MOUT situations may require precise application of firepower. This is true of a MOUT environment where the enemy is mixed with noncombatants. The presence of civilians can restrict the use of fires and reduce the combat power available to a platoon leader. His platoon may have to operate with "no fire" areas. Rules of engagement (ROE) can prohibit the use of certain weapons until a specific hostile action takes place. The use of hand grenades and suppressive fire to enter rooms may be prohibited to preclude noncombatant casualties and collateral damage. All leaders must be aware of the ROE. They must include the precise use of weapons in their planning for MOUT missions. This includes how the platoon will employ its organic weapons including snipers and other weapon systems it may have in support; for example, AC 130 or AH 64 aircraft. They must coordinate the use of marking systems to prevent casualties due to friendly fire. FM 90-10 and FM 90-10-1 provide additional techniques for platoons and squads in MOUT.

1. The fire team initiating contact establishes a base of fire and suppresses the enemy in and around the building.
2. The squad leader determines that he can maneuver by indentifying—
 - a. The building and any obstacles.
 - b. The size of the enemy force engaging the squad.
 - c. An entry point. (Assaulting fire teams should enter the building at the highest level possible.)
 - d. A covered and concealed route to the entry point.
3. The fire team in contact—
 - a. Destroys or suppresses enemy crew-served weapons first.
 - b. Obscures the enemy position with smoke (M203).
 - c. Sustains suppressive fires.
4. The squad leader directs the fire team in contact to support the entry of the other fire team into the building.

5. If necessary, the supporting fire team repositions to isolate the building as well as continue suppressive fires. (Normally, the platoon has added its supporting fires against the enemy.)

6. The squad leader designates the entry point of the building. The platoon and squad shift direct fires and continue to suppress the enemy in adjacent positions and to isolate the building. The platoon FO lifts indirect fires or shifts them beyond the building.

7. The squad leader and the assaulting fire team approach the building and position themselves at either side of the entrance. (Soldiers should avoid entering buildings through doors and windows, because they will normally be covered by enemy weapons inside the building.)

8. Allowing cook-off time (two seconds maximum), and shouting FRAG OUT, the lead soldier of the assaulting fire team prepares and throws a grenade into the building.

DANGER

If walls and floors are thin, they do not provide protection from hand grenade fragments.

9. After the explosion, the next soldier enters the building and positions himself to the right (left) of the entrance, up against the wall, engages all identified or likely enemy positions with rapid, short bursts of automatic fire, and scans the room. The rest of the team provides immediate security outside the building.

a. The size and shape of the room may cause the soldier entering the room to move to the left or right. The first soldier in the room decides where the next man should position himself and gives the command NEXT MAN IN, LEFT (or RIGHT). The next man shouts COMING IN, LEFT (RIGHT), enters the building, positions himself to the left of the entrance, up against the wall, and scans the room. Once in position, he shouts NEXT MAN IN (RIGHT or LEFT).

b. Depending on the enemy's situation, the size of the entry and the training of the squad, two soldiers can enter the room simultaneously after the grenade detonates. The soldier from the right side of the entry enters, fires from left to right, and moves to right with his back to the wall. At the same time, the soldier on the left enters from the left, fires from right to left, and moves to the left with his back to the wall. One soldier goes high, the other low, to prevent firing at one another. This method puts more firepower in the room more quickly, but is more difficult and requires more practice. When both soldiers are in position, the senior soldier gives the command NEXT MAN IN (RIGHT or LEFT).

10. The assaulting fire team leader shouts COMING IN (RIGHT or LEFT), enters the building initially moving left or right and against the wall, and positions himself where he can control the actions of his team. He does not block the entrance way. He makes a quick assessment of the size and shape of the room, and begins to clear the room. He determines if the remaining man in his team is required to assist in clearing the room.

a. If the team leader decides to bring the last man in, he shouts NEXT MAN IN LEFT (or RIGHT). The last man in the fire team shouts COMING IN LEFT (or RIGHT), enters the building, and begins to clear through the room.

b. If the team leader decides not to bring the last man in, he shouts NEXT MAN, STAND FAST. The last man remains outside the building and provides security from there. The team leader then directs the soldier on the right of the entrance to begin clearing. The team leader reports to the squad leader and then assumes the duties of the soldier on the right of the entrance to provide support.

DANGER _____

While clearing rooms, soldiers must be alert for trip wires and booby traps. They should not expose themselves through open windows or doors.

11. Once the room is cleared, the team leader signals to the squad leader that the room is cleared.

12. The squad leader enters the building and marks the entry point in accordance with the SOP. The squad leader determines whether or not his squad can continue to clear rooms and still maintain suppressive fires outside the building. Normally, it takes a platoon to clear a building.

13. The squad leader and assault fire team move to the entrance of the next room to be cleared and position themselves on either side of the entrance. The squad enters and clears all subsequent rooms by repeating the actions discussed in paragraphs 8 through 12, above.

14. The squad leader directs the team to continue and clear the next room. The squad leader rotates fire teams as necessary to keep the soldiers fresh, to equitably distribute the dangerous duties, and to continue the momentum of the attack.

15. The squad leader follows the fire team that is clearing to ensure that cleared rooms are properly marked in accordance with the SOP.

16. The squad leader assesses the situation to determine if he can continue clearing the building. He reports the situation to the platoon leader. The platoon follows the success of the entry into the building.

17. The squad consolidates its position in the building and then reorganizes as necessary. Leaders redistribute ammunition.

NOTE: Normally the squad/platoons will suppress enemy in buildings with large caliber weapons (particularly if HMMWVs with caliber .50, BFVs, or tanks are available).

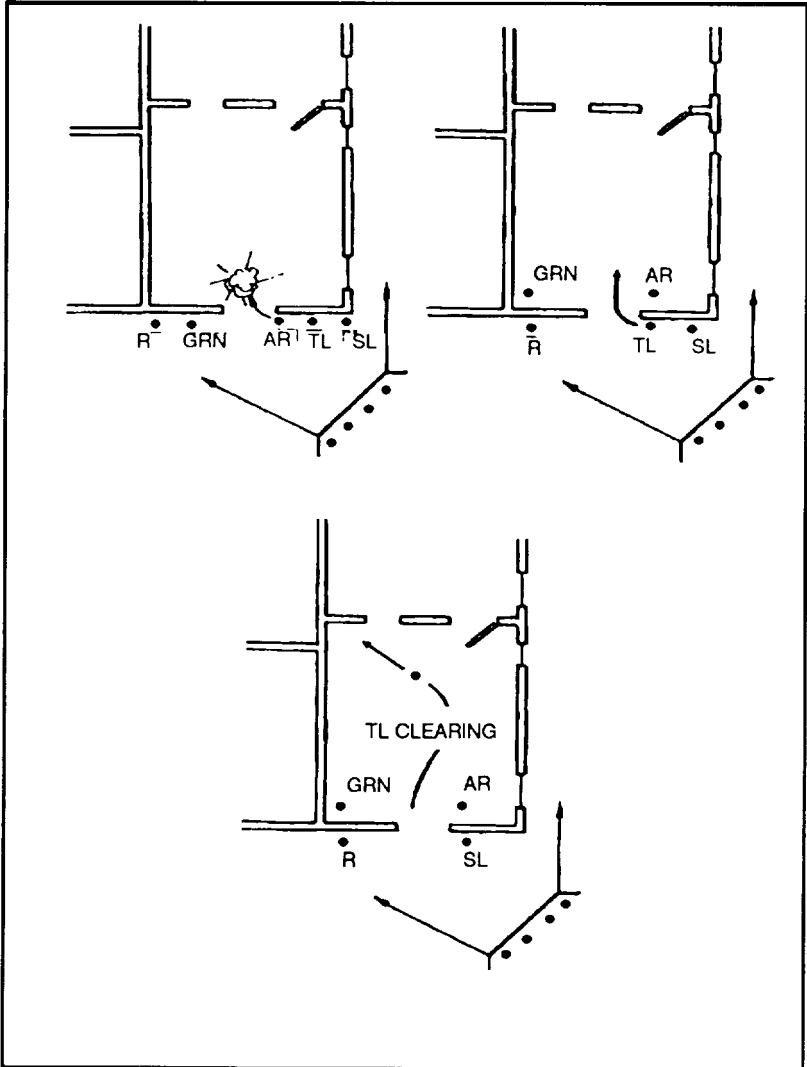

Figure 4-9. Enter a building (squad).

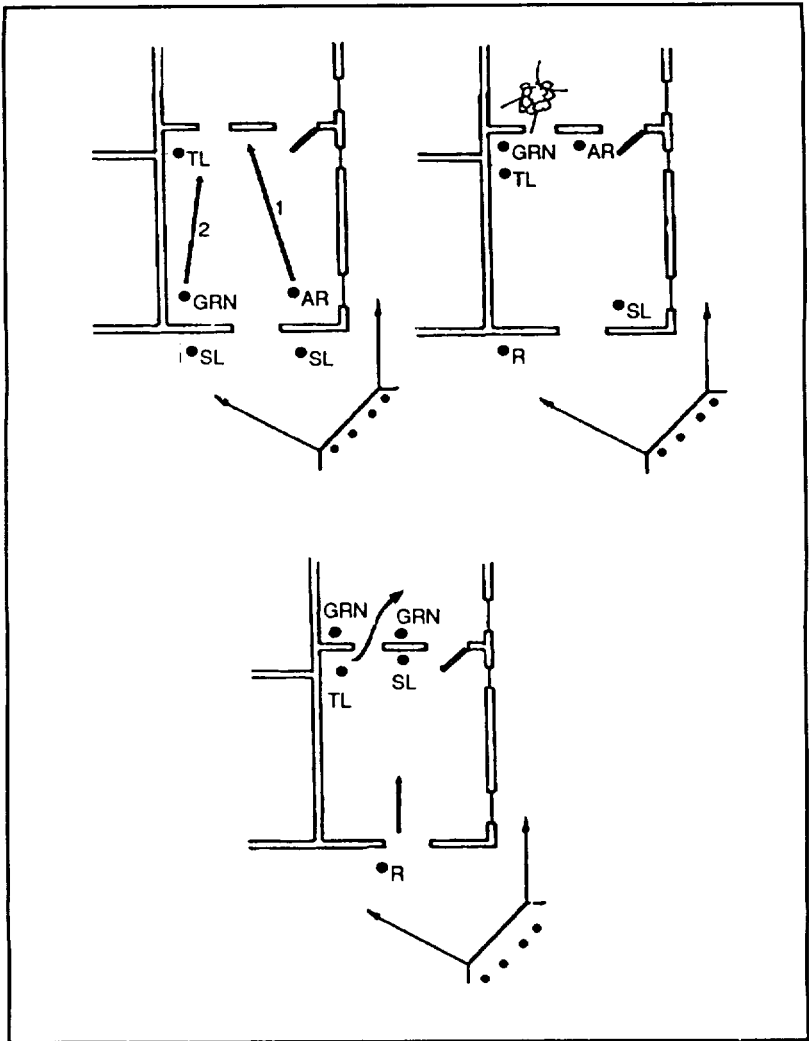

Figure 4-10. Clear a building (squad).

BATTLE DRILL 7. ENTER/CLEAR A TRENCH

SITUATION: The platoon is attacking as part of a larger force and identifies enemy in a trench line. The platoon deploys and establishes a base of fire. The platoon leader determines that he has sufficient combat power to maneuver and assault the trench line.

REQUIRED ACTIONS: (Figures 4-11 and 4-12.)

1. The platoon leader directs one squad to enter the trench and secure a foothold.

2. The platoon leader designates the entry point of the trench line and the direction of movement once the platoon begins clearing.

3. The platoon sergeant positions soldiers and machine guns to suppress the trench and isolate the entry point.

4. The assaulting squad executes actions to enter the trench and establish a foothold. The squad leader directs one fire team to assault and one fire team to support by fire initially, then follow and support the assaulting fire team. He designates the entry point of the trench line.

a. The squad leader and the assault fire team move to the last covered and concealed position short of the entry point.

(1) The squad leader marks the entry point.

(2) The base-of-fire element shifts direct fires away from the entry point and continues to suppress adjacent enemy positions or isolate the trench as required.

(3) The assault fire team leader and the automatic rifleman remain in a position short of the trench to add suppressive fires for the initial entry.

(4) The two remaining soldiers of the assault fire team (rifleman and grenadier) continue toward the entry point. They move in rushes or by crawling.

(5) The squad leader positions himself where he can best control his teams.

b. The first two soldiers (rifleman and grenadier) of the assault fire team move to the edge of the trench; parallel to the trench and on their backs; on the squad leader's command, cook-off grenades (two seconds maximum), shout FRAG OUT, and throw the grenades into the trench.

(1) After ensuring that both grenades detonate, the soldiers roll into the trench, landing on their feet, and back-to-back. They fire their weapons down the trench in opposite directions. Immediately, both soldiers move in opposite directions down the trench, continuing to fire three-round bursts. Each soldier continues until he reaches the first corner or intersection. Both soldiers halt and take up positions to block any enemy movement toward the entry point.

(2) Upon detonation of the grenades, the assault fire team leader and the automatic rifleman immediately move to the entry point and enter the trench. The squad leader directs them to one of the secured corners or intersections to relieve the rifleman or grenadier who then rejoins his buddy team at the opposite end of the foothold.

c. The squad leader remains at the entry point and marks it.

d. The squad leader reports to the platoon leader that he has entered the trench and secured a foothold. The platoon follows the success of the seizure of the foothold with the remainder of the platoon as part of the platoon actions to clear a trench line.

e. The squad reorganizes as necessary. Leaders redistribute ammunition.

5. The platoon leader directs one of the base-of-fire element squads to move into the trench and begin clearing it in the direction of movement from the foothold.

6. The base-of-fire element repositions as necessary to continue suppressive fires.

7. The platoon leader moves into the trench with the assaulting squad.

8. The assaulting squad passes the squad that has secured the foothold and executes actions to take the lead and clear the trench.

a. The squad leader designates a lead fire team and a trail fire team.

b. The lead fire team and the squad leader move to the forward-most secure corner or intersection. The squad leader tells the team securing that corner or intersection that his squad is ready to continue clearing the trench. The trail fire team follows maintaining visual contact with the last soldier of the lead team.

NOTE: Throughout this technique, the team leader positions himself at the rear of the fire team to have direct control (physically, if necessary) of his soldiers. Other soldiers in the fire team rotate the lead. Soldiers rotate the lead to change magazines and prepare grenades. Rotating the lead provides constant suppressive fires down the trench and maintains the momentum of the attack as the squad clears the trench.

c. The lead fire team passes the element securing the foothold.

(1) The lead soldier of the fire team moves abreast of the soldier securing the corner or intersection, taps him, and announces **TAKING THE LEAD**.

(2) The soldier securing the corner or intersection acknowledges that he is handing over the lead by shouting **OKAY**. He allows the fire team to pass him.

d. The lead fire team starts clearing in the direction of movement. They arrive at a corner or intersection.

(1) Allowing for cook-off (two seconds maximum) and shouting FRAG OUT, the second soldier prepares and throws a grenade around the corner.

(2) Upon detonation of the grenade, the lead soldier moves around the corner firing three round bursts and advancing as he fires. The entire fire team follows him to the next corner or intersection.

e. The squad leader—

(1) Follows immediately behind the lead team.

(2) Ensures that the trailing fire team moves up and is ready to pass the lead at his direction.

(3) Rotates fire teams as necessary to keep his soldiers fresh and to maintain the momentum of the attack.

(4) Requests indirect fires, if necessary, through the platoon leader.

DANGER _____

The fire teams must maintain sufficient interval to prevent them from being engaged by the same enemy fires.

f. At each corner or intersection, the lead fire team performs the same actions described above (paragraph d).

g. If the lead soldier finds that he is nearly out of ammunition before reaching a corner or intersection, he announces AMMO.

(1) Immediately, the lead soldier stops and moves against one side of the trench, ready to let the rest of the team pass. He continues to aim his weapon down the trench in the direction of movement.

(2) The next soldier ensures that he has a full magazine, moves up abreast of the lead soldier, taps him and announces TAKING THE LEAD.

(3) The lead soldier acknowledges that he is handing over the lead by shouting OKAY, positions rotate, and the squad continues forward.

h. The trailing fire team secures intersections and marks the route within the trench as the squad moves forward. The trailing fire team leader ensures that follow-on squads relieve his buddy teams to maintain security.

i. The squad leader reports the progress of the clearing operation. (The base-of-fire element must be able to identify the location of the lead fire team in the trench at all times.)

9. The platoon leader rotates squads to keep soldiers fresh and to maintain the momentum of the assault.

10. The platoon sergeant calls forward ammunition resupply and organizes teams to move it forward into the trench.

11. The base-of-fire element ensures that all friendly forces move into The trench ONLY through the designated entry point. (All movement must be made in the trench to avoid casualties by friendly fires.)

12. The platoon leader reports to the company commander that the trench line is secured, or that he is no longer able to continue clearing.

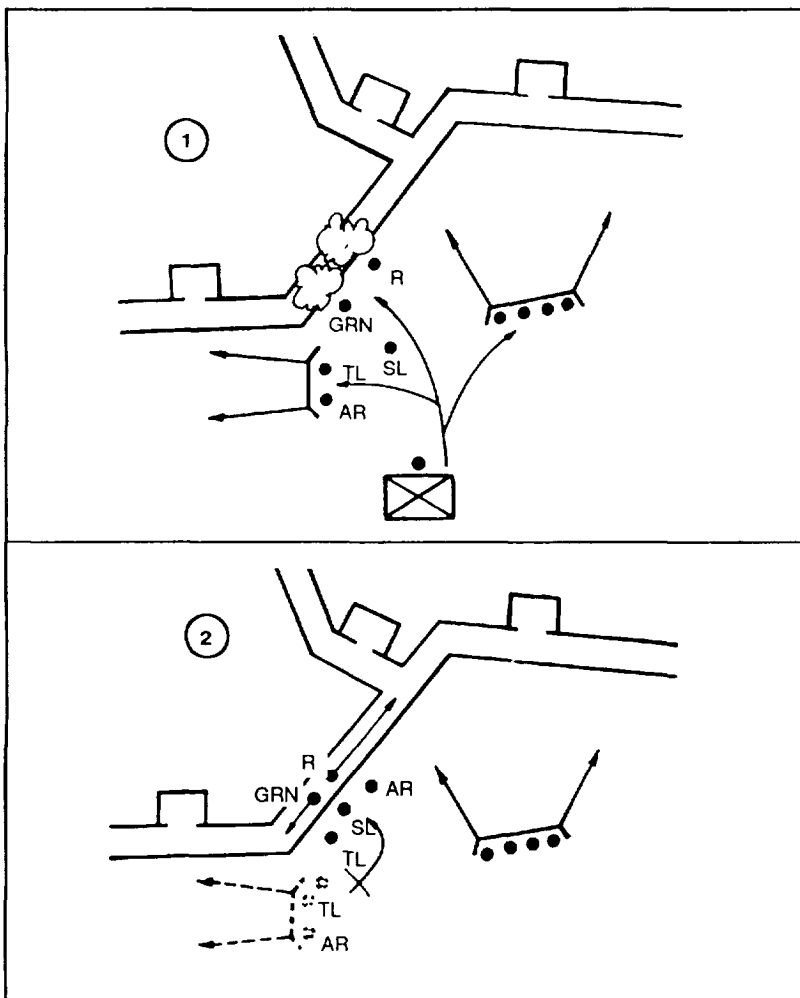

Figure 4-11. Enter a trench (squad).

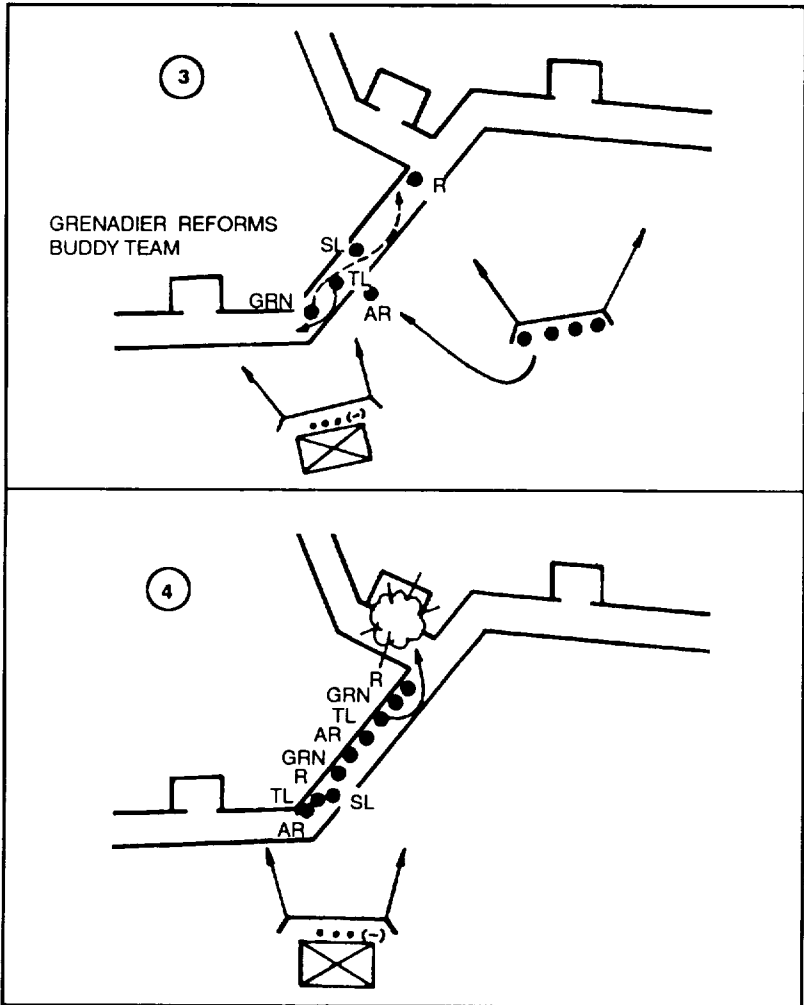

Figure 4-11. Clear a trench line (squad) (continued).

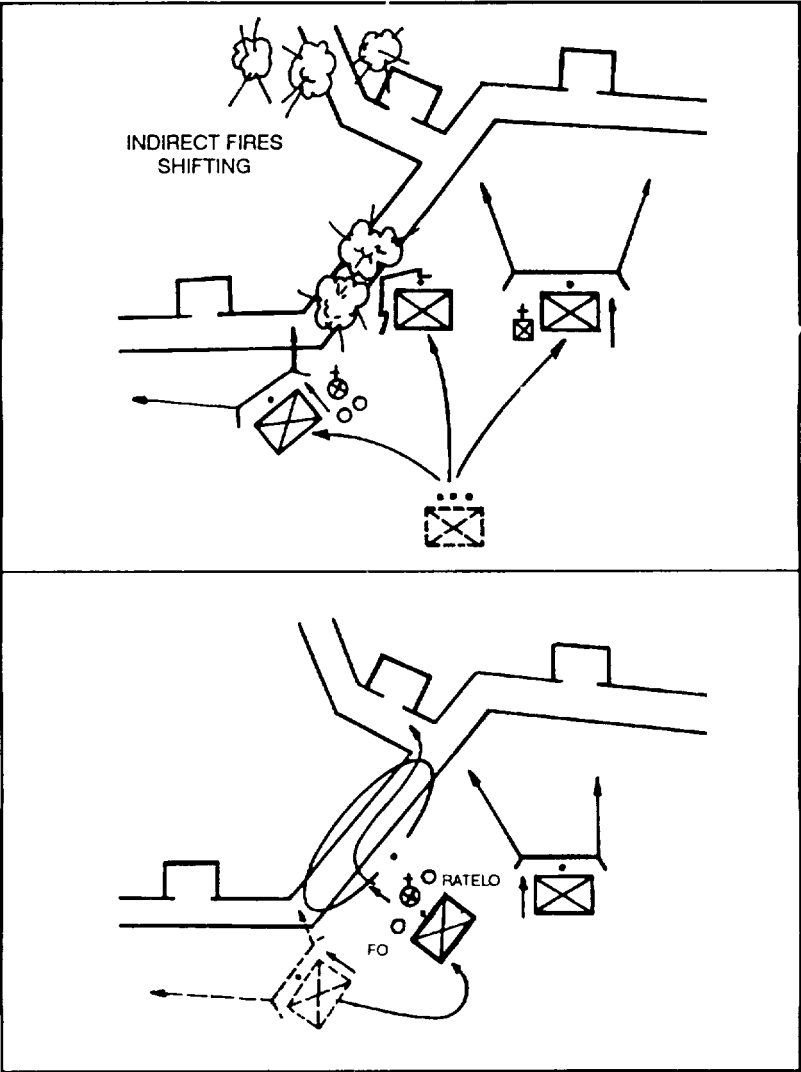

Figure 4-12. Clear a trench line (platoon).

BATTLE DRILL 8. CONDUCT INITIAL BREACH OF A MINED WIRE OBSTACLE

SITUATION: The platoon is operating as part of a larger force. The lead squad identifies a wire obstacle, reinforced with mines, that cannot be bypassed and enemy positions on the far side of the obstacle.

REQUIRED ACTIONS: (Figures 4-13 and 4-14.)

1. The platoon leader, his RATELO, platoon FO, and one machine gun team move forward to link up with the squad leader of the lead squad.
2. The platoon leader determines that he can maneuver by indentifying–
 - a. The obstacle and enemy positions covering it by fire.
 - b. The size of the enemy force engaging the squad. (The number of enemy automatic weapons, the presence of any vehicles, and the employment of indirect fires are indicators of enemy strength.)
 - c. A breach point.
 - d. A covered and concealed route to the breach point.
- c. A support-by-fire position large enough for a squad reinforced with machine guns.
3. The platoon leader directs one squad to support the movement of another squad(s) to the breach point. He indicates the support-by-fire position, the route to it, the enemy position to be suppressed, the breach point, and the route that the rest of the platoon will take to it. He also gives instructions for lifting and shifting fires.
4. The platoon leader designates one squad as the breach squad, and the remaining squad, as the assault squad once the breach has been made. (The assault squad may add its fires to the base-of-fire element. Normally, it follows the covered and conceded route of the breach squad and assaults through immediately after the breach is made.)
5. The designated squad moves to and establishes a base of fire.
6. The platoon sergeant moves forward to the base-of-fire element with the second machine gun team and assumes control of the element.
7. On the platoon leader's signal, the base-of-fire element–
 - a. Destroys or suppresses enemy crew-served weapons, first.
 - b. Obscures the enemy position with smoke (M203).
 - c. Sustains suppressive fires at the lowest possible level.
8. The platoon leader designates the breach point and leads the breach and assault squads along the covered and concealed route to it.
9. The platoon FO calls for and adjusts indirect fires as directed by the platoon leader.
10. The breach squad executes actions to breach the obstacle.

a. The squad leader directs one fire team to support the movement of the other fire team to the breach point.

b. The squad leader identifies the breach point.

c. The base-of-fire element continues to provide suppressive fires and isolates the breach point.

d. The breaching fire team, with the squad leader, move to the breach point using the covered and concealed route.

(1) The squad leader and breaching fire team leader employ smoke grenades to obscure the breach point. The platoon base-of-fire element shifts direct fires away from the breach point and continue to suppress key enemy positions. The platoon FO lifts indirect fires or shifts them beyond the obstacle.

(2) The breaching fire team leader positions himself and the automatic rifleman on one flank of the breach point to provide close-in security.

(3) The grenadier and rifleman of the breaching fire team probe for mines, and cut the wire obstacle, marking their path as they proceed. (Bangalore is preferred, if available.)

(4) Once the obstacle has been breached, the breaching fire team leader and the automatic rifleman move to the far side of the obstacle and take up covered and concealed positions with the rifleman and grenadier. The team leader signals to the squad leader when they are in position and ready to support.

c. The squad leader signals the supporting fire team leader to move his fire team up and through the breach. He then moves through the obstacle and joins the breaching fire team, leaving the grenadier and rifleman of the supporting fire team on the nearside of the breach to guide the rest of the platoon through.

f. Using the same covered and concealed route as the breaching fire team, the supporting fire team moves through the breach and takes up covered and concealed positions on the far side.

g. The squad leader reports to the platoon leader and consolidates as needed.

11. The platoon leader leads the assault squad through the breach in the obstacle and positions them beyond the breach to support the movement of the remainder of the platoon or assaults the enemy position covering the obstacle.

12. The platoon leader reports the situation to the company commander and directs his base-of-fire element to move up and through the obstacle. The platoon leader leaves guides to guide the company through the breach point.

13. The company follows up the success of the platoon as it conducts the breach and continues the assault against the enemy positions.

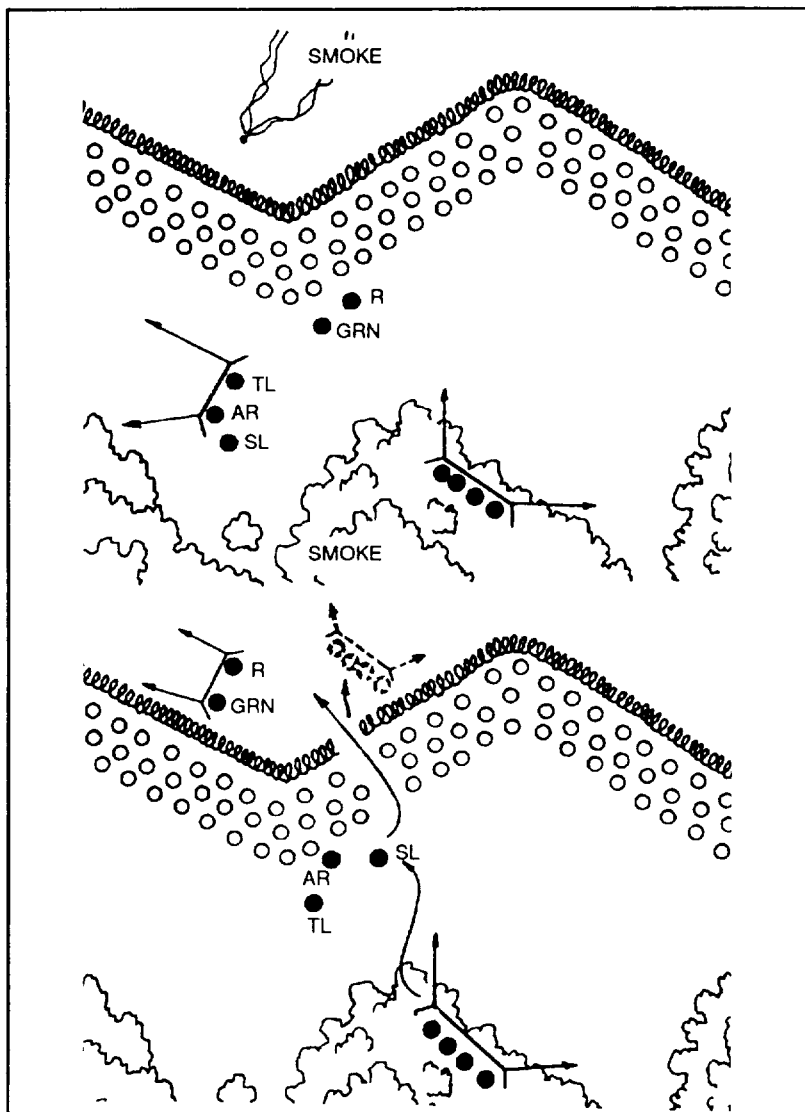

Figure 4-13. Conduct initial breach of a mined wire obstacle (platoon).

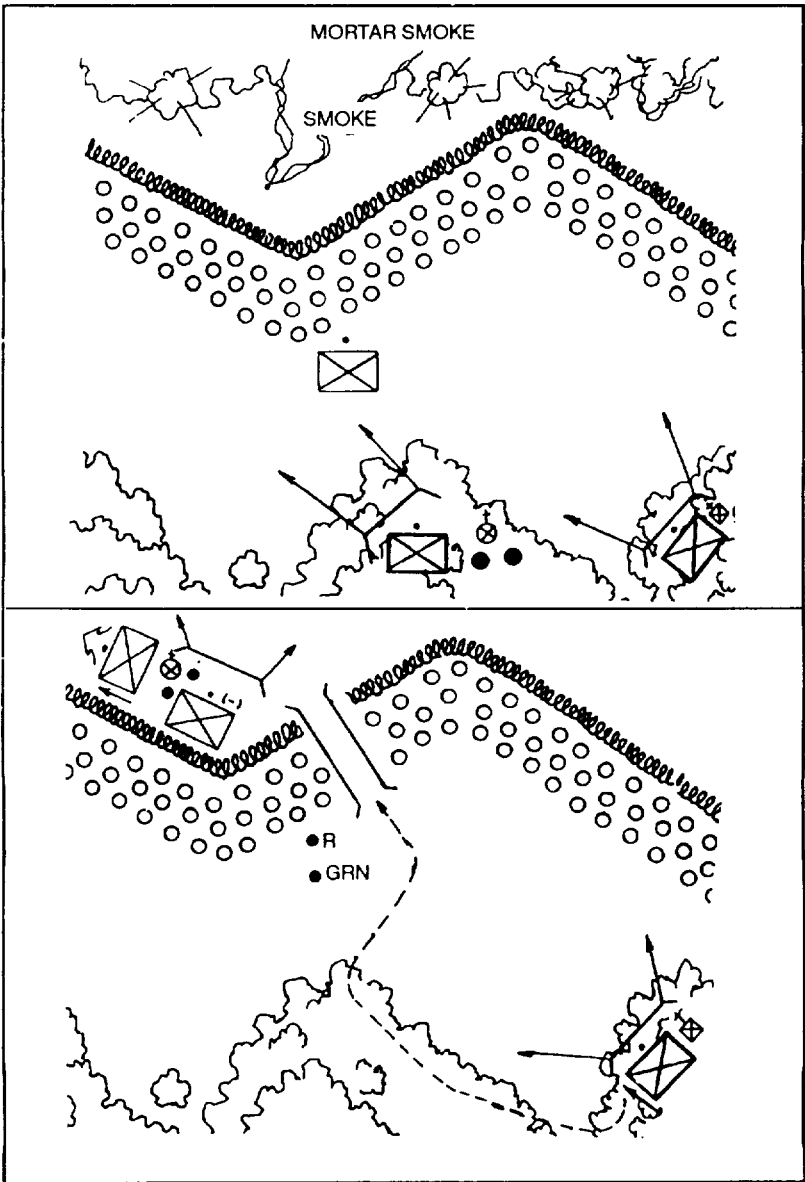

Figure 4-14. Conduct initial breach of a mined wire obstacle (platoon).

CHAPTER 5

INFANTRY PLATOON TACTICAL STANDING OPERATING PROCEDURE

This chapter provides the tactical standing operating procedures for infantry platoons and squads. The procedures apply unless a leader makes a decision to deviate from them based on the factors of METT-T. In such a case, the exception applies only to the particular situation for which the leader made the decision.

CONTENTS

ANNEX A. TASK ORGANIZATION

ANNEX B. COMMAND AND CONTROL
Appendix 1. **Duties and Responsibilities**
Appendix 2. **Communication**
Appendix 3. **Estimate of the Situation**
Appendix 4. **Orders and Reports**
Appendix 5. **Movement**

ANNEX C. OPERATIONS
Appendix 1. **Assembly Area Procedures**

ANNEX D. NBC

ANNEX E. AIR DEFENSE ARTILLERY

ANNEX F. FIRE SUPPORT

ANNEX G. FIRE CONTROL AND DISTRIBUTION

ANNEX H. OPERATIONAL SECURITY

ANNEX I. COMBAT SERVICE SUPPORT

ANNEX A (TASK ORGANIZATION)
to
INFANTRY PLATOON TACTICAL SOP

Task organizations may vary according to METT-T. The following items are considered before task organizing for a particular mission.

1. **MAIN EFFORT.** The platoon leader designates the main effort. He sufficiently weighs the main effort for each mission (for example, machine guns and antiarmor weapons) to ensure success.
2. **SUPPORTING EFFORT.** The platoon leader also designates supporting efforts that will aid in the accomplishment of the mission.
3. **PLATOON HEADQUARTERS.** The platoon headquarters normally consists of the platoon leader, platoon sergeant, platoon RATELO, forward observer and his RATELO, platoon aidman, two machine gun teams, and any other elements that may be attached, under operational control, or in a supporting role.
4. **ATTACHMENTS.**

a. **Engineers.** Engineers normally have already been assigned a priority of work by the company commander. The platoon leader will not dictate the employment or further suballocate or task organize any supporting engineer elements. He is responsible for coordinating with all engineers operating in his area to ensure the commander's priorities are being adhered to. He must also ensure that engineer assets are not wasted and he must also provide guides to and from his platoon area. The platoon leader may be required to provide labor support and or security to assist the engineers.

b. **Stinger Teams.** Stinger teams are usually in direct support of the company during the defense and under OPCON during the offense. The platoon leader does not change the priority of air defense protection established by the commander. The Stinger leader positions the Stingers where they can best provide support. The infantry platoon will frequently need to provide security for the Stinger team.

c. **Antiarmor Sections.** The antiarmor section's primary mission is to destroy armor vehicles. The platoon leader does not change the priority of antiarmor engagements established by the commander. He locates the section where it can best support the mission. The infantry platoon will frequently be required to provide security for the antiarmor section.

d. **GSR, IPW, and CI Teams.** Often collocated with the infantry platoon. These elements are usually in direct support to the battalion. The platoon leader coordinates with these teams to ensure a mutual understanding of the mission exists.

ANNEX B (COMMAND AND CONTROL) to INFANTRY PLATOON TACTICAL SOP

1. **COMMAND.** Platoon leaders are responsible for effectively using the platoon's resources and for employing, organizing, and directing the platoon during combat operations. Effective command allows subordinate leaders to exercise their initiative, take risks, and seize opportunities during the mission.

a. **Succession of Command.** During combat, any member of the platoon may be required to assume command. Frequently, the platoon FO or RATELO may need to continue operations and direct the operation until the chain of command can be reestablished. Under normal conditions, the platoon succession of command will be—

- Platoon leader.
- Platoon sergeant.
- Main effort squad leader.
- Supporting effort squad leaders by rank.

b. **Assumption of Command.** When it is necessary for a new leader to assume command of the platoon, if and when the situations allows it, he will accomplish the following tasks:

- (1) Inform higher headquarters of the change.
- (2) Reestablish the platoon chain of command and ensure all subordinates are made aware of changes.
- (3) Check the platoon's security and the emplacement of key weapons.
- (4) Check the platoon's equipment and personnel status.
- (5) Pinpoint the platoon's location.
- (6) Assess the platoon's ability to continue the mission.
- (7) Inform higher command of assessment.
- (8) Continue the mission.

2. **CONTROL.** The challenge to the leader is to use the minimal amount of control required to synchronize the operation, while still allowing decentralized decision making.

3. **COORDINATION.** Adjacent unit coordination is accomplished from left to right and from front to rear. Adjacent unit coordination is done face to face when possible. The following information is exchanged by adjacent units:

- Unit identification.
- Mission.
- Unit locations.

- Frequencies and call signs.
- Security plans.
- Fire support plans.
- Obstacle plans.
- CP and OP locations.
- Challenge and passwords.
- Sector sketches and or scheme of maneuver.
- Routes.
- Pyrotechnic signals.
- Fire control measures.

APPENDIXES:

1. DUTIES AND RESPONSIBILITIES
2. COMMUNICATION
3. ESTIMATE OF THE SITUATION
4. ORDERS AND REPORTS
5. MOVEMENT

APPENDIX 1 (DUTIES AND RESPONSIBILITIES)
to
ANNEX B (COMMAND AND CONTROL)
to
INFANTRY PLATO ON TACTICAL SOP

1. **PLATOON LEADER.** The platoon leader is responsible for accomplishing the platoon's mission. He is responsible for positioning and employing all assigned and attached crew-served weapons. He must also know how to employ supporting weapons.

a. He leads the platoon in support of company and battalion missions.

b. He informs his commander of his actions at all times.

c. He plans missions with the help of the platoon sergeant, squad leaders, and other key personnel.

d. He stays abreast of the situation and goes where he is needed to supervise, issue FRAGOs, and accomplish the mission.

e. He requests support for the platoon from the company commander to perform its mission.

f. He directs the platoon sergeant in planning and coordinating the platoon's CSS effort.

g. During planning, he receives on-hand status reports from the platoon sergeant and squad leaders.

h. He reviews platoon requirements based on the tactical plan.

i. He develops the casualty evacuation plan.

j. During execution, he checks the work of the platoon sergeant and the squad leaders.

k. He ensures the soldier's load is reasonable.

2. **PLATOON SERGEANT.** The platoon sergeant is the senior NCO in the platoon and second in command.

a. He supervises the logistics, administration, and maintenance activities of the platoon.

b. He organizes and controls the platoon alternate CP.

c. He trains the crews and employs the platoon's machine guns IAW the platoon leader's orders.

d. He receives the squad leaders' requests for rations, water, and ammunition. He works with the company XO and first sergeant to request resupply. He also directs the routing of supplies and mail.

e. He maintains platoon strength information, consolidates and forwards the platoon's casualty reports. (DA Forms 1155 and 1156) and receives replacements.

f. He monitors the morale, discipline, and health of platoon members.

g. He commands task-organized elements in the platoon during tactical operations. This can include, but is not limited to, quartering parties, security forces in withdrawals, support elements in raids or attacks, and security patrols.

h. He coordinates and supervises company directed platoon resupply operations.

i. He ensures that ammunition and equipment are evenly distributed. (This is a critical task during consolidation and reorganization.)

j. He ensures that the casualty evacuation plan is complete and executed properly by directing the platoon's aidman, and aid and litter teams.

3. **SQUAD LEADER.** The squad leader is responsible for the squad.

a. He controls the maneuver of his squad and its rate and distribution of fire.

b. He exercises his command through the fire team leaders.

c. He manages the logistical and administrative needs of his squad. He requests and issues ammunition, water, rations, and special equipment.

d. He maintains accountability of his soldiers and equipment.

e. He completes casualty feeder reports and reviews the casualty reports completed by squad members.

f. He supervises the maintenance of the squad's weapons and equipment.

g. He conducts inspections of his soldiers, their weapons and their equipment.

h. He keeps the platoon sergeant and platoon leader informed on his squad's supply status and equipment readiness.

i. He ensures that supplies and equipment are internally cross-leveled.

APPENDIX 2 (COMMUNICATION)
to
ANNEX B (COMMAND AND CONTROL)
to
INFANTRY PLATOON TACTICAL SOP

1. **GENERAL.** The three primary means of communication available to the infantry platoon are radio, wire, and messenger. Normally, the platoon uses one or all of these during an operation. Additionally, the platoon leader plans an alternate means of communication in case the primary means fails.

a. **Radio.** Radio is the least secure means of communication. Radio is susceptible to interception and jamming. Proper radio procedures must be used to reduce the enemy's opportunity to hamper radio communications.

(1) **Radio procedures:**

(a) Change frequencies and call signs IAW unit SOI.

(b) Use varied transmission schedules and lengths.

(c) Use established formats to expedite transmissions such as SALUTE.

(d) Encode messages or use secure voice.

(e) Use brevity codes when possible.

(2) **Actions if jamming is suspected:**

(a) *Continue to operate.* (Do not let the enemy know that he is having any affect on communications.)

(b) *Disconnect the antenna.* If interference stops, communications are probably being jammed.

(c) *Switch to highest power.*

(d) *Relocate the radio.* Terrain may mask the enemy's jamming signal.

(e) *Use a directional antenna.*

(f) *Turn the squelch off.*

(3) **Radio nets:** The platoon must monitor and operate on several radio nets. These include—

(a) *Company command net.* The platoon leader will continuously monitor the company command net.

(b) *Platoon net.* The platoon headquarters controls the platoon net. The platoon net is be continuously monitored by all elements of the platoon.

(c) *Fire support net.* The fire support net is controlled by the battalion FSO and is monitored by the platoon's FO.

b. **Wire.** Wire is more secure than radio and is effected less by weather and terrain. When possible, the platoon uses wire in lieu of radio. When the tactical situation permits, the platoon establishes a wire net or “hot loop.” This is accomplished as follows:

(1) Each element is responsible for running wire to the platoon headquarters.

(2) Each element of the platoon is responsible for running wire to the element on its left.

(3) Each element is responsible for running wire to their OP.

(4) Once established, each element is responsible for the maintenance of the wire it laid. Additionally, each element continuously monitors the wire net.

(5) When breaking down the wire net, each element is responsible for recovering its wire.

(6) The platoon headquarters maintains overall control of the wire net.

c. **Messenger.** Messenger is the most secure means of communications. Messengers should vary their routes and schedules. Platoon leaders weigh the risk associated with using messengers. Although secure, messengers are the slowest form of communication.

2. CODE WORDS AND SIGNALS.

a. **Code Words.** Code words are used for a multitude of reasons. Code words are established to speed up communications, add a degree of security, and help with command and control. Code words are usually established during tactical operations for (but not limited to) objectives, phase lines, check points, link ups, and so forth.

b. **Signals.** Signals can be used in many forms on any operation. Signals are usually either audio or visual. The key to the use of signals is ensuring everyone is aware of the signal and its meaning, (See FM 21-60.)

**APPENDIX 3 (ESTIMATE OF THE SITUATION)
to
ANNEX B (COMMAND AND CONTROL)
to
INFANTRY PLATOON TACTICAL SOP**

1. MISSION ANALYSIS.

- a. Mission and intent of commander two levels up.
- b. Mission and intent of immediate commander.
- c. Assigned tasks (specified and implied).
- d. Constraints and limitations.
- e. Mission-essential tasks.
- f. Restated mission.
- g. Tentative time schedule.

2. ESTIMATE OF THE SITUATION AND DETERMINE COURSES OF ACTION.

a. Terrain and weather.

- (1) Terrain - OCOKA.
- (2) Weather - visibility, mobility, survivability.

b. Enemy situation and most probable courses of action.

- (1) Composition.
- (2) Disposition.
- (3) Recent activities.
- (4) Capabilities.
- (5) Weaknesses.
- (6) Most probable course of action (enemy use of METT-T)

C. Friendly Situation.

- (1) Troops available.
- (2) Equipment status.
- (3) Time available.

d. **Friendly Courses of Action.** (Develop at a minimum two courses of action.)

3. ANALYSIS OF COURSES OF ACTION.

- a. **Significant factors.**
- b. **Wargame.**

4. COMPARISON OF COURSES OF ACTION.

5. DECISION.

APPENDIX 4 (ORDERS AND REPORTS)
to
ANNEX B (COMMAND AND CONTROL)
to
INFANTRY PLATOON TACTICAL SOP

1. ORDERS.

a. Orders Group.

(1) *Company orders.* As a minimum, the platoon leader, platoon FO, and attachments leaders will attend company orders.

(2) *Platoon orders.* As a minimum, the following individuals will attend platoon orders:

- Platoon leader.
- Platoon sergeant.
- Squad leaders.
- Platoon FO.
- Aidman.
- Attachment leaders.

b. Orders Formats.

(1) *Warning order.* A warning order has no specific format. One technique is to use the five-paragraph operation order format. The leader issues the warning order with all the information he has available at the time.

(2) *Operation order.* The operation order is normally issued orally. The leader uses notes that follow the five-paragraph format.

(3) *Fragmentary order.* The format for a FRAGO is that portion of the current OPORD that has changed. If significant changes have occurred since the last OPORD, a new OPORD should be prepared.

c. Reports. The following reports are used.

(1) *SALUTE*— Size, Activity, Location, Unit/uniform, Time, Equipment.

(2) *SITREP*— (situation report) given IAW OPORD.

(3) *ACE*— (ammunition, casualty, equipment) normally, squad leaders give ACE reports to the platoon sergeant after contact with the enemy.

(4) *Logistics*— team leaders and squad leaders report twice daily up the chain of command.

(5) *Sensitive item*— status reported by team leaders and squad leaders up the chain of command twice daily.

(6) *Personnel status*— team leaders and squad leaders report twice daily. Normally, reports are given at stand-to and before nightfall.

(7) *NBC 1 and NBC 4*— whoever recognizes an NBC attack will report on the platoon net and preface the message with FLASH - FLASH-FLASH. NBC 1 and 4 reports are sent to the company CP and then forwarded to battalion.

APPENDIX 5 (MOVEMENT)
to
ANNEX B (COMMAND CONTROL)
to
INFANTRY PLATOON TACTICAL SOP

1. MOVEMENT

a. **Formation.** Leaders choose the formation based on their analysis of METT-T and likelihood of enemy contact.

(1) **Fire team formations.** All soldiers in the team must be able to see their leader.

(a) **Wedge.** This is the basic fire team formation; it will be used unless modified because of terrain, dense vegetation, terrain or mission.

(b) **File.** Used in close terrain, dense vegetation, limited visibility.

(2) **Squad formations.** Squad formations describe the relationships between fire teams in the squad.

(a) **Column.** Primary squad formation and will be used unless METT-T dictates otherwise.

(b) **Line.** Used when maximum fire power is needed (to the front).

(c) **File.** Used in close terrain, dense vegetation, or limited visibility.

(3) **Platoon formations.** METT-T will determine where crew-served weapons move in the formation. They normally move with the platoon leader so he can quickly establish a base of fire.

(a) **Column.** Primary platoon formation—used unless METT-T dictates otherwise.

(b) **Platoon line, squads on line.** Used when the platoon leader wants all soldiers on line for maximum firepower forward. Used when the enemy situation is known.

(c) **Platoon line, squads in column.** Used when the platoon leader does not want everyone forward, but wants to be prepared for contact such as near the objective.

(d) **Platoon Vee.** Used when enemy situation is vague, but contact is expected to the front.

(e) **Platoon wedge.** Used when enemy situation is vague and contact is not expected.

(f) **Platoon file.** Used when visibility is poor due to terrain or light.

b. **Movement Techniques.** Leaders choose a movement technique based on their mission analysis of METT-T and likelihood of enemy contact.

(1) **Traveling.** Used when contact is not likely and speed is important.

(2) **Traveling overwatch.** Used when contact is possible but speed is important.

(3) **Bounding overwatch.** Used when contact is likely or imminent and speed is not important.

c. **Foot Marches.** When moving along a road in a relatively secure area, the platoon will move with one tile on each side of the road. Fire teams are not split up. There will be 3 to 5 meters between soldiers and 25 to 50 meters between platoons.

(1) The normal rate of march for an 8-hour march is 4 kmph. The interval and rate of march depend on the length of the march, time allowed, likelihood of enemy contact (ground, air, artillery), terrain and weather, condition of the soldiers, and the weight of the soldiers' load.

(2) A 15-minute rest will be conducted at the end of the first 45 minutes of a road march. During this halt, the aidman and squad leaders will check the soldiers' feet and report the physical condition of the soldiers to the platoon leader and platoon sergeant. Thereafter, a 10-minute rest is conducted every 50 minutes.

2. **ACTIONS AT HALTS.** During halts, security is posted and all approaches into the platoon's area are covered by key weapons. The platoon sergeant moves forward through the platoon, checking security as he goes, and meets the platoon leader to determine the reason for the halt.

a. During halts of 30 seconds or less, the soldiers drop to one knee and cover their assigned sector.

b. During halts longer than 30 seconds, a cigar-shaped perimeter is formed, and the soldiers assume the prone position.

3. **ACTIONS ON CONTACT.** On contact, the platoon executes the appropriate battle drill.

a. **React to Contact.**

b. **Break Contact.**

c. **React to Ambush.**

ANNEX C (OPERATIONS)
to
INFANTRY PLATOON TACTICAL SOP

1. **OFFENSE.** The platoon leader receives the mission from the company commander.

a. Preparation.

(1) The platoon leader conducts a mission analysis (see operations section).

(2) The platoon leader issues a warning order.

(3) The platoon members concurrently perform readiness, maintenance, and functional checks under the supervision of their leaders. The chain of command checks weapons, night observation devices, communications equipment, NBC equipment, and any special equipment.

(4) Weapons will be test fired if the situation permits.

(5) The platoon leader makes his tentative plan.

(6) The platoon initiates movement as required—quartering party, selected elements, or the entire platoon.

(7) The platoon conducts required reconnaissance—determines location, strength, disposition, and activity of the enemy, and accurate in formation on the terrain (OCOKA).

(8) Based on METT-T considerations, intelligence from the reconnaissance, and other sources, the platoon leader completes the plan. If time is available, he always gives a briefback to the commander before issuing the order.

(9) The platoon leader issues his order to his subordinates providing them with adequate time to develop their plans, brief the soldiers, and conduct rehearsals.

(10) The PSG requests CSS assets.

(11) The platoon leader or responsible representative coordinates with higher, supporting, and adjacent units:

- Fire plans.
- Scheme of maneuver.
- Current intelligence.
- Control measures.
- Communications and signals.
- Time schedules.
- Support requirements.

(12) The platoon leader supervises mission preparation. Subordinate leaders conduct briefbacks of the plan to ensure his intent is understood. Key platoon actions are rehearsed as time permits. Certain rehearsals should take place before the OPORD (wise use of time). First priority for rehearsals is actions on the objective.

(13) The platoon leader plans for sustainment of combat operations.

(a) Platoon leader, platoon sergeant, squad leaders determine ammunition requirements and other supply needs.

(b) Platoon leader issues guidance on soldier's load and ensures loads are distributed equally. The combat load includes the fighting load and approach march load. The sustainment load includes the equipment required for sustained operations and are stored by the battalion at the BSA and brought forward as needed.

(c) Platoon leader and platoon sergeant determine the transportation needed to support the operation and request it.

(d) Platoon sergeant coordinates with the ISG, supply sergeant, and XO for support. He distributes supplies according to the plan.

(e) Platoon leader establishes and enforces a rest plan for all platoon members, particularly for key personnel.

(14) Platoon continues to conduct reconnaissance during operation.

(15) The platoon leader monitors the actions of higher, adjacent, and supporting units.

(16) The platoon leader issues orders or modifies original plan as needed.

(17) The platoon headquarters reports combat critical information to higher, adjacent, and supporting units:

- SALUTE on enemy contact.
- Terrain information.
- Changes in platoon actions from the plan.
- Changes in the friendly situation (including attachments).
- Initiation of action by the platoon.
- CS or CSS requests required to execute tasks.
- Friendly information from other units that higher headquarters cannot monitor.

b. **Execution.** The two types of attacks are hasty and deliberate.

(1) **Hasty attack.** When the platoon or squad makes unexpected contact with the enemy, the platoon or squad executes the contact drill.

- Deploy.
- Establish a base of fire.
- Find the enemy flank, gap, or weak point.
- Suppress the enemy.
- Attack through the flank, gap, or weak point.
- Report to the commander.

(2) **Deliberate attack.** A planned attack against the enemy.

(a) The platoon leader organizes the platoon for the attack—assault element and support element.

(b) The platoon positions for the assault. The platoon leader, PSG, or squad leader reconnoiter the tentative support position, establish local security, ensure the position provides observation of the objective and overwatch for the assault element.

The support element moves by a covered and concealed route into the support position. The support element occupies the support position. The platoon sergeant and squad leaders assign covered and concealed positions, sectors of fire, and necessary fire control measures. The enemy positions are located. All weapons are oriented along sectors of fire toward the enemy positions.

The support element overmatches the assault element's movement. The support element maintains continuous communications with the assault element. If possible, the support element maintains observation of the assault element and its route. The support element ensures the assault element's route does not cross into the support positions' sectors of fire. The support element alerts the platoon leader of any movement on the objective or change in the enemy situation.

The support element suppresses the objective with direct or indirect fires.

The platoon leader leads the assault element into the last covered and concealed position before the objective.

The assault element uses smoke, if available, to cover its movement. The assault element ensures it does not move into the support element's sector of fire.

The platoon leader or FO calls for preparatory indirect fire on the objective.

The platoon leader ensures all elements are in position before beginning the assault.

(c) The platoon performs the assault. The platoon leader signals to lift or shift the suppressive fires of the support element. (Primary signal is FM radio; alternate signal is visual.)

The support element lift or shifts fires and continues to observe the objective.

The assault element begins to deliver suppressive fire on the objective once the support element shifts fire. The assault element assaults the objective from the flank, a gap, or a known weakness. The assault element tightens through the objective using available cover and concealment, appropriate movement techniques, and appropriate battle drills.

On order, the support element moves onto the objective and clears the objective of any remaining enemy.

(d) The platoon consolidates, then reorganizes. (Many events that occur during consolidation and reorganization will be concurrent.)

c. Consolidation.

(1) The platoon occupies a hasty fighting position and prepares for counterattack.

- (a) The platoon leader assigns the squad sectors of fire.
- (b) The squad leaders assign positions and sectors of fire.
- (c) The platoon leader positions key weapons systems.

(2) The platoon leader positions OPs to provide security and early warning.

d. Reorganization.

(1) The platoon leader reestablishes the chain of command and tills key positions:

- PSG, squad leaders, and team leaders.
- Machine gunners.
- Dragon gunners.
- RATELOs.
- M203 gunners.

(2) The platoon leader establishes communications with the company commander, adjacent units, and battalion FSO.

(3) Leaders redistribute ammunition and equipment.

(a) The squad leaders give the ACE report to the platoon leader.

(b) The platoon leader reports the status to higher headquarters and requests any required resupply.

(c) The PSG redistributes ammunition and equipment between the squads as necessary.

(4) The platoon evacuates casualties. The platoon handles all EPWs IAW the five S's. The platoon evacuates all KIA.

2. **DEFENSE.** The platoon leader receives the operations order from the company commander.

a. Preparation of the Defense.

(1) The platoon leader performs a mission analysis and issues a warning order to the platoon.

(2) Platoon members begin performing readiness, maintenance, and functions checks on all assigned weapons and equipment.

(3) The platoon leader makes an estimate of the situation and a tentative plan.

(4) The platoon leader and squad leaders conduct a leader's reconnaissance. They check for past or present enemy activity. They determine the enemy's most probable course of action. They confirm or adjust the tentative plan.

- Squad positions.
- Key weapons positions.
- CP and OP locations.

(5) The platoon sergeant does an initial inspection of all the platoon's weapons and assigned equipment.

(6) The platoon leader completes the plan and issues the platoon operations order.

(7) The platoon sergeant ensures the platoon has a basic load of Class I, IV, V, and VIII.

(8) The platoon sergeant requests additional Class I, IV, V, and VIII to be brought forward to the platoon battle position.

(9) All platoon members camouflage themselves and their equipment.

(10) The platoon leader conducts adjacent unit coordination.

(11) The platoon test fires all assigned weapons.

(12) The platoon leader conducts the final inspection.

(13) The platoon conducts rehearsals. The most critical tasks are rehearsed first. Movement to alternate and subsequent positions is rehearsed. When possible, a full-force rehearsal is conducted. If the platoon is designated as a reserve, it rehearses those actions as stated in the OPORD. As a minimum, briefback rehearsals are conducted with key leaders.

(14) The platoon begins movement to the platoon battle position.

b. Execution.

(1) The platoon stops at the last covered and concealed position before the platoon battle position.

(2) The platoon leader and squad leaders move forward to the battle position. They ensure there has been no change to the enemy situation. They clear the area and establish local security.

(3) The platoon leader assigns squad battle positions and sectors of fire, locations of the PEWS and the M8 chemical alarm, and positioning of key weapons systems.

(4) The platoon leader returns to the platoon and leads them to the platoon battle position. The squad leaders guide their squads into their squad battle positions. The squad leaders assign temporary positions and sectors of fire.

(5) The platoon leader coordinates for indirect fire.

(6) The platoon begins executing priorities of work.

(a) *Establish security.* As a minimum, each squad has one OP forward of its position during preparation of the defense.

(b) *Position key weapons.* The platoon leader positions the platoon's key weapons and assigns them sectors of fire.

(c) *Position squads.* The platoon leader verifies each squad's position and assigns the squad a sector of fire. The squad leader assigns individual fighting positions and sectors of fire.

(d) *Establish communications.* As minimum, the platoon establishes a “hot loop” wire net.

(e) *Coordinate with adjacent units.* Each squad coordinates with the squad on its left ensuring all sectors of fire are interlocking and all dead space is covered by indirect fire.

(f) *Clear fields of fire.* Each position clears its sectors of fire.

(g) *Prepare range cards.* Each gunner prepares an original and one copy of the range card. The original copy remains with the weapon, and the copy is turned in to the squad leader.

(h) *Prepare squad sector sketches.* The squad leaders prepare an original and one copy of the sector sketch. The original remains in the squad CP, and the copy is turned in to the platoon leader. As a minimum, the squad sector sketch includes—

- Key terrain within the squad sector.
- Each individual fighting position and its primary and secondary sectors of fire.
- Key weapons positions and their primary sector of fire, secondary sector of fire, and any fire control measures.
- All CP and OP locations.
- All dead space within the squad sector.
- Any obstacles and mines within the squad sector.

(i) *Prepare platoon sector sketch.* The platoon leader prepares an original and one copy of the sector sketch. The original remains in the platoon CP, and the copy is turned in to the company commander. As a minimum, the platoon sector sketch includes—

- Squad positions and sectors of fire.
- Key weapons positions and their sectors of fire and fire control measures.
- CPs, OPs, and patrol routes.
- Platoon maximum engagement lines.
- All dead space within the platoon sector.
- All mines and obstacles within the platoon sector.
- Any TRPs or FPFs within the platoon sector.

(j) *prepare fighting positions.*

(k) *Eplace minefields and obstacles.* Prepare IAW the company or battalion obstacle plan.

(l) *Establish fire control measures.* Establish and mark all required fire control measures.

(m) *Assign alternate and supplementary battle positions.* The platoon leader assigns each squad and key weapons system an alternate and a supplementary battle position.

(n) *Improve fighting positions.*

(o) *Prepare alternate and supplementary positions.*

(p) *Establish a rest plan.*

(7) The platoon conducts a rehearsal.

(a) Movement from primary positions to alternate and supplementary position.

(b) Initial engagements at trigger lines and TRPs.

(c) Casualty evacuation.

(d) Any planned counterattacks.

(8) The platoon sergeant stockpiles additional Class I, V, and VIII.

(9) If time allows, communications trenches are dug between positions and CPs.

(10) As time allows, the platoon's positions are continually improved.

c. React to Indirect Fire.

(1) When in defensive positions, soldiers seek the protection of their fighting positions. (Fighting positions require a minimum of 18 inches of overhead cover to provide protection from artillery rounds impacting nearby.)

(2) While moving or halted in unprotected positions, soldiers immediately assume prone positions. After the initial incoming rounds impact, the platoon leader determines the extent of the impact area (its length and width) and the nearest edge out of it (still heading roughly in the direction of travel, if possible). Then, he gives the direction and distance to move out of the impact area (for example, "Two o'clock, two hundred meters, follow me").

(3) Leaders report and continue the mission.

NOTE: In some cases, the platoon may immediately don protective masks. If shells with other than an HE burst (for example, smoke) or if there is an indication of a chemical attack, the platoon should mask.

d. Consolidation.

(1) The platoon leader adjusts squad positions, if required, and reassigns sectors of fire. The squad leaders and team leaders adjust positions to cover assigned sectors of fire. The platoon leader adjusts crew-served weapons to cover most dangerous avenues of approach.

(2) The platoon leader positions OPs to provide security and early warning.

e. Reorganization.

(1) The platoon reestablishes the chain of command and fills key positions:

(a) Platoon leader, platoon sergeant, squad leaders, and team leaders.

(b) Key weapons: machine guns, M203s, antiarmor.

(2) The platoon establishes communications with the company commander, the adjacent units, the battalion FSO, and the squads.

(3) Leaders redistribute ammunition and equipment. The platoon leader receives ACE report from squad leaders. The platoon leader reports the status to the company commander and requests any supplies that are required. The platoon sergeant redistributes ammunition and equipment among the squads.

(4) The platoon evacuates casualties, handles all EPWs IAW the five S's, and evacuates KIA.

(5) The platoon repairs fighting positions as required.

APPENDIX

1. ASSEMBLY AREA PROCEDURES

APPENDIX 1 (ASSEMBLY AREA PROCEDURES)
to
ANNEX C (OPERATIONS)
to
INFANTRY PLATOON TACTICAL SOP

When directed to occupy an assembly area, the platoon leader designates a quartering party. Each squad will provide two men for the quartering party. The platoon sergeant or selected NCO will be in charge of the quartering party.

1. The quartering party reconnoiters the assembly area to ensure no enemy are present and to establish initial security.
2. The quartering party determines initial positions for all platoon elements.
3. The quartering party provides security by forcing enemy reconnaissance probes to withdraw and providing early warning of an enemy attack.
4. As the platoon clears the release point, quartering party members, waiting in covered and concealed positions, move out and guide the platoon to its initial position without halting.
5. The platoon establishes and maintains local security. The platoon leader assigns each squad a sector of the perimeter to ensure mutual support and to cover all gaps by observation and fire. The platoon leader designates OPs and squad leaders select OP personnel. OPs have communications with the platoon CP. OPs warn the platoon of enemy approach before the platoon is attacked.
6. The platoon leader establishes a priority of work, to include—
 - a. Positioning of crew-served weapons, chemical-agent alarms, and designating PDF, FPL, and FPFs.
 - b. Constructing individual and crew-served fighting positions.
 - c. Setting up wire communications between the squads and the platoon CP. (Radio silence is observed by the platoon.)
 - d. Preparing range cards.
 - e. Camouflaging positions.
 - f. Clearing fields of fire.
 - g. Distributing ammunition, rations, water, supplies, and special equipment.
 - h. Conducting preventative maintenance checks and services on weapons and equipment.
 - i. Preparing Dragon nightsight.

- j. Inspection platoon members and equipment.
- k. Rehearsing critical aspects of the upcoming mission.
- l. Test firing small-arms weapons (if the tactical situation permits).
- m. Conducting personal hygiene and field sanitation.
- n. Instituting a rest plan.
- o. Completing the Work priorities as time permits.

7. The platoon leader conducts adjacent unit coordination. The platoon leader assigns security patrols, if applicable. The platoon leader establishes responsibility for overlapping enemy avenues of approach between adjacent squads and platoons. The leaders ensure there are no gaps between elements. The platoon leader exchanges information on OP locations and signals. The platoon leader coordinates local counterattacks.

8. The platoon leader forwards a copy of the sector sketch to the company.

ANNEX D (NBC)
to
INFANTRY TATICAL SOP

1. **REACT TO NUCLEAR ATTACK.** All soldiers assigned to the platoon reacts to an unwarned nuclear attack by doing the following:

a. Immediately drop to a prone position and close their eyes. Turn their bodies so their heads face toward the blast. Place their thumbs into their ears. Cover their faces with their hands. Place their arms under their bodies. Tuck their heads down into their shoulders and keep their faces downward.

b. Remain in the prone position until the second blast wave passes, and the debris has stopped falling.

c. Check themselves and their buddies for injuries and damage to assigned equipment.

d. Give first aid to any casualties and prepare them for evacuation.

e. Report the situation to higher headquarters using the NBC 1 report.

2. **REACT TO CHEMICAL ATTACK.** All soldiers assigned to the platoon reacts to a chemical attack by doing the following:

a. Stop breathing.

b. Within 9 seconds, put on their protective masks.

c. Within an additional 6 seconds, pull their hoods over their heads.

d. Shout "Gas" and give the appropriate arm-and-hand signal.

3. **UNMASKING PROCEDURES.** Selected soldiers use the M256 kit to determine if the area is clear. If the area is clear, the platoon leader selects two soldiers and begins unmasking procedures. He moves the soldiers to a shady area and has the soldiers unmask for 5 minutes. He observes soldiers for 10 minutes. If no symptoms occur, he reports to higher headquarters; based on the response, he issues all clear. He continues to observe soldiers for delayed reactions.

4. **HASTY DECONTAMINATION PROCEDURES.** The platoon leader ensures each soldier has one M258 personal decontamination kit. Each soldier decontaminates himself and his equipment IAW instruction on the M258 kit.

5. **MOPP GEAR EXCHANGE.** MOPP gear exchange is always conducted in buddy teams in the following sequence:

- Decontaminate protective mask and hood.
- Remove overgarment, overboots and gloves, and undergarment.
- Put on undergarment, overgarment, and overboots and gloves.
- Secure protective mask hood.

ANNEX E (AIR DEFENSE ARTILLERY)
to
INFANTRY TACTICAL SOP

1. **PASSIVE AIR DEFENSE.** Passive air defense is always used. By using available cover and concealment, camouflage, and dispersion, the platoon avoids being detected from the air.

2. **ACTIVE AIR DEFENSE.** Once detected, the platoon leader decides, based on the weapons control status, if he uses active air defense. Active air defense is conducted in one of the following ways:

a. For a high-performance aircraft, soldiers aim at a point two football field lengths in front of the aircraft and fire on automatic. This makes the aircraft fly through a “wall” of bullets.

b. For a low-performance aircraft or a rotary aircraft, soldiers aim at a point half of a football field length in front of the aircraft and fire on automatic.

c. For any aircraft heading directly at the platoon, soldiers aim at a point directly above the nose of the aircraft and fire on automatic.

ANNEX F (FIRE SUPPORT)
to
INFANTRY TACTICAL SOP

1. **TARGETING.** During mission planning, the platoon leader makes adjustments to the company's indirect fire support plan. Possible targets include—

- a. Known or suspected enemy locations not targeted by higher.
- b. Dead space not covered by organic weapons.
- c. Gaps between adjacent units not targeted by higher.
- d. Likely mounted and dismounted avenues of approach and withdrawal.
- e. Key terrain or obstacles not targeted by higher.

2. **FORWARD OBSERVER.**

a. **Duties and Responsibilities.**

- (1) The FO is the platoon's link to the battalion fire support system.
- (2) He assists the platoon leader in developing a platoon fire support plan that supports the platoon scheme of maneuver.
- (3) He advises the platoon leader on the capabilities, limitations, and effects of the various types of available munitions.
- (4) He continually updates the battalion FSO on his position and situation, ensuring the platoon is able to receive responsive fire support.
- (5) He submits targets into the battalion fire support system and updates them as necessary throughout the mission.

b. **Positioning.** The position of the FO always depends on METT-T. Generally, he moves as a member of the platoon headquarters. On rare occasions, the FO might be separated from the platoon leader. The FO must be readily available to the platoon leader, maintain communication with the battalion FSO, and be able to observe the battlefield.

3. **FIRE SUPPORT IN THE OFFENSE.**

- a. Targets are planned in front of and on the objective to support the platoon's approach, deployment, and assault during the attack.
- b. Targets are planned beyond the objective to support the platoons consolidation and reorganization after the attack.
- c. Targets are planned on all known or suspected enemy positions.
- d. Targets are planned on likely enemy withdrawal and counterattack routes.
- c. Targets are planned on key terrain features throughout the platoon area of operations.

f. Smoke is planned to obscure the platoon's movement through or across danger areas.

4. FIRE SUPPORT IN THE DEFENSE.

- a. Targets are planned on all known or suspected enemy positions.
- b. Targets are planned along likely enemy avenues of approach.
- c. Targets are planned in front of, on top of, and behind the platoon battle position.
- d. An FPF is planned along the enemy's most dangerous avenue of approach.
- c. Smoke is planned to screen the platoons withdrawal to alternate or supplementary positions.
- f. Illumination is planned BEHIND THE ENEMY. This exposes the enemy without exposing the platoon.

5. INDIRECT FIRE CONTROL.

- a. Before the start of any operation, the platoon leader ensures the FO knows the following:
 - (1) Target locations and descriptions.
 - (2) The effects required or purpose of the target.
 - (3) The priority of targets.
 - (4) Target engagement criteria.
 - (5) The method of engagement and control for the target.
 - (6) The location of all TRPs, trigger lines, and any other fire control measure used by the platoon leader.

6. **CALL FOR FIRE.** A call for fire is a message prepared by an observer. It has all the information needed to deliver indirect fires on the target. Any soldier in the platoon can request indirect fire support by use of the call for fire. Calls for fire must include—

- a. Observer identification and warning order: adjust fire, fire for effect, suppress, immediate suppression (target identification).
- b. Target location methods: grid, polar, shift from a known point.
- c. Target description. A brief description of the target using the acronym SNAP is given: Size/shape, Nature/nomenclature, Activity, Protective/posture.

ANNEX G (FIRE CONTROL AND DISTRIBUTION)
to
INFANTRY TACTICAL SOP

1. FIRE CONTROL.

a. Fire control measures.

(1) **Graphic measures.**

(a) *Boundaries or sectors.* Divide areas of tactical responsibility between units.

(b) *Battle positions.* Defensive position oriented along likely enemy avenues of approach.

(c) *Engagement areas.* The area in which the leader intends to destroy the enemy.

(d) *TRPs.* TRPs are used to reference enemy locations. They can be man made or natural. TRPs must be easily identifiable.

(e) *Maximum engagement lines.* Imaginary line which identifies the point where a particular weapon system is engaging at its maximum effective range.

(f) *Trigger lines.* An imaginary line where, once the enemy crosses, friendly units can engage. Trigger Lines can be oriented to terrain, obstacles, TRPs, or maximum engagement lines.

(g) *Phase lines.* Imaginary line placed along identifiable terrain which is used to control movement or coordinate fires.

(h) *Final protective fire.* A preplanned barrier of both direct and indirect fire designed to prevent or disrupt the enemy assault.

(2) **Rules of engagement.** Rules of engagement are directives issued by military or political authorities that specify circumstances under which the platoon will initiate or continue combat operations. Rules of engagement will generally be issued with the company operations order. Ensure everyone understands ROE.

(3) **Engagement priorities.** Targets appear in random order at different times and locations throughout the battlefield. Engagement priorities allow the leader to designate which target he wants destroyed first. Engagement priorities are usually done by weapons systems.

(a) *Antiarmor weapons systems.* The platoon antiarmor weapons engage targets in the following priority:

- Most threatening armor.
- Armor in primary sector.
- Armor in secondary sector.
- Unarmored command and control vehicles.

(b) *Platoon machine guns.* Machine gunners should always attempt to engage at their maximum effective range and should strive for grazing fire. Machine guns have the following target priority:

- The FPF, if directed.
- The most dangerous or threatening target.
- Groups of dismounted infantry in primary sector.
- Enemy crew-served weapons.
- Groups of dismounted infantry in secondary sector.
- Unarmored command and control vehicles.

(c) M203s. The grenadiers are used to cover the platoon's dead space. The target priority for M203s is—

- The most dangerous or threatening target.
- Light-armored vehicles.
- Groups of three or more in primary sector.
- Groups of three or more in secondary sector.

b. **Fire Commands.** Leaders use fire commands to direct the fires of the unit. A subsequent fire command adjusts or changes information given in the initial fire command. Only the elements that change are given. Fire is terminated by the command or signal for CEASE FIRE, END OF MISSION. A fire command has the following six parts.

(1) **Alert.** The leader can alert the soldiers by name or unit designation, by some type of visual or sound signal, by personal contact, or by any other practical way.

(2) **Direction.** The leader tells the soldiers the general direction or pinpoint location of the target.

(3) **Description.** The leader describes the target briefly but accurately. The formation of enemy soldiers is always given.

(4) **Range.** The leader tells the soldiers the range to the target in meters.

(5) **Method of fire.** The leader tells the soldiers which weapons to fire. He can also tell the type and amount of ammunition to fire, and the rate of fire.

(6) **Command to fire.** The leader tells soldiers when to fire. He can use an oral command, a sound or a visual signal. When he wants to control the exact moment of fire, he says AT MY COMMAND (then pauses until ready to commence firing). When he wants to start firing upon completion of the fire command, he just says FIRE.

c. **Fire Control During Limited Visibility.** During limited visibility, leaders ensure that the platoon's fires are controlled. To do this, they can use aiming stakes, T&Es for all machine guns, illumination, TRPs, and night vision devices.

2. FIRE DISTRIBUTION. The two methods of fire distribution are point fire and area fire.

a. **Point Fire.** The platoon's fires are directed at one target. The platoon leader accomplishes this by marking the desired target with tracer fire or by M203 fire.

b. **Area Fire.** The platoon's fires cover an area from left to right and in depth. The platoon leader accomplishes this four ways.

(1) **Frontal fire.** Frontal fire is used when the enemy is moving perpendicular to the platoons direction of fire. Each squad engages the targets to their immediate front. As targets are destroyed, fires are shifted toward the center of the enemy.

(2) **Cross fire.** Cross fire is used when the enemy is moving perpendicular to the platoon's direction of fire and terrain does not allow frontal fire. It is also used when the enemy is moving oblique to the platoons direction of fire. When using cross fire, squads engage targets from left to right or from right to left depending on their location.

(3) **Depth fire.** Depth fire is used when the enemy is moving parallel to the platoon's direction of fire. Squads engage targets from front to rear or from rear to front. As targets are destroyed, fires are shifted toward the center of the enemy.

(4) **Combination.** Depending on the METT-T, the platoon may use any combination of the above techniques.

ANNEX H (OPERATIONAL SECURITY)
to
INFANTRY TACTICAL SOP

1. COVER AND CONCEALMENT.

a. **Camouflage.** All soldiers use camouflage paint to cover exposed skin. The outline of an individual is broken using vegetation, burlap, or any other available means. Fighting positions are camouflaged using all exposed dirt to breakup the outline of a position. The position is checked from the enemy's view. Equipment is camouflaged using vegetation to break up the outline of the equipment and to cover all reflective surfaces.

b. **Protection.** Fighting positions have 18 inches of overhead. Helmets are worn during tactical operations.

c. **Concealment.** In order to avoid detection, soldiers operate using terrain and vegetation.

2. OBSERVATION POSTS.

a. Positioning. OPs always contain a minimum of two soldiers and have communication with the platoon headquarters (land line, FM, or signaling device). OPs are positioned IAW METT-T Routes to and from the OP are recorded and rehearsed. Each member of the OP is thoroughly briefed on the rules of engagement before departing for their post. Signals for the return of OPs (running password, challenge/password, light signals) will be established and briefed to all platoon personnel.

b. Relief of OPs. When an OP is relieved, the relieving personnel meet with the current OPs and receive a briefing that contains, as a minimum:

- Call signs and frequencies.
- Routes to and from perimeter.
- All signals and passwords.
- Area of responsibility for observation.

3. STAND-TO. A stand-to will be conducted 30 minutes before dawn and 30 minutes after sunset.

a. Team leaders and squad leaders check every individual soldier to ensure he is awake and alert, to ensure his equipment is packed in his rucksack, and to ensure he is observing his sector in his assigned fighting position.

b. Team leaders and squad leaders gather sensitive items report and weapons operational status, and passes the report to the platoon sergeant.

c. The platoon sergeant gathers the reports, spot checks squad position, and passes the reports to platoon leader.

d. The platoon leader reports to higher headquarters, spot checks squad and crew-served weapon positions.

4. NOISE, LIGHT, AND LITTER DISCIPLINE.

a. During preparation for combat, each platoon conducts final inspections. Shortcomings in noise discipline are identified. Clanking, rattling, and so forth, is subdued by the use of tape or cloth as required.

b. When lights are necessary for planning or map reading, a poncho is used to conceal them.

c. Cigarettes and cooking fires are not lit during daylight or darkness without permission of the company commander, or the leader of an independent element.

d. Nonverbal means of communication are used to the maximum extent possible.

e. During stationary operations, trash is collected and backhauled during logistics runs. If this is not practical (and in all other operations), soldiers carry trash until it can be disposed of securely (it is not buried or hidden unless specifically authorized).

ANNEX I (COMBAT SERVICE SUPPORT) to INFANTRY TACTICAL SOP

1. SOLDIER'S LOAD. Determining the soldier's load is a critical leader task. The soldier's load is always METT-T dependent and must be closely monitored. Soldiers cannot afford to carry unnecessary equipment into the battle. Every contingency cannot be covered. The primary consideration is not how much a soldier can carry, but how much he can carry without impaired combat effectiveness.

a. Combat Load. The mission-essential equipment, as determined by the commander responsible for carrying out the mission, required for soldiers to fight and survive immediate combat operations. When possible, a soldier's combat load should not exceed 60 pounds. There are two components:

(1) **Fighting load** (the essential items needed to fight) includes bayonet, weapons, clothing, helmet, and LBE and ammunition. Items will be added or deleted based on METT-T and other factors.

Load	Weight (Pounds)
Helmet, ballistic	3.4
Pistol belt, suspenders, and first-aid pouch	1.6
Canteen, 1-quart, and cover with water (2 each)	5.6
Case, small-arms (2each)	1.8
Bayonet with scabbard	1.3
Protective mask with decontamination kit	3.0
Rifle, M16A2 with 30 rounds 5.56 Ball.	8.8
Magazines (6) with 180 rounds of 5.56-mm.	5.4
Grenade, fragmentation (4)	4.0

Total 34.9

(2) **Approach march load** includes those items that are needed for extended operations. These are dropped in an assault position, ORP, or other points before or on enemy contact. Items may be added or deleted from this list based on METT-T and other factors.

Load	Weight (Pounds)
ALICE, medium with frame	6.3
Rations, MRE (2each)	2.6
Canteen, 2-quart, and cover with water	4.8
Toilet articles	2.0
Towel	0.2
Bag, waterproof	0.8
E-tool with carrier	2.5
Poncho, nylon	1.3
Liner, poncho	1.6

Total 22.1

NOTE: This list keeps the “droppable” rucksack load under 30 pounds and the overall combat load under 60 pounds.

b. **Sustainment Load.** The remaining equipment and materials needed for sustained combat operations must be carried by company and battalion assets.

c. **Load Management Techniques.** The leader decides, based on METT-T what will be carried in rucksack and what will be carried within immediate reach of soldier.

(1) Soldiers distribute loads evenly over body and LBE.

(2) Nothing is carried on the front side of the LBE that prevents the soldiers from taking well-aimed shots.

(3) Distribute loads throughout the platoon.

(4) Rotate heavy loads among several soldiers.

(5) Always consider transportation assets to carry loads.

(6) Drop rucksacks on enemy contact, or leave them in an ORP, an assault position, or the assembly area.

(7) Share or consolidate items.

(8) Consider carrying fewer rations for short operations.

(9) While carrying rucksacks, use water and rations carried in it first.

After rucksacks have been dropped, soldiers will still have a full supply on their LBE.

NOTE: Items common to everyone’s load are located in the same place.

2. **SUPPLY.** Policies and procedures are applied for supply requests and resupply operations. CSS operations are driven by the tactical setting for the infantry platoon. Resupply operations are planned in advance so as to not interfere with combat operations. The team leader and squad leader implement CSS by inspecting their soldiers for shortages and shortcomings in equipment and supplies. Once the squads have compiled their lists, they report their status to the platoon sergeant who in turn reports his status to the company XO. To standardize resupply operations, requests are submitted to the company XO for resupply.

a. **Requests for Resupply.** During the reorganization phase of combat operations, the squad leader, within 10 minutes, must access his squad’s status of ammunition, equipment, food and water, and submit his report to the platoon sergeant. Any time a weapon is fired by a soldier, the resupply system begins to work to prevent soldiers from being without ammunition and equipment. The system will not wait for minimum allocations, but it will be aggressive to anticipate future demands.

b. **Priority of Resupply.** Class V, ammunition; Class VII, weapons systems; Class IX, repair parts; Class VIII, medical supplies; and Class I, food and water.

3. **MAINTENANCE.** All weapons systems and equipment are cleaned by the user and inspected by squad leaders.

a. **Priority for Cleaning and Maintenance.** The priority is mission and situational dependent but will normally be antiarmor, crew-served weapons, and individual weapons.

b. **Stand-Down for Maintenance.** Stand-down occurs by having no more than 50 percent of the antiarmor and crew-served weapons at any time out of actions for maintenance. The rest of the squads' small-arms weapons will stand-down at no more than 33 percent at one time.

c. **PMCS Requirements.** All weapons systems and equipment receive an operator's cleaning inspection.

d. **Evacuation Responsibilities and Procedures.** Once the soldier completes the inspection of his weapons system, the squad leader verifies the work, and if a problem occurs, the squad leader fixes it or informs the platoon sergeant of the problem. The platoon sergeant then consolidates all of the maintenance requests, and informs the company XO during scheduled resupply. The XO evacuates the weapons and equipment to the battalion trains. The XO makes arrangement for a float from higher support.

4. PERSONNEL.

a. **Strength Reports.** The platoon's strength is reported at least twice daily on a secure net or land line from the platoon battle roster.

b. **Replacements.** Care should be taken when integrating new soldiers into the platoon. They are briefed by their entire chain of command. Their equipment is inspected by their squad leader, and any problems that have surfaced during in-processing are immediately remedied. Squad leaders explain the current situation and inform new soldiers of their duties and SOPs.

c. **EPWs and Civilian Internees and Detainees.** All EPWs and civilians are handled IAW with international law. The platoon sergeant monitors all activities dealing with EPWs and civilian internees and detainees. He ensures that they are searched, segregated, silenced, safe-guarded and sped to the rear. He is in charge of providing their medical treatment and their physical security. In addition, he assigns a team or squad to help with this mission, and to help maintain control throughout this process.

5. HEALTH SERVICES.

a. **Medical Evacuation.** Each platoon contains at least one MOS qualified aidman. Every effort is made to train as many personnel as possible as combat lifesavers. However, their primary skills areas infantrymen not aidmen. Each squad appoints one man as an assistant aidman

to help the platoon aid man with treatment of the casualties. The platoon sergeant coordinates with the platoon aidman and squad leaders for the location of the casualty collection point. The squad's chain of command is responsible for evacuating their troops to the location. Once the mode of evacuation has been established, the platoon sergeant secures the casualties' weapons, equipment, and ammunition and cross levels them, if need be. Requests for medical evacuation is handled by the platoon sergeant and routine sick is handled by the platoon aidman. Priority categories for medical evacuation are urgent, urgent surgical, priority, routine, and convenience.

b. **Field Sanitation.** Field latrines are dug at least 100 meters from platoon positions, if the tactical situation permits. If not, the trench is constructed within the platoon perimeter. The trench is constructed under the supervision of the platoon aidman. The only water to be consumed by soldiers should be potable or treated water. If located near a stream, the latrine is constructed downstream from the platoon's positions.

*CHAPTER 6

URBAN OPERATIONS

This chapter describes techniques, procedures and special considerations that are used by platoons and squads throughout the planning and execution of operations in an urban area.

Section I. OFFENSE

While operating in urban areas, the major offensive collective tasks at platoon and squad level are attacking and clearing buildings. This involves isolating the objective, suppressing the threat, advancing the assault element, assaulting the building, clearing the building, and consolidating and reorganizing the force.

Regardless of the type of urban area or the structural characteristics, there are six interrelated requirements for attacking a defended building:

- Isolation of the building or objective.
- Supporting fires.
- Tactical movement
- Breaching.
- Assaulting.
- Reorganization.

Proper application and integration of these requirements can reduce casualties and hasten accomplishment of the mission. The platoon leader, when developing the plan for an attack on an urban objective, must consider the type of building to be assaulted, the rules of engagement (ROE), and the nature of the surrounding urban area. These considerations will determine the method of execution. For

example, medium-size towns have numerous open spaces, and larger cities have high-rise apartments and industrial and transportation areas that are separated by parking areas or parks. Increased fire support is required to suppress and obscure enemy observation and fires that may be covering the open terrain and spaces between buildings. Conversely, the centers of small- and medium-sized towns, with twisting alleys and narrow roads or adjoining buildings, provide the platoon and squad with numerous covered and concealed routes that could decrease fire support requirements.

Platoon and squad leaders must consider the task and purpose they have been given and the method they will use to achieve the desired results. To seize or gain control of a building, group of buildings, or an area may not always require the platoon or squad to commit troops into the structures or to close with the enemy. For example, if the threat personnel are of low morale, poorly trained, under equipped, or lack leadership, they may be convinced to surrender or withdraw simply by a show of force and the use of a skilled PSYOPS team. At the other end of the spectrum, an enemy that is well trained, prepared to defend, and has the means to resist may be encountered. In this case the leader may decide (ROE permitting) to concentrate his direct and indirect fire weapons and other combat support systems onto the objective area to neutralize the threat without maneuvering troops to conduct an assault.

6-1. TASK ORGANIZATION (PLATOON ATTACK OF A BUILDING)

The platoon leader will normally organize his platoon into at least two elements: an assault element consisting of two rifle squads, and a support element consisting of the platoon's

crew-served weapons and one rifle squad as the support/reserve (Figure 6-1, page 6-4). If engineers are not available, he can designate a breaching team from within either the assault or the support element or, depending on the situation, he may task organize a separate breach element. The size and composition of these elements are determined by the mission given, the number of troops available, the type and size of the objective building, whether the adjacent terrain provides open or covered approaches, and the organization and strength of the enemy defenses. As part of a company operation, the platoon will be part of either the assault element or the support element.

- As part of the company's assault element, the platoon would organize into three assault squads with two assault teams each, and will attach the machine guns to the company support element.
- As the part of the company's support element, the platoon may be organized into three support squads with machine guns and antiarmor weapons attached. The attached machine guns provide the support element with added firepower for increased lethality.

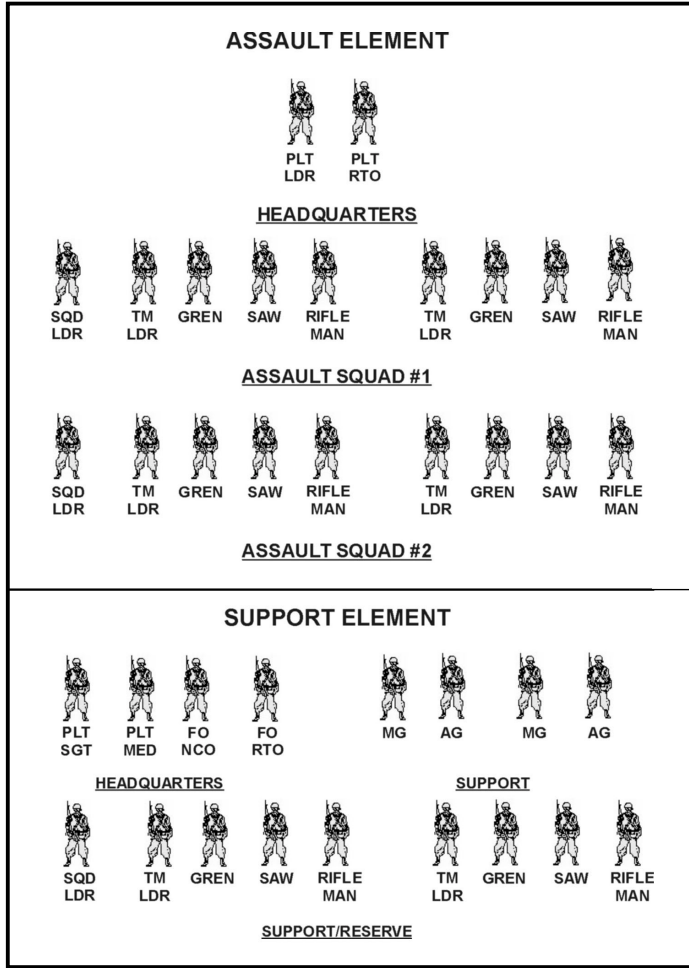

Figure 6-1. Platoon organization.

a. **Assault Element.** The purpose of the assault element is to kill, capture, or force the withdrawal of the enemy from an urban objective and to seize key terrain. The

assault element of a platoon may consist of one, two, or three squads. Squad leaders will normally organize their two fire teams into two assault teams or, in special circumstances, the squad may be kept as a single assault element.

Note: Clearing techniques are designed to be executed by the standard four-man fire team. This does not mean that all four members must enter a room to clear it. Because of the confined spaces typical of building/room clearing operations, units larger than squads quickly become awkward and unmanageable. When shortages of personnel demand it, two- and three-man teams can conduct room-clearing operations, but four-man teams are best suited. Using fewer personnel adds to the combat strain and greatly increases the risks to the team. For clearing large open buildings, such as hangars or warehouses, it may be necessary to commit two squads simultaneously using a bounding overwatch movement technique to effectively cover the entire structure and provide force protection.

b. **Support Element.** The purpose of the support element is to provide immediate suppressive fire support to enable the assault element to close with the enemy. Suppressive fires must be closely controlled to avoid excessive expenditure of ammunition and prevent fratricide. The support element is normally controlled by the platoon sergeant or a senior squad leader and normally consists of the platoon's crew-served weapons, light and medium antitank weapons systems, forward observer team, platoon medic, and any personnel not designated as part of the

assault element (Figure 6-2). The support element provides both direct and indirect fire support and other assistance to advance the assault element. This support includes, but is not limited to, the following:

- Suppressing enemy weapons systems and obscuring the enemy's observation within the objective building(s) and adjacent structures.
- Isolating the objective building(s) with direct and indirect fires to prevent enemy withdrawal, reinforcement, or counterattack.
- Obscuring enemy observation of obstacles en route to the objective and at the entry point of the objective during breaching operations.
- Destroying or suppressing enemy positions with direct fire weapons.
- Engaging armored vehicles.
- Securing cleared portions of the objective.
- Providing replacements for the assault element.
- Providing the resupply of ammunition and pyrotechnics.
- Bringing up specific equipment that the assault element could not carry in the initial assault.
- Evacuating casualties, prisoners, and civilians.

Note: The platoon sergeant must be prepared to rapidly evacuate wounded from the objective area to the company casualty collection point (CCP). The use of ground ambulances may be impeded by rubble in the streets, barricades, and demolition of roads; therefore, litter teams could be used extensively. Also, snipers can affect medical evacuation from forward positions.

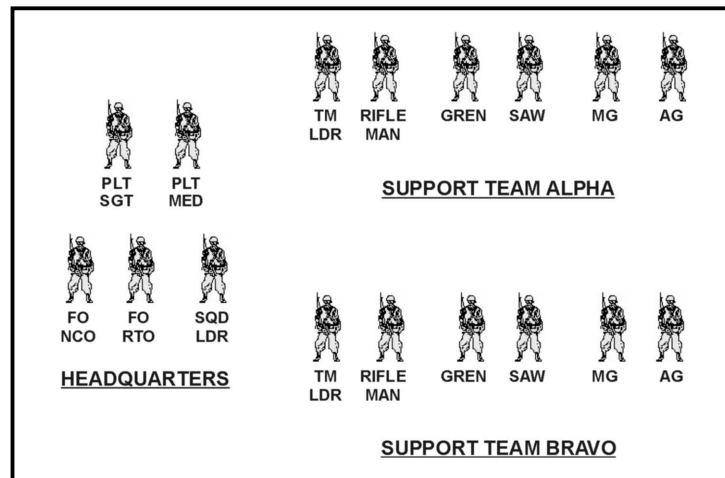

Figure 6-2. Platoon support element with squad integrated.

c. **Breaching Element.** The purpose of the breaching element is to clear and mark lanes through obstacles during movement, providing the assault element with access to an urban objective. The platoon leader organizes the force to ensure breaching elements are designated. One technique is to assign one fire team from the assault element as the breaching element. Alternatively, the breach can be conducted using an attached engineer or any member of the assault or support element who has had additional breach training.

6-2. MOVEMENT

When moving in an urban area, squads and platoons use variations of the traveling, traveling overwatch, and

bounding overwatch movement techniques. Often squads and fire teams will use the modified wedge (file or column) to move. Leaders must be aware of the three-dimensional aspect of urban terrain (streets, buildings, subsurface, and airspace) and anticipate enemy contact from all directions (Figure 6-3). Squads and platoons are extremely vulnerable to sniper fire; therefore, countersniper TTP must be well rehearsed and implemented to prevent excess casualties. (See FM 90-10-1 for more information concerning countersniper techniques.)

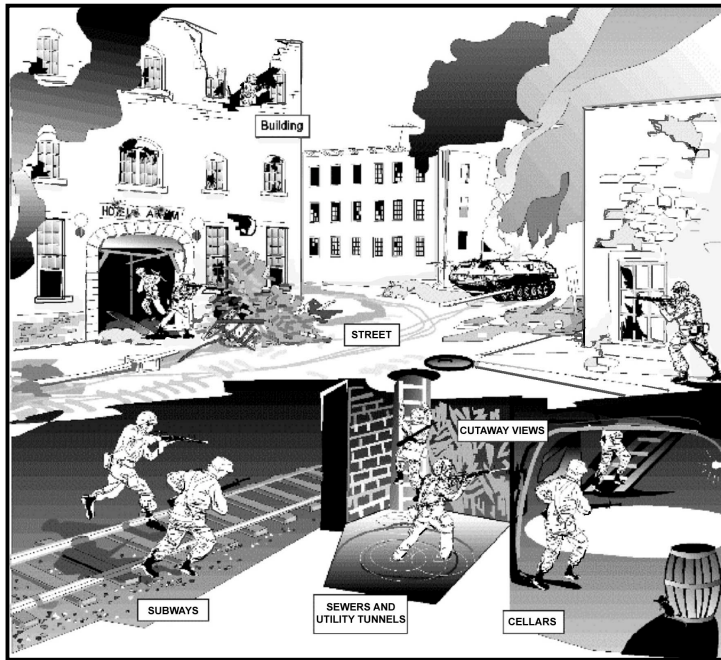

Figure 6-3. Three-dimensional urban terrain.

- a. The assault force (squad or platoon) minimizes the effects of the enemy's defensive fires during movement by:
- Using covered and concealed routes.
 - Moving only after enemy fires have been suppressed or enemy observation obscured.
 - Moving at night or during other periods of reduced visibility.
 - Selecting routes that will not mask friendly suppressive fires.
 - Crossing open areas quickly under concealment of smoke and suppressive fires.
 - Moving on rooftops not covered by enemy fires.
- b. In lightly defended areas, the type of operation may dictate moving along streets and alleys without clearing all the buildings.
- c. The squads move along streets and alleys on one side of the street supported by an overwatching element. Each man is assigned a specific sector to observe and cover.
- d. To avoid exposure on the street or to provide mutual support, the squads should move through the buildings if possible.
- e. When armored vehicles are attached, the platoon moves on foot with two squads leading, one on each side of the street, using bounding overwatch movement techniques (Figure 6-4, page 6-10). This technique is used to quickly locate, identify, engage, and eliminate any antiarmor threat.

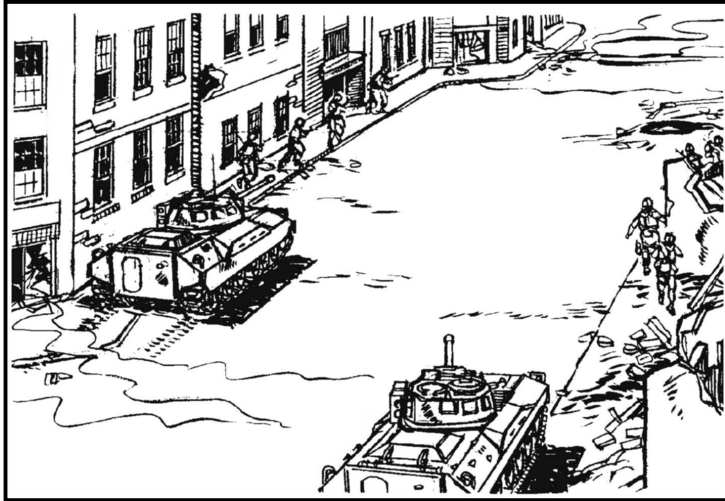

Figure 6-4. Armored vehicles supporting infantry.

Note: When armored vehicles are employed with the infantry, the platoon leader must brief his personnel to the dangers associated with vehicles engaging targets close to them (explosive effects, fragmentation fallout, and blast over-pressure). (For more specific information on the effects of weapons see FM 90-10-1.)

6-3. ASSAULTING A BUILDING

The assault force, regardless of size, must quickly and violently execute the assault and subsequent clearing operations. Once momentum has been gained, it is maintained to deny the enemy time to organize a more determined resistance on other floors or in other rooms. The small unit leaders are responsible for maintaining the

momentum of the assault, controlling movement, yet not allowing the operation to become disorganized. Enemy obstacles may slow or stop forward movement. Leaders must maintain the momentum by rapidly creating a breach in the obstacle, or by redirecting the flow of the assault over or around the obstacles.

a. **Approaches.** All routes to the breach and or entry point are planned in advance. The best route is confirmed and selected during the leaders' reconnaissance. The route should allow the assault element to approach the breach (entry) point from the blind side, if possible.

b. **Order of March.** The assault team's order of march to the breach point is determined by the method of breach and their intended actions at the breach (entry) point. This preparation must be completed prior to or in the last covered and concealed location before reaching the breach (entry) point. Establishing an order of march is done to aid the team leader with C2 and to minimize exposure time in open areas and at the entry point. An order of march technique is to number the assault team one, two, three, and four. The number one man should always be responsible for frontal/door security. If the breach has been conducted prior to their arrival the assault team quickly moves through the breach (entry) point. If a breach has not been made prior to their arrival at the breach (entry) point, and depending on the type of breach to be made, the team leader conducts the breach himself or signals forward the breach man/element. One option is to designate the squad leader as the breach man. If the breach man is part of the assault team, he will normally be the last of the four men to enter the building or room. This allows him to transition from his breaching task

to his combat role.(See FM 90-10-1 for more information concerning movement and breaching methods.)

(1) **Ballistic Breach (Shot Gun).** A suggested order of movement for a ballistic (shot gun) breach has the gunner up front, followed by the number one man, number two man, and then the number three man (team leader). After the door is breached, the gunner moves to the rear of the lineup and assumes the position of the number four man.

(2) **Explosive Breach.** A suggested order of movement for an explosive breach without engineer support is; number one, number three (team leader), number two, and then number four man. The number one man provides security at the entry point. The number three man (team leader) carries the demolition charge and places it. Number four provides rear security. After the demolition charge is placed, team members reform in the original configuration and take cover around a corner or behind other protection. Team members can line up on either or both sides if there is adequate protection from the blast.

(3) **Mechanical Breach.** A suggested order of movement for a mechanical breach is the initial assault team in order, followed by the breach man/element. At the breach point the team leader will bring the breach element forward while the assault team provides local security. After the breach is made, the breach element moves aside and provides local security as the assault team enters the breach.

c. **Security.** Because of the three-dimensional threat associated with urban terrain, the assault element must maintain 360-degree security during movement to the breach (entry) point. If the assault element is to stop in the vicinity of the breach (entry) point to wait for the breach

element to complete its task, the support element must maintain suppressive fire to protect the assault element.

d. **Assault Locations.** Entry at the top and fighting downward is the preferred method of clearing a building (Figure 6-5, page 6-14). This forces the defenders down and out of the building where the support element can engage them. This method is only feasible, however, when access to an upper floor or rooftop can be gained from the windows or roofs of adjoining, secured buildings. Rooftops are treated as danger areas when surrounded by higher buildings from which enemy forces could engage the assault element. Helicopters should land only on those buildings that have a roof structure that can support their weight. If the structure cannot support the helicopter, soldiers can dismount as the helicopter hovers a few feet above the roof. Troops then breach the roof or common walls to gain entrance into the building. (If using explosives on the rooftop, ensure cover is available to the soldiers.) They may use ropes or other means to enter the lower floors through the holes created.

Note: Soldiers should consider the use of devices and techniques that allow them upper level access without using interior stairways. These devices and techniques include, but are not limited to, adjacent rooftops, fire escapes, portable ladders, and various soldier-assisted lifts.



Figure 6-5. Assault element entering from the top.

e. **Support Element.** The support element isolates the building with direct and indirect fires to support the assault element's move to the breach point. The support element covers mounted avenues of approach with antiarmor weapons, covers dismounted avenues of approach with automatic weapons, and suppresses enemy fires and neutralizes enemy positions to enable the breach team and assault element to move into position. The location of adjacent units must be considered in the emplacement of supporting fires.

(1) The support element uses smoke to obscure the movement of the breach team and assault element to the building. If possible, the smoke obscuration is maintained until the assault element has entered the building.

(2) Depending upon the ROE, just before the rush of the assault element, the support element increases suppressive fires on the objective and continues until masked by the

advancing assault element. (See Figure 6-6 for grid fire control technique.) Once masked, fires are shifted to upper or lower windows and continued until the assault element has entered the building. At that time, fires are shifted to adjacent buildings to prevent enemy withdrawal or reinforcement.

(3) If the ROE are very restrictive, the use of supporting fires may be restricted to known enemy locations that have engaged the unit.

(4) The support element must also deal with civilians displaced by the assault, EPWs, and casualties.

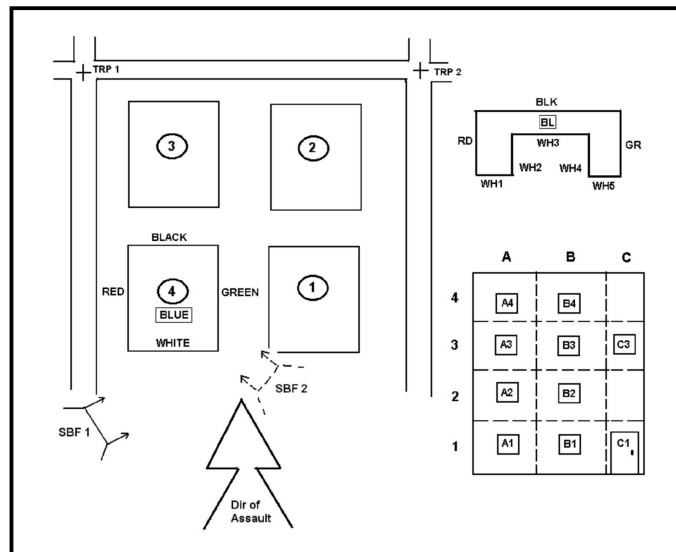

Figure 6-6. Example grid fire control technique.

f. **Direction of Assault Technique of Direct Fire Planning and Control.** In this technique, building numbers

are assigned in a consistent pattern in relation to the direction of assault. In the example shown in Figure 6-6, the buildings are numbered consecutively, in a counterclockwise manner. Further, the sides of the buildings are color-coded consistently throughout the objective area (WHITE—direction of assault side; GREEN—right side; BLACK—rear side; RED—left side; BLUE—roof). An odd-shaped building is also shown. Note that a “four-sided” concept was retained to minimize confusion. Further designations of WHITE 1, WHITE 2, WHITE 3, and so on from left to right can be added to specify which wall will be engaged. Apertures on the buildings are also labeled consecutively using rows and columns, as shown. In the example, “OBJ 4, WHITE, window A1” is the lower left-hand window on the direction of assault side of OBJ 4. All designations are labeled in relation to the direction of assault. (See FM 34-130 for additional information on building shapes and structural labeling.)

6-4. CONDUCT OF THE BREACH

The assault element may be fighting just to get to the breach point; therefore, proper fire and movement will be required all the way to the breach (entry) point. The rest of the squad/platoon will provide support to secure (left, right, up, and down) the assault element. Remember that the fight is three-dimensional and in 360 degrees. If doors and windows are not used for the entry, the assault element must remain oriented on these danger areas as they approach the breach location. The assault element may need to augment or create obscuration with hand-held smoke, but must remember not to mask the fires of the support element or obscure the breach (entry) point from friendly observation and fires. If

possible, the breach is conducted in such a manner as to allow the assault element to continue movement without having to wait at the breach (entry) point. Deception should be used to confuse the enemy as to the location of the primary entry point. This can be achieved by using fragmentation grenades, concussion grenades or stun grenades in an area other than the actual breach/entry point.

a. **Breaching Methods.** The three breaching methods discussed here are mechanical, ballistic, and explosive.

(1) ***Mechanical Breach.*** This method requires increased physical exertion by one or more soldiers using hand tools such as axes, saws, crowbars, hooligan's tools, or sledgehammers. The mechanical breach is not preferred as the primary breaching method because it may be time consuming and defeat the element of surprise. However, the ROE and situation may require the use of these tools, so soldiers should be proficient in their use. (See FM 90-10-1 for additional information concerning mechanical breaching.)

(2) ***Ballistic Breach.*** This method requires the use of a weapon firing a projectile at the breach point.

(a) For exterior walls, the use of a tank or an artillery piece in the direct fire role is ideal if the structure will support it and if the ROE will allow it (see Section IV). The main gun of an M1 tank is very effective when using the HEAT round; however, the SABOT round rarely produces the desired effect because of its penetrating power. The 12-gauge shotgun breaching round is effective on doorknobs and hinges, while standard small arms (5.56-mm and 7.62-mm) have proved to be virtually ineffective for breaching. Because of their ricochet potential and their "shoot-through" capability, small arms (5.56-mm and

7.62-mm) should not be used except as a last resort. Ballistic breaching of walls by shotgun fire is normally an alternate means of gaining entry. In most cases, ballistic breaching should not be considered the primary method for gaining initial entry into a structure because it is not a positive means of gaining entry. It may not provide the surprise, speed, and violence of action necessary to minimize friendly losses on initial entry. In certain situations, ballistic breaching may become necessary as a back-up entry method. A misfire of an explosive charge or the compromise of the assault force during its approach to the target may necessitate the use of ballistic breaching as a means of initial entry into the structure. Ballistic breaching may have to be followed up with a fragmentation, concussion, or stun grenade before entry.

WARNING

The fragmentation and ricochet effects of standard small arms (5.56-mm and 7.62-mm) as breaching rounds is unpredictable and considered extremely dangerous. Do not attempt in training.

(b) Once initial entry is gained, shotgun ballistic breaching may become the primary method for gaining access to subsequent rooms within the structure. Surprise is lost upon initial entry, and other breaching methods are often too slow and tend to slow the momentum of the assault team. If a door must be used for entry, several techniques can be used to open the door. Doors should be considered a fatal funnel because they are usually covered

by fire, or they may be booby-trapped. (See FM 90-10-1 for more information concerning weapon employment and effects.)

(c) Rifle-launched entry munitions (RLEM) (Figure 6-7) allow a remote ballistic breach of an exterior door or window without having the assault or breaching element physically present at the breach (entry) point. This allows the assault element to assume a posture for entry in the last covered and concealed position before the breach. The RLEM firer is not normally part of the assault element, but rather a part of the breaching or support element. This allows the RLEM to be fired from one position while the assault element waits in another position. In the event that the first round does not affect the breach, either the firer should prepare a second round for the breach or a second firer should be prepared to engage the target.



Figure 6-7. Rifle-launched entry munitions (RLEM).

WARNING

Firer must be a minimum of 10 meters from target to safely employ a 150-gram round.

Note: Exact minimum safe distances for firers and assault elements have not been established for this round.

(3) **Explosive Breach.** This type of breaching requires the use of an explosive composition such as C4 or TNT, or a manufactured shape charge directed against the target.

(a) **Exterior Walls.** One of the most difficult breaching operations for the assault team is breaching masonry and reinforced concrete walls. Composition C4 is normally used for explosive breaching because it is safe and easy to use, and is readily available. Engineers are usually attached to the platoon if explosive breaching operations are expected. The attached engineers will either conduct the breach themselves or provide technical assistance to the infantrymen involved. The typical thickness of exterior walls is 15 inches or less. Assuming that all outer walls are constructed of reinforced concrete, a rule of thumb for breaching is to place 10 pounds of C4 against the target between waist and chest height. When detonated, this charge normally blows a hole large enough for a man to go through. However, on substandard buildings, a charge of this size could rubble the building. When explosives are used to breach windows or doors the blast should eliminate any booby traps in the vicinity of the window or door frame. (See FM 90-10-1 for information concerning demolitions.)

(b) **Charge Placement.** Place charges (other than shape charges) directly against the surface that is to be breached. When enemy fire prevents an approach to the wall, a technique may be to attach the breaching charge to a pole and slide it into position for detonation at the base of the

wall untamped. Small-arms fire will not detonate C4 or TNT. Take cover before detonating the charge.

(c) *Tamping*. Whenever possible, explosives should be tamped or surrounded with material to focus the blast to increase their effectiveness. Tamping materials could be sandbags, rubble, desks, chairs, and even IV bags. For many exterior walls, tamping may be impossible due to enemy fire. An untamped charge requires approximately twice the explosive charge to produce the same effect as a tamped charge.

(d) *Second Charges*. Breaching charges will not cut metal reinforcing rods inside concrete targets. If the ROE permits, hand grenades should be thrown into the opening to clear the area of enemy. Once the area has been cleared of enemy, the reinforcing rods can be removed using special steel cutting explosive charges or mechanical means.

b. **Breach Locations**. The success of the assault element often depends on the speed with which they gain access into the building. It is important that the breach location provide the assault element with covered or concealed access, fluid entry, and the ability to be overwatched by the support element.

(1) *Creating Mouseholes*. Mouseholes provide a safe means of moving between rooms and floors. C4 plastic explosive can be used to create mouseholes when lesser means of mechanical breaching fail. Because C4 comes packaged with an adhesive backing, or can be emplaced using pressure-sensitive tape, it is ideal for this purpose. When using C4 to blow a mousehole in a lath and plaster wall, one block or a strip of blocks should be placed on the wall from neck-to-knee height. Charges should be primed with detonating cord or MDI to obtain simultaneous

detonation, which will blow a hole large enough for a man to fit through.

(2) ***Expedient Breaching Methods.*** Because the internal walls of most buildings function as partitions rather than load-bearing members, smaller explosive charges can be used to breach them. When C4 or other military explosives are not available, one or more fragmentation grenades or a Claymore mine can be used to breach some internal walls. These field expedient breaching devices should be tamped to increase their effectiveness and to reduce the amount of explosive force directed to the rear. Extreme care must be taken when attempting to perform this type of breach since fragments may penetrate walls and cause friendly casualties. If walls are made of plaster (dry wall), mechanical breaching may be more effective.

(3) ***Door Breaching Charges.*** The general-purpose charge and the flexible linear charge are field expedient charges that can be used to breach interior and exterior doors. These charges give the breach element an advantage because they can be made ahead of time and are simple, compact, lightweight, and easy to emplace. (See FM 90-10-1 for more information concerning door breaching charges.)

(4) ***Windows and Restrictive Entrances.*** Regardless of the technique used to gain entry, if the breach location restricts fundamental movement into the room or building, local or immediate support must be used until the assault team can support itself. For example, as a soldier moves through a window and into the room, he may not be in a position to engage a threat; therefore, another window that has access to the same room may be used to overwatch the lead clearing team's movement into the room. The overwatching element can come from the initial clearing

team or from the team designated to enter the breach location second.

6-5. ENTER AND CLEAR A BUILDING

A large portion of combat in urban areas takes place at very close ranges, often between small groups of combatants within the confines of a single room. Success or failure is often determined by actions taken instinctively by individual soldiers and fire teams as they encounter complex situations. One of the complexities often encountered is the intermixing of combatants with noncombatants in the same building and often in the same room.

a. **Principles.** The principles of precision combat are surprise, speed, and controlled violence of action. These principles do not change regardless of ROE. The three principles of precision combat are each relative to one another—successful surprise allows increased speed; controlled violence coupled with speed increases surprise.

(1) **Surprise.** Surprise is one of the elements necessary for a successful assault at close range. The assault team achieves surprise by attacking at a time and location unexpected by the defender. Hand grenades, concussion grenades, or stun grenades are used to achieve surprise. These techniques are most effective against a nonalert, poorly-trained enemy. An explosive or ballistic breach will also provide the element of surprise by stunning the occupants of a room.

(2) **Speed.** Speed provides a measure of security to the clearing unit. Speed allows soldiers to use the first few seconds provided by surprise to their advantage. In urban combat, speed does not mean incautious haste. It can best be described as a “careful hurry.”

(3) ***Controlled Violence of Action.*** Controlled violence of action eliminates or neutralizes the enemy and decreases his chances of inflicting friendly casualties. Controlled violence of action is not limited to the application of firepower only. It also involves a highly motivated soldier and his ability to dominate and control the combat situation.

b. **Fundamentals of Clearing Operations.** The fundamentals of clearing operations are the actions soldiers take while moving along confined corridors to the room to be cleared, while preparing to enter the room, during room entry and target engagement, and after contact. Team members must—

- Move tactically while securing the corridors to the room to be cleared. To prevent fatigue, noise, and interference while moving, the assault team should minimize the equipment they carry.
- If possible, arrive undetected at the entry to the room and in the correct order of entrance, prepared to enter on a single command or signal.
- Ensure security is maintained outside the room to protect the assault team inside the room.
- Enter quickly and dominate the room. They must move immediately to positions that allow complete control of the room and provide unobstructed fields of fire.
- Eliminate all enemy within the room with quick, accurate, and discriminating fires.
- Gain and maintain immediate control of the situation and all personnel in the room.
- Confirm whether enemy casualties are wounded or dead. They must search all enemy casualties, disarming them and segregating the wounded.

Note: Soldiers can carry and use small plastic flex cuffs to control civilian detainees or captured military personnel.

- Immediately perform a cursory search of the room and determine if a detailed search is required.
- Evacuate all wounded as quickly as possible. Friendly wounded should be evacuated as soon as they are out of direct small arms fire.
- Evacuate any friendly dead.
- Mark the room as cleared in accordance with unit TACSOP using simple, clearly identifiable markings (Figure 6-8, page 6-26). Some common markings can include spray paint, a reflective physical training strap, chalk, engineer tape, chem lights, and NATO marking panels. Markings may be placed on the outside of cleared floors on multistory buildings to show friendly forces the progress of the clearing operation if this will not give intelligence to enemy forces.
- Provide a SITREP in accordance with the unit TACSOP when the room is cleared.
- Maintain security at all times and be prepared to react to more enemy contact at any moment. Priority must be given to the direction of attack, but rear security should not be neglected.
- Rotate assault teams to maintain the momentum of the attack.

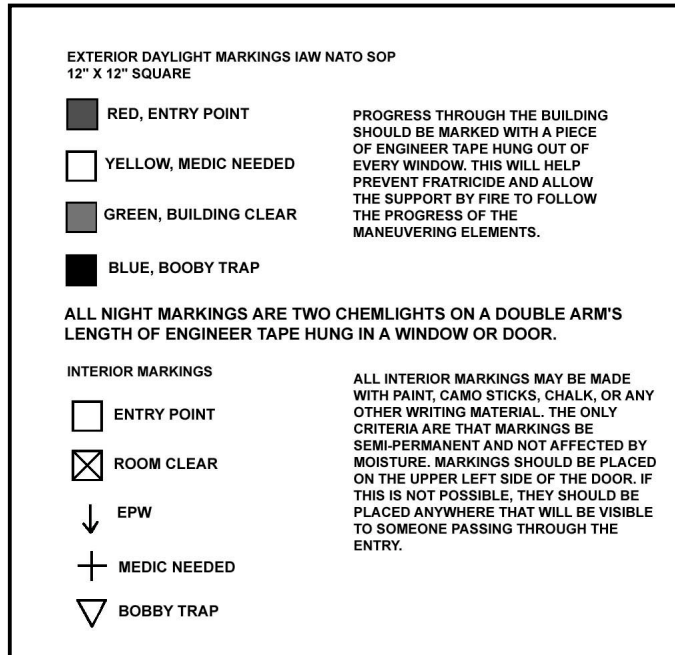

Figure 6-8. Sample marking SOP.

c. **Clearing Techniques.** Methods of movement, firing techniques, weapon positioning, and reflexive shooting, are fundamentals used in urban combat. Employing these techniques is an effective means of achieving success, minimizing noncombatant casualties, and conserving ammunition. Each member of the unit must understand the principles of precision combat and his part in their successful execution.

(1) Special clearing techniques may be required when highly restrictive ROE are in effect. The enemy situation may require that, rather than using firepower to suppress

and neutralize buildings in the objective area, the units may need to clear only a few selected buildings methodically to accomplish its mission. Examples of reasons for a highly restrictive ROE are:

- Use of heavy supporting fires and demolitions would cause unacceptable collateral damage.
- Enemy combatants are so intermixed with noncombatants that the ROE prevents US forces from using all their available supporting fires, and room-by-room clearing may be necessary.
- The likelihood of fratricide requires restrictive ROE.

(2) In a situation where the ROE favor overwhelming firepower, units should employ direct and indirect fires, demolitions, and fragmentation or concussion grenades as necessary to assist in clearing an objective defended by an alert and determined force without noncombatants. (Refer to Chapter 4 of this manual for specific information concerning Battle Drill 6, Enter Building/Clear Room.)

Note: To prevent the possibility of fratricide or injury to friendly inhabitants, leaders should consider the use of nonlethal stun grenades rather than the fragmentation or concussion grenade.

6-6. CONSOLIDATION AND REORGANIZATION

The squad and platoon will conduct consolidation and reorganization immediately after each action where soldiers are engaged and ammunition is expended. Consolidation is the action taken by the squad or platoon to ensure its

security, to prepare for a counterattack by the enemy, and to prepare to continue the mission. Consolidation in an urban environment must be quick in order to repel enemy counterattacks and to prevent the enemy from infiltrating back into cleared buildings or floors. After securing a floor (bottom, middle, or top), selected members of the unit are assigned to cover potential enemy counterattack routes to the building. Priority must be given initially to securing the direction of attack. Security elements alert the unit and place a heavy volume of fire on enemy forces approaching the unit. Reorganization occurs after consolidation. These actions prepare the unit to continue the mission by ensuring key leadership positions are filled and important weapon systems are manned. Many reorganization actions occur simultaneously during the consolidation of the objective.

a. **Consolidation Actions.** Squads assume hasty defensive positions to gain security immediately after the objective has been seized or cleared. Squads that performed missions as assault elements should be prepared to assume an overwatch mission and to support another assault element. Units must guard all avenues of approach leading into their area. These may include:

- Enemy mouse-holes between adjacent buildings.
- Covered routes to the building.
- Underground routes into the basement.
- Approaches over adjoining roofs.

b. **Reorganization Actions.** After consolidation, leaders ensure the following actions are taken:

- Resupply and redistribute ammunition.
- Mark buildings to indicate to friendly forces that they have been cleared.

- Treat and evacuate wounded personnel. Once the objective area is secure, begin evacuating noncombatants then enemy wounded.
- Treat and process EPWs.
- Segregate and safeguard noncombatants.
- Reestablish the chain of command.

6-7. CONTINUATION OF THE ASSAULT MISSION

If the unit is going to continue with its original mission, its “be prepared/on order” mission, or receives a new mission, it must accomplish the following tasks:

- The momentum must be maintained. This is a critical factor in clearing operations. The enemy cannot be allowed to move to its next set of prepared positions or to prepare new positions.
- The support element pushes replacements, ammunition, and supplies forward to the assault element.
- Security for cleared areas must be established IAW the OPORD or TACSOP.
- The support element must displace forward to ensure that it is in place to provide support to the assault element such as isolation of the new objective.

Section II. DEFENSE

In urban areas, buildings provide cover and concealment, limit fields of observation and fire, and block movement of troops, especially mechanized troops. This section covers the key planning considerations, weapons selection,

preparations, and the construction of a platoon defensive position on urbanized terrain.

6-8. PLANNING THE DEFENSE

Planning the defense begins when the leader receives a mission or determines a requirement to defend such as during consolidation and reorganization after an assault. The leader must use terrain wisely and designate a point of main effort. He chooses defensive positions that force the enemy to make costly attacks or conduct time-consuming maneuvers to avoid them. A position that the enemy can readily avoid has no defensive value unless the enemy can be induced to attack it. The defense, no less than the offense, should achieve surprise. As platoon leaders conduct their troop-leading procedures, they also have to consider civilians, ROE, limited collateral damage, and coordination with adjacent units to eliminate the probability of fratricide. Maneuver, methods, and courses of action in establishing defensive positions in and around urbanized terrain are METT-TC intensive.

a. The squad's and platoon's focus for defending in an urban area is the retention of terrain. As with most defensive scenarios, the squad and platoon will defend as part of the company. The platoon will either be given a sector to defend or a battle position to occupy and the platoon leader must construct his defense within the constraints given to him. In an urban area, the defender must take advantage of the abundant cover and concealment. He must also consider restrictions to the attacker's ability to maneuver and observe. By using the terrain and fighting from well-prepared and mutually supporting positions, a defending

force can delay, block, fix, or inflict heavy losses on a much larger attacking force.

b. One of the most common defensive tasks a platoon will be given during urban operations is to conduct a strongpoint defense of a building, part of a building, or a group of small buildings (Figure 6-9). The platoon's defense is normally integrated into the company's mission. The platoon leader organizes the strongpoint defense by positioning personnel and their weapons systems to maximize their capabilities. Supporting fires are incorporated into the overall defensive plan to provide depth to the engagement area

(1) The platoon leader organizes the defense into a series of individual, team, and squad fighting positions located to cover avenues of approach and obstacles, and to provide mutual support in order to repel the enemy advance. Snipers should be positioned to support the commander's intent and to allow for the opportunity to engage C2 and key targets.

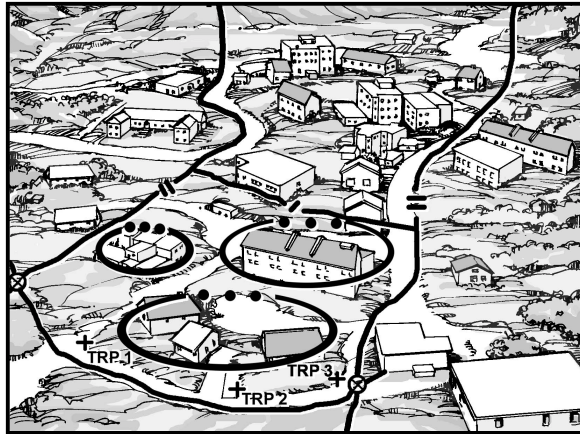

Figure 6-9. Defensive strongpoint.

(2) Depending on the length of the mission, the platoon should stockpile munitions (especially grenades), food and water, medical supplies, and fire-fighting equipment.

6-9. HASTY DEFENSE

While operating in an urban area, it is highly possible that the infantry platoon will be called upon to conduct a hasty defensive mission. Unlike the deliberate defense, the hasty defense is characterized by the lack of information about enemy forces and the lack of time to prepare the defense. All of the troop-leading procedures are the same, and many of the priorities of work of the deliberate defense will be the same but may take place concurrently. Units are deployed, weapons emplaced, and fighting positions prepared in accordance with the amount of time available to the unit.

a. **Occupation and Preparation of Positions.** The extent of preparation the platoon is able to accomplish will depend on the amount of time available. Normally, when occupying hasty defensive positions, the platoon takes advantage of the cover and concealment already present. Given time and materials, the platoon will continue to make improvements to the positions.

(1) In a hasty defense, the platoon will first establish security and position crew-served weapons. The priorities of improvements may be directed by the priority of work contained in the unit TACSOP. As a minimum, these improvements should include fields of fire, overhead cover as well as additional direct fire protection, and camouflaging of individual positions. Fighting positions in buildings are constructed away from windows and other openings in the shadows of the room using appliances, furniture, and other convenient items and materials. Some of the more common

hasty fighting positions in an urban area are corners of buildings, behind walls, windows, unprepared loopholes, and the peak of a roof (Figure 6-10).

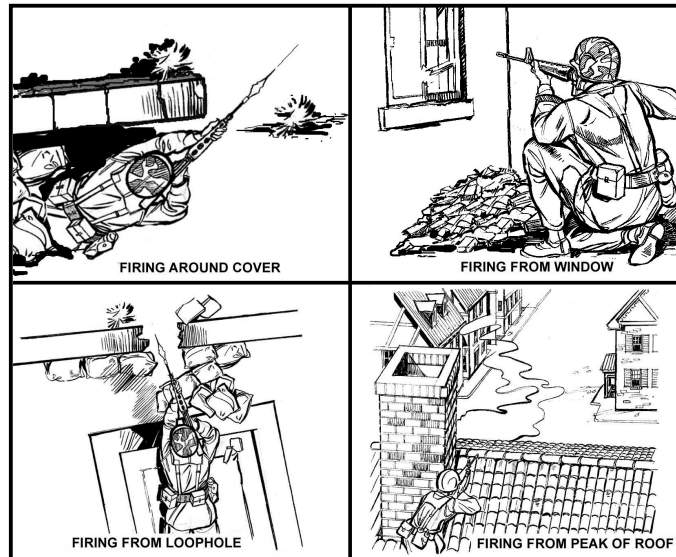

Figure 6-10. Hasty firing positions.

(2) Throughout the defense, the platoon continues to improve its hasty defensive positions. Over time, the hasty defense can become a deliberate defense. The platoon leader and his squad leaders make continuous adjustments to the defense to reduce weaknesses that could result in the failure of the overall defense. The priority of work will serve as the guide for improving the defense, and the leaders will supervise the accomplishment of the following tasks:

- Position crew-served and special weapons.
- Construct barriers and emplace obstacles.

- Prepare individual, alternate, and supplementary fighting positions.
- Rehearse the counterattack force, engagement sequences, and repositioning.
- Enhance mobility.

b. **Improving the Defense.** As time permits, the leaders ensure the following improvements are accomplished:

- Barrier and obstacle improvement.
- Improvement of primary and alternate positions.
- Preparation of supplementary positions.
- Additional movement enhancement efforts.
- Initiation of patrols.
- Improvement of camouflage.
- Continued rehearsals for counterattack and withdrawal.
- Sleep plan.

6-10. PRIORITIES OF WORK AND DEFENSIVE CONSIDERATIONS

A critical platoon- and squad-level defensive task during defensive urban operations is the preparation of fighting positions. General defensive considerations in urban terrain are similar to any other defensive operations. Fighting positions in urban areas are usually constructed inside buildings and are selected based on an analysis of the area in which the building is located, the individual characteristics of the building, and the characteristics of the weapons system.

a. **Priorities of Work.** The priorities of work are the same as those listed in Chapter 2, Section V, of this manual. However, because of the unique qualities of the urban

environment, special attention should be given to the following:

(1) Select key weapons and crew-served weapon positions to cover likely mounted and dismounted avenues of approach. To cover armored avenues of approach, position antiarmor weapons inside buildings with adequate space and ventilation for backblast (on upper floors, if possible, for long-range shots). Position MGs/SAWs to cover dismounted avenues of approach. Place them near ground level to increase grazing fires. If ground rubble obstructs grazing fires, place MGs/SAWs in the upper stories of the building. Ensure weapons are mutually supporting and are tied in with adjacent units.

(2) Ensure the position is free of noncombatants. Remove them from the area of operations before occupying the position.

(3) Clear fields of fire. Prepare loopholes, aiming stakes, sector stakes, and TRP markings. Construct positions with overhead cover and camouflage (inside and outside).

(4) Identify and secure subsurface avenues of approach (sewers, basements, stairwells, and rooftops).

(5) Stockpile ammunition, food, fire-fighting equipment, and drinking water.

(6) Construct barriers and emplace obstacles to deny the enemy access to streets, underground passages, and buildings, and to slow his movement (Figure 6-11, page 6-36). Integrate barriers and or obstacles with key weapons. Cover all barriers and obstacles by fire (both direct and indirect) and or observation. Conceal the obstacle from enemy observation as much as possible. Erect the obstacle in an irregular pattern to hinder enemy movement. Employ

the obstacle in depth (if possible). Tie the obstacle in with existing obstacles.

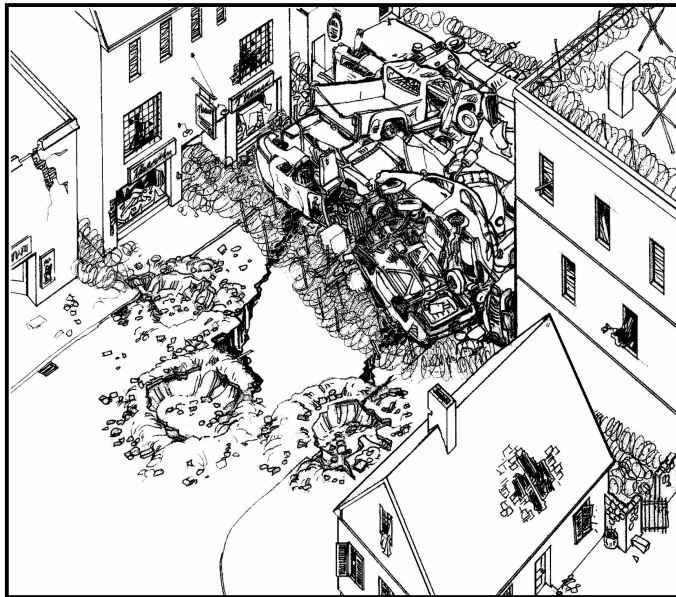

Figure 6-11. Obstacles blocking street.

(7) Improve and mark movement routes between positions as well as to alternate and supplementary positions. Improve routes by digging trenches, using sewers and tunnels, creating entry holes, and emplacing ropes for climbing and rappelling and ladders for ascending and descending.

b. **Considerations.** The following must be considered when establishing a defensive position.

(1) **Security.** The first priority is establishing all-around security. Each position should have at least one soldier providing security during all preparations.

(2) **Protection.** Select buildings that provide protection from direct and indirect fires. Reinforced concrete buildings with three or more floors provide suitable protection while buildings constructed of wood, paneling, or other light material must be reinforced to provide sufficient protection. One- and two-story buildings without a strongly constructed cellar are vulnerable to indirect fires and require construction of overhead protection for each fighting position. If possible, use materials gathered from the immediate area to build the overhead cover.

(3) **Dispersion.** A platoon position should not be established in a single building when it is possible to occupy two or more buildings that permit mutually supporting fires. A position without mutual support in one building is vulnerable to bypass, isolation, and subsequent destruction from any direction.

(4) **Concealment.** Do not select buildings that are obvious defensive positions (easily targeted by the enemy). If the requirements for security and fields of fire dictate the occupation of exposed buildings, the platoon will be required to add reinforcement materials to the building to provide suitable protection to the troops inside.

(5) **Fields of Fire.** To prevent isolation, individual and crew-served weapons positions should be mutually supporting and have fields of fire in all directions. When clearing fields of fire, try to maintain the natural appearance of the surrounding area if possible. Removing objects that interfere with the gunner's field of vision may be necessary.

(6) **Covered Routes.** Defensive positions should have at least one covered and concealed route that allows resupply, medical evacuation, reinforcement, or withdrawal from the building without being detected, or at least provides protection from direct fire weapons. The route can be established using underground systems, communications trenches, or walls and buildings that allow covered movement.

(7) **Observation.** Positions in buildings should permit observation of enemy avenues of approach and adjacent defensive sectors. Upper stories offer the best observation but also attract enemy fire.

(8) **Fire Hazard.** If possible, avoid selecting positions in buildings that are obvious fire hazards. If these flammable structures must be occupied, reduce the danger of fire by wetting down the immediate area, laying an inch of sand on the floors, and providing fire extinguishers and fire fighting equipment. Ensure that each defender is familiar with the withdrawal routes and that they have the opportunity to rehearse their withdrawal using these planned routes in the event of fire.

(9) **Time.** Time is the one element in METT-TC that the platoon and its leaders have no control over. The most important factor to consider when planning the use of time is to provide subordinate leaders with two-thirds of all available time. The unit TACSOP provides the leaders with their priorities when time does not allow for detailed planning. The platoon will complete defensive preparation IAW the TACSOP and the commander's operational priorities.

c. **Preparation.** Preparation of the platoon's individual fighting positions will normally be conducted inside the

buildings the platoon has been assigned to defend. As with all defensive positions, the leader's first task is to establish security. This will normally be in the form of an observation post located within the protection of the platoon's direct fire weapons. The OP should be manned with at least two personnel. Leaders then assign individual or two-man positions to adequately cover his sector. The squad leader will position himself to best control his squad. The platoon leader will designate the level of security to be maintained. The remaining personnel will continue to work preparing the defense. The leaders will continue to make improvements to the defense as time permits. (The preparation of fighting positions is discussed in detail in FM 90-10-1.)

d. **Other Typical Tasks.** Additional defensive preparation tasks may be required in basements, on ground floors, and on upper floors.

(1) **Basements and Ground Floors.** Basements require preparation similar to that of the ground floor. Any underground system not used by the defender that could provide enemy access to the position must be blocked.

(a) **Doors.** Unused doors should be locked or nailed shut, as well as blocked and reinforced with furniture, sandbags, or other field expedients (Figure 6-12, page 6-40).

(b) **Hallways.** If not required for the defender's movement, hallways should be blocked with furniture and tactical wire.

(c) **Stairs.** Unused stairs should be blocked with furniture and tactical wire, or removed (Figure 6-12, page 6-40). If possible, **all** stairs should be blocked, and ladders should be used to move from floor to floor and then removed.

(d) *Windows*. Remove all glass. Block unused windows with boards or sandbags to prevent observation and access.

(e) *Floors*. Make fighting positions in the floors. If there is no basement, fighting positions can give additional protection from heavy direct-fire weapons.

(f) *Ceilings*. Erect support for ceilings that otherwise would not withstand the weight of rubble from upper floors.

(g) *Unoccupied Rooms*. Block rooms not required for defense with tactical wire.

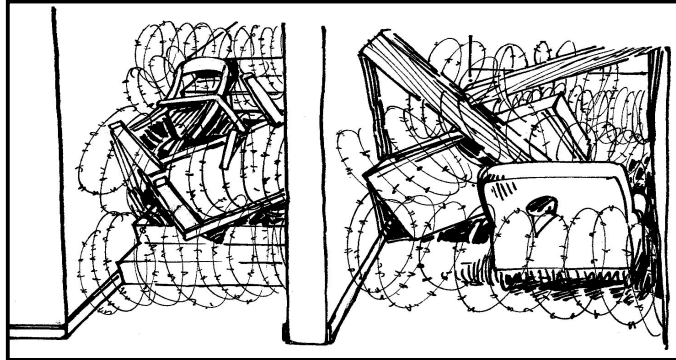

Figure 6-12. Blocking stairs and doorways.

(2) *Upper Floors*. Upper floors require the same preparation as ground floors. Windows need not be blocked, but should be covered with wire mesh, canvas, ponchos, or other heavy material, to prevent grenades from being thrown in from the outside. The covering should be loose at the bottom to permit the defender to drop grenades.

(3) *Interior Routes*. Routes are required that permit defending forces to move within the building to engage enemy forces from any direction. Plan and construct escape

routes to permit rapid evacuation of a room or a building. Mouseholes should be made through interior walls to permit movement between rooms. Such holes should be marked to enable defenders to easily locate them during day and night conditions. Brief all personnel as to where the various routes are located. Conduct rehearsals so that everyone becomes familiar with the routes.

(4) **Fire Prevention.** Buildings that have wooden floors and rafter ceilings require extensive fire prevention measures. Cover the attic and other wooden floors with about one to two inches of sand or dirt, and position buckets of water for immediate use. Place fire-fighting materials (dirt, sand, fire extinguishers, and blankets) on each floor for immediate use. Fill water basins and bathtubs as a reserve for fire fighting. Turn off all electricity and gas. If available, use any existing fire extinguishers found in buildings.

(5) **Communications.** Conceal radio antennas by placing them among civilian television antennas, along the sides of chimneys and steeples, or out of windows that would direct FM communications away from enemy early-warning sources and ground observation. Lay wire lines through adjacent buildings or underground systems or bury them in shallow trenches. Lay wire communications within the building through walls and floors.

(6) **Rubbling.** Rubbling parts of the building may provide additional cover and concealment for weapons emplacements or serve as an obstacle against the enemy. Because of the inherent danger associated with rubbling a building, engineers should perform this task. Units should limit rubbling so as not to impede their own movement within the urban area. If not designated by higher, the

platoon must receive permission from higher before rubbleing a building within its sector.

(7) **Rooftops.** Platoons must position obstacles on the roofs of flat-topped buildings to prevent helicopters from landing and to deny troops from gaining access to the building from the roof. Cover rooftops that are accessible from adjacent structures with tactical wire or other expedients and guard them. Block entrances to buildings from rooftops if compatible with the overall defensive plan. Remove or block any structure on the outside of a building that could aid the attacker in scaling the building to gain access to upper floors or to the rooftop.

(8) **Obstacles.** Position obstacles adjacent to buildings to stop or delay vehicles and infantry. To save time and resources in preparing the defense, platoon leaders must allow the use of all available materials, such as automobiles, railcars, and rubble, to create obstacles. Vehicles can be tied together by running poles through their windows. Leaders must supervise the construction of obstacles to ensure they are tied to buildings and rubble areas to increase effectiveness, and to canalize the enemy into engagement areas selected by the leader. Direct support engineers can provide advice and resources as to the employment of obstacles and mines.

(a) The principles for employing mines and obstacles do not change in the defense of an urban area; however, techniques do change. For example, burying and concealing mines in streets is difficult due to concrete and asphalt. Mines may be placed in sandbags as a technique of camouflage.

(b) Civilian construction equipment and materials must be located and inventoried. This equipment can be used with

engineer assets or in place of damaged equipment. In host nation countries, coordination must be made with proper civilian officials before use.

(9) ***Fields of Fire.*** The field of fire is the area a weapon or group of weapons may cover effectively with fire from a given position. After the defensive positions are selected and the individuals have occupied their assigned positions, they will determine what clearance is necessary to maximize their field of fire. Leaders and individuals must view fields of fire from the fighting position and from the view of the enemy. Only selective clearing will be done to improve the field of fire. If necessary, the position will be relocated to attain the desired field of fire. Within the field of fire leaders will designate for each weapons system a primary and an alternate sector of fire. Each weapons system has unique requirements for its field of fire, and the platoon and squad leaders must ensure these requirements are met. Each position is checked to ensure that the fields of fire provide the maximum opportunity for target engagement and to determine any dead space within the sector of fire.

e. **Antitank Weapons Positions.** Employ antitank weapons in areas that maximize their capabilities in the urban area. The lack of a protective transport could require the weapon to be fired from inside a building, from behind the cover of a building, or from behind the cover of protective terrain. Leaders should make every effort to employ antitank weapons in pairs so that the same target can be engaged from different positions. Another consideration is security for the crew and system. This is necessary to allow the gunner to concentrate on locating and engaging enemy armor.

f. **Sniper Positions.** Snipers give the platoon a force multiplier by providing an overwatch capability and by engaging enemy C2 targets. Snipers normally operate in two-man teams, which provides the shooter with security and another set of eyes for observation and to locate and identify targets. Leaders should allow the snipers to select their own positions for supporting the defense. An effective sniper organization can trouble the enemy far more than its cost in the number of friendly soldiers employed. Snipers deploy in positions where they are not easily detected (Figure 6-13), and where they can provide the most benefit. (See FM 23-10 and FM 90-10-1 for more information on the employment of snipers.)

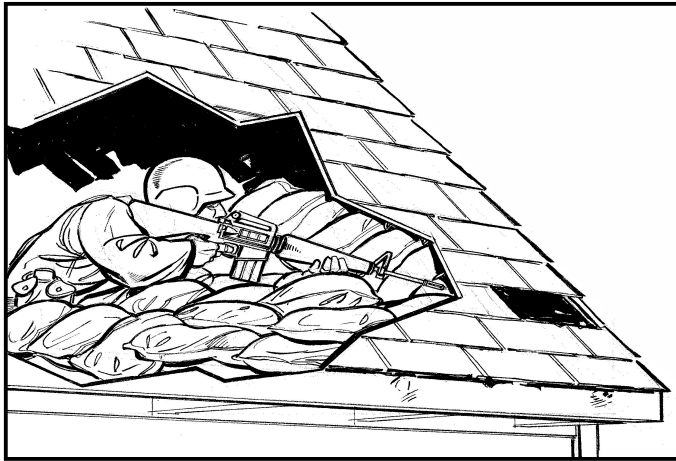

Figure 6-13. Sniper position (cut away).

6-11. CONDUCT OF THE DEFENSE

The conduct of the defense in an urban area is similar to the conduct of the defense in any other area. The current standard sequence of actions is listed in Chapter 2, Section V of this manual.

6-12. CONSOLIDATION AND REORGANIZATION

The process of consolidation and reorganization in an urban area is similar to the process in any other area. The current standard sequence of actions is listed in Chapter 2, Section V of this manual.

6-13. COUNTERATTACK

A platoon may be given the mission to counterattack in order to retake a defensive position or key point, to destroy or eject an enemy foothold, or to stop an enemy attack by hitting his flank and forcing him to stop his movement and establish a hasty defense.

a. A platoon counterattack is planned at company level to meet each probable enemy penetration. They must be well coordinated and violently executed. Counterattacks should be directed at the enemy's flank and supported with direct and indirect fires.

b. If tank support is available, it should be used to spearhead the counterattack. Tanks have the mobility, firepower, and survivability to quickly execute the counterattack mission. Tanks are ideally suited for destroying enemy armor, heavy weapons, and fortifications with their main gun and engaging enemy infantry with their coaxial machine gun. This capability will assist the infantry in executing their part of the mission.

c. The counterattack mission is planned and coordinated as part of the defensive operation.

(1) Considerations for counterattack planning may include, but are not limited to, the following:

- Location of friendly units.
- Location of noncombatants.
- Critical location in the defense that, if threatened, could collapse.
- Size and type of force required to defeat and eject the enemy.
- Where in the defense do we want the enemy to think he is successful?
- Who determines and initiates the execution of the counterattack?

(2) Control measures needed for the conduct of the counterattack include:

- Assembly area or blocking position.
- Start point, route, and release point, if necessary.
- Attack position.
- Line of departure or line of contact.
- Zone of action, direction of attack, and or axis of advance.
- Objective.
- Limit of advance.

Section III. STABILITY AND SUPPORT

As part of a brigade or joint task force, the infantry platoon may be required to conduct stability and support operations in environments that are not traditional combat missions. In this situation, the platoon must be prepared to conduct stability or support operations and then transition into a

conventional offensive or defensive mission. The platoon may also be called on to conduct stability or support operations following the successful completion of a combat mission. A well-trained unit will be able to transition from war fighting to stability and support operations, or from stability and support operations to war fighting quickly and effectively. During stability or support operations, the platoon can expect to conduct a wide range of combat or noncombat tasks. Essentially, the unit accomplishes these tasks through the execution of tactical tasks such as security patrols, road blocks, check points, convoy escort, and food distribution.

6-14. STABILITY OPERATIONS.

Stability operations apply military power to influence the political environment, facilitate diplomacy, and interrupt specified illegal activities. They include both developmental and coercive actions. Developmental actions enhance a government's willingness and ability to care for its people. Coercive actions apply carefully prescribed limited force and the threat of force to achieve objectives. Units conduct stability actions to accomplish one or more of the following:

- Deny or hinder aggression.
- Reassure allies, friendly governments, and agencies.
- Support a weak or failing government.
- Stabilize a restless population.
- Maintain and restore order.
- Insure agreements and policies are maintained.

Platoons will normally employ TTP similar to combat actions in order to facilitate the unit's ability to accomplish the above. The major distinguishing characteristic will be the ROE. (Table 6-1 shows examples of tactical tasks.)

TYPE OF OPERATION	TACTICAL TASKS
<i>Peace Operations</i>	Move tactically; Conduct a route reconnaissance; Conduct an area reconnaissance; Establish roadblocks and checkpoints; Enter and clear a building/room; Conduct offensive and defensive subterranean operations; Defend a building; Establish static security positions in an urban area; Perform surveillance from an OP; Employ force protection measures; Conduct convoy security; Maintain communications in an urban area; Conduct resupply operations; treat and evacuate casualties; Handle noncombatants and detained personnel; Conduct platoon riot control formations. Employ quick reaction force.
<i>Antiterrorism</i>	Move tactically in urban area; Conduct an area reconnaissance; Conduct a route reconnaissance; Establish a static security position in an urban area; Perform surveillance from an OP; Enter and clear a building/room; Establish roadblocks and checkpoints; Employ force protection measures; Maintain communications in an urban area; Handle noncombatants and detained personnel. Employ quick reaction force.

Table 6-1. Example of tactical tasks.

<i>Noncombatant Extraction Operations</i>	Infiltrate an urban area, Move tactically in urban area, Establish roadblocks and checkpoints; Protect the force; Defend a convoy; Defend; Maintain communications in an urban area; Perform delay. Employ quick reaction force.
<i>Arms Control</i>	Establish roadblocks and checkpoints; convoy escort; Assist and monitor inspection of arms; Maintain communications in an urban area; and conduct surveillance. Employ quick reaction force.
<i>Support to Counterinsurgencies</i>	Defend, Protect the force; Conduct area and route reconnaissance; Conduct combat patrols; Conduct an assault; Maintain communications in an urban area; Handle noncombatants and detained personnel. Employ quick reaction force.
<i>Show Of Force</i>	Move tactically; Demonstrate capabilities; Prepare a defense; Maintain communications in an urban area; Conduct training exercises. Employ quick reaction force.
<i>Civil Disturbance Operations</i>	Maintain communications in an urban area; Conduct patrols; Handle noncombatants and detained personnel. Employ quick reaction force.

Table 6-1. Example of tactical tasks (continued).

6-15. SUPPORT OPERATIONS

The purpose of support operations is to provide essential supplies and services to aid designated groups. These activities are conducted to assist foreign and domestic civil authorities responding to crises. Platoons will conduct

support actions as part of a company support operation in order to save or protect lives, reduce suffering, recover essential infrastructure, improve the quality of life, and restore situations to normal. Because of the nature of humanitarian and environmental assistance, the platoon can expect to interact with other units and agencies such as engineers, MPs, and NGOs. Support actions rely on a partnership with other government and nongovernment agencies. Liaison with these agencies and between local governments is critical. Regardless of the positive relationships built, force protection always remains a top priority. (Table 6-2 shows typical tasks associated with each type of support operation.)

TYPE OF OPERATION	TASKS
<i>Humanitarian Assistance</i>	Provide manpower for relief efforts, Conduct search and rescue actions, Conduct security patrols.
<i>Environmental Assistance</i>	Provide manpower for relief efforts, Establish communications, Provide water distribution, debris removal, and Conduct security patrols.

Table 6-2. Example of tasks.

6-16. TRANSITION TO COMBAT OPERATIONS

Stability and, to a lesser extent, support operations are missions that begin with humanitarian goals and objectives and can escalate to combat. Whenever the peace process fails, the mission of the platoon can change quickly. The platoon leader must ensure his unit is prepared to make this

transition. The unit must retain the ability to conduct offensive and defensive operations by reinforcing humanitarian tasks with training that is realistic, challenging, and meaningful.

a. **Plan for Contingencies.** Contingencies are events that may occur but are not likely or intended. Contingencies are planned for as an “on order” or “be prepared” mission. When conducting stability and support operations the platoon leader makes plans to shift his effort as the situation develops. He must ensure his platoon can shift from peace operations to a combat mission as required.

b. **Balanced Mindset.** The platoon leaders are responsible for the training and discipline of their soldiers and how they will respond when confronted with a variety of situations during full spectrum operations. A balanced mindset must be achieved between peace operations and the conduct of war fighting. Soldiers cannot become so complacent during peace operations that they lose their warrior spirit, nor must they be so aggressive that they use unnecessary force to resolve conflict. This balance is the essence of peace operations and the fundamental aspect that will enable the unit to perform its mission successfully and avoid an escalation to combat. Proactive leaders that are communicating and enforcing the ROE are instrumental to achieving this mindset.

c. **Combat Skills Training.** In the event that the stability or support operation is extended over a prolonged period, training will need to be conducted that focuses on individual and collective combat tasks. This training should include transitioning from peace operations to combat operations. Leaders can incorporate some of the training in the stability or support actions they are conducting.

Section IV. COMBAT MULTIPLIERS

One of the most important lessons learned from recent urban operations is the need for a fully integrated combined arms team. The nature of urban operations makes it infantry-centric. However, the urban battle should never be exclusively an infantry fight. A powerful combined arms team properly employed in an urban area will enhance mission accomplishment. Although the infantry soldier is required in order to clear and secure an urban area, the integration of mechanized infantry, armor, and engineers is needed for increased lethality. These teams must be supported by closely integrated aviation, field artillery, communications, and logistical elements. This section discusses the more common combat multipliers available to the infantry platoon during the execution of UO.

6-17. ARMORED VEHICLES

Based on the considerations of the METT-TC analysis and the operational ROE, a situation may arise that requires the attachment of heavy forces in direct support of the light infantry mission. Tanks and Bradley fighting vehicles (BFVs), with their mobility, armor, and firepower can provide direct support to the infantry from securing a foothold to supporting their advance through the urban area. This paragraph discusses tactics and techniques used by infantry units when working with armored vehicles.

a. Task Organization for Light/Heavy Operations.

(1) *Maneuver.* Leaders must understand the principles of employing infantry and armor forces to maximize their capabilities and ensure mutual support. Maneuver by the infantry is enhanced by support from the armored vehicles.

(a) The infantry assists the heavy forces by infiltrating to clear obstacles or key enemy positions and disrupt the enemy defense. They provide security for the armored vehicles by detecting and suppressing or destroying enemy antitank weapons. They designate targets and spot the impact of fires for tanks and BFVs.

(b) Heavy forces support the infantry by moving with them along an axis of advance and providing a protected, fast moving assault weapons system. They suppress and destroy enemy weapons, bunkers, and tanks by fire and maneuver (Figure 6-14). They also provide transport when the enemy situation permits. (See Chapter 2, Section IX, paragraph 2-47, Infantry Riding on Armored Vehicles.)

(c) Armored vehicles should never be maneuvered individually. The smallest maneuver level for armor is a section (two vehicles).

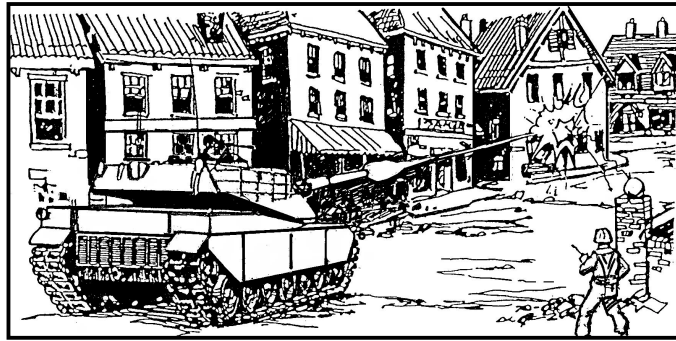

Figure 6-14. M1 in direct support of infantry.

(2) *Command and Control.* The infantry platoon may have combat elements in direct support. The platoon leader is responsible for incorporating these elements into his

command and control functions. Because most support elements have a habitual relationship with the combat unit they support, the platoon leader may only need to give them an update to recent changes to guarantee the C2 remains a high priority.

(a) Tanks, BFVs, and infantry must work closely at platoon level. In most operations where they work together, infantrymen must establish direct communication with individual vehicles to ensure quick and accurate response to directions given.

(b) Infantrymen and vehicle crews must know how to communicate by radio, telephone, and visual signals. Prior to the start of an operation, infantry and tank leaders must coordinate the methods of communication and the types of signals that will be used. For immediate, direct communication with the M1, the crew can run communication wire from the AM-1780 through the loader's hatch or vision block and be connected to a field phone attached to the outside of the tank.

(c) During the planning phase of an operation, infantry and armor leaders must allocate sufficient time for the conduct of detailed brief-backs and rehearsals. The purpose of these activities is to verify that long- and short-range communications are effective, and that what is expected from each organization is understood.

Note: For further discussion concerning the strengths, limitations, and employment considerations of armor with the infantry, see C1, FM 7-10, Appendix L and FM 90-10-1.

b. **Weapon System Considerations.** While operating in concert with armored forces, infantry leaders must be knowledgeable of the capabilities, limitations, and effects of the armor weapon systems. He must understand the dangers these systems pose to his soldiers when operating together. He is responsible for ensuring that his soldiers are briefed about these dangers.

(1) ***MI-Series Tanks.***

(a) Normally, the primary ammunition for the main gun in the urban environment is the HEAT round. It is the most effective round against masonry and will penetrate all but the thickest reinforced concrete. A HEAT round will create a hole large enough for a man to fit through in masonry or concrete but will not cut the reinforcing steel bars. HEAT is also effective against earthen and sandbag reinforced strong-points. A 120-mm HEAT round does not become armed until it is about 36 feet from the end of the gun tube.

(b) Multipurpose antitank (MPAT) rounds will penetrate masonry and concrete, but are less effective than HEAT rounds against heavier structures.

(c) Armor-piercing discarding sabot (APSD) ammunition has limited use against nonvehicular targets, and its discarding petals endanger accompanying infantry. Sabot petals create a hazard area extending 70 meters on either side of the gun target line for a distance of one kilometer.

(d) The external M2 HB machine gun can elevate to +36 degrees; however, to fire the M2 on the M1A2 Abrams, the tank commander must be exposed to enemy fire

(2) ***BFVs.***

(a) The primary role of the Bradley fighting vehicle in an urban environment is to provide suppressive fires and to

breach exterior walls (Figure 6-15). The vehicles' armor-piercing rounds can be very useful in urban terrain. They can penetrate concrete up to 16 inches thick and can easily penetrate brick structures. They are highly effective against earthen and sandbag reinforced structures.

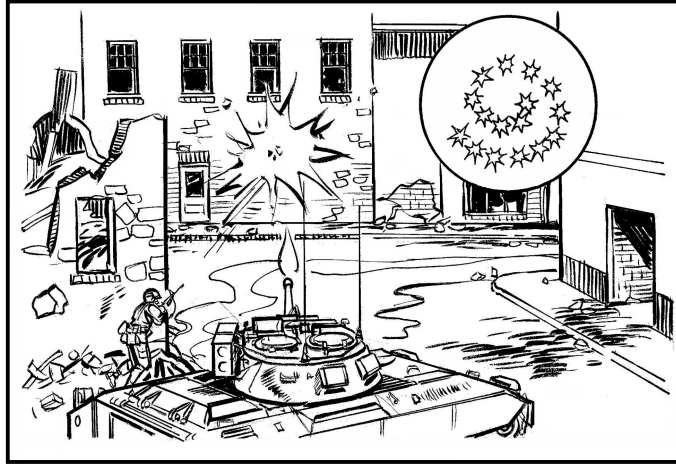

Figure 6-15. BFV conducting a breach using the spiral firing method.

- (b) The BFV can elevate its 25-mm gun to about +60 degrees and depress the gun to about -10 degrees.
- (c) The crew has limited visibility to the sides and rear and no visibility to the top when buttoned up.
- (d) The BFV can be outfitted with an external phone hookup for communications with accompanying infantry.
- (e) The 25-mm gun can be used effectively against enemy-occupied buildings and fortifications, firing AP, HE, and even TP-T rounds.

(3) Figure 6-16 shows the difference in the capabilities of the BFV and the M1 tank with regard to fields of fire on urban terrain. Note that the BFV can engage a target 9 to 10 stories high at 20 meters, whereas an M1 tank requires 90 meters.

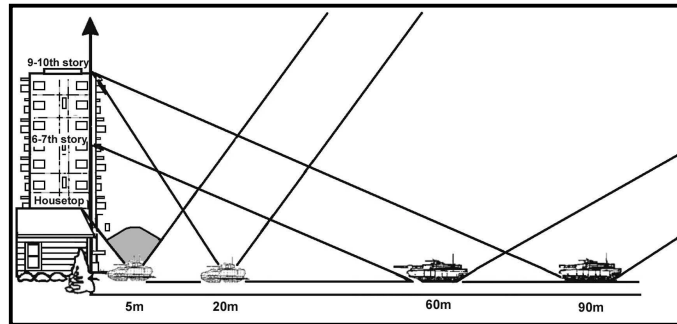

Figure 6-16. Fields of fire on urban terrain.

Note: When employing these weapon systems to support the infantry assault, leaders must be aware of the explosive effects and fragmentation fallout, as well as the blast overpressure, and how it will affect the infantry on the ground. (For more specific information on the effects of weapons see FM 90-10-1.)

6-18. ENGINEERS

Normally an engineer squad will be attached to an infantry company. Most engineer manual labor tasks (for example, preparing fighting positions) will have to be completed by infantry units, with reinforcing engineer heavy-equipment support and technical supervision. (For further discussion on

the employment of engineers with the infantry, see C1, FM 7-10, Appendix L and FM 90-10-1.)

a. **Offensive Missions.** During offensive operations, an engineer sapper team may be attached to the infantry platoon that is designated as the primary assault element. They may be required to conduct the following tasks in support of the infantry platoon.

- Use explosives to destroy fortifications and strongpoints that cannot be reduced with the maneuver unit's organic assets.
- Locate and remove mines that may hamper the unit's movement.
- Conduct breaching operations.

b. **Defensive missions.** Engineers may perform the following tasks in support of the platoon during the defense of an urban area.

- Construct complex obstacle systems.
- Assist in the preparation of defensive positions and strong-points.

Note: When employing demolitions in conjunction with the infantry assault, leaders must be aware of the explosive effects and fragmentation fallout, as well as the blast overpressure, and how it will affect the infantry on the ground. (For more specific information on the effects of weapons, see FM 90-10-1.)

6-19. MORTARS

Mortars are the most responsive indirect fires available at battalion and below. Their mission is to provide close and immediate fire support to maneuver units. Mortars are well

suited for combat in urban areas because of their high rate of fire, steep angle of fall, and short minimum range. Leaders must plan mortar support with the FSO as part of the total fire support system. (See FM 7-90 for detailed information on the tactical employment of mortars.)

a. **Role of Mortar Units.** The primary role of mortar units is to deliver suppressive fires to support maneuver, especially against dismounted infantry. Mortars can also be used to obscure enemy observation and to illuminate the target area at night. Mortar fires inhibit enemy fires and movement, allowing friendly forces to maneuver to a position of advantage. Effectively integrating mortar fires with dismounted maneuver is key to successful combat in an urban area at the rifle company and battalion level.

b. **Position Selection.** The selection of mortar positions depends on the size of buildings, the size of the urban area, and the mission.

(1) The use of existing structures (for example, garages, office buildings or highway overpasses) for hide positions is recommended to afford maximum protection and minimize the camouflage effort.

(2) Mortars should not be mounted directly on concrete; however, sandbags may be used as a buffer. Sandbags should consist of two or three layers, be butted against a curb or wall, and extend at least one sandbag width beyond the baseplate.

(3) Mortars are usually not placed on top of buildings because lack of cover makes them vulnerable. Overpressure can injure personnel, and the shock on the floor can weaken or collapse the structure. Mortars should not be placed inside buildings with damaged roofs unless the structure's stability has been checked.

c. **High-Explosive Ammunition.** During urban combat, mortar HE fire is used more than any other type of indirect fire weapon. The most common and valuable use for mortars is harassment and interdiction fires. One of their greatest contributions is interdicting supplies, evacuation efforts, and reinforcement in the enemy rear just behind his forward defensive positions. Although mortar fires are often targeted against roads and other open areas, the natural dispersion of indirect fires will result in many hits on buildings. Leaders must use care when planning mortar fires during urban combat to minimize collateral damage.

(1) High-explosive ammunition, especially the 120-mm projectile, provides good results when used on lightly built structures within cities. It does not perform well against reinforced concrete found in larger urban areas.

(2) When using HE ammunition in urban fighting, only point-detonating fuzes should be used. The use of proximity fuzes should be avoided, because the nature of urban areas causes proximity fuzes to function prematurely. Proximity fuzes, however, are useful in attacking targets such as OPs on tops of buildings.

(3) During World War II and recent Middle East conflicts, light mortar HE fires have been used extensively during urban combat to deny the use of streets, parks, and plazas to enemy personnel.

d. **Illumination.** In the offense, illuminating rounds are planned to burst above the objective to put enemy troops in the light. If the illumination were behind the objective, the enemy troops would be in the shadows rather than in the light. In the defense, illumination is planned to burst behind friendly troops to put them in the shadows and place the enemy troops in the light. Buildings reduce the effectiveness

of the illumination by creating shadows. Continuous illumination requires close coordination between the FO and FDC to produce the proper effect by bringing the illumination over the defensive positions as the enemy troops approach the buildings.

e. **Special Considerations.** When planning the use of mortars, leaders must consider the following:

(1) FOs should be positioned in the upper levels of buildings so target acquisition and adjustments in fire can be accomplished effectively.

(2) Leaders must understand ammunition effects correctly to estimate the number of volleys needed for specific target coverage. The effects of using WP or RP may create unwanted smoke screens or limited visibility conditions that could interfere with the tactical plan.

(3) FOs must be able to determine dead space. Dead space is the area in which indirect fires cannot reach the street level because of buildings. This area is a safe haven for the enemy. For mortars, the dead space is about one-half the height of the building.

(4) Mortar crews should plan to provide their own security.

(5) Commanders must give special consideration to where and when mortars are to displace while providing immediate indirect fires to support the overall tactical plan. Combat in urban areas adversely affects the ability of mortars to displace because of rubble and the close nature of urban combat.

6-20. FIELD ARTILLERY

During urban combat, field artillery provides general support, direct support, and general support reinforcing to

infantry units. This paragraph provides considerations for the use of field artillery in the direct-fire mode. (For further discussion on the employment of field artillery in urban terrain, see C1, FM 7-10, Appendix L and FM 90-10-1.)

a. When FA supports fighting in urban areas, the fire support coordination measures necessary to provide adequate, yet safe, support must be carefully considered because of the close proximity of friendly forces to the enemy. When planning for fire support leaders should consider the following:

(1) The increased cover and concealment afforded by the terrain.

(2) Ground observation is limited in urban areas.

(3) Adjusting fires is difficult since buildings block the view of adjusting rounds.

(4) Acquiring targets is difficult in urban terrain because the enemy has many covered and concealed positions and movement lanes.

(5) Forward observers must be able to determine where and how large the dead spaces are.

(6) The use of air burst fires is an effective means of clearing snipers from rooftops.

b. Employing artillery in the direct-fire mode to destroy fortifications should be considered, especially when assaulting well prepared enemy positions (Figure 6-17). Also, restrictive fire support coordination measures, such as a restrictive fire area or no-fire area may be imposed to protect civilians and critical installations.



Figure 6-17. SP howitzer in direct-fire mode.

(1) The 155-mm self-propelled howitzer is extremely effective in neutralizing concrete targets with direct fire.

(2) Concrete-piercing 155-mm rounds can penetrate 36 inches of concrete at ranges up to 2,200 meters.

(3) When employing artillery in the direct-fire mode and maneuvering the self-propelled howitzers within the urban area, it is important that the infantry secure them because they do not have any significant protection for their crews.

Note: When employing these weapon systems to support the infantry assault, leaders must be aware of the explosive effects and fragmentation fallout, as well as the blast overpressure, and how it will affect the infantry on the ground. (For more specific information on the effects of weapons, see FM 90-10-1.)

6-21. ATTACK HELICOPTERS

Infantry units may receive support by a variety of attack helicopters including (but not limited to) the AH-64, AH-1, OH-58D/RAH-66, MH-6, and MH-60. Attack helicopters can provide area fire to suppress targets and precision fire to destroy specific targets or breach structures. Attack helicopters can also assist with intelligence, surveillance, reconnaissance, and communications using their advanced suite of sensors and radios. Other supporting helicopters, such as the UH-60, CH-47, and MH-47, may also have weapons systems (7.62-mm machine gun, .50-caliber machine gun, 7.62-mm mini-gun) that aid in the suppression of enemy forces when operating in urban terrain. Operational control of attack helicopter units will remain at the level of battalion or higher; however, attack helicopters may conduct direct air-to-ground coordination with companies and platoons during combat operations. (For further discussion on the supporting role of the attack helicopter, see C1, FM 7-10, Appendix L and FM 90-10-1.)

6-22. ANTIARMOR WEAPONS

The tactical use of antiarmor weapons does not change in the urban environment but how they are employed does. Some of those employment limitations are: stand-off, displacement after engagements, the ability to fire in-depth engagements, more obstacles, increased danger zones, and all-round security. (For further discussion on the employment of antiarmor weapons in the urban environment, see FM 7-8, Chapters 2 and 3; C1, FM 7-10, Appendix L; and FM 90-10-1.)

a. Although antiarmor weapons are primarily designed to destroy armored vehicles, they can also be used to

damage or destroy fortifications. Additionally, they can be used for ballistic breaching of doorways and the walls of lightly constructed buildings to create entry points. They may also be used for creating deceptions, just before the assault element enters the actual initial breach (entry) point. The larger systems (TOW and Dragon), which have highly magnified day and thermal sights, can be used to detect snipers and to disrupt or kill them with long-range missiles.

b. Engaging targets from an enclosure creates unique hazards. Before positioning soldiers in enclosures (combat only), leaders must consider several factors that affect safety. Only in combat, and when no other tactical option exists, should antiarmor weapons be fired from an enclosure. If antiarmor weapons must be employed this way, the enclosure must meet the following minimum requirements.

- Construction of wood or stucco buildings must be sturdy to reduce the damage that will occur.
- All objects and debris must be removed from the rear of the weapon because the backblast will cause loose objects to fly around the enclosure, possibly injuring someone.

Note: When employing these weapon systems to support the infantry assault, leaders must be aware of the explosive effects and fragmentation fallout, as well as the blast overpressure, and how it will affect the infantry on the ground. (For more specific information on the effects of weapons see FM 90-10-1, Chapter 8.)

6-23. SNIPERS

The company sniper team is an important and effective combat multiplier. While conducting offensive operations in urban areas, the sniper can be used as part of the support element to provide precise, long and short-range fires. They can also be an invaluable source of information with their observation capability. The sniper team is a company asset and may be attached to a platoon in order to conduct a mission specific task. However, it is unlikely that the platoon would be given tactical control of a sniper team. (For further discussion on the employment of snipers, see FM 23-10 and FM 90-10-1.)

APPENDIX A

ORGANIZATION

All dismounted infantry units use the same basic doctrinal principles in combat, but some differences exist between organizations. Leaders must know these differences.

A-1. RIFLE PLATOON

Most units operate from a modified table of organization and equipment (MTOE) based on their organization, mission, and location. There are five different types of rifle platoon organizations. These rifle platoons are discussed below.

a. The light infantry rifle platoon consists of three rifle squads and a platoon headquarters with two machine gun teams (Figure A-1). Each machine gun team consists of two men—a machine gunner and an assistant machine gunner.

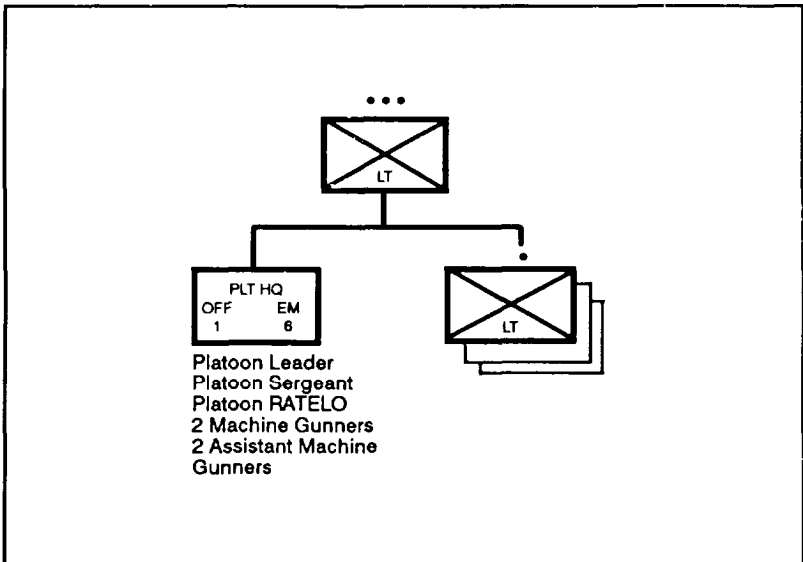

Figure A-1. Light infantry rifle platoon organization.

b. The infantry, air assault, and airborne rifle platoons consist of a platoon headquarters, three rifle squads, and a weapons squad (Figures A-2 through A-4). There are two machine gun teams and two antiarmor teams in the weapons squad. Each machine gun team and antiarmor team consists of two men—a gunner and an assistant gunner.

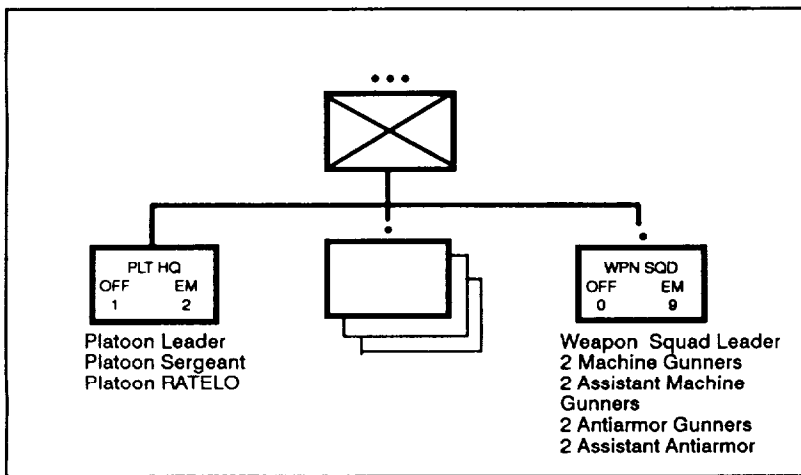

Figure A-2. Infantry rifle platoon organization.

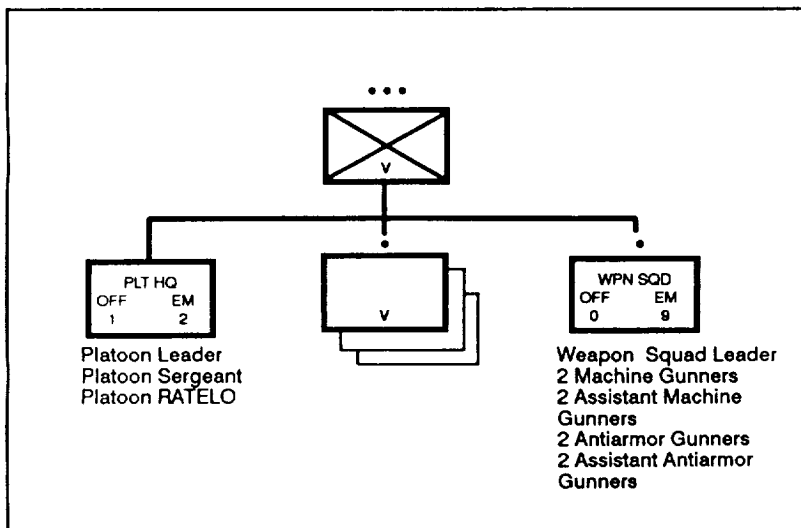

Figure A-3. Air assault rifle platoon organization.

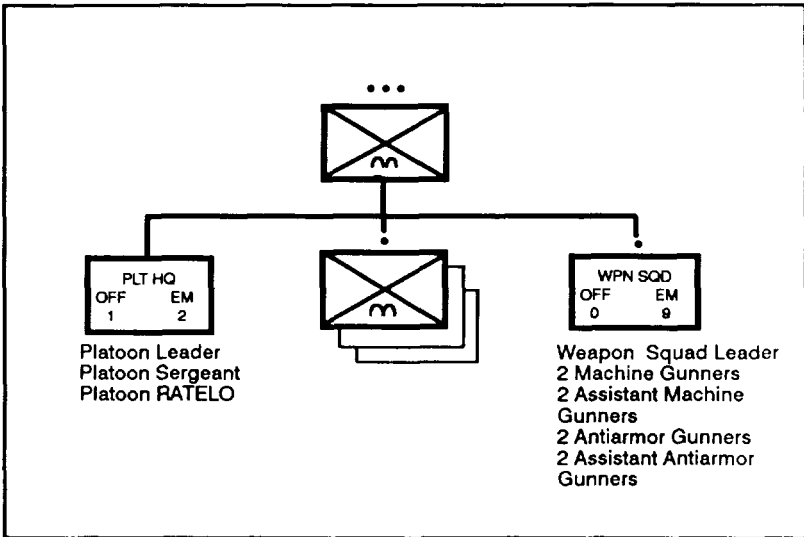

Figure A-4. Airborne rifle platoon organization.

c. The ranger rifle platoon consists of a platoon headquarters, three rifle squads, and a machine gun squad (Figure A-5). There are three machine gun crews in the machine gun squad. Each machine gun crew consists of three men—a machine gunner, an assistant machine gunner, and an ammunition bearer.

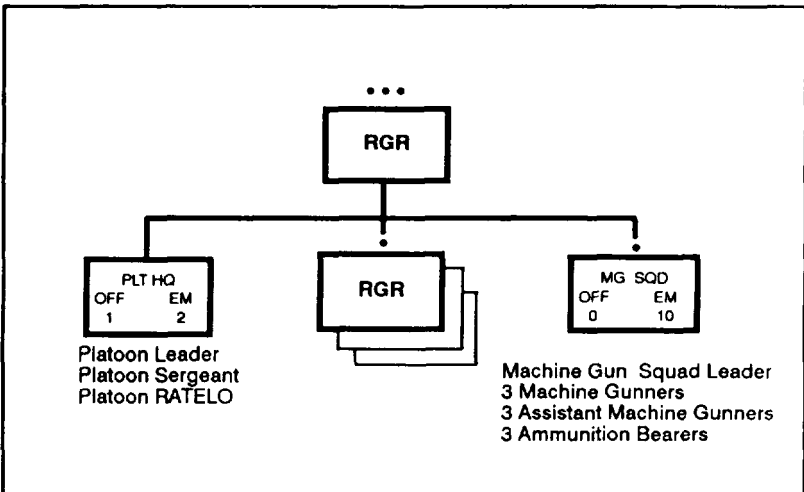

Figure A-5. Ranger rifle platoon organization.

A-2. RIFLE SQUAD

The most common rifle squad has nine soldiers (Figure A-6). It fights as two fire teams. The squad has one squad leader, two fire team leaders, two automatic riflemen, two riflemen, and two grenadiers.

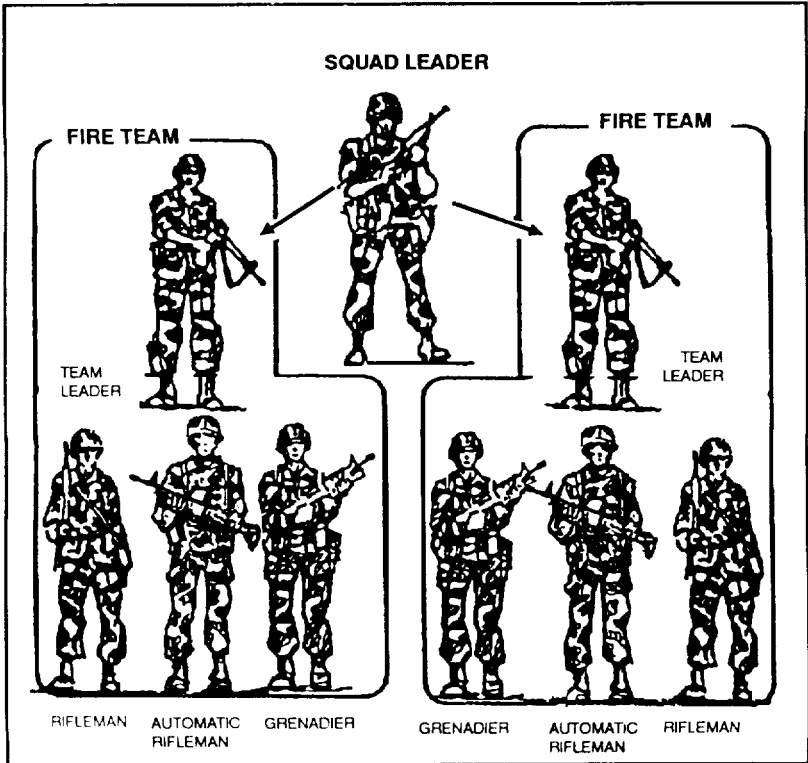

Figure A-6. Rifle squad.

A-3. DUTIES AND RESPONSIBILITIES

To complete all assigned tasks, every soldier in the platoon must do his job. Each soldier must accomplish his specific duties and responsibilities and be a part of the team.

a. **Rifle Platoon Leader.** He is responsible for all that the platoon does or fails to do. This includes the tactical employment, training, administration, personnel management, and logistics of his platoon. He must know his men and how to employ the platoon's weapons. He is

responsible for positioning and employing all assigned or attached crew-served weapons. He must also know how to employ supporting weapons. The rifle platoon leader—

- (1) Sets the example and the standards.
- (2) Leads the platoon in support of company and or battalion missions.
- (3) Informs his commander of his actions when operating without orders.
- (4) Plans with the help of the platoon sergeant, squad leaders, and other key personnel (FO, leaders of attachments, and so on).
- (5) Stays abreast of the situation and goes where he is needed to supervise, issue FRAGOs, and accomplish the mission.
- (6) Requests more support for his platoon from the company commander to perform its mission, if needed.
- (7) Assists the platoon sergeant in planning and coordinating the platoon's CSS effort.
- (8) During planning, receives on-hand status reports from the platoon sergeant, squad leaders, or both.
- (9) Reviews platoon requirements based on the tactical plan.
- (10) Develops a casualty evacuation plan.
- (11) During execution, checks the work of the platoon sergeant and squad leaders.
- (12) Ensures the soldier's load is reasonable.

b. Rifle Platoon Sergeant. This soldier is the senior NCO in the platoon and second in succession of command. He helps and advises the platoon leader, and leads the platoon in the platoon leader's absence. He supervises the platoon's administration, logistics, and maintenance. He may prepare and issue paragraph 4 of the platoon OPORD. The rifle platoon sergeant is responsible for individual training. He must ensure that soldiers can perform their individual MOS tasks. He advises the platoon leader on appointments, promotions and reductions, assignments, and discipline of NCOs and enlisted soldiers in the platoon. The rifle platoon sergeant—

- (1) Organizes and controls the platoon CP IAW the unit SOP, platoon leader guidance, and METT-T factors.
- (2) Trains the crews and employs the platoon's machine guns IAW the platoon leader's orders, appropriate field manuals, unit SOP, and METT-T factors.
- (3) Receives squad leaders' requests for rations, water, and ammunition. Works with the company's first sergeant or XO to request resupply. He also directs the routing of supplies and mail.

(4) Directs the platoon aidman and platoon aid and litter teams in moving casualties to the rear.

(5) Maintains platoon strength information, consolidates and forwards the platoon's casualty reports (DA Forms 1155 and 1156), and receives and orients replacements.

(6) Monitors the morale, discipline, and health of platoon members.

(7) Takes charge of task-organized elements in the platoon during tactical operations. This can include, but is not limited to, the following:

- Quartering parties.
- Security forces in withdrawals.
- Support elements in raids or attacks.
- Security patrols in night attacks.

(8) Coordinates and supervises company-directed platoon resupply operations.

(9) Ensures that supplies are distributed IAW the platoon leader's guidance and direction.

(10) Ensures that ammunition, supplies, and loads are properly and evenly distributed (a critical task during consolidation and reorganization).

(11) Ensures the casualty evacuation plan is complete and executed properly.

c. Rifle Squad Leader. This soldier is responsible for all that the rifle squad does or fails to do. He is a tactical leader and, as such, leads by example. The rifle squad leader—

(1) Controls the maneuver of his squad and its rate and distribution of fire.

(2) Trains his squad on the individual and collective tasks required to sustain combat effectiveness.

(3) Manages the logistical and administrative needs of his squad. He requests and issues ammunition, water, rations, and special equipment.

(4) Maintains accountability of his soldiers and equipment.

(5) Completes casualty feeder reports and reviews the casualty reports completed by squad members.

(6) Submits requests for awards and decorations.

(7) Directs the maintenance of the squad's weapons and equipment.

(8) Inspects the condition of soldiers' weapons, clothing, and equipment.

(9) Ensures that material and supplies are distributed to the soldiers in the squad.

(10) Keeps the platoon sergeant/leader informed on squad supply status and squad requirements.

(11) Ensures supplies and equipment are internally cross-leveled within the squad.

d. **Weapons Squad Leader (Infantry, Airborne, and Air Assault Divisions Only).** This soldier is responsible for all that the weapons squad does or fails to do. His duties are the same as the rifle squad leader. He also controls the machine guns and MAWs in support of the platoon's mission. He advises the platoon leader on employing his squad.

e. **Machine Gun Squad Leader (Ranger Rifle Company Only).** This soldier is responsible for all that the machine gun squad does or fails to do. His duties are the same as the rifle squad leader, and he also controls the machine guns in support of the platoon's mission. He advises the platoon leader on employing the squad.

f. **Team Leader.** This soldier is a fighting leader who leads by personal example and helps the squad leader as required. He controls the movement of his fire team and the rate and placement of fire by leading from the front and using the proper commands and signals. He maintains accountability of his soldiers and equipment. He ensures his soldiers maintain the unit standards in all areas.

g. **Platoon Aidman.** This soldier helps the platoon sergeant direct aid and litter teams; he monitors the health and hygiene of the platoon. The platoon aidman—

(1) Heats casualties and assists in their evacuation under the control of the platoon sergeant.

(2) Aids the platoon leader/sergeant in field hygiene matters, personally checks the health and physical condition of platoon members.

(3) Requests Class VIII (medical) supplies through the platoon sergeant.

(4) Provides technical expertise and supervision of the combat lifesavers.

(5) Carries out other tasks assigned by the platoon leader and platoon sergeant.

h. **Platoon Radiotelephone Operator.** The platoon RATELO must know the use and care of the radio to include waterproofing and presetting frequencies, the use of the SOI, and how to construct and erect field-expedient antennas.

i. **Fire Support Team.** The company has a fire support team attached from the DS FA battalion. This team provides each platoon with a two-soldier FO party—an FO and his RATELO.

NOTE: FO party for a ranger rifle company is assigned not attached.

(1) **Forward observer.** The FO acts as the eyes of the FA and mortars. He works for the platoon leader. The FO's main responsibilities are to locate targets and to call for and adjust indirect fire support. The FO must be familiar with the terrain that the platoon is operating in and the tactical situation. He must know the mission, the concept, and the platoon's scheme of maneuver and priority of fires. The FO must—

- Inform the FIST headquarters of platoon activities and the fire support situation.
- Prepare and use situation maps, overlays, and terrain sketches.
- Call for and adjust fire support.
- Operate as a team with the RATELO.
- Select targets to support the platoon's mission based on the company OPORD, platoon leader's guidance and an analysis of METT-T factors.
- Select OPs and movement routes to and from them.
- Maintain communications as prescribed by the FSO.
- Operate the digital message device.
- Maintain the six-digit grid coordinates of his location.

(2) **Radiotelephone operator.** The RATELO's main duties are to set up, operate, and maintain the FO party's communications equipment. At times, he must also perform the duties of the FO for the platoon.

APPENDIX B

INFANTRY PLATOON REFERENCE GUIDE

To succeed in combat, infantrymen must be experts in employing their organic and supporting weapons and in employing mines.

B-1. ORGANIC WEAPONS

Organic weapons are weapons that are assigned to the platoon over which the platoon leader has direct control. All leaders must know how to employ these weapons effectively in all tactical situations (Figure B-1). The infantry platoon routinely uses antiarmor weapons (Figure B-2) and hand grenades and mines (Figure B-3).

	M9 Pistol	M16A2	M249 MG	M203	M60
WEIGHT (lbs)	2.6	8.7	15.5	11	23
LENGTH (in)	8.5	39	41.1	39	43
MAX RANGE (m)	1,800	3,600	3,600	400	3,750
ARMING RANGE (m)	N/A	N/A	N/A	14	N/A
MIN SAFE RANGE (m)	N/A	N/A	N/A	31	N/A
RATE OF FIRE					
CYCLIC (rpm)	N/A	700-800	600	N/A	550
RAPID (m)	N/A	N/A	200'	35	200*
SUSTAINED	60	16	85	35	100
EFFECTIVE RANGE					
AREA (m)	N/A	800	800	350	1,100
POINT	50	580	600	160	600
MOVING (m)	N/A	200	N/A	N/A	N/A
AMMUNITION					
TYPE	BALL	BALL, TRACER, DUMMY, PRACTICE, and BLANK	BALL, TRACER, DUMMY, PRACTICE, and BLANK,	HE, WP CS, ILLUM, TP and BUCK- SHOT	BALL, TRACER and BLANK
EXAMPLE LOAD (rds)	30	210	600		
*With barrel change.					

Figure B-1. Organic weapons.

	M72 LAW	M136 AT4	M47 DRAGON
WEIGHT (lbs)	4.7	14.8	68.5
LENGTH (in)	22/35	40	44
MAX RANGE (m)	1,000	2,100	1,000
ARMING RANGE (m)	10	30	65
MIN SAFE RANGE (m)	30	30	65
EFFECTIVE RANGE			
STATIONARY (m)	200	300	1,000
MOVING (m)	125	300	100
BACKBLAST (m)	50	60	50

Figure B-2. Antiarmor weapons.

	FRAG	WP	THERMITE	CONCUSS
WEIGHT (lbs)	1	2	2	1
RANGE (m)	40	30	25	40
	(Thrown by average soldier)			
PACKING (box)	30	N/A	16	20
BURST RADIUS (m)	15	17	40-see burn	2
		60-sec burn	40-see burn	
	M21 ANTITANK MINE	M14 APERS MINE (Toe Popper)	M16A1 APERS MINE (Bouncing Betty)	M1 8A1 APERS MINE (Claymore)
WEIGHT (lbs)	18	3.6	8.3	3.5
PACKING (box)	4 mines 4 fuzes	90 ea mines and deton	4 fuzes tripwire	6 mines w/accy
BURST RADIUS	1 tank	1 indiv	30 meters	50 meters (eff) 250 meters (max)

Figure B-3. Hand grenades and mines.

B-2. SUPPORTING WEAPONS

Supporting weapons provide the platoon and squad leaders additional fire-power. They must know how to effectively integrate the fires of these weapons with the fires of their organic weapons. See Figures B-4 through B-7.

	M2 (.50 CAL)	MK 19	M202 FLASH	M3 RAAWS
WEIGHT (lbs)	64	76	26.7	22
LENGTH (in)	66	43	34.7	42.6
MAX RANGE (m)	6,765	2,212	N/A	
ARMING RANGE (m)	N/A	18	N/A	
MIN SAFE RANGE (m)	N/A	28	20	50 (HEAT) 500 (illum) 250 (HE) 50 (SMOKE) 50 (TNG)
RATE OF FIRE				
CYCLIC (rpm)	500	375	N/A	
RAPID (rpm)	40*	60	N/A	
SUSTAINED (rpm)	40*	40	N/A	6
EFFECTIVE RANGE				
AREA (m)	1,830	2,212	750	
POINT (m)	1,200	1,500	200	
STATIONARY (m)	N/A	N/A	N/A	700 (HEAT)
MOVING (m)	N/A	N/A	N/A	250
BACKBAST (m)			50	60
BURST RADIUS (m)			20	
AMMUNITION				
TYPE	BALL, AP TRACER, API API-T, INCEN and BLANK	HEDP HE TP, and BUCKSHOT		HEAT, ILLUM HE, SMOKE, TNG
*With barrel change				

Figure B-4. Supporting weapons.

WEAPON	AMMUNITION MODEL TYPE		METERS		RATE OF FIRE
			MIN RANGE	MAX RANGE***	
M224 60-mm	M720/M888	HE	70	3,500*	30 rounds per minute for 4 minutes**, then 20 rounds per minute, sustained.
	M722	WP	70	3,500	
	M721	ILLUM	200	3,200	
	M302A1	WP	33	1,625	
	M63A3	ILLUM	725	950	
	M49A4	HE	45	1,925	
M29A1 81-mm	M374A2	HE	70	4,600	12 rounds per minute for 2 minutes, then 5 rounds per minute, sustained
	M374A3	HE	73	4,725	
	M375A2	WP	73	4,775	
	M301A3	ILLUM	100	2,950	
M252 81-mm	M821/M889	HE	83	5,600	30 rounds per minute for 2 minutes, then 15 rounds per minute, sustained.
	M374A3	HE	73	4,775	
	M819	RED P	300	4,875	
	M375A3	WP	73	4,775	
	M853A1	ILLUM	300	5,050	
	M301A1	ILLUM	100	2,950	
M30 107-mm	M329A2	HE	770	6,850	18 rounds per minute for 1 minute, then 9 rounds per minute for 5 minutes, then 3 rounds per minute, sustained
	M328A1	WP	720	5,650	
	M335A2	ILLUM	400	5,500	
M120 120-mm	M57	HE	200	7,200	15 rounds per minute for 1 minute, then 4 rounds per minute, sustained
	M68	SMOKE	200	7,200	
	M91	ILLUM	200	7,100	
*Biped mounted, charge 4 maximum range handheld is 1.300 meters.					
**Charge 2 and above, 30 rounds per minute can be sustained with charge 0 or 1.					
***Rounded to nearest 25 meters.					

Figure B-5. Type and characteristics of mortars.

	M102	M119	M198
CALIBER	105-mm	105-mm	155-mm
MAX RANGE (For HE) (m)	11,500	14,000	18,100
LANNING RANGE (m)	11,500	11,500	14,600
MIN RANGE (m)	DIRECT FIRE	DIRECT FIRE	DIRECT FIRE
DANGER CLOSE RANGE	600	600	800
RATE OF FIRE			
MAXIMUM (rpm)	10	10	4
USTAINED (rpm)	3	3	2
PROJECTILE			
TYPE	HE, WP, ILLUM, HEP-T, APICM, CHEM, APERS, RAP	HE, M760, ILLUM, HEP-T, APICM, CHEM, RAP	HE, WP, ILLUM, SMOKE, CHEM, NUC, RAP, FASCAM, CPHD AP/DPICM
FUZES			
TYPE	PD, VT MT, MTSQ, CP, DELAY	PD, VT, MT, MTSQ, CP, DELAY	PD, VT, CP, MT, MTSQ, DELAY
LEGEND:			
AP	—Armor-piercing	HEP-T	—High-Explosive Plastic Tracer
APERS	—Antipersonnel	ILLUM	—Illumination
APICM	—Antipersonnel Improved Conventional Munitions	MT	—Mechanical Time
CHEM	—Chemical	MTSQ	—Mechanical Time Super Quick
CP	—Concrete Piercing	NUC	—Nuclear
CPHD	—Copperhead	PD	—Point Detonating
DPICM	—Dual Purpose Improved Conventional Munitions	RAP	—Rocket Assisted Projectile
FASCAM	—Family of scatterable Mines	VT	—Variable Time
		WP	—White Phosphorus

Figure B-6. Types and characteristics of field artillery.



ANTIPERSONNEL	SYSTEM	CASUALTY RADIUS	ACTUATION
	GEMSS GATOR MOPMS VOLCANO	10-15 meters	Tripwire (20-40 feet)
	ADAM	6-10 meters	Tripwire
ANTITANK	SYSTEM	TYPE OF KILL	ACTUATION
	GEMSS GATOR MOPMS VOLCANO RAAMS	Crew Kill	Magnetic Influence
<p>LEGEND: RAAMS —Remote Antiarmor Mine System ADAM —Artillery-Delivered Antipersonnel Mine GEMSS —Ground-Emplaced Mine Scattering System GATOR —Aircraft-Delivered System MOPMS —Modular Packed Mine System</p>			

Figure B-7. Family of scatterable mines.

WARNING

Scatterable mines are above ground and have delay as well as immediate fuzes. Soldiers and leaders must treat scatterable mines as active mines. Scatterable mines should not be moved, gathered, or tampered with in any way.

B-3. MINES

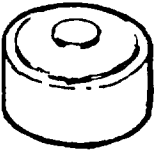
B-3. MINES

Mines are one of the most effective tank and personnel killers on the battlefield, especially in the close-in battle. Mines not only have the capability to disrupt the enemy but also to destroy him. Mines are especially useful when combined with direct and indirect fires. (Figures B-8 and B-9.)



M14 ANTIPERSONNEL MINE (BLAST)

Weight 3.33 oz

Explosive 1 oz TETRYL

Fuze Integral
(With Belleville spring)

Functioning 20 to 35 lbs

Penetrate boot and foot

1 Unscrew shipping plug from bottom of mine. Turn pressure plate to ARMED position with arming tool.



2 Remove safety clip. Check for malfunctions.

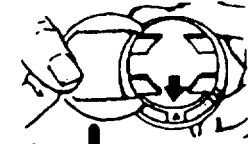

3 Replace safety clip.

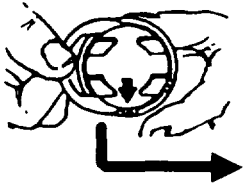

4 Screw detonator into detonator well



5 Bury mine and remove safety clip.



TO BURY: Pressure plate should be slightly above ground.

TO DISARM: Insert safety clip and remove detonator.

CAUTION
Repeated turning of arming dial may cause excessive wear.

Figure B-8. Antipersonnel mines.

B-7

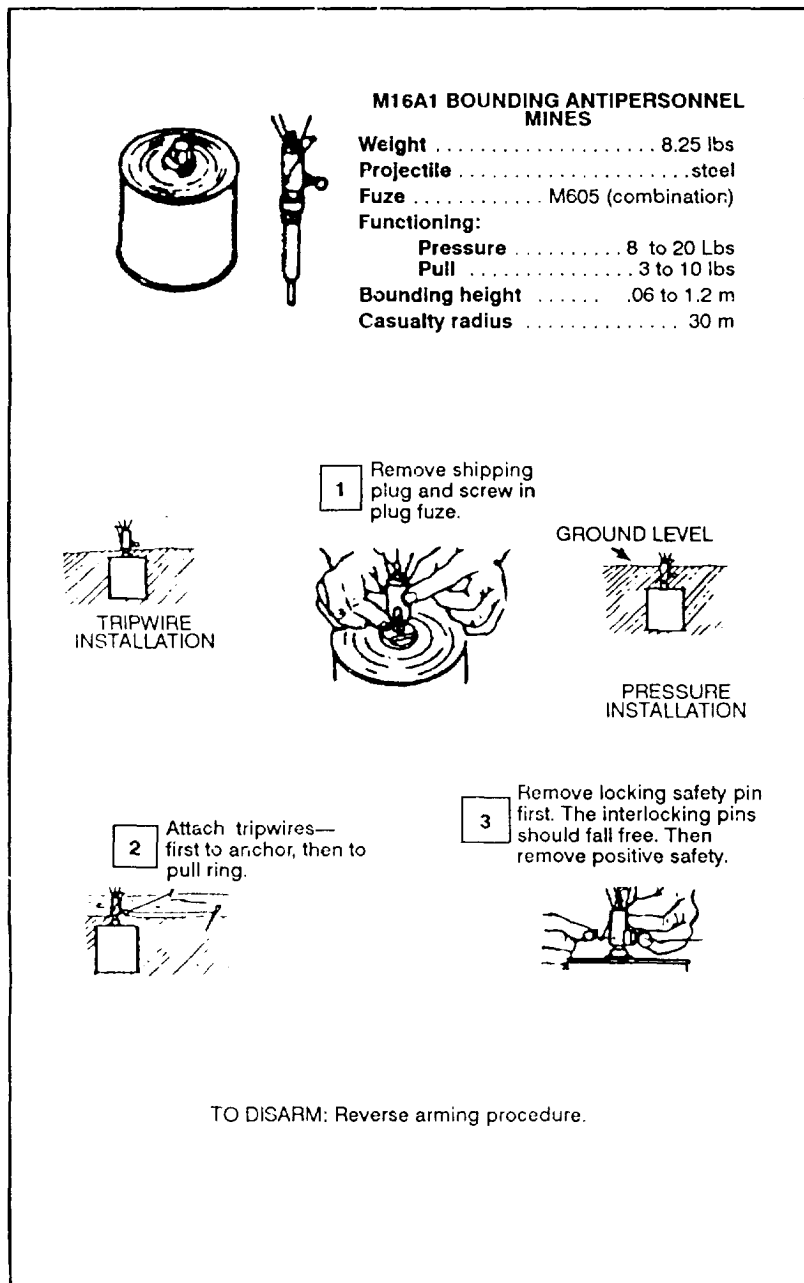

Figure B-8. Antipersonnel mines (continued).

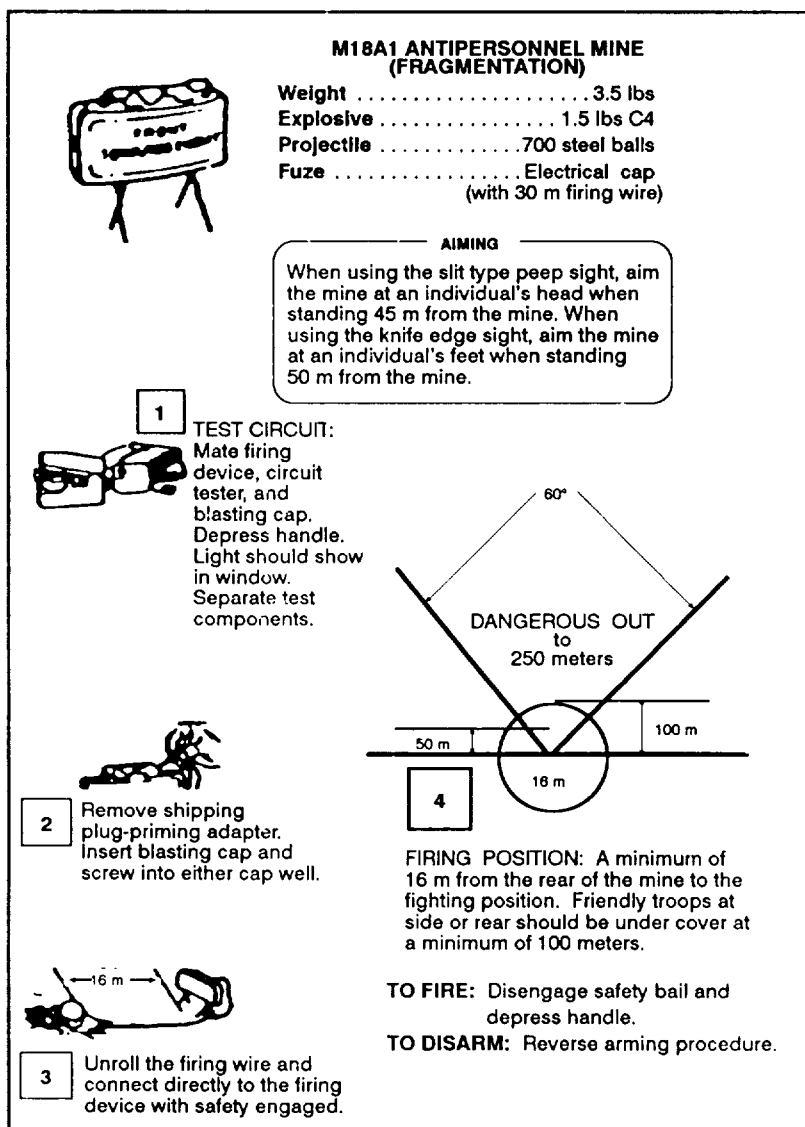
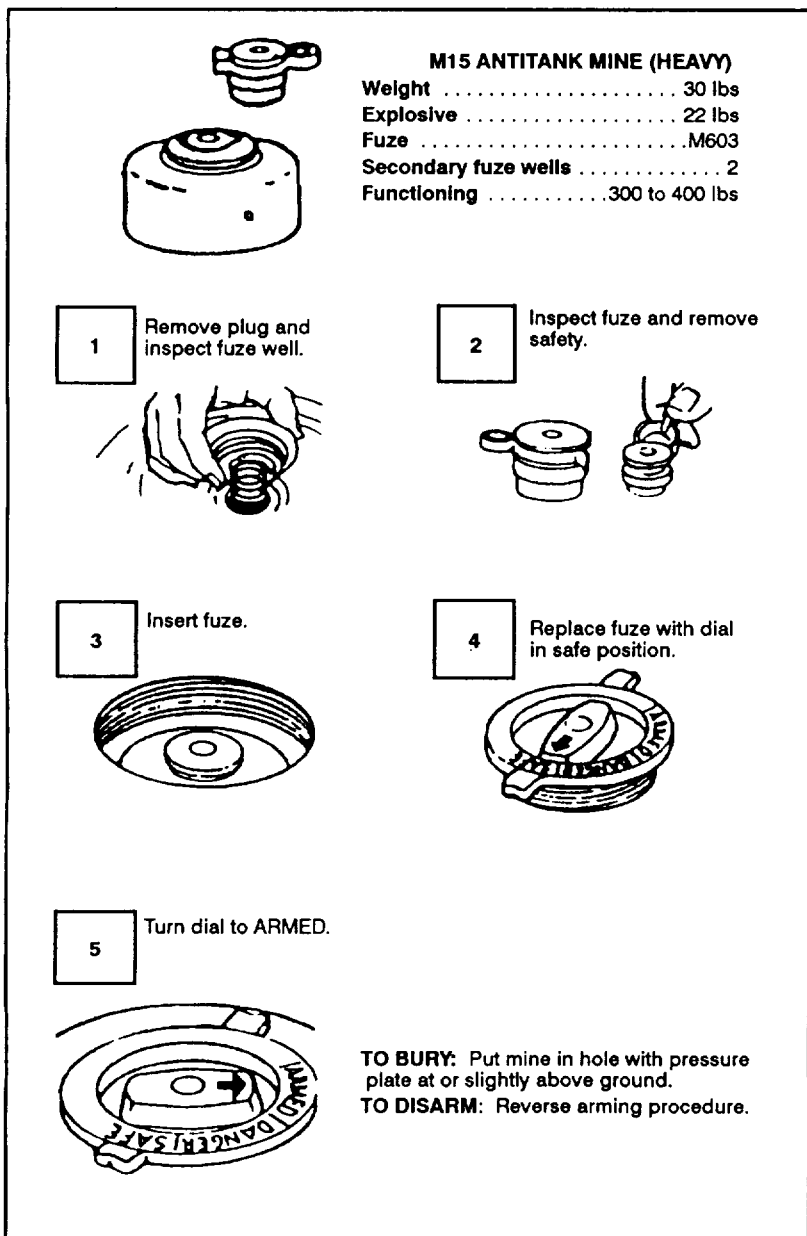
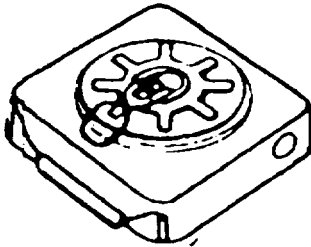

Figure B-8. Antipersonnel mines (continued).



Figuer B-9. Antitank mines.



M19 PLASTIC ANTITANK MINE (HEAVY)

Weight 28 lbs

Explosive 21 lbs

Fuze M606 Integral
(with pressure plate)

Secondary fuze wells 2

Functioning 350 to 500 lbs

1 Remove pressure plate fuze.

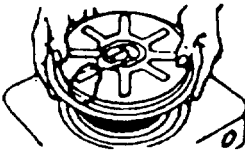

2 Remove shipping plug; check position of striker (offset). Remove safety fork, turn dial to ARMED position. Check position of striker (center). turn to SAFE and replace safety fork.



3 Screw threaded detonator into detonator well.

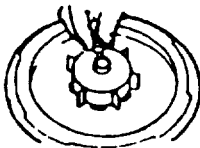

4 Place mine in hole, remove safety fork; turn dial to ARMED.

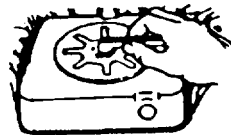

5 Complete camouflage.



TO BURY: Put mine in hole with pressure plate at or slightly above ground level.

TO DISARM: Reverse arming procedure.

Figure B-9. Antitank mines (continued).

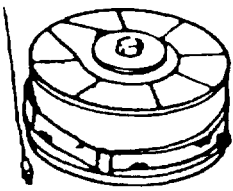

**M21 METALLIC ANTITANK MINE
(KILLER)**

Weight 18 lbs
Explosive 10.5 lbs
Fuze M607
Functioning 290 lbs
 (Pressure on pressure ring or
 20-degree deflection of tilt rod).

1 Remove closing plug, insert M120 booster in bottom, and replace closing plug.



2 Remove closure assembly from fuze.

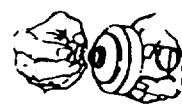

3 Remove shipping plug from mine and screw in tilt rod extension.

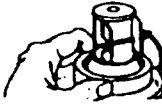

4 Bury mine.

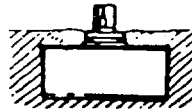

5 Remove safety (pull-ring assembly) and complete camouflage.

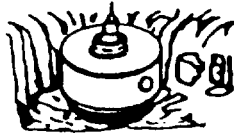

TO BURY:
 —For pressure type mines, bury with fuze cap flush with ground surface.
 —Tilt-rod mines should be seated firmly in a snug-fitting hole. Most effective in tall brush or grass.

TO DISARM: Reverse arming procedure.

Figure B-9. Antitank mines (continued).

GLOSSARY

ACRONYMS AND ABBREVIATIONS

ACE	ammunition, casualty, and equipment (report)
accy	accuracy
ADA	air defense artillery
ADAM	. . .	artillery-delivered antipersonnel mine
ALICE	. . .	all-purpose, lightweight, individual carrying equipment
ammo	ammunition
AO	area of operation
AP	armor-piercing
API	armor-piercing incendiary
API-T	. . .	armor-piercing incendiary tracer
APERS	. . .	antipersonnel
AR	Army regulation; automatic rifleman
ARTEP	. . .	Army Training and Evaluation Program
ASAP	as soon as possible
BAS	battalion aid station
BFV	Bradley fighting vehicle
BMP	(a Threat fighting vehicle)
BP	battle position
BTR	(a Threat vehicle)
cal	caliber
CCP	casualty collection point
cGy	centigray
chem	chemical
ci	counterintelligence
co	company
Co	commanding officer
COMSEC	. .	communications security
CP	command post

CPHD Copperhead
CP-OP command post-observation post
CS combat support
CSS combat service support
CTT common task test
DADepartment of the Army
demo demolition
deton detonation
DOA direction of attack
DLICdetachment(s) left in contact
DPICM dual-purpose improved conventional munition
m.. direct support
DZ drop zone
ea each
EA engagement area
em. effective
EM enlisted member
EPW enemy prisoner of war
FA field artillery
FASCAM family of scatterable mines
FEBA forward edge of the battle area
1SG first sergeant
FIST fire support team
FM field manual; frequency modulated
FO forward observer
FPF final protective fires
FPL final protective line
frag fragmentaion
FRAGO fragmentary order
FSO fire support officer
GL grid line
grn grenadier
GSR ground surveillance radar
GTA graphic training aid
HE high explosive
HEAT high-explosive antitank

HEDP . . . high-explosive dual purpose
HEP high-explosive plastic
HEP-T . . . high-explosive plastic-tracer
HMMWV . high-mobility, multipurpose, wheeled vehicle
hq headquarters
HUMINT . human intelligence
IAW in accordance with
illum illumination
in inch
incen incendiary
IPW prisoner of war interrogation
KIA killed in action
kmph kilometers per hour
LAW light antitank weapon
lb pound
LBE load-bearing equipment
L D line of departure
ldr leader
LOGPAC . logistics package
LOS line of sight
It light
LZ landing zone
m meters
MAW medium antitank weapon
max maximum
MEDEVAC medical evacuation
METT-T . . mission, enemy, terrain, troops and time available
mg machine gun
min minimum
mm millimeter
MOPP . . . mission-oriented protective posture
MOS military occupational specialty
MOUT . . . military operations on urbanized terrain
MRE meal, ready-to-eat
MRP motorized rifle platoon (Threat)
MT mechanical time

MTOE . . . modified table of organization and equipment
MTP . . . mission training plan
MTSQ . . . mechanical time, super quick (fuze)
N/A not applicable
NAI named area of interest
NATO . . . North Atlantic Treaty Organization
NBC nuclear, biological, chemical
NCO . . . noncommissioned officer
NLT not later than
nuc nuclear
NW) night vision device
obj objective
OCOKA . . observation and fields of fire, cover and concealment, obstacles and movement, key terrain, and avenues of approach

off officer
OP observation post
OPCON . . operational control
OPORD . . operation order
ORP objective rally point
oz ounce
P phosorus
PAC Personnel and Administration Center
PB patrol base
PDF principal direction of fire
PEWS . . . platoon early warning system
PL phase line
Pm probable line of deployment
plt platoon
PMCS . . . preventive maintenance checks and services
PSG platoon sergeant
PW prisoner of war
R rifleman
RAAWS . . ranger antiarmor weapon system
R&S reconnaissance and security
RAP rocket-assisted projectile
RATELO . . radiotelephone operator

RCLR . . . recoilless rifle
rd round, road
RDF radio direction finder
recon reconnaissance
rgr ranger
ROE rules of engagement
RP release point
rpm revolution per minute
RRP reentry rally point
S1 Adjutant (US Army)
S3 Operations and Training Officer (US Army)
S4 Supply Officer (US Army)
SALUTE . . . size, activity, location, unit, time, and equipment
SDT self-development test
sec section, second
SFC sergeant first class
SGT sergeant
S1 squad leader
SMCT . . . soldier's manual of common tasks
SOI signal operation instructions
SOP standing operating procedure
SOSR suppress, obscure, secure, and reduce
sqd squad
SSG staff sergeant
SSN social security number
SSSC self-service supply centers
SSW south southwest
STANAG . . . Standardization Agreement
STB supertropical bleach
STP soldier's training publication
T&E traversing and elevating mechanism
TACSOP . . . tactical SOP
TL team leader
TLP troop-leading procedure
tm team
TM technical manual

tng	training
TOE	table(s) of organization and equipment
TOW . .	tube-launched, optically tracked, wire-guided
TP	training practice
TRADOC	United States Army Training and Doctrine Command
TRP . . .	target reference point
US	United States
vic	vicinity
VT	variable time
w	with
WP	white phosphorus
wpn	weapon
XO	executive officer

REFERENCES

SOURCES USED

These are the sources quoted or paraphrased in this publication.

- FM 6-20. Fire Support in the AirLand Battle. 17 May 1988.
- FM 6-30. Observed Fire Procedures. 17 June 1985.
- FM 19-4. Military Police Team, Squad, Platoon Combat Operations. 23 May 1984.
- FM 21-11. First Aid for Soldiers. 27 October 1988.
- STANAG 2003. Patrol Reports (Edition 6).
- STANAG 2044. Procedures for Dealing With Prisoners of War (PW) (Edition 3).
- STANAG 2084. Handling and Reporting of Captured Enemy Equipment and Documents (Edition 5).

DOCUMENTS NEEDED

These documents must be available to the intended users of this publication.

- AR 350-42. Nuclear, Biological, and Chemical Defense and Chemical Warfare Training. 14 October 1988.
- AR 385-62. Regulations for Firing Guided Missiles and Heavy Rockets for Training Target Practice and Combat. 5 January 1977.
- AR 385-63. Policies and Procedures for Firing Ammunition for Training, Target Practice and Combat. 15 October 1983.
- * ARTEP 7-8-DRILL. Battle Drills for the Infantry Rifle Platoon and Squad. 22 January 1990.
- * ARTEP 7-8-MTP. Mission Training Plan for the Infantry Rifle Platoon and Squad. 30 September 1988.
- DA Form 1155. Witness Statement of Individual. Jun 66.
- DA Form 1156. Casualty Feeder Report. Jun 66.
- DA Form 1355-I-R. Hasty Protective Minefield (LRA). Jul 75.
- DA Form 5517-R. Standard Range Card (LRA).
- DA Pamphlet 350-38. Training Standards in Weapon Training. 1990.

FM 7-8

- *FM 3-5. NBC Decontamination. 24 June 1985.
 - *FM 3-100. NBC Operations. 17 September 1985.
 - *FM 7-10. The Infantry Rifle Company. 14 December 1990.
 - FM 20-32. Mine/Countermine Operations. 9 December 1985.
 - FM 21-60. Visual Signals. 30 September 1987.
 - FM 21-75. Combat Skills of the Soldier. 3 August 1984.
 - FM 22-100. Military Leadership. 31 July 1990.
 - *FM 25-100. Training the Force. 15 November 1988.
 - *FM 25-101. Battle Focused Training. 30 September 1990.
 - *FM 90-10 (HTF). Military Operations on Urbanized Terrain (MOUT) (How to Fight). 15 August 1979.
 - *FM 90-10-1 (HTF). An Infantryman's Guide to Urban Combat (How to Fight). 30 September 1982.
 - FM 100-5. Operations. 5 May 1986.
 - *FM 101-5-1. Operational Terms and Symbols. 21 October 1985.
 - STP 21-1 -SMCT Soldier's Manual of Common Tasks, Skill Level 1. 1 October 1990.
 - STP 21-24 -SMCT Soldier's Manual of Common Tasks, Skill Levels 2-4. 10 January 1989.
 - TM 3-6665-225-12. Operator's and Organizational Maintenance Manual: For Alarm, Chemical Agent, Portable, Manpack, M8. 29 August 1975.
- *This source was also used to develop this publication.

READINGS RECOMMENDED

These readings contain supplemental information.

- FM 5-34. Engineer Field Data. 14 September 1987.
- FM 5-102. Countermobility. 14 March 1985.
- FM 7-20. The Infantry Battalion. TBP.
- FM 19-10. The Military Police Law and Order Operations, 30 September 1987.
- FM 19-40. Enemy Prisoners of War, Civilian Internees and Detailed Persons. 27 February 1976.

References-2

- FM 20-32. Mine/Countermine Operations. 9 December 1985.
- FM 20-33. Combat Flame Operations. 16 July 1970.
- FM 21-10. Field Hygiene and Sanitation (AFM 161-10).
22 November 1988.
- FM 21-18. Foot Marches. 1 June 1990.
- FM 21-76. Survival. 26 March 1986.
- FM 22-9. Soldier Performance in Continuous Operations.
8 December 1983.
- FM 23-9. M16A1 Rifle and Rifle Marksmanship. 3 July 1989.
- FM 23-11. 90-mm Recoilless Rifle, M67. 6 July 1965.
- FM 23-14. Squad Automatic Weapon (SAW), M249. 10 December 1985.
- FM 23-24. Dragon Medium Antitank/Assault Weapon System.
3 April 1990.
- FM 23-25. Launcher and Cartridge, 84-mm, M136 (AT4) HEAT
22 November 1988.
- FM 23-27. MK 19, 40-mm Grenade Machine Gun, Mod 3.
27 December 1988.
- FM 23-31. 40mm Grenade Launchers M203 and M79. 1 May 1972.
- FM 23-33. 66-mm HEAT Rocket, M72A1, M72A2 (Light Antitank
Weapon). 20 April 1979.
- FM 23-34. TOW Weapon System. 30 September 1987.
- FM 23-35. Combat Training With Pistols and Revolvers.
3 October 1988.
- FM 23-65. Browning Machinegun, Caliber .50 HB, M2. 19 May 1972.
- FM 23-67. Machinegun, 7.62mm, M60. 29 February 1984.
- FM 23-90. Mortars. 19 September 1990.
- FM 44-3. Operations and Training, Chaparral. 2 November 1984.
- FM 44-16. Chaparral/Vulcan/Stinger Platoon Combat Operations.
29 May 1987.
- FM 90-4. Air Assault Operations. 16 March 1987.
- FM 90-13-1. Combined Arms Breaching Operations.
- FM 100-5. Operations. 5 May 1986.

FM 7-8

STP 19-95 B1-SM. Soldier's Manual: 95B Military Police (Skill Level 1).
11 March 1986.

STP 19-95 B23-SM-TG. Soldier's Manual and Trainer's Guide:
MOS 95B, Military Police Skill Level 213.11 March 1986.

TB Med 524. Occupational and Environmental Health: Control of
Hazards to Health From Laser Radiation. 20 June 1985.

INDEX

- aerial resupply** 2-112
- ambush**, 2-25, 3-19, 3-20
 - antiarmor, 3-28
 - area, 3-27
 - deliberate, 3-24
 - hasty, 3-22
 - point, 3-25
- armored vehicle support**, 2-124
 - mechanized infantry, 2-126
 - tanks, 2-125
- assault**, 2-58
- assembly area**, 5-22
- attack**
 - limited visibility, 1-10, 2-60
 - fire control techniques, 2-61
 - security, 1-19
 - types of,
 - ambush, 1-8
 - deliberate, 1-8, 2-25, 2-56
 - hasty, 1-8, 2-25
 - raid, 1-8, 3-30
- avenues of approach**, 2-8
- battle drills**, 4-1
 - break contact, 4-14
 - conduct initial breach of a mined wire obstacle, 4-33
 - enter building/clear room, 4-22
 - enter/clear a trench, 4-27
 - knock out bunkers, 4-18
 - platoon attack, 4-2
 - react to ambush, 4-16
 - react to contact, 4-12
 - squad attack, 4-8
- battle positions**, 1-17
- combat service support**, 2-109, 2-166
 - health services support, 2-119
 - maintenance, 2-113
 - personnel service support, 2-114
 - planning, 2-109
 - resupply, 2-109
 - soldier's load, 2-113
 - transportation, 2-113
- command post, 2-72
- communication, 2-63 to 2-65, 2-72, 5-8
 - with tanks, 2-126
- concept sketch**, 2-22
- consolidation**, 2-26, 2-58, 2-63, 2-70
 - clock technique, 2-58
 - terrain feature technique, 2-59
- control measures**, 1-9, 1-18, 2-2, 2-3
- coordination**, 2-85
- cover and concealment**, 2-8
- DA Form 5517-R (Standard Range Card)**, 2-76, 2-77 (illus)
- danger areas**, 2-47
 - crossing of, 2-48 to 2-51
 - enemy contact at, 2-51
- defense, 1-10, 2-66
 - perimeter, 1-14, 2-25
 - reverse slope, 1-11
 - sector, 1-15
 - security, 1-20
- defensive positions**, 2-67
- delay**, 2-101
- deliberate attack**, 1-8, 2-25, 2-56

disengagement, 2-98

duties,

- fire support team, A-7
- forward observer, 5-26, A-8
- machine gun squad leader, A-7
- platoon aidman, A-7
- platoon leader, 5-6
- platoon radiotelephone operator, A-7
- platoon sergeant, 5-6
- rifle platoon leader, A-4
- rifle platoon sergeant A-5
- rifle squad leader, A-6
- squad leader, 5-7
- team leader, A-7
- weapons squad leader, A-7

fighting positions, 2-86

- alternate, 2-79
- hasty, 2-90
- preparation of, 2-86 to 2-89
- primary, 2-79
- supplementary, 2-89
- three-soldier, 2-91
- two-soldier, 2-91

fire commands, 2-158, 5-29

fire control, 2-82, 5-28, 5-29

- methods of 2-158
- types of,
 - direct, 2-82 to 2-84
 - indirect, 2-106, 5-27

fire control techniques, 2-61

fire distribution, 2-157, 5-28, 5-30

- area, 2-157, 5-30
- point, 2-157, 5-30

firepower, 1-2

fire support, 2-105

- defense, 2-105
- offense, 2-105

hasty attack, 1-8, 2-25

infiltration, 1-7

inspections, 2-10

key terrain, 2-8

leadership, 1-3

limited visibility techniques, 2-160

- combat service support, 2-166
- dark adaptation, 2-162
- equipment, 2-163
- illumination, 2-164
- land navigation, 2-163
- maneuver, 2-165
- night vision, 2-160 to 2-162
- security, 2-164
- smoke, 2-164

linkup, 2-102

maneuver, 1-2, 1-9, 1-11, 2-165

minefield,

- hasty protective, 2-135
- phony, 2-142
- point, 2-142

mission tactics, 2-1 to 2-3

MOPP, 2-152,5-24

movement, 1-5, 2-9, 2-56 to 2-58, 2-67,5-12

movement formations, 1-5, 2-24, 2-27,5-12

- fire team, 2-27 to 2-29, 5-12
- platoon, 2-31 to 2-37, 5-12
- squad, 2-29 to 2-31, 5-12

movement techniques, 1-5, 2-24, 2-38,5-12

- individual, 2-44
- platoon, 2-41 to 2-44
- squad, 2-38 to 2-40

movement to contact, 1-6, 2-25, 2-54

- approach march technique, 2-54
- search and attack technique, 2-54

movement with armored vehicles, 2-44

- movement by water**, 2-44
- movement during limited visibility**, 2-45 to 2-47, 2-163
- NBC**, 2-66, 2-147, 5-24
- observation posts**, 1-12, 1-13, 1-19, 1-20, 2-26, 2-70, 2-153, 5-31
- obstacles**, 1-18, 2-8, 2-129
breaching, 2-142, 2-143
bypassing, 2-142
minefield,
 hasty protective, 2-135
 phony, 2-142
 point, 2-142
types of,
 existing, 2-130
 reinforcing, 2-131
- offense**, 1-6 to 1-10, 1-19
- orders**, 5-11
fragmentary, 2-4, 2-22, 2-25, 2-26
operation, 2-4, 2-10, 2-11 to 2-21 (illus)
warning, 2-4, 2-5 to 2-7 (illus)
- organization**
air assault rifle platoon, A-2
airborne rifle platoon, A-3
infantry rifle platoon, A-2
light infantry rifle platoon, A-1
ranger rifle platoon, A-3
rifle squad, A-4
- patrol base**, 3-37
- patrol report**, 3-10
- patrols**, 2-25, 2-26, 3-1
organization of, 3-1, 3-11, 3-19, 3-30
types of
 combat, 3-19
 reconnaissance, 2-25, 3-11
 tracking, 3-30
- platoon positions**, 2-80
- positions**,
 alternate, 2-79
 AT4, 2-96
 Dragon, 2-94
 fighting, 2-86
 hasty, 2-90
 preparation of, 2-86 to 2-89
 three-soldier, 2-91
 two-soldier, 2-91
Flash, 2-96
light antitank weapon, 2-96
machine gun, 2-93
90-mm recoilless rifle, 2-95
ranger antiarmor weapon
 system, 2-95
squad, 2-80
 platoon, 2-80
 primary, 2-79
 supplementary, 2-79
protection, 1-2
- raid**, 1-8, 3-30
- rally points**, 3-6
 en route, 3-7
 far-side, 3-9
 initial, 3-6
 near-side, 3-9
 objective, 3-7
 reentry, 3-8
- range card**, see standard range card
- reconnaissance**, 2-9, 3-11
 area, 3-11
 organization, 3-11
 route, 3-17
 zone, 3-12
- rehearsals**, 2-10
- relief in place**, 2-103
- reorganization**, 1-11, 2-60, 2-63, 2-70

- reports**, 5-11
- resupply techniques**, 2-110
 - in-position, 2-110
 - pre-position, 2-112
 - service station, 2-111
- retirement**. 2-102
- sector sketches**, 2-80
 - squad, 2-80, 2-81 (illus)
 - platoon, 2-82,2-83 (illus)
- security, 1-19**
 - at danger areas, 2-24,2-47
 - at halts, 2-25
 - at night, 2-164
 - during movement, 1-19, 2-24, 2-46
 - in the defense, 2-26 to 2-27, 2-72
 - in the offense, 2-25
- soldier's load**, 2-113, 5-33
- squad positions**, 2-80
- STANAG 2003**, 3-1
- standard range card** (see also DA Form 5517-R), 2-76
- standing operating procedure, 5-1**
- stay-behind operations**
 - deliberate, 2-103
 - unplanned, 2-102
- tactical marches** 2-45
- target detection**, 2-65
- terrain model**, 2-22, 2-23 (illus)
- trenches**. 2-96
- troop-leading procedure**, 2-3
- weapons**,
 - organic, B-1, B-2
 - supporting, B-3 to B-6
 - mines, B-7 to B-12
- weapons emplacement** 2-72
 - antiarmor weapons, 2-75
 - grenade launchers, 2-75
 - machine gun, 2-73
 - rifles, 2-75
- weapons position**,
 - AT4, 2-96
 - Dragon, 2-94
 - Flash. 2-96
 - light antitank weapon, 2-96
 - machine gun, 2-93
 - 90-mm recoilless rifle, 2-95
 - ranger antiarmor weapon system, 2-95
- withdrawal**, 2-97
 - disengagement, 2-98 to 2-99
 - not under pressure, 2-100
 - under pressure, 2-101

By Order of the Secretary of the Army:

Official:

GORDON R. SULLIVAN
General, United States Army
Chief of Staff

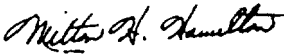

MILTON H. HAMILTON
Administrative Assistant to the
Secretary of the Army

01348

DISTRIBUTION:

Active Army, USAR, and ARNG: To be distributed in accordance with DA Form 12-11-E, Requirements for Infantry Rifle Platoon and Squad (Qty rqr block no. 782).

PIN: 069817-001