

# **THE INFANTRY BATTALION**

**HEADQUARTERS  
DEPARTMENT OF THE ARMY**

**DISTRIBUTION RESTRICTION: Approved for public release; distribution is unlimited.**

FM 7-20  
C1

HEADQUARTERS  
DEPARTMENT OF THE ARMY  
Washington, DC, 29 DECEMBER 2000

**CHANGE 1**

1. Change FM 7-20, dated 6 April 1992, as follows:

**REMOVE OLD PAGES**

None

**INSERT NEW PAGES**

G-1 through G-53

2. A star (★) marks new or changed material.
3. File this transmittal sheet in front of the publication.

DISTRIBUTION RESTRICTION— Approved for public release; distribution is unlimited.

By Order of the Secretary of the Army:

ERIC K. SHINSEKI  
*General, United States Army*  
*Chief of Staff*

Official:

  
JOEL B. HUDSON  
*Administrative Assistant to the*  
*Secretary of the Army*  
0031906

*Active Army, Army National Guard, and U.S. Army Reserve:* To be distributed in accordance with the initial distribution number 110079, requirements for FM 7-20.

# THE INFANTRY BATTALION

## Contents

|  | Page |
|--|------|
| Preface .....  | viii |
| <b>CHAPTER 1. INTRODUCTION</b>                             |      |
| <b>Section I. The Role of the Infantry Battalion</b> ..... | 1-1  |
| 1-1. The AirLand Battle .....                              | 1-1  |
| 1-2. Fundamentals of the AirLand Battle .....              | 1-1  |
| 1-3. Combat Power .....                                    | 1-2  |
| 1-4. Mission .....   | 1-3  |
| <b>Section II. Operating Systems</b> .....                 | 1-3  |
| 1-5. Intelligence System .....                             | 1-4  |
| 1-6. Maneuver System .....                                 | 1-4  |
| 1-7. Fire Support System .....                             | 1-4  |
| 1-8. Mobility/Counter mobility/Survivability System .....  | 1-4  |
| 1-9. Air Defense System .....                              | 1-4  |
| 1-10. Combat Service Support System .....                  | 1-4  |
| 1-11. Command and Control System .....                     | 1-4  |
| <b>CHAPTER 2. COMMAND AND CONTROL</b>                      |      |
| <b>Section I. Command and Control System</b> .....         | 2-1  |
| 2-1. Elements of Command and Control .....                 | 2-1  |
| 2-2. Command .....   | 2-2  |

DISTRIBUTION RESTRICTION: Approved for public release; distribution is unlimited.

\*This publication supersedes FM 7-20, 28 December 1984; and FM 7-72, 16 March 1987.



|   | <b>Page</b> |
|---|-------------|
| 2-3. Control . . . . .  | 2-2         |
| 2-4. Commander's Authority . . . . .                                      | 2-2         |
| 2-5. Commander's Presence . . . . .                                       | 2-2         |
| 2-6. Commander's Leadership . . . . .                                     | 2-2         |
| 2-7. Commander's Intent . . . . .   | 2-3         |
| 2-8. Mission Tactics . . . . .  | 2-3         |
| 2-9. Mission Orders . . . . .   | 2-3         |
| 2-10. Main Effort . . . . .   | 2-4         |
| 2-11. Chain of Command . . . . .  | 2-4         |
| 2-12. Command Relationships . . . . .                                     | 2-4         |
| 2-13. Support Relationships . . . . .                                     | 2-5         |
| 2-14. Organization . . . . .  | 2-5         |
| <b>Section II. Command and Control Process . . . . .</b>                  | <b>2-6</b>  |
| 2-15. Planning . . . . .  | 2-6         |
| 2-16. Decision-Making Process . . . . .                                   | 2-6         |
| 2-17. Troop-Leading Procedures . . . . .                                  | 2-9         |
| 2-18. Receipt of Mission . . . . .  | 2-9         |
| 2-19. Issuance of Warning Order . . . . .                                 | 2-10        |
| 2-20. Tentative Plan . . . . .  | 2-10        |
| 2-21. Initiation of Movement . . . . .                                    | 2-22        |
| 2-22. Reconnaissance . . . . .  | 2-22        |
| 2-23. Completion of Plan . . . . .  | 2-23        |
| 2-24. Issuance of OPORD . . . . .   | 2-23        |
| 2-25. Supervision and Refinement . . . . .                                | 2-23        |
| <b>Section III. Intelligence Preparation of the Battlefield . . . . .</b> | <b>2-25</b> |
| 2-26. Role of IPB . . . . .   | 2-26        |
| 2-27. Five Functions of IPB Process . . . . .                             | 2-26        |
| 2-28. Intelligence Collection Process . . . . .                           | 2-26        |
| <b>Section IV. Command and Control During Battle . . . . .</b>            | <b>2-27</b> |
| 2-29. Planning . . . . .  | 2-27        |
| 2-30. Preparation . . . . .   | 2-27        |
| 2-31. Execution . . . . .   | 2-27        |

## **CHAPTER 3. OFFENSIVE OPERATIONS**

|  |            |
|--|------------|
| <b>Section I. Doctrine . . . . .</b>                   | <b>3-1</b> |
| 3-1. Purpose . . . . .                                 | 3-1        |
| 3-2. Characteristics of Offensive Operations . . . . . | 3-1        |
| 3-3. Offensive Framework . . . . .                     | 3-3        |
| 3-4. Forms of Maneuver . . . . .                       | 3-4        |
| <b>Section II. Offensive Planning . . . . .</b>        | <b>3-8</b> |
| 3-5. Scheme of Maneuver . . . . .                      | 3-8        |
| 3-6. Fire Support . . . . .                            | 3-8        |
| 3-7. Task Organization . . . . .                       | 3-8        |
| 3-8. Offensive Concept Development . . . . .           | 3-9        |

|  | Page        |
|--|-------------|
| 3-9. Breaching Operations . . . . .                            | 3-10        |
| 3-10. Limited Visibility Operations . . . . .                  | 3-11        |
| <b>Section III. Movement to Contact . . . . .</b>              | <b>3-14</b> |
| 3-11. Planning . . . . .                                       | 3-14        |
| 3-12. Approach March Technique . . . . .                       | 3-15        |
| 3-13. Search-and-Attack Technique . . . . .                    | 3-18        |
| 3-14. Actions on Contact . . . . .                             | 3-23        |
| <b>Section IV. Attacks . . . . .</b>                           | <b>3-24</b> |
| 3-15. Hasty Attack . . . . .                                   | 3-24        |
| 3-16. Deliberate Attack . . . . .                              | 3-25        |
| 3-17. Attack of Fortified Positions and Strongpoints . . . . . | 3-28        |
| 3-18. Task Organization . . . . .                              | 3-29        |
| 3-19. Sequence of Attack . . . . .                             | 3-30        |
| 3-20. The Assault . . . . .                                    | 3-32        |
| 3-21. Culminating Point . . . . .                              | 3-33        |
| 3-22. Consolidation and Reorganization . . . . .               | 3-34        |
| <b>Section V. Other Offensive Operations . . . . .</b>         | <b>3-35</b> |
| 3-23. Follow-and-Support Operations . . . . .                  | 3-36        |
| 3-24. Exploitation . . . . .                                   | 3-36        |
| 3-25. Pursuit . . . . .  | 3-36        |
| <br>   |             |
| <b>CHAPTER 4. DEFENSIVE OPERATIONS . . . . .</b>               | <b>4-1</b>  |
| <b>Section I. Doctrine . . . . .</b>                           | <b>4-1</b>  |
| 4-1. Purpose . . . . .   | 4-1         |
| 4-2. Characteristics of Defensive Operations . . . . .         | 4-1         |
| 4-3. Defensive Framework . . . . .                             | 4-2         |
| <b>Section II. Planning and Preparation . . . . .</b>          | <b>4-5</b>  |
| 4-4. Commander's Intent . . . . .                              | 4-5         |
| 4-5. Development of Defensive Concept . . . . .                | 4-6         |
| 4-6. Limited Visibility Operations . . . . .                   | 4-7         |
| <b>Section III. Counterreconnaissance . . . . .</b>            | <b>4-7</b>  |
| 4-7. Planning . . . . .  | 4-8         |
| 4-8. Execution . . . . .                                       | 4-10        |
| 4-9. Displacement of the Counterreconnaissance Force . . . . . | 4-11        |
| <b>Section IV. Conduct of Operations . . . . .</b>             | <b>4-11</b> |
| 4-10. Occupation . . . . .                                     | 4-11        |
| 4-11. Priority of Work . . . . .                               | 4-11        |
| 4-12. Sequence of the Defense . . . . .                        | 4-11        |
| 4-13. Counterattacks . . . . .                                 | 4-12        |
| 4-14. Spoiling Attacks . . . . .                               | 4-13        |
| 4-15. Integration of Combat Support . . . . .                  | 4-14        |
| 4-16. Consolidation and Reorganization . . . . .               | 4-14        |

|   | Page |
|---|------|
| <b>Section V. Types of Defense</b> . . . . .        | 4-15 |
| 4-17. Defense of a Sector . . . . .                 | 4-15 |
| 4-18. Defense from a Battle Position . . . . .      | 4-17 |
| 4-19. Reverse Slope Defense . . . . .               | 4-19 |
| 4-20. Perimeter Defense . . . . .                   | 4-22 |
| 4-21. Linear Defense . . . . .                      | 4-24 |
| 4-22. Defense of a Strongpoint . . . . .            | 4-25 |
| 4-23. Defense Against Infiltration . . . . .        | 4-26 |
| 4-24. Defense Against Air Attack . . . . .          | 4-26 |
| <br><b>CHAPTER 5. RETROGRADE OPERATIONS</b>         |      |
| <b>Section I. Doctrine</b> . . . . .                | 5-1  |
| 5-1. Purpose . . . . .                              | 5-1  |
| 5-2. Types of Retrograde Operations . . . . .       | 5-1  |
| 5-3. Planning . . . . .                             | 5-1  |
| <b>Section II. Delay Operations</b> . . . . .       | 5-2  |
| 5-4. Purpose . . . . .                              | 5-3  |
| 5-5. Fundamentals . . . . .                         | 5-3  |
| 5-6. Degrees of Risk . . . . .                      | 5-3  |
| 5-7. Methods of Delay . . . . .                     | 5-4  |
| 5-8. METTT Analysis . . . . .                       | 5-6  |
| 5-9. Planning . . . . .                             | 5-7  |
| 5-10. Conduct of a Delay . . . . .                  | 5-10 |
| <b>Section III. Withdrawal Operations</b> . . . . . | 5-11 |
| 5-11. Purpose . . . . .                             | 5-11 |
| 5-12. METTT Analysis . . . . .                      | 5-12 |
| 5-13. Planning . . . . .                            | 5-12 |
| 5-14. Conduct of a Withdrawal . . . . .             | 5-12 |
| 5-15. Withdrawal Not Under Enemy Pressure . . . . . | 5-12 |
| 5-16. Withdrawal Under Enemy Pressure . . . . .     | 5-15 |
| <b>Section IV. Retirement Operations</b> . . . . .  | 5-21 |
| 5-17. Purpose . . . . .                             | 5-21 |
| 5-18. METTT Analysis . . . . .                      | 5-22 |
| 5-19. Planning . . . . .                            | 5-22 |
| 5-20. Conduct of a Retirement . . . . .             | 5-22 |
| <br><b>CHAPTER 6. OTHER TACTICAL OPERATIONS</b>     |      |
| <b>Section I. Passage of Lines</b> . . . . .        | 6-1  |
| 6-1. Purpose . . . . .                              | 6-1  |
| 6-2. Planning . . . . .                             | 6-1  |
| 6-3. Conduct of a Rearward Passage . . . . .        | 6-3  |
| 6-4. Conduct of a Forward Passage . . . . .         | 6-5  |

|  | Page |
|--|------|
| <b>Section II. Relief Operations</b> . . . . .           | 6-6  |
| 6-5. Purpose . . . . .                                   | 6-6  |
| 6-6. METTT Analysis . . . . .                            | 6-6  |
| 6-7. Conduct of a Relief . . . . .                       | 6-7  |
| 6-8. Liaison . . . . .                                   | 6-7  |
| 6-9. Sequence . . . . .                                  | 6-7  |
| 6-10. Reconnaissance and Surveillance . . . . .          | 6-8  |
| 6-11. Locations and Types of Obstacles . . . . .         | 6-8  |
| 6-12. Fire Support Assets/Plan . . . . .                 | 6-8  |
| 6-13. Movement Control . . . . .                         | 6-9  |
| 6-14. Passage of Command . . . . .                       | 6-9  |
| 6-15. Enemy Contact During a Relief in Place . . . . .   | 6-9  |
| 6-16. Exchange of Equipment . . . . .                    | 6-9  |
| 6-17. Security and Deception . . . . .                   | 6-9  |
| 6-18. Relief Order . . . . .                             | 6-9  |
| <b>Section III. Breakout from Encirclement</b> . . . . . | 6-10 |
| 6-19. Purpose . . . . .                                  | 6-10 |
| 6-20. METTT Analysis . . . . .                           | 6-10 |
| 6-21. Preparation . . . . .                              | 6-11 |
| 6-22. Organization . . . . .                             | 6-12 |
| 6-23. Conduct of a Breakout from Encirclement . . . . .  | 6-14 |
| 6-24. Support to Encircled Companies . . . . .           | 6-17 |
| <b>Section IV. Linkup Operations</b> . . . . .           | 6-17 |
| 6-25. Purpose . . . . .                                  | 6-17 |
| 6-26. Planning . . . . .                                 | 6-17 |
| 6-27. Conduct of a Linkup . . . . .                      | 6-19 |
| 6-28. Stay-Behind/Hide Forces . . . . .                  | 6-19 |
| 6-29. Stay-Behind/Hide Force Scenario . . . . .          | 6-23 |
| <br><b>CHAPTER 7. COMBAT SUPPORT</b>                     |      |
| <b>Section I. Indirect Fire Support</b> . . . . .        | 7-1  |
| 7-1. Mission . . . . .                                   | 7-1  |
| 7-2. Planning . . . . .                                  | 7-1  |
| 7-3. Top-Down Fire Planning . . . . .                    | 7-3  |
| 7-4. Schedules of Fires . . . . .                        | 7-4  |
| 7-5. Field Artillery . . . . .                           | 7-4  |
| 7-6. Mortars . . . . .                                   | 7-5  |
| 7-7. Naval Gunfire . . . . .                             | 7-8  |
| <b>Section II. Tactical Air Support</b> . . . . .        | 7-10 |
| 7-8. Planning . . . . .                                  | 7-10 |
| 7-9. Employment . . . . .                                | 7-10 |
| 7-10. Suppression of Enemy Air Defense . . . . .         | 7-11 |
| 7-11. Joint Air Attack Team . . . . .                    | 7-12 |

|  | <b>Page</b> |
|--|-------------|
| <b>Section III. Aviation Support</b> . . . . .                           | 7-12        |
| 7-12. Army Aviation . . . . .  | 7-12        |
| 7-13. Employment . . . . .   | 7-13        |
| <b>Section IV. Air Defense Support</b> . . . . .                         | 7-14        |
| 7-14. Support Relationships and Missions . . . . .                       | 7-14        |
| 7-15. Air Defense Weapons Systems . . . . .                              | 7-15        |
| 7-16. Employment Considerations . . . . .                                | 7-15        |
| <b>Section V. Engineer Support</b> . . . . .                             | 7-16        |
| 7-17. Planning . . . . .   | 7-17        |
| 7-18. Capabilities . . . . .   | 7-18        |
| 7-19. Offensive Operations . . . . .                                     | 7-18        |
| 7-20. Defensive Operations . . . . .                                     | 7-20        |
| 7-21. Fighting as Infantry . . . . .                                     | 7-21        |
| <b>Section VI. Intelligence and Electronic Warfare Support</b> . . . . . | 7-21        |
| 7-22. Interrogation Team . . . . .                                       | 7-21        |
| 7-23. Ground Surveillance Radar . . . . .                                | 7-21        |
| 7-24. Remote Sensor Teams . . . . .                                      | 7-23        |
| <b>Section VII. Nuclear, Biological, and Chemical</b> . . . . .          | 7-24        |
| 7-25. Avoidance . . . . .  | 7-24        |
| 7-26. Operations . . . . .   | 7-25        |
| 7-27. Use of Smoke . . . . .   | 7-25        |
| <b>Section VIII. Other Combat Support</b> . . . . .                      | 7-27        |
| 7-28. Scout Platoon . . . . .  | 7-27        |
| 7-29. Antiarmor Company and Platoons . . . . .                           | 7-29        |
| 7-30. MK 19 40-mm Grenade Machine Gun . . . . .                          | 7-30        |
| 7-31. MMWV Interchangeable Mount System . . . . .                        | 7-31        |
| <br><b>CHAPTER 8. COMBAT SERVICE SUPPORT</b>                             |             |
| <b>Section I. Organizations and Functions</b> . . . . .                  | 8-1         |
| 8-1. Categories of Combat Service Support. . . . .                       | 8-1         |
| 8-2. Sources of Combat Service Support . . . . .                         | 8-2         |
| 8-3. S1 Section . . . . .  | 8-2         |
| 8-4. S4 Section . . . . .  | 8-3         |
| 8-5. Medical Platoon . . . . .   | 8-3         |
| 8-6. Support Platoon . . . . .   | 8-3         |
| 8-7. Maintenance Platoon/Section, Light Infantry Battalions . . . . .    | 8-4         |
| 8-8. Maintenance Platoon/Section, Other Infantry Battalions . . . . .    | 8-4         |
| <b>Section II. Planning</b> . . . . .                                    | 8-4         |
| 8-9. Principles of Combat Service Support. . . . .                       | 8-4         |
| 8-10. Support of the Offense . . . . .                                   | 8-5         |
| 8-11. Support of the Defense . . . . .                                   | 8-5         |
| 8-12. Continuous Support . . . . .                                       | 8-6         |
| 8-13. Battalion Logistical Estimate . . . . .                            | 8-6         |
| 8-14. Soldier's Load . . . . .   | 8-6         |

|   | Page         |
|---|--------------|
| <b>Section III. Missions and Operations</b> . . . . .                             | 8-7          |
| 8-15. Battalion Trains . . . . .  | 8-7          |
| 8-16. Resupply Techniques . . . . .   | 8-8          |
| 8-17. Trains Security . . . . .   | 8-10         |
| 8-18. Command and Control . . . . .   | 8-11         |
| 8-19. Communications . . . . .  | 8-11         |
| <b>Section IV. Supply System</b> . . . . .  | 8-12         |
| 8-20. Operations . . . . .  | 8-12         |
| 8-21. Classes . . . . .   | 8-12         |
| <b>Section V. Maintenance Support</b> . . . . .                                   | 8-15         |
| 8-22. Terminology . . . . .   | 8-15         |
| 8-23. Categories of Maintenance . . . . .   | 8-15         |
| 8-24. Maintenance Program . . . . .   | 8-15         |
| <b>Section VI. Field Services</b> . . . . .                                       | 8-17         |
| 8-25. Mortuary Affairs . . . . .  | 8-17         |
| 8-26. Clothing Exchange and Bath Services . . . . .                               | 8-17         |
| 8-27. Salvage . . . . .   | 8-17         |
| 8-28. Laundry and Renovation . . . . .  | 8-18         |
| 8-29. Airdrop . . . . .   | 8-18         |
| <b>Section VII. Personnel Support</b> . . . . .                                   | 8-18         |
| 8-30. Personnel Services Support . . . . .  | 8-18         |
| 8-31. Religious Support . . . . .   | 8-20         |
| 8-32. Legal Services Support . . . . .  | 8-21         |
| 8-33. Finance Support . . . . .   | 8-21         |
| 8-34. Public Affairs Support . . . . .  | 8-22         |
| 8-35. Health Services Support . . . . .   | 8-22         |
| 8-36. Disposition of Enemy Prisoners of War . . . . .                             | 8-24         |
| <br>  |              |
| <b>APPENDIX A. BATTALION TACTICAL STANDING OPERATING PROCEDURE</b> . . . . .      | A-1          |
| <b>APPENDIX B. COMMAND AND CONTROL RESPONSIBILITIES AND FACILITIES</b> . . . . .  | B-1          |
| <b>APPENDIX C. THE INFANTRY BATTALION IN LOW-INTENSITY CONFLICT</b> . . . . .     | C-1          |
| <b>APPENDIX D. MECHANIZED-ARMOR/LIGHT AND SPECIAL OPERATIONS FORCES</b> . . . . . | D-1          |
| <b>APPENDIX E. SNIPER EMPLOYMENT</b> . . . . .                                    | E-1          |
| <b>APPENDIX F. CASUALTY EVACUATION</b> . . . . .                                  | F-1          |
| <br>  |              |
| <b>GLOSSARY</b> . . . . .   | Glossary-1   |
| <br>  |              |
| <b>REFERERENCES</b> . . . . .   | References-1 |
| <br>  |              |
| <b>INDEX</b> . . . . .  | Index-1      |

# PREFACE

This manual presents doctrine for the infantry battalion to use in combat. Rather than try to solve every tactical situation, this manual establishes a common base of tactical knowledge from which specific solutions to battalion-level tactical problems can be developed. This manual is designed to increase the effectiveness of battalion-level operations by providing doctrinal principles and selected battlefield-proven tactics, techniques, and procedures.

The target audience for this manual includes battalion commanders and staffs, company commanders, and special platoon leaders for all infantry battalions—light, air assault, airborne, ranger, and H-edition (Reserve Component). It also includes service school, ROTC, and military academy instructors, and others who require a single-source reference to dismounted infantry battalion operations. The concepts are based on FM 100-5. Terms and graphics used conform to those in FM 101-5-1. ARTEP 7-20-MTP provides training standards used to prepare the battalion to execute the operations in FM 7-20.

Tough, realistic preparation for combat is dangerous. Commanders and subordinate leaders must instill an awareness of individual and unit safety. Soldiers must be constantly alert and careful in situations that could result in injury or death. They must know the capabilities, functioning, limitations, and hazards of their equipment to use it safely. Risk must be balanced against requirements. Hazardous conditions must be monitored and controlled. **THE WELFARE OF SOLDIERS MUST BE CONSIDERED IN ALL SITUATIONS.**

The provisions of this publication are subject to two international agreements:

**STANAG 2082    Relief of Combat Troops**  
**STANAG 2129    Identification of Land Forces on the Battlefield**

The proponent for this publication is US Army Infantry School. Send comments and recommendations on DA Form 2028 directly to Commandant, US Army Infantry School, ATTN: ATSH-ATD, Fort Benning, Georgia 31905-5410.

Unless this publication states otherwise, masculine nouns and pronouns do not refer exclusively to men.

## CHAPTER 1

# INTRODUCTION

*AirLand Battle doctrine has produced great changes in the Army. It has affected everything from equipment to the way we fight. Commanders need to understand these concepts and how they affect the employment of an infantry battalion. This chapter introduces AirLand Battle doctrine and explains its effect on battalion-level tactical doctrine.*

## Section I THE ROLE OF THE INFANTRY BATTALION

The infantry battalion serves many roles on the airland battlefield. It engages most often in close battles and may conduct raids or stay-behind operations as part of deep operations. The battalion may participate in rear battle as part of a tactical combat force. Also, due to their rapid deployability by air, infantry units are ideally suited for executing strategic contingency plans and establishing lodgements. Limited visibility is the basis for infantry battalion operations. It is the environmental condition that the US military seeks to take advantage of its technology and training. Darkness, fog, heavy rain, and falling snow all limit visibility. A combination of technical ability (afforded by NVDs) and tactical prowess (afforded by training) allows the infantry battalion to operate routinely during these conditions. Limited visibility operations strike the defender when the range of his weapons and the mutual support between his positions are reduced.

### 1-1. THE AIRLAND BATTLE

Infantry forces can operate effectively in low-intensity, mid-intensity, or high-intensity conflict and in most terrain and weather conditions.

a. Infantry may dominate in low-intensity conflicts due to its rapid strategic deployability and its ability to meet the enemy on equal terms.

b. Mid-intensity to high-intensity conflicts may be chaotic, intense, and destructive. Such operations rarely maintain a linear character. The speed with which forces can concentrate and the high volumes of supporting fires they can bring to bear make the mixing of opposing forces almost inevitable.

c. The AirLand Battle is the doctrinal basis for meeting these challenges. It involves

maneuver at all levels and tries to use the full potential of US forces. It is offensively oriented so commanders may go to the offense as soon as possible. No matter what level the conflict, the side that keeps the initiative through offensive action forces the other side to react rather than to act. The thrust of AirLand Battle doctrine is to disrupt the enemy's synchronization, preventing him from applying combat power at a decisive point; and to create opportunities for US forces to destroy his force.

### 1-2. FUNDAMENTALS OF THE AIRLAND BATTLE

FM 100-5 states that success on the modern battlefield depends on commanders at all levels understanding and implementing the basic tenets



of AirLand Battle doctrine: *initiative, depth, agility, and synchronization.*

a. **Initiative.** This is the ability to set or change the terms of battle through action. It requires commanders to maintain an offensive spirit. It means that, when an opportunity presents itself, the commanders may depart from planned actions to hasten mission accomplishment. To do this without jeopardizing the higher plan requires that the commander understand and work within the intent of the commander two levels up. This implies a degree of independence and risk. Commanders translate their initiative into action by issuing mission-type orders. These orders in turn give subordinate commanders the flexibility, within the scope of their commander's intent, to improvise and act aggressively to accomplish assigned missions and defeat the enemy. In addition to understanding the scope of their commander's intent, each leader must understand his unit's part in the commander's concept (as the main or a supporting effort), so that he may confidently and boldly exploit success.

b. **Depth.** This is measured in time, distance, and resources. At battalion level, depth is achieved by positioning forces to deny the enemy the ability to maintain mass, momentum, and mutual support. The battlefield is no longer a one-dimensional or two-dimensional entity. The commander must understand how he and the enemy fit into the higher commander's deep, close, and rear battles. When possible, reserves are employed. This gives depth to the battalion and provides the commander with a form to counterattack and completely destroy the enemy.

c. **Agility.** This is the ability to think and act faster than the enemy. It involves mental, command and control, and organizational abilities to adjust rapidly and to use the situation, terrain, and weather to defeat the enemy. The plan must be simple, yet flexible enough that the commander can react when an opportunity presents itself.

(1) Mobility, flexibility of task organization, timely intelligence, and rapid decision-making enable the commander to cause the enemy to react, which sets the terms of the battle. At the battalion level, these terms are often simplified by positioning the command group well forward so they can see the battlefield, recognize opportunities, and rapidly seize the initiative.

The commander and his subordinates rely on IPB, a sound R&S plan, and accurate reports to quickly understand enemy intentions.

(2) Reaction time is reduced by rehearsing SOPs and drills, by choosing sound initial positions for dismounted units that simplify their ability to maneuver. Assets from CS and CSS are positioned to sustain the main effort and to provide flexibility to the plan. *Complexity reduces agility.*

d. **Synchronization.** This is the arrangement of battlefield activities in time, space, and purpose to produce the greatest possible relative combat power at the decisive point. Synchronization is both a process and a result.

(1) Synchronization extends from planning the maneuver to integrating CS and CSS assets to ensure mission accomplishment.

(2) Leaders at all levels must understand friendly and enemy capabilities. They must know how to relate these capabilities to time and space to produce synchronized plans that satisfy the commander's intent.

(3) Synchronization begins in the mind of the commander with his concept of operations. The concept must clearly focus the main effort at a decisive point and must clearly designate the effects (tasks and purposes) of the subordinates. Understanding and using a common doctrine and military language enhances synchronization.

(4) The commander creates synchronization by developing, issuing, and rehearsing clear, succinct orders supplemented by well-established SOPs. Using SOPs enables the commander to rapidly employ assets and to seize tactical opportunities without lengthy explanations and orders.

### 1-3. COMBAT POWER

Combat power is the ability to fight. It is relative, not absolute, because it has meaning only as compared to the combat power the enemy can generate. Combat power includes the numbers of weapons systems and soldiers; the unit's state of training, cohesion, discipline, and morale; and the leader's and soldiers' tenacity, competence, and boldness. It measures the *effect* created by combining maneuver, firepower, protection, and leadership in combat actions against an enemy. Friendly combat power is *relative* to that of enemy forces committed at the point of decision;

therefore, any actions taken to degrade enemy firepower, protection, maneuver, and leadership increase friendly relative combat power.

a. **Maneuver.** This is the movement of forces, relative to the enemy, to secure or retain a positional advantage. Combat units must maneuver to win. Unit commanders boldly maneuver their forces at the critical times and places to attack enemy weaknesses, gain favorable positioning, and exploit success. The effects of maneuver may also be achieved without movement of friendly forces by allowing the enemy to move into a bad position such as into an ambush or a stay-behind operation.

b. **Firepower.** This is the intelligent use of direct and indirect fires (FA, mortars, and CAS), as well as other combat multipliers (ADA, EW, AHs, and engineers) to support the scheme of maneuver. Firepower provides the destructive force vital to realizing the effects of maneuver. To be effective, firepower must be distributed and controlled at the critical time and place. Soldiers should be committed only when firepower alone is insufficient to accomplish the mission.

c. **Protection.** This is preserving the unit's fighting potential so it can be applied at the decisive time and place. Protection has two components. The first includes all actions taken to make the friendly unit hard to find or destroy. These actions include security, camouflage, deception, suppression, and mobility. The second component includes all actions taken to keep soldiers healthy and maintain their fighting morale, and to diminish the impact of severe weather. Safety is a key element of protection.

Leaders must instill an awareness of individual safety in all subordinate leaders and soldiers. Soldiers must be constantly alert for and avoid situations that may result in injury or death. Also, leaders must verify the soundness of all tactical operations to prevent fratricide. This includes using appropriate control measures, conducting rehearsals, and ensuring soldiers understand the rules of engagement.

d. **Leadership.** This is the component on which all others depend. The main purpose of leadership in battle is to inspire and motivate soldiers to perform difficult tasks under trying circumstances. Before the battle, only capability or combat potential exists. However, a skillful leader, using the right combination of maneuver, firepower, and protection within a sound operational plan, can turn combat *potential* into real combat *power*. Confident, competent leaders are needed at all levels to train, discipline, and motivate units to achieve superior combat power. Leaders must set the example in all areas. In battle, they must lead their units from the front.

#### 1-4. MISSION

The fundamental combat mission of the infantry battalion, regardless of the type of battalion, is to close with the enemy by means of fire and maneuver to destroy or capture him or to repel his assaults by fire, close combat, and counterattack. To accomplish specific missions and conduct sustained operations, the battalion is normally augmented by additional combat, CS, and CSS assets.

## Section II OPERATING SYSTEMS

Battalion functions are grouped into seven battlefield operating systems (BOSs). These systems must be integrated to support the commander's concept of the operation. The functioning of each operating system requires all elements of the battalion to coordinate their efforts. Each battle staff officer (for example, the FSO, signal officer, and engineer officer) must ensure that his area of responsibility is integrated into the overall battalion plan. The commander and staff integrate these BOSs into a combined arms force tailored to the situation. BOSs should be used as a planning tool, not as a framework for execution or issuing orders.

**1-5. INTELLIGENCE SYSTEM**

All units must report information obtained in the normal course of operations. The battalion's few dedicated, organic information-gathering assets include the scout platoon, infantry patrols, and PEWS. The artillery FSE may also contribute by passing targeting information to the S2. IPW teams, GSR, LLVI, CI team, and REMS teams may support the battalion from the divisional MI battalion. The maneuver battalion must obtain other timely intelligence from brigade. The S2 is responsible for collecting, analyzing, and disseminating information about the enemy and the area of interest. The S2 also prepares the collection plan designed to support the staff-developed decision-support template.

**1-6. MANEUVER SYSTEM**

The combat elements of the battalion provide the means to destroy enemy forces, seize and retain terrain, and secure other forces. All other assets support the maneuver elements.

a. The rifle company is the basic maneuver element of the battalion. It can close with and destroy enemy infantry. When properly employed, it can defeat enemy armored vehicles from close ranges. Organic TOW systems provide the battalion with a long-range antiarmor capability. The infantry is most effective when visibility, observation, and fields of fire are limited; and when it must fight in close combat.

b. Tanks (when supporting) are most effective where they can move fast and provide rapid, accurate, direct fire. Thermal sights permit them to fight during limited visibility almost as well as in good visibility.

c. Helicopters, when combined with infantry to form an air assault task force, are a valuable maneuver asset. Aviation units are normally under OPCON of the brigade. Attack helicopters may also maneuver against the enemy and are most effective against enemy armored formations.

**1-7. FIRE SUPPORT SYSTEM**

The commander may receive fire support beyond organic mortars in the form of FA, CAS, and NGF. All maneuver battalions have FSEs and FISTs attached from the direct-support FA battalion. The FSO helps the commander plan and coordinate fire support assets.

**1-8. MOBILITY/COUNTERMOBILITY/SURVIVABILITY SYSTEM**

Infantry units should be trained and prepared to execute mobility/countermobility/survivability missions with or without engineer support. Combat engineers may augment the battalion, providing expertise, equipment, and limited manpower. The senior engineer unit leader advises the battalion commander on employing his engineer assets. With or without augmentation, the battalion constructs obstacles, emplaces and clears minefield, prepares demolitions, improves roads, provides bridging, and digs fighting positions.

**1-9. AIR DEFENSE SYSTEM**

The infantry battalion has no organic, dedicated, air defense weapons. It may be supported by a Stinger section, a Vulcan platoon, or both from the divisional ADA battalion. However, the infantry battalion's main air defense asset is a passive measure: remaining undetected. Other protective measures include moving during limited visibility and adverse weather conditions, and using effective camouflage techniques. If necessary, the battalion can use organic direct-fire systems to defend itself from air attack.

**1-10. COMBAT SERVICE SUPPORT SYSTEM**

Infantry battalions have an austere CSS structure. Battalions may operate in restrictive terrain with few access roads. Weapons systems must be fueled, repaired, armed, and manned as near the battle area as tactically feasible. Supplies must be delivered as close to the user as possible. The S1, S4, medical officer, support platoon leader, and maintenance officer supervise the CSS system under the supervision of the XO.

**1-11. COMMAND AND CONTROL SYSTEM**

Command is a personalized function in which the commander controls the battlefield interaction of his units and weapons with the terrain and enemy. The battalion commander controls by being on the battlefield where he can see, feel, and command the battle. He fights forward and issues orders as needed, orally and face-to-face when possible. His subordinate commanders and soldiers must know he is on the battlefield.

He must be proficient and confident, and must lead by example. This is possible when he gives subordinate leaders mission-type orders and

allows them—within the scope of his intent—to exercise initiative. The efforts of the battalion must be synchronized.

## CHAPTER 2

# COMMAND AND CONTROL

*Command and control is the process through which the activities of military forces are directed, coordinated, and controlled to accomplish the mission. Effective command and control is directly linked to how well the commander implements troop-leading procedures. Skillful leadership is the main factor in deciding victory. At the battalion level, leadership must be supported by a reliable, flexible, secure, fast, and durable command and control system. This system must communicate orders, coordinate support, and provide direction to the battalion despite enemy interference, loss of command facilities, or loss of key soldiers. This chapter outlines a system of command and control that allows the battalion commander to use the operational concepts of AirLand Battle doctrine. It also discusses the command and control process, IPB, and command and control during battle.*

### Section I COMMAND AND CONTROL SYSTEM

The command and control system includes the facilities, equipment, communications, procedures, and personnel essential to a commander for planning, directing, and controlling operations of assigned forces pursuant to the missions assigned.

#### 2-1. ELEMENTS OF COMMAND AND CONTROL

The five interrelated elements of command and control are as follows:

a. **Facilities.** Command and control facilities at battalion level are classified by echelon as main, combat trains, field trains, and alternate CPs. The command group is a temporary facility. It comprises the commander, the soldiers in the command group, and the equipment the commander has with him forward to help command and control the immediate battle. The main CP includes all soldiers, equipment, and facilities employed in commanding and controlling the battalion. The TOC is the operations cell within the main CP. Integration of CSS is vital to successful combat operations. The combat trains CP is the battalion's CSS planning facility. An alternate

CP is needed in case either the tactical or main CP is destroyed. (Appendix B shows a typical layout of command and control facilities.)

b. **Equipment.** Command and control equipment is provided by the specific MTOEs for each unit. Appendix B describes the functional command post and discusses how the equipment is typically organized.

c. **Communications.** Command and control communications are the means by which the command transmits and receives information and orders. As such, having these means is vital to the commander and his staff in the execution of military operations. The commander and staff must understand the capabilities, limitations, and vulnerabilities of their communications systems. They must expect and plan for interference from friendly and enemy units where radar, radios, and lasers can operate in the same

electromagnetic spectrum. (Appendixes A and B provide more information about communications.)

**d. Procedure.** Command and control procedure is a mode or course of action that describes how to perform a certain task. (Appendix A provides an example of a battalion standing operating procedure.)

**e. Personnel.** The battalion commander has a staff to aid him in the exercise of command. The staff consists of the personnel necessary to perform command and control and supporting functions. The commander cannot abdicate his command responsibilities to the staff. Rather, the commander's job is to achieve his goals by intelligently using the unique abilities of his staff and subordinate commanders. Functional responsibilities and interrelationships of staff members are defined in Appendix B.

## 2-2. COMMAND

Command is the authority that a commander in the military service lawfully exercises over subordinates by virtue of rank or assignment. Command includes the authority and responsibility for effectively using available resources and for planning the employment of, organizing, directing, coordinating, and controlling military forces for the accomplishment of assigned missions. It also includes responsibility for health, welfare, morale, and discipline of assigned personnel.

## 2-3. CONTROL

Control is the exercise of authority and is the counterpart of command. It means following up a decision and minimizing deviation from the commander's concept. Control refers to the supervision of the operation while ensuring all systems and activities are synchronized.

## 2-4. COMMANDER'S AUTHORITY

Command authority derives from law and regulation. Command authority is accompanied by responsibilities that cannot be delegated. To accomplish specific functions, the commander can delegate his authority to his subordinates. However, the commander is solely responsible for his command. He meets this responsibility by leading, planning, making decisions, issuing orders, and supervising the execution of his orders.

## 2-5. COMMANDER'S PRESENCE

The commander must position himself on the battlefield where he can exert the greatest influence. This includes face-to-face orders in the operational area. At the same time, he must avoid sacrificing the ability to influence the battle by shifting the main effort or communicating orders without a loss of coordination, cohesion, and effectiveness. At times the commander may be forward with the foremost elements, while at other times he will be in the main command post. He must have equal ability to command and control his forces from either location. The commander establishes an environment of trust in his leaders-trust that gives them the freedom to operate within mission-type orders and to use initiative.

## 2-6. COMMANDER'S LEADERSHIP

Leadership is the key element of combat power. Leadership is personal and intangible; it is a combination of example, persuasion, and influence; it serves as an extension of the commander's self. Effective field commanders exhibit the following characteristics of leadership:

**a. Supervision and Standards.** The commander knows the standards that he wants to see on the ground. He communicates these standards clearly and with authority. He enforces them, holding soldiers accountable for their jobs and making rapid corrections. The commander enforces standards by supervising tasks after he gives the order: either he walks the line and inspects positions or he ensures this is done.

**b. Technical and Tactical Proficiency.** The commander knows the technical and tactical aspects of all assets that comprise his battlefield operating systems. He understands and uses terrain well. He communicates this knowledge and his professionalism through his actions and through interactions with other officers and soldiers.

**c. Time Management.** The commander conducts his planning to allow subordinates the time to prepare for the next mission. He manages time well and sets work priorities.

**d. Delegation.** The commander trusts his subordinate leaders and delegates authority to them. He develops them so the mission can continue when he is gone. This is leadership in depth throughout the chain of command.

e. **Decisiveness.** The commander adjusts quickly to difficult situations and makes sound decisions rapidly.

f. **Respect and Concern.** The commander knows and cares about the people in his unit. He respects subordinates. He knows subordinate leaders' and soldiers' strengths, weaknesses, and motivations. He rewards good performers and appropriately counsels substandard performers.

## 2-7. COMMANDER'S INTENT

The commander's intent drives mission tactics. It is the commander's stated vision, which defines the purpose of the operation and the end state with respect to the relationship among the force, the enemy, and the terrain. It should also include how this end state will support future operations. (Appendix A shows how the commander's intent is integrated into the OPORD.)

a. The overall purpose of the mission is more important than the individual assigned tasks. Each subordinate commander must know why and how his assigned tasks relate to the overall concept of the operation. Then, if the situation changes and contact with higher headquarters is lost, the subordinate can use his initiative to achieve the desired end results.

b. The battalion commander has a dual responsibility. He must understand the intent of the brigade and division commanders (two levels up) and must ensure his intent is understood at company and platoon levels (two levels down). The commander's intent paragraph in the OPORD should begin with the words, "My intent is..." so it can be understood and relayed to subordinates easily.

c. A clear commander's intent enhances agility, timing, and initiative at all levels. It helps in shifting the main effort on a fluid battlefield.

## 2-8. MISSION TACTICS

The purpose of command and control is to allow the commander to generate and apply combat power at the decisive point on the battlefield. Mission tactics is a method of directing military operations; subordinates are encouraged and expected to act alone in executing assigned missions, consistent with the intent of senior commanders. The commander must—

a. Anticipate a free-willed opponent; expect uncertainty. The enemy does not always follow

his doctrine or act as IPB indicates he will. The commander must be flexible. War games, contingency plans, employment in depth, well-developed and rehearsed SOPs, and a reserve all contribute to flexibility.

b. Organize and direct operations to require minimum intervention. When precise control is required for synchronization, such as an on-order task, the commander should provide the subordinate with the criteria for making the decision.

c. Allow time for subordinate planning. The one-third/two-thirds rule applies not only to OPORDs but also to rehearsals, briefbacks, or any other centralized events that reduce subordinates' preparation time.

d. Assign resources with as few restrictions on employment as possible. The commander allocates assets and support priorities to subordinates and specifies only the results he wants achieved.

e. Allow maximum freedom of action within the scope of his intent. Because battles often develop in unforeseen directions, leaders often must act with incomplete information or instructions. Failure to act quickly can result in a lack of superior combat power at critical times and places. Taking advantage of opportunities to accomplish the mission is allowed, encouraged, expected, and sometimes required. Higher commanders should be informed before action is taken, if feasible.

f. Structure communication to allow subordinates to command well forward. The commander must position himself on the battlefield where he can exert the greatest influence, both through subordinate leaders and directly. At the same time, he must retain the ability to shift the main effort of the battle. The commander can be forward with the lead elements in the command group, or he can be in the main CP. He must be able to command and control all organic and supporting elements equally from either location.

## 2-9. MISSION ORDERS

AirLand Battle doctrine requires mission tactics. This decentralization provides latitude to subordinates to make decisions rapidly within the framework of the commander's concept and intent.

a. Mission orders address only the required information. They provide the framework of *what* the commander wants done—not *how* it is to be done. Such orders need only three important things. First, they must clearly state what the commander issuing the order wants accomplished. Second, they must point out limiting factors that must be observed for coordinating purposes. Third, they must state what resources are to be made available to the subordinate commander and what support he can expect outside his command.

b. Execution of mission tactics requires initiative, resourcefulness, and imagination. Commanders must be ready to adapt to situations as they are, not as they were expected or desired to be.

c. Subordinate leader initiative is based on mission orders and the commander's intent, which define the limits of unit operations. They provide the opportunity for a subordinate to take advantage of opportunities on the battlefield. The subordinate leader is positively aggressive. He asks his commanding officer for information, resources, or revision of plans as needed, and stands up for his position when he feels he is right.

d. Subordinate initiative and independence, though encouraged, is limited by the requirements for unity of command, unity of effort, and the commander's intent. Subordinates who feel they must disobey orders due to a perceived change in the situation must accept the responsibility for their actions. The commander's intent must be clearly stated and foremost in the minds of subordinate leaders. To win, subordinate leaders must display initiative, but their initiative must be driven by their understanding of the commanders' intent, not by a desire for independent action. For best results, unit actions are synchronized. If independent action is required to meet the commander's intent for the operation, the action is taken—but subordinate leaders must carefully balance the need for synchronized unit action with the changing tactical situation. They must look at the big picture. Thus initiative and freedom of action are more likely used during an exploitation or pursuit; an independent action during a delay or during a withdrawal under enemy pressure could produce disaster for the entire force.

e. Commanders normally use mission-type orders. However, due to the requirement for synchronization of the overall mission, they must occasionally give subordinates specific instructions on how to accomplish a mission.

## 2-10. MAIN EFFORT

The company with the most important task in the commander's concept at a particular time is designated as the main effort. All other units support the quick success of this company. Subordinate commanders link their actions to the actions of those around them, but leave room for initiative. They base their decisions about independent actions on how their unit relates to the main effort. Success by the main effort at the decisive point should result in the success of the commander's mission. If conditions change and success of the overall mission can be obtained more cheaply or quickly another way, the commander shifts the main effort to another unit. Support priorities also change to assure the success of the newly designated main effort.

## 2-11. CHAIN OF COMMAND

The chain of command consists of the successive commanders and leaders through which command actions are directed. Military operations demand strict adherence to this chain. Under unusual conditions, a commander might bypass levels in the chain of command. If he does so, he assumes responsibility for orders given. He must inform the intermediate commander of the actions taken as soon as he can and must quickly reestablish the normal chain of command. Sometimes, loss of the means of communication can prevent orders from being issued. In this case, the subordinate is expected to base his actions on the commander's intent. Commanders must prescribe the succession of command for all contingencies, from temporary absences to the loss of the commander and the staff.

## 2-12. COMMAND RELATIONSHIPS

The command relationship refers to the way the command relates to the various units of the battalion. More information on the following five possible command relationships can be found in FM 101-5:

a. **Organic.** This refers to an essential unit listed in the TOE.



b. **Assigned.** This refers to a unit permanently operating with an organization.

c. **Attached.** This refers to a unit operating temporarily with an organization. Logistics for this unit are the responsibility of the supported unit.

d. **Operational Control.** This refers to a unit provided to another commander for specific missions or tasks. Logistics for this unit are the responsibility of the OPCON unit.

### 2-13. SUPPORT RELATIONSHIPS

Support relationships are the specific relationships and responsibilities that exist between supporting and supported units. The assigning commander retains both the logistical support responsibility for and the authority to reorganize or reassign part or all of a supporting force.

a. **Direct Support.** A unit in DS gives priority of support to a specific unit.

b. **General Support.** A unit in GS provides support to an entire force.

c. **General Support Reinforcing.** The main task of a general support reinforcing unit is to support an entire force. Its secondary task is to provide reinforcing fires to a like unit.

### 2-14. ORGANIZATION

The battalion commander has a staff to help him exercise command; this staff consists of the personnel needed to perform command and control and supporting functions. The commander cannot give up his command responsibilities to his staff—rather, he achieves his goals by wisely using the unique abilities of his staff and subordinate commanders. Functional responsibilities and interrelationships of staff elements must be clearly defined and made into an SOP. Within functional elements of the staff, personnel are held responsible for accomplishing tasks assigned to them, and for coordinating their work with other staff elements according to established procedures. Command and control responsibilities and the duties of the staff are described in Appendix B. (Chapter 8 provides more information about the S1 and S4.)

a. **Battalion Headquarters.** The battalion headquarters consists of the commander, the XO, coordinating staff officers, special staff officers, personnel to support staff functions, and

the command sergeant major. The headquarters is organized to allow for continuous operations in combat.

b. **Staff.** The commander has a personal staff, a coordinating staff, and a special staff. The personal staff works under the direct control of the commander and helps him directly instead of working through the XO. The coordinating staff reduces the demands on the commander's time by coordinating plans, activities and operations. This staff is responsible directly to the XO. The special staff includes officers who have special or technical skills. It also includes leaders of elements supporting the the battalion; these leaders work directly with the commander or work through the coordinating staff. All three staffs exist only to serve the commander. Their common functions include gathering information, estimating, anticipating, informing, recommending, ordering, and supervising.

(1) Staff sections must continuously collect, collate, analyze, and disseminate information gathered from all available resources. This information must be rapidly processed to provide the commander with data that is useful for making decisions. The information must be passed quickly among the staff and to units that need it, while at the same time ensuring that it is not disclosed to the enemy.

(2) Staff officers have no command authority, but they act for the commander as he directs or delegates. The commander may delegate authority to the staff or to a specific staff officer to take final action on matters as established within command policy. The authority delegated to individual staff officers varies with the level and the mission of the command, the immediate of the mission, and the staff officer's area of interest. The commander may delegate authority to staff officers to issue plans and orders without his personal approval. Such decentralization of authority promotes efficiency, reduces reaction time, and streamlines operations. Although the commander authorizes staff officers to issue orders in his name, he retains responsibility for these orders. Staff officers must keep the commander informed of actions that affect the command and the tactical situation.

## Section II COMMAND AND CONTROL PROCESS

Command and control is the process through which the activities of military forces are directed, coordinated, and controlled to accomplish the mission. This section describes the basic structure of the command and control process.

### 2-15. PLANNING

The situation changes rapidly in combat; communications are disrupted, units are disrupted, and the commander's personal presence is limited in time and space. Under these conditions, command and control cannot depend on positive control. Commanders and subordinates must be able to do what their commanders want them to do. Mission-type orders and the commander's intent provide soldiers and leaders with guidance for their initiative. All must have and apply a full and common understanding about the way the Army operates. This requires a common doctrine and vocabulary. These are supplemented by unit-specific factors, which are contained in SOPs (Appendix A).

a. **Doctrine.** Doctrine covers the basic principles by which the Army fights. It is authoritative, but judgment is required in its application. Doctrine focuses unity of action and provides a common language. Leaders use doctrine as a guide when making their plans. An example of doctrine is the principles of war.

b. **Operations.** An operation is a group of similar missions. FM 100-5 cites five general types: offensive, defensive, joint, combined, and contingency. More specific operations are performed under each of these categories. An example is a battalion defense with stay-behind operations. The tactics, techniques, and procedures for the various operations focus on training. They do not set forth a ready-made course of action for a mission.

c. **Tactics.** Tactics is the employment of units in combat. It is the ordered arrangement and maneuver of units in relation to each other, to the enemy, or both, to utilize their full potential—for example, a commander's plan to designate and employ a reserve.

d. **Techniques.** Techniques are the detailed methods for accomplishing a task. They are not

the only way to do a task or the way a task must be done. They can be changed as needed. The use of checkpoints to control the movement of companies is an example of a technique.

e. **Procedures.** A procedure is a standard and detailed mode or course of action that describes how to perform a certain task. The "call for fire" is an example of a procedure.

f. **Tasks.** A task is a clearly defined and measurable activity accomplished by individuals and units. It is a specific activity that contributes to the accomplishment of a mission. Mission tactics requires a common vocabulary. FM 101-5-1, AR 310-25, and Joint Pub 1-02 provide definitions for common military terms. This section defines terms excluded from those sources or further clarifies their usage in this FM.

(1) **Clear.** To destroy or force the withdrawal of all enemy forces and reduce obstacles that may interfere with subsequent operations.

(2) **Delay.** To trade space for time, inflict maximum damage on the enemy force, and preserve the force within limits established by the issuing commander.

(3) **Destroy.** To physically disable or capture an enemy force.

(4) **Deny.** To maintain constant pressure against an enemy force that tries to pass through an area and to hinder the enemy's use of the area for command and control, combat support, or combat service support.

(5) **Isolate.** To prevent the enemy from gaining access to or from influencing a specific area.

(6) **Retain.** To occupy and hold a terrain feature to ensure it is free of enemy occupation or use.

(7) **Seize.** To gain physical possession of a terrain feature. The enemy may or may not be occupying the terrain.

**2-16. DECISION-MAKING PROCESS**

The commander, his staff, and his chain of command use the troop-leading procedures and command and staff actions to make decisions.

a. This process begins and ends with the commander. It is dynamic, it requires him to know the troop-leading procedures and METT-T (Figure 2-1). (FM 101-5 discusses this in detail.) The decision-making process permits

full coordination by the commander and staff; development of staff estimates; and preparation of synchronized, detailed orders. The detail in which actions are accomplished is based on the time and soldiers available.

NOTE: In time-critical situations, the commander may be forced to base his estimate on his personal knowledge of the situation and to issue oral orders to his subordinates.

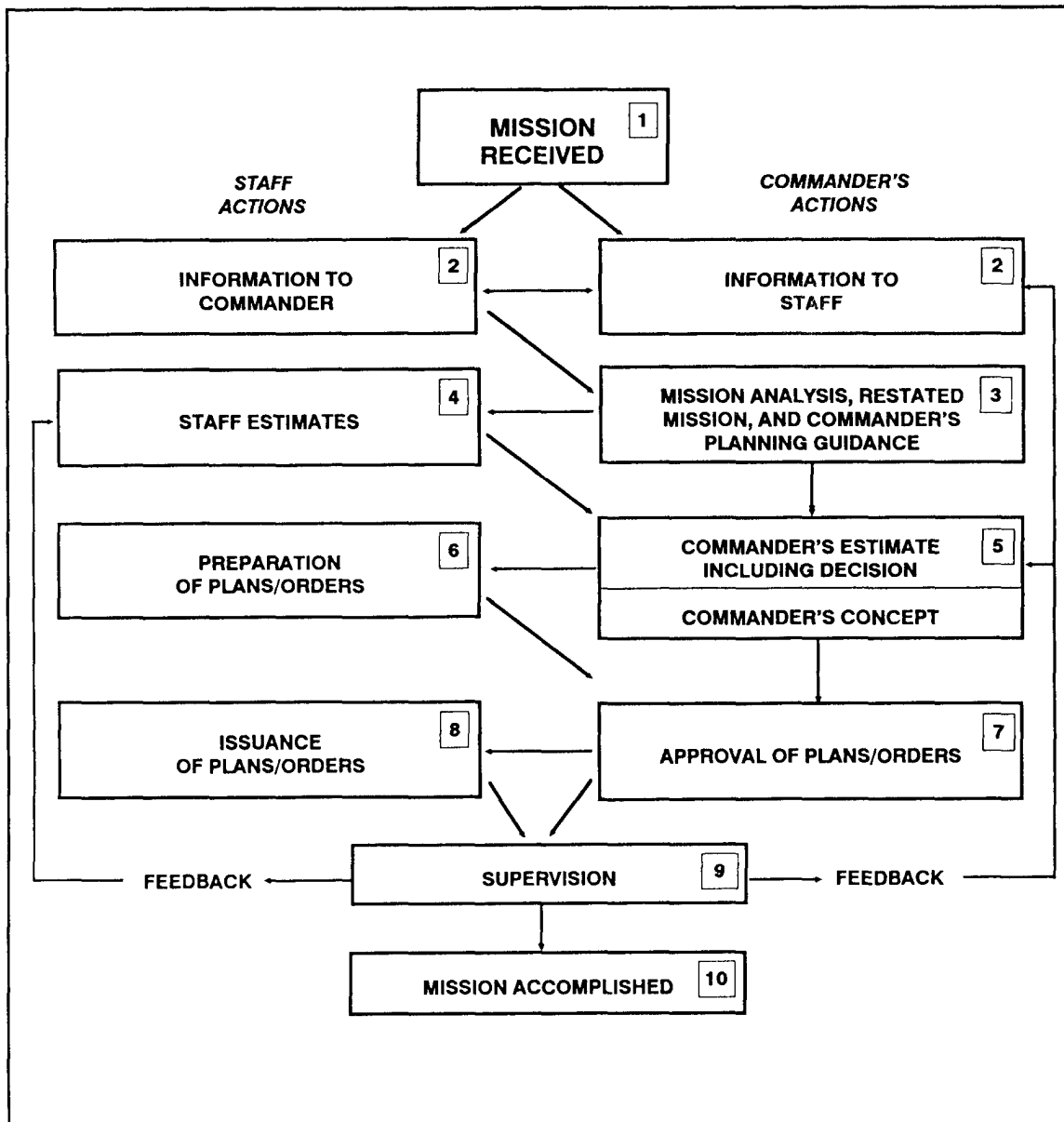

Figure 2-1. Decision-making process.

b. Time constraints may require the commander to use the abbreviated decision-making process (Figure 2-2). This technique is based on experience or intuition; it focuses on the commander's ability to recognize tactical patterns, to determine the correct counterpattern, and to apply it rapidly to meet the demands of time-pressured situations. With this technique,

the commander skips some of the routine tasks normally associated with the formal decision-making process so he can reach a solution quickly. He skips tasks when he observes that the situation and indicated reaction are both typical; he evaluates this indicated reaction for its feasibility then he either implements it, improves upon it, or rejects it for another reaction.

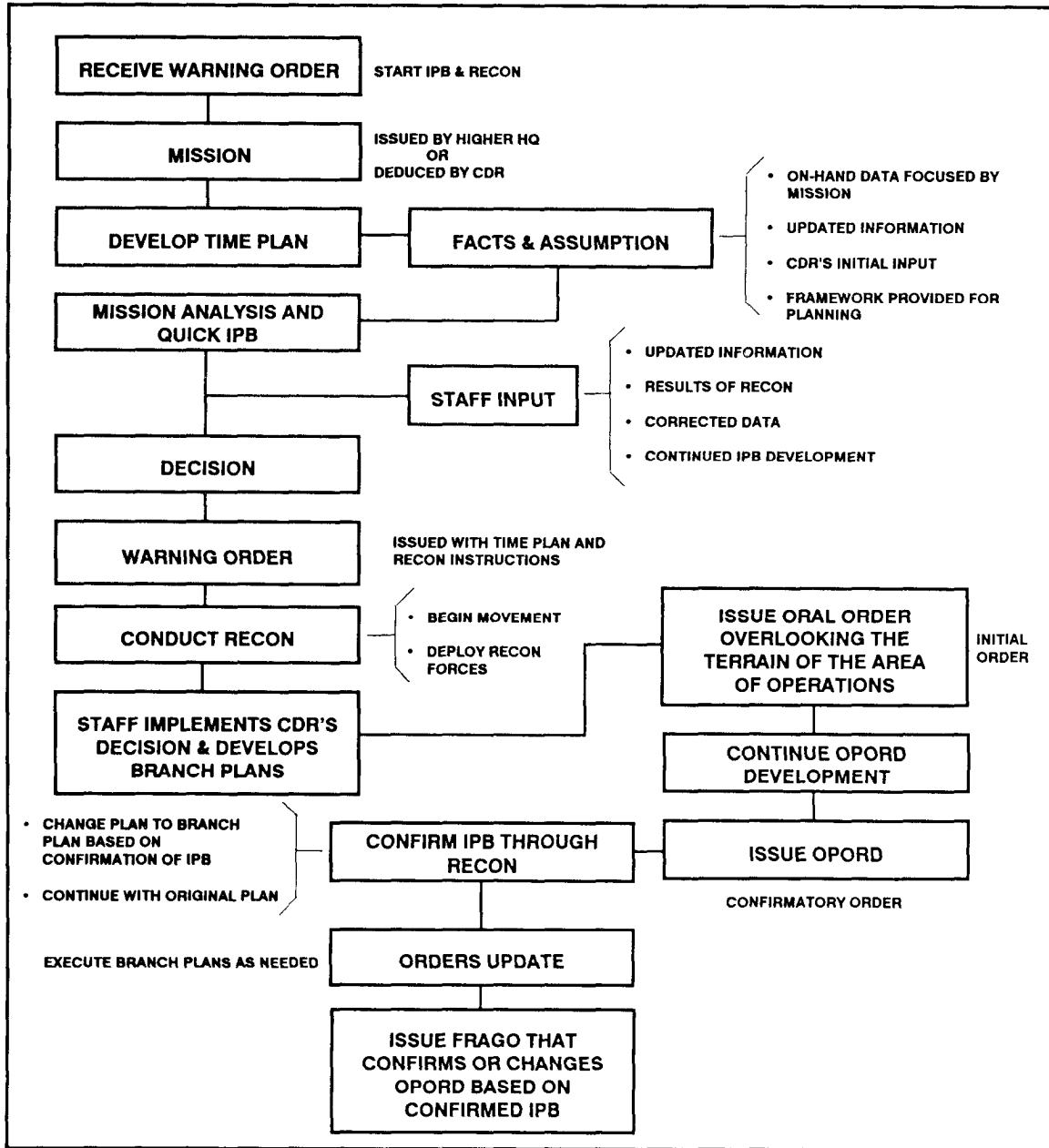

Figure 2-2. Proposed scheme for abbreviated decision-making process.

c. The analytical and the abbreviated decision-making techniques should not be considered as competing decision-making strategies. Instead, they offer the commander complementary options for making decisions.

**2-17. TROOP-LEADING PROCEDURES**

Troop-leading procedures are the dynamic processes by which a commander receives, plans, prepares for combat, and executes a mission

(Figure 2-3). Staffs provide information during these processes as time and situations permit. These procedures include the estimate of the situation.

**2-18. RECEIPT OF MISSION**

The battalion may receive a mission in the form of a warning order, operation order, or fragmentary order. The battalion should use no more than one-third of available time for planning and issuing the battalion OPORD.

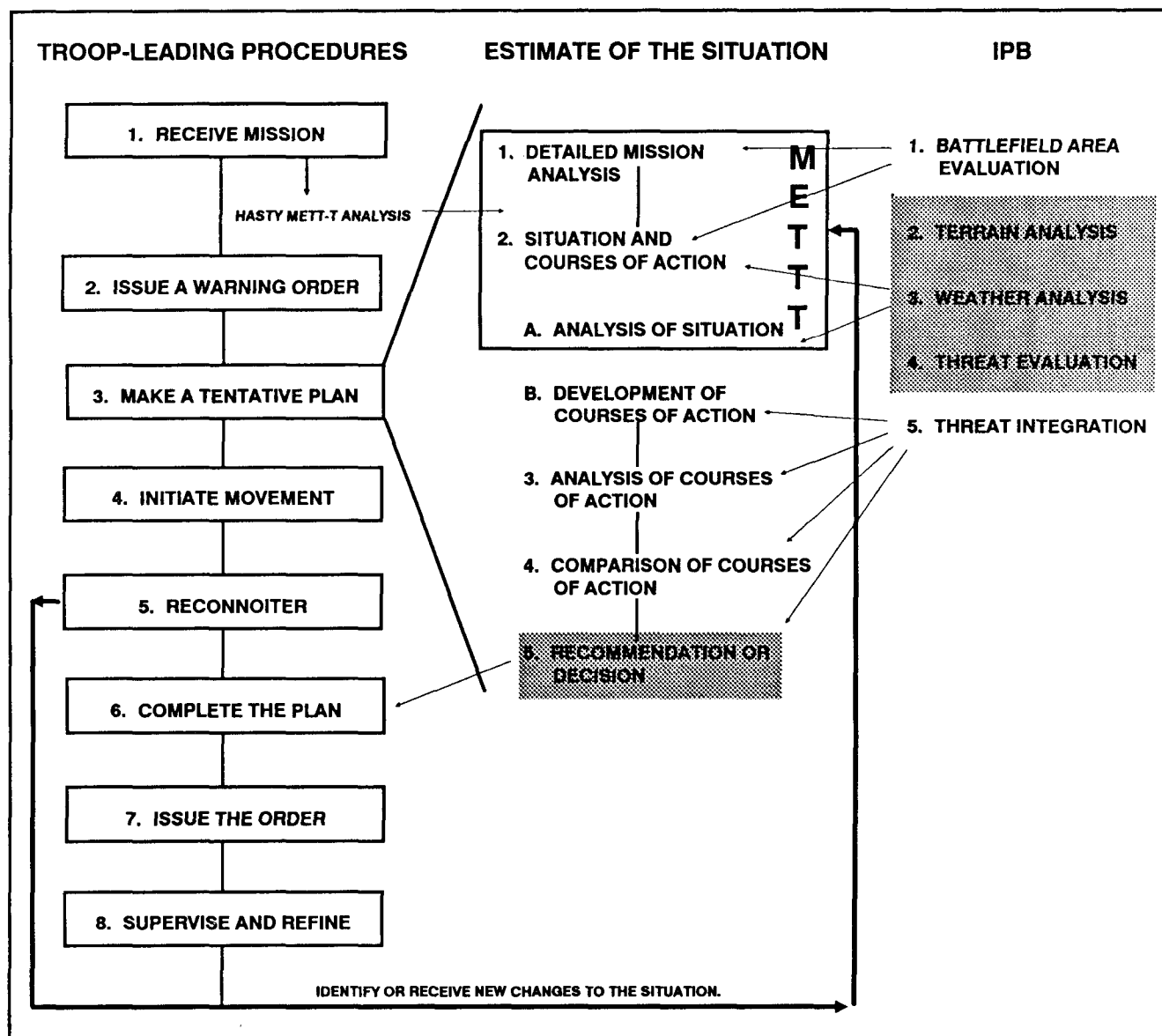

**Figure 2-3. The TLP, the estimate, METT-T analysis, and IPB.**

The remaining two-thirds is used by subordinates to planned prepare for the operation. Leaders should also consider other factors, such as available daylight and travel time to and from orders and rehearsals. In the offense, the leader has one-third of the time from mission receipt to the time the unit crosses the LD. In the defense, he has one-third of the time from mission receipt to the time the unit must be prepared to defend. Brigade headquarters assigns the mission. Ideally, the battalion commander receives a written OPORD in person with his key staff present. However, the battalion commander often receives the mission in a FRAGO over the radio. On the receipt of the mission, the battalion commander and staff exchange information and conduct a preliminary METT-T analysis. The purpose of this preliminary analysis is to quickly gather pertinent information for the WO that allows troop-leading procedures to begin at the next lower level. With this first look, the commander determines the mission, enemy, attachments and detachments, and time available; and forms a preliminary analysis of terrain. He determines the battalion's combat, CS, and CSS status; initial preparation actions required; and information needed to continue the planning process. The commander and staff draw up an informal time schedule. Use of this schedule ensures that no more than one-third of the available time is used to prepare and issue the order. This includes time required to conduct briefbacks, rehearsals, or any other centralized event that reduces subordinates' preparation time. Information is given to the staff and subordinate commanders as soon as it is available. Special consideration is given to providing the intelligence requirement. To enable units to begin reconnaissance operations, the commander, S2, and S3 must have current information on the enemy and terrain.

#### **2-19. ISSUANCE OF WARNING ORDER**

Issuance of the warning order is the second step in the troop-leading procedures. Prompt issuance is vital to effective use of available time. While no prescribed format exists, a WO at least should include information on the general situation, the mission, the time and nature of the operation, the earliest time of move, and the REDCON (Appendix A). OPORD time, place,

and attendees are included, if known. Special instructions for preliminary actions are important. They can include reconnaissance and surveillance activities, employment of quartering parties, changes to task organization, special instructions for rehearsals and training requirements, and administrative instructions (logistics, equipment, supplies). If possible, a tentative time schedule is provided to guide unit preparatory activities. The more information given in a WO, the more subordinates can prepare. A WO should be updated as new information develops.

#### **2-20. TENTATIVE PLAN**

Development of the tentative plan is the third step in the troop-leading procedures. With the commander's guidance, the staff develops the tentative plan using the estimate of the situation. Conducting an estimate of the situation also consists of five steps: making a detailed mission analysis, analyzing the situation (METT-T) and developing courses of action, analyzing courses of action, comparing courses of action, and making a decision. The estimate process is dynamic. As new information is received, the estimate is reviewed. The time available and the planner's experience determine the thoroughness of the estimate. No matter how short the time, each step of the estimate must be at least considered.

a. **Mission Analysis.** The first step of the estimate is mission analysis. It is the means for the commander to gain an understanding of the mission. Information pertaining to mission analysis is found in the higher unit's order to the battalion, mainly in paragraph 3 of the OPORD, EXECUTION, which provides the brigade commander's concept of the operation as well as subunit tasks and coordinating instructions. The division mission and the division commander's intent are included in paragraph 1 of the brigade OPORD. Paragraph 2 contains the brigade's mission. Other pertinent information is included in annexes and in overlays. Three key products result from the mission analysis: the commander's intent, the restated mission, and the initial PIR.

(1) **Commander's intent.** The commander's intent one and two echelons higher provides a framework for the remainder of mission analysis

and the estimate process. The higher brigade commander's intent is stated in the brigade order in paragraph 3a (brigade commander's concept of the operation).

(2) **Task analysis.** The commander must identify and understand all tasks required for success, including those required to ensure unity of effort with adjacent units. This includes specified and implied tasks. As shown in Table 2-1, tasks received in the brigade mission statement are oriented as to terrain, enemy forces, friendly forces, or a combination of these factors.

| TERRAIN | ENEMY       | FRIENDLY  | COMBINATION<br>TERRAIN AND ENEMY |
|---------|-------------|-----------|----------------------------------|
| SEIZE   | DESTROY     | OVERWATCH | RECONNOITER                      |
| SECURE  | NEUTRALIZE  | SCREEN    | DENY                             |
| OCCUPY  | SUPPRESS    | COVER     | CONTAIN                          |
| RETAIN  | DISRUPT     | GUARD     | ISOLATE                          |
|         | FIX         | CLEAR     |                                  |
|         | INTERDICT   |           |                                  |
|         | BREACH      |           |                                  |
|         | FEINT       |           |                                  |
|         | DEMONSTRATE |           |                                  |
|         | BLOCK       |           |                                  |
|         | CANALIZE    |           |                                  |
|         | ISOLATE     |           |                                  |

**Table 2-1 Typical tasks.**

(a) **Specified tasks.** These are tasks stated by the higher commander or published in the OPORD.

(b) **Implied tasks.** These are tasks not stated in the OPORD but that must be done for the mission to be accomplished. They are implied by the situation, the mission, or the purpose. Routine or inherent tasks that must be performed for most tactical missions are not implied tasks—for example, coordinating fires across boundaries and refueling units are routine tasks that are part of SOP. They are not implied tasks. Responsibilities, such as providing flank security for your own unit or clearing your zone of enemy forces, are implied tasks (if not stated in the OPORD) and can be addressed in paragraph 3 of the OPORD.

(3) **Limitations.** These are restrictions on the freedom of action of the friendly force. Restrictions prohibit the commander from doing something specific. The statements,

“be prepared to...,” “not earlier than...,” and so on, are limitations. Radio listening silence and time are also limitations.

(4) **Initial time analysis.** Time is analyzed to determine how much is available, how it should be allocated, and how it will affect the command and control cycle.

(a) The ability to appreciate time and space is one of the most important qualities in a commander. Time is vital to all operations. It drives planning and execution. The commander gets his first indication of time available from the

higher headquarter's WO. The amount of time a unit has to prepare for or to execute an operation determines the detail required of the planning process. For this reason, commanders must know the command and control process and must have a command and control organization, facilities, and communications to support it.

(b) Reverse planning begins with the actions on the objective and works backwards to find a start time for events. The following events must be accomplished at all levels: conduct reconnaissance, plan,

issue orders, and deploy forces. All are performed at the same time, if possible. If not, the events that take longest must beset in motion first. The commander also considers movement times from assembly areas or present positions to sectors, battle positions, or LZs. In the offense, he estimates time from crossing the LD to seizing the objective or specific key terrain, then he plans the sequences of units and events associated with it. Other important time considerations include how long key terrain must be held and how long the enemy will take to react.

(c) Time factors should be conservatively planned. During operations, the unexpected occurs. Time-distance factors are only a guide. When synchronizing operations, leaders consider how the factors of METT-T affect their unit.

(d) The time analysis produces a schedule of the activities that must occur. Since it drives everything the unit does, the commander must approve this schedule.

(e) The orders spectrum shown in Figure 2-4 offers the commander several methods he can use to develop an order. The spectrum ranges from the quickest methods (on the left end of the spectrum) to the most time-consuming (on the right end of the spectrum). The time a particular staff requires to develop an order depends on many factors, including—

- Physical condition of the staff.
- Quality of command guidance.
- Staff's level of training.
- Staff's level of cohesion.

format of who, what, when, where, and why. This statement becomes paragraph 1 of the commander's or staff's estimate and paragraph 2 of the OPORD. Those tasks not deemed mission-essential can reappear elsewhere in the OPORD. (The maneuver paragraph should include company mission-essential tasks and their purposes.)

(7) **Command guidance.** The staff completes their mission analysis, then briefs the commander. Having also done a mission analysis, the commander can then issue initial planning guidance. This guidance focuses the staff's efforts and speeds the development of COAs. When time is critical, the commander can omit the staff from the process, proceeding through the decision-making process and issuing oral orders on his own.

**b. Situation and Courses of Action.**

The second step of the estimate process consists of analyzing the situation using METT-T factors to determine their influence on feasible COAs. Once this is done, courses of action are developed.

(1) **Terrain/weather analysis.** The S2 provides his analysis of the five military aspects of terrain to the S3. These aspects are identified by the mnemonic device "OCOKA." The S2 considers weather factors and other characteristics at the same time. Having received the S2's analysis, the S3 can more easily analyze the areas of operations with respect to friendly and enemy capabilities. In offensive operations, this means that the S3 works from the objective area back to the LD. In the defense, he might work from the security zone to the rear area or from the main effort to supporting efforts. The best sequence for analyzing terrain based on the five military aspects of terrain is as follows:

(a) **Obstacles.** Obstacles are any natural or man-made obstruction that canalizes, delays, restricts, or diverts movement of a force. All terrain is evaluated relative to the type of force that is to move, and is then coded as either NO-GO, SLOW-GO, or GO. Any reinforcing obstacles that hinder movement must be identified, whether established by higher headquarter or by the enemy.

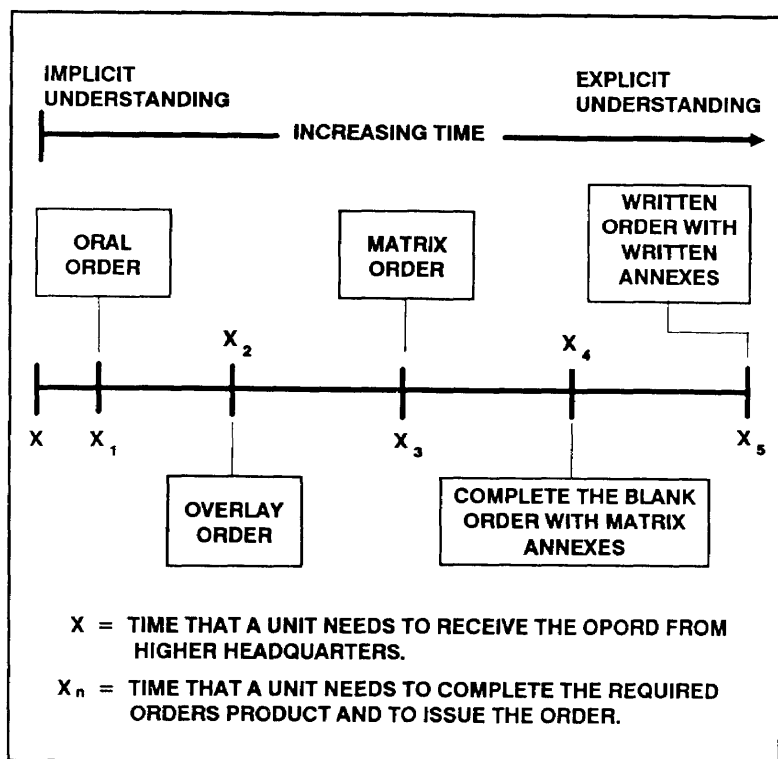

**Figure 2-4. Orders spectrum.**

(5) **Identification the mission-essential task(s).** The four previous factors should be reviewed. After this, all tasks should be identified that, if not accomplished, could cause the unit to fail to accomplish its primary purpose for that operation. Normally, only one mission-essential task is given.

(6) **Restated mission.** The commander constructs his restated mission statement clearly and concisely from the mission-essential task and its purpose. For clarity, it is restated in the



**NO-GO.** Terrain is judged NO-GO if movement through it by a particular type of force seems impractical unless much effort is made to enhance mobility. The road network in an area might still support mounted movement, even if the terrain itself does not support maneuver. Little terrain is NO-GO for dismounted infantry.

**SLOW-GO.** Terrain is judged SLOW-GO if the slopes or vegetation it contains can slow or disrupt maneuver of the force being considered to move through it. SLOW-GO terrain hinders maneuver less than NO-GO terrain. Other assets are also needed to enhance mobility. Terrain that is SLOW-GO to a mechanized force might be GO to a dismounted force.

**GO.** Terrain that is judged GO is fairly open and presents no hindrance to maneuver. Nothing need be done to enhance mobility. Again, terrain that would hinder one type of unit may not hinder another type unit.

(b) *Avenues of approach.* Avenues of approach are movement routes to an objective. A viable avenue of approach usually offers mobility corridors. These are areas within the avenue of approach that permit movement and maneuver. They permit friendly and enemy forces to advance or withdraw in doctrinal configuration, and to capitalize on the principles of mass momentum, shock, and speed. The S2 determines enemy avenues of approach one echelon above, and mobility corridors two echelons below the level of the command conducting the analysis. This is the one-up, two-down rule. He determines *friendly* avenues of approach and mobility corridors one echelon below and mobility corridors two levels below the level of the command conducting the analysis. This is the one-down, two-down rule. Both mounted and dismounted avenues of approach must be identified. For some operations, aerial or subterranean avenues might also be considered. When friendly forces are attacking, friendly avenues of approach to the objective must be identified, and enemy avenues of approach that could affect friendly movement—for example, counterattack avenues—must be identified. When friendly forces are defending, the opposite must be done. Possible movement routes for enemy reconnaissance units should also be noted. Obstacle considerations can be applied

once potential avenues of approach have been identified. To do this, the following questions are asked:

- What existing obstacles in the avenues can impede advance?
- How would reinforcing obstacles (or proposed reinforcing obstacles) affect the avenues of approach?
- What existing obstacles parallel to the avenues afford flank protection or limit lateral movement?

Deductions should be made about the various avenues of approach and their abilities to support the plan while each of these questions is answered.

(c) *Key terrain.* Key terrain is any area whose seizure, retention, or control affords a marked advantage to either combatant. Using the map and information already generated, the commander must find terrain that could be used as positions for weapons or for units to dominate friendly or enemy approaches or the objective area. Remember, key terrain need not be occupied to be controlled. Direct or indirect fire can be used to control enemy access to key terrain. Decisive terrain should be sought that, if held or controlled, would have an extreme impact on the mission. This is “mission-hinging” terrain that must be retained or seized for the mission to be accomplished. Not every operation has decisive terrain. The commander, based on this analysis, should decide on potential positions for friendly and enemy units and weapons systems. These locations must be considered during development of COAs.

(d) *Observation and fields of fire.* Observation is the influence of terrain on reconnaissance and target acquisition. Fields of fire are the influence of terrain on the effectiveness of weapons systems. Terrain that provides the best of both relative to the systems available must be determined. The commander/S3 must determine the potential of friendly or enemy forces to overwatch or support with direct fire the movement of their forces; he must also determine the potential of enemy or friendly forces to observe movement along the avenue of approach and to place fire on it from various positions on the terrain; he

must analyze fields of fire to determine the ability to cover the terrain with direct fire from likely or known positions; he must determine where fires might be concentrated; and he must consider observation and fields of fire during conditions of limited visibility. After selecting a particular COA, he considers adjustments based on this analysis.

(e) *Cover and concealment.* Cover is protection from the effects of firepower. Concealment is protection from enemy observation or target acquisition. The analysis of cover and concealment is often inseparable from the fields of fire and observation. Weapons systems must have both cover and concealment to be effective and to survive. The effect of enemy NVDs or thermals on available concealment must be considered. Locations in which the enemy can be covered and concealed must be located.

(f) *Weather.* Weather is analyzed using the five military aspects of weather: temperature and humidity, precipitation, wind, clouds, and visibility (to include light data). To determine its cumulative effect on the operation, weather must be considered along with terrain. Weather affects equipment (including electronic and optical), terrain (trafficability), and visibility, but its greatest effect is on the soldier. In bad weather or in extreme heat or cold, the amount of time spent on leadership must increase as the severity of the weather increases. Inclement weather limits visibility, has obvious effects on soldier efficiency, and makes command and control more difficult.

(g) *Other characteristics.* Other characteristics are those, other than weather and terrain, that influence enemy and friendly actions. This includes sociological, political, psychological, and economic characteristics of an indigenous population or area of operations. (FM 34-130 provides more information about this subject.)

(2) *Enemy situation.* The goal of an enemy analysis is to predict the enemy's most probable COAs. Information for its development comes from a number of sources including enemy doctrine as well as current enemy activities. Information required to analyze the enemy situation includes the following:

(a) *Composition.* This can be in the form of an order-of-battle worksheet or doctrinal

template from the S2. It is an identification of the forces and equipment that the enemy can bring to bear in the friendly area of operations.

(b) *Disposition.* This is an identification of the enemy's physical array in the battlefield. The disposition can be provided in the form of an overlay, situational template, intelligence summary, or other format from the S2. The S2 develops situational templates based on this information, on avenues of approach previously determined, and on enemy doctrinal templates.

(c) *Strength.* This information is found in paragraph 3c of the intelligence estimate. Committed forces, NBC, EW, air, artillery, reinforcements, and any other units the unit might have that could interfere with mission accomplishment should be considered.

(d) *Significant activities.* These are the enemy's most recent activities and intentions. The S2 and S3 exchange this information as they receive it. One example of such a significant activity is increased night operations.

(e) *Peculiarities and weaknesses.* These exploitable characteristics are examined carefully by planners. The inability of an enemy main gun to elevate or depress enough to fire up or down steep hills is such a characteristic.

(f) *Enemy capabilities.* These are actions that the enemy can perform and that influence the friendly accomplishment of the mission. The S2 identifies enemy capabilities and presents them in the intelligence estimate. Whether or not the enemy has chemical or nuclear weapons should be considered.

(g) *Enemy probable courses of action.* These are developed by the S2 from the previously listed information. The focus of this analysis is to locate the enemy's strengths (to avoid them) and his weaknesses (to exploit them). During the estimate process, the S3 and commander can accept, revise, or discard enemy COAs; and can develop other possible enemy COAs to consider. This interaction is vital in developing feasible friendly COAs. The result is a detailed statement of the enemy's most probable COA. This information allows the commander/S3 to war-game friendly COAs and to form tactical decisions.

(3) *Troops available.* The S3 receives information from all staff officers to help him determine the status of friendly forces relative to

the type of operation to be conducted. Much of this information (facts) might have been identified when the staff and commander exchanged information before the development of the restated mission (mission analysis) and commander's planning guidance. With the aid of the staff, the S3 projects the status of the unit at the beginning of the operation. The S3 does this by making assumptions about the changes that can occur between then and the time of execution.

(a) *Composition.* This is a summary of forces that can aid in accomplishing the mission. Familiarity with the unit, task organization, staff officers, subordinate leaders, and reference documents can aid the S3 in determining the unit's composition. Command and support relationships must be identified.

(b) *Disposition.* This is determined for the present and the future by the S3 with the aid of the commander, subordinate leaders, and other staff officers. The S3 can also use overlays, situational maps, or previously published documents. The information addressed should include the location of combat, CS, and CSS units.

(c) *Strength.* This listing develops friendly capabilities and vulnerabilities to aid the commander in selecting COAs. Factors to be considered include the unit mission and intent of the commander one and two levels up, current location of subelements, current and future locations of flank units and higher commander's reserve, the seven operating systems, and morale. The commander should also consider the soldiers themselves; pacing items; and the logistical status of the organic, attached, and OPCON combat, CS, and CSS units for this operation. Strength is determined by number of weapon systems and personnel strength, not by unit size. Battalions determine strength based on the number, type, and status of available platoons.

(d) *Significant activities.* This refers to the selected items of information, such as successful tactical techniques or unit morale, considered during planning.

(e) *Peculiarities and weaknesses.* These should be considered. Their influence on possible friendly COAs should be noted. Only pertinent headings are used; they can include personnel, intelligence, operations, logistics, and

civil-military operations. Input from the appropriate staff officer is added.

(4) *Time.* Initial estimates of time should be reevaluated. The backward planning process should be used to identify any critical timings in the operation. The one-third/two-thirds rule applies. Time-space factors must also be considered. Critical times can include planning and rehearsal time, LD time, time to begin movement, defend-no-later-than time, time available to prepare and rehearse the attack or defense, time available for reconnaissance, and ranking of tasks based on time available. Both opposed and unopposed rates of movement should be considered. A time manager must be designated to ensure proper use of time during planning. He should be the senior officer responsible for coordinating planning; normally this is the battalion S3 or XO.

(5) *Assumptions and deductions.* The commander and his staff complete the METT-T analysis and form assumptions and deductions about the situation. The commander and his staff analyze the facts. In the absence of facts, they form assumptions to complete the picture of the situation. Also, they form assumptions for anything that can change before execution.

(a) These assumptions are based on the planner's knowledge of enemy doctrine and capabilities, on friendly doctrine and capabilities, and on the effects of the terrain and weather in a particular situation. From these facts and assumptions the commander and his staff deduce possible enemy and friendly actions. Knowing the key assumptions and deductions regarding the decision-making process, they can better assess the risks of an operation.

(b) The commander and his staff determine the relative combat power of enemy and friendly forces, which can suggest the nature and characteristic of feasible COAs. Potential combat power integrates firepower, maneuver, and protection (physical) with leadership (human dimension). If the S3 determines that more resources might be needed or could aid in the completion of the mission, he recommends that more resources be requested.

(c) A summary of the key deductions the commander and his staff must develop from the METT-T analysis are shown in Table 2-2, page 2-16).

| AREA OF ANALYSIS | DEDUCTIONS  |
|------------------|---|
| MISSION          | <p>What is our unit's purpose within the higher commander's intent?</p> <p>Which tasks allow us to accomplish our purpose?</p>  |
| TERRAIN/WEATHER  | <p>How do terrain/weather factors affect our soldiers/units and employment of our weapons system?</p> <p>Where can we focus our combat power (potential EAs, objectives, SBF positions) to accomplish our unit's purpose?</p> |
| ENEMY            | <p>What are the enemy's most probable COAs given the terrain and his probable objectives? Where will contact first occur and how is the enemy arrayed?</p> <p>What are probable enemy weaknesses and vulnerabilities?</p>     |
| TROOPS           | <p>How can we focus our strength on enemy weaknesses?</p> <p>How can we make the most of our combat power given the current status of our soldiers?</p>   |
| TIME             | <p>What are the critical time aspects of the operation, (for us to accomplish our purpose, what must happen and when must it happen)?</p>   |

**Table 2-2. METT-T deductions.**

(6) *Development of courses of action.* A COA is a possible plan to accomplish the battalion's mission. It should be brief and clear. It should describe how the unit will accomplish the mission; it must provide enough detail to allow the COA to be war-gamed during Step 3 of the estimate. Two or three COAs should be developed. By considering more than one feasible COA the S3 does not limit and commit his unit too early to only one option. Developing more than one COA also aids in contingency planning, which increases the flexibility of the command during execution. Each COA must be—

(a) *Feasible.* It must accomplish the mission and support the commander's intent.

(b) *Reasonable.* It must not cause undue harm to the battalion.

(c) *Distinguishable.* It must differ in missions assigned to subordinates to allow the

consideration of options. Planning one good COA then planning others that are not feasible or are like the first is a common pitfall.

(7) *Decisive point.* The battalion commander focuses his main effort during the critical phase of the battle on destroying or seizing a decisive point. Units are complex—their effectiveness depends on more than the performance of each component part. It also depends on the ease with which the parts work together and on how well they implement the will of the commander. Some components are more vital than others to the smooth operation of the whole. Loss of any of these parts unbalances the unit's cohesion and effectiveness. Different COAs may focus on different potentially decisive points, or they may concentrate combat power at the same point using different tasks, purposes, positions, and so on. For deployed tactical units, the enemy command post or a key piece of enemy-held terrain may be the decisive point.

(8) *Method of developing courses of action.* The following is a useful method for developing a course of action:

(a) *Determine the decisive point.* The commander, as previously discussed, seeks out the enemy where he is most vulnerable. Ideally, the commander identifies the point where an enemy weakness is or will be positioned at a time when the battalion can generate overwhelming combat power against him.

(b) *Determine supporting efforts.* The commander can determine what supporting efforts are needed by asking the question, "What else must be done to allow the main effort to succeed?"

(c) *Determine purposes.* The commander determines the purposes to be achieved by the main and supporting efforts. He links the main effort's purpose directly to the battalion's purpose. He links the supporting efforts' purposes as clearly to the main effort's purpose.

(d) *Determine essential tasks.* The commander determines the essential task(s) for subordinate units (main and supporting efforts) to achieve the purposes stated above.

(e) *Identify types of forces required to accomplish the mission.* The commander considers only the organic and attached units. The main effort is weighted. More risk is taken

in non-main effort areas (economy of force). Assets, such as CAS or FASCAM, which may be unavailable to the battalion during execution, should not be considered.

(f) *Assign control measures.* Control measures are established that clarify responsibilities and synchronize the efforts of subordinates to support the main effort. As much freedom of action is allowed as possible.

(g) *Prepare a COA statement and sketch.* A sketch of the COA enhances clarity. The sketch should show the maneuver aspects of the COA. Proper graphic control measures (FM 101-5-1) are used, but extra graphics may also be used to clarify the COA. If this sketch is used as part of the OPORD, the nonstandard graphics must be explained in a legend.

(9) *Goal of COA statement.* A COA statement should answer the following questions:

(a) *What.* What task(s) is involved?

(b) *When.* When does the action begin or end—for example, on order, D-day, H-hour, or 280305ZJUN90? (These are time limitations.)

(c) *Where.* Where are the areas assigned in the defense or where is the zone assigned in the offense?

(d) *How.* What is the scheme of maneuver, and what are the purposes of the maneuver element and subelement? What is the main effort?

(e) *Why.* What is the desired purpose and result (intent) of the operation?

(10) *Example COA statement and sketch.* The following scenario demonstrates an offensive COA and sketch (Figure 2-5):

- **BATTALION MISSION STATEMENT:**  
2-66 IN (L) attacks 250100JAN to destroy enemy security elements vic NB135871 (OBJ WOLF) to allow TF 1-12 Mech to continue the attack east along Osborne Road.

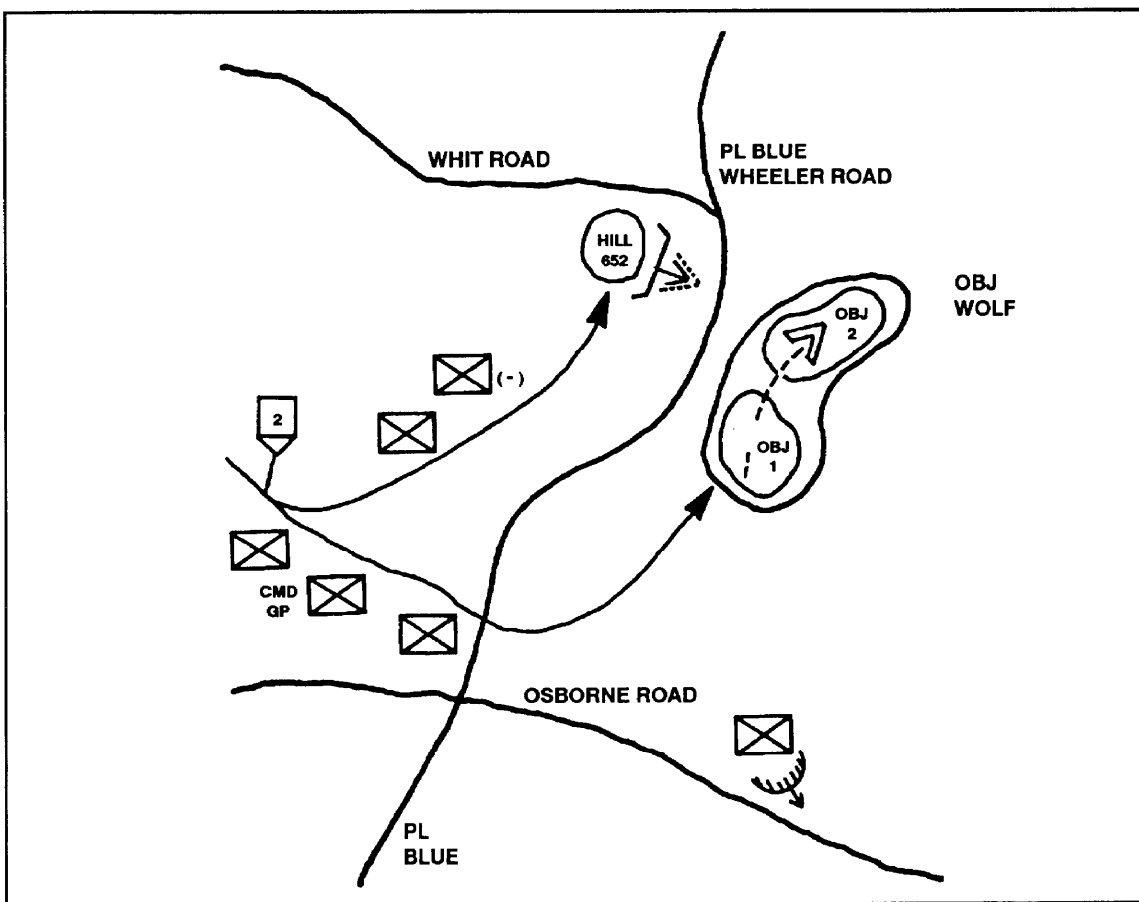

Figure 2-5. Example course of action sketch.

- **COA STATEMENT:** The battalion crosses the LD at 0100 along a direction of attack with one company (three infantry platoons, one engineer platoon, and one Stinger section) in the lead; followed by the command group; another infantry company (three infantry platoons, one Stinger section); and a third infantry company (minus) in trail (two infantry platoons and the AA platoon). At Checkpoint 2, the company (minus) and antiarmor platoon move to seize Hill 652 to support by fire the main attack. An infantry platoon establishes an ambush vic NV140857 to destroy enemy armored vehicles to prevent the enemy from reinforcing on OBJ Wolf. The lead company seizes OBJ 1 to allow the trail company (battalion main effort) to pass through and seize the decisive terrain. The trail company passes through OBJ 1, seizes OBJ 2 and prevents enemy security forces from firing on TF 1-12 as they attack south along Wheeler Road and east along Osborne Road.

(11) **COA options.** Development of a COA is a creative process. However, when little time is available, a COA can be developed in seconds.

c. **Analysis of Courses of Action.** The third step in the estimate of the situation is analysis of COAs. Short of combat, a war game is the best test of a COA. War games rely heavily on the tactical judgment and experience of the commander/S3 and staff, but is a step-by-step process.

(1) **Purpose of war games.** The commander/S3 analyzes (war-games) each friendly COA to determine its advantages and disadvantages, to incorporate improvements, and to identify any other tasks that might make the COA(s) more viable. During the war-game process, the staff identifies locations where combat multipliers, (indirect fire, obstacles, attack helicopters, and so on) can be used most effectively.

(2) **Action-reaction-counteraction.** The commander/S3 and staff war-game (mentally fight) the battle as it is expected to occur, pitting friendly COAs against the enemy's expected

COA. The commander divides the COAs into a series of actions or events, analyzes each to determine its likely result or reaction, and then considers the likely counteraction. This process of action, reaction, and counteraction continues until the mission is accomplished or until the COA fails. The most probable enemy COA should be given the most time and emphasis during the war-game process.

(3) **Critical events.** The commander/S3 must break down the war game into critical events to analyze it more deeply. This could be as simple as making each essential task a critical event; or, the war gamer could go into more detail. Passage of lines, breach of an obstacle, seizure of the objective, and use of the reserve are examples of critical events in the offense. Operations in the security area, destruction of enemy first-echelon forces, and destruction of follow-on forces are examples in the defense. Other critical events can be determined during the war game.

(4) **Significant factors.** The S3 must next select the criteria (significant factors) that are used to analyze the COAs. The degree to which a COA satisfies a significant factor results in an advantage or disadvantage for that particular COA. This information helps the commander select the best COA. The significant factors the commander/S3 selects help him improve and evaluate the overall concept of each COA during the war game. As the planner war-games, he asks for each factor, "Does the COA accomplish this?" If the answer is no, the COA must be disregarded or modified. For the war game to be manageable, the number of significant factors should be small. Three to seven are enough. For COAs to be compared to a common standard, the same significant factors must be used to war-game all COAs. These factors include mission-specific factors, doctrinal fundamentals, the commander's planning guidance, or any other criteria that the commander/S3 deems appropriate for this specific situation. One technique for determining which significant factors should be used in COA comparison is to analyze several different criteria for each METT-T factor and for logistics. The factors that should be selected are those that both relate

specifically to the planned mission and that will have a different outcome for each COA. The following are some of these criteria, by factor:

(a) *Mission.*

- Will COA accomplish mission?
- Is COA within commander's intent?
- Is COA restrictive or flexible?
- Does COA allow for follow-on mission posture?
- Is COA within constraints?

(b) *Enemy.*

- Does COA exploit enemy weaknesses?
- Will COA limit enemy capabilities?
- How will COA affect enemy morale or will to fight?
- How will COA affect enemy likely COA?
- How will COA affect enemy intentions?
- How will COA affect enemy reserves, reaction, or both?

(c) *Terrain and weather.*

- How does COA use avenues of approach?
- How does COA use concealment and cover?
- How does COA use or avoid obstacles?
- How does COA use key or decisive terrain?
- How does COA use ground conditions, speed of movement, and trafficability?
- How does COA facilitate fire and control of movement?
- How is COA affected by water drainage?
- How is the COA affected by weather and visibility?
- How is the COA affected by the availability of PZs, LZs, and DZs?

(d) *Troops.*

- How does COA utilize number and type?

- How does COA utilize location and disposition?
- How does COA utilize past performance?
- How does COA utilize leadership and morale?
- How does COA utilize level of training?
- How does COA utilize level of discipline?
- How does COA utilize combined arms?
- How does COA utilize relative mobility?
- How does COA utilize CS and CSS assets?
- How does COA facilitate task organization?

(e) *Time available.*

- How simple or complex is COA?
- Does COA provide adequate time for movement?
- Does COA provide adequate time for planning and preparation?
- Does COA limit enemy reaction time?
- Does COA meet time limitations imposed by higher?
- Does COA provide time for synchronization of the battle?
- Does COA provide time for limited visibility operations?

(f) *Logistics (supply and services).*

- How does supply availability affect COA?
- How does transportation availability affect COA?
- How does maintenance availability affect COA?
- How does water availability affect COA?

(5) **War-game techniques.** A planner can war-game each COA in any of several ways. The commander/S3 can use one or a combination of three techniques to conduct his war game.

(a) *Avenue-in-depth technique.* The planner focuses on one avenue of approach at a time.

This technique is the one most often used to war-game defensive COAs when several avenues of approach must be considered.

(b) *Belt technique.* The planner using the belt technique divides the battlefield into sections that run the width of the sector or zone. This is the preferred technique; it ensures simultaneous consideration of all factors that could affect a particular event.

(c) *Box technique.* The planner using the box technique focuses the war-game process on a specific area (box) of the battlefield. This can be the objective area, an engagement area, or some other critical area where the decisive action is most likely to occur. The war gamer uses the same action-reaction-counteraction method already discussed, but he limits himself to actions within the box. If time is short, this technique might be the best one to use.

(6) *War game planning.* The planner begins the war game by visualizing the flow of a battle, given friendly strengths and dispositions, enemy assets, probable COA, and a set piece of ground. He considers all facts, assumptions and deductions, and their effects on each COA. He tries to foresee the actions-reactions-counteractions of the battle. The war game allows him to analyze each selected event. He focuses on the tasks of subordinates one level down (companies) and on assets two levels down (platoons). By war-gaming each COA, the planner can determine whether force allocation, dispositions, combat multipliers (obstacles, FA), and logistical resources are adequate or correct, and he can adjust as appropriate.

(a) *Conduct of war game.* The battle is visualized from the point where initial contact is expected. Using one or a combination of the three war-game techniques, he pictures the interaction of his soldiers, the enemy, and the environment (terrain and weather). When possible, the entire staff should take part in the war game. Each staff officer should be an expert in his branch and should know the the planning factors specific to his branch. The S2 acts as the enemy—the S3 war-games each COA against the S2. Each friendly COA must be analyzed against all of the feasible enemy COAs or capabilities, with extra emphasis on the most probable enemy COA. As the action/reaction/counterreaction drills are conducted for each COA the degree to

which it satisfies each significant factor counts as an advantage or a disadvantage for that COA. At any time, the COA can be changed or adjusted to better meet the criteria of the significant factors. New COAs can be introduced—others can be eliminated from further consideration.

(b) *Benefits of war game.* War-gaming each COA helps to identify its advantages and disadvantages. The analysis that continues throughout provides a better appreciation of time/space factors that apply to subordinate units. Other benefits of the war-game process concern the battalion's intelligence collection effort. The S2 can refine his NAls to develop his collection and reconnaissance and surveillance plans. Also, based on the S2's identification of the threat, the S3 begins to develop DPs to be incorporated into the DST of the IPB product. No attempt should be made during the war-game process to compare COAs.

d. **Comparison of Courses of Action.** The fourth step in the estimate process consists of comparing options and choosing a COA.

(1) *Using a comparison matrix.* An effective technique for comparing COAs is using a comparison matrix. To set it up, list the significant factors used in step 3 (analysis) of the estimate on the left side of the chart; list the COA numbers across the top. (Table 2-3 provides an example format for a COA comparison matrix.) The simplest way to use this matrix is to give a plus to the best COA for each factor. If two or more COAs are equally superior, give them both a plus. All others receive a minus. Another way is to rank the COAs. The best COA for each significant factor is given a 1, the second best a 2, and so on. The COA with the lowest total sum supports the significant factors best. This comparison matrix conveniently summarizes the results of the analysis and comparison. It aids the staff in deciding their recommendations, and aids the commander in forming his decision during the decision brief.

(2) *Weighting significant factors.* The weights of one factor's advantages and disadvantages are rarely the same as those for another factor, so weighting significant factors might be necessary. One or several of the METT-T factors might be considered more important than others—for example, an assault might need to be conducted



on a particular objective before BMNT. In this example, time may be more important than the other significant factors. If the example chart in Figure 2-6 is used, speed may be weighted as twice as important as the other factors. The commander/S3 could annotate (x2) beside "SPEED" on Figure 2-6. If the numbering system previously described is used to rank COAs, the value assigned to each COA is doubled. This makes the already significant COA factor "speed" more significant than other significant COA factors.

NOTE: This method of "weighting" a COA is just one way the commander can indicate the importance of one factor over others. However, the commander should be careful when weighting significant factors. Seldom is one factor so vital to the mission that it causes the planners to rule out other viable COAs that do not take advantage of that specific factor.

e. **Decision.** The fifth step in the estimate process is a recommendation (with sketch) prepared by the S3 for the commander. The S3 also recommends the types of forces to be employed, but not the specific units. The commander then decides on a general scheme of maneuver.

(1) *S3's recommendation.* The S3 considers other staff estimates so his recommendation represents a coordinated staff position. If the commander greatly changes a COA or "creates" another one by combining parts of existing COAs, the staff must war-game the new COA to allow development of the tentative plan.

(2) *Commander's decision.* The commander considers the staff recommendation presented by the S3, completes his estimate, and announces his decision and concept.

(3) *Concept of the operation.* The commander's concept provides the necessary elements of paragraph 3a of the OPORD, concept of the operation. The commander's concept is a clear,

concise statement of the task organization, the mission statement, the commander's intent, the general scheme of maneuver, supporting fires, and the acceptable degree of risk. The commander's concept takes the same form as the staff recommendation, except that the commander confirms the units to be employed. The main effort in the scheme of maneuver is critical—it affects all planning. The commander's concept provides the least information needed to further develop the tactical plan and to issue the order. The decision is the last step of the commander's estimate.

(4) *Additional guidance.* The commander can provide the staff with more planning guidance besides his decision and concept. How much he provides depends on the experience of the staff and on how well they know the commander. This extra

| WEIGHT     | RATINGS<br>++, +, 0,<br>--, -- | CA1 | CA2 | CA3 | CA4 | REMARKS |
|------------|--------------------------------|-----|-----|-----|-----|---------|
|            |                                |     |     |     |     |         |
| 0,1,2      |                                |     |     |     |     |         |
| MISSION    |                                |     |     |     |     |         |
| ENEMY      |                                |     |     |     |     |         |
| TERRAIN    |                                |     |     |     |     |         |
| TROOPS     |                                |     |     |     |     |         |
| TIME       |                                |     |     |     |     |         |
| 3, 5, M, M |                                |     |     |     |     |         |
| OVERALL    |                                |     |     |     |     |         |

Figure 2-6. Example COA comparison matrix.

guidance helps the staff complete the plan and prepare orders. The commander can include an elaboration on the scheme of maneuver, fire support plan, and CSS. He outlines any task organization changes he wishes to make. He also designates subordinate units to be employed, which is a command responsibility that cannot be delegated. The S3 can only recommend units (though not as part of the operations estimate "recommendation").

(5) **Tentative plan.** The commander should expand the selected COA into a tentative plan. The plan is expressed as a broad concept; it includes a supporting overlay that shows its vital elements. It should relate to the OPOD format and should be complete enough that it can be executed as a FRAGO if time does not permit physical reconnaissance to verify the plan.

## 2-21. INITIATION OF MOVEMENT

Initiation of movement is step four of the troop-leading procedures. Movement can occur at any time in the troop-leading procedures to ensure the most efficient use of time. If time is short and much movement is required, the commander can start the necessary movement early, under the control of the XO. The task organization can also change. As much as possible, units should move to task-organize during daylight hours. The goal of the troop-leading procedures should be to build effective task forces and teams by starting movement and making decisions about task organization as early as possible.

## 2-22. RECONNAISSANCE

Reconnaissance is step five of troop-leading procedures. Reconnaissance actions must be carefully planned to quickly gather the terrain and enemy information the commander needs to complete his plan. Ground reconnaissance is conducted to confirm, adjust, or deny all or part of the tentative plan. If he has time, the commander might conduct an initial reconnaissance before he develops the tentative plan. Even if he does this, he should conduct another at the conclusion of the estimate to confirm the tentative plan. Reconnaissance is continuous; the battlefield is an ever-changing environment. A well-developed tentative plan makes the reconnaissance easier,

because subordinates can be given specific guidance.

a. A reconnaissance and surveillance plan (as part of the intelligence collection plan) and counterreconnaissance tasks must be developed and updated throughout the operation. The plan is keyed on the commander's PIR. It involves not only personal reconnaissance by the commander but also the employment of all feasible collection assets. These assets include scouts, company patrols, aviation, artillery, and available MI. Time and assets dictate how the reconnaissance is conducted. The commander also considers the risk of compromising the operation or losing key leaders if his reconnaissance force is discovered.

b. The reconnaissance plan can be issued as a FRAGO. It should include the following items:

- Composition/task organization for reconnaissance.
- Key facts (PIR) to be gained by the reconnaissance.
- Movement routes/formations to the reconnaissance location.
- Actions on reaching the location.
- Special instructions to members of the reconnaissance party. Collection tasks should be specified.
- Any special equipment required (chemical detection kits, expedient or directional antennas, and so on).
- Contingency plans.
- Requirements for continued surveillance after the reconnaissance. Indirect fire support for reconnaissance.
- Communications arrangements (nets, retransmission sites, and so on).
- Withdrawal, linkup, and dissemination plans.
- Security arrangements.

c. The commander continues to think about his estimate during the reconnaissance. If possible, he holds a first meeting on the reconnaissance site with the company commanders and staff. He then assigns specific requirements to his subordinates to collect information he cannot collect. The company commanders and staff conduct their

reconnaissances. Afterwards, the battalion commander meets with the company commanders and his staff, receives their recommendations, and modifies his concept if appropriate. If he chooses, the battalion commander can go through another war-game process with them, adding the new factors learned from the reconnaissance.

### 2-23. COMPLETION OF PLAN

Completion of the plan is the sixth step of the troop-leading procedures. A synchronized, viable, and timely plan is one of the most important preliminaries to battle. The commander and his staff continue to add detail, expanding the tentative plan into a five-paragraph OPORD.

### 2-24. ISSUANCE OF OPORD

Issuance of the OPORD is the seventh step of the troop-leading procedures. The OPORD is issued at the time and place stated in the WO. The way an OPORD is issued affects how clearly it is understood. A well-developed but poorly presented plan hinders mission accomplishment. Whenever possible, the orders group should rehearse the presentation and use terrain models or other visual aids to enhance clarity and understanding. An overlay, including an execution matrix and concept sketch, should be prepared and available for subordinate unit commanders and leaders when they come to receive the order. Written orders and overlays help counter the effects of stress and fatigue from continuous operations. Leaders should not have to copy anything. (Appendix A provides techniques for production and issuance of OPORDs.) The OPORD should be issued from a location that overlooks the terrain on which the operation is to be conducted, if possible. If so, the S3 or commander should orient the audience to the terrain and all briefers should reference the terrain rather than a map or sand table. If not possible, the commander should use any aids he can obtain or should construct aids, such as sand tables, large sketch maps, or relief maps, to help soldiers visualize the terrain. All soldiers who receive the OPORD should have a copy of the operations overlay. Graphics should be nonrestrictive, yet

complete, and should include EEI for the flank unit.

### 2-25. SUPERVISION AND REFINEMENT

Supervision and refinement is the eighth step of the troop-leading procedures. The issuance of the OPORD does not end the troop-leading procedures. The TLP continues until the mission is accomplished. New information is fed back into the commander/S3's estimate so the commander can determine whether assigned tasks should be changed. Plans are good only when subordinates clearly understand their purpose within the commander's concept, coordinate with adjacent units, and rehearse critical events. During the operation, the command group and the TOC monitor the operation closely. The command group should be ready to make decisions on subordinate commanders' requests for changes to the tactical plan and should issue FRAGOs as needed. The requirement to supervise is continuous and is as important as issuing orders. Briefbacks, rehearsals, inspections, and continual coordination of plans are techniques that should be used to supervise and refine troop-leading procedures.

a. **Briefbacks and Rehearsals.** Briefbacks focus on the planning process; rehearsals focus on execution.

(1) **Briefbacks.** The commander should conduct at least two briefbacks with subordinate commanders. When possible, briefbacks should be conducted collectively at a meeting of the orders group. This simplifies the exchange of information, improves coordination among units, and speeds the distribution of changes.

(a) The first briefback occurs immediately after the battalion OPORD has been issued. The purpose of this briefback is to ensure the subordinate commander or special platoon leader understands his mission or critical actions he must accomplish.

(b) The second briefback occurs after subordinates have formulated their own concepts of the operation, but before they have issued their OPORDs. The purpose of this briefback is to ensure the commander concurs with the subordinate leader's concept, and to allow the commander to recommend changes before the subordinate issues his OPORD.

(2) **Rehearsals.** Combat rehearsals are conducted to help a unit gain agility, to ensure synchronization, to increase initiative, and to improve the depth of a force through practice. Both fire support and maneuver actions should be rehearsed, which reinforces the scheme of maneuver and the fire plan. A rehearsal should be conducted for all critical actions. When conducting one, the commander should emphasize key events that trigger friendly actions. Rehearsals ensure the unit can accomplish these actions based on its state of training, the orders issued, and the expected terrain and weather conditions. Rehearsals identify problem areas and contingency actions, determine movement reaction times, enhance coordination, and enable the commander to refine his plan. The commander uses the rehearsal to reinforce subordinates' understanding of the plan; to help them visualize the exact meaning of his intent; and to help them know what to do when the battle does not go according to plan. At the end of all rehearsals, the commander must review the plan to ensure that all of the BOSs have been properly synchronized. Commanders can choose from several types of rehearsals, based on time and feasibility. Figure 2-7 show six types of rehearsal on a time line. The types areas follows:

(1) **Full rehearsal.** This type of rehearsal is the most effective, but consumes the most time and resources. It involves every soldier who will participate in the operation. If possible, it should be conducted under the same conditions (weather, time of day, terrain, and so on) that are expected to exist during the actual operation.

(2) **Key leader rehearsal.** This type of rehearsal requires less time and resources than a full rehearsal. It involves only the key unit leaders, down to a level determined by the commander. However, it should also be conducted under the same conditions that are expected to exist during the actual operation. Selected leaders rehearse the plan in their assigned tactical vehicles, if applicable.

(3) **Terrain model rehearsal.** This type of rehearsal requires less time and resources than a key leader rehearsal. Its three-dimensional aspect helps subordinate leaders visualize the battle. When possible, the terrain model should be constructed overlooking the actual terrain or, if the situation requires more security, on the reverse slope and within walking distance of a

vantage point that overlooks the actual terrain. Terrain models should be made to scale, and should include the grid lines from military maps. They should depict all information from the operations overlay, including the names of key terrain features enemy positions (known and suspected), and all critical fire control measures.

(4) **Sketch map rehearsal.** This type of rehearsal requires less time and resources than a terrain model rehearsal. Except that a sketch is used instead of a terrain model, the procedure for this type of rehearsal is the same as for the terrain model rehearsal. Using sketches large enough for all participants to see, the commander and his staff discuss the flow of the operation with subordinate leaders.

(5) **Map rehearsal.** This type of rehearsal requires less time and resources than a sketch map rehearsal. The procedure is the same for the sketch map rehearsal, except a military map with an operations overlay is substituted for a sketch. This technique works best if each subordinate leader has his own map and if the rehearsal is conducted from a vantage point that overlooks the terrain of operations.

(6) **Radio rehearsal.** This type of rehearsal, often referred to as a COMMEX, requires less time and resources than any of the other types—but is the least desirable. Also, the lengthy radio communications required endanger OPSEC. Consequently, a commander should use this method only when he has no other option. To conduct such a rehearsal, he and his staff transmit the execution of critical portions of the operation over the radio. For this technique to be effective, every participant must have working communications and a copy of the unit OPORD and overlays. Only essential phases are rehearsed.

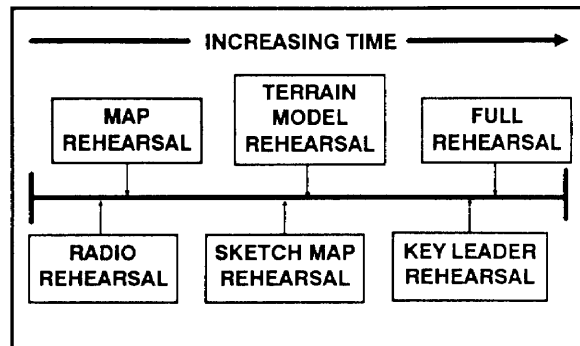

Figure 2-7. Types of rehearsals.

b. **Inspection.** Leaders at all levels inspect soldiers, their levels of knowledge, and their equipment. This is done to ensure that combat preparations are complete and that the commander's intent is understood two levels down.

c. **Coordination.** The commander visits his subordinates and discusses their plans. Changes resulting from this second set of briefbacks are given to everyone concerned. The commander and his staff supervise to ensure that all preparations necessary for conduct of the operation are being made. These include coordinating fire support and engineer activities,

maintenance, resupply, casualty evacuation, movement, and any other required actions. Any departures from the plan, both before and during the operation, are coordinated with the battalion commander. However, this coordination might not be possible during the battle due to communications problems. In these cases, subordinate commanders should act on their understanding of the battalion commander's intent and on their own judgement. Staff officers must be ready to change their plans to take advantage of tactical opportunities that occur during the operation.

### Section III INTELLIGENCE PREPARATION OF THE BATTLEFIELD

Intelligence preparation of the battlefield (IPB) is a systematic and continuous process used to reduce uncertainties about the weather, enemy, and terrain in a specific battlefield area. It integrates enemy doctrine with the terrain and weather to evaluate enemy capabilities, vulnerabilities, and possible COAs. The formal IPB is performed at corps and division levels; the informal IPB is performed at brigade and battalion levels. (FM 34-130 provides more information on IPB.) Though the information flows through the S2, who also prepares the various overlays and templates, the IPB is the commander's decision-making tool. The S2 relies on higher headquarters to provide detailed terrain and weather information. During planning, IPB allows the S2 to develop probable enemy COAs against which the commander/S3 can war-game friendly COAs. During execution, the IPB aids the commander with situational development by showing him when and where he must make decisions. This provides him with the means to *influence* rather than just *react* to enemy actions (Figure 2-8).

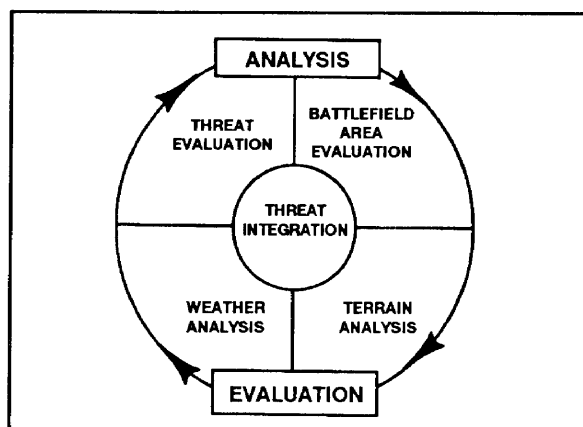

Figure 2-8. Intelligence preparation of the battlefield.

## 2-26. ROLE OF IPB

The commander must anticipate events on the battlefield and design friendly COAs to succeed despite enemy capabilities. The commander and staff must use IPB to assess the enemy's capabilities and possible COAs and must not expect to accurately predict enemy intentions or a specific COA. In fact, they must also remember that the enemy can "predict" IPB predictions and choose a less obvious COA.

## 2-27. FIVE FUNCTIONS OF IPB PROCESS

The five functions of the IPB process are battlefield area evaluation, terrain analysis, weather analysis, threat evaluation, and threat integration. Graphics are basic to IPB analysis. Intelligence is often best communicated with pictures, so the products are designed to be visual to increase understanding.

## 2-28. INTELLIGENCE COLLECTION PROCESS

The intelligence collection process is integrated along with the IPB into the commander/S3's estimate as follows:

a. The S2 reviews the doctrinal template (already prepared) on receipt of the mission and analyzes intelligence summaries from higher while the commander conducts his mission analysis. The S2 uses operations graphics, the terrain and weather analyses, the doctrinal template, and current enemy activities from INTSUMS (Functions 1 through 4) to provide the staff with a situational template.

b. The commander completes his mission analysis and provides his initial PIR to the S2. The priority intelligence requirement includes elements of information needed by the commander to confirm his estimate. The S2 uses the commander's PIR, along with the situational template and the INTSUMs from higher, to focus the intelligence collection plan. This plan goes to the scout platoon and to all other potential sources of combat information in the battalion. Other staff officers use the situational template

as they conduct their estimates and determine their recommended COA. If the commander does not provide PIR, the staff should recommend PIR and the S2 should present them for the commander's approval. Completion of the IPB process identifies critical intelligence gaps that aid the staff in developing other PIR.

c. The S2 uses the situational template to identify NAIs from which to create the event template. He develops the event template by rapidly war-gaming each potential *enemy* COA from the point where friendly or enemy activity begins until the mission is accomplished. Depending on the situation, the assistant S3 can aid the S2 in developing the event template.

d. The S2 can also begin a reconnaissance and security matrix once he has identified the NAIs. This matrix is a good tool to ensure all NAIs are covered and the collection plan is synchronized.

e. The commander and S3 now war-game their maneuver COAs, by priority, against the S2's analysis of the enemy probable COAs. This war-game process identifies a friendly COA that has now been tried and refined based on the enemy's probable actions. This COA is the basis for the tentative plan that is then expanded into the OPORD.

f. DST is developed based on the selected COA. Specific units are assigned responsibility for observing and reporting activity at specific NAIs. Maneuver, fire support, and EW assets are given specific responsibilities to prepare to attack specific enemy targets at each TAI. Based on the response time required, the S3, with the aid of the special staff, assigns decision points.

g. Table 2-3 shows an example format for a reconnaissance and security matrix as completed after the war game and after assignment of specific responsibilities. This matrix, along with a combined obstacle overlay showing the locations of the NAIs and a copy of the commander's PIR, are the main tools needed by information collectors.

| NAI | HIGHER/ADJ | BN  | SUBUNIT | ACTIVITY  | ACTION                                |
|-----|------------|-----|---------|---|---------------------------------------|
| 10  | 2-21 IN    | GSR | SCOUTS  | ENEMY MOVEMENT WEST, COMPANY-SIZED FORMATION                | ALERT COMPANY A TO CLOSE OBSTACLE GAP |
| 11  | 4-73 FA    | GSR | SCOUTS  | CONFIRMATION OF RAG LOCATION                                | FA COUNTERBATTERY FIRES TAI           |
| 12  |            |     | SCOUTS  | ENEMY MOVEMENT WEST   | ALERT COMPANY B TAI 12 (FA)           |
| 13  |            |     |         | ENEMY MOVEMENT SOUTH FROM AA C TO AA D                      | NOTIFY COMPANY C                      |
| 14  |            |     |         | ENEMY MOVEMENT NORTHWEST, COMPANY-SIZED OR LARGER FORMATION | NOTIFY 2-21 IN & BDE                  |
| 15  |            |     |         | ENEMY MOVEMENT NORTH FROM AA D TO AA C                      | NOTIFY COMPANY B & C                  |

**Table 2-3. Example of format for completed reconnaissance and security responsibility matrix.**

## Section IV COMMAND AND CONTROL DURING BATTLE

The processes of planning, command, control, and communications discussed previously in this chapter allow the commander to synchronize and support the combat, CS, and CSS elements of the battalion and to accomplish his mission. Battle command and control must be simple and responsive due to the violence, confusion, and pace of the battlefield. The battalion command and control system must work better and faster than the enemy's command and control system.

### 2-29. PLANNING

Execution unfolds from a sound plan. This plan must be simple and flexible. Planning must be conducted with an emphasis on preventing fratricide. Commanders must ensure adequate control measures are planned and rehearsals are conducted to help prevent fratricide. The following guidelines, which are all equally important, apply:

- a. Subordinate input and recommendations should be sought and considered.
- b. Initial plans must clearly establish the intent of the next higher commander and the battalion's concept of operations. To aid in understanding, orders should be delivered face-to-face.
- c. Responsibilities and tasks should be clearly assigned and IAW units' capabilities.

- d. The greatest possible tactical freedom is left to subordinate leaders within the requirement to synchronize operations with other elements.
- e. A main effort is designated as a focal point.
- f. Plans are simple in concept and follow a logical sequence.
- g. Stand-alone graphics, including fire-control measures, should simplify cooperation between forces without restricting the freedom of junior leaders.
- h. Planners should consider the responsibilities and the operational concepts of flanking and supporting units.
- i. Forces are planned for and positioned in anticipation of tactical events and major contingencies.

- j. All plans should be war-gamed.
- k. Task organization is based on METT-T (not on habit).
- l. Succession of command is planned for and rehearsed.
- m. A training plan is prepared for any specific training that must be conducted before rehearsals.
- n. Schemes of maneuver, fire support, indirect fire plans, and CAS requests must be reviewed to prevent fratricide.

### **2-30. PREPARATION**

Preparation ensures that the mission and concept of the operation are understood, and enables units to better perform their roles. Preparation should include the following:

- Thorough briefbacks including all attachments.
- Rehearsals of plan and major contingencies at all levels.
- Rehearsal by reserves IAW priority of mission.
- Inspections at all levels.

### **2-31. EXECUTION**

Execution of plans requires leaders to remain flexible, to retain and enhance synchronization, and to cope with the dynamic events of the battlefield. They must perform all of these more rapidly than the enemy. The following steps help them meet these requirements:

- a. Junior leaders exploit changes in the tactical situation, within the commander's intent.
- b. Commanders ensure that a leader is present at each critical point on the battlefield. Tactical leaders position themselves wherever the situation calls for their presence, but they retain their option to respond with the entire

force to opportunities or changing circumstances. The commander can position the S3 to command and control an area that the commander cannot monitor.

c. Commanders observe the battle. Reconnaissance, surveillance, security, and IPB are all continuous.

d. Command and control is continual and rapid. Time is used wisely. Situational updates, WOs, and FRAGOs are used often. Critical combat information and intelligence are passed rapidly. Communications are redundant (sent by more than one means) to enhance survivability and to simplify the transmission of changes to the effort, the intent, or both.

e. Subordinate feedback and reports are continuous and rapid to expedite combat decisions and adjustments during battle. To prevent overloading the commander, the main CP should screen all information. The scout net is used to pass most information, which leaves the command net open for more vital information.

f. Execution of command and control focuses combat power on the objective of the operation. Movement is supported by direct and indirect fire. Mutual support is maintained to prevent defeat in detail.

g. Fire control and discipline are maintained. Graphics supply the framework and fire discipline (training) ensures success.

h. Succession of command is accomplished smoothly and rapidly.

i. The unit consolidates and reorganizes during lulls in the battle or after seizing an objective. Steps for consolidation and reorganization are discussed in Chapters 3 and 4. Within the context of sustained operations, consolidation must aid in future operations.



## CHAPTER 3

# OFFENSIVE OPERATIONS

*The object of battle is to win. TO WIN, ONE MUST ATTACK. Both offensive and defensive operations are aggressive—both are conducted to gain and maintain the initiative. This chapter provides the foundation for offensive actions. It discusses the concept of infantry attacks and the planning and conduct of offensive operations.*

### Section I DOCTRINE

Most infantry battalion operations are offensive operations. Attacking battalions must identify the decisive point in the enemy's defense, choose a form of maneuver that avoids the enemy's strength, and concentrate the effects of their combat power against the decisive point.

#### 3-1. PURPOSE

Infantry battalions undertake offensive operations—

- To defeat enemy forces.
- To secure key or decisive terrain.
- To deprive the enemy of resources.
- To gain information.
- To deceive and divert the enemy.
- To hold the enemy in position.
- To disrupt an enemy attack.

#### 3-2. CHARACTERISTICS OF OFFENSIVE OPERATIONS

Successful offensive operations are characterized by surprise, concentration, speed, flexibility, and audacity.

a. **Surprise.** Surprise is achieved by striking the enemy at a time or place or in a manner for which he is unprepared. The enemy may learn of the attack, but he must do so too late to react effectively.

(1) The shock of an unexpected attack slows enemy reactions, overloads his command and control system, and reduces the effectiveness of his weapons. This allows the attacker to quickly overcome the defender.

(2) The attacker's initiative allows him to choose the time, place, and means of battle. Surprise is enhanced by striking the enemy's flank or rear; by infiltrating; or by rapidly, unexpectedly inserting combat forces to the enemy's rear.

(3) The shock of surprise is brief, so the attacker must exploit it and deny the enemy time to regain his equilibrium.

b. **Concentration.** Concentration of the battalion's combat power on the enemy at the point of the attack is required.

(1) The lethality of modern weapons—especially artillery and NBC weapons—increases the threat to massed formations. The battalion must avoid patterns or obvious movements that reveal the time or direction of its attack. Security, deception, tactical mobility, and proper use of terrain and weather are vital to success. Other ways to concentrate the effects of the battalion's weapons on the enemy include the following:

(a) Designate the main effort, focus the resources to support it, and prepare to shift it rapidly.

(b) Synchronize direct fires, indirect fires, and CAS. Weight the main effort with indirect

fire assets, aviation, or CAS, which can be shifted rapidly as the situation changes.

(c) Integrate CS and CSS assets. Organize and coordinate support well to give the battalion the sustainment required for success.

(2) Reconnaissance and surveillance are important to allow the attacker to focus the combat power of his weapons on the weakness of the enemy.

c. **Speed.** Speed is vital to infantry offensive operations. Speed can prevent the enemy from using effective countermeasures. Speed and surprise together compensate for a lack of mass; they deny the enemy the time to recover or to identify the main effort and react effectively.

(1) Speed must not be confused with haste. General Patton, who stressed the efficient use of time in all his operations, carefully distinguished *haste* from *speed*.

*“Haste exists when troops are committed without proper reconnaissance, without the arrangement for proper supporting fire, and before every available man has been brought up. The result of such an attack will be to get the troops into action early, but to complete the action very slowly.*

*“Speed is acquired by making the necessary reconnaissance, providing proper artillery and other tactical support, including air support, bringing up every man, and then launching the attack with a plan so that the time under fire will be reduced to the minimum. At the battalion level, four hours spent in preparation for an attack will probably ensure the time spent under fire not exceeding thirty minutes. One hour spent in.. preparation... will most certainly ensure time under fire lasting many hours with bloody casualties.”*

(2) Speed can be attained in many ways.

(a) Training and an effective command and control system that translates mental agility into decisive, quick action are needed. Mission-type orders at all echelons allow subordinates to use enemy weaknesses created by the rapid-tempo attack.

(b) Tactical mobility is enhanced by the use of movement techniques, formations, and drills that allow the force to move and react rapidly and use the terrain. Proper planning for the use of engineer, air defense, and aviation assets

increases tactical mobility. Good reconnaissance and intelligence collection are vital.

(c) Responsive logistical support results in rapid resupply. This ensures the attack can continue.

d. **Flexibility.** Flexibility is a trait required of commanders. Combat requires that they expect uncertainties and that they be ready to exploit opportunities. To develop flexibility, commanders must develop a detailed war game. The following actions also increase battalion flexibility:

(1) Conducting IPB to learn the terrain and enemy dispositions for initial and subsequent actions.

(2) Conducting continuous reconnaissance to discover the enemy’s weaknesses and ways to attack him on the flank and rear.

(3) Maintaining a reserve that can assume the mission of the main attack or exploit tactical opportunities.

(4) Establishing a command and control system that allows the commander to make and transmit timely decisions.

(5) Communicating the commander’s intent by mission-type orders and FRAGOs.

e. **Audacity.** Audacity is the willingness to risk bold action to achieve decisive results. The audacious commander is daring, confident, and original—he is not rash.

(1) The audacious commander’s actions, though quick and decisive, are based on a reasoned approach to the tactical problem and on his knowledge of soldiers, terrain, and enemy. This commander maneuvers to maintain a positional advantage over the enemy, seeks to attack the enemy on the flank or rear, and exploits success at once, even if this briefly exposes flanks. He issues mission-type orders and moves to the place on the battlefield where he can best influence the critical aspects of his attack.

(2) Boldness and willingness to accept calculated risk have always been the keystones of successful offensive action. The concept of combat power is more than the sum of a force’s combat systems. Audacious commanders throughout history have used the “indirect approach.” To defeat a numerically superior opponent, they strike at an unexpected time and place.

**3-3. OFFENSIVE FRAMEWORK**

All tactical offensive actions are based on a simple and complete concept of the operation. This paragraph describes the offensive framework common to the operations of a division and its elements (Figure 3-1). Battalions can participate in combat actions in any part of this framework. They can be employed as security forces, as elements of main or supporting attacks, as reserves or, in some cases, as elements of deep or rear operations.

a. **Reconnaissance and Security.** The purpose of reconnaissance is to learn about the enemy or terrain. The purpose of security operations is to find the enemy before the attack

begins. Security elements are sent forward and to the flanks and rear of main and supporting attacks. These elements also provide the battalion with flank and rear security. An aggressive offense inherently provides security.

b. **Main Attack with Supporting Attacks.** The battalion commander designates companies as the battalion's main and (if necessary) supporting attacks.

(1) The main attack accomplishes the decisive action. A company is the main attack for the battalion if the company's attack will accomplish the battalion's mission.

(2) Companies designated as supporting attacks help the main attack succeed. They can

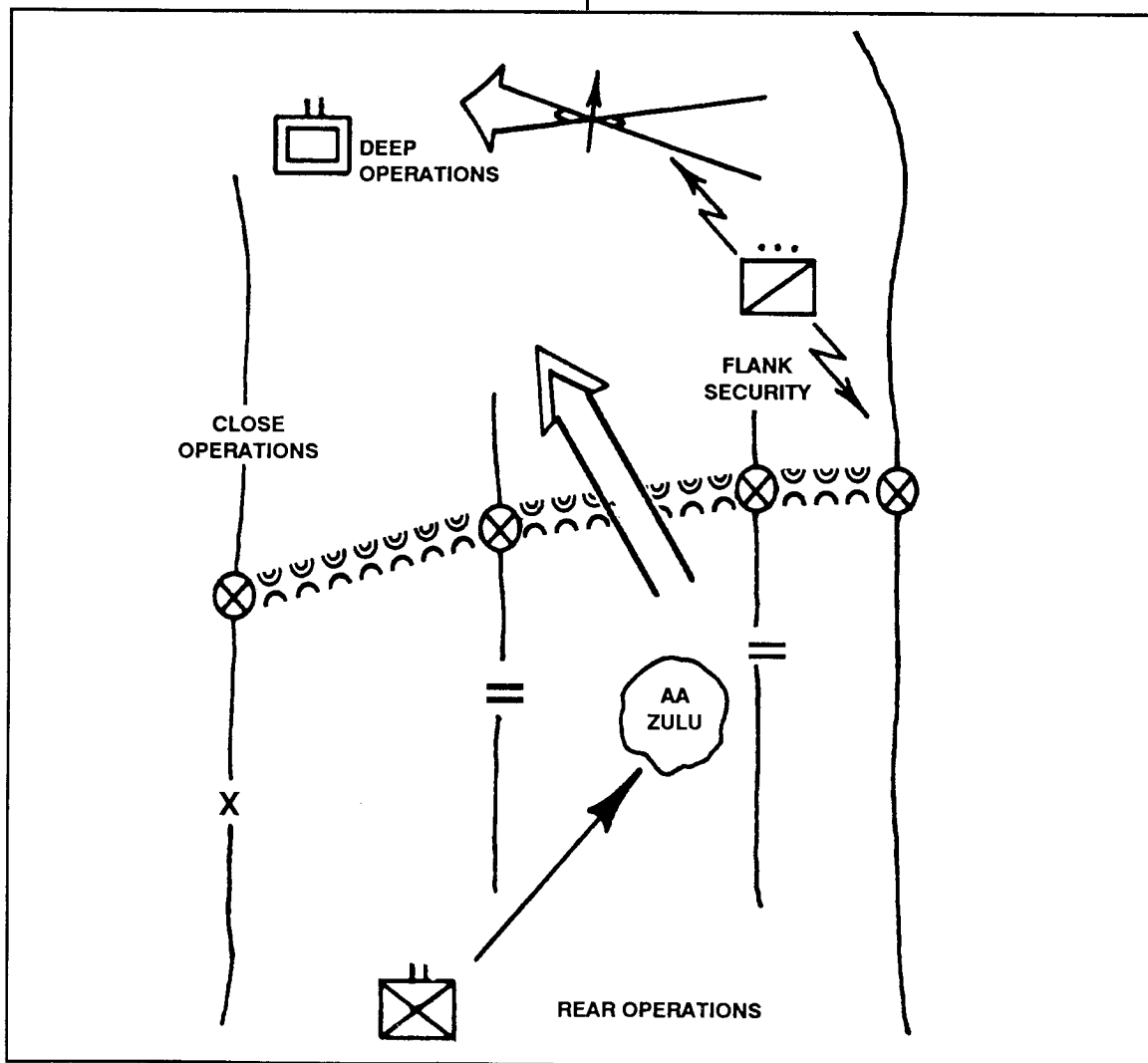

Figure 3-1. Offensive framework.

attack and seize terrain, or they can fix the enemy in position. They can also deceive the enemy about the location of the main attack and force him to commit reserves early, partially, or wrongly. Also, they can prevent enemy reinforcement in the area of the main attack.

(3) The main effort is the focus of combat power at any phase of the operation. For example, before the attack, the scout platoon may be designated as the main effort and receive priority of available combat multipliers. As units cross the LD, the main effort might shift to the company most likely to make contact with the enemy first. At the decisive point of the attack, the unit designated as the main attack also becomes the main effort.

**c. Reserve Operations.** The battalion achieves flexibility by having its reserves positioned to weight the main attack. The commander commits the reserve to the attack at a decisive time and place, then uses it to either exploit success or complete the mission. Reserves are committed to reinforce success, not failure.

(1) The size of the reserve depends on the commander's estimate of the situation. The less commanders know about the enemy situation, the larger the reserve should be. It must be large enough to be decisive when committed.

(2) The position of the reserve should be one that allows security from enemy targeting assets and that allows rapid movement to points of probable employment.

(3) The commander plans the reconstitution of the reserve before the attack. The reserve should be reconstituted after the initial reserve is committed. Once the battalion has committed its reserve, it reports to brigade.

**d. Continuous Deep Operations.** Divisions and brigades can use continuous deep operations in vital parts of the zone of attack. These operations keep the enemy off balance. Though infantry battalions may be employed in this effort, maneuver battalions conduct no separate deep operations.

**e. Rear Area Operations.** The battalion must secure its logistics assets to maintain offensive momentum. Rear operations ensure maneuver forces have freedom of action. These operations also ensure the

continuity of CS and CSS. The battalion provides all-round security.

### 3-4. FORMS OF MANEUVER

The five forms of maneuver describe the relationships of attacking units to each other and to the enemy. Attacks match a light infantry battalion against an enemy weakness and focus on the decisive point in the enemy defense. The estimate process provides the commander with information to select the correct form of maneuver. To accomplish its mission, the battalion can combine forms of maneuver. For example, one element of the battalion can attack frontally to fix the enemy while another element executes an envelopment. The form(s) of maneuver selected must support the intent of the commander. Infiltration, penetration, envelopment, turning movement, and frontal attack are the five forms of maneuver.

**a. Infiltration.** The purpose of an infiltration is to move by stealth to place a maneuver force in a more favorable position to accomplish the mission. This is a preferred form of infantry maneuver, because it permits a smaller force to use stealth and surprise to attack a larger or fortified force. Infiltration helps avoid detection and engagement (Figure 3-2). Movement is usually by foot or air but can be by vehicle or watercraft. Along with other units, an infiltrating force can attack the rear and flanks of enemy forward positions to accomplish its mission and as a means to facilitate a penetration of a larger force. It can also attack lines of communication, administrative rear installations, headquarters, CPs, and CS or CSS activities and facilities. Infiltrating units can seize key terrain, destroy critical communications nodes, and interfere with the resupply and reinforcement of enemy positions.

(1) **Types.** Three types of infiltration may be used.

(a) **Land.** Infiltration by foot is most common and is discussed in detail in this manual, but infiltration by vehicle is also possible. It is most feasible in areas with large gaps between forces or where flanks might be impossible to secure. Many infiltrations have been conducted by vehicle, especially when force-to-space ratios were small.

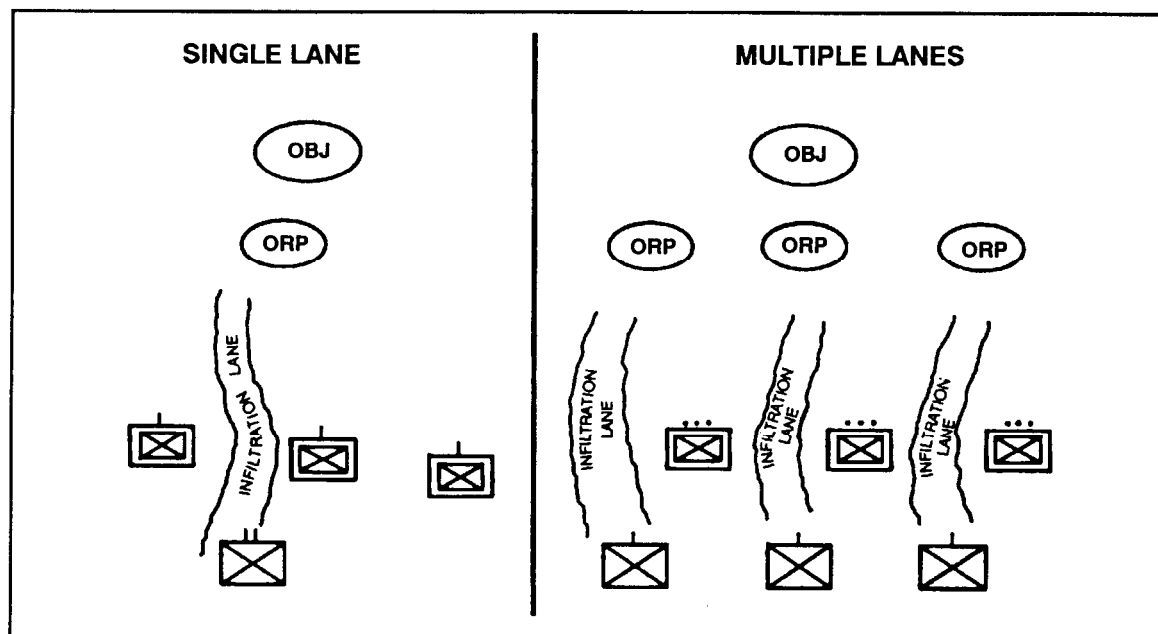

Figure 3-2. Examples of infiltration.

(b) *Water.* Forces can infiltrate by sea or by inland waterway. (FM 31-25 and FM 31-11 describe various aspects of the TTP of waterborne infiltrations.)

(c) *Air.* (FMs 90-4, 100-27, 90-26, and 31-24 provide TTP for infiltration by air.)

(2) **Advantages.** Infiltration can be used when enemy firepower discourages the use of another form of maneuver or when a light force is employed against a mechanized or motorized force. Infiltration can panic and disorganize an enemy oriented physically and mentally to fight to the front. This can sometimes cause the enemy to withdraw even if he is too strong to be driven out by other means.

(3) **Disadvantages.** The main disadvantage of an infiltration is that small infiltrating elements can be destroyed piecemeal if the defending force detects them, does not panic, and uses its full combat power. Also, successful overland infiltration requires time. An infiltration requires small-unit leaders to have excellent navigational skills. For an infiltration to be successful, all forces must link up as planned behind enemy lines.

(4) **Conditions.** The commander's knowledge of enemy dispositions and the battalion's ability to conceal plans and movements allow the

commander to create surprise. An infiltration conducted over rough, heavily wooded terrain against a widely dispersed enemy or conducted on a front with fluid positions can succeed.

(a) A rough, almost inaccessible location is best for an infiltration.

(b) Darkness and bad weather reduce the chance that the enemy will detect the infiltration.

(c) Infiltration should be conducted through areas not occupied or covered by enemy surveillance and fire.

(d) The local population should be avoided unless known to be friendly. Civilians positively confirmed as friendly can help with the infiltration and can be used as guides.

(e) Enemy electronic surveillant devices used to cover gaps must be neutralized or avoided. An active and aggressive reconnaissance provides information on enemy strengths, weaknesses, and dispositions.

(5) **Training.** Soldiers must be well trained before they can infiltrate successfully. Minor breaches of noise and light discipline can compromise the entire force. If compromised, the force should break contact and continue the mission. It must have an offensive frame of mind, be able to use its initiative, and be proficient in patrolling for gaps and weak points

in the enemy's defense. Leaders ensure soldiers take only the required equipment and supplies.

(6) **Phases.** An infiltration over land can be accomplished in five phases.

(a) **Patrol.** Gaps are identified in the enemy position through aggressive patrolling and sound IPB. This phase is critical to determine the gaps in the enemy positions through which the unit will infiltrate.

(b) **Prepare.** The unit conducts troop-leading procedure.

(c) **Infiltrate.** The unit infiltrates the gaps, avoiding detection and engagement, and ignoring ineffective enemy fire.

(d) **Consolidate.** The unit infiltrates to the enemy's rear, then reassemble at one or more ORPs and prepares to complete its assigned mission.

(e) **Execute.** The unit completes its mission from its position of advantage to the rear of the enemy.

(7) **Lane selection.** One of the most important decisions a commander must make when planning an infiltration is whether to use single or multiple routes or lanes.

(a) **Infiltration lanes.** The battalion selects infiltration lanes based on terrain analysis, gaps in the enemy's defensive system, and locations of the enemy security elements. Lanes should offer cover and concealment. They should help soldiers avoid detection by enemy radar, sensors, surveillance, target acquisition, and NVDs. If enemy acquisition assets are unavoidable, heavy patrolling can precede use of infiltration tactics. Radio-linked sensors are jammed. The battalion uses active deception measures such as artillery fire into other sectors, diversionary attacks, feints, and ruses.

(b) **Infiltration route.** The battalion assigns an infiltration route if precise information is known about enemy dispositions. When detailed intelligence is unavailable, an infiltration lane is used instead.

(c) **Single or multiple routes or lanes.** The number of routes or lanes used depends on the size of the force to be infiltrated, the amount of detailed information available on enemy dispositions and terrain, the time available, and the number of possible routes or lanes. Without sacrificing stealth, the battalion infiltrates the largest subunit it can—for example, if the

battalion can infiltrate in company-sized units and remain undetected, this is preferred to infiltrating in platoon-sized units. Normally, units will infiltrate by platoon or company; however, units may infiltrate by squad or battalion depending on METT-T. For control, speed, and responsive combat power, all infiltrating subelements move together. A *single route or lane* is used for ease of navigation, control, and reassembly. This decreases the size of the area for which detailed intelligence is required. *Multiple routes or lanes* are used to reduce the risk of compromising the entire force and to allow faster movement. However, multiple routes complicate control.

(8) **Other control measures.** Other measures are instituted as appropriate during infiltration planning.

(a) **Roads and trails.** These should be avoided. However, if they must be used, flank and rear security must be maintained. During the infiltration, radio should be used only with great caution. Using thermal imagery devices helps the infiltrating force avoid detection and contact.

(b) **Rally points.** These are easily identifiable places where units can reassemble or reorganize if they disperse. Rally points that provide cover and concealment are chosen along each route or lane. An ORP that does not compromise security is selected near the objective. Before they occupy it, units should reconnoiter and secure the ORP. It must be large enough to allow the infiltrating force to deploy.

b. **Penetration.** The infantry concentrates in a penetration to strike at the enemy's weakest point. They then break through the position to rupture the enemy's defense (Figure 3-3). A successful penetration requires the concentrated effects of all combat multipliers. This includes the use of limited visibility, stealth, and covered and concealed terrain at a selected breach point. If the METT-T analysis identifies multiple weaknesses in the enemy's position, then multiple penetrations are considered.

c. **Envelopment.** The basic form of maneuver is envelopment. An enveloping unit seeks to apply friendly strength against enemy weakness by striking the enemy in the flank or rear (Figure 3-4). The enemy must be forced to fight along undefended or lightly defended

avenues of approach. An envelopment can also interdict the enemy's lines of communication, which reduces his ability to fight.

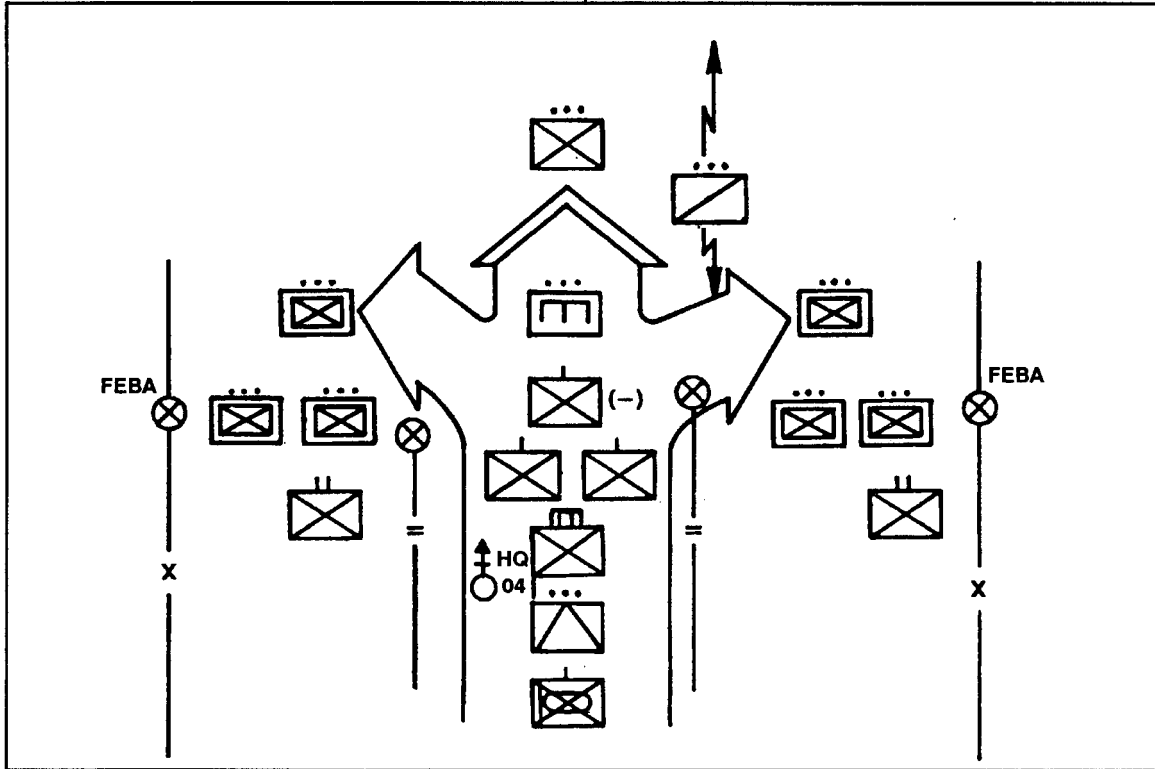

Figure 3-3. Battalion conducting a penetration.

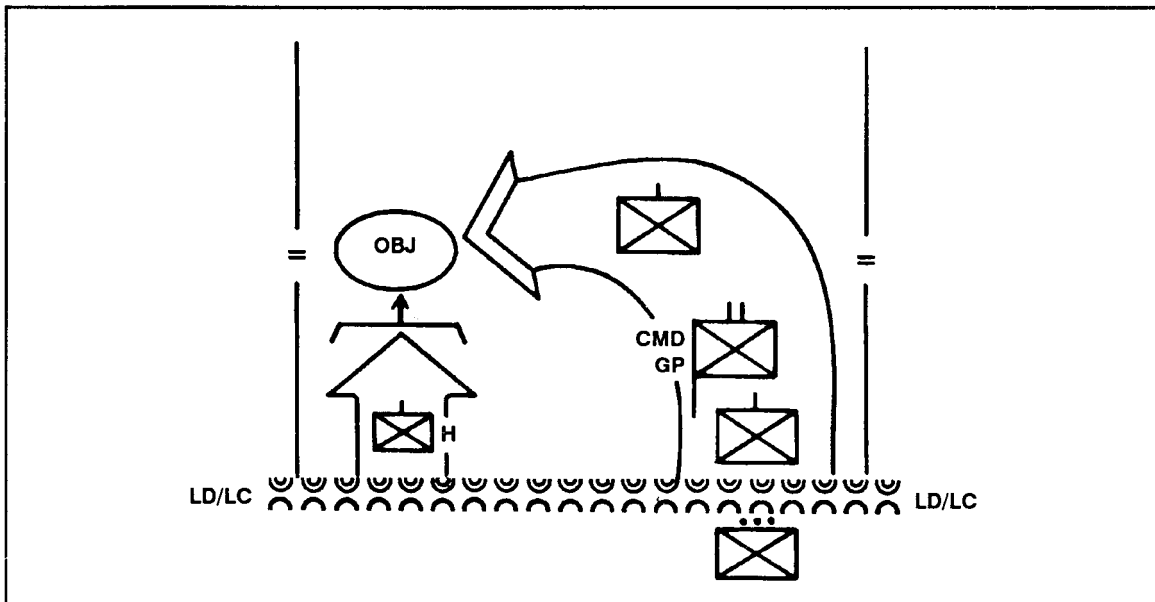

Figure 3-4. Battalion conducting an envelopment.

d. **Turning Movement.** The attacking force making the turning movement passes around the enemy, avoiding him entirely, to secure an objective deep in the enemy's rear area. This maneuver forces the enemy to abandon his position or to divert major forces to meet the threat (Figure 3-5). The selected objective must be along the enemy's LOC. The objective must be important enough to the enemy to cause him to abandon his forward defenses—for example, a key bridge over an unfoldable river.

e. **Frontal Attack.** The least desirable form of maneuver is the frontal attack. In a frontal attack, the most direct routes are used to strike the enemy all along his front. When possible, companies should try to seize their objective from a direction other than the front.

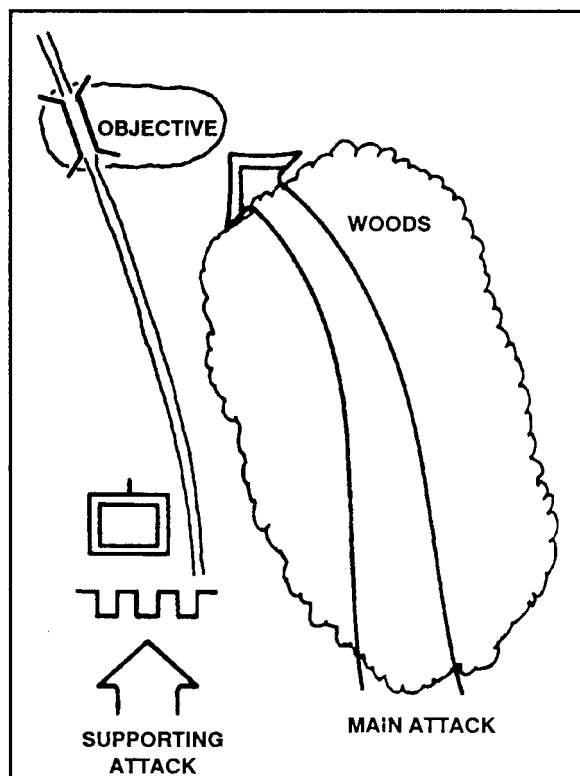

Figure 3-5. Battalion conducting a turning movement.

## Section II OFFENSIVE PLANNING

The considerations discussed in this section may be applied to all types of offensive operations. However, they must be applied IAW the command and control process explained in Chapter 2.

### 3-5. SCHEME OF MANEUVER

The scheme of maneuver is the commander's plan for placing or moving maneuver units to accomplish the mission. At battalion level, the scheme of maneuver is based on the mission, forces available, enemy, terrain, weather, space, and time. When supported by Army aircraft, the battalion can integrate air assault operations into the scheme of maneuver.

### 3-6. FIRE SUPPORT

The fire support plan states how fire is allocated or executed to support the maneuver plan. The battalion commander and his FSO integrate and synchronize the firepower of FA, mortars,

CAS and, when available, naval gunfire with the maneuver of combat units.

### 3-7. TASK ORGANIZATION

Task organization is the distribution of assets to subordinate control headquarters under the appropriate command or support relationship (Chapter 2). The brigade allocates resources to the battalion, as needed to accomplish the assigned mission, based on the brigade commander's estimate. Assets are not distributed on a "fair share" basis. If necessary, battalion commanders may request more assets from brigade. Task organization is changed during the operation only if changing conditions dictate.



a. **TOWS, MK 19s, and .50- Caliber Machine Guns.** These assets are usually used to support by fire and to secure the flanks of the main attack. Their main mission is to aid in the forward movement of the battalion. During limited visibility, the antiarmor platoon members can gather information through their sights.

b. **Aviation Assets.** These assets might be given to the commander to aid in offensive operations. Attack helicopters can target repositioning and counterattacking enemy forces and, during a movement to contact, can target exposed enemy positions. Lift assets can be used for maneuver, reconnaissance, command and control, deception (through false insertions), and CSS (depending on enemy air defense threat).

c. **Tanks.** These assets increase the combat power of an infantry battalion. Infantry and tank companies can be cross-attached to form task forces (Appendix D).

d. **Engineers.** These assets are controlled by the task force. Most missions performed by engineer units in the offense are mobility missions. However, they may also perform countermobility and survivability missions. Engineer units perform mobility missions and aid in breaching and reducing obstacles. Engineers move with the main effort and place breaching assets with the lead element. Some engineers can accompany the reconnaissance effort to identify obstacles, advise on breaching attempts, and aid in the selection of bypass routes. The engineer plan should include emplacing obstacles for flank protection during offensive operations.

e. **Air Defense Artillery.** Attacking maneuver elements are vulnerable to enemy CAS and attack helicopters. Stingers can be attached to the leading or overmatching company teams. Those under section or centralized control overwatch the task force maneuver and protect the combat trains and TOC. To increase forward coverage, Vulcans are left well forward under task force control.

(1) The priority of air defense protection is assigned to attacking maneuver elements when air defense missiles are available.

(2) The main means of air defense protection for the battalion is avoiding detection.

f. **Ground Surveillance Radar.** This asset has several uses. It can monitor enemy activity

on the objective; detect movement of enemy weapons systems into firing positions; or vector friendly forces through smoke, fog, and other limited visibility conditions. GSR can also monitor potential enemy counterattack routes during the attack and after seizure of the objective.

g. **Scouts.** These assets form the basis of the commander's reconnaissance and surveillance effort. They can reconnoiter to determine enemy dispositions, obstacles, and minefield; they also provide guides to aid in friendly unit movement. They can screen the battalion's front, flanks, or rear during movement. They can also occupy OPs from which they can see the battle and relay information to the battalion commander. Once contact is established, scouts can move around the enemy position and provide information that allows the commander to "see" more deeply into the enemy's sector. Scouts should concentrate on the most important information requirements—they should not be overtasked.

h. **Mortars.** These assets are the most responsive indirect fire available to the battalion. The mortar mission is to provide close and immediate fire support to maneuver units. (Chapter 7 provides more information on this subject.)

### 3-8. OFFENSIVE CONCEPT DEVELOPMENT

The restated mission statement and other critical facts and deductions provide the focus for the development of the offensive concept. (Chapter 2 provides more information about developing the course of action.) The commander—

a. Begins developing the concept with the decisive point on the objective and works backward to the LD. He considers the decisive action on the objective. As required, he considers the conduct of the breach; the positions of the support, assault, and breach elements; the leaders' reconnaissance; and any maneuvers from current locations to the assault positions. Once the commander has determined potentially decisive points(s), he develops his concept.

b. Determines decisive points and the times when combat power should be focused. The brigade commander's concept may focus the battalion on a specific decisive point and time.

c. Determines the results that must be achieved at decisive point(s) to accomplish the mission. Normally, the purpose (in the battalion mission statement) clearly states the desired results for the main attack. However, the commander may be required to analyze the situation again to determine the desired results.

d. Determines the purposes to be achieved by the main and supporting efforts throughout the operation. (The purposes of the supporting efforts must be linked clearly with the purpose assigned to the main effort.)

e. Determines the tasks for each subordinate unit (main and supporting efforts) essential to achieving the selected purposes.

f. Identifies types of forces required to accomplish the mission (companies, special platoons, and CS or CSS units, as appropriate). The commander allocates assets first to the main effort, then to the supporting efforts.

g. Assigns command and control headquarter for each of the task-organized units.

h. Completes a task organization by assigning all organic or attached units.

i. Establishes control measures that clarify and support the accomplishment of the assigned mission.

j. Ensures the main effort is weighted once the essence of the concept development—the part concerned with actions at the decisive point—has been completed. He can weight the main effort—

(1) By attaching additional platoons or weapons systems.

(2) By assigning priority of fire or allocating a priority target.

(3) By limiting the area of main effort responsibility to allow it to focus on the critical action.

k. Completes the concept development—

(1) By finishing the plan for movement of the unit from its present location through consolidation.

(2) By ensuring fires are integrated into and can support the maneuver plan.

(3) By ensuring CSS operations can support the plan through consolidation.

(4) By planning for contingencies.

### 3-9. BREACHING OPERATIONS

Obstacle breaching is the employment of a combination of tactics and techniques to project combat power to the far side of an obstacle. It is perhaps the most difficult combat task. Breaching is a synchronized combat arms operation under the control of an infantry commander. Infantry units employ breaching operations (FM 90-13-1).

a. **Types.** Breaching operations include in-stride, deliberate, assault, or covert breaches.

(1) **In-stride breach.** This rapid technique uses standard actions on contact and normal movement techniques. It consists of preplanned, well-trained, and well-rehearsed breaching actions and reduction procedures by predesignated combined arms elements. The in-stride breach takes advantage of surprise and initiative to get through the obstacle with a minimum loss of momentum. The force uses the in-stride breach against either weak defenders or against simple obstacles, and executes the breach from the march. Subordinate forces always move configured to execute an in-stride breach with organic and task-organized assets (except when a deliberate breach is planned).

(2) **Deliberate breach.** This technique is used when a maneuver force attacks a stronger defense or a more complex obstacle system. It is similar to a deliberate attack, requiring detailed knowledge of both the defense and the obstacle system. Subordinate elements are task-organized to accomplish the breach, and they receive specific missions and objectives for it. The deliberate breach often requires that the far side of the obstacle be secured by an assault force either before or during the reduction. Deliberate breaching operations require significant planning and preparation.

(3) **Assault breach.** This technique is used by the maneuver force to break a dismounted force by assaulting through enemy-protected obstacles onto the enemy position. Depending on the size and difficulty of the defensive obstacle system, the assault breaching procedure can be a variation of either the in-stride or deliberate breaching technique.

(4) **Covert breach.** This technique is used by light and dismounted forces to pass secretly through obstacles. The covert breach also uses elements of the deliberate or in-stride breach.

Surprise is the main factor in the commander's decision to conduct a covert breach. Covert breaching means using stealth to reduce the obstacle; support and assault forces only execute their missions if the reduction is detected.

b. **Organization.** The commander will organize the support, breach, and assault forces with the necessary assets to accomplish their missions.

(1) **Support force.** The primary responsibility of this force is to prevent the enemy from interfering with the breaching operation. Suppression is critical for a successful breach; therefore, the first priority of force allocation is the support force. The commander allocates direct-fire and indirect-fire systems to achieve a support force ratio of three-to-one for the deliberate attack. The support force must accomplish the following:

(a) Isolate the battlefield with fires and suppress enemy fires covering the obstacle.

(b) Mass direct and indirect fires to fix the enemy in position and to destroy any weapons that could bring fires on the breaching force.

(c) Control obscuring smoke to prevent enemy-observed direct and indirect fires.

(2) **Breach force.** The primary responsibility of the breach force is to create lanes to enable the attacking force to pass through the obstacle and to continue the attack. The breach force also marks the lanes along the length of each and at entry points to speed passage of the assault and follow-on forces. The breach force is a combined arms force. It includes engineers, breaching assets, and enough infantry force to provide local security. Since the support force may not be in a position to effectively suppress all enemy direct-fire systems, the breach force must be able to provide suppressive fires. The breach force secures itself from any small threat forces providing short-range protection of the obstacle. After reducing the obstacle, the breach force may be required to secure a lodgment on the far side of the obstacle, where the assault force could deploy into an assault formation. The breach force must be able to deploy and begin reducing the obstacle as soon as enemy fires have been suppressed. The engineers with the breach force are allocated and organized by platoons and must have the breaching assets

necessary to handle mines, nonexplosive obstacles, and small gaps. The breach force must be able to create at least one lane for each assaulting company; it must be able to create at least two lanes for an assaulting battalion. Once the breach force has reduced the obstacle and passed the assault force through, it hands over the lanes to follow-on units.

(3) **Assault force.** The primary responsibility of the assault force is to destroy or dislodge the enemy on the far side of the obstacle. The assault force secures the far side by physically occupying it. The assault force may be tasked to help the support force suppress enemy fires while the breach force reduces the obstacle. If the obstacle is defended by only a small force, the assault force mission may be combined with the breach force mission. This simplifies command and control, and provides more immediate combat power for security and suppression. The commander must be sure to leave sufficient combat power to overcome any defenders beyond the obstacle after all breaching element missions are accomplished. Fire control measures are vital to prevent fratricide, because both the support and breach forces are firing on the enemy when the assault force is committed. The support force continues to suppress overmatching enemy positions and to fix other enemy forces by fires until the enemy has been destroyed or dislodged. As support force fires are lifted or shifted, the assault force must assume control for direct fires on the assault objective. The battalion commander should allocate sufficient combat power to the assault force to achieve a three-to-one ratio on the assault objective. In the deliberate breach, the assault force maneuvers as a separate force, attacking through the breached obstacle. However, breach and assault assets may maneuver as a single force when conducting an in-stride breach.

### 3-10. LIMITED VISIBILITY OPERATIONS

Limited visibility is the basis for infantry battalion operations. Darkness, fog, heavy rain, and falling snow all limit visibility. A combination of technical ability (afforded by NVDs) and tactical prowess (afforded by training) allows the infantry battalion to operate routinely during these conditions.

Limited visibility operations strike the defender when the range of his weapons and the mutual support between his positions are reduced.

a. **Purpose.** Operations are conducted during limited visibility for the following reasons:

- (1) To achieve surprise.
- (2) To gain positions of advantage over the enemy by stealth.
- (3) To exploit success and maintain momentum.
- (4) To disrupt the enemy defense by infiltrating to key terrain in his rear.
- (5) To exploit US technological and training advantages.

b. **Conditions.** The battalion tries to conduct limited visibility attacks much like daylight attacks. However, techniques can vary. For example, units must observe more control measures during limited visibility than during daylight. Darkness complicates movement, navigation, and control. Moving and emplacing weapons take longer at night than in daylight. To simplify control, schemes of maneuver should be simple with well-defined objectives and routes. Leaders must be well forward in attacking echelons. Low light levels reduce the ranges of NVDs, and illumination adjustment must be more accurate to be useful.

c. **Impact.** Limited visibility conditions affect the plans of battalion and company commanders.

(1) Control of movement to the objective is difficult. Leaders down to squad level should have the chance to look at their routes and objectives during good visibility.

(2) Target acquisition is complicated by the difficulty of distinguishing friends from enemies.

(3) Radar efficiency drops in snow, rain, or fog; nonthermal NVDs help little. Thermal devices do help; they enable the user to see through most fog, rain, snow, and smoke. However, illumination during these conditions does not increase visibility and may even reduce it.

d. **Other Considerations.** Limited visibility operations offer advantages as well as disadvantages to both sides.

(1) **Attacker.** The attacker has more opportunities to infiltrate when enemy gunners and observers are restricted by limited visibility. If occupied objectives must be attacked, units can

move near the enemy undetected. However, a force that must assault during such conditions also has problems, though the effects of fog, rain, or snow are seldom severe enough to disrupt control at platoon level. Artificial illumination is normally ineffective.

(2) **Defender.** The defender knows the terrain and has weapons laid for FPFs. However, he is at a psychological disadvantage. His fears increase, and he is less likely to maintain security. The defender loses the ability to maintain mutual support between positions; also, he can no longer effectively engage targets of opportunity. His capability to rapidly reinforce with fire or movement and to detect infiltration is severely degraded.

e. **Attack of an Occupied Objective.** This type of attack is one of the most difficult military operations. Successful limited visibility attacks depend on direction, control, and surprise. Direction helps focus maneuver and firepower for decisive results. Control ensures that units and fires are mutually supporting and that objectives are identifiable and achievable. Control also reduces confusion and prevents fratricide. Surprise is critical. It reduces the enemy's ability to react or focus combat power against the attacker.

(1) **Attacks during limited visibility.** Attacks during limited visibility must be deliberate, not hasty, due to the control problems that could otherwise result for leaders from squad to battalion level. That is, time must be allowed to gather intelligence and then to develop a simple plan that everyone understands.

(a) **Simple plan.** Complicated moves that require coordination between converging forces invite disaster. Once the assault begins, changing the plan is difficult.

(b) **Rehearsals.** Soldiers must feel confident that they know where to go and what to do. To reduce confusion, the battalion rehearses when visibility is good. Leaders down to squad level must know exactly what is expected of them.

(2) **Planning considerations.** The following should be considered in planning and preparation for limited visibility attacks:

(a) **Reconnaissance.** The battalion should perform a detailed reconnaissance of the route of march, the attack position, mortar positions,

points of departure, and routes from the RPs to the PLD and to the objective under all visibility conditions. Terrain not held by friendly soldiers can be reconnoitered during the day by aircraft and from friendly vantage points. The need for detailed information about the enemy must be balanced against the risk of being detected and the loss of surprise. Reconnaissance is conducted by all leaders down to platoon level and, if time permits, to lower levels. Enemy obstacles must be located and plans made to breach or bypass them before the attack.

(b) *Synchronization.* Pyrotechnic signals, assault wire, or radio helps coordinate between overmatching and assault elements. Control measures, such as limits of advance, can also be used. As the battalion closes to locations where indirect fires must be shifted, the last round should be of an identifiably different type to signal that the shift has occurred. This helps to prevent fratricide from artillery fired on the objective.

(c) *Visual control measures.* Colored panels, arm bands, luminous strips or patterns, or other visual aids help in the control of forces. The battalion should avoid using aids that the enemy can also identify.

(d) *Surprise.* Surprise is achieved through speed and secrecy. Since surprise is neither constant nor lasting, it must be exploited rapidly.

(e) *Scheme of maneuver.* The battalion attacks in one direction only; changing direction during a limited visibility attack is difficult. By avoiding complicated movements, the battalion decreases the danger of firing on friendly soldiers. The commander planning a night attack must consider how visibility limitations will complicate controlling units, soldiers, and fires; identifying and engaging targets; navigating and moving without being detected; locating, treating, and evacuating casualties; locating and either bypassing or breaching enemy obstacles.

(f) *Illumination.* Units with sufficient NVDs normally conduct nonilluminated attacks to exploit their technological and training advantage. Artificial illumination is optional. However, it is always planned in case the enemy detects the attack and uses his own NVDs or illumination. Surprise can sometimes be gained by withholding illumination until the enemy either places effective fires on the attacker or illuminates the

battlefield. Tactics for an illuminated attack are like those for a daylight attack. Authority to fire illumination is often retained by the battalion commander, because illumination will also expose adjacent unit operations. Illumination rounds may be fired so they hit the ground; this orients the attack by providing light and marking the objective. Illumination rounds may also be fired so they hit behind the objective and silhouette the enemy. Once illumination has begun, it should continue until the objective is secure.

(g) *Supporting fires.* Indirect fire is planned and used for supported attacks; it is planned only as a contingency for unsupported attacks. Even when available, indirect fire is used only if the expected gain outweighs the loss of surprise. When used, supporting fires are planned and controlled as they would be in a daylight attack. Once the assault on the objective begins, indirect fires are used to suppress and isolate the objective and to prevent or limit counterattacks. Before and during the attack, the battalion maintains routine fires on other targets. These fires should not alert the enemy; instead, their purpose is to help maintain secrecy by muffling the noise of the advancing force. Positions for supporting weapons are reconnoitered and marked, and firing data are prepared in daylight. Weapons are moved at night.

(h) *Communications.* The battalion maintains radio listening silence until the attack is discovered. When the enemy discovers the attack, radio listening silence is lifted. Other means of communication, such as pyrotechnic signals and electronic devices, are also planned and employed.

f. **Conduct.** Limited visibility assault techniques depend on the level of training and on the type and number of NVDs available to the battalion.

(1) A battalion equipped with sufficient NVDs conducts limited visibility assaults based on the same fundamentals used for daylight assaults. (FM 7-10 provides more information on NVD-aided limited visibility assaults.) This type of assault requires—

- A battalion of soldiers who are well trained in limited visibility assaults.
- Sufficient natural light to employ the unit's NVDs.

- A simple, effective concept that takes advantage of the enemy's surprise and confusion.
- A successful reconnaissance of the objective area.
- Additional control measures, techniques, or both, as needed.

(2) The following applies to all limited visibility assaults, regardless of the type of NVDs the battalion has:

(a) *The advance.* Commanders remain well forward during the advance to the objective. They do this to ensure navigation, fire support, aggressive movement, and coordination. Leading elements dispose of enemy security forces encountered during the advance. This might require friendly forward elements to deploy early.

(b) *Actions on the objective.* A simple concept supports control during the assault. A small assault force maneuvering on the objective is easier to control and less likely to suffer casualties from friendly or enemy fires.

The assault element must have clear signals to ensure control of all direct and indirect supporting fires. (FM 7-10 provides specific details about fire control techniques.)

(c) *Consolidation and reorganization.* The battalion sends out security elements when it seizes the objective. The purpose of these security elements is to detect enemy forces forming for counterattack. They also provide early warning of enemy reinforcements. During consolidation and reorganization, the security elements use thermal devices and passive and infrared NVDs. If they use illumination, the attacking unit will suffer from night blindness for 15 to 30 minutes after the illumination stops. Task organization should not be changed. Guides should lead trains and support elements forward to their positions. Casualties may be moved to the rear of the objective and kept there until further evacuation is possible. Before daylight, all elements should be in position, prepared to continue the attack or defend the position.

### Section III MOVEMENT TO CONTACT

A movement to contact is an offensive operation conducted to gain or reestablish contact with the enemy. Its purpose is also to develop the tactical situation. To maintain flexibility and security when moving to contact, the battalion makes contact with the smallest element possible. This is most important for infantry battalions due to their limited mobility and dependence on restrictive terrain. Two of the techniques used most commonly by infantry battalions to conduct a movement to contact are the approach march technique and the search-and-attack technique.

#### 3-11. PLANNING

The battalion tries to establish contact on ground of its own choosing and to develop the situation more rapidly than the enemy does.

a. Two contradictory factors are involved in the movement to contact—the battalion must be both aggressive and cautious.

(1) *Aggressive.* The battalion moves as aggressively and rapidly as the terrain and enemy situation allow. Moving too slowly can jeopardize the success of an operation by giving the enemy time to move or to fire on the force.

(2) *Cautious.* The battalion must avoid blundering into enemy killing zones.

b. Aviation and modem intelligence-collection devices reduce the chance of unexpected contact between combatants. However, adverse weather and rough, broken terrain increase the chance that the movement to contact will result in a chance contact between two forces.

c. Units must prepare to initiate or continue the movement to contact during limited visibility. For example, at night, approaches are harder to make, direction and control are harder to

maintain, enemy forces can be more easily bypassed, and enemy kill zones can be entered more easily. To compensate for these disadvantages, the battalion uses NVDs and reduces its rate of movement (Section V).

### 3-12. APPROACH MARCH TECHNIQUE

The approach march is an advance of a combat unit when direct contact with the enemy is imminent. Troops are fully or partially deployed. The approach march ends when ground contact with the enemy is made or when an attack position is occupied. The approach march technique is the "conventional" technique for conducting a movement to contact. Using this technique, battalions normally organize into a security force, advance guard, main body, flank guards, and rear guard (Figure 3-6). These guarding elements move with and secure the main body.

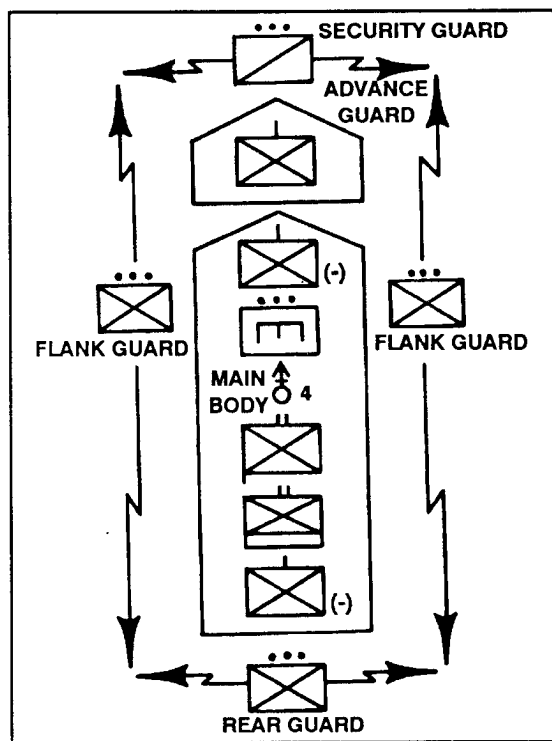

Figure 3-6. Single battalion in march column.

a. **Planning.** Planners of the approach march should consider the following:

(1) The commander should assign the unit an axis of advance or a zone. He assigns a march

objective to orient movement. The unit might not be required to seize, hold, or occupy the march objective. The objective can be any terrain feature that is easy to find and that is at a depth sufficient to ensure contact. If the unit does not contact the enemy before reaching the march objective, it establishes hasty defenses and seeks guidance from higher.

(2) The commander must select routes for the approach march based on his IPB. Based on guidance from the brigade commander, he should seek approaches that offer cover and concealment for the force but that allow contact with elements of any size. He should use flank and rear guards for all-round security. The well-armed guard forces should be located to protect the force and to allow the main body time to deploy if the enemy attacks.

b. **Organization.** The battalion organizes into a security force, advance guard, main body, flank guards, and rear guards when it is conducting the movement to contact alone.

(1) **Employment of support assets.** Units should be close enough that succeeding units can rapidly aid the unit ahead. However, they should be far enough apart that enemy fire falling on the leading unit does not limit the trailing unit's ability to maneuver. Support assets are used as in a search and attack except as follows:

(a) **Antiarmor assets.** Most antiarmor assets provide protection for forward and flank guard units. Except for the units held in reserve, antiarmor units displace forward by echelons to successive selected positions.

(b) **Tanks.** A tank platoon, if available, can be OPCON to the company providing the advanced guard. These tanks move under the control of the company commander and are committed with the company using tank/infantry formations and tactics (Appendix D). As they can, the tanks move by bounds to positions where they can support by fire. Employment of antiarmor assets for overwatch frees tanks to move farther forward.

(c) **Air defense.** Air defense weapons are dispersed in movement formations to provide continuous air defense coverage of the battalion. In addition to moving with the main body, ADA elements can also operate from key terrain overmatching the route, cooperating with the flank guards.

(d) *Engineers.* Engineers are task-organized (either attached or OPCON) forward within the battalion. This ensures engineers are available to conduct an in-stride breach. Small engineer elements help scouts breach the obstacles by stealth. The engineers could be OPCON to the advance guard; engineers conduct breaching operations better as intact platoons or larger forces. Infantry should be trained and prepared to execute limited mobility/countermobility/survivability missions with or without engineer support. Information on damaged bridges and other obstacles is relayed rapidly to higher headquarters. This keeps follow-on units from “stacking up” and allows the commander time to change the route of march if required.

(e) *Electronic warfare.* Military intelligence assets can accompany the battalion and can be employed on threatened flanks as part of the guard force.

(f) *Aviation.* CAS assets are used the same as in search-and-attack operations.

(g) *Close air support.* Support assets are used the same as in search-and-attack operations.

(h) *Artillery.* Artillery must be in position to provide continuous and responsive support to leading elements. To avoid accidentally getting in front of the fires of friendly artillery, the commander and FSO must maintain close contact with supporting artillery elements. Mountainous terrain increases the need for combat aviation, close air, and mortar support. The FSO plans on-call fires on likely enemy locations (based on the IPB). As the force advances, on-call targets are updated. Using indirect fire on prominent terrain can help the battalion navigate. The FSO must also plan fires to the flanks, mainly those with high-speed avenues of approach.

(i) *Mortars.* The priority of battalion mortars during the approach march is to the advanced guard, because mortars can respond rapidly. The mortar platoon must prepare to engage targets at once using direct-lay, direct-alignment, or hip-shoot techniques of engagement.

(j) *Command posts.* The commander positions himself during the approach march so he can receive information, see the ground, and plan ahead for the deployment of his subordinate units. After the unit makes contact with the

enemy, the commander should be far enough forward to influence the battle at the critical time, but not so far that he loses control of the battalion. Lateral liaison can be setup with flank units.

(2) *Security forces.* The battalion can employ more R&S and security forces to the front and flanks during an approach march. Depending on METT-T, security forces operate 2 to 6 kilometers forward of the advance guard. Once they find the enemy, the security force should remain oriented on him.

(a) The scout platoon is deployed forward of the battalion. The scout platoon’s task is to locate the enemy. While moving to do so, it can reconnoiter routes or zones over which the battalion will advance. Because it must investigate lateral routes and check key terrain, the scout platoon might require vehicles/aircraft for increased mobility. To reduce the number of tasks each scout team must perform, more soldiers from maneuver companies might be required. If available, engineers may help scouts develop obstacle intelligence.

(b) The scout platoon tries to maintain contact with a higher unit covering force, if one is employed, or positions LOS with the covering force. Once the strength and location of enemy positions are known, the battalion deploys and the scout platoon moves to provide flank security.

(3) *Advance guard.* The advance guard operates 1 to 2 kilometers ahead of the main body to develop the enemy situation, to provide for the uninterrupted advance of the main body, to protect the main body from surprise, and to cover the deployment of the main body if it is committed to action (Figure 3-7).

(a) The critical tasks for the advance guard include the following:

- Reconnaissance along the main body of advance.
- Continuous surveillance of avenues of approach.
- Destruction of enemy reconnaissance and security elements.
- Prevention of enemy ground forces from engaging the main body with direct fire.

(b) The battalion can be designated as the advance guard when it is the lead element of a larger force (except for the covering force).



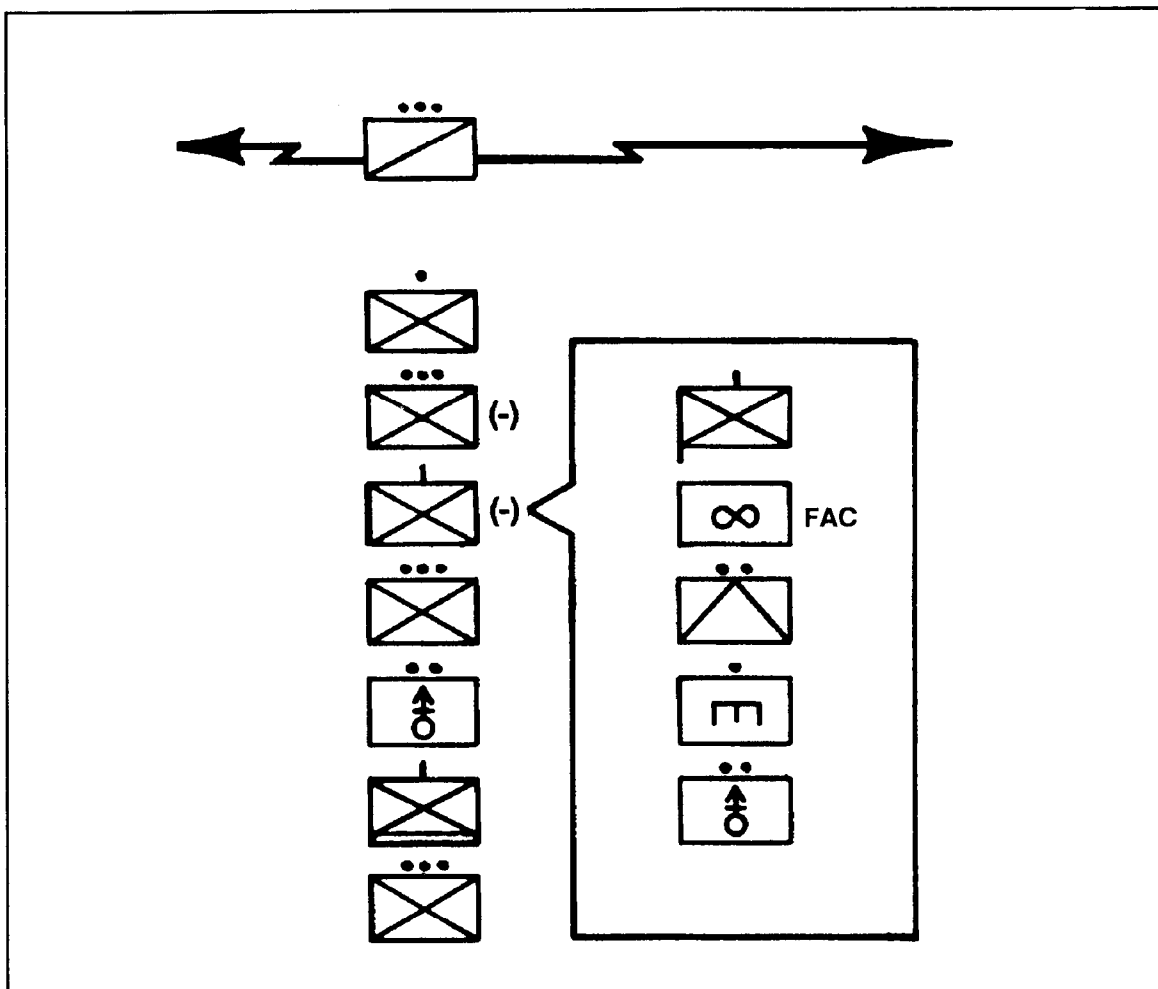

**Figure 3-7. Organization of an advance guard.**

When the battalion moves alone, the commander designates a reinforced rifle company as the advance guard. The advance guard provides its own flank and rear security.

(c) The lead element of the advance guard is a rifle squad. The squad advances steadily by traveling overwatch until it draws fire or sights the enemy. This allows the main body to advance rapidly and steadily. Rifle squads rotate for efficiency, especially after contact.

(d) The lead platoon may be reinforced with a 60-mm mortar squad from the company mortar section. If the terrain and enemy situation allow and if a vehicle is available, the vehicle can be attached to follow the platoon with a mixed load of ammunition (FLASH, bangalore torpedoes, and line charges) to eliminate enemy positions and to breach obstacles.

(e) The lead company can be reinforced with a section from the battalion mortar platoon. An engineer detachment can be added to work with the company FSO and with TACP/ANGLICO elements; this detachment can reconnoiter and breach obstacles.

(4) **Flank and rear guards.** Flank and rear guards are designated when enemy contact on an approach march is possible.

(a) Flank guards operate between the rear of the advance guard and the front of the rear guard to protect the flanks of the main body. Depending on METT-T, they try to operate 1 to 2 kilometers from the main body.

(b) Flank and rear guards are usually no more than platoon-sized when the battalion is conducting an independent movement to contact. Company-sized or larger guard forces

from the battalion might be needed when the battalion is moving to contact as part of the brigade.

(c) Flank guards remain within supporting range of the main body. They provide information and early warning unless ordered to attack enemy forces. To enhance the effects of the artillery, engineer countermobility assets—for example, Volcano or GEMSS minelayers—are used to support the flank guard. Helicopters or vehicles can be used to “leap frog” elements. The main body must try to maintain sight contact with flank elements. Flank guard elements need radios to accomplish their mission. If antiarmor sections are operating with the flank guard, then the antiarmor radios might suffice.

(5) **Main body.** The main body comprises most of the battalion force when the battalion moves to contact. Units in the main body must know the situation at all times. To avoid bypassing enemy units and to prevent the enemy from infiltrating, the main body maintains local security. Commanders try to balance conservation of the battalion’s fighting strength with the need for march discipline and security. Commanders lighten the soldier’s load as much as possible and allow soldiers to ride when the tactical situation permits and vehicles are available.

c. **Conduct of the Approach March.** The battalion should follow several guidelines during movement:

(1) The battalion makes contact with the smallest possible force.

(2) The commander selects the movement technique based on the likelihood of enemy contact and speed of movement desired. Bounding overwatch provides the best security, but traveling overwatch is faster. Tanks lead if available and if the terrain allows.

(3) The commander visualizes how his force will be deployed when contact is made and moves it accordingly. He moves the battalion on either single or multiple columns.

(a) **Single column.** A single column is used for ease of control or when the terrain permits movement on one axis only. Its disadvantages are that it permits the enemy to achieve maximum delay with minimum force, requires more time to deploy than multiple columns, and increases the length of the column. When

sufficient trafficable routes are available and the battalion commander wants a wider band of security to the front, he can organize two reinforced platoons into advance parties to move on parallel routes. Then, if one route is blocked by the enemy or is otherwise unsuitable for movement, the rest of the battalion (moving in single column) can shift to the other route. Battalions moving in single column move cross-country or by roads as required.

(b) **Multiple columns.** Multiple columns allow greater security to the flank, are quicker to deploy than a single column, and allow mutual support. Though this formation complicates control, multiple columns do present multiple threats to the enemy. The command group moves in the column where it can best influence the overall action. An alternate command group under control of the XO, S3, or antiarmor company commander (as designated by the TOE) can be formed to move in the other column. The columns move within supporting distance of each other and maintain contact. When the columns are widely separated and contact is not possible, separate flank guards can be established for and controlled by each column.

(4) The commander must consider other factors also, even though a single column is easier to control than multiple columns.

(a) **Number of units.** A battalion reinforced with several other maneuver and CS elements might be forced to move in multiple columns to reduce the length of the column.

(b) **Enemy situation.** The battalion should move with depth and minimum forces forward-in single column-when the enemy is known to be in a defensive posture. A mission such as a zone reconnaissance might require multiple columns.

(c) **Width of zone.** A wide zone favors multiple columns, particularly if the zone must be cleared.

(d) **Routes.** Advancement in multiple columns requires adequate maneuver space for forward and lateral routes.

### 3-13. SEARCH-AND-ATTACK TECHNIQUE

The search-and-attack technique is a decentralized movement to contact, requiring multiple, coordinated patrols (squad-sized and platoon-sized) to locate the enemy. It is most

often used in low-intensity conflict (Appendix C) against an enemy operating in dispersed elements. When conducting a search and attack, units can expect to spend more time operating in an area of operations rather than just “sweeping” through it. Search and attack can be conducted for many reasons. (FM 7-10 provides more information on search and attack.)

a. **Purpose.** The commander’s concept focuses the battalion on one or more of the following:

(1) **Destruction of enemy.** Enemy units operating in the area must be killed or captured.

(2) **Area denial.** The enemy must be prevented from operating unhindered in any area—for example, in any area he is using for a base camp or for logistic support.

(3) **Force protection.** The enemy must be prevented from disrupting and destroying friendly military or civilian operations,

equipment, and property such as key facilities, brigade headquarters, polling places, or dams.

(4) **Information collection.** Intelligence preparation of the battlefield, if not provided by higher, must be done as soon as the battalion enters an area, before it conducts any of the above activities.

b. **Tasks.** Search-and-attack operations can be conducted in a company-sized or battalion-sized area of operations. Figure 3-8 shows an example of a unit dispersing to search and Figure 3-9, page 3-20, shows an example of a unit massing to attack. The unit can be tasked—

(1) To locate enemy positions or routes normally traveled by the enemy.

(2) To destroy enemy forces within its capability or to fix or block the enemy until reinforcements arrive.

(3) To maintain surveillance of a larger enemy force through stealth until reinforcement arrive.

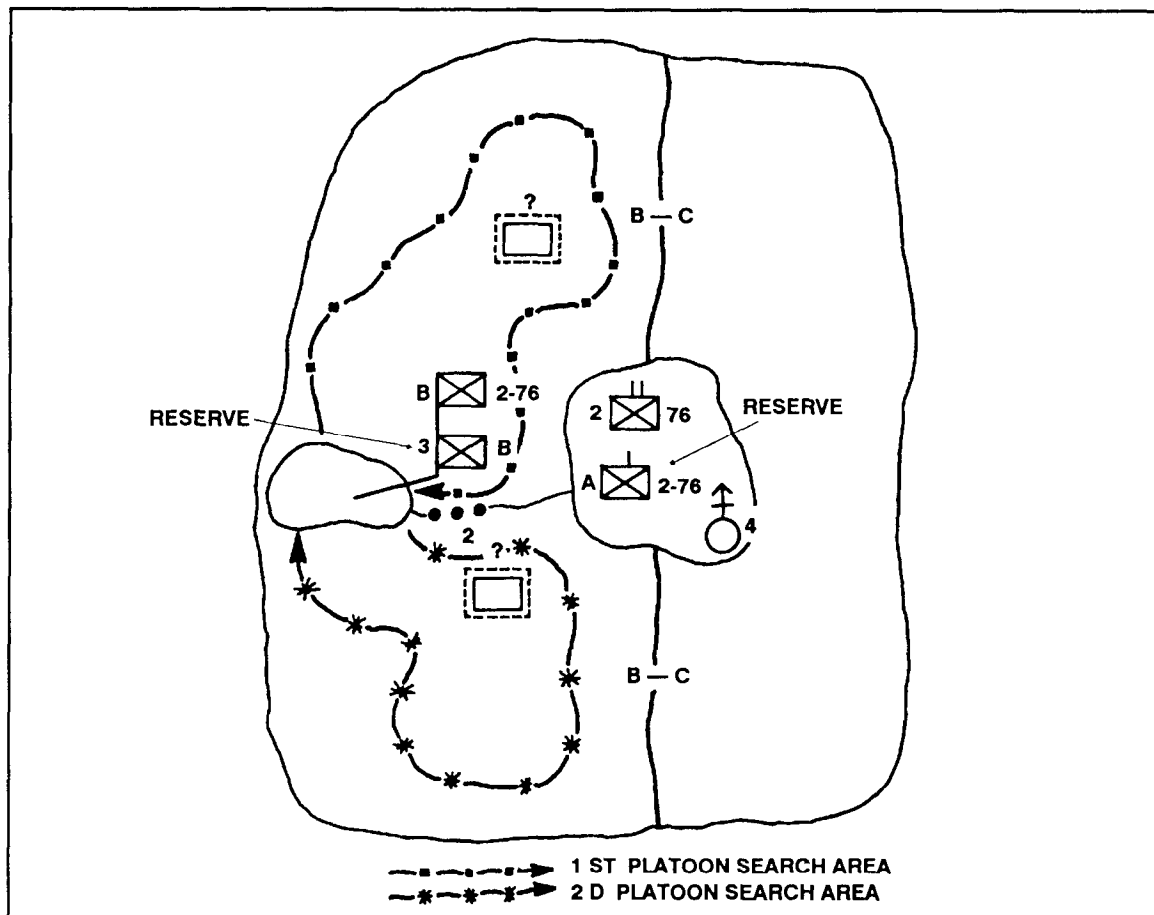

Figure 3-8. Example of unit dispersing to search.

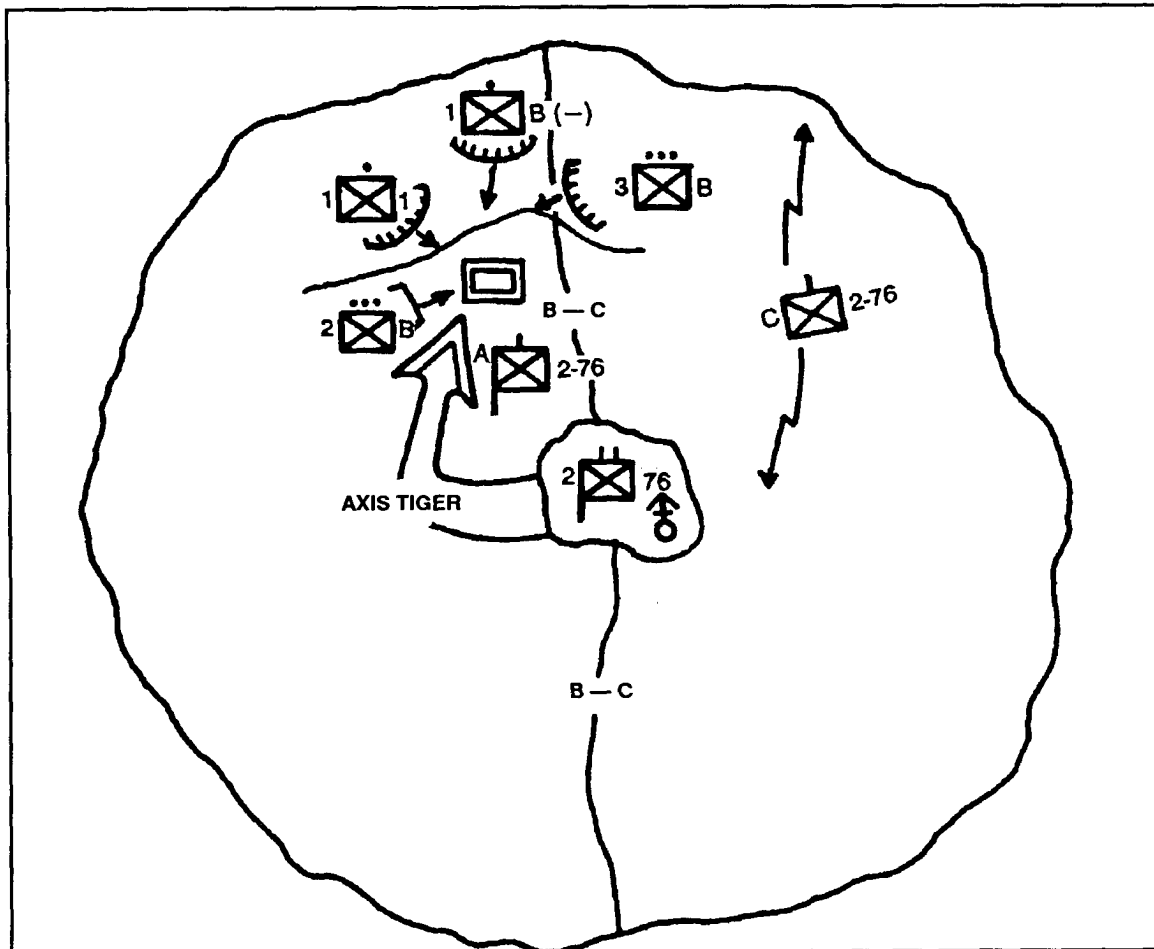

Figure 3-9. Example of unit massing to attack.

(4) To setup ambushes.

(5) To search towns or villages. (A host nation representative should accompany the search party.)

(6) To secure military or civilian property or installations.

(7) To act as a reserve.

**c. Concept Development.** The commander must consider the following when developing his concept:

(1) **Finding the enemy.** Much time may be required to pattern enemy operations. However, the commander will be effective only once the pattern has been identified.

(a) The commander may consider using another technique to find the enemy. He can subdivide his area of operations into smaller ones and have the scout platoon stay a step ahead of

the rest of the battalion (Figure 3-10). The scout platoon should be reinforced for this operation. In this example, it conducts a zone reconnaissance in AO Green, while the remainder of the battalion conducts search-and-attack operations in AO Blue. At a designated time, the commander directs the battalion to link up with the scouts at Contact Point 1 to exchange information. If necessary, the scouts guide the battalion to sites of suspected or confirmed enemy activity. The scouts can then move on to reconnoiter AO Red. (This process is repeated for other areas of operations until it is stopped by the commander.) The commander may decide to emplace sensors along the border from AO Red to AO Blue to identify enemy attempts to evade the battalion. In Figure 3-10, a squad has been tasked to emplace and monitor the sensors.

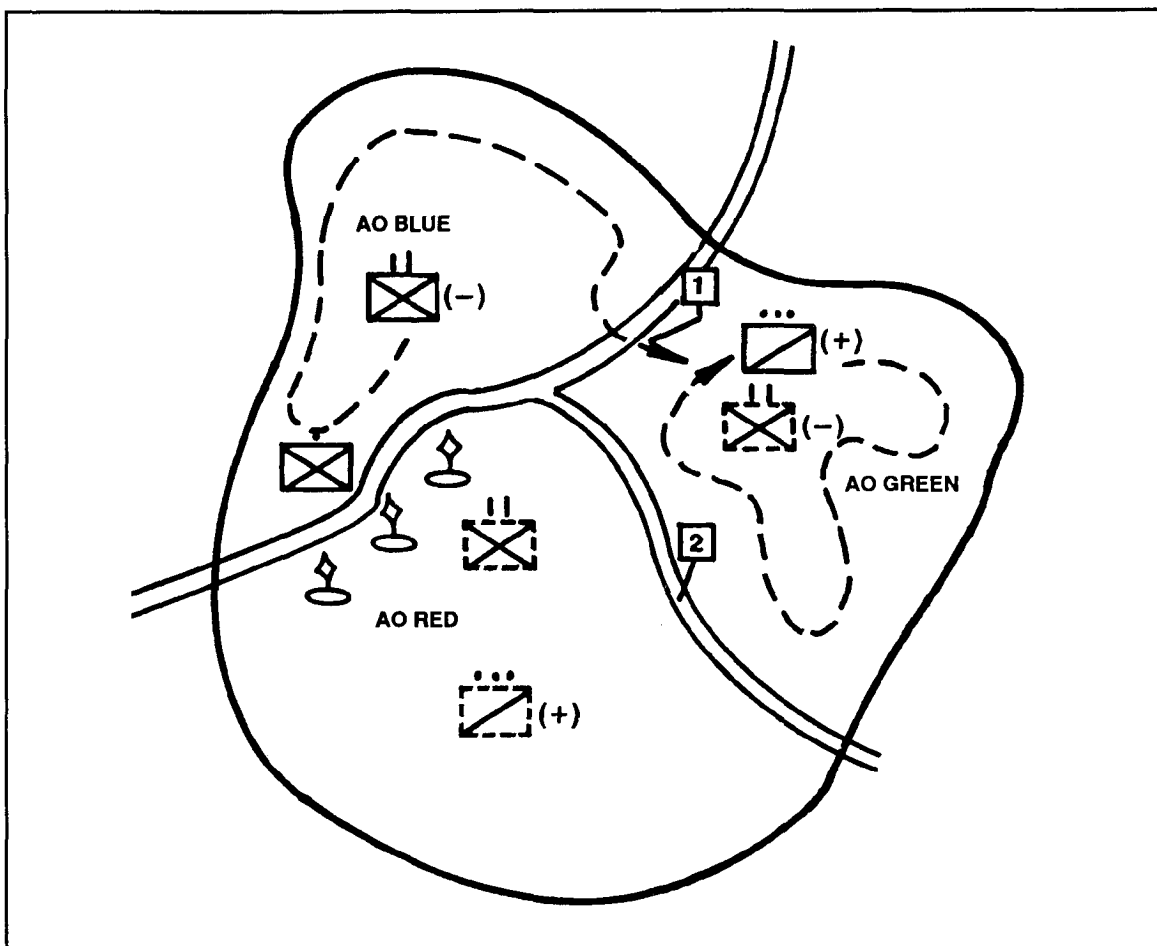

**Figure 3-10. Example search-and-attack method with scouts forward.**

(b) The successive method of reconnaissance just discussed, in which the scouts reach the area of operations before the remainder of the battalion, allows the scouts more chances to gain information on enemy activity in the area. It also helps the battalion commander focus his search-and-attack operation when the battalion moves to the new area. Logistical support for the reinforced scout platoon is most often provided by cache or airdrop.

(2) **Firing the enemy.** The unit will conduct one of the following actions after developing the situation, based on the commander's guidance and on METT-T factors:

(a) Prepare to block enemy escape/reinforcement routes for another unit's attack. The unit maintains contact and positions its forces to isolate and fix the enemy so another unit can attack

Control measures and communications must be established between closing units to prevent fratricide.

(b) Conduct a hasty attack. The unit will do this if it is in line with the commander's guidance and if the available friendly forces can generate enough relative combat power.

(c) Maintain surveillance. The unit avoids detection so it can report enemy dispositions, composition, and activities. The unit must use stealth to be successful in this effort.

(d) Remain undetected and follow the enemy. The unit does this to continue to gather information. It must be careful to avoid an enemy ambush.

(3) **Finishing the enemy.** Battalions destroy enemy forces during a search and attack by doing the following:

(a) Conduct hasty or deliberate attacks, or maneuver to block enemy escape routes while another unit conducts the attack.

(b) Conduct R&S activities and collect information while remaining undetected to develop the situational template.

(c) Employ indirect fire or CAS to destroy the enemy. The battalion may establish an area ambush and use these assets to drive the enemy into the ambushes.

d. **Execution.** The commander must do the following to help ensure successful synchronized and decentralized operations:

(1) Specify where each unit will operate, establish measures to consolidate units before attacks, and establish fire control measures for each unit. The commander seeks the most likely locations of enemy base camps, command and control sites, ADA sites, and mortars (Appendix C). He designates the company most likely to make contact as the main effort and prepares to shift the main effort rapidly, if necessary.

(2) Concentrate battalion combat power. He does this so that once a patrol finds the enemy, the battalion can fix and destroy him rapidly.

(a) Each company operating in a dispersed company area of operations can be tasked to destroy the enemy within its capability. The battalion commander can direct each company to retain a reserve; or, he can retain a battalion reserve and provide additional mobility assets. He tries to arrange for indirect-fire weapons that can respond to all companies as needed. He uses the reserve, priority of fire, and other available assets to weight the main effort.

(b) The battalion commander considers means to fix or contain the enemy if the company cannot destroy him. The commander uses the battalion reserve, FA, or CAS to do this. Aviation assets increase the mobility of the battalion reserve.

(3) Provide control, but allow for decentralized actions and small-unit initiative.

(4) Ensure CS assets support the main effort while remaining responsive to the rest of the battalion. Mortars remain GS to the battalion. If the mortar platoon cannot support the entire dispersed battalion, the commander may consider splitting the platoon into sections.

#### e. **Employment of Support Assets.**

Synchronization of CS and CSS assets is harder to achieve in search-and-attack operations than in most other types of operations. Distances between units, the terrain, and a vague enemy situation contribute to this difficulty. Combat and combat support assets are employed as follows:

(1) **Antiarmor assets.** The antiarmor unit selects TOW positions where it can provide direct-fire support. Based on his estimate, the commander can use the MK 19, the .50-caliber machine gun, or the M60 machine gun in place of the TOWs against light vehicles, for convoy security, or in dismounted operations. However, the antiarmor platoon can also provide mobility and additional firepower for the reserve and, during limited visibility, can augment security forces at key locations, monitoring areas where the enemy is expected to travel at night.

(2) **Tanks.** Tanks can have great value during search-and-attack operations. They can be used in combat operations to assault, to support by fire the assault of an infantry unit, or to clear fields of fire around key defensive installations. Tanks support CS and CSS activities by conducting convoy security, hauling supplies, and aiding with deception.

(3) **Artillery.** The FSO prepares fire plans for hasty attack contingencies and can request that a COLT from brigade be attached to the main effort company. Mountainous terrain increases the need for combat aviation, close air, and mortar fire support.

(4) **Mortars.** The priority of battalion mortars during the search and attack is normally to the main effort. Mortars usually collocate with another unit for security.

(5) **Air defense.** The battalion can have Stingers and Vulcans attached during a search and attack. In addition to providing security for the CP or moving with the main body, ADA elements can also operate from key terrain overmatching the route. If they do so, they must also have additional security.

(6) **Engineers.** Engineers provide advisers to help identify breach points in enemy defenses and methods. When the battalion has tanks available, engineers conduct route reconnaissance, determine bridge classifications, and find or make bypass routes where necessary.

If demolitions or chain saws are available, engineers can clear LZs for helicopter support.

(7) **Aviation.** Aviation units (assault and attack) can reconnoiter, guide ground forces to the enemy, provide lift and fire support assets for air assaults, direct artillery fires, aid command and control, and protect the flanks. Attack helicopters can reinforce when antiarmor firepower is used to block the enemy.

(8) **Close air support.** TACPs are located well forward to increase the speed and accuracy of CAS. To reduce the danger of fratricide, the battalion must issue aircraft identification panels or other means of identification to its soldiers.

(9) **Command posts.** The commander positions himself to receive information during the search and attack. He plans ahead for shifting assets or committing the reserve. After a unit makes contact with the enemy, the commander must reach the critical point rapidly.

### 3-14. ACTIONS ON CONTACT

Commanders at all levels must know their higher commander's intent and concept for actions on contact so that no time is lost waiting for orders (Figure 3-11). These engagements often occur in small-unit operations and where reconnaissance has been ineffective. One of the most important aspects of actions on contact is to fight through at the lowest level unit possible.

a. Movements to contact are characterized at all echelons by aggressive offensive action. The advance guard pushes back or destroys small enemy groups before they can hinder the advance of the main body. When the advance guard encounters large enemy forces or heavily defended areas, it acts promptly and aggressively to develop the situation and, within its capability, to defeat the enemy.

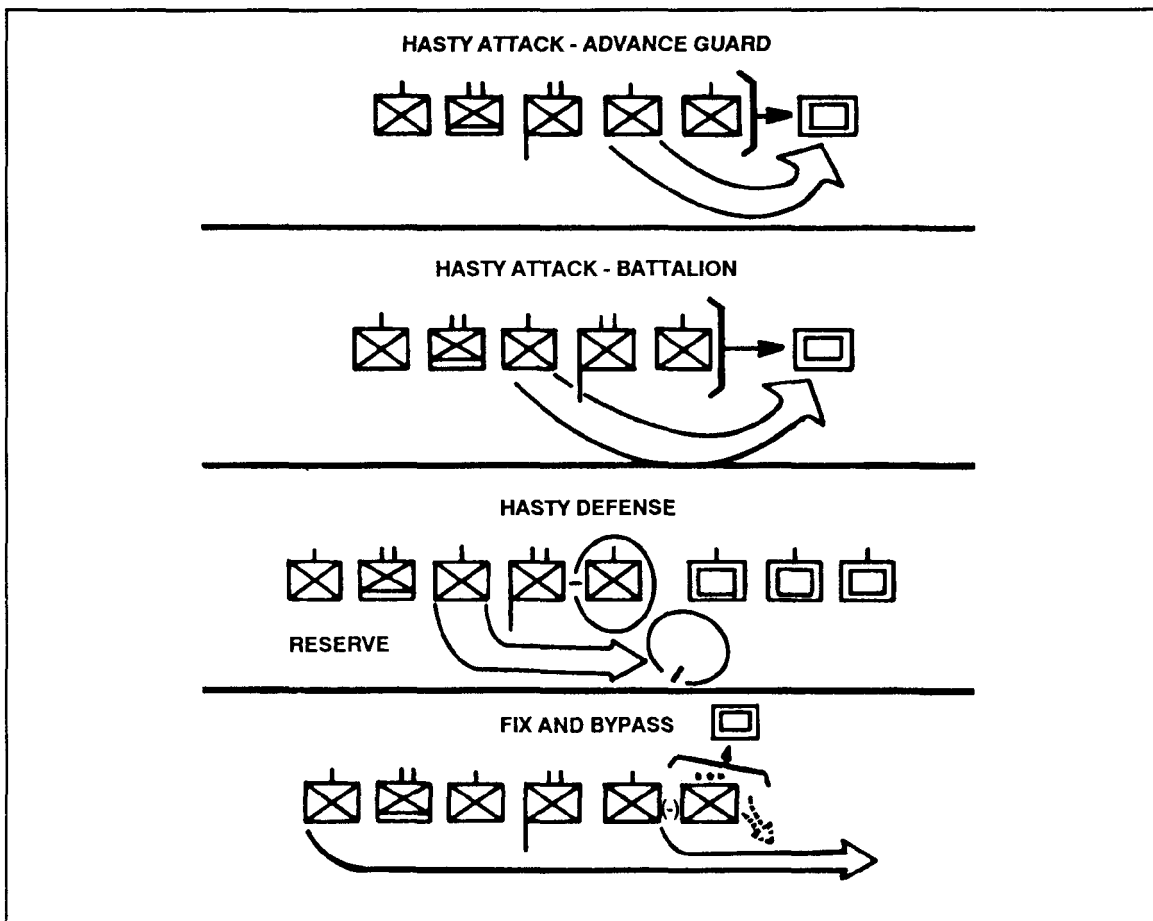

Figure 3-11. Actions on contact.

(1) Available combat power might be insufficient to eliminate the threat. The advance guard can then be used to identify enemy dispositions and to contain enemy forces until main body elements can be committed.

(2) The battalion commander must decide, if the advance guard makes contact, whether to order the advance guard to destroy the enemy and continue with the movement to contact. He can order a company to fix the force and to bypass with the rest of the battalion. Or, he can order the company to conduct a hasty attack as part of the entire battalion. If the battalion cannot overcome or bypass the enemy, the battalion commander can conduct a hasty defense while the brigade commander develops the situation.

b. Light enemy resistance should not slow the advance; the battalion must remain mission-oriented. If the enemy is weak and a bypass is authorized, the battalion should use a covered route to suppress and obscure him while bypassing. Commanders must report all bypassed forces to higher headquarters.

c. The battalion can withdraw to a more favorable position and can maintain contact through patrols if its encounter has been unsuccessful and if it is in a bad position in close contact with the enemy. If the enemy can be induced to follow up the withdrawal, the battalion might have an opportunity for another offensive move.

## Section IV ATTACKS

The objective of offensive operations is to defeat the enemy. This is best achieved by getting through the enemy's defenses and into his rear area. Inside the enemy's rear area, the battalion can destroy the enemy's artillery positions, CPs, logistical support areas, ADA positions, and lines of communication. The two types of attack are hasty and deliberate. A hasty attack differs from a deliberate attack only in the amount of time spent developing the plan. The commander's intent, scheme of maneuver, and plan of fire support form the basis for all attacks. Each attack should strike a weak front, flank, or rear area.

### 3-15. HASTY ATTACK

A hasty attack is one in which preparation time is traded for speed to exploit an opportunity. The commander can conduct a hasty attack to destroy the enemy after a movement to contact (Figure 3-12); he can conduct a hasty attack to maintain momentum following the seizure of an objective; or, he can conduct a hasty attack to gain or maintain the initiative following a successful defense against an enemy attack.

a. Clausewitz stated that "time not used by the attacker benefits the defender." When the enemy is unprepared for defense, a hasty attack might be appropriate. Therefore, it is appropriate if the enemy's fortifications are poorly constructed or nonexistent, if his defenses are shallow, or if gaps exist between his units.

b. Tactical units use SOPs and battle drills to switch rapidly to a hasty attack. The scheme

of maneuver must be simple and the form of maneuver appropriate to the conditions.

c. Forces in contact deploy and engage the enemy. They report the size and composition of the enemy force, the location of enemy flanks, and routes through or around enemy positions. To support the scheme of maneuver and to synchronize supporting assets, commanders issue FRAGOs to all units.

d. The enemy is fixed in position and isolated from reinforcements. Overwatch units suppress his known and suspected positions with direct and indirect fire. TOWs provide antiarmor suppression and overwatch; scouts push forward and observe likely enemy counterattack routes; indirect fires block enemy routes of reinforcement and withdrawal; FA and mortars provide smoke to screen or deceive. If the enemy is stationary, he can be



destroyed in position. If he is mobile, an engagement area can be established. If he is withdrawing, he can be pursued by fire, movement, or both.

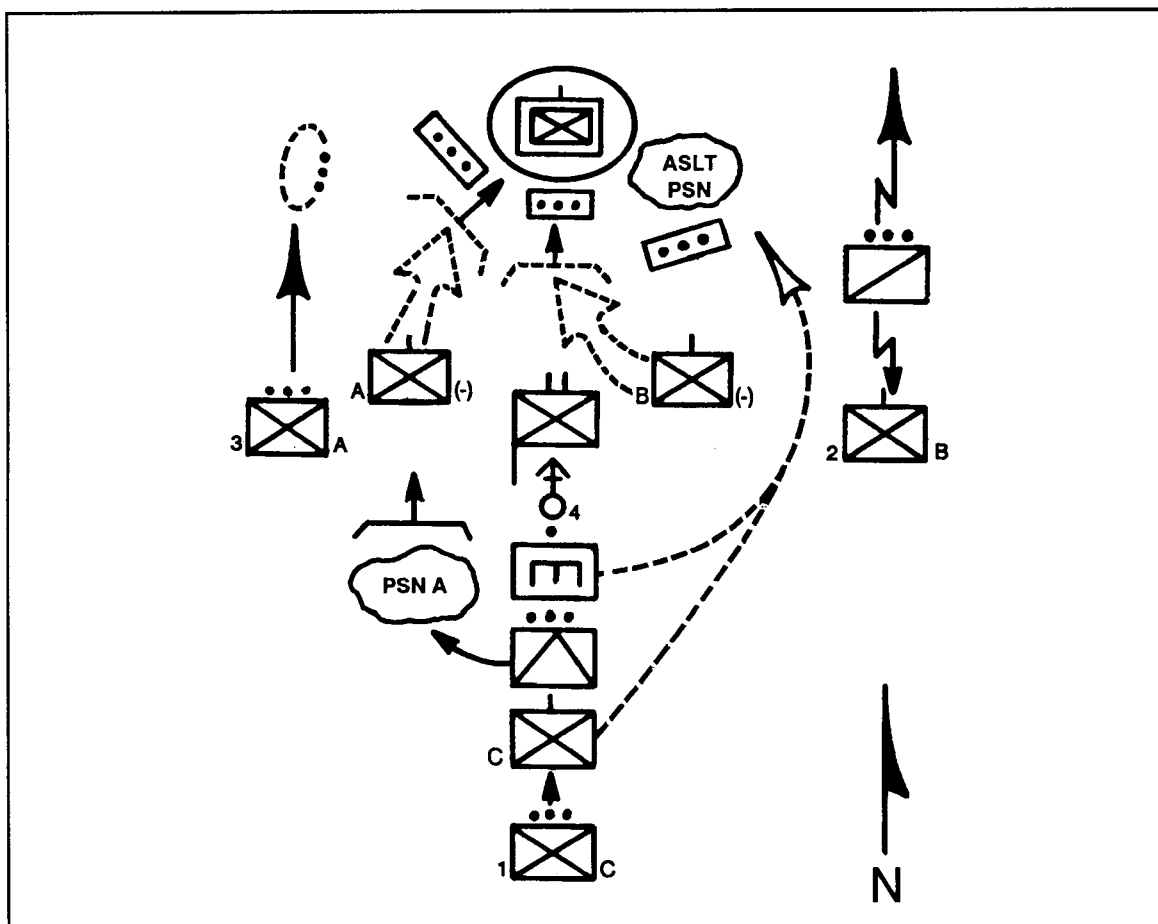

Figure 3-12. Example of hasty attack.

### 3-16. DELIBERATE ATTACK

A deliberate attack requires detailed planning to eliminate enemy forces in prepared positions that have been pinpointed by intelligence. Frontal attacks should be avoided.

a. **Planning.** The object is to concentrate strength against the enemy's weakness to shatter his defense.

(1) Detailed information about the enemy and terrain is collected from higher, lower, and adjacent units. Sources for the information can include patrols, reconnaissance by fire, aerial photographs, prisoners, refugees, EW, radar, sensors, and other means. Leaders at all levels

should look at the terrain in the dark and in the daylight.

(2) The attacker has two options when his deliberate attack breaches enemy defenses. The first is to press forward with committed forces toward the defense's expected center of gravity. The second is to turn left or right to attack more enemy positions, one after another, from the flank, while follow-on forces exploit the breach. Most often, one of these options evolves into a series of hasty attacks.

(3) The attacker's freedom of maneuver is limited if the enemy has had time to develop a well-prepared defense. Alert, mutually

supporting enemy positions can prevent infiltration. To overcome the defense, combat power must be concentrated at the point of decision. The battalion can use fire, movement, or the threat of maneuver to fix the enemy and to reduce his ability to react. A strong force then overwhelms the enemy at a point of weakness. Sequential or piecemeal attacks are doomed. When an attacking subordinate unit is reaching its culminating point, fresh units should be committed to continue the attack through to the decisive point.

(4) Attacking companies can be assigned terrain features as final objectives; this aids in reorganization and defense against counterattack.

(5) CS and CSS elements must be positioned where they can best support the assaulting force.

(a) Engineers position themselves well forward to breach minefield and obstacles, to destroy captured positions, and to give technical aid to infantry. Tanks and artillery might be available to supplement antiarmor weapons in the direct-fire role; however, artillery is seldom used this way.

(b) Combat trains remain one terrain feature behind the trail combat element. To ease resupply and casualty evacuation, combat trains move forward as the battalion moves (Chapter 8). For convenience, soldiers assemble ammunition and special equipment at forward LRPs.

#### **b. Preparation for a Deliberate Attack.**

Much of the power of a deliberate attack derives from planning initial actions in detail down to platoon and squad level. The preparatory phase of an attack includes preliminary actions such as resupply operations and movement to assembly areas. Intelligence activity, especially ground and aerial surveillance, intensifies to detect the enemy's reaction to movement and deception. Soldiers move forward from assembly areas to or through attack positions and prepare to cross the LD at the prescribed time. Indirect fires can cover this movement.

c. **Execution.** The attack begins when units cross the LD. If the unit uses routes to the LD, it should reconnoiter and mark the routes or should use guides. It should time movement to the LD so that supporting weapons or overwatch units are in position before maneuver units cross the LD. Unless the unit is ahead of schedule

or adjustments are required before the attack, it does not stop in the attack position. For information updates, the commander should link up with the scout platoon leader. The commander should then update his subordinate commanders before they deploy (Figure 3-13).

(1) The LD/LC is the line where contact can be expected. Therefore, the unit should use overwatch techniques.

(2) The entire attack is characterized by a series of rapid advances and assaults, which the battalion closely supports by fire. The unit should move along covered and concealed avenues of approach. If such approaches are unavailable, the unit should use smoke to obscure enemy observation or to provide deception. If possible, it should conduct the attack in limited visibility.

(3) The momentum of the attack should be maintained. Commanders should expect the enemy to use obstacles. During the reconnaissance, scouts report, mark, and reconnoiter obstacle bypasses. If the situation allows, engineers breach lanes in obstacles. Until the enemy discovers the attack, radio silence aids in OPSEC during movement. Movement and assault plans must be simple so they can be controlled without radios.

(4) Assault elements continue without stopping on intermediate objectives. To stop would slow an attack and increase vulnerability. The force must close on the objective rapidly with all of its combat power. The longer the force is exposed to enemy fire, the greater the losses. Assault elements use minimum force to bypass weak enemy units. Battalion reports to brigade the location of bypassed elements. If the unit has been tasked to clear a zone, it leaves sufficient forces with adequate supporting fires to destroy the enemy force without slowing the attack.

(5) CSS elements trail maneuver units by enough distance to avoid interfering with maneuver or coming under direct fire. If possible, they should remain in covered positions until the commander brings them forward as needed or until forward movement permits. If the distance to the objective is short, the battalion can hold CSS elements in the attack position and bring them forward while it consolidates the objective.

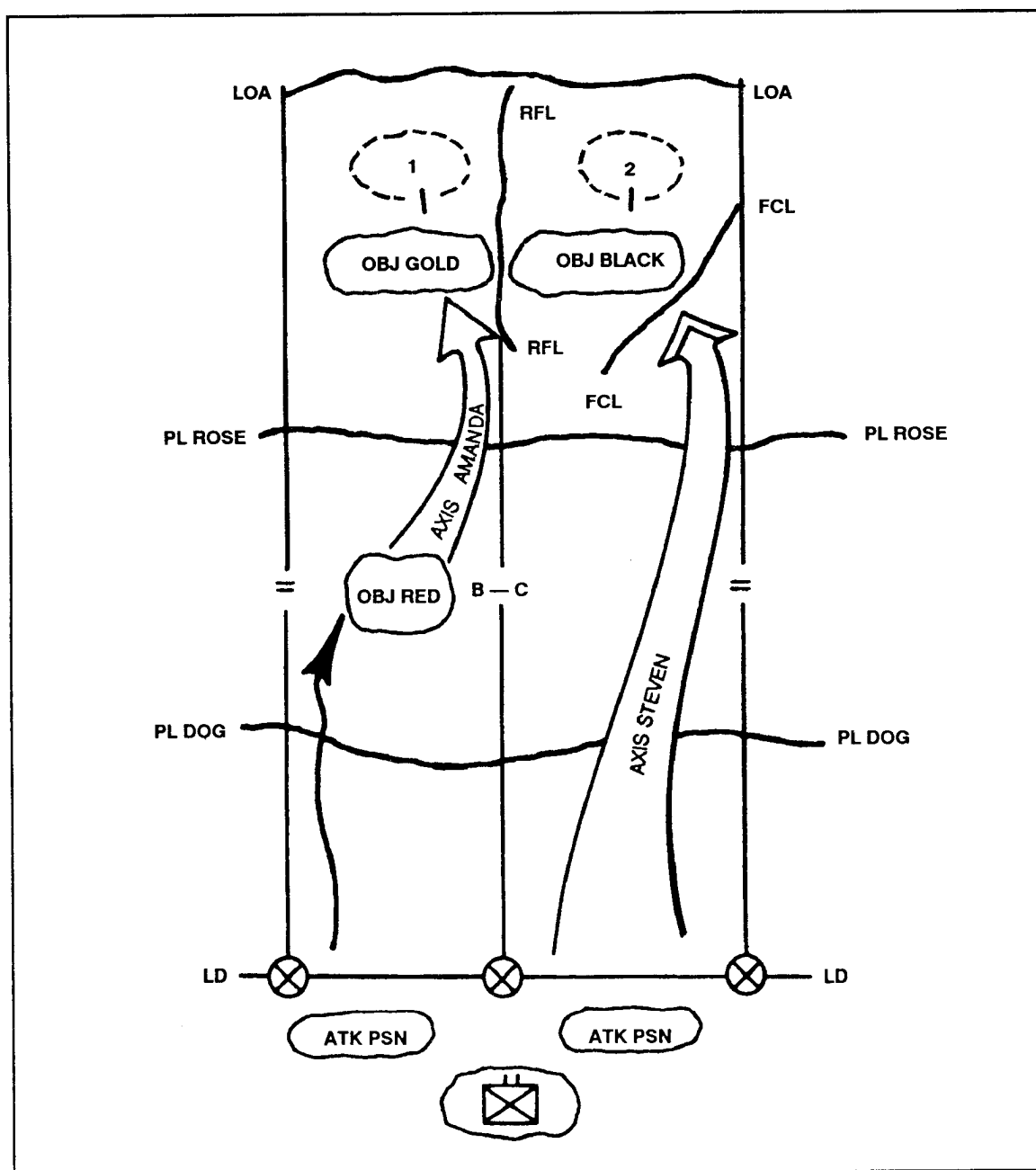

Figure 3-13. Example of deliberate attack.

**d. Actions on Contact.** A company hit by indirect fire en route to the objective should move rapidly out of or around the impact area and continue its advance. If the company receives direct fire short of the objective, it should return fire at once. Planned indirect fire can be used to neutralize enemy positions or to obscure his observation.

**e. Actions in the Assault Position.** The battalion should maintain the pace of its advance as it approaches assault positions. The battalion can increase suppressive fire on the enemy if he has discovered the battalion attack. As the battalion shifts artillery fires from the objective to other targets, the assault element prepares to move rapidly onto the objective. The battalion

must not allow suppressive fire to lapse. It isolates the objective, and it prevents the enemy from reinforcing the objective, from escaping, or from counterattacking. The battalion assumes the prescribed assault formation as it moves through the assault position. If the battalion must halt in the assault position and if the enemy knows of the attack, the battalion deploys in covered positions, screens its position with smoke, and waits for the order to assault. While the battalion remains in the assault position, it continues all available suppressive fires on the objective.

f. **Final Assault.** The assault begins as units leave the assault position and continue their move to the objective. Companies and platoons employ fire and movement. The key is to close rapidly on the objective before the defense can react. The battalion's direct-fire weapons support the assault from an overwatch position.

g. **Reserves.** The battalion commander keeps his reserve near, but clear of, the maneuver of the main effort. He can use his reserve to shift the main effort. He also can reinforce success by continuing the attack when the main effort has reached its culmination point.

h. **Consolidation and Reorganization.** The battalion commander reports to brigade when an objective has been seized and whether it has been cleared. The consolidation should be quick, the battalion is most vulnerable to conventional, nuclear, and chemical fires at this point in an attack. The battalion should avoid occupying the enemy's defensive positions, because these positions are not situated to repel a counterattack. The battalion should continue the attack or fight through and beyond the objective to a secure position that offers dispersal.

### 3-17. ATTACK OF FORTIFIED POSITIONS AND STRONGPOINTS

Fortified positions are well-constructed defensive positions. A fortified area comprises more than one mutually supporting fortified position. A strongpoint is organized for an all-round defense. Strongpoints dominate key terrain and serve as the hub of a defense to slow, canalize, or restrict the attacker's maneuver. If enemy fortified areas cannot be avoided and the battalion must reduce a strongpoint or penetrate a fortified area, the following principles should guide their actions:

a. Understand the enemy's defensive array and his doctrine. Use continuous reconnaissance to locate all enemy positions, find weaknesses, and mark and study all possible approaches. Use all available assets to gather information about the enemy. Use valuable ground reconnaissance patrols aggressively to obtain detailed information about enemy defenses in the area. Weigh the requirement for information against the danger of compromise. Some information can be obtained by questioning local inhabitants.

b. Determine the location and nature of all fortifications. The following information is needed:

- Locations of enemy armored vehicles, machine guns, antitank weapons positions, and bunkers.
- Thickness of walls.
- Locations and types of entrances and exits.
- Existence and layout of trench systems.
- Construction materials used.
- Number of soldiers in each position.
- Covered routes to the objective.
- Friendly support-by-fire positions.

c. Determine the location, type, and array of all obstacles and potential bypass routes. Find the "safe lanes" the enemy has planned to allow him to pass safely through his defensive obstacles. If such lanes are found, use them to infiltrate soldiers. Know the order in which the various obstacles will be encountered. This enables the breaching team to rehearse and to pre-position equipment.

d. Locate command and control facilities.

e. Locate covered and concealed approaches.

f. Achieve surprise by carefully selecting the time, place, and method of attack.

g. Find or create weak points in the enemy's defense. Use reconnaissance units to locate and attack fortifications from the blind side or rear.

h. Penetrate narrow fronts.

i. Task-organize properly. Infantry must be trained in the basic skills of the combat engineer. Daring and skilled soldiers, under competent leadership, succeed if they are trained, equipped, and organized. Rehearse the reduction of obstacles and fortifications. Maintain unity of command over all participants.

### 3-18. TASK ORGANIZATION

Attacks that occur at the same time require decentralized control. Therefore, though an attack on a fortified position is a large-scale operation, success hinges on small units. To attack a strongpoint, a battalion is organized into three elements. Each has several missions to perform within the overall scheme of maneuver; each designates subelements as shown in Figure 3-14.

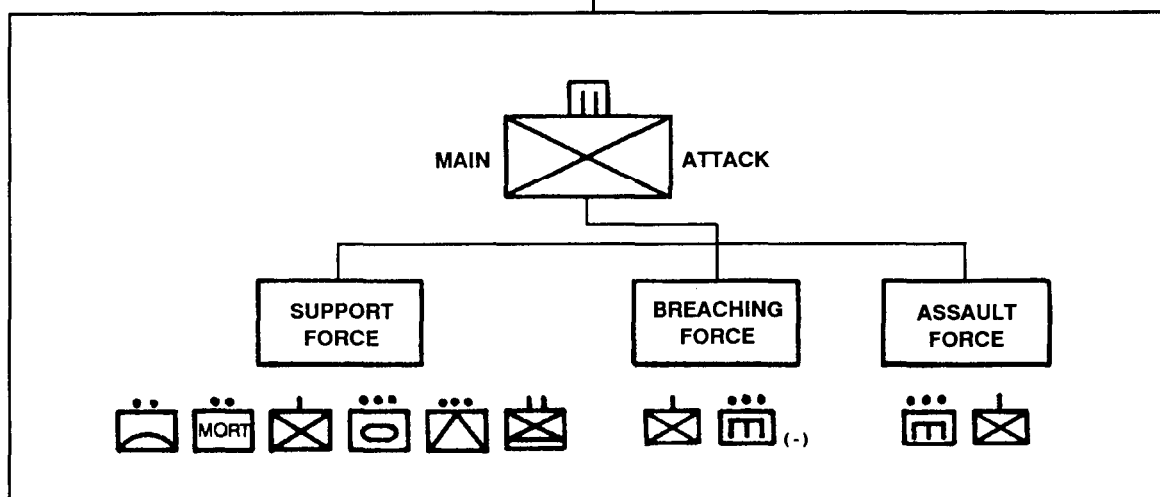

Figure 3-14. Typical task organization for attack of fortified position.

a. **Support Force.** The support force provides suppressive fire on enemy elements adjacent to the point of the breach. This helps fix, isolate, and suppress possible enemy reinforcements. To overwatch and support the breaching and assault elements, the support force should be heavy in armor/antiarmor weapons. Commanders give TOWs and MK 19s (and armored vehicles, when available) fire control measures and a priority of target engagements. The antiarmor platoon can use its fires not only to destroy armored vehicles, but also to engage hard-to-hit point targets such as bunkers. If fires are to be effective in close terrain, support positions must be near the breach point.

(1) The support force is first in the order of march in the move toward the objective (Figure 3-15).

(2) The support force becomes part of an assault force to exploit the breach once its mission has been completed and the assault element has seized a foothold.

(3) Mortars provide indirect fires. These fires help suppress the enemy or seal the flanks of the objective against enemy reinforcements or counterattacks. FA smoke is planned to augment mortar smoke. The battalion sites ADA assets to protect all approaches to the intended breach site.

b. **Breaching Force.** The breaching force is second in the order of march. While overmatched by the support force, the breaching force creates a gap in the obstacle. The breaching force is usually an infantry company. It requires supporting engineers and special equipment (mine detectors, line charges, bangalore torpedoes, and so on). The breaching force comprises a close-in support element, a breaching element, and an assault element. The breaching element comprises an infantry squad, engineering personnel, mine detectors, and other engineer breaching equipment. The close-in support element is an infantry platoon. The assault element of the breaching force is two

infantry platoons. To secure the far side of the obstacle and to provide close supporting fires for the battalion's assault force, the breaching force assault elements conduct the initial assault on the enemy fortification. The company commander can follow his lead assaulting platoon or displace with the close-in support force.

c. **Assault Force.** The assault force is the battalion's main attack. It is tasked to cross through the gap created by the breach force and to accomplish the battalion's purpose. The assault force is third in the battalion's order of march (FMs 7-8 and 7-10).

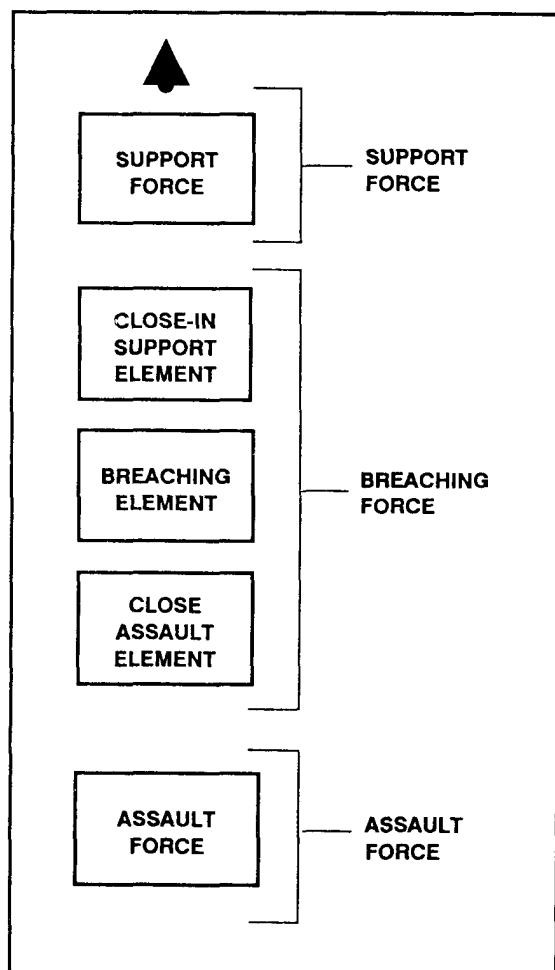

Figure 3-15. Order of movement.

### 3-19. SEQUENCE OF ATTACK

The attack of a strongpoint follows a general sequence. If the enemy main defensive area and security positions have enough depth or strength

to require a systematic reduction, the following sequence of attack applies:

a. The battalion reduces or neutralizes enemy security positions. Information obtained through reconnaissance helps determine what special soldiers, equipment, and strength the battalion needs to break through the enemy's security area. The commander then task-organizes and assigns missions (A, Figure 3-16).

b. The enemy obstacle system is defeated. A bypass must be found first, if METT-T permits. The battalion establishes a control point at or near the entrance to the obstacle system. A staff officer is designated as the battalion control point OIC. The XO or CSM may perform this function. The control point is then used to control unit access to the system area and to set priorities for crossing. The battalion control point OIC chooses a location where he can observe and control to help battalion elements move smoothly through the obstacle system. If a bypass is not possible, the battalion must use SOSR.

(1) **Suppress.** The battalion suppresses the enemy covering the obstacle continuously throughout the breaching operation.

(2) **Obscure.** The battalion obscures the obstacle from view. Soldiers use both handheld and indirect smoke to cover the assault up to the site of the breach. The battalion should obscure both the enemy overmatching the obstacle and the site of the breach.

(3) **Secure.** The battalion secures the site of the breach and the far side of the obstacle to disrupt enemy maneuver against the breaching team.

(4) **Reduce.** The battalion proofs the lane rapidly and marks it with something durable and visible. This allows follow-on forces to locate the cleared lane. (FMs 7-8, 7-10, 5-101, and 90-13-1 discuss various aspects of breaching techniques.)

c. Units should be controlled throughout the breach. The breach site is controlled by the company commander responsible for conducting the breach (the breach site OIC) (B, Figure 3-16). This officer's position depends on the situation. However, the commander should be near the breach site (200 to 300 meters). He must prevent a bottleneck and ensure that soldiers (and vehicles, if used) enter and exit the area rapidly without stopping.

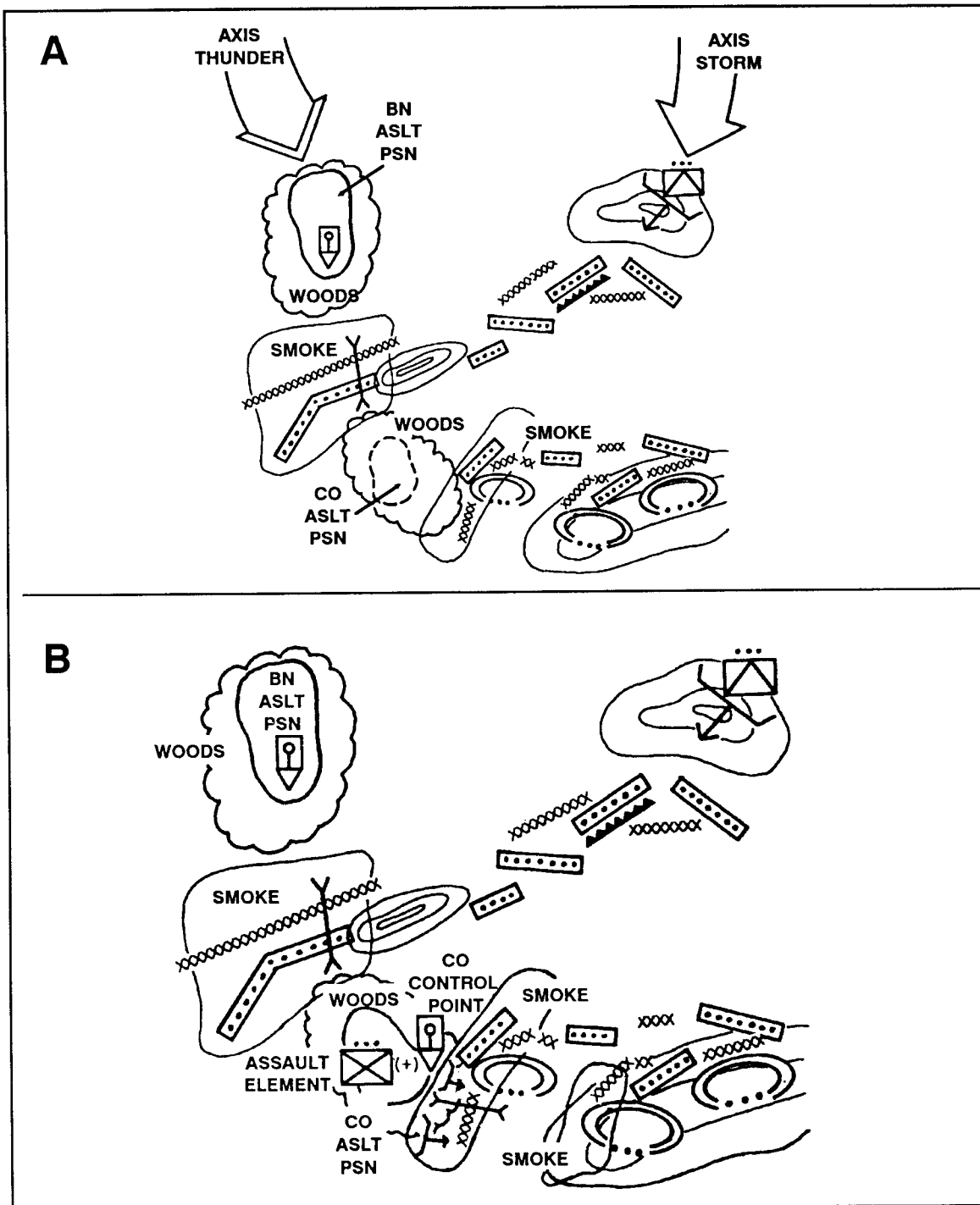

Figure 3-16. Control of the deliberate breach.

(1) Each element should remain in planned assault positions until called forward by the company commander. This simplifies dispersal.

(2) The lead company commander is responsible for control within his unit; the battalion control point OIC is responsible for regulating the follow-on units.

d. Indirect fire and CAS should be used to support the assault. Intense massed air and artillery bombardment may precede the assault against the main position.

e. The strongpoint or fortified position is reduced. Infantry companies cross the breach sites and move into the assault. When the assaulting companies cross the far side of the obstacle, they must be ready to breach any close-in obstacles in front of the fortifications.

(1) The company commander and platoon leaders control suppressive fires from the ground. They use star clusters, grenade-launched flares, and tracers to designate general or specific targets for the overwatch/support force. Flare colors indicate which weapons or support sections engage which targets.

(2) The support force delivers close supporting fires in three phases for an assault against the main position.

- *Phase 1.* The assault force starts moving forward to breach under the cover of the support force once artillery and CAS have been completed. To aid in control, the assault force must have well-defined objectives. The assault force advances through the breach until the supporting fire becomes dangerous to it and must be shifted to other targets. Designated direct-fire weapons move forward with the assaulting platoons to secure more suitable firing positions where they can fire into the emplacements.
- *Phase 2.* The fire support mission is assumed by weapons organic to or forward with the assault force. The assault force advances, and again the supporting fires come too close to it for safety. Supporting fire then shifts to targets in the rearer flanks.
- *Phase 3.* The assault force's support element provides the supporting fires. Their weapons neutralize the bunker under attack. They cover the demolitions parties who move forward to destroy it. On breaching the emplacement, elements of the assault force destroy all remaining enemy resistance. Then the platoon's base-of-fire element moves to cover the reorganization. The strongpoint is cleared to the extent required by reserve elements.

f. A series of attacks penetrate to the depth of the fortification belts. Units should bypass (leapfrog through) the leading units. The bypassed units then reorganize and prepare to protect the flanks of the penetration.

g. Designated forces begin clearance operations as soon as possible after the assault. Within the penetrated area, they should reduce or seal underground installations. They should use shaped charges, dozers, armored vehicles, and gasoline to seal or destroy these fortifications and to deny the use of them to the enemy.

### 3-20. THE ASSAULT

The most critical phase of any attack is the assault. During this phase, supporting direct and indirect fires must be placed on the enemy position. These fires must continue as long as the safety of the assaulting soldiers permits. Some type of fires must be used to neutralize or suppress the enemy until the objective is seized. Friendly supporting fires should never threaten assaulting units and thus cause them to halt.

a. Weapons with the greatest accuracy, smallest range probable error, and smallest bursting radius should continue firing the longest. As one type of fire is lifted or shifted, other weapons still firing increase their rate of fire. Just as the assaulting platoons arrive at a point considered to be the minimum safe distance from the objective, the last rounds land on the objective area. The commander specifies clear signals (controlled by the assaulting element) for lifting or shifting these fires.

b. The assault is supported only by direct-fire weapons for the last 50 to 100 meters. To maintain the fires of all weapons, these fires should be shifted progressively. Since tanks can move and deliver close effective fire with several types of weapons until the seizure of the objective, they continue throughout the assault.

c. The attacker must know the effectiveness of his organic and supporting weapons against enemy buildings and fortifications. The following (as well as FM 90-10-1 and applicable weapons manuals) provide the basis for weapons employment:

(1) The battalion positions direct-fire weapons in defilade. The attacker should at least conceal these weapons from all emplacements other than the target.



(2) The battalion can employ snipers against emplacements, OPs, and CPs (Appendix E). It can mount some NVDs onto LAWs, whose close-in fire is suitable for inflicting casualties in bunkers.

(3) The battalion uses flame weapons to effectively neutralize emplacements. A main advantage of this type weapon, in addition to its psychological effect, is that flame and smoke spread; they fill the position and neutralize adjacent emplacements. The M202A2 FLASH is the main flame weapon employed. However, USAF-delivered napalm, thermite grenades, and flame field expedients that use thickened gasoline are also useful for reducing fortifications.

(4) The battalion uses hand-emplaced explosive charges to reduce any fortifications the assault unit can reach. Cratering charges can breach the strongest parts of any emplacement.

d. The key to forward movement when under enemy direct fire is to return effective fire on the enemy. Destructive or suppressive fires are most effective when fired by a stationary “base-of-fire” unit. This fire prevents the enemy from firing effectively at the moving force.

(1) The base-of-fire element—once it is in position and once the moving element is prepared to move—places a heavy volume of fire on the enemy position to destroy, neutralize, or suppress it. Once the enemy position is suppressed, the rate of fire is reduced. However, suppressive fire continues. When the moving force nears its objective, the base-of-fire element increases its rate of fire to suppress the enemy. This lets the moving force assault the position before the enemy can react. Either on signal or when the assault begins, the base-of-fire element—

- Ceases fire.
- Shifts its fire to another target area.
- “Walks” its fire across the objective in front of the moving force, then shifts beyond the objective.

(2) Units select positions for the base-of-fire element so that the moving force does not mask the supporting fires. For this reason, base-of-fire element positions are on the flank of the moving force and are elevated, impossible.

(3) The base-of-fire element can concentrate or distribute its fire. In either case, the fire

must be controlled and directed at the enemy. It should not endanger the moving force.

e. A coordinated fire line (CFL) can be used, permitting observed and unobserved fires to be fired without clearance from units in the area. The CFL should be far enough from friendly positions to allow normal security measures and patrolling.

### 3-21. CULMINATING POINT

The culminating point is the moment when the strength of the attacker, including its reserves, no longer exceeds that of the defender. Beyond this point, continuing offensive operations could cause overextension, counterattack, and defeat. The attack must achieve decisive objectives before this point is reached.

a. Attackers lose momentum when they encounter heavily defended areas that cannot be bypassed. They could also reach the culminating point—

(1) When the supply of ammunition falls short of requirements.

(2) When attacking soldiers become physically exhausted.

(3) When casualties and equipment losses mount.

(4) When replacement operations are inadequate.

(5) When reserves are unavailable to continue the attack.

(6) When the defender is reinforced.

(7) When the defender counterattacks with fresh soldiers.

b. The battalion must establish hasty defenses when the attack loses momentum for any reason. Fighting a defensive battle after reaching a culminating point is difficult for several reasons.

(1) Defensive preparations are hasty and forces are ill-disposed for defense. Because attacking forces are dispersed, reorganizing for defense requires more time than the enemy allows.

(2) The shift to defense requires a psychological adjustment. Soldiers who have become accustomed to advancing, and thus “winning,” must now halt deep in enemy territory and fight defensively on new and often unfavorable terms.

(3) Attacks rarely culminate on ground ideally suited for defense. A decision to conduct retrograde operations on more defensive ground

compounds the psychological adjustment required of soldiers.

**3-22. CONSOLIDATION AND REORGANIZATION**

Consolidation of the objective and reorganization of the unit are critical to the attack. Both must be planned and coordinated before the attack. During consolidation and reorganization, command and control is often difficult. An aggressive enemy, supported by all available fires, can deliver a carefully planned and

coordinated counterattack. To avoid presenting a lucrative nuclear target in a nuclear environment, an attacking unit can disperse and occupy terrain that dominates the objective (Figure 3-17).

a. **Consolidation.** This means organizing and strengthening a newly captured position for defense. Consolidation can be the rapid redistribution of forces and security elements on the objective to defeat the counterattack; or, it can be the organization and detailed improvement of the position for defense.

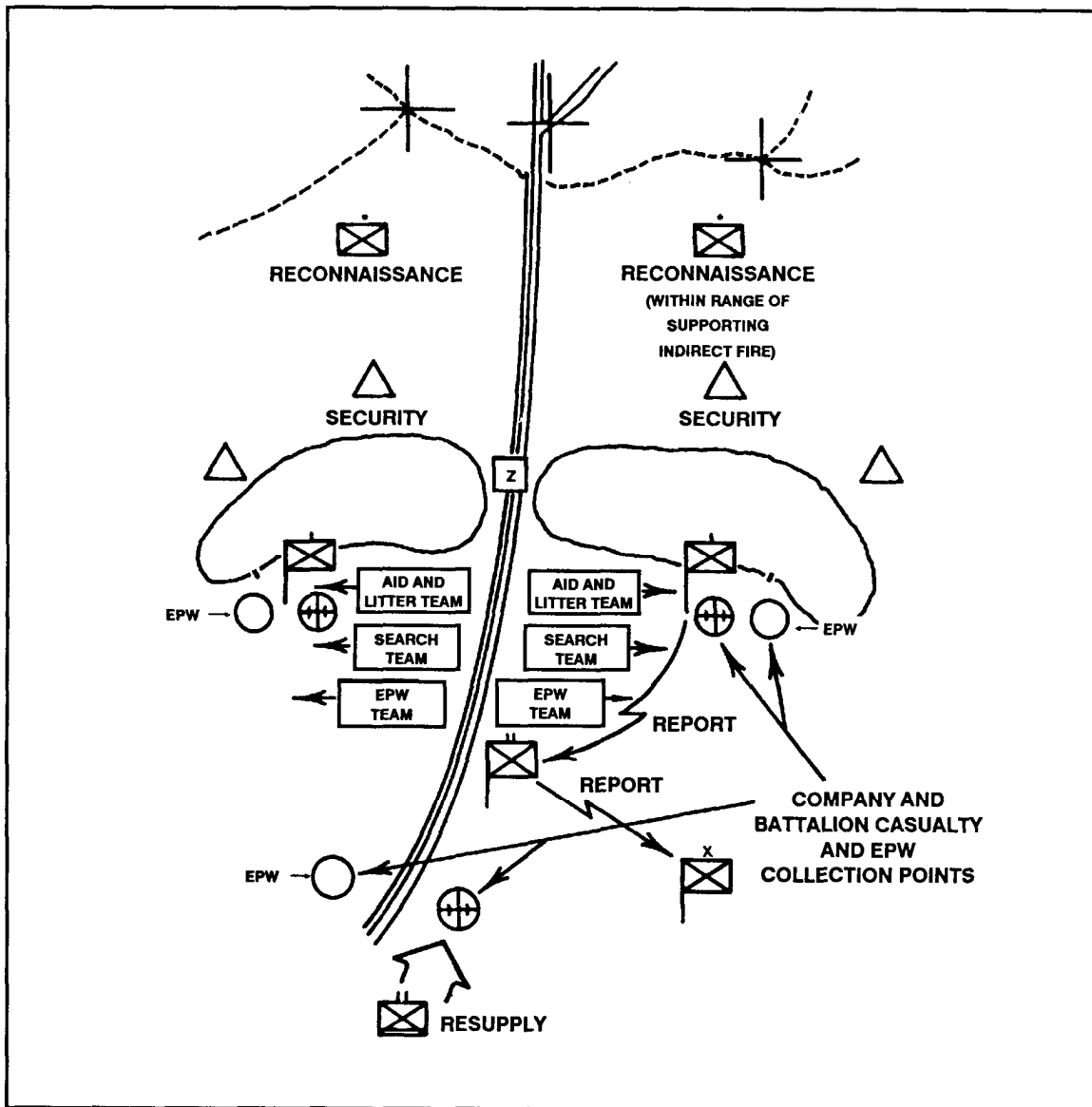

Figure 3-17. Consolidation and reorganization.

(1) The commander always plans to consolidate after an attack. However, the battalion might avoid consolidating if the attack has been unsuccessful or if the battalion can further exploit a successful attack within the framework of the brigade concept.

(2) The battalion consolidates on the objective only if the mission or situation requires. The battalion tries to consolidate on terrain *adjacent* to the objective. Disadvantages to consolidating on the objective include the fact that the enemy knows the terrain and might have indirect fires/counterattacks planned on that objective. Planning considerations for consolidation are the same as for a perimeter defense (Chapter 4).

(a) *Establish security.* This task is accomplished as soon as each assault element occupies its position. Each establishes OPs to monitor the most likely enemy avenues of approach.

(b) *Eliminate the enemy.* The companies must destroy, capture, or cause the withdrawal of all enemy vehicles and soldiers on their respective objectives.

(c) *Position forces in a hasty defense.* Once companies reach their objectives, they occupy firing positions and prepare for an enemy counterattack. Commanders consider follow-on missions when positioning forces during consolidation. Attacking elements occupy enemy positions *only* when necessary, such as when indirect fire is incoming. Armor and antiarmor platoons move to cover likely mounted avenues of approach; infantry orients along likely dismounted avenues of approach. Overmatching forces, TOWs, companies with support-by-fire missions, mortars, the TOC, CSS, and GSRs are displaced forward to aid in consolidation. The location and mission of each should be planned.

(d) *Plan fires.* Target reference points (TRPs) are designated as part of the consolidation. Once the company or platoon is in position, its

leaders establish or adjust TRPs. Also, indirect fires are planned and existing targets refined as needed to support the defense.

(e) *Conduct reconnaissance.* The commander directs companies to conduct mounted or dismounted local patrols along likely enemy avenues of approach while local security is established. The companies assign infantry squads to this task.

(f) *Prepare for on-order missions.* The most likely on-order mission is to continue the attack. During consolidation, the commander and staff continue troop-leading procedure in preparation for on-order missions. Intelligence gathered during reconnaissance is used to adjust plans for contingency missions.

**b. Reorganization.** This includes all actions to prepare for further attack or pursuit of the enemy. Reorganization is continuous throughout the attack. Actions that were impossible during movement are completed during reorganization.

(1) *Replace key soldiers.* Leadership positions must be filled. If heavy losses have occurred, companies can be reconstituted from the remnants of other companies.

(2) *Report unit status.* Units inform their next higher commander of their location and status.

(3) *Evacuate required soldiers/equipment.* Casualties, EPWs, and damaged equipment are evacuated or recovered IAW the plans developed before the attack.

(4) *Redistribute required items.* Logistics packages are used to redistribute supplies, ammunition, and equipment within the units as needed and as time permits.

(5) *Plan for further operations.* Fragmental orders are issued as required. Command and control facilities are located for control during the consolidation and for the conduct of further operations.

## Section V OTHER OFFENSIVE OPERATIONS

This section discusses operations that units can conduct as part of a larger force. In the offense, these operations include follow and support, exploitation, and pursuit.

### 3-23. FOLLOW-AND-SUPPORT OPERATIONS

A unit conducting a follow-and-support operation follows a force that is conducting an offensive operation, an exploitation, or a pursuit.

a. The purpose of a follow-and-support operation is as follows:

- (1) To destroy bypassed enemy units.
- (2) To widen or secure the shoulders of a penetration.
- (3) To relieve supported units that have halted to contain enemy forces. (Once relieved, the forward unit continues with its mission.)
- (4) To block the movement of enemy reinforcements. Depending mainly on the type of enemy force and on the terrain, this task may involve part or all of the battalion.
- (5) To help the lead unit with casualty evacuation.
- (6) To open and secure lines of communication.
- (7) To guard prisoners, key areas, and installations.
- (8) To control refugees.

b. The follow-and-support force is considered to be committed and thus is not available as a reserve. It is used for purposes other than to provide flexibility for various contingency missions; however, planning for the follow-and-support force is much like planning for a reserve. Therefore, the follow-and-support force must do the following:

- (1) Maintain a proper location on the battlefield to accomplish the primary tasks provided by brigade (FM 7-30).
- (2) Prepare for contingencies such as helping or assuming the mission of the lead battalion.
- (3) Maintain a close liaison with the supported unit. The commander might consider detaching an LO to the supported unit to maintain continuous communications.

c. The follow-on battalion must be movable by helicopter or other means to be able to respond to a mechanized attacking force. When operating as a follow-on force, a battalion moves in a formation similar to that used for a movement to contact.

### 3-24. EXPLOITATION

An exploitation follows a successful attack and prevents the enemy from rebuilding his defenses. A bold exploitation should follow every attack unless the unit is restricted by higher headquarters or lack of resources. This keeps the enemy under pressure. Due to its limited combat power and its limited logistics and intelligence-gathering capabilities, the battalion takes part in the exploitation as part of a larger force.

a. The battalion attacks to disrupt rear areas in an exploitation. It destroys enemy CPs, communications facilities, logistical installations, and artillery units. It also secures critical objectives that cut off the enemy's routes of withdrawal.

b. The battalion moves like it is moving to contact if the enemy situation and terrain permit. Speed is vital. The battalion is ready to conduct hasty attacks to destroy vulnerable targets. It clears only as much of the zone as it needs to continue the advance. Unless enemy units jeopardize the mission, the battalion bypasses them or contains them with as small a unit as possible. The battalion reports bypassed enemy forces to brigade headquarters; follow-on forces capture or destroy the bypassed forces. Though minimum control measures are used, maximum latitude is given to subordinate commanders.

c. The exploiting battalion is reinforced with armored vehicles to form a task force. Due to the depth of the objectives, artillery and other CA and CSS elements can be attached to the battalion. Army aviation and tactical air are used for reconnaissance and fire support.

### 3-25. PURSUIT

Pursuit is an offensive operation designed to annihilate a retreating enemy force. It orients on the force rather than on terrain objectives.

a. The pursuit should follow any successful breach and exploitation of the enemy's defensive sector. It should continue throughout the depth of the defensive sector.

b. The pursuit can begin when the enemy withdraws due to pressure from friendly forces to his flank. The enemy tries to disengage suddenly, most likely at night, so he can retire under cover of his rear guard to a more defensive position. The pursuit often begins or continues

into the night, because the enemy will usually try to conceal his withdrawal by moving after dark.

c. The pursuit must be rapid, though the battalion's speed must not exceed the enemy's speed. If it does, the battalion is just hurrying or accompanying the enemy, not pursuing him, which results only in a gain of territory. The battalion can attain decisive results only by destroying the enemy main body. Once the pursuit begins, the battalion uses all means to maintain the continuity of the attack and to exert unyielding pressure on the enemy.

d. Commanders push soldiers to the limits of their endurance. To keep up the momentum, reserves are committed freely to a pursuit. The battalion must pursue day and night; if it stops for rest, maintenance, reorganization, or any other reason, the enemy gains time. He can pull his scattered units together, gain distance, and place obstacles between himself and the battalion. He might even be able to slip out of position. Pursuing forces must prevent the enemy from breaking contact or reconstituting his defense.

e. The pursuit can be conducted by a direct-pressure force alone or with an encircling force. The battalion can be part of either. The direct-pressure force must have sufficient combat power to maintain pressure on the enemy. The encircling force must have good firepower and greater mobility than the enemy. An ideal encircling force consists of air assault forces, attack helicopters, or tactical air support.

f. The pursuit requires commanders and leaders to use their energy and willpower; they must act with initiative, and they must maintain their flexibility of maneuver.

(1) **Energy and willpower.** A vigorous pursuit relies on the energy and willpower of the commander and of his subordinate leaders, because soldiers and units may tire and become disorganized from their initial combat. As a result, they might relax mentally. For decisive action, small unit commanders lead, initiate, and exploit opportunities.

(2) **Activity and initiative.** A pursuit can sap the strength of the pursuers. Commanders need to use their initiative to find ways to conserve their strength and to increase their speed and mobility. The battalion uses all

available motor transportation, including that captured from the enemy.

(3) **Flexibility of maneuver.** Commanders know little about enemy or friendly dispositions during a pursuit due to extended distances and fluid situations. Therefore, mission-type orders are needed to give subordinates sufficient flexibility to accomplish their mission. Control measures can be limited to the assignment of distant objectives with directions of attack, axes of advance, routes, or zones of action. Phase lines are incorporated for control.

g. The pursuit requires decentralized command. To simplify command and control, CPs closely follow lead units. Battalion commanders operate with their command group forward. If terrain allows, vehicles are used for speed and flexibility. Moving by bounds, main and combat trains CPs coordinate resupply, evacuation of prisoners, and other administrative activities. They receive general instructions by radio from the command group.

h. The pursuit requires only those security measures that add mobility and speed such as flank security. No attempt is made to check each defile, village, hill mass or fold in the ground. Flank security is not emphasized. However, the commander can increase dispersion to prevent ambushes and to deceive the enemy as to the exact length and composition of columns. He must ensure the enemy withdrawal is not a ruse.

i. The pursuit must be rapid. Its speed of advance often depends on pioneer work and on engineer support. Engineers advance ahead with lead elements, clear the way, and repair destroyed bridges and crossings. To ensure that units are rerouted and that repairs are performed rapidly, information must pass rapidly to higher headquarters.

j. A successful pursuit depends on air assault assets to rapidly seize key terrain or on tactical locations deep in the hostile rear. Attack helicopters and CAS are used against the targets whose destruction will contribute most to the success of pursuit. These targets include critical points on the enemy's lines of communication, hostile columns in retreat, and enemy reserves trying to reestablish the defense. The air assault continues until encircling or direct-pressure forces arrive.

k. Pursuit logistics rely on aviation assets as well. These assets backhaul casualties; they also supply ammunition and fuel to leading units. Inoperative vehicles are left behind for recovery by follow-on forces. Rations are MREs.

Since unit locations change quickly and supplies (especially fuel) are consumed as quickly, coordinating resupply requires close liaison between the S3 and the S4.

## CHAPTER 4

# DEFENSIVE OPERATIONS

*Battalions defend for many reasons: to retain ground, to gain time, to deny the enemy access to an area, or to defeat the enemy attack. However, defense entails more than just killing the enemy and destroying his equipment before he can move these resources to the battlefield. The enemy's plan, the cohesion and synchronization of his forces, his morale, and his ability to see the battlefield must also be destroyed. Defensive operations must be planned and conducted with the spirit of the offense. Whatever its larger purpose, the immediate challenge of any defensive operation is to recapture the initiative and thus to create the opportunity to shift to the offensive. This chapter describes how the infantry battalion defends within the framework of AirLand Battle.*

### Section I DOCTRINE

AirLand Battle doctrine stresses initiative. Even in the defense, offensive action is used to gain the initiative. This requires successful reconnaissance and counterreconnaissance. It also requires that a reserve be maintained for quick transition to the offense. Supporting fires and reinforcing obstacles are planned to shape the battlefield, to disrupt and confuse the enemy, and to destroy the synchronization of his attack.

#### 4-1. PURPOSE

The main purpose of the defense is to defeat the enemy's attack and to regain the initiative. Defense is a temporary measure used to identify or create enemy weaknesses. Use of the defense provides the opportunity to change to the offense.

a. The infantry defends aggressively to accomplish this. It must defend from positions that are mutually supporting and arrayed in depth. It must attack the enemy throughout the depth of his formations.

b. A cohesive defensive plan includes ambushes, reverse slope positions, and depth to disrupt the enemy. Use of these measures forces the enemy to fight in more than one direction; this increases the opportunities to disrupt his command and control, CS, and CSS systems.

Thus, friendly forces can regain the initiative and shift to offensive operations.

#### 4-2. CHARACTERISTICS OF DEFENSIVE OPERATIONS

The fundamentals of a successful defense are preparation, disruption, concentration, and flexibility.

a. **Preparation.** The defender arrives in the battle area before the attacker. He must use his early arrival to prepare thoroughly for combat within his time constraints.

(1) The attacker must learn the terrain by seeing each part of it for the first time. The defender can prepare positions, construct obstacles, and conceal his efforts in advance. The attacker must commit assets to learn where the defender is located. The defender initiates

the fight from hard-to-detect stationary positions that provide cover from enemy fire. The attacker must react to the defender by either firing while moving or by seeking covered positions, thereby losing momentum.

(2) The defender develops flexible plans to control fire, movement, communications, and logistics in all possible situations. The attacker must either adhere to a planned scheme and risk destruction, or alter his plan and risk an uncoordinated effort.

(3) The defender must know how enemy units are organized and how they deploy in an attack. He must also know the abilities and limitations of enemy weapons systems and equipment. The battalion S2 provides this information, but the commander must understand it. Thorough preparation begins with sound IPB.

(4) The defender organizes his defense around the weapons most effective against the principal threat. When facing an armored force, the defender's allocation and positioning of antiarmor weapons (TOW missile systems, Dragons, antitank mines, and tanks) is most important; other assets supplement their fires and minimize vulnerabilities. Against an infantry threat, infantry-defeating weapons (machine guns, mortars, artillery, small arms) and antipersonnel obstacles (wire and mines) are integrated to reduce the momentum of the enemy's attack and to destroy the enemy forward of the defender's positions. The effects of all weapons greatly increase when the weapons are positioned where cover and concealment reduce or neutralize enemy suppressive fires.

**b. Disruption.** The defender must disrupt the synchronization of the enemy's operations. This counters the attacker's initiative and prevents him from concentrating overwhelming combat power against a single part of the defense.

(1) Units maintain OPSEC and avoid patterns to hide their dispositions. Enemy reconnaissance efforts and probing attacks must be defeated without disclosing the scheme of defense to the enemy.

(2) An attacker's strength comes from speed, mass, and the mutual support of maneuver and CS elements. The defender must disrupt the attacker's synchronization and destroy the

mutual support between the attacker's combat and CS elements. This makes it hard for the attacker to coordinate and concentrate forces and fires or to isolate and overwhelm the defender.

**c. Concentration.** The defender is often forced to economize and accept risks elsewhere to gain local superiority in one area. Reconnaissance and security forces must enable him to "see" the battlefield, thereby reducing risk. Due to the limited mobility of infantry weapons, the battalion must concentrate the *effects* of its weapons rather than the weapons themselves. They should do this *before* the battle.

(1) The commander concentrates weapons effects by designating the main effort. All elements and assets support and sustain this main effort. By redesignating it, the commander can shift the focus of his combat power. To weight his main effort, the commander can—

(a) Focus counterattack plans to support the main effort.

(b) Reduce the size of the main effort's area of operations.

(c) Assign the main effort priority for obstacles preparation.

(d) Give the main effort priority of indirect fires.

(e) Position the reserve near, in, or behind the main effort.

(2) The commander integrates available assets so that their combined effect on the enemy exceeds the sum of their individual effects.

**d. Flexibility.** The defender is assured flexibility by sound preparation, disposition in depth, retention of reserves, and effective command and control. Contingency planning permits flexibility. Flexibility also requires that the commander "see the battlefield" to detect the enemy's scheme of maneuver early. IPB determines likely enemy actions, and security elements verify which actions are occurring.

### 4-3. DEFENSIVE FRAMEWORK

The battalion normally defends as part of a larger force. Because of this, battalion commanders must understand the defensive framework within which divisions and brigades organize and fight.



**a. Elements of the Divisional Defense.** Divisions fight conventional defenses that are organized into five elements. These elements are complementary, as shown in Figure 4-1. Three of these, security operations, MBA operations, and reserve operations, apply at all echelons. The five elements are as follows:

- (1) Deep operations in the area forward of the FLOT.
- (2) Security operations forward and to the flanks of the defending force.
- (3) Main battle area defensive operations.
- (4) Reserve operations in support of the main defensive effort.
- (5) Rear operations to retain freedom of action in the rear area.

**b. Deep Operations.** Deep operations are actions against enemy forces not yet in contact with friendly forces. Deep operations prevent the enemy from massing, and they create opportunities for offensive action by the

defender. A deep operation enables the defender to separate the attacking echelons; disrupt the attacker's command and control, CS, and CSS; and slow the arrival times of succeeding echelons. Battalions may participate in deep operations IAW brigade or division plans.

**c. Close Operations.** Close operations include security area operations, battle handover, and main battle area operations.

(1) **Brigade and higher security area operations.** The forward security force established by corps or division is called a covering force. This covering force is tactically self-contained—it is organized with enough CS and CSS forces to operate independently from the main body. This force begins the fight against the attacker's leading echelons in the security area. The covering force gains and maintains contact, develops the situation, delays or defeats the enemy's lead forces, and deceives the enemy as to the location of the MBA.

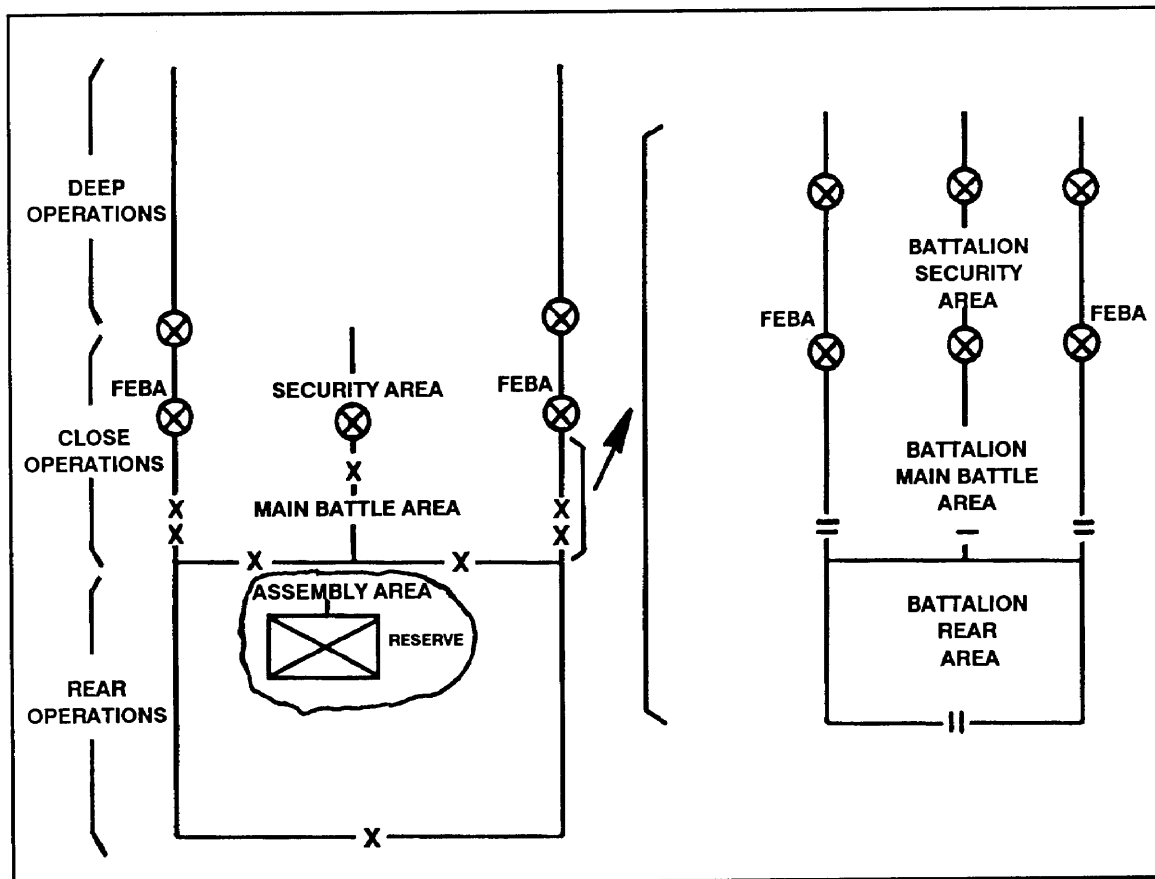

Figure 4-1. Defensive framework.

(2) **Battalion security area operations.** The infantry battalion uses a screening force as its forward security echelon. The exact size and composition of the security force depends on the width of the sector, the nature of the terrain, and the specific tasks the security force is expected to accomplish. It is always tasked with providing early warning. The battalion security force is normally required to establish contact with the covering force, if one is employed, and to aid in its rearward passage and BHO. When no covering force is employed, the battalion security force might be required to move farther forward of the MBA to increase its early-warning ability.

(3) **Battle handover.** Battle handover provides an orderly transition between the security force battle and combat in the MBA (Figure 4-2). The enemy should be unable to determine that this transition has occurred. The problems inherent in a battle handover arise from when, where, and how the covering force gives up responsibility for the fight to the MBA battalion. The BHL and contact points on the ground must be coordinated and clearly identifiable to both forces. The headquarters that establishes the covering force designates the BHL and sets up contact points to aid contact between MBA units and the covering force. MBA and covering force commanders coordinate and recommend BHL location changes to the higher commander. The BHL is shown on the operation overlay as a phase line. The BHL represents the location where control of the battle passes from the covering force to the MBA commander. The BHL is 2 to 4 kilometers forward of the FEBA, where MBA forces can use direct fire and observed indirect fire to aid

the covering force in its final delay, disengagement, withdrawal, and passage of lines. The battle handover takes place at the time or event coordinated between the commanders or as directed by the senior commander.

(4) **Main battle area operations.** The brigade commander assigns MBA battalion-sized sectors, areas of operation, or battle positions based on his intent and estimate of the situation.

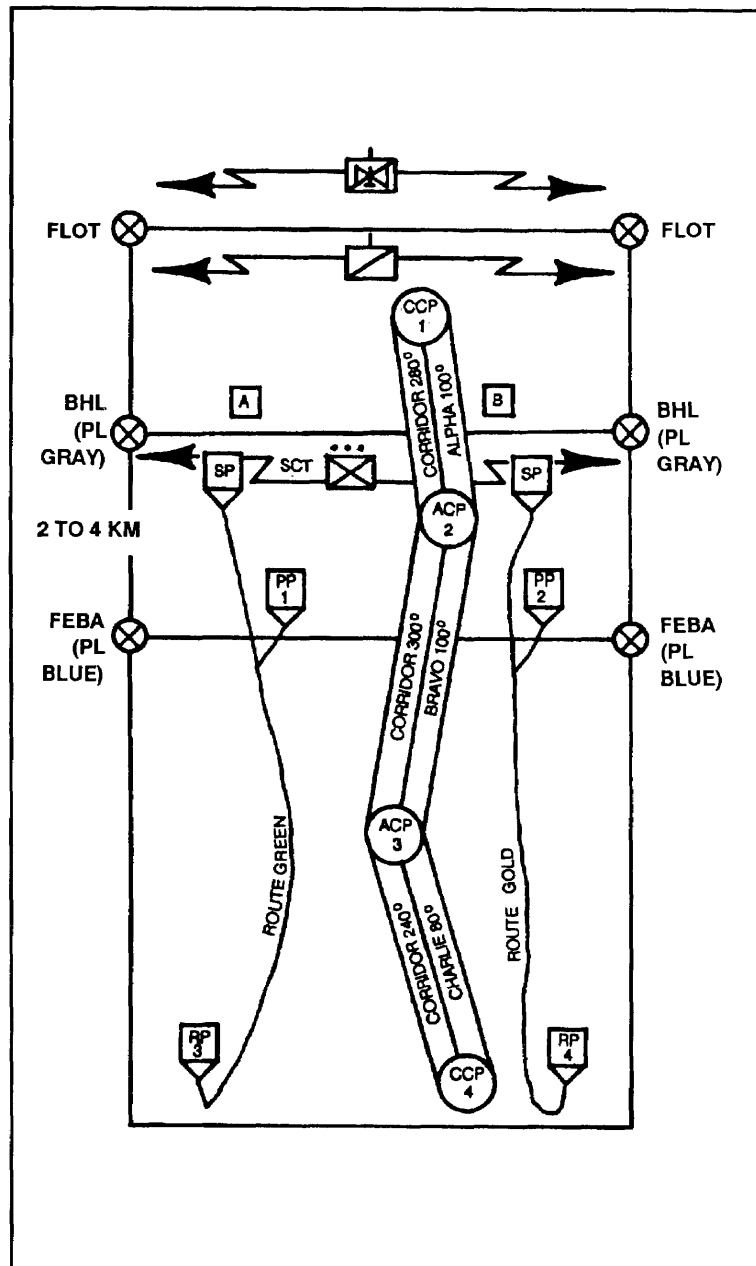

Figure 4-2. Battle handover.

The brigade commander can strengthen the effort on the most dangerous avenue by narrowing the sector of the unit astride it or by positioning more forces to cover it. He might be required to use fewer maneuver forces in minimum-risk sectors. The battalion fights the decisive battle in the MBA. The commander positions forces there to control or repel enemy penetrations. He employs reserves to halt the attack, to destroy penetrating enemy formations, and to regain the initiative.

d. **Reserve Operations.** The primary purpose of the reserve is to retain flexibility. The secondary purpose includes reinforcing success or regaining the initiative through counterattacks. The commitment of reserve forces at the decisive point and time may be the key to the success of a defense. The commander should decide the size, composition, and mission of the reserve early in the planning stage regardless of the defensive technique employed. The reserve is normally positioned near its most probable area of employment. All movement by the reserve to BPs

during counterattack or reinforcement occurs on routes that provide cover from direct fire and concealment from ground or air observation. The reserve can also be tasked—

(1) To block any penetration until the enemy is destroyed or additional forces can be committed.

(2) To prepare one or more positions on less dangerous approaches.

(3) To reinforce a forward unit when casualties or heavy enemy pressure reduces its relative combat power.

(4) To counterattack to regain critical positions or terrain.

e. **Rear Area Operations.** Many command and control, CS, and CSS units are located in the rear area. Their importance, as well as their survivability, reduced mobility, and relatively small-caliber weapons, makes them prime targets for enemy deep attack. However, a maneuver battalion can be assigned a rear area protection mission and can conduct offensive operations there against enemy conventional or unconventional forces.

## Section II PLANNING AND PREPARATION

Defensive doctrine, rather than being prescriptive, allows the commander freedom to plan and conduct his defense. The commander may defend well forward to strike the enemy as he approaches. The commander may fight the defensive battle in the main battle area; or, he may fight a nonlinear defense, drawing the enemy deep into the area of operations then striking his flanks and rear. This section contains considerations for development of defensive COA, based on the types of defense employed by infantry battalions.

### 4-4. COMMANDER'S INTENT

The commander's intent in defensive situations plays a major role in his development of viable COAs. He normally expresses his intent in terms of the enemy, the terrain, or his own force.

a. **Enemy Destruction or Enemy Disruption.** When conducting these tasks, soldiers must consider the locations of friendly units and must know their ability to control or retain terrain in order to destroy or disrupt the enemy. Normally, a large reserve is maintained so that units can maneuver aggressively to attack the enemy. The intent should be clarified by control measures that specify which avenues of

approach or engagement areas a unit must engage. OPORDs should state which critical targets or elements the friendly unit must destroy—for example, the enemy's reconnaissance forces, reserve forces, infiltrating forces, or logistics formations.

b. **Area Denial or Terrain Retention.** In certain defensive situations, the enemy is important only if he threatens the unit's control over the terrain or affects battalion operations.

(1) **Area denial.** The battalion may have a defensive situation in which it must deny an area to the enemy. The enemy must be prevented from using the area for command and control,

CS, or CSS operations. For example, a battalion may be given an area-denial task in a specific sector. It can then choose to fight an infiltrating enemy in one of three ways. It can conduct active patrols or ambushes; it can have scouts call for indirect fires; or it can deploy sharpshooters and snipers to kill enemy leaders and reconnaissance elements (Appendix E). It continues these tactics as long as the enemy remains in the battalion sector.

(2) **Terrain retention.** The battalion may have a defensive mission to hold terrain. That is, it may be required to hold a specific location or sector free of enemy—for example, to secure a decisive terrain feature, LZ, or lodgment area throughout an air assault or airborne operation.

c. **Force Preservation.** The terrain and enemy are important in this mission only if they aid or threaten the unit's ability to survive or to prepare for other operations. The unit avoids enemy contact and positions itself in terrain that is easily defensible. Use of assembly areas and hide positions are examples of this type of defense.

#### 4-5. DEVELOPMENT OF DEFENSIVE CONCEPT

The restated mission statement and other critical facts and deductions focus the development of the defensive concept. The commander begins developing the course of action by understanding when and where the enemy reconnaissance will probe and when and where the enemy will direct the attack. Therefore, he must —

a. Determine decisive points and the times to focus combat power. The brigade may focus the battalion on a decisive point in an engagement area, or the battalion may be required to determine this point.

b. Determine the results that must be achieved at the decisive point to accomplish the mission. The commander must know the brigade commander's concept and intent.

c. Determine the purposes to be achieved by the main and supporting efforts. The purpose of the main effort is often derived from the battalion's mission statement. The purposes of the supporting efforts must be linked clearly to that of the main effort.

d. Determine the essential tasks of the subordinate units (main and supporting efforts)

that achieve these purposes. The assigned task must clearly focus the subordinate unit on the terrain, the enemy, or a friendly unit. A purpose linked with a decisive, attainable, well-defined task produces a good mission statement.

e. Identify types of forces required to accomplish the mission (companies, special platoons, and CS and CSS units as appropriate).

f. Assign command and control headquarters for each of the task-organized units. The commander should fully utilize all subordinate unit commanders and leaders. If additional leaders are required, he uses key coordinating or special staff members.

g. Complete a generic task organization by assigning all organic or attached units.

h. Establish control measures that clarify and support the assigned mission. Control measures should only aid in synchronization. Overuse of control measures can stifle subordinate leader initiative and should be avoided.

i. Ensure the main effort is weighted once the essential part of concept development is completed. He can weight it—

(1) By attaching additional platoons or weapons systems.

(2) By assigning priority of fire or allocating a priority target.

(3) By limiting the area of responsibility of the main effort, which allows the main effort to focus on the critical action.

j. Complete the concept development—

(1) By including the occupation plan for the defense.

(2) By positioning other assets, such as the CP, the battalion mortars, or the trains, and assigning them missions.

(3) By developing the CSS plans for resupply, casualty evacuation, and movement of supplies.

(4) By planning for likely contingencies.

k. Develop this concept within a time framework. He must backwards plan from the following:

- The arrival of the enemy main body.
- The arrival of the enemy reconnaissance forces.
- The preparation time for defensive positions and obstacles.

- The time required for rehearsals.
- The time needed for any required movement.

#### 4-6. LIMITED VISIBILITY OPERATIONS

Battalions must always have plans for both good and limited visibility operations. This is required, since the enemy might not attack during good visibility, and since he can use indirect fires and smoke for obscuration. Also, day attacks can continue into darkness. The battalion must be able to move quickly from its original defensive positions to its limited visibility positions.

a. Technology has changed how soldiers fight on the limited-visibility battlefield. Friendly force use of NVDs and thermal-imaging sights reduces the enemy's advantage in an attack during limited visibility. Despite this fact, limited visibility still reduces effective defensive engagement ranges. Therefore, the commander can expect an attacker to use limited visibility conditions to reconnoiter defender's weapons, obstacles, and positions and to move support elements into position. In addition, the enemy may use the reduced detection distances to infiltrate, breach obstacles, or move elements through gaps in the defender's coverage.

b. Defensive operations during limited visibility—mainly at night—are common. The defender must be able to adapt plans rapidly and to overcome the impact of limited visibility on the defense. To help solve limited visibility problems, the defender—

(1) Uses long-range detection equipment (radar, sensors, NVDs) on well-defined enemy avenues of approach.

(2) Increases surveillance of obstacles, of potential enemy overmatch and assault positions, and of the routes into them.

(3) Repositions some units and weapons along avenues of approach that the enemy will likely use during limited visibility. TRPs must be visible at night for the unit to properly execute its responsibilities in the engagement area.

(4) Uses more resources (infantry, scouts, OPs, patrols, and armor-killer teams) forward on secondary avenues of approach and between positions to detect and slow enemy movement—particularly enemy infiltration. The defender uses the scout platoon on the most important enemy avenue of approach. Units conduct a stand-to each morning and evening IAW battalion SOP (Appendix A).

(5) Uses point obstacles and early warning devices along likely night approaches to slow the enemy and to alert defenders to the presence of the enemy.

(6) Plans and rehearses the required movement of weapons and units and the massing of fires.

(7) Plans illumination on or behind likely engagement areas to silhouette enemy forces and to leave defenders in shadows and darkness.

(8) Begins movement to night defensive positions just before dark and completes the return to daylight positions before dawn.

(9) Uses some of the techniques described for night defense when smoke, dust, heavy rains, snowstorms, fog, or other conditions limit the use of mechanical vision aids. When any of these conditions exist, the defender moves nearer the enemy avenues of approach he is guarding. Sensors can still be useful in limited visibility, and radar can still reveal enemy activity.

### Section III COUNTERRECONNAISSANCE

Counterreconnaissance is defined as the sum of the actions taken at all echelons throughout the depth of the area of operations to counter enemy reconnaissance efforts. Counterreconnaissance is both active and passive; it includes all combat actions designed to deny the enemy information about friendly units by destroying enemy reconnaissance elements (active measures) and by concealing friendly information through OPSEC (passive measures). An analysis of battles throughout history shows that the initial stages of battle are mainly a fight for information. Both sides try to learn as much as possible

about each other without committing their main efforts or disclosing their primary positions. The force that wins this battle normally wins the MBA battle.

**4-7. PLANNING**

Counterreconnaissance is just one aspect of security. The counterreconnaissance force commander is given specific tasks, such as “destroy” or “deny,” rather than the general task “conduct counterreconnaissance.” Counterreconnaissance continues throughout a defensive operation. It is more than just a forward security area mission. All maneuver units must also plan to counter enemy reconnaissance elements that try to penetrate security forces. All units, including CPs, CS, and

CSS units, must establish local security and use hide positions. OPs with an ambush ability should cover obstacles, gaps between units, and avenues of approach. These efforts are coordinated through the S2/S3 to ensure full coverage and to avoid friendly force engagements. The S2 consolidates all counterreconnaissance efforts into the battalion R&S plan. Figure 4-3 shows various considerations for conducting counterreconnaissance functions.

**a. Resources.** Commanders must have sufficient resources to support the

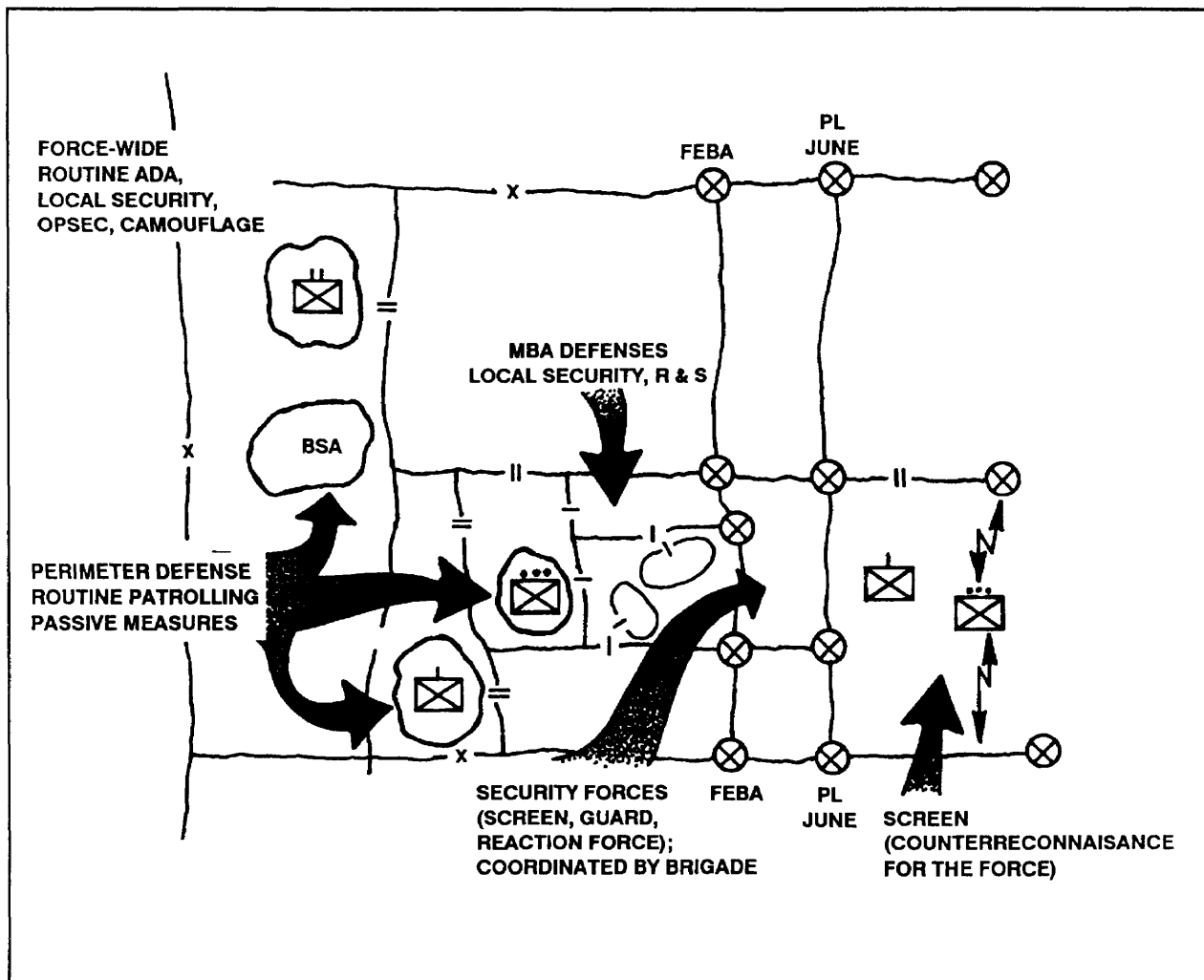

Figure 4-3. Counterreconnaissance considerations.

reconnaissance and security effort. Scouts are just part of the counterreconnaissance effort in the security area. Also, counterreconnaissance requires a two-function organization with distinct responsibilities. The first part, finders, conduct surveillance and acquire enemy reconnaissance elements. The second, killers, close with and destroy the enemy elements.

(1) **Finders.** The finders include scouts, aviation, MI, and FA information gatherers; and maneuver forces. The killers include assets brought forward from the MBA.

(2) **Fighters.** An MBA maneuver company/team used as a fighter is pushed forward for this purpose and pulled back before the MBA defense is executed. This is risky and difficult to synchronize, but detailed planning and rehearsals reduce the risk and simplify synchronization.

Another technique used in forming the counterreconnaissance unit is that of building a team composed of HHC and maneuver company assets around the HHC commander or the assistant S3. This team must have radios, FOs, medical personnel, and finding and killing systems. Depending on the time the commander estimates the team will be in position, the team may plan to cache water and additional Classes I, V, and VIII.

b. **Security Area.** The battle in the security area must be planned in the same detail as the one in the MBA. Unity of command is vital. Commanders should be involved in the counterreconnaissance efforts of the battalion; they should fully appreciate the function of the IPB process and the integration of reconnaissance assets. Denying the enemy intelligent enhances the ability to defeat enemy main body forces.

(1) A detailed IPB discloses likely enemy reconnaissance actions. For example, the most likely avenues of approach for mounted and dismounted enemy reconnaissance elements must be identified.

(2) The leader of the counterreconnaissance team receives a detailed order that specifies expected enemy reconnaissance measures and the actions required to counteract them. The S2 recommends to the S3 the placement of the force for final approval by the commander. The unit

leader adjusts these positions on the ground to ensure long-range observation and complete, overlapping sector coverage. He reports all adjustments to the main CP and to the command group. Counterreconnaissance forces consist of some or all of the following:

(a) **Scouts.** Scouts are finders, not killers.

In counterreconnaissance operations, they help locate enemy reconnaissance units for destruction by other elements or systems. Scouts can engage the enemy with indirect fire but must avoid direct-fire battles (except in self-defense). Elements that become involved in direct-fire engagements usually stop observing their designated areas, allowing other enemy reconnaissance elements to enter.

(b) **Maneuver units.** Maneuver units participate in counterreconnaissance by manning OPs, by patrolling, and by practicing OPSEC. Battalion-directed emplacement of PEWS can supplement other sensors, OPs, and patrols. If available, tanks or mechanized forces can help with the counterreconnaissance effort in the forward security area.

(c) **TOW systems and MK 19s.** TOW systems provide a good long-range observation ability in all environments and conditions in addition to their firepower and mobility. MK 19s can defeat thin-skinned enemy reconnaissance vehicles. However, using TOW missile systems or MK 19s for security missions reduces their availability to prepare for the defense. The commander uses METT-T to determine the mix and allocation of weapons to the counterreconnaissance force and to the MBA force.

(d) **Ground surveillance radar.** GSR can help identify enemy reconnaissance units, especially during limited visibility. Since GSR is a line-of-sight acquisition system other assets must be used to cover dead spaces. If GSR is located behind scouts, it might mistake scouts moving on the screen line for enemy. To prevent this from happening, GSR can be placed on line with the scouts. The counterreconnaissance team commander positions the GSR with technical advice from the GSR section NCOIC and in coordination with the battalion S2. The counterreconnaissance force provides security for the GSR.

(e) **Aviation.** Observation, lift, and attack helicopters can help with counterreconnaissance. The counterreconnaissance team

commander should get an LO from the aviation unit, include the air battle captain in the planning process and rehearsals, assign specific missions and responsibilities, and define the reporting channels. The ABC should report to the battalion commander. The plan must include contingencies in case aviation elements are unable to fly.

(f) *Field artillery*. Responsive fire support is vital for a successful counterreconnaissance mission. Based on the IPB, the FSO should develop a flexible fire support plan tailored to the commander's concept. He should ensure the plan is distributed to the leaders of the screening force. Indirect fire is required to the limit of the battalion's observation, normally from 3 to 5 kilometers forward of the security force. The FA battalion commander may need to position one or more batteries forward in the MBA. Detailed coordination of positions, timing, passage lanes, and signals is required. The commander integrates FISTs into the security force to remain mobile, ensuring responsive fire support.

(g) *Air defense artillery*. Battalion commanders must consider how to provide air defense for counterreconnaissance forces. Stingers and Vulcans extend the battalion ADA umbrella farther into the security area (Chapter 7).

(3) Deception measures can be effective if they are believable. Deception is based on IPB and should have specific objectives. Effective deception techniques include skillfully emplacing heavy concentrations of smoke and frequently repositioning. The deception operation must not disrupt position preparation or remove too many resources from the main effort.

#### 4-8. EXECUTION

The counterreconnaissance force should be emplaced as soon as the battalion either completes an attack or moves into a sector to establish a defense. A retransmission team or relay station may be needed forward to satisfy communications requirements.

a. The killing team should choose a position astride the enemy reconnaissance force's most likely avenue of approach. Leaders of the killing team must know *exactly* where the scouts and GSR elements are positioned beside or forward of them. Designating "no-movement areas" for specific times also helps prevent fratricide.

b. Observation posts should be planned in depth, not spread out in a line across the battalion front. They should have overlapping fields of observation so the forward OPs can visually hand over the advancing enemy to the next OP. Based on the commander's PIR, some OPs may be required to remain forward and to continue observing NAIs, TAIs, or DPs after the enemy passes. Companies, CPs, and trains should also plan OPs and patrols forward and around their positions.

c. The battalion FSO considers counterreconnaissance operations as priority missions. He ensures the fire support plan will help the counterreconnaissance force strip the initiative from the enemy attacking force.

d. Procedures for communicating with the battalion and with fire support units should be described in the plan. Reports may be passed directly on the command net.

(1) The S2, FSO, and XO should analyze the information from the counterreconnaissance force and other units of the battalion. Speculation by the counterreconnaissance unit may lead to poor preparation in the MBA.

(2) A schedule should be established for making routine reports (Appendix A). This ensures soldiers who occupy OPs remain vigilant and that combat information and negative reports continue to arrive at the main CP.

e. CSS considerations must also be planned in detail. Battalion support assets should be positioned forward initially to reduce response time.

(1) Resupply periods should be planned carefully to prevent the enemy from learning of screening force locations; the movement of resupply vehicles should be restricted. Frequent vehicular movement at night can hinder counterreconnaissance efforts. Also, because the frequent presence of friendly vehicles can make soldiers complacent, enemy reconnaissance elements can enter more easily.

(2) Commanders should develop a responsive casualty evacuation plan. The locations of casualty collection points should be known by all soldiers in the counterreconnaissance force.

f. The position of the counterreconnaissance force commander is an important planning



consideration. He should be located centrally or astride the most dangerous enemy avenue of approach.

g. Rehearsals increase the probability of a successful reconnaissance just as they do with any other complex operation. If practical, units should rehearse two drills in particular: acquiring enemy reconnaissance patrols and guiding killing force elements into positions to engage them.

#### **4-9. DISPLACEMENT OF THE COUNTERRECONNAISSANCE FORCE**

Planning and executing the withdrawal of counterreconnaissance forces to the MBA

are critical. Too often, units underestimate the speed of an enemy attack and withdraw too late. The withdrawal of the screening force should be planned as a rearward passage of lines under enemy pressure. (Chapter 6 provides more information about this type of movement.) Route recognition signals and timing for withdrawal to the MBA must be coordinated and rehearsed between forward security elements and company teams in the MBA. Withdrawal must be planned for both daylight and darkness. Uncontrolled withdrawal to the MBA results in fratricide from friendly obstacles, direct fire, or artillery.

### **Section IV CONDUCT OF OPERATIONS**

This section aids leaders in executing the operation to accomplish the combat mission through prescribed tactical and defensive techniques.

#### **4-10. OCCUPATION**

The scouts are usually the first to reconnoiter the proposed defensive position during this phase. They check for enemy OPs and NBC contamination, establish security, and confirm information as directed by battalion. Leaders then reconnoiter and prepare their assigned areas. Units occupy these areas as soon as practical after receiving the mission. Some assets are brought forward to secure the area and to help prepare or confirm fields of fire for their positions. Security forces, consisting of surveillance and counterreconnaissance units, are established in the security area to prevent enemy observation of position and obstacle preparation. During occupation and setup, movement is reduced to avoid enemy observation.

#### **4-11. PRIORITY OF WORK**

Many tasks are accomplished at the same time, but the battalion commander, based on his defensive plan, may give priority to specific tasks. The following is a possible sequence:

- a. Position the security force, which includes a counterreconnaissance force.
- b. Establish local security for defensive positions.
- c. Identify engagement areas and TRPs.

d. Position key weapons (TOW missile systems, MK 19s, Dragons, machine guns, grenade launchers, and available combat vehicles).

- e. Site FPFs or other priority targets.
- f. Clear fields of observation and fire; determine ranges to probable target locations.
- g. Emplace wire, mines, and other obstacles; cover them with fire.
- h. Prepare fighting positions and protective positions.
- i. Prepare range cards and sector sketches.
- j. Establish a wire communications system.
- k. Select and prepare routes for supply and evacuation.
- l. Prepare alternate and supplementary positions.
- m. Confirm and prepare the reserve's position.
- n. Rehearse defensive plans, including counterattacks. Focus on the most critical area first.
- o. Execute deception plans. Ensure they are IAW higher headquarters' deception plans.

#### **4-12. SEQUENCE OF THE DEFENSE**

Defenses are often conducted in the following sequence, because enemy attacks follow this scenario:

a. **Defeat of Enemy Reconnaissance and Enemy Preparatory Fires.** The enemy uses reconnaissance elements and probing attacks to try to discover the defensive scheme. He also tries to breach or bypass the defender's obstacles. Battalion security forces must use fire and movement to defeat these efforts. At the same time, the enemy may increase the preparatory fires when he increases his reconnaissance efforts. Consistent with the need to maintain security, battalion elements should remain in defilade, should hide, and should prepare positions to avoid the casualties and shock associated with these enemy fires.

b. **Approach of the Enemy Main Attack.** Battalion security elements observe and report enemy approach movement. Enemy units may approach in columns to ensure rapid advance and to avoid the defender's fires and obstacles. The battalion commander orients his forces against the enemy's main effort. He may initially withhold fires to allow the enemy to close into an engagement area so that, at the decisive time, he can concentrate fires on the enemy formation. His other option is engaging at maximum range with supporting fires and CAS to cause casualties, to slow and disorganize the enemy, to cause the enemy to button up, and to impair enemy communications. Direct-fire weapons are repositioned or maneuvered to attack the enemy from the flank.

c. **Enemy Assault.** The enemy becomes more vulnerable to obstacles as he deploys. The battalion uses a combination of obstacles and direct and indirect fires to disperse and disrupt the assaulting formation. Some security elements may stay in forward positions to monitor enemy second-echelon movement and to direct supporting fires on these forces as well as on enemy artillery, air defense, supply, and command and control elements. If the enemy assaults, FPFs and all other available fires are placed on his assaulting formations. The decision to use the FPFs can be delegated to platoon leaders in forward platoons. The FPFs are fired only when needed and are terminated or resumed as needed. Prematurely firing FPFs wastes ammunition. Before the enemy penetrates the battalion's defensive sector and seizes or threatens to seize key terrain, the commander should first try to destroy or repel

him by using all available fires. If that fails, the commander must decide whether to use his reserves or his least committed forces to block further penetration.

#### 4-13. COUNTERATTACKS

A counterattack is an attack by part or all of a defending force against an enemy attacking force. It is conducted for specific purposes such as regaining lost ground or cutting off or destroying enemy advance units. The objective of a counterattack is to regain the initiative and to prevent the enemy from attaining his purpose in attacking. In sustained defensive operations, a counterattack is conducted to restore the battle position and is directed at limited objectives. The commander must prepare counterattack plans for likely penetrations. Priority is given to areas that are vital to the success of the defense.

a. A counterattack is delivered from a defensive posture. Like other attacks, it depends on surprise and speed of execution and it requires carefully coordinated support from available weapons. The counterattack plan involves one coordinated strike delivered by an appropriate force. Success of a counterattack depends on detailed planning and timing.

b. Penetrations often occur under tactical conditions that would prevent a counterattack and, as such, are not an automatic signal for a counterattack. Therefore, the commander should employ whatever measures are needed to limit penetrations. In the battle position or sector, positions are prepared to add depth to the defense. These positions, when occupied, can limit likely penetrations. If the commander decides that the situation is unfavorable for a counterattack, he orders his reserve to contain the enemy by occupying these prepared positions. He fixes and holds the enemy by fire and informs the next higher commander of his actions.

c. The defending commander evaluates the situation to determine whether he can afford a counterattack, even though one may be needed to reduce the threat. Some of the factors that he must consider are as follows:

(1) **Surprise.** The counterattacking force gains surprise by using concealed routes to the LD. The force moves—

(a) Under the cover of smoke or noise from supporting weapons.

(b) By coordinating the efforts of all units in the defending force.

(c) By deceiving the enemy as to the time and direction of the counterattack.

(2) *Availability of adequate reserves and supporting fires.* The commander may need all the soldiers under his command, including reserves, to contain the enemy in the penetrated area. Also, hostile fire may inflict such high casualties within the reserve that the commander no longer has an adequate counter-attacking force. If this happens, the commander should fix the enemy by fire from prepared positions and should inform the next higher commander of the situation.

(3) *Armored elements in the penetrated area.* Defending infantrymen use restrictive terrain to close with and destroy enemy tanks that dominate the penetrated area. If the terrain prohibits them from destroying the tanks, the soldiers counterattack

the enemy's flanks and rear from prepared positions to destroy him and most of his tanks.

#### 4-14. SPOILING ATTACKS

Spoiling attacks (Figure 4-4) are mounted to disrupt an expected enemy attack before it is launched. A unit conducting a spoiling attack tries to strike the enemy while he is most vulnerable, while he prepares for an attack in his assembly areas or attack positions, or while he moves to his line of departure. A unit conducts a spoiling attack much like any other attack: it may be either hasty, when time is short; or deliberate, when the unit receives adequate warning. Sometimes, circumstances prevent the unit from fully exploiting this attack, it may either halt on its objective or withdraw to its original position. However, when the situation permits, the unit should exploit the situation as it would in any other attack.

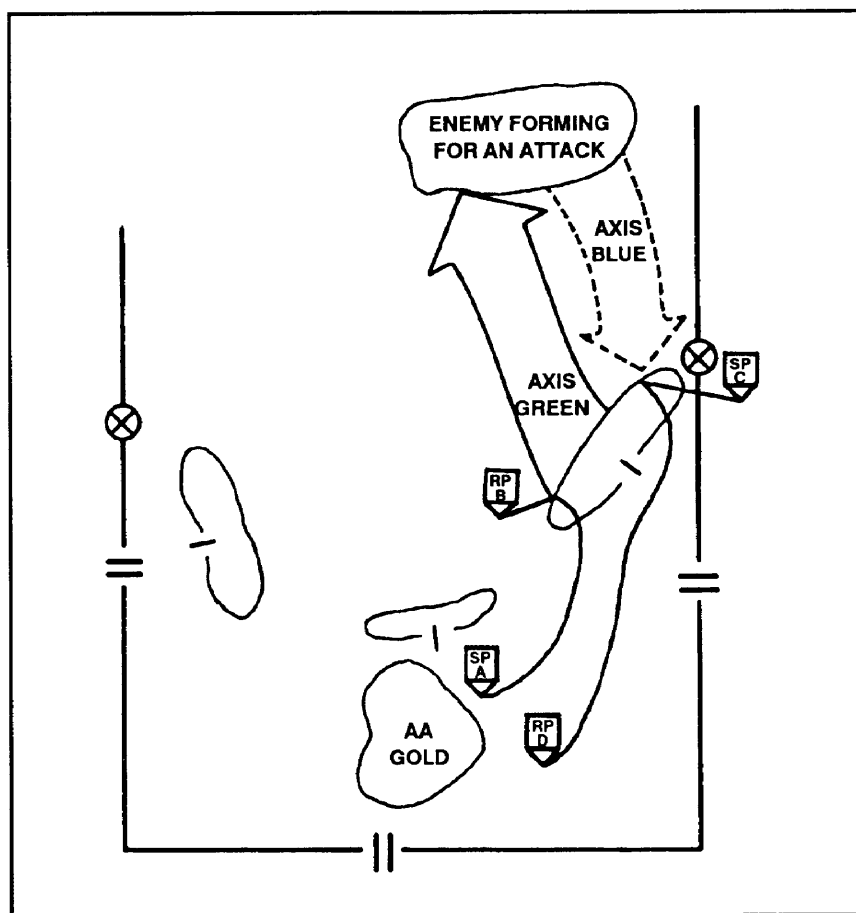

Figure 4-4. Spoiling attack.

#### 4-15. INTEGRATION OF COMBAT SUPPORT

The key CS elements in the forward defense are those that can destroy infantry. Other CS elements help by acquiring targets or providing security.

a. The mortar platoon provides close and continuous fire support for the battalion. The commander designates a priority of fire to a subordinate unit and allocates its FPF. This method of employment provides flexibility in shifting and massing fire; it also simplifies platoon control and logistics support.

b. Artillery gives the commander a means of projecting destructive power on an enemy at longer ranges. At shorter ranges, artillery is integrated with infantry weapons and mortar fire for added firepower to critical areas. The commander accomplishes this by assigning priority of fire, priority targets, and FPF.

c. Forward observers play a key role in putting these supporting fires on target. FOs must be placed in protected positions where they can observe and report timely and accurate requests for appropriate fires. This positioning requirement may influence the positioning of infantry and other elements.

d. Tactical air support can deliver quantities of cannon fire, iron or smart bombs, and scatterable mines to breakup and destroy massed enemy elements.

e. The main role of the engineers is to provide advice about and emplacement of tactical obstacles. These obstacles reduce the enemy's ability to maneuver, mass, and reinforce, and they increase his vulnerability to fires. Engineers can advise and aid units in building survivability positions and in emplacing protective obstacles. These obstacles protect defensive forces and prevent the enemy from penetrating their positions. If strongpoints are used, engineers help prepare them.

f. Attack helicopters can rapidly and effectively destroy exposed enemy forces that other elements cannot detect or engage. The helicopters' ability to move rapidly to threatened areas enhances their value to a defender threatened by large enemy forces.

g. The scout platoon, though best used for forward security missions, can screen a dangerous flank, maintain contact with adjacent

units, patrol gaps between company positions, or perform in an economy-of-force role. Scouts can also operate traffic control points, guide forces conducting rearward passage through the battalion, or perform other infantry tasks.

h. Remotely employed sensors and GSR can help detect the enemy, especially during limited visibility. These resources are initially attached to the security element to monitor forward of the MBA. When the security element is withdrawn, REMS and GSR can be employed to cover unoccupied areas between defensive forces and on the flanks of the battalion.

#### 4-16. CONSOLIDATION AND REORGANIZATION

The battalion must quickly reorganize to continue the defense. Attacks are conducted to destroy enemy remnants, casualties are evacuated, and units are shifted and reorganized to respond to losses. Ammunition and other critical items are cross-leveled and resupplied. Security and obstacles are reestablished and reports are submitted.

a. **Consolidation.** This means reorganizing and strengthening a position after an enemy attack. Consolidation can vary from rapidly redeploying forces and security elements to defeat the next attack to organizing and improving the position. The commander always plans to consolidate after a defense. Planning considerations are as follows:

(1) **Reestablish security.** Observation posts and screening forces are repositioned.

(2) **Eliminate the enemy.** Companies ensure remnants of enemy units are captured, destroyed, or forced to withdraw.

(3) **Reposition forces in a hasty defense.** Armor and antiarmor platoons reposition as needed to cover likely mounted avenues of approach; infantry reorients along likely dismounted avenues of approach. Overmatching forces, TOW missile systems, companies with support-by-tie missions, mortars, the TOC, CSS, and GSRs displace to aid in consolidation.

(4) **Plan fires.** TRPs can be redesignated as part of the consolidation. Also, indirect fires are modified and existing targets are refined to support the defense.

(5) **Conduct reconnaissance.** The commander directs companies to conduct mounted or

dismounted local patrols along likely enemy avenues of approach while local security is being reestablished. Infantry squads are assigned this task. These squads patrol within the overwatch range of established forces. Scouts are deployed to screen beyond the local patrols.

(6) **Prepare for on-order missions.** The most likely on-order mission is to continue the defense. During consolidation, the commander and staff continue troop-leading procedures in preparation for on-order missions. Intelligence gathered during reconnaissance is used to adjust plans for contingency missions.

b. **Reorganization.** This includes all actions to prepare for the next enemy attack or to go on the offense. Reorganization is continuous throughout the defense.

(1) **Replace key soldiers.** Leadership positions must be filled. If heavy losses have

occurred, companies can be reconstituted from the remnants of companies.

(2) **Report unit status.** Units inform their next higher commander of their location and status.

(3) **Evacuate required soldiers and equipment.** Casualties, EPWs, and damaged equipment are evacuated or recovered IAW the plans developed before the defense.

(4) **Redistribute required items.** Supplies, ammunition, and equipment are redistributed by LOGPACs within the units as needed and as time permits.

(5) **Plan for further operations.** FRAGOs are issued as required. Command and control facilities are located for control during the consolidation and for the conduct of further operations. Units repair gaps in obstacles and continue to improve fighting positions.

## Section V TYPES OF DEFENSE

Many techniques can be used in the defense to capitalize on the abilities of the infantry forces. No best technique exists for defending successfully. The ideal concept may be a combination of several different techniques. This section discusses several techniques that may be used to accomplish the assigned defensive operation. (FMs 3-4,31-71,90-3,90-5, 90-10, and 90-10-1 provide guidance on establishing the defense in unique environments.)

### 4-17. DEFENSE OF A SECTOR

The defensive operation the battalion commander receives most often is defense of a sector (Figure 4-5, page 4-16). Use of sectors allows flexibility and prevents the enemy from concentrating overwhelming firepower on the bulk of the defending force. Infantry forces defending against an enemy with superior mobility must use the depth of their positions to defeat the enemy. The depth of the defense must come from the initial positioning of units throughout the sector—not from maneuvering. Depth is enhanced by a properly positioned and viable reserve.

a. **Positions.** A battalion defending against a mounted enemy uses a series of mutually supporting antiarmor BPs. These should be located on armor-restrictive terrain, protected by infantry, and strengthened by obstacles.

b. **Security.** This disposition is stronger against armor but more vulnerable to infantry attack or combined arms action, which can be directed against one position at a time. Therefore, position preparation must emphasize all-round security and mutual support. (FM 7-10 provides more detailed information about security.)

c. **Deployment in Depth.** Forces deployed in depth must confront the enemy with effective antiarmor fires from multiple locations as he tries to maneuver. The sector is organized around dispersed, small units, which attack the enemy throughout the depth of his formations. The focus of this technique is the enemy force. Mines and other obstacles, infantry positions, and patrols are used to close gaps that cannot be covered effectively by fire due to terrain masking or heavily wooded areas.

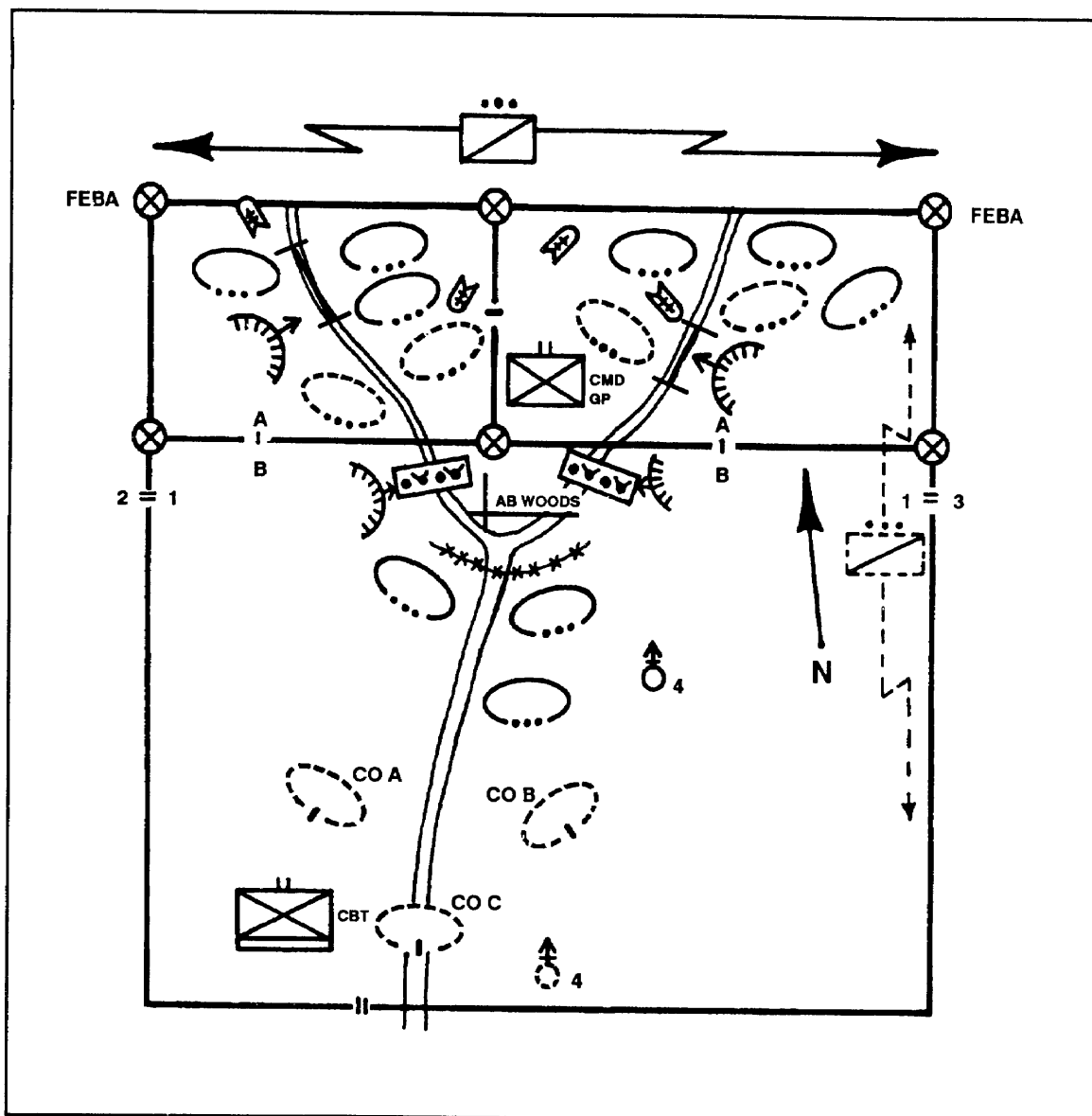

Figure 4-5. Defense in sector.

d. **Engagement Options.** The commander has two engagement options when defending a sector. He chooses one based mainly on the restrictions of the terrain and his expectation of achieving surprise. His first option is to begin engaging at maximum optimum range, based on the terrain and available weapons systems. His second option is to allow the enemy to close to within direct-fire range of antiarmor weapons and machine guns. The defender then engages the enemy with violent hasty and deliberate counterattacks designed to destroy the enemy

from any direction. In restrictive terrain, this option denies a more mobile enemy force any firepower or mobility advantage.

(1) **Beginning the engagement at long range.** The defender initiates fires at long ranges with FA, tactical aircraft, and attack helicopters to begin to breakup the continuity of the attack. As the enemy closes to within range of organic heavy antiarmor weapons, these weapons further disrupt enemy synchronization and destroy key vehicles. When the enemy enters the engagement range of the battalion's organic

weapons, antiarmor weapons engage him from multiple unexpected directions and destroy him.

(2) **Allowing the enemy into the depth of the position.** This technique is offensively oriented. It allows for planned penetration, ambushes, and counterattacks throughout the enemy formation. Armor approaches cannot be defended by a forward array of forces. Such an array can be rapidly overrun or penetrated while under massive artillery, smoke, and direct-fire suppression. To avoid rupture, the battalion must array forces in depth. Concentrating the battalion on narrower fronts is risky.

e. **Planning.** The commander considers the following factors when facing a mostly mechanized or armored threat:

(1) The commander determines enemy mounted avenues of approach and the size force that can move on each. The commander or S3 estimates the maximum number of vehicles the enemy can deploy at one time on given avenues of approach and the length of time this target array would be exposed.

(2) The commander determines where vehicles can be killed and where antiarmor weapons can be positioned to kill them in these engagement areas. All potential positions throughout the sector are identified. If all positions are used, the commander disperses antiarmor systems. By doing this, he reduces his vulnerability to total suppression. However, he increases the vulnerability of his forces by having many small units that can be defeated in detail or bypassed by dismounted infantry. Dispersion also increases his command, control, and logistical concerns. The commander could go to the other extreme—he could place all his forces in a few positions; this would lessen command and control problems and enhance the security of his forces. However, this extreme makes his antiarmor weapons more vulnerable to suppression and mounted bypass. The prudent commander balances these choices to allow maximum freedom of decentralized action for subordinates.

(3) Dispersion of antiarmor weapons may be modified so that enough infantrymen can be provided to protect these weapons. The infantry prevents dismounted infiltration, provides security for antiarmor weapons (mainly during

reduced visibility), and destroys armor at short ranges.

(4) Massing of antiarmor fires is achieved by assigning target engagement areas, primary and alternate sectors of fire, and TRPs. Battalion antiarmor sections can be attached to or in DS of a company. The battalion commander may also keep antiarmor sections in GS under the control of the antiarmor platoon leader or company commander. This is done when weapons are required to cover two or more engagement areas at the same time. To mass antiarmor fires, company Dragons can be placed under battalion control.

(5) The commander plans obstacles to disrupt, fix, turn, or block the enemy, and to protect positions. Encountering these obstacles increases enemy exposure time and enhances the effect of antiarmor fires.

(6) All available fire support is integrated. Planned CAS sorties can provide rapid and concentrated aerial-delivered firepower in the first, crucial engagements of the battle. Mortars and artillery increase the effect of antiarmor weapons by suppressing enemy overwatch elements, forcing enemy armor to button up. Attack helicopters can rapidly mass antiarmor and antipersonnel weapons. They can also provide security on flanks and in other unoccupied areas.

#### 4-18. DEFENSE FROM A BATTLE POSITION

A battle position is a general location and orientation of forces on the ground from which units defend. Battalion-sized to squad-sized units can use BPs (Figure 4-6, page 4-18).

a. Use of battle positions (BPs) reduces the instructions needed to move a force. BPs are often used as graphic control measures for a FRAGO and are identified by number, letter, name, or a combination of these. BPs can be oriented to enemy or terrain.

b. The three levels of preparation for a BP are occupy, prepare, and reconnoiter. The use of on-order BPs with the associated tasks, “prepare” or “reconnoiter,” adds flexibility and depth to the defensive plan.

(1) **Occupy.** The unit must, in positions first occupied, accomplish all actions that must be completed before the assigned mission (FM 7-10).

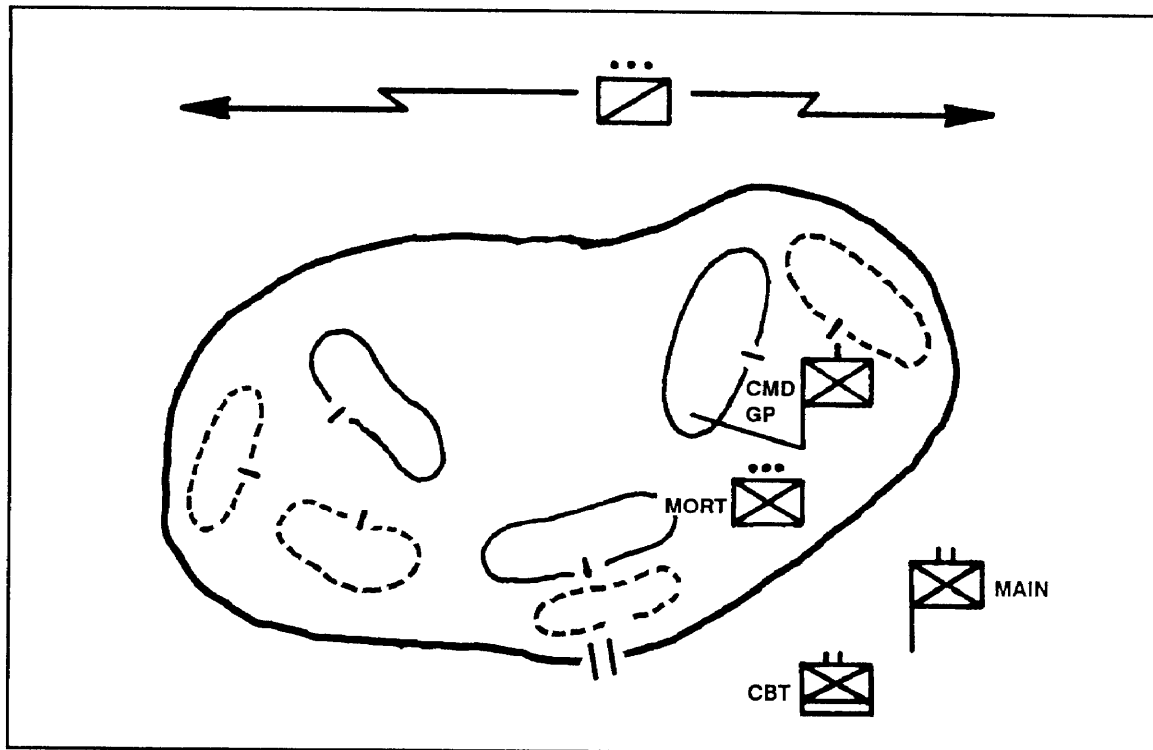

Figure 4-6. Disposition of forces in and about a BP.

(2) **Prepare.** The unit must, from that position, accomplish all actions that will enable it to execute the mission immediately on occupation. Planning, coordinating, and rehearsing are required for the unit to displace to this position and to accomplish the mission from it. Within time constraints, fighting positions are constructed, TRPs are designated, direct-fire and indirect-fire plans are developed, obstacles are emplaced, fields of fire are cleared, and ammunition is prestocked. Prepare missions are normally critical to the defense. A unit assigned such a mission must maintain security on the position and on the routes to it.

(3) **Reconnoiter.** The unit must coordinate and plan for defense from this position. Leaders reconnoiter, select, and mark positions, routes, and locations for security elements. Movement and other actions, such as the preparation of obstacles and occupation plans, are coordinated with other elements of the battalion.

c. The commander can maneuver his elements freely within the assigned BP. To comply with the commander's intent, units can maneuver outside the BP to adjust fires or to

seize opportunities for offensive action. Battalion security, CS, and CSS assets are often positioned outside the BP with approval from the headquarters assigning the BP.

d. The commander allocates space to subordinate elements within the area of the BP, based on the space available and the relative danger of nuclear and chemical attack.

(1) The battalion commander thinks two levels down or in terms of platoon BPs when he selects a BP for subordinate companies. He must allow enough space on each BP for dispersed primary, supplementary, and alternate positions for key weapons.

(2) The battalion commander can vary the degree of maneuver of companies within the battalion BP by allocating larger company BPs. Battle positions can also reflect positions in depth. They may take a shape other than the standard oblong shape, which suggests a linear defense within the BP. Large positions also allow increased dispersion in a nuclear and chemical environment.

e. The commander can combine sectors and BPs within the battalion sector to suit the tactical situation.



### 4-19. REVERSE SLOPE DEFENSE

A reverse slope defense is organized to use a topographical crest to mask the defender from the attacker's observation and from supporting direct fire (Figure 4-7).

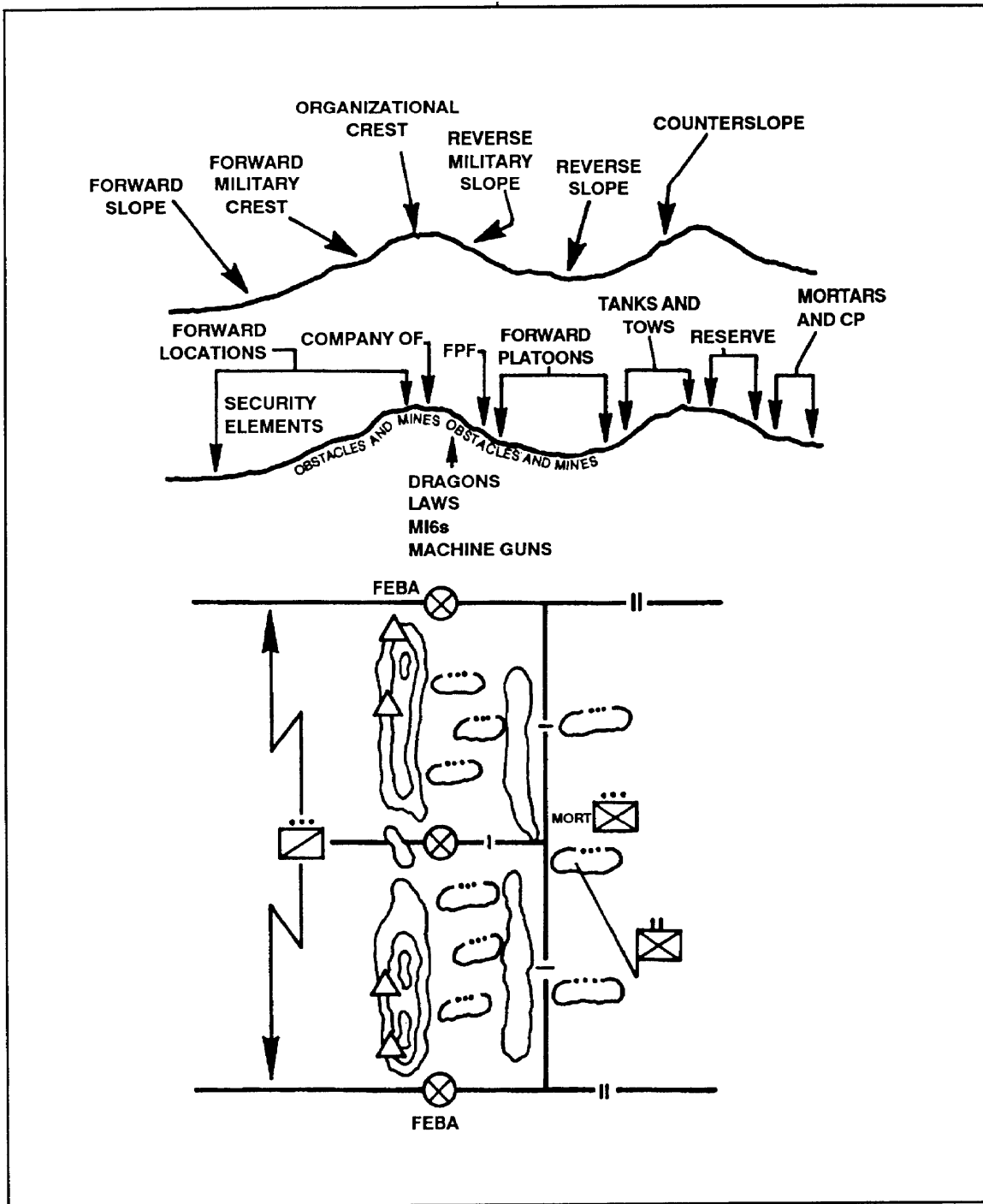

Figure 4-7. Organization of the reverse slope defense.

a. The battalion commander may adopt a reverse slope position for elements of the battalion—

(1) When enemy fire makes the forward slope untenable.

(2) When the lack of cover and concealment on the forward slope makes it untenable.

(3) When the forward slope has been lost or not yet gained.

(4) When the forward slope is exposed to enemy direct-fire weapons fired from beyond the effective range of the defender's weapons. Moving to the reverse slope removes the attacker's standoff advantage.

(5) When the terrain on the reverse slope affords better fields of fire than are available on the forward slope.

(6) When the defender must avoid creating a dangerous salient or reentrant in friendly lines.

(7) To surprise the enemy and to deceive him as to the true location of the battalion defensive positions.

b. Some advantages of a reverse slope defense are as follows:

(1) Enemy ground observation of the battle area is masked, even from surveillance devices and radar.

(2) Enemy direct-fire weapons cannot effectively fire on the position without coming within range of the defender's weapons.

(3) The enemy is forced to try to breach obstacles on the reverse slope within direct-fire range of all the defender's weapons. The attacker cannot locate these obstacles until he runs into them.

(4) The enemy is deceived as to the strength and location of defensive positions.

(5) Enemy indirect fire is less effective since he cannot see the defender.

(6) The defender gains tactical surprise.

(7) The lack of enemy ground observation allows more freedom of movement within the battle area.

(8) Dragons, TOW missile systems, and MK 19s, if positioned properly, can mass fires on the reverse military crest; infantry small-arms weapons can contribute their close fires to the battle.

(9) The unit can dig in more quickly even when the enemy is approaching; this is because

the slope of the hill covers and conceals the unit from the direct fire and observation of approaching enemy ground forces. Defenders can thus concentrate more fully on position preparation.

(10) The terrain protects the unit from the blast and thermal effects of enemy or friendly force nuclear weapons.

c. Some disadvantages of a reverse slope are as follows:

(1) Observation of the enemy may be limited, and the defender may be unable to cover obstacles to the front by direct fire.

(2) The range of important direct-fire weapons, such as TOW missile systems and MK 19s, may be limited by the topographical crest. However, such weapons may have to be sited separately from infantry to exploit their range.

(3) The enemy holds the high ground in an attack. Therefore, his attack is downhill, but the counterattack is uphill. This may provide a psychological advantage to the enemy.

(4) The effectiveness of the reverse slope defense is reduced during limited visibility, because the reverse military crest must be controlled.

d. The battalion commander organizes the defensive position IAW procedures that apply to all defensive techniques.

(1) The forward edge of the position should be within small-arms range of the crest; however, it should be far enough from the crest that fields of fire allow the defender time to place well-aimed fire on the enemy before he reaches friendly positions.

(2) A reverse slope position is most effective when flanking fires from units on adjacent terrain can be placed on the forward slope.

(3) A security force should be established to the front to stop or delay the enemy, to disorganize his attack, and to deceive him as to the location of the defensive position. When this security element is withdrawn, observation, indirect fire, and security must be maintained to the front.

(4) Observation posts are established on or forward of the topographical crest. This allows long-range observation over the entire front and indirect fire coverage of forward obstacles.

OPs are usually provided by the reserve; they may vary in size from a few soldiers to a reinforced squad. They should include FOs. At night, their number should be increased to improve security.

e. The conduct of a reverse slope defense closely parallels that of a forward slope defense. TOW missile systems, MK 19s, and tanks (if available) may be positioned first on the forward slope to engage the enemy at long ranges. As the enemy nears, they move to positions on the reverse slope or on the forward slope of the next hill to the rear (counterslope).

f. Two other adaptations remain for the reverse slope defense of an area (Figure 4-8).

(1) Firing positions are prepared on or forward of the topographical crest when the commander wants to use the fields of fire afforded by the forward slope. However, the personnel manning these positions remain on the reverse slope to reduce their exposure to fire. Only a skeleton force is kept forward to slow the attackers while the rest of the soldiers occupy their fighting positions. Reserves are held in covered positions. These forces are used for counterattacks either over the crest or around the flanks of the hill.

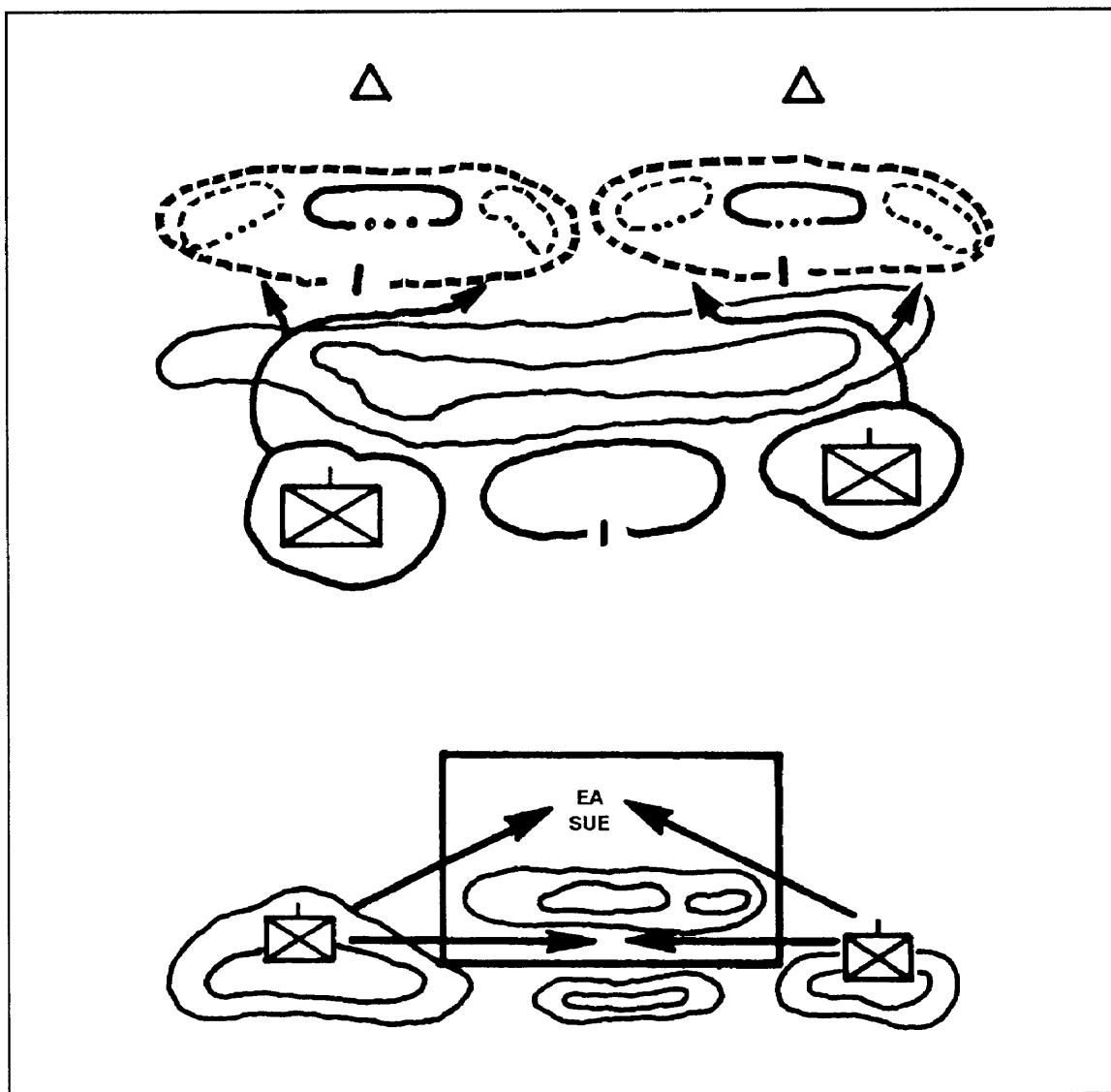

Figure 4-8. Adaptions of the reverse slope defense.

(2) The enemy may be denied the hill or suffer high casualties fighting for it even if neither the forward nor reverse slope is suitable for the BP. The defender can engage the enemy on the reverse slope from positions on other hills. Mortar, FA, and long-range machine gun fires are targeted on the reverse slope, the crest, and the forward slope. Using flanking hills for positions often allows grazing machine gun fire, which rakes otherwise protected areas just over the crest.

#### 4-20. PERIMETER DEFENSE

A perimeter defense is oriented in all directions. The battalion can organize a perimeter defense to accomplish a specific mission or to provide immediate self-protection such as during resupply operations. A perimeter is established when the battalion must hold critical terrain in areas where the defense is not tied in with adjacent units. This can occur when the battalion is operating behind enemy lines or when it is securing an isolated objective such as a bridge, mountain pass, or airfield. The battalion may also form a perimeter when it has been bypassed and isolated by the enemy and must defend in place.

a. The need to hold or protect features, such as bridges, airfields, or LZs, from enemy observation and fires may restrict the positioning of units within a perimeter. These factors, and an inability to achieve depth, also make a perimeter defense vulnerable to armor. The commander reduces these vulnerabilities by doing the following:

(1) Positioning antiarmor weapons systems on armor-restrictive terrain to concentrate fires on armor approaches.

(2) Providing as much depth as the diameter of the perimeter allows through his location of security elements, the reserve, and secondary sectors of fire of antitank weapons.

(3) Constructing obstacles to fix or block the enemy so he can be effectively engaged.

b. Perimeters vary in shape, depending on the terrain and situation. If the commander determines the most probable direction of enemy attack, he may weight that part of the perimeter to cover that approach. The perimeter shape conforms to the terrain feature that best uses

friendly observation and fields of fire. The effectiveness of the perimeter maybe enhanced by tying it in to a natural obstacle, such as a river, which allows combat power to be concentrated in more threatened sectors (A, Figure 4-9).

c. Several methods maybe used to organize a battalion perimeter. One method is to place all platoons in the battalion in positions on the perimeter (B, Figure 4-9). This is least desirable since it facilitates an enemy penetration. However, certain positioning techniques can create some depth in the defense.

(1) The perimeter is divided into company sectors with boundaries and coordinating points, which are established based on the same considerations discussed earlier. When possible, two platoons (each with three squads abreast) are placed on the outer perimeter and one on the inner perimeter of each sector (C, Figure 4-9). This gives depth to the company position and facilitates control. It gives one platoon from each rifle company the mission to support front-line platoons (just as in the defense). Also, it enables the company commander to locate his CP and his 60-mm mortars near the reserve platoon, enhancing control and security.

(2) The battalion commander may elect to assign two rifle companies to the outer perimeter and the third to an inner perimeter (D, Figure 4-9). Regardless of the method used, the inner perimeter should be far enough from the outer perimeter to prevent the enemy from suppressing both with the same fires. However, the inner perimeter must be close enough to support the outer perimeter with small-arms fire. Gaps on the outer perimeter between units in open terrain must be covered by fire. When units are in restrictive terrain with restricted fields of fire and observation, no gaps should be allowed, and a narrower frontage may be required. This may also require the company commander to deploy all his platoons on line.

d. The commander ensures the outer perimeter positions have rearward protection from inner perimeter weapons once the inner perimeter is established.

e. Combat vehicles supporting the defense are normally assigned firing positions on the perimeter, covering the most likely mounted

avenue of approach. Additional firing positions and routes to them should be selected and prepared. If the perimeter has several mounted approaches, combat vehicles may be held in a mobile position.

Therefore, units must prepare routes, firing positions, and range cards for all positions in advance. Also, commanders must ensure that vehicles do not destroy wire communications.

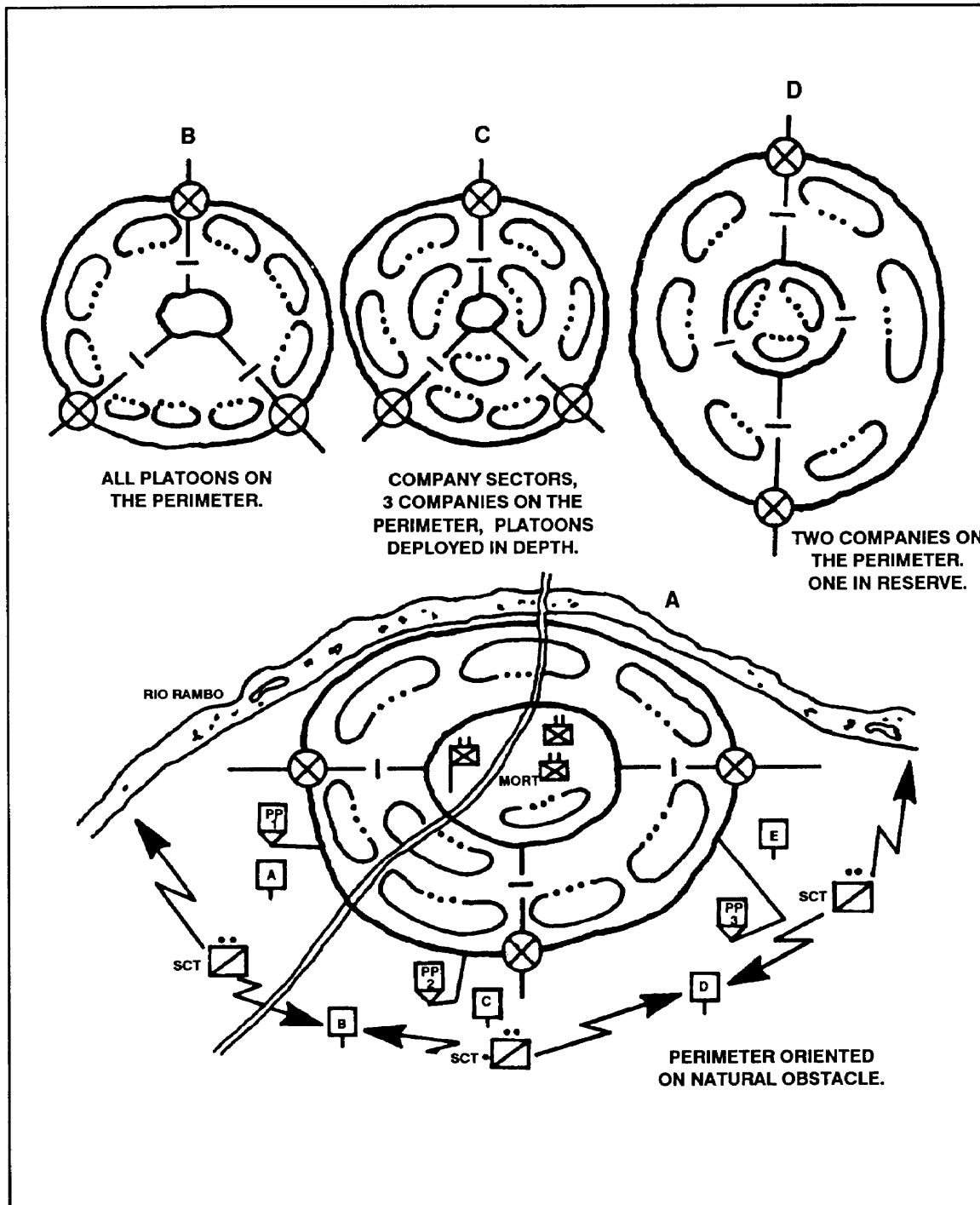

Figure 4-9. Methods of organizing a battalion perimeter.

f. Isolation may drive the battalion commander to form a perimeter. If so, combat and combat support elements from other units may seek the battalion's protection. These units are given missions based on their support abilities. Any fire support provided from outside the perimeter is coordinated and integrated into the overall defensive plan. This extra fire support conserves the ammunition of units within the perimeter.

g. The battalion commander normally employs the scout platoon outside the perimeter for early warning. He may augment security with squad-sized or smaller elements, which are provided and controlled by units on the perimeter. The security elements are positioned to observe avenues of approach. Patrols cover areas that cannot be observed by stationary elements. If the scout platoon remains under battalion control, it must coordinate with units on the perimeter for a passage of lines (Chapter 6).

h. Reserve elements may consist of a designated unit or a provisional force organized from headquarters and support personnel. They form the second line of defense behind the perimeter elements. Ideally, reserves are mobile enough to react to enemy action in any portion of the perimeter. They are positioned to block the most dangerous avenue of approach and are assigned on-order positions on other critical avenues. If available, combat vehicles initially occupying firing positions on the perimeter may be tasked to reinforce the reserve on-order.

i. The perimeter defense is conducted much like a forward defense. Mortars, FA, tanks, and TOW missile systems engage the enemy at long ranges. As the enemy comes within small-arms range, other weapons on the perimeter engage him. If the assault continues, FPFs are fired. If the perimeter is penetrated, the reserve blocks the penetration or counterattacks to restore the perimeter. After committing the initial reserve, the commander must reconstitute a reserve to meet other threats. This force normally comes from an unengaged unit in another portion of the perimeter. If an unengaged force is used to constitute anew reserve, sufficient forces must be retained to defend the vacated sector.

j. CSS elements may support from within the perimeter or from another location,

depending on the mission and status of the battalion, the type of transport available, the weather, and the terrain. Resupply is often by air. The availability of LZs and DZs protected from the enemy's observation and fire is a main consideration in selecting and organizing the position. Since aerial resupply is vulnerable to weather and enemy fires, commanders must emphasize supply economy and protection of available stocks.

#### 4-21. LINEAR DEFENSE

The commander commits most of his combat power to the FEBA when he must locate his main effort well forward. Using this linear defensive technique, he must plan to defeat the enemy early when the enemy is still arrayed along the FEBA or beyond it. This technique is more difficult to execute than a defense in greater depth—it lacks flexibility due to the early commitment to decisive combat. Also, this technique depends on rapid and accurate identification of and concentration against the enemy main effort.

a. **Conditions.** Adoption of a linear defense may be appropriate—

(1) When defensible terrain, such as along a significant obstacle, is available in the forward part of the battalion's sector.

(2) When the enemy threat is mainly infantry.

(3) When natural or man-made obstacles neutralize the mobility of a mounted enemy, forcing him to attack dismounted.

(4) When specific terrain along the FEBA must be retained.

(5) When enough resources are available to provide the required density of combat power across the sector to detect and stop an infantry attack.

b. **Characteristics.** A linear defense has interlocking and overlapping observation and fields of fire along the FEBA to preclude penetration. The bulk of the maneuver units is forward to gain interlocking small-arms fire within and between companies. The main effort is assigned to the most likely avenues of enemy approach. The reserve is usually small and is used to reinforce forward units, to give depth to the defense, to block penetrations, or to counterattack to regain key terrain. If available, tanks form the basis of a counterattack force

c. **Organization.** The battalion commander considers several points when establishing the linear defense as part of COA development. He tries to concentrate forces where enemy attacks are most likely and to give wider sectors to less threatened units. He must gain mutual support between companies when arraying his forces linearly. To do this, he visualizes the building of the defense using infantry platoons as building blocks. In addition, he must—

(1) Identify enemy avenues of approach and determine the size enemy force that can use each avenue. He must also allocate enough infantry platoons to block the avenues by fire and to cover gaps. Finally, he must allocate and position the battalion reserve.

(2) Determine how to divide his area among his companies. Areas of responsibility, or sector locations, are designated by coordinating points and lateral boundaries. The commander tries to keep his company commanders' control problems to a minimum. He locates coordinating points and lateral boundaries so that avenues of

approach or major terrain features are not divided. He tries to concentrate forces where enemy attacks are most likely and to give wider sectors to less threatened units.

(3) Consider that lateral boundaries should provide suitable terrain and depth for companies to deploy their mortars and support elements.

#### 4-22. DEFENSE OF A STRONGPOINT

The mission to create and defend a strongpoint implies retaining terrain to stop or redirect strong enemy formations. Strongpoints are usually on high-speed enemy avenues of approach. They are tied to the defensive positions of units on their flanks (Figure 4-10). A bypassed strongpoint exposes the enemy's flanks to attacks from friendly forces in and outside the strongpoint. Battalion strongpoints can be established in isolation only when tied to restrictive terrain on their flanks.

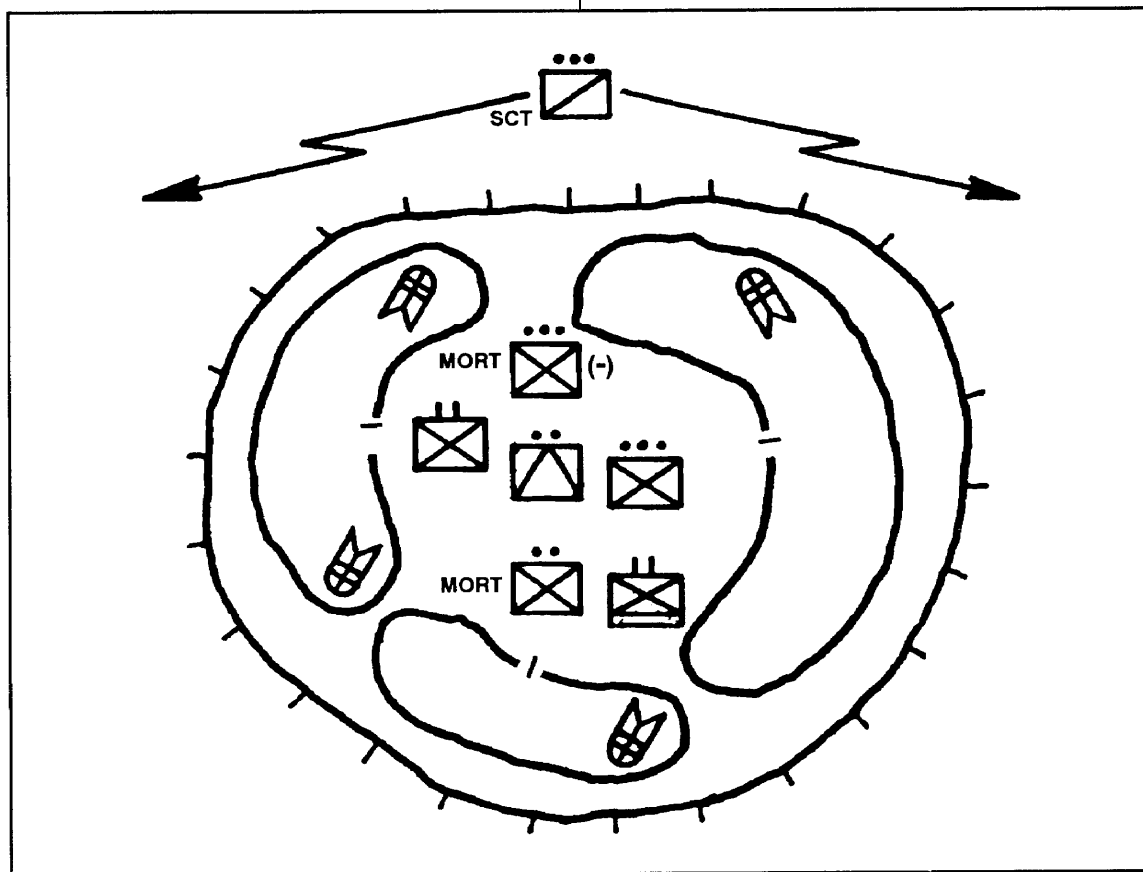

Figure 4-10. Strongpoint.

a. The battalion pays a high cost in manpower, time, and assets for building a strongpoint. To build one requires many days of dedicated work, normally with engineer support. As a guideline, a strongpoint requires at least one day of effort from an engineer organization the size of the defending force.

b. A strongpoint cannot be easily bypassed, so repeated dismounted assaults must be expected and repelled. The strongpoint receives intensive artillery attacks and must be prepared with sufficient overhead cover. Also, defense in depth is achieved through multiple positions within the strongpoint. If used, combat vehicles dig in multiple firing positions, while dismounted infantry use positions tied together with trenches. Strongpoints may be on the FEBA or in depth in the MBA (Figure 4-11).

c. The battalion commander and the commander of the supporting engineer unit must conduct a ground reconnaissance to determine their priorities of position construction. The first priority is to make the position impassable to armor. The second priority is to protect the antiarmor weapons with terrain, obstacles, and infantry. The third priority is to protect infantrymen who are guarding antiarmor weapons.

d. The battalion establishes security around a strongpoint before occupying it. A typical security force consists of a scout platoon, remote sensors, and radar. It may also include a maneuver platoon or company. The battalion must consider leaving stay-behind OPs to report enemy activity and to disrupt the enemy with indirect fire.

e. Tanks (if available), TOW missile systems, and MK 19s may first be positioned in BPs, if defensible terrain is available forward of the strongpoint, to begin disrupting and destroying the enemy early. Pushing mobile force-s forward also deceives the enemy as to the location of the main effort. As the enemy nears the forward positions, available TOW missile systems and tanks move to their primary positions, drawing the enemy into prepared engagement areas. These elements must anticipate the speed of the advancing enemy and establish criteria so they can begin disengaging before they are decisively

engaged. This distance is 2 or 3 kilometers against a mounted enemy. Scouts occupy OPs to observe the enemy and to adjust fire, assisting maneuver elements that are returning to the strongpoint.

f. The battalion selects and prepares positions and routes such that combat vehicles can be moved to supplementary and alternate positions within the strongpoint. All positions within a strongpoint are mutually supporting, with interconnecting trenches to allow rapid reinforcement of a threatened area. Proper positioning also allows the massing of fire from two or more units against an assault. This prevents the enemy from isolating positions and defeating them in detail.

g. ADA weapons may first be positioned forward with the security element. Also, mortars normally operate in split section and are GS to the battalion.

h. Combat trains are in defilade positions or buildings within the strongpoint. Supplies are pre-positioned near primary, alternate, and supplementary positions. The MSR to the field trains is kept open as long as possible.

#### **4-23. DEFENSE AGAINST INFILTRATION**

Infiltration is a constant threat to a defense usually when forces in the forward defense area are dispersed. The enemy may try an infiltration to disrupt operations and to harass installations in the rear area, or he may try a massive infiltration. Specific measures to aid in controlling infiltration include extensive counterreconnaissance, combat patrols, antipersonnel obstacles, warning devices, NVDs, and electronic surveillance devices. If the threat of attack by infiltration exists, a mobile combat force receives the mission of engaging the infiltration forms once they are detected.

#### **4-24. DEFENSE AGAINST AIR ATTACK**

Air defense measures performed by the battalion include passive protective measures such as using a warning system, assigning firing areas, and attacking air targets IAW established ROE. Air defense units may operate in the battalion area under the control of battalion or higher headquarters (FM 44-100).



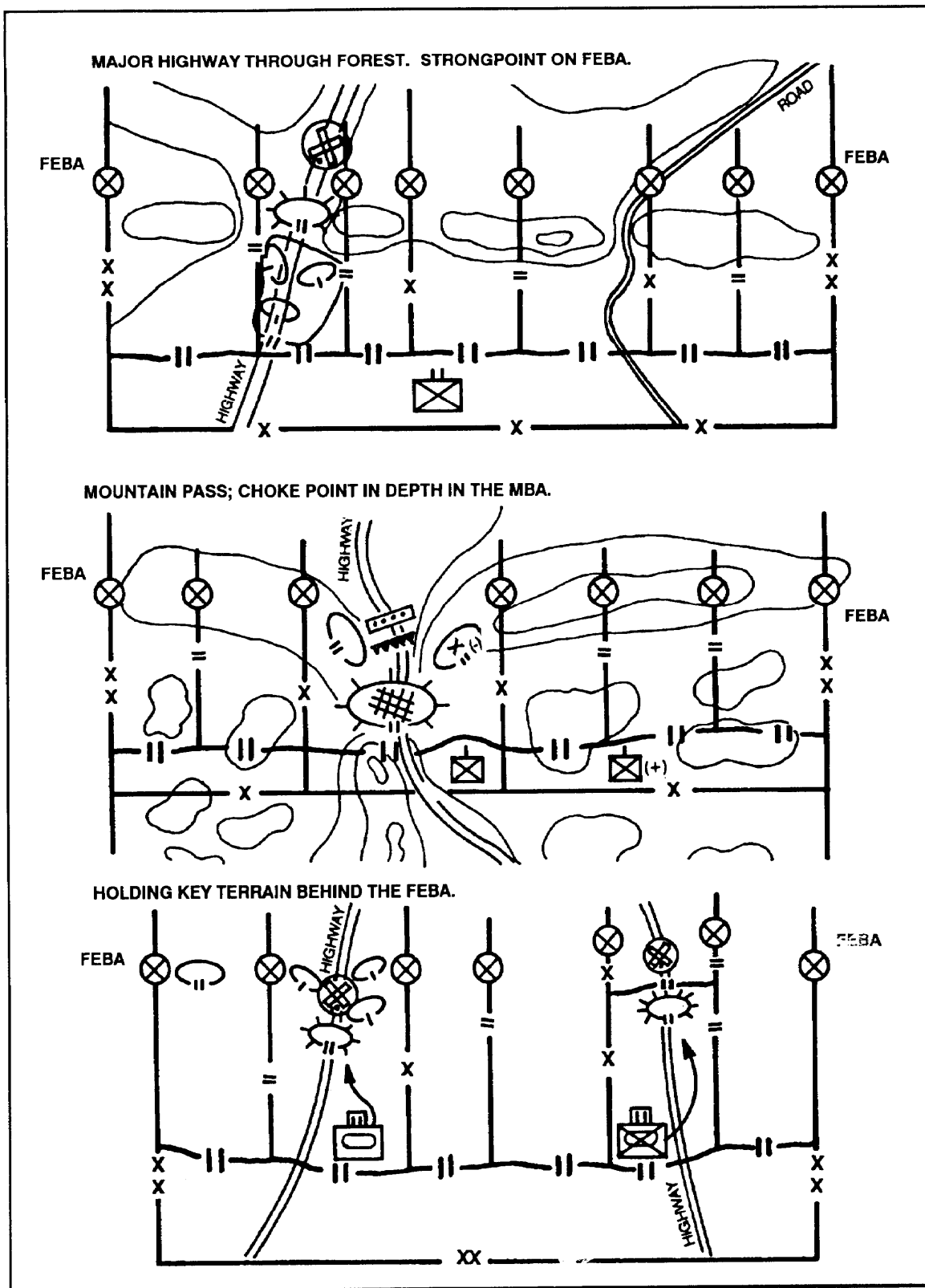

Figure 4-11. Examples of strongpoints.

## CHAPTER 5

# RETROGRADE OPERATIONS

*This chapter discusses battalion retrograde operations, which are characterized by centralized planning and decentralized execution. The next higher authority (normally brigade) must approve retrograde operations.*

### Section I DOCTRINE

Retrograde operations are organized movements to the rear of or away from the enemy. They can be forced by enemy action or executed voluntarily.

#### 5-1. PURPOSE

A retrograde operation can be used to avoid decisive combat under unfavorable conditions, to maintain freedom of maneuver, or to save forces for decisive action elsewhere. The underlying reason for conducting a retrograde operation is to improve a tactical situation or to prevent a worse one from occurring. A battalion conducts a retrograde as part of a larger force—

- To harass, exhaust, resist, and delay the enemy.
- To gain time.
- To reposition or preserve forces.
- To use a force elsewhere.
- To draw the enemy into an unfavorable position.
- To shorten lines of communication and supply.
- To clear zones for friendly use of chemical or nuclear weapons.
- To conform to the movement of other friendly forces.

#### 5-2. TYPES OF RETROGRADE OPERATIONS

Types of retrograde operations areas follows:

a. **Delay.** A delay trades space for time, inflicts maximum damage on the enemy, and avoids decisive engagement.

b. **Withdrawal.** A withdrawal breaks contact (frees a unit for a new mission).

c. **Retirement.** A retirement moves a force not in contact to the rear.

#### 5-3. PLANNING

All retrograde operations are difficult and risky. To succeed, they must be well organized and well executed.

a. **Leadership and Morale.** The offensive spirit must be maintained among subordinate leaders and soldiers. Movement to the rear can be seen as a defeat or a threat of isolation unless soldiers have confidence in their leaders and know the purpose of the operation and their roles. Rumors are suppressed and results of successful offensive actions are disseminated. Firm control of movements to the rear is essential.

b. **Reconnaissance, Surveillance, and Security.** Timely and accurate intelligence is vital. The battalion commander must rely more heavily on brigade and division intelligence assets, and he should ensure brigade knows the battalion's PIR. The battalion commander must constitute a security force that is strong enough—

(1) To deceive the enemy and defeat his intelligence efforts.

(2) To overwatch retrograding units.

(3) To provide rear guard, flank security, and choke point security.

c. **Mobility.** The battalion must increase its mobility and slow or halt the enemy for the retrograde to be successful. If the battalion has less mobility than the enemy, the battalion must develop contingency plans for operation as a bypassed force.

(1) The battalion improves its mobility—

(a) By reconnoitering routes and battle positions.

(b) By fully employing organic and attached transportation assets.

(c) By employing Army aviation.

(d) By improving roads, controlling traffic flow, and restricting refugee movement to routes not used by the battalion.

(e) By rehearsing movements. To reduce congestion and confusion, each unit is given its own route. If routes must converge, an order of movement is established and times or events that start movement are specified.

(f) By evacuating casualties, recoverable supplies, and excess materiel before the operation.

(g) By displacing nonessential CSS activities early in the operation.

(2) The battalion degrades the mobility of the enemy—

(a) By occupying and controlling choke points and terrain that dominate high-speed avenues of approach.

(b) By positioning air defense and security forces at critical points.

(c) By destroying roads, bridges, and raft and ford sites on the avenues not required for friendly forces.

(d) By improving existing obstacles and covering them with fire.

(e) By employing indirect fire and smoke to degrade the enemy's vision and to slow his rate of advance. By ensuring continuous coverage, battalion mortars move in split sections.

(f) By conducting spoiling attacks to unbalance the enemy and force him to deploy.

(g) By covering movements by fire.

d. **Deception.** The purpose of the deception is to prevent the enemy from knowing when a retrograde is taking place. Deception provides security to cover moving units and their inherent vulnerabilities. It also provides surprise, which is vital to success. The proper use of deception causes indecision and more delays in enemy actions. Deception is achieved by maintaining normal patterns of activity such as radio traffic, artillery fires, patrolling, and vehicle movements. Other measures include using dummy minefield or decoy positions, feints, and demonstrations to indicate other than actual activities, and employing all available EW measures. When possible, retrogrades are conducted under limited visibility conditions. Retrograde plans are never discussed on nonsecure radio nets.

e. **Conservation of Combat Power.** The commander must know the relationship between conservation of combat power and risk. Leaving too few combat elements in contact with the enemy could result in a pursuit. The commander must conserve his combat power—

(1) By covertly displacing less mobile units before the retrograde, especially nonessential CSS elements.

(2) By using mobile forces, such as antitank assets, to cover the retrograde of less mobile forces.

(3) By using the fewest essential forces to provide security for the retrograde of the main body.

## Section II DELAY OPERATIONS

A delay is an operation in which a force trades space for time while avoiding decisive engagement and inflicting maximum destruction on the enemy. The battalion might be ordered to delay as part of the covering force, in an economy-of-force operation, or if forces are inadequate for defense. The battalion is the lowest unit to conduct a delay operation. Companies defend or disengage and move as part of a battalion delay.

#### 5-4. PURPOSE

The delay incorporates all the aspects of a defense, but it emphasizes preserving the force and maintaining a mobility advantage. The battalion can attack, defend, or conduct other actions during the delay, such as ambushes and raids, to destroy or slow the enemy.

#### 5-5. FUNDAMENTALS

The basic concept for a delay is to retain freedom to maneuver while forcing the enemy to deploy repeatedly against successive BPs. As the enemy uses FA deploys ground units, and begins maneuver against the delay force, the battalion moves to subsequent BPs to make the enemy start the same time-consuming proms again. In so doing, the battalion trades space for time. A delay is impossible if the initiative is left to the enemy. Therefore, the commander must try to seize the initiative.

**a. Centralize Control and Decentralize Execution.** A delay is conducted on a wide front with maximum forces in contact and minimum forces in reserve. This results in a series of independent actions. Therefore, antitank, engineer, and air defense assets are often attached to companies or scouts. In the delay, units must maintain enemy contact and flank security. This helps detect enemy attempts to bypass or surround elements of the delay force or to achieve a penetration that would prevent the success of the mission. Control is maintained through the use of phase lines, checkpoints, and adequate communications.

**b. Use Terrain.** Cross compartments are natural delay lines formed by parallel ridgelines or water obstacles across the enemy axis of advance. Delay positions should be on terrain features that control the likely avenues of enemy approach. They should block the enemy where his movement is most centralized and should allow the longest delay with the fewest soldiers. Ideal terrain provides long-range observation and fires, offers concealment, and provides for covered routes of withdrawal.

**c. Force the Enemy to Deploy Repeatedly.** Enemy reconnaissance elements are ambushed if possible. The enemy main body is engaged at maximum range of all weapons to cause the enemy to deploy and maneuver. Repeated use of this technique slows the enemy and allows the commander to exchange space for time. As

much of the enemy force is destroyed as possible without decisive engagement.

**d. Use Obstacles.** Reinforcing and existing obstacles are used on high-speed routes. They disrupt the enemy's progress, force him into selected avenues of approach, or block him from high-speed avenues of approach to gain time for disengagement. For the delay force to be effective, obstacles (including FASCAM) must be covered by fire. Choke points to the rear of the delay force must be secured to prevent seizure by enemy forces infiltrated to the rear.

**e. Maintain Contact With the Enemy.** The delay force conducts continuous reconnaissance to maintain contact with the enemy. Enemy forces try to bypass, to envelop the flanks, or to penetrate between units conducting the delay.

**f. Avoid Decisive Engagement.** Positions in a delay action are occupied only long enough to force the enemy to deploy and maneuver. Disengagement criteria must be specified. The delay force moves from one delay position to another without becoming decisively engaged with the enemy unless required. It maintains freedom to maneuver.

**g. Achieve Depth.** Depth is achieved to the extent possible based on the terrain, enemy abilities, friendly strengths, and mobility.

**h. Use Long-Range Fires.** The delay force uses long-range fires to halt, confuse, and disrupt the enemy as far forward as possible.

**i. Achieve Surprise.** Surprise is achieved through selection of different types of positions at different intervals. The delay force uses obstacles, counterattacks, ambushes, raids, sudden massing of fires, and smoke.

**j. Establish Flexibility.** Flexibility is established through mission-type orders that provide an adequate means of communication, event-oriented disengagement criteria, a provision of mobility, deployment in depth, contingency planning, and use of reserves.

#### 5-6. DEGREES OF RISK

The commander specifies the degree of risk, which is used to aid in understanding how the delay is to be fought. He determines whether time or the preservation of the force is more important. Specified times for holding the enemy forward of delay lines or positions indicate increased degrees of risk.

a. **Low Risk.** The battalion must delay the enemy as long as it can without accepting decisive engagement. At the same time, it must maintain the combat effectiveness of the task force. No time limit is specified-the battalion trades space for time.

b. **High Risk.** A delaying force that must hold the enemy forward of a delay line or other location for a specified time is described as having a high degree of risk. The battalion may have to accept decisive engagement to gain more time.

**5-7. METHODS OF DELAY**

The two methods of conducting a delay are *delay from successive positions* and *delay from*

*alternate positions.* Either be be modified to fit the situation. The delaying force can select one method or can combine methods. A company might be in successive platoon positions along a dangerous avenue of approach while the rest of the battalion is delaying by alternate positions.

a. **Delay from Successive Positions.** A delay from successive positions involves fighting rearward from one position to the next, holding each as long as possible or for a specified time period (Figure 5-1). In this type of delay, all companies are committed on each of the battalion delay positions or across the sector on the same phase line.

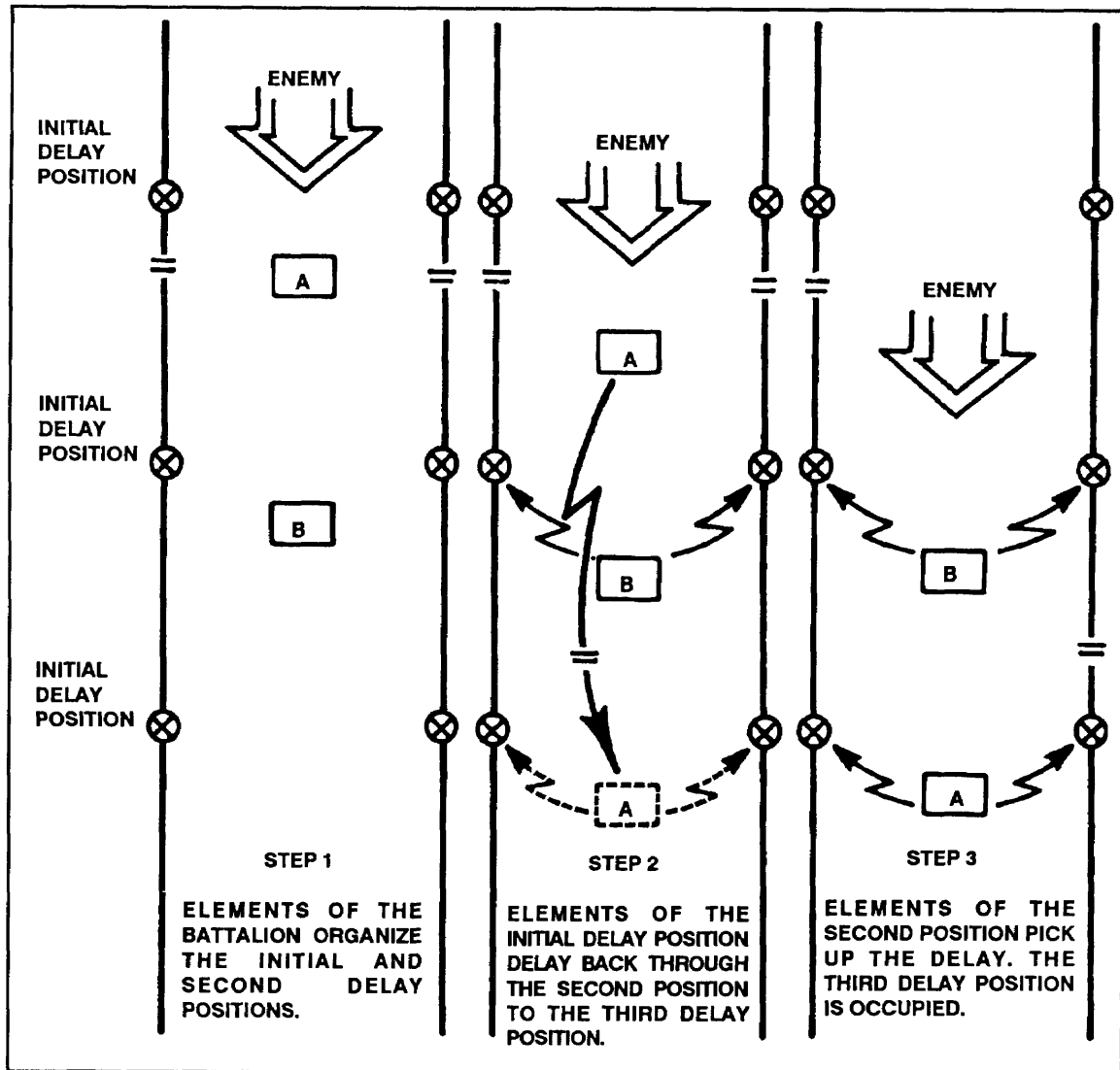

Figure 5-1. Delay from successive positions.

(1) A delay from successive positions is used when a sector is so wide that available forces cannot occupy more than a single line of positions. The disadvantages of this delay are lack of depth, less time to prepare successive positions (than in a delay from alternate positions), and the possibility of gaps between units. When ordered to move, the battalion disengages, moves, and occupies the next designated position.

(2) A part of the unit displaces directly to the rear when the order to begin the delay is received and occupies the next designated position. The rest of the unit maintains contact with the enemy between the first and second

delay positions. As these elements pass through the second position, the forces on that position engage the enemy at maximum effective range. When the battalion can no longer hold the position without becoming decisively engaged, it moves to the next successive position.

(3) If a high-risk delay is required or becomes necessary, the battalion retains the terrain until the conditions required to justify the high risk are met. The battalion then conducts the delay.

b. **Delay from Alternate Positions.** A delay from alternate positions can be used when a force has a narrow sector or has been reinforced to allow positioning in depth (Figure 5-2). This is the preferred method of delay.

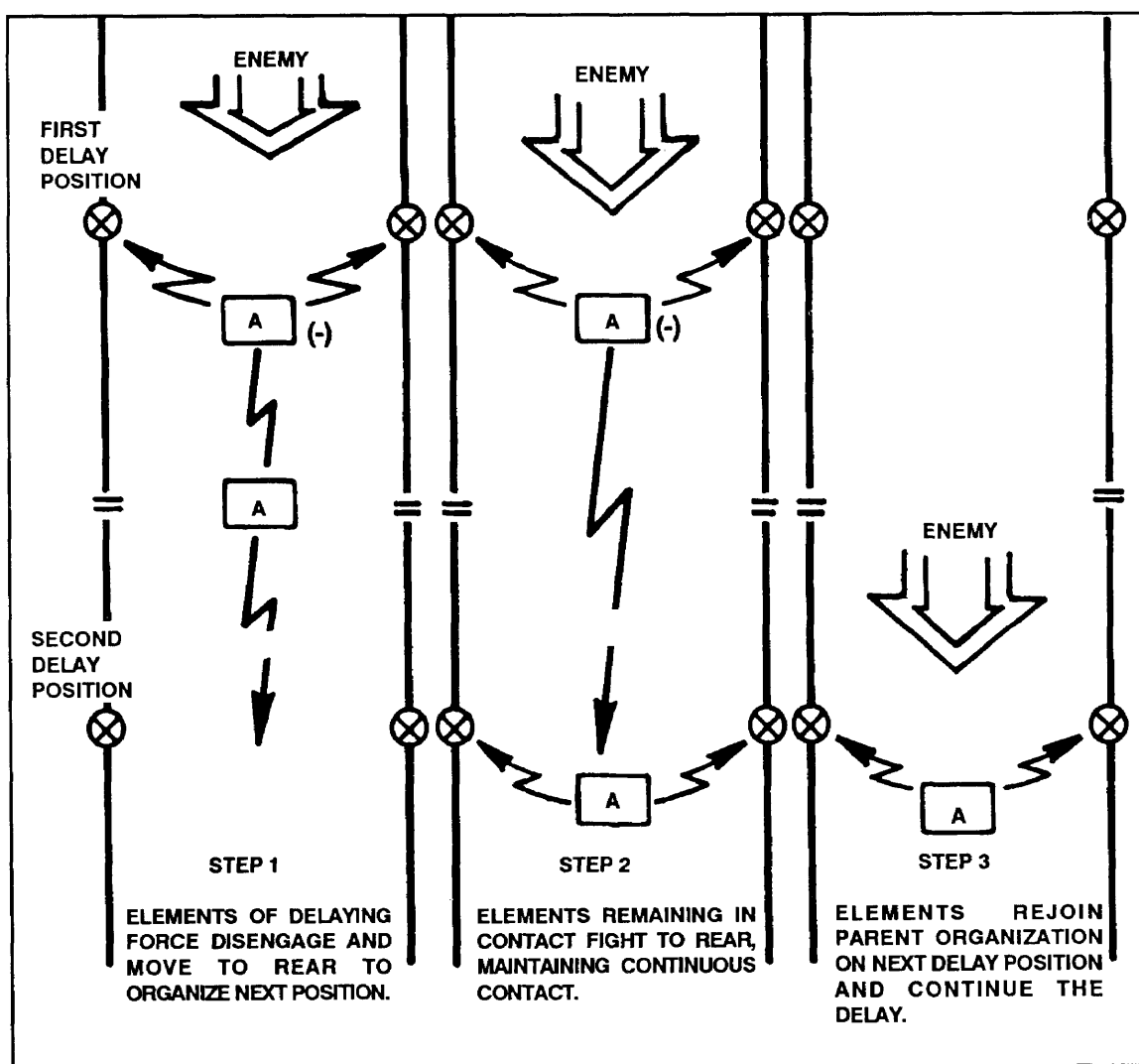

Figure 5-2. Delay from alternate positions.

(1) One or more companies employ this method to occupy the initial delay position and engage the enemy. The other companies occupy and prepare a second delay position. These elements alternate movement in the delay. While one element is fighting, the other occupies the next position in depth and prepares to assume responsibility for the fight.

(2) Units occupying the initial delay position can delay between it and the second position. When the delaying units arrive at the second delay position, they move through or around the units that are occupying the second position and occupy the third delay position. The units on the second delay position assume responsibility for delaying the enemy; the delaying procedure is then repeated. Moving around the unit on the next delay position is preferred because this simplifies passage of lines. The alternate method provides the greater amount of security to the delay force and more time to

prepare and improve delay positions. It requires continuous coordination of maneuver.

**5-8. METT-T ANALYSIS**

Basic factors that affect the methods of delay should be considered during METT-T analysis (Table 5-1).

a. **Mission.** The battalion commander must know his commander's intent before he decides how to delay. This intent is expressed in terms of time, terrain (or space), and presentation of the force; it indicates the degree of risk the battalion commander must accept.

b. **Enemy.** The commander must use all intelligence sources to determine the enemy's strength, location, mobility, and capability. The S2 should provide his assessment of the situation and recommendations as to enemy COAs to the battalion commander or S3. The more the enemy's relative firepower, protection, and mobility exceeds that of the delaying force, the more a delay on alternate positions becomes favorable.

| METHOD OF DELAY                 | FAVORED WHEN  | ADVANTAGES   | DISADVANTAGES   |
|---------------------------------|---|--|---|
| DELAY FROM SUCCESSIVE POSITIONS | SECTOR IS WIDE<br><br>FORCES AVAILABLE PREVENT SPLIT OPERATIONS | INCREASED ABILITY TO MASS FIRES  | LIMITED DEPTH TO THE DELAY POSITIONS<br><br>LESS TIME AVAILABLE TO PREPARE EACH POSITION<br><br>LESS FLEXIBLE |
| DELAY FROM ALTERNATE POSITIONS  | SECTOR IS NARROW<br><br>FORCES ARE ADEQUATE FOR SPLIT POSITIONS | ALLOWS POSITIONING IN DEPTH<br><br>ALLOWS MORE TIME FOR POSITION PREPARATION AND EQUIPMENT AND SOLDIER MAINTENANCE | REQUIRES CONTINUOUS COORDINATION<br><br>REQUIRES PASSAGE OF LINES   |

Table 5-1. Comparison of methods of delay.

c. **Terrain.** The commander/S3 analyzing terrain (IAW OCOKA) determines how to use the terrain to gain and maintain a mobility advantage over the enemy. He must consider factors that favor delaying from BPs or sectors.

(1) Conditions that favor delaying from BPs include a narrow delay sector that allows mutual support between company BPs. Also included are well-defined avenues of approach to canalize the enemy that dominates terrain along avenues of approach. Conversely, conditions favoring delaying in sector are wide sectors that prevent mutual support and a lack of well-defined avenues of approach and dominating terrain.

(2) The battalion commander must consider how many suitable delaying positions are available in depth and how much delay (time) can be obtained on each position. Bad weather or poor visibility might require him to narrow sectors. Limited visibility and the lack of defensible terrain in depth might favor delaying on successive positions to aid command and control.

(3) Key terrain includes defensible delay positions, choke points, and routes of withdrawal.

d. **Troops and Time Available.** The battalion commander must know what assets are available to him and how the time available influences the mission. If the battalion is reinforced with tanks, delay on alternate positions can be used by placing tanks with some infantry forward, thus allowing the remaining infantry to prepare positions in depth. Tanks can use their mobility, firepower, and armor protection to move quickly to a subsequent position. Also, attack helicopters can be used to provide antiarmor and flank protection and to overwatch for disengaging infantry. If a high-risk delay is ordered, forces can be concentrated forward. This may require successive positioning.

## 5-9. PLANNING

The initial delay position is specified in the order or on an overlay. Instructions pertaining to the delay sector and the time of the delay are also given. The plan must be flexible enough to react to the enemy's attack wherever or whenever it occurs. Brigade or higher headquarters can also

prescribe the method of delay, phase lines, and successive or alternate delaying positions. Within this framework, the battalion commander develops his tentative plan of maneuver and fire support, and he gives planning guidance to his staff.

a. **Task Organization.** The battalion commander, based on the factors of METT-T, organizes for combat and integrates all available assets.

b. **Command and Control.** Command and control *must* ensure order and simplicity. It is aided by control measures, communications redundancy, locations and organization of the main CP and command group, and the delegation of authority to subordinate commanders. Also, proper use of graphic control measures portrays the commander's intent.

c. **Scheme of Maneuver.** The commander's scheme of maneuver describes how he envisions the delay taking place. The commander organizes the delay around a series of ambushes or engagement areas to keep the enemy off guard, to slow and harass him, and to reduce his forces. The concept might require a series of contingency plans such as ambushes, use of artillery, spoiling attacks, and counterattacks. The commander can describe the successive or alternate method of delay or a combination of these. He must be aware of gaps in his dispositions and try to strengthen them. He should consider employing artillery, sensors, security patrols, and obstacles.

d. **Courses of Action.** The following should be considered in developing COA to accomplish the delay mission:

(1) Delaying forces try to maintain a mobility advantage over the attacker. Enemy closure rates for the terrain should be calculated during war-gaming and compared to friendly displacement rates between positions. Time-distance factors dictate the amount of time the commander has to engage the enemy and to move his unit before becoming decisively engaged. These times should be calculated for each avenue of approach and disseminated to soldiers on positions along these avenues.

(2) Situational templates show the commander how the enemy might deploy and operate within the constraints imposed by weather and terrain. They help him to identify



critical enemy activities and locations, to identify where to emplace obstacles, and to identify where decisive engagement is likely. Obstacles must slow or stop the enemy long enough for the battalion to disengage and displace.

(3) The commander assigns sectors of responsibility to each company during the planning for a delay. He assigns boundaries so that terrain features that control fire and observation into a sector belong to the unit responsible for that sector. He also designates contact and coordinating points. Existing obstacles are improved, and reinforcing obstacles are built within the limitations of available materials, time, and manpower. However, unless obstacles are adequately covered by fire, they will not halt the enemy's progress.

(4) Battle positions are preferred in the delay if the terrain is suitable. The commander must emphasize reconnaissance outside the BP, preparation of routes for disengagement, and coordination for passage of lines. Units should know the routes from their primary, alternate, and supplementary positions. Less emphasis is placed on FPFs, installation of tactical and protective wire, and stockpiling of ammunition. The position is wide but not deep.

**e. Reconnaissance and Selection of Delay Positions.** A reconnaissance of delay positions is made as early as possible. Likely avenues of approach are located, and plans are made to deny their use to the enemy.

(1) The commander, in selecting positions, considers the same factors he would in selecting any defensive position (Chapter 4). He selects positions that allow long-range fields of fire with routes suitable for rearward and lateral movement, and he establishes priorities of movement on routes. Positions should incorporate good observation and long-range fields of fire, covered or concealed routes of movement to the rear, existing or reinforcing obstacles on the front and flanks, or all of these,

(2) The commander assigns company sectors astride likely avenues of approach. Where possible, a company covers one major avenue of approach and the terrain dominating that avenue. Each company sector should include at least one good route for rearward movement. If used, the reserve is located in an

area it can counterattack or move quickly to reinforce. The battalion main CP and combat trains are located well to the rear and behind the next rearward phase line. The command group remains well forward in positions best suited to control the operation.

**f. Combat Support.** The commander's plan for a delay addresses CS in a statement of how the battalion's assets are to be used. The assets are as follows:

(1) **Mortars.** The battalion mortars provide the most responsive fire support. Priorities of fires are flexible. A unit that can observe at longer ranges might have the priority at first; later, the priority might change to a unit facing an imposing threat. Mortars can operate by split section to cover a wide sector or to provide continuous fire in depth. The planned use of smoke to cover movement can decrease the number of HE rounds carried.

(2) **Antiarmor assets.** Antiarmor assets should remain under battalion control. They are employed in depth. The commander might want to employ TOWs to engage the enemy as far forward as possible. The TOWs would then move to subsequent positions to provide in-depth and overmatching fires for the conduct of the delay. In a delay against another infantry force, TOW assets can be used for surveillance (thermal sights) or, if equipped with automatic weapons, to increase the mobility and firepower of the delaying force.

(3) **Scouts.** The battalion scouts can perform several tasks during the delay however, overtasking should be avoided. Scouts can be employed forward of the initial delay position to provide early warning, to provide intelligence, and possibly to disrupt enemy forces through the employment of indirect fire. They can also be used to screen a flank, to reconnoiter routes throughout the sector, to conduct liaison with adjacent units, or to screen gaps between delay positions spread over a wide sector.

(4) **Artillery.** Fire support for the delay must be planned in depth for the entire sector. Mass fires along likely enemy avenues of approach cause him to button up, to strip away dismounted elements, and to direct him into kill zones. Commander's must plan fires, including smoke and artillery-delivered mines, to help units disengage

and must plan PPFs. The effective use of COLTs can help control these fires. Artillery-delivered mines are effective for sealing gaps in existing obstacles but require time to emplace.

(5) **Close air support.** Planned CAS sorties can be requested and are an excellent means to aid in disengagement. Subordinate commanders use procedures for immediate requests. CAS can also deliver FASCAM and might be more effective than artillery.

(6) **Attack helicopters.** Attack helicopters can be OPCON to the brigade or battalion. They have an excellent antiarmor ability, and they can respond quickly to protect flanks and seal gaps. Attack helicopters can provide quick and violent assistance to the battalion disengaging from the enemy. They must arrive with the correct ordnance appropriate to the enemy force.

(7) **Other Army aviation assets.** Utility helicopters can increase the mobility of a delay force. Also, army aviation assets can aid in medical evacuation, resupply, reconnaissance, and command and control.

(8) **Air defense assets.** The battalion should use ADA to protect soldiers, choke points, and command groups. Air avenues of approach should be identified and ADA assets placed accordingly security must be provided.

(9) **Engineers.** Engineers can be attached or DS to a battalion. The battalion commander decides to allocate the platoon to the main effort or particular company, to provide area support to specific tasks, or to provide a specific number of hours to given units, engagement areas, or BPs. Creating obstacles and defensive positions should have top priority. The commander also integrates obstacles into the terrain to use existing obstacles and to increase the length of the delay, while helping to preserve the delay force.

(10) **Communications.** The means of communication must be redundant. The force must reduce radio transmissions to prevent the enemy from locating friendly positions. Other means of communications must be considered such as messengers and pyrotechnics. If available, EW assistance to deceive the enemy and to disrupt his command and control can be obtained from brigade.

(11) **Security and surveillance.** Ground sensors and surveillance devices can provide

some security in unobserved areas (flanks, dead space, and gaps) and during limited visibility.

g. **Combat Service Support.** Movement of trains and other CSS must be timely. Those assets must provide responsive service, yet their movement must not disrupt friendly combat units. Supplies and equipment that cannot be used or evacuated must be destroyed; however, destruction of medical supplies is a violation of the Geneva Convention.

(1) **Class V supplies.** Ammunition is expended in great amounts especially for mortars, TOWs, Dragons, and machine guns. The delay plan should include provisions for resupply such as pre-positioning ammunition at successive positions.

(2) **Medical evacuation.** Soldiers know they will receive care if they are wounded, which enhances morale. The commander must plan for and expect high casualty rates. He must use all available means of transportation to evacuate the nonwalking wounded. When possible, wounded soldiers should be evacuated quickly to prevent slowing the delay. If wounded soldiers must be left behind, they should be consolidated and a medic should remain with them.

h. **NBC Environment.** The battalion commander must prepare to operate routinely in an NBC environment, not as a special operation. In a chemical environment, the commander might choose the alternate method of delay to disperse his forces and to provide time for decontamination. The forward elements perform basic skills or hasty decontamination until they move to a position where other elements take up the battle. At positions in depth, soldiers can thoroughly decontaminate and change protective clothing.

i. **River Crossing.** The commander, during the analysis of terrain, must give priority to any obstacles that might have to be breached or crossed during the delay such as a river. In the case of a river crossing, any existing crossing sites must be protected. Engineers can prepare crossing sites if no sites exist. Planning can prevent the delay plan from being jeopardized by water obstacles.

j. **Military Operations on Urbanized Terrain.** MOUT should not be considered special operations but should be incorporated

into the terrain analysis of METT-T. Built-up areas can provide formidable obstacles, good defensive terrain, or both. (FMs 90-10 and 90-10-1 provide more information about MOUT.)

k. **Limited Visibility.** Disengagement might be easier during limited visibility. Limited visibility can be natural or man-generated. Smoke can be used to silhouette and confuse the enemy. As enemy vehicles emerge from smoke, they should be easier to see and engage. Systems that have a see-through-smoke or shoot-through-smoke ability should be concentrated along the most dangerous avenues of approach. Also, limited visibility increases security requirements for the delaying force.

l. **Contingency Planning.** Contingency planning, especially counterattack planning, for a delay operation is required to extend reaction time and to take advantage of opportunities.

#### 5-10. CONDUCT OF A DELAY

The initial delay position is occupied in the same manner as a defensive position. The same techniques of security and priority of work apply in conducting the delay (Chapter 4). The use of deception to make the enemy think he will encounter a determined defense increases the amount of delay.

a. The battalion takes the approaching enemy under long-range fires. Every effort is made to inflict casualties on the enemy, to disorganize him, and to make him stop for reorganization. If the enemy masses, he becomes susceptible to the battalion's fires.

b. Decisive engagement is avoided except when needed to accomplish the mission. Each position occupied by a forward unit is defended until the enemy threatens decisive engagement or envelopment of the position.

c. Brigade approves battalion disengagement criteria. In turn, battalion approves company disengagement criteria. These criteria allow units to begin movement IAW established plans—for example, when the enemy reaches Phase Line Blue or on order of the higher commander. Since the battalion might be more vulnerable as it moves, the move is conducted only after considering the following questions:

(1) What is the strength, composition, and location of the enemy attacking force?

(2) Are elements of the company threatened with decisive engagement or bypass?

(3) What is the status of adjacent units, and how does it affect the battalion's ability to continue to delay?

(4) What is the condition of the delay force in terms of losses in men, equipment, and weapons?

(5) How strong is this particular position in relation to other positions that can be occupied? If extensive effort has been put into preparation of the position, or if it is the last one available, the battalion commander might be forced to remain in the position longer.

(6) Is unit survivability or time the key to the mission? If it is a high-risk delay and the company has gained only one of an anticipated five hours on the position, more effort might be required to retain the position. However, the conditions that impose time requirements are subject to change and should be revised, if needed.

(7) Can other means be used, besides movement, to continue the delay—for example, nuclear, chemical, and conventional fires; spoiling attacks; reinforcements?

d. The movement to the next delay position begins when the required delay has been achieved. Coordination of fires between the moving element and adjacent, supporting, and overwatch elements is critical. Primary and backup signals for exact locations of the lead, trail, and flank elements must be planned for all conditions of visibility to ensure the best use of available combat power.

e. The commander has several disengagement options for aiding elements of the battalion that are threatened with decisive engagement or that have become decisively engaged. In order of priority, the commander has the following options:

(1) Allocate priority of indirect supporting fires and aerial fires to the threatened unit. This is the most rapid and responsive method of increasing relative combat power of the unit.

(2) Direct adjacent units to engage enemy targets forward of the threatened unit.

(3) Reposition combat and CS elements so that they can support the threatened unit. This might require changes in tasks or in task organization.

(4) Counterattack to disengage. The battalion commander must make a rapid, yet cautious, evaluation of the potential gains or losses of this COA. The counterattack force must have greater relative mobility than the attacker. Attack helicopters are suitable for this mission.

f. All forces can be deployed during the delay. If they are, the battalion commander should designate the least engaged force to constitute a reserve. This is true when delaying on successive positions. When using the alternate method, the reserve might consist of an element in depth. When assigned multiple missions, the reserve force must be given a priority of missions for planning. Reserve tasks include the following:

- Reinforcing.
- Assisting disengagement.
- Providing overwatch.
- Blocking.
- Assuming another unit's mission.

g. Reorganization of forces might be SOP, but it requires attention to detail. Key leaders must be replaced, ammunition redistributed, and elements reorganized. Soldiers, squads, or

platoons may need to be integrated into other units to maintain combat power. The chain of command must be more than two deep to ensure a logical replacement sequence and to lessen confusion. Crew-served weapons receive a priority of manning, and ammunition is cross-leveled to ensure all systems are used. Radios are replaced on critical nets—for example, command and control, fire direction to maintain control, and fire support.

h. Command and control of the delay requires close coordination. The successive technique, which the battalion commander can control by being forward, might be easier to control than the alternate technique. With the alternate technique, the battalion commander can be well forward since the XO is in charge of positions in depth. The commander can take charge of the forces in depth once the forward elements move back. He can assign the XO to reorganize the depleted forces and to supervise preparation of the next position. A plan must be developed so that the delay can be executed smoothly.

i. Delays are not an end in themselves; each delay operation must end with a planned result such as a defense, a withdrawal, or an attack.

### Section III WITHDRAWAL OPERATIONS

A withdrawal is an operation in which a force in contact with the enemy frees itself for a new mission.

#### 5-11. PURPOSE

A withdrawal is conducted to disengage from the enemy when the battalion commander decides to reposition all or part of his force. The two types of withdrawals are withdrawal under enemy pressure and withdrawal not under enemy pressure. The main difference is the intensity of enemy pressure.

a. All or part of the battalion can conduct a withdrawal while engaged in a defensive, delaying, or offensive operation. The commander designates elements to remain in contact with the enemy for deception and security. He can designate a reserve or allow the least engaged unit to constitute the reserve. In withdrawals, reserves are positioned well forward. Battalion withdrawal

operations can include the battalion operating as a flank or rear guard for a brigade or division withdrawal. When the battalion is withdrawing under pressure, its reserve can launch attacks to disorganize, disrupt and delay the enemy attack.

(1) ***Withdrawal under enemy pressure.*** This type of withdrawal depends on maneuver, firepower, and control since the enemy will try to pursue the withdrawing force.

(2) ***Withdrawal not under enemy pressure.*** This type of withdrawal requires deception and depends on speed of execution.

b. Withdrawals are either assisted or unassisted.

(1) ***Assisted withdrawal.*** In this type of withdrawal, security elements provided by the

next higher headquarters help the main body break contact with the enemy.

(2) **Unassisted withdrawal.** In this type of withdrawal, the battalion provides its own security element.

### 5-12. METT-T ANALYSIS

The battalion commander considers METT-T factors when planning a withdrawal based on the mission statement.

a. **Mission.** Mission orders are essential. Missions given to units depend on whether the unit is under enemy pressure. The future mission of the battalion affects planning of the withdrawal.

b. **Enemy.** The following questions about the enemy must be answered:

(1) How can the enemy interfere with disengagement and displacement?

(2) What deceptive means can be taken?

c. **Terrain.** The following questions about the terrain must be answered:

(1) What terrain is available to complement the withdrawal plan?

(2) How can obstacles be used to facilitate the withdrawal?

(3) What effects will routes and the availability of overwatch positions and choke points have on movement?

(4) Can limited visibility aid in the withdrawal?

(5) How will weather affect trafficability?

d. **Troops and Time Available.** The following questions about troops and time available must be answered:

(1) How much time is available for reconnoitering, planning, issuing orders, moving to initial positions, and preparing obstacles and positions?

(2) What assets are available to improve the battalion's mobility? To decrease the enemy's mobility?

(3) Is the brigade providing a security force? If so, where is it? If not, how many and what type of security elements must be designated within the battalion?

### 5-13. PLANNING

Planning for withdrawal requires attention to detail, widest possible dissemination of the plan, and reconnaissance by all subordinate elements.

Due to the benefit of remaining undetected, the battalion must consider deception and OPSEC. Control measures are important during planning for a withdrawal. When observation is restricted, the control measures for a withdrawal from linear positions under pressure include the following:

a. A phase line aids in control of unit movements and fires, and marks where responsibility for the sector is transferred.

b. On-order boundaries are designated in advance for use when the security force fails to slow the enemy, becomes bypassed, or cannot disengage the bulk of the battalion.

### 5-14. CONDUCT OF A WITHDRAWAL

Withdrawals are accomplished in three overlapping phases.

a. **Preparation Phase.** Elements reconnoiter and dispatch quartering parties, issue warning orders, and begin planning. Those not required to support the operation, such as trains, elements of the main CP, and nonessential vehicles, are relocated to the rear. The enemy must not know about this relocation. As time allows, obstacles are prepared to slow enemy movement. If appropriate, preparation begins on rearward positions to be occupied.

b. **Disengagement Phase.** Designated elements begin their movement to the rear. When covered from enemy direct fire and observation, they assemble and conduct a tactical movement to a subsequent position.

c. **Security Phase.** A security element aids disengagement of other elements, assumes responsibility for the battalion sector, deceives the enemy, and protects the movement of disengaged elements through the use of fire and movement. This phase ends when security forces have conducted a rearward passage through the next occupied position to the rear.

### 5-15. WITHDRAWAL NOT UNDER ENEMY PRESSURE

Speed and deception measures are vital to the success of the mission in the withdrawal not under pressure. The enemy must not know that a withdrawal is taking place. The DLIC is not large or strong enough to withstand a large enemy force. If the withdrawal is discovered, the

enemy might overwhelm the DLIC and expose the rest of the battalion.

a. The DLIC can deceive the enemy into believing that friendly forces are remaining in position. Other deceptive measures include the following:

- (1) Continue communications; neither increase nor decrease radio traffic.
- (2) Continue patrolling activity, if established.
- (3) Use limited visibility to cover withdrawal.

b. Operations security complements the deception plan. The battalion maintains noise and light discipline, masks movements by surrounding noise such as artillery fire, and continues counterreconnaissance activities.

c. The commander conducts a reconnaissance and establishes control measures before a withdrawal not under pressure (Figure 5-3).

(1) Routes are identified by a name or number. They begin at an easily recognized point (preferably to the rear of the assembly area or position); they continue directly to the next position. Units are released only after they cross the last obstacles forward of that position. Alternate routes may also be selected if primary routes cannot be used. One route may be used by two or more units if a priority is established. When a unit withdraws from a mounted enemy, all of its routes should be on restrictive terrain. To prevent the enemy from following, the last unit to use each route emplaces obstacles.

(2) Assembly areas should be located on good routes of withdrawal well forward. This allows the units to regain control rapidly while under cover from enemy direct fires and observation. To allow rapid access to all using elements away from CPs and FSEs, the assembly areas are positioned laterally and are large enough for dispersion.

(3) Traffic Control points maybe established where routes merge or where other problems or confusion could occur during movement.

(4) Phase lines, TRPs, and checkpoints may be designated to aid in movement control and to shift direct-fire responsibility, which simplifies possible changes in the mission.

(5) Element locations are designated for future missions.

(6) On-order boundaries or battle positions are planned in depth. This gives the commander flexibility if the withdrawal is temporarily stopped or if the enemy threatens bypass or engagement of withdrawing elements. If on-order boundaries are used, projected unit responsibilities should be clear. Battle positions can be numbered or lettered for ease of identification.

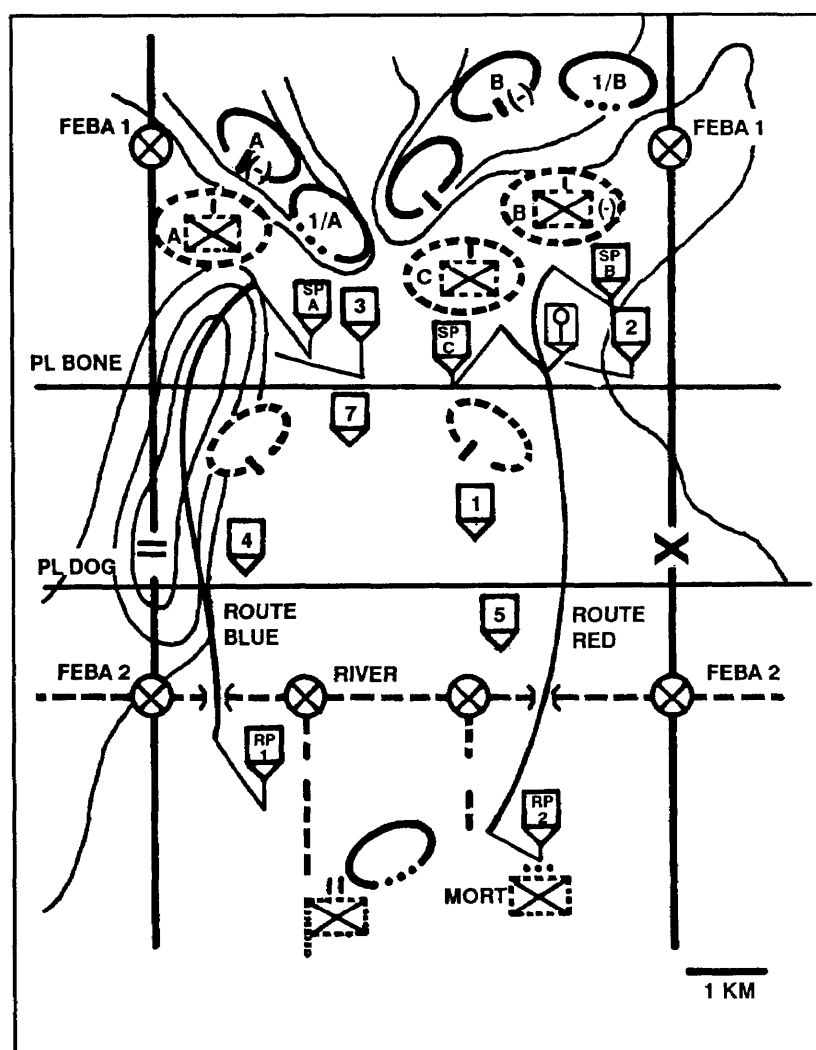

Figure 5-3. Control measures for a withdrawal not under pressure.

d. Key leaders, during the reconnaissance, learn start points, routes, release points, and avenues of approach. Routes with few choke points are selected for the cover and concealment they provide. Reconnaissance should be performed under the same conditions of visibility expected at the time of the withdrawal. This might entail a daylight and night reconnaissance. Guides ensure that units move in the specified direction.

e. The OPORD directs the following:

(1) The size, composition, mission, and commander of the DLIC. (The DLIC is normally up to one-third of the size of the force.)

(2) The time for the withdrawal to start.

(3) The location of the battalion avenue of approach (if used), and the actions each company performs on its arrival.

(4) The location of each company avenue of approach.

(5) The location of routes from the company avenues of approach to the battalion avenue of approach or to the next position.

(6) Subsequent battalion and company missions.

f. Simultaneous disengagement and movement by all battalion elements without a DLIC might be feasible when the battalion has a mobility advantage over enemy forces such as when a major obstacle separates the battalion from the enemy or transport is available. If more than one battalion conducts the withdrawal, the brigade order can specify the use of a DLIC.

g. The battalion commander can use one of two methods to establish a DLIC. First, the DLIC can be organized from elements of each company in contact with or near the enemy. Command and control of the DLIC is exercised by a part of the battalion command element to simulate normal battalion activities. The battalion XO might be in charge of the battalion DLIC, with company XOs in charge of their DLICs. Second, the battalion commander can leave a company intact as the DLIC under the control of the company commander. When that occurs, elements of the company have to be repositioned to cover the entire battalion sector.

h. The battalion commander prescribes, within limitations imposed by brigade, the size of the DLIC. He can also state that specific

elements remain such as TOWs, Dragons and, when available, armored vehicles. Depending on METT-T factors, the DLIC might consist of one-third of the force. It must detect and engage the enemy on all avenues of approach with both direct and indirect fires. The location of the DLIC should provide an ability to fight if the enemy attacks during the withdrawal. Because of the mission, the DLIC is provided with available helicopters, tanks, trucks, or other means to make it as mobile and lethal as possible. In an assisted withdrawal not under pressure, the brigade establishes the DLIC. The battalion might be tasked to augment the brigade DLIC.

i. The main body of the battalion consists of all maneuver, CS, and control elements not required by the DLIC. The mission of the main body is to disengage using stealth, to move rapidly along designated routes, to assemble, and to move to a new location in preparation for the next mission.

j. Reserves or combat elements positioned in depth can withdraw before elements of the forward companies, but they withdraw after the forward elements have disengaged. This provides more flexibility and security if the enemy detects the withdrawal and attacks. When a security force is provided from a higher level, reserves can withdraw before the bulk of the forward units. This can also be done when preparation for the future mission of the battalion is of higher priority than the security the reserve could offer to the withdrawing unit.

k. Vehicles and personnel not required and quartering parties from battalion units use infiltration techniques to move to their next positions before the effective time of the withdrawal. At the time designated for the withdrawal, forward elements not required by the DLIC leave their positions, move to the rear, and assemble.

(1) Widely dispersed elements in depth or reserves can assemble then move to the rear, based on the commander's priorities (A, Figure 5-4).

(2) Elements of the main body move to the rear either on order of the commander or IAW plans and priorities. Due to the lack of a higher level security force and to the availability of only two routes to the rear, the battalion commander

is most likely to leave his reserve in position until other elements begin their movement. Once the forward companies have cleared a given point—in this case, a phase line—the reserve moves to its new position and begins to prepare for its next mission (B, Figure 5-4, page 5-16).

(3) The main body elements of the battalion are met at release points by individual quartering parties; they all move to and occupy designated positions and continue to prepare for their new mission. To deceive the enemy, the DLIC commander assumes full control of and responsibility for the battalion sector, covers the movement of the main body, and maintains activities previously conducted by the entire battalion (C, Figure 5-4, page 5-16).

(4) The rest of the battalion disengages and moves to the rear on order of the brigade DLIC commander. They use the same assembly areas and routes used by the main body, are met by parent elements, and are guided into their positions to begin their new mission. Contact with the enemy is maintained either by a security element from a higher headquarters or by the

battalion DLIC. The element that maintains contact provides rear security and accomplishes its mission by screening between the withdrawing security force and the enemy; it either makes a rearward passage or continues its security mission forward of the battalion as it arrives at the new FEBA (D, Figure 5-4, page 5-17).

1. The main body moves on designated routes to the next position. They can be given on-order missions to defend, delay, or counterattack during the withdrawal.

### 5-16. WITHDRAWAL UNDER ENEMY PRESSURE

The sequence of events in a withdrawal under enemy pressure is different from the sequence in a withdrawal not under enemy pressure.

a. A reconnaissance is conducted to the rear during a withdrawal under pressure to identify routes that offer the best cover and concealment and to determine engineer assistance required to overcome obstacles. The planning resembles that for a delay in regard to the use of organic and nonorganic assets.

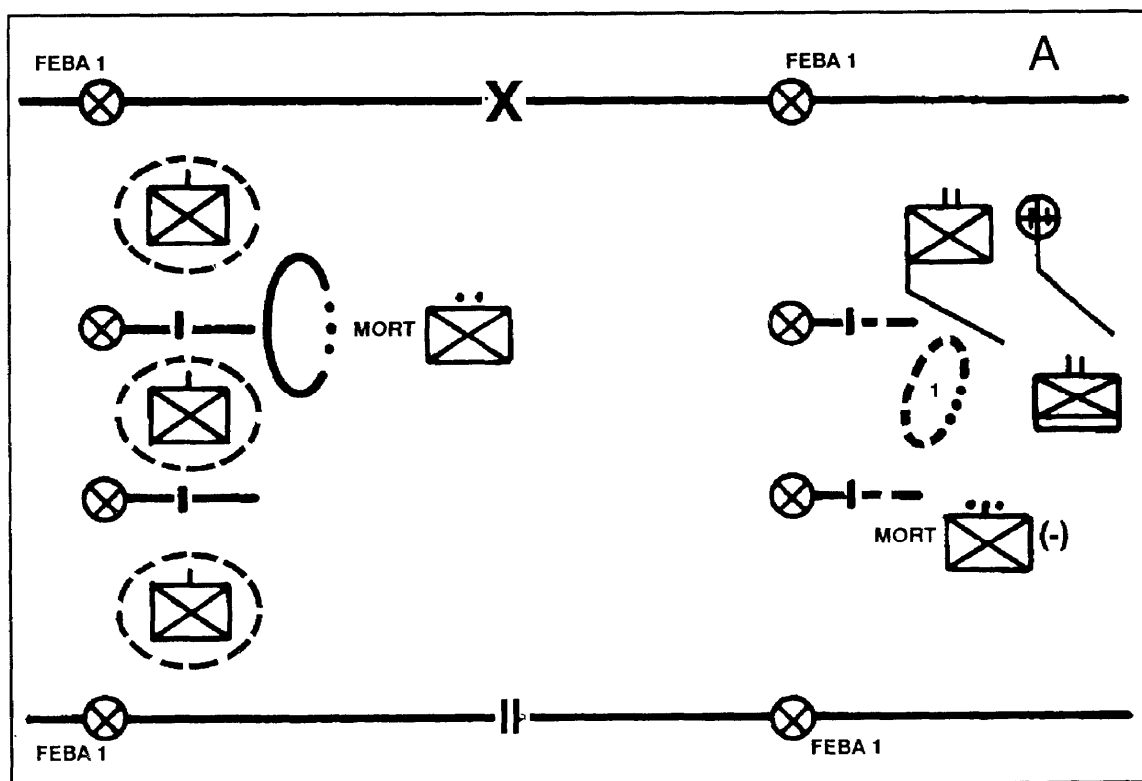

Figure 5-4. Sequence of withdrawal not under pressure.



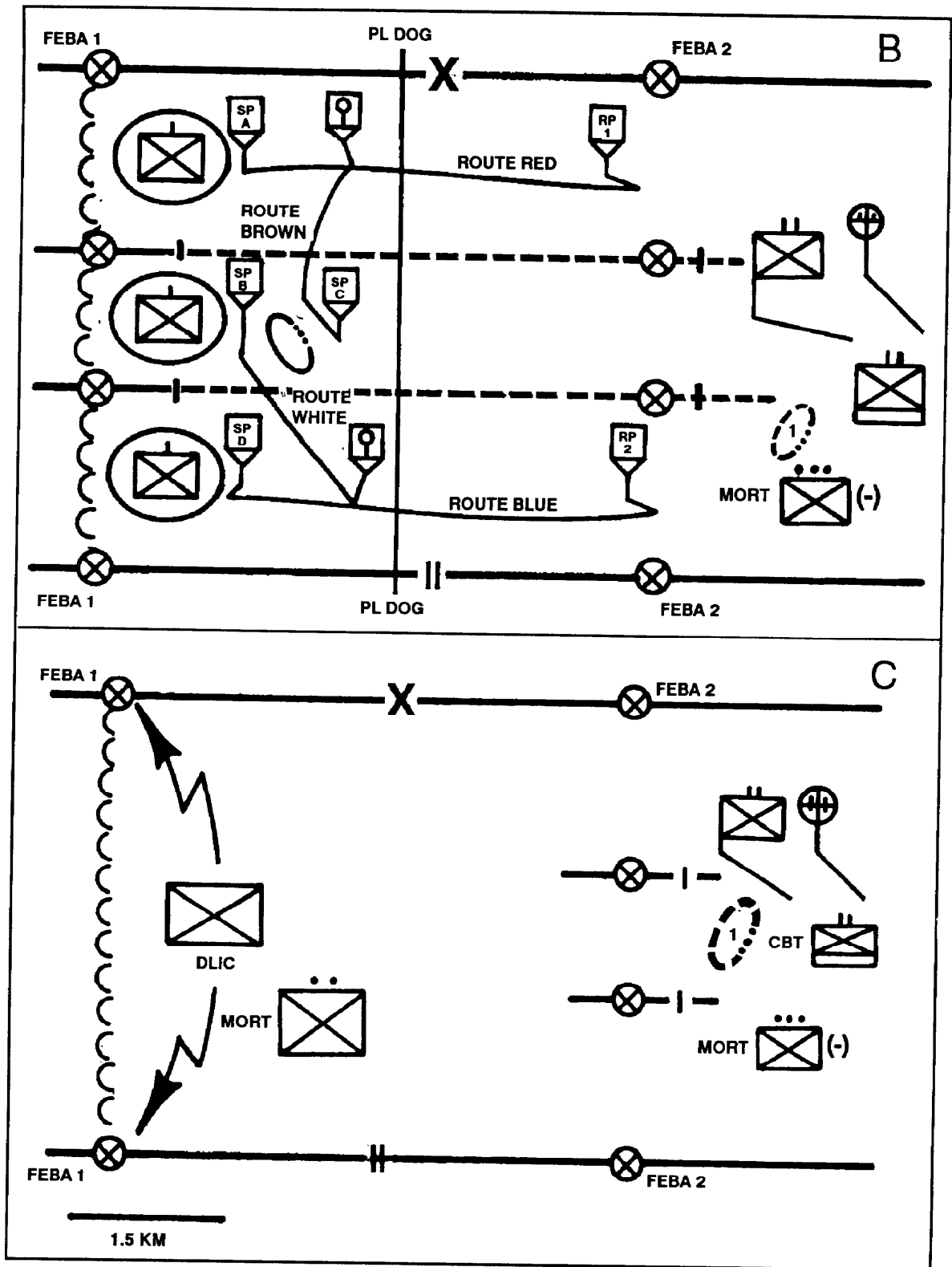
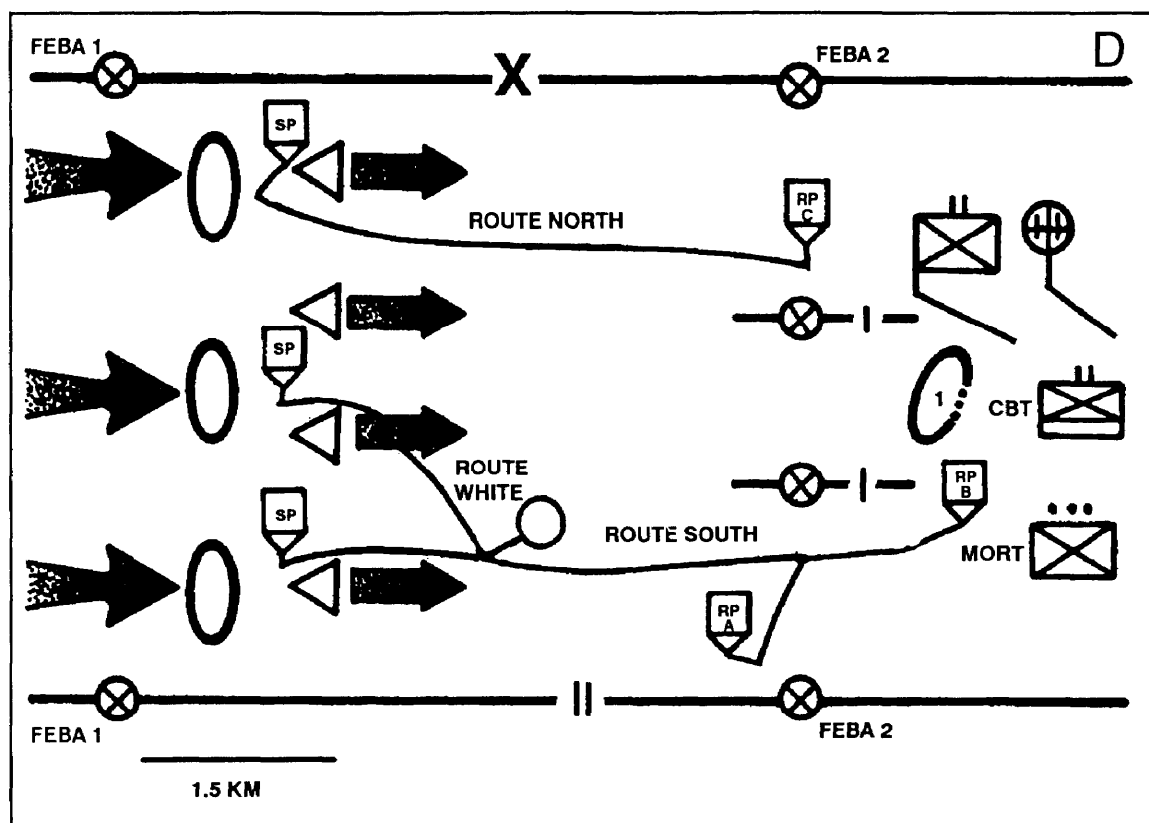

Figure 5-4. Sequence of withdrawal not under pressure (continued).



**Figure 5-4. Sequence of withdrawal not under pressure (continued).**

b. In open terrain, higher headquarters sometimes provides security for a battalion withdrawal under pressure. This security force comprises elements that can detect the enemy at long ranges such as air cavalry or air assault forces. This force is in turn supported by long-range fires from artillery, close air support, and attack helicopters. Normally, all battalion forces disengage at the same time, relying on the firepower of the security elements to obscure and suppress the enemy. Once the battalion has disengaged, it assembles its elements and moves on multiple routes or by aircraft to a designated location (Figure 5-5, page 5-18).

(1) When observation is unrestricted, the sequence of withdrawal from linear positions under pressure is as follows:

(a) All battalion units disengage covered by security elements of the brigade or division.

(b) Battalion units out of contact assemble and move on designated routes to their next position.

(c) The battalion reserve can move on a designated route, make a passage, and continue to its next position.

(2) When observation is unrestricted, control measures for a withdrawal from linear positions under pressure are as follows:

(a) Lateral boundaries are solid back to where security forces assume responsibility of the sector.

(b) Passage lanes and contact points are provided for units making a rearward passage, for support elements, and for units not in contact.

(c) On-order boundaries are designated in advance for use if the security force fails, is bypassed, or is otherwise unable to slow the enemy or disengage the battalion.

(d) A phase line is used to aid in control of unit movement and fires and to mark where responsibility for the sector is transferred.

c. The security force is critical to the success of the withdrawal under pressure. Options exist for organizing and deploying the security force.

Critical planning factors are terrain, enemy mobility, and the amount of pressure being applied. If the situation permits, the security force can be placed in an Overwatch position. A security force mission could be assigned to

a unit in reserve or could be provided by a higher headquarters. The forward companies would use fire and movement to fight their way behind the security forces, who would pick up the battle.

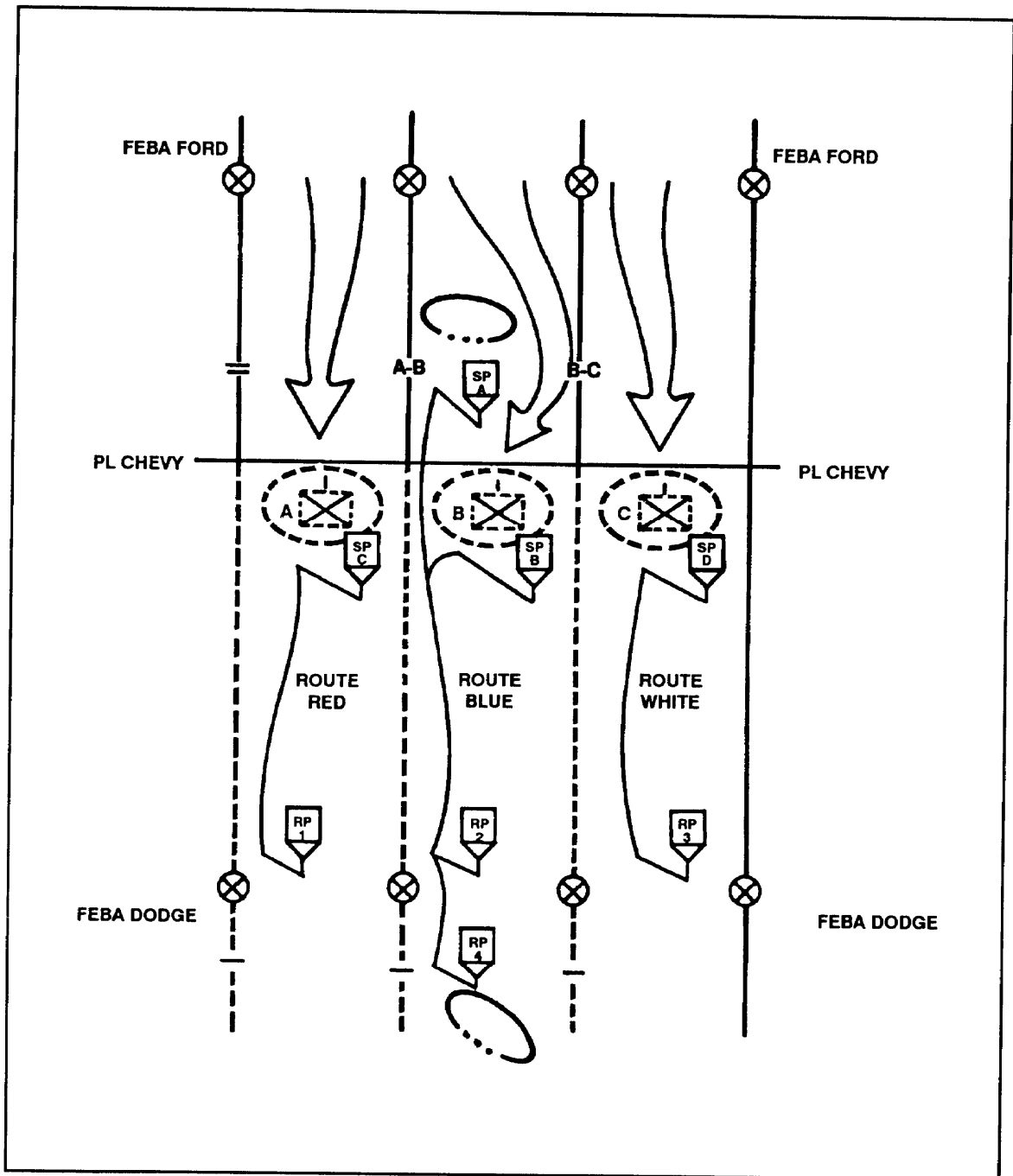

Figure 5-5. Withdrawal from linear positions under pressure (open observation).

d. The battalion must form the security force from forward company elements if the terrain restricts observation of the enemy to short ranges (Figure 5-6). The elements, generally the battalion reserve augmented with other infantry, mortar, and supporting elements, position themselves to observe infantry approaches and to direct efforts of artillery, mortars, tactical air, and air cavalry in support of the force. They can support the force—

(1) To disrupt, disorganize, or retard the enemy's ability to pursue withdrawing elements of the battalion.

(2) To use smoke to reduce the enemy's ability to observe movement of the battalion.

(3) To concentrate more combat power in critical areas to prevent decisive engagement of battalion elements.

e. The sequence of withdrawal from linear positions under pressure (Figure 5-6) is as follows when observation is restricted:

(1) Forward units disengage, covered by elements of the battalion security force. To ensure continuous observation across the battalion sector, forward companies detach elements as required. Task organization changes

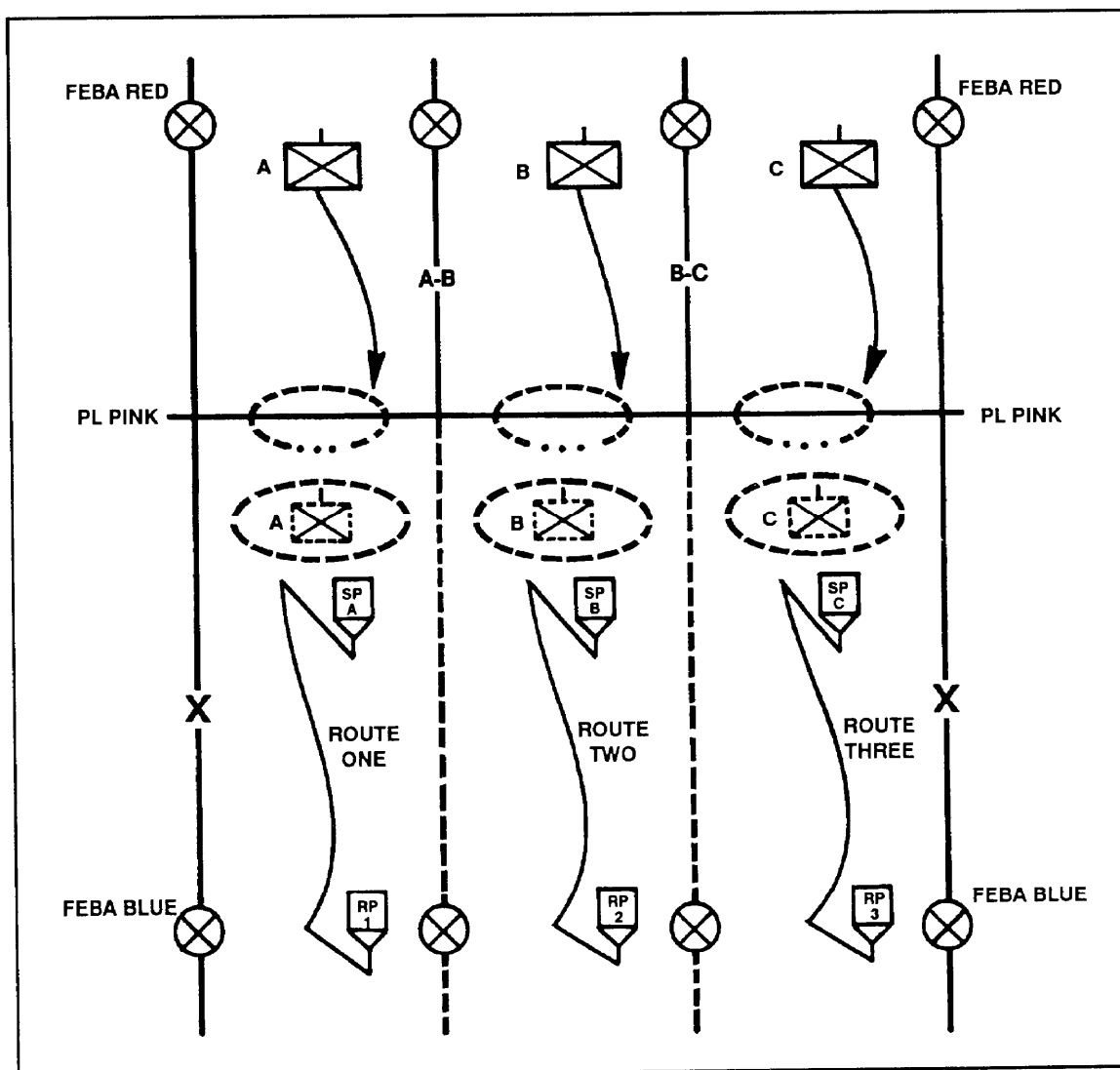

Figure 5-6. Withdrawal from linear positions under pressure (restricted observation).

are made at mutually agreed upon times and places. In this example, Companies A, B, and C each detach a platoon to the overwatch force at PL PINK. These platoons should be in position before forward elements withdraw.

(2) The battalion security force deploys to engage the enemy on all avenues of approach then, until instructed to disengage, delays the enemy forward of the next occupied position to the rear.

(3) Forward units assemble when out of contact then move on designated routes to the next position.

f. Units in contact engage the enemy, as the order to withdraw is given, with concentrated direct and indirect fires. These fires, coupled with obstacles and the proper use of terrain, create a temporary mobility advantage for the withdrawing force, enabling it to disengage, assemble, and move to the next position.

g. The security force must “pick up” the fight from the disengaging forward elements. It assumes responsibility for the entire battalion

sector, delays the enemy advance while the bulk of the battalion conducts movement to the rear, and then, on order or when other predetermined criteria are met, disengages and moves to the rear (Figure 5-7). Depending on the battalion’s next mission, the security force might need to maintain contact with the enemy throughout the operation by fighting to the rear. The security force can join the main body or pass through the next occupied position. It then moves to its prescribed position.

(1) Targets are planned before the withdrawal—

- (a) On known and suspected enemy locations (including indirect-fire targets).
- (b) Along avenues of approach.
- (c) On and behind unit positions.
- (d) Along routes of withdrawal.
- (e) To cover obstacles.

(2) Target reference points are designated—

- (a) At first, to mass antiarmor fires to aid in disengagement of the withdrawing unit.

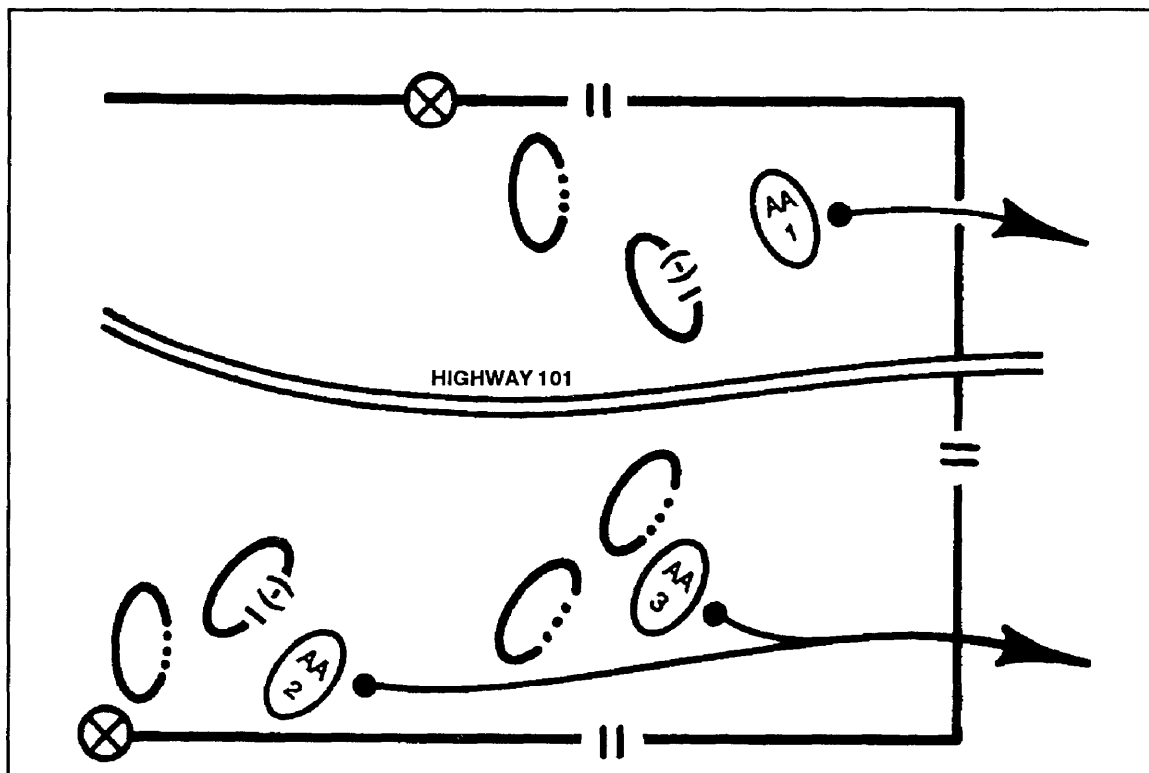

Figure 5-7. Withdrawal from dispositions in depth under pressure.

(b) Later, to shift fires to compensate for gaps in antiarmor coverage created by the displacement of units.

(3) Assembly areas should be—

(a) Located on armor-restrictive terrain.

(b) Covered from enemy direct fire.

(c) Concealed from air or ground observation.

(d) Large enough to allow adequate dispersion.

(e) Occupied as necessary to regain control before movement.

(4) Routes are designated where withdrawing units can move undetected from their assembly area to their subsequent positions by the most direct means. One route may be used by two or more units when a priority of movement is established. Alternate routes are selected and used as necessary. To preclude enemy pursuit, obstacles are planned and executed along with withdrawal routes. These routes—

(a) Are on armor-restrictive terrain.

(b) Provide cover from enemy direct fire.

(c) Provide concealment from air and ground observation.

(5) Checkpoints, contact points, phase lines, and other control measures can also be used as required to aid in control of movement.

(6) Supporting fires are concentrated to suppress enemy fires in the area of the withdrawing element.

(7) Antiarmor fires from all units are used against exposed enemy.

(8) The sequence of withdrawal from positions in depth under pressure is as follows:

(a) Infantry not required for security of antiarmor weapons assembles and moves to the rear.

(b) Security forces provide security for withdrawal of infantry, then disengage.

(c) Remaining elements of the battalion disengage in turn, employing the same procedure.

(9) The battalion's organic firepower is reduced as elements withdraw. The remaining elements become increasingly dependent on indirect fires, attack helicopters, and obstacles to slow the enemy. If sufficient combat power cannot be massed in a given area, units might be required to infiltrate from positions during reduced visibility.

h. The brigade commander can commit the brigade reserve if the enemy attack is stronger than the security force can disrupt; or, he can direct counterattacks by units already disengaged from the battalion. If the battalion elements are required, the most mobile assets available should be used. The early use of attack helicopters or CAS can keep ground forces from having to reengage the enemy before the withdrawal is completed.

## Section IV RETIREMENT OPERATIONS

A retirement is an operation where a force not in contact moves away from the enemy in an organized manner. A withdrawal from action becomes a retirement after the main force has disengaged from the enemy and march columns have been formed. A battalion usually conducts a retirement as part of a larger force. A retirement can have an adverse impact on the morale of friendly soldiers. Leadership must be positive and discipline maintained. Any rumors associated with the conduct of a retirement can be stopped by informing soldiers of the purpose of the retirement and the future intentions of the battalion.

### 5-17. PURPOSE

A retirement can be made—

a. To increase the distance between the defender and the enemy.

b. To occupy more favorable terrain.

c. To reduce the distance between maneuver and CSS elements.

d. To conform to the disposition of a higher command.

e. To permit employment of a unit in another sector.

**5-18. METT-T ANALYSIS**

A METT-T analysis for retirements is similar to one for delay and withdrawal. Security and speed must be emphasized when conducting a retirement. The battalion is organized to fight but does so only in self-defense. Units move at night when possible. The battalion may be required to infiltrate during daylight. Commanders emphasize the use of OPSEC measures during their movement.

**5-19. PLANNING**

planning for a retirement is also similar to that for a delay and withdrawal.

**5-20. CONDUCT OF A RETIREMENT**

Appropriate advance security, flank security, and rear security are provided. When contact with the enemy is possible, such as when a withdrawal has preceded a retirement, a strong rear guard is employed. If the enemy attacks the rear, the rear guard uses delay tactics to extend the distance between the main body and the enemy.

## CHAPTER 6

# OTHER TACTICAL OPERATIONS

*This chapter discusses tactical operations that require special planning. The fluid environment of the airland battlefield requires infantry battalions to conduct these types of operations more often and more rapidly than ever. Also, because each of these usually involves the meeting of friendly forces on or forward of the FLOT, each also offers the increased risk of fratricide. Commanders must inform all personnel of this potential and must closely monitor the operations with this in mind.*

**THIS SECTION IMPLEMENTS STANAG 2082**

### Section I PASSAGE OF LINES

A passage of lines is an operation in which one battalion passes through the positions of another—for example, a covering force withdraws through the main battle area or an exploiting force moves through the initial attacking force. Forward passage is the movement by a battalion toward the enemy through a stationary battalion. Rearward passage is movement away from the enemy through friendly battalions.

#### 6-1. PURPOSE

This operation is necessary when one battalion cannot bypass another and must pass through it. The battalion is vulnerable during a passage of lines. Concentrated friendly forces are a lucrative target. The concentration of friendly units can mask the fires of the friendly stationary battalion, which might be unable to react to the enemy. Also, since the stationary friendly battalion is so near, the passing battalion lacks freedom of maneuver. Detailed reconnaissance and coordination can ensure a quick and smooth passage. The battalion can conduct a passage of lines for the following reasons:

- To initiate or continue an attack or counterattack.

- To envelop an enemy force.
- To pursue a fleeing enemy.
- To withdraw covering forces or main battle area forces.

#### 6-2. PLANNING

The commander of the passing battalion makes a tentative plan for the conduct of the passage.

a. **Organization.** Continuous unit integrity provides positive command and control.

b. **Order of Movement.** The order of movement should be prescribed based on the number of passage points, the degree of security required, the enemy situation, and the terrain. A movement order prevents confusion and



congestion by setting priorities for battalion movements.

c. **Command and Control.** The command and control techniques used depend on the number of passage points. Ideally, command and control of multiple passage points and routes is decentralized. The battalion commander decides how he can best influence the passage and positions himself accordingly.

(1) The time or circumstances when responsibility for the zone or sector is transferred must be agreed on by the passing and stationary commanders or must be specified by the headquarters directing the passage. The command groups of the passing and stationary battalions should be collocated so the transfer is orderly and correct. At an agreed time, the FSOs and FACs of the two battalions also coordinate and transfer responsibility. If the brigade commander and his command group move forward to assume control of a passage, the command groups of the passing and stationary battalions need not collocate.

(2) The commander of a passing battalion making a forward passage of lines usually assumes responsibility for the zone of attack only when at least one company and a control element are forward of the LD. In a rearward passage of lines, the responsibility for a sector changes when the disengaging battalion passes a specific location, usually the battle handover line. Responsibility can also be based on an event such as the passage of a specific number of companies through the passage points. Coordination and control of the battalion through the passage points are easier if the boundaries of the passing battalion and stationary battalion coincide.

d. **Augmentation.** The scout platoon can help during the passage of lines by screening between the enemy and the battalion for early warning and limited protection.

e. **Control Measures.** Both passing and stationary battalions should use the same control measures within the area of passage. Control measures include the following:

(1) **Passage lanes.** Lanes along which a passing battalion moves to avoid stationary

battalions and obstacles are called passage lanes. Planning should provide for primary and alternate lanes.

(2) **Passage point.** A point where battalions pass through one another, either in an advance or a withdrawal, is called a passage point. The passage point is where the commander wants subordinate units to execute a passage of lines.

(3) **Time of passage.** The commander who orders the passage may prescribe the time of passage.

(4) **Recognition signals.** Friendly units recognize one another by the use of recognition signals. These signals can consist of one or more letters, words, visual displays, characters, signal flags, or special lights/sounds with prearranged meaning.

(5) **Contact point.** The place where two or more units are required to make physical contact before executing a passage is called the contact point. The stationary unit positions guides to help the passing unit throughout the passage.

(6) **Release point.** The place on a route where specified units come back under the control of their respective commanders is the release point.

(7) **Battle hangover line.** The phase line where one battalion assumes responsibility from another battalion for the conduct of a battle is the battle handover line. If required, the stationary battalion must be able to engage out to this line and help the passing battalion disengage.

f. **Fire Supporting.** Direct and indirect fires of the stationary battalion are integrated into the fire support plan of the passing battalion. Fire support elements can be collocated for coordinated and responsive support.

g. **Reconnaissance.** A thorough reconnaissance covers routes to, through, and beyond the area of passage. The reconnaissance should note existing and proposed locations of soldiers. Unit intentions must not be compromised. Therefore, the number and size of reconnaissance parties should be limited. The passing battalion should consider using the vehicles or aircraft of the stationary battalion.

|   |
|---|
| <p><b>THIS PARAGRAPH IMPLEMENTS<br/>STANAG 2129</b></p> |
|---|

**h. Coordination.** Commanders and staffs of the battalions involved coordinate the following during the planning process:

- (1) Exchange of intelligence.
- (2) Exchange of tactical plans.
- (3) Exchange of signal operation

instructions.

(4) Arrangements for reconnaissance.

(5) Security during the passage.

(6) Areas of passage and provisions for guides.

(7) Priorities for routes and facilities, including provisions for movement control. The passing battalion has priority.

(8) Times or circumstances during which responsibility for the control of the area of operations is transferred.

(9) Fire and other combat support to be provided by the stationary battalion.

(10) Combat service support to be provided by the stationary battalion, including medical, maintenance, and recovery assistance.

(11) Exchange of liaison personnel.

(12) Exchange of information on minefield or other obstacles.

(13) Command relationship between the passing battalion's CS/CSS assets and the stationary battalion, including site locations.

(14) Tactical deception plans.

### 6-3. CONDUCT OF A REARWARD PASSAGE

The commander considers many factors when planning for and conducting a rearward passage of lines (Figure 6-1, page 6-4).

a. The commander of the stationary battalion must designate the contact point for coordination if it has not already been designated by higher headquarters; then he must notify the passing battalion of its location. He can use radio, higher headquarters, or a liaison officer/NCO. To stay abreast of the tactical situation, the stationary battalion should also monitor the forward unit's net.

b. The contact point is forward of and within small-arms range of the BHL. This point should also be on or near an easily identifiable terrain feature. At the prescribed time, liaison parties

from the two battalions meet. Passing battalions can send their XO's and other liaison personnel to the contact point. At the contact point, the commander, S3, or XO of the stationary battalion briefs the commander of the passing battalion and exchanges information with personnel from the passing battalion who have been sent to the contact point. Together the representatives from both battalions develop a plan for the passage. The scout platoon leaders from both the passing and stationary battalions remain together near the BHL.

(1) **Exchange.** The following subjects are discussed at this meeting:

- Latest enemy information (size and type force, location and direction of movement).
- Friendly tactical situation.
- Recognition signals.
- Signs/countersigns.
- Any signal operation instructions.

(2) **Verify.** The following arrangements are confirmed at this meeting:

- Provisions for and placement of guides.
- Estimated time of main body arrival, numbers and types of units and vehicles to pass.
- Time or event for battle handover.
- Minefield and obstacle information.
- Passage points, lanes, and alternates.

(3) **Coordinate.** The following are coordinated at the meeting:

(a) Positions forward of the BHL to be occupied by the stationary battalion's security force.

(b) Direct and indirect supporting fires. Fires should be planned to support the disengagement of the passing battalion, to support the obstacle/barrier plan, and to support the deception plan. Smoke should be planned to conceal movement through the passage points. Fires on the passage points should be planned for after the passing battalion moves through them. The stationary battalion plans fires to support operations after the passage.

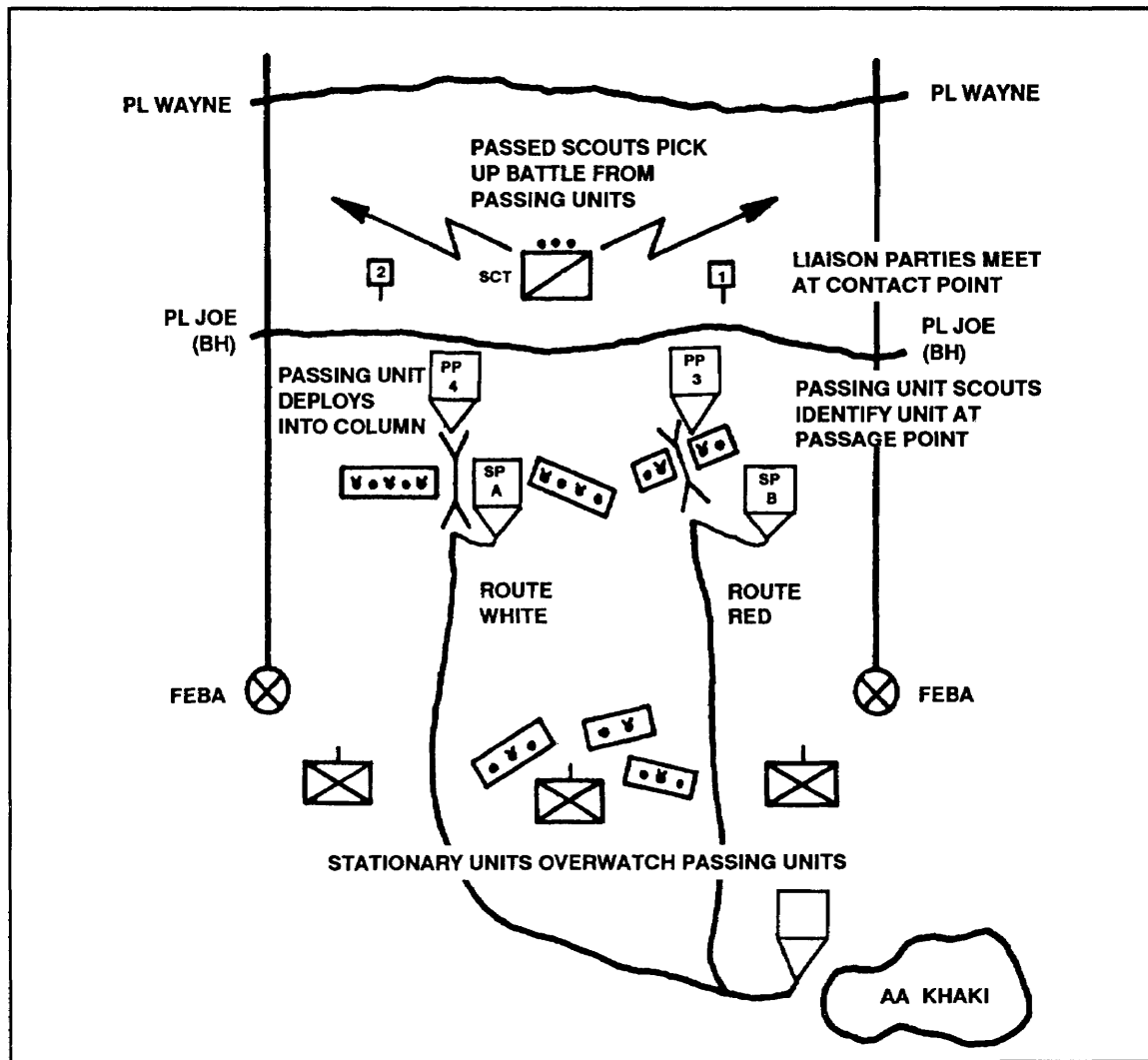

Figure 6-1. Rearward passage of lines.

(c) Combat service support to include casualty evacuation and EPW control.

c. Scouts from the stationary battalion can screen along the BHL and monitor the passing battalion's command net.

d. Scouts or liaison parties make contact at each passage point after verifying that it is occupied. The passing battalion must know which of its elements are to pass through each passage point. For ease of control, the passing battalion temporarily collocates its command group with that of the stationary battalion. Passing battalion elements normally go through the passage points in the following order:

- Combat service support elements.
- Main command post.
- Combat support elements.
- Command group.
- Combat units.

e. The passage points should be manned by representatives from the passing battalion and by the forward companies of the stationary battalion. Lanes through obstacles are marked and provisions made to close them quickly.

f. The stationary battalion assumes responsibility for the fight at the BHL from the passing battalion and supports their

disengagement if required. The stationary battalion's forward elements notify their forward companies by prearranged signal(s) that friendly forces are at the BHL and are en route to the passage point.

g. The passing battalion, overwatched by the stationary battalion, moves through the passage points and along the routes to the rear without pausing. The stationary battalion commander, company commanders, and platoon leaders must observe this passage carefully. The only time the stationary battalion should fire is when positive enemy identification is made.

h. Disabled vehicles are self-recovered or are aided by other elements of the passing

battalion. The stationary battalion provides required maintenance and medical assistance as far forward as possible.

**6-4. CONDUCT OF A FORWARD PASSAGE**

The commanders of the stationary and passing battalions initiate actions much like those for a rearward passage as soon as one receives the order to pass forward through the other. Forward passages normally occur during offensive operations to begin or continue an attack or to penetrate, envelop, or pursue the enemy force. In the defense, a forward passage can be used to counterattack one battalion through another (Figure 6-2).

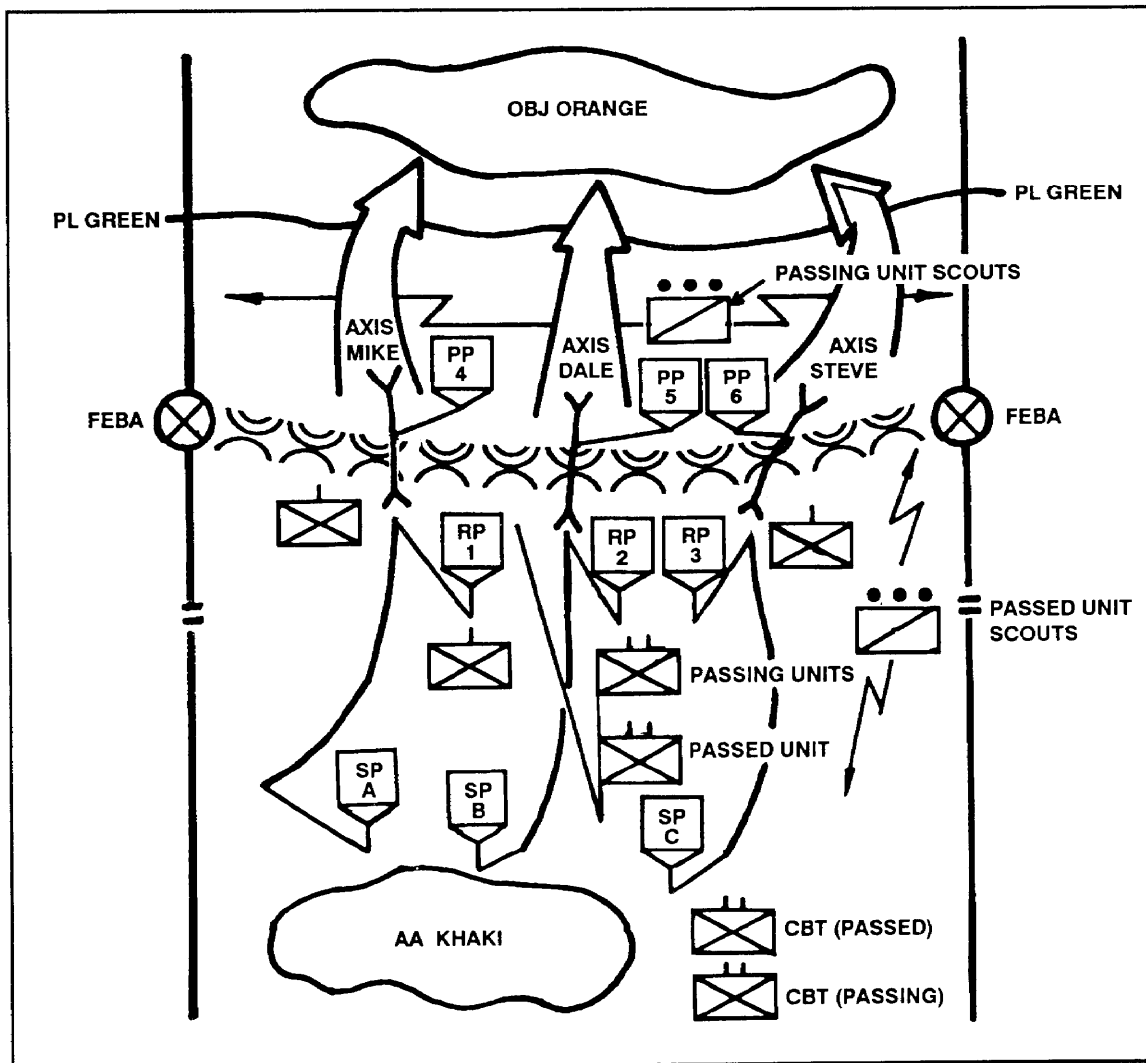

Figure 6-2. Forward passage of lines.

a. The battalion commander, S3, or both coordinate a forward passage. Critical information exchanged is the same as in a rearward passage.

b. The commander of the stationary battalion establishes contact points, passage points, and routes, if not specified in the brigade order. He must provide guides at contact points to lead the passing battalion to passage or release points near the FEBA or LD/LC.

c. The command group of the passing battalion temporarily collocates with that of the stationary battalion. Passed forces maintain normal radio traffic. Passing companies maintain listening silence on their battalion command net. The stationary battalion's guides notify their commander that the passing force has begun moving forward from the contact points. At the agreed point in the passage—normally when two-thirds of the passing battalion has completed

its passage—the two battalion commanders transfer responsibility for the zone or sector.

d. The stationary force provides the passing forces with overmatching direct and indirect fires. The passing force FSO collocates with the stationary force FSO. The commander of the passing force positions passing force mortars after he coordinates with the stationary force commander. However, until sector responsibility is transferred, the FSO of the stationary battalion approves fire missions. After that, any fire missions for the stationary battalion mortar platoon are cleared through the passing battalion FSO. The stationary battalion lifts or shifts its direct fire as coordinated by the two commanders.

e. Nuclear and chemical considerations for a forward passage of lines are similar to those for a rearward passage. Since it is moving into areas not under friendly control, the passing battalion must emphasize dispersion and chemical monitoring.

### THIS SECTION IMPLEMENTS STANAG 2082

## Section II RELIEF OPERATIONS

A relief is an operation in which a unit is replaced in combat by another unit. The incoming unit assumes responsibilities for the assigned sector or zone of action. Reliefs can be conducted during offensive or defensive operations and in any weather or light conditions. To reduce the possibility of detection, the unit normally executes a relief during limited visibility.

### 6-5. PURPOSE

The purpose of a relief is to maintain the combat effectiveness of committed elements. A relief can be conducted for the following specific reasons:

- a. To reorganize, reconstitute, or reequip a unit that has sustained heavy losses.
- b. To introduce a new unit into combat.
- c. To rest units that have conducted prolonged operations in adverse weather or terrain.
- d. To replace a unit that requires medical treatment or decontamination resulting from chemical or nuclear exposure.
- e. To conform to a larger tactical plan.
- f. To make mission changes.

### 6-6. METT-T ANALYSIS

Commanders should consider the following METT-T factors in planning for and conducting relief operations:

a. **Mission.** Both battalion commanders, once they understand the mission, must coordinate plans between themselves and ensure coordination between key subordinates.

b. **Enemy.** An exchange of enemy information helps the incoming commander adjust his defense or plans of attack. The enemy must not know that a relief is about to occur. Since the concentration of friendly forces increases their vulnerability to enemy attack, stringent OPSEC is necessary.

c. **Terrain and Weather.** The terrain must be reconnoitered and routes chosen that provide the greatest possible cover and concealment for the incoming unit. Routes for the incoming and outgoing units must be chosen to prevent choke points and massing. Limited visibility helps in maintaining OPSEC for the relief.

d. **Troops.** The disposition and strength of friendly soldiers must be considered when conducting a relief. Knowing the locations and the strength of friendly units helps the commander plan routes and priorities of relief. In the defense, the relieving commander should compare his organization with that of the battalion being relieved. This ensures continuity of the defense. The commander adjusts the concept of the relief as needed. A relief is conducted to maintain the tactical integrity of the position and to offer the least profitable target for nuclear, chemical, or area fire weapons. Combat support units should be relieved after the units they support.

e. **Time.** A relief in place can be conducted in one night or over a longer period. A relief in one night increases the density of soldiers and their vulnerability to conventional, chemical, and nuclear fires. However, this disadvantage is offset by the fact that a faster relief reduces the chances of detection and simplifies the command and control problems associated with intermingled forces.

### 6-7. CONDUCT OF A RELIEF

As the battalion commander makes his tentative plan, he emphasizes the following:

- Liaison.
- Reconnaissance and surveillance.
- Location and types of obstacles.
- Fire support assets and fire support plan.
- Movement control.
- Passage of command.
- Enemy contact during a relief in place.
- Exchange of equipment.
- Sequence of relief.

### 6-8. LIAISON

The battalion commander and staff develop their estimates as soon as they receive the order to conduct the relief. The relieving battalion establishes continuous liaison with

the relieved battalion. Liaison personnel are exchanged down to company level as soon as the relief order is received. So it can coordinate the operation, the orders group moves to the main CP of the battalion being relieved. If required, the relieving battalion XO supervises unit movement to an assembly area to the rear of the relieved battalion. Liaison is conducted between the relieving and relieved battalions. The commander should coordinate the battalion maneuver and fire support plans and an intelligence update to include past, present, and probable enemy action. Combat support units—for example, engineer, ADA, and artillery—should support the coordination and liaison. Liaison personnel from the outgoing battalion remain with the incoming battalion until the incoming battalion knows the situation.

### 6-9. SEQUENCE

The sequence of relief is based on the disposition of the relieved battalion, its mission, and the probability of enemy activity in the area. To reduce the unit's vulnerability, the sequence should support a rapid relief. Once the sequence is determined, timing must be considered.

a. The best sequence of relief when few forces are forward is from rear to front; when many forces are forward, from front to rear. If an enemy attack is likely, the first unit to be relieved should be the one with the most critical mission. If a particular unit is likely to be detected during the relief, that unit should be scheduled for the last relief. This allows most soldiers to occupy their positions before the unit is detected.

b. The slowest method of relief is one unit at a time. However, this method might be required when unit movement routes are limited. When two or more units are to move on the same routes, extra control might be required. To simplify coordination and transfer of equipment, excess ammunition, fuel, water, and medical supplies, the units' combat trains can be collocated. Companies relieve each other in designated sequence. (Figure 6-3, page 6-8, shows some commonly used graphic control measures.)

c. The fastest method of relief is to relieve all units at the same time. However, security is sacrificed with this method since all units move at once. When command groups and combat

trains are collocated and plans and equipment have been exchanged, relieving battalion units move at once along designated routes. Though relief occurs at each location at the same time, relieved units withdraw as soon as they are relieved; they do not wait for the other units of the battalion.

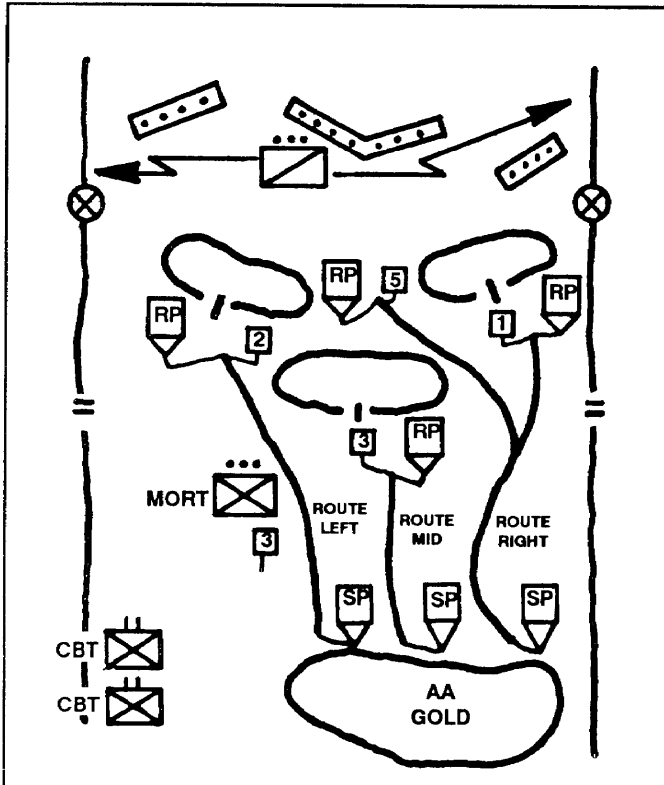

**Figure 6-3. Geographic control measures for the relief in place.**

d. Area relief, which is relief by occupation of in-depth or adjacent positions, can be used when terrain allows. The relieving unit should be able to place direct fire on the other unit's TRPs and engagement areas. This method is most useful if the unit being relieved has been chemically or radiologically contaminated. It might also be effective when the units involved are different such as when a light unit relieves a heavy unit. A main drawback to this method is that the relieving unit lacks the advantage of occupying prepared fighting positions with existing projective obstacles. The relieving unit maintains radio listening silence until the responsibility of the sector or zone is transferred

to the relieving unit. The unit being relieved maintains normal traffic. Coordination between units is directed by higher headquarters and accomplished at brigade, division, or both designated contact points. Depending on the situation, the relieved unit withdraws one unit at a time or all at the same time.

e. The commander and staff determine the sequence to be used based on their understanding of the possible sequences of relief. They must consider the following factors:

- Companies' combat effectiveness.
- Terrain characteristics.
- Enemy capabilities.
- Control of units.
- Company subsequent missions.

### 6-10. RECONNAISSANCE AND SURVEILLANCE

Normal patrols and radar activity are continued; however, patrols exclude members of the incoming unit who, if captured, could reveal the presence of a new unit in the area. The outgoing units' surveillance teams and radar equipment remain in position until the relief is completed. If time and the situation permit, company commanders and scout and mortar platoon leaders reconnoiter before the relief. Since the incoming unit must know the location of individual and vehicle positions, weapons, communication centers, command posts, aid stations, and all other essential facilities, reconnaissance should be conducted during both daylight and darkness. This reconnaissance should also include all routes for vehicle and foot traffic and the locations of assembly areas and service support units. In the forward areas, reconnaissance parties should be small. Vehicles and aircraft used for the reconnaissance should be furnished by the unit being relieved.

### 6-11. LOCATIONS AND TYPES OF OBSTACLES

The unit must identify obstacle locations and minefield, record and verify minefield, and transfer minefield records.

### 6-12. FIRE SUPPORT ASSETS/PLAN

Detailed fire support coordination and liaison are conducted between both units at the relieved

unit's main CP. Range cards, target lists, and overlays should be given to the incoming unit to ensure the effective delivery of fire. Relief of fire support assets occurs after the relief of all maneuver units. Therefore, the fire support assets of the relieved unit can support both relieving and relieved units during the relief of the maneuver units. As soon as the relief of maneuver units is complete, the fresher fire support assets move in rapidly to assume fire support.

### **6-13. MOVEMENT CONTROL**

Commanders control movement by designating and ranking routes as to priority. They position traffic controllers at critical points along the routes, designate assembly areas, and specify activities. To lessen confusion, commanders use separate assembly areas for incoming and outgoing units. To reduce vulnerability to enemy fires, they separate company assembly areas as much as possible. Also, to avoid compromise, they ensure time spent in assembly areas is minimized. Precise planning, timing, and execution allow these to be achieved. Guides from both incoming and outgoing units are designated, and all personnel are informed where and when to report.

### **6-14. PASSAGE OF COMMAND**

The time for the passage of command can be specified in the brigade order. If not, battalion commanders can agree on the sequence and time for the passage of command. Usually, it occurs when two-thirds of the relieving unit is in position, front line subordinate commanders have assumed responsibility for their sectors, and the incoming unit commander has sufficient communications to control his entire sector.

### **6-15. ENEMY CONTACT DURING A RELIEF IN PLACE**

The presence of the relieving unit's command group at the main CP of the unit being relieved simplifies rapid coordination and action in case of enemy contact during the relief. If either unit gains direct-fire contact with an enemy force, it immediately notifies the other unit and the higher headquarters directing the relief. If command has not passed, the relieving unit immediately comes under OPCON of the relieved unit, is absorbed into that unit's

positions, and begins normal radio traffic. The relieving unit's mortars fire missions as directed by the commander of the unit being relieved. If command has passed, the relieved battalion commander and staff can come under OPCON of the relieving unit.

### **6-16. EXCHANGE OF EQUIPMENT**

Grounded crew-served weapons should not be moved; re-laying them is difficult when a relief is conducted during limited visibility. To preserve secrecy, commanders maintain normal patterns of activity in a defense sector during the relief. The following equipment can be exchanged:

- Machine gun tripods and other supports for crew-served weapons or equipment.
- Bulky or excess supplies.
- Wire.
- Emplaced sensors and radar sets.
- M8 alarms.

### **6-17. SECURITY AND DECEPTION**

Communications security measures include using wire as the main means of communication. Radios are used as little as possible and, to prevent the enemy from detecting a change, the outgoing unit's radios are manned until the relief is completed. Security is further enhanced if the FO and FSOs remain in position until the relief is completed. Also, deception plans must help protect secrecy and surprise. The relieved unit must maintain normal patterns of activity. The relieving unit must conform to this pattern until the relief is completed.

### **6-18. RELIEF ORDER**

The battalion commander issues his order when planning and coordination are complete. On completion of the order, the command group remains at the relieved units' main CP until the relief is complete. Orders group personnel complete their troop-leading procedure and begin the relief as prescribed in the order. To reduce confusion and maintain secrecy, the relief order should include the following:

- Time that responsibility for the sector, battle position, or zone is effective.
- Fire support plan.
- OPSEC considerations.



- Deception plans.
  - Time, method, and sequence of relief.
  - Routes and critical control measures.
  - Concept of subsequent mission.
  - Plans for additional positions—changes to present concept.
- Contingency plans.
  - Location and transfer of responsibility for obstacles.
  - Transfer of ammunition, wire lines, POL, and materiel to incoming unit.

### Section III BREAKOUT FROM ENCIRCLEMENT

A unit is considered encircled when it is surrounded by an enemy force that has blocked all ground routes of evacuation and reinforcement. On a nonlinear battlefield, battalion commanders must plan for the possibility of being encircled. Units can conduct a perimeter defense until they link up with another friendly unit or they can conduct a breakout. While conducting either offensive, defensive, or retrograde operations, a unit can become encircled. The enemy might or might not know it has encircled the unit. The chance of encirclement increases during airborne, air assault, infiltration, and strongpoint operations, and is planned for during stay-behind operations.

#### 6-19. PURPOSE

A breakout from encirclement is conducted to allow the encircled force to regain freedom of movement, contact with friendly units, or both. A breakout can mean using a rupture force to attack to open a gap—penetrating outward—through the encircling forces; it can also mean using stealth and deception to exfiltrate through the enemy positions.

a. Encirclement does not imply that the battalion is surrounded by enemy forces in strength. Threat doctrine stresses using momentum to bypass forces that cannot be quickly reduced. An enemy force might be able to influence a battalion's later operations while occupying only scattered positions; and may be unaware of the battalion's dispositions, strength, or composition. The battalion can attack to break out before the enemy can develop his situation. Obviously, when a battalion has adequate CSS resources and is holding a strongpoint, a breakout might not be required or desirable.

b. A battalion must do the following to be successful in a breakout from encirclement:

(1) Deceive the enemy as to its composition, strength, and intentions.

(2) Concentrate sufficient combat power at an enemy weak point.

(3) Provide security to the flanks and rear of the battalion as it moves out of the encircled area.

(4) Make timely decisions on a course of action. Indecision or delay can cause any action to fail. However, the need for a quick decision should not lead the commander to try a breakout without adequate planning.

#### 6-20. METT-T ANALYSIS

The following METT-T factors must be analyzed when planning a breakout:

a. **Mission.** A force that becomes encircled can assume anew mission or continue its original mission. A knowledge of the higher commander's intent and his plan for future operations helps the encircled commander plan his breakout. In coordination with higher authority, the commander must select a course of action. His options are as follows:

(1) Continue or assume the defense and wait for friendly linkup.

(2) Break out to continue or assume an offensive mission (to include stay-behind operations).

(3) Break out to link up with friendly elements.

(4) Exfiltrate, evade and escape, or both.

**b. Enemy.** Planners must assess enemy strength, intentions, and locations. Intelligence information helps in determining if the unit is encircled and identifies enemy weaknesses or gaps.

(1) Planners can more easily decide on the direction for the breakout if they know where the gaps are. If they find gaps, planners must setup surveillance to prevent compromise at the gap sites.

(2) Intelligence might indicate that the enemy is unaware that he has a unit encircled, or it can confirm that he is planning an encirclement. If he intends to complete an encirclement, the enemy might establish strong blocking positions on likely avenues out of the encircled area, with light screening elements between these positions.

(3) A unit unarmed with intelligence information, but planning a breakout, must initiate aggressive and continuous reconnaissance to obtain information. It must also avoid any routes that could lead to enemy strengths.

**c. Terrain.** The encircled force must use terrain to its advantage. Because it knows the terrain, a force that is encircled while defending has some terrain advantage. It has already reconnoitered exit routes, which aids planning and time factors. Existing defensive positions should be used. However, because the force is encircled, the defensive posture might have to be changed to add a perimeter defense. Limited visibility helps if exfiltration is used as a means of escape. An encircled battalion presents a lucrative target for nuclear, chemical, or artillery weapons. Therefore, it should use dispersion and any other possible protective measures.

**d. Troops Available.** The encircled force can consist of a maneuver battalion or a mixture of friendly forces. The battalion can be a subordinate element of a larger encircled force. Regardless, strength and capabilities should be assessed.

(1) Soldiers must be organized and integrated into a breakout force to ensure unity of command. Aviation and CAS can be

instrumental in obtaining information on enemy weaknesses and reserve locations, and can ease the evacuation of wounded. If the encircled force must maintain its defense until relieved, aviation assets might be the only means of resupply. If it is beyond range of friendly artillery, aviation assets might also be the only fire support asset.

(2) Both enemy and friendly situations and terrain influence the selection of the breakout route and the decision whether to move cross-country or by road. Though road-bound routes might simplify the extraction of vehicles and wounded, they are easy for the enemy to block and counterattack. Using routes through rough terrain might dictate destruction of heavy equipment and limit evacuation of wounded. Options include using a single breakout with diverging routes for vehicles and dismounted soldiers or mounting a second breakout for vehicles.

**e. Time.** This might be the most important factor at first. If the enemy's intent is a complete encirclement, he requires time to redistribute and position his forces. The breakout should be made before the enemy can establish a cohesive encirclement. If a friendly unit can link up with the encircled forces, the commander of the encircled force must determine if he has the resources to maintain his defense until the linkup force arrives. If he has insufficient combat potential to await the relief, he should request permission to conduct a breakout as soon as possible.

## 6-21. PREPARATION

The battalion commander should prepare for the possibility of encirclement.

**a. Authority to Withdraw.** The battalion commander should request the authority to withdraw beforehand if an encirclement appears imminent. If permission to withdraw is denied, the commander should consider the following:

(1) Active reconnaissance activities should be conducted to develop information on the terrain and enemy. This information is used to plan a breakout.

(2) Excess personnel and equipment should be evacuated by foot, vehicle, or air.

(3) Positions should be reduced in size to simplify defense and future breakout operations.

(4) Terrain should be retained to ease a future breakout.

(5) Casualties should be evacuated to enhance both morale and force mobility.

**b. Pre-Encirclement Tasks.** The commander must perform specific tasks vital to the preservation of the force if an encirclement is imminent. These tasks include the following:

(1) *Establishing all-round defense.*

(2) *Establishing the chain of command.* During the encirclement, other friendly units will probably become part of the encircled force. The senior commander then organizes and takes charge of the encircled force.

(3) *Organizing/consolidating resources.* Unattached units and soldiers must be organized into a cohesive force. During reorganization, all elements—maneuver, combat support, and combat service support—are included in the defense and breakout effort. Combat service support personnel can be used to reconstitute maneuver elements.

(4) *Trying to communicate with higher command.* A coordinated effort with higher command can enhance the survivability of the encircled force. The encircled force commander gives an assessment of his situation and seeks further instructions. He might be instructed to wait for a linkup or to conduct a breakout. Either way, fire support and logistical support from higher command must be part of the coordinated effort.

(5) *Maintaining morale.* Along with the fear of being surrounded, the possibilities that supplies will be limited and resupply will not arrive present leadership challenges. To keep the force effective, morale must be maintained. To reinforce morale, leaders should inform soldiers of communications from higher headquarters and of plans to break out or link up.

## 6-22. ORGANIZATION

The battalion is organized into four main elements for breakout operations. If possible, the task organization of the battalion should complement both the breakout and the subsequent linkup.

a. The breakout plan must detail the four elements.

(1) *Rupture force.* Maneuver elements strong enough to penetrate the enemy line make the rupture. The strength of the attacking force is tailored to known enemy strength. A favorable combat power ratio must be achieved by means of surprise, strength, mobility, and firepower. The rupture force has to be able to widen the gap made by the attack and to hold the gap shoulders until the encircled forces can move through. A combined arms team has the best chance of success as a rupture force.

(2) *Reserve force.* The reserve follows the rupture force to maintain attack momentum or to secure the objectives of the rupture. If the rupture force secures the gap, the reserve becomes the battalion's lead element. If it secures the gap, the reserve force performs rear security once other elements have passed through. Once the reserve is committed, a new reserve is designated as soon as possible. The reserve has a contingency mission to help free elements of the rear guard that become decisively engaged. To defend against counterattack, the reserve should employ TOWs.

(3) *Main body.* This includes the trains, other soft-skinned vehicles, casualties, and CS elements unattached to the other functional forces. All of these should move as one unit under the control of either the HHC commander or the battalion XO. To speed movement out of the encircled area, traffic along the route must be strictly controlled.

(4) *Rear guard.* The rear guard consists of the soldiers and equipment left on the perimeter to provide protection for the rupture and diversionary attacks. In addition to providing security, the rear guard deceives the enemy as to the encircled force's intentions. The rear guard must be strong enough to maintain the integrity of the defense. Once the breakout begins, the rear guard disengages or delays toward the rupture.

b. A breakout can be organized in either of two ways.

(1) Unit integrity can be maintained by assigning each company a functional area as its mission if the encircled force consists mainly of the units of an infantry battalion—for example,

A Company could be the rupture force, B Company could be the reserve, C Company could provide the rear guard, and headquarters elements could provide the diversionary attack.

(2) A battalion might be only a small part of the encircled force, most of which comprises miscellaneous units. In this case, the encircled force must be organized into a cohesive fighting unit. This is best accomplished by organizing the available units into four elements, strength permitting, and assigning each a function. If unit identities have been lost, it might be easier to organize the force by the function it performs and to identify it accordingly—rupture, reserve, rear guard, or main body.

c. An exfiltration during reduced visibility offers the best chance of a successful breakout if combat power is insufficient to create a rupture or if the battalion is in close terrain. The breakout plan must provide for command and control, fire support, disposition of wounded, and destruction of excess equipment and supplies.

(1) **Command and control.** Coordinating movement and integrating supporting fires are major challenges in a breakout. Therefore, the commander locates where he can best influence the rupture attack. A good location might be behind the rupture attack or on the perimeter near the rupture point where he can direct the movement of the reserve. The battalion XO can command the rear guard.

(a) The commander establishes control measures for the breakout to simplify command and control. These measures include LD, direction of attack, PLs, and objectives. Objectives can be oriented on known enemy locations or on terrain. They must correspond to the point where the rupture attack is to penetrate. To ensure aggressive movement out of the area or key terrain that controls the approaches into the area of the breakout, subsequent in-depth objectives can be terrain features.

(b) The commander can also use time phasing and pyrotechnics for other techniques of control that can aid in the conduct of a breakout. Time phasing starts a sequence of events such as a diversionary attack. A matrix serves as the tool

for this purpose. Pyrotechnics signal the lifting and shifting of fires, the commitment of the reserve, or a diversionary attack.

(2) **Fire support.** Fire support assets might be available within the encircled area. If so, commanders organize assets under central control and integrate fire support coordination into the breakout plan. Once the breakout begins, artillery in the encircled area can be used in a direct-fire role. If artillery fire is used in this way, it should be masked at the critical point of breakout. The artillery units should be sequenced in the order of breakout to ensure they have adequate security during movement. Also, if within range, fire support should be requested from higher command. If available, on-order RFLs are established between the encircled force and friendly units. This prevents fratricide while the breakout force approaches friendly forward lines (Figure 6-4, page 6-14 and Figure 6-5, page 6-15).

(3) **Disposition of wounded.** All wounded soldiers who can fight should be assigned duties consistent with their wounds. Those who cannot care for themselves must be evacuated if means are available. If wounded are left behind, morale can suffer greatly. However, situations can arise when carrying the wounded can result in the destruction of the battalion. Although leaving wounded behind with medical personnel is not a preferred option, the commander's main responsibility is preservation of the force. He can provide for their extraction from secure LZs after the breakout.

(4) **Destruction of excess equipment and supplies.** Disabled vehicles and excess supplies must be destroyed; Class III and V supplies are inventoried and reallocated. No equipment that cannot be manned or maintained should be taken. If done too soon, the destruction of excess equipment alerts the enemy to the battalion's intention. Therefore, the equipment must be disposed of at the proper time. The commander carefully weighs the chances of success in the breakout attempt. If the breakout fails, equipment should not be destroyed prematurely. Medical supplies must NEVER be destroyed. To do so is a violation of the Geneva Convention. Equipment can be rendered inoperable by dismantling its essential components.

**6-23. CONDUCT OF A BREAKOUT FROM ENCIRCLEMENT**

A strict sequence of events must be developed and disseminated to all participating units since secrecy and security are vital to a breakout.

a. **Methods.** The breakout can be conducted in three ways.

(1) The commander can ensure security by assigning a company or reinforced company to occupy the perimeter if the enemy situation permits (Figure 6-4). Remaining units occupy positions within the perimeter and prepare to break out. The advantage of this method is that little movement is needed to organize and position for the breakout. The disadvantage is that, unless the breakout is executed immediately, the massing of soldiers within the perimeter can result in high casualty rates.

(2) The enemy situation may require that all available forces occupy the perimeter (Figure 6-5). When the time arrives to execute the breakout, security forces remain on the perimeter to deceive the enemy as to the battalion's intentions and to protect the massing rupture and diversionary forces. The security force comprises elements left in contact, while the rest of the units move to commence the breakout. To preclude halts and to maintain momentum once the breakout begins, timely coordination and execution are vital.

(3) Limited visibility requires another method of conducting a breakout. When the battalion commander determines that a successful breakout attack is not possible, the battalion might have to exfiltrate out of the area (Figure 6-6, page 6-16). The encircled

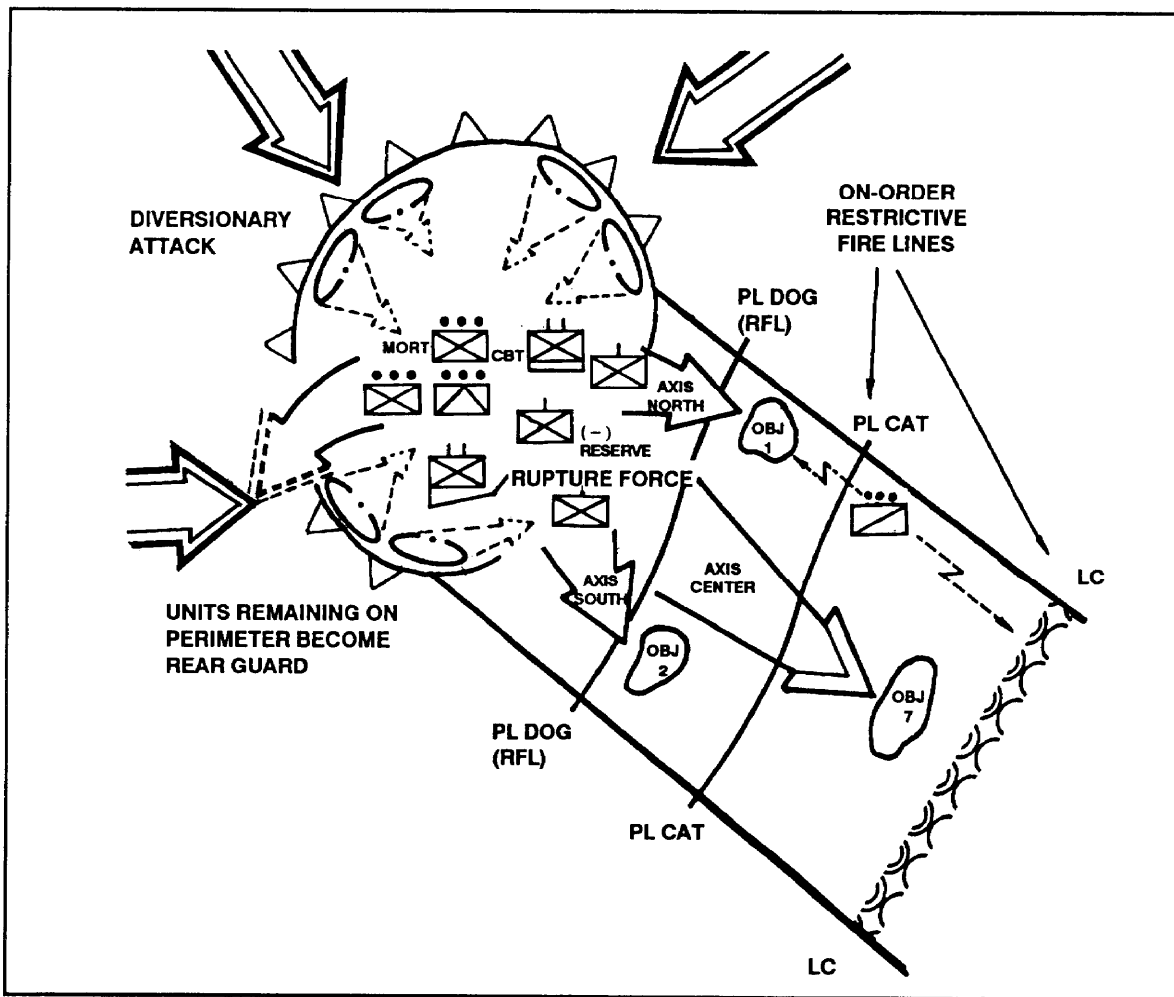

Figure 6-4. Breakout, reinforced company as security.

force is organized into small groups under small-unit leaders. During reduced visibility, it uses stealth and exits through gaps in the encircling forces. To keep them from falling into enemy hands during an exfiltration, major weapons systems and supplies might need to be destroyed. If possible, litter personnel are carried out with the force. However, circumstances might not allow for this; preservation of the force takes priority. In such cases, these soldiers are left with attendants and sufficient medical supplies.

(4) Units located far from friendly lines can exit to a designated location also behind enemy lines. If they are located near friendly lines in a fluid situation, units can exit to friendly lines. Through patrolling and by maintaining contact with higher headquarters, the units must obtain

as much information as possible about enemy dispositions.

**b. Sequence.** The first two methods of conducting a breakout have one sequence, while the other method follows a different sequence.

(1) The first two methods of conducting a breakout have the following sequence:

(a) The diversionary attack is executed vigorously to divert the enemy from the rupture attack. The diversionary attack must be strong enough to convince the enemy that it is the genuine breakout. If the diversionary attack ruptures the encirclement, the battalion must be ready to exploit the success. This change in main effort must be a planned contingency. Also, if contingencies must be exercised, reliable communications to all units are vital, especially with a composite force.

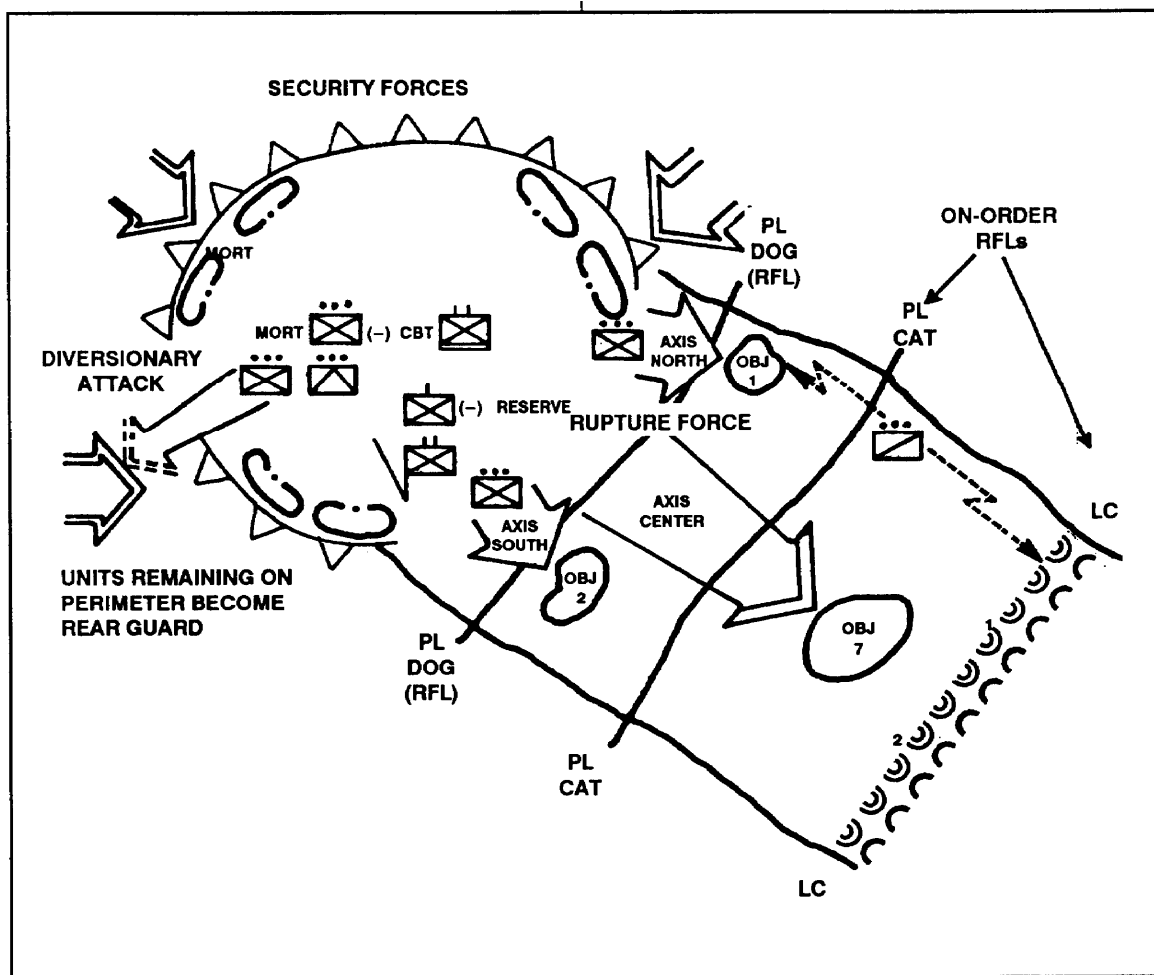
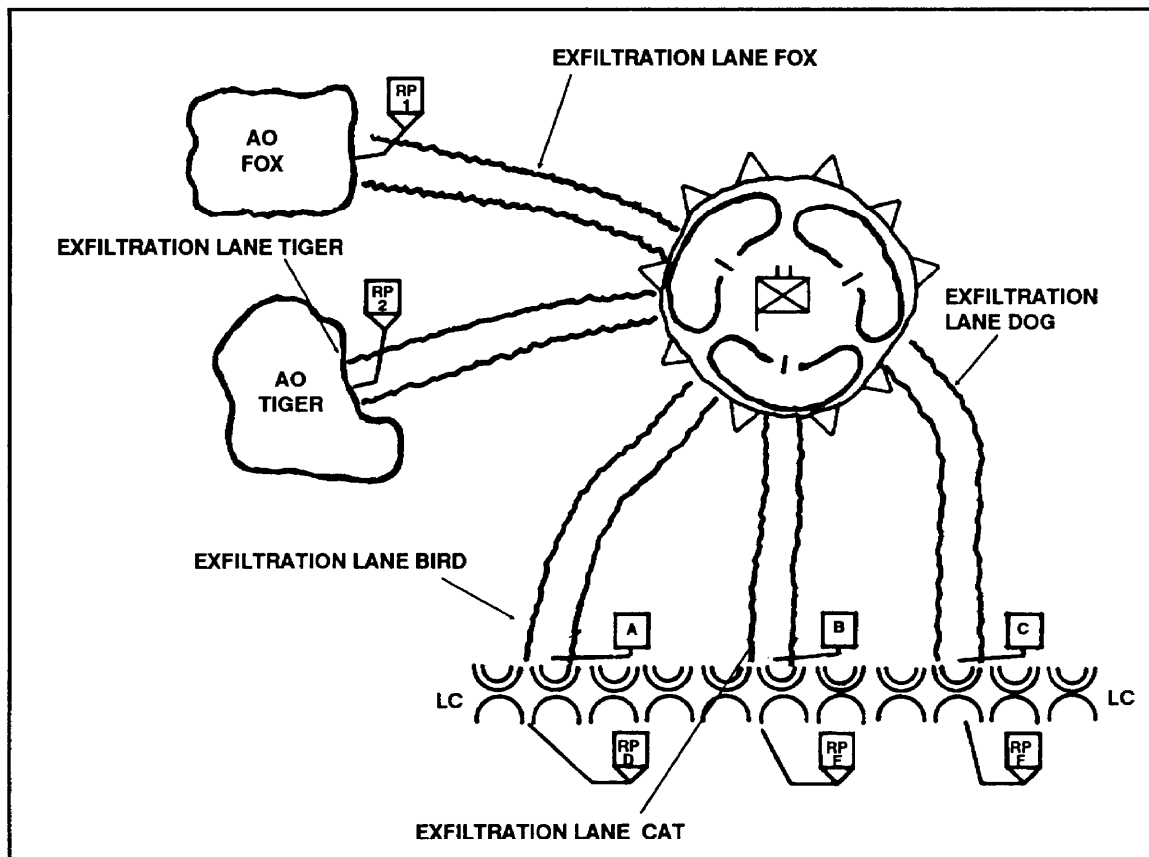

Figure 6-5. Breakout, all forces on the perimeter.



**Figure 6-6. Breakout by exfiltration.**

(b) Encirclement of a large force is difficult; the enemy will probably maintain a reserve to deal with an attempted breakout. The diversionary attack is intended to force the enemy to commit his reserve so that it cannot interfere with the main effort. To meet this intent and still return in time to take part in the breakout, the diversionary force should be light, fast, and heavily armed. Also, the diversionary attack can create plausibility by attacking an objective whose gain would help accomplish a breakout and by the presence of direct and indirect fire support. Once the enemy reserve is committed, the diversionary force breaks contact with aid from supporting elements.

(c) The rupture attack starts as soon as the diversionary attack succeeds in diverting the enemy and prompting him to commit his reserve. The rupture attack is directed toward an enemy weakness. However, other considerations can cause the rupture attack to be conducted in the direction of friendly forces.

(d) The reserve ensures the momentum of the rupture attack. It might already be poised within the perimeter or can be located on the perimeter. Locating it on the perimeter allows the reserve to remain in position; this maintains the integrity of the perimeter and reduces movement. This technique sets up the reserve as the force the unit plans to pass through to conduct the rupture attack. As the rupture force passes through, a gap is created. The rupture force holds the shoulders of the gap open while the reserve force passes through it to continue the attack. The success of breakout operations depends greatly on speed. Once the rupture is achieved, battalion elements must move rapidly out of the encircled area.

(e) The diversionary force, CS/CSS units, and the rear guard withdraw on order and follow the reserve force. When all encircled forces have passed through the gap, the rupture force withdraws, prepared to fight as the rear guard. Once outside the encircled area, forces continue

the attack to link up with friendly units or to seize attack objectives. During this time, the force assumes a formation that ensures maximum speed and security to the front, flanks, and rear.

(2) The third method of conducting a breakout has the following sequence:

(a) **Mounted exfiltration.** A battalion organizes into small groups for a mounted exfiltration, keeping unit integrity as much as possible. All nonessential equipment and supplies are rendered useless and left in place. At the designated time, exfiltration begins under cover of darkness and battlefield noise.

(b) **Dismounted exfiltration.** The same sequence applies to a dismounted exfiltration, except that the disposition of wounded and equipment requires special consideration. For this method to be used, it must offer the battalion a good chance to reach friendly lines and to survive the risks involved.

c. **Follow-Up Actions.** The commander must reorganize to replace key leaders and restore the perimeter defense, if the breakout

fails. Ammunition and equipment should be cross-leveled. The commander regroups and begins planning his next course of action. Once the breakout is completed, the battalion continues its attack to link up with friendly units. As it does so, it might have to conduct hasty attacks or to bypass enemy resistance.

#### 6-24. SUPPORT TO ENCIRCLED COMPANIES

Fewer enemy forces are needed to encircle companies than battalions. Therefore, companies are more likely to be encircled. (FM 7-10 provides more information on actions by encircled companies. ) The battalion can support the breakout of individual companies—

- a. By providing the encircled company all available indirect fire.
- b. By conducting an attack to link up with the encircled force.
- c. By conducting a feint to draw enemy attention away from the location of the breakout.

### Section IV LINKUP OPERATIONS

A linkup is an operation that involves the meeting of friendly ground forces. The battalion can participate as part of a larger force, or it can link up using its own resources.

#### 6-25. PURPOSE

A linkup can be part of airborne or air assault operations such as when an advancing force reaches an objective area previously seized by an airborne or air assault force. Linkups also occur when an encircled element breaks out to rejoin friendly forces, or when converging maneuver forces mass for attack after infiltrating into an enemy rear area. For many attacks, the main effort can use reconnaissance elements as guides in the linkup.

#### 6-26. PLANNING

A linkup operation requires detailed coordination and planning of movement, fires, control measures, and recognition signals. Ideally, an exchange of liaison officers occurs

before the operation. This is important when linking up with an allied army that speaks no English. The headquarters directing the linkup establishes the command relationship. Depending on the mission after linkup, either force can be attached to the other or both can remain under control of the directing headquarters.

a. **Mission.** The mission of the linkup force is to arrive intact at the linkup point as rapidly as possible. The linkup can be similar to a movement to contact; however, the linkup force should bypass or rupture enemy forces and obstacles encountered en route to the linkup. The force avoids decisive engagement whenever possible.

b. **Information Requirements.** Detailed information about the enemy helps planners



determine routes to the linkup point. They need to know enemy locations and strengths. Thus friendly units can avoid the enemy and exploit gaps. Knowing the enemy's capabilities, such as his level of mobility, helps planners determine how to move linkup forces. Aviation assets can offset a mobility difference and aid rapid linkup of forces.

c. **Routes.** Routes to the objective are planned on terrain unlikely to be used by the enemy but able to support the mobility of the linkup force. One technique that can be used is to infiltrate forces to conduct the linkup. All linkups require careful route selection and coordination to prevent friendly forces from engaging each other in a chance contact. Security might be enhanced by moving under the cover of limited visibility.

d. **Organization.** The battalion is organized much like it would be for a movement to contact. Security elements to the front, flanks, and rear provide early warning to the main body. The linkup force uses the smallest element possible to engage the enemy. Timing can influence the mode of movement.

e. **Movement.** Linkup forces exchange their proposed schemes of maneuver to ensure compatibility. Changes by one force must be coordinated with the other. Fire support plans must also be exchanged and control measures established.

f. **Logistics.** The battalion might exceed its transportation capability in linkup operations conducted over extended distances. In such a case, it would require resupply by air or additional vehicles.

(1) Supplies for the linkup force can be flown into the objective area. They can be pre-positioned when the objective area is to be defended jointly by the linkup force and the airborne or air assault force.

(2) Evacuation of equipment and casualties can create problems for the linkup force. If supply routes are open, casualties can be evacuated normally, and damaged equipment can be carried forward with the linkup force until it can be evacuated.

g. **Command and Control.** The headquarters directing the linkup operation must establish the command relationships and responsibilities of the forces involved. They also set the time and

location of the linkup. Both the forces involved in the linkup—

- (1) Can remain under control of the directing headquarters.
- (2) Can be attached to the other.
- (3) Can be under OPCON of the other.

h. **Liaison.** Liaison begins during planning and continues throughout the operation. As the forces close, they must increase coordination. Aircraft improve and expedite this exchange. Liaison officers exchange at least the same types of information exchanged in a passage of lines (Section I).

i. **Communications.** The communications plan specifies the radio channels on which the two forces will communicate. It must also prescribe day and night identification procedures, including primary and alternate means. Aircraft can be used to signal or to otherwise extend communication. Any SOI information should be exchanged before linkup. The headquarters directing the linkup ensures SOI and recognition signals are compatible between the two forces. If the linking units do not have the same SOI, higher headquarters directs one unit to change (normally the unit not in contact). If the units involved in the operation are neither under OPCON nor attached, they maintain their parent command nets.

j. **Recognition.** Planners devise a system of mutual recognition to keep friendly units from firing on each other. This system can include the use of visual signals such as armbands, panels, flags, vehicle markings, smoke, infrared, radar devices, lights of distinctive patterns/colors, or arm-and-hand signals. Though they are less desirable, sound signals (whistles, horns, passwords) must often be used in restrictive terrain or during limited visibility.

k. **Contingency Plans.** Actions following the linkup are established in advance. Alternate plans are considered if the linkup force cannot reach the linkup point at the prescribed time. Contingent plans should include fire support, close air support, and aerial resupply. The linkup force—

- (1) Can reinforce or assume the defense of the area.
- (2) Can conduct a coordinated attack.
- (3) Can pass through and continue to attack.

### 1. Coordination of Schemes of Maneuver.

All elements in a linkup carefully coordinate their operations to prevent fratricide. During the operation, they coordinate often; they increase coordination as the units approach the linkup points. The following are useful control measures:

(1) **Zones of attack/axes of advance.** Higher headquarters controls the directions and objectives of any moving forces. A battalion given a zone of attack should move its companies along axes of advance. This allows centralized control and keeps units oriented on the linkup point.

(2) **Phase lines.** Phase lines control the movement of friendly forces to prevent them from engaging one another.

(3) **Restrictive fire lines.** Restrictive fire lines prevent friendly forces from engaging one another with direct or indirect fires. One technique is to make the phase lines on-order restrictive fire lines. As the unit crosses one phase line, the next becomes the restrictive fire line.

(4) **Coordinated fire line.** A coordinated fire line is a fire control measure beyond which conventional surface fire support need not be coordinated. In linkup operations, this line allows engagement of targets outside the areas of both units.

(5) **Checkpoints.** These points control movement and designate overwatch positions.

(6) **Linkup and alternate linkup points.** A linkup point is a designated location where two forces meet and coordinate operations. The point must be easily identifiable from the ground; recognition signals must be planned for the forces that meet there. Alternate linkup points should be established if enemy action prevents forces from linking up at the primary point.

### 6-27. CONDUCT OF A LINKUP

Guides should travel with the lead element if the mission after linkup requires reorganization within or between the linkup forces or if it requires integration of the forces. If possible, one or both forces halt briefly before linkup. Operations to follow the linkup should be coordinated before the linkup operation; they can be modified during the linkup. The two commanders collocate near the linkup point or

at a prearranged location to confirm or coordinate their subsequent operations.

a. **Linkup of Two Moving Units.** The most difficult linkup to coordinate is one between two moving units. As the units move closer together, the chances of their engaging each other increase. Therefore, the leading linkup units adjust their movements to each other and communicate continually on a planned radio net. Once they establish contact, if no physical integration of units is planned, the lead elements maintain radio contact between the linkup forces (Figure 6-7, page 6-20).

b. **Linkup of Moving Unit and Stationary Unit.** Linkup between a moving and a stationary force requires detailed coordination, particularly if the stationary force is under enemy pressure (Figure 6-8, page 6-21). The moving force must orient on the stationary force and keep the stationary force advised of its location. The stationary force guides the lead element to the contact point by radio or may, if the enemy situation permits, send out a patrol to meet and guide the moving force. Guides aid in passage of minefield and other defensive obstacles in front of and within the stationary force defense sector. The stationary force must be prepared to accept the moving force, to provide guides to its position and, as required, to position it. If two forces have been directed to merge, they are vulnerable to enemy attack as they come together. Guides must deploy the moving force quickly and efficiently.

### 6-28. STAY-BEHIND/HIDE FORCES

Stay-behind operations are well suited to light infantry forces. They offer the light infantry commander a high-risk, yet high-payoff, tactical operation. The commander can use terrain to hide an offensive force in a perimeter defense until forward enemy elements pass the unit. Units inadvertently bypassed by the enemy may be ordered not to break out. This allows division and brigade commanders to capitalize on the unit's position and use it for offensive action in the enemy rear.

a. The purpose of a stay-behind force is to destroy, disrupt, and confuse the enemy. The stay-behind or hide force attacks or ambushes critical enemy elements. It may attack enemy combat forces from the rear, but this is not

normally the best employment of this asset. Due to the high-risk nature of this operation, the commander should only try it if he feels it is necessary and feasible (Figure 6-9, page 6-22). Units that perform stay-behind operations can do the following:

- (1) Disrupt the cohesion of the enemy offense by attacking key C2, CS and CSS elements and by blocking lines of communication and logistics.
- (2) Inflict casualties on the enemy throughout the depth of his formations.
- (3) Detract from the enemy's main effort by forcing him to allocate combat forces for rear area operations.
- (4) Supply HUMINT on enemy forces in their area.
- (5) Complement a friendly counterattack by conducting offensive operations (raids, ambushes, or deliberate attacks) in enemy rear areas.
- (6) Call for and control artillery and CAS.

b. Infantry units maybe employed as hide forces using a number of techniques. Their options include infiltrating to establish a hide position, allowing attacking enemy forces to bypass friendly units in hide positions, and air assaulting into enemy areas to establish and operate from hide positions.

c. Planning considerations for a stay-behind force include the following:

(1) The force may be positioned initially in the MBA or the security area. Close rugged terrain and a low profile (minimal signature from the battalion in the form of movement, radio communications, and so on) are requirements for success. Selection of a hide position that restricts enemy movement and avoids aerial detection is vital. Camouflage, cover, concealment, and SIGSEC must be planned in detail.

(2) Positions of the stay-behind force subelements should be chosen for the best possible trade-off between dispersion (so they

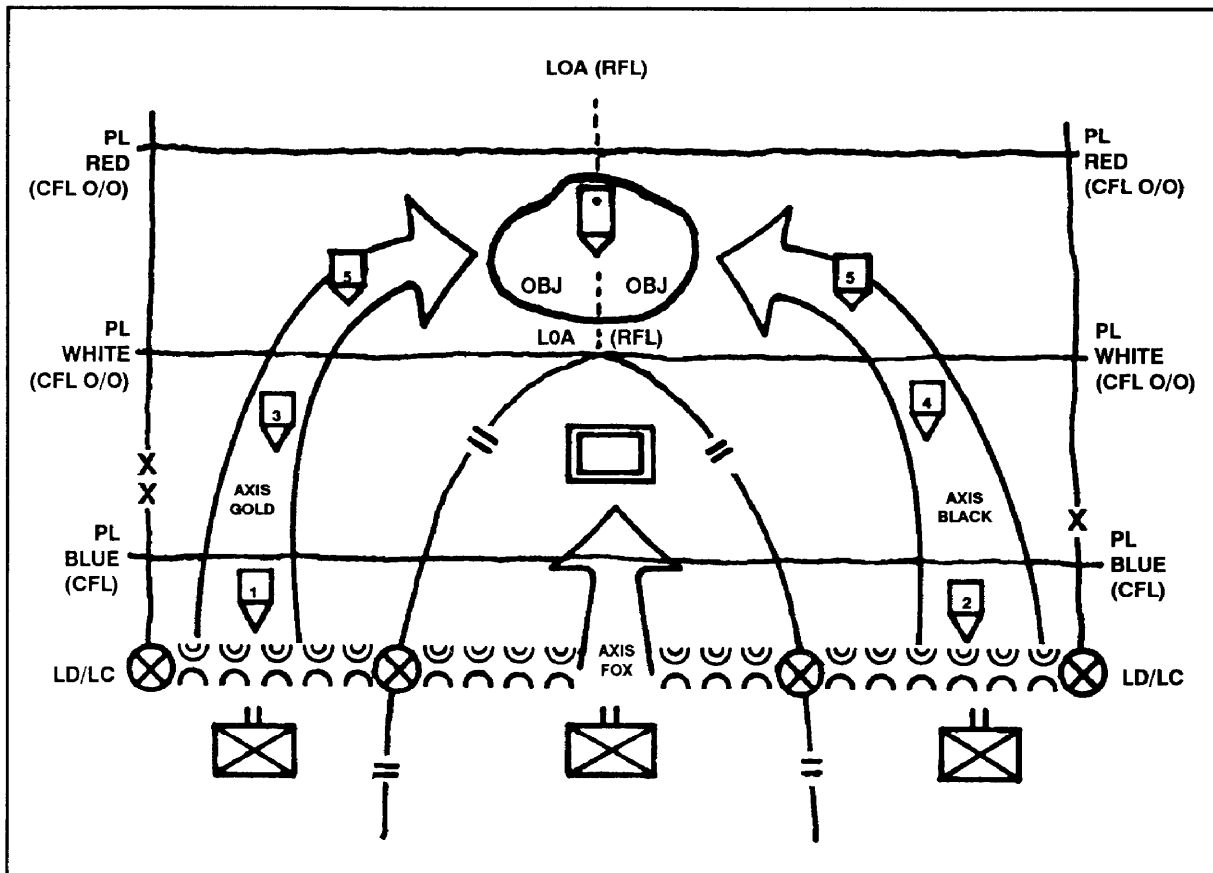

Figure 6-7. Linkup of moving forces.

can remain undetected) and mutual support (so they can mass quickly).

(3) Mortars and FA should be positioned in support of the stay-behind force and restrictive fire control measures planned. Artillery raids and CAS should be planned when supporting artillery units are no longer within range.

(4) The communications signature must be reduced to avoid early detection. Runners and wire should be used when possible. If radio transmissions are necessary, operators should use directional antennas and low power settings.

(5) The battalion combat trains are the only logistics asset that accompany a stay-behind force. This means fewer vehicles are needed. Resupply and evacuation should be by air. If possible, supplies should be cached and equipment buried.

(6) Unit medical facilities should be established within the hide position; only the most serious cases should be evacuated.

(7) Return routes for the stay-behind force must be the best covered and concealed routes

available. Obstacles that cannot be bypassed should have guarded lanes or gaps. Rally points are designated.

(8) The stay-behind force should plan for an exfiltration/breakout and should link up with the parent unit on completion of the operation.

(9) Deception measures should be planned to convince the enemy that the stay-behind force is still part of the MBA force.

d. Stay-behind operations are either planned or unplanned. An unplanned stay-behind operation is one in which a unit finds itself cut off from other friendly elements for an indefinite period without specific planning or targets. A planned stay-behind operation is one in which a unit operates in an enemy-controlled area as a separate and cohesive element for a specified time or until a specified event occurs. Planned stay-behind operations have an establishment plan, an operation plan, and a linkup plan.

(1) *Establishment plan.* This plan addresses the positioning of combat, CS, and CSS units,

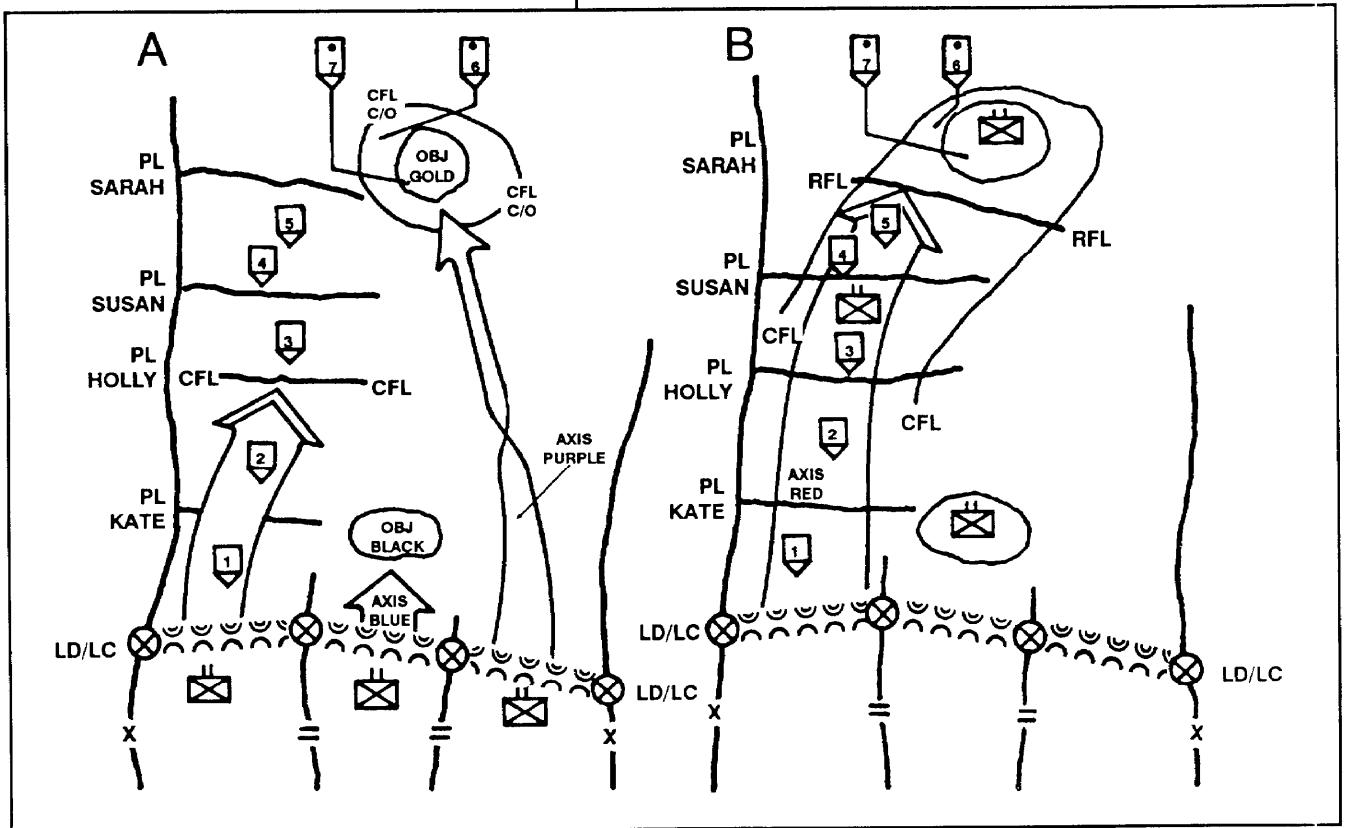

Figure 6-8. Linkup of moving and stationary forces.

along with the required logistics, in the desired area of operation and the evacuation of unneeded vehicles and equipment. To avoid detection, the unit uses clandestine techniques to move its elements. The unit allows the enemy to bypass and does not make contact until the battalion is ready to begin attacking vulnerable targets. Techniques for doing this are limited only by the commander's imagination. Two examples follow:

(a) Units can establish stay-behind positions to the rear of defending forces and allow those forces to withdraw through them.

(b) Units can prepare for stay-behind operations while conducting a defense; that is, fake a false withdrawal to deceive the enemy while units staying behind infiltrate to patrol bases and wait to begin operations.

(2) **Operation plan.** This plan applies once the stay-behind units are positioned and other friendly forces are withdrawn. During this phase, units conduct combat operations to support their missions and the commander's intent. Most often these operations are reconnaissance, raids, and ambushes and are conducted by platoons and squads against targets of opportunity. In some cases, the battalion conducts operations against high-priority targets. However, massed forces present the enemy with an identifiable target on which to focus his superior combat power. Therefore, units should disperse in small groups as soon as possible after massing. Commanders may exercise more control by establishing an engagement priority—for example, enemy air defense artillery, logistics elements, and

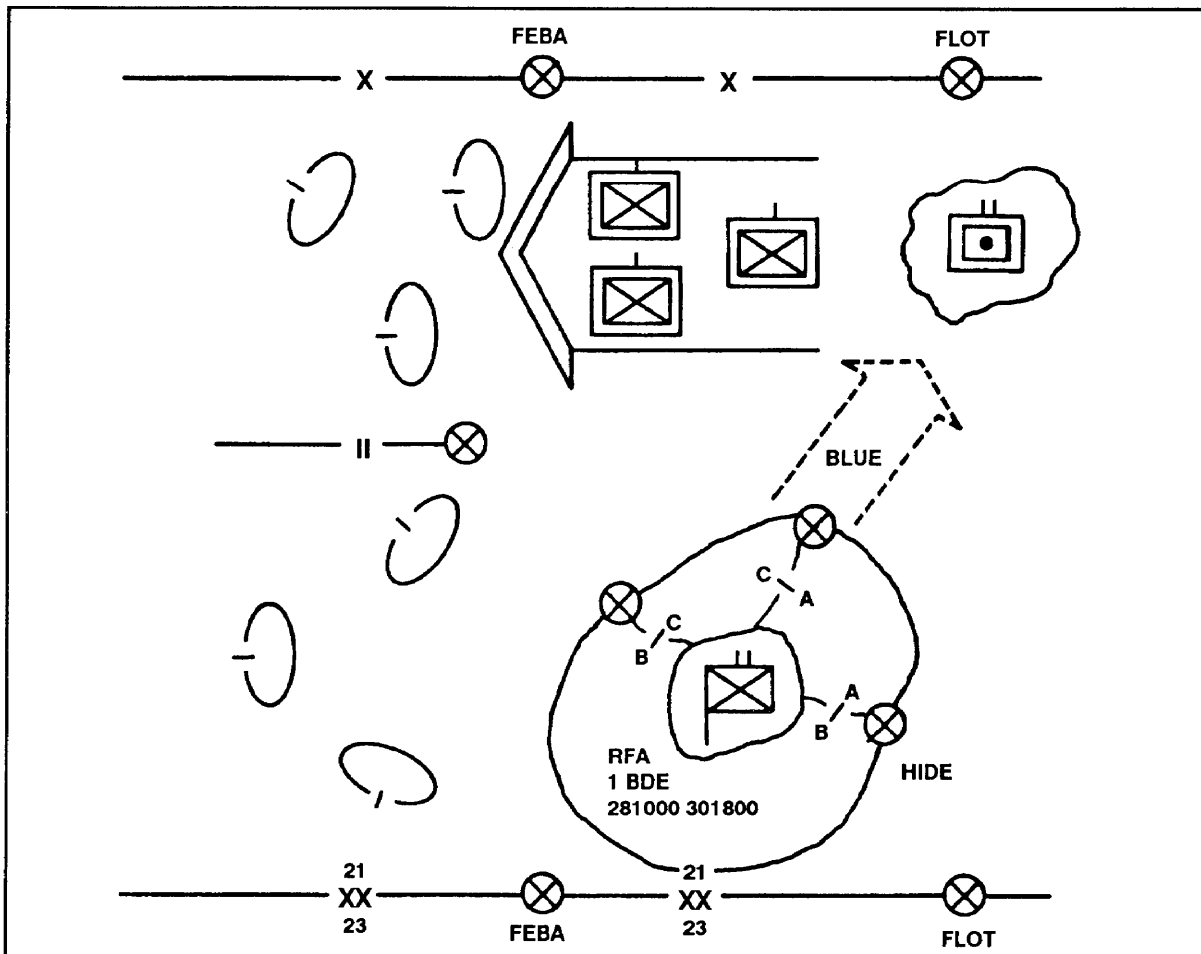

Figure 6-9. Battalion in stay-behind/hide force operations.

C2 elements—or tasks in reference to specific avenues of approach—for example, the commander might have the unit disrupt all enemy movement along AA1.

(3) **Linkup/exfiltration plan.** This includes any plans to link up with friendly forces and end the stay-behind operation. It does not include linkups between stay-behind forces to conduct missions during the operational phase. The linkup can be made after consolidation, though this presents all the disadvantages of any massed operation. In most cases, the linkup is conducted by small units infiltrating into friendly units. The stay-behind unit can either wait in place until friendly forces counterattack to its location or it can exfiltrate through enemy territory to friendly territory. A movement through enemy territory is most often an exfiltration; however, if METT-T factors require, the stay-behind unit can attack or move to contact toward friendly territory.

## 6-29. STAY-BEHIND/HIDE FORCE SCENARIO

A light infantry task force remains in a well-prepared hide position after the covering force withdraws (Figure 6-9). The light infantry task force is in position along the flank of an enemy avenue of approach, because that is a likely place to find enemy command and control, CS, or CSS elements. Specific light infantry task force preparations include the following:

a. **Operational Concept.** The battalion commander divides the assigned area of operations into company areas of operations. He selects locations for CS and CSS elements for the best support of the task force. The companies can position forces anywhere within their assigned areas of operations and are tasked to conduct reconnaissance/counterreconnaissance operations outside the hide position.

b. **Task Organization.** The battalion has a light engineer platoon (with special equipment as required by METT-T), a GSR section, an ALO, the FSE, and the company FIST. The brigade commander detaches the assembly area platoon to one of the other battalions in the MBA.

c. **Engagement Criteria.** Operations in the enemy rear are to be decentralized to the platoon level. The battalion commander establishes

engagement criteria. These criteria guide company commanders as to appropriate targets, timing, and circumstances of an attack. They also guide commanders in hiding from the enemy the presence of their sizable forces in his rear area. The engagement criteria are reviewed and approved by the division area damage control and air defense officers to ensure consistency with the division commander's intent.

d. **Contingency Annex.** The battalion commander provides company commanders with detailed guidance as to what sections they should take if all or part of their forces are detected early. Guidance is disseminated down to the last soldier. Any unit, if discovered, is to maintain that it was disoriented and cut off from a parent unit. Discovery/loss of caches are also covered in the commander's guidance.

e. **Reduction of Communication Signature.** FM radio silence should be mainlined in the hide position except for a daily report at a set time. Wire should be laid between positions and CPs. Communications with brigade headquarters should be via single-channel TACSAT radio. The battalion monitors the brigade FM nets to track the battle and receive prearranged burst messages. Once offensive operations begin, battalion units using FM communications use directional antennas and low power settings.

f. **Prevention of Aerial Detection.** Careful study of the area of operations may reveal, for example, that less than one-fourth of the area is usable if aerial detection is to be avoided. All hide positions are located in the area that provides concealment from aerial detection. Also, all positions are dug-in with extensive overhead cover to blend with the surroundings. The battalion plans to use abandoned buildings. All movement is limited to hours of limited visibility. Friendly overflights are planned to check the effectiveness of the camouflage effort.

g. **Cache Composition and Positioning.** Much effort is given to deciding what items need to be cached to sustain the force and conduct offensive operations. Obvious items to be cached include: water (depending on its availability in the area); Classes I, III, IV, V, VIII, IX; and batteries. These supplies are to be cached both inside and outside the hide position to simplify future operations. RB-15s are cached

to provide a means of crossing a major local river. Redundancy is planned and all caches guarded.

**h. Aid Station Setup and Medical Care.** The battalion plans to set up the entire BAS in an abandoned building within the area of operations. All medical assets are needed; the battalion will only try to evacuate the most serious medical emergencies. All evacuations are to be done at night by a single helicopter. Class VIII is cached in larger-than-normal quantities.

**i. Soldier's Load.** Soldiers initially moving to the area of operations by truck are overloaded with all types of equipment and supplies. They know that as soon as they arrive they will drop most of the equipment in a central cache area or

they will stockpile it in their own positions. Once in the area of operations, soldiers reconfigure their fighting loads and prepare for combat. To reduce the possibility of discovery, civilian vehicles are used in the area of operations.

**j. Deception Operations.** The battalion's vehicles and drivers and the trains personnel are positioned in an assembly area to the rear of the expected main battle area. A key role for them is to replicate battalion radio traffic to convince the enemy that the entire battalion is occupying the assembly area. Also, the actual location of the area of operations is reflected only on a few overlays within the division.

## CHAPTER 7

# COMBAT SUPPORT

*Effective combat support is the responsibilities of the battalion commander. Combat support elements enhance the combat power of the maneuver companies. Knowledge of CS capabilities, assignment of appropriate CS missions, and control of CS operations are vital to the application of superior combat power at the decisive time and place. Combat support elements can be used in attached, OPCON, DS, or GS roles. Regardless of which relationship is used, the battalion commander ensures the CS units are properly supported by the battalion. He decides, based on his estimate, how to employ his CS assets. He retains centralized control of the organic and attached CS assets by specifying tasks and assigning priorities of support to his subordinate companies. However, in some cases he might need to attach a CS element and logistical support to a company.*

### Section I INDIRECT FIRE SUPPORT

This section discusses responsibilities, considerations, and procedures for the employment of all indirect assets routinely supporting the battalion.

#### 7-1. MISSION

The mission of fire support is to destroy, neutralize, suppress, degrade, or disrupt enemy operations in support of the scheme of maneuver.

#### 7-2. PLANNING

To defeat the enemy, the battalion commander and his FSO integrate and synchronize the firepower of mortars, FA, CAS, and (when available) naval gunfire with the maneuver of combat units. As the commander develops his plan to employ maneuver forces, he and the FSO decide how to best use fire support resources. The FSO must understand the commander's requirements for fire support. The commander must first develop his intent for fire support. It sets priorities for fire support on the battlefield and provides for fire support at the critical time and place. The commander's intent for fire

support also allows the FSCoord/FSO to integrate and synchronize the fire support system into the overall concept of the operation. (Appendixes A and B provide more information.)

a. In using fire support, the commander—

- (1) Ensures simplified plans. A simple plan fully disseminated and understood by all is far better than a more complicated one still being prepared when the enemy strikes.
- (2) Anticipates, along with the FSO and staff, the dynamics of the battlefield and prepares for each enemy reaction or counteraction.
- (3) Knows the capabilities and limitations of all supporting fires and ensures that fire support is used where and when it will be most effective.
- (4) Begins the engagement with massed fire whenever possible. Massed fire allows the enemy less reaction time and provides the best effect.



(5) Estimates priorities for those assets allocated to him by brigade. He suballocates priority targets, priority of fire, and ammunition to his subordinate units. Also, he assigns priorities and tactical missions to his organic mortars.

(6) Determines minimum-essential effects desired on each target. He must also establish ammunition expenditure limits.

(7) Plans to achieve surprise. Massed surprise fires are most effective—the destruction that can be achieved by supporting fire is directly proportional to the enemy's unpreparedness.

(8) Establishes fire superiority. The commander positions weapons to place fire on the enemy as soon as he is discovered. This allows effective maneuver and hinders the enemy's ability to maneuver.

(9) Avoids unnecessary restriction of fire. The commander uses restrictions only to reasonably protect units from friendly fires or to control those fires on the enemy.

(10) Takes precautions to avoid engaging friendly forces.

b. The commander must address the following areas with the FSO:

(1) **Ground scheme of maneuver:** the area of operation, timing of advance, rate of movement.

(2) **Fire support scheme of maneuver:** how fire support batteries are to be controlled and displaced, and where they will be located.

(3) **Purpose of fires:** how the commander expects the fires to support the scheme of maneuver and the direct-fire battle.

(4) **Priority of fire:** which unit has priority of available assets and when that priority shifts.

(5) **Priority targets:** the priority of targets and how long these priorities will be in effect.

(6) **Effects of fire:** indirect fire effects as follows:

(a) **Suppression** limits the ability of personnel in the target area to perform their jobs. However, the effects of suppressive fire last only as long as the fires continue.

(b) **Neutralization** “knocks” a target out of action temporarily it should produce 10 percent or more casualties. Neutralization can be achieved by using any type of shell-fuze combination suitable for attacking a particular type of target. Because little ammunition is

required, this is the most practical type of mission. Most missions are neutralization fire.

(c) **Destruction** “knocks” the target out of action permanently it should produce 30 percent or more casualties. Direct hits with HE or concrete-piercing shells are required to destroy hard-materiel targets. This type of mission is seldom economical due to the amount of ammunition required.

(7) **Mortars:** how mortars fit into the overall fire support plan.

(8) **Close air support:** what CAS is available, when it is available, and how it will be used.

(9) **Fire support coordination measures:** existing or proposed permissive or restrictive control measures.

(10) **Ammunition restrictions:** what limitations exist on the use of smoke, improved conventional munitions, or other ammunition (including established controlled supply rates).

c. The FSO is aided by the fire support section (FSS) and company fire support teams (FISTs). The FSS, battalion S3 Air, and advisers on other fire support means are collocated in the battalion main CP. There they plan and coordinate fire support and form the fire support cell. A FAC from the TACP is part of the fire support cell; if naval air support, naval gunfire support, or both are available, the fire support cell can also include a SALT. The fire support cell coordinates closely with the brigade fire support cell, the fire support cells for other battalions, the DS field artillery battalion FDC, the S2, the S3, the mortar platoon leader, the engineer platoon leader, and the company FISTs.

d. A battalion fire support plan can include the following:

- Purpose for fires.
- Target list.
- Priority of fire.
- Priority of targets.
- Allocation of priority targets and FPFs.
- Execution matrix.
- Coordination measures.

e. Company FSOs accompany their commanders to receive the battalion OPORD. This allows them to hear the concept of the operation at the same time. It also allows the

battalion FSO to brief company FSOs on the battalion commander's plans.

f. Target planning includes the following considerations for fire support:

(1) **Fires supporting attacks.** Fires in support of hasty or deliberate attacks are planned sparingly to avoid over-burdening the fire support system with targets.

(a) *Preplanned fires.* Fires should be planned on easily identifiable locations so they can be shifted easily. Targets along avenues of approach to, on and beyond the objective should be considered.

(b) *Obscuration fires.* The attacking force usually benefits more than the defending force from partial obscuration of the battlefield. A defender denied observation cannot place effective observed fires within his zone. This allows the attacker to reach the defended positions with more of his forces intact.

(c) *Preparation fires.* A preparation is an intense volume of prearranged fire delivered IAW a time schedule and supporting an attack.

(2) **Final protective fires.** A final protective fire is a prearranged barrier of fire to protect friendly soldiers and installations by impeding enemy movement across defensive lines or areas.

(a) Field artillery and mortar FPFs are used only in the defense and are an integral part of the supported unit's FPL. The FA and mortar FPFs are located where they can best augment the fires of the company's organic weapons.

(b) The length of an FPF is not fixed (Table 7-1). It depends on such factors as the

bursting diameter of the round, range dispersion, and formation. The FPFs of the DS FA battalion are available to the supported brigade. The FPFs of any FA reinforcing the DS battalion are also available to the brigade.

(c) The brigade commander allocates field artillery FPF priority targets to maneuver battalions. The maneuver battalion commander in turn designates general locations for FPFs or allocates them to maneuver companies. Designating the precise location of an FPF is the responsibility of the company commander in whose sector it falls.

(3) **Fires supporting counterattacks.** Fire support assets must be divided in the counterattack between forces counterattacking and those still defending. Otherwise, planning fire support for a counterattack is much like planning for the offense—both forces need the available assets. These fires are employed to do the following

(a) Blunt the nose of the penetration by providing fires to maneuver forces whose mission is to contain the enemy penetration.

(b) Seal off the penetrated area from outside help. Fire support is provided by FA units with GS or GSR missions.

(c) Support the counterattacking forces to destroy the enemy in the penetration.

### 7-3. TOP-DOWN FIRE PLANNING

Top-down fire planning is a technique for preparing the maneuver plan and developing a fire support plan at the same time to support the

| SIZE   | TYPE  | NUMBER OF MORTARS | APPROXIMATE       |                   |
|--------|-------|-------------------|-------------------|-------------------|
|        |       |                   | WIDTH (IN METERS) | DEPTH (IN METERS) |
| 120-mm | M120  | 6 (platoon)       | 350               | 60                |
| 120-mm | M120  | 3 (section)       | 180               | 60                |
| 107-mm | M30   | 6 (platoon)       | 250               | 40                |
| 107-mm | M30   | 4 (platoon)       | 160               | 40                |
| 107-mm | M30   | 3 (section)       | 120               | 40                |
| 81-mm  | M29A1 | 4 (platoon)       | 140               | 40                |
| 81-mm  | M29A1 | 3 (section)       | 100               | 40                |
| 81-mm  | M252  | 4 (platoon)       | 150               | 50                |
| 60-mm  | M224  | 2 (section)       | 75                | 30                |

Table 7-1. Normal FPF dimensions.

maneuver commander's intent. Though the concept of the top-down fire plan begins at brigade-level, battalions and companies also perform vital roles.

a. Top-down fire planning is most important when time is critical. In most tactical situations, observers have too little time for a "bottom-up" fire plan in which they develop, identify, and plan targets or fires to support the maneuver force. Then, they forward them up through fire support channels for consolidation at each level.

b. Top-down fire planning is simple. Planning starts at the higher levels; it is supervised by the most experienced fire support planner in the force. The brigade FSO and FSCOORD conduct the planning for their subordinate units, then disseminate the plan to their units for refinement, adjustment, and execution. Top-down planning is not a shortcut it just makes the best use of available planning time.

(1) The top-down plan, in its completed form, contains a limited number of targets (45 to 60 for the brigade). The brigade fire support annex contains only those targets deemed vital by the FSCOORD to support the brigade commander's intent. The rest are allocated to the battalions IAW priorities for FA support.

(2) The battalion commander uses his allocation of targets to support his plans; he allocates targets to companies IAW his priorities.

(3) Battalion FSOs work for the battalion commander, not for the brigade FSO or FSCOORD. Battalion commanders, not FSOs, execute the brigade-planned targets within their area of operations.

#### 7-4. SCHEDULES OF FIRES

Commanders have several fire support techniques available to complement the battalion maneuver. The two most commonly used by battalion commanders are preparation fires and programmed fires.

a. **Preparation Fires.** An intense volume of fire delivered to support an attack IAW a time schedule is called preparation fires. These fires are normally planned at brigade or higher echelon.

(1) A preparation can be phased to permit successive attacks on certain types of targets.

**Phase I.** The first phase provides for the early attack of slow recovering targets such as hostile fire support means and all observation systems. Mortars seldom fire these targets.

**Phase II.** The second phase includes attack of command posts, communication facilities, assembly areas, and reserves. The goal is degradation of the enemy's ability to reinforce his defense and shift forces to counter the main effort.

**Phase III.** The third phase includes an attack of the enemy's battle positions. The purpose of this phase is to suppress enemy direct-fire systems until attacking maneuver forces have closed with them.

(2) The battalion FSO must ensure that the preparation fires, especially those fired during the final phase on forward enemy positions, do not interfere with the battalion scheme of maneuver. This is critical when the battalion commander plans to infiltrate dismounted infantry forward of the LD ahead of attack time. The FSO ensures that any fires within the battalion area of operations have the approval of the battalion commander.

b. **Programmed Fires.** Programmed fires are a number of planned targets of a similar kind. All targets in a particular program are of the same type—for example, all enemy ADA or all enemy mortars. A program can be scheduled or on-call. Once a program is initiated, targets within the program are fired on a predetermined time sequence as listed in the schedule. In both the offense and defense, a SEAD program and a countermortar program are the typical ones fired at battalion level.

#### 7-5. FIELD ARTILLERY

The battalion's FA support is provided by the 105-mm or 155-mm howitzer battalion (towed) in DS of the brigade. Other fires can be provided by artillery units that reinforce the DS battalion and by units in GS of the division. The brigade commander normally assigns priority of FA fires to one of his maneuver battalions or establishes a sequence of priorities. He then plans and establishes priority of artillery fires for his subordinate elements. He must also know the capabilities of several types of munitions that can aid maneuver operations.

## 7-6. MORTARS

The battalion mortar platoon provides the most responsive indirect fire available to the battalion. The platoon's mission is to provide close and immediate fire support to the maneuver units. In addition to supporting its parent battalion, the mortar platoon can support other units. This can occur when units are conducting a passage of lines or a relief. Mortars might also be needed to aid in the withdrawal of a covering force or to help threatened adjacent units. Reserve unit mortars can help units on the FEBA. The battalion must plan mortar support with the FSO as part of the total fire support system. (FM 7-90 provides detailed information about the tactical employment of mortars.)

**a. Role of Mortar Units.** The role of mortar units is to deliver deadly suppressive fires to support maneuver, especially against dismounted enemy infantry. Mortar units also fire smoke missions, mark targets, and provide point battlefield illumination. Mortar fires inhibit enemy fire and movement, allowing friendly forces to maneuver to a position of advantage. Effectively integrating mortar fires with dismounted maneuver is key to successful combat at the rifle company and battalion level.

(1) Mortar units are organic to all infantry battalions and to all nonmechanized infantry rifle companies. Thus, mortar fire is always available and responsive, regardless of whether the battalion is allocated supporting artillery.

(2) Mortar units stay close to the company and battalion fights. This eases the commander's coordination burden; it also enables the mortars to respond quickly to sudden enemy actions without lengthy planning.

(3) Mortar fires complement FA they do not replace FA. Mortar FPF thickens the defender's fires. The mortar's high-angle, plunging fire is often the only way to attack enemy forces in deep defilade—in wadis, in ravines, on reverse slopes, in thick jungle, or in narrow streets and alleys.

(4) The mortar's high rate of fire and lethality allow it to supplement fire during the lifting and shifting of heavier artillery fires and during the infantry's final assault of the objective. Mortar fires also reinforce the direct fires of the maneuver force. The combined effect is greater

than either the mortar unit or the maneuver force could achieve alone.

(5) Mortar units enable the commander to cover his key obstacles with indirect fire at all times to ensure their integrity. This cover continues even while the commander uses supporting artillery to attack the enemy in depth.

**b. Command Relationships.** The mortar platoon, as the battalion's organic indirect-fire support element, fires for all maneuver elements of the battalion (to include attached and OPCON units) on a mission-by-mission basis.

(1) The battalion commander normally assigns a priority of fire and the priority mortar target to one of the companies. This allows him to retain control while making the fire support more responsive to a company.

(2) A mortar platoon under battalion control is sometimes unable to support the entire battalion. This can occur, for example, when a company is separated from the battalion by a restrictive terrain feature. It can also occur if a maneuver unit has a mission, such as raid, guard, or DLIC, that separates it from the rest of the battalion. If such a situation should occur, the mortar platoon can be attached or OPCON to a subordinate maneuver unit.

**c. Tactical Employment.** The mortar platoon leader's or platoon sergeant's primary duties are those of combat leaders. The battalion staff develops a detailed concept and provides the mortar platoon leader with a detailed description of his mission and with the commander's concept for mortar support. The platoon leader uses this detailed concept for employment and the accompanying fire plan—the "what" to plan the "how." The platoon leader must know how his fires support maneuver and what the roles of other fire support systems are so he can remain flexible on a dynamic battlefield. The missions assigned to mortars must be defined in terms of the following factors:

- Targets critical to the success of the battalion mission.
- The effects required on those targets.
- The specific time and circumstances in which these fires are required.

d. **Mortar Employment Concept.** The battalion staff develops a mortar employment concept based on the capabilities and limitations of the mortar platoon (Figure 7-1). This concept addresses communications, positioning and movement, survey requirements, who makes calls for fire on each target, and the desired effects of the mortars on each target.

(1) **Calls for fire.** Maneuver company commanders and platoon leaders are vital to mortar fire planning and execution. Their call-for-fire or execution responsibilities are established during top-down fire planning. Primary and alternate observers are assigned to each target. Fire support teams and forward observers work for their supported company commander or for the rifle platoon leader; responsibilities for calls for fire are thus

established through command rather than fire support channels.

(a) Units position observers to watch the target and trigger lines. They refine target locations as required and plan and coordinate additional targets IAW the plan for fire support.

(b) Observers must know the targets, timing, and controls required in the calls for fire to synchronize fires with maneuvers. The targets, timing, and controls are coordinated with the battalion staff and with the mortar platoon. The company commander briefs this information back to the battalion commander, and details of the plan are rehearsed. Both the observer and the FDC must know the primary and alternate communications nets, antijamming procedures, alternate communications routes, and alternate means of communication. Effective communications are necessary for the indirect fire support plan to succeed.

| WEAPON      | AMMUNITION |       | METERS        |               | RATES OF FIRE<br>(APPLY TO HE AND WE ONLY)  |
|-------------|------------|-------|---------------|---------------|---|
|             | MODEL      | TYPE  | MINIMUM RANGE | MAXIMUM RANGE |   |
| 60-mm M224  | M720/M888  | HE    | 70            | 3,500         | 50 rounds per minute for 4 minutes, then 20 rounds per minute, sustained.                                       |
|             | M722       | WP    | 70            | 3,500         |   |
|             | M721       | ILLUM | 200           | 3,500         |   |
|             | M302A1     | WP    | 35            | 1,630         |   |
|             | M83A3      | ILLUM | 725           | 950           |   |
|             | M49A4      | HE    | 45            | 1,930         |   |
| 81-mm M29A1 | M374A2     | HE    | 70            | 4,800         | 25 rounds per minute for 2 minutes, then 8 rounds per minute, sustained.  |
|             | M374A3     | HE    | 73            | 4,790         |   |
|             | M375A2     | WP    | 73            | 4,595         |   |
|             | M301A3     | ILLUM | 100           | 3,950         |   |
| 81-mm M252  | M821/M889  | HE    | 80            | 5,800         | 30 rounds per minute for 2 minutes, then 15 rounds per minute, sustained.                                       |
|             | M374A3     | HE    | 73            | 4,790         |   |
|             | M819       | RP    | 300           | 4,800         |   |
|             | M375A3     | WP    | 73            | 4,790         |   |
|             | M853       | ILLUM | 300           | 5,050         |   |
|             | M301A3     | ILLUM | 100           | 2,950         |   |
| 107-mm M30  | M329A2     | HE    | 770           | 6,840         | 18 rounds per minute for 1 minute, then 9 rounds per minute for 5 minutes, then 3 rounds per minute, sustained. |
|             | M329A1     | HE    | 920           | 5,650         |   |
|             | M328A1     | WP    | 770           | 5,650         |   |
|             | M335A2     | ILLUM | 440           | 5,490         |   |
| 120-mm M120 | M59        | HE    | 180           | 7,200         | 15 rounds per minute for 1 minute, then 5 rounds per minute, sustained.   |
|             | M58        | SMOKE | 180           | 7,200         |   |
|             | M90        | ILLUM | 180           | 7,200         |   |

Figure 7-1. Mortar characteristics and capabilities.

(2) **Communications.** FM radio range and LOS requirements must be met before reliable radio communications can be established. Mortar and tactical radio ranges are usually compatible. However, the observer or FSO and the battalion FSE must also be able to talk to the FA FDC. Mortars can exploit high-angle fires and occupy positions in deep defilade. These abilities enhance their counterfire survivability but can prevent the unit from maintaining an LOS.

(a) The rule of "supporting to supported" can be applied to the responsibility to establish communications. However, fulfilling this responsibility may sometimes be impossible. Retransmission assets are scarce, and mortar platoons may engage targets in a variety of locations. Sometimes company commanders must choose between relocating observers and adhering to communications position constraints. Inspecting maps can aid in predicting LOS problems. This, along with adjustment of mortar or observer locations, is part of planning. When EW constraints allow, the communications plan should be tested.

(b) Observers should be required to change nets as few times as possible during battle—not because changing nets is difficult, but because doing so is easily overlooked in the heat of battle. Also, the FOS must concentrate on the mortars rather than on communications adjustments.

(3) **Positions and movement.** Mortar positions and movement require the attention of the battalion staff and of the mortar platoon leader.

(a) Plans for movement and positions include the targets, effects required on those targets, movement times between positions, and the availability and role of other fire support systems. Once critical mortar engagements have been identified, movements to support them must be considered. In restrictive terrain, the priority of routes and the management of terrain may be critical. Adequate time should be allowed for movement, for a thorough route reconnaissance, and for a movement rehearsal.

(b) Movement and position considerations include assigning targets that are within range; ensuring security, survivability, and flexibility; establishing communications with supported units and with observers; and anticipating future operations.

(c) Mortars employed by platoon respond to each mission and fire as a unit to support the battalion. Firing sections can be dispersed to improve survivability against enemy indirect fire.

(d) Mortars employed by section respond to calls for fire from the maneuver element(s) it supports. Mortars can also be employed by section when the zone or sector of the maneuver battalion is too wide for the platoon to cover from one location. Each section is positioned to provide fires within the supported unit's area of responsibility. Fires can be massed on targets within range of both sections.

(e) Mortars employed by squad are placed on the battlefield with each squad as a separate firing unit. This is done for special reasons such as one-mortar illumination or support of an antiarmor ambush.

(4) **Survey support.** Survey support is critical and essential. Map-spotting techniques can result in an error of up to 500 meters. This can cost time and surprise and can increase radio transmissions, the numbers of adjusting rounds, and the risk of counterbattery acquisition. Large errors can also increase the risk of fratricide. The platoon leader coordinates, through the FSO, for survey support. When external support is unavailable, the platoon conducts a hasty survey. The platoon leader ensures the unit has the knowledge, training, and equipment (on hand). (FMs 23-90 and 23-91 include hasty survey procedures. TC 6-50, Chapter 5, provides a detailed discussion of survey. Field artillery units can provide training support.)

(5) **Mortar effects.** Commanders must understand ammunition effects to correctly estimate the number of volleys needed for the specified target coverage. This number determines the amount of ammunition resupply that must be planned. The nature of targets, the effects desired, and the unit's ammunition haul and resupply capabilities may constrain the number of targets in the fire plan. The volume or mass of fire needed may require that mortars be moved and deployed by platoon rather than by section. The requirement for mass and the requirement to move by platoon to achieve that mass can prevent the supported unit from receiving continuous fire support from the mortars. On the other hand, continuous support

of fast-moving offensive operations may result in piecemeal mortar commitment. Also, mortars cannot successfully attack some types of targets regardless of the number of volleys fired. The commander must focus the mortar platoon mission on critical targets compatible with mortar capabilities. He must maneuver the mortar platoon into position to provide these fires at the time and the volume required.

(6) **Fire support matrix.** The battalion commander's next task after developing the concept for employment of mortars is to quickly and clearly explain the nature of the mortar mission to the mortar platoon leader. The commander can use a fire support matrix to do this. Table 7-2 shows an example of the minimum details the battalion commander must convey regardless of how he explains the mission.

(a) If priority of any indirect fire support asset is allocated to a company or team, this fact is indicated by the inclusion of the abbreviation for that asset in the appropriate box in the fire support matrix.

(b) If an FPF is allocated to a company or team, the type of indirect fire unit responsible for firing that FPF appears in the appropriate box in the fire support matrix followed by the acronym "FPF."

(c) If a priority target is allocated to a team, the type of indirect fire unit responsible for firing that target appears in the appropriate box in the fire support matrix followed by "PRI TGT." This is then followed by the corresponding target number.

(d) If a certain company FSO is responsible for initiating specific fires, the target number, group, or series is listed in the appropriate box in the fire support matrix for that FSO.

(e) If a particular FSO is to activate an ACA, the acronym "ACA" and the corresponding code word is shown along with the TOT for the planned CAS or attack helicopters in the appropriate fire support matrix box.

e. **Displacement.** Mortars should displace by platoon or section based on their assigned tactical mission and on the purpose of their fires. Displacing as a platoon reduces the command and control and Class III and IV resupply needed. Task and purpose dictate the displacement method.

f. **Pre-Positioned Resupply.** Offensive and defensive resupply should be considered for mortar

units. In deliberate attacks, pre-positioned resupply can be placed on initial firing positions. In a defense, pre-positioned resupply can be planned on both initial and subsequent positions. Combat trains should also include emergency mortar resupply. (FM 7-90 provides detailed information about mortar platoon operations.)

## 7-7. NAVAL GUNFIRE

Naval gunfire (NGF) can provide large volumes of responsive, immediate, accurate fire support to light forces operating on land near coastal waters or to amphibious operations within their range. The following addresses NGF support of land operations:

a. **Tactical Missions of Naval Gunfire Support.** Naval gunfire ships are assigned to direct or general support.

(1) **Direct support.** A single ship provides DS to a battalion. The ship delivers both planned and on-call fires. (On-call fires are to a ship what targets of opportunity are to artillery units.) The battalion fire control party conducts on-call fires. The firepower control team (FCT) or supporting arms liaison team (SALT) conduct on-call fires. The FCT or air spotter can adjust fires.

(2) **General support.** Ships provide GS to units of brigade size or larger. The fires of the general support ship are adjusted by an aerial observer or, for fire missions, assigned by the LO to a battalion SALT. If the second occurs, the ship reverts to GS when the mission has been completed.

b. **Supporting Arms Liaison Team Officer.** A battalion supported by NGF receives a supporting arms liaison team from the air and naval gunfire liaison company (ANGLICO). The SALT coordinates all NGF and supervises the activities of its firepower control teams in support of maneuver companies. The SALT officer advises the FSO on all matters pertaining to NGF employment. This includes NGF capabilities, limitations, and suitable targets. The SALT officer operates on the NGF ground spot net.

(1) The LO and the fire control teams operate in the ground spot net, communicating with the ship by HF radio to request and adjust NGF. The fire control team can use VHF radios to communicate with the LO; the LO can use UHF radios to communicate with aircraft.

| UNIT   | PHASE/TRIGGER LINES |   |                    |   |  |
|--|---------------------|---|--------------------|---|--|
|  | PL MACE             | PL BOW  | PL ARROW           | PL BLUE                                 |  |
| TF   |                     |   |                    |   |  |
| TM/CO A  |                     |   | BB 3401            | BB 3111<br>BB 0012<br>←MORTAR PRIORITY→ |  |
| TM/CO B  | BB 0001<br>BB 3003  | BB 3001<br>←MORTAR PRIORITY→<br>←FA PRIORITY→ |                    |   |  |
| TM/CO C  |                     |   | BB 3010            |   |  |
| TM/CO D  |                     | BB 0007<br>BB 3002                            | BB 0013<br>BB 0009 | BB 0015<br>GP B1B<br>←FA PRIORITY→      |  |
| SCOUTS   | BB 0029<br>BB 3004  | BB 0017                                       |                    |   |  |
| MORTARS  | PSN A1, A2          | BB 3001<br>PSN B1                             | PSN B2, C1         | BB 3111<br>PSN C2                       |  |
| FA ORGANIZATION FOR COMBAT   |                     | MORTAR POSITIONS                              |                    | AMMUNITION AVAILABLE                    |  |
| 4-5 FA (155SP) DS TO 2 BDE   |                     | PSN A1 123455                                 |                    | 12 BN 3 RDS DPICM                       |  |
|  |                     | A2 124456                                     |                    | 20 PLT 6 RDS HE                         |  |
| FS COORD MEASURES  |                     | PSN B1 1274556                                |                    | 30 MIN ARTY SMOKE                       |  |
| CFL: PL BOW  |                     | B2 128452                                     |                    | 20 MIN MORTAR SMOKE                     |  |
| O/O CFL: PL ARROW  |                     | PSN C1 131500                                 |                    | 30 MIN ARTY ILLUM                       |  |
| O/O CFL:   |                     | C2 130495                                     |                    | 30 MIN MORTAR ILLUM                     |  |
| O/O CFL:   |                     |   |                    | TACAIR                                  |  |
| FASCAM   |                     |   |                    | 4 TF SORTIES                            |  |
| TF ALLOCATION: 2 BDE 2   |                     | BDE CDR ATT GUIDANCE                          |                    | 4 ACAs (#) 20-23                        |  |
| PLANNED:   |                     | DEST ADA                                      |                    | (SEE ACA OVERLAY)                       |  |
| 195450 200444  |                     | NEUT RECON ELEMENTS                           |                    | HIGH PAYOFF TARGETS                     |  |
| 199455 221456  |                     | SUPPRESS AR, MECH PLTS                        |                    | ZSU 32-4, SA 9                          |  |
|  |                     |   |                    | MRB's CRP (3 BMPs, 1 BRDM)              |  |
|  |                     |   |                    | ENGINEERS                               |  |
| COC IS: - A -, - B -, - C -, - D - FSO WITH - A - FSE BEING O/O BN FSE                     |                     |   |                    |   |  |
| S  | DAY - 1 -           | FA DS BN CDR: H70__                           | A FSO: A99__       | FA FDC: __H55__                         |  |
| O  | CF 2: 45.20         | BDE FSCoord: E24__                            | B FSO: B99__       | MORTAR FDC: __U55__                     |  |
| I  | FD 1: 55.70         | BDE FSO: J99__                                | C FSO: C99__       |   |  |
|  | MORTAR: 32.60       | BN FSO: C99__                                 | D FSO: D99__       | OIC - O - NCOIC - N - RATELO - R -      |  |
| COORDINATING INSTRUCTIONS:   |                     |   |                    |   |  |
| 1. TARGET ALLOCATION: A 3, B 3, C 2, D 4.  |                     |   |                    |   |  |
| 2. CUTOFF FOR TARGET SUBMISSION 052200 OCT.  |                     |   |                    |   |  |
| 3. SURVEY TARGETS FOR D, A, B, MORTAR FIRING POSITIONS. FSOs TAKE SURVEY TO NEXT LOCATION. |                     |   |                    |   |  |

Table 7-2. Example fire support matrix.



(2) Coordination and control measures that apply to NGF are the same as for FA except for the addition of the following two terms:

(a) *Fire support area*. This is a sea area within which a ship can position or cruise while firing in support. It is labeled “FSA” and numbered with a Roman numeral—for example, “FSA II.”

(b) *Fire support station*. This is a specified position at sea from which a ship must fire. An FSS is restrictive positioning guidance. It is also

labeled with a Roman numeral—for example, “FSS VI.”

c. *Adjustment of Naval Gunfire by the FIST*. The FIST might have to adjust NGF due to a shortage of SALTs. The FIST cannot communicate directly with the fire support ship. However, it can relay calls for fire through the NGLO at the FSE or through an FCT located with a company FIST.

## Section II TACTICAL AIR SUPPORT

The air component commander provides tactical air (TACAIR) support to ground forces IAW the directives of the joint force commander.

### 7-8. PLANNING

The battalion commander, aided by the S3, is responsible for planning fire and movement, just as he is in other fire support planning. This includes use of TACAIR. The following personnel also are involved in planning the use of TACAIR, particularly CAS:

a. **Battalion S3 Air**. The battalion S3 air receives, ranks, approves, and coordinates requests for planned CAS. He integrates CAS into the ground commander’s scheme of maneuver. The S3 air also keeps Air Force TACPs advised of the current ground tactical situation, of the location of friendly units, and of any fire support coordination and control measures established.

b. **Battalion Fire Support Officer**. The battalion FSO is the full-time fire support coordinator for the battalion. He advises the battalion commander on all fire support matters, including the use of CAS. He is also a focal point for CAS planning and coordination between the battalion commander, the S3 air, and other interested parties. The FSO integrates CAS into the fire support plan. He plans and executes local SEAD campaigns as required.

c. **Tactical Air Control Parties**. The Air Force provides one TACP to each maneuver battalion. Each TACP includes an ALO, who performs FAC duties, and two TACAIR command and control specialists. One of the specialists is trained in terminal air control

techniques and can perform FAC duties. The ALO supervises the activities of TACP personnel; he advises the commander, FSO, and S3 air on capabilities and limitations of TACAIR and other technical or tactical aspects of TACAIR missions as required. The ALO uses Air Force TACAIR requests to maintain radio contact with all other TACPs in the division and with the SOC. When possible, he provides final control of CAS missions in the battalion area. The TACP transmits to the ASOC all requests for immediate CAS. He advises the S3 air and FSO of other units’ immediate air requests. As changes in the TACAIR situation are transmitted over the TACAIR request net, the ALO relays them to the S3 air and FSO.

### 7-9. EMPLOYMENT

Successful air/ground integration of fires begins with a well-coordinated plan. Requests for air support must contain the information Army commanders need to rank the request and Air Force planners need to decide on the type of aircraft and ordnance. Also, aircraft armament must be appropriate to achieve the desired results. This is most important when airborne strike flights are diverted and the best ordnance for the job is unavailable. If on-board ordnance is inappropriate for the target, the ordnance should not be wasted. For example, antipersonnel ordnance should not be used against tanks, and

Maverick missiles should not be used against dismounted infantry (Table 7-3). Use of friendly unit identification methods and markings are key to successful CAS, ALOs must prevent friendly fire engagements.

**7-10. SUPPRESSION OF ENEMY AIR DEFENSE**

Concentrated, lethal enemy air defense systems threaten tactical aircraft conducting CAS strikes. SEAD and electronic warfare missions can enhance mission success and the survivability of tactical aircraft. Artillery and small-arms fire can also be used to suppress enemy ADA assets. While they are being supported by tactical aircraft, ground units should suppress enemy air defenses.

a. **Priority Targets.** Air defense weapons in the immediate target area, such as ZSU 23-4, SA-6, SA-9/13, SA-7, SA-8, and SA-14, are priority SEAD targets. The ground commander

has primary responsibility for SEAD from the FLOT to his limits of observed fire and secondary responsibility out to the limits of indirect fire (USAF has primary responsibility for this). During the air strike, “check fire” should not be imposed, but the fires should be shifted so as not to conflict with aircraft activity. After the FAC, ALO, or both verify the aircraft’s intended attack path, fires can be shifted to suspected and actual ADA sites.

b. **Weapons Control Status.** The status of weapons control for fixed-wing aircraft during the air strike should be changed to at least “weapons tight.” This reduces the chance of loss due to friendly ADA fire. Direct fire of organic weapons, such as small-arms, tanks, and machine guns, on the enemy positions seldom degrade the tactical aircraft attack on the target. Direct fire can help suppress enemy small-arms fire directed at the aircraft.

| MUNITION              | PROTECTED<br>(METERS) | UNPROTECTED<br>(METERS) |
|-----------------------|-----------------------|-------------------------|
| 20-mm                 | 25                    | 200                     |
| 250-lb GP             | 200                   | 900                     |
| 500-lb GP             |                       |                         |
| (MK 82)               | 200                   | 1,050                   |
| (MK 82HD)             | 100                   | 800                     |
| 750-lb GP             | 200                   | 1,000                   |
| 1,000-lb GP           | 200                   | 750                     |
| 2,000-lb GP           | 250                   | 1,000                   |
| 3,000-lb GP           | 250                   | 1,400                   |
| NAPALM                | 100                   | 100                     |
| ROCKETS (HE)          | 100                   | 300                     |
| ROCKETS (AP)          | 100                   | 300                     |
| ROCKETS (FLECHETTE)   | 150                   | 400                     |
| ROCKETS (WP)          | 50                    | 100                     |
| CBU—SEEK ALO’S ADVICE |                       |                         |

ASSUME:  
 —DELIVERY IS PARALLEL TO FRIENDLY LINES. FOR AN ATTACK OVER SOLDIERS, ADD 150 METERS TO THE FIGURES IN THIS TABLE. HOWEVER, ATTACKS OVER SOLDIERS ARE NOT RECOMMENDED.  
 —NO MALFUNCTIONS OR RICOCHETS OCCUR.  
 —FRIENDLY POSITIONS ARE CLEARLY VISIBLE TO PILOTS.  
 —PROTECTED PERSONNEL ARE THOSE IN BUNKERS OR ARMORED VEHICLES.  
 —UNPROTECTED PERSONNEL ARE THOSE STANDING IN THE OPEN.

**Table 7-3. Minimum safe separation distance for for air-delivered munitions.**

**7-11. JOINT AIR ATTACK TEAM**

Attack helicopters and TACAIR, when they work together, are called a joint air attack team (JAAT). JAATs have no formal organization. Artillery is normally integrated into a JAAT operation, but a JAAT can be executed without artillery. They form into a team as attack helicopters and tactical aircraft enter a fight against the same target array on the same part of the battlefield. The overall JAAT commander is the Army aviation commander. (FM 6-20 provides more information.)

a. The JAAT is best employed against counterattacks during offensive operations. During defensive operations, the JAAT is most often used to reinforce committed ground maneuver units or to wear down or eliminate armor thrusts into or through friendly lines. The maneuver commander has responsibility for planning, coordinating, and employing the JAAT. The maneuver commander, FSO, aviation unit commander, and the ALO/FAC must coordinate JAAT with the scheme of maneuver and must work to integrate TACAIR and artillery.

b. The JAAT is either immediate or preplanned, as the situation dictates. The battalion commander or S3 air requests and

coordinates the JAAT through the battalion FSO, the air liaison officer, and the Army aviation LO. If necessary, JSEAD supports the JAAT. Informal ACAs are established to aid in simultaneous target engagement.

c. The battalion commander can initiate a request for and specify a JAAT mission through normal air support request channels on the advice of his FSO and ALO/FAC. If the attack helicopters are in an OPCON status, battalion requests can be approved and executed at brigade level.

d. All JAATs are normally coordinated and executed at the brigade level due to the coordination required. When JAATs are employed in a battalion sector, the battalion commander designates supporting fires, enemy and friendly locations, and other specifics. He then uses any means possible to get these directions to the aviation unit commander, who executes the JAAT.

e. Artillery fire support for the JAAT is planned by the FSO of the ground maneuver unit that is controlling the overall operation. Fire support plans are kept simple so the aviation commander and FAC can be briefed rapidly. Since the FSO normally briefs them over the radio, they can sometimes have problems interpreting incomplete data.

### Section III AVIATION SUPPORT

The infantry battalion needs extensive aviation support on some missions. The battalion is trained and organized to move quickly to the objective area by air and to be resupplied by airdrop for short periods. Often the decision to execute a mission depends on the amount and type of aviation insertion and extraction support available.

**7-12. ARMY AVIATION**

Battalion commanders can request Army aviation support from division and brigade. Helicopters can be used for command and control, reconnaissance, MEDEVAC, movement of soldiers and supplies, and reinforcement by fire.

a. **Assault Helicopter Mission.** One assault helicopter company can lift all the assaulting elements of one rifle company at once. In support, aviation brigade assets can be used for command, control, communication, reconnaissance, and air

assault security. These assets are provided based on mission requirements and guidance from the division commander. (FM 1-113 and FM 90-4 provide more information on air assault operations.)

(1) The assault helicopter company conducts air movement operations, aerial delivery of mines, and limited evacuation of downed aircraft. Assault helicopter companies perform unit maintenance on organic aircraft.

(2) Tactical employment of assault helicopters is best when part of the combined

arms team. Assault helicopters concentrate aerial forces at critical times and places. They extend the battalion's ability to strike the enemy from all directions. With their ability to maneuver, identify, report, and quickly use opportunities, assault helicopters help synchronize the battle.

b. **Attack Helicopter Mission.** The attack helicopter is used to destroy massed enemy forces with aerial firepower, mobility, and shock effect. Units with attack helicopter augmentation can gain, maintain, and exploit the initiative to defeat the enemy. They operate in offensive, defensive, or special purpose operations. The attack helicopter can be committed early in battle. It can reinforce ground combat units and can attack, delay, or defend by engaging the enemy with direct and indirect fires. Attack helicopter battalions cannot seize or retain terrain without cross-attached ground maneuver forces. However, to deny terrain to the enemy for a time, they can dominate the terrain by fire. Also, attack helicopters are limited by a combination of fuel capacity and flight time, weather and visibility restrictions, and the air defense environment. They are most effective when employed as a battalion. Attack helicopters can also be assigned to do the following:

- (1) Conduct rear operations.
- (2) Coordinate and adjust indirect fires.
- (3) Suppress or destroy enemy air defense assets.
- (4) Reinforce ground maneuver forces by fire.
- (5) Conduct JAAT operations with CAS and FA assets.
- (6) Destroy enemy communication and logistical assets.
- (7) Disrupt and destroy enemy second echelon and follow-on forces.
- (8) Protect air assault forces during all phases of air assault operations.
- (9) Destroy enemy helicopters that pose an immediate threat to mission accomplishment.

### 7-13. EMPLOYMENT

The commander must consider the following factors before employing attack helicopters and air cavalry/reconnaissance troops:

a. **Offense.** Attack helicopters conduct combat operations against an enemy force alone or along with friendly ground forces. In the offense, attack helicopters are most effective against a moving or counterattacking enemy force. They are least effective against a dug-in enemy force. With proper planning, attack helicopter battalions can provide antiarmor firepower against an enemy armored force. Rather than being used as a reaction force, attack helicopter battalions should be integrated into the maneuver battalion's scheme of maneuver. This is normally done at division or brigade level and must include coordination for terrain to support attack helicopter operations. Attack helicopter graphics and control measures vital to maneuver units include attack routes, holding areas, battle positions, and engagement areas (Figure 7-2, page 7-14).

b. **Defense.** Attack helicopters, due to their mobility, are shifted on the battlefield as needed. They are used to stop enemy penetration into the main battle area, to attack enemy in the covering force area, or to reinforce or thicken the defense on parts of the battlefield. They can also perform effectively in an economy-of-force defensive role. Planners must coordinate battle positions for attack helicopters.

c. **Air Cavalry/Reconnaissance Troops.** These units can be employed to provide screening operations, to locate routes, to perform a route reconnaissance, or to gain and maintain contact with the enemy force. Reconnaissance troops and air cavalry troops have limited attack helicopter assets. However, they can still perform missions such as counterreconnaissance; command, control, and intelligence enhancement; air assault security; and assistance in passage of lines.

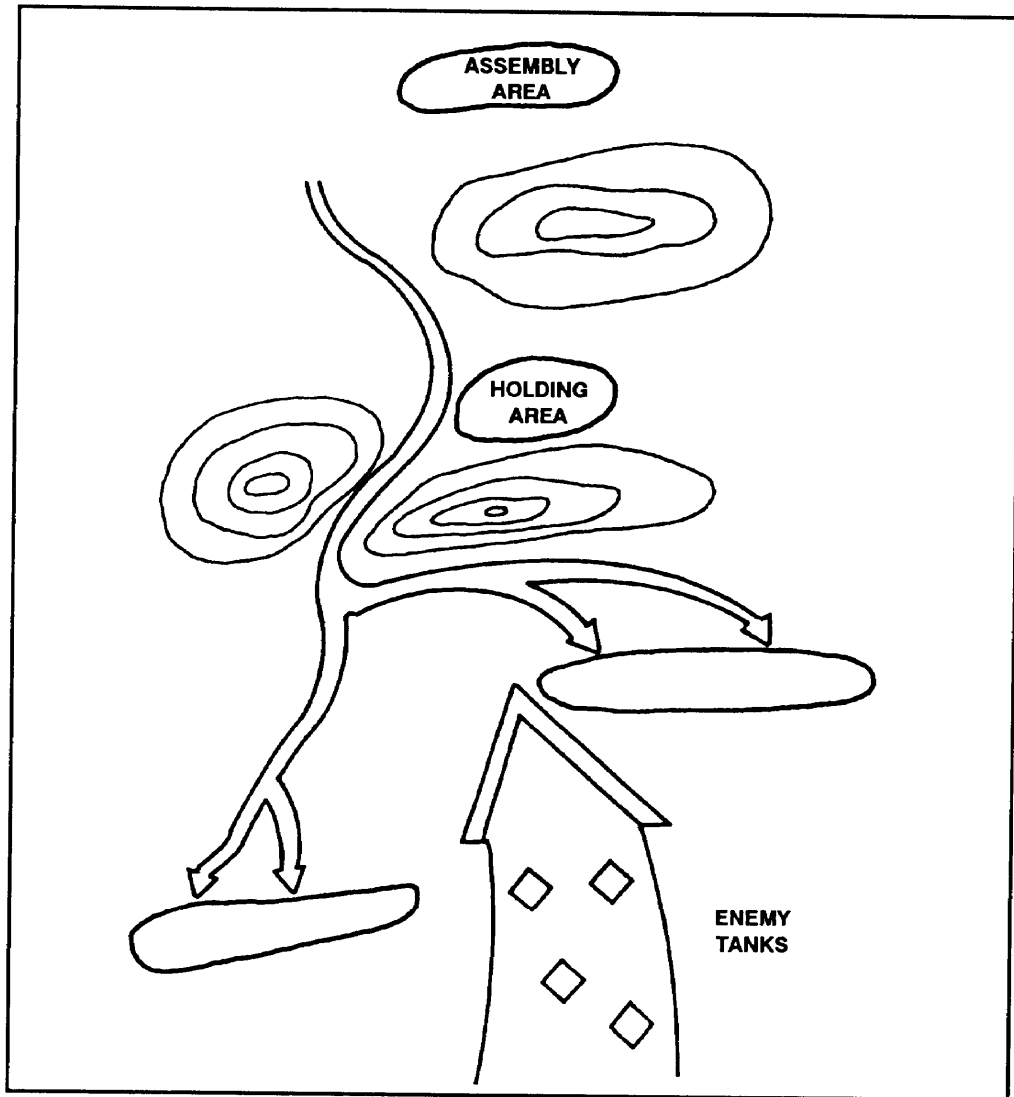

Figure 7-2. Aerial graphic control measures.

#### Section IV AIR DEFENSE SUPPORT

The objective of air defense is to limit the effectiveness of enemy offensive air efforts to a level that permits freedom of action to all friendly forces.

##### 7-14. SUPPORT RELATIONSHIPS AND MISSIONS

The battery commander is the brigade ADA officer. Therefore, he must respond to the supported commander's scheme of maneuver. ADA planning must be top-down. The battery

commander integrates his battery into the brigade scheme of maneuver while positioning his forces to defeat the air threat. Based on the battery commander's guidance, the brigade commander can retain all allocated ADA or can suballocate (in DS or attached) some of the ADA

to infantry battalion(s). The amount and type of ADA support a brigade receives depends on METT-T. The battery commander and S2 use the DST to produce a coordinated sensor plan, ADA scheme of maneuver, command and control, early warning, and all arms for air defense (AAAD), in response to each probable enemy course of action.

a. The senior air defense officer functions during the planning process as a special staff officer. He provides his estimate and recommendations to the battalion commander. The fact that, in many cases, ADA elements with a GS mission can provide incidental coverage over the battalion area should be considered in the planning process.

b. The battalion commander must assign tactical missions to the ADA element and establish priorities for air defense, to properly employ air defense assets—for example, specific companies or choke points. He also can give guidelines for selecting firing positions. The ADA unit leader then positions his weapons to support the battalion. The battalion provides CSS to the attached ADA elements and coordinates with the ADA headquarters for CSS equipment and personnel needed for the ADA attached element.

#### 7-15. AIR DEFENSE WEAPONS SYSTEMS

Battalions are most often supported by air defense weapons systems.

a. **Stinger.** The Stinger man-portable air defense system (MANPADS) counters high-performance, low-altitude ground attack aircraft, helicopters, and observation and transport aircraft. A Stinger section includes a headquarters element. This element has a section chief, a driver, and three to five Stinger crews. Each two-man Stinger crew has an M998 with six Stinger weapons in its basic load. The Stinger's planning range is 5,000 meters.

b. **Vulcan.** The Vulcan system is employed in forward area air defense to counter low-altitude aircraft. Because its aerial range is only 1,200 meters, the Vulcan is normally employed with Stingers. Each self-propelled Vulcan carries a four-man crew and two Stingers. The SP Vulcan's maximum rate of fire is 3,000 rounds per minute, but it only carries 1,100 rounds in the weapons and 1,000 rounds ready to

load. The ground range is from 2,200 meters (direct fire) to 4,500 meters (indirect fire). However, use of a Vulcan in a ground support role must be weighed against the degradation of its primary mission.

#### 7-16. EMPLOYMENT

Planners must consider the following before air defense weapons are tactically employed to support the battalion:

a. Air avenues of approach are determined jointly by the ADA officer, S2, and ALO (Chapter 2). Their decisions are disseminated to subordinates. Pilots of rotary and fixed-wing aircraft choose terrain to avoid ADA fires and radar detection; they avoid overflying friendly positions; and they use major terrain features to help them navigate.

b. Enemy attack helicopters with stand-off ATGM capabilities are usually employed in groups of three or four. Synchronized with ground elements, they can be expected to use concealed routes to try flanking attacks on concealed firing positions. They vary attack routes on their strafing and rocket runs. The mobility of the attack helicopter increases the need for all-round security, passive air defense measures, and forward positioning of air defense weapons.

c. Enemy CAS capabilities include smart munitions and other advanced ordnance loads. The enemy most often uses CAS against positions in depth such as battalions in reserve. In these cases, passive defense measures are vital.

d. The battalion's employment of ADA support is based on the commander's air defense priorities. These priorities are developed with the help of the ADA officer. They change during the course of an operation. Priorities for air defense protection are based on the enemy threat, the importance of the asset to the mission, the vulnerability of the asset to enemy destruction by air attack, and the ability of the asset to recover and continue to function after the attack (recuperability). In determining priorities for attached assets, the commanders considers the coverage provided by other air defense systems.

(1) In offensive operations, the battalion air defense priority goes to companies. Each company should be supported by one or more MANPADS teams. A company with one or

more critical missions or more vulnerable to air attack than others can be supported by ADA.

(2) In defensive operations, the priority shifts to battalion fire support, command and control, and logistical assets. Companies relying on passive air defense measures and moving on covered and concealed routes are ineligible for dedicated ADA support. Typical priorities might be mortar platoon first, battalion TOC second, trains third, then maneuver companies fourth.

e. The ADA platoon/section leader and the S3 determine ADA asset allocation, positioning, and missions after the battalion commander establishes priorities. The four principles of ADA weapons employment are mass (concentration of systems), mix (overlap of systems), mobility (equal to the supported unit), and integration (tying in of all systems). These principles are implemented by the following employment guidelines:

(1) Balanced fires should provide nearly equal firepower in all directions.

(2) Firepower should be weighted (concentrated) toward a known or most likely avenue of approach.

(3) Aircraft should be engaged before they can release their ordnance.

(4) Firing units should have mutual support and overlapping fires.

(5) Defense in depth should subject an attacking aircraft to an ever-increasing volume of fire as he nears his target.

f. The ADA elements supporting the battalion can be kept under the centralized control of the platoon leader or attached to companies. Centralized control is favored—it allows for better coordination of ADA support. Though the Vulcan platoon is employed under platoon control, Stingers can be employed by team.

(1) The normal mission given to ADA elements employed under centralized control is providing general support with priorities to unit or tasks. The ADA leader and the S3 coordinate

positioning with appropriate maneuver units. Centralized control is favored—

(a) When ADA elements can protect critical areas (choke points and routes).

(b) When sector or objective is shallow, allowing area coverage.

(c) When battle position or a projected slow rate of advance allows area coverage.

(d) When all ADA assets are defending a single asset or activity.

(2) Direct communications and coordination are maintained with the commander of a company for positioning of the weapons when ADA is placed in DS to that company. Fire control information is passed through ADA communication nets.

(3) Stingers can be attached in mobile operations to locate this coverage well forward and to allow Stinger gunners to move with the security of a rifle company. When an enemy artillery threat exists, decentralized Stinger employment should be considered. The weight of the Stinger and its missiles should also be considered. When moving cross-country, Stinger gunners need help from the company, especially in rugged terrain.

(4) The method of employment can change as the battalion shifts phases. For example, Stingers can be attached to companies in a hasty defense at first, but they can be returned to centralized control as the defense is improved.

g. Infiltrating infantry discovered in open terrain is vulnerable to attack helicopters. When the threat of enemy air attack is high, dismounted Stinger gunners should accompany infantry elements. In this case, the load of the soldiers carrying Stinger missiles should be considered.

h. More ADA Class V immediate resupply should be carried in the battalion combat trains in addition to that carried on the platoon leader's vehicle. This additional Class V can be moved on battalion trucks or on trucks provided by the ADA parent unit.

## Section V ENGINEER SUPPORT

This section discusses the main role of engineer units in supporting offensive and defensive operations as well as their secondary role—fighting as infantry.

**7-17. PLANNING**

The battalion commander and the battalion engineer plan for the best use of engineer resources as the commander develops his plan for the employment of maneuver forces. To accomplish this, the battalion engineer work closely with the battalion staff throughout the planning process. The engineer works with the S2 during the IPB process and development of the situational template. He contributes to the R&S plan to help confirm or deny the enemy situation. He also works with the S3, S4, and FSO to develop the engineer plan, to provide resources to support the plan, and to coordinate fires with obstacles as required. Areas that the battalion commander must address with the battalion engineer are as follows:

a. **Purpose of Obstacles.** The engineer must know what obstacles need to do to the enemy, that is, whether the obstacle will be used to turn, block, fix, or disrupt the enemy.

b. **Priority of Effort.** The commander should consider different priorities of mobility, countermobility, and survivability during offensive, defensive, and other tactical operations. Also, priorities for engineer equipment might be different than priorities for personnel effort.

c. **Priority of Work.** The commander identifies his priorities for specific units, battle positions, engagement areas, or weapons systems. He considers where he wants to engage and destroy the enemy. He considers the distribution of work between initial and subsequent positions.

d. **Scatterable Mines.** The battalion commander and the battalion engineer develop emplacement guidance and coordinate delegation of authority, which originates at

corps. The battalion commander may receive emplacement authority for scatterable mine systems that can self-destruct within 24 hours (Table 7-4). These systems include ADAM, RAAMS, MOPMS, Volcano, and Gator. Use of these systems must economically support the commander's intent (turn, fix, disrupt, and block) and must fit in the overall obstacle plan. Artillery-delivered scatterable mine systems, which include only ADAM and RAAMS, require the following special planning considerations:

(1) Artillery emplacement of minefield requires more time than does the delivery of other munitions.

(2) Artillery elements can fire no other type of round while firing ADAM or RAAMS.

(3) Artillery may be detected (if firing high-angle), resulting in time lost while displacing.

(4) The large safety zone typically required around artillery-delivered scatterable minefield may limit maneuver.

e. **Restrictions on Obstacle Use.** The commander should explain restrictions. For example, he might direct that obstacles not be used along friendly counterattack routes; or he might restrict the use of FASCAM.

f. **Guidance to Commanders.** The commander gives guidance to company commanders concerning obstacle sites, lane closures, control of blade assets, marking of breaches/lanes, turnover of targets, securing of obstacles, and infantry support to the engineer effort.

g. **Guidance to the S3/S4.** The commander gives guidance to the S3/S4 concerning the positioning and allocating of barrier material. Whoever defends the obstacle first also positions it. Whoever builds the obstacle also coordinates the positioning of barrier materials.

| MINE          | ARMING TIME<br>(MINUTES) | SELF-DESTRUCT TIMES |          |        |         |
|---------------|--------------------------|---------------------|----------|--------|---------|
|               |                          | 4 HOURS             | 48 HOURS | 5 DAYS | 15 DAYS |
| ADAM/RAAMS    | 2                        | X                   | X        |        |         |
| GEMSS         | 45                       |                     |          | X      |         |
| MOPMS         | 1 1/2                    | X                   |          |        |         |
| GATOR/VOLCANO | 2                        | X                   | X        |        | X       |

Table 7-4. Scatterable mines.



## 7-18. CAPABILITIES

Engineers give the maneuver commander the extra technical skills and equipment needed to enhance mobility, countermobility, and survivability.

a. **Tactical Engineering Missions.** The three types of tactical engineering missions differ as follows:

(1) **Mobility support.** The mission of mobility support requires the engineers to maintain the forward momentum of maneuver forces and critical supplies. The engineers breach obstacles, help in the crossing of gaps, and improve routes for maneuver and supply.

(2) **Countermobility support.** The mission of countermobility support is divided into mine warfare and obstacle development. The engineers use both to disrupt, fix, turn, or block the enemy. Both mines and obstacles increase the enemy's target acquisition time. Therefore, they also increase the effectiveness of friendly direct-fire and indirect-fire weapons systems.

(3) **Survivability support.** The mission of survivability support requires the engineers to construct vehicle and dismounted fighting positions. The dismounted positions should have overhead protection to reduce the effectiveness of enemy weapons.

b. **Engineer Assets.** The brigade commander may allocate an engineer platoon or company to the battalion. He gives the battalion other engineer assets, such as FASCAM, as needed. The engineer platoon/company is used mainly to hand-emplace and breach obstacles and to help with the battalion reconnaissance effort.

c. **Key Equipment.** The engineer platoon has organic mine detectors, demolition kits, carpenter kits, and pioneer tool kits. Other engineer equipment can be requested from the supporting engineer battalion.

## 7-19. OFFENSIVE OPERATIONS

The primary mission of engineers during offensive operations is to enhance the battalion's mobility. This paragraph discusses engineer employment in offensive operations.

a. **Mission in the Offense.** Engineers working in the offense help the battalion maneuver over existing terrain and obstacles. That is, they help the battalion—

- (1) Cross gaps (including rivers).

- (2) Breach or construct bypasses around minefield, fortified positions, and other obstacles.

- (3) Emplace minefield on exposed flanks.

- (4) Prepare positions for overwatch.

- (5) Construct and maintain combat roads and trails.

- (6) Clear landing zones/repair airfields.

- (7) Conduct route reconnaissance.

b. **Support by Type of Offensive Operation.**

Engineers support each type of offensive operation as follows:

(1) **Movement to contact.** Engineer support consists of engineers task-organized to the lead element to support in-stride breaches, engineers under battalion control to react to the situation, and engineers with the flank and rear security. To obtain an early estimate of their tasks and the materials required, engineer personnel can move with the scouts. The infantry battalion must supplement its basic load with extra demolitions, line charges, and bangalore torpedoes. Also, equipment such as dozers and ACEs help in breaching and reducing obstacles. Engineer elements with flank and rear security elements must block enemy avenues of approach into the battalion's flanks and rear. The engineers must develop obstacles that are simple and quick to employ such as craters, minefield, and demolished bridges.

(2) **Hasty and deliberate attacks.** The role of the engineers in an attack resembles their role in a movement to contact. However, reconnaissance, planning, and preparation time is increased.

(3) **Exploitation and pursuit.** Engineers in exploitation and pursuit operations should be well forward in the columns, where they can help the force move. Breaching equipment must be well forward for breaching destroyed bridges, road craters, abatises, and interdiction mines.

c. **Reconnaissance.** Engineers must reconnoiter both before and during the attack. Before the attack, the engineers study the terrain, bridges, routes of advance, and reinforcing obstacles such as minefield, tank traps, and emplacements. The engineers' actions during the attack and their requirements for breaching personnel and supplies are based on this study. Information comes from map, aerial, and ground reconnaissance.

#### d. Breach of Obstacles and Minefields.

The battalion integrates breaching operations into all breaching plans and task-organizes the engineers to provide responsive support since obstacles may be encountered anywhere. Depending on the situation and on the amount of intelligence gathered, the battalion and subordinate units plan for an in-stride, deliberate, assault, or covert breaching operation. When encountering an obstacle, the lead element should do the following (in this order):

(1) Report.

(2) Try to bypass (after ensuring the purpose of the obstacle is not to canalize the force in that direction).

(3) Execute the breach plan.

(a) Conduct an in-stride breach using available assets against either weak defenders or simple, unexpected obstacles to maintain momentum. The breach is planned, prepared, and executed at company level to maintain momentum. The company commander designates support, breach, and assault teams, and synchronizes SOSR by planning thoroughly and by rehearsing immediate action drills.

(b) Conduct a deliberate breach to attack a stronger defense or more complex obstacle system. The battalion conducts a deliberate breach when the company team is insufficient to overcome an obstacle. The deliberate breach is characterized by thorough reconnaissance, detailed planning, extensive preparation, and explicit rehearsal as a combined arms team. One or more companies are tasked as support, breach, and assault teams. Engineers are task-organized to both the breach and assault teams. Engineers in the breach team reduce the obstacle. Some of the soldiers in the breach team help them while the others provide local support and security. Engineers in the assault team help breach the obstacle and destroy bunkers.

(c) Conduct an assault breach to break through enemy protective obstacles onto the enemy position.

(d) Conduct a covert breach to reduce the obstacle if surprise is the main consideration. The covert breach is used during limited visibility or when the obstacle is undefended to achieve surprise and minimize casualties. Support and assault forces execute their missions only on order or if the breach is detected. Engineers

provide support by probing lanes through minefield and cutting wire. (FM 90-13-1 provides more information about covert breaches.)

e. **Assault of Strongpoints.** Engineers use the same technique for assaulting a strongpoint that they use to breach any other obstacle. (Chapter 3 discusses tactical considerations for assaulting strongpoints.)

(1) The engineers work with infantry to form assault elements. Before the assault, reconnaissance parties seek to determine the best locations for the assault and to prepare the breaching packages. During rehearsals, they ensure infantry forces know how to use these munitions.

(2) The engineers' primary mission during the assault is to breach the enemy's defensive tactical and close-in protective obstacles. Specially organized and equipped infantry squads neutralize weapons emplacements, bunkers, and pillboxes with the help of two-member sapper teams; then clear close-in and minor obstacles.

(3) The engineers' main task after the obstacle has been breached is to create and maintain routes to and through the gaps. Handover of lanes is important; the battalion must leave guides at all the lanes it has breached until the guides are relieved by the next unit. Guides should come from the company that makes the breach—they must orient the soldiers who relieve them.

f. **Maintainance of Combat Roads and Trails.** Engineers developing and maintaining routes concentrate on repairing bomb damage and removing obstructions that hamper the movement of advancing units.

g. **Obstacles.** Engineers construct or enhance obstacles in the offense to block or inhibit enemy movement or to concentrate combat power by allowing an area to be held by fewer men. Emplaced obstacles must not hinder friendly maneuver. Therefore, control of their employment is usually retained above battalion level. Control measures for obstacle use include terrain limitations and time restrictions.

h. **Survivability.** Engineers use protective measures, such as camouflage and deception, to enhance survival during the offense. To counter enemy intelligence systems, engineers can install

and remove decoys, fabricate disguises, and construct or improve covered routes and positions. They can also use smoke to obscure these activities.

### 7-20. DEFENSIVE OPERATIONS

The engineers' role in the defense is to use the terrain to increase the battalion's combat effectiveness. Proper use of the engineers enhances the battalion's mobility and survivability and impairs the enemy's mobility. The battalion shapes the battlefield for two reasons. First, it can better target the enemy; second, it can better employ its forces to fight and defeat a numerically larger force. The commander must decide which engineer efforts are most important to support the scheme of maneuver: preparation of obstacles and fighting positions or repair of combat trails. Engineers must begin work as soon as the defensive mission is received. The engineers' function in the defense falls into three support categories.

a. **Mobility Tasks.** Engineers must identify covered and concealed routes to simplify lateral and forward movement. They advise the battalion commander on which routes should be used. Rather than construct new routes, they try to improve or maintain existing ones. They can cut selectively in forests to leave a concealing umbrella over the routes. Time and the effort required are prime considerations in determining the degree to which these tasks can be accomplished.

b. **Countermobility Tasks.** The senior engineer prepares an obstacle plan to support the battalion's scheme of fires and maneuver. He plans tactical obstacles based on the battalion commander's intent and on the brigade obstacle plan (Appendix A). The brigade plan may limit the employment of tactical obstacles to within obstacle belts. Each obstacle in these belts must perform one of the four obstacle functions—disrupt, turn, fix, or block. Which function each must perform depends on the commander's intent for the belt. Normally, only protective obstacles can be employed outside of designated belts. Sometimes, however, brigade may allow the battalion commander to employ tactical obstacles throughout his sector as needed. The battalion engineer supervises the engineers who are emplacing tactical obstacles.

He coordinates the integration of these obstacles into the battalion indirect-fire plan and into battalion and company direct-fire plans. He advises units on how to employ, record, and remove protective obstacles. The battalion engineer works closely with the S4, who requisitions Classes IV and V (barrier materials) for obstacles. They also requisition transportation assets needed to bring the barrier materials near the emplacement areas. They do this because light units lack the organic equipment needed to reposition the barrier material. The battalion engineer and the S4 must also consider how the light unit will unhand supplies and dispose of packing materials.

(1) **Tactical obstacles.** These are normally emplaced by engineers. They are used to turn, fix, block, and disrupt enemy formations.

(a) **Turn.** Turning obstacles move and manipulate the enemy to the force's advantage by enticing or forcing him to move in a desired direction, by splitting his formation, by canalizing him, or by exposing his flank.

(b) **Fix.** Fixing obstacles slow and hold the enemy in a specific area so that he can be killed with fires. They also allow the time for the force to break contact and disengage. Fixing obstacles can be thought of as "making the ground sticky" to slow the enemy.

(c) **Block.** Blocking obstacles are complex, employed in depth, and integrated with fires. They prevent the enemy from proceeding along a certain avenue of approach (or allow him to proceed only at unacceptable cost). Blocking is never achieved solely by the use of obstacles. Blocking obstacles just limit the enemy's movement. Instead of constructing new obstacles, engineers often improve the existing obstacle characteristics of the terrain. This saves valuable construction and demolition materials as well as equipment and personnel hours. Widening a gully or drainage ditch or steepening the side of a hill, levee, or road embankment is easier than digging anew antitank ditch. Also, a tactical obstacle is not planned and sited simply because the terrain allows or because it would work well with the terrain. The obstacle must support the tactical plan by physically manipulating the enemy in a way that is critical to the commander's concept. Tactical obstacles

are a means to shape the battlefield and bend the enemy to the battalion's advantage.

(d) *Disrupt*. Disrupting obstacles are used against enemy attack formations to break up operation timing, to exhaust enemy breaching assets, and to separate forward enemy combat elements from wheeled supply vehicles. Obstacles also disrupt assault formations; disrupting obstacles degrade low-level command and control while the enemy is under direct fire.

(2) *Protective obstacles*. The battalion normally uses its own assets to emplace these obstacles. When employed along with direct fires and final protective indirect fires, these obstacles can help defeat mounted and dismounted assaults on defensive positions. Antipersonnel obstacles, antitank obstacles, or a combination of both types are used depending on what type of close combat threat is most severe. Antipersonnel obstacles are used against dismounted infantry antitank obstacles are used against mounted elements.

c. **Survivability Tasks**. Engineers support in the defense by constructing vehicle fighting positions and protective positions and, when time permits, by helping construct crew-served and individual fighting positions. Engineers provide staff advice on camouflage, cover, and concealment.

(1) *Protective positions*. Engineers can provide equipment for preparing protective positions. Protective positions for infantry and dismounted TOW missile systems (referred to as "TOWs") MK 19 40-mm grenade machine guns, and .50-caliber machine guns are constructed with available material. This material must support at least 18 inches of sandbags, rocks, or

dirt on top of the position. This cover protects the position against shrapnel from air bursts but not against direct hits. Protective positions must be built to standard (IAW FM 5-103) to provide adequate safety protection to soldiers. Fighting positions for vehicles are constructed with both hull-down and turret-down locations. Since freshly dug earth invites detection, no berms are created. However, berms are ineffective against kinetic energy rounds. The engineers use bulldozers, CEVs, ACEs, SEEs, front loaders, backhoes, and blade tanks, as available, to enhance survivability by modifying the terrain. As time permits, engineers use them to construct defilade positions by priority for tanks and antiarmor vehicles.

(2) *Countersurveillance measures*. The engineers' role includes advising and aiding the battalion in camouflage and deception measures to include concealment, dummy positions, and decoy construction.

## 7-21. FIGHTING AS INFANTRY

Engineers have a secondary mission to reorganize and fight as infantry. The division commander decides when they will do so but only in critical circumstances. If so, the engineers reorganize into infantry formations; engineer equipment is placed into a rear echelon. In infantry formations, engineers lack heavy weapons, such as mortars and ATGMs, and they have no means to control indirect fires. A long-term loss of engineer support can jeopardize future missions. However, engineers often must use infantry fighting tactics to accomplish their engineering missions.

## Section VI INTELLIGENCE AND ELECTRONIC WARFARE SUPPORT

To best use his combat power, the battalion commander must know enemy dispositions and probable course of action. The main means used to obtain information in the battalion area are subordinate maneuver companies, patrols, scouts, OPs, and FISTs. The battalion S2 coordinates and disseminates information collected. He plans the use of battalion R&S resources. He also requests support from

higher headquarters (HUMINT, SIGINT, and IMINT) to meet the commander's intelligence requirements. Also, he can send immediate requests for aerial coverage (Army, Air Force, or both) by S3 Air or TACP communications channels. Other timely sources of intelligence information include forward and adjacent units and the artillery nets monitored by the FSE.

**7-22. INTERROGATION TEAM**

An interrogation team can directly support a battalion for a specific mission and time. The commander usually positions the interrogation team near the PW collection point in the combat trains.

**7-23. GROUND SURVEILLANCE RADAR**

The main advantage of radar is its ability to detect objects and provide accurate target locations when other surveillance means cannot. Radar is used mostly for limited visibility operations—operations during darkness, haze, fog, or smoke. Radar can penetrate light camouflage, smoke, haze, light rain, light snow, darkness, and light foliage. Heavy rain or snow restrict radar-detection capabilities. However, having a well-trained operator can compensate in part for these negative effects. Radar is limited to line-of-sight. (Table 7-5 shows radar capabilities.) Ground surveillance radar provides a highly mobile, nearly all-weather 24-hour capability—including night and poor

daylight visibility—for battlefield surveillance. One or two GSR teams can be attached to a battalion. They can be augmented by remotely-employed sensor (REMS) teams.

a. The battalion S2 employs the GSR teams. Combat information collected by each team is passed to the battalion S2, who analyzes and disseminates it to the commander, S3, FSE, and subordinate units within the battalion.

b. Equipment for GSR can be either vehicle-or ground-mounted; it complements other battalion combat surveillance and target acquisition means. Its employment is coordinated closely with that of patrols, observation posts, and infrared and other sensor devices.

c. GSR is ineffective against air targets unless the target is flying near the ground. This is because GSR is designed to detect moving targets in front of a background. It is also vulnerable to direction-finding and jamming by enemy electronic combat and other deception means.

|  | AN/PPS-4                 | AN-PPS-5   | AN/PPS-15   |
|--|--------------------------|--|---|
| <b>RANGE:</b><br>PERSONNEL<br>VEHICLES | 1,500 MILS<br>6,000 MILS | 6,000 MILS<br>10,000 MILS  | 1,500 MILS<br>3,000 MILS                          |
| <b>ACCURACY:</b><br>RANGE<br>AZIMUTH   | ±25 MILS<br>±10 MILS     | ±0 MILS<br>±10 MILS  | ±20 MILS<br>±10 MILS                              |
| <b>SECTOR SCAN:</b>                    | MANUAL                   | AUTOMATIC 553,<br>1,067, 1,600<br>AND 1,955 MILS<br>(SELECTABLE) | AUTOMATIC<br>800 OR<br>1,600 MILS<br>(SELECTABLE) |
| <b>INDICATORS:</b>                     | AUDIO                    | AUDIO AND VISUAL<br>(A-SCOPES AND<br>B-SCOPES)                   | AUDIO AND VISUAL<br>(DIGITAL<br>READOUT)          |
| <b>REMOTE CAPABILITY:</b>              | NONE                     | 50 FEET  | 30 FEET   |

Table 7-5. Capabilities of ground surveillance radar.

d. GSR can be employed in all types of tactical operations. Radar personnel use it for two types of surveillance missions: search and monitor. Using GSR, radar personnel can perform a variety of tasks. They can—

(1) Search avenues of approach, possible enemy attack positions, assembly areas, or other sectors or areas. They use GSR on a time schedule at random or continuously to learn and report the location, size, composition, and nature of enemy activity.

(2) Monitor point targets, such as bridges, defiles, or road junctions, and report quantity, type, and direction of movement of targets through the point.

(3) Monitor and search FPF areas or barrage locations to permit timely firing.

(4) Search areas of nuclear and conventional fires to assess the effects on the target.

(5) Extend the observation capabilities of patrols by enabling them to survey distant points or areas of special interest.

(6) Aid units in their daylight visual observation by detecting partly obscured (hazy) targets at long ranges.

(7) Aid in the movement control of units during limited visibility operations.

(8) Increase the effectiveness of fire support. When targets have been detected with reasonable certainty by radar, fire support elements can take the target under fire immediately.

(9) Determine a target's rate of movement by plotting its location at two known points and the time used to move from one point to the other.

e. To provide good coverage, GSR teams must know the mission, the concept of the operation, and the targets expected in the area of operations. Each team must be assigned a specific sector of surveillance, a specific degree of overlapping coverage, and a frequency of coverage. To prevent detection by enemy direction-finding equipment and enemy ECM, operators turn on equipment only when needed.

f. The battalion S2 advises the commander on where and how GSR is best employed to support the scheme of maneuver. When this has been determined, the S2 assigns GSR locations, areas, and methods of search. Each team reports information to the supported unit or S2. Information must be reported by the most secure

means—wire if possible. Radio is used when information requires immediate action of the supported unit or when no other means of communication is available. Also, for full coverage of the battalion area of operations, the S2 ensures that GSR positions and coverages are integrated with other R&S means (patrols, scouts, OPs, TOW sights, NVDs). The S2 prepares and distributes an R&S plan to subordinate companies and to the brigade.

g. The battalion S2 directs the general positioning of the radars, the section leader or senior operator selects the exact locations, then reports them once the radars are in place. Because the forward slopes of radar sites positioned on hills will be dead space to the radar, they must be covered by other observation means. GSR teams displace only on order of the GSR section leader or supported unit commander.

h. Alternate and supplementary positions are selected and prepared as time permits. The senior radar operator prepares radar surveillance cards and gives a copy to the battalion S2.

i. GSR teams should remain as far forward as the tactical situation and terrain permit. However, their displacement should not be delayed arbitrarily until they can no longer provide effective support. Timely displacement enables forward units to maintain fire on withdrawing enemy units or to detect enemy activity that indicates a counterattack. When feasible, teams displace by bounds.

j. GSR is used both in the security area and in the main battle area. All GSR assets are placed in GS of the battalion to screen avenues of approach and gaps between companies.

#### **7-24. REMOTE SENSOR TEAMS**

Remote sensor teams can be placed in DS of or attached to the battalion during defensive operations. The S2 designates the area to be covered by remote sensors. He integrates remote sensor coverage with other surveillance means to cover gaps, flanks, dead space, or avenues of approach into the battalion area.

a. The remote sensor team emplaces the REMS to best cover the assigned area whether REMS employed in the battalion area of operations are in DS of the battalion or are in GS of the division or brigade. The exact locations of sensors must be reported to the battalion

commander. If he is convinced that sensors were activated by enemy forces, the commander can fire on any location. Ideally, the team locates with the battalion main CP; however, the team's priority is to monitor the sensor signals.

b. The number and size of the teams vary with the brigade or battalion mission. Two factors that limit sensor use are that they must be hand-emplaced and that they are susceptible to ECM.

c. Sensors can monitor road junctions, river-crossing and fording sites, or previously occupied positions. Operators can determine the target's rate of speed and length; they can also determine the type and number of vehicles or personnel in a column. To prevent accidental

activations or false signals, sensor fields or strings are mixed. This means any sensor activation must be confirmed by other types of sensors. For example, severe weather can activate the seismic sensor but not the magnetic sensor. Winter conditions, such as falling snow, snow cover, and frozen ground, can limit the effectiveness of acoustic/seismic and infrared sensors. An animal can activate the seismic and infrared sensors but cannot activate the magnetic sensors.

d. Use of sensors allows a battalion to monitor many avenues of approach or flanks with few soldiers in high risk areas. To confirm enemy activity, sensors should be used along with other R&S assets.

## Section VII NUCLEAR, BIOLOGICAL, AND CHEMICAL

Introducing NBC weapons into conventional tactical operations results in an integrated battlefield. A battalion fights on an integrated battlefield the same as on the conventional battlefield. Tactics used on the conventional battlefield—such as cover and concealment, overwatch, and suppression—are well suited to the integrated battlefield. However, in an NBC environment, the battalion must be ready to implement protective measures to enhance its survivability and must provide timely information to higher headquarters about possible contaminations to aid in protecting the brigade and other units. A battalion commander must consider three aspects of NBC while conducting his battle analysis. The first and most important is NBC avoidance and decontamination; the second is the use of smoke; and the third is the use of field flame expedients. The battalion commander should make a mental check of these systems to ensure they support his intent.

### 7-25. AVOIDANCE

NBC avoidance starts with passive measures before the outbreak of hostilities. Some of the elements of NBC avoidance include OPSEC and COMSEC, dispersion, position improvement, site hardening, training, and equipment maintenance. Most of the following measures are part of a unit's SOP. Used properly, they can increase a unit's probability of surviving in an NBC environment.

a. The chemical officer and the S2 determine indicators of a future chemical strike. They do this during the buildup and with the

onset of hostilities. The indicators can include chemical munitions sighted in the enemy's corps or division area, chemical bombs or spray tanks uploaded onto enemy aircraft, enemy troops wearing chemical protective gear, chemical strike reported in the theater of operations, and repositioning of known enemy chemical units (especially decontamination units). If any of these indicators are identified, the chemical officer helps the S2 develop the IPB. The chemical officer uses templates to estimate the probability that the enemy will use chemical agents for the each of the following reasons:

- (1) To block positions.
- (2) To deny terrain.
- (3) To canalize forces.
- (4) To reinforce obstacles.
- (5) To slow reinforcements.
- (6) To block the flow of supplies.
- (7) To cause casualties.
- (8) To breakthrough friendly defenses.

b. The battalion commander determines the minimum MOPP level based on the intelligence information identified by the S2 and the chemical officer. The battalion commander allows company commanders the flexibility to increase the protective posture of their unit, based on the situation. This enables the company commanders to maintain combat effectiveness despite MOPP degradation. The company commander does this because he has a better appreciation than the battalion commander for what the company can do.

## 7-26. OPERATIONS

The commander should ensure that decontamination operations are planned to support contaminated maneuver forces. In the defense, this support is planned from the FLOT to the battalion rear boundary. In the offense, decontamination support is planned from the battalion rear boundary through to the objective. Due to time and resource constraints, the unit must know how to conduct decontamination operations. Actions to be taken during and after an attack should be outlined in the unit's SOP. (FM 3-4, FM 3-5, and FM 3-100 provide more information about this subject.) The battalion commander must provide specific guidance to his subordinate commanders about their follow-on mission.

a. A commander should request the NBC reconnaissance vehicle (FOX) when his unit maneuvers through an area known or suspected to be contaminated by chemicals or radiation. The vehicle's reconnaissance system can quickly identify and mark the contaminated area and determine uncontaminated maneuver routes for the unit. This saves time and resources. The reconnaissance vehicle will require support if it encounters enemy fires or obstacles.

b. The entire unit is responsible for monitoring for an NBC hazard. The commander ensures that appropriate personnel are trained to

operate chemical detection equipment, identification equipment, and radiac equipment; and to conduct surveys as required from higher headquarters. Radiological and chemical surveys are planned and controlled at battalion or higher level. Surveys require time and coordination. Men and equipment must be diverted from primary missions. These constraints require that surveys be conducted only when the intensity of contamination must be known.

## 7-27. USE OF SMOKE

Another major factor that the commander should consider to increase his unit's survivability is how to defeat enemy electro-optical systems. Smoke is used to defeat the enemy's battlefield viewers. These viewers include binoculars, weapon sights, laser range finders, and weapon guidance systems. These weapon guidance systems include command LOS or terminal homing systems on antitank and air defense missiles. Table 7-6, page 7-26, identifies different types of electro-optical systems and the types of smoke that defeat them.

a. Information needed by the commander to plan the use of obscurants will be difficult to obtain. This is due to the number of types of electro-optical devices and the number of visual obscurants that will be commonly used on any future battlefield. The information the commander needs includes the following:

(1) The electro-optical capabilities of the enemy force.

(2) The extent to which electro-optical devices are employed, and whether they are being employed on reconnaissance systems, direct-fire systems, or all systems.

(3) The smoke-delivery capabilities of the enemy force.

(4) The extent of enemy smoke employment.

(5) The directed-energy weapons (DEW) capabilities of the enemy force.

b. The commander must decide how to use smoke to reinforce his mission once he has this information. Smoke aids in deceiving the enemy, conceals maneuver, and increases potential force-on-force ratio when friendly forces using target-acquisition systems can see



through the smoke and the enemy cannot. For his use of smoke to be effective, the commander must synchronize smoke with the tactical plan. The commander can determine if smoke will meet this tactical plan by answering the following questions:

- (1) What should the smoke and obscurants accomplish?
- (2) Where and for how long should smoke be sustained?

(3) How much mobility restriction is acceptable?

(4) How much restriction to target-acquisition and engagement capabilities can I accept?

(5) When might on-call hasty or deliberate smoke benefit the unit?

(6) How will countermoke help?

(7) Can the smoke from field flame weapons degrade or defeat enemy laser systems?

| SPECTRAL RANGE   | ELECTRO-OPTICAL SYSTEM OBSCURED   | TYPE OF SMOKE  |
|--|---|--|
| <b>VISIBLE</b><br>0.40 TO 0.75 mm                      | <b>VIEWERS:</b><br>—DAYLIGHT SIGHTS<br>—NAKED EYE<br>—CAMERA LENS<br>—BINOCULARS/STANDARD OPTICS<br>—BATTLEFIELD TELEVISION<br>—CLOS MILLILES (FOR EXAMPLE, AT-3)<br>—NIGHTSIGHTS | <b>ALL</b>   |
| <b>NEAR INFRARED</b><br>0.75 TO 4 mm                   | <b>VIEWERS:</b><br>—SACLOS MILLILES (FOR EXAMPLE, AT-4 AND AT-5)<br>—NIGHTSIGHTS<br><br><b>SENSORS:</b><br>—LASER DESIGNATORS<br>—LASER RANGE FINDERS                             | <b>ALL</b><br><br><br><b>ALL</b>   |
| <b>MID INFRARED</b><br>4 TO 100 mm                     | <b>VIEWERS:</b><br>—PASSIVE THERMAL SIGHTS  | <b>WHITE PHOSPHORUS, PLASTICIZED WHITE PHOSPHORUS, RED PHOSPHORUS, TYPE III INFRARED OBSCURANT, DUST</b> |
| <b>FAR INFRARED</b><br>14 TO 100 mm                    | <b>SENSORS:</b><br>—THERMAL IMAGERS<br>—TERMINAL HOMING MISSILES (AT-6)   | <b>WHITE PHOSPHORUS, PLASTICIZED WHITE PHOSPHORUS, RED PHOSPHORUS, TYPE III INFRARED OBSCURANT, DUST</b> |
| <b>MILLIMETER WAVE AND LOWER FREQUENCY,</b><br>1.10 mm | <b>RADAR RADIO MICROWAVES</b>   | <b>WHITE PHOSPHORUS AND PLASTICIZED WHITE PHOSPHORUS (INSTANTANEOUS INTERRUPTION ONLY)</b>               |
| <b>X-RAY AND HIGHER FREQUENCY</b>                      | <b>DIRECTED EMP NUCLEAR WEAPONS</b>   | <b>OIL SMOKE (ATTENUATION ONLY), DEVELOPMENTAL OBSCURANTS</b>  |

Table 7-6. Electro-optical systems defeated by smoke.

c. The smoke produced from field flame weapons absorbs light particles and easily degrades the effectiveness of laser weapons. Flame weapons reinforce obstacles, create obstacles, and enhance the defensive plan. They also generate violent, effective combat power at decisive times and locations on the battlefield. Tactical commanders can use these systems to do the following:

- Repel enemy penetrations.
- Destroy enemy forces.
- Gain time.
- Provide obstacles.
- Isolate or canalize an enemy.
- Slow enemy movement.
- Surprise enemy forces.
- Degrade enemy morale.

d. Application of flame weapons at decisive times and places on the battlefield reinforces fighting positions, achieves surprise, and produces casualties and psychological shock. Man's natural fear of fire produces perhaps the

most important benefit derived from the use of flame weapons. Use of tactical flame weapons is an effective deterrent due to the human fear of being burned. This fear has caused well-trained troops to falter, throw down their weapons, and run in terror.

e. Flame weapons can be used tactically to warn of enemy approach, especially when trip wires and flares are used to ignite the expedients. Casualties are produced by container fragmentation and burns (from thickened fuel). Battlefield illumination restricts the enemy's use of his most likely avenues of approach. Field flame weapons force the enemy into areas where he can be engaged easily. They reinforce obstacles by slowing down armor and allowing artillery to effectively engage the target. Flame weapons must be integrated into the overall plan to ensure their use complements the commander's intent. Properly planned and executed, use of flame weapons can defeat armored vehicles and ensure a successful defense.

## Section VIII OTHER COMBAT SUPPORT

The infantry battalion organic CS elements are of four main types. The first is the scout platoon. The second is the mortar platoon. The third is the antiarmor platoon, which, depending on the organization of the battalion, is part of CSS, HHC, or the antiarmor company. The fourth is the communications platoon, which, as part of HHC, is also organic to the battalion.

### 7-28. SCOUT PLATOON

The mission of the scout platoon is to perform reconnaissance and surveillance, to provide limited security, and to help control movement of the battalion or its elements. The scout platoon is normally under battalion control. However, for certain specific operations, it can be attached to another unit within the battalion. Scouts are finders, not fighters. They are the eyes and ears of the battalion, not the fists. FOs may be attached to scout platoons.

a. **Reconnaissance.** The S2 coordinates reconnaissance requirements with the S3, who supervises the scout platoon during its conduct

of operations. The platoon may report directly to the battalion commander. Whether mounted or dismounted, reconnaissance requires the same preparation and stealth as any other operation. (Leaders follow the troop-leading procedure described in Chapter 2.) The commander must carefully develop communications, resupply, and other CSS plans. He must develop contingency plans for leaders whose units make contact. The three types of reconnaissance operations—route, zone, and area—require the use of similar techniques, but the mission dictates the type of information required. Scouts must be given time to complete their mission. (FM 7-92 provides additional information.)

(1) **Route reconnaissance.** A route reconnaissance is conducted to obtain detailed information about specific routes—for example, road and bridge classification, obstacles, chemical or radiological contamination, proximity of enemy, and terrain that, if occupied or controlled by the enemy, would affect battalion movement. The number of routes that can be reconnoitered by the scout platoon depends on the length of the routes, the enemy situation, and the nature of the routes themselves. When enemy contact is likely or expected or when the route is long and stretches through difficult terrain, the entire scout platoon is probably required for that one route. However, if routes are short and enemy contact is unlikely, the platoon can reconnoiter as many as three routes (one for each squad), but no more.

(2) **Zone reconnaissance.** A zone reconnaissance involves the detailed reconnaissance of an entire zone defined by boundaries. Its purpose is to obtain detailed information on all enemy, terrain, and routes within the zone. The commander must state his intent for a zone reconnaissance. This may be to determine the best routes, to move through the zone, or to locate an enemy force.

(a) A zone reconnaissance mission is normally assigned when the enemy situation is in doubt or when information on cross-country trafficability is desired. The width of a zone a scout platoon can reconnoiter depends on the type of enemy force and terrain.

(b) The zone to be reconnoitered is defined by lateral boundaries, a line of departure, and an objective. The objective provides a termination point for the mission and might be occupied by the enemy. A phase line can also be used as a termination point.

(3) **Area reconnaissance.** An area reconnaissance obtains information about a specified area such as a town, ridge, woods, or other feature critical to operations. The unit should be told specifically what to look for and why. The area to be reconnoitered is designated by a boundary line that encircles it. Area reconnaissance differs from zone reconnaissance in that the unit moves to the assigned area by the most direct route, avoiding enemy contact and reporting any enemy encountered. Once in the area, the unit

reconnoiters in detail using zone reconnaissance techniques.

b. **Security.** Security operations protect the battalion from tactical surprise. Battalion security forces must find the enemy before the enemy finds the battalion. Properly conducted security operations give the battalion commander time to react to the enemy force. The scout platoon conducts security operations to provide early warning of enemy maneuvers and to deny the enemy information about the battalion's disposition or movements. The S3 supervises staff planning and the conduct of security operations; he also coordinates with the S2 for information on enemy activity. The two types of security operations are screen and guard.

(1) **Screen.** Screening missions require the unit to give early warning of the enemy and to identify the location of an enemy attack. Screening forces are normally employed over a wide area; they are too dispersed to delay the enemy. A screening force fights only to protect itself or, as it can, to prevent the enemy from observing the main body closely. A screen is a series of OPs from which enemy avenues of approach and areas between them can be observed. Patrols cover dead space and make contact between OPs. Once in contact with the enemy, the screening force withdraws on order; it maintains visual or electronic contact with the enemy and reports his movements. A scout platoon employed as a screening force can occupy three OPs for extended periods or six OPs for shorter periods. In extremely broken terrain or woods, or when visibility is otherwise limited, the scout platoon should be reinforced and the number of OPs increased.

(2) **Guard.** Guarding missions require the unit to give early warning and to delay the enemy, giving the main body time to react to the enemy threat. Because guard operations require larger forces with more firepower than screens have, the scout platoon participates in guard operations only as part of a larger force or when suitably reinforced. The scout platoon normally screens forward or to the flank(s) of a guard force.

c. **Other Tasks.** Some situations warrant employing the scout platoon for other tasks. (The tactical chapters of this manual provide more detailed discussions of these tasks.) The scout platoon can be used on short notice to help

the battalion control movement. This may occur when elements of the battalion are separated or under conditions of limited visibility. The scout platoon can also be used to establish liaison, contact, and quartering parties. During conduct of the security mission, the scout platoon can conduct limited pioneer and demolition work, conduct patrols, and establish roadblocks. It can perform two tasks if NBC weapons have been employed: chemical detection and radiological monitoring and surveying; or help with ADC.

### 7-29. ANTIARMOR COMPANY AND PLATOONS

The antiarmor company and platoon provide the battalion with direct-fire support by destroying enemy armored vehicles. The antiarmor unit can also destroy point targets, including helicopters and fortified positions, from long ranges; it can help the battalion with surveillance of critical avenues of approach during all types of visibility conditions.

a. **Planning.** The battalion S3 and the antiarmor company commander or platoon leader advise the battalion commander on employing and integrating TOWs with other direct-fire weapons.

(1) The battalion antiarmor company or platoon is best employed as a unit, providing general support to the battalion. When this is not feasible, elements can be attached to or placed OPCON to one or more of the maneuver companies. Based on the requirement for mutual support, a section of two TOWs is the smallest unit that can be detached. When positioning the unit the commander considers its limited ability to provide for its own local security. Terrain and scheme of maneuver give the commander central control of all fire and movement. However, at maneuver company level, terrain prevents the use of fire and movement.

(2) Antiarmor units maybe employed using a combination of the above methods. The battalion commander can increase the combat power of maneuver elements when needed, while retaining a direct-fire support element with which to influence the battle.

(3) The number of sections attached to a particular company is based on the IPB product. Companies covering the most dangerous avenues of approach with adequate fields of fire

for the TOW missile receive more antiarmor assets. The units can also share the same terrain without a command or support relationship. The battalion commander may designate that the antiarmor unit has priority of positioning. If not, the commander of the company that owns the area allocates firing positions.

b. **Employment.** The battalion commander should consider employing the company and platoon headquarters as well as the sections.

(1) The battalion commander can either employ the antiarmor unit intact, or he can send it to the company that has the most TOW resources. The leader can help the maneuver company commander by reconnoitering and recommending positions, selecting positions, or both for antiarmor weapons. Also, he can control TOW fires during engagements.

(2) An antiarmor company already assigned to a unit can serve as a headquarters for a fourth maneuver element if the antiarmor company is task-organized with the infantry.

c. **TOW Missile Systems.** TOW missile systems should be employed in any operation only where their capabilities offset their vulnerabilities. They need not be employed where tanks or Dragons should be employed. (FM7-91 and the tactical chapters of this manual discuss employment of the antiarmor company and platoon in various operations.)

(1) Use of TOWs is critical to the battle against motorized and tank forces, so the battalion should notify brigade if it is operating in terrain that lacks adequate fields of fire for TOWs. Based on the criticality of other battalion's situations, the brigade commander can direct temporary attachment of one battalion's TOWs to another battalion. This rarely used technique is appropriate when terrain restricts employment in the parent unit's area or when fires must be massed elsewhere.

(2) Thermal TOW sights provide a means of surveillance and direct and indirect fire control in limited visibility, even when terrain restrictions limit TOW fires.

(3) TOWs can also be attached to the scout platoon when terrain restricts their use with the companies, when scouts anticipate meeting an armored force, or to enhance—

(a) *Scout surveillance capabilities.* TOWs offer personnel and thermal sights.

(b) *Scout tactical mobility.* Based on METT-T, vehicles equipped with TOWs can assist movement of the scout platoon.

(c) *Scout communications.* Radios in TOW vehicles can extend the communications capabilities of the scout platoon.

(d) *Scout endurance and sustainability.* TOW vehicles can be used for hauling personnel and equipment.

(4) TOW vehicles can augment logistical assets when the TOWs cannot be employed or when no armor threat exists. However, TOW units should only be used this way when the situation clearly indicates that TOW vehicles can be more useful in this role. When fulfilling this role, the leader considers mounting the .50-caliber machine gun to protect the unit and the convoys it escorts.

### 7-30. MK 19 40-MM GRENADE MACHINE GUN

The MK 19 expands the infantry forces' ability to conduct close combat in all environments. It can suppress armored vehicles and formations; it can also destroy infantry, light armor, and field fortifications. In MOUT, the MK 19 can breach 16-inch concrete walls (FM 23-27).

a. **Weapon Characteristics.** The MK 19 has a maximum range of 1,500 meters for point targets and 2,212 meters for area targets. Rates of fire are 40 rpm (rapid), and 350 rpm (cyclic). The MK 19 can be ground-mounted or vehicle-mounted. The gun weighs 75.6 pounds; the MK 64 gun cradle weighs 21 pounds; and the M3 tripod weighs 62 pounds.

b. **Ammunition Characteristics.** The MK 19 fires two types of explosive ammunition. Each type arms within 18 to 30 meters, detonates on impact, and has a 15-meter bursting radius. Each also has a flat trajectory out to 800 meters.

(1) **High-explosive dual purpose.** An HEDP round is the standard round; it can penetrate 2 inches of RHA at zero-degree obliquity. It is effective against light armored vehicles (BMP1s and BTRs). The round has a 20-second flight time to reach its maximum range.

(2) **High-explosive.** An HE round is most effective against exposed infantry and other "soft" targets such as civilian vehicles or logistics.

c. **Mounts.** The MK 19 can be mounted on the HMMWV interchangeably with the .50-caliber machine gun if the HIMS is used. The MK 19 can also be mounted on the M3 tripod. Use of the range card and the tripod's T&E mechanism allow accurate visibility engagements.

d. **Employment.** The MK 19 is useful in both offensive and defensive operations. It enhances the fires of other weapons systems, especially the .50-caliber machine gun and the TOW. This fact should be considered in siting the MK 19. Members of the MK 19 crew who become casualties should be replaced immediately.

(1) The MK 19 should operate during offensive operations from hide, defilade, or fortified positions. In these positions, the MK 19 is protected from both direct and indirect fire. During offensive operations, the MK 19 should—

(a) Provide immediate suppression on armor, antiarmor, and infantry encountered en route to and on the objective.

(b) Neutralize some obstacles and provide overwatch for breaching forces.

(c) Overwatch bounding elements and augment TOWs in overwatch.

(d) Provide close-in protection to infantry to allow TOWs to be used on tanks and other high-priority targets.

(e) Support infantry attacks by providing suppressive fire to fix or isolate the enemy on the objective.

(f) Shift fires beyond the objective to destroy withdrawing enemy.

(g) Displace rapidly to the objective to provide fire to defeat enemy counterattack.

(h) Conduct reconnaissance by fire.

(2) The MK 19 in defensive operations can operate from defilade positions; its fires should be controlled by an observer. These positions should be along the most likely enemy avenues of approach in the defensive sector. During defensive operations, the MK 19 should—

(a) Cover critical obstacles by fire.

(b) Cover dead space beyond 800 meters in the machine guns' FPF.

(c) Use the tripod and range card to fire accurately out to 1,500 meters during limited visibility.

(d) Disrupt armor formations by forcing them to button up. The MK 19 can destroy critical enemy reconnaissance vehicles, command and control, and ADA.

(e) Support counterreconnaissance and counterattacks.

(f) Augment rear area defenses of the field or combat trains.

(g) Provide security and fires during convoy escort.

### 7-31. HMMWV INTERCHANGEABLE MOUNT SYSTEM

The HMMWV interchangeable mount system (HIMS) provides the capability to exchange multiple vehicle-mounted weapons; this increases unit employment options. Based on METT-T, the commander can mount TOWs, MK 19s, or .50-caliber machine guns. Since the HIMS must be removed for the TOW to be mounted in the HMMWV, the commander must determine which system to employ before the operation.

a. Each weapon system is best employed in pairs, so the commander can configure the antiarmor platoon as follows:

(1) Mount all TOWs as they might be mounted against a significant armored threat.

(2) Mount all MK 19s as they might be mounted against a motorized or dismounted threat.

(3) Mount two MK 19s and two .50-caliber machine guns as they might be mounted when the battalion is defending against an enemy light infantry attack or when the battalion is attacking an enemy defending prepared defensive positions.

(4) Mount two MK 19s and two TOWs as they might be mounted to defend against a mixed infantry and light armored threat.

b. All of the weapons in the defense can be simultaneously integrated in the fire plan. However, when this is done, the commander may need to attach additional personnel to the antiarmor platoon. TOWs and .50-caliber machine guns can be employed using organic tripods while the MK 19 is mounted on the vehicle. Crew members fire the M249 machine gun. These weapons should be employed as follows to best complement one another:

(1) To provide interlocking fields of fire.

(2) To destroy lightly armored vehicles, and to defeat infantry, field fortifications, and hovering aircraft.

(3) To gain and maintain fire superiority when enough ammunition is available.

(4) To overcome limited visibility conditions with appropriate NVDs.

c. The priority of target engagement by weapon systems employed simultaneously is an important consideration. The TOW provides a long-range armor and point target-defeating capability. The .50-caliber machine gun and the MK 19 have similar heavy machine gun capabilities. The .50-caliber machine gun can be used effectively to designate targets day and night with tracers. The MK 19 can suppress out to its maximum range and can cover deadspace beyond 800 meters. The MK 19 has a greater armor-defeating capability than does the .50-caliber machine gun; it can also neutralize infantry, antiarmor gunners, and lightly armored vehicles moving with tanks. Use of either machine gun can force armored vehicles to button up when attacking.

## CHAPTER 8

# COMBAT SERVICE SUPPORT

*Combat service support for the infantry battalion is characterized by constrained organic assets. Requirements range from sustaining platoons and companies operating independently to sustaining battalions operating in restrictive terrain with little or no access by road. These operations, coupled with the division's requirement for rapid aerial deployment, create a challenging CSS environment. CSS must sustain the battalion's combat power; it must also sustain battalion operations conducted with heavy forces (Appendix D). Requirements for CSS vary, depending on the unit mission. Commanders, mainly through their XOs, SAs, and SIs, plan and employ CSS assets to ensure success of missions. The constraints inherent in the CSS organization require infantry commanders to rely on their ingenuity, endurance, and initiative to succeed in rugged environments.*

### Section I ORGANIZATIONS AND FUNCTIONS

Battalion CSS operations sustain subordinate units, which allows subordinate commanders to concentrate on fighting their unit to accomplish the tactical mission. The main company-level CSS responsibilities are to report and request CSS and to ensure CSS is properly executed. Battalion commanders and staffs must plan tactical and support operations simultaneously to ensure the tactical scheme of maneuver and fire support are logistically supportable. They plan CSS for organic and attached elements and for any supporting units. Large attachments joining the battalion should bring CSS assets from their parent units. Battalion CSS assets may be centralized (unit trains) or placed in multiple locations (echeloned trains). The method chosen depends on the battalion's tactical needs.

#### 8-1. CATEGORIES OF COMBAT SERVICE SUPPORT

The two categories of CSS are logistical support and personnel service support.

a. The four functional areas of battalion logistics are supply, transportation, maintenance, and field services. Field services include mortuary affairs, clothing exchange, bath, salvage, laundry, textile renovation, airdrop, airlift, and bakery.

b. Personnel service support is the management and execution of all personnel-related matters. It includes the following:

(1) **Personnel and administration services.** These services include personnel accountability, strength reporting and management, replacement operations, casualty management, awards and decorations, morale welfare, and recreation.

(2) **Health services support.** These services include collection, treatment and evacuation,

medical supply support, and preventive medicine.

(3) **Religious support.** This includes conduct of religious services, personal and religious counseling, and pastoral care.

(4) **Legal support.** This includes advice and aid to soldiers and commanders concerning law and regulations.

(5) **Finance support.** This includes all matters involving soldiers' pay.

(6) **Public affairs.** This includes all matters relating to command information, public information, and community relations.

(7) **Postal operations.** This includes the movement, delivery, and collection of mail in the battalion.

(8) **EPW support.** This includes all aspects of handling and evacuating EPWs.

## 8-2. SOURCES OF COMBAT SERVICE SUPPORT

The battalion receives service support from various elements inside and outside the battalion.

a. **Inside the Battalion.** The XO supervises CSS coordination in the battalion. Aided by the S4 section and the support platoon, the S4 manages battalion logistical support and prepares paragraph 4 of the OPORD. The S1 manages personnel support within the battalion and coordinates the actions of the medical platoon. The battalion personnel administration center (PAC) helps the S1. In light infantry organizations, the brigade HHC provides food preparation and, above crew level, unit maintenance for all assigned battalions.

b. **Outside the Battalion.** The battalion also depends on the division support command (DISCOM) and other external units for support. A DISCOM is organized in one of two ways.

(1) A DISCOM organized with functional battalions consists of a maintenance battalion, a supply and transport battalion, a medical battalion, and an aviation maintenance company (or, in the air assault division, an aviation maintenance battalion). A forward area support team (FAST) is organized from assets in these functional battalions to provide DS to each brigade. In addition to the forward area support coordinating office (FASCO), who manages it, the FAST consists of the supply company, the medical company, and the maintenance company.

(2) A DISCOM organized with multi-functional battalions consists of a main support battalion (MSB), three forward support battalions (FSB), and an aviation maintenance company. An FSB supports each maneuver brigade and consists of a headquarters, a supply company, a maintenance company, and a medical company.

## 8-3. S1 SECTION

The S1 section consists of the S1 and the PAC. As the personnel staff officer, the S1 exercises the coordinating staff responsibility for personnel service support matters. He is aided by the PAC supervisor and by the personnel staff NCO (PSNCO). The S1, PSNCO, and two administrative specialists collocate with the S4 at the combat trains CP; the PAC is located in the field trains.

a. The S1 takes part in the full range of staff officer functions. These include taking part in the OPORD process; developing personnel estimates, loss rate estimates, and portions of the CSS annex; and recommending replacement priorities. He coordinates his areas fully with other staff officers.

b. The S1 section has soldiers at both the combat trains CP and the field trains. S1 personnel at the combat trains CP perform strength accounting, casualty reporting, and CP functions. Those in the field trains perform replacement operations, administrative services, personnel actions, legal services, and finance services.

c. The S1 has the staff responsibility for EPWs, religious support, and medical planning. He coordinates with the S2 for interrogating prisoners and with the S4 for processing captured equipment and planning transportation requirements. The medical platoon leader (battalion surgeon), whose duties make him a vital special staff officer, executes medical support. The S1 coordinates with him and with the medical operations officer to ensure that patient treatment and evacuation are planned and coordinated throughout the battalion area. The S1 also coordinates for religious support with the battalion UMT section, which consists of one chaplain and one chaplain's assistant.

d. The S1 assumes public affairs responsibilities since no public affairs assets are



available to aid the commander at battalion level. These responsibilities include the following:

(1) Monitoring the need for command information in the battalion to counter enemy propaganda and rumors, to maintain morale, and to maintain the will to fight.

(2) Coordinating with higher headquarters PAO to receive needed command information support.

(3) Identifying unescorted news media in the battalion's area of operations, verifying their credentials, and coordinating their presence with higher headquarters PAO or the media escort.

(4) Observing OPSEC and responding to news media inquiries concerning battalion activities only.

(5) Referring other inquiries to the higher headquarters PAO or the media escort.

#### **8-4. S4 SECTION**

The S4 section assumes responsibility for supply, transportation, maintenance, and field service functions. It coordinates the requisition and distribution of supplies to companies. The S4 section also turns in captured supplies and equipment as directed.

a. Personnel in the S4 section are located in the field and combat trains CPs. They are cross trained with soldiers of the S1 section in critical tasks to permit continuous operations. Aided by the battalion supply sergeant, the S4 supervises the S4 section.

b. The S4 concentrates on water and seven classes of supply in combat: Classes I through V, VII, and IX. The support platoon leader working with the S4 and HHC commander coordinates the requisition, receipt, preparation, and delivery of water and Classes I, III, and V. The S4 section coordinates the requisition, receipt, and delivery of Classes II, IV, and VII (as well as Class IX in the light infantry). If the battalion has a maintenance platoon/section, the battalion maintenance technician (BMT) requests, receives, and delivers Class IX items.

c. Water is obtained from the water supply point in or near the BSA and from forward sources tested and approved by the medical platoon leader.

d. Maps are stocked by the headquarter and supply company of the supply and transportation battalion or the supply and service company of the MSB. The S2 determines map requirements.

The S4 obtains the maps through supply channels, except for classified maps, which he obtains from the G2.

#### **8-5. MEDICAL PLATOON**

The medical platoon provides unit-level medical support for the battalion. It collects, triages, and treats patients, then either evacuates them or returns them to duty. The medical platoon establishes and applies preventive medicine programs aimed at preventing disease and illness.

a. The medical platoon stocks and provides all Class VIII supply support for the battalion. It also maintains and requests repair for organic medical equipment.

b. The medical platoon leader, who is the battalion surgeon, operates the BAS with the aid of a physician's assistant (PA). The medical operations officer, who is a medical service corps officer, coordinates the operations, administration, and logistics of the medical platoon. He is aided by the medical platoon sergeant. They coordinate patient evacuation to the supporting medical company, request more forward evacuation assets from the medical company, and support infantry companies.

#### **8-6. SUPPORT PLATOON**

The support platoon has a headquarters, a transportation section (with a decontamination specialist in H-edition infantry and airborne/air assault battalions) and a mess section (less the light infantry battalion).

a. The transportation section is organized and equipped to transport ammunition, supplies, water, and fuel to the companies and to move soldiers by organic vehicles when required. The transportation section in both the infantry and air assault battalions is equipped with a tank and pump unit (TPU) for bulk fuel distribution. In light infantry and airborne battalions, 500-gallon fuel bladders are employed in bulk fuel distribution.

b. The mess section (less the light infantry battalion) is organized and equipped to prepare meals for all elements of the battalion. Mess support for light infantry battalions is provided by the brigade mess platoon organic to the brigade HHC. The brigade mess section, while able to operate four independent mess teams, operates consolidated from the BSA.

c. The support platoon leader works for the S4, but is supervised by the HHC commander in the field trains.

### **8-7. MAINTENANCE PLATOON/SECTION, LIGHT INFANTRY BATTALIONS**

Unit-level maintenance is consolidated at brigade level for the light infantry battalion. Maintenance teams of two to four men may be formed to support maneuver battalions. They will work from their battalions' field trains. They carry with them stocks of assemblies and other high-demand repair parts. Procedures are established for repair parts delivery from the brigade consolidated PLL section. The battalion team is responsible for repairing deadlined equipment that can be repaired in time to return it to the current battle. If the item is badly damaged, the team arranges for its evacuation.

### **8-8. MAINTENANCE PLATOON/SECTION, OTHER INFANTRY BATTALIONS**

The maintenance platoon/section performs unit maintenance. This applies to all battalion

equipment except COMSEC and medical equipment. The platoon leader is the battalion maintenance technician. He is assisted by the battalion motor sergeant (BMS). The responsibility for operator and crew maintenance remains with the companies.

a. The administration section requests and maintains Class IX (repair parts) and manages the Army Maintenance Management System (TAMMS) records. The prescribed load list (PLL) stocks for the entire unit are consolidated at battalion control and maintained by this section. To facilitate rapid repair, selected high usage PLL items might accompany combat and tactical vehicles supporting a company.

b. The recovery support section provides limited welding, metalworking, and recovery support.

c. The maintenance services section provides maintenance support to the battalion.

d. Each battalion maintenance team always supports the same company, based on the weapons systems within the companies.

## **Section II PLANNING**

CSS planning ensures support during all phases of an operation. A CSS plan is developed along with the tactical plan. Each CSS plan is as detailed as planning time permits. SOPs help the CSS staff officer plan; battalion orders address only the deviations from the routine planning priorities established in the SOP. Planners also consider contingencies such as emergency resupply.

### **8-9. PRINCIPLES OF COMBAT SERVICE SUPPORT**

All CSS functions are estimates of expected needs. They are performed as far forward as the tactical situation permits to enhance combat power.

a. Combat service support must be continuous; available assets must be used. Ammunition, fuel, parts, and replacements are "pushed" forward to the combat trains and logistical release points (LRPs). End items and maintenance personnel are brought forward on request.

b. Combat service support planning is a continuous function. Coordination among tactical planners and those planning CS/CSS is

vital and must address all factors that can greatly affect the tactical mission.

c. Combat service support staff officers and commanders must act rather than react to support requirements. They must be personally involved. This means they must remain abreast of the tactical situation and must appraise the situation on the scene. This is critical to mission accomplishment.

d. Combat service support operators and planners must understand the commander's tactical plans and intent to ensure effective support. (Appendix D provides more information about CSS for light/heavy operations.)

(1) Planners and operators must know the following:

- How the unit is task-organized.
- What each of the supported elements will be doing.
- When they will do it.
- How they will do it.

(2) Planners must correctly predict support requirements after analyzing the concept of operations. They must determine the type, quantities, and priority (by type and unit) of support.

(3) Planners assess support capabilities by understanding the requirements and asking the following questions:

(a) What CSS resources are available (organic, attached/OPCON, and higher headquarters)?

(b) When can CSS resources be available to the maneuver units?

(c) How can CSS resources be made available?

#### **8-10. SUPPORT OF THE OFFENSE**

CSS is used to maintain the momentum of an attack. Otherwise, the enemy might recover from the initial assault, gain the initiative, and mount a successful counterattack. In the offense, support planners must consider several points and techniques. All apply to any offensive operation. Changing from one type of offensive operation to another does not require a great shift in CSS plans and procedures. However, since a change of operation might require a change in emphasis, the S4 must organize in ways that permit CSS operators to change from supporting one type of operation to supporting another without interruption of service. The main purpose of CSS in the offense—supporting the momentum of the attack—must not be forgotten.

a. Position vital CSS elements and supplies, such as Classes III, V, and water, well forward in the combat trains.

b. Plan for increased consumption of POL.

c. Preplan for air resupply (airlift or airdrop) consistent with ADA threat.

d. Use previously planned and configured logistics packages (LOGPACs) of supplies whenever possible.

e. Plan for increased vehicle and weapon maintenance problems.

f. Plan for increased use of MREs with a corresponding decrease in prepared meals (A-rations, B-rations, or T-rations).

g. Use host nation or captured enemy supplies and equipment, particularly support vehicles and POL.

h. Identify and validate natural water sources in forward areas when water resupply is difficult or not feasible.

i. Prepare for increased casualties. Plan casualty collection points as well as evacuation means and routes for each phase of the operation.

j. Select supply routes and LRPs carefully. When possible, rehearse vehicular routes.

k. Ensure CSS preparations for the attack do not give away tactical plans.

l. Request unit distribution at forward locations.

m. Suspend all field service functions except mortuary affairs.

n. Plan and coordinate EPW operations; expect more EPWs.

o. Plan replacement operations based on known and projected losses.

p. Consider the implications of the increasing distances and longer travel times between the battalion and its sources of supply.

q. Plan for the use of follow-on logistical assets.

r. Request more medical evacuation (air or ground) assets.

s. Plan for reconstitution.

#### **8-11. SUPPORT OF THE DEFENSE**

The first purpose of defense is to thwart an enemy attack or, in contrast to offensive operations, to break the momentum of an enemy attack. In consideration for the defense—

a. Maintain the lowest levels of supply forward in the combat trains.

b. Resupply during limited visibility to reduce the chance of enemy interference; infiltrate resupply vehicles to reduce the chances of detection.

c. Plan to reconstitute battalion CSS capability lost to enemy fire. Coordinate with the brigade rear CP to ensure the battalion can be supported in an emergency.

d. Plan more transportation for movement of Class IV barrier material, mines, and pre-positioned ammunition; plan also any CSS requirements that might be necessary for assigned engineers at the completion of the defensive operation.

e. Pre-position ammunition on occupied and prepared positions. However, plan also for the control and possible destruction of this ammunition.

f. Coordinate for the delivery of required Class IV materials as near to the emplacement location as possible.

g. Plan for increased ammunition consumption and decreased fuel consumption.

h. Prepare for possible temporary isolation of forward elements as a result of barriers or enemy encirclement.

i. Rehearse evacuation and supply routes between the combat trains and the company areas.

#### **8-12. CONTINUOUS SUPPORT**

CSS elements conduct sustainment operations continuously. When maneuver companies are not fighting, battalion CSS elements use the lull to prepare maneuver elements for the next operation.

a. Maintenance and repair work on individual and crew-served weapons as well as on other combat systems is performed at every opportunity. Repair and return of damaged equipment to the fight require early diagnosis and identification of faults and are performed as far forward as possible.

b. Routine resupply is conducted at night, whenever possible. Vulnerability and limited cross-country mobility of CSS vehicles dictate that LOGPACs use existing roads at night.

c. Continuous CSS operations require careful personnel management. A carefully planned and strictly enforced rest-work schedule or sleep plan ensures continuous capability. Cross training is crucial to ensure low-density MOS support is continuously available.

#### **8-13. BATTALION LOGISTICAL ESTIMATE**

A logistical estimate is an analysis of logistical factors that affect mission accomplishment. Logistics planners use these estimates to recommend COAs and to develop plans to support selected courses of action.

a. The key concerns of battalion logistics planners are the status of supply Classes I, III, V, and water, and the operational status of key weapons systems and of MEDEVAC and other CSS vehicles. (FM 101-5 contains a detailed discussion of the logistical estimate).

b. Logistical estimates are rarely written at the battalion level. However, they often address the following questions:

(1) What are the current and projected status of maintenance, supply, major weapons systems, and transportation?

(2) How much of that is needed to support the operation?

(3) How will it get to the unit(s) who needs it?

(4) What external (FSB/FAST, DISCOM or aviation lift assets) support is needed?

(5) Can the requirements be met using LOGPAC operations or are other techniques necessary?

(6) What are the shortfalls and negative impacts?

(7) What are the anticipated equipment losses and how can the equipment be replaced?

(8) What COAs can be supported most easily?

(9) Are logistics a significant limiting factor in any of these COAs?

#### **8-14. SOLDIER'S LOAD**

Light forces are designed to be flexible and responsive. Therefore, they consist mainly of foot-mobile fighters. Units are organized, equipped, and trained to conduct effective combat operations against light enemy forces, and to engage in conflict at all intensity levels when appropriately augmented with more forces, transportation, and other resources. Their success is limited by the physical ability of infantrymen to deliver to the appropriate place on the battlefield, in a timely manner, the weapon systems and materiel required to defeat the enemy and survive. Sometimes, battlefield operations occur in terrain impassable to vehicles. (FM 7-10 or FM 21-18 provide a detailed discussion about planning soldier's load.)

a. The ability of an infantry soldier to fight is directly related to the load he is required to carry. Excessive loads cost soldiers their energy and agility. Soldiers carrying excessive loads are at a disadvantage when they must react to enemy

contact. Also, the rate of march is affected adversely by excessive soldier load. Physical training does not compensate for overloading.

b. The best load for a properly conditioned soldier of average weight is less than 30 percent of his body weight. The heaviest load is 45 percent of his body weight. These weights include all clothing and equipment worn and carried. They should be adjusted if a soldier's weight is far from average. The unit's load plan should not be based on distributing the unit's equipment equally among the soldiers but on the soldiers' relative body sizes and weights.

c. Risk acceptance, based on a well-planned METT-T analysis, is basic to lightening the soldier's load. Commanders must remove the mind-set that they must carry everything to be ready for anything that might happen. In some cases, soldiers have to carry more than the recommended combat weight. Leaders must know how excess weight negatively affects the mission and must set the example by traveling light.

d. All the supplies and equipment a battalion (including attachments) carries is

echeloned into the combat load (at company level), sustainment load (at battalion level) and contingency loads (at division or higher level). Commanders at these levels are responsible for the storage and movement of loads as required. When echeloning loads, leaders must consider the availability of ground or air transportation support.

(1) **Combat load.** This includes mission-essential equipment the commander requires soldiers to have to fight and survive immediate combat operations. This equipment is carried by the soldier or on a close support vehicle.

(2) **Sustainment load.** This includes equipment the commander requires soldiers to have for sustained operations. It is stored and brought forward to the soldier as required by the commander under S4 arrangements.

(3) **Contingency load.** This refers to all other items of individual and unit equipment not required by the commander for ongoing operations. It is stored in an operational area and is called forward under division or corps arrangements.

### Section III MISSIONS AND OPERATIONS

Battalion CSS elements are organized based on their missions, support assets available, and commanders' operational concepts.

#### 8-15. BATTALION TRAINS

Whether battalion CSS assets are centralized or placed in multiple locations depends on the tactical needs of the battalion.

a. The battalion uses unit trains only when occupying a battalion assembly area or when the terrain restricts movement so that the battalion must depend on aerial resupply and evacuation for support. Unit trains and all CSS assets are placed in a central location—for example, this is true for airland, airdrop, and air assault operations.

b. The battalion CSS assets normally are located in echeloned trains (multiple locations). Echeloned trains place CSS assets at the company trains, battalion combat trains, and battalion field trains. The battalion combat trains are organized to provide immediate critical support for the combat operation. Field

trains are in the BSA and under the control of the HHC commander, who coordinates with the brigade S4 or FSB commander/FASCO for security and positioning.

c. Combat trains CP is the focal point of CSS for the unit when the battalion uses echeloned trains. Under the supervision of the S4, the combat trains CP anticipates, requests, coordinates, and supervises the execution of CSS.

(1) The most forward CSS elements are at the company trains. A HMMWV ambulance can be positioned at the company trains. The company trains can serve as a distribution point for resupply operations or merely as a control point for casualty evacuation and damaged equipment recovery. The company 1SG supervises the establishment and execution of resupply operations. To decentralize CSS operations in offensive operations, the battalion

can choose one vehicle to follow each company and carry an emergency resupply of Class V and water. This vehicle follows as close behind the company as tactically possible (1 to 2 kilometers behind the unit), just out of direct-fire range.

**NOTE:** Leaders must carefully consider whether to position a resupply vehicle or HMMWV ambulance at the company trains. Doing so limits the flexibility of the S4 and medical platoon and might compromise the location of the company.

(2) The company supply sergeant operates from the field trains when trains are echeloned. He coordinates over the administrative/logistics net with the company XO or ISG through the combat trains CP to the HHC commander. He supplements this with face-to-face coordination during LOGPAC operations.

(3) The battalion combat trains include the combat trains CP, medical platoon elements, decontamination assets (airborne only), the UMT, emergency Class V, Class III, elements of the communications platoon, and the maintenance platoon (except light). The combat trains are controlled by the S4, who is aided by the S1. Elements of the combat trains operate on the administrative/logistics net and, when possible, are linked to the combat trains CP by landline.

(4) The battalion combat trains should be close enough to the FLOT to be responsive to the forward units, but they should be beyond the range of enemy direct fires. The combat trains can expect to move often to remain in supporting distance of the combat elements. Built-up areas are good locations for trains. They provide cover and concealment for vehicles and shelter that enhance light discipline during maintenance. When built-up areas are used, battalion trains elements should occupy buildings near the edge of the area to avoid being trapped in the center. The following factors also govern the positioning of the combat trains:

(a) Communications must exist between the combat trains CP, the main CP, the field trains CP, the brigade rear CP, and forward units.

(b) Room for dispersion and cover and concealment from both air and ground observation is desirable.

(c) The ground must support vehicle traffic.

(d) A suitable helicopter landing site should be located nearby.

(e) Routes to LRPs or to company positions must be available.

(f) Movement into and out of the area must be unrestricted.

(5) The field trains are in the BSA and are controlled by the HHC commander. They include the PAC, the S4 section (–), the mess section (except light), the company supply sections, the remainder of maintenance (except light), all support platoon elements that are not forward, and the field trains CP. The field trains CP is vital to sustainment operations (Appendix B). At the CP, the HHC commander supervises all elements at the field trains. He receives requirements and information from the S1 and S4; he advises the appropriate element (PAC, S4 section, support platoon, company supply sections, maintenance section [–], FSB/FAST, or brigade rear CP) and ensures it acts on the information provided. The HHC commander and other CP personnel ensure the sustainment plans and requirements developed by the battalion staff are executed by those responsible at the field trains and at the BSA.

(6) The BSA is the part of the brigade rear area that is occupied by the brigade's CSS assets. These assets include the brigade rear CP, battalion field trains, trains of supporting units' (field artillery, engineers, and soon), FSB/FAST, and possibly selected COSCOM elements.

## 8-16. RESUPPLY TECHNIQUES

The battalion uses several techniques to resupply subordinate elements. These techniques involve the use of battalion logistical assets (personnel and equipment).

a. The most efficient resupply of forward units is accomplished by LOGPACs. These are organized in the field trains by the company supply sergeant under the supervision of the HHC commander and the support platoon leader. One is organized for each company and separate element in the battalion and is moved forward daily. When possible, all LOGPACs are moved forward in a march unit, under the control of the support platoon leader. Special LOGPACs are organized and dispatched as required by the tactical situation and logistical demands.

(1) The battalion S4 must plan and coordinate LOGPAC operations to ensure full support of the commander's tactical plan. Battalion SOP establishes standard LOGPAC composition. Vehicle type and quantity provided for LOGPAC execution varies based on the type of battalion and on the battalion's task organization. The LOGPAC supporting the company should provide, as much as possible, the supplies, equipment, and soldiers required to sustain the company for the next 24 hours or until the next scheduled LOGPAC.

(2) A company LOGPAC is ready to move forward under the control of the company supply sergeant once it has been formed (in the field trains). The support platoon leader organizes a convoy for the movement of all company LOGPACs. The convoy might contain other vehicles, such as another ammunition vehicle for the combat trains or a maintenance vehicle (less light) with Class IX. The LOGPACs move along a supply route to an established logistical release point where the 1SG or unit guide takes control of the company LOGPAC. Because the company has no organic vehicles, LRPs must be located near the company position to ease linkup. Procedures for communications must also be established to ease linkup.

(3) The company 1SG or guide controls the LOGPAC from the LRP and conducts resupply (FM 7-10). The 1SG informs the company supply sergeant of requirements for the next LOGPAC, and he ensures that soldiers and equipment requiring movement to the rear, as well as outgoing mail, return with the supply sergeant. The LOGPAC then follows unit SOP and returns to the LRP or to the combat or field trains.

(4) The S4 chooses logistical release point locations based on the tactical situation. Locations should be well forward and easily located. LRPs, supply routes, combat trains, and field trains locations are included on the operations overlay, if possible, or on a service support overlay. The combat trains CP notifies subordinates and the field trains CP, well in advance, which LRP(s) will be used. The LOGPAC convoy arrival time at the LRP and the length of time it remains are established by SOP. If the tactical situation dictates otherwise, the S4 must state the time and inform the units

accordingly. Because vehicles are limited, subordinates must ensure that the resupply vehicles are returned to the LRP ASAP so that they can return to the field trains and begin preparation for the next mission. If the LOGPAC cannot be completed on schedule, the combat trains CP must be notified.

(5) At least one senior representative from the combat trains (S4, S1, or senior NCO) should be present at the LRP while it is in effect. He meets with the unit first sergeants, separate element guides (support platoon, mortar platoon, and soon), and support platoon leader. They coordinate logistical requirements and ensure an efficient release and return of the LOGPAC. A brief meeting is held just before the 1SG picks up his LOGPAC. Coordination can include the following:

- Changes in logistical requirements that reflect last-minute task organization.
- Reports on soldiers, logistics, and maintenance from the first sergeants.
- First-hand updates on the tactical and logistical situation.
- Delivery and receipt of unit mail and distribution.

(6) The company supply sergeant or support platoon leader moves the LOGPAC from the LRP back to the field trains. The supply sergeant and support platoon leader then begin organizing the next LOGPAC.

b. The battalion can place (pre-position or cache) supplies on the battlefield and direct companies to these supplies. The battalion pre-positions supplies and equipment along the route to or at the location where the company is moving. Though this technique can be employed in both offensive and defensive operations, it is associated with defensive operations for which supplies are positioned in subsequent battle positions. For the pre-positioned supplies to be accessible in a fluid tactical environment or so they can be destroyed if the unit is compromised, control and coordination are critical.

c. Resupply originating from the combat trains in response to an urgent need by one or more of the companies is executed using either the LOGPAC or pre-positioning technique. Resupply from the combat trains is usually limited to distribution of supplies (Class III, V,

and water) located at the combat trains for the purpose of immediate, unplanned resupply.

d. Companies in an assembly area either procure supplies within their sector from support platoon assets or acquire supplies from established battalion supply points. Companies must precisely identify requirements, LZs/DZs, and pickup zones for aerial resupply. The S4 ensures that support personnel are skilled in both internal and external aircraft loading and that the battalion has the required air items (cargo nets, slings, and rigging equipment). Sling-loading, which is a useful technique for lightening the soldier's load, should be used whenever possible. Enemy air defenses might limit aerial resupply operations to periods of limited visibility. Helicopter-delivered demolitions and ammunition must be unpacked before delivery. This reduces the need to conceal the refuse.

### 8-17. TRAINS SECURITY

Battalion CSS assets are vulnerable to enemy attack. The main function of combat and field trains is to sustain the force—not to engage in combat. Limited firepower and defensive personnel, and the critical role of sustainment, make CSS assets a good target for the enemy. Protection of these assets against guerrillas, partisans, and other enemy forces is crucial to the success of all combat operations.

a. The battalion S4 is responsible for trains security when the unit is operating in a unit trains configuration. When trains are echeloned, he is responsible for combat trains security, and the HHC commander is responsible for field trains security.

b. Indirect fires must be planned in support of both combat and field trains as well as along battalion supply routes.

(1) Requests for preplanned targets in support of the combat trains and along the supply route(s) back to the battalion rear boundary are coordinated with the battalion S3 and FSO.

(2) Requests for preplanned targets in support of the field trains and along the battalion supply route within the brigade rear area are coordinated through the brigade S4 or through the FSB commander/FASCO to the brigade S3 and FSO.

(3) The battalion logistics overlay should contain all approved preplanned targets in support of the combat trains and field trains and along the supply route from the field trains to the company LRP.

(4) The approved fire plan on the logistics overlay should be disseminated to the lowest level possible. It should be sent to representatives of each section who are positioned at either trains location and to all vehicle drivers, both organic and those in support of the battalion, who travel the battalion's supply route.

c. A perimeter defense is planned in all trains areas. Each section is assigned a sector to defend. Automatic weapons or vehicles armed with heavy machine guns are positioned in mutually supporting positions that cover likely avenues of approach. Soldiers are assigned individual positions that tie into the overall defensive plan. Replacements awaiting transportation to forward or rear are incorporated into the trains defensive plan. Soldiers' positions should be near their work/sleep location. Reaction forces, local patrols, and OPs are established based on unit SOP. To enhance security, an alarm or warning system is arranged. Sector sketches, fire plans, and obstacle plans should be prepared. Rehearsals are conducted to ensure that each soldier knows his part in the defensive scheme. A 24-hour shift schedule for operations and security is established.

d. Battalion field trains are located in the BSA. Thus the HHC commander must coordinate his positioning and defensive plan with the brigade S4 or FSB commander/FASCO. They ensure that the battalion field trains defensive plan complements the plans of other units positioned in the BSA. The overall BSA defensive plan must be understood by all participating units.

e. Combat trains security, especially in light infantry battalions, can be attained through passive measures. These measures ensure strict noise and light discipline and restrict traffic in the selected location.

f. Single, unescorted vehicles provide a lucrative target for the enemy. Resupply vehicles are more secure when traveling in convoy with



LOGPAC operations and when they mount automatic weapons or heavy machine guns.

### 8-18. COMMAND AND CONTROL

The battalion XO supervises CSS command and control. The S4 routinely coordinates all logistics operations based on the XO's guidance. Combat trains CP and the field trains CP are the command and control facilities.

a. The combat trains must know the tactical situation and task organization; monitor the battalion command net to identify CSS requirements; and receive requests, reports, and requirements from battalion subordinate elements over the administrative/logistics net. Requirements are analyzed, consolidated, and forwarded to the field trains CP or to the appropriate supporting agency. The combat trains must be prepared to perform as the battalion alternate CP.

b. The field trains CP, established by the HHC commander, is the coordination and control center for the support platoon, PAC, maintenance platoon (-) (except light), and battalion and company supply sections. Personnel from these sections operate the field trains CP under supervision of the HHC commander. The HHC commander coordinates requirements for battalion organic and attached elements with units in the BSA and parent units as necessary.

c. The unit-level logistics system (ULLS), operating on the unit-level computer (ULC), provides the infantry battalion with an automated CSS capability. The module is for unit maintenance/PLL. Transactions automatically update data within the files, which are stored on magnetic tape. The ULLS interfaces with the Standard Army Maintenance System and Standard Army Retail Supply System (SAMS-1 and SAM-1).

### 8-19. COMMUNICATIONS

The administrative/logistics radio net is used for most CSS traffic. However, at battalion level, CSS communications can be via any combination of FM radio, mobile subscriber equipment

(MSE), courier, computer, or wire. Lengthy reports should be sent by messenger, wire, computer, or tactical facsimile (FAX).

a. The combat trains CP is the NCS for the administrative/logistics net. The S4, S1, HHC commander, BMT (less light), support platoon leader, medical platoon leader, company XOs or ISGs, and others (as required) operate in the battalion administrative/logistics net. The combat trains CP also operates in the brigade administrative/logistics net and in the battalion command net.

b. The main CP and combat trains CP should be positioned, when wire is available and circumstances permit, so wire can be used as the main means of communication between them. Wire allows a constant flow of information between the CPs. It also enhances the ability of the combat trains CP to stay abreast of the tactical situation and thus to provide better support. Wire communications produce no electronic signature, and therefore are more secure than radio. When MSE is fielded, wire is needed only as a backup means of communication.

c. Communications are critical in expediting CSS. Units must report their losses and requirements as soon they can. When radio cannot be used, messages are sent with resupply or evacuation vehicles. The combat trains CP and field trains CP maintain control of vehicles moving forward to the LRPs. In case communications are not possible, battalion SOP establishes procedures for resupplying units without requests. Dedicated company supply vehicles require radio communications.

d. The Tactical Army CSS Computer System (TACCS) is used in some infantry battalions to process SIDPERS data input. This system is maintained in the battalion field trains and is connected by electronic data link or through the exchange of disk media to the brigade S1 and AG channels. The system is the key to the automated maintenance of a battle roster system. From the roster, personnel data can be collected quickly for casualty reporting, strength accounting, manifesting, and replacement operations.

## Section IV SUPPLY SYSTEM

The supply system provides many types of supplies to the battalion. The most important are ammunition, repair parts for weapons systems, water, subsistence, and POL. To ensure continuous support, the leader ensures supplies are provided as far forward as the tactical situation permits.

### 8-20. OPERATIONS

The battalion maintains combat-essential supplies and repair parts called *basic loads* and *prescribed load lists*. The minimum stockage level for these loads is directed by division or higher-level command. This stockage level enables a unit to sustain itself in combat for a limited time, until either the supply system is established or is interrupted.

a. The battalion uses the following two methods to replenish its stock of supplies:

(1) **Supply point distribution.** The battalion support platoon uses organic transportation to go to the supply point and acquire supplies.

(2) **Unit distribution.** Supplies are delivered to a unit by transportation assets other than its own. The battalion employs unit distribution to resupply its subordinate elements (LOGPAC and pre-position). When feasible, supplies are shipped directly to the battalion from the issuing agency (DISCOM, COSCOM, or higher). They are usually shipped no farther forward than the field trains. An exception is Class IV issued in bulk for deliberate defense preparation. It is delivered as close to the defensive position as possible.

b. The battalion S4 uses established requisition channels, regardless of the issue method employed. The commander determines distribution priorities based on recommendations from the S4. These priorities must be consistent with the operational requirements of the battalion.

### 8-21. CLASSES











The ten classes of supply are shown in Figure 8-1.

a. **Class I.** This class of supply includes subsistence items.

(1) The battalion deploys with a basic load of subsistence (rations). For Class I, this is usually a three-day supply of MREs.

(2) Class I is requested based on the daily strength report. The DISCOM ration

breakdown point provides rations, based on battalion strength, to the supply company of the FSB. The battalion mess section picks up rations from the supply company's Class I section.

| CLASS     | SYMBOL  | CLASS      | SYMBOL  |
|-----------|---|------------|---|
| CLASS I   |    | CLASS VI   |    |
| CLASS II  |    | CLASS VII  |    |
| CLASS III |    | CLASS VIII |    |
| CLASS IV  |  | CLASS IX   |  |
| CLASS V   |  | CLASS X    |  |

**Figure 8-1. Classes of supply.**

(3) Rations requiring preparation (A-rations, B-rations, and T-rations) are prepared in the field trains. They are delivered to companies and attached units during LOGPAC operations. In a light infantry battalion, the support platoon picks up rations prepared by the brigade mess platoon and delivers them during LOGPAC operations.

(4) Water is not a Class I supply item, but is delivered forward with Class I in water cans, trailers, collapsible drums, or pillow tanks filled at the BSA location. The forward support company of the light infantry DISCOM delivers water to the light infantry battalion trains. Depending on the environment, water can be one of the most critical supply items in the area of operations. Units should always be prepared to use natural water sources (and to purify water

from these sources) to help reduce the logistical burden. In areas where each soldier should use between 3 and 12 gallons of water each day, resupply is a constant challenge. If routine delivery is insufficient, company supply sergeants might have to keep water moving forward constantly. Aerial resupply of water cans or bundles of full canteens can become routine. Refilling each soldier's water container as often as possible is mandatory.

**b. Class II.** This class of supply includes general supplies such as clothing, individual equipment, NBC clothing, tentage, and organizational tool sets.

(1) Units must deploy with sufficient quantities of Class II items to last until the supply system is set up.

(2) The S4 section (-) in field trains requisitions needed Class II supplies from the FSB's supply company. These supplies are provided to the companies during LOGPAC operations.

**c. Class III.** This class of supply includes petroleum, oil, and lubricants.

(1) Battalion vehicles and spare fuel cans are filled before operations. They are kept as full as possible throughout the operation.

(2) The quantity of bulk Class III on hand in the FSB supply company is based on forecasts made by the battalion S4s as reviewed, consolidated, and forwarded by the brigade S4. These forecasts or projections reflect the anticipated fuel quantities required to sustain the battalion for a specified time.

(3) The battalion support platoon obtains bulk Class III from the Class III section of the supply company in the BSA. If the situation dictates and transportation assets allow, the supply company can provide bulk Class III as far forward as the battalion combat trains.

(4) The support platoon provides resupply to companies and attachments by using TPUs, 600-gallon fuel pods, collapsible fuel drums, or 5-gallon fuel cans (depending on the type of battalion). Due to the limited quantity of vehicles that can haul Class III, a supply point is established in the combat trains. Exchange of empty fuel cans for full ones is the normal method of resupply in the infantry battalion (light) for vehicles positioned forward (mortar platoon, antiarmor platoon, and so on).

(5) The S4 section obtains packaged POL products, including weapons' lubricants and cleaners, from the supply company. Supplies are then transported to the requiring unit during LOGPAC operations.

**d. Class IV.** This class of supply includes construction, barrier, and fortification materials such as wire, lumber, and cement.

(1) Class IV materials are requisitioned from the FSB's supply company. However, due to its limited availability and to its transportation and MHE requirements, Class IV is often a command-controlled item.

(2) COSCOM or DISCOM transportation assets deliver Class IV materials. Materials are carried as far forward as possible to reduce handling; they should be prepackaged or preconfigured to suit the mission. Coordination with the battalion engineer allows Class IV (and Class V) to be delivered as close to the emplacement site as possible. Sufficient manpower or MHE must be available. Traffic control points must be used in moving material forward to the proper sites. Sling-load operations are a viable method of deploying material forward when the air defense environment permits. Since infantry companies must usually reposition these materials by hand, each delivery point must be manned to ensure materials are emplaced properly.

**e. Class V.** This class of supply includes ammunition.

(1) Class V supply is based on a required supply rate (RSR) determined by higher-level tactical planners and a controlled supply rate (CSR) determined by higher-level logistical planners. The CSR is based on the amount of ammunition (by type) that can be provided. This depends on the quantity available, transportation assets, and other logistical considerations. The CSR for weapons systems is expressed as rounds per weapon per day. Allocation for other types of ammunition, such as hand grenades, is expressed as rounds (or pounds) per person per day. When a CSR is in effect for a type munition, the battalion is limited in the quantity it can receive.

(2) The FSB's supply company establishes an ATP in the BSA COSCOM or DISCOM transportation assets deliver the battalion's ammunition to the ATP, where support platoon personnel pick it up. The corps ASP, located

near the division rear boundary, provides backup capability to meet surge and unusual requirements. To speed resupply, the division ammunition officer can direct units to draw ammunition from a nearby ASP rather than an ATP.

(3) Class V is delivered to companies during LOGPAC operations. Ammunition is also positioned in the combat trains to provide for the emergency needs of a company or attached element.

(4) The configuration of ammunition in the light infantry soldier's load is critical to ammunition support operations. Commanders must consider the sustainment requirements and ammunition-carrying capabilities of their soldiers.

f. **Class VI.** This class of supply includes personal demand and morale items such as candy, cigarettes, soap, and cameras (nonmilitary sales items), and sundry packs. When an Army exchange is not available, the S1 submits requests for Class VI support through supply channels. Resupply flow is the same as for Class I resupply.

g. **Class VII.** This class of supply includes major end items. A major end item is the final combination of end products, parts, and materials that is ready for its intended use—for example, a vehicle or weapon.

(1) Class VII items are issued based on battle loss reports or formal requisitions submitted by the S4 section to the FSB's supply company.

(a) Large items (vehicles and TOW missile systems) are delivered to the battalion field trains by DISCOM or COSCOM assets.

(b) Smaller items (M16s, compasses, and so on) are picked up from the supply company's distribution point.

(2) Class VII for light infantry battalions is limited to combat-essential items needed to support combat readiness of systems selected by the division commander. Critical Class VII items are transported in a ready-to-use condition to the BSA or using unit. Noncritical items are requested and handled as normal supply transactions. All end items are delivered to the BSA and picked up by the battalion support platoon or delivered to using units by division assets.

h. **Class VIII.** This class of supply includes medical materials, including supplies such as bandages, syringes, stretchers, drugs, and repair

parts peculiar to medical equipment. The medical platoon obtains medical supplies from the medical company in the BSA. These supplies are distributed by evacuation vehicles returning from the BSA to the BAS and from the BAS to the company team. Packaged and inventoried combat aid bags are replaced for used ones at the BAS. The medical platoon leader coordinates with the S4 for more supplies as required or based on the S1 loss estimate and projection for mass casualties situations.

i. **Class IX.** This class of supply includes repair parts, including kits, assemblies and sub-assemblies-repairable or unrepairable—that are required for maintenance support of all equipment.

(1) Repair parts are issued in response to a specific request or by reparable exchange. The battalion obtains repair parts from the Class IX supply point in the BSA. Parts are moved forward during routine LOGPAC operations or as required. The maintenance platoon requests Class IX items (less reparable exchange) from the FSB maintenance company. Reparable exchange is exchange of an unserviceable item, with an attached request for issue or turn-in, for a serviceable item. In combat, commanders can approve cannibalization of disabled equipment to repair other equipment for return to combat.

(2) The brigade provides Class IX repair part support for a light infantry battalion. Battalions request supply support for all Class IX requirements (less QSS and major Class IX subassemblies) by submitting single line requests for issue or turn-in to the brigade maintenance section. Low-dollar value, high-demand parts (light bulbs, wiper blades, and common nuts and bolts) are obtained from the repair parts QSS without formal requests.

j. **Class X.** This class of supply includes materials (not included in Classes I through IX) to support nonmilitary programs such as agriculture and economic development. The S4 requests Class X items based on civil-military requirements. The division or higher provides specific instructions for request and issue of Class X supplies.

k. **Miscellaneous.** Supply items other than the ten classes of supply include water, maps, salvage, captured materiel, and so on.

## Section V MAINTENANCE SUPPORT

Maintenance support includes inspecting, testing, servicing, repairing, requisitioning, and recovering. Repair and recovery are completed as far forward as possible and at the lowest capable echelon. When equipment cannot be repaired on site, it is moved only as far as it has to be for repair. When not all battalion maintenance requirements can be met, the XO sets priorities based on operational requirements and on the recommendations of the S4 and BMO/BMT.

### 8-22. TERMINOLOGY

The following are explanations of some common maintenance terminology:

a. **Maintenance Support Team.** The MST is a mobile team from the FSB maintenance company. It is organized and equipped to provide forward support.

b. **Unit Maintenance Collection Point.** The UMCP is a facility operated by the battalion or light infantry brigade maintenance platoon/section. It is the first place where battalion maintenance teams recover equipment and where some DS maintenance is performed.

c. **Controlled Exchange.** This refers to the removal of serviceable repair parts from unserviceable but repairable vehicles (end items) and the installation of those parts on like vehicles (end items) to restore them to operation.

d. **Cannibalization.** This refers to the removal of serviceable and unserviceable (repairable) parts from damaged (unrepairable) equipment. This technique is used to keep as many combat systems in the battle as possible.

e. **Battle Damage Assessment and Repair.** BDA is an inspection of battle damage to learn its extent, to classify the type of repairs required, and to determine the maintenance activity best suited to accomplish the repair. It is the immediate repair of equipment by field-expedient methods.

### 8-23. CATEGORIES OF MAINTENANCE

The Army maintenance system consists of four categories of maintenance—unit, direct support, general support, and depot.

a. **Unit.** Unit maintenance consists of preventive maintenance tasks performed by the

operator, crew, and unit mechanics. Unit mechanics use test equipment to isolate faults, inspect visually, make minor adjustments, and repair end items by exchanging faulty modules and parts. These actions can be performed on site or in the UMCP. Unit mechanics also perform recovery tasks.

b. **Direct Support.** DS mechanics diagnose and isolate equipment or module failure, adjust and align modules and parts, and repair defective end items. MSTs from the FSB can operate from the UMCP. If equipment cannot be repaired in the UMCP due to time constraints, workload, or the tactical situation, the equipment is recovered to the maintenance company in the BSA for repair.

c. **General Support.** GS maintenance involves repair of modules and parts by replacing internal pieces or parts, and repair of end items involving time-consuming tasks.

d. **Depot.** Depot maintenance personnel rebuild end items, modules, parts, and assembling, perform cyclic overhaul; perform inspections; and complete modifications requiring extensive disassembly or elaborate testing.

### 8-24. MAINTENANCE PROGRAM

Combat power is increased when disabled equipment is repaired as far forward and as fast as possible. The BMO, in coordination with the XO, directs the maintenance effort for the battalion. In doing so, he uses established time guidelines and coordinates maintenance actions. The battalion S4 is the main proponent in the light infantry battalion. He is aided by a maintenance NCO who coordinates and monitors battalion maintenance support.

a. **Preventive Maintenance.** Preventive maintenance is the keystone of a good maintenance program. It includes systematic service, inspection, and correction of failures before damage occurs. It also includes detection and correction of abuse and instruction in the proper care and use of equipment. PMCS requires a joint effort between equipment operators, crews, and unit maintenance personnel. The operator or crew uses the PMCS table in the equipment technical manual for daily inspection and maintenance. This table lists before-, during-, and after-operation checks and services. The operator and crew also aid unit mechanics with scheduled maintenance. A systematic and thorough PM program prevents minor problems from becoming major problems, which would require extensive repair. Preventive maintenance must be scheduled at definite intervals, as the tactical situation allows. Periodic announced and unannounced inspections and spot checks must be conducted by company, battalion, and DS units to ensure that the program is being implemented.

b. **Repair Decisions.** Equipment should be repaired as far forward as possible, consistent with the tactical situation and with available maintenance skills, tools, and equipment. Maintenance allocation charts (MACs) in technical manuals identify which level of maintenance is capable and authorized to perform specific repairs.

(1) Equipment is repaired on-site if possible. Battalion and DS maintenance teams perform on-site repairs within maintenance time criteria from the commander. Ideally, these repairs are made when repair teams are safe from enemy direct-fire weapons and when the site is secure. However, sometimes the criticality of the inoperable equipment warrants on-site repairs under less favorable conditions. At such times, the commander must balance mission benefits against the cost to long-term maintenance capability that could result from the loss of skilled maintenance personnel.

(2) Equipment is recovered to the UMCP in the combat trains area or to an MCP in the BSA if on-site repair is impossible. Consolidation of maintenance activities in the UMCP reduces exposure of repair teams to enemy fires, eliminates travel times for on-site repairs, and provides a pool

of manpower and equipment for anticipated requirements. Maintenance teams from the battalion and from DS maintenance are employed at the UMCP as required. Also, equipment is recovered to MCPs in the BSA if it requires maintenance that is unavailable at the UMCP.

(3) The tactical situation and the criticality of the equipment to the battalion mission must always be considered when repair decisions are made. Therefore, responsible maintenance personnel must maintain close and continual liaison with the battalion S3 and unit commanders to ensure that responsive support is provided. The commander must establish priorities for commodities.

(4) BDA is an estimate of required repair time. Depending on the results of the BDA, an item is repaired on site or recovered directly to the appropriate maintenance echelon in the appropriate support area based on the following factors:

- Tactical situation.
- Echelon of work required.
- Availability of required repair parts.
- Current workload in each area.
- Maintenance time guidelines.

(5) Maintenance time guidelines establish the most time that unserviceable equipment can remain in various support areas.

(6) Responsible use of controlled exchange or cannibalization, when authorized, is critical in the often austere environment of the infantry battalion. Improvisation and field-expedient recovery and repair are vital for effective short-term solutions to maintenance problems.

c. **Communication Equipment.** Company communications personnel perform unit maintenance on communication equipment. Signal equipment requiring repair is sent to the communications platoon. If the deficiency is such that it requires DS maintenance, the equipment is recovered to the FSB in the BSA. Signal cryptographic equipment that cannot be repaired by the communications platoon is recovered to the division signal battalion.

d. **Medical Equipment.** The battalion medical platoon performs unit maintenance on

medical items. Medical equipment requiring maintenance above the unit level is recovered through medical channels to the DISCOM medical company in the BSA.

e. **Weapons.** Soldiers, crews, and company armorers perform unit maintenance on weapons. Weapons requiring recovery are sent to the FSB in the BSA.

f. **Other Types of Materiel.** Equipment requiring evacuation, except for ordnance, signal, medical equipment, and vehicles, is sent to the FSB in the BSA. The following special considerations apply:

(1) **Vehicles.** The commander recovers his own disabled vehicles. However, recovery of vehicles disabled or abandoned in combat is the responsibility of the command in whose area they are found. These vehicles are recovered

promptly to prevent their destruction or capture by the enemy. Recovered vehicles are inspected and repaired by normal repair and placed in operation at the lowest level possible by controlled exchange, IAW established policies. The aim is to get them quickly back into the fight. Vehicles requiring extensive repairs or salvage are either towed to the next higher maintenance agency/collecting point or are reported. The report includes the location, number, type, and condition of the vehicle.

(2) **Equipment.** Abandoned equipment must be recovered cautiously. The recovery team must ensure that weapons systems are unloaded and that the abandoned equipment is not booby-trapped. If NBC weapons have been used, the abandoned equipment might be contaminated.

## Section VI FIELD SERVICES

Unless nondivisional teams augment the DISCOM, the FSB in DS of the brigade does not have clothing exchange, bath, laundry and renovation, or bakery services. When the mission dictates, the brigade S4 should coordinate requests for these services with the division FSB/FASCO.

### 8-25. MORTUARY AFFAIRS

Mortuary affairs, when provided, operates under the supervision of the FSB supply company. At battalion level, it has three functions: collection, identification, and evacuation. Casualty feeder reports (DA Form 1156) and witness statements (DA Form 1155) are completed by a soldier who knows how the casualty died. The casualty's military equipment is collected and turned over to the supply sergeant during LOGPAC operations. Remains are placed in a body bag along with personal effects. The completed DA Forms 1155 and 1156, the remains, and personal effects are evacuated by LOGPAC vehicles returning to the field trains. If necessary, companies evacuate remains to the supply route and report the location to the combat trains CP; a collection point can be established at the combat trains under the control of the S4. Remains are evacuated as quickly as possible to the brigade collection point in the BSA (FM 10-63-1 provides more details.)

### 8-26. CLOTHING EXCHANGE AND BATH SERVICES

Clothing exchange and bath services are established in or near the BSA when they are available through augmentation from division or corps. These services, supervised by the supply company, provide uniform/clothing exchange (dirty for clean) and showers. A unit requesting this service must specify the sizes of clothing needed for exchange and must be prepared to furnish soldiers to aid in the operation.

### 8-27. SALVAGE

The FSB supply company provides salvage services. A salvage collection point is established in the BSA. Serviceable excess, unserviceable (repairable), discarded, abandoned, and captured supplies and equipment are received at a salvage collection point in the BSA. The salvage point does not accept COMSEC or medical supplies, toxic agents, radioactive materials, aircraft, explosives,

ammunition, and contaminated equipment. This salvage point evacuates materials to the division support area but does not renovate or retain them.

#### 8-28. LAUNDRY AND RENOVATION

The COSCOM provides this service, which includes cleaning and mending soldiers' uniforms.

#### 8-29. AIRDROP

Airdrop support units are allocated to the corps and theater, but only the airborne division has organic airdrop support. Airdrop resupply missions are classified as either preplanned or

immediate. Procedures for requesting airdrop resupply are detailed in FM 100-27. (FMs 55-2, 57-230, and 100-27 provide more details on airdrop resupply to include its advantages and disadvantages.) The unit receiving airdrop resupply support must—

- a. Select, mark, and secure the DZ.
- b. Ensure the safety of the DZ during the airdrop operation.
- c. Recover the supplies/equipment provided by airdrop.
- d. Recover and evacuate airdrop equipment, if time and the situation permit.
- e. Perform CCT functions in the absence of an Air Force CCT (DZST).

## Section VII PERSONNEL SUPPORT

Personnel support encompasses many CSS functions that sustain soldiers' morale and welfare. These include personnel services support, religious support, legal services support, finance support, public affairs support, health services support, and disposition of enemy prisoners of war.

#### 8-30. PERSONNEL SERVICES SUPPORT

The battalion S1 supervises personnel service support, which includes the following:

a. **Replacement Operations.** Replacement operations plan for and coordinate the support and delivery of replacements and RTD soldiers. This includes issuing orders, accounting for personnel, providing logistical support, processing, and transporting. In the field trains, the PAC monitors replacement flow. The HHC commander establishes a replacement receiving point in the battalion field trains and notifies the brigade S1 of its location. The division is responsible for delivering all replacements to their point. The division AG manages hospital returnees as replacements if they have been evacuated beyond the BSA clearing station. All replacements or returnees are brought to the replacement receiving point for initial processing then moved with the daily LOGPAC forward to their teams. Returnees from the BSA clearing station are released directly to their battalion field train location. Replacements are equipped with necessary

field gear before departing the field trains (Figure 8-2).

b. **Strength Management.** Strength management assesses the unit's personnel strength and anticipated future operations, and it assigns replacements accordingly. Companies submit a PDS to the battalion S1 in the combat trains CP. The S1 forwards a battalion consolidated report through brigade to division. The PAC in the field trains is furnished an information copy. These reports, together with authorized position vacancies, are the basis for requesting individual replacements. Accurate strength reports also provide the commander and staff with information to plan future operations. Reports covering the past 24 hours are submitted to the combat trains CP daily. Unit SOP describes this report (Figure 8-3, see page 8-20).

c. **Personnel Accounting and Strength Reporting.** The S1 must ensure that strength reporting occurs in a timely and accurate manner during combat operations. This system accounts for soldiers, reports their duty status, and allows input for the personnel estimate.



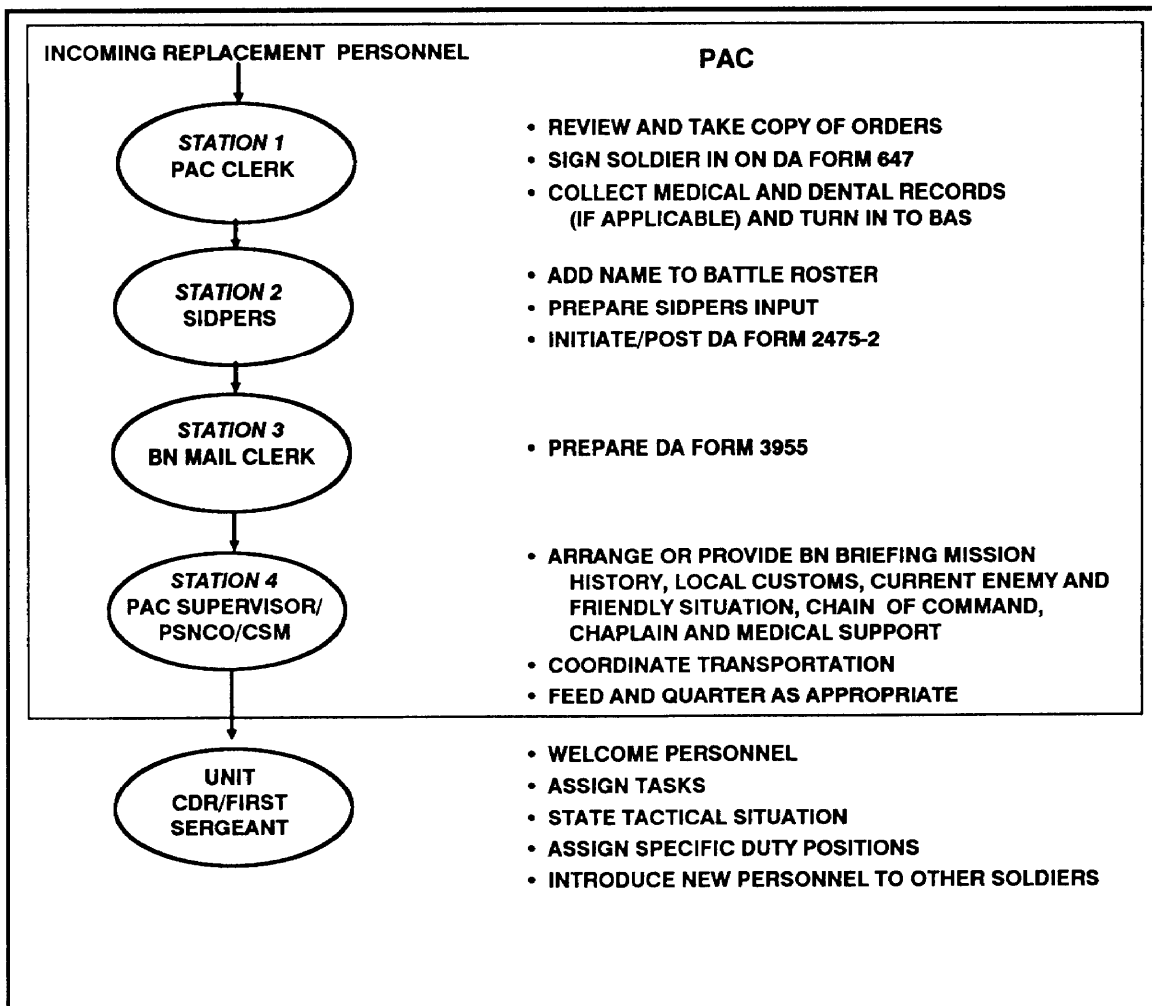

**Figure 8-2. Battalion replacement operations.**

d. **Casualty Reporting.** The S1 must ensure that casualty reporting occurs in a timely and accurate manner during combat operations (Figure 8-4, see page 8-21).

(1) Casualty reports provide the detailed information necessary to requisition specific replacements. The Casualty Feeder Report (DA Form 1156) is carried by all small-unit leaders to report battle/hostile action casualties and nonbattle/nonhostile casualties. It provides initial information to the AG for preparing the report that is used by DA to notify next of kin (NOK). The report also validates the soldier's line of duty status. This status determines the benefits paid. When a soldier is reported "missing" or "missing in action," or when the

remains are not under US control, a Witness Statement (DA Form 1155) accompanies the Casualty Feeder Report.

(2) Casualties are reported to the 1SG, who collects the reports and forwards them to the combat trains CP. The S1 confirms the report, requests any clarification necessary, adjusts unit strength reports, and forwards the report to the PAC. The PAC maintains a casualty log, verifies casualty data, updates the personnel data base, and forwards completed reports through the brigade S1 to the PSC.

e. **Postal Operations.** Postal operations include managing and operating a postal network to move, deliver, and collect mail in the battalion. The postal network delivers official mail,

including critical spare parts and medical supplies, and provides an alternate delivery system for personnel information.

(1) Postal support is provided by a postal element assigned to the AG unit supporting the division. The postal element receives and separates mail by battalion, then transfers it to the battalion mail clerk. The battalion mail clerk delivers mail to the company mail handlers, who deliver it to the individual soldiers. When a soldier wants to mail a letter home, this procedure is reversed. Mail is picked up or delivered along with the LOGPAC.

(2) Postal services to soldiers are limited to personal mail (incoming and outgoing) that conforms to type and size limitations prescribed by the theater headquarters.

f. **Other Administrative Services.** The S1 completes all other necessary personnel administrative actions during lulls in the battle. If possible, he can accomplish this by forming and using personnel contact teams, which move forward to company locations.

**8-31. RELIGIOUS SUPPORT**

The battalion UMT provides religious support to the battalion and supporting units as far forward as the most exposed units on the battlefield. The UMT addresses the spiritual needs of soldiers. The team performs religious rites, sacraments, ordinances, and memorial services. Other important services include pastoral care, counseling, and ministry for battle fatigue. The UMT is vital for support in mass casualty

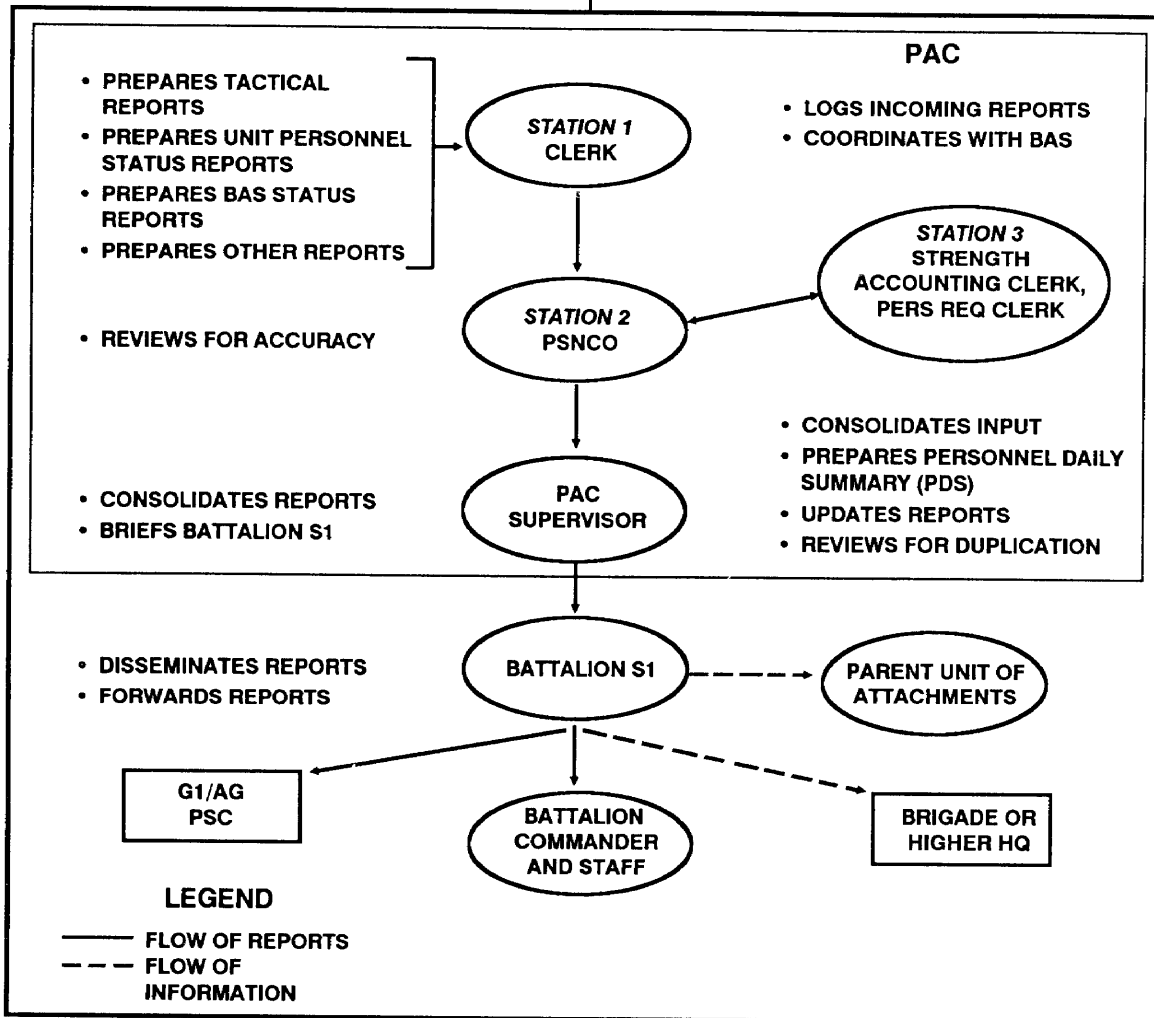

Figure 8-3. Battalion strength accounting process.

situations, mortuary affairs, unit reconstitution, and emergency religious services.

**8-32. LEGAL SERVICES SUPPORT**

Legal specialists in the battalion S1 section provide limited legal services. The corps provides more staff judge advocate support. SJA responsibilities include legal advice and aid on all matters involving military, domestic, foreign, and

international law and regulations. The SJA also supervises the administration of military justice, processes claims for and against the US government, and furnishes personal legal aid to authorized soldiers.

**8-33. FINANCE SUPPORT**

Finance support commands are assigned responsibility by battalion deployment area.

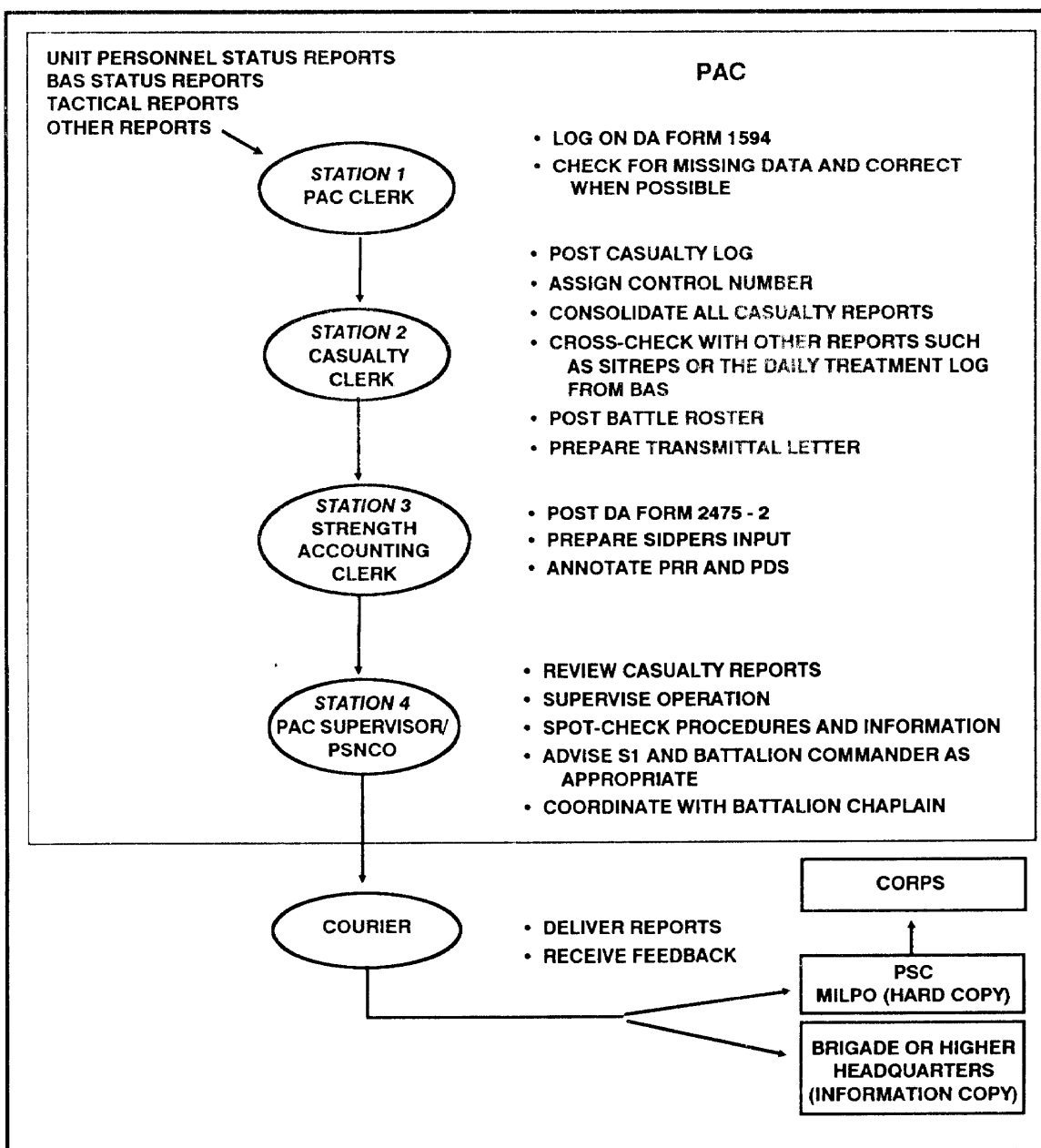

Figure 8-4. Battalion casualty reporting process.

Finance support commands provide their services through finance support teams. The teams make combat payments to soldiers in amounts established by the theater commander. Payment of lesser amounts (with the remainder held for future payment) can be authorized by intermediate commanders or by the soldiers. The commander determines when and where the soldier is paid. The S1 coordinates with the finance support command for payments and for other finance actions beyond the capability of the PAC.

#### **8-34. PUBLIC AFFAIRS SUPPORT**

Information support for the division is provided by the public affairs officer. The PAO is the commander's official spokesman on all matters related to command information, public information, and community relations. In wartime, the PAO supports the S5 in civil affairs matters that involve community relations. The PAO controls all public affairs assets assigned or attached to the division. In combat, the command must keep soldiers well-informed. A well-managed command information program dispels rumors and keeps soldiers confident and motivated.

#### **8-35. HEALTH SERVICES SUPPORT**

The medical platoon conserves the battalion's fighting strength by providing health service support (HSS) which includes preventive medicine; patient acquisition, treatment, evacuation, and stabilization; and routine medical care (sick call) services. A medical platoon is organic to each combat battalion HHC. The platoon organization consists of a headquarters section, a treatment squad (two treatment teams), an ambulance section, a combat medic section, and a combat lifesaver.

a. **Medical Platoon Headquarters.** The headquarters section, under the direction of the battalion surgeon, provides for platoon command, control, and logistics. The field medical assistant and the platoon sergeant remain in platoon headquarters. This headquarters is normally collocated with the treatment squad to form the BAS.

(1) The battalion surgeon or medical platoon leader is the medical advisor to the battalion commander and his staff and is the

supervising physician of the medical platoon treatment squad.

(2) The field medical assistant, a Medical Service Corps (MSC) officer, is the operations/readiness officer for the platoon. The field medical assistant coordinates HSS operations with the battalion S3 and S4 and coordinates patient evacuation with the supporting medical company. The field medical assistant serves as the medical platoon leader in the absence of an assigned physician.

(3) The platoon sergeant helps supervise platoon operations and serves as the ambulance section sergeant. He supervises the activities and functions of the ambulance section, including operator maintenance of ambulances and equipment, operations security (OPSEC), and emergency medical treatment.

(4) The physician's assistant (PA) is a warrant officer. He performs general technical health care and administrative duties. The PA is qualified in advanced trauma management (ATM) and works under the clinical supervision of the medical officer.

b. **Treatment Squad.** The treatment squad is the basic medical treatment element of the BAS. This squad provides routine medical care, triage, ATM, and tailgate medicine. It consists of a battalion surgeon, a PA, two EMT NCOs, and four medical specialists.

(1) The treatment squad can split into two treatment teams and operate as two separate aid stations (BAS minus) up to 24 hours. Each team deploys treatment vehicles with two medical equipment sets, one trauma set, and one general sick call set.

(2) The BAS is under the tactical control of the battalion S4 and is deployed near the combat trains. To reduce ambulance turnaround time in providing ATM to patients within 30 minutes of wounding, the BAS may split and place its treatment teams as close to maneuver companies as tactically possible. Treatment teams situated close to (within 1000 meters of) maneuvering companies on contact must be prepared to withdraw to preplanned, alternate positions on short notice.

(3) When maneuvering companies anticipate large numbers of casualties, augmentation of the medical platoon with one or

more treatment teams from the forward support medical company should be made. Augmentation treatment teams are under the tactical control of the battalion S4 but are under the operational control of the battalion surgeon. Patients are triaged (sorted), as the treatment squad receives them, according to the extent of their injuries. The triage categories are as follows:

(a) *Minimal*: Those patients who have minor injuries and can be expected to return to duty quickly.

(b) *Delayed*: Those patients who require medical treatment but can await treatment without endangering life, limb, or eyesight.

(c) *Immediate*: Those patients who without immediate medical treatment are in danger of losing life, limb, or eyesight.

(d) *Expectant*: Those patients whose injuries are so severe that they are beyond the medical capability of sustaining life.

(4) At the BAS, patients requiring further evacuation to the rear are stabilized for movement. Constant efforts are made to prevent unnecessary evacuation; patients with minor wounds or illnesses are treated and returned to duty as soon as possible.

(5) Evacuation from the BAS is performed by the FSMC ambulance platoon and by corps air ambulance teams.

(6) Patient holding and food service are not available at the BAS. Therefore, only procedures necessary to preserve life or limb, or to enable a patient to be moved safely, are performed at the BAS.

c. **Ambulance Section.** Medical platoon ambulances provide evacuation within the battalion. Ambulance teams provide medical evacuation and en route care from the soldier's point of injury to the BAS. In mass casualty situations, nonmedical vehicles may be used to assist in casualty evacuation (Appendix F) as directed by the commander. Plans for the use of nonmedical vehicles to perform medical evacuation should be included in the battalion's tactical SOP (Appendix A). Under the modular medical system, the ambulance squad consists of two ambulance teams. Infantry battalions have two ambulance squads, each equipped with HMMWV ambulances.

(1) The ambulance team is a mobile combat medic team. It collects, treats, and evacuates the sick and wounded to the nearest treatment station or AXP. To do this, it must maintain contact with supported elements. For communications, the team uses an FM radio mounted on its ambulance. The team is deployed in the medical platoon's operations net; however, in certain circumstances it may operate in the S4 net or as established in the SOI. The team also provides Class VIII resupply to combat medics and serves as messengers within medical channels.

(2) The ambulance team routinely deploys with the maneuver company trains; however, it operates as far forward as the tactical situation permits, and frequently finds and treats patients who have not been seen by the company medic. This team, when operating in a company's area of operations, is normally under the tactical control of the company XO or first sergeant. However, it remains under the technical and operational control of the medical platoon. An ambulance team is normally designed to support a specific company.

(3) During static situations where the company is not in enemy contact or is in reserve, the team returns to the BAS to serve as back-up support for other elements in contact. During movement to contact, however, the ambulance trains immediately deploys to its regularly supported company. During combat operations, the team may dismount (leaving the ambulance in the trains area), find, treat, and move patients to safety, and later evacuate them to the BAS.

d. **Combat Medic Section.** To foster good interpersonal relations and morale of combat troops, combat medics are attached to maneuver companies on a continuing basis. However, during lulls in combat operations, they should return to the medical platoon for consultation and proficiency training. Functions of combat medics are as follows:

(1) Perform triage and EMT for the sick and wounded.

(2) Arrange medical evacuation for litter patients and direct ambulatory patients to patient collecting points or to the BAS.

(3) Initiate the field medical card for the sick and wounded and, as time permits, prepare an FMC on deceased personnel.

(4) Screen, evaluate, and treat, within their capability, those patients suffering from minor illnesses and injuries. Return to duty those patients requiring no further attention.

(5) Inform the company commander and the battalion surgeon (or the PA in the absence of the surgeon) on matters pertaining to the health and welfare of the troops.

(6) Maintain sufficient quantities of medical supplies to support the tactical operation.

(7) Serve as a member of the unit field sanitation team. In this capacity, advise the commander and supervise unit personnel on matters of personal hygiene and field sanitation (FM 21-10-1).

e. **Combat Lifesaver.** The combat lifesaver is a nonmedical soldier selected by the unit commander for medical training beyond basic first-aid procedures. The soldier serves as a combat lifesaver when the situation permits, but mission accomplishment always takes priority.

(1) **Combat lifesaver duties include stabilizing the casualty before he can be medically evacuated.** Combat lifesavers also help evacuate casualties.

(2) **Combat lifesavers help the morale of the unit and allow soldiers to attack more vigorously by giving them confidence that they will be cared for if wounded.**

(3) Units should strive to have one combat lifesaver for each squad-sized organization. This includes maintenance platoons and all CPs as well as maneuver units.

f. **Medical Support Matrix.** The medical support matrix provides an easy way to understand the medical support plan. It is a planning and execution technique used to explain how each maneuver element is medically supported during the battle (Appendix F).

### **8-36. DISPOSITION OF ENEMY PRISONERS OF WAR**

Enemy prisoners of war are evacuated from the battalion area ASAP. Companies follow the five S's when handling EPWs. Documents with intelligence value must be removed quickly and reported to the S2 who reviews and reports documents or information of immediate value. The EPWs are evacuated on returning LOGPAC vehicles to the brigade EPW collection point, or they are moved to the supply route under guard. The location is reported to the S4 who coordinates further transportation (Figure 8-5). The S4 also coordinates the evacuation of large amounts of enemy equipment. Wounded EPWs are treated through normal medical channels, but separately from US and allied patients.

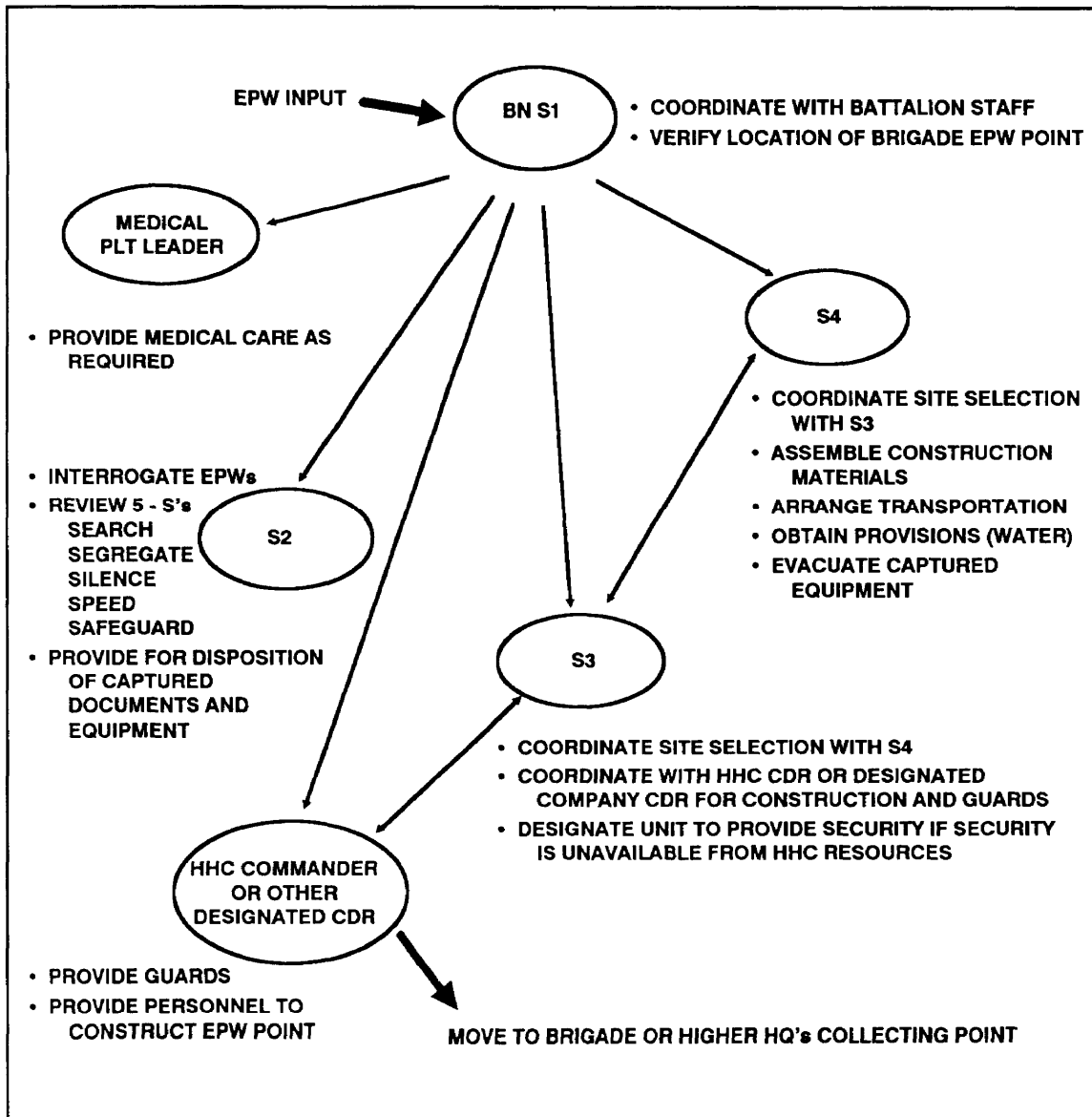

Figure 8-5. EPW collection responsibilities.

## APPENDIX A

# BATTALION TACTICAL STANDING OPERATING PROCEDURE

*This appendix provides the tactical standing operating procedure for infantry battalions. The procedure applies unless a leader makes a decision to deviate from it based on the factors of METT-T. In such a case, the exception applies only to the particular situation for which the leader made the decision.*



# BATTALION TACTICAL STANDING OPERATING PROCEDURE

(Classification)

HEADQUARTERS

\_\_\_\_\_ Battalion

(Location)

(Date)

\_\_\_\_\_ BATTALION TACTICAL STANDING OPERATING  
PROCEDURE

## SECTION I. GENERAL.

**A. Purpose.** This TSOP prescribes guidance for the conduct of sustained tactical operations. It standardizes the recurring operational routines, procedures, and responsibilities executed by both organic and supporting organizational elements throughout the battalion.

**B. Application /Scope.** This TSOP covers only wartime operations that occur after a deployment. It does not repeat doctrine, tactics, or techniques provided in FMs, TMs, and MTPs. This TSOP applies to all supporting units operating in or occupying areas within the battalion area. All TSOP provisions apply except as modified by operations orders and plans. However, no provision replaces good judgment and common sense.

### C. Directed Supporting Documents.

1. This TSOP and subordinate TSOPs incorporate all current provisions of FMs, TMs, Army and division regulations, STANAGs, joint agreements, and status-of-forces agreements.

2. Each battalion staff section develops and implements TSOPs to govern procedures in their functional area. Staff section TSOPs conform to the procedures contained in this SOP.

**D. Proponency.** The battalion XO is the proponent for this TSOP. The battalion commander ensures compliance with established TSOPs throughout the battalion; commanders and staffs at all levels monitor activities for compliance.

**E. Changes.**

1. Changes are submitted through the appropriate staff officers or company commanders to the battalion XO.

2. The battalion XO coordinates the changes.

3. The battalion commander is the approving authority.

## **SECTION II. CONTENTS.**

### **ANNEX A. COMMAND AND CONTROL**

#### **APPENDIX 1. Orders**

Warning Orders

Operation Order Format

Fragmentary Orders

#### **APPENDIX 2. Communications**

#### **APPENDIX 3. Battalion CP Organization (see Appendix B of this Manual)**

### **ANNEX B. OPERATIONS**

#### **APPENDIX 1. Priority of Work**

#### **APPENDIX 2. Aviation**

#### **APPENDIX 3. Engineer**

#### **APPENDIX 4. Air Defense**

#### **APPENDIX 5. NBC Defense**

#### **APPENDIX 6. Reliefs in Place**

#### **APPENDIX 7. Linkups**

#### **APPENDIX 8. Passages of Lines**

#### **APPENDIX 9. Assembly Areas**

### **ANNEX C. FIRE SUPPORT**

#### **APPENDIX 1. Field Artillery**

#### **APPENDIX 2. Offensive Air**

#### **APPENDIX 3. Target Numbering System**

#### **APPENDIX 4. Coordinated Surface and Air-Delivered Fire**

### **ANNEX D. INTELLIGENCE**

#### **APPENDIX 1. Intelligence Annex OPORD Format**

**ANNEX E. OPERATIONS SECURITY**  
**APPENDIX 1. Priority Intelligence Requirement**

**ANNEX F. LOGISTICS**

**ANNEX G. PERSONNEL AND ADMINISTRATION**

**ANNEX H. REPORTS AND REQUESTS**

**APPENDIX 1. Personnel Reports**

PERSTATREP  
Casualty Feeder Report  
Witness Statement  
Serious Incident Report

**APPENDIX 2. Intelligence Reports**

Patrol Report  
EPW/Captured Material Report  
SALUTE Report  
Intelligence Summary  
Air Request Reconnaissance  
MIJI Feeder  
Weather Forecast  
RFI Format

**APPENDIX 3. Operations Reports**

Results of Contact Report  
Commander's Situation Report  
Minefield Report  
Naval Gunfire Request  
TACAIR Request  
Air Support Request  
SHELREP, MORTREP, BOMREP  
Order Message  
OPLAN/OPORD Change  
Air Defense Alert Message  
Fire Support SITREP  
Deployment/Redeployment Report  
Closure Report

**APPENDIX 4. Logistics Reports**

LOGSTAT Report  
Battle Loss Report  
Resupply Insertion Request

**APPENDIX 5. NBC Reports**

NBC 1 Report  
NBC 2 Report  
NBC 3 Report  
NBC 4 Report  
NBC 5 Report  
NBC 6 Report  
NUCWARN/CHEMWARN  
Effective Downwind Message  
Chemical Downwind Message

**ANNEX I. OPSKEDs**

| <b>TASK</b>                            | <b>CODE NAME</b> |
|--|------------------|
| <b>APPENDIX 1. Movement to Contact</b> | Gold             |
| <b>APPENDIX 2. Ambush</b>              | Black            |
| <b>APPENDIX 3. Road March</b>          | Silver           |
| <b>APPENDIX 4. Patrol</b>              | Khaki            |
| <b>APPENDIX 5. Raid</b>                | White            |
| <b>APPENDIX 6. Air Assault</b>         | Gray             |
| <b>APPENDIX 7. Relief in Place</b>     | Green            |
| <b>APPENDIX 8. Defense</b>             | Pink             |
| <b>APPENDIX 9. Passage of Lines</b>    | Orange           |
| <b>APPENDIX 10. Linkup</b>             | Yellow           |
| <b>APPENDIX 11. River Crossing</b>     | Purple           |
| <b>APPENDIX 12. MOUT</b>               | Brown            |

**ANNEX A (COMMAND AND CONTROL) to BATTALION TSOP**

**1. ORGANIZATION FOR TACTICAL COMMAND AND CONTROL.**

(See Appendix B of this manual.)

**2. BATTALION COMMAND SUCCESSION.**

The succession is battalion commander, battalion XO, battalion S3, then company commanders (in order of seniority).

**APPENDIXES:** 1— Orders

2— Communications

## **APPENDIX 1 (ORDERS) to ANNEX A (COMMAND AND CONTROL) to BATTALION TSOP**

### **1. ORDERS DISSEMINATION**

Orders are delivered from commander to commander. If this cannot be accomplished, orders are disseminated IAW the following priorities:

- a. Battalion commander to company commanders.
- b. S3 to company commanders.
- c. FRAGO (TOC to company CP).

### **2. COMMANDER'S INTENT**

This item is the intent stated and disseminated by the commander two levels higher.

### **3. GRAPHICS**

Graphics should be nonrestrictive.

### **4. ORDERS GROUPS**

The three battalion orders groups include:

**a. Orders Group A.** This is used to disseminate battalion orders when the tactical situation allows maximum participation. The following personnel attend:

- Battalion commander
- Battalion CSM
- Battalion XO
- S1
- S2
- S3
- S4
- All special staff
- FSO
- Signal Officer
- ALO
- All company commanders
- Mortar platoon leader
- Scout platoon leader
- Attachments OIC/NCOIC

**b. Orders Group B.** This is used to disseminate battalion orders when the tactical situation restricts attendee availability. The following personnel attend:

- Battalion commander
- S2
- S3
- S1/S4 representative
- FSO
- Signal officer
- All company commanders

**c. Orders Group C.** This is used to plan battalion orders. The following personnel attend:

- Battalion commander
- Battalion XO
- S1 representative
- S2
- S3
- S4 representative
- FSO
- Signal officer
- Special staff (as directed by the battalion XO)

**TABS:** A — Warning Orders  
B — Operation Order Format  
C — Fragmentary Orders

---

**TAB A (WARNING ORDERS) to APPENDIX 1 (ORDERS) to ANNEX A (COMMAND AND CONTROL) to BATTALION TSOP**

The warning order format should follow the five-paragraph operation order format. The following is an example warning order:

**1. SITUATION**

This item briefly describes the enemy and friendly situations. It includes a list of attachments and detachments to the battalion.

**2. MISSION**

The commander uses the restated mission from the mission analysis for this item.

**3. EXECUTION**

This item includes the following information:

- a. Special teams or task organization within the battalion.
- b. Uniform and equipment changes (from the SOP) that apply to all, for example, drop rucksacks, or drop/pick up helmets.
- c. Special weapons, ammunition, or items of equipment (other than those in the SOP) such as mines, satchel charges, grappling hooks, or night vision devices.
- d. The tentative time schedule, which is formed on the basis of mission analysis, including—
  - (1) The earliest time of move.
  - (2) The time and place of OPORD.
  - (3) The probable execution time.
  - (4) The times of inspection and items to be inspected, if these differ from the SOP.
  - (5) Rehearsal times and actions to be rehearsed if time allows, for example, actions at the objective, formation of special teams for bridges, searches, EPWs, or other actions.
- e. Special instructions.
- f. Other general instructions as needed or by SOP.

**4. SERVICE SUPPORT**

This item includes any logistical information other than that in the battalion SOP.

**5. COMMAND AND SIGNAL**

**NOTE:** The following should be considered during the preparation of a warning order:

- Staff estimates briefing
- Time of early personnel attachments (FIST, FACs, and so on)
- OPORD



- Air mission briefing/TACAIR briefing
- Company commanders' briefbacks to battalion commander
- Strength figures to S1/S3 Air for planning
- Issue of equipment and SOIs
- COMMEX times
- Test fires and zeros (including NVDs)
- Vehicle TI/test run
- Rehearsals (squad/platoon/company/battalion/brigade)
- Distribute ammunition
- Initial/final inspections
- Refit schedule
- Reverse cycle requirements
- Religious services
- Staff/commander meetings/final briefback
- JM briefings/initial manifest call/SAT/final manifest call/load time/TOT  
(airborne units only)
- Battalion commander's final premission talk to troops
- Final sanitizing of troops
- Security sweep by S2/counterintelligence

**TAB B (OPERATION ORDER FORMAT) to APPENDIX 1 (ORDERS) to  
ANNEX A (COMMAND AND CONTROL) to BATTALION TSOP**

(CLASSIFICATION)

Copy no. \_\_\_ of \_\_\_ copies  
*Issuing headquarters*  
*Place of issue (maybe in code)*  
*Date-time group of signature*  
*Message reference number*

OPERATION ORDER NO. \_\_\_\_\_

References: *Maps, charts, other relevant documents.*

Time Zone Used Throughout the Order:

Task Organization: *This explains how the commander has organized the unit for the operation. If the organization has not changed, this item should state "no change."*

## 1. SITUATION

This paragraph contains information on the overall situation that the subordinate commanders need to understand the current situation.

**a. Enemy Forces.** This subparagraph refers to the overlay and to written products from the IPB process such as the situation template.

(1) Disposition, composition, and strength. This includes information about known enemy locations, current activities, the type of unit the friendly force is facing (for example, light infantry, mechanized or armored forces, forces equipped with T-64s or BMP 2s), and strength estimates with respect to major combat systems and personnel.

(2) Capabilities. This highlights what courses of action the enemy could execute and how much time each would require.

(3) Most probable COA. This concisely states the enemy's most probable course of action.

**b. Friendly Forces.** This subparagraph provides only the information the subordinate commanders need to accomplish their assigned missions.

(1) Higher unit. This includes the higher unit commander's mission statement (paragraph 2) and concept of the operation (paragraph 3a). It may also include a statement of intent, which precedes subparagraph 3a (often included in orders at division or higher). Each of these items is incorporated verbatim.

(2) Left unit's mission.

(3) Right unit's mission.

(4) Forward unit's mission.

(5) Unit in reserve or unit following.

(6) Units in support of or reinforcing the higher unit.

**c. Attachments and Detachments.** This subparagraph lists units attached or detached from the issuing headquarters; it lists effective times, unless this information is shown under “Task Organization” or is provided in an annex.

## 2. MISSION

This paragraph clearly and concisely states the purpose to be accomplished by the command (as this purpose relates to the main effort). Also, to further clarify the desired outcome, this paragraph lists the accompanying mission-essential task (for example, seize or destroy). The format used is WHO, for example, B Company; WHAT, for example, the mission-essential tasks; WHEN, for example, NLT 190500 Dec 91; WHERE for example, vic GL 123456; and WHY (the purpose of the mission). The mission statement should also include the type of operation (attack or defend) and the control measures that will be used (such as “objective” and “battle position”).

## 3. EXECUTION

An intent statement is included here only if the commander believes he must expand on the purpose in the higher unit mission statement included in paragraph 1b. At battalion level and below, the commander’s intent may be the same as the purpose in the mission statement. If so, it need not be restated. Intent is the commander’s stated vision. It defines the purpose of an operation and the desired end state with respect to the relationships between the force, the enemy, and the terrain.

**a. Concept of the Operation.** This is where the commander explains, in general terms, how his unit will accomplish its mission. This general statement always has the first three of the four elements that follow. The fourth is optional:

—A statement by the commander expanding on his purpose as stated in paragraph 2 (required).

—Designation of the decisive point (required).

—A statement of the array of forces. This should be a form of maneuver (for offensive actions) or a defensive pattern or technique (for defensive actions) (required).

—A brief statement of the most critical of the significant factors, unifying concepts, or principles underlying the plan, and why it is important (optional—not to exceed six sentences.)

(1) **Maneuver.** This addresses all major subordinate maneuver units by name. It includes the mission-essential task and purpose for each maneuver unit to achieve and designates the main effort.

(2) **Fires.** This describes how the tasks and purposes of fire support synchronize and complement the maneuver plan. It addresses all available fire support assets. It clearly states the commander’s intent for fire support (see Annex C). The fires paragraph also addresses the following:

—Priority of fire (to include shifting of priorities).

—Allocation of targets (such as priority targets). Identification of control of priority targets (FASCM, FPF, and so on).

---

—Restrictive fire control measures and restrictions on the use of fires.

(3) **Counterair operations.** This describes the overall concept of ADA employment in support of the maneuver plan as well as specific tasks and purposes assigned to an ADA unit. It also describes employment of passive and active air defense measures (if other than SOP). This item establishes the priority of air defense and provides weapons control and warning status.

(4) **Intelligence.** This describes how the overall information collection plan supports and complements the maneuver plan. It establishes priorities and coordinates responsibility for collection between organic and supporting units.

(5) **Electronic warfare.** This describes how electronic warfare supports and complements the commander's maneuver plan as well as specific tasks and purposes assigned to the EW unit. It also includes employment of passive and active measures (if these differ from SOPs).

(6) **Engineering.** This describes how the integration of mobility, countermobility, and survivability assets and activities support the maneuver plan. This item may also refer to the overlay that shows obstacles and barriers. In addition, it should address the following issues:

—Purpose to be achieved through the employment of engineer assets, obstacles, mines, and fortifications.

—Priority of effort, both for engineer personnel and engineer equipment (mobility, countermobility, or survivability).

—Priority of support both for engineer personnel and engineer equipment.

—Employment of FASCAM.

—Restrictions on the employment of engineer assets.

(7) **Other.** This includes additional subparagraphs as required for combat support assets such as deception, PSYOP, civil affairs.

**b. Tasks to Maneuver Units.** This subparagraph specifies tasks to be accomplished by each subordinate unit. The tasks are included as they appear in the task organization: in separate, numbered paragraphs. The purposes from “on-order” and “be prepared” mission statements may be included.

**c. Tasks to Combat Support Units.** This subparagraph lists the combat support unit tasks in the same order they appear in the task organization.

**d. Coordinating Instructions.** This subparagraph contains details of coordination and control that apply to two or more units in the command. Items that may be addressed in coordinating instructions include the following:

(1) Timing paragraph.

(2) Movement paragraph.

(3) PIR/IR reporting tasks.

(4) MOPP level.

(5) Troop safety and OEG.

(6) Engagement and disengagement criteria and instructions.

(7) Fire distribution and control measures.

- (8) Consolidation and reorganization instructions.
- (9) Reporting requirements (such as crossing phase lines, checkpoints).
- (10) Terrorism/counterterrorism instructions.
- (11) Rules of engagement.
- (12) Specified tasks that pertain to more than one subordinate unit.

#### 4. SERVICE SUPPORT

This paragraph contains a statement of the CSS instructions and arrangements supporting the operation that are of primary interest to the unit being supported.

**a. General.** This subparagraph should explain generally how the CSS assets support the overall concept of operations. It provides current and proposed train locations. It also identifies a service support or operations overlay, which must show the following: locations of supply routes, combat and field train CPs, and LRPs.

**b. Material and Services.**

(1) **Supply.** This maybe followed by a list of classes of supply, maps, water, special supplies, and captured enemy material.

(2) **Transportation.** This provides route limitations and each unit's traffic priorities.

(3) **Services.** This includes the types of service available, the designation and location of the unit(s) or installation(s) providing the services, assignments to support units, and schedules for services.

(a) Mortuary affairs.

(b) Field services.

- Laundry.
- Bath.
- Decontamination.

(c) Health services.

(4) **Labor.** This includes instructions and restrictions on the use of civilian and EPW labor.

(5) **Maintenance.** This includes maintenance priorities by unit, vehicle type, or both; recovery priorities; location of facilities and collection points; and authority for controlled substitution.

**c. Medical Evacuation and Hospitalization.** This includes procedures for evacuating wounded: locations for unit casualty collection points, higher casualty collection points, the jump aid station, the BAS, and ambulance exchange points.

**d. Personnel.** This includes the procedure for evacuating PWs, the location of a PW collection point, and unit replacement activities.

**e. Civil-Military Cooperation.** This subparagraph includes instructions that affect the civilian population, such as PSYOP and restrictions on civilian actions.

**f. Miscellaneous.** This subparagraph includes the procedure for destroying supplies, if it was omitted from the SOP, plus any CSS information that was omitted from the SOP.

---

## 5. COMMAND AND SIGNAL

### a. Command.

- (1) Location of higher commander and CP.
- (2) Locations of the unit commander and of the CP. If the unit commander's location will change during the operation, this indicates his locations throughout the mission.
- (3) Location of 2IC. If the location of the 2IC will change during the operation, this indicates his locations throughout the mission).
- (4) Succession of command (if other than in the SOP).

**b. Signal.** This contains the index of the current SOI and all other signal information.

- (1) The SOI index that is in effect.
- (2) State of listening silence.
- (3) Methods of communication, by priority.
- (4) Code words and signals.

Acknowledge.

Smith

LTC

OFFICIAL:

Annexes: A—

B—

C—

D—

Distribution:

**ANNEXES**

Not all annexes listed below are required for every OPORD. When they are used, they are labeled and those included are sequenced as follows:

| <i>Title</i>                                    | <i>Responsibility</i>                  |
|---|--|
| <b>ANNEX A. TASK ORGANIZATION</b>               | <b>S3</b>                              |
| <b>ANNEX B. INTELLIGENCE</b>                    | <b>S2</b>                              |
| <b>APPENDIX 1. Light Data</b>                   |  |
| <b>APPENDIX 2. Counterintelligence</b>          |  |
| <b>APPENDIX 3. Targeting</b>                    |  |
| <b>APPENDIX 4. Reconnaissance</b>               |  |
| <b>APPENDIX 5. Counterterrorism</b>             |  |
| <b>ANNEX C. OPERATIONS</b>                      | <b>S3</b>                              |
| <b>APPENDIX 1. Operations Overlay</b>           | <b>S3</b>                              |
| <b>APPENDIX 2. Chemical Warfare and NBC</b>     | Chemical Defense<br>Operations Officer |
| <b>APPENDIX 3. Electronic Warfare</b>           | Signal Officer                         |
| <b>APPENDIX 4. Psychological Warfare</b>        | <b>S3</b>                              |
| <b>APPENDIX 5. Search and Rescue Operations</b> | <b>S3 Air</b>                          |
| <b>APPENDIX 6. Cover and Deception</b>          | <b>S3</b>                              |
| <b>APPENDIX 7. Rules of Engagement</b>          | <b>S3</b>                              |
| <b>APPENDIX 8. Air Movement</b>                 | <b>S3 Air</b>                          |
| <b>APPENDIX 9. Boat Movement</b>                | <b>S3</b>                              |
| <b>APPENDIX 10. Road Movement</b>               | <b>S3</b>                              |
| <b>APPENDIX 11. Escape and Evasion</b>          | <b>S3</b>                              |
| <b>APPENDIX 12. Contingency Plans</b>           | <b>S3</b>                              |
| <b>APPENDIX 13. Rehearsals</b>                  | <b>S3</b>                              |
| <b>APPENDIX 14. Air Defense</b>                 | <b>FSO</b>                             |
| <b>APPENDIX 15. Linkup</b>                      | <b>S3</b>                              |
| <b>APPENDIX 16. Passage of Lines</b>            | <b>S3</b>                              |
| <b>APPENDIX 17. Relief in Place</b>             | <b>S3</b>                              |
| <b>APPENDIX 18. Stream/River Crossing</b>       | <b>S3</b>                              |
| <b>APPENDIX 19. Counterattack Plan</b>          | <b>S3</b>                              |
| <b>ANNEX D. LOGISTICS</b>                       | <b>S4</b>                              |
| <b>ANNEX E. PERSONNEL</b>                       | <b>S1</b>                              |
| <b>APPENDIX 1. Medical</b>                      | <b>S1</b>                              |

| <i>Title</i>  | <i>Responsibility</i> |
|---|-----------------------|
| <b>APPENDIX 2. Prisoners of War, Civilian Internees,<br/>and Other Detained Personnel</b> | S1                    |
| <b>APPENDIX 3. Noncombatant Evacuation</b>  | S1                    |
| <b>ANNEX F. PUBLIC AFFAIRS</b>  | S1                    |
| <b>ANNEX G. CIVIL AFFAIRS</b>   | S1                    |
| <b>ANNEX H. COMMAND RELATIONSHIPS</b>   | S3                    |
| <b>ANNEX I. SIGNAL</b>  | Signal Officer        |
| <b>ANNEX J. OPERATIONS SECURITY</b>   | S3/S2                 |
| <b>ANNEX K. MAPPING, CHARTING, AND GEODESY<br/>(OPLANs)</b>                               | S2                    |
| <b>ANNEX L. SAFETY</b>  | S1                    |
| <b>ANNEX M. FIRE SUPPORT</b>  | FSO                   |
| <b>ANNEX N. AIR SPACE MANAGEMENT</b>  | S3 Air                |
| <b>ANNEX O. ENGINEER</b>  | S3                    |
| <b>ANNEX P. TIME SCHEDULE</b>   | S3                    |
| <b>ANNEX Q. SPECIAL REPORTS</b>   | S3 (All staff)        |
| <b>ANNEX R. REDEVELOPMENT</b>   | S3                    |
| <b>ANNEX S. LIAISON</b>   | S3                    |
| <b>ANNEX T. EXECUTIVE CHECKLIST (See Enclosure 1)</b>                                     | S3                    |
| <b>ANNEX U. DISTRIBUTION</b>  | S3                    |

**ENCLOSURE:** 1- Execution Checklist



**ENCLOSURE 1 (EXECUTION CHECKLIST) to TAB B (OPERATION ORDER FORMAT) to APPENDIX 1 (ORDERS) to ANNEX A (COMMAND AND CONTROL) to BATTALION TSOP**

**EXECUTION CHECKLIST.** This is a sequential outline of the operation.

Page No. \_\_\_\_\_

**EXECUTION CHECKLIST**

**FORMAT FOR RADIO CALLS**

| No. | Event/Situation | Report | Net | To | From | Code   | Time |
|-----|-----------------|--------|-----|----|------|--------|------|
|     |                 |        |     |    |      | Word   |      |
| 1   |                 | M(1)   |     |    |      | DOG(2) |      |
| 2   |                 | M      |     |    |      | BAT    |      |
| 3   |                 | X      |     |    |      | CAT    | 3/3  |
| 4   |                 | X      |     |    |      | RAT    |      |

**NOTES:**

1. **M/X.** Events/situations labeled “M” (mandatory) require a report. Events/situations labeled “X” (by exception) require a report only if the unit cannot or has not accomplished the event as scheduled.

2. **DOG.** Units report key events by code word to the operations center of the headquarters with the net control responsibility.

3. **1500/1515.** The planned execution time appears in the top left block in the time column. The actual execution time appears in the event/situation block and in the lower right block. Units do not use the code word until execution. They use the execution number (left column) to report the *expected* time of an event. For example, “Expect No. 1 at 2345” or “What is the status of Item No.4?”

---

**TAB C (FRAGMENTARY ORDERS) to APPENDIX 1 (ORDERS) to ANNEX A  
(COMMAND AND CONTROL) to BATTALION TSOP****1. USE**

Commanders use FRAGOs to change specific missions or to provide timely changes to existing orders.

**2. BREVITY**

Commanders include only the items that differ from the original OPORD in the FRAGO.

**3. FORMAT**

FRAGOs follow the standard five-paragraph order format. Commanders omit unneeded items.

**EXAMPLE FORMAT**

1. SITUATION
2. MISSION
3. EXECUTION
  - (a) Commander's intent
  - (b) Maneuver
  - (c) Fires
  - (d) Intelligence and electronic warfare
  - (e) Obstacles, mines, and fortifications
  - (f) Unit tasks
  - (g) Coordinating instructions
4. SERVICE SUPPORT
5. COMMAND AND SIGNAL

APPENDIX 2 (COMMUNICATIONS) to ANNEX A (COMMAND AND CONTROL) to BATTALION TSOP

1. NETS

a. **Battalion Command Net (Secure Voice):** The battalion commander and his company commanders use this net to control the tactical situation and the flow of maneuver. No one else uses this net.

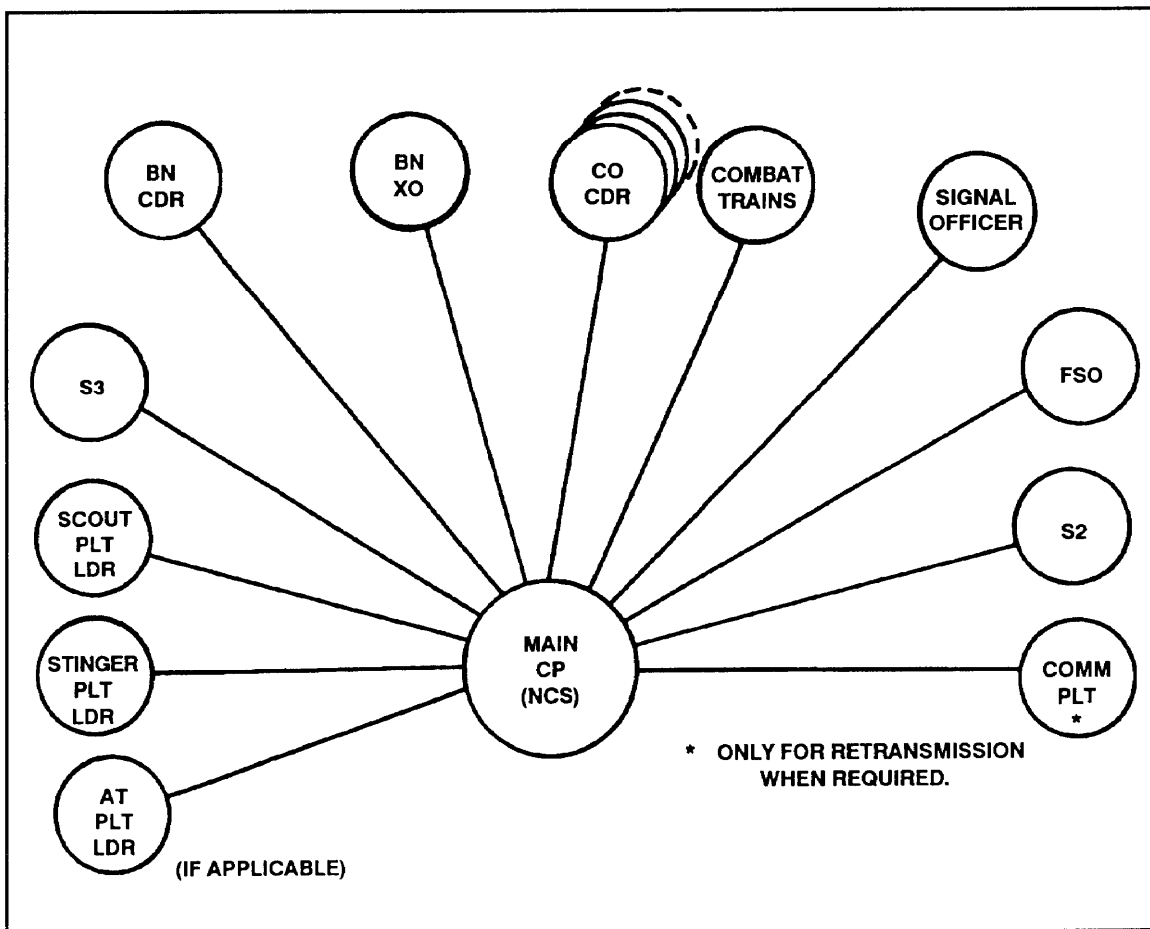

Figure A-1. Battalion command net.

b. **Battalion Administrative/Logistics Net (Secure Data):** Units use this net for administrative or logistical traffic. They may transmit either teletype and facsimile messages on it.

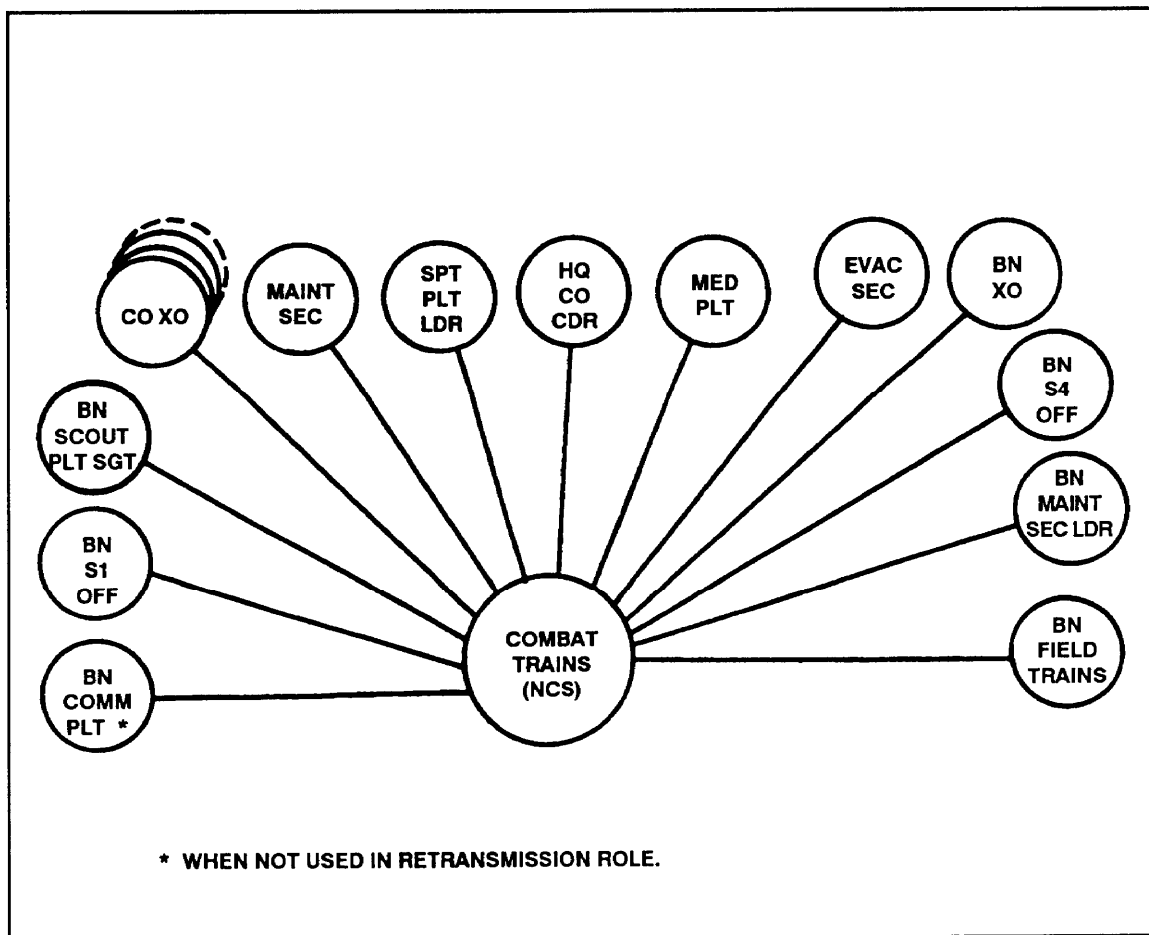

Figure A-2. Battalion administrative/logistics net.

c. **Battalion Fire Support Net** (FM Secure Voice, AN-PRC/77 with KY57):  
The FSO and FISTs coordinate all fire support assets on this net, which is the main fire support net. Requests for fires go directly to the battalion FSO.

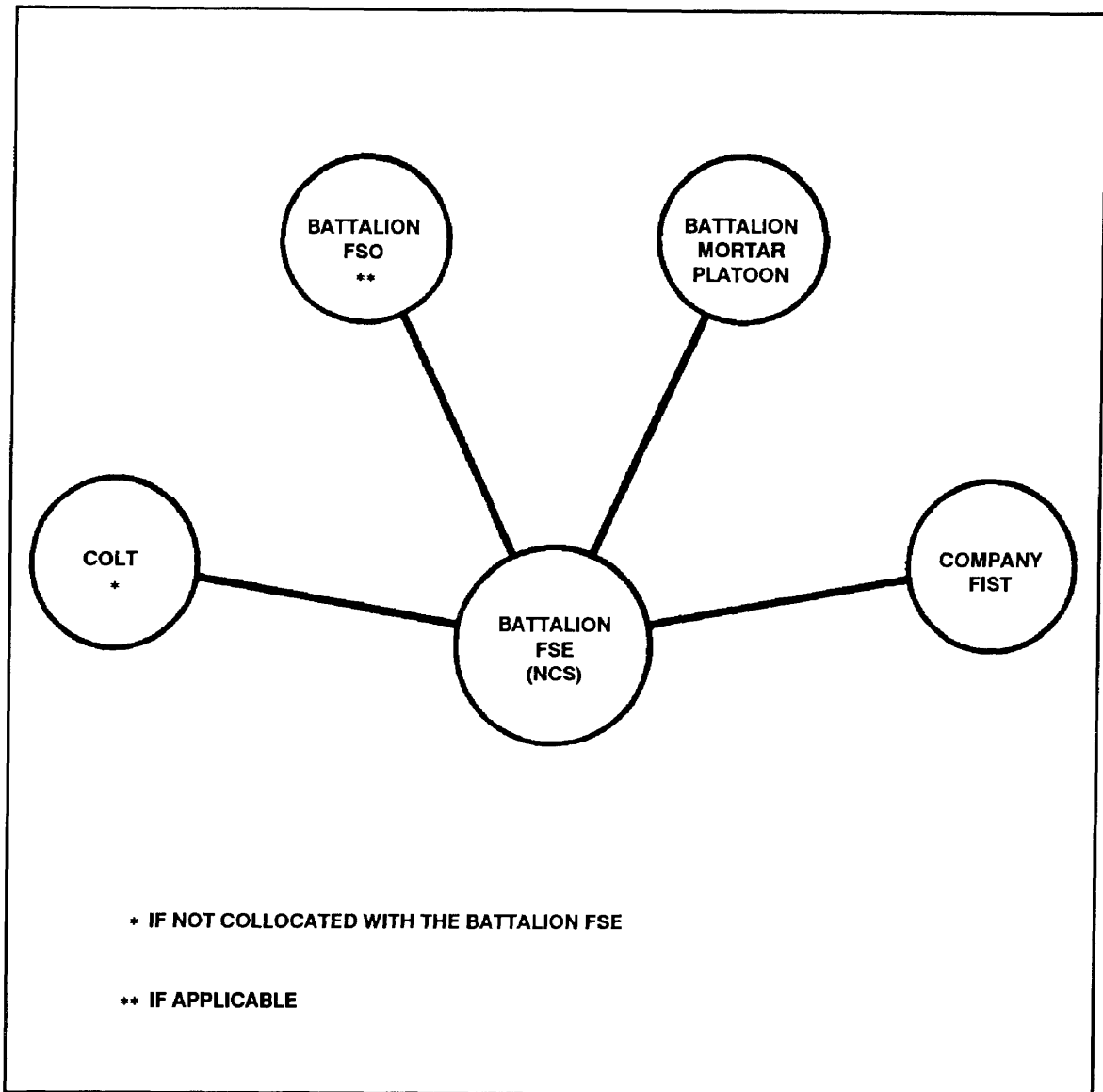

Figure A-3. Battalion fire support net.

d. **Tactical Air Request Net** (UHF Unsecure Voice/AN/PRC-113 w/HAVE QUICK): ALOs routinely use this net to request and position immediate CAS through USAF channels (ABCCC, AWACS, and so on) for handoff to users.

e. **Company FM Nets:** The NCS for the company FM net is normally the company headquarters or the company CP.

## 2. FREQUENCY CHANGES

This refers to frequency changes occurring outside of standard SOI periods.

a. **Directed Frequency Changes.** Units make these changes IAW the supplemental instructions in the SOI.

(1) The NCS directs the frequency change by doing the following:

(a) Determining the frequency is unusable.

(b) Making the net call to announce the new frequency and the change time.

—Units notify stations of frequency by secure means.

—All stations acknowledge.

(2) The NCS makes a net call on the new frequency and calls again every five minutes to reach stations that do not answer on the new frequency.

(3) Stations that cannot reach the NCS within 15 minutes must use an alternate means of communication.

b. **Automatic Frequency Changes.** These changes are made only IAW the supplemental instructions to the battalion SOI.

(1) Stations change frequency automatically only if the original frequency is unusable.

(2) Stations try all other means of alternative communications before automatically changing the frequency.

## 3. VINSON PROCEDURES

a. Units change TEKs weekly at 0001Z unless the OPORD states otherwise. They update the TEKs by manual rekeying or over-the-air rekeying (OTAR). When feasible, operators physically transfer TEKs.

b. OTAR allows units to rapidly, automatically key the entire net. Units prefer this method of changing the TEK (traffic encryption key). Stations that miss the OTAR function can be keyed by a second attempt. If this fails, the station must be manually keyed.

## 4. SOI AND TEK REQUIREMENTS

The battalion must have the SOI and TEKs of controlling higher headquarters to maintain the ability to communicate outside the battalion.

## 5. STANDARD TIME HACK

The battalion Signal Officer is the proponent for official time. He obtains the official time by calling the Naval Observatory (DSN 294-1920 or commercial [900]410-8463). The TOC transmits a daily time hack over the battalion command net

at a noncritical, nonpriority time. This includes a 60-second warning, a 15-second warning, then a 5-second countdown and “mark” transmitted in bursts of no more than 15 seconds each. All stations in the net respond in alphanumeric order.

**ANNEX B (OPERATIONS) to BATTALION TSOP.**

This annex standardizes selected routine operational procedures within the battalion.

- APPENDIX ES:**
- 1—Priority of Work
  - 2—Aviation
  - 3—Engineer
  - 4—Air Defense
  - 5—NBC Defense
  - 6—Reliefs in Place
  - 7—Linkups
  - 8—Passages of Lines
  - 9—Assembly Areas



## **APPENDIX 1 (PRIORITY OF WORK) TO ANNEX B (OPERATIONS) TO BATTALION TSOP**

### **1. GENERAL**

All tactical situations are unique and depend upon METT-T. In every situation, the battalion must meet two basic requirements.

- a. Establish security.
- b. Prepare to protect the force and engage the enemy.

### **2. STAND-TO**

The battalion holds a stand-to both morning and evening to ensure that each soldier adjusts to the changing light and noise conditions; and to ensure that each is dressed, equipped, and ready for action. The morning stand-to starts just before first light and continues for about 30 minutes until after first light. The evening stand-to starts just before dark and continues for about 30 minutes until after dark. Although the starting and ending times should vary to prevent the enemy from detecting a pattern, the stand-to must last long enough to accomplish its purpose.

### **3. PRIORITY OF WORK (DEFENSE)**

An infantry battalion in the defense must observe the following priority of work:

- a. Establish security (one OP with Claymore for each platoon; R&S patrol; and local security). Tie in with wire. Conduct local R&S patrolling within the company or platoon sector in a clockwise rotation from left to right.

- b. Position crew-served weapons, attached weapons systems, or both. Coordinate with flank elements and establish communications with them.

- c. Establish other positions and assign sectors of fire. Walk fields of fire.

- d. Clear fields of fire. Emplace sector stakes and prepare range cards.

- e. Register mortars and adjust FPFs (artillery and mortar).

- f. Emplace early warning devices such as trip flares.

- g. Begin preparing crew-served weapons emplacements and individual fighting positions (remember limit-of-fire stakes).

- h. Emplace wire barriers, obstacles, mines, demolitions, and additional Claymores.

- i. Provide or establish wire communications.

- j. Select and reconnoiter routes for movement, resupply, and MEDEVAC.

- k. Select alternate and supplementary positions. Have all soldiers walk to these positions after assigning them sectors of fire and routes to the positions. After the FPFs are executed, ensure platoons move to their alternate defensive positions.

- l. Maintain weapons and equipment. Establish and enforce the following criteria to maintain adequate security and fire support:

- (1) No more than 33 percent of the machine guns and individual weapons are cleaned at the same time.

(2) No more than one antitank weapon in each company is cleaned at the same time.

(3) No more than one 60-mm mortar in each section is out of action at the same time.

(4) No more than 33 percent of the equipment (for example, NVDs, M8 alarms, radios) in each platoon are cleaned at the same time. In each two-soldier position, no more than one weapon is cleaned at the same time, and no more than 33 percent of the total weapons in each platoon are cleaned at the same time.

m. Improve primary positions, to include overhead cover (this should be done continuously throughout the operation).

n. Establish supply and resupply points.

o. Prepare alternate and supplementary positions.

p. Prepare NBC protective shelters as required.

q. Enforce personal hygiene.

r. Eat.

s. Rest.

t. Prepare deceptive positions IAW deception plans.

#### **4. DEFENSE PLANS**

a. Each company submits its sector sketch (to include positioning of crew-served weapons, fire, and barriers and the antitank defense plans) to battalion NLT two hours after the company occupies the front line trace. Companies update their sector sketches at occupation plus 8 hours and include all crew-served weapon and obstacle locations.

b. The battalion provides companies with a patrol plan, the battalion counterattack plan, and the defense plan for the battalion antitank weapons and ADA.

c. The battalion submits one copy of each of the following to regiment, brigade, or both as soon as the battalion completes it:

—Battalion sector sketch.

—Patrol plan.

—Counterattack plan.

—Defense plan for antitank weapons and ADA.

**APPENDIX 2 (AVIATION) TO ANNEX B (OPERATIONS) TO BATTALION TSOP**

- TABS:** A—Air Assault Operations Checklist. (See Appendix C, FM 90-4.)  
B—Helicopter Landing Zones. (See Appendix E, FM 90-4.)  
C—Slingload Operations. (See FM 55-450-3.)  
D—Rotary Wing Specifications. (See Appendix D, FM 90-4.)  
E—Rotary Wing Safety. (See Section VI, Appendix E, FM 90-4.)  
F—Air Mission Briefing Checklist. (See Section VIII, Chapter 3, FM 90-4.)

---

## APPENDIX 3 (ENGINEER) TO ANNEX B (OPERATIONS) TO BATTALION TSOP

### 1. GENERAL

This appendix provides guidance for enhancing the capabilities of combat engineer assets.

### 2. COMMAND AND CONTROL

An engineer unit providing support to a battalion unit is normally OPCON (preferred command relationship) or DS (preferred support relationship) to the battalion. The battalion commander gives the engineer unit its task priorities.

### 3. EMPLOYMENT

a. Engineers may perform the following tasks during battalion operations:

(1) Seize and secure airfields, communications centers, command and control facilities, and key bridges.

(2) Increase sustained combat capability for battalion units through mobility, countermobility, and survivability.

(a) **Mobility** — The unit should plan to reduce obstacles to improve movement. Engineer tasks include—

- Countermine (detect, bypass, breach, and mark enemy obstacles).
- Counterobstacle (detect, bypass, breach, and reduce enemy obstacles).
- Gap-crossing (prepare assault sites, secure far shore, and construct or emplace bridges).

(b) **Countermobility**—These are the highest priority engineer tasks. The unit should plan to construct obstacles to delay, disrupt, and kill the enemy. Engineer tasks include—

- Mine warfare (conventional or scatterable mines).
- Demolition-type obstacles.
- Conventional obstacles (craters, abatis, wire, and ditches).

(c) **Survivability**— The unit should develop its fighting or protective position. Engineer tasks include—

- Preparation of crew-served weapon and antitank positions.
- Establishment of command and control facilities.
- Choosing of vital logistics positions.

b. The battalion gives the following information to engineer units addressed in OPORDs:

- (1) The mission and the enemy situation.
- (2) The concept of the operation and the commander's intent.

- (3) The initial location.
- (4) Displacement instructions.
- (5) On-order or be-prepared missions and tasks.
- (6) Priorities of effort, support, or both.

---

**APPENDIX 4 (AIR DEFENSE) to ANNEX B (OPERATIONS) to BATTALION TSOP****1. GENERAL**

a. The battalion must use passive air defense measures (cover, concealment, camouflage, dispersion, fire discipline, and protective construction) when the enemy can easily conduct tactical air or attack helicopter operations over the battalion area.

b. The battalion uses active air defense measures only in extreme circumstances such as in the case of direct enemy attack.

**2. ADA CONTROL AND COORDINATION**

a. When the battalion has no qualified air defense personnel available, the FSO manages air defense and airspace. He and the S3 air work together to plan these centrally. The commander of any forward area ADA element attached to or supporting the battalion acts as the battalion special staff officer (the ADO). If the battalion commander places any subordinate unit Stinger sections under centralized battalion control, he may designate a Stinger section leader to help the S3 plan and conduct air defense.

b. Air defense warnings require immediate dissemination and immediate acknowledgement by any available means. All other air defense coordination is given on the FSC net.

**3. AIR DEFENSE WARNINGS**

a. **Red.** An attack is imminent or in progress.

b. **Yellow.** An attack is probable.

c. **White.** An attack is neither probable nor imminent.

**4. CONTROL OF AIR DEFENSE FIRES**

a. **Weapon Control Status.** Weapons-tight status applies unless higher specifies otherwise.

(1) **Weapons hold.** Gunners fire only in self-defense.

(2) **Weapons tight.** Gunners fire only at aircraft positively identified as hostile.

(3) **Weapons free.** Gunners fire at any aircraft the not positively identified as friendly.

b. **Hostile Criteria.** Units use the following criteria to determine what aircraft are hostile:

(1) Aircraft are attacking friendly elements.

(2) Aircraft have the military insignia or configuration of an aircraft employed by a known enemy nation.

(3) Aircraft spray or smoke friendly units without prior coordination.

(4) Aircraft drop flares or ECM devices over friendly territory without prior coordination.

(5) Aircraft discharge parachutists or unload troops without prior coordination and in numbers that exceed the size of a normal crew.

(6) Aircraft lay mines without prior coordination.

(7) Aircraft conduct improper or unauthorized entry into an area designated "restricted."

**c. Rules of Engagement.**

(1) Individual gunners and fire unit commanders may not deviate from the established weapons control status or hostile identification criteria during individual operation, except that the rule of self-defense applies. The commander changes the weapon control status and hostile identification criteria only—

(a) On order of higher headquarters. Verbal authentication is mandatory.

(b) By subordinate commanders, who may impose a *more restrictive* status or criteria.

(2) Soldiers under direct attack use individual and crew-served weapons (M16, M60, M249) to engage low-flying, positively identified hostile aircraft. They may do this only after a platoon leader or higher authorizes fire. Under special operational circumstances, company commanders may delegate this authority to squad leaders.

## **5. COMMUNICATION**

The battalion TOC must verify changes to weapons control status, hostile identification criteria, and friendly flight information monitored on warning nets before the battalion retransmits the information to subordinate units. The TOC obtains verification via OP-intelligence or command nets.

## APPENDIX 5 (NBC DEFENSE) to ANNEX B (OPERATIONS) to BATTALION TSOP

### 1. GENERAL

This annex provides guidance for effectively implementing NBC defense procedures in tactical situations, based on METT-T analysis.

### 2. EARLY WARNING AND MARMS

a. **NBC Reconnaissance.** The battalion uses an M256 chemical detection kit and M8/M9 chemical detection paper to detect chemical contamination or the IM-174 radiacrometer to detect radiological contamination.

b. **Alarms.** This includes vocal and hand-and-arm signals.

(1) The battalion uses the vocal alarm “GAS” to signal any chemical or biological hazard.

(2) STP 21-1-SMCT describes the standard hand-and-arm signal for any NBC hazard.

(3) The battalion may improvise an audio alarm such as metal on metal or three long blasts on a vehicle horn or siren.

(4) The battalion TOC may employ an automatic alarm system consisting of two automatic (M8A1) alarm systems.

### 3. MASKING

a. **Automatic Masking.** Individuals should mask automatically—

(1) When an automatic alarm sounds.

(2) When a positive reading is obtained on detector paper or chemical agent detection kits.

(3) When anyone shows symptoms of chemical agent poisoning.

(4) When a spray or artillery attack occurs in an NBC threat environment.

b. **Unmasking.** Units should unmask—

(1) As soon as possible, except when the battalion suspects a biological or chemical agent attack. The senior soldier in charge directs the unmasking procedures.

(2) Only IAW the procedure outlined in FM 3-4.

### 4. NBC WARNING REPORTS (See Annex H for list of NBC warning reports.)

a. All NBC defense personnel maintain a copy of GTA 3-6-3.

b. FM 3-3 provides specific instructions for preparing and interpreting NBC messages.

### 5. DECONTAMINATION

Units conduct decontamination operations IAW the procedures outlined in FM 3-5.



**6. MISSION-ORIENTED PROTECTIVE POSTURE**

a. **Mask Only.** The protective mask with hood, if worn with fatigues, leather work gloves, and jungle or combat boots, provides adequate protection against known vapor hazards. Soldiers need overgarments, rubber gloves, and boots only when liquid or solid contamination (persistent agents) are present.

b. **MOPP Levels 0 through 4.**

(1) Chemical protective overgarments, rubber gloves and boots, and decontamination kits are palletized for immediate deployment or are issued at the home station before deployment, depending on the METT-T analysis.

(2) The battalion implements the following actions based on designated MOPP levels:

| <b>MOPP LEVEL</b> | <b>OVERGARMENTS</b>        | <b>OVERBOOTS</b> | <b>MASK/HOOD</b> | <b>GLOVES</b>  |
|-------------------|----------------------------|------------------|------------------|----------------|
| <b>0</b>          | <b>CARRIED</b>             | <b>CARRIED</b>   | <b>CARRIED</b>   | <b>CARRIED</b> |
| <b>1</b>          | <b>WORN OPEN OR CLOSED</b> | <b>CARRIED</b>   | <b>CARRIED</b>   | <b>CARRIED</b> |
| <b>2</b>          | <b>WORN OPEN OR CLOSED</b> | <b>WORN</b>      | <b>WORN</b>      | <b>CARRIED</b> |
| <b>3</b>          | <b>WORN OPEN OR CLOSED</b> | <b>WORN</b>      | <b>WORN</b>      | <b>WORN</b>    |
| <b>4</b>          | <b>WORN CLOSED</b>         | <b>WORN</b>      | <b>WORN</b>      | <b>WORN</b>    |

---

## APPENDIX 6 (RELIEFS IN PLACE) TO ANNEX B (OPERATIONS) TO BATTALION TSOP

### 1. GENERAL

The S3/2 of the relieving unit contacts the relieved unit as soon as the order to conduct a relief in place is received.

### 2. PREPARATION FOR THE RELIEF IN PLACE

The following is coordinated:

- a. Exchange of enemy information.
- b. Reconnaissance of the area.
- c. Exchange of communications information.
- d. Use of guides and liaison personnel.
- e. Security measures to be used, including deception plans.
- f. Control measures to be used.
- g. Fire support.
- h. Method and sequence of relief.
- i. Traffic control.
- j. Transfer of responsibility.
- k. Transfer or exchange of equipment, supplies, ammunition, and minefield.

### 3. RECONNAISSANCE OF AREA

Commanders and leaders of both units reconnoiter the area to determine—

- a. The disposition of the relieved unit in its defensive positions. Each commander should obtain a copy of the sector sketch.
- b. Locations of separate unit areas.
- c. Locations of the release points.
- d. Locations of the contact points.
- e. Separate routes to be used for each unit.
- f. Locations of any obstacles.
- g. Locations of the CS and CSS elements such as CPs, trains, aid stations, mortars, and antitank weapons.

### 4. CONDUCT OF THE RELIEF

a. The units collocate their command and control for ease of control and coordination. After linkup, battalion and company CPs collocate and operate OPCON to the unit being relieved. The relieving unit assumes listening silence and moves from designated assembly areas only under the control of the unit being relieved.

b. Commanders transfer responsibility face-to-face once the entire relieving unit is in position. They should apply the doctrinal rule for two-thirds turnover of sector responsibility only up through company echelon. Fire support, in-progress ground

operations, and other associated joint operations dictate that sector responsibility be relinquished at the time relief is complete at battalion and higher echelons.

c. Fire support elements (mortars) of the relieving unit collocate with the unit being relieved.

d. Units make physical contact at the contact point(s) IAW the coordination meeting and the OPORD.

e. The relieving units already in position are OPCON to the relieved unit if the enemy attacks before the responsibility is actually transferred. However, if contact is made after the responsibility is transferred, all units in position are OPCON to the relieving unit.

f. The relieving unit assumes the exact defensive positions of the relieved unit until the relief is complete.

g. Events—not time—determine how the commander conducts a relief. However, time lines help him plan for follow-on operations.

h. Subordinating one battalion to another during the relief and switching their roles after the relief in place enhances control, reduces signatures, and aids in the transition to follow-on operations.

---

## APPENDIX 7 (LINKUPS) to ANNEX B (OPERATIONS) to BATTALION TSOP

### 1. GENERAL

The commander, S3/2, or LO of the unit that receives a warning order to execute a linkup contacts the other unit concerned. The moving unit always moves to the stationary unit. If both are moving, higher headquarters determines which unit should make contact.

### 2. PREPARATION FOR LINKUP

- a. The commanders establish coordination to provide for the following:
  - Command relationship of units upon linkup and effective time.
  - Mutual recognition system.
  - Communications plan.
  - Schemes of maneuver (to include control measures).
  - Fire support (to include control measures).
  - Actions to be taken after linkup.
  - Assistance.
  - Alternate plans.
- b. The stationary unit can normally provide the following:
  - Guides.
  - Lanes through obstacles or airhead.
  - Traffic control.
  - Limited logistical and maintenance support.
  - Limited medical support.
  - Information on recent enemy activity.
- c. The moving unit can normally provide the following:
  - Logistical support.
  - Maintenance support.
  - Medical support.
  - Fire support.

### 3. CONDUCT OF THE LINKUP

a. **Moving Units.** The linkup units must adjust their movements to each other and must continuously coordinate on a predesignated secure radio net. One or both units should halt briefly before the linkup.

b. **Moving and Stationary Units.** The moving unit must orient on the stationary unit and must keep the stationary unit advised of its location. The stationary unit guides the moving unit to the linkup point by radio. The stationary unit must be ready to accept and position the moving unit as smoothly and quickly as possible. The moving element controls the overall operation.

c. **Actions Following Linkup.** The units maintain security by continuing the mission as quickly as possible.

#### **4. LINKUP SIGNALS**

The units use red-filtered flashlight signals.

a. The stationary unit initiates signaling after gaining radio contact with the moving unit or at a predesignated time. They initiate it by flashing the red-filtered flashlight once in the expected direction of the moving unit.

b. The moving unit answers the stationary unit by flashing their red-filtered flashlight twice toward the linkup point.

c. The units use the same signaling procedure for flashlights with infrared lens covers that they use for red-filtered flashlights. Both units may use infrared lens covers on flashlights.

---

## APPENDIX 8 (PASSAGES OF LINES) TO ANNEX B (OPERATIONS) TO BATTALION TSOP

### 1. GENERAL

The commander and S3/2 of the moving unit contact the stationary unit on receipt of a warning order to execute a passage of lines or withdrawal through a rearward position.

### 2. PREPARATION FOR THE PASSAGE OF LINES

a. **Liaison.** The units establish immediate liaison and maintain it until the operation has been completed.

b. **Forward and Rearward Passage of Lines.**

(1) Units establish coordination to provide for the following:

- (a) Selection of location for moving unit CP near that of the stationary unit CP.
- (b) Exchange of intelligence.
- (c) Exchange of tactical and communication plans.
- (d) Arrangements for reconnaissance of routes and for passage or withdrawal point patrols.
- (e) Security measures for the operation (recognition signals, exchange of SOI items, and so on).
- (f) Time and location for passage of command.
- (g) Administrative, refueling, supply, and medical support.
- (h) Route priority and movement control.
- (i) Areas of passage or withdrawal, and guides.
- (j) Fire support.
- (k) Signal support.

(2) Areas selected for the passage or withdrawal should be unoccupied between or on the flanks of units in position. Units should use multiple routes to reduce their vulnerability during the operation.

(3) Priority of routes go to units executing the passage or withdrawal. The unit in position controls traffic. This responsibility transfers along with the passage of command.

(4) Passage of command is determined by mutual agreement by both commanders and is approved by the higher commander who directed the passage or linkup.

(5) Tactical support.

- (a) The unit in position provides all possible assistance. It breaches minefield, provides guides, and provides indirect and direct fire support.
- (b) The unit in position provides fire support during a passage of lines until responsibility for the zone transfers to the passing unit. Then the passing unit artillery commander assumes responsibility for coordinating the artillery fires of both units.

(c) The unit in position supports the unit in contact throughout the withdrawal. Then the artillery commander of the unit in position begins coordinating artillery fires of both units.

(6) The unit in position provides the following administrative support:

- (a) Evacuation of casualties and PWs.
- (b) Civil-military operations (CMO).
- (c) Unit facilities (fueling points, water points, and so on).
- (d) Route priority and traffic control.

**c. Conduct.**

(1) Liaison is established from the moving unit to the unit in position, down to and including company level.

(2) Movement during execution must be as deliberate and rapid as the tactical situation, light, and terrain allow.

(3) Subordinate commanders report as soon as the operation has been completed.

(4) The commanders plan movement schedules to preclude assembly in the sector of the unit in position.

(5) Units reconnoiter routes, passage points, and soon to the lowest level practicable.

---

## **APPENDIX 9 (ASSEMBLY AREAS) TO ANNEX B (OPERATIONS) TO BATTALION TSOP**

### **1. GENERAL**

The battalion occupies an assembly area for security while preparing for future operations. Preparations can include reorganizing the battalion, planning and issuing the order, rehearsing, receiving and issuing supplies, and maintaining vehicles and equipment.

### **2. QUARTERING PARTY**

The commander sends a quartering party to the forward assembly area in advance of the main body. The quartering party precedes the main body and moves by infiltration—not as part of the march column.

a. The quartering party reconnoiters the new area and guides march elements into the assembly area. The party also ensures that the assembly area is free of enemy, obstacles, and NBC hazards. The commander informs the quartering party OIC of the main body's route, order of march, and ETA. The S1 or the HHC XO usually lead the battalion quartering party, which consists of the quartering parties from each subordinate company. A company quartering party usually consists of a headquarters representative and one element from each platoon.

b. A quartering party should have an OIC, a security element, communications and medical personnel, and necessary staff section and subunit representatives. The quartering party should also have sufficient guides, markers, and pioneer tools to improve the new area. To secure the area, the quartering party must establish OPs, set up early warning devices and NBC alarms, or provide early warning by some other means. As march elements clear the RP, quartering party members (waiting in covered and concealed positions) move to guide the march elements to selected or designated areas without halting.

c. The quartering party reconnoiters and organizes the assembly area before the battalion arrives. This reduces the possibility of detection during the occupation of the position. The quartering party ensures that the area has the characteristics described above. It selects and marks areas for each company, for the CP, and for each CS/CSS element. It then guides arriving elements into position to avoid congesting or stopping the unit on an exposed route of march.

### **3. ORGANIZATION**

The commander may organize the assembly area by assigning companies either sectors of the battalion perimeter or dispersed assembly areas within the battalion assembly area.

a. Units may use visual observation, sensors, and surveillance devices to augment security. The commander may designate contact points for units to aid in coordinating security efforts. All routes in and out of the assembly area are strictly controlled.



Roads are not used to define unit boundaries. Roads are the specific responsibility of the company whose sector they pass through.

b. The scout platoon may be tasked to reconnoiter routes of movement to counterattack positions, defensive positions, or passage lanes; or, it may be tasked to provide security by establishing OPs, roadblocks, or traffic control points.

c. The commander positions CS elements with units they are to support or positions them to provide support to all elements of the battalion.

d. The assembly area must allow adequate dispersion of all elements of the battalion.

e. OPs cover key terrain features and avenues of approach.

f. The commander locates the battalion CP and trains centrally for security and to simplify planning, issuing orders, distributing supplies, and other activities.

g. Elements communicate by wire (if time and distance allows wire to be installed) or by messenger to avoid enemy direction-finding capabilities. Radio is used only when necessary.

h. The commander must choose company assembly areas that are large enough to allow dispersion. These areas must be sited to use available concealment from enemy observation and available cover from enemy direct fires. Locating company positions within the battalion assembly area should ease movement in future operations.

i. Locations for mortar positions are chosen based on employment distances. If some mortars must be positioned in adjacent company sectors, the company commander coordinates their placement.

j. Occupation of an assembly area during limited visibility requires preparation by the quartering party. Usually, the most critical handover occurs at the RP. Thorough coordination is necessary for the march unit to pass smoothly through the RP without halts.

k. Units use several marking techniques to aid in smooth nighttime occupation. Guides using prearranged colored or infrared lights for recognition signals meet the march unit at the RP and lead the unit along a marked route to the assembly area. All units practice light discipline. They shield all illumination devices, including infrared. They can use communication wire, engineer tape, or both to mark routes to platoon RPs. Subunit guides, using prearranged infrared or colored lights or flash recognition signals, link up with platoons or sections and lead them to prepared sectors. The unit can mark individual, vehicle, crew, or squad positions with stakes, chemical lights, engineer tape, and (prelaid) communication wire. The unit uses these markings to guide other the elements into position. Soldiers connect telephones to the wire once all units are in position, and the guide wire becomes the communications network.

---

## **ANNEX C (FIRE SUPPORT) to BATTALION TSOP**

### **1. BATTALION FIRE SUPPORT ELEMENT.**

- a. The battalion FSE—
  - (1) Produces the fire support portions of the battalion OPLANs and OPORDs.
  - (2) Coordinates fire support for the current battle.
- b. The FSE (with TACP augmentation) is collocated with the battalion commander. Fire support personnel are located in TOC 2. (See Appendix 3 to Annex A.)
- c. One ANGLICO representative maybe attached to each battalion task force.

### **2. COMMUNICATIONS NETS.**

(See Annex A, Appendix 2, paragraph 1e.)

### **3. COMMANDER'S INTENT FOR FIRE SUPPORT**

Development of the commander's intent for fire support is an important first step in fire support. The commander's intent sets priorities for fire support on the battlefield and provides for fire support at the critical time and place. The commander's intent for fire support also allows the FSCoord/FSO to integrate and synchronize the fire support system into the overall concept of the operation. To be useful, the commander's intent for fire support must be feasible and clear. This requires a combined effort by both the FSCoord/FSOs and the supported commanders; they must spell out and understand exactly what fire support can do and what it is expected to do during an operation. The commander's fire support requirements must fall within the capabilities of the fire support system.

- APPENDIXES:**
- 1—Field Artillery
  - 2—Offensive Air
  - 3—Target Numbering System
  - 4—Coordinated Surface and Air-Delivered Fire

## **APPENDIX 1 (FIELD ARTILLERY) TO ANNEX C (FIRE SUPPORT) TO BATTALION TSOP**

### **1. PURPOSE**

This appendix establishes procedures for planning field artillery in support of battalion operations.

### **2. OPERATIONS**

- a. Close support fires have priority over all other conventional missions.
- b. All planned fire requests from company FISTS are coordinated through the battalion FSO.
- c. All shell reports, bomb reports, and chemical reports are sent to the battalion FSE IAW Appendix 3 to Annex 1.
- d. The battalion FSO obtains the locations of ground sensors from the S2. The FSE integrates this information into its planned target data.

### **3. FIRE PLANNING**

Company FISTs submit the target list and target overlays to the FSE as their first priority of work. They forward additional reports as required. The FSE provides final copies of the consolidated target list and overlay to the next higher headquarters, the supporting FA units, and subordinate units.

### **4. FIRE SUPPORT CONTROL MEASURES**

- a. An RFL is established between converging friendly forces. Fires and the effects of fires across the RFL are prohibited unless the firing force coordinates with the affected force. This includes all supporting fire within 1,000 meters of the RFL, which is coordinated between the FSEs of the converging force.
- b. The battalion FSE disseminates airspace coordination area data and aviation control measures.

---

## APPENDIX 2 (OFFENSIVE AIR) TO ANNEX C (FIRE SUPPORT) TO BATTALION TSOP

### 1. GENERAL

Offensive air support consists of tactical surveillance and reconnaissance (TSR), BAI, air interdiction, counterair, and close air support. The battalion is involved most often with CAS. The FSO integrates offensive air support missions. To do so, he works closely with the S3 Air and with members of the TACP.

### 2. REQUEST CHANNELS

#### a. Planned Missions.

(1) Requests for planned CAS missions originating at the company are forwarded to the battalion FSE over the FSC net (FM voice) or any other means available.

(2) The battalion FSO, working with the ALO, coordinates preplanned CAS and forwards the consolidated requests to the brigade FSE.

(3) The brigade FSO and ALO eliminate duplications, assign priorities, and forward requests to the supporting air operations center over the Army fire support net, external (FM voice).

(4) The battalion FSE prepares BAI requests.

#### b. Immediate Missions.

(1) Companies request CAS over the FSC net (FM secure voice) using the joint application of firepower (J-Fire) reference guide (TRADOC Pam 34-2).

(2) The battalion FSO/ALO forwards the request over the TAR net to the appropriate (USAF/Navy/USMC) air support operations center.

(3) The brigade TACP monitors the transmission and acknowledges its receipt.

(4) Brigade approves or disapproves the request within 10 minutes. Silence indicates approval.

### 3. EMPLOYMENT OF CAS

a. **Target Identification.** Targets are identified by the casualty-producing ordnance used. This includes artillery or mortar rounds, illumination rounds with point-detonating fuzes, tracer rounds, 90-mm rounds, DEWs such as lasers, and so on.

b. **Friendly Position Identification.** Units mark friendly positions using noncasually-producing devices, grenades, flares, fires, signal mirrors, panels, strobe lights, reflecting tape, and so on.

c. **Munitions Restrictions.** Units avoid using certain munitions during preparation of DZs, LZs, or PZs or within an objective area. These include CBUs and proximity, long-delayed, magnetic, or seismic-fuzed ammunition.

#### d. Impact Adjustment.

(1) Units try to mark the target and to make the fighters confirm the mark.

(2) Cardinal directions are preferred over clock references or corrections to attack headings.

(3) CAS aircraft must be cleared hot by the ground observer before they may deliver ordnance.

(4) Available FSE/TACP/ANGLICO personnel may exercise terminal control in the absence of a qualified FAC to ensure fires are timely and effective.

e. **Battle Damage Assessments.** BDAs are given IAW COMSEC requirements.

---

## **APPENDIX 3 (TARGET NUMBERING SYSTEM) to ANNEX C (FIRE SUPPORT) to BATTALION TSOP**

### **1. SYSTEM**

a. Target numbers are alphanumeric designators that each consist of two letters and four numbers. This system excludes the letters “I” and “O” to prevent confusion between the numbers one and zero.

b. This numbering system identifies a series of targets by a code name or nickname that does not correspond to the phonetic alphabet.

c. A group of targets is identified by a designator that consists of the two letters assigned to the battalion, such as “X” and “A” with a number inserted between them. For example, if the first group of targets is “X1A,” the second may be “X2A,” and so on.

### **2. SECURITY**

Target assignments are sent by a secure means of communication or are encoded and transmitted over a unsecure means. However, if the enemy attacks the target within 15 minutes from the time of transmission, further target assignments maybe sent in the clear by unsecure means.

### **3. TARGET NUMBER ALLOCATIONS**

The battalion allocation of target numbers is as follows:

- 000—199..... Battalion FSE
- 200—299..... FIST, Company A
- 300—399..... FIST, Company B
- 400—499..... FIST, Company C
- 500—699..... Additional FISTs
- 700—799..... Battalion mortar section
- 800—999..... As required

## **APPENDIX 4 (COORDINATED SURFACE AND AIR-DELIVERED FIRE) TO ANNEX C (FIRE SUPPORT) TO BATTALION TSOP**

### **1. PLANNING PROCEDURES**

Before an operation, the FSO, S3 Air, and TACP prepare a complete plan of engagement. The plan must allow for tactical air and Army aviation. It must include but is not limited to the following elements:

- a. Artillery gun-target lines.
- b. Location of friendly troops (including adjacent units) in relation to the gun-target lines and to the probable flight corridors of aircraft.
- c. Orbit areas, immediate safe bail-out, and the nearest recovery base or ship for tactical and Army aviation.
- d. H-hour for airborne or air assault operations.
- e. Sequence of employment for fire support means.
- f. Employment of FSC measures.
- g. Plans for tactical air, Army aviation, FA and naval gunfire.
- h. Signals for shifting or lifting fires.
- i. Ground marking systems.
- j. Designation of personnel to control each type of fire support.
- k. Channels of radio communication.

### **2. EXECUTION PROCEDURES**

a. Effective artillery fire employed in support of soldiers in close contact may shift, but does not lift to allow simultaneous attack by aircraft.

b. The FSO obtains the center of impact and the gun-target line maximum ordinate in front of supporting artillery and organic mortar fire. He relays this information to the TACP/FAC/pilot.

c. The battalion commander specifies FSC measures. These restrictive measures should be applied at the latest possible time before the air strike, and should be removed upon completion of the air strike.

d. The FSO/ALO employs aircraft maneuver coordination measures, such as an ACA when notified that aircraft are on station; this allows a safe distance to remain between aircraft maneuvers and the unit.

e. Tactical air and Army aviation employed simultaneously must be separated laterally and must know the other's attack heading, ordnance, breakaway direction, and orbit area.

### **3. SEPARATION PROCEDURES**

a. Artillery and tactical air can be separated laterally, vertically, or both.

b. Fighters on high-angle attack with a pullout over 1,000 feet above the target surface can use vertical separation to work near or directly above low-angle artillery.

c. Fighters on low-angle attack must be separated laterally from mortar or artillery firing high angle.

---

## ANNEX D (INTELLIGENCE) TO BATTALION TSOP

### 1. GENERAL

The battalion S2 maintains continuous radio contact with the brigade S2 on the brigade O&I Net. He sends priority and perishable intelligence to brigade by voice. He sends routine intelligence, such as INTSUMs, weather reports, and so on, by DMDG at noncritical times to keep the command net free for priority traffic.

### 2. INTELLIGENCE PRODUCTS

a. **Intelligence Annex.** This is a formal intelligence-tasking document. Commanders use it to disseminate information about enemy forces; higher commanders use it to instruct subordinate commanders to acquire information necessary for the conduct of the operation.

b. **Intelligence Estimate.** This is a logical and orderly examination of the intelligence factors affecting mission accomplishment. The intelligence estimate provides the commander with an analysis of the area of operations and of enemy strengths and capabilities that can influence his mission. The intelligence estimate provides the basis for planning operations and for disseminating intelligence assets.

### 3. REQUESTS AND REPORTS. (See Annex H.)

a. Each OPORD establishes the reports required for that particular mission and the times each report should be submitted.

b. SALUTE reports are submitted when any known or suspected enemy activity has been observed.

c. The S2 dispatches INTSUMs to companies and to higher headquarters.

### 4. INTELLIGENCE OPERATIONS CHECKLIST

a. Planning phase.

(1) Analyze the mission.

(2) Prepare analysis of the area of operations and of IPB.

(3) Prepare the intelligence estimate.

(4) Recommend PIR and IR.

(5) Forward RFI.

(6) Coordinate with the S3 to determine the need for EW and deception.

(7) Request and distribute maps and imagery.

(8) Coordinate with the S3 to develop intelligence-acquisition tasks for higher, lower, and adjacent units.

(9) Coordinate with the S1 and S4 to develop EPW, refugee, captured material, and document plans.

(10) Coordinate with the S3 and Signal Officer to develop SIGSEC and OPSEC measures.

(11) Prepare the intelligence annex to the OPORD/OPLAN.



- (12) Request intelligence augmentation support.
  - (a) Intelligence analysts.
  - (b) Interpreters.
  - (c) Interrogators.
  - (d) SIGINT.
  - (e) Psychological warfare teams.
  - (f) COMSEC monitoring teams.
- (13) Determine and coordinate intelligence communications links.
- (14) Coordinate with the S3 and S4 on rehearsal target construction.
- (15) Coordinate weather support.
- (16) Coordinate with the S3 to establish PIR.
- (17) Conduct threat and OPSEC briefings.
- (18) Coordinate reporting schedules with higher and subordinate units.
- (19) Coordinate LO functions.
- (20) Develop access controls for planning, rehearsing, and staging areas.
- (21) Verify the construction of targets at the rehearsal sites.

**b. Execution Phase.**

- (1) Report all significant information to higher using the proper report (see Annex H).
  - (2) Ensure subordinate units report promptly.
  - (3) Disseminate information to subordinates promptly.
  - (4) Keep the commander and S3 informed.
  - (5) Check the fire support net periodically for information.
  - (6) Recommend changes to PIR and IR.
  - (7) Provide updated information about the effects of weather and terrain on enemy operations.
  - (8) Report the capture of EPW and equipment (especially radio frequencies) promptly.
  - (9) Debrief patrols and raids.
  - (10) Conduct OPSEC.
    - (a) Monitor nets for unnecessary chatter.
    - (b) Ensure soldiers carry no personal items on operations.
    - (c) Ensure friendly units leave no compromising trash behind.
    - (d) Control access into the TOC area.

**APPENDIX: 1—Intelligence Annex OPORD Format**

**APPENDIX 1 (INTELLIGENCE ANNEX OPORD FORMAT) to ANNEX D (INTELLIGENCE) to BATTALION TSOP****1. GENERAL**

The intelligence annex is a formal intelligence-tasking document that usually accompanies an OPORD or OPLAN. The commander uses it to disseminate information about enemy forces and to instruct subordinate commanders to acquire information necessary for the conduct of the operation.

**2. FORMAT**

- a. Summary of enemy situation.
- b. Intelligence requirements.
  - (1) PIR.
  - (2) IR.
- c. Intelligence acquisition tasks.
  - (1) Orders to subordinate and attached units.
  - (2) Requests to higher, adjacent, and cooperating units.
- d. Measures for handling personnel, documents, and material.
  - (1) EPWs, deserters, repatriates, inhabitants, and other persons.
  - (2) Captured documents.

**3. Captured material**

- e. Documents or equipment required.
- f. Counterintelligence.
- g. Reports and distribution.
- h. Miscellaneous instructions.

## **ANNEX E (OPERATIONS SECURITY) to BATTALION TSOP**

### **1. GENERAL. OPSEC**

OPSEC is the protection of military operations and activities. Good OPSEC results from identifying and eliminating friendly intelligence weaknesses. OPSEC applies to all battalion and subordinate activities. OPSEC must preserve the advantage of surprise by continuously protecting classified and unclassified information.

### **2. PHYSICAL SECURITY**

Security forces restrict access to areas and limit access to equipment, activities, materials, and so on. Methods of enhancing physical security include the following:

- a. Using sandbags on headlights.
- b. Covering windshields of parked vehicles with ponchos or poncho liners.
- c. Employing at least one OP per platoon.
- d. Employing at least 33 percent security.
- e. Employing at least one security patrol from each unit. These patrols should be sent out at first light and sporadically during other times.
- f. Reconnoitering by air at first light and last light (if assets are available).
- g. Departing from the perimeter only with approval through the chain of command.
- h. Strictly enforcing noise and light discipline. Limiting light, including IR, to essential requirements to achieve a blackout. (Burning open fires and smoking cigarettes at night are prohibited.)

### **3. SIGNAL SECURITY**

SIGSEC includes COMSEC and ELSEC. Whoever transmits information over the radio must observe SIGSEC as follows:

- a. Use proper authentication procedures in all operations.
- b. Have SOI secured around his neck on a tie-down cord for security.
- c. Use radios on low power.
- d. Transmit for no more than 15 seconds.
- e. Use directional antennas.
- f. Use abbreviated radio procedure and send abbreviated reports.
- g. Use the secure mode when possible.
- h. Send timely, accurate reports, following the *SALUTE* format.
- i. Keep radio volume low and use hand mikes while listening.
- j. Use brevity codes and OPSKEDs where possible.
- k. Whisper at night.

### **4. INFORMATION SECURITY**

Material that might provide the enemy with intelligence, including classified and unclassified information, must be protected. Examples include documents,

requisitions, and reports that might expose sensitive operations. Techniques include screening or protecting orders, news releases, and graphic information. Battalion commanders should ensure subordinates—

- a. Classify all plans and OPORDs, mark them with appropriate downgrading instructions, and destroy them accordingly.
- b. Classify all training orders.
- c. Sign out plans/OPORDs only on a need-to-know basis.
- d. Brief supporting units on the sensitive nature of the plans/OPORDs.
- e. Safeguard unit rosters and follow proper mail-handling procedure.
- f. Adhere to trash discipline.
- g. Use expedient methods, such as burning, crumbling, chewing, or swallowing, to destroy PIR.
- h. Never discuss PIR items with unauthorized personnel; also, never mention these items over telephones, radios, or radiotelephones. (PIR are listed in Appendix 1 to Annex E.)

## **5. DECEPTION AND COUNTERSURVEILLANCE MEASURES**

Leaders should consider the following:

- Dummy weapons positions.
- Dummy radio traffic.
- Air assault false insertions.
- Dummy resupply operations.
- Vehicle movement.
- Lighting.
- Engineer work (obstacles).
- Fictional overlays, maps, or both, left where the enemy will find them.

**APPENDIX: 1**—Priority Intelligence Requirement

## **APPENDIX 1 (PRIORITY INTELLIGENCE REQUIREMENT) to ANNEX E (OPERATIONS SECURITY) to BATTALION TSOP**

### **1. GENERAL**

The battalion OPSEC plan must include safeguards to prevent the enemy from learning the PIR listed in succeeding paragraphs.

### **2. ORGANIC ASSETS**

- a. Communications assets.
- b. Special weapons systems.
- c. Special deployment equipment (infiltration or exfiltration).
- d. Units, especially their combat efficiency.
- e. REMAB sites.
- f. Intelligence, surveillance, and reconnaissance resources.

### **3. LOCATIONS**

- a. Deployment sites, rehearsal sites, and assembly areas (REMAB, ISB).
- b. Command posts.
- c. Units deployed on any contingency mission.
- d. Tactical or strategic objectives.
- e. VIPs in the unit area.
- f. Key personalities in the command.
- g. LZs and DZs

### **4. PLANS AND OPERATIONS**

- a. Alert and mobilization.
- b. Deployment.
- c. Contingency requirements, including pre-positioning of equipment.
- d. Air and artillery support.
- e. Deception.
- f. Reconnaissance and security.
- g. Security of unit buildings and areas.
- h. Infiltration techniques (by parachute, helicopter, or small boat).
- i. Unit SOPs.
- j. Command relationships between brigade and higher headquarters.
- k. Contingency areas of command/operational interest.
- l. Logistics.

### **5. REPORTS**

- a. Casualties.
- b. Operational status.
- c. Results of enemy action.

- d. Personnel status.
- e. Availability of replacements.
- f. Success or failure of tactical operations.
- g. Requests for key mission-essential items of equipment.
- h. Operations or communications security violations.
- i. Logistics capabilities.
- j. Unit morale/desertions.

**6. SOI AND ENCRYPTION.**

**7. RULES OF ENGAGEMENT.**

**8. SPECIALIZED TRAINING.**

## **ANNEX F (LOGISTICS) to BATTALION TSOP**

### **1. GENERAL**

- a. The field trains is normally located in the BSA and is manned by representatives of the S1 and S4 as the mission requires.
- b. The combat trains functions as the main control cell for administrative and logistical actions.

### **2. REPORTS (See Annex H.)**

- a. **Daily LOGSTAT Report.** (Page I-4-A-1.) This report is due to the S4 NLT 0600Z daily indicating status as of 2400Z (6 hours earlier). Submission is by secure means. The LOGSTAT report is confidential when filled in. After initial submission, only changes are reported.

- b. **Battle Loss Report.** (Page I-4-B-1.) This is a spot report indicating a loss of such significance that mission accomplishment may be impaired. Submission of such a report constitutes a request for corrective action. The logistics operations center immediately coordinates with higher headquarters as appropriate to effect corrective action.

- c. **Resupply Insertion Request.** (Page I-4-C-1.) This request provides for needed resupply into the objective area.

### **3. SOLDIER'S LOAD**

- a. Leaders must plan detailed logistics support to reduce the soldier's load.
- b. Rucksacks do not exceed 35 pounds.
- c. Total soldier load does not exceed 60 pounds.

---

## ANNEX G (PERSONNEL AND ADMINISTRATION) TO BATTALION TSOP

### 1. PERSONNEL MANAGEMENT

a. **Reports.** Units report their status ASAP when PDY strength falls below 85 percent, then 70 percent, then 50 percent. Key personnel losses and any identified or temporary replacements are highlighted. (See Annex H, Appendix 1 for a list of personnel management reports.)

b. **Replacements.** Assignment of all replacements is controlled at the logistics operations center. Their transportation to the units is coordinated through this center; pickup times and locations are published if the tactical situation allows.

c. **Casualties.** All casualties are reported on the administrative/logistics radio net via PERSTATREP. Team leaders and above each carry DA Form 1155/1156 pads in the top flaps of their rucksacks for recording casualty information. Transportation of bodies is coordinated on the administrative/logistics net by the unit S4 as soon as the tactical situation allows. If no evacuation/transportation is available, the dead are buried and the area's eight-digit grid coordinates are recorded for future recovery. The unit S4 arranges for the recovery of bodies and personal effects for evacuation to the soldiers' home stations.

d. **Prisoners of War.** Prisoners of war are evacuated to a collection point as specified in the OPOD—not to command posts. Units provide guards to remain with PWs until they are transferred to MP custody.

### 2. PERSONNEL ADMINISTRATION

a. **Postal.** Delivery and postal services are established at the logistics operations center. Only first-class mail is delivered to the objective area. Mail received at battalion for dispatch to units in the objective area is bundled for delivery. Unit mail clerks collect and distribute mail IAW AR 67-75. Mail is secured and transported in a locked mail bag.

b. **Awards and Decorations.** All awards and decorations are processed IAW AR 672-5-1. Any nomination for a valor award must include two witness statements.

c. **Finance.** The Secretary of Defense notifies units about areas subject to hostile fire. Determination of hostile-fire pay is made IAW the DOD Military Pay and Allowances Entitlements Manual.

### 3. MEDICAL

#### a. Planning.

(1) The senior medical officer/NCO, in coordination with the S1, plans medical support for the battalion. The three basic elements are:

- (a) Triage/treatment.
- (b) Evacuation.
- (c) Supply/resupply.



(2) Medical augmentation is established by brigade or other higher headquarters on a mission-by-mission basis.

b. **MEDEVAC.** Reports are initiated on the command net, then transferred to administrative/logistics for execution and recovery. Units must try to evacuate patients back to unit aid stations for sustained treatment. Evacuation priorities are determined by the unit senior medic based on patient condition. Personal equipment is evacuated with the individual.

c. **Preventive Medicine.**

(1) Daily personal hygiene includes washing, shaving, and brushing teeth.

(2) Soldiers in heavily forested/jungle areas should inspect themselves and remove any ticks they find every six hours. They should report all parasitic infestations (ticks, fleas, lice, and so on) to medical personnel immediately.

(3) Soldiers must avoid trying to capture or handle snakes for any reason. Snake bite first aid should include the following:

(a) Apply a tourniquet above the bite between the injury and the heart. The tourniquet should not be applied too tightly—the soldier should be able to pass one finger under the tourniquet.

(b) A soldier bitten by a snake should be evacuated immediately for expert medical care (usually to the location of the senior medic or battalion surgeon).

(4) Soldiers avoid trying to capture or handle animals. They must report any animal bites immediately to the battalion surgeon.

(5) Company preventive medical teams must inspect latrine and mess facilities daily and report the results to the company XO. The XO ensures deficiencies are corrected immediately.

(6) Soldiers report all diarrhea illnesses to the battalion surgeon/PA.

#### **4. RELIGIOUS SERVICES**

Battalion chaplains coordinate religious services within their units.

#### **5. LEGAL**

a. **Discipline, Law, and Order.**

(1) Personnel remain assigned to their units for military justice. Commanders may exercise the full range of judicial, nonjudicial, and administrative measures available to them. If judicial action is contemplated, units preserve evidence (as much as possible), make sketches, and take statements for eventual action upon redeployment.

(2) Follow-on forces may pick up soldiers separated from their units and stragglers for rapid return to their units or for other appropriate disposition.

(3) Legal defense services are unavailable during the initial stages of deployment. The division SJA can provide legal assistance as appropriate.

b. **Conduct if Captured.** Captured soldiers identify themselves as American soldiers and insist on proper treatment IAW the 1949 Geneva Convention. The Code of Conduct and the UCMJ remain in effect.

c. **Claims.** The unit claims officer refers claims by local citizens to the SJA for disposition. The unit should make a reasonable effort to preserve evidence of accidents for further investigation by US Claims authorities. Under no circumstances should soldiers promise or commit the US to reimburse for damages.

d. **War Crimes.** Suspected violations of the law of war committed by anyone—the enemy, US allies, or US personnel—are immediately reported through the chain of command or through other appropriate channels (PM, IG, JAG, or chaplain) for rapid investigation.

e. **Disposition of Captured Weapons, Material, and Equipment.**

(1) All captured material is evacuated through appropriate channels as US Government property.

(2) No war trophies or mementos are taken.

(3) Personal property of EPWs, civilians, or enemy KIA remains with them.

f. **Weapons and Munitions.**

(1) No privately owned weapons, ammunition, or explosives are carried or used by soldiers during operations.

(2) All military munitions, explosives, ammunition, and firing devices are controlled, accounted for, secured, and turned in upon completion of operations.

## ANNEX H (REPORTS AND REQUESTS) to BATTALION TSOP

### 1. SCHEDULE OF REPORTS

The following is a schedule of mandatory recurring reports and the times they are due:

| REPORT                       | FREQ | NET USED  | AS-OF TIME             | DUE TO BN OPS CENTER | DUE TO BDE OPS CENTER | PROPO-NENT |
|------------------------------|------|-----------|------------------------|----------------------|-----------------------|------------|
| PERSTATREP                   | D/X  | ADMIN/LOG | 1100Z                  | 1300Z                | 1500Z                 | S1         |
| PERSTATREP (Sec I)           | X    | ADMIN/LOG | 2400Z                  | 0100Z                | 0300Z                 | S1         |
| Commander's situation report | D    | COMMAND   | 2400Z                  | 0600Z                | 0800Z                 | S3         |
| LOGSTAT                      | D    | ADMIN/LOG | 2400Z                  | 0600Z                | 0800Z                 | S4         |
| Battle loss                  | D/X  | CMD       | 2400Z                  | 0600Z                | 0800Z                 | S4         |
| Effective downwind message   | D/X  | CMD       | Updated every 12 hours | N/A                  | N/A                   | S3         |
| Chemical downwind message    | D/X  | CMD       | Updated every 6 hours  | N/A                  | N/A                   | S3         |

(D = Daily, X = by exception)

### 2. MEANS OF TRANSMISSION

Reports should be transmitted by messenger. However, commanders use wire or secure radio when messengers cannot be used.

### 3. REPORT MATRIX

This matrix recaps all reports required within the battalion daily. Battalion/company listings are included to help leaders log in reports at all levels. This matrix can also be used as a checklist for RATELOs.

---

| DUE (NLT)<br>Z ____ L ____ | REPORT _____        | AS OF<br>Z ____ L ____ | FROM | TO  |
|----------------------------|---------------------|------------------------|------|-----|
| 0345                       | Battle loss         | 2400                   | CO   | BN  |
| 0400                       | LOGSTATREP          | 2400                   | CO   | BN  |
| 0415                       | Commander SITREP    | 2400                   | CO   | BN  |
| 0430                       | PERSTATREP          | 2400                   | CO   | BN  |
| 0600                       | Battle loss         | 2400                   | BN   | BDE |
| 0600                       | LOGSTAT             | 2400                   | BN   | BDE |
| 0600                       | Commander SITREP    | 2400                   | BN   | BDE |
| 1300                       | PERSTATREP          | 1100Z                  | BN   | BDE |
| 0100                       | PERSTATREP          | 2400Z                  | BN   | BDE |
| 0300                       | Fire support SITREP | 2400                   | BN   | BDE |
| ASAP                       | Results of contact  | ASAP                   | CO   | BN  |
| ASAP                       | Results of contact  | ASAP                   | BN   | BDE |
| ASAP                       | Salute              | ASAP                   | CO   | BN  |
| ASAP                       | Salute              | ASAP                   | BN   | BDE |

---

#### 4. FORMATS

##### a. Appendix 1—Personnel Reports

- (1) Tab A—PERSTATREP
- (2) Tab B—Casualty Feeder Report
- (3) Tab C—Witness Statement
- (4) Tab D—Serious Incident Report

##### b. Appendix 2—Intelligence Reports

- (1) Tab A—Patrol Report
- (2) Tab B—EPW/Captured Material Report
- (3) Tab C—SALUTE Report
- (4) Tab D—Intelligence Summary
- (5) Tab E—Air Request Reconnaissance
- (6) Tab F—MIJI Feeder
- (7) Tab G—Weather Forecast
- (8) Tab H—RFI Format

**c. Appendix 3—Operations Reports**

- (1) Tab A—Results of Contact Report
- (2) Tab B—Commander’s Situation Report
- (3) Tab C—Minefield Report
- (4) Tab D—Naval Gunfire Request
- (5) Tab E—TACAIR Request
- (6) Tab F—Air Support Request
- (7) Tab G—SHELREP, MORTREP, BOMREP
- (8) Tab H—Order Message
- (9) Tab I—OPLAN/OPORD Change
- (10) Tab J—Air Defense Alert Message
- (11) Tab K—Fire Support SITREP
- (12) Tab L—Deployment/Redeployment Report
- (13) Tab M—Closure Report

**d. Appendix 4—Logistics Reports**

- (1) Tab A—LOGSTAT Report
- (2) Tab B—Battle Loss Report
- (3) Tab C—Resupply Insertion Request

**e. Appendix 5—NBC Reports**

- (1) Tab A—NBC 1 Report
- (2) Tab B—NBC 2 Report
- (3) Tab C—NBC 3 Report
- (4) Tab D—NBC 4 Report
- (5) Tab E—NBC 5 Report
- (6) Tab F—NBC 6 Report
- (7) Tab G—NUCWARN/CHEMWARN
- (8) Tab H—Effective Downwind Message
- (9) Tab I—Chemical Downwind Message

---

**ANNEX I (OPSKEDs) to BATTALION TSOP**

| <b>TASK</b>                     | <b>CODE NAME</b> |
|---------------------------------|------------------|
| Appendix 1. Movement to Contact | GOLD             |
| Appendix 2. Ambush              | BLACK            |
| Appendix 3. Road March          | SILVER           |
| Appendix 4. Patrol              | KHAKI            |
| Appendix 5. Raid                | WHITE            |
| Appendix 6. Air Assault         | GRAY             |
| Appendix 7. Relief in Place     | GREEN            |
| Appendix 8. Defense             | PINK             |
| Appendix 9. Passage of Lines    | ORANGE           |
| Appendix 10. Linkup             | YELLOW           |
| Appendix 11. River Crossing     | PURPLE           |
| Appendix 12. MOUT               | BROWN            |

**NOTE:** Appendix 1 is an example OPSKED. Appendixes 2 through 12 are omitted.

**APPENDIX 1 (MOVEMENT to CONTACT) TO ANNEX I (OPSKEDs)  
to BATTALION TSOP**

**MOVEMENT TO CONTACT OPSKED (GOLD)**

1. Executing movement.
2. Conducting passage of lines.
  - a. Completed.
  - b. Passage halted.
3. Crossing LD.
4. Crossing phase line \_\_\_\_\_.
5. Crossing intermediate march objective \_\_\_\_\_.
6. Occupying battle position \_\_\_\_\_.
7. Requesting additional forces.
  - a. Infantry.
  - b. Engineers.
  - c. Fire support.
  - d. ADA.
  - e. Medic.
  - f. Other.
8. Sending forces to \_\_\_\_\_.
9. Holding up movement at \_\_\_\_\_.
10. Commencing hasty attack on objective \_\_\_\_\_.
11. Destroying enemy at OBJ \_\_\_\_\_.
12. Announcing objective secured.
13. Continuing advance/pursuit.
14. Arriving at LOA.
15. Requesting resupply at \_\_\_\_\_.
16. Spare.
17. Spare.

# COMMAND AND CONTROL RESPONSIBILITIES AND FACILITIES

**T**he commander establishes a standard command and control system by defining the functions of keypeople, organizations, and facilities. His link to the battle is most efficient if only key people have access to him. These people in turn control the rest of the command, and normally include the second in command, the operations officer, the FSO, and the subordinate unit or element commanders.

## Section I. RESPONSIBILITIES

This section discusses soldier and staff functions and responsibilities.

### B-1. COMMANDER

The commander commands and controls subordinate combat, CS, and CSS elements that are organic or attached to his unit or that are under its OPCON. The commander's main concerns are completing his mission and ensuring the welfare of his soldiers.

a. The commander cannot win the battle alone. He must—

(1) Rely on his staff and subordinate commanders for advice and aid in planning and supervising operations.

(2) Understand their limits and capabilities.

(3) Train them to execute his concept in his absence.

(4) Institute cross-training among the staff so the unit can operate with combat losses or fatigue in the staff elements.

b. The staff reduces the demands on the commander's time and aids him by providing information; estimating; recommending; preparing plans and orders; and supervising the execution of orders issued by, or in the name of, the commander. To ensure conflicts do not arise, the commander assigns responsibility for

specific functions to unit staff officers. Though they must be responsive to command prerogative, the staff must have the authority to be responsive to subordinate unit commanders, and to say "yes" to requests from them.

### B-2. EXECUTIVE OFFICER

The XO is second in command and the battalion commander's main assistant. As the second in charge, he must be prepared to assume the duties of the commander.

a. The XO, as the coordinator of the battalion staff, establishes staff operating procedures. He ensures the commander and staff are informed on matters affecting the command. To coordinate and synchronize the plan, the XO assembles and supervises the staff during the decision-making process. He establishes the required liaison. Unless instructed otherwise by the commander, all staff officers inform the XO of any recommendations or information they give directly to the commander or any instructions they receive directly from the commander. When required, he represents the commander, supervises the



main CP and its operations, and provides for battalion logistical support.

b. The XO, as the second in command, transmits the commander's decision to staff sections and, in the name of the commander, to subordinate units as needed. The XO keeps abreast of the situation and future plans and represents the commander during the commander's absence, directing action IAW established policy. He is considered a combat leader and is prepared to assume command at any time. During combat, he supports the commander by anticipating problems and synchronizing operations at the main CP. Although the XO normally stays in the CP during combat, he must be ready to move if he is required at another location.

c. All information flows through the TOC and the XO except when circumstances require otherwise. The exception occurs during fast-paced operations when vital information flows via orders and reports between the command group and the key maneuver elements. In this situation, the XO is a key leader in the TOC, sometimes checking attachments—for example, monitoring the nets and progress of supporting units—monitoring the overall battle, ensuring reports are rendered as necessary, supervising planning of future operations, and providing the commander with situational assessments as needed.

d. The XO assumes responsibility for the diverse elements operating in the TOC during the battle. Those elements receive and analyze information from a wide variety of sources. The XO analyzes all of this for information that might be immediately useful to the commander. The commander uses the XO's analysis along with the steady flow of information coming from his subordinate commanders and the advice of the operations officer.

### **B-3. COMMAND SERGEANT MAJOR**

The CSM is the senior NCO in the unit. He acts in the name of the commander when dealing with other NCOs in the unit and advises the commander concerning the enlisted ranks. Though he is not an administrator, he must understand the administrative, logistical, and operational functions of the unit to which he is assigned. Since he is normally the most

experienced soldier in the unit, his attention should be focused on operations and training and on how well the commander's decisions and policies are being carried out. He is the senior enlisted trainer in the organization. He works closely with company commanders when reaching and training first sergeants and platoon sergeants. He maintains close contact with subordinate and attached unit NCOs. The CSM must be tactically and technically proficient in combat operations at battalion, company, platoon, and squad levels. The CSM should act as the commander's representative in supervising aspects vital to an operation, as determined by the commander and by himself. For example, he can help control movement through a breach in a critical obstacle or at a river crossing, or, he can help coordinate a passage of lines. The CSM can lead the quartering party during a major movement. He can also help in the CSS effort during the battle; he can perform tasks such as monitoring casualty evacuation.

### **B-4. COORDINATING STAFF**

Coordinating staff officers aid the commander by coordinating the plans, activities, and operations of the command. Collectively, they have responsibility for the commander's entire field of responsibilities, except in areas that the commander decides to control personally or in those that are reserved by law or regulation for specific staff officers. Coordinating staff officers are responsible directly to the XO. At battalion level, the coordinating staff includes the S1, S2, S3, and S4. Some battalions might be authorized an S5 to aid in civil-military cooperation. (Chapter 8 provides more information about the S1 and S4.)

a. **S1 (Adjutant).** The S1 has the responsibility for all personnel matters. The S1—

(1) Maintains unit strength and personnel service support.

(2) Supervises medical, legal, safety, and civil affairs (including civilian labor) assets.

(3) Monitors postal services and public affairs.

(4) Coordinates religious support with the battalion UMT.

(5) Operates from the combat trains with the S4. The S1 also shares supervisory responsibility for logistical operations with the S4.

They must cross train to be able to conduct continuous operations.

(6) Moves around as necessary to accomplish his mission.

(7) Is responsible for—

- Replacement policies and requirements.
- Unit strength and loss estimation.
- Morale support.
- Battalion administration.
- Administrative support of EPWs and civilian internees.
- Staff supervision of casualty evacuation.

b. **S2 (Intelligence Officer)**. The S2 is responsible for intelligence. The S2's role in target analysis and his important linkage with the S3 and FSO is vital to mission accomplishment. The S2—

(1) Performs the IPB with the commander and S3 using higher collection sources, ground and aerial reconnaissance, observation posts, GSR, target acquisition, and electronic warfare assets.

(2) Prepares and disseminates intelligence estimates.

(3) Aids the commander with the PIR and generates other IR.

(4) Obtains and disseminates weather information and predicts (with the assistant S3/Chemical Officer) the probability of use and effects of enemy NBC weapons.

(5) Supervises counterintelligence efforts, intelligence training, map procurement/distribution, and storage and control of classified information.

(6) Remains at the main CP where he has the communications assets to plan, prepare, and supervise reconnaissance and surveillance activities (in coordination with the S3) and to update the intelligence estimate.

(7) Maintains the enemy SITMAP, and evaluates and interprets enemy information.

(8) Plans all battalion patrols, intelligence collection, reconnaissance, and surveillance.

(9) Supervises the activities of GSR when attached.

(10) Informs the XO about the enemy situation.

(11) Works closely with the FSO and assistant S3 to ensure information is passed between staff sections.

(12) Supervises the tactical intelligence officer, who is part of the two-man BICC. The BICC manages the collection, processing, and dissemination of battalion intelligence for the S2. It develops and initiates the reconnaissance and surveillance plan, identifies IR, and notifies the brigade S2 of information that cannot be collected by the battalion's assets.

c. **S3 (Operations and Training Officer)**. The S3, as the operations officer, is the commander's main assistant in coordinating and planning the battle. The S3—

(1) Monitors the battle, ensures that CS assets are provided when and where required, and anticipates developing situations.

(2) Advises the commander on combat, CS, and operational matters; organization; and training.

(3) Prepares the operations estimate. When the XO is absent, the S3 coordinates and synchronizes the battle plan and supervises the staff during the decision-making process.

(4) Plans and coordinates with other staff sections. This results in published OPORDs, OPLANs, and training programs.

(5) Is responsible (with the aid of other staff officers) for integrating the following operations into the tactical plan:

- Psychological operations.
- Electronic warfare.
- Jamming/ECM operations.
- Operations security.
- Counterreconnaissance.
- Deception.
- Tactical troop movements.

(6) Establishes priorities for communications to support tactical operations.

(7) Coordinates with the XO and battalion signal officer on the location of the main CP.

(8) Coordinates the activities of the S2, the FSO, the FAC and, if supporting, the engineer and ADO, to ensure their plans support the commander's concept.

(9) Supervises the chemical and signal officers and the assistant S3/S3 air.

(10) Coordinates closely with the S4 to ensure tactical plans are logistically supportable.

(11) Trains and provides an S3 cell to control and operate forward with the command group when required.

(12) Remains with the commander during the fight, if the commander directs.

(13) Provides the commander with information that has an immediate impact on the battle. To provide such information, he follows the same process outlined for the XO. The S3 and XO complement each other by providing the commander with continuous vital information.

(14) Considers information that affects the area of operations, which complements the XO's focus on the unit's area of interest.

(15) Works directly with elements of the command group to receive information; and to analyze, integrate, and convey his assessment to the commander.

(16) Is aided by the S3 air, who is at the main CP. The S3 air coordinates the employment of CAS with the FSO and the TACP, as well as with the air defense section leader. The S3 air assumes the S3's duties when the S3 is absent. The S3 Air supervises the A2C2 element, which consists of representatives of the fire support and defense elements and of the tactical air control party.

d. **S4 (Logistics Officer).** The S4 has the main staff responsibility to determine CSS requirements and priorities.

(1) The S4—

(a) Designates lines of movement and locations of CSS elements.

(b) Prepares and develops CSS plans in concert with the current tactical plan and anticipates future logistical needs.

(c) Is responsible for the preparation and distribution of CSS support plans and orders when they are published separately.

(d) Establishes the requirements for civilian labor and the collection and disposal of excess property, salvage, and captured material.

(e) Is OIC of the combat trains and is collocated with the S1.

(f) Monitors closely the tactical situation to begin resupply as soon as possible.

(g) Pushes ammunition, food, fuel, and other supplies forward when a lull in the battle occurs.

(h) Designates two or three soldiers from the section to aid him in running the combat trains.

(i) Supervises the support platoon leader, who is based in the field trains.

(2) The S4's section—

(a) Is responsible for the procurement, receipt, storage, and distribution of supplies.

(b) Is responsible for transportation of units, soldiers, and logistics items to their required locations.

(c) Is (except for elements in the combat trains) in the field trains under the supervision of the HHC supply sergeant. This element collocates with the PAC under command of the HHC commander and maintains communication with the S4 on the administrative/logistics net.

## B-5. SPECIAL STAFF

The special staff aids the commander in professional, technical, or other functional areas. Leaders of elements supporting the battalion make up the special staff. These leaders can be officers or NCOs.

a. **Headquarters and Headquarters Company Commander.** The HHC commander must ensure the command facilities have logistical support. He places his XO with the main CP to supervise support, security, and movement. The HHC commander goes to the field trains to control and coordinate all battalion activities there. He uses land lines and messengers to control all elements in the field trains and communicates with the combat trains using the administrative/logistics net (FM). These actions help free the battalion XO to perform as the second in charge. During operations other than sustained ground combat operations, the HHC commander is available for other tactical missions as ordered by the battalion commander/S3. He can coordinate and control the reconnaissance/counter-reconnaissance effort, combat patrols, or any other task designated by the battalion commander.

b. **Fire Support Officer.** The FSO tries to locate near the commander, but must locate

where he can communicate best. The integration of fire support into the maneuver operation is a decisive factor in the success of battle. The FSO is responsible—

- (1) For advising the commander on the best available fire support resources.
- (2) For developing the fire support plan.
- (3) For issuing the necessary orders in the name of the commander.
- (4) For implementing the approved fire support plan.

**c. Nuclear, Biological, and Chemical Personnel.** A chemical officer is assigned to the S3 section of each combat battalion. A chemical NCO assists him. A decontamination specialist is assigned to the HHC of airborne and air assault battalions. The chemical officer and NCO train and supervise the battalion decontamination crew. During combat operations, the chemical officer and NCO provide a constant capability within the S3 section to receive, correlate, and disseminate information on NBC attacks. They consolidate reports of subordinate units' OEG radiation status and pass on the results to higher headquarters as required. They provide recommendations concerning the MOPP analysis and the employment of supporting NBC reconnaissance and smoke units. If the unit comes under NBC attack, battalion NBC personnel organize and establish a battalion NBC center. From it they supervise the activities of radiological survey and monitoring teams and chemical detection teams. They also coordinate and supervise decontamination missions conducted with or without supporting divisional decontamination assets.

**d. Battalion Signal Officer.** The signal officer—

- (1) Advises the commander and staff officers on all signal matters.
- (2) Plans, manages, and directs all aspects of the unit communications systems.
- (3) Supervises the communications activities of subordinate and attached units.
- (4) Plans and supervises the integration of the unit communications system into the the systems of higher, lower, and adjacent headquarters.
- (5) Supervises the unit maintenance of signal equipment for the unit and for subordinate

units. He also monitors the status of support maintenance on unit and subordinate unit signal equipment.

- (6) Prepares and writes the signal annex of unit orders and plans.
- (7) Advises the commander and staff on the ECCM aspects of EW and develops procedures for MIJI reports.
- (8) Determines, with the unit S3, the location of the main, combat trains, and field trains CPs.
- (9) Ensures selected areas afford the most in communications potential and the least in potential enemy EW interference.

**e. Scout Platoon Leader.** The scout platoon leader advises the commander and the S2 on the employment of the scout platoon. He is responsible for conducting tactical reconnaissance in support of the battalion.

**f. Battalion Mortar Platoon Leader.** The battalion mortar platoon leader advises the battalion commander and the FSO on the tactical employment of the battalion mortar platoon. He can help the FSO fulfill his FSCOORD responsibilities. The mortar platoon's headquarters can also serve as an alternate CP.

**g. Antiarmor Company Commander/Platoon Leader.** The antiarmor company commander/platoon leader advises the commander on the tactical employment of battalion antiarmor assets. In the absence of an armor threat, he aids/advises the commander about other supporting antiarmor roles. If it is properly task-organized, the antiarmor company/platoon can serve as a fourth maneuver element or its headquarters can serve as an alternate battalion CP.

**h. Engineers.** The leader of the supporting engineer unit serves as the battalion engineer. He advises the commander on the use of engineer assets. He aids the staff in analyzing terrain, templating enemy obstacles, and coordinating a mobility/countermobility plan to accomplish the scheme of maneuver. If an engineer platoon supports the battalion, it must maintain continuous communications with the main CP.

**i. Air Defense Artillery Assets.** The commander might have a MANPADS section in support. The MANPADS section leader is located at the TOC to plan and control ADA integration and early warning. He immediately

analyzes the changing air defense posture, and recommends how to deal with the air threat. If a platoon of Vulcans is supporting the battalion, the ADA platoon leader coordinates use and employment of all supporting air defense assets. He stays with his platoon, but enters the battalion command net and moves to the TOC to participate in planning.

j. **Chaplain.** The chaplain works closely with the S1. He is a special/personal staff officer with access to the commander. He advises the commander on the religious welfare, morals, and morale of the unit, as well as about local religions. The chaplain and his assistant form the UMT section. They provide comprehensive religious support to soldiers on the battlefield. The religious support mission includes performing/providing sacraments, rites,

ordinances, and worship services; pastoral care and counseling; battle fatigue ministry; and memorial services.

k. **Surgeon.** The surgeon is the medical advisor to the battalion commander and his staff. He also serves as the medical platoon leader and is the supervising physician of the treatment squad. He is responsible for all medical treatment provided by the platoon. With the aid of the physician's assistant, he operates the BAS at the combat trains. He and assistants train the medical platoon, treat for the wounded and sick, and inform the commander about the health of the battalion. They aid the S1 in making medical estimates. An MSC field medical assistant officer, aided by his platoon sergeant, handles the administration and logistics of the medical platoon.

## Section II. FACILITIES

The command and control facilities at battalion level can be classified by echelon as main, combat trains, field trains, and alternate CPs. Figure B-1 shows a typical layout of command and control facilities.

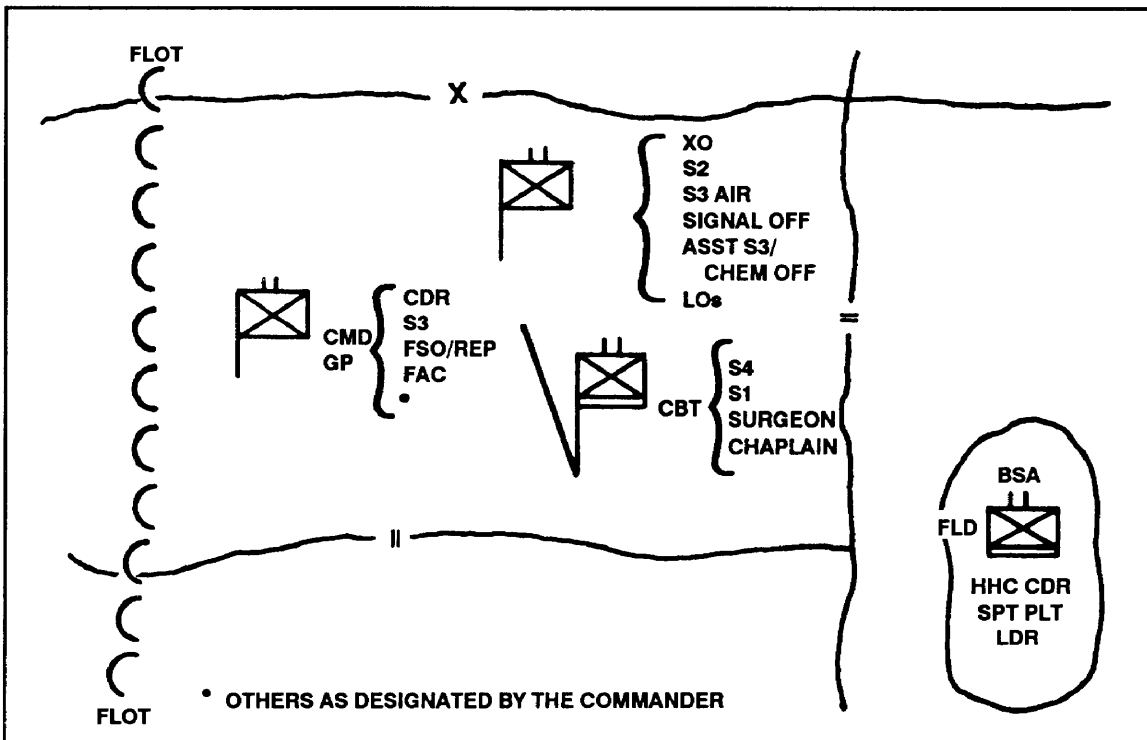

Figure B-1. Command and control organization on the battlefield.

## B-6. COMMAND GROUP

The command group is composed of the commander, the soldiers in the command group, and the equipment the commander has forward with him to help command and control the immediate battle. The command group is not a permanent organization. It is organized by the commander to operate as needed. The command group in the infantry battalion can be organized with or, if terrain is too restrictive, without vehicles (soldiers walk).

a. **Personnel.** The command group consists of the commander, the S3, the FSO, and the FAC. Depending on the situation, the engineer, the ADA representative, and the reserve company commander can also accompany the command group.

(1) **S3.** The commander can send his S3 to observe or to provide command and control to another area. Otherwise, the S3 remains with the command group.

(2) **S2.** The S2 can go forward with the commander and monitor the scout platoon net. Doing this allows him to give information to the commander sooner than it could be relayed from the TOC.

(3) **Fire support officer.** The FSO is forward with the commander. The FSO coordinates fire support and immediately analyzes and advises on ways to increase the capabilities of the fire support system and thereby increase the combat power of the force. The FSO remains with his vehicle at the main CP with the FSE to monitor fire support and to help with planning. The FSO deploys forward with a manpack radio and DMD. He recommends priorities of fire and integrates CAS and all indirect fire assets, including mortars, to support the battle.

(4) **Forward air controller.** The FAC should be forward with the commander. Seeing the battlefield enables him to provide more accurate and responsive CAS. He uses a UHF/VHF manpack radio. His vehicle and other communications remain at the main CP as backup.

(5) **Enlisted personnel.** This includes command group drivers, RATELOs, and security personnel. Security personnel must be proficient and well-trained.

b. **Location.** The command group must be mobile and must be able to communicate with other elements. The command group is often collocated with a subordinate maneuver unit for security.

(1) The command group must be able to move often or continuously. The commander positions his command group to influence or observe the most critical event or location in the battle area, though factors of METT-T determine the exact location.

(2) The command group should always be near the battalion main effort. Thus, the commander can maintain control through immediate physical contact in the event of a communications failure. Communications are an important factor in deciding the location of the command group, which must communicate constantly with subordinate maneuver units, the TOC, and the brigade command group. This can be accomplished through the use of FM retransmission sites controlled by the command group, although direct FM contact is preferred.

c. **Operation.** The command group fights the battle. They can form early to conduct a physical reconnaissance as part of their planning. They may then return to the main CP to complete planning and issue the order, or they may have the staff come forward to complete planning and issue the order. The commander positions himself in a critical position (determined during his estimate) on the battlefield. He does this to control the battle and to be able to issue orders at critical times.

## B-7. MAIN COMMAND POST AND TACTICAL OPERATIONS CENTER

The main CP includes all soldiers, equipment, and facilities employed in commanding and controlling the battalion. The TOC is the operations cell within the main CP. The TOC includes all the staff activities involved in sustaining current operations and in planning future operations. Its staff activities are grouped by function (S2, S3, FSE and so on). (Figure B-2, page B-8, shows the standardized organization of a main CP.)

a. **Personnel.** The battalion TOC is supervised by the XO. It is composed of the S2 and S3 sections, FSE, elements of the communications platoon and of the TACP, and another support element—for example, engineer or air defense, depending on the unit's task organization.

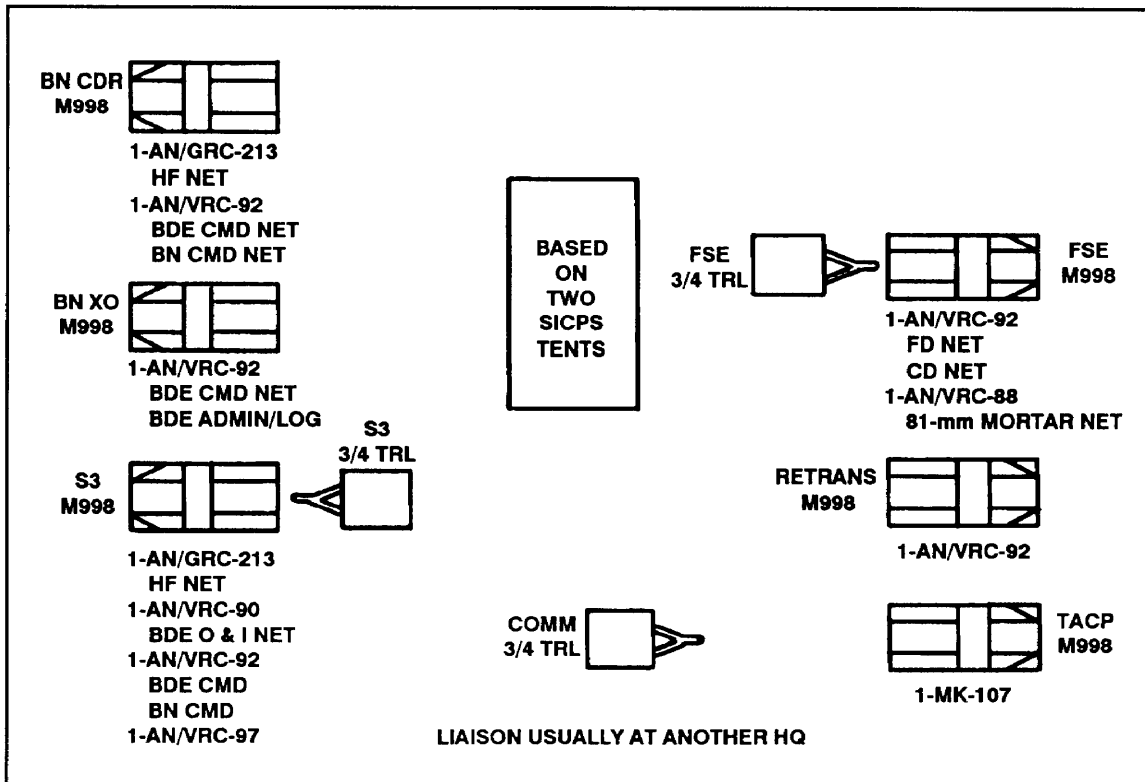

Figure B-2. Standardized organization of a main CP.

b. **Functions.** The TOC helps with tactical control and plans immediate and future tactical operations. The TOC must include a place for planning and orders production and must serve as a tactical briefing area for orders. The TOC must be organized to ease planning and continuous operations and must be able to displace rapidly with little degradation in command and control. (Figure B-3 shows the standardized TOC configuration.) The TOC also must—

(1) Exercise terrain management. The TOC monitors and controls the battalion's movement. It tracks fire support, NBC attacks, employment of illumination and smoke, adjacent units, and the status of CS/CSS.

(2) Stay abreast of the situation and ease the flow of information. The TOC maintains communications with organic, higher, and adjacent units. It answers traffic on the command net so the commander need only monitor radio traffic. It also posts maps, maintains records, monitors BDA and sends reports to higher and adjacent headquarters as required.

(3) Continuously plan and provide information and aid to the commander and his subordinate commanders. To do this, the TOC receives, processes, and analyzes information; maintains historical journals; and updates the S3, XO, and commanders. During engagements, everyone at the main CP is either involved in coordinating and controlling the operation or is on security, and the main CP is prepared for displacement. During lulls or periods of light contact, shifts can be reestablished.

c. **Location Requirements.** Main CP locations are selected by the S3 with the signal officer. The HHC XO selects the precise location.

(1) **Communications.** The main CP must be able to communicate with subordinate and supporting units and higher headquarters on all required nets. The site location varies according to whether the operation is offensive or defensive. The main CP is farther forward during an offensive operation than it is during a defensive one. In the defense, the main CP is as far back as it can be and still maintain

adequate communications. Radios are remoted as necessary to provide security and protection.

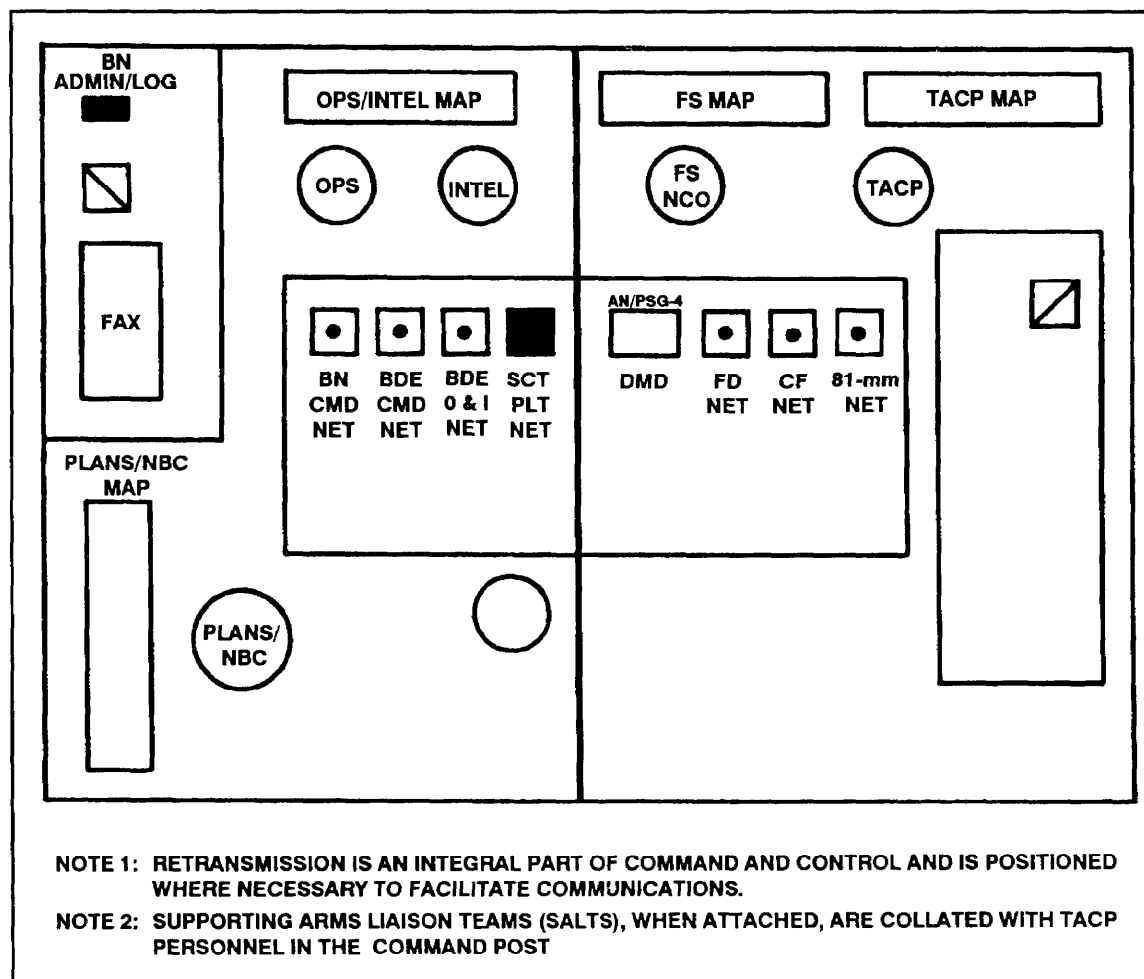

**Figure B-3. Standardized TOC configuration.**

(2) **Access.** The main CP should be centered in the unit area. It should be near, but not next to, a high speed avenue of approach. No more than one or two routes should lead into the main CP. These routes should be covered, concealed, and connected with routes of communication that provide access to most of the units. Regardless of whether the operation is offensive or defensive, the physical presence of the main CP must not interfere with the tactical maneuver of friendly units. When possible, a helicopter LZ should be nearby.

(3) **Survivability.** Survivability is equally important. If the main CP is located other than

in a built-up area, the best place for it is on a reverse slope with cover and concealment. Key terrain features such as hilltops and crossroads should be avoided, yet the TOC must be accessible for occupation, convening of the orders group, and displacement.

(4) **Size.** The area selected must be large enough to accommodate all main CP elements when the command group is not deployed forward. This includes liaison soldiers from attached and supporting units. The area selected must include space not only for the TOC and for communications support, but also for eating, sleeping, latrine, and maintenance areas.



Also, sufficient area must be available for positioning security and for vehicle dismount points and parking.

(5) **Concealment.** The main CP must be stationary to be fully effective regardless of its location. Displacements depend on the ability of the enemy to locate and target the TOC. They should be planned to allow the main CP to remain stationary at critical phases of the battle.

(6) **Shelter.** Dryness and light are vital when working with maps and producing orders and overlays. A CP should be sheltered from weather conditions and should have lights for night work, so an inside CP is preferable.

(a) If buildings are available, the commander should consider using them for the CP. They can provide the required space and protection from the elements. Vehicles can be hidden in barns or garages and radios can be remoted.

(b) If buildings are not available, the TOC can be organized using tentage. Although displacement time for tents is higher than for buildings, this arrangement is sometimes required.

(c) If weather is good or if rapid displacement is required, a TOC designed to operate from organic vehicles can be employed.

(d) If operations are conducted in areas that lack a good road network, they might require a dismounted TOC. Whatever the situation, the TOC must be organized to support its main functions of tactical control and planning.

(7) **Security.** The HHC XO, supervised by the battalion XO, is responsible for the security of the main CP from ground or air attack. The best way to secure the CP is to prevent the enemy from detecting it. This is enhanced by good noise, light, and signal discipline and by good camouflage from both ground and air observation.

d. **Operations.** The main CP must be organized into echelons to ease continuous operations and the rapid execution of the command and control process. The use of echelons aids in control during displacement. If the main CP displaces in a single echelon, the command group can control operations during displacement. The physical layout of the main CP should contribute to the speed of coordination and the flow of information. Planners must try to reduce the number and

length of message and information stoppages; information must travel quickly and directly to the place of action. The SOP must be known to all and rehearsed. It must include—

- Organization.
- Setup.
- Plans for teardown.
- Displacement.
- Eating and sleeping plans.
- Shift guidelines.
- Physical security plans.
- Priorities of work.
- Cross loading plans and checklists.
- Orders production.
- Techniques for monitoring enemy and friendly situations.
- Posting of map boards.
- Maintenance of journals.

## B-8. BATTALION TRAINS

Integration of CSS is vital to successful combat operations. The combat trains CP is the battalion's CSS planning facility. The combat trains CP and the main CP must coordinate to ensure a unified effort toward mission accomplishment. To aid in this, combat trains should be located near the main CP.

a. The combat trains must have a SITMAP (of operations and intelligence). They must monitor the command net to keep this map current (Figure B-4). The S1 and S4 must continually assess the situation, anticipate the needs of units, and prepare to push the necessary support forward. Anticipating logistical and casualty evacuation requirements is the key to successful CSS.

b. The battalion XO is responsible for ensuring that the necessary staff coordination between the main CP and the combat trains occurs. The main CP must report to the combat trains any important change in the thrust of operations. Conversely, the combat trains report to the main CP any major changes in the logistical system's ability to support an operation. The unit SOP states who leads the combat trains.

c. The HHC commander is located in the battalion field trains. The HHC commander is responsible for battalion assets in the field trains.

He coordinates battalion logistical operations with the brigade through the battalion S4 (Figure B-5, page B-12).

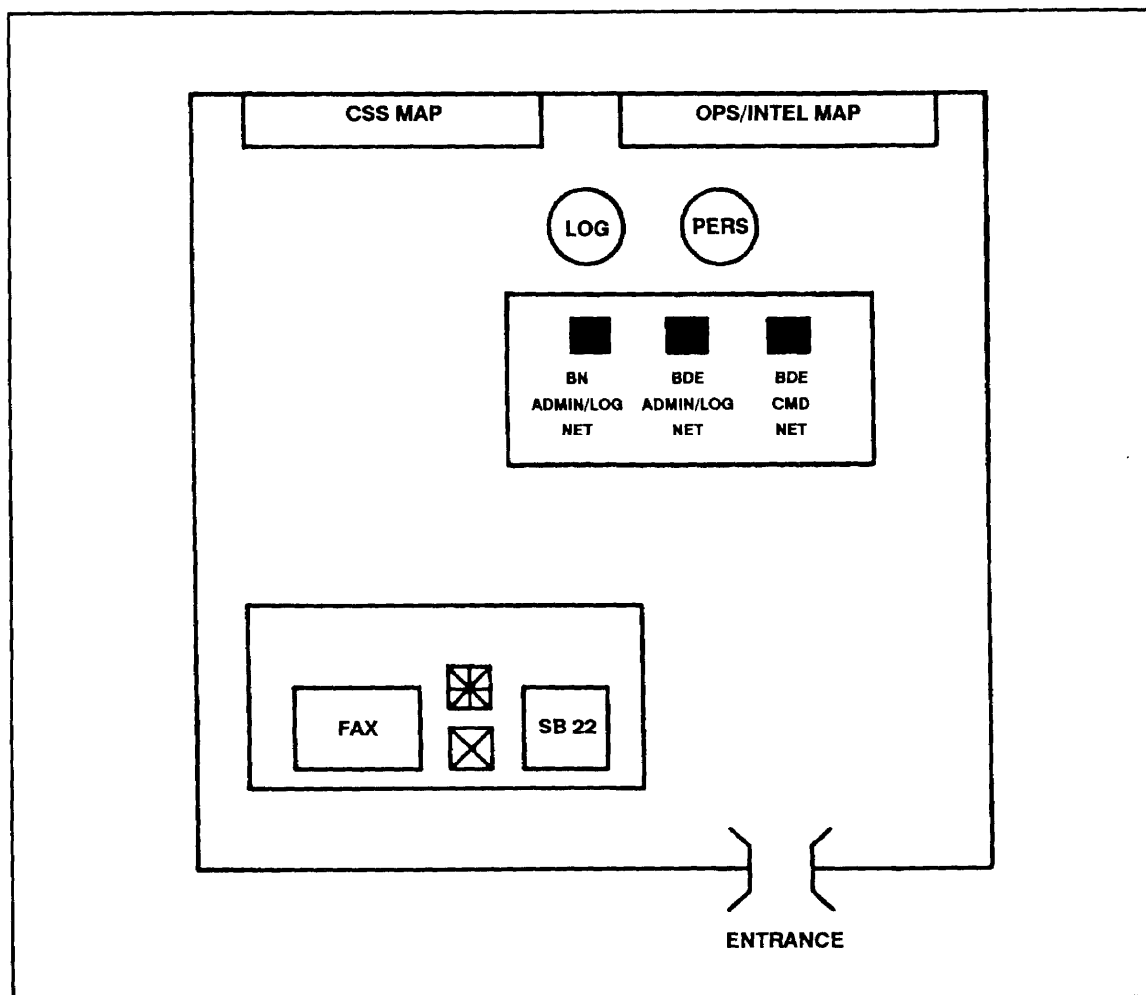

Figure B-4. Combat trains.

### B-9. ALTERNATE COMMAND AND CONTROL FACILITIES

An alternate CP is needed in case either the tactical or main CP is destroyed. Command and control facilities can be reconstituted by higher headquarters, from within the battalion headquarters company, or from subordinate units.

a. The combat trains CP is the organic battlefield facility most appropriately used for the alternate CP. The CP can be re-formed using the antiarmor company headquarters (depending

on the TOE), airborne/assault reserve company assets, or the battalion mortar platoon.

b. The alternate CP should be located far enough from the main CP to avoid simultaneous destruction. As much as possible, communications and physical setup in the alternate CP should mirror the TOC. Certain soldiers should be designated by SOP to be the nucleus of the alternate CP. These soldiers monitor the command and administrative/logistics nets as part of their normal duties. The FSE functions might be the

hardest to replace. However, a FIST can assume FSE duties if the mortar platoon lacks communications.

c. The alternate CP assumes command and control if the main CP is disrupted by the loss of soldiers, equipment, or communications. The alternate CP needs a good SOP. The alternate CP should have enough trained soldiers and

equipment that it can take control without confusion. Repeated rehearsal is vital to success—control must be seized aggressively with the least disruption possible. This must be done while operations are in progress and when the threat is greatest. During transition, the command group assumes many of the main CP's control and coordination functions.

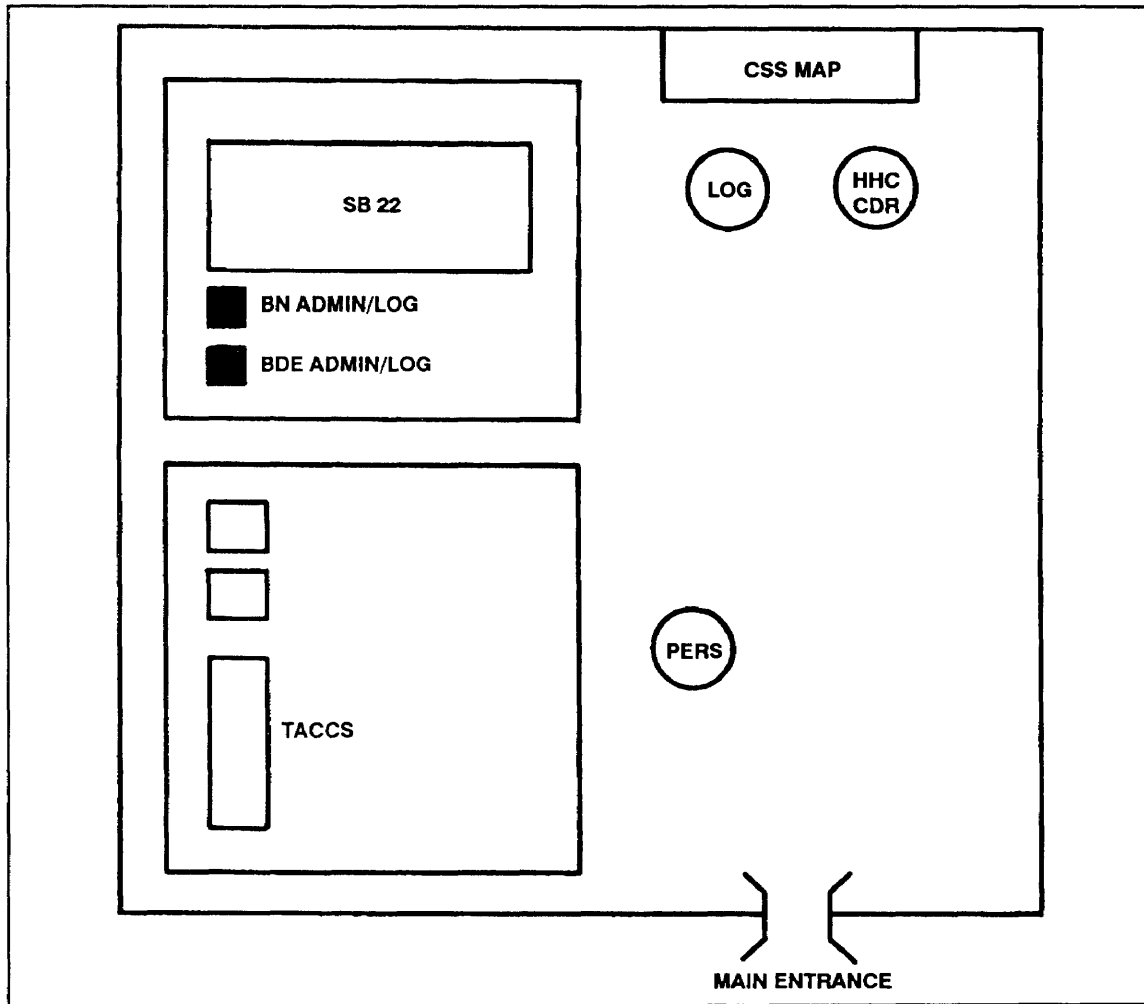

Figure B-5. Combat trains.

## APPENDIX C

# THE INFANTRY BATTALION IN LOW-INTENSITY CONFLICT

*Low-intensity conflict (LIC) is a political-military confrontation between contending states or groups. It is below conventional war and above the routine, peaceful competition among states. LIC frequently involves protracted struggles of competing principles and ideologies. LIC ranges from subversion to the use of armed force. US policy recognizes that indirect rather than direct, application of US military power is the most appropriate and cost-effective way to achieve national goals and to protect US interests in a LIC environment. The indirect means used most frequently by the US is security assistance. This can be provided in the form of training equipment, services, combat support, or a combination of these. Any US military response must be conducted IAW the principles of international and domestic laws. This appendix provides an overview of the LIC environment; it also provides the tactics, techniques, and procedures for battalion and subordinate unit operations in LIC. (FMs 7-10, 7-30, and 100-20 provide more information about LIC.)*

### Section I NATURE OF LOW-INTENSITY CONFLICT

Low-intensity conflict is a political contest. It includes violence, but is won or lost in the minds of men. Low-intensity conflict is most often less violent than modern conventional war. However, the parties fighting in low-intensity conflict may use the military resources available to them, which may result in heavy fighting.

#### **C-1. UNITED STATES SUPPORT**

The US provides assistance to several countries throughout the world. Some of these countries have ongoing internal conflicts; in some cases, these conflicts are compounded by insurgency. Other countries, friendly to the US, face external rivalries or international conflicts. The US aids these countries to promote the growth of democracy, to protect US lives and property, and to protect vital natural resources. Most US

support is provided through political, economic, and informational initiatives. It is coordinated through the US political representatives within a country, mainly the ambassador and the country team. The military supports other US initiatives indirectly, mainly by supporting security assistance; that is, it provides equipment, supplies, services, training, and advice to an ally. The military representative on the country team, referred to as the security

assistance officer, coordinates this indirect support. When US national interests are threatened and indirect support is inadequate, National Command Authorities may use the US military more directly. Force is used carefully, if at all, to achieve the desired political and psychological results.

## C-2. IMPERATIVES

The following imperatives of low-intensity conflict must be honored for success to be achieved:

a. **Political Dominance.** Political dominance is based on the nature of the conflict and refers to the fact that a political solution is preferable to a military solution. The military instrument cannot achieve victory in LIC. The objective of LIC is to avoid a military solution and instead to support growth and development within a country. A hostile environment encourages neither. The military instrument can provide the security that allows for growth and development.

b. **Unity of Effort.** Unity of effort is required, all the instruments of national power must work together. These include the political, economic, informational, and military instruments. The political instrument leads—the others provide support. This requires the Army to cooperate with the Department of State and with other government agencies.

c. **Adaptability.** Adaptability refers to changes in the nature of the fight, the threat, the measures of success, and the application of combat power. The use of politically-imposed restrictions, such as ROE, requires the commander to adapt his planning and fighting to meet the unique challenges of the LIC environment.

d. **Legitimacy.** Legitimacy refers to public acceptance and approval of the way in which low-intensity conflict is conducted. The US military must do everything it can to protect and improve the legitimacy of its own actions and of the people it is supporting. This means that soldiers must carefully avoid actions that offend and must conduct themselves at all times according to law, regulation, and local customs. It also means that the US must avoid taking over the struggle for the people it supports. Winning in LIC is the responsibility of the country or group being supported.

e. **Perseverance.** Perseverance means that the US military must be prepared to remain for a long time. In a contest for public support, quick victories are unlikely. Perseverance also means patience. Sometimes opportunities for short-term success must be sacrificed to achieve long-range goals. The perseverance imperative affects tactical operations. For example, sometimes an enemy force must be allowed to escape to avoid harming innocent civilians.

## Section II MILITARY OPERATIONS IN LOW-INTENSITY CONFLICT

The military in LIC supports other instruments of national power, and protects US personnel, property and interests. The military is often used in LIC to avoid escalating the conflict, to return as quickly as possible to a peaceful end state, or both. This fact, coupled with the interaction of the US military with political authorities in the US as well as in other countries, may result in the political imposition of restrictions on movement, in the use of force, in engagement criteria, and possibly in the sizes and types of forces used. Established infantry doctrine, tactics, techniques, and procedures apply. However, these might need to be adapted when the battalion is operating in LIC.

## C-3. OPERATIONAL CATEGORIES

The types of operations the Army conducts in low-intensity conflict are divided into four

operational categories: support for insurgency or counterinsurgency; combatting terrorism; peacekeeping operations; and peacetime

contingency operations. The role of the infantry battalion in each of these broad categories is discussed in Sections III through VI of this appendix.

#### **C-4. RULES OF ENGAGEMENT**

Politically-imposed restrictions on military operations are called rules of engagement. These restrictions may require, for example, that the battalion limit its use of firepower to a certain

geographical area or that it limit the duration of its operations. Soldiers at battalion and lower levels must understand and abide by these restrictions. The restrictions change as often as do political and military security factors, and so must be explained to soldiers continually. Each soldier must execute ROE properly, because violations are easily exploited. Figure C-1 provides an example ROE.

**RULES OF ENGAGEMENT**

**ALL ENEMY MILITARY PERSONNEL AND VEHICLES TRANSPORTING THE ENEMY OR THEIR SUPPLIES MAY BE ENGAGED SUBJECT TO THE FOLLOWING RESTRICTIONS:**

- A. WHEN POSSIBLE, THE ENEMY WILL BE WARNED FIRST AND ASKED TO SURRENDER.**
- B. ARMED FORCE IS THE LAST RESORT.**
- C. ARMED CIVILIANS WILL BE ENGAGED ONLY IN SELF-DEFENSE.**
- D. CIVILIAN AIRCRAFT WILL NOT BE ENGAGED WITHOUT APPROVAL FROM DIVISION LEVEL EXCEPT IN SELF-DEFENSE.**
- E. CIVILIANS SHOULD NOT BE HARMED UNLESS DOING SO IS NECESSARY TO SAVE U.S. LIVES, IF POSSIBLE, CIVILIANS SHOULD BE EVACUATED BEFORE ANY U.S. ATTACK.**
- F. IF CIVILIANS ARE IN THE AREA, ARTILLERY, MORTARS, ARMED HELICOPTERS, AC-130S, TUBE-LAUNCHED OR ROCKET-LAUNCHED WEAPONS, AND TANK MAIN GUNS SHOULD NOT BE USED AGAINST KNOWN OR SUSPECTED TARGETS WITHOUT THE PERMISSION OF A GROUND MANEUVER COMMANDER, LTC OR HIGHER.**
- G. IF CIVILIANS ARE IN THE AREA, ALL AIR ATTACKS MUST BE CONTROLLED BY A FAC OR FO.**
- H. IF CIVILIANS ARE IN THE AREA, CLOSE AIR SUPPORT, WHITE PHOSPHORUS WEAPONS AND INCENDIARY WEAPONS ARE PROHIBITED WITHOUT APPROVAL FROM DIVISION LEVEL.**
- I. IF CIVILIANS ARE IN THE AREA, INFANTRY SHOOTS ONLY AT KNOWN ENEMY LOCATIONS.**
- J. PUBLIC WORKS SUCH AS POWER STATIONS, WATER TREATMENT PLANTS, DAMS, AND OTHER UTILITIES MAY NOT BE ENGAGED WITHOUT APPROVAL FROM DIVISION LEVEL.**
- K. HOSPITALS, CHURCHES, SHRINES, SCHOOLS, MUSEUMS, AND OTHER HISTORICAL OR CULTURAL SITES WILL BE ENGAGED ONLY IN SELF-DEFENSE AGAINST FIRE FROM THESE LOCATIONS.**
- L. ALL INDIRECT FIRE AND AIR ATTACKS MUST BE OBSERVED.**
- M. PILOTS MUST BE BRIEFED FOR EACH MISSION AS TO THE LOCATION OF CIVILIANS AND FRIENDLY FORCES.**

**Figure C-1. Example of rules of engagement.**

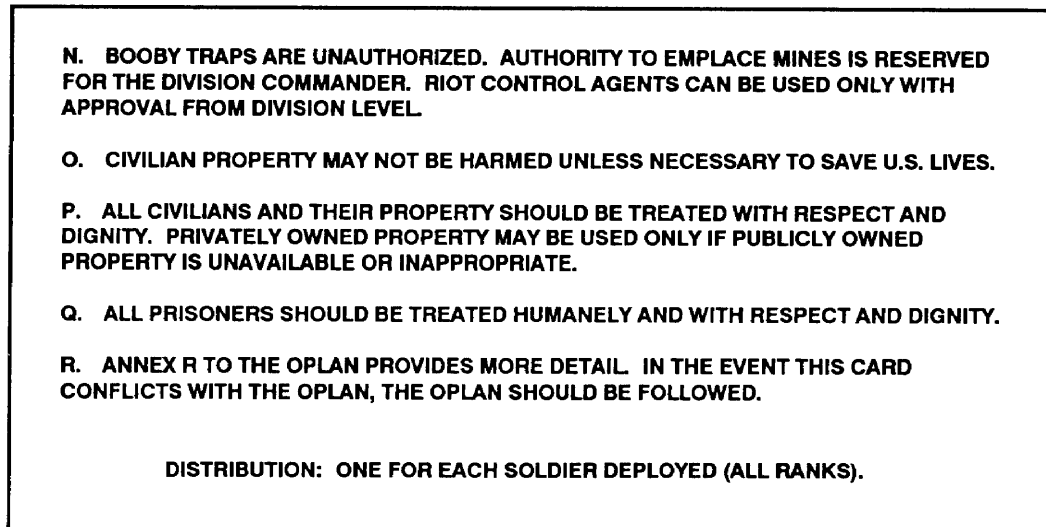

**Figure C-1. Example of rules of engagement (continued).**

a. Minimizing violence and limiting collateral damage do not require tactically unsound decisions or unnecessary risk to the force. On the contrary, an overpowering use of force can reduce violence or prevent an opposing force response. In either case, force protection is a constant priority.

b. The personal conduct of US soldiers during LIC operations affects the opinions and thus the support of the host nation's populace. Soldiers must understand that misconduct by US forces (even those deployed only for a short time) can damage rapport that took years to develop. Soldiers should treat local civilians and military as personal and professional equals, affording them the appropriate military customs and courtesies.

c. Soldiers may have more contact with host nation civilians during LIC than during other types of operations. To enhance civilian cooperation and support of US units, the commander might choose to issue a "key word and phrase card" (Figure C-2) to translate key English phrases to the language of the host nation. These phrases should apply specifically to the area of operations.

#### **C-5. INTELLIGENCE PREPARATION OF THE BATTLEFIELD**

The commander uses IPB to help determine what kind of threat the battalion may face, who will

present a threat, and when and where it is expected to occur. When faced with large areas of operations, limited maneuver units, and finite collection assets, the commander must rely on IPB for the locations of enemy elements. This allows him to best determine his actions against the threat. IPB must be updated continuously. (FM 34-130 provides a detailed discussion of IPB in LIC.)

#### **C-6. COMBAT SUPPORT AND COMBAT SERVICE SUPPORT**

Personnel in CS and CSS units are significant multipliers in both war and conflict. Familiar support bases may be unavailable in remote or less-developed areas. Procuring support locally may prove inadequate or may deny the local area or host nation much-needed resources. The US may be required to establish storage facilities or a logistics base for its own sustainment. However, doing this may not be readily acceptable to the supported nation or to personnel in the affected area. Support personnel may establish a positive rapport with the local populace by their actions. Commanders use these capabilities to enhance operations. For example, an engineer helps build a bridge, road, or school; a medic inoculates villagers against diseases; a veterinarian cares for cattle or inspects foodstuffs; a legal representative understands international law and treaties; and a quartermaster understands

local contracting, field laundry, and water desalinization.

**C-7. COMMAD AND CONTROL**

US military forces may operate in support of other US agencies or in support of another government. Both command and support relationships may be modified to accommodate this participation. In combined or coalition

operations, US commanders may also have under their charge soldiers from the host nation or from other services or nationalities. These commanders must contend with the disorientation caused by different cultures and values, different levels of prosperity or poverty, uncertainty of purpose, and difficulty in identifying the enemy (who maybe the same race or nationality as the host nation).

| KEY WORDS |                 | KEY PHRASES                 |                                 |
|-----------|-----------------|-----------------------------|---------------------------------|
| ENGLISH   | SPANISH         | ENGLISH                     | SPANISH                         |
| BATHROOM  | BANOS (SAN-YOS) | MAY I ____?                 | PUEDO ____?                     |
| BOY       | MUCHACHO        | DO YOU HAVE A ____?         | TIENE USTED UN ____?            |
| BRIDGE    | PUENTE          | MY NAME IS ____.            | MI NOMBRE ES ____.              |
| BUS       | BUS (BOOS)      | SPEAK SLOWLY.               | HABLE DESPACIO.                 |
| EAST      | ESTE            | DO NOT TALK.                | NO HABLES.                      |
| FOOD      | COMIDA          | WHAT IS YOUR NAME?          | COMO SE LLAMA (YAMA)?           |
| FRIEND    | AMIGO (A)       | HANDS UP!                   | MANOS ARRIBA!                   |
| GIRL      | MUCHACHA        | WHAT TIME IS IT?            | QUE HORA ES?                    |
| HALT      | ALTO            | DROP YOUR WEAPON!           | BAJA TU ARMA!                   |
| HELP      | AYUDA           | I WILL SEARCH YOU.          | TE VOY A REGISTRAR.             |
| I         | YO              | WHERE ARE YOU FROM?         | DE DONDE ERES?                  |
| LEFT      | IZQUIERDA       | WHERE IS ____?              | DONDE ESTA ____?                |
| MAN       | HOMBRE          | I DON'T KNOW.               | NO SE.                          |
| MAP       | MAPA            | DO YOU SPEAK ENGLISH?       | HABLAS INGLES?                  |
| NORTH     | NORTE           | CAN YOU GET AN INTERPRETER? | PUEDES CONSEQUIR UN INTERPRETE? |
| PLEASE    | POR FAVOR       | GOOD MORNING.               | BUENOS DIAS.                    |
| QUICKLY   | RAPIDO          | I WANT ____.                | YO QUIERO ____.                 |
| RIGHT     | DERECHA         | IDENTIFY YOURSELF.          | IDENTIFIQUESE.                  |
| RIVER     | RIO             |                             |                                 |
| SOLDIER   | SOLDADO         |                             |                                 |
| SOUTH     | SUR             |                             |                                 |
| STRAIGHT  | RECTO           |                             |                                 |
| TELEPHONE | TELEFONO        |                             |                                 |
| THANKS    | GRACIAS         |                             |                                 |
| WAIT      | ESPERA          |                             |                                 |
| WATER     | AGUA            |                             |                                 |
| WEAPON    | ARMA            |                             |                                 |
| WEST      | OESTE           |                             |                                 |
| WOMAN     | MUJER           |                             |                                 |
| YOU       | USTED           |                             |                                 |

Figure C-2. Example key word and phrase card.



When commanders have no formal authority, such as when they must rely on permission to deal with foreign forces, other US government agencies, or nongovernmental organizations and individuals,

they must exert a positive influence. When working with civilian agencies or with the forces of another nation, commanders also must consider equipment compatibility.

### Section III SUPPORT FOR INSURGENCY OR COUNTERINSURGENCY

The US can aid either a counterinsurgent force (government) or an insurgent force operating against a government. Because most insurgency operations involve SOF, support for insurgency is discussed in other manuals. Counterinsurgency operations can involve infantry battalions, and are discussed in this section.

#### C-8. INTERNAL DEFENSE AND DEVELOPMENT

The way in which the US supports another nation's efforts against an insurgent threat is referred to as internal defense and development (IDAD). An IDAD plan combines a program of balanced political, economic, and social development with a program of defense against insurgent violence.

a. The US military normally conducts strategically defensive operations while providing the security that allows for growth and development. However, if US military forces are committed to combat, their roles are similar to those of the host country's forces.

b. Military operations support political action. US forces support an insurgency or a government (counterinsurgency force) to improve the efficiency and military operations of the supported force. All forces involved try to avoid killing or injuring noncombatants or destroying property. The US military must understand the causes of unrest, the nature of the threat, and the organization and tactics used, whether training, advising, and equipping a friendly foreign force or, less likely, participating in combat operations in counterinsurgency.

#### C-9. INSURGENT ORGANIZATIONS

Both a political and military component usually make up an insurgent organization. The personnel in the military arm are referred to as guerrillas. Their tactics may differ from those used by the personnel in the political arm.

a. Insurgents may be treated as criminals unless the host nation recognizes the legitimacy of the insurgent organization.

b. Insurgents often employ guerrilla tactics against militarily superior government forces. The insurgents attack when they can gain local superiority and when they have a high probability of success. When challenged by a superior force, insurgents retreat, disperse, and hide—they do not stand and fight. If the territory of a neighboring country has safe haven, the insurgents may use it.

c. Insurgents gain several advantages by attacking small government forces and installations. They undermine the ability of the established government to protect itself, possibly forcing it to consolidate its forces into large units for protection.

(1) They establish themselves as a political or military alternative for the populace.

(2) They take government weapons, ammunition, and supplies for their own use. This may result in insurgent's assuming control over certain territory and people.

(3) They usually attack the police first then, as their strength grows, they attack small military units. These attacks divert the government from its routine procedures, and prevent it from protecting all the installations and people in the country. This leaves the populace open for insurgent propagandizing and recruiting. Insurgents use their successes and their propaganda effectively. As their strength grows, they may attack even larger targets. These

actions discredit the government and disrupt its ability to focus on growth and reforms.

### C-10. OPERATIONS IN COUNTERINSURGENCY

The presence and authority of the host nation's government must be secured throughout the country. Combat operations in counterinsurgent must protect development and must prevent the insurgents from gaining control of the populace. Combat forces face a dilemma in defending against an insurgent attack: they cannot be everywhere at once. If they divide their forces into small units to protect important installations and population centers, they can be defeated in detail. If they concentrate their forces, they abandon these same installations and population centers to the insurgents. The fight against insurgency is more than a military operation. The government must persuade the people to support it and to deny support to the insurgents. Thus, the fight against insurgency must include political, economic, and informational programs. PSYOP and civil affairs personnel should be involved early to best complement other military involvement. The battlefield in an insurgency is completely nonlinear. The enemy may come from any direction; indeed, elements of the insurgent organization are everywhere. Therefore, planners for all tactical combat operations must consider the requirement for all-round security. Advance, flank, and rear guards must accompany every movement; at every halt, a hasty but complete perimeter defense must be established.

a. **Combat Operations.** These are conducted IAW methods outlined in this and other doctrinal publications. Each operation must be modified to fit the political nature of the conflict and to offset offensive tactics used by the guerrillas. The infantry battalion in LIC requires a more careful and selective application of force than that used for similar operations in war. (FM 90-8 provides more information about counterinsurgency operations.)

b. **Defensive Operations.** All defensive operations, which include those by police, paramilitary, and military forces, must be fully integrated. This is true regardless of whether the military forces are only those of the host

government or are a combination of host government and US Army units.

(1) Police are a permanent government presence throughout the country. They are a valuable source of information. They also prevent and punish criminal action, and seek out the insurgent infrastructure. They may be aided by paramilitary and military organizations. For the police to be effective, they must be sufficiently protected from insurgent attack.

(2) Military forces (host country or US) can help guarantee police presence in the face of the insurgent threat. The military forces add strength to the defense, permitting a government presence in larger areas than the police alone can maintain. More importantly, military forces can provide much greater security than can police and paramilitary forces. If the enemy attacks, military forces reinforce friendly outposts. Thus, these forces must be ready to act and mobile.

(3) A US Army infantry battalion conducts combat operations against insurgent guerrillas. The battalion may defend a territorial area. It may also maintain strong defensive positions, connected by communications and readily reinforcing by a strong and mobile reserves, in its own area. However, its greater mission is to provide back-up combat power for the host country military, paramilitary, and police forces in a much larger area. The infantry battalion enables other security forces to maintain their positions by protecting them from attack and by aiding them when such attacks occur. The infantry battalion should avoid being tied down in static defense.

(4) A common guerrilla tactic is to attack a small outpost and then prepare an ambush for reaction forces. Thus, while one enemy force attacks, an even larger guerrilla force may be waiting for reinforcement on roads, waterways, air avenues of approach, DZs, or helicopter LZs. Intelligence must warn the battalion if the insurgents are able to ambush the reaction force. If they are, an air assault operation should be conducted to insert the reaction force to the flanks or rear of the enemy to prevent the reaction force from being attacked during a direct approach to the outpost. Also, the reinforcing unit must be ready to deal with this tactic.

(5) Air and ground reconnaissance and armored vehicle units can spoil a guerrilla

ambush. The relieving force can frustrate the guerrilla ambush by using unexpected avenues of approach. Tactical air, armed helicopters, and artillery fire on the enemy as soon as the target can be positively identified and as soon as the risk of death or injury to noncombatants and the destruction of their property would be minimal. Carelessness with regard to the safety or property of noncombatants can negate the success of military operations.

**c. Offensive Operations.** The infantry battalion can and should carry the fight to the enemy. Taking the initiative in this way protects the government, the people, and installations. The battalion can seek out and defeat or capture the enemy, and disrupt the insurgents' plans.

(1) **Disruption and defeat of the infrastructure.** The insurgents' strength derives from strong political leadership, intelligence nets, and propagandists who live and operate secretly among the populace. Finding and neutralizing each of these is the function of the host nation's police, with help from the US military.

(2) **Defeat of the insurgent combat force (guerrillas).** A secure environment that permits political, social, and economic development depends largely on the disruption and defeat of the guerrillas.

(3) **Intelligence.** Accurate information is needed about the locations, strength, and activities of guerrilla forces. Friendly combat

units must protect their own intentions and actions, yet must be prepared to act on time-critical information without delay. If the insurgents learn of an impending attack, they will withdraw, disperse, and take refuge in safe areas.

(4) **Guerrillas.** The guerrillas will withdraw to avoid battle on unfavorable terms. Strong forces can be positioned on likely avenues of regress to prevent the enemy from withdrawing. Indirect fires may be preplanned to complement this effort, but must be planned carefully to avoid harming noncombatants. Trapped between the hammer of an attacking force and the anvil of a blocking force, the enemy will be forced to defend in place. This way, the battle is fought on the government's terms, and the guerrilla force can be defeated or captured.

(5) **Operations.** Successful offensive operations rely on monitoring the movements of and ambushing the enemy rather than on stomping the bush. After a victory over the enemy, the battalion should give him an opportunity to surrender. The guerrillas are citizens of the country, potentially capable of making positive contributions to the society. Many of them may have been conscripted by the insurgency and will change over to the government side if given the chance. These people are good sources of intelligence; if re-indoctrinated, they may be converted to support the government, perhaps to the extent of serving in the government's security forces.

## Section IV COMBATING TERRORISM

Terrorism programs are violent campaigns to alter political behavior. Therefore, battalions supporting a government force are likely targets for terrorists who oppose the government. Combatting terrorism consists of two parts: antiterrorism, which consists of defensive measures used to reduce the vulnerability of individuals, units, and installations; and counterterrorism, which consists of offensive measures to deter or respond to a terrorist attack. The US military is mainly concerned with antiterrorism, which is a force-protection responsibility of commanders at all levels.

### C-11. TACTICS

Terrorism can be used either in war or in low-intensity conflict. Terrorism is a weapon of

political psychology commonly directed at innocent parties who neither caused nor are able to solve the problem which motivates

the terrorist. Acts of violence are committed for their effects on an audience other than the victim. This audience generally consists of governments. These acts are intended either to coerce officials into acting or to intimidate them into not acting. Since terrorism is a political psychological act, it must be dealt with in the same dimensions. The LIC imperatives apply.

### C-12. ANTITERRORISM

Individuals, vehicles, installations, and units are all vulnerable to terrorist attack.

a. **Individuals.** Terrorist tactics against individuals include bombing, kidnapping, taking hostages, and assassinating people. Terrorists avoid conspicuous activity. They blend with the populace and are difficult to identify. Old men, women, and children may be employed in terrorist operations. Some simple precautions reduce the chance of effective terrorist attacks against people.

(1) The first requirement is awareness of the threat. Personnel must avoid being lulled into complacency. During their off-duty time, they should travel in groups; they should avoid conspicuous behavior and known dangerous areas; and they should remain constantly alert. At times of heightened threat, the pass policy may have to be curtailed or limited to certain hours and places.

(2) Predictable patterns of activity should be avoided. Routes and times of travel should be varied from day-to-day. If local conditions and directives permit, soldiers should remain armed. However, soldiers must exercise discipline in the use of weapons; they should fire only if fired on.

b. **Vehicles.** Vehicles not in use should be stored in secured motor parks. Before operating any vehicle, the crew should inspect it for bombs. A pass system can be instituted to aid in control of personnel. Any person whose purpose for being in the battalion area is unclear should be detained and questioned. Packages or any other object that appears to be out of place must be investigated.

c. **Installations.** Billeting areas must be protected in ways appropriate to the threat. When the level of violence is low, the fortress mentality must be avoided, though prudent precautions should be taken. Approaches to the

battalion area must be restricted by obstacles that can be covered by fire. Car or truck bombs area favorite, devastating terrorist device. Especially at night, access to billeting areas can be controlled by such expedient means as parking heavy vehicles across roadways or filling 55-gallon drums with sand. In semipermanent installations, heavy obstacles such as large, concrete flower planters afford significant security without creating an inappropriate impression. Guards equipped with automatic weapons must cover all avenues of approach. Sentries must patrol the perimeter of the garrison area accompanied by military working dogs. When the situation requires, Claymore mines and other heavy weapons should be sited to cover avenues of approach. Patrols should move through the surrounding areas to discover and disrupt possible terrorist attack.

d. **Units.** The battalion S2 must obtain current estimates of the threat situation from higher headquarters. He must initiate collection within the battalion to focus on the terrorist threat. Local civilians who can provide services to the battalion must first be registered and subjected to background checks. Also, their behavior must be carefully monitored. As the terrorist threat increases, or when the battalion is deployed in field positions, the full range of protective measures is put into effect. Bunkers and fighting positions are constructed. Buildings and tents are protected by sandbags. Fencing, including barbed and concertina wire, is used to define the perimeter and mines are implanted. However, the commander must remember that the terrorist, unlike an attacking military force, gains access by subterfuge. A terrorist will present a logical reason for his presence. The use of fortifications is only part of preventing a terrorist attack.

### C-13. COUNTERTERRORISM

Forces designed, trained, and equipped for counterterrorism maybe augmented or replaced by the infantry battalion in extreme circumstances. The tactics for raids, cordons and searches, and roadblocks may apply. (FM 100-37 provides more information on combatting terrorism.)

## Section V PEACEKEEPING OPERATIONS

Peacekeeping operations are conducted with the consent of the belligerent parties. The purpose of such operations is to maintain a truce and to aid in diplomatically resolving a conflict. Peacekeeping operations consist of placing a neutral force or observers between the belligerent parties. This gives each party confidence that the other is abiding by the cease-fire agreement. Peacekeeping operations may include supervising the truce, aiding in withdrawal and disengagement, exchanging prisoners of war, supervising arms control agreements, and aiding in demilitarization and demobilization. Soldiers in the peacekeeping force must maintain the highest standards of conduct; they must understand and enforce the rules of engagement provided by the commander of the peacekeeping force.

### C-14. ORGANIZATION

Peacekeeping forces are established under the auspices of the United Nations, another international organization such as the Organization of American States or the Organization of African Unity, an ad hoc international group such as the Multilateral Force and Observers, or less likely, are established as a unilateral American operation. Operational control is vested in a single combined commander who reports to the political authority in charge. In the case of the UN, the secretary general has that authority. National contingents maintain unit integrity the regular functions of command are retained by the country providing the force. Logistical support may be centralized for the entire peacekeeping force, but more often remains in national channels. The US often provides logistical support for other national contingents.

### C-15. UNIFORMS AND EQUIPMENT

Peacekeeping forces wear distinctive uniform items. For example, UN forces wear a blue helmet or beret. Peacekeeping forces display the flag of the sponsoring organization conspicuously at all times. Vehicles and equipment are painted in distinctive colors and are clearly marked. (UN vehicles are painted white.) Installations are identified by flags and signs, and are illuminated at night.

### C-16. CONDUCT

The actions of peacekeeping forces are clearly defined by political mandate and terms of reference. Unit SOPs are modified to support established guidelines. Operations are strictly limited as to what may be included in unit SOPs. Peacekeeping forces are seldom permitted to use violence to accomplish their mission. They may use force only in self-defense. Detailed ROE are provided by the sponsoring organization. The mandate and terms of reference may both restrict the types of weapons the peacekeeping force may possess. For example, mortars and antitank weapons may be prohibited.

a. **People.** Peacekeeping personnel must be oriented on the language and customs of the area where they will be deployed. They must know the basic issues involved in the late conflict and must know which ones remain unresolved. Also, peacekeeping personnel must remember they will be the constant target of targets of foreign intelligence.

b. **Units.** Units operate in alternating conditions of tension and boredom. Therefore, they must develop patience. They must be approachable, understanding, tactful, and fair, yet firm. They must be able to cope with unpopularity. They must be prepared to execute their mission effectively during long periods of isolation. Units as small as squads may operate for long periods without direct contact with their superiors. Soldiers must be able to respond to and defuse confrontations while minimizing the use of force.

**c. Operational Security.** A battalion may have limitations imposed on its own information and intelligence. Political sensitivities (the need to remain neutral, yet to protect the force) makes this a delicate issue. Because these forces are multinational, the sharing of information and of operational security needs must be carefully considered.

**d. Observations and Reports.** Peacekeeping personnel must learn to complete observation reports in the standard format of the peacekeeping force. These reports include situation reports, shooting reports, and overflight and aircraft recognition reports.

### C-17. TECHNIQUES

Soldiers taking part in peacekeeping operations must modify their warfighting tasks to accommodate their unique environment. This requires them to adhere strictly to mandates, terms of reference, ROE, and discipline; and to understand the difference between conduct and actions. At battalion level, greater emphasis may be placed on standardization and debriefings.

**a. Patrolling.** Patrols are conducted in daylight, either on foot, in vehicles, or in aircraft. A peacekeeping patrol must be readily identifiable as such by all parties. Movement is conducted openly. Distinctive items of uniform are worn and the flag of the United Nations or of another peacekeeping force is carried by the patrol. In night operations, the patrol displays lights, and the flag is illuminated.

(1) Patrols are conducted to accomplish the following:

- (a) Deter potential truce violations by displaying their presence.
- (b) Cover gaps between fixed observation posts.
- (c) Confirm reports from observation posts.
- (d) Investigate alleged breaches of the armistice.
- (e) Monitor the execution of agreed actions.

(2) A patrol must do the following:

- (a) Avoid deviating from the planned route.
- (b) Record in writing and sketch all observations.

(c) Halt when challenged; identify itself; and report any attempt to obstruct its progress.

(d) Maintain continuous radio contact with its base.

(e) Record any changes in the disposition of the opposing forces.

**b. Observation Posts.** These must be sited for maximum view of the surrounding area, for clear radio communications, and for defensibility. Their locations are recorded; any relocation must be authorized by the peacekeeping force commander. OPs are manned at all times. They are marked with the peacekeeping force flag and with signs on the walls and roof. OPs are protected by field fortifications. Access to them is limited to peacekeeping personnel. An OP is usually manned by one squad, and a log of all activities is maintained. Personnel are continuously accountable for weapons and ammunition. When the personnel in an OP are relieved, they conduct a joint inventory for the record. If weapons are discharged, this fact is reported immediately to headquarters, and a written record is made of the circumstances. (SOPs include details on these and similar matters.) The mission of OPs is to report the following:

(1) Movement of the military forces of the belligerent parties, including unit identification, time, direction, and other details that can be ascertained.

(a) Shooting, hostile acts, or threats directed against the peacekeeping force or civilians.

(b) Any improvement to defensive positions of either of the former belligerents.

(c) An overflight by unauthorized aircraft, either military or civilian, along with the time, direction, aircraft type, and nationality.

(d) Any observed violations of the armistice agreement.

(2) The peacekeeping force relies mainly on the goodwill of the former belligerent parties for its safety. Conspicuous markings on installations, vehicles, and personnel are a source of protection. The peacekeeping force maintains its legitimacy and acceptability to the former belligerents by its professional, disinterested, impartial conduct of the peacekeeping mission. However, factions in one

or both of the former belligerents' armed forces, in the civilian population, or among other interested parties may want to disrupt the peacekeeping operation and subvert the diplomatic process. Therefore, the peacekeeping force must be prepared to defend itself.

(a) Limitations on the use of force and the ROE must be strictly followed.

(b) Each unit must maintain a ready reserve which can reinforce an OP or aid a patrol in distress.

(c) Installations must be protected by field fortifications, barriers, and well-sited weapons.

(d) Precautions, prescribed elsewhere in this appendix, must be observed to protect personnel and facilities from terroristic attacks.

(e) The peacekeeping force must fight defensive engagements only if they cannot avoid such an engagement.

(f) The commander must be prepared to recommend withdrawal of the force when a serious threat appears.

## Section VI PEACETIME CONTINGENCY OPERATIONS

Peacetime contingent operations are politically sensitive military activities characterized by short-term, rapid projection or employment of forces. These operations are often conducted when the military is required to enforce or support diplomatic initiatives taken to avoid or manage crises. Military efforts in peacetime contingency operations complement political activities. Wartime contingency operations are often conducted for military objectives. (FM 7-30 provides more information on wartime contingency operations.)

### C-18. NATURE

Peacetime contingency operations are conducted in support of diplomacy when a brief military intervention can decisively affect a specific situation. Such operations are usually executed to prevent or manage crises. These operations are typically rapid, short-term projections of force under politically-sensitive conditions. They are usually joint or combined. As the name implies, they are executed on short notice in response to a precipitating event or condition. Contingency operations in LIC differ from those in war in that they are limited in time and scope and are conducted under restrictive ROE.

### C-19. TYPES

Some contingency operations are violent, while others are quite benign. The infantry battalion may be employed in any of them. This paragraph discusses some of the types of peacetime contingency operations. Peacetime contingency operations are conducted IAW basic combat doctrine described in this manual, with modifications to fit the special requirements of the situation. A common feature of all

peacetime contingency operations is that the least possible violence necessary to accomplish the mission is used. None of these peacetime operations are conducted to destroy enemy forces, although that might become necessary if lesser means do not suffice. ROE are likely to be very restrictive. Representative types of contingency operations in LIC include the following:

a. **Disaster Relief.** Infantry battalions and other US Army forces are sometimes called on by the government to provide manpower in emergency conditions, such as in natural disasters. Their organization, leadership, discipline, equipment, deployability, and availability make them a valuable asset to the government under emergency conditions. In disaster relief and in similar emergencies, the battalion may also provide backup for police forces. It can help control crowds and prevent looting, and can perform other security functions.

b. **Security Assistance Surges.** The US may provide a large influx of equipment to another nation when it deems this appropriate. An

infantry battalion may be required to turn in equipment, which in turn will be sold or leased to this nation.

**c. Support to US Civil Authorities.** The military may be required to support political, economic, and informational initiatives of the US government inside or outside the US. For example, they may provide support to an ambassador and his country team or support to drug law-enforcement agencies.

**d. Noncombatant Evacuation Operations.** Infantry battalions may be employed to aid in the evacuation of US and other noncombatants from hostile areas. If all goes according to plan, no fighting is required. However, these operations only occur when there is a threat of danger, so violence may ensue at any time and the force must be prepared to deal with it.

(1) The objective is not to destroy an enemy force, but to get people out of a dangerous situation. Fighting should be avoided, but may become necessary. The infantry battalion so engaged must protect not only itself, but also the people or things it is trying to rescue or evacuate.

(2) The battalion must establish a perimeter of defense, because an attack can come from any direction. The threat may consist of hostile individuals, a mob, an organized guerrilla force, or even the police or military forces of the country being evacuated. The battalion must mount patrols to search for people or things to be recovered, and must avoid ambushes while returning to the departure airport or seaport.

(3) Physical barriers may be needed to protect the area to be evacuated. Blowing bridges or tunnels, or preparing to do so, may be necessary when and if the threat materializes.

(4) The battalion must warn an approaching mob or organized force, ordering them to advance no further. The objective is always to avoid a fight. Infantry may be able to use their rifle butts and bayonets to penetrate the threatening force and extract people to be evacuated. The battalion may also need to use riot control agents or to fire warning shots.

(5) The battalion may have to withdraw under pressure of an enemy attack.

(a) Noncombatants must be evacuated first. They are escorted to air or sea transportation under the protection of the contingency force, which can conduct defensive combat operations.

Aircraft take off as they are loaded. Ships stand off shore, and the evacuees are ferried as they arrive at the evacuation site by boat or helicopter.

(b) Forward elements of the contingency force are withdrawn into a defensive perimeter around the evacuation site. As soldiers embark on aircraft or ships, the perimeter is contracted. Light forces are the last to depart. These forces use automatic weapons fire to hold off the enemy as they embark. Equipment that cannot be evacuated is destroyed. Fire support is provided by Air Force, Naval, and Marine Corps tactical aircraft, armed helicopters, and naval gunfire.

**e. Counterdrug Operations.** Military personnel help train drug law-enforcement personnel in the eradication of drug trafficking. Drug traffickers are often linked with insurgent organizations. The drug traffickers may provide financial support to insurgent organizations or guerrillas; the insurgent organizations or guerrillas may in turn protect the drug operations.

**f. Rescue and Recovery.** Rescue refers to the withdrawal of people from positions of danger. Rescues may be conducted in the manner of noncombatant evacuation operations. Recovery refers to the reestablishment of US control over an object, such as a downed satellite or a sensitive item of military equipment. Like noncombatant evacuation, these operations may be either opposed or unopposed. The intent is to try to accomplish the mission without fighting. If the operation is opposed by a hostile force, combat is conducted IAW the warfighting doctrine described elsewhere in this manual. Violence is limited to assure the safe withdrawal of the force and the persons or objects which are the subject of their mission.

**g. Shows of Force and Demonstrations.** These consist of the deployment of military forces to the locale of threatened violence to demonstrate US political resolve and support for the threatened country. The rapid deployment of a military capability may deter hostile acts. Combined exercises are a means of portraying continued US commitment while reinforcing relationships, interoperability, and the foundations of democracy. The intent is to avoid war by threatening to engage in it. Both the psychological effect, and the fact that the enemy



may not be deterred by such a show, demand that a unit involved in a show of force or demonstration be fully capable of executing combat operations without notice.

**h. Peacemaking Operations.** Infantry battalions may be employed to force an end to lawlessness. An example is the intervention by a large joint US force into the Dominican Republic in 1965 (Operation Power Pack) to end fighting between political factions, restore order, and establish an effective government. Some aspects of Operation Urgent Fury in Grenada in 1986 resembled this class of operations. These operations differ from peacekeeping in that the parties to the conflict have not consented to them and force must be used to bring the situation under control. Like other operations in LIC, the mission is to accomplish a political objective with

minimum violence. Casualties and property damage must be limited; the safety of noncombatants, who may be present in large numbers, is a major consideration; and ROE are restrictive. These operations end with a planned withdrawal or transition to a peacekeeping operation.

**i. Strikes and Raids.** These are attacks on specific limited objectives, followed immediately by a planned withdrawal. They are not used to occupy territory. In the LIC environment, strikes and raids may be conducted against terrorist bases, drug traffickers, or similar targets. Strikes and raids are narrow in scope. Like other operations in LIC, they require a concern for legitimacy and the avoidance of death and injury of noncombatants and unnecessary destruction of property.

## Section VII FORCE PROTECTION

Security measures are necessary to safeguard individuals, units, and installations. Force protection measures apply in the conduct of all operations. These measures are most needed during operations in areas with a known terroristic or guerrilla threat.

Good security and defensive measures reduce losses and discourage enemy operations. The tactics, techniques, and procedures for force protection are based on METT-T factors. (FM 90-12 provides more information about multiservice procedures for the defense of a joint base.)

### C-20. SECURITY MEASURES

Security measures safeguard individuals, units, and installations.

**a. Individual Security Measures.** Soldier security is a command responsibility and function. All elements of the battalion must be briefed on known or suspected insurgent forces. Supply discipline must be strictly enforced. Leaders must emphasize to soldiers that supplies lost, traded, or thrown away will be recovered by the enemy and used against friendly forces. Arms and equipment must be salvaged from battle areas and from civilians who have collected them. All soldiers, including battalion and company headquarters personnel, are trained in the tactics to be used against the enemy.

Soldiers may also be given the mission to safeguard key personnel.

**b. Unit Security Measures.** Combat security measures, including extensive patrolling, are used on the march, during halts, and in the combat base to reduce losses from ambushes and attacks. Specially trained dogs can be used along with guards and patrols. Soldiers in rear areas can acquire a sense of false security that causes them to relax. However, the threat to these soldiers is as great as in the forward areas. Commanders of units that have not experienced or witnessed an enemy attack must supervise methodically to maintain security discipline. Units may establish static security posts to protect themselves or a fixed installation.

### c. Installation Security Measures.

Command posts and support installations are secured from attacks and sabotage. Special attention is given to the security of arms, ammunition, and other equipment of critical value to the enemy. To economize on manpower, the sites selected for CPs and trains installations must be readily defensible. Installations are grouped together so they can be guarded as a unit. To conserve personnel, physical obstacles; restricted areas; and aids such as wire, mines, alarms, illumination, and searchlights are used. Fields of fire are cleared and field fortifications are constructed for guards and security forces. The guard or security system should be supplemented by a vigorous patrol system. Rigid security is enforced on native labor; as a defense against sabotage within installations, native labor personnel are screened, identified, and supervised. All security measures are kept ready, and all soldiers keep their weapons available for instant use. Routines for securing an installation are altered frequently to prevent the enemy from obtaining accurate detailed information about the composition and habits of the defense.

## C-21. GUARDING OFFICIALS

Indigenous authorities or other high-ranking officials might require the protection of a military escort when moving by road.

a. The following should be considered:

(1) The strength of the escort required depends on the circumstances; a platoon is seldom adequate.

(2) An armored vehicle should be provided as optional transportation for the official(s).

(3) The vehicle carrying the official(s) must be closely supported throughout the move by a second vehicle—preferably armored—with at least one automatic weapon and “bodyguard” soldiers.

(4) The vehicle carrying the official(s) should bear no distinguishing marks, and more than one vehicle of that type should be employed.

(5) The “bodyguard” soldiers protect the official(s) in the event at an attack they get the official vehicle out of the danger area as quickly as possible. Contingent plans, alternate routes and actions in case of attack must be developed and rehearsed.

b. The escort commander should brief the official before starting the move about what will be done in the event of an attack. Regardless of the official’s seniority, the escort commander is in command of the move.

## C-22. STATIC SECURITY POSTS

A static security post is any security system organized to protect critical fixed installations—military or civil—or critical points along lines of communication such as terminals, tunnels, bridges, and road or railway junctions (Figure C-3, page C-16).

a. The size of the post depends on the mission, the size and characteristics of the hostile force, the attitude of the civil populace, and the importance of the item being secured. The post can vary from a two-man bridge guard to a reinforced company securing a key communications center or civilian community. However, establishment of security posts must be coordinated with the host nation.

b. The organization of a static security post varies with its size, its mission, and its distance from reinforcing units. For security reasons, static security posts in remote areas must be larger than the same type post would be if located closer to supporting forces. In any case, it is organized for the security of both the installation and the security force. Reliable communications must be established between remote static security posts and the parent unit’s base.

c. Access by indigenous personnel to the security post must be controlled. People living near the positions are screened and evacuated. Along the routes of approach to an installation, informers from the local population can be established.

d. All possible consideration is given to soldier comfort during the organization and preparation of the security post. Even under the best conditions, morale suffers among soldiers who must operate for prolonged periods in small groups away from their parent organization.

e. Sustaining supplies are prestocked in sufficient quantities within the static security post if it is far removed from other battalion units and if it might be isolated by enemy action. A static security post should never have to depend solely on the local populace for supplies.

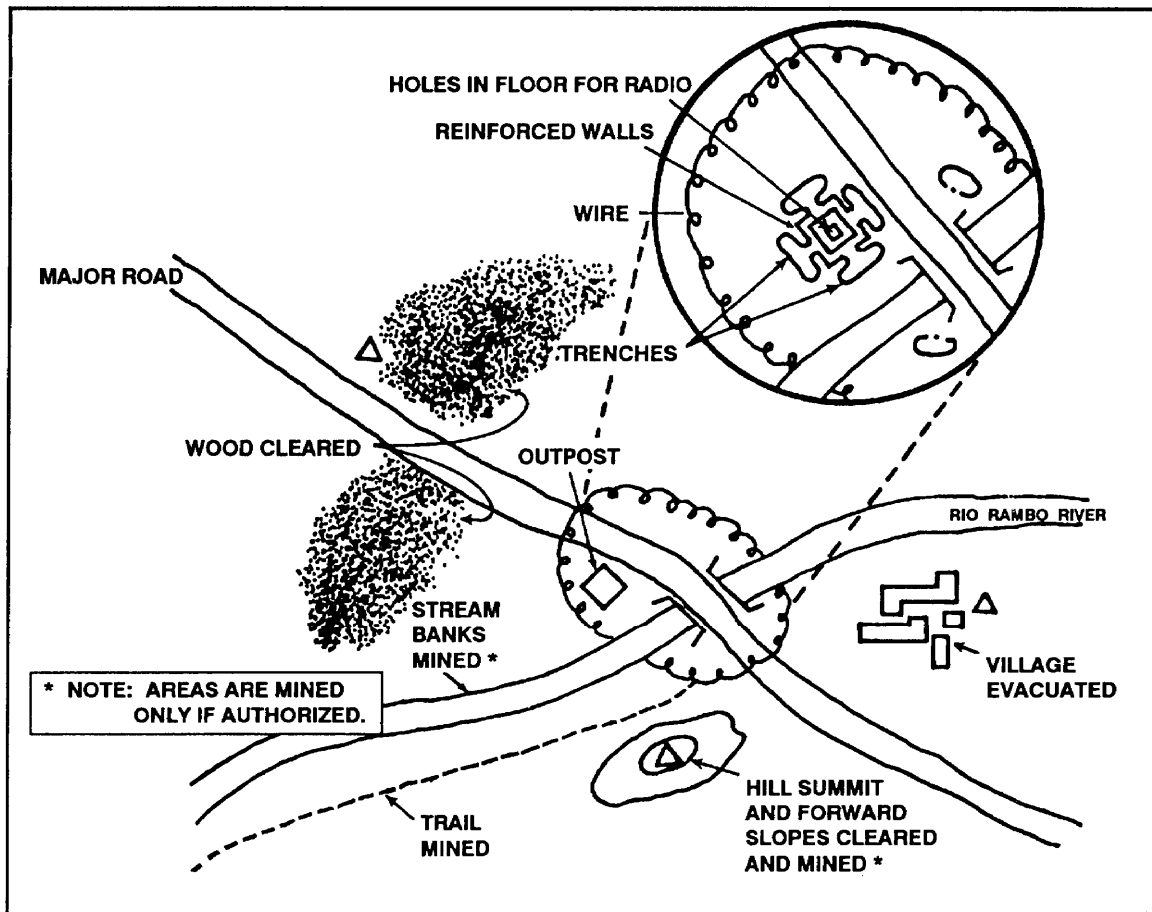

Figure C-3. Security post.

### C-23. SECURITY OF LINES OF COMMUNICATION

The infantry battalion maybe required to secure the lines of communication in its assigned area or to secure a major route or network of routes. Lines of communication are difficult to secure. Limited manpower and long lines of communication make this task more difficult. Armored vehicles help.

a. **Concept.** All movements of soldiers and supplies must be planned and conducted as tactical operations with emphasis on extensive security measures. These security measures can include—

- (1) Operations security and deception plans.
- (2) Front, flank, and rear security during movement and halts. This includes positioned security elements along the route of

movement, which aid in performing route reconnaissance and movement security.

- (3) Fire support and air cover.
- (4) Battle drills, OPs, and contingency plans.
- (5) Communications with supporting units and higher headquarters, to include airborne radio relay.
- (6) Varying the locations of leaders, communications, and automatic weapons within the movement formation.
- (7) Interrogation of local civilians along the movement route to obtain intelligence information, including possible ambush sites.
- (8) Movement by bounds with over-matching fire.
- (9) Use of scout dogs and other ambush detection means.

b. **Operations.** Plans for movement should be coordinated with military units along the routes. The following should be considered during this planning:

(1) Radio communication and prearranged visual and sound signals must be planned between convoy serials and march units, artillery FOs, air controllers, units, and population centers in the areas along the route of movement.

(2) Artillery and mortar support may be provided by units within range of the route of movement or by artillery and mortars that can be moved within range of the proposed route. Movements requiring artillery and mortar support need observers with them or in observation aircraft. Using strip maps marked with planned fires enables personnel with communications capability (other than FOs) to request fires. The FO must be able to coordinate with FDCs who can provide fire along the route of movement. The FO must also be able to enter the FDC net, make routine location reports, and request and adjust fires. The FO must coordinate call signs, frequencies, secure communications, authentications, areas of possible employment, schedules of movement, and indirect-fire target numbers with the FDC in advance.

(3) Close air and aerial fire support planning provides for armed helicopters and fixed-wing strike aircraft. Methods of employment include column cover, air alert, and ground alert. Column cover should always be requested, because the presence of aircraft deters ambushes. However, column cover by fighter aircraft is expensive in terms of crew fatigue and equipment maintenance. Therefore, light observation aircraft are sufficient for short movements over frequently-used routes in more secure areas. In planning column cover, special attention must be given to the enemy air defense threat.

(4) Route-clearing operations might be needed before critical movements. Whether the roads and other routes are cleared depends on the availability of soldiers, the importance of the movement, and the threat within the area to be traversed. Mounted and dismounted elements from the unit responsible for the area are designated to clear the routes. This may include both engineer and armor assets. The main route

must be thoroughly reconnoitered and all critical terrain nearby must be secured.

(5) Reserves (reaction forces) are vital in planning and coordinating movements. They are designated in case of ambush. The enemy must believe that, if he ambushes friendly soldiers, he will be hit back hard with a fast, relentless response that will include air strikes and ground pursuits. Before a movement, reserve force commanders and aviators are briefed on the general area of operations. Landing areas, known and suspected enemy locations, communications, and other normal preoperational information are emphasized. If the route is long, reserve forces are designated in successive areas.

c. **Motor Movement.** Convoys must be prepared to secure themselves because the extent of the threat may limit the availability of special escort attachments. Highway systems can be identified according to the levels of threat affecting their parts. Corresponding security measures are then identified.

(1) **Roads with negligible ambush risk.** These include roads that lie within the city limits of large towns and other roads as designated by the responsible headquarters. Subject to restrictions imposed by local commanders, military personnel may travel on these roads in any type of vehicle. No special measures exist concerning the movement of military convoys.

(2) **Roads with limited ambush risk.** All personnel transported in military or civilian police vehicles should be armed; also, each military vehicle should carry at least one other armed person besides the driver. Military personnel may travel alone in civilian cars but should be armed when doing so. Armored escorts are unnecessary. Convoys of up to ten vehicles may move at normal intervals; convoys of more than ten vehicles should be approved by the commander of the operational area concerned; convoys of any size should move in blocks of no more than five or six vehicles each.

(3) **Roads subject to ambush or interference.** All soldiers in combat areas should be armed, and each military vehicle should have at least one armed soldier besides the driver. Travel at night is restricted to trips of operational necessity. Movement of single, unescorted military vehicles is prohibited. Vehicles move close enough to

each other that they can help each other in an emergency, but not so close that an ambush is likely to catch several of them. Soldiers and

armored vehicles should accompany convoys. Helicopter or other observation aircraft should be assigned for reconnaissance and control.

## **Section VIII POPULACE AND RESOURCE CONTROL**

The battalion might be required to conduct concurrent security force and offensive operations. However, all actions must follow the established ROE and the law of land warfare. The objective of the security force is to protect the civilian populace and to prevent them from interfering in friendly operations (populace control); to secure soldiers, military and civilian installations, and lines of communication from attack; and to establish secure communities.

### **C-24. FUNDAMENTALS OF POPULACE CONTROL**

The host nation government may impose certain controls on the movements and activities of the people and the traffic in various kinds of goods which would be of use to the insurgents. The possession of such items as weapons and ammunition, explosives, large amounts of cash, fuel, communications equipment, and even food may be more stringently regulated. Some items are forbidden for civilian use. Others may require a license or be subject to rationing. This prevents people from having more than they need for their own use and supplying the excess to the enemy. Establishing curfews and off-limits areas makes movement difficult for the enemy. Such measures are known as "populace and resource control." They must be no more restrictive than necessary to meet the threat. When the situation improves, restrictions are immediately relaxed, as they are a hardship on the people and can, if abused, undermine the legitimacy of the government. Enforcement is the responsibility of the host country government and its police, paramilitary, and military forces. If the US Army infantry battalion is called on in an emergency to help enforce these regulations, the battalion must always act in concert with host country officials.

### **C-25. ROLES OF THE MILITARY**

Populace and resource control measures are used to deny support and aid to the insurgents by controlling the movement of people, information, and goods. These controls are

levied by the host government; for US forces to assume this role would undermine the legitimacy of the host government and convert the conflict into an American war.

a. US forces participating in populace control operations should be accompanied by members of the host nation's military or police. The extent of the control and the degree of sternness imposed on the civilian populace depends on the situation in the locale. Information about public attitudes must be gathered and judged with sensitive perception. Control and restrictions are relaxed on a populace in direct proportion to its efforts to cooperate. The overriding objective to isolate the enemy force from the populace, must be kept in mind.

b. Measures imposed to control the populace and reduce its ability to collaborate with enemy forces can include the following:

- Registration and documentation of all civilians.
- Curfew.
- Establishment of off-limits areas.
- Restrictions on public and private transportation and on communication means.
- Block control for constant urban surveillance.
- Roadblocks and patrols.
- Search and seizure operations.
- Apprehension or relocation of known or suspected sympathizers.
- Inspection of individual identification documents, permits, and passes.

- Control of the possession of arms, ammunition, demolitions, drugs, medicine, food, and money.
- Complete evacuation or depopulation of areas.

c. Populace control measures are vigorously enforced and stern punishment meted out by civilian authorities if the control measures are ignored. Half-hearted or lax enforcement breeds contempt and defiance among the populace. Violators must be apprehended and justly but fairly punished; care must be taken to punish the true offenders. To provoke unjust retaliation against communities, the enemy can initiate acts of violence in communities that are earnestly cooperating with the government. To gain sympathizers and strengthen their own cause, the enemy may exploit any unjust or misplaced punishment. Every means is used to publicize the nature of offenses for which punishment is imposed. The populace must realize that the action taken is not arbitrary, but necessary to enforce law and order.

## C-26. TECHNIQUES OF POPULATION CONTROL

The host nation must be an equal or greater player than US forces in populace control, which is exercised IAW host nation support agreements. Some techniques are as follows:

a. **Registration of Civilians.** Civilians may be registered by the host nation and, if it requests, by US civil affairs units. This is done to screen civilian officials, employees of the military, and the paramilitary organizations of allied forces. Civil affairs units also establish an office of records and documents that pertain to everyone in the area of operations. This is done to find and control people who are hostile to the allied operations.

b. **Curfews.** Curfews are one of the simplest and best means used to isolate civilians and to prevent them from interfering with military operations (Figure C-4, page C-20). Curfew regulations are rigidly enforced, preferably by civil police, who can check anyone on the streets after curfew hours and spot-check residences to determine that residents are home. The power to grant curfew exemptions can be delegated to the local police in most cases. Exemptions should be numbered serially the reason for the

exemption, the conditions of the exemption, and the name of the issuing officer should be clearly stated. Anyone who misuses their curfew exemption should be publicly deprived of their exemption. Those who may be excepted from curfew restrictions are as follows:

- The clergy.
- Doctors and midwives.
- The civil police.
- Public officials and employees specified by civil affairs officers.
- Fire-fighting personnel.
- Emergency repair crews of water, gas, and power concerns.
- Private employees providing vital services.
- Individual meritorious requests.

### c. **Establishment of Restricted Areas.**

Areas that can be designated as restricted include military and critical civil installations (police facilities, communications centers, utilities activities, supply agencies, and so on). This is done to prevent insurgent interference and limit civilian access. The installations should be fenced off, gate guards established, and warning signs, in the language of the host nation) conspicuously posted. Vegetation or obstructions are cleared to at least 100 meters on both sides of the fence. Fenced areas are patrolled. People who try to cross the fence or flee the cleared area are dealt with IAW ROE. People who enter or leave the area are subject to search. The percentage of people searched in detail depends on the degree of security required, the amount of support the local populace is suspected of rendering the insurgent and the amount of traffic.

d. **Restrictions on Communications and Transportation.** The exchange of information and the amount of traffic allowed to enter or leave an area maybe limited in certain situations. These are normally host nation decisions.

(1) **Communications.** Telephones and telegraphs can be restricted from general civilian use in cooperation with civil police to prevent civilians from passing messages that could be important to the enemy. Radio transmitters can also be restricted from civilian use. Mail can be censored. Search parties should be alert for written messages. Printed matter such as books and newspapers can be coded to carry messages.

**NOTICE**

**CURFEW**

Until further notice, people within \_\_\_\_\_ are prohibited from moving in the streets or outside their own homes between the hours of \_\_\_\_\_ and \_\_\_\_\_ without a permit from \_\_\_\_\_.

Anyone found in the streets without a permit between those hours will be severely punished.

Military guards/civil police are instructed to shoot people seen outside their home(s) after hours trying to hide or escape.

Exceptions to this order include \_\_\_\_\_

---

Signature  
Name  
Host Nation Commander

**Figure C-4. Example completed curfew notice.**

NOTE: All searches should have host government representation.

(2) **Transportation.** Personnel movement may be controlled at fixed or mobile sites. Gate checkpoints should be established to control traffic entering restricted areas. These can also be required in specific villages and settlements.

e. **Block Control.** Constant surveillance and reports of civilian activities within a block or other small populated area are referred to as block control. An appropriate authority appoints a loyal resident of the block or area to do this, then supervises them.

(1) Block control is one of the most effective and economical means of populace control. However, much time is required to set this up. Also, due to its nature, block control operates much better under civil authority than under

military control. A battalion may establish a system of block control in the absence of an effective civil administration.

(2) A block leader is appointed for each block. Each block or area is divided into zones. Each zone includes all buildings on one side of a street within a block. For each zone, a zone leader is appointed from among trusted residents. Zone leaders report all movements within their zones, including arrivals and departures, to their block leaders, who periodically report all movements within their blocks. Unusual activities are reported immediately.

(3) Informants can be placed throughout a block or area if the loyalty of the zone or block leaders is questionable. The informant system is set up like the block control system.

f. **Rewards and Inducements.** Rewards can be given to civilians who inform military or

civilian authorities of illegal actions taken by other civilians. Rewards may also be given for information leading to the apprehension of insurgents. For example, information about curfew violations or about possession of weapons, restricted articles, or illegal food. Rewards can take the form of local currency, extra food and clothing, or supplies in critical demand.

(1) People who inform should not receive confidences or privileges that could violate security. Inducements should be scaled to provide greater value in proportion to the value of the information received.

(2) Reward systems can backfire. People may begin by readily volunteering information, without reward. If they are then paid for information, they begin to withhold it. For example, they may begin to piecemeal their information to increase their rewards.

**g. Formation of Self-Defense Units.** Self-defense units from the civil populace provide some security from attack. These units can also help enforce civil populace control measures and help with area damage control. The military capabilities of these units vary. However, they provide the military commander with another means of economy of force. Care must be taken in arming self-defense units; they might be easy prey for local insurgents. Their weapons can be secured under military custody when not in use. Training of self-defense forces can be conducted by the host nation or, in certain cases, by US forces. The ability of these units to contact local police or military must be considered.

**h. Civil Disturbances.** Plans should provide for civil disturbances. Local civil police or civil defense units should be employed to quell riots, strikes, or disturbances. Military action is used as a last resort. (FM 19-15 discusses in detail the techniques to be employed.)

## C-27. RESOURCE CONTROL

Resource control, like populace control, is exercised IAW host nation support agreements. The host nation plays the most important part in resource control.

**a. Control of Materiel and Equipment.** Control must begin at the point of origin and

continue throughout the cycles of storage, transit, distribution, and use. Control can be achieved by licensing, prohibiting, or substituting relatively harmless materials.

**b. Control of Weapons.** Weapons control must be planned in detail and analyzed carefully before any order or decree is issued to disarm the civil populace.

(1) The weapons control plan should include the following:

(a) The measures necessary to strengthen existing civil laws.

(b) The allocation of force needed to execute the order or decree.

(c) The form and method that used to announces the order or decree.

(d) The designation and preparation of storage areas for arms, ammunition, and explosives.

(e) The disposition of munitions collected.

(f) The method of accounting for such munitions, including the methods of preparation for receipts, tags, and permits to be used.

(g) The designation of the types and classes of munitions to be turned in.

(h) Any people who are exempted from the order or decree. These people are issued a special permit.

(i) The agencies (civil, military, or both) who are to collect, guard, and transport the material.

(j) The time limit for compliance and penalties assigned thereafter.

(2) Control of knives, machetes, and certain agricultural tools can cause problems and misunderstandings. The most common and sometimes the only implement on a farm or in a forest may be a working machete or knife; these tools are used to clear land as well as to harvest crops. Civilians must be allowed to keep these general utility tools. The disarming order (or supplementary instructions) should be specific enough in describing the weapons to be controlled to properly guide subordinates executing the weapons control order.

**c. Control of Food and Restricted Articles.** Control of food and other articles, conducted in cooperation with civil agencies, can effectively reduce civilian support of insurgent forces. The harvesting, distribution, and sale of these items must be supervised closely. The development of



a food and restricted article denial plan should cover the following points:

(1) Foodstuffs must be defined to include all types of prepared or unprepared food, grain, oil, sugar, and canned goods that could be used in any way for human or animal consumption. Crop audits may be required.

(2) Restricted articles are defined. This usually includes paper, ink, medical supplies, flashlights, clothing, and cloth. Items such as fertilizer and photographic chemicals may also be controlled. Currency control provisions may also be instituted.

(3) Restrictions on the sale, movement, or possession of foodstuffs and restricted articles are carefully prepared and thoroughly publicized.

### C-28. SEARCHES

Searches are an important aspect of populace and resource control. The need to conduct search operations or to employ search procedures is a continuous requirement. A search can orient on people, materiel, buildings, or terrain. It usually involves both civil police and soldiers.

a. **Planning.** Misuse of search authority can adversely affect the outcome of operations; thus, the seizure of contraband, evidence, intelligence material, supplies, or other minor items during searches must be conducted and recorded lawfully to be of future legal value. Proper use of authority during searches gains the respect and support of the people.

(1) Authority for search operations is carefully reviewed. Military personnel must know that they may perform searches only in areas within military jurisdiction (or where otherwise lawful). Searches may be conducted only to apprehend suspects or to secure evidence proving an offense has been committed.

(2) Search teams have detailed instructions for handling of controlled items. Lists of prohibited or controlled-distribution items should be widely disseminated and on hand during searches. The military or civil police who work with the populace and the resource control program are contacted before the search operations or periodically if search operations are a continuing activity. Units must consider

the impact of early warning on the effectiveness of their operation.

(3) Language difficulties can interfere when US forces conduct search operations involving the local populace. Therefore, US units given a search mission are provided with interpreters as required.

(4) Search operations are conducted slowly enough to allow for an effective search but rapidly enough to prevent the enemy from reacting to the threat of the search.

(5) Minimum essential force is used to eliminate any active resistance encountered.

(6) Searchers can return to a searched area after the initial search to surprise and eliminate insurgents or their leaders who might have either returned or remained undetected during the search.

(7) Plans should be developed for securing the search area (establishing a cordon) and for handling detained personnel.

b. **Procedures.** Search procedures are as follows:

(1) **Search of individuals.** The fact that anyone in an area to be searched could be an insurgent or a sympathizer is stressed in all search operations. However, to avoid making an enemy out of a suspect who may support the host country government, searchers are tactful. The greatest caution is required during the initial handling of a person about to be searched. One member of the search team covers the other member, who makes the actual search. (FM 19-40 and STP 19-95 B1-SM discuss the procedure for searching people.)

(2) **Search of females.** The enemy will use females for all types of tasks when they think searches might be a threat. To counter this, female searchers should be used. If they are not available, doctors, medics, or male members of the local populace should be used. If male soldiers must search females, all possible measures must be taken to prevent any inference of sexual molestation or assault.

(3) **Search of vehicles.** Searching of vehicles may require that equipment such as detection devices, mirrors, and tools be made available. Specially trained dogs may be used to locate drugs or explosives. A thorough search of a vehicle is a time-consuming process. Impact on

the population must be considered. A separate vehicle search area should be established to avoid unnecessary delays.

(4) **Search of built-up areas.** These searches are also referred to as cordon-and-search operations. This subparagraph discusses the principles, command, control, and procedures for this type of search. When intelligence identifies and locates members of the insurgent infrastructure, an operation is mounted to neutralize them. This should be done by police, acting on the warrant of a disinterested magistrate, and based on probable cause. In the more violent stages of an insurgency, emergency laws and regulations may dispense temporarily with some of these legal protections. The method used should be the least severe method that is adequate to accomplish the mission. Care should be taken to preserve evidence for future legal action.

c. **Cordon and Search.** The area to be searched in a built-up area should be divided into zones and a search party assigned to each. A search party consists of a security element (to encircle the area, to prevent entrance and exit, and to secure open areas), a search element (to conduct the search), and a reserve element (to help as required) (Figures C-5 and C-6, page C-24).

(1) **Establishing the cordon.** An effective cordon is critical to the success of the search effort. Cordons are designed to prevent the escape of individuals to be searched, and to protect the forces conducting the operation. In remote areas, the cordon may be established without being detected. The use of limited visibility aids in the establishment and security of the cordon, but is difficult to control. ROE must be enforced. Plans should be developed to handle detained personnel. Infantrymen accompany police and intelligence forces who will identify, question, and detain suspects. Infantry may also conduct searches and assist in detaining suspects, under police supervision, but their principal role is to reduce any resistance which may develop and to provide security for the operation. Use of force is kept to a minimum. Deployment for the search should be rapid, especially if the enemy is still in the area to be searched. Ideally, the entire area should be surrounded at once; observed fire

covers any gaps. The security element surrounds the area while the search element moves in. Members of the security element orient mainly on people evading the search in the populated area; however, the security element can also cut off any insurgents trying to reinforce others within the area. Checkpoints and road blocks are established. Subsurface routes of escape in built-up areas, such as subways and sewers, may also need to be searched. The following procedures should be considered when preparing for the search of a built-up area:

(2) **Conducting the search.** A search of a built-up area must be conducted with limited inconvenience to the populace. However, the populace *should* be inconvenienced enough for them to discourage insurgents and sympathizers from remaining in the locale, but not enough to drive them to collaborate with the enemy as a result of the search. A large-scale search of a built-up area is a combined civil police and military operation. Such a search should be planned in detail and rehearsed. Physical reconnaissance of the area just before a search is avoided. Information needed about the terrain can be obtained from aerial photographs. In larger towns or cities, the local police might have detailed maps showing relative sizes and locations of buildings. For success, the search plan must be simple and the search must be conducted swiftly. The search element conducts the mission assigned for the operation. The element is organized into special teams. These teams can include personnel and special equipment for handling of prisoners, interrogations, documentation (using a recorder with a camera), demolitions, PSYOP/civil affairs, mine detection, fire support, employment of scout dogs, and tunnel reconnaissance. Three basic methods are used to search the populated area.

(a) **Assemble inhabitants in a central location** if they appear to be hostile. This method provides the most control, simplifies a thorough search, denies insurgents an opportunity to conceal evidence, and allows for detailed interrogation. It has the disadvantage of taking the inhabitants away from their dwellings, thus encouraging looting which, in turn, engenders ill feelings.

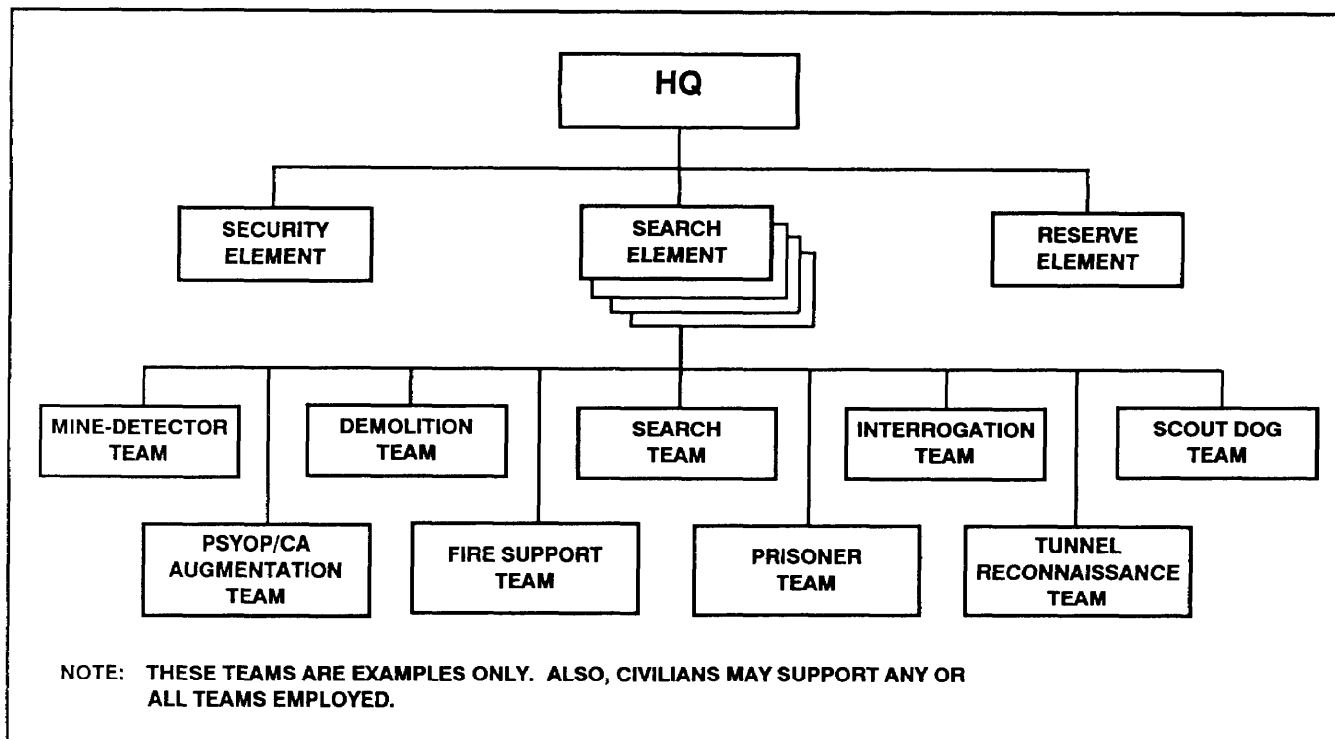

Figure C-5. Typical organization for search operations.

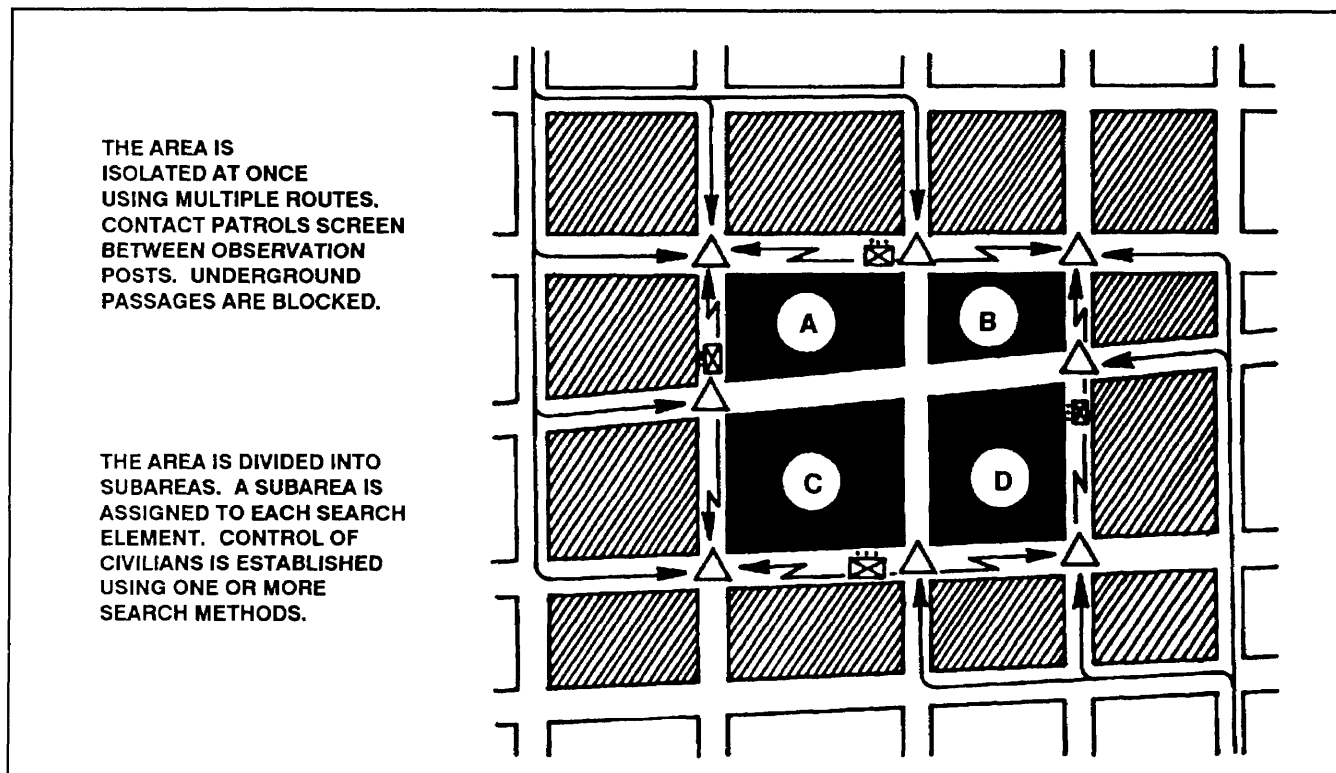

Figure C-6. Conduct of a search.

(b) Restrict inhabitants to their homes. This prohibits movement of civilians, allows them to stay in their dwellings, and discourages looting. The disadvantages of this method are that it makes control and interrogation difficult and gives inhabitants time to conceal evidence in their homes.

(c) Control the heads of the households. The head of each household is told to remain in front of the house while everyone else in the house is brought to a central location. During the search, the head of the household accompanies the search team through the house. Looting is reduced, and the head of the household sees that the search team steals nothing. This is the best method for controlling the populace during a search.

(3) **Searching a house.** The object of a house search is to screen residents to determine if any are suspected insurgents or sympathizers and to look for controlled items. A search party assigned to search an occupied building should consist of at least one local policeman, a protective escort, and a female searcher. Escort parties and transportation must be arranged before the search of a house. Forced entry may be necessary if a house is vacant or if an occupant refuses to allow searchers to enter. If a house containing property is searched while its occupants are away, it should be secured to prevent looting. Before US forces depart, the commander should arrange for the community to protect such houses until the occupants return.

d. **Other Considerations.** The reserve element is a mobile force positioned in a nearby area. Its mission is to help the other two elements if they meet resistance beyond their ability to handle. The reserve element can replace or reinforce either of the other two elements if the need arises. Any enemy material found, including propaganda signs and leaflets, should be treated as if it is booby-trapped until inspection proves it safe. Underground and underwater areas should be searched thoroughly. Any freshly excavated ground could be a hiding place. Mine detectors can be used to locate metal objects underground and underwater.

e. **Aerial Search Operations.** Search units mounted in armed helicopters take full

advantage of the mobility and firepower of these aircraft.

(1) Air assault combat patrols conducting an aerial search reconnoiter an assigned area or route in search of enemy forces. When the patrols locate an enemy force, the patrol may engage it from the air or may land and engage it on the ground. This technique has little value in areas of dense vegetation or when a significant man-portable air defense threat is present.

(2) Use of air assault combat patrols should be used only in operations when sufficient intelligence is available to justify their use. Even then, such patrols should be used along with ground operations.

f. **Apprehended Insurgents.** Certain principles govern actions taken when insurgents desert or surrender voluntarily and indicate that, at least in part, their attitudes and beliefs have changed. In this situation, the following guidelines apply:

(1) Confine them only for screening and processing, and keep them separate from prisoners who exhibit no change in attitude.

(2) Supervise them after their release, though the supervision need not be stringent.

(3) Relocate them if they are in danger of reprisal from the enemy.

(4) Remember that they expect any promises that were made to induce their defection or surrender to be met.

(5) Provide special handling to nonindigenous members of the insurgency who were captured.

g. **Captured Insurgents.** Captured insurgents who retain their attitude of opposition are handled IAW the following principles:

(1) These insurgents must be confined, for long periods.

(2) Captured insurgents charged with specific crimes are brought to justice immediately. Each is charged for their individual crimes. They are not charged for their participation in the resistance movement, because that could make them martyrs and cause other insurgents to increase their activities.

(3) Families of imprisoned insurgents may have no means of support. A program of care and reeducation should be initiated to administer adequate support.

**C-29. ROADBLOCKS AND CHECKPOINTS**

A related aspect of populace and resource control mentioned previously was the control of transportation. Individuals and vehicles may be stopped during movement to assist in individual accountability or capture of enemy personnel, or to control the trafficking of restricted material. The ability to establish roadblocks and checkpoints is an important aspect of movement control and area denial. The fundamentals of searches, discussed previously, apply to roadblocks and checkpoints also. (FM 7-10 provides more information about roadblocks and checkpoints.)

a. Roadblocks and checkpoints prevent traffic in contraband and stopping the movement of known or suspected insurgents. They should be manned by police or paramilitary forces, who stop vehicles and pedestrians and conduct searches as required by conditions. Either host country or US Army combat forces defend these roadblocks and checkpoints from enemy attack. If police strength is insufficient for the number of positions required, the Army can operate them. Whenever US Army forces operate roadblocks and checkpoints, host country police or other forces should be present to conduct the actual stop and search. US forces should establish communications with other elements of the site,

but should also remain in contact with their own chain of command. The same principles apply to waterways as to land lines of communication.

b. Roadblocks are established in locations where they cannot be observed by approaching traffic until it is too late to withdraw and escape. Narrow defiles, tunnels, bridges, sharp curves, and other locations which channel traffic are the preferred sites. Obstacles slow traffic, restrict it to a single lane, and finally bring it to a halt. An area off the main road should be provided to conduct detailed search of suspect vehicles and people without unduly delaying innocent traffic. A small reserve in nearby defended areas, using hasty field fortifications, should provide immediate support to operating personnel in case of attack. A larger reserve, which serves a number of posts, should be capable of rapid reinforcement (Figure C-7).

c. US forces should be used in the reserve role in combined operations with host nation personnel. The reserve invulnerable to being set up or ambushed, especially if an enemy has observed rehearsals. The enemy may hit multiple locations simultaneously to test responsiveness or to aid his future planning. Locations of roadblocks and routes used should be varied.

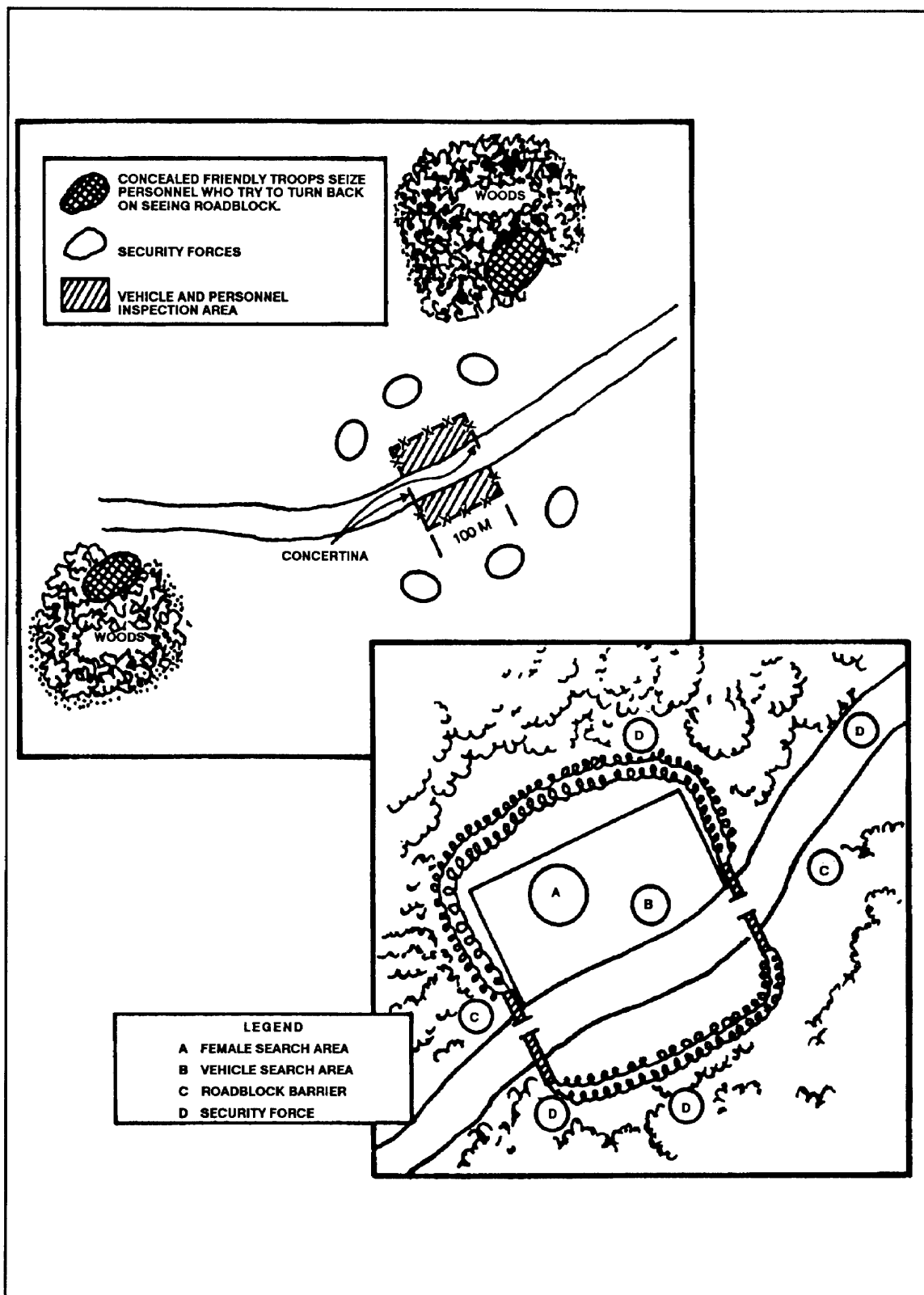

Figure C-7. Physical layout of roadblock.

## APPENDIX D

# MECHANIZED-ARMOR/LIGHT AND SPECIAL OPERATIONS FORCES

*Employment of light units with heavy and special operations forces is a combat multiplier. The battalion may be augmented with armored vehicles (light/heavy) or cross-attached to a heavy brigade (heavy/light). (FMs 71-2 and 71-3 discuss heavy/light operations further.) SOF provide the commander with the potential to receive time-sensitive information. This appendix focuses on the planning considerations, tactics, techniques, and procedures used when the battalion is task organized with subordinate armored assets or when it works with SOF.*

## Section I FUNDAMENTALS

Light/heavy unit operations take advantage of the light unit's ability to operate in restrictive terrain such as urban areas, forests, and mountains. These operations also increase the unit's survivability and takes advantage of the heavy units' mobility and firepower. Infantry leaders must know the tactics, techniques, and procedures used by the heavy force. An infantry battalion becomes a strong combat multiplier when it is augmented with a heavy force. The battalion must be able to conduct light/heavy operations in any environment or type of conflict.

### D-1. DEFINITIONS

The following definitions apply to light/heavy operations:

a. **Light/Heavy Operations.** These are conducted by a task force or team made up of infantry, mechanized infantry, and motorized or armored forces under the control of a light headquarters.

b. **Heavy/Light Operations.** These are identical to light/heavy operations, except that the forces are under the control of a heavy headquarters.

c. **Heavy Forces.** These are friendly mechanized infantry or tanks.

d. **Special Operations Forces.** These may be special forces, rangers, PSYOP, civil affairs, or SOF personnel from other services.

### D-2. VEHICLE CHARACTERISTICS

Tactics and techniques explained in this appendix are for infantry working with armored vehicles such as the M551, M60A3, M1 (series), M2, M3, and M113. The techniques often apply also to armored fighting vehicles of allied nations such as the Warrior IFV and the Leopard. Infantry leaders must know the tactical doctrine for employing a heavy company team (FM 71-1), a tank platoon (FM 17-15), and a mechanized

infantry platoon (FMs 7-7 and 7-7 J). To effectively employ any armored vehicle, the leader must know the specific capabilities and limitations of the vehicle and its weapon system.

a. **Tanks.** The M1-series and M60A3 tanks provide rapid mobility as well as excellent protection and lethal, accurate fires. These tanks are most effective in open terrain with extended fields of fire.

(1) **Mobility.**

(a) **Capabilities.** The tanks' mobility comes from their ability to move fast either on or off the road. The ability to cross ditches; to ford streams and shallow rivers; and to push through small trees, vegetation, and limited obstructions allows tanks to move effectively in various types of terrain. Tanks provide tremendous firepower and shock effect for use against the enemy.

(b) **Limitations.** Tanks are noisy (especially the M60 series). During cold weather or when thermal nightsights or radios are used, the tanks' engines must be run at least 30 minutes every 2 to 4 hours to keep the tanks' batteries charged. Because tanks lack bridging equipment, they can only cross bodies of water less than 4 feet deep.

(2) **Firepower.**

(a) **Capabilities.** The tank's main gun is accurate and lethal at ranges out to 2,500 meters. The stabilized gun allows effective fires even when the tank is moving cross-country. The best antitank weapon on the battlefield is the tank. The various machine guns (the tank commander's .50-caliber and 7.62-mm coax machine guns and the loader's 7.62-mm machine gun on the M1) provide a high volume of suppressive fires for self-defense and provide supporting fires for the infantry. The tank's ability to acquire targets exceeds that of all other infantry battalion systems.

(b) **Limitations.** The tank's top, rear, and flank is vulnerable to lighter antitank weapons and (especially) to handheld antitank weapons. The top is also vulnerable to precision-guided artillery or air-delivered munitions. Antitank mines can destroy or disable the vehicle. Fighting with closed hatches reduces the crew's ability to see, acquire, and engage targets.

(3) **Protection.**

(a) **Capabilities.** The tank provides excellent protection. Across the frontal 60-degree arc, the

tank is safe from all weapons except heavy antitank missiles or guns and the main gun on enemy tanks. When fighting with the hatches closed, the crew is safe from all small-arms fire, artillery rounds (except direct hits), and antipersonnel mines. The tank's smoke grenade launcher and on-board smoke generator provide fast concealment from observation (other than by thermals).

(b) **Limitations.** The tank is vulnerable from the flanks, top, and rear to lighter antitank weapons and especially to hand-held antitank weapons. The top is also vulnerable to precision-guided munitions (artillery or air-delivered). Antitank mines can destroy or disable the vehicle. However, fighting with their hatches closed reduces the crew's ability to see, acquire, and engage targets.

b. **Infantry Fighting Vehicle.** The M2/M3 BFVs provide mobility and protection against small arms fire and shrapnel; they also provide excellent firepower. These vehicles operate best on terrain that works well for mounted maneuver. However, to best employ IFVs, commanders must consider their limited protection. Each BFV is designed to carry a 9-man squad.

(1) **Mobility.**

(a) **Capabilities.** The M2/M3 has a mobility capability similar to that of the tank, except that the M2/M3 can swim large bodies of water in slight current when entry and exit points are available. If required, each IFV can carry soldiers inside and outside.

(b) **Limitations.** The M2/M3 uses a lot of fuel, especially in offensive or fast-paced operations. Also, IFVs are noisy. During cold weather or when thermal nightsights or radios are used, the IFV's engines must be run periodically to keep the vehicle's batteries charged. The noise, smoke, dust, and heat generated by IFVs make surprising the enemy difficult.

(2) **Firepower.**

(a) **Capabilities.** The M2/M3 has a 25-mm chain gun as its main weapon. It also has a TOW missile system and a coaxially-mounted machine gun. The chain gun is accurate and lethal against lightly armored vehicles, bunkers, trench lines, and people out to 2,000 meters. Its stability



allows the gunner to fire effectively even when the vehicle is moving cross-country. The TOW system provides an effective antitank weapon for destroying enemy tanks or other point targets out to 3,750 meters. The 7.62-mm coax machine gun provides a high volume of suppressive fires for defense and supporting fires for the infantry. The combination of the stabilized turret, the thermal sight, the high volume of fire, and the mix of weapons and ammunition (TOW missiles, 25-mm APDS and HEI-T, and 7.62-mm) makes the M2/M3 an excellent fire support asset for suppression in support of an infantry assault. The M2/M3 can acquire targets better than other infantry battalion systems. The thermal sight allows the crew to observe, reconnoiter, and control fire. This sight can also be used during the day to identify heat sources (people and vehicles), even through light vegetation or other concealment.

(b) *Limitations.* The M2/M3 thermal sight, when operated with the vehicle's engine off, clicks loudly enough to be heard at a good distance from the vehicle. Depending on the number of vehicles attached and on the amount of POL and ammunition expended, logistical resupply of Class III and V maybe difficult and external support might be required.

(3) *Protection.*

(a) *Capabilities.* The M2/M3 provides good overall protection. When fighting with the hatches closed, the crew is safe from small-arms fire, fragmentation munitions, and antipersonnel mines. The vehicle's smoke grenade launcher and smoke generator conceal the tank quickly from observation by all but thermal means.

(b) *Limitations.* The M2/M3 is vulnerable in all directions to antitank weapons, especially to those on enemy tanks. Antitank mines can destroy or disable the M2/M3. Also, when operating with the hatches open, the crew is vulnerable to small-arms fire (especially to sniper fire).

c. **M551 Sheridan.** The M551 is a light reconnaissance vehicle that provides good firepower and mobility but little protection for an armored vehicle.

(1) *Mobility.* The M551 Sheridan's mobility is comparable to that of the M2/M3.

(2) *Firepower.*

(a) *Capabilities.* The M551's main weapon is a combination gun and missile launcher. The 152-mm gun fires HEAT and HEP rounds; the launcher fires antitank missiles. The M551 also has a 7.62-mm coax machine gun and a .50-caliber machine gun for suppression.

(b) *Limitations.* The M551 is ineffective against enemy main battle tanks, even with its antitank missile launcher, because the turret is not stabilized and the fire control system is outdated.

(3) *Protection.* The M551 has less protection than the M2/M3.

d. **M113.** The M113 is a lightly armored personnel carrier that combines good mobility with fair firepower and protection.

(1) *Mobility.*

(a) *Capabilities.* The M113 can carry a nine-man squad inside and more soldiers on top if required. The M113 uses fuel more slowly than the M2/M3. It can also swim deep bodies of water if the current is slow (1.5 meters per second or less) and if entry and exit points are available.

(b) *Limitations.* The M113 moves slower and is less able to negotiate obstacles than the M2/M3.

(2) *Firepower.*

(a) *Capabilities.* The M113's main weapon system is the .50-caliber machine gun. From a stationary position, this weapon is effective against area targets out to its maximum effective range of 1,800 meters. A tripod and T&E mechanism are also available for dismounting the weapon and firing from a well-prepared fighting position. Although heavy, the weapon system can be broken down into lighter loads and carried cross-country.

(b) *Limitations.* The M113 is not stabilized, is inaccurate when fired on the move, and exposes the gunner.

(3) *Protection.*

(a) *Capabilities.* The M113 provides limited protection from small-arms fires (7.62-mm coax machine gun and smaller) and fragmentation munitions.

(b) *Limitations.* The M113 is vulnerable to all fires heavier than small-arms fires.

### D-3. SAFETY CONSIDERATIONS

Infantry leaders at all levels should know the safety precautions to take when the battalion operates with armored vehicles or with SOF. Leader awareness and involvement is especially important for an infantry unit that has had little training with armored vehicles. All personnel in the unit must know what precautions to take and must remain alert during light/heavy operations to prevent unnecessary casualties. Before engaging targets, infantry forces need to know the locations of SOF.

a. Armored vehicle crews, especially those in tanks, are blind to infantry soldiers near their vehicle. This limitation is worse during limited visibility or when the hatches are closed. This causes the crew to focus on the enemy or on potential enemy locations rather than on infantry moving close to the vehicle. Therefore, the infantry soldiers must remain alert and must maintain a safe position relative to the vehicle.

b. Infantry soldiers near armored vehicles are exposed to the effects of any fire the enemy directs against the vehicles. This is true whether the soldiers and vehicles are moving or stationary. Also, the soldiers are less able to avoid detection when they are near the armored vehicles. However, even when they are providing security or close support to the vehicles, the infantry can usually maintain enough distance to avoid much of the effects of fires directed against the vehicles.

c. The high velocity, armor-piercing discarding sabot round fired by tanks and by the 25-mm gun on the M2/M3 presents a safety problem.

d. The temperature of the M1's exhaust may be over 1,700 degrees. Soldiers following behind the tank must be to the side of the exhaust grill or at a safe distance away if they are moving directly behind it.

e. Infantry may ride on top of armored vehicles, but must be aware of several safety concerns. (FM 7-8 provides more information on this subject.) The main concern is the soldiers' exposure to any weapon the enemy may direct against the vehicle. If soldiers ride on the vehicle, they have given up their best protection—the ability to move with stealth and avoid detection. The only advantages gained are speed and increased haul capability. Infantry should ride on

vehicles *only* when the risk of enemy contact is low or when the need for speed is great.

(1) Soldiers should avoid riding on the lead vehicle; it is the most likely to make contact and can react quicker without soldiers on top.

(2) Infantry leaders should be positioned with the armored vehicle leaders. Contingency plans for chance contacts and danger areas should be discussed and prepared. Infantry should dismount and clear choke points or other danger areas.

(3) Air guards and sectors of responsibility for observation should be assigned. All personnel must remain alert and be prepared to dismount immediately. In the event of contact, the armored vehicle crew immediately reacts to protect their vehicle. The infantry on top are responsible for their own safety. They should rehearse rapidly dismounting the vehicle.

(4) Infantry leaders should consider loading soldiers' rucksacks and excess equipment on the vehicles and having the soldiers themselves move on more suitable terrain near the vehicles. This is better use of the terrain and reduces the soldier's load.

### D-4. EMPLOYMENT CAPABILITIES

The heavy force is best employed on terrain that allows it to maneuver and to use its longer range weapon systems effectively. Tanks are employed for their speed, firepower, and shock effect. The armored force is most effective when the heavy and light forces achieve mutual support and complement each other.

a. Armored vehicles support infantry—

(1) By providing accurate long-range supporting fires, day or night, even during movement.

(2) By suppressing or destroying enemy vehicles, weapons, and personnel to allow the infantry to assault.

(3) By fixing or suppressing enemy forces to allow the infantry to breach obstacles or maneuver to the enemy's weak point.

(4) By breaching any obstacles they can such as chain link fences or wire obstacles.

NOTE: Soldiers traveling with tracked vehicles that must breach concertina or barbed wire obstacles should stop occasionally to clear wire that has wrapped around the vehicles' sprockets.

Otherwise, the wire may destroy the sprocket bearings.

(5) By attacking independently and linking up after the infantry has assaulted by air or infiltrated.

(6) By carrying the infantry in or on the vehicle to increase mobility.

(7) By using the on-board smoke capabilities to provide limited obscuration.

(8) By providing long-range observation and target detection, especially at night.

(9) By helping with casualty evacuation and providing a haul capability to manage the soldiers' loads.

b. Tanks support the infantry—

(1) By leading movement; by using their firepower and mobility, and their ability to protect the infantry, to quickly develop the situation on contact.

(2) By following the infantry to the objective after a lane is cleared.

(3) By leading the assault too provide protection for following infantry when the enemy antitank capability is limited.

(4) By destroying enemy armored vehicles, especially tanks.

c. Infantry supports armored vehicles—

(1) By clearing or breaching obstacles and marking lanes, especially in minefields, to allow the armored vehicles to exploit their speed and mobility.

(2) By destroying, suppressing, or neutralizing antitank weapons; or by destroying bunkers.

(3) By following the tank assault closely to protect the rear and flanks of the tanks from hand-held HEAT weapons, to clear the objective, or to reduce bypassed enemy forces.

(4) By securing or clearing choke points such as towns, forests, stream crossings, or narrow defiles.

(5) By providing close security at night or in restrictive terrain.

(6) By conducting reconnaissance to support the heavy unit's maneuver.

## D-5. PLANNING CONSIDERATIONS

The battalion staff must be proficient in the conduct of light/heavy operations. If possible, an

officer from the parent heavy unit is attached to the light battalion. If not, the commander of the heavy unit recommends how his unit should be employed. Specific staff officer responsibilities, such as performing resupply, reporting casualties, and enforcing the Uniform Code of Military Justice are based on the command relationship directed by the higher headquarters. The battalion staff officers must know the abilities, limitations, and requirements of the heavy force and must integrate these factors into their planning and into their recommendations to the commander. Specific planning considerations include command and control, maneuver, fire support, mobility and survivability, intelligence, CSS, and air defense. (FM 100-25 and FM 7-10 address planning considerations for working with SOF.)

### a. Intelligence.

(1) Reconnaissance and surveillance plans that integrate heavy force requirements are developed.

(2) Commanders should use the light unit's night vision and dismounted reconnaissance capabilities and the heavy unit's thermal imagery and long-range night vision capabilities.

(3) The heavy force commander should provide input to the S2's PIR recommendation.

(4) The use of an infantry for the screening force to find the enemy and a mobile heavy force to destroy him should be considered in a counterreconnaissance mission.

### b. Maneuver.

(1) Infantry units often conduct operations during limited visibility to gain surprise and reduce their vulnerability.

(2) The difference in mobility between heavy and light units should always be considered and terrain assigned based on the unit's capabilities. The timing for every operation must be planned to avoid leaving either force, especially the light force, in a vulnerable position.

(3) The strengths of both heavy and light units should be used to advantage; appropriate tasks should be assigned and each unit fought to capitalize on these strengths.

(4) Each force should compensate for the limitations of the other throughout the operation.

(5) The tactical signature of each force should be considered. The heavy force is more easily detected in any situation. As a result, accompanying infantry may be targeted even if it is not detected. If infantry with the heavy force can effectively accomplish the mission from a more secure location, they should be allowed to do so.

(6) Armored vehicles and infantry can provide mutual support without being located together.

(7) The characteristics of heavy forces must be considered to prevent friendly casualties. These characteristics also must be considered in the planning of fire control measures.

#### c. Fire Support.

(1) The heavy force commander/FSO must be involved in the fire planning.

(2) The target-acquisition capability of the heavy force's integrated sights (thermals) should be considered when either the priority of fires or the responsibility to fire certain targets is assigned.

(3) Tank platoons have no FOs.

#### d. Mobility, Countermobility, and Survivability.

(1) Heavy forces defend from prepared firing positions. If engineer assets are unavailable, the concept and the terrain allocation must allow either for protection through maneuver or for the use of hide positions.

(2) A common obstacle plan is developed to fully integrate the requirements for both forces.

(3) The S2's terrain analysis addresses the requirements of both forces to allow the S3/engineer representative to develop an effective plan.

(4) Range disparities between weapons should be considered when handing over obstacles.

#### e. Air Defense.

(1) The heavy force presents the most lucrative target to enemy aircraft.

(2) The mobility requirements for the heavy force are more similar to those of the HMMWV-mounted Stingers than to those of the infantry.

(3) The heavy force's vehicle weapon systems may be employed in an ADA role.

#### f. Combat Service Support.

(1) Light/heavy operations increase the requirement for CSS supervision. As second in command, the battalion XO must monitor the status of CSS.

(2) The light battalion S4 must also, in all cases, integrate the heavy unit's CSS slice into the battalion trains. The light battalion S4 must ensure in all cases that the heavy unit knows the situation and that all logistical actions conducted in the battalion's area of operations are coordinated, to include the following:

- Routes, locations, and timings to be used for conducting the heavy force LOGPACs.
- Casualty evacuation plan.
- Vehicle evacuation plan.

(3) The light battalion S4 must ensure that the CSS slice is adequate for the situation when the heavy unit is attached to the light battalion. If not, he should request more assets from the heavy force's parent unit or through his brigade S4. The S4 also must assume control of the CSS slice and, based on the heavy unit commander's recommendation, coordinate the integrated CSS plan. Normally the heavy force CSS slice consists of the following:

(a) Company combat trains (M88 recovery vehicle, a M113 maintenance vehicle, and an M113 MEDEVAC vehicle).

(b) Maintenance support vehicles for the UMCP (two trucks, one for parts and one for tools).

(c) Two fuel HEMMTs.

(d) At least one cargo HEMTT.

#### g. Command and Control.

(1) The heavy force is OPCON only to the battalion because the battalion cannot sustain the heavy force logistically. In some situations, the heavy force may be attached for short times—for example, when it brings sufficient CSS to sustain itself or when the parent unit cannot provide the support.

(2) All units must know the frequency and call signs the heavy force will use.

(3) The commander/S3 should consider the following when task-organizing a heavy force (company) into the battalion:

(a) The heavy force commander should retain control of most of his unit to use his expertise.

(b) A tank company is most effective when employed in mass.

(c) Task organizing should occur at platoon level or above to ensure an effective chain of

command and to allow the heavy unit to fight as trained.

(d) Task organizing by sections may be reasonable in certain situations such as MOU or LIC. Individual tanks or armored vehicles should not be task organized. They need a like vehicle to allow them to maneuver with mutual support.

## Section II MECHANIZED-ARMOR/LIGHT OFFENSIVE OPERATIONS

Effective light/heavy offensive operations apply the fundamentals discussed in Chapter 3. The only other requirement is to effectively integrate the heavy force into the battalion's operation. The estimate of the situation conducted by the commander and the battalion staff provides critical information to help the commander decide how to use his available resources. Every tactical situation is unique; a thorough estimate conducted by a capable, trained staff provides the most effective concept for each situation.

### D-6. PLANNING CONSIDERATIONS

The commander should provide some planning guidance early in the staff planning process concerning the employment of the heavy force. The amount and detail of guidance for light/heavy operations vary but may include the following:

a. Task organization options for the heavy force.

(1) Maintaining the heavy force as a pure company (when suitable avenues of approach are very limited).

(2) Cross attaching platoons to provide two company teams (when two or more good mounted avenues of approach lead to the objective).

(3) Using all or part of the heavy force as the battalion reserve—

(a) If the enemy can produce a sizeable counterattack force.

(b) If the heavy unit is a tank company.

b. Considerations for using the heavy force in the attack, such as mounting a supporting attack by fire, conducting a feint or demonstration, or using an exploitation force.

c. Specific areas of concern for each staff officer such as—

(1) S2. The potential for armored vehicle mobility in certain areas.

(2) S4. The adequacy of the logistical support.

(3) S1/medical platoon leader. Medical support for the heavy unit.

d. Specific courses of action that the commander wants developed.

### D-7. METHODS OF ATTACK

The infantry and armored vehicles can operate in the attack in many ways. This paragraph discusses some of the most basic methods for conducting light/heavy attacks. The battalion commander, supported by the recommendations of his staff, must decide if the light/heavy attack would be more effective if conducted by company teams or by a closely integrated heavy company and infantry company maneuver. The following methods can all be used in either case, but the specifics of the tactical situation determine how decentralized the attack will be:

a. Armored vehicles initially attack by fire, then move forward rapidly and join the infantry for the assault. In this method, the vehicles first suppress the objective from hull defilade positions while the infantry moves to an assault position. When the infantry masks the vehicle fires or on a prearranged signal, the armored vehicles move forward quickly and join the infantry in the final assault.

(1) This method should be used only with tanks in the assault. Other armored vehicles should assault with the infantry only when the antitank threat is small. When they cannot assault with the infantry, the armored vehicles can instead isolate the objective area and, once the objective is secure, support the consolidation of the objective. During the assault, tanks and infantry may move together, or the tanks may move slightly ahead of the infantry.

(2) This method is used when the enemy has prepared obstacles on the mounted avenues of approach. When this happens, the infantry must first breach the obstacles and clear a lane for the tanks to reach the objective. Time is needed for careful coordination and preparation of a detailed supporting fire plan. Because they can move forward at their own speed, tanks using this method are exposed more briefly to enemy fire than those using the other method. This method is also safer for infantry, because the infantry is not endangered by enemy fire directed at the friendly tanks. Also, this method may provide the tanks with a better chance to approach the objective undetected.

b. Infantry and armored vehicles advancing together try to advance at the same speed (Figure D-1). The vehicles may advance rapidly for short distances, stop to fire, then move forward again as the infantry comes abreast. Although tanks are best suited for assaulting under fire, other armored vehicles may be used if the threat of antitank fires is small. The infantry almost always leads and the vehicles follow as closely as needed to provide fire support.

(1) This method may be used when the enemy situation is vague; when the objective is very large and consists of both open and restrictive terrain; or when visibility, fields of fire, and tank movements are restricted—for example, in fog, in towns, in woods, and at night. When this method is used, the vehicles provide immediate, close, direct fires and the infantry protects the armored vehicles from individual antitank measures.

(2) The infantry may follow closely behind the tanks to gain protection from frontal fires when the main threat is small-arms fire. From there, they can protect the flanks and rear of the tanks from handheld antitank weapons.



**Figure D-1. Infantry and armored vehicles advancing together.**

(3) The infantry and tanks may advance together in operations that require long and fast moves; the infantry rides on the tanks until they make contact with the enemy. This method is quick, but increases infantry exposure to enemy fire, especially to airburst munitions. Also, having infantry riding on them interferes with the operation of the tanks. This method should be used only when the chance of enemy contact is small and the need for speed is crucial.

c. Armored vehicles may attack by fire while the infantry assaults the objective. When this method is used, vehicles fire from hull-defilade positions until the infantry can mask tank fires (Figure D-2). This is the best method for armored vehicles other than tanks. However, this method may also be used with tanks when antitank weapons or obstacles block movement to the objective.

(1) A feint may be used with this method to deceive the enemy as to the location of the main attack. If this is done, the heavy force supporting attack by fire is timed to divert the enemy's attention from the infantry force's assault. The

fires of the heavy force may also cover the sounds of the infantry approach or breach. Close coordination between the heavy and light force commanders is vital to ensure effective fire control.

(2) Another variation of this method may be used when the terrain or the enemy disposition limits the heavy forces' ability to support the infantry assault by fire. In this case, the heavy force may be tasked to suppress or fix adjacent enemy positions or to accomplish other tasks that isolate the objective area.

d. Armored vehicles and infantry may converge on the objective from different directions and assault at the same time. The infantry elements must often move out first so both forces can close on the objective. This method—

(1) Provides surprise, increases fire effect, and maximizes shock action.

(2) Works extremely well when tanks are used. As stated earlier, other armored vehicles are less suitable. Open or partially open terrain free of mines and other tank obstacles is vital. Effective neutralization of enemy antitank

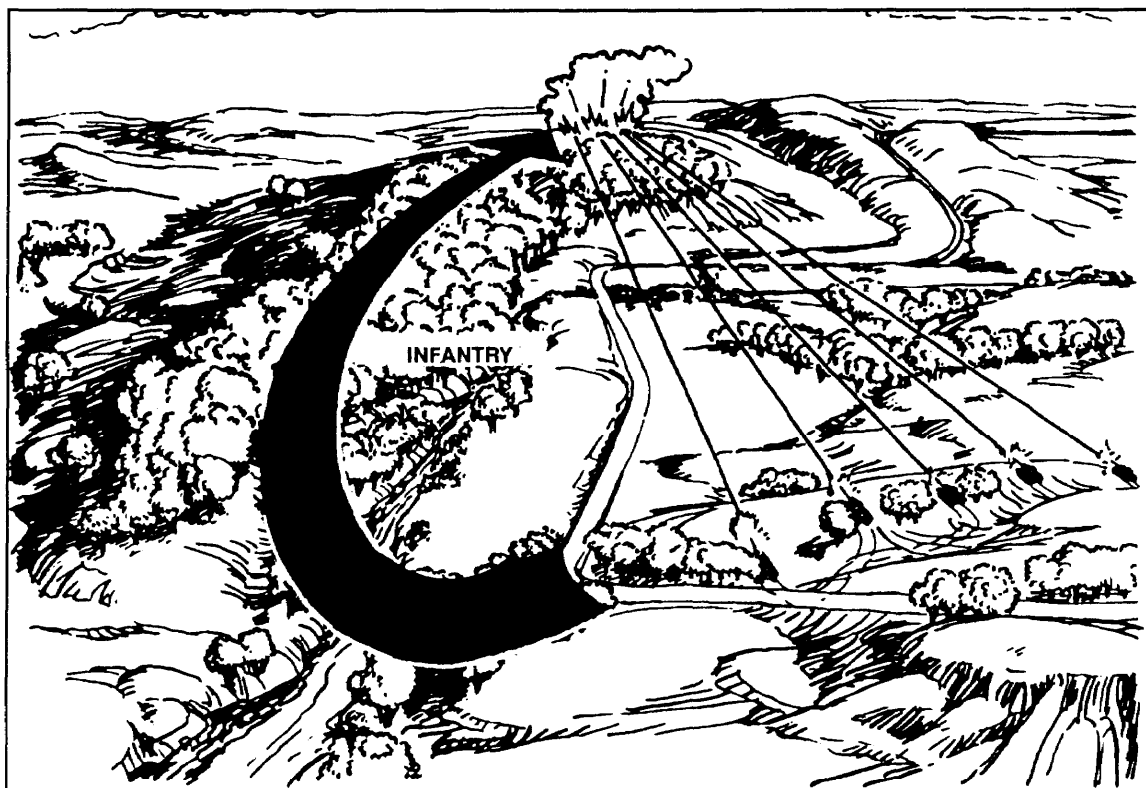

Figure D-2. Armored vehicles overwatching Infantry.

weapons by supporting fires and smoke is also necessary. However, neutralization is needed only during the time required for tanks to move from their LD to the near edge of the objective.

(3) Requires coordination between tanks and infantry to provide effective fire control on the objective. When armored vehicles cannot advance quickly, infantry should accompany them to provide protection.

#### **D-8. CONDUCT OF THE ATTACK**

The light/heavy attack is conducted like any other attack. The fundamentals, principles, and concepts discussed in Chapter 3 apply.

a. The supporting fire plan must be flexible enough to permit changes during the action. Unforeseen incidents must be expected. Fire control measures are developed based on the capabilities of heavy force weapons. Engagement priorities should be established based on the capabilities of the vehicle systems and on the enemy threat. Tanks or IFVs destroy enemy armored vehicles, automatic weapons' positions, and other hard targets. When they can, tanks or IFVs also breach antipersonnel obstacles. The infantry protects the tanks from enemy personnel and antitank weapons, and breaches antitank obstacles.

b. The infantry company team assaults the objective after fire superiority is established and members of the team can maneuver themselves into a good position. The assault may be made by infantry, tanks, or both. Infantry and tank elements can best exploit the full firepower and shock action of the team by assaulting together. Normal supporting fires are lifted for the assault. The tanks give the team a heavy volume of direct fire not otherwise available. In the assault phase, the team increases its rate of movement and volume of fire. The tanks suppress the objective with machine gun fire and use their tank cannons against suitable targets

c. The plan must ensure that obstacles are rapidly cleared or breached so that, even if they are delayed from joining the infantry in the assault, they can still join the infantry as soon as possible. If tanks assault alone, the commander uses all available supporting fires from infantry as well as supporting weapons to cover the tank assault.

d. The consolidation of the objective must effectively integrate the heavy force; it should be

as simple as possible to rapidly secure the objective. The heavy force may be used against the mounted avenues of approach into the objective or as a mobile reserve.

e. The wounded from both infantry and heavy units are evacuated through the brigade evacuation system. Heavy vehicles are used for evacuation only if they already are moving to the rear for other reasons.

#### **D-9. EXPLOITATION**

Exploitation in battle follows success. Commanders and leaders should take full advantage of the enemy's lack of organization to defeat and destroy him. The heavy company, especially if it is a tank company, is usually the commander's most capable exploitation force. Exploitation is conducted to destroy all enemy personnel and installations in the area. A common combination is the tank company reinforced by an attached infantry platoon(s), engineers, and other supporting units. The infantry may be transported in armored vehicles or trucks, or they may ride on the tanks. Riding on tanks maybe the most desirable method since it reduces road space required, decreases supply problems, and keeps the members of the team together. The infantry company commander and platoon leaders ride with the corresponding tank unit commanders. Each rifle company platoon is loaded on tank platoon tanks. The command groups of the infantry company headquarters are loaded on the tank company headquarters section tanks.

#### **D-10. RECONNAISSANCE IN FORCE**

Vital information can often be obtained only through attack; contact must never be lost. Hostile resistance may be encountered that cannot be overcome or enveloped. When an uncertain situation such as this occurs, the only way to develop it may be to conduct a reconnaissance in force (Figure D-3). When expedient, tank companies, platoons, and individual tanks may operate with appropriate groups of infantry.

a. The infantry's method of advance depends on the type of action expected and on whether or not tanks lead initially. When enemy resistance is met, the situation is developed and



the attack launched just as it would be in other offensive actions.

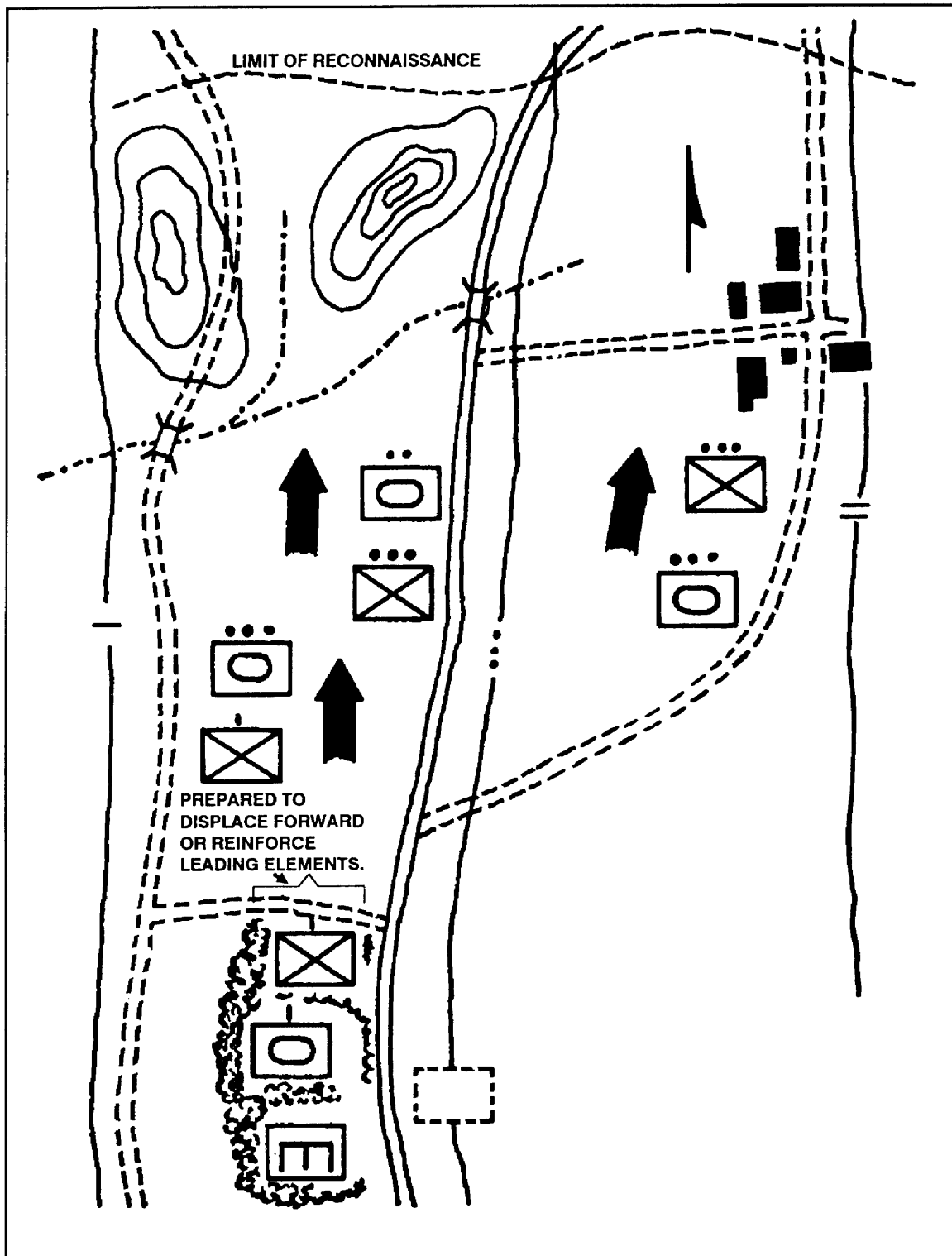

Figure D-3. Reconnaissance in force.

b. Units conducting a reconnaissance in force usually make local attack with limited objectives. The plans of higher unit commanders should

include reinforcing leading elements and counterattacking to hold objectives seized and to exploit success.

### Section III THE INFANTRY/TANK TEAM IN DEFENSIVE OPERATIONS

The commander should consider of the heavy force's mobility, shock effect, and firepower when assigning its defensive mission. The heavy force may be assigned to counterattack or it may be assigned to cover an engagement area into which the light unit will canalize the enemy. If the situation calls for a capable reserve, the heavy reserve may form its center. The size of the heavy unit employed in the defense depends on the terrain, the extent of the front held, and the enemy situation. In general, wide fronts and open terrain support the use of the heavy force in mass; narrow fronts and close terrain justify more dispersion. The heavy unit will require attached infantry forces in some situations—for example, a heavy unit defending in terrain with dismounted avenues of approach may require an extra infantry company. Sometimes the heavy force may require infantry augmentation.

#### D-11. TANKS

Tanks can defend much like the infantry, but they are most effective when employed in a mobile situation that exploits their speed, shock, and firepower. Tanks are most effective if the enemy is unaware of their presence and has planned to fight only against the infantry forces that he has identified.

#### D-12. OTHER ARMORED VEHICLES

Armored vehicles other than tanks in the defense mainly provide direct-fire support, mobility, and limited protection. They can conduct mobile operations, but are more vulnerable than a tank unit. Vehicles in a mobile operation that lack organic infantry must have a dismounted company team. Though they are effective without infantry as a direct-fire support asset, heavy-force vehicles are vulnerable in many situations. In addition to mobile operations, these armored vehicles can—

- a. Defend battle positions or a sector.
- b. Augment an infantry platoon or company sector.
- c. Conduct many of the same tasks as an infantry unit.

- d. Conduct counterattacks.
- e. Act as a battalion reserve.
- f. Provide mobility support to an infantry force.
- g. Help the infantry unit with CSS activities.
- h. Provide the infantry commander a capable, versatile force in the defense.
- i. Destroy enemy forces in an engagement area.
- j. Conduct the counterreconnaissance fight.
- k. Conduct a counterattack, or provide a mobile reserve.

#### D-13. ATTACKS FROM A DEFENSIVE POSTURE

The best mission for tanks in the defense is counterattack, whether alone (to destroy an enemy who is forming for an attack [spoiling attack]) or along with other soldiers (to eject an enemy who has penetrated the battle position). Chapter 4 discusses the principles and details of counterattack planning. When these attacks are conducted with armored vehicles other than tanks, they should counterattack by fire. This allows them to move where they can place

effective fires on the enemy force without getting into a close fight.

a. A tank spoiling attack is conducted to disrupt an enemy force forming for an attack. The terrain in the area of the attack must be suitable for tank action. Also, no strong hostile forces of tanks or antitank weapons should be present. Tanks may conduct a spoiling attack alone or supported by fires of the infantry and artillery. The attack stops at the range of that support.

b. A counterattack exploits the strongest characteristics of tank forces—high mobility, armor-protected fire power, and shock effect (Figure D-4). Infantry may take part in this type of counterattack. The commander must prepare a coordinated plan that includes both direct and indirect fires. He coordinates his counterattack plans with the tank commander. If time permits, the counterattack is rehearsed over the area of most likely enemy penetration. At the least, routes and fire plan should be rehearsed by key personnel.

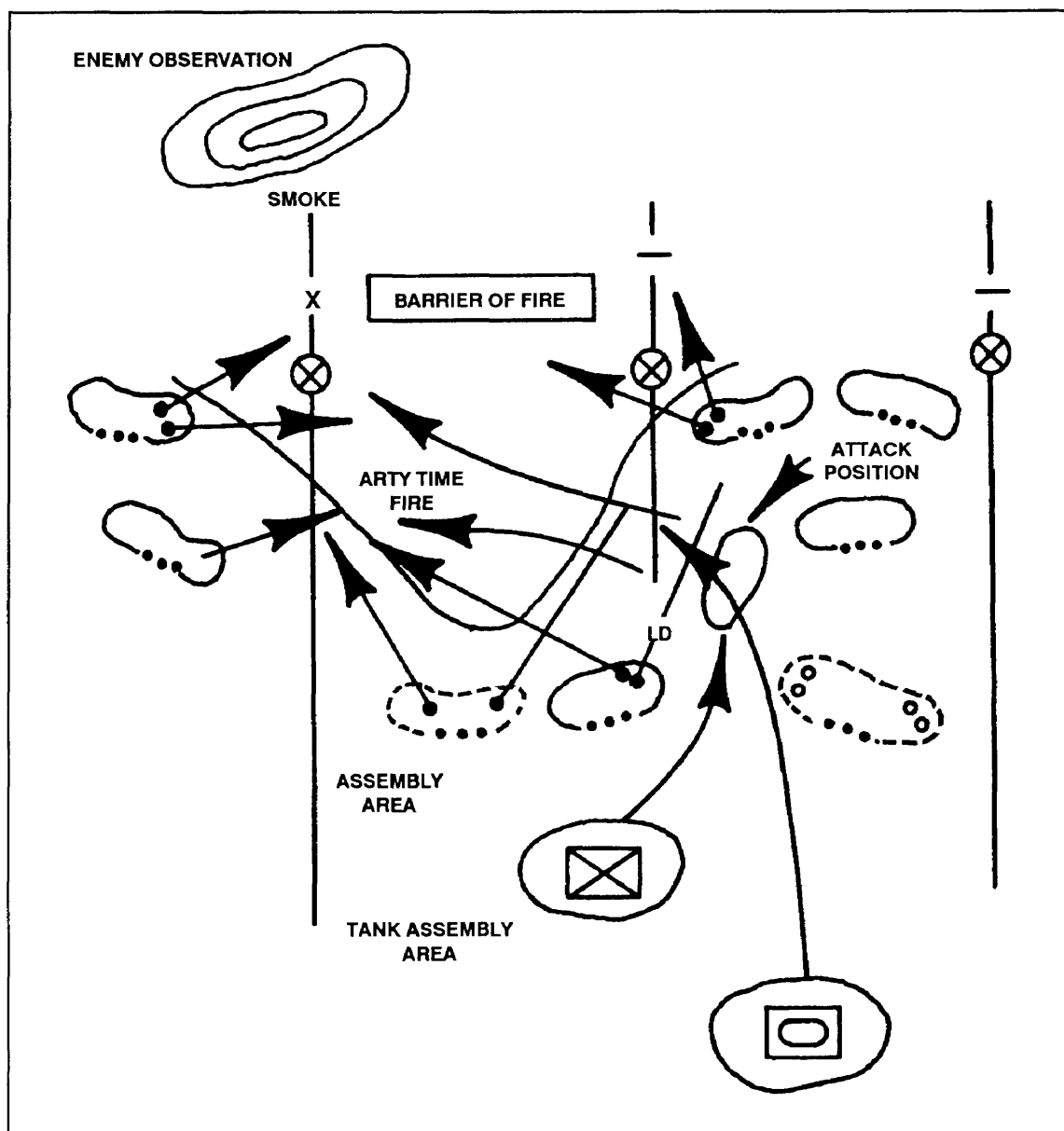

Figure D-4. Tanks in a counterattack.

**D-14. SECURITY MISSIONS**

Armored elements can provide security to the infantry force. Their mobility and firepower equips them to perform screen and guard missions, to provide route security (convoy escort), and to help in counterreconnaissance operations. When assigned these missions, tank units should be augmented by infantry. Observation posts are established to screen the BP, to deceive the enemy as to the unit's location, and to slow the enemy's advance. Soldiers in these posts can also perform delaying actions. Figure D-5 shows three possible schemes of employment for tanks in support of infantry in an OP. Plan 1 involves either direct fire from hull-defilade positions. Plan 2 is a quick, direct thrust from concealed positions against the advancing enemy. Plan 3 is a surprise flank attack

across the route of the enemy advance. Plans 2 and 3 must be strongly supported by artillery.

**D-15. DELAYING ACTIONS AND WITHDRAWALS**

The purpose of a delaying action is to gain time while avoiding decisive action. Armored forces are employed against hostile elements and on avenues of approach that most seriously threaten the success of the operation.

a. Fundamental movement techniques used in a delaying action or withdrawal are fire and maneuver, and a bounding overwatch, both in reverse. Armored sections with small infantry units mounted in combination with infantry reconnaissance platoons and antitank elements move to subsequent delay lines under the cover of mutually supporting fires.

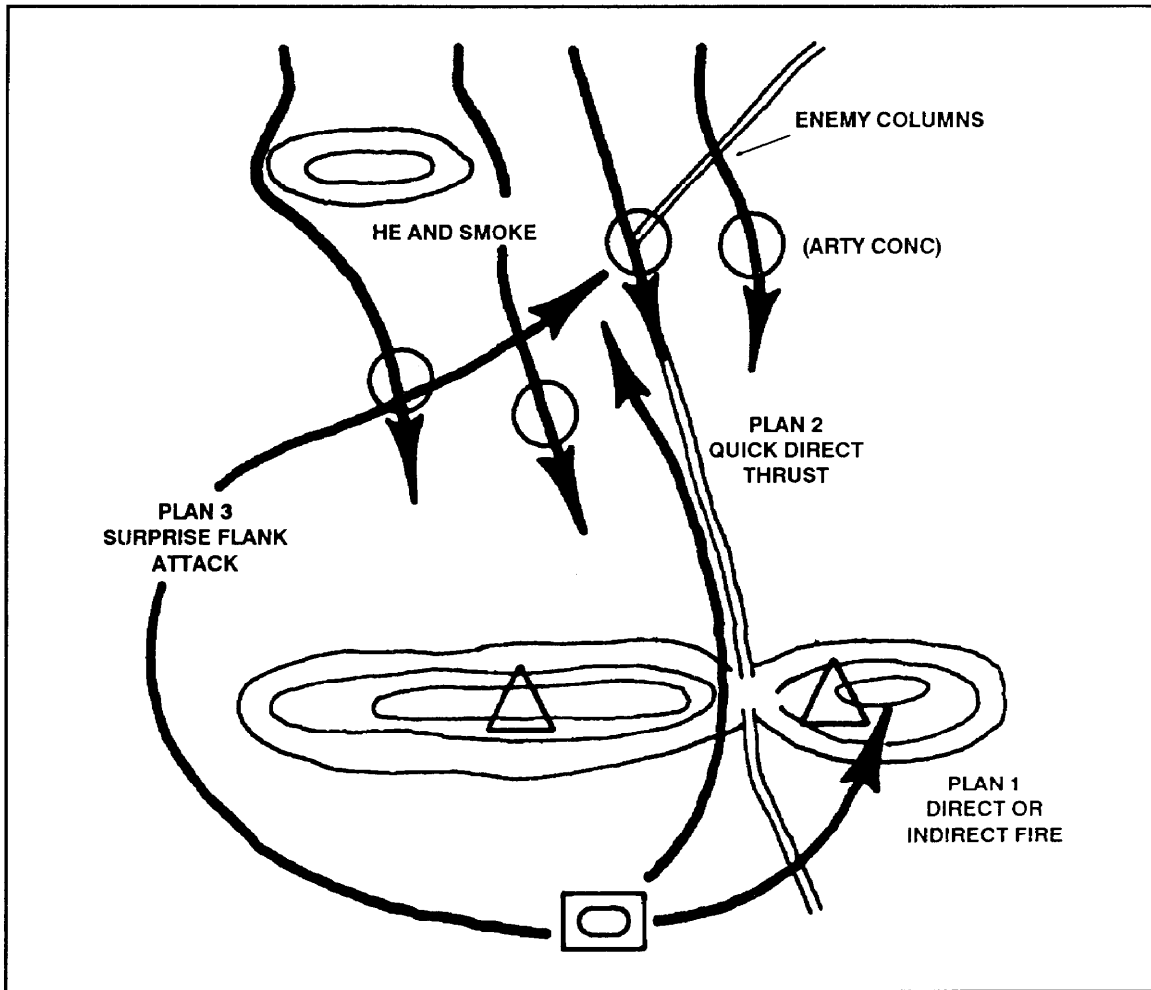

Figure D-5. Tanks in support of an OP.

b. Armored vehicles may also be used to cover a withdrawal. A daylight withdrawal is conducted only if deferring the action until dark would result in disaster to the command.

c. All tank attacks for delaying purposes have strictly limited objectives and must be strongly supported by artillery and all units present in the covering force.

## **Section IV**

### **MILITARY OPERATIONS ON URBANIZED TERRAIN**

Towns or other urban areas are considered restrictive terrain, so close teamwork between infantry and tanks is critical. If SOF are working in the same area with conventional forces, the battalion commander and S3 should consider this when they develop the scheme of maneuver. In MOUT, infantry company teams may be used to encircle, to penetrate the outer defenses of, or to fight house-to-house within the town.

#### **D-16. RESTRICTIONS ON ARMORED VEHICLES**

Armored vehicles operating inside the built-up area are vulnerable to enemy ambush or fires at close ranges. This degrades the strengths of the armored vehicles. Their target-acquisition capabilities, effectiveness of long-range fires, speed, and mobility are limited by the restrictive nature of this terrain. Armor protection is degraded by the close ranges of engagements. Hand-held antitank weapons or explosives employed from the roofs or upper floors of the buildings can easily penetrate the tops of armored vehicles.

#### **D-17. ROLE OF INFANTRY**

Any operation conducted in a MOUT environment is fought mainly with infantry. Tanks and other armored vehicles can be effective when used as mobile fire support assets, but their survival requires the close support of the infantry. Therefore, the armored force is usually task-organized into infantry heavy company teams. In this environment, tank (or armored vehicle) sections also are commonly task-organized to an infantry platoon.

#### **D-18. LIGHT/HEAVY OPERATIONS**

Light/heavy operations in a MOUT environment are planned the same as in any other terrain. If possible, the armored force is employed in terrain that allows the greatest potential for offensive maneuver. In some situations, the use

of armored forces exclusively around the perimeter of the town maybe possible. Armored vehicles can operate outside a small town or village and still provide adequate fire support to the infantry.

#### **D-19. OFFENSIVE CONSIDERATIONS**

The battalion conducts a light/heavy attack by isolating the area, seizing a foothold, and clearing an area.

a. The armored force can help with each of these steps. Its offensive role in MOUT is as follows:

(1) *To isolate the area.* The area maybe the entire village or small town, or it may be part of a larger built-up area. The armored force is usually effective in this phase of the operation. Operating outside the town allows the heavy force to use its long-range fires, speed, and mobility. Since the defender often positions much of his force outside the town at first (to disrupt an attack, limit reconnaissance, and prevent bypass), the armored force may be able to prevent him from withdrawing into the town. For an isolation plan to be effective, it must support the next step: seizure of a foothold. Sometimes, to provide armored vehicle support to each infantry company within the town, the task organization may be changed after the objective has been isolated.

(2) *To seize a foothold.* The armored force can support this phase of the operation by using their sights/thermals to initially conduct a

longer-range reconnaissance. The armored force may provide the most effective means for locating enemy positions/vehicles during limited visibility. Once enemy weak points have been located, the armored vehicles can provide fire support for the infantry assaulting to secure the foothold. This assault is conducted like any other light/heavy assault. As an option, the heavy force (or a part of it) may divert the enemy's attention away from the point of the main attack. Vehicles with an on-board smoke capability can provide concealment for the infantry assault.

(3) **To clear the objective.** The armored vehicles continue, once the infantry has seized a foothold, to provide close supporting fires while the infantry clears each building. Due to the danger of ambush, tanks support by fire from cleared positions rather than move ahead of the infantry. The tanks may be able to provide fire support without entering the town. Armored vehicles in the town must be closely controlled by the infantry leader. Target identification and fire-control measures change rapidly as clearing progresses. The vehicles provide suppressive fires to allow the infantry to establish a foothold in each building. To isolate the building, the vehicles engage known or suspected enemy locations. Once the infantry is inside the building, the armored vehicles may continue to suppress other floors within the building or may shift their fires to adjacent buildings.

(a) Visual signals are the most effective and reliable means of communication between the infantry force and the armored vehicles. Targets can be identified with tracer fire, grenade launcher rounds, smoke grenades, or arm-and-hand signals. Specific actions, such as initiating fires, lifting or shifting fires, moving forward to the next position, or providing smoke obscuration, can be directed in a similar manner.

(b) Communications between the armored vehicles and the infantry leader may also be by FM radio or by landline. Radio communications may be disrupted by the terrain. Landlines are an option only when the leader can operate while walking behind the vehicle. To use landlines, soldiers must run the wire to the inside of the vehicle through the hatch or to the sponson box on the rear of the M2/M3; the leader then uses

TA-1s to relay fire control instructions from the assaulting infantry force to the tank commander.

b. Specific actions of the armored force include the following:

(1) Firing into the upper stories of buildings to drive the enemy to the basement, where the infantry traps and destroys him. The weapon systems on the armored vehicles maybe limited in their ability to engage upper floors of buildings.

(2) Suppressing and destroying enemy weapons and personnel.

(3) Providing antitank protection.

(4) Making openings in walls and reducing barricades with cannon fire. The main tank round (APFSDS) makes only a small (1-inch diameter) hole in the wall. If available, HEP is used to destroy emplacements and blow access holes into buildings.

## **D-20. DEFENSIVE CONSIDERATIONS IN MOUT**

Armored forces defending in a MOUT environment have the same weaknesses as attacking forces. Therefore, they also require the close support of infantry forces. Armored forces can support the infantry defense of an urban area by defending or delaying forward of the town, fighting a mobile battle around the town, or defending within the built-up area along with the infantry.

a. Fighting forward of the built-up area, the armored force can either delay the enemy, disrupt his attack, or prevent him from conducting a timely reconnaissance of the defenses within the town. When fighting outside the town, the heavy force requires infantry augmentation. The heavy force may delay the enemy while defenses within the town are completed. After this, they may withdraw into defensive positions integrated into the MOUT defense or outside the town to prevent the enemy from enveloping or bypassing the town.

b. Fighting on the perimeter of the built-up area may enable the heavy force to use terrain that is more suitable to their capabilities. They can also prevent the enemy force from isolating the town (or part of town) they plan to assault. Conducting spoiling attacks or counterattacking against enemy forces may also be easier from the

perimeter. To avoid detection, the heavy force can occupy a concealed location outside the built-up area before conducting the counterattack. The heavy force can produce decisive results if it prevents the enemy from seizing a foothold or if it times the attack so part of the enemy's force starts clearing into the built-up area.

c. Fighting within the built-up area, armored forces may be employed as fire support for infantry positions or strongpoints or as a

mobile defense where the terrain allows. Defenses may be shaped to draw the enemy into position where part of his forces can be destroyed or cutoff by a mobile armor-heavy counterattack. Depending on the type of construction in the built-up area, armored vehicles may be able to reduce buildings to rubble or burn them to develop routes for movement. When used for direct-fire support of infantry positions, armored vehicles operate most often in sections and at other times as individual vehicles.

## Section V OTHER SPECIAL SITUATIONS

Light/heavy forces, whether working with SOF or not, face other types of special situations in addition to mobile operations in urbanized terrain.

### D-21. NIGHT ATTACKS

The decision to employ tanks with the assault echelon in a night attack is made after consideration of their capabilities and limitations. Tanks have excellent night-vision capabilities and may be effective in the assault if control and close mutual support between infantry and tanks is maintained. When not accompanying assault rifle units, tanks use fires to isolate and suppress the objective. Then they join the infantry on the objective after it has been secured or just before daylight. Maintaining direction, leading soldiers, and moving become more difficult in the dark, which places more responsibility on the small-unit commander.

a. The infantry company team can attack a strongpoint at night if it has time for daytime reconnaissance and detailed coordination. Night attacks offer tanks the important advantage of protection against long-range antitank weapons. They also may increase the shock effect of an attack; the enemy may not be able to see the tanks but will hear them coming for some time. Often, when a daytime attack would have resulted in high casualties, the same objectives are taken with few losses at night. However, night attacks make tanks more vulnerable to enemy close antitank measures; to protect the tanks, accompanying infantry must be especially alert.

b. Detailed plans for a night attack are made early enough to allow thorough reconnaissance by all units. Definite objectives and boundaries are assigned to each unit and control measures are perfected. Control is simplified; only one direction of attack is assigned and communications are coordinated between the assault units. Direction is maintained by compass, by flares, by tracers, by illuminating shells fired behind the objective, or by a combination of these methods. If time permits, the attack is rehearsed on similar terrain so the tank commanders and squad leaders know what each must do during the actual attack. Before the attack and in daylight, artillery is closely coordinated and other supporting weapons are laid on definite targets.

c. The tank elements of the infantry company team must be in position by daylight to help repel counterattacks. When conditions prevent the tanks from moving with the assaulting infantry, tank unit leaders may accompany the leading infantry elements on foot to reconnoiter routes, plan movement around obstacles or through minefield, and select tank firing positions. The tank unit leader then leads the tanks to the selected positions.

d. The tanks and infantry reorganize after capturing the objective the same as they do during daylight. Because of reduced visibility, the effectiveness of tank fire against a

counterattacking enemy is limited. The movement of the tanks to firing positions should be controlled by infantry guides or a dismounted member of the tank crew.

#### **D-22. RIVER CROSSINGS**

Tanks provide direct-fire support and antitank protection during the first stages of a river crossing. They cover probable enemy armor approaches on the far side of the river. The infantry clears the far side of the river to prevent direct fire on the crossing site. This allows the engineers to begin bridging/rafting operations. To help the infantry secure a bridgehead, some tanks may be rafted across the river in the early stages of the operation. As soon as crossing facilities are available, the tanks move from their direct-fire positions over previously reconnoitered routes to an assembly area near the crossing site. So they can quickly join the infantry soldiers to support the attack, tanks are given a high priority for use of the crossing facilities. During a night crossing, tanks can be used for fire support. Tank platoons seldom accompany infantry battalions during the actual crossing, but after the river is crossed, they operate as they would in any other type of attack.

#### **D-23. JUNGLE OPERATIONS**

Combat in any close, difficult, wooded terrain shares characteristics with jungle operations, so most of the same combat methods apply. The considerations for employing armored vehicles and infantry in this type of terrain are similar to those for employing them in the MOUT environment. Armored vehicles require infantry support to fight and survive in a jungle environment. They normally follow the infantry closely enough to provide effective fire support; the infantry in turn protects them from enemy hand-held antitank weapons.

a. Tank canister (for M60-series tanks only) and machine gun fires often clear enough jungle growth for bunker openings to be seen. HEAT rounds are designed to destroy bunkers.

b. The rate of advance in the jungle is slow, tanks must pick their way through the jungle growth. If open ground is encountered, tanks can move rapidly with close and continuous support from the infantry.

c. Tanks are committed to combat in jungles—

(1) Against definitely located resistance that has been holding up the infantry advance.

(2) In sufficient numbers to ensure a continuing effort and to make full use of the tank's own powers of fire and maneuver.

(3) After a thorough reconnaissance has been made by personnel who know the capabilities and limitations of tanks.

(4) After detailed planning for coordinated action of the combined arms forces taking part in the attack. This planning is conducted down to the lowest infantry unit/tank crew operating closely together.

d. Infantry fire support should be close and continuous to prevent the enemy from destroying or damaging tanks.

#### **D-24. MOUNTAIN OPERATIONS**

Each tactical group within a terrain compartment makes its main effort in mountain operations along the crests and slopes or by a combined advance along heights and valleys. The initial advance may be made by infantry along slopes and ridges so they can outflank resistance in defiles. The technique used to force a defile depends on how it is held and on the accessibility of its flanks. To advance on a broad front and outflank defended areas, small forces can move through or around the obstacles creating the defile.

#### **D-25. AIRBORNE OPERATIONS**

Light armor units may take part in the airborne assault. These units may be delivered by LAPES or by airlanding C-130 or C-141 aircraft. Tanks (M1s) may be delivered into the airhead by C-17 aircraft.

#### **D-26. INTEGRATION OF SPECIAL OPERATIONS FORCES**

Infantry battalions may operate near or with SOF. The command relationship will be determined by a higher headquarters. Special operations personnel normally provide a liaison team (a SOCCE—special operations command and control element) to interface at brigade or battalion level and control the SOF within the area of operations. Most often, SOF personnel



precede conventional forces into an area of operations. (FMs 7-30 and 100-25 provide more information on organizations, capabilities and limitations, missions, and planning considerations for operations with SOF.)

a. Information and assistance the SOF may be able to provide the infantry battalion areas follows:

- Enemy movement patterns within an area of operations.
- Cultural background information.
- Interface with the indigenous population.
- Interface with other US agencies within the area of operations.
- Civil affairs guidance.
- Limited PSYOP support.

b. Infantry battalions may be tasked to do the following when operating with SOF

(1) Provide additional combat power to an SF-supported indigenous combat force or host nation force during counterinsurgency operations.

(2) Provide a reaction force or reinforcements to SOF during direct action or special reconnaissance operations.

(3) Conduct linkups and reliefs in place with SOF (Chapter 6).

(4) Deny enemy access to or reinforcements of areas where SOF are operating.

(5) Provide support to civil affairs and PSYOP personnel.

## APPENDIX E

# SNIPER EMPLOYMENT

*The sniper plays an important role in the infantry battalion. Snipers give the commander accurate, discriminate, long-range, small-arms fire. These fires are best used against key targets that, due to their range, size, or location; visibility; security and stealth requirements; collateral damage; intensity of conflict; or rules of engagement; cannot be destroyed by other available weapon systems. Also, the individual techniques snipers use enable them to gather detailed, critical information about the enemy. However, gathering information is a secondary role, (TC23-14 describes some individual techniques.) The effect of a sniper is measured by more than the casualties he causes or targets he destroys. Commanders know the effect snipers have on enemy activities, morale, and decisions. The presence of snipers hinders enemy movement, creates continuous personal fear, causes confusion, disrupts enemy operations and preparations, and compels the enemy to divert forces to deal with the snipers. (TC 23-14 addresses individual sniper equipment, marksmanship, field techniques, and training.)*

### E-1. SNIPER TEAMS

Snipers are employed in two-man teams; each team consists of one sniper and one observer. Normally, the observer carries an M16 rifle, the sniper carries the sniper weapon system, and each has a side arm. Snipers should avoid sustained battles. During long periods of observation, team members help each other with range estimation, round adjustment, and security.

a. Sniper teams should be centrally controlled by the commander or task organized to companies. Once they are deployed, snipers must be able to operate independently, as required. Therefore they must understand the commander's intent, his concept of the operation, and the purpose for their assigned tasks. This allows them to exercise initiative, within the framework of the commander's intent and to support the commander's concept and achievement of the unit's mission. To ensure clear fields of fire and observation, the teams must be able to choose their own positions once they are on the ground. Snipers are effective only in areas that offer good fields of fire and observation.

The number of sniper teams participating in an operation depends on their availability, on the expected duration of the mission, and on the enemy's strength.

b. Sniper teams should move with a security element (squad/platoon) when possible. This allows the sniper teams to reach their areas of operation faster and safer than if they went alone. The security element also protects the snipers during operations. When moving with a security element, snipers follow these guidelines:

(1) The leader of the security element leads the sniper team.

(2) Sniper's must appear to be an integral part of the security element. To do so, the sniper weapon system is carried in line with and close to the body to hide its outline and barrel length. Sniper-unique equipment (optics, ghillie suits) is also concealed from view. The uniform is the same as that of element members, and proper intervals and positions in the element formation are maintained.

c. History has proven that commanders must be educated as to the proper use of a sniper.

If commanders know the abilities and limitations of a sniper, the sniper can contribute significantly to the fight. Commanders should consider carefully all the factors of METT-T when conducting their estimate of the situation.

(1) **Mission.** The sniper's primary mission is to support combat operations by delivering precise rifle fire from concealed positions. The mission assigned to a sniper team for a particular operation consists of the task(s) the commander wants the sniper team to accomplish and the reason (purpose) for it/them. The commander must decide how he wants his sniper team to affect the battlefield. Then he must assign missions to achieve this effect. The commander should be sure to prioritize targets so snipers can avoid involvement in sustained engagements. Regardless of the method used, the sniper team must be free to change targets to support the commander's intent.

(a) The commander may describe the effect or result he expects and allow the sniper team to select key targets. Whether the commander does this depends on the snipers' skills and on how well he trusts them.

(b) The commander may assign specific types of targets. For example, if he wants to disrupt the defensive preparations of the enemy, he may task snipers to kill operators of bulldozers and other engineer equipment. He may task them to disable vehicles carrying supplies. Or, he may task them to engage soldiers digging enemy defensive positions.

(c) The commander may also assign specific targets. These can include leaders, command and control operators, ATGM gunners, armored-vehicle commanders, or crew-served weapons crews. In cases where large crowds pose a threat to US forces, selected individuals can be singled out by snipers. In populated areas where casualties should be kept low, the snipers can be assigned to kill enemy snipers.

(2) **Enemy.** The commander must consider the characteristics, capabilities, strengths, weaknesses, and disposition of the enemy. Is the enemy force heavy or light, rested or tired, disciplined or not? Is it motorized infantry or towed artillery? Is it well-supplied or severely short of supplies? Is it patrolling aggressively or is security lax? Is it positioned in assembly areas

or dug in? The answers to such questions help the commander determine the enemy's susceptibility and reaction to effective sniper operations. Naturally, a well-rested, well-led, well-supplied, and aggressive enemy with armored protection poses a greater threat to snipers than one who is tired, poorly led, poorly supplied, lax, and unprotected. Also, the commander needs to know if enemy snipers are present and if they are effective; they can pose a significant danger to his own snipers. Also, the enemy's DEW capability should be considered. Since snipers use optical devices, they are particularly vulnerable to this threat.

(3) **Terrain.** The terrain in the sniper's area of operations and the terrain he must travel to reach it must be evaluated. The commander must consider the time and effort snipers will expend getting into position. He must also consider the effect of weather on the sniper and on his visibility. The snipers will need good firing positions. They prefer positions at least 300 meters from their target area. Operating at this distance allows them to avoid effective fire from enemy rifles, yet they retain much of the 800-meter to 1,000-meter effective range of the sniper rifle. To be most effective, snipers need areas of operations with adequate observation and fields of fire.

(4) **Troops.** The commander must decide how many sniper teams to use for the operation. This depends on their availability; the duration of the operation; the expected opposition; and the number and difficulty of tasks, targets, or both assigned to snipers. The snipers' level of training and physical conditioning must also be considered. Commanders must remember the effect of these human factors on sniper operations.

(5) **Time.** Commanders must consider how long the snipers will have to achieve the expected result. Time must be allocated for snipers to plan, coordinate, prepare, rehearse, move, and then to establish positions. Commanders must know the increased risk snipers are forced to accept when they lack adequate time for planning or for other preparations such as moving to the area of operations. The amount of time a sniper team can remain in a position without losing effectiveness due to eye fatigue, muscle strain, or cramps depends mostly on the type of position.

Snipers can usually remain in an expedient position for 6 hours before they must be relieved. They can remain in belly positions or semipermanent hides for up to 48 hours before they must be relieved. Mission duration times average 24 hours. (TC 23-14 provides guidance on sniper position considerations, construction, preparation and occupation.) Movement factors for snipers moving with a security element are the same as for any infantry force. When snipers are moving alone in the area of operations, they move slowly, their movement can be measured in feet and inches. The sniper team is the best source for determining an accurate time estimate for a particular movement.

## E-2. OFFENSIVE EMPLOYMENT

Offensive operations carry the fight to the enemy to destroy his capability and will to fight. By killing enemy targets that threaten the success of the attack, the sniper can play a major role in offensive operations.

a. **Offensive Operations.** During offensive operations, snipers perform the following tasks:

- (1) Kill enemy snipers.
- (2) Overwatch movement of friendly forces and suppress enemy targets that threaten the moving forces.
- (3) Place precision fire on enemy crew-served weapons teams and into exposed bunker apertures.
- (4) Place precision fire on enemy leaders, drivers or armored-vehicle commanders, FOs, or other designated personnel.
- (5) Place precision fire on small, isolated, by-passed forces.
- (6) Place precision fire on targets threatening a counterattack or fleeing.
- (7) Help screen a flank using supplemental fires.
- (8) Dominate key terrain by controlling access with fires.

b. **Movement to Contact.** During a movement to contact, snipers move with the lead element. They can be employed 24 to 48 hours before the unit's movement to do the following:

- (1) To select positions.
- (2) To gather information about the enemy.
- (3) To dominate key terrain, preventing enemy surprise attacks.

c. **Mounted Attack.** During a mounted attack, the sniper's role is limited by fast movement. However, when the unit dismounts, snipers can be employed to support the assault.

d. **Raid.** During a raid, sniper teams can be employed with either the security element or the support element—

- (1) To cover avenues of approach and escape that lead in and out of the objective.
- (2) To cover friendly routes of withdrawal to the rally point.
- (3) To provide long-range fires on the objective.

e. **Consolidation.** After consolidation, snipers may displace forward to new positions. These positions need not be on the objective. However, the snipers must be able to place precision fire on bypassed enemy positions, enemy counterattack forces, or other enemy positions that could degrade the unit's ability to exploit the success of the attack.

## E-3. ACTIONS AGAINST FORTIFIED AREAS

Assaulting forces usually encounter fortified positions prepared by the defending force. These can range from field-expedient, hasty positions, produced with locally available materials, to elaborate steel and concrete emplacements complete with turrets, underground tunnels, and crew quarters. Field-expedient positions are those most often encountered. However, elaborate positions should be expected when the enemy has significant time to prepare his defense. He may have fortified weapons emplacements or bunkers, protected shelters, reinforced natural or constructed caves, entrenchments, and other obstacles.

a. The enemy will try to locate these positions so they are mutually supporting and arrayed in depth across the width of his sector. He will also try to increase his advantages by covering and concealing positions and by preparing fire plans and counterattack contingencies. Because of this, fortified areas should be bypassed and contained by a smaller force.

b. The sniper's precision-fire and observation capabilities are invaluable in the assault of a fortified area. Pinpoint targets

invisible to the naked eye are readily detected and destroyed by precision rifle fire. The snipers' role during the assault of a fortified position is to deliver precision fire against the embrasures, air vents, and doorways of key enemy positions; against observation posts; and against exposed personnel. The commander must plan the order in which sniper targets should be destroyed. This destruction should systematically reduce the enemy's defenses by destroying the ability of enemy positions to support each other. Once these positions are isolated, they can be more easily reduced. Therefore, the commander must decide where he will try to penetrate the enemy's fortified positions; then, he must employ his snipers against those locations. Snipers can provide continuous fire support for both assaulting units and other nearby units when operating from positions near the breach point on the flanks. Their fires add to the effectiveness of the entire unit; snipers can be used when other precision weapons, such as the TOWs, cannot be used for various reasons.

c. The sniper team plans based on information available. The enemy information needed includes the following:

(1) Extent of and exact locations of individual and underground fortifications.

(2) Fields of fire, directions of fire, locations and number of embrasures, and types of weapons systems in the fortifications.

(3) Locations of entrances, exits, and air vents in each emplacement.

(4) Locations and types of existing and reinforcing obstacles.

(5) Locations of weak spots in the enemy's defense.

#### **E-4. DEFENSIVE EMPLOYMENT**

Snipers may effectively enhance or augment any unit's defensive fire plan. After analyzing the terrain, the sniper team should recommend options to the commander.

a. **Primary Positions.** Snipers are generally positioned to observe or control one or more avenues of approach into the defensive position. Due to the types of weapons systems available, snipers may be used against secondary avenues of approach. They can be used to increase all-round security and to allow the commander to concentrate his combat power against the

most likely enemy avenue of approach. Snipers may support the battalion by providing precise long-range fires to complement those of the M249 machine gun and extra optics for target-acquisition. This arrangement best utilizes the unit's weapon systems. Snipers may be used in an economy-of-force role to cover a dismounted enemy avenue of approach into positions the battalion cannot cover.

b. **Alternate and Supplementary Positions.** Snipers establish alternate and supplementary positions for all-round security. Positions near the FEBA are vulnerable to concentrated attacks, enemy artillery, and obscurants. If multiple teams are used, they can be positioned for surveillance and mutual fire support. If possible, these teams should establish positions in depth for continuous support during the fight. The sniper's rate of fire neither increases nor decreases as the enemy approaches. Specific targets are systematically and deliberately shot; accuracy is more important than speed.

c. **Overwatch.** Snipers can be placed to overwatch key obstacles or terrain such as river-crossing sites, bridges, minefield that canalize the enemy directly into engagement areas, and so on. Snipers are mainly used where weapons systems are less effective due to security requirements or terrain. Even though the commander has access to weapons systems with greater ranges and optical capabilities than those of the snipers' weapons, he may be unable to use these for any of several reasons. They might present too large a firing signature, be difficult to conceal well, create too much noise, or be needed more in other areas. The sniper's weapons lack these problems. Therefore, the sniper team provides the commander with greater observation and killing ranges than do other soldiers.

d. **Counterreconnaissance.** Snipers can be used as an integral part of the counterreconnaissance effort. They can help acquire or destroy targets, or both. They can augment the counterreconnaissance element by occupying concealed positions for long periods. They can also observe, direct indirect fires (to maintain their security), and engage targets. Selective long-range sniper fires are difficult for the enemy to detect. A few well-placed shots can disrupt enemy reconnaissance efforts, force him to

deploy into combat formations, and deceive him as to the location of the main battle area. The sniper's stealth skills counter the skills of enemy reconnaissance elements. Snipers can be used where scout or rifle platoon mobility is unnecessary, freeing the scouts and riflemen to cover other sectors. Snipers can also be used to direct ground maneuver elements toward detected targets. This also helps maintain their security so they can be used against successive echelons of attacking enemy.

e. **Strongpoint.** Snipers should be tasked to support any unit defending a strongpoint. The sniper team's characteristics enable it to independently harass and observe the enemy in support of the force in the strongpoint, either from inside or outside the strongpoint.

f. **Reverse-Slope Defense.** Snipers can provide effective long-range fires from positions forward of the topographical crest or on the counterslope if the unit is occupying a reverse-slope defense.

g. **Tasks.** The sniper team can perform the following tasks during defensive operations:

- (1) Cover enemy obstacles, mine fields, and demolitions.
- (2) Perform counterreconnaissance (kill enemy reconnaissance elements).
- (3) Engage enemy OPs, armored-vehicle commanders exposed in turrets, and ATGM teams.
- (4) Damage enemy vehicle optics to degrade movement.
- (5) Suppress enemy crew-served weapons.
- (6) Disrupt enemy follow-on units with long-range small-arms fire.

#### E-5. RETROGRADE EMPLOYMENT

The sniper team must know the concept, intent, and scheme of maneuver. Key information the sniper team must have includes the withdrawal times, conditions, or both; priorities for withdrawals; routes; support positions; rally points; and locations of obstacles. Both engagement and disengagement criteria must be planned and coordinated to ensure snipers achieve the desired effect without compromising their positions. (Chapter 5 discusses retrograde operations.)

a. **Role.** Snipers can help the delaying force cause the enemy to deploy prematurely during

retrograde operations. To do so, the snipers inflict casualties with accurate, long-range, small-arms fire. When the enemy receives effective small-arms fire from unknown positions, he is likely to assume he is near an enemy position (most likely one with ATGMs) and he will begin to maneuver to a position of advantage against the perceived threat. Thus, using a sniper team, the commander can achieve the same effect that he could with another infantry unit. The snipers' stealth also gives them a better chance of infiltrating out of positions close to the enemy.

b. **Transportation.** Delaying forces risk being bypassed or overtaken by attacking enemy forces during retrograde operations. Commanders may provide transportation to move snipers to successive positions. Vehicles must remain in defilade positions to the rear of the sniper position; or, they must occupy different positions away from the sniper's area of operations so as not to compromise the snipers. In either case, a linkup point, egress routes, and conditions for executing the linkup must be fully coordinated. Commanders may also provide communications assets to the sniper team to simplify control and movement.

c. **Positioning Considerations.** Snipers, as well as other units, may find themselves behind the enemy's front; therefore, they must be prepared to infiltrate back to friendly positions. Their infiltration plans must be fully coordinated to prevent fratricide when they try to reenter a friendly position. When planning successive positions, the commander must realize that the sniper team may be unavailable to him if its members are destroyed or are having trouble disengaging from an enemy force. In view of this, the commander must consider carefully how and where he wants snipers to contribute to the operation. Planning too many positions for the sniper team in a fast-paced retrograde is sure to result in failure.

d. **Tasks.** The sniper team may perform any of the following tasks in a retrograde operation:

- (1) Delay the enemy by inflicting casualties.
- (2) Observe avenues of approach.
- (3) Cover key obstacles with precision fire.
- (4) Direct artillery fire against large enemy formations.

## E-6. MOUT EMPLOYMENT

The value of the sniper to a unit operating in an urban area depends on several factors. These factors include the type of operation, the level of conflict, and the rules of engagement. Where ROE allow severe destruction, other weapons systems available to a mechanized force have greater destructive effect than the snipers. However, the snipers can still contribute to the fight. Where the ROE prohibit collateral damage, snipers may be the commander's most valuable tool.

a. **Terrain.** Sniper effectiveness depends in part on the terrain. Control is degraded by the characteristics of an urban area. To provide timely and effective support, the sniper must have a clear picture of the scheme of maneuver and commander's intent.

(1) **Observation and fields of fire.** These are clearly defined by roadways, but surveillance is limited by rooftops, windows, and doorways; each of these require constant observation. Also, the effects of smoke from military obscurants and burning buildings can degrade what appeared to be an excellent vantage point. The requirement for all-round defense must be met because the enemy can fire from many directions and because his infiltration attempts must be countered.

(2) **Cover and concealment.** These are excellent for both attackers and defenders. However, the defender has a decisive advantage; the attacker normally must expose himself during movement through the area.

(3) **Avenues of approach.** Those that remain inside buildings are best. Movement there is less easily detected than movement through the streets. The sniper must know of ALL avenues of approach and must be prepared to engage targets that appear on any of them.

b. **Positions.** Snipers should be positioned in buildings of masonry construction, ideally. These buildings should offer long-range fields of fire and all-round observation. The sniper has a distinct advantage because he need not move with or be positioned with lead elements. The sniper may occupy a higher position to the rear or flanks and some distance away from the supported element. By operating far from the other elements, the sniper avoids decisive engagement but remains close enough to kill

distant targets that threaten the unit. Snipers should *not* be placed in obvious positions, such as church steeples and rooftops, since the enemy often observes these and targets them for destruction. Indirect fires can generally penetrate rooftops and cause casualties in top floors of buildings. Also, snipers should be positioned in locations free of heavy traffic; these areas invite enemy observation as well.

c. **Multiple Positions.** Snipers should operate throughout the area of operations, moving with and supporting the companies as necessary. Some teams may operate independently from other forces. These teams search for targets of opportunity, especially for enemy snipers. The team may occupy multiple positions. A single position may afford adequate observation for the entire team, but at the cost of increasing the risk of detection by the enemy. Separate positions must maintain mutual support. Alternate and supplementary positions should also be established in urban areas.

d. **Tasks.** The sniper team may perform any of the following tasks in a MOUT operation:

- (1) Kill enemy snipers (countersniper fire).
- (2) Kill targets of opportunity. These targets may be prioritized by the commander. For example, enemy snipers first, then leaders, vehicle commanders, radio men, sappers, and machine gun crews, in that order.
- (3) Deny enemy access to certain areas or avenues of approach (controlling key terrain).
- (4) Provide fire support for barricades and other obstacles.
- (5) Maintain surveillance of flank and rear avenues of approach (screening).
- (6) Support local counterattacks with precision fire.
- (7) Prevent enemy observation by killing or suppressing reconnaissance elements and enemy systems with optics.

## E-7. LOW-INTENSITY CONFLICT

Snipers can be valuable to commanders in low-intensity conflicts. Collateral damage and civilian casualties are normally restricted by the ROE. Key people who pose a threat to friendly forces often hide among civilians. A friendly force overmatching sniper can selectively kill or wound these targets more easily than can the

infantry on the ground. He can look down on the crowd, use his optics to scan continuously, and employ precision fire to eliminate (killer wound) the identified threat. The unit's other weapon systems (Dragons and TOWs) are used from the ground or from the upper floors of buildings to supplement the sniper's surveillance effort. However, after identifying the target, soldiers using Dragons and TOWs would still need time to guide a precision weapon or maneuver unit to the target to deal with it. The sniper rifle is the only system that can both identify and engage a target with precision.

### E-8. RIVER CROSSINGS

The observation and precision-fire capabilities of sniper teams enable them to cover the initial stages of a river crossing. Snipers are normally employed in general support of the battalion both before and during the crossing.

a. **Planning.** Snipers should be positioned as early as possible, preferably as part of the reconnaissance force. Their movement across the river must also be planned in advance. Their means of crossing and the locations of their subsequent positions must be coordinated. They displace once friendly elements reach the far side.

b. **Support Before Crossing.** Snipers assume positions across the total width of the crossing area (if possible) before the crossing. Their main task is to observe. They should be located as far above or below possible crossing sites as is consistent with observation and fields of fire. Snipers report all sightings of enemy positions and activity immediately. They provide the only stealthy observation capability available to the commander. This stealth prevents the enemy from learning what type of unit is trying to cross, and so on. Snipers supplement normal reconnaissance assets.

c. **Support During Crossing.** Snipers provide support during the crossing. They continue to observe and suppress enemy OPs and other key targets that might be overlooked by heavier supporting elements. Snipers continue close-in suppressive fire up to the moment elements reach the far side and begin moving to establish the bridgehead line.

d. **Support After Crossing.** Snipers are placed with elements controlling an air assault or boat crossing. The snipers expand the capability

of the inserted force to engage threatening targets at long ranges. Their priority of engagement is the same as that for the remainder of the inserted force. Once on the far side, snipers may be used to screen the flank or rear of the inserted force; to infiltrate and destroy key targets, such as a demolition guard or fortified emplacements; or to man OPs well to the front of the inserted force. This increases both early warning time and the ability of the inserted force to disrupt enemy counterattack forces. This also confuses the enemy as to the type, strength, and location of the opposing force.

### E-9. PATROLLING

The effective employment of sniper teams with any size or type patrol is limited only by the terrain and by the patrol leader's ingenuity. Snipers must know all aspects of patrolling.

a. **Reconnaissance Patrol.** Snipers normally remain with the security element during reconnaissance patrols. They provide long-range protection for the reconnaissance element. If the terrain permits, the long-range accuracy of the sniper's rifle permits the reconnaissance element to patrol farther away from the security element yet remain within effective support range. To prevent compromise of the reconnaissance element's position, snipers only fire in self-defense or when ordered by the patrol leader. Normally, the only appropriate time to fire at a target of opportunity is when extraction or departure from the position is imminent and firing will not endanger the success of the patrol.

b. **Combat Patrols.** Two of the combat patrols in which snipers may be used include raids and ambushes

(1) **Raids.** Sniper employment on a raid is influenced by the time of day the raid is to be conducted and the size of the patrol. When maximum firepower is needed and the size of the patrol must be limited, snipers may be excluded. If long-range precision fire is needed and patrol size permits, sniper teams may be attached to the security element. If appropriate, the sniper team may be attached to the support element to help provide long-range supporting fires. When attached to the security element, the sniper team helps observe, helps prevent enemy escape from the objective area, and helps cover the



withdrawal of the assault force to the rally point. When the element withdraws from the rally point, the sniper team may be left behind to delay and harass enemy counteraction or pursuit.

(2) **Ambush.** Snipers are positioned during ambushes in areas that afford observation and fields of fire into terrain features the enemy might use for cover after the ambush has begun. The long range of the sniper rifle allows the sniper team to be positioned away from the main

body. Sniper fires are coordinated into the fire plan. Once the signal to initiate fires is given, snipers add their fires to that of the rest of the patrols. Snipers shoot leaders, radio operators, and crew-served weapons teams. If the enemy is mounted, every effort is made to kill drivers of his lead and trail vehicles to block the road, prevent escape, and create confusion. Snipers may remain in position to cover the withdrawal of the patrol.

## APPENDIX F

# CASUALTY EVACUATION

*This chapter discusses battalion casualty evacuation operations. Casualty evacuation requires extensive plans, preparation, battlefield initiative, and coordination. The effectiveness of casualty evacuation influences the unit's morale and combat electiveness.*

### F-1. PLANNING

Large numbers of unexpected casualties and casualties in unexpected locations can hinder or defeat an attack. Commanders and medical platoon leaders must plan beyond their immediate tactical objectives. Medical support must be positioned so the commander can exploit the opportunities created by tactical success. The BAS must mutually support companies; however, as with any battlefield system, its positioning should weight the main effort. Evacuation assets should be task organized and allocated by projected casualties.

### F-2. PREPARATION

The S1 is the coordinating staff officer most concerned with casualty evacuation. As such, he is an integral war gamer during the IPB process. This allows him to analyze the tactical plan and terrain and to identify areas of anticipated casualty density. The BAS should be located as far forward as METT-T allows. The BAS must have enough medical supplies to treat the highest number of expected casualties. Casualty collection points should be predesignated and routinely planned. Ambulance exchange points (AXP) should be used. Extra casualty evacuation and treatment support should be planned for and requested from the forward support medical company. The medical support matrix should be integrated with the tactical overlay. Table F-1 shows an example format for a medical support matrix. If deviation from the matrix occurs, the BAS location must be known at all times. The BAS should remain on location as long as practical. Extra medical supplies can

be issued to maneuver elements to help them treat casualties.

a. **Offense.** BAS mobility must be maintained. During offensive operations, BAS can travel with the combat trains or with the last maneuver company in the order of movement. This way the BAS can obtain aid in the event of a breakdown or navigational help.

b. **Defense.** The depth and dispersion of the defense creates important time and distance considerations. In a nonlinear defense, enemy and friendly units intermingle, especially in poor visibility. MSR and routes between positions might be interdicted. Tactical and logistical vehicles should be used as needed for patient evacuation, as this does not adversely affect their mission. For example, empty ammunition trucks can backhaul casualties. Also, damaged vehicles can be towed to the BSA and used to carry casualties. A platoon can be tasked to "follow and provide casualty evacuation support" to the main effort.

### F-3. EXECUTION

Casualty evacuation is a team effort. It is the responsibility of all soldiers-not just the medics. This includes combat lifesavers, infantry squad leaders, staff officers, the medical platoon leader, and the battalion commander. The primary duty of a combat lifesaver is the mission. Treatment of casualties is secondary. Appropriate ground and air evacuation techniques should be used based on METT-T and on patient categories of precedence (URGENT, PRIORITY, and ROUTINE).

| UNITS  | CROSS LD                       | CROSS PL RED                  | CROSS PL BLUE                  | ON OBJ DALLAS                 |
|--|--------------------------------|-------------------------------|--------------------------------|-------------------------------|
| CO A<br>AND<br>CO B (-)                        | TT 1<br>(NB 583492)<br>(TOM)   | TT 1<br>(NB 585501)<br>(JIM)  | TT 1<br>(NB 587507)<br>(BILL)  | TT 1<br>(NB 591510)<br>(GREG) |
| CO C<br>AND<br>RESERVE                         | TT 2<br>(NB 581489)<br>(VICKY) | TT 2<br>(NB 583499)<br>(BETH) | TT 2<br>(NB 585505)<br>(JANET) | TT 2<br>(NB 589508)<br>(JOY)  |
| RM 1: USE ROUTE STEVEN<br>RM 2: USE ROUTE ANNA |                                |                               |                                |                               |

**Table F-1. Example medical support matrix.**

**F-4. FOLLOW-AND-SUPPORT CONCEPT**

Use of a “jump” aid station by the medical platoon can be effective. In anticipating surge requirements, the medical platoon leader should forward deploy, or jump, part of the BAS. The distance is determined mostly by the operation (offensive or defensive) and by the enemy threat. The senior enlisted medic should accompany the forward aid station to provide medical advice and expertise. This “follow and support” concept simplifies triage forward, which in turn improves the rate at which casualties are treated in the main aid station. To prevent ambulances and aid stations from being positioned accidentally at risk from enemy action, “jump” aid stations must be properly controlled. Planned checkpoints that are possible aid station locations must be designated along the MSR. They should be included in the operation overlay in the OPORD. The jump aid station follows the lead maneuver units; as one of these maneuver units comes into contact, the jump aid station should move to the nearest checkpoint and prepare to treat casualties. As the jump aid station moves into position, the administrative/logistical net should be used to inform units of its location. Medical leaders must be proactive and push forward. Ambulance drivers must have mounted land navigation skills to allow them to move over unfamiliar terrain at night. This makes finding CCPs, aid stations, and AXPAs easier. Some wounded soldiers require limited treatment only

and can be returned to duty at once. While they wait to rejoin their units, these soldiers can carry litters, freeing medics for patient care. They can also help guard the perimeter, act as ground guides, handle patient administration, or work mess duty.

**F-5. COMMUNICATIONS**

Redundant communications are important to timely casualty evacuation. In the BAS, they monitor the battalion command net. If message traffic indicates units in contact and casualties, the jump aid station moves forward IAW a predetermined plan and begins treating patients. This works faster than if the jump aid station waits for a message. It also provides a backup in case the administrative/logistical net is jammed.

**F-6. MAINTENANCE AND CASUALTY EVACUATION**

Collocating maintenance and medical assets is useful for evacuating casualties. Maintenance soldiers should be cross trained as combat lifesavers and should know how to extract casualties from combat vehicles. They should carry any appropriate medical supplies such as litters and IV units. Vehicles evacuated to the rear for repair can also carry casualties.

**F-7. COLOR-CODED TRIAGE SYSTEM**

This system involves the use of color-coded signs during daylight hours and color-coded chemical

lights at night. The signs are placed in front of the appropriate treatment areas. Any color combination can be used. For example, red can be used for expectant, blue for immediate, and green for minimal. When casualties arrive, a DA Form 1380 is marked for each with the appropriate color. The litter team then takes the casualty to the treatment area for that color code. Litter bearers are seldom medics; this method helps get the patients treated faster. The color codes used should not conflict with other tactical signals. (AR 140-185, Chapter 3, provides instructions on how to complete DA Form 1380.)

### F-8. SPECIALTY PLATOONS

Members of specialty platoons are not authorized medics. Scouts often operate forward of the FEBA; mortars operate up to 1,500 meters behind the FEBA. These distances from the companies (which have medics) can inhibit timely casualty evacuation. This situation may also apply to other dispersed elements such as ADA and GSR teams. To offset this problem, thorough coordination with maneuver units near the dispersed unit is required. Maneuver units can help the scouts by evacuating casualties from forward of the FEBA to preplanned CCPs in the company zone or sector. Battalions must maximize combat lifesaver training for mortar and scout platoons.

### F-9. LOCATION OF CASUALTIES

Locating casualties during and after a battle can be a time-consuming and difficult task, especially at night or in dense woods. Whatever the signal used, it must conform with the unit TACSOP and not conflict with other signals. Several techniques to facilitate patient locating follow:

a. Vehicles carrying critically wounded personnel can be identified by a red flag during daylight and a red chemiluminescent light at night. This tells medics which vehicle they should go to first.

b. Fallen casualties can be marked with visible or infrared chemiluminescent lights or glint tape. These can be located at night by medics using the infrared source on night vision goggles.

### F-10. EVACUATION TECHNIQUES

The rapidly employable lightweight litter, referred to as the SKEDS litter, is designed to be

used as a rescue system in most types of terrain, including mountains, jungle, waterborne, and on snow or ice (Figure F-1).

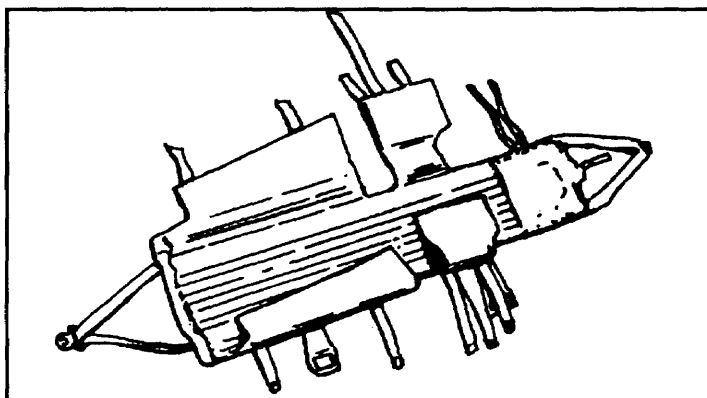

Figure F-1. SKEDS litter.

a. The SKEDS litter is made of durable plastic. It can be rolled and carried in a camouflage case. The basic litter weighs 16 pounds complete with carrying case, straps, snap link, and a 30-foot kernmantle rope. Other optional items, such as the spine immobilize and flotation system, increase the weight to 32 pounds.

b. The SKEDS litter enables a single soldier to pull a casualty over most types of terrain; a field-expedient poncho litter requires two soldiers or more. Up to four soldiers can use hand loops to carry a SKEDS litter containing a seriously injured casualty across difficult terrain.

c. The SKEDS can be used to move equipment, ammunition, or other heavy loads to and from DZs, LZs, and objective areas in addition to its medical use.

d. The litter is listed in the GSA Federal Supply Schedule, March 1989, FSC Group 42, Part I, Section B, Special Item Number 465-10, Emergency Stretchers, Brand SKEDCO Incorporated, page 8.

### F-11. SAFETY

Leaders must retain common sense and attention to safety considerations despite their concern for casualties. Ambulance drivers or soldiers working around MEDEVAC helicopters must keep the risks in balance.

\*Appendix G  
**URBAN OPERATIONS**

*The battalion plan of action was as follows: one platoon of Company "F," with a light machine gun section, would stage the initial diversionary attack. It would be supported by two tanks and two tank destroyers, who were instructed to shoot at all or any suspected targets. Observation posts had been manned on a slag pile to support the advance with 81-mm mortar fire...The platoon action was to be the first step...to reduce the town of Aachen.*

*...the remainder of our zone of action...would be cleared by Companies "F" and "G," who would execute a flanking attack, jumping off abreast of each other through the area secured by the Company "F" platoon...Preparatory fire by medium artillery was to be planned...Mortar observers would accompany each company...Tanks and tank destroyers were assigned to each company...*

LTC Darrel M. Daniel  
Commander, 2nd Bn, 26th Inf Regt  
October, 1944, Battle of Aachen

### **Section I. INTRODUCTION**

Urban operations (UO) are operations planned and conducted in an area of operations (AO) that includes one or more urban areas. An urban area is a topographical complex where man-made construction or high population density are the dominant features. The increasing world population and accelerated growth of cities means that UO in future conflicts will be very likely. The Infantry brigade will be the primary headquarters around which units will be task organized to perform UO. Operations in urban areas usually occur when—

- The battalion's assigned objective lays within an urban area.
- The urban area is key (or decisive) in setting and or shaping the conditions for current or future operations.
- The urban area is in the path of a general advance and cannot be surrounded or bypassed.
- Political or humanitarian concerns require the control of an urban area or necessitate operations within it.
- Defending from urban areas supports a more effective overall defense or cannot be avoided.
- Occupation, seizure, and control of the urban area will deny the threat control of the urban area and the ability to impose its influence on both friendly military forces and the local civilian population, therefore, allowing friendly forces to retain the initiative and dictate the conditions for future operations.

UO are often conducted against enemy forces that may be mixed in with the civilian population. Therefore, the ROE and the use of combat power can often be more restrictive.

**G-1. FULL SPECTRUM OPERATIONS/VO CONCEPT**

Battalions will conduct offensive, defensive, stability, and support (ODSS) operations within the operational concept shown in Figure G-1. (See FM 3-06 [90-10].) These operations comprise the spectrum of UO that a battalion must be prepared to conduct. Army commanders assigned to conduct UO will:

- Continually *assess* the urban environment to determine effects on operations.
- Conduct *shaping* operations that emphasize isolation and set the conditions for decisive operations.
- *Dominate* through simultaneous and or sequential operations that establish and maintain preminent military control over the enemy, geographical area, or population.
- Plan for and execute *transitions* between mission types and forces, and ultimately to the control of a non-Army agency.

Figure G-1 depicts the potential simultaneity of UO. Battalions must be prepared to transition from one type of ODSS operation to another. Infantry battalions will normally conduct UO as part of a brigade, however there may be situations, such as stability and support missions, where an Infantry battalion may conduct independent UO. How battalions prepare for and execute ODSS UO will be determined by the factors of METT-TC (mission, enemy, terrain, time and troops available, and civil considerations). The ROE has significant importance within the mission and civil portions of METT-TC considerations.

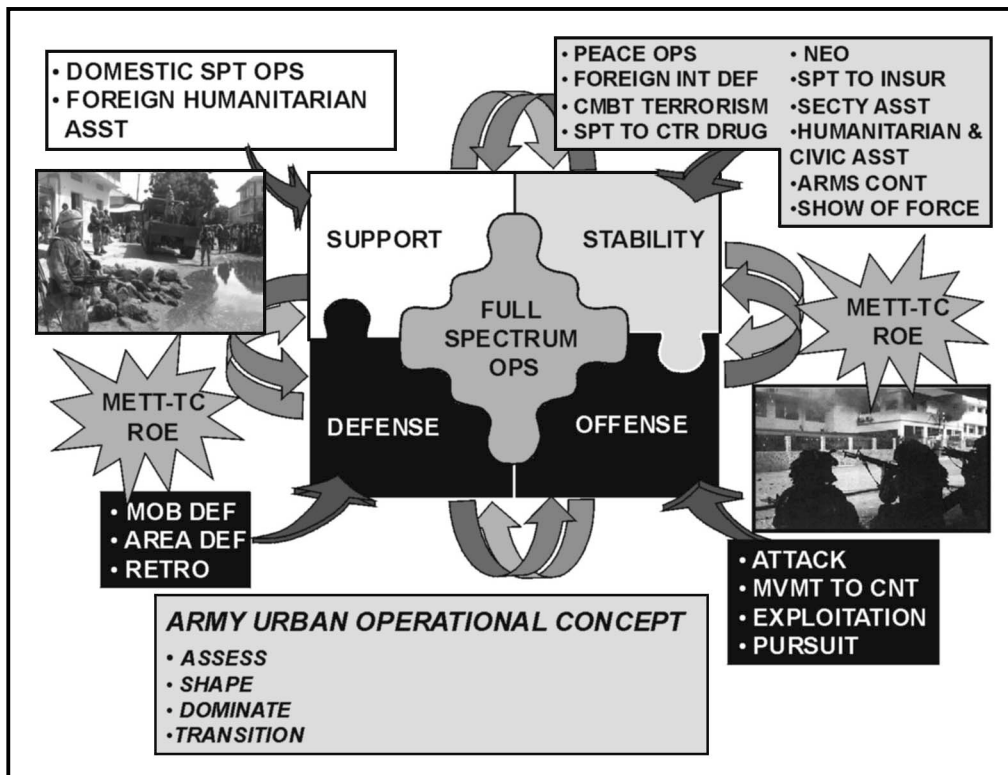

**Figure G-1. Full spectrum operations/operational concept.**

## G-2. TACTICAL CHALLENGES

The Infantry battalion will face a number of challenges during the planning and execution of UO. The most likely challenges are discussed below.

a. **Contiguous/Noncontiguous Areas of Operations.** The battalion must be prepared to conduct ODSS operations in both contiguous and noncontiguous areas of operations.

(1) Contiguous operations are military operations that the battalion conducts in an area of operations that facilitates mutual support of combat, CS, and CSS elements. Contiguous operations have traditional linear features including identifiable, contiguous frontages and shared boundaries between forces. For Infantry battalions, contiguous operations are characterized by relatively close distances between adjacent battalions, supporting brigade assets, and subordinate units and elements.

(2) In noncontiguous operations, the battalion may be required to operate independently, removed from brigade CS and CSS assets by distance and time. Additionally, subordinate companies may operate in isolated pockets, connected only through integrating effects of an effective concept of operations. Noncontiguous operations place a premium on initiative, effective information operations, decentralized security operations, and innovative logistics measures. Noncontiguous operations complicate or hinder mutual support of combat, CS, and CSS elements because of extended distances between subordinate units and elements.

b. **Symmetrical/Asymmetrical Threats.** In addition to being required to face symmetrical threats, the battalion must be prepared to face threats of an asymmetrical nature.

(1) Symmetrical threats are generally “linear” in nature and include those threats that specifically confront the battalion’s combat power and capabilities. Examples of symmetrical threats include conventional enemy forces conducting offensive or defensive operations against friendly forces.

(2) Asymmetrical threats are those that are specifically designed to avoid confrontation with the battalion’s combat power and capabilities. Asymmetrical threats are most likely to be based in and target urban areas to take advantage of the density of civilian population and infrastructure. Examples of asymmetrical threats include terrorist attacks; EW, to include computer-based systems; criminal activity; guerilla warfare; and environmental attacks. Asymmetrical threats may also attack the battalion and civilian population with weapons of mass destruction (WMD).

c. **Minimization of Collateral Damage and Noncombatant Casualties.** During urban operations, battalion commanders may be directed to minimize unnecessary collateral damage and noncombatant casualties. This must be balanced with mission accomplishment and the requirement to provide force protection. In all cases, commanders must comply with the law of war principles of military necessity and prevention of unnecessary injury or damage. Battalion commanders must be aware of the ROE and be prepared to request modifications when the tactical situation requires them. Changes in ROE must be rapidly disseminated throughout the battalion. Commanders and leaders must ensure that changes to the ROE are clearly understood by all soldiers.

d. **Quick Transition from Stability or Support Operations to Combat Operations and Back.** Battalion commanders must ensure that contingencies are

planned to transition quickly from stability and support to offensive or defensive operations and vice-versa. For example, it may be tactically wise for commanders to plan a defensive contingency with on-order offensive missions for certain stability and support operations that may deteriorate. Subordinate commanders and leaders must be fully trained to recognize activities that would initiate this transition.

### **G-3. URBAN BATTLESPACE**

The battalion commander and staff can enhance situational understanding by maintaining a clear understanding of their urban battlespace. Urban battlespace includes urban airspace, supersurface (buildings), surface (street level), and subsurface (sewers, tunnels, subways) areas. Commanders and staff must be able to identify building types, construction materials, and building design and must understand the effectiveness and limitations of weapons against these factors. (See FM 90-10-1.) Commanders must also understand that combat under urban conditions will require them to visualize a three-dimensional battlespace. They must be aware of how their urban battlespace changes as friendly and enemy forces and civilians move, and as weather and environmental conditions change. Commanders must be prepared to react to these changes as necessary; for example, by moving assault and support elements in the offense, repositioning units in the defense, and synchronizing CS and CSS assets. Other factors that will impact battlespace are:

- CASEVAC and resupply procedures.
- Handling EPWs and noncombatants.
- Rules of engagement. (See paragraph G-4.)
- Weather conditions.
- Battlefield obscuration.
- Communications.
- Movement of vehicles. (How will the battlespace affect movement and target engagement?)

### **G-4. RULES OF ENGAGEMENT**

Battalions must always follow ROE of some kind. ROE have a significant impact on how missions are executed during UO. The ROE must provide clear guidance to soldiers about when and how to employ force to accomplish the mission and to defend themselves.

a. Under certain conditions of UO, the ROE will be much more restrictive than under other conditions. For example, a particular mission might require ROE that limit the use of indirect fire weapons. On the other hand, a mission to clear buildings may require ROE that authorize force to clear rooms, and include authoritative guidance concerning measures to protect noncombatants, to breach obstacles, and to react to snipers.

b. One of the most significant issues raised is that of collateral damage. Collateral damage is the unintended and undesirable civilian personnel injuries or material damage adjacent to a target produced by the effects of friendly weapons. ROE will provide guidance concerning how to minimize collateral damage. For example, ROE may require use of nonlethal capabilities and munitions to the maximum extent possible prior to use



of lethal weapons and munitions, or restrict use of indirect fire weapons. The ROE will establish when certain types of weapons and munitions can be used (Table G-1).

**Note:** Nonlethal capability battalion kits will be in contingency stocks by September 2000 and will be issued to units on an as needed basis. Kits contain nonlethal weapons, devices, and munitions that are designed to incapacitate personnel or materiel.

c. A mission can transition quickly from a stability or support operation to offense or defense. This transition may be caused by threat actions or actions of noncombatants. Commanders must be prepared to react to this situation and request changes in the ROE when necessary.

d. ROE differentiate between the use of force for self-defense and for mission accomplishment. Commanders always retain the inherent authority and obligation to use necessary and proportional force for unit and individual self-defense in response to a hostile act or demonstrated hostile intent. The ROE used during Operation JUST CAUSE in Panama are shown in Table G-1.

| <b>ALL ENEMY MILITARY PERSONNEL AND VEHICLES TRANSPORTING THE ENEMY OR THEIR SUPPLIES MAY BE ENGAGED SUBJECT TO THE FOLLOWING RESTRICTIONS:</b>   |
|---|
| <ul style="list-style-type: none"> <li>a. Armed force is the last resort.</li> <li>b. When possible, the enemy will be warned first and allowed to surrender.</li> <li>c. Armed civilians will be engaged only in self-defense.</li> <li>d. Civilian aircraft will not be engaged without approval from above division level unless it is in self-defense.</li> <li>e. Avoid harming civilians unless necessary to save US lives. If possible, try to arrange for the evacuation of civilians prior to any US attack.</li> <li>f. If civilians are in the area, do not use artillery, mortars, armed helicopters, AC-130s, tube- or rocket-launched weapons, or M551 main guns against known or suspected targets without the permission of a ground maneuver commander, LTC or higher (for any of these weapons).</li> <li>g. If civilians are in the area, all air attacks must be controlled by a FAC or FO.</li> <li>h. If civilians are in the area, close air support (CAS), white phosphorus, and incendiary weapons are prohibited without approval from above division level.</li> <li>i. If civilians are in the area, do not shoot except at known enemy locations.</li> <li>j. If civilians are not in the area, you can shoot at suspected enemy locations.</li> <li>k. Public works such as power stations, water treatment plants, dams, or other utilities may not be engaged without approval from above division level.</li> <li>l. Hospitals, churches, shrines, schools, museums, and any other historical or cultural site will not be engaged except in self-defense.</li> <li>m. All indirect fire and air attacks must be observed.</li> <li>n. Pilots must be briefed for each mission on the location of civilians and friendly forces.</li> <li>o. No booby traps. No mines except as approved by division commander. No riot control agents except with approval from above division level.</li> <li>p. Avoid harming civilian property unless necessary to save US lives.</li> <li>q. Treat all civilians and their property with respect and dignity. Before using privately owned property, check to see if any publicly owned property can substitute. No requisitioning of civilian property without permission of a company-level commander and without giving a receipt. If an ordering officer can contract for the property, then do not requisition it. No looting. Do not kick down doors unless necessary. Do not sleep in their houses. If you must sleep in privately owned buildings, have an ordering officer contract for it.</li> <li>r. Treat all prisoners humanely and with respect and dignity.</li> <li>s. Annex R to the OPLAN provides more detail. Conflicts between this card and the OPLAN should be resolved in favor of the OPLAN.</li> </ul> |
| <b>DISTRIBUTION:</b> 1 per every trooper deployed to include all ranks.   |

**Table G-1. ROE used during Operation JUST CAUSE.**

| <b>SUPPLEMENTAL RULES OF ENGAGEMENT FOR SELECTED RECURRING OPERATIONS:</b>  |
|---|
| <p>1. CONTROL OF CIVILIANS ENGAGED IN LOOTING.</p> <ul style="list-style-type: none"> <li>a. Senior person in charge may order warning shots.</li> <li>b. Use minimum force but not deadly force to detain looters.</li> <li>c. Defend Panamanian (and other) lives with minimum force including deadly force when necessary.</li> </ul>  |
| <p>2. ROADBLOCKS, CHECKPOINTS AND SECURE DEFENSIVE POSITIONS.</p> <ul style="list-style-type: none"> <li>a. Mark all perimeter barriers, wires, and limits. Erect warning signs.</li> <li>b. Establish second positions to hastily block those fleeing.</li> <li>c. Senior person in charge may order warning shots to deter breach.</li> <li>d. Control exfiltrating civilians with minimum force necessary.</li> <li>e. Use force necessary to disarm exfiltrating military and paramilitary.</li> <li>f. Attack to disable, not destroy, all vehicles attempting to breach or flee.</li> <li>g. Vehicle that returns or initiates fire is hostile. Fire to destroy hostile force.</li> <li>h. Vehicle that persists in breach attempt is presumed hostile. Fire to destroy hostile force.</li> <li>i. Vehicle that persists in flight after a blocking attempt IAW instruction 2b is presumed hostile. Fire to destroy hostile force.</li> </ul> |
| <p>3. CLEARING BUILDINGS NOT KNOWN TO CONTAIN HOSTILE FORCE.</p> <ul style="list-style-type: none"> <li>a. Warn all occupants to exit.</li> <li>b. Senior person in charge may order warning shots to induce occupants to exit.</li> <li>c. Do not attack hospitals, churches, shrines, or schools, museums, and any historical or cultural sites except in self-defense.</li> <li>d. Respect and minimize damage to private property.</li> <li>e. Use minimum force necessary to control the situation and to ensure the area is free of hostile force.</li> </ul>   |

**Table G-1. ROE used during Operation JUST CAUSE (continued).**

**Section II. MISSION, ENEMY, TERRAIN AND WEATHER,  
TROOPS AND TIME AVAILABLE, AND CIVIL CONSIDERATIONS (METT-TC)**

Planning, preparation, and conduct of UO are generally the same as any for other operation. However, the commander and staff must take into account special considerations when operating in this environment. The following paragraph provides special considerations for UO.

**G-5. MISSION**

In offensive operations, the battalion may have to assist with isolation of the objective, attacking an objective(s) within the urban area (securing footholds, seizing and or clearing buildings), and transitioning from combat to stability and support operations. In defensive operations, the battalion may be assigned the task to defend from a large urban area, or may integrate smaller urban areas into its defensive scheme.

a. **Objective.** The commander and staff must clearly understand the purpose of the operation. The battalion’s objective may be terrain or force oriented. The commander must consider if committing his force in urban areas is required or beneficial to achieving his purpose.

b. **Intent.** During planning for offensive operations, the commander and staff must consider the overall purpose and intent of the operation and define what is required. For example, the commander must determine if clearing means every building, block by block, or seizure of a key objective, which may only require clearing along the axis of advance. During planning for defensive operations, the commander and staff must determine if retention of urban areas within the battalion AO is necessary to support

mission accomplishment, or directed by higher headquarters. Often, the battalion can integrate urban areas into the defensive scheme to develop a stronger defense.

### **G-6. ENEMY**

The commander and staff must consider the strength, composition, disposition, and activities of the threat. They must consider both conventional and unconventional enemy forces and the tactics the enemy may employ. Enemy tactics may range from ambushes and snipers to large-scale conventional actions conducted by heavy forces. The IPB must address the known and potential tactics of all enemy forces and threats operating within and outside the urban area and their vulnerabilities. The IPB must consider the three-dimensional environment of urban areas - airspace, supersurface, surface, and subsurface. It should also consider the political, racial, ethnic, tribal, and religious factors that influence the enemy. (See FM 34-130 for a detailed discussion of urban IPB.)

a. The increasing availability of sophisticated technology has created unorthodox operational approaches that can be exploited by potential opponents. These approaches seek to counter the technological and numerical advantages of U.S. joint systems and forces, and to exploit constraints placed on U.S. forces due to cultural bias, media presence, ROE, and distance from the crisis location.

b. Offsetting their inherent weaknesses, enemy forces seek an advantage in urban terrain to remain dispersed and decentralized, adapting their tactics to provide them the best success in countering a U.S. response. Threats, in addition to conventional forces, may consist of:

- Unconventional forces.
- Paramilitary forces.
- Militia and special police organizations.
- Organized criminal organizations.

These forces range from units equipped with small arms, mortars, machine guns, antiarmor weapons, and mines to very capable mechanized and armor forces equipped with current generation equipment. Urban environments also provide many passive dangers such as disease from unsanitary conditions and psychological illnesses. While the active threats will vary widely, many techniques will be common to all. Figure G-2 provides a set of tactics available to potential threats opposing mission accomplishment in urban areas.

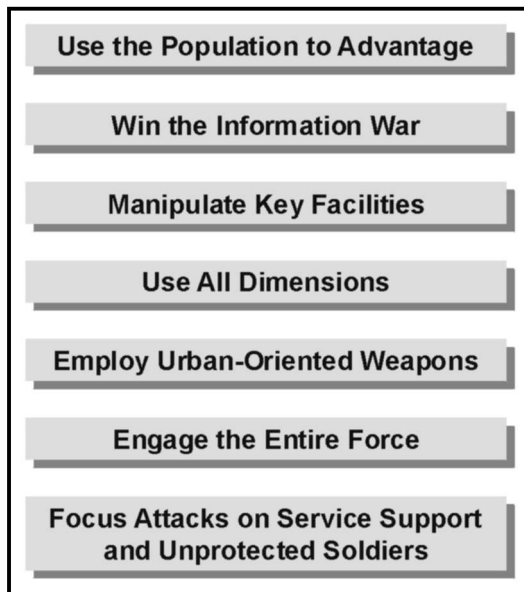

**Figure G-2. Urban threat tactics.**

(1) *Use the Population to an Advantage.* The populace of a given urban area represents key terrain; the side that manages it best has a distinct advantage. Future urban battles may see large segments of the populace remain in place, as they did in Budapest and Grozny. Battalions involved in urban stability and support operations will certainly conduct missions in and among the residents of the area.

(a) Threat forces may use the population to provide camouflage, concealment, and deception for their operations. Guerilla and terrorist elements may look no different than any other members of the community. Even conventional and paramilitary troops may have a “civilian” look. Western military forces adopted the clean-shaven, close-cut hair standard at the end of the nineteenth century to combat disease and infection, but twenty-first century opponents might very well sport beards as well as civilian-looking clothing and other “nonmilitary” characteristics.

(b) The civil population may also provide cover for threat forces, enhancing their mobility close to friendly positions. Threat forces may take advantage of U.S. moral responsibilities and attempt to make the civil population a burden on the Army’s logistical and force protection resources. They may herd refugees into friendly controlled sectors, steal from U.S.-paid local nationals, and hide among civilians during offensive operations.

(c) The civil population may also serve as an important intelligence source for the threat. Local hires serving among U.S. soldiers, civilians with access to base camp perimeters, and refugees moving through friendly controlled sectors may be manipulated by threat forces to provide information on friendly dispositions, readiness, and intent. In addition, threat special purpose forces and hostile intelligence service assets may move among well-placed civilian groups.

(2) *Win the Information War.* Threat forces may try to win the information war as much as they may directly oppose the battalion’s operations.

(a) Portable video cameras, Internet access, commercial radios, and cellular telephones are all tools that permit threat forces to tell their story. American “atrocities” may be staged and broadcast. Electronic mail may be transmitted to sympathetic groups to help undermine resolve. Internet websites provide easy worldwide dissemination of threat propaganda and misinformation. Hackers may gain access to U.S. sites to manipulate information to the threat’s advantage.

(b) The threat may make skillful use of the news media. Insurgent campaigns, for example, need not be tactical military successes; they need only make the opposition’s campaign appear unpalatable to gain domestic and world support. The media coverage of the TET Offensive of 1968 affected the will of both the American people and their political leadership. Although the battle for Hue was a tactical victory for the U.S., the North Vietnamese clearly achieved strategic success by searing the American consciousness with the high costs of urban warfare.

(3) ***Manipulate Key Facilities.*** Threat forces may identify and quickly seize control of critical components of the urban area to help them shape the battlespace to their own ends. Telephone exchanges provide simple and reliable communications that can be easily secured with off-the-shelf technologies. Sewage treatment plants and flood control machinery can be used to implement weapons of mass destruction (WMD) strategies or to make sections of the urban area uninhabitable. Media stations significantly improve the information operations position of the controlling force. Power generation and transmission sites provide means to control significant aspects of civilian society over a large area.

(4) ***Use the Three Dimensions of Urban Terrain.*** The threat will think and operate throughout all dimensions of the urban environment. Upper floors and roofs provide the urban threat forces excellent observation points and battle positions above the maximum elevation of many weapons. Shots from upper floors strike friendly armored vehicles in vulnerable points. Basements also provide firing points below many weapons’ minimum depressions and strike at weaker armor. Sewers and subways provide covered and concealed access throughout the area of operations. Conventional lateral boundaries will often not apply as threat forces control some stories of the same building while friendly forces control others.

(5) ***Employ Urban Oriented Weapons.*** Whether they are purpose-built or adapted, many weapons may have more utility in an urban environment while others may have significant disadvantages. Urban threat weapons are much like the nature of urbanization and the urban environment: inventive and varied. Small, man-portable weapons, along with improvised munitions, will dominate the urban environment. Figure G-3 lists examples of threat weapons favored in UO.

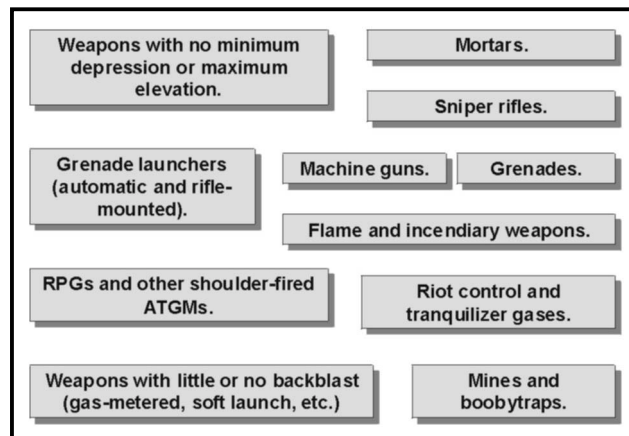

**Figure G-3. Favored threat weapons.**

(6) *Engage the Entire Enemy Force.* Threat forces may “hug” battalions operating in an urban area to avoid the effects of high-firepower standoff weapon systems. They may also try to keep all or significant portions of the battalion engaged in continuous operations to increase the susceptibility to stress-induced illnesses. UO, by their nature, produce an inordinate amount of combat stress casualties, and continuous operations exacerbate this problem. The threat may maintain a large reserve to minimize the impact of this on their own forces.

(7) *Focus Attacks on Service Support and Unprotected Soldiers.* Threat forces may prey on soldiers poorly trained in basic Infantry skills. Ambushes may focus on these soldiers while they are conducting resupply operations or moving in poorly guarded convoys. UO are characterized by the isolation of small groups and navigational challenges, and the threat may use the separation this creates to inflict maximum casualties even when there is no other direct military benefit from the action.

## **G-7. TERRAIN AND WEATHER**

An urban area is a concentration of structures, facilities, and people that form the economic and cultural focus for the surrounding area. Battalion operations are affected by all five categories of urban areas. Cities, metropolises, and megalopolises with associated urban sprawl cover hundreds of square kilometers. Battalions normally operate in these urban areas as part of a larger force. Extensive combat in these urban areas involves units of division level and above.

- *Villages (population of 3,000 inhabitants or less).* The brigade’s AO may contain many villages. Battalions and companies bypass, move through, defend from, and attack objectives within villages as a normal part of brigade operations.
- *Towns (population of over 3,000 to 100,000 inhabitants and not part of a major urban complex).* Operations in such areas normally involve brigades or divisions. Brigades may bypass, move through, defend in, or attack enemy forces in towns as part of division operations.
- *City (population over 100,000 to 1 million inhabitants).*

- *Metropolis (population over 1 million to 10 million inhabitants).*
- *Megalopolis (population over 10 million inhabitants).*

a. **Terrain.** A detailed analysis of the urban area and surrounding terrain is vital to the success of any operation in an urban area. (See FM 34-130.) The battalion commander must understand the elements of the urban infrastructure that are necessary for achieving the intent and end-state of the battalion's mission. Military maps normally do not provide sufficient detail for terrain analysis of an urban area. Recent aerial photographs and other current intelligence products are critical. Maps and diagrams of the city from other sources, such as local governments, tourist activities, or law enforcement services, can be useful. Products that can be developed by the National Imagery Mapping Agency (NIMA) can be specifically tailored for the area of operations. Also, the S2 should obtain maps and diagrams of the following:

- Subway systems, railways, and mass transit routes.
  - Underground water, sewer, and utility systems.
  - Electrical distribution systems/power stations and emergency services.
  - Fuel supply and storage facilities.
  - Mass communications facilities such as cellular phones, computer hubs, radio, and telephone.
  - Public administration buildings, hospitals, and clinics.
- (1) The terrain analysis should also identify the following:
- Structural characteristics of buildings, bridges, and transportation networks.
  - Roads/highways and rivers/streams or other waterways that may be used as high speed avenues of approach.
  - Analysis of the natural terrain surrounding the urban area (OAKOC).
  - Analysis of the urban area itself to include street patterns, structure types, and available maneuver space. (See FM 34-130.)
  - Covered and concealed approaches to the urban area.
  - Key and decisive terrain inside and outside of the urban area.
  - Identification of buildings, areas, or facilities protected by the law of land warfare and or restricted by current ROE such as churches, medical facilities, historic monuments, and other facilities dedicated to arts and sciences, provided they are not being used for military purposes. (See FM 27-10.)
  - Stadiums, parks, open fields, playgrounds, and other open areas that may be used for landing zones or holding areas.
  - Location of prisons and jails.
  - Potential host nation support facilities such as quarries, lumber yards/major building supply companies, and warehouses.
  - Power lines, telephone lines, and raised cables that may be hazards to helicopters.
  - Significant fire hazards and locations of other toxic industrial materials (TIM).
  - Weather effect products from topographic models or historical sources; for example, effects of heavy rains on local areas.

**Note:** Recent incidental or intentional destruction of structures or new construction can change the topography of an urban area.

(2) A close relationship with the local government and military forces can be very beneficial. They can provide information about population, fire fighting capabilities, locations of TIM, police and security capabilities, civil evacuation plans, location of key facilities, and, possibly, current enemy activities. They may also be able to provide translators.

(3) An infrastructure analysis of the urban area is also important. Because urban infrastructures vary greatly, a comprehensive list cannot be provided. However, common characteristics include:

- Urban street patterns and trafficability.
- Sources of potable water.
- Bulk fuel and transport systems.
- Communications systems.
- Rail networks, airfields, canals and waterways, and other transportation systems.
- Industries.
- Power (to include nuclear) and chemical production facilities and public utilities.

b. **Weather.** Weather analyses that are important to battalion operations include visibility, winds, precipitation, and temperature and humidity.

(1) **Visibility.** Light data have special significance during urban operations. Night and periods of reduced visibility, to include fog, favor surprise, infiltration, detailed reconnaissance, attacks across open areas, seizure of defended strong points, and reduction of defended obstacles. However, the difficulties of night navigation in restrictive terrain, without reference points and near the threat, forces reliance on simple maneuver plans with easily recognizable objectives. Many major cities are located along canals or rivers, which often create a potential for fog in low-lying areas. Industrial and transportation areas are the most affected by fog due to their proximity to waterways. In heavy industrial areas, smog can also limit observation under all light conditions.

(2) **Winds.** Wind chill is not as pronounced in urban areas. However, the configuration of streets, especially in close-orderly block and high-rise areas, can cause wind canalization. This increases the effects of the wind on streets that parallel the wind direction, while cross-streets remain relatively well protected. Because of these factors, swirling winds occur and the wind speed and direction may constantly change. This factor also affects the use of smoke for both friendly and threat forces. Downwind predictions for NBC and TIM will also be difficult.

(3) **Precipitation.** Rain or melting snow often floods basements and subterranean areas, such as subways. This is especially true when automatic pumping facilities that normally handle rising water levels are deprived of power. Rain also makes storm and other sewer systems hazardous or impassable. Chemical agents and other TIM are washed into underground systems by precipitation. As a result, these systems may contain toxic concentrations much higher than surface areas and become contaminated "hot spots." These effects become more pronounced as chemical agents or TIM are absorbed by brick or unsealed concrete sewer walls.



(4) **Temperature and Humidity.** Air inversion layers are common over cities, especially cities located in low-lying “bowls” or in river valleys. Inversion layers trap dust, chemical agents, and other pollutants, reducing visibility and often creating a greenhouse effect, which causes a rise in ground and air temperature. The heating of buildings during the winter and the reflection and absorption of summer heat make urban areas warmer than surrounding open areas during both summer and winter. This difference can be as great as 10 to 20 degrees, and can add to the already high logistics requirements of urban combat. Summer heat, combined with the very physical requirements of urban combat, can cause severe heat-related injuries. Changes in temperature as a result of air inversions can also affect thermal sights during crossover periods of warm to cold and vice-versa. This period needs to be identified as it may differ from urban area to urban area.

## **G-8. TROOPS**

During UO, the battalion is often augmented with additional assets, which may include engineers, ADA, and mechanized Infantry or armor support. Army aviation, FA, MP, public affairs, PSYOP, civil affairs, smoke and or decontamination, and LRS assets, when available, may also support the battalion under brigade control. (Sample task organizations are found in Figure G-4.) Actual task organizations are METT-TC dependent. How the battalion commander task organizes so that the BOS can be synchronized during mission execution is critical to tactical success. (See Appendix D.)

a. **Troop Density, Equipment, and Ammunition.** Troop density for offensive missions in urban areas can be as much as three to five times greater than for similar missions in open terrain. Troops require additional equipment such as ladders, ropes, grappling hooks, and other entry equipment. The ammunition consumption rates for small arms, grenades (all types), Claymore mines, handheld recoilless weapons (light antitank weapons [LAWs] and AT4s), 25- and 120-mm HE, and explosives can be four times the normal rate. The staff must ensure the continuous supply of Classes I, III, V, and VIII supplies and water to forward units. Supplies should be configured for use and delivered as far forward as possible to supported units.

b. **Stress.** The commander and staff must consider the effects of prolonged combat on soldiers. Continuous close combat produces high psychological stress and physical fatigue. Rotating units that have been committed to combat for long periods can reduce stress. This may require the battalion to maintain a large reserve to assume the mission of committed forces, or the battalion may need to employ units in a follow and support role to reduce the strain on lead units. Extra effort and time should be taken to train and psychologically prepare soldiers for this type of combat. Ensuring that the proper support systems are in place and functional also reduces potential causes of stress (for example, medical/psychological, resupply, and so forth).

c. **Discipline.** All commanders must ensure their soldiers understand and follow the established ROE. The law of land warfare prohibits unnecessary injury to noncombatants and needless damage to property. This may restrict the commander’s use of certain weapons, munitions, and tactics.

### **G-9. TIME**

Combat in urban areas has a slower tempo and an increased use of methodical, synchronized missions. Additionally, the battalion may find itself planning different operations simultaneously. For example, a company team may have the mission to conduct offensive operations in one part of the battalion's AO and another company may be conducting stability missions in a different part of the AO. In planning UO, the commander and staff must take these factors into account. More time must be allowed for thorough reconnaissance and subordinate unit rehearsals. Mission-specific, in-country training may be required to orient soldiers on how to deal with civilians and provide soldiers with cultural awareness. Other key skills include sniper/countersniper operations, demolitions, breaching, fire fighting, entry and movement techniques, fighting position construction, booby trap recognition/neutralization skills, combat lifesaver training, and crowd control.

### **G-10. CIVIL CONSIDERATIONS**

The commander and staff must understand the composition, activities, and attitudes of the civilian population, to include the political infrastructure, within the urban area. Various options are available to the commander to control the impact of civilians on the operation such as screening civilians, prohibiting unauthorized movement, diverting or controlling refugee movements, and evacuating noncombatants. Understanding the urban society requires comprehension of:

- Living conditions.
- Cultural distinctions.
- Ethnicity.
- Factions.
- Religious beliefs.
- Political affiliation and grievances.
- Attitude toward U.S. forces (friendly, hostile, neutral).

a. **Curfew and Evacuation.** A commander with the mission of defending an urban area may need to establish a curfew to maintain security or to aid in control of military traffic. (Curfews are not imposed as punishment. They are normally established to reduce noncombatant casualties and provide a measure of force protection.) A commander can require civilians to evacuate towns or buildings if the purpose of the evacuation is to use the town or building for imperative military purposes, to enhance security, or to safeguard those civilians being evacuated. If the commander takes this action, he must specify and safeguard the evacuation routes. Infantry battalions may be involved in securing routes, as well, and possibly safeguarding food, clothing, medical, and sanitary facilities. Evacuated civilians must be transferred back to their homes as soon as hostilities in the area have ceased. The staff must plan for and coordinate the movement and evacuation of civilians to ensure their actions do not interfere with the military operation. The battalion staff and supporting civil affairs units working with local officials coordinate the movements of civilians.

b. **Resistance Groups.** The battalion may encounter civilian resistance groups whose actions may range from providing the enemy with supplies, services, and noncombat support to actively fighting against friendly forces. Members of such resistance groups should be dealt with in accordance with applicable provisions of the

law of war. Commanders should seek guidance from the JAG concerning the detention and disposition of persons participating in acts harmful to friendly forces. The S2, PSYOP, and civil affairs units must work together to identify these threats and recommend, within the ROE, the appropriate preemptive action or response, when required. The activities of resistance groups may also benefit friendly forces. They may provide HUMINT; act as guides, liaisons or translators; and provide subject matter expertise on local public facilities such as refineries, power plants, and water works. They may also provide active resistance against the threat.

### **Section III. COMMAND AND CONTROL**

Urban operations require centralized planning and decentralized execution. Therefore the staff must develop a detailed plan that synchronizes the BOS in order to meet the commander's intent and also provide subordinate units with the means to accomplish the mission.

#### **G-11. FOCUS ON THE THREAT**

During the mission analysis, the plan should focus on the factors of METT-TC. Make the plan enemy oriented instead of terrain oriented. Use terrain factors to defeat the threat. Considerations include, but are not limited to, the following:

- Thorough evaluation of the urban area's related terrain and threat may take much longer than other environments. This time factor will also impact friendly planning efforts.
- Determine the threat's location, strength, and capabilities. Develop a plan that defeats his direct and indirect fire systems.
- Focus the axis of advance on the threat's weaknesses while maintaining adequate force protection measures. When possible employ multiple and supporting axes of advance.
- Divide the objective area into manageable smaller areas that facilitate battalion TF maneuver.
- Isolate the objective area and establish a foothold at the point of entry. The location chosen for the foothold must allow for expansion.
- The brigade and battalion maneuver plans directly affect the company schemes of maneuver. Every platoon within the battalion must know what enemy targets will be engaged by brigade and battalion assets.

#### **G-12. COMMANDER'S CRITICAL INFORMATION REQUIREMENTS (CCIR)**

The is information required by the commander that directly affects his decisions and dictates the successful execution of tactical operations. The battalion staff must develop the components of CCIR that facilitate the commander's ability to make decisions that impact the plan during urban operations. Essential elements of friendly information (EEFI) should address the enemy commander's priority intelligence requirements (PIR) and friendly forces information requirements (FFIR) should be items that cause the commander to make decisions that impact the plan. The following are examples of PIR, EEFI, and FFIR that would help the commander in an urban environment.

a. **PIR.** These are intelligence requirements that a commander has anticipated and that have stated priority in task planning and decision making. They include requirements about threat force disposition, composition, capabilities, and strength in relation to friendly forces and the AO. Examples include:

- Where are the threat battalion and company command posts?
- What are the most likely threat infiltration routes into the battalion area of operations?
- What streets and alleys restrict movement of friendly armored and wheeled vehicles?
- Where are the likely threat strong points and engagement areas?
- What is the threat air defense capability against Army aviation assets?

b. **EEFI.** These are critical aspects of a friendly operation that, if known by the threat, would subsequently compromise, lead to failure, or limit success of the operation and, therefore, must be protected from detection. Examples include:

- Is the battalion command net vulnerable to intercept, direction finding, and electronic attack?
- Is the battalion vulnerable to HUMINT collection and sabotage by local nationals?
- Where are the battalion supply routes/LOC most vulnerable to ambush and snipers?
- Are friendly troop concentrations and movement under threat observation?

c. **FFIR.** This is information the commander and staff need about the friendly forces available for the operation. Examples include:

- Scouts captured or compromised.
- Main bridge locations along ground route that have been blown.
- OPORD compromised.
- Loss of cryptographic equipment.
- Expected personnel and equipment replacements that did not arrive.

### **G-13. TASK-ORGANIZE UNITS TO ACCOMPLISH SPECIFIC TASKS**

UO may require unique task organizations. For example, UO provide one of the few situations where Infantry and armor elements may be effectively task-organized below platoon levels. Battalion commanders must consider providing assets where they will be needed to accomplish specific tasks. All phases of mission execution must be considered when developing task organization. Changes in task organization may be required to accomplish different tasks during mission execution. Figure G-4 depicts a sample task organization for a light Infantry TF conducting an offensive UO that consists of a main effort, two supporting efforts, and a reserve.

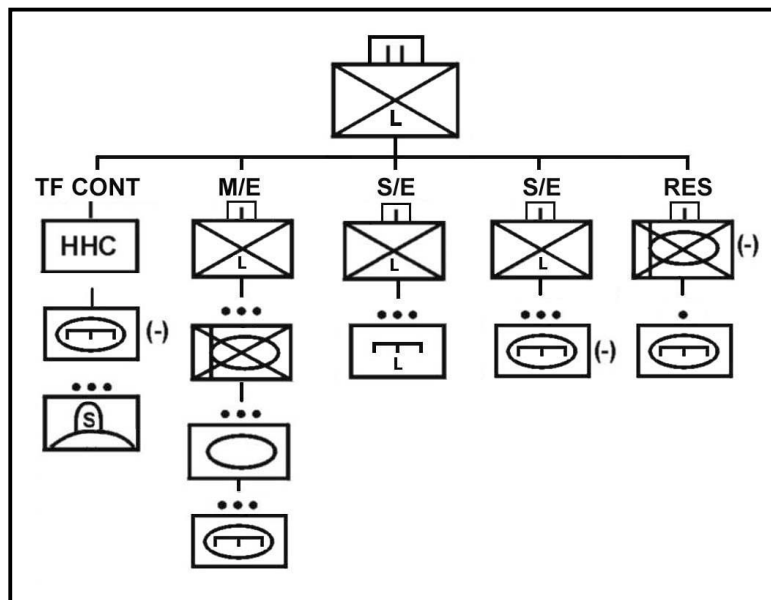

**Figure G-4. Sample offensive task organization.**

**Note:** The task organization shown in Figure G-4 may change after the assault when the TF reorganizes for follow-on missions.

#### **G-14. REHEARSALS**

After developing a thorough, well-synchronized plan, battalion commanders should require subordinate units to conduct combined arms rehearsals at the levels at which they occur, and include all phases of the operation. When conducted properly, combined arms rehearsals identify potential problems in the synchronization of the plan between maneuver, combat support, and combat service support elements. Rehearsals provide a means for units that seldom operate together to train collective skills. Rehearsals should be started early in the troop-leading process. Some rehearsals can start shortly after receipt of warning orders. Subordinate units can rehearse drills, such as breaching, clearing buildings, and moving between buildings, before receiving a detailed plan. Infantry can also rehearse aspects of operating close to armored vehicles. The battalion commander and staff must allocate sufficient time to subordinate units to conduct rehearsals. Rehearsals that subordinate units should consider include, but are not limited to, the following:

- Communications procedures.
- Direct fire control plan.
- Fires (lethal and nonlethal effects).
- Breaching.
- Maneuver.

#### **G-15. FIRE SUPPORT**

Often, the role of fires in UO is to get the maneuver force into or around the urban area with minimal casualties, so the commander has the maximum combat power to close with the enemy and finish the fight. The fire support officer can use the acronym SOSR

(suppress, obscure, secure, reduce) as a reference to assist the commander in developing his intent for fires. History has shown that short, violent preparatory fires are much more effective than fires of long duration. Fires of shorter duration also produce less rubble and collateral damage. If available, the smoke decontamination platoon should be considered as a fire support asset for obscuration. Nonlethal capabilities are also planned and coordinated by the fire support officer for the battalion commander. Civil affairs and PSYOP assets should be coordinated with the appropriate command and control warfare/information operations planning headquarters.

#### **Section IV. OFFENSIVE OPERATIONS**

*“From 1942 to the present, shock units or special assault teams have been used by attackers (and often by defenders) with great success. These assault teams are characterized by integration of combined arms. Assault teams typically contain Infantry with variable combinations of armor, artillery, or engineers.”*

Technical Memorandum 5-87  
Modern Experience in City Combat  
U.S. Army Human Engineering Laboratory  
March, 1987

#### **G-16. OFFENSIVE FRAMEWORK**

Figure G-5 depicts the urban operational framework applied to offensive operations. (The brigade commander’s primary responsibility is to set the conditions for tactical success for his subordinate units. Whenever possible, close combat by maneuver units is minimized and the brigade commander attempts to move from shape to transition.) The tactical tasks of subordinate units are also shown in Figure G-5. Infantry battalions will be used as maneuver elements to execute the tactical tasks shown. Specific discussion of these tasks is contained in paragraph G-17. While the elements of the operational framework are not phases, tactical tasks may become phases at the battalion level and below, based on the factors of METT-TC. There is no clear line of distinction that delineates when the battalion moves from one task to another. Properly planned and executed offensive operations will involve all tactical tasks shown. They may be conducted simultaneously or sequentially, depending on the factors of METT-TC. During offensive operations, the brigade commander’s intent normally includes:

- Synchronizing precision fires, information operations, and nonlethal capabilities.
- Isolating decisive points.
- Using superior combat power to destroy high pay-off targets.
- Using close combat, when necessary, against decisive points.
- Transitioning quickly to stability and or support operations.

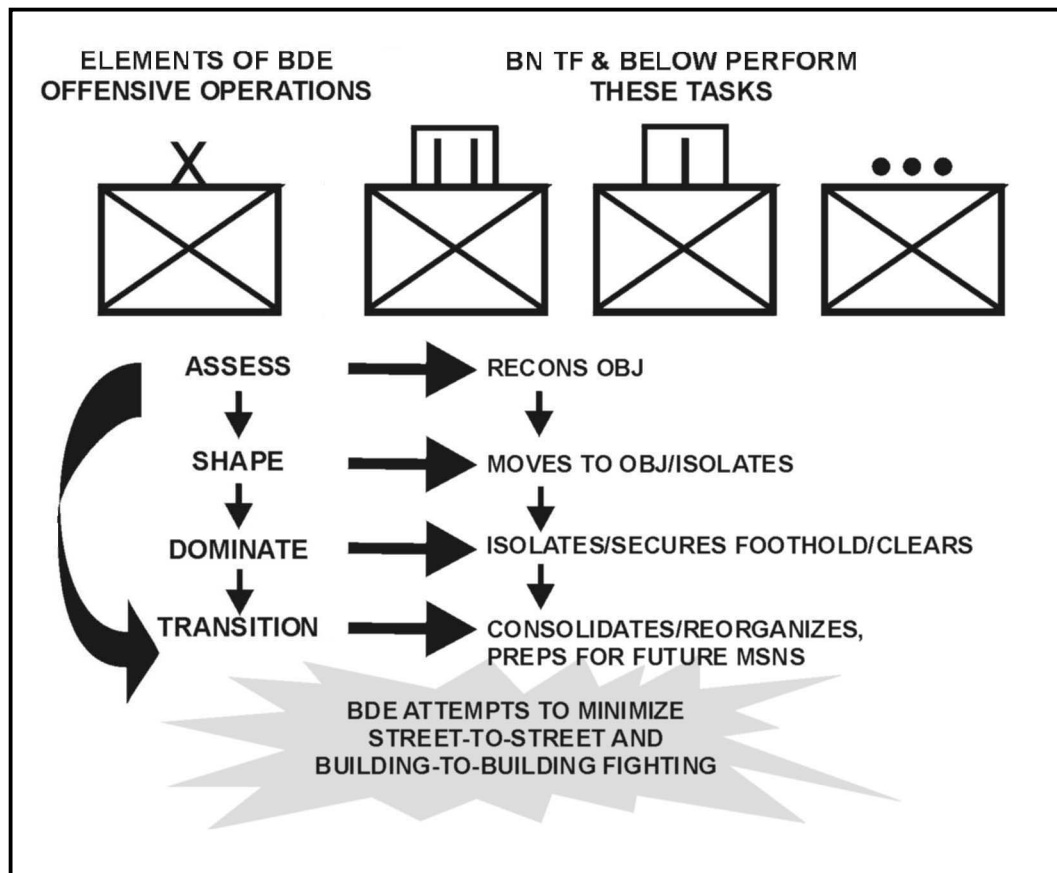

**Figure G-5. Offensive urban operational framework.**

### G-17. TYPES OF OFFENSIVE OPERATIONS

At battalion level, the offense takes the form of either a hasty or deliberate attack. Both hasty and deliberate attacks are characterized by as much planning, reconnaissance, and coordination as time and the situation permit.

a. **Hasty Attack.** Infantry battalions conduct hasty attacks as a result of a movement to contact, a meeting engagement, or a chance contact during a movement; after a successful defense or part of a defense; or in a situation where the unit has the opportunity to attack vulnerable enemy forces, IAW the ROE. Battalions may also be required to conduct hasty attacks for force protection as a result of deteriorating conditions from stability and support operations. The hasty attack in an urban area differs from a hasty attack in open terrain because the close nature of the terrain makes command, control, and communications difficult. Also, massing fires to suppress the enemy may be difficult. In urban areas, incomplete intelligence and concealment may require the maneuver unit to move through, rather than around, the friendly unit fixing the enemy in place. Control and coordination become important to reduce congestion at the edges of the urban area.

b. **Deliberate Attack.** A deliberate attack is a fully synchronized operation that employs all available assets against the enemy's defense, IAW with the ROE. It is necessary when enemy positions are well prepared, when the urban area is large or

severely congested, when the element of surprise is lost, or when the ROE requires the precise application of combat power and lethal force. Deliberate attacks are characterized by detailed planning based on available information, thorough reconnaissance, preparation, and rehearsals. Given the nature of urban terrain, the deliberate attack of an urban area is similar to the techniques employed in assaulting a strong point. Attacking the enemy's main strength is avoided and combat power is focused on the weakest point of his defense. At the battalion level, a deliberate attack of an urban area usually involves the sequential execution of the following tactical tasks.

(1) **Reconnoiter the Objective.** This involves making a physical reconnaissance of the objective with battalion assets and those of higher headquarters, as the tactical situation permits. It also involves making a map reconnaissance of the objective and all the terrain that will affect the mission, as well as the analysis of aerial imagery, photographs, or any other detailed information about the building(s) or other urban terrain the battalion is responsible for. Additionally, any human intelligence (HUMINT) collected by reconnaissance and surveillance units, such as the battalion reconnaissance platoon, snipers, and so forth, should be considered during the planning process.

(2) **Move to the Objective.** This may involve moving through open and or urban terrain. Movement should be made as rapidly as possible without sacrificing security. Movement should be made along covered and concealed routes and can involve moving through buildings, down streets, in subsurface areas, or a combination of all three. Urban movement must take into account the three-dimensional aspect of the urban area.

(3) **Isolate the Objective.** Isolation begins with the efforts of SOF units controlled by higher headquarters to influence enemy and civilian actions. The battalion commander should consider using PSYOP teams to broadcast appropriate messages to the threat and to deliver leaflets directing the civilian population to move to a designated safe area, if the units are available to support the battalion. These actions must be coordinated with the overall PSYOP plan for the brigade and must not sacrifice surprise. By themselves, PSYOP are seldom decisive. They take time to become effective and often their effects are difficult to measure until after the actual attack. Under some METT-TC conditions, PSYOP have achieved results far outweighing the effort put into them.

(a) In certain situations that require precise fire, snipers can provide an excellent method of isolating key areas. Skillful application of snipers can provide lethal fire while simultaneously minimizing collateral damage and noncombatant casualties.

(b) Isolating the objective also involves seizing terrain that dominates the area so that the enemy cannot supply, reinforce, or withdraw its defenders. It also includes selecting terrain that provides the ability to place suppressive fire on the objective. (This step may be taken at the same time as securing a foothold.) If isolating the objective is the first step, speed is necessary so that the defender has no time to react. Battalions may be required to isolate an objective as part of brigade operations, or may be required to do so independently (Figure G-6). Depending on the tactical situation, companies within the battalion may isolate an objective by infiltration and stealth.

(c) Cordon is a tactical task given to a unit to prevent withdrawal from or reinforcement of a position. A cordon is a type of isolation. It implies seizing or controlling key terrain and or mounted and dismounted avenues of approach. Figure G-6 depicts a brigade attacking to seize and clear OBJ EAGLE using the cordon and attack technique. One battalion TF (four company teams) cordons (isolates) OBJ EAGLE by



occupying battle positions. (A cordon may also be accomplished through use of ambushes, roadblocks, checkpoints, OPs, and patrols.) Skillful application of fires and other combat multipliers may also defeat the enemy when this technique is used and minimize or preclude close combat. In the example shown in Figure G-6, the battle positions are oriented to place fires on the enemy leaving OBJ EAGLE and to prevent his withdrawal from the objective area. The factors of METT-TC will determine how the battle positions are oriented and what the mission end-state will be. Additional direct fire control measures, such as TRPs and engagement areas, as well as indirect fire control measures, can focus fires and assist in canalizing the enemy into desired areas.

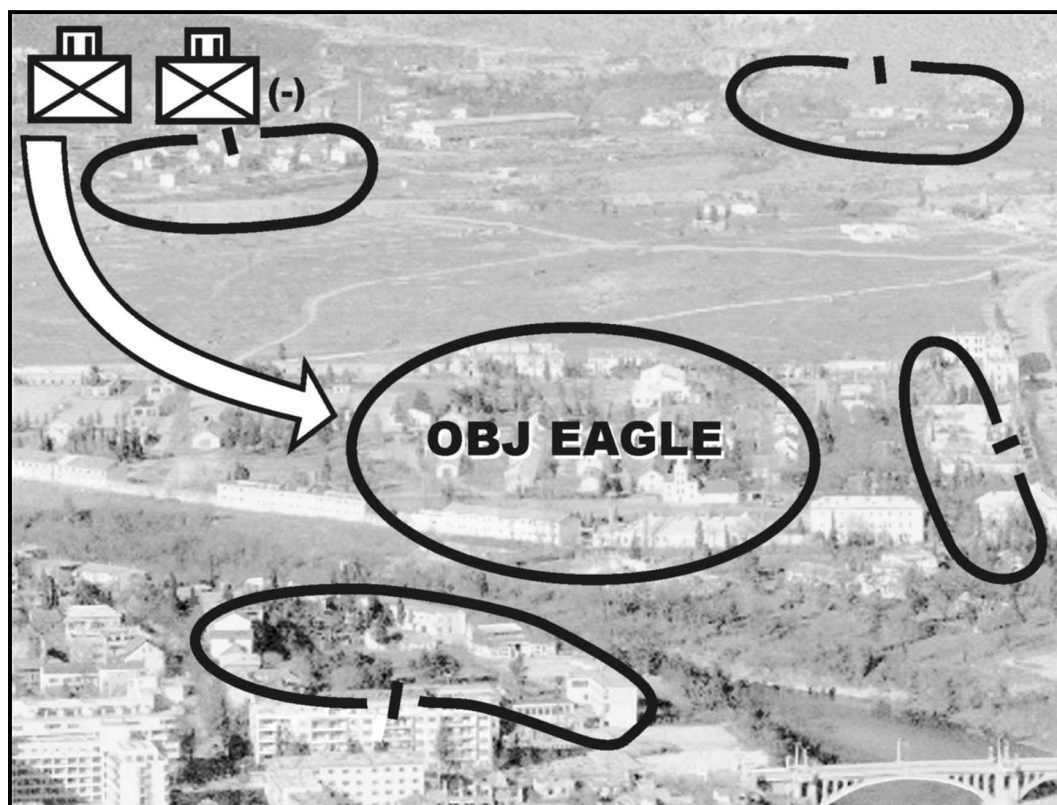

**Figure G-6. Isolation of an urban area by an Infantry battalion using the cordon technique.**

**Note:** Combat experience and recent rotations at the CTCs have shown that many casualties can be sustained when moving between buildings, down streets, and through open areas to enter a building either to gain a foothold or to clear it. One purpose of isolation at the company and battalion levels must be to dominate the area leading to the point(s) of entry to protect assaulting troops entering the building from effective enemy fire. This is accomplished by using direct and indirect fires and obscurants, maintaining situational understanding, and exercising tactical patience prior to movement.

(4) **Secure a Foothold.** Securing a foothold involves seizing an intermediate objective that provides cover from enemy fire and a location for attacking troops to enter the urban area. The size of the foothold is METT-TC dependent and is usually a company intermediate objective. In some cases a large building may be assigned as a company intermediate objective (foothold).

(a) As a company attacks to gain a foothold, it should be supported by suppressive fire and smoke. In the example shown in Figure G-7, the center TF conducts a supporting attack to seize OBJ DOG. (In the brigade scheme of maneuver, the TF on the left conducts the main attack to seize and clear OBJ CAT, and the TF on the right conducts a supporting attack to seize OBJ RAT. The seizure of OBJs RAT and DOG isolates OBJ CAT). In order to seize OBJ DOG the TF commander determined that two intermediate objectives were necessary.

(b) One company will secure a foothold in OBJ Y. As a follow-on mission, the same company will seize OBJ Z and support the battalion main effort by fire, or facilitate the passage of another company through OBJ Y to seize OBJ Z to support the battalion main effort by fire.

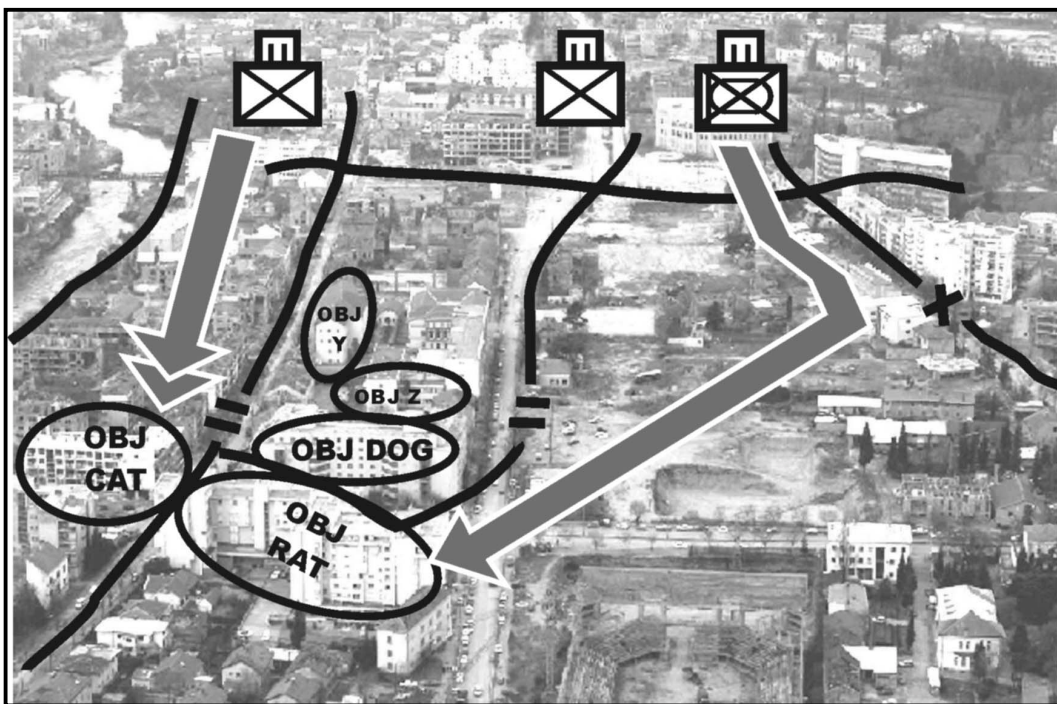

**Figure G-7. Securing a foothold, battalion attack.**

(5) **Clear an Urban Area.** Before determining to what extent the urban area must be cleared, the factors of METT-TC must be considered. The ROE will affect the TTP subordinate units select to move through the urban area and clear individual buildings and rooms. The commander may decide to clear only those parts necessary for the success of his mission if—

- An objective must be seized quickly.

- Enemy resistance is light or fragmented.
- The buildings in the area have large open areas between them. In this case, the commander would clear only those buildings along the approach to his objective, or only those buildings necessary for security.

An Infantry battalion may have a mission to systematically clear an area of all enemy. Through detailed analysis, the commander may anticipate that he will be opposed by strong, organized resistance or will be in areas having strongly constructed buildings close together. Companies may be assigned sectors within the battalion sector or AO in order to conduct systematic clearing (Figure G-8).

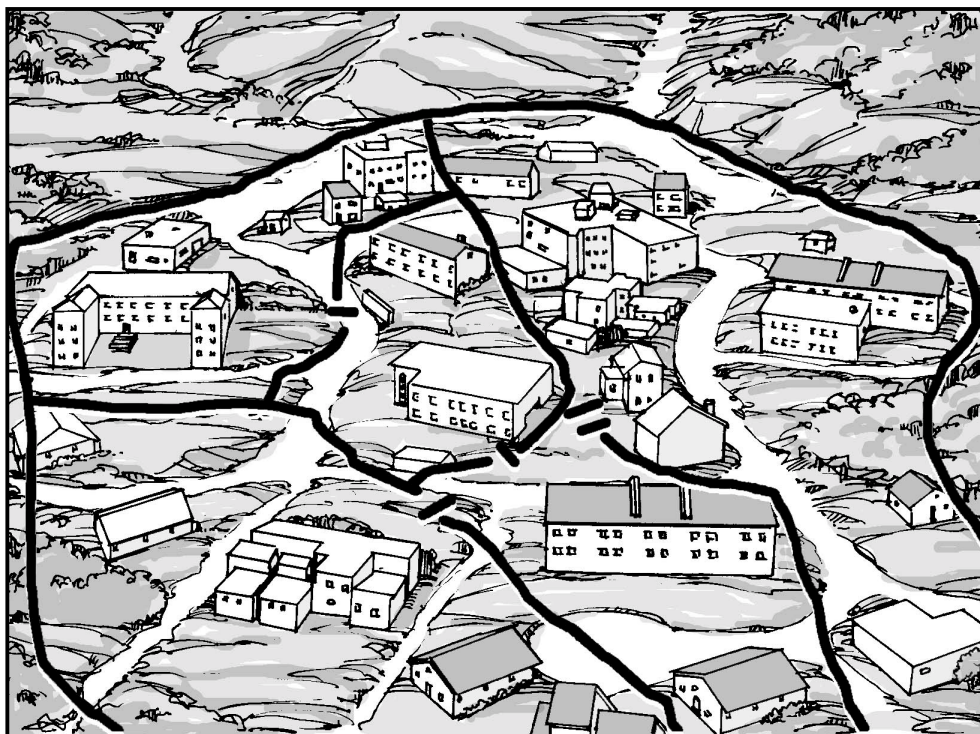

**Figure G-8. Systematic clearance within assigned areas.**

(6) *Consolidate/Reorganize and Prepare for Future Missions.* Consolidation occurs immediately after each action. Reorganization and preparation for future missions occurs after consolidation. Many of these actions occur simultaneously.

(a) Consolidation provides security and facilitates reorganization, and allows the battalion to prepare for counterattack. Rapid consolidation after an engagement is extremely important in an urban environment. The assault force in a cleared building must be quick to consolidate in order to repel enemy counterattacks and to prevent the enemy from infiltrating back into the cleared building. After securing a floor, selected members of the assault force are assigned to cover potential enemy counterattack routes to the building. Priority must be given to securing the direction of attack first.

(b) Reorganization actions (many occurring simultaneously) prepare the unit to continue the mission. The battalion prepares to continue the attack, prepares for future missions, and prepares for the possible transition to stability and support operations.

**Note:** Friendly force situational understanding is significantly improved in digitally equipped units through the use of Force XXI Battalion Command Brigade and Below (FBCB2) assets.

### **G-18. TRANSITION**

During transition, the battalion continues to use all CS and CSS assets consistent with the mission end-state and ROE to move from offensive operations to stability and or support operations in order to return the urban area to civilian control. During this step, the roles and use of SOF, CS, and CSS units, such as civil affairs (CA), PSYOP, medical, and MPs, become more important with the requirements to maintain order and stabilize the urban area. These assets will normally support the battalion's transition efforts under brigade control. The battalion and other brigade units will consolidate, reorganize, conduct area protection and logistical missions, and prepare for follow-on missions. The battalion staff, in coordination with the brigade staff, must prepare to transition from being a "supported" force to being the "supporting" force.

### **G-19. MOVEMENT TO CONTACT**

Figure G-9 depicts a movement to contact in an urban area using the search and attack technique. This technique is used when knowledge of the enemy is unclear and contact is required. It is normally employed against a weak enemy force that is disorganized and incapable of massing strength against the battalion; for example, urban insurgents or gangs. The battalion divides its portion of the AO into smaller areas and coordinates the movement of companies. The battalion can either assign sectors to specific companies or control movement of companies by sequential or alternate bounds within the battalion sector. In the example shown in Figure G-9, individual companies would find, fix, and finish the enemy (company sectors), or they would find and fix the enemy and the battalion would assign another company the task of finishing the enemy (sequential or alternate bounds). During a mission of this type, the urban environment makes finding, fixing, and finishing the enemy difficult for conventional Infantry forces. For example, movement of units may become canalized due to streets and urban "canyons" created by tall buildings. The application of fire power may become highly restricted based on the ROE. The use of HUMINT in this type of action becomes increasingly more important and can be of great assistance during the "find" portion of the mission.



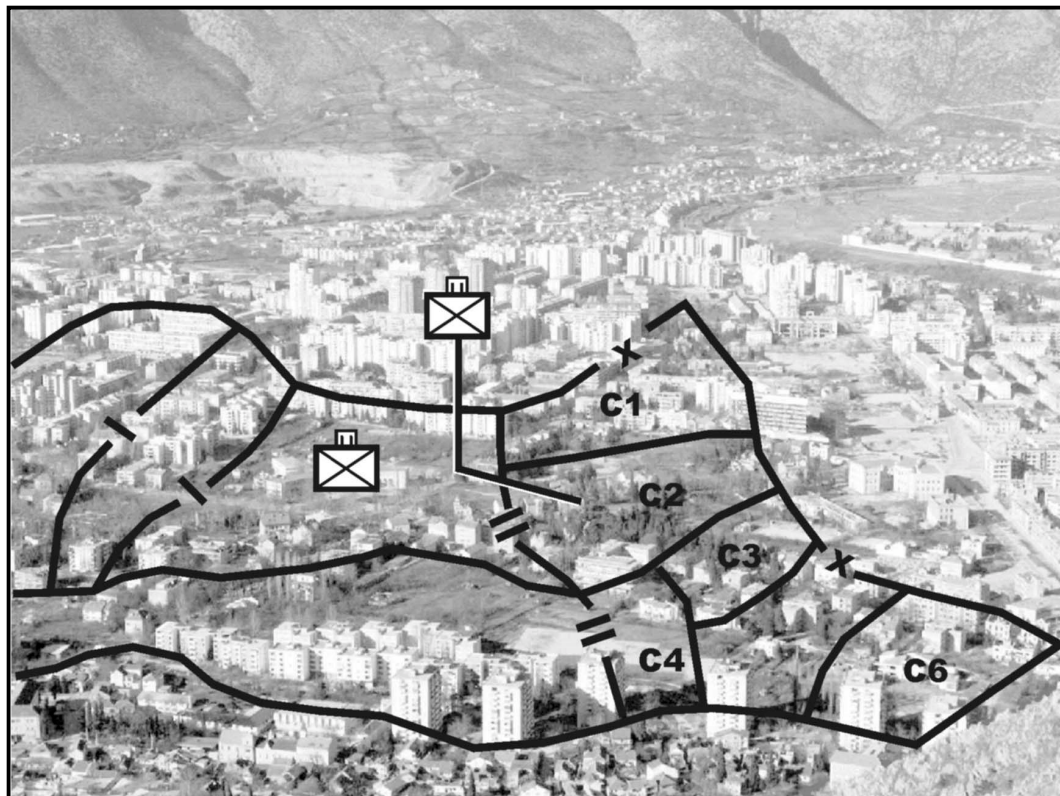

**Figure G-9. Search and attack technique.**

## **G-20. INFILTRATION**

The following example describes the actions of an Infantry battalion conducting an infiltration. With some modification, it could also apply to a dismounted mechanized Infantry battalion.

a. The outskirts of an urban area may not be strongly defended. Its defenders may have only a series of antiarmor positions, security elements on the principal approach, or positions blocking the approaches to key features in the town. The strongpoints and reserves are deeper in the urban area.

b. A battalion may be able to seize a part of the urban area by infiltrating platoons and companies between those enemy positions on the outskirts. Moving by stealth on secondary streets by using the cover and concealment of back alleys and buildings, the battalion may be able to seize key street junctions or terrain features, to isolate enemy positions, and to help following units pass into the urban area. Such an infiltration should be performed when visibility is poor and no civilians are in the area.

c. The Infantry battalion is organized into infiltration companies with appropriate attachments and a reserve consistent with METT-TC. Each company should have an infiltration lane that allows stealthy infiltration by company or smaller size units. Depending on the construction of the urban area and streets, the infiltration lane may be 500 to 1,500 meters wide.

d. The infiltrating companies advance stealthily on foot using available cover and concealment. Mortar and artillery fire can be used to divert the enemy's attention and cover the sound of infiltrating troops.

e. Armored vehicles and antiarmor weapons are positioned to cover likely avenues of approach for enemy armored vehicles. The battalion commander may position antiarmor weapons to cover the likely avenues of approach, if no BFVs or tanks are available. The reconnaissance platoon and antiarmor company screen the battalion's more vulnerable flanks. Also, the antiarmor company can support by fire if the situation provides adequate support by fire positions.

f. As the companies move into the urban area, they secure their own flanks. Security elements may be dropped off along the route to warn of a flank attack. Engineers assist in breaching or bypassing minefields or obstacles encountered. Enemy positions are avoided but reported.

g. The infiltrating companies proceed until they reach their objective. At that time, they consolidate and reorganize and arrange for mutual support. They patrol to their front and flanks, and establish contact with each other. The company commander may establish a limit of advance to reduce chances of enemy contact or to ensure safety from friendly forces.

h. If the infiltration places the enemy in an untenable position and he must withdraw, the rest of the battalion is brought forward for the next phase of the operation. If the enemy does not withdraw, the battalion must clear the urban area before the next phase of the operation (Figure G-10).

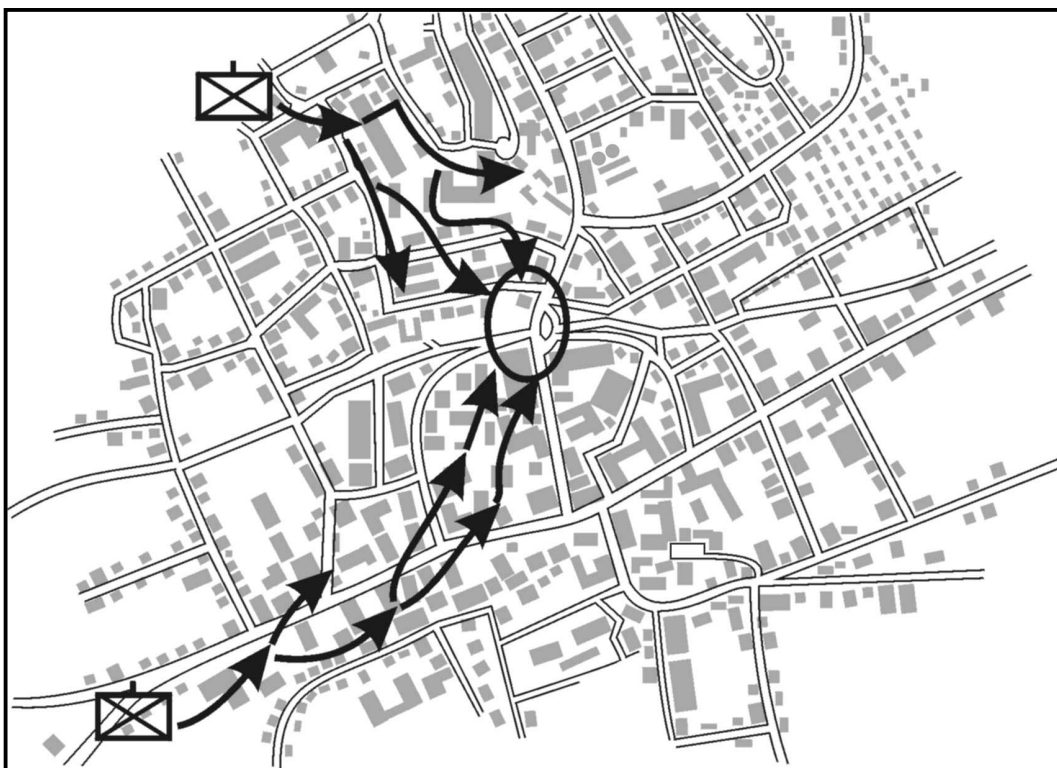

**Figure G-10. Infiltration.**

### G-21. ATTACK OF A VILLAGE

The battalion may have to conduct either a hasty or deliberate attack of a village that is partially or completely surrounded by open terrain. (Figure G-11 depicts an Infantry battalion conducting such an attack.) After the factors of METT-TC have been considered, the tactical tasks discussed in paragraph G-17 are performed (specifically, reconnoiter the objective, move to the objective, isolate the objective, secure a foothold, clear the objective, and consolidate and reorganize and or prepare for future missions). In the example shown in Figure G-11, two companies and or company teams isolate the village, and a company team secures a foothold and enters and clears the village.

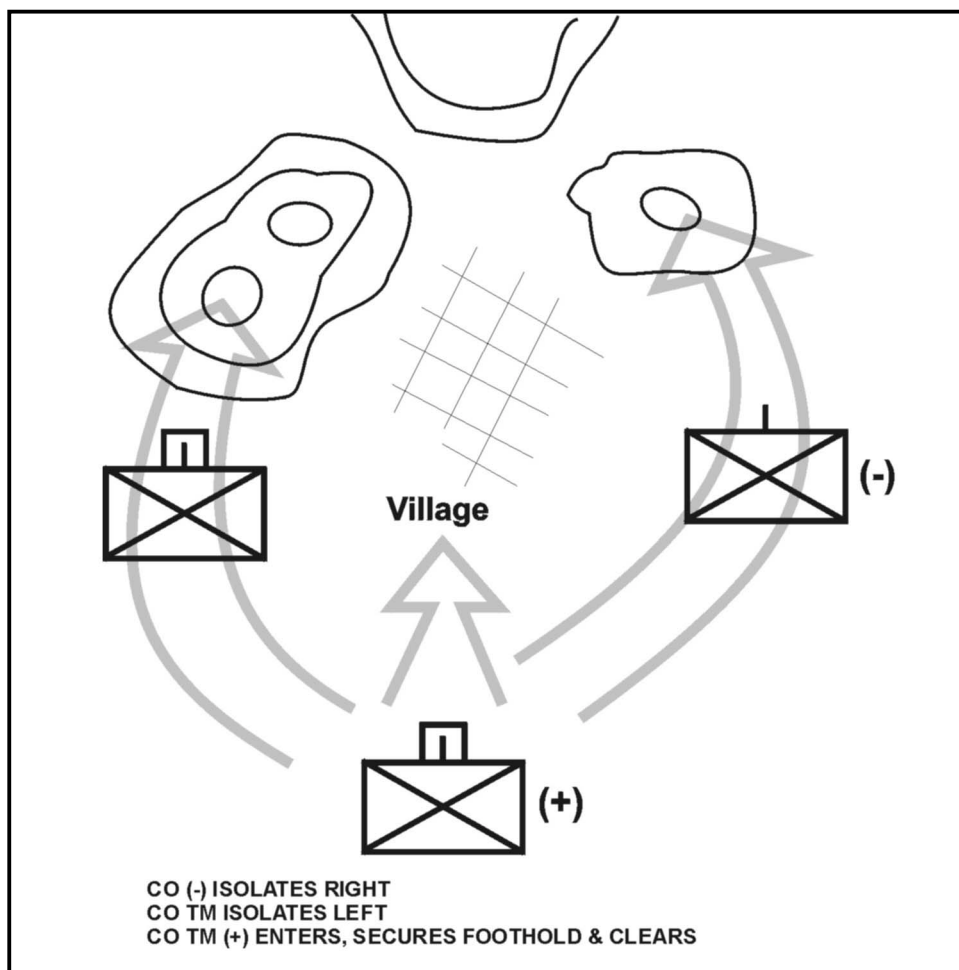

**Figure G-11. Attack of a village.**

### G-22. NODAL ATTACK

The battalion may be given the mission to seize a key node(s) as part of a brigade operation. (See Figures G-12 and G-13.) In certain situations, the battalion may be required to seize nodes independently. This mission is characterized by rapid attacks followed by defensive operations. The enemy situation must permit the attacking force to

divide its forces and seize key nodes. Multiple attacks, as depicted in Figures G-12 and G-13, will require precise maneuver and supporting fires. This mission may be given to a battalion before an anticipated stability and or support operation, or to isolate an urban area for other units that will be conducting offensive operations inside the urban area. Figure G-12 depicts a brigade conducting multiple nodal attacks. Figure G-13 depicts a battalion TF executing its assigned mission. This technique is used to deny the enemy key infrastructure. Use of this technique may also require a designated rapid response element(s) in reserve in the event that enemy forces mass and quickly overwhelm an attacking battalion. Normally the reserve is planned at brigade level. Battalions executing a nodal attack independently will need to plan for a designated rapid response reserve element. The duration of this attack should not exceed the battalion's self-sustainment capability.

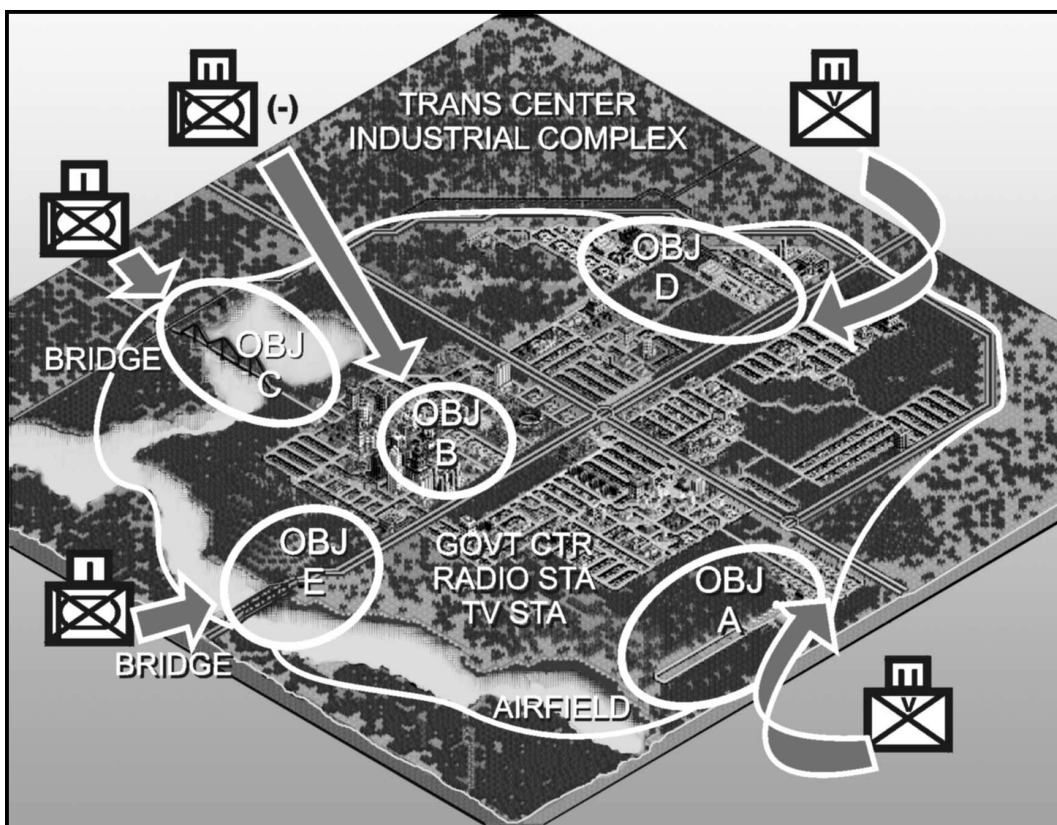
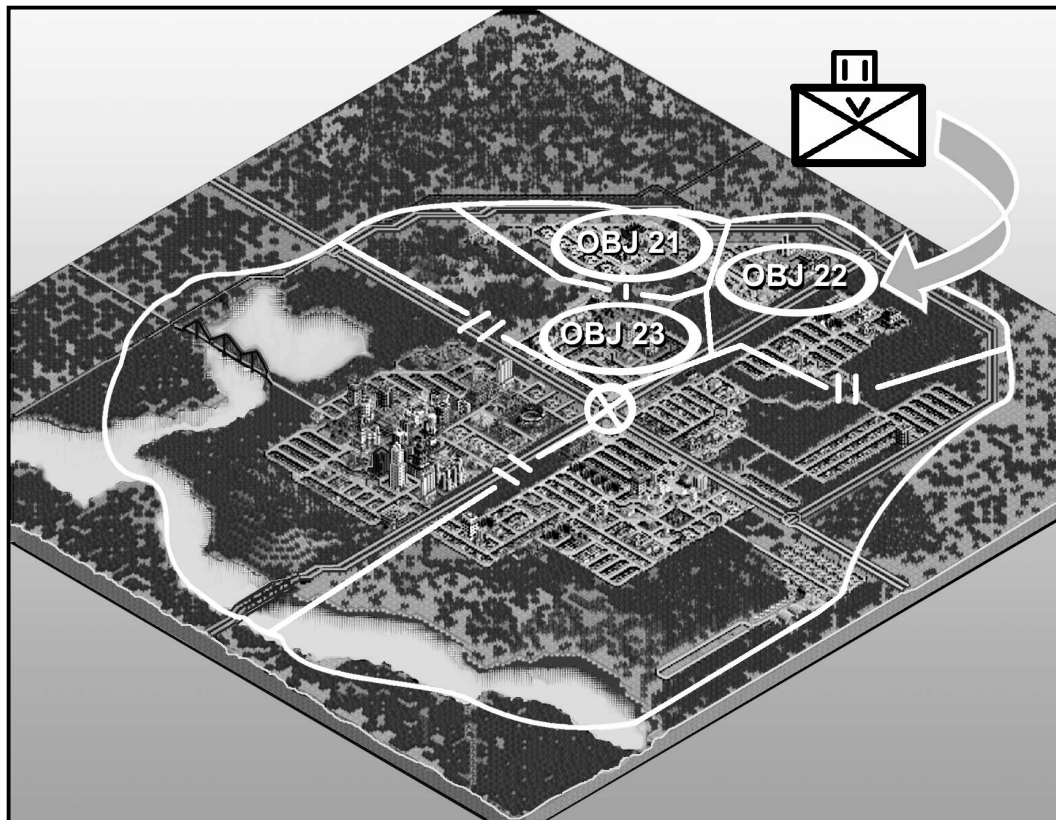

Figure G-12. Brigade scheme of maneuver, nodal attack.





**Figure G-13. Battalion nodal attack.**

### **Section V. DEFENSIVE OPERATIONS**

Of the two types of defense, area and mobile, the area defense will probably be the type most used since most of the reasons for defending an urban area are focused on retaining terrain. The mobile defense pattern is more focused on the enemy and the commander may decide to use it based on his estimate of the situation. In an urban area, the defender must take advantage of the abundant cover and concealment. He must also consider restrictions to the attacker's ability to maneuver and observe. By using the terrain and fighting from well-prepared and mutually supporting positions, a defending force can inflict heavy losses upon, delay, block, or fix a much larger attacking force. A commander must decide whether defending a urban area is needed to successfully complete his mission. Before making his decision, he should consider the issues discussed in this paragraph.

#### **G-23. DEFENSIVE FRAMEWORK**

Normally, the battalion will conduct defensive operations as part of a brigade. The brigade can conduct the full range of defensive operations within a single urban area or in an AO that contains several small towns and cities using the elements of the urban operational framework shown in Figure G-14. Similar to offensive operations, the brigade commander attempts to set the conditions for tactical success. Isolation of the

brigade by the enemy is avoided through security operations; defensive missions are assigned to subordinate battalion task forces in order to achieve the commander’s intent and desired end-state; and then the brigade transitions to stability and or support actions. During urban defensive operations, the transition to stability and support operations may not be clear to the soldiers conducting the missions. Commanders must offset this tendency with clear mission-type orders and updated ROE. Again, as in offensive operations, the elements are not phases; they may occur simultaneously or sequentially. Well-planned and executed defensive operations will have all four elements present. During defensive operations the brigade commander seeks to:

- Avoid being isolated by the enemy.
- Defend key and decisive terrain, institutions, or infrastructure.
- Use offensive fire and maneuver to retain the initiative.

Battalions will conduct defensive operations by conducting counterreconnaissance missions and patrols (shaping/avoiding isolation); assigning battle positions or sectors to companies (dominating); and consolidating/reorganizing and preparing for follow-on missions (transitioning).

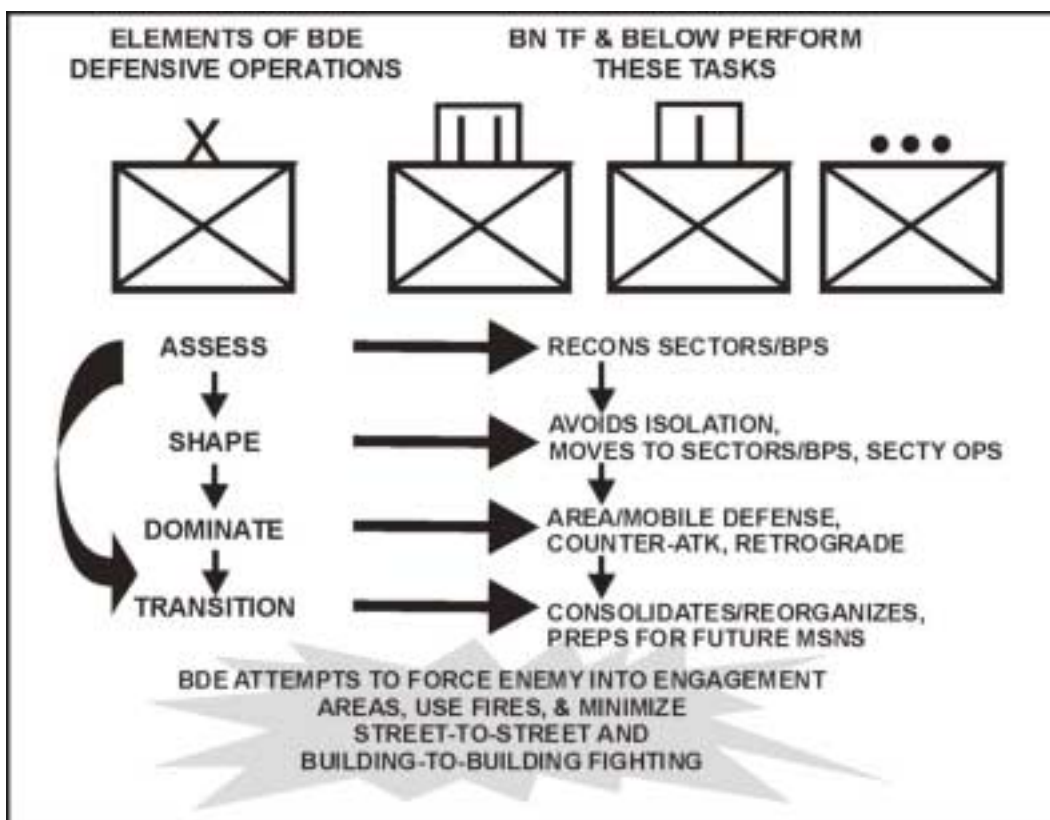

Figure G-14. Defensive urban operational framework.

**G-24. DEFENSIVE PLANNING**

In planning a defense in an urban area, the staff must identify the following:

- Positions and areas that must be controlled to prevent enemy infiltration.
- Sufficient covered and concealed routes for movement and repositioning of forces.
- Structures and areas that dominate the urban area.
- Areas, such as parks and broad streets, that provide fields of fire for tanks and antiarmor weapons.
- Areas to position artillery assets.
- C2 locations.
- Protected areas for CSS activities.
- Suitable structures that are defensible and provide protection for defenders.
- Contingency plans in the event that the battalion must conduct breakout operations.
- Plans for rapid reinforcement.

a. Battalions defending in urban areas must prepare their positions for all-round defense. Units must employ aggressive security operations that include surveillance of surface and subsurface approaches. Battalions must constantly patrol and use OPs and sensors to maintain effective security. Special measures must be taken to control possible civilian personnel who support the enemy or enemy combatants who have intermixed with the local population. Consideration must also be given to the protection of noncombatants that remain in the AO, and contingency actions in the event that the situation deteriorates and requires their evacuation.

b. Defensive fire support in urban operations must take advantage of the impact of indirect fires on the enemy before he enters the protection of the urban area. Fire support officers at all levels must coordinate and rehearse contingencies that are inherent to nonlinear fire support coordination measures and clearance of fires. Mutually supporting observation plans for daylight and periods of limited visibility must account for the degradation of lasers in well-lit urban areas. The fire support officer also plans and coordinates nonlethal capabilities for the brigade. Civil affairs and PSYOP assets should be coordinated with the appropriate command and control warfare/information operations headquarters.

**G-25. INTEGRATING THE URBAN AREA INTO THE DEFENSE**

The battalion may also integrate villages, strip areas, and small towns into the overall defense, based on higher headquarters' constraints and applicable ROE. (See Figure G-15.) A defense in an urban area, or one that incorporates urban areas, normally follows the same sequence of actions and is governed by the principles contained in Chapters 5 and 6. When defending on predominately urban areas, the battalion commander must consider that the terrain is more restrictive due to buildings that are normally close together. This usually requires a higher density of troops and smaller company sectors or battle positions than in open terrain.

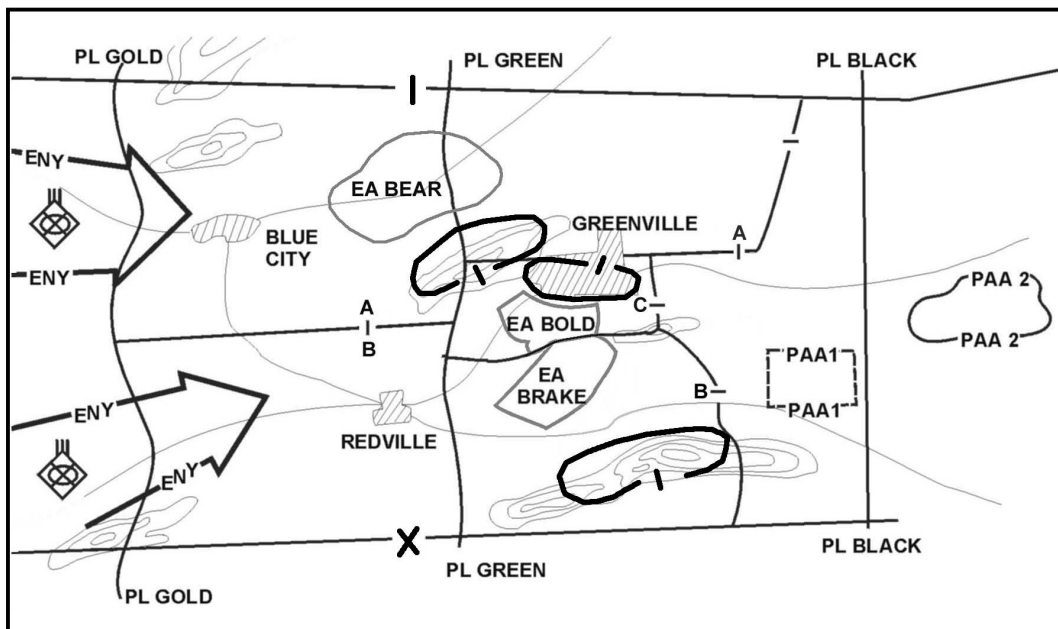

**Figure G-15. Integrating urban areas into a defense.**

### G-26. NODAL DEFENSE

Figure G-16 depicts a transitional situation where the battalion moves from an offensive to a defensive or stability operation. The brigade mission may contain METT-TC factors that require varying defensive techniques by the subordinate battalions under the brigade's control. Figure G-17 depicts a nodal defense where battalions employ different defensive techniques in order to achieve the brigade commander's desired end-state. The brigade commander's intent is to safeguard the key nodes that were seized during the offensive action in order to eventually return the infrastructure of this particular urban area back to civilian control. A combination of sectors, battle positions, strong points, roadblocks, checkpoints, security patrols, and OPs could be employed within the TF sector or AO. Figure G-17 depicts the changed TF task organizations, the extended boundaries, and directed brigade OPs. Considerations in a situation such as this include:

a. **Task Organization.** Companies may have to be task organized differently to conduct the specific missions assigned by the battalion or TF commander. The task organization required for the defensive or stability operation will probably be different from the task organization used in an offensive operation.

b. **Symmetrical/Asymmetrical Threats.** The battalion or TF will likely respond to both symmetrical and asymmetrical threats within the area of operations. The defensive techniques chosen by subordinate companies should allow them to respond to the specific threats in their respective AOs, battle positions, or sectors.

c. **Boundary Changes.** Again, based on the commander's intent and the battalion's or TF's defensive scheme of maneuver, boundary changes may be required in order to give companies more or less maneuver space.

d. **ROE Modification.** The ROE may require modification based on the type of mission to be conducted. The ROE may become more or less restrictive based on METT-TC factors. Commanders and leaders must ensure that the ROE are clearly stated and widely disseminated at the beginning and conclusion of each day.

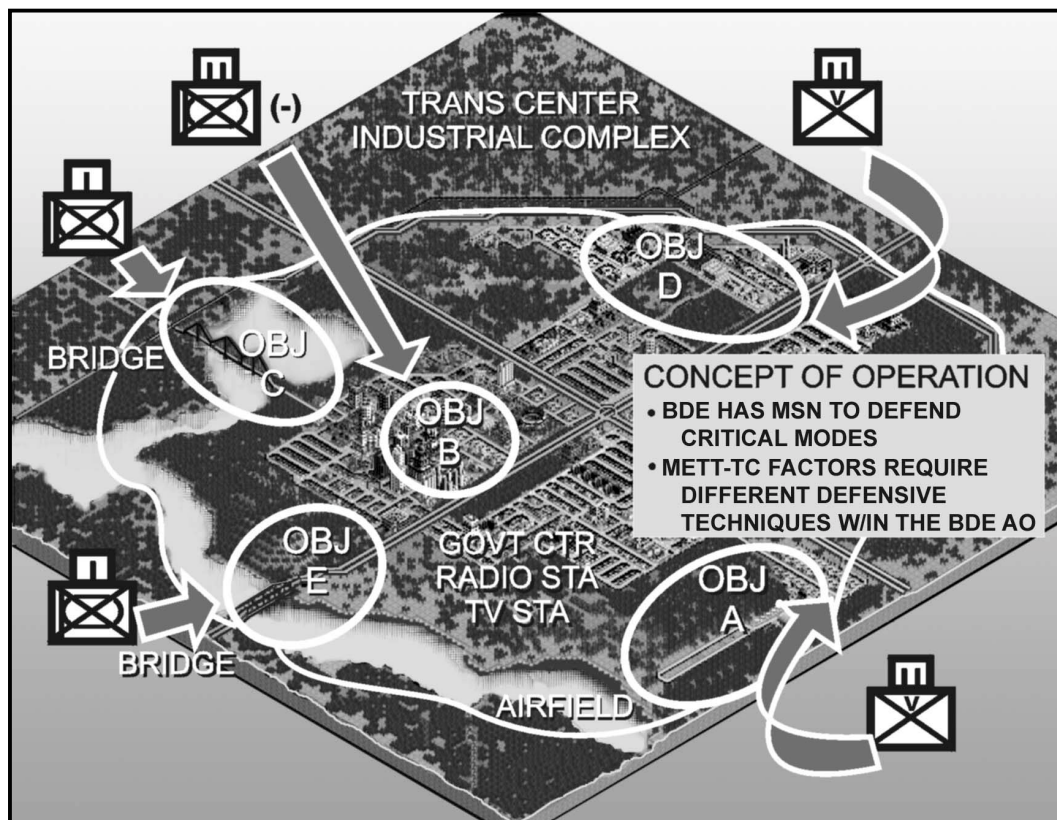

**Figure G-16. Nodal defense, transitional situation.**

**Note:** In Figure G-17 the northern TF defending the transportation center/industrial complex has decided to use a perimeter defense for inner security and has assigned the attached mechanized Infantry company the mission to conduct outer security by means of a screen and manning the designated brigade OP. Other TFs within the brigade AO may be required to use different defensive techniques.



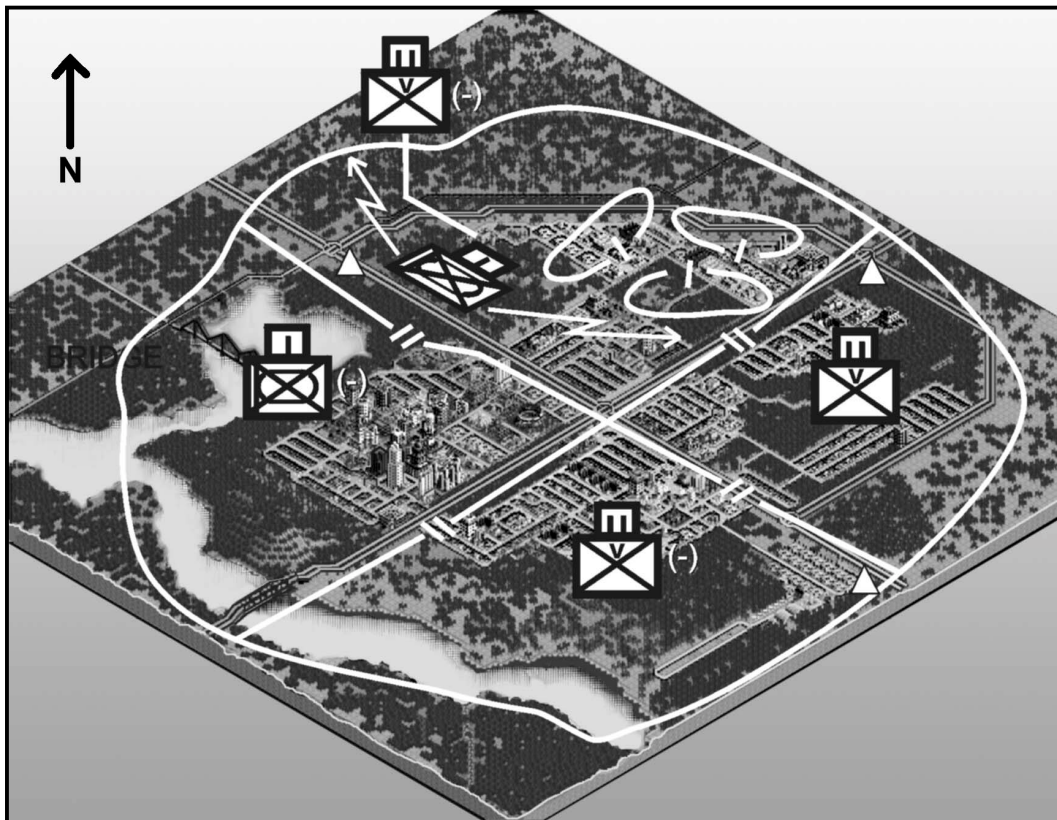

**Figure G-17. Nodal defense, different defensive techniques.**

**Note:** The digital force has the potential to provide accurate threat information that can enhance situational understanding, which facilitates targeting and obstacle placement. JSTARS; GUARDRAIL; unmanned aerial vehicles, if present; and other reconnaissance assets will significantly improve the threat situational understanding and targeting capability of the unit.

### **G-27. DELAY**

The purpose of a delay is to slow the enemy, cause enemy casualties, and stop the enemy (where possible) without becoming decisively engaged or bypassed. The delay can be oriented either on the enemy or on specified terrain such as a key building or manufacturing complex.

a. **Ambushes and Battle Positions.** A delay in an urban area is conducted from a succession of ambushes and battle positions (Figure G-18). The width of the TF zone depends upon the amount of force available to control the area, the nature of the buildings and obstacles along the street and the length of time that the enemy must be delayed.

(1) **Ambushes.** Ambushes are planned on overwatching obstacles and are closely coordinated but they are executed at the lowest levels. The deployment of the TF is realigned at important cross streets. The ambushes can be combined with limited objective attacks on the enemy's flanks. These are usually effective in the edge of open

spaces, parks, wide streets, and so on. Tanks and BFVs should execute these along with dismounted Infantry.

(2) **Battle Positions.** Battle positions should be placed where heavy weapons, such as tanks, BFVs, antiarmor weapons, and machine guns, will have the best fields of fire. Such locations are normally found at major street intersections, parks, and at the edge of open residential areas. Battle positions should be carefully and deliberately prepared, reinforced by obstacles and demolished buildings, and supported by artillery and mortars. They should be positioned to inflict maximum losses on the enemy and cause him to deploy for a deliberate attack.

b. **Two Delaying Echelons.** The TF is most effective when deployed in two delaying echelons, alternating between conducting ambushes and fighting from battle positions. As the enemy threatens to overrun a battle position, the company disengages and delays back toward the next battle position. As the company passes through the company to the rear, it establishes another battle position. Smoke and demolitions are used to aid in the disengagement. Security elements on the flank can be employed to prevent the enemy from out-flanking the delaying force. A small reserve can be used to react to unexpected enemy action and to conduct continued attacks on the enemy's flank.

c. **Engineers.** The engineer effort should first be centralized to support the preparation of battle positions and then decentralized to support the force committed to ambush.

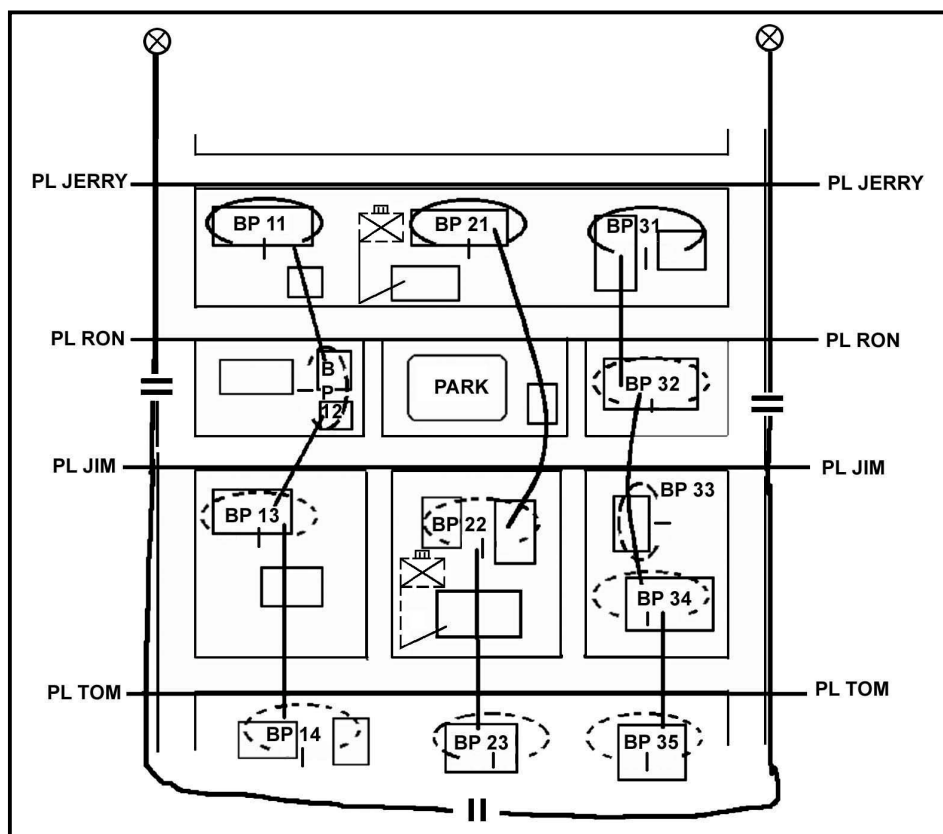

Figure G-18. Battalion delay in an urban area.

## Section VI. STABILITY AND SUPPORT OPERATIONS

Infantry battalions may have to conduct operations in environments that do not involve traditional combat. A battalion may be called upon to conduct a stability or support contingency operation and then have to quickly transition into offensive or defensive operations. The Infantry battalion may also be utilized in a stability or support operation at the successful conclusion of a combat operation. When assigned a stability or support mission, a well-trained battalion must be able to rapidly shift its mission focus from war fighting to stability and support and also from stability and support to war fighting. During a stability or support operation, the Infantry battalion performs numerous missions and tasks not necessarily contained in its mission-essential task list (METL). Essentially, the battalion accomplishes these activities through execution of tactical missions and tasks. Although stability and support operations can occur anywhere, they will most likely occur in an urban environment. (See Appendix C and TC 7-98-1 for additional considerations and specific TTP.) (Definitions of stability and support operations and the types of those operations are included in this paragraph.)

### G-28. STABILITY OPERATIONS

Stability operations encompass a range of actions that shape the strategic environment and respond to developing crises. The purposes of stability operations are to:

- Protect national interests.
- Promote peace or deter aggression.
- Satisfy treaty obligations or enforce agreements and policies.
- Reassure allies, friendly governments, and agencies.
- Encourage a weak or faltering government.
- Maintain or restore order.
- Protect life and property.
- Demonstrate resolve.
- Deter or respond to terrorism.
- Reduce the threat of conventional arms and WMD to regional security.
- Eliminate or contain subversion, lawlessness, and insurgency.

a. **Considerations for Stability Operations.** Conducting stability operations is fundamentally identical to conducting combat operations. While each stability operation is different, the military decision-making process (MDMP) and troop-leading procedures methodologies apply. The considerations listed below supplement those processes and can help the battalion commander and staff in developing tailored concepts and schemes of maneuver for stability operations.

- Leverage interagency, joint, and multinational cooperation.
- Enhance the capabilities and legitimacy of the host nation.
- Understand the potential for unintended consequences of individual and small unit actions.
- Display the capability to use force without threatening the population.
- Act decisively to prevent escalation.
- Apply force selectively and discriminately.
- Stress force protection.



- Emphasize information operations.

b. **Types of Stability Operations.** Table G-2 depicts the types of stability operations a battalion may be called upon to conduct and the missions it will issue its subordinate companies/company teams in order to execute its stability operation(s).

| TYPE                                      | MISSIONS   |
|---|--|
| <b>Peace Operations</b>                   | <p><b>Peacekeeping:</b> employ patrols, establish checkpoints, roadblocks, buffer zones, supervise truce, EPW exchange, reporting and monitoring, negotiation and mediation, liaison, investigation of complaints and violations, civil disturbance missions, and offensive and defensive missions.</p> <p><b>Peace Enforcement:</b> separate belligerents; establish and supervise protected zones, sanction enforcement, movement denial and guarantee, restoration and maintenance of order, area security, humanitarian assistance, civil disturbance missions, and offensive and defensive missions.</p> <p><b>Operations in Support of Diplomatic Efforts:</b> conduct military-to-military contacts, conduct exercises, provide security assistance, restore civil authority, rebuild physical infrastructure, provide structures and training for schools and hospitals, and reestablish commerce.</p> |
| <b>Foreign Internal Defense</b>           | <p><b>Indirect Support:</b> military-to-military contacts, exercises, area security.</p> <p><b>Direct Support:</b> civil-military operations, intelligence and communications sharing, and logistical support.</p> <p><b>Combat Operations:</b> offensive and defensive missions.</p>  |
| <b>Support to Insurgencies</b>            | Show of force, defensive missions, raids, area security, employ patrols, and provide CSS.  |
| <b>Counterdrug Operations</b>             | Liaison and advisor duty, civic action, intelligence support, surveillance support, reconnaissance, logistical support, and information support.   |
| <b>Combating Terrorism</b>                | Conduct force protection, offensive and defensive missions.  |
| <b>Noncombatant Evacuation Operations</b> | Attack to seize terrain that secures evacuees or departure area, guard, convoy security, delay, and defend. (See FM 90-29.)  |
| <b>Arms Control</b>                       | Seize and destroy weapons, convoy escort, assist and monitor inspection of arms, and conduct surveillance.   |
| <b>Show of Force</b>                      | Perform tactical movement, demonstration, defensive operations, and perform training exercises.  |

**Table G-2. Types of stability operations, missions.**

**G-29. SUPPORT OPERATIONS**

Support operations provide essential supplies and services to assist designated groups. They are conducted to help foreign and civil authorities respond to crises. Battalions conduct support operations to save or protect lives, reduce suffering, recover essential infrastructure, improve the quality of life, and restore situations to normal. Again, planning for support operations is fundamentally identical to planning for combat and stability operations. While each support operation is different, the military decision-making process and troop-leading procedures methodologies apply. Considerations that can assist the brigade commander and staff in developing plans for support operations are:

- Provide essential support to the largest number of people.
- Coordinate actions with other agencies.
- Establish measures of effectiveness.
- Hand over to civilian agencies as soon as feasible.
- Conduct robust information operations.
- Secure the force.

a. **Types of Support Operations.** The two types of support operations that battalions will conduct are domestic support operations (DSO) and foreign humanitarian

assistance (FHA). Battalions conduct DSO in the U.S. and its territories and FHA outside the U.S. and its territories. Battalions normally conduct stand-alone FHA operations only in a permissive environment. In uncertain and hostile environments, battalions conduct FHA operations as part of larger stability or offensive and defensive operations.

b. **Forms of Support Operations.** During DSO, battalions perform relief operations, provide support to incidents involving WMD, provide support to law enforcement, and provide community assistance. In FHA, battalions most often conduct relief operations; however, FHA may also involve support to incidents involving WMD and community assistance. Missions and tasks assigned to subordinate companies/company teams often overlap during the conduct of support operations. Table G-3 depicts the more common missions that will be assigned to subordinate companies/company teams.

| FORMS OF SUPPORT OPERATIONS               | MISSIONS   |
|---|--|
| <i>Relief Operations</i>                  | Search and rescue, food & water distribution, providing temporary shelter, transportation support, medical support, sanitation, area security.   |
| <i>Support to Incidents Involving WMD</i> | Assisting law enforcement, area security, protection of critical assets (utilities, transportation, banking, telecommunications), responding to WMD casualties, establishing roadblocks/checkpoints.                           |
| <i>Support to Civil Law Enforcement</i>   | Civil disturbance missions; support to counterterrorism and counterdrug operations; providing resources, training, and augmentation; assisting with cordon and search; security patrols; establish roadblocks and checkpoints. |
| <i>Community Assistance</i>               | Search and rescue, firefighting, assistance in safety and traffic control, emergency snow removal, providing temporary shelter.  |

**Table G-3. Types of support operations, missions.**

c. **Other Agencies.** Support operations rely on a partnership with other government and nongovernment organizations. Liaison with these agencies and between local governments is critical. Regardless of the positive relationships built, force protection always remains a top priority.

**G-30. TRANSITION TO COMBAT OPERATIONS**

Stability, and to a lesser extent, support operations are missions that may transition to combat. An escalation to combat is a clear indicator that the peace operation failed. The battalion must always retain the ability to conduct offensive and defensive operations. Preserving the ability to transition allows the battalion to maintain initiative while providing force protection.

a. **Perception of Power.** The knowledge that the battalion is a viable presence because of the combat power it possesses must be coupled with the perception that it will employ its power if necessary. This perception is the primary means by which the battalions deter escalation to hostile action. The commander must plan for contingency operations that factor in what actions companies will perform if combat cannot be averted. In addition, how the battalion is task organized and how the AO is designed must support an expeditious transition.

b. **Balanced Mindset.** Soldiers must be able to properly adjust and balance the mindset of peace operations and the mindset of war fighting. Soldiers cannot become too

complacent in their warrior spirit, but also must not be too eager to rely on the use of force to resolve conflict. This balance is the essence of peace operations and the fundamental aspect that will enable the Infantry battalion to perform its mission successfully and avoid an escalation to combat.

c. **Combat Skills Training.** If the stability or support operation extends over prolonged periods of time, training should be planned that focuses on the individual and collective combat tasks that would be performed during transition to offensive and or defensive missions.

## Section VII. OTHER ASSETS

Lessons learned from recent operations in urban areas have clearly demonstrated the value of the fully integrated combined arms team. Urban combat never should be considered a pure Infantry task. Urban combat by units composed entirely of Infantrymen is a historical anomaly. Across the spectrum of combat action in urban areas, powerful combined arms teams produce the best results. Infantry units operating alone suffer from critical shortcomings that can be compensated for only by appropriate task organization with mechanized Infantry, armor, and engineers. These teams must be supported by closely integrated aviation, fire support, communications, and logistical elements. This paragraph discusses the more common combat support assets available to the Infantry battalion for the execution of UO.

### G-31. ARMORED VEHICLES

The capabilities, limitations, and employment of armored vehicles are discussed in the following paragraphs. (See Appendix D, Section IV for additional considerations and TTP.)

a. **Capabilities.** Some of the capabilities of armored vehicles are:

(1) The thermal sights on armored vehicles can detect enemy activity through darkness and smoke, conditions that limit even the best-equipped Infantry. They also provide greater range (4,000+ meters) in most instances.

(2) Armored vehicles can deliver devastating fires; are fully protected against antipersonnel mines, fragments, and small arms; and have excellent mobility along unblocked routes.

(3) Armored vehicles project a psychological presence, an aura of invulnerability that aids the friendly forces in deterring violence. Mounted patrols by armored vehicles can monitor large areas of a city while making their presence known to the entire populace, both friendly and unfriendly.

(4) BFVs can move Infantrymen rapidly to points where, together, they can dominate and isolate the cordoned area. Armored vehicles can also support troop convoy movements in wheeled vehicles. With their long-range sights and weapons, armored vehicles can dominate large expanses of open area and thus free Infantry to isolate closer terrain and visual dead space.

(5) The mobile protected firepower of armored vehicles can be used to add security to resupply convoys and to extract wounded personnel under fire. The armored vehicle's smoke grenade launcher capability can aid this and other small-unit actions.

b. **Limitations.** Some of the limitations of armored vehicles are:

(1) Armored vehicle vision blocks provide the crewman with poor all-round vision. Smoke or dust easily blinds crewmen. Tanks cannot depress their main gun enough to engage targets at very close range to the vehicle or elevate it to engage targets in tall buildings.

(2) If isolated or unsupported by Infantry, armored vehicles are vulnerable to enemy hunter/killer teams firing light and medium antiarmor weapons. Because of the abundance of cover and concealment in urban terrain, armored vehicle gunners may not be able to easily identify enemy targets unless the commander exposes himself to fire by opening his hatch or Infantrymen direct the gunner to the target.

(3) Armored vehicles are noisy. Therefore, there is little chance of them arriving in an area undetected. Improvised barricades, narrow streets and alleyways, or large amounts of rubble can block armored vehicles.

(4) Due to the length of the tank main gun, the turret will not rotate if a solid object is encountered; for example, a wall, post, and so forth. Heavy fires from armored vehicles cause unwanted collateral damage or can destabilize basic structures.

(5) The main gun of an M1A1 can only elevate (+)20 degrees and depress (-)9 degrees. Examples of standoff distances for buildings where a HEAT round is used are:

- Ground floor - 2.5 meters from the target.
- 3d story - 23 meters from the target.
- 18th story - 132 meters from the target.

**Note:** Figure G-19 shows the difference in the capabilities of the BFV and the M1 tank with regard to fields of fire on urban terrain. Note that the BFV can engage a target 9 to 10 stories high at 20 meters, whereas an M1 tank requires 90 meters. While the tank main gun has these limitations, targets can be engaged by the M2HB and M240 machine guns that are part of the tank's weapon system.

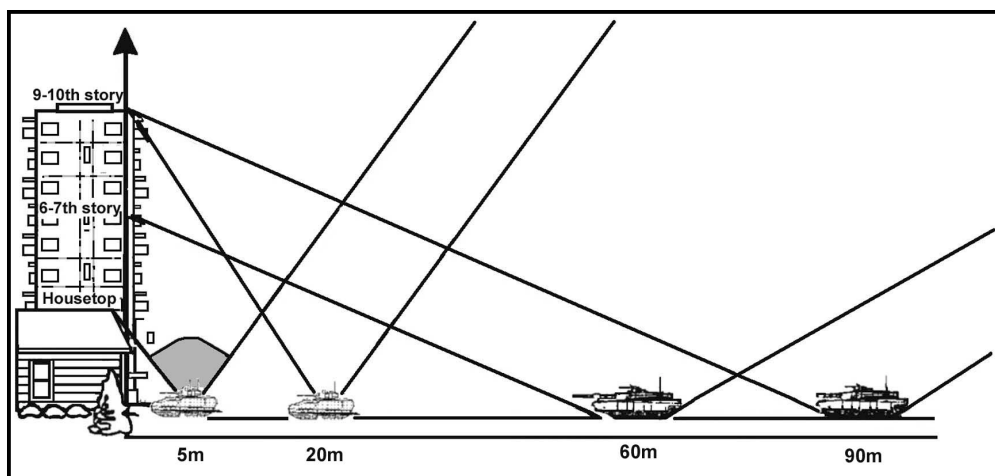

**Figure G-19. Fields of fire on urban terrain.**

c. **Employment.** Armored vehicles can support Infantry during urban combat operations by:

- Providing shock action and firepower.

- Isolating objectives with direct fire to prevent enemy withdrawal, reinforcement, or counterattack.
- Neutralizing or suppressing enemy positions with smoke, high explosive (HE), and automatic weapons fire as Infantry closes with and destroys the enemy.
- Assisting opposed entry of Infantry into buildings when doorways are blocked by debris, obstacles, or enemy fire.
- Smashing through street barricades or reducing barricades by fire.
- Obscuring enemy observation using on-board smoke generators.
- Holding cleared portions of the objective by covering avenues of approach.
- Attacking by fire any other targets designated by the Infantry.
- Establishing roadblocks or checkpoints.
- Suppressing identified sniper positions.

### **G-32. ENGINEERS**

Normally an engineer platoon will be attached to an Infantry battalion. In some situations, additional engineers may be attached or OPCON to the battalion depending on the mission that it may have to conduct. For example, a battalion that has a requirement to conduct numerous explosive breaches as the main effort for a brigade attack may receive additional engineer units.

a. **Offensive Missions.** Engineers may perform the following missions during offensive operations in an urban area:

- Conduct a technical reconnaissance to determine the location and type of enemy obstacles and minefields, and to make breaching recommendations.
- Clear barricades and heavy rubble with earth-moving equipment or explosives to assist forward movement.
- Use explosives to destroy fortifications and strongpoints that cannot be reduced with the maneuver unit's organic assets.
- Use the engineer equipment, if available, to destroy structures or to clear rubble.
- Lay mines to protect flanks and rear areas.
- Conduct mobility operations (gap crossing).
- Locate and remove mines that may hamper the unit's movement.
- Conduct breaching operations.
- Conduct route reconnaissance.

b. **Defensive Missions.** Engineers may perform the following missions during the defense of an urban area:

- Construct complex obstacle systems.
- Rubble buildings.
- Lay mines.
- Develop and provide mine/obstacle overlay to leaders.
- Assist in the preparation of defensive positions and strongpoints.
- Maintain counterattack, communications, and resupply routes.
- Enhance movement between buildings, catwalks, bridges, and so on.
- Crater roads.

- Clear fields of fire.
  - Fight as Infantry, when needed.
- c. **Defense Against Armor.** In defensive situations, when opposed by an armor-heavy enemy, priority should be given to the construction of antiarmor obstacles throughout the urban area. Use of local materials, where possible, makes obstacle construction easier and reduces logistics requirements. Streets should be barricaded in front of defensive positions at the effective range of antitank weapons. These weapons are used to increase the destruction by antiarmor fires, to separate enemy Infantry from their supporting tanks, and to assist in the delay and destruction of the attacker. Antitank mines in and around obstacles and covered by fires help synchronize a defensive fire plan.

### **G-33. FIELD ARTILLERY**

Appropriate fire support coordination measures should be carefully considered since fighting in urban areas results in opposing forces fighting in close combat. When planning for fire support in an urban area, the battalion S3 and FSO should consider the following:

- a. Target acquisition may be more difficult because of the increased cover and concealment afforded by the terrain. Ground observation is limited in urban areas, therefore FOs should be placed high. Adjusting fires is difficult since buildings block the view of adjusting rounds; therefore, the lateral method of adjustment may be most useful.
- b. Initial rounds are adjusted laterally until a round impacts on the street perpendicular to the FEBA. Airburst rounds are best for this adjustment. The adjustments must be made by sound. When rounds impact on the perpendicular street, they are adjusted for range. When the range is correct, a lateral shift is made onto the target and the gunner fires for effect.
- c. Special consideration must be given to shell and fuze combinations when effects of munitions are limited by buildings.
- Careful use of VT is required to avoid premature arming.
  - Indirect fires may create unwanted rubble and collateral damage.
  - The close proximity of enemy and friendly troops requires careful coordination.
  - WP may create unwanted fires and smoke.
  - Fuze delay should be used to penetrate fortifications.
  - Illumination rounds can be effective; however, friendly positions should remain in shadows and enemy positions should be highlighted. Tall buildings may mask the effects of illumination rounds.
  - VT, TI, and ICM are effective for clearing enemy positions, observers, and antennas off rooftops.
  - Swirling winds may degrade smoke operations.
  - Scatterable mines (SCATMINE) may be used to impede enemy movements. SCATMINE effectiveness is reduced when delivered on a hard surface.
- d. Target acquisition is difficult in urban terrain because the enemy has many covered and concealed positions and movement lanes. The enemy may be on rooftops and in buildings, and may use sewer and subway systems. Aerial observers are extremely valuable for targeting because they can see deep to detect movements, positions on

rooftops, and fortifications. Targets should be planned on rooftops to clear away enemy FOs as well as communications and radar equipment. Targets should also be planned on major roads, at road intersections, and on known or likely enemy positions. Employing artillery in the direct fire mode to destroy fortifications should be considered, especially when assaulting well prepared enemy positions. Also, restrictive fire support coordination measures, such as a restrictive fire area or no-fire area may be imposed to protect civilians and critical installations.

e. Self-propelled howitzers, 155-mm, are effective in neutralizing concrete targets with direct fire. Concrete-piercing 155-mm rounds can penetrate 36 inches of concrete at ranges up to 2,200 meters. The mounted .50-caliber machine gun can also be used as direct fire support. This howitzer must be closely protected by Infantry when used in the direct-fire mode, since the howitzers do not have any significant protection for their crews.

f. Forward observers must be able to determine where and how large the dead spaces are. This area is a safe haven for the enemy because he is protected from indirect fires. For low-angle artillery, the dead space is about five times the height of the building. For high-angle artillery, the dead space is about one-half the height of the building.

g. Aerial observers are effective for seeing behind buildings immediately to the front of friendly forces. They are extremely helpful when using the ladder method of adjustment because they may actually see the adjusting rounds impact behind buildings. Aerial observers can also relay calls for fire when communications are degraded due to power lines or masking by buildings.

h. Radar can locate many artillery and mortar targets in an urban environment because of the high percentage of high-angle fires. If radar is sited too close behind tall buildings, some effectiveness will be lost.

i. The use of airburst fires is an effective means of clearing snipers from rooftops. HE shells with delay fuzes may be effective against enemy troops in the upper floors of buildings, but, due to the overhead cover provided by the building, such shells have little effect on the enemy in the lower floors.

#### **G-34. MORTARS**

Mortars are well-suited for combat in urban areas because of their high rate of fire, steep angle of fall, and short minimum range. The battalion commander and S3 must plan mortar support in conjunction with the FSO as part of the total fire support system. (See FM 7-90 for detailed information on the tactical employment of mortars.)

a. **Role of Mortar Units.** The role of mortar units is to deliver suppressive fires to support maneuver, especially against dismounted Infantry. Mortars can be used to obscure, neutralize, suppress, or provide illumination during urban operations. Mortar fires inhibit enemy fires and movement, allowing friendly forces to maneuver to a position of advantage. The most common and valuable use for mortars is often harassment and interdiction fires. One of their greatest contributions is interdicting supplies, evacuation efforts, and reinforcement in the enemy rear just behind his forward defensive positions. During both World War II and Middle East conflicts, light mortar HE fires have been used extensively during urban combat to deny the use of streets, parks, and plazas to enemy personnel. Finally, mortars can be used, with some

limitations, against light armor and structures. Effectively integrating mortar fires with dismounted maneuver is key to successful combat in an urban area.

b. **Position Selection.** The selection of mortar positions depends on the size of buildings, the size of the urban area, and the mission. Rubble can be used to construct a parapet for firing positions. Positions are also selected to minimize counterbattery fire.

(1) **Existing Structures and Masking.** The use of existing structures (for example, garages, office buildings, or highway overpasses) for positions is recommended to afford maximum protection and minimize the camouflage effort. Proper masking can enhance survivability. If the mortar has to fire in excess of 885 mils to clear a frontal mask, the enemy counter-battery threat is reduced. These principles can be used in both the offense and the defense.

(2) **Use of Sandbags.** Mortars should not be mounted directly on concrete; however, sandbags may be used as a buffer. Sandbags should consist of two or three layers; be butted against a curb or wall; and extend at least one sandbag width beyond the baseplate.

(3) **Placement.** Mortars are usually not placed on top of buildings because lack of cover and mask makes them vulnerable. They should not be placed inside buildings with damaged roofs unless the structure's stability has been checked. Overpressure can injure personnel, and the shock on the floor can weaken or collapse the structure.

c. **Communications.** Initially, radio may be the primary means of communication during urban combat. An increased use of wire, messenger, and visual signals will be required. However, wire should eventually be the primary means of communication between the forward observers, fire support team, fire direction center, and mortars since elements are close to each other. Also, FM radio transmissions in urban areas are likely to be erratic. Structures reduce radio ranges; however, placing antennas on upper floors or roofs may improve communications and enhance operator survivability. Another technique that applies is the use of radio retransmissions. A practical solution is to use existing civilian systems to supplement the unit's capability, understanding that this is an unsecure method of communication.

d. **Magnetic Interference.** In an urban environment, all magnetic instruments are affected by surrounding structural steel, electrical cables, and automobiles. Minimum distance guidelines for the use of the M2 aiming circle (FM 23-90) will be difficult to apply. To overcome this problem, an azimuth is obtained to a distant aiming point. From this azimuth, the back azimuth of the direction of fire is subtracted. The difference is indexed on the red scale and the gun manipulated until the vertical cross hair of the sight is on the aiming point. Such features as the direction of a street may be used instead of a distant aiming point.

e. **High-Explosive Ammunition.** During urban combat, mortar HE fires are used more than any other type of indirect fire weapon. Although mortar fires are often targeted against roads and other open areas, the natural dispersion of indirect fires will result in many hits on buildings. Leaders must use care when planning mortar fires during MOUT to minimize collateral damage.

(1) High-explosive ammunition, especially the 120-mm projectile, provides good results when used against lightly built structures within cities. However, it does not perform well against reinforced concrete found in larger urban areas.

(2) When using HE ammunition in urban fighting, only point detonating fuzes should be used. The use of proximity fuzes should normally be avoided, because the nature of



urban areas causes proximity fuzes to function prematurely. Proximity fuzes, however, are useful in attacking some targets such as OPs on tops of buildings.

f. **Illumination.** Based on the close nature of urban combat, consideration should be given to the use of infrared (IR) illumination if the factors of METT-TC permit its use and friendly forces have a technological advantage over the enemy in terms of night vision devices (NVDs). Both IR and standard illumination rounds may cause unwanted urban fires if they come in contact with flammable structures or materials. Planning considerations must also include building height and the probability of rounds drifting and making contact with the sides of buildings, thus reducing their effectiveness. In some cases, ground burst may be more advantageous. In the offense, illumination rounds are planned to burst above the objective. If the illumination were behind the objective, the enemy troops would be in the shadows rather than in the light. In the defense, illumination is planned to burst behind friendly troops to put them in the shadows and place the enemy troops in the light. Buildings reduce the effectiveness of the illumination by creating shadows. Continuous illumination requires close coordination between the FO and FDC to produce the proper effect by bringing the illumination over the defensive positions as the enemy troops approach the buildings.

g. **Special Considerations.** When planning the use of mortars, commanders must consider the following:

(1) FOs should be positioned where they can get the maximum observation so target acquisition and adjustments in fire can best be accomplished. This is not necessarily on tops of buildings

(2) Commanders must understand ammunition effects to correctly estimate the number of volleys needed for the specific target coverage. Also, the effects of using WP or RP may create unwanted smoke screens or limited visibility conditions that could interfere with the tactical plan and may cause unwanted structural fires.

(3) FOs must be able to determine dead space in urban terrain. Dead space is the area in which indirect fires cannot reach the street level because of buildings. This area is a safe haven for the enemy. For mortars, the dead space is about one-half the height of the building.

(4) Mortar crews should plan to provide their own security.

(5) Commanders must give special consideration to where and when mortars are to displace while providing immediate indirect fires to support the overall tactical plan. Combat in urban areas adversely affects the ability of mortars to displace because of rubble and the close nature of urban combat.

### **G-35. HELICOPTER SUPPORT**

Infantry units may be supported by attack helicopters and assault and lift helicopters.

a. **Attack Helicopters.** Infantry units may be supported by a variety of attack helicopters ranging from fully modernized AH-64s to lightly armed but agile OH-58Ds. Regardless of the specific type of attack helicopter available, the same missions and tasks can be accomplished due to the inherent flexibility of Army aviation units. Due to the increased risk of small arms and man-portable air defense systems (MANPADS) engagements, aviation forces normally support UO by operating away from urban areas (such as isolation of objective); however, if the payoff is higher than the associated risk, aviation forces can be employed in and around the urban area.

(1) **Common Missions.** The most common missions assigned to attack helicopters during urban operations are:

- Escort of troop-carrying aircraft during air assaults.
- Overwatch and support attacks integrated with the ground commander's maneuver.
- Interdiction and destruction of enemy armored vehicles moving against friendly forces.
- Isolation of urban objectives.
- Reconnaissance.
- Security of friendly locations.
- Convoy escort duty.
- Precision engagement of hardened point targets.
- Participating in show of force operations.
- Escorting NEO mission aircraft.

(2) **Other Missions.** Attack helicopters may be called on to perform some additional, nontraditional roles during urban operations. This is particularly true during support operations and stability operations in urban areas. Additional missions may include:

- Assisting, for limited periods, in the control and coordination of fires with the maneuver of ground forces.
- Providing limited relay of radio messages from isolated ground units.
- Marking or identifying specific buildings and areas by smoke, fires, or targeting lasers.
- Videotaping routes or objectives for later analysis by ground commanders.
- Providing navigational and directional assistance to ground units.
- Providing limited area illumination by infrared or white light using either on-board sources or illumination rockets.
- Providing countersniper and countermortar armed reconnaissance patrols around friendly unit locations.

(3) **Weapons Limitations.** Urban terrain limits weapons employment.

(a) Weapons use may be limited by the short arming/slant ranges within the urban area. Precision weapons, such as TOW and Hellfire missiles, require about 65 and 500 meters minimum range, respectively, to reliably arm and stabilize on the intended target. Often, fire from longer ranges actually improves accuracy. The shaped charge of the Hellfire produces less damage and over-pressurization than the TOW's high-explosive rounds when fired against buildings. Window engagements are generally not recommended, since the missile will usually impact the far wall of the structure, expending its blast energy away from the structure. Missile impact on the facing structure will normally cause over-pressurization inside the structure (near the impact) as well as secondary fragmentation of wood/concrete, which can neutralize or stun occupants in the vicinity of the impact.

(b) Extensive use of precision weapons by several units in close proximity may cause coordination problems with target identification and designation.

(c) Laser designation by both ground and aerial systems may be degraded by the large expanses of polished, flat reflective surfaces common in many urban areas. High

volumes of smoke and dust associated with burning buildings and urban combat can prevent accurate laser designation required for precision engagements.

(d) Aircraft cannon fire against buildings can be devastating. These fires provide excellent suppression and can drive enemy forces away from firing positions or fix the enemy in place until ground maneuver forces can destroy him. Enemy positions that have been struck by fire can normally be reoccupied quickly by the enemy. Ricochets from these rounds are common; they can cause additional collateral damage and pose a danger to nearby friendly forces.

(e) Target identification and marking may be difficult because of heavy smoke and dust rising from urban fires and explosions. Some smoke from fires in industrial areas may be highly toxic or irritating. Pilots may have to don chemical protective equipment that hinders target detection and engagement. Friendly unit locations and personnel can be marked with colored panels, glint tape, strobe lights, and colored smoke. Targets can be marked with infrared laser pointers, such as the GCP-1 Ground Commander Pointer/Illuminator, colored M203 smoke rounds, M203 or mortar flares burning on the ground, or tracer fires. In some situations, improvised spotlights can also be used.

(f) Although fire from stationary positions is more accurate, running fire is normally safer for the aircraft due to enemy ground fire. If possible, ground commanders should avoid directing pilots along a gun-target line that passes over friendly troops. Gun-target runs that are perpendicular to the friendly unit's front are normally best.

(g) 2.75 rockets (area fire) with HE warheads have a burst radius in excess of 50 meters and are effective in the destruction of C4 structures, thin-skinned vehicles, ADA and damaging/breaching concrete and wood structures. But when fired in pairs or more, the rockets have a large dispersion pattern and pose a potential accuracy and fratricide problem.

b. **Assault and Lift Helicopters.** Infantry units may be supported by a variety of assault or lift helicopters, normally the UH-60 and CH-47. These assets can be crucial for the flexible and responsive movement of troops and supplies and C2.

(1) **Common Missions.** The most common missions assigned to assault and lift helicopters during urban operations are:

- Air assaults.
- CASEVAC/MEDEVAC.
- Air movement of troops and supplies.
- Emplace logistical resupply points.
- Conduct/support C2 operations.
- Conduct/support NEO.

(2) **Other Missions.** In addition to the missions listed above, assault/lift helicopters may be called on to perform some additional, nontraditional roles or roles requiring special mission equipment. Additional missions may include the following:

- Conduct EW operations.
- Conduct combat search and rescue (CSAR).
- Emplace aerial delivery mines; for example, Volcano mines.
- Emplace large/heavy obstacles (abandoned vehicles, concrete dividers, and so on).

c. **Aircraft Power Limitations and Time on Station.** The need to deliver hovering fires from temporary battle positions may require the aircraft to carry less than a full load

of munitions or fuel. This is especially true in hot climates and high altitudes. Reduced loads mean more frequent trips to forward area refuel and rearm points and less time on station. Long route distances during air movements may require the establishment of forward arming and refuel points (FARP) along the route prior to operations. Climate will also affect the number of troops or amount of supplies the aircraft can transport.

d. **Command and Support Relationships.** From the ground unit perspective, helicopters are most effective when they operate under the OPCON of the ground unit commander closest to the enemy. Normally, the Infantry battalion is the lowest level granted formal OPCON of helicopters. During attack helicopter operations, the Infantry battalion commander is rarely able to identify the precise location of enemy forces or to coordinate aerial fires with friendly squad and platoon maneuver. He often must pass the responsibility for close coordination of attack helicopter fires to the company commander or platoon leader on the scene. This ground maneuver leader can direct the efforts of only a few aircraft at a time. It may be more effective for the aviation unit to retain control of its individual aircraft and operate by continuously rotating attack helicopter elements into the battle area where they then coordinate their attacks with the ground commander's maneuver. Generally, the smaller and more decentralized the combat operations, the better it is to have armed aircraft coordinate directly with the small-unit leader on the ground. The larger, more centralized the combat action, the better it is to retain control of armed aircraft by the aviation headquarters. Whichever command and support relationship is chosen, both the ground and the aviation headquarters must understand what is expected of the other. Close liaison and clear, concise verbal communications are important.

e. **Pickup Zone (PZ) and Landing Zone (LZ) Selection.** Care must be taken when selecting a PZ or LZ. Urban areas may often contain actual or potential debris that is either on the surface or supersurface of the urban area. For example, surface debris can contain rubble that can damage the helicopter due to the aircraft's rotor wash. Likewise, buildings may be poorly constructed and pieces of roofing or siding may also damage the helicopter due to the rotor wash. Downing of rotary wing aircraft is possible and significant collateral damage may occur.

### **G-36. TACTICAL AIR**

A battalion may be supported by USAF, USN, USMC, or allied fighters and attack aircraft while fighting in urban areas.

a. **Advantages and Disadvantages.** Some advantages and disadvantages of CAS are:

(1) **Shock and Concussion.** Heavy air bombardment provides tactical advantages to an attacker. The shock and concussion of the bombardment reduce the efficiency of defending troops and can destroy defensive positions.

(2) **Rubble and Debris.** The rubble and debris resulting from air attacks may increase the defender's cover while creating obstacles and obstructions to the movement of attacking forces.

(3) **Proximity of Friendly Troops.** The proximity of opposing forces to friendly troops may require the use of precision-guided munitions and may require the temporary disengagement of friendly forces in contact. The AC-130 is an air weapons platform of

choice for precision urban engagements if the proximity of friendly troops precludes other tactical air use.

(4) **Indigenous Civilians or Key Facilities.** The use of air weapons may be restricted by the presence of civilians or the requirement to preserve key facilities within a city.

(5) **Limited Ground Observation.** Limited ground observation may require the use of airborne FAC.

b. **Offensive Operations.** CAS may be employed during offensive operations—

- To support the isolation of the urban area by interdicting entry and exit routes.
- To support attacking units by reducing enemy strongpoints with precision-guided munitions.
- To conduct tactical air reconnaissance and to provide detailed intelligence of enemy dispositions, equipment, and strengths.

c. **Defensive Operations.** CAS may be employed during defensive operations—

- To strike enemy attack formations and concentrations outside and inside the urban area.
- To provide precision-guided munitions support to counterattacks for recovering fallen friendly strongpoints.

### G-37. AIR DEFENSE

Basic air defense doctrine does not change when units operate in urban areas. The fundamental principles of mix, mass, mobility, and integration all apply to the employment of air defense assets.

a. The battalion staff must consider the following when developing the air defense plan:

(1) Enemy air targets, such as principal lines of communications, road and rail networks, and bridges, and friendly troop locations are often found in and around urban areas.

(2) Good firing positions may be difficult to find and occupy for long-range air defense missile systems in urban areas. Therefore, the number of weapons the commander can employ may be limited.

(3) Movement between positions is normally restricted in urban areas.

(4) Long-range systems can provide air defense cover from positions on or outside of the edge of the urban area.

(5) Radar masking and degraded communications may reduce air defense warning time for all units. Air defense control measures must be adjusted to permit responsive air defense within a reduced warning environment.

b. Positioning of the Avenger weapons system in urban areas is often limited to more open areas to prevent weapons masking such as parks, fields, and rail yards. Avengers may be placed on rooftops in dense urban areas to provide protection against air attacks from all directions. This should be accomplished only when justified by the expected length of occupation of the area and the enemy air threat.

c. MANPADS, such as Stingers, provide protection similar to nonurban operations. When employed within the urban area, rooftops normally offer the best firing positions.

d. Heavy machine guns emplaced on rooftops can also provide additional air defense protection.

**G-38. ANTIARMOR WEAPONS**

The urban environment will not change the tactical use of these weapons, but it can limit how they are employed. Some of those limitations are: stand-off; obstructions for wire-guided missiles; displacement after engagements; firing in-depth engagements; more obstacles; increased danger zones; and all-round security. Although antiarmor weapons are primarily designed to destroy armored vehicles, they also can be used to damage or destroy some field fortifications. Additionally, they can be used for ballistic breaching of doorways that are being used for entry points to buildings, or by creating deceptions just before the assault element enters the actual initial breach (entry) point. Larger antiarmor systems that have high magnification day and thermal sights can be used to detect snipers and to suppress or destroy them with long-range precision fires. Most medium and heavy antiarmor weapons have their own local security since they are crew served, thus eliminating the need to assign additional security. However, when these weapons are fired, they quickly become priority targets, making them susceptible to enemy fire. Major considerations for planning offensive and defensive operations are:

a. **Offensive Operations.** When employing antiarmor weapons in the offense, assign them to an area that overwatches the assault force and where mounted enemy ambushes are likely such as roads, road intersections, alleys, and large open areas. Place them so they can establish a blocking force along main access routes to the objective and where they can isolate the objective against armor counterattacks.

**Note:** Overhead wire obstructions are the main concern when firing guided missiles. Wire obstacles will be prevalent throughout urban areas causing problems with in flight missiles, wire guided missiles, and rockets. Overhead wires can deflect guided missiles from their flight path when their control fins make contact with the wire. Firing a wire guided missile over power lines can burn the tracking wires, causing the loss of the missile, and, possibly, causing damage to the weapon system and crew. Most missiles are armed 50 meters or more from the weapon.

b. **Defensive Operations.** When assigning the antiarmor weapons their engagement areas, ensure they are positioned to achieve maximum standoff. They should also be positioned in-depth to exploit their maximum ranges. This may not always be possible within urban areas, which contain numerous obstacles and relatively short engagement ranges. Close engagement areas that limit standoff will only give the crew time for one shot, with no time for reloading if they have to fire multi-engagements. For this reason, antiarmor weapons should always be employed in pairs. One fires and the other supports by fire.

c. **TOW.** These weapon systems are used to defeat heavy or light armor threats from outside or inside the urban area, in lieu of assigned armored vehicles. They cannot apply the same amount of firepower but, when employed in pairs, they can destroy and disrupt armored units long enough to give commanders time to bring other assets into play. The TOW can engage targets at a range of 3,750 meters using an AN/TAS 4 12X day/night 24X zoom thermal sight. All BFV platoons have organic TOWs on each BFV.

(1) **Advantages.** Some of the employment advantages of the TOW are:

- Offers greater range, accuracy, and lethality than other antiarmor weapons.

- Will destroy all known armor vehicles.
- Gives leaders far seeing OP capabilities day or night using the day sight and thermal sight.
- The HMMWV TOW carrier has a M240 machinegun for crew safety, and can be used against dismounted enemy troops. This gives the leader a two-fold weapon when used to overwatch assault elements or when isolating buildings.
- The HMMWV carrier has a HIMS (HMMWV Interchangeable Mount System) that allows the TOW system to be in a ready to fire configuration with the addition of the M249 or the M240/.50 caliber also mounted. The HIMS can also mount an M19 Grenade launcher but not at the same time as the TOW.
- The TOW system can assist in detecting enemy snipers and destroy or suppress them. When engaging a sniper in a building, aim at the wall next to the window or fortified position he is firing from. The structure will set off the missile warhead, causing inner spalling of the wall and tremendous heat within the room. If a missile is fired through a window and impacts on a back wall, debris and heat from the explosion will permeate the room.

(2) **Disadvantages.** Some of the employment disadvantages of the TOW are:

- The missile is wire guided, which restricts firing from elevated positions where power lines cross the engagement areas.
- The crew is vulnerable to small arms fire when mounted on the HMMWV carrier.
- The missile has a noticeable firing signature that can give away positions.
- The missile has dangerous backblast areas that restrict firing inside of structures.

d. **Javelin.** The Javelin is a crew-served, medium range, fire-and-forget system. Unlike conventional wire-guided missiles, the Javelin automatically guides itself to the target after launch. Soldiers can reposition immediately after firing or reload to engage another threat. The Javelin has two attack modes, the top-attack and the direct-attack. The Javelin command launch unit (CLU) incorporates a passive surveillance sight, fully capable in day or night, at ranges of 2,000 meters, in most weather conditions.

(1) **Advantages.** Some of the employment advantages of the Javelin are:

- Has a soft launch design, which allows it to be safely fired from inside buildings or covered fighting positions.
- Will destroy all known armored vehicles.
- Gives leaders far seeing OP capabilities day or night using the 4X day sight and 4X and 9X thermal sight
- Offers more range, accuracy, and lethality, than the Dragon.
- Fire-and-forget, with no attached wires.
- In lieu of the TOW, the Javelin can assist in locating enemy snipers and destroy or disrupt them. When engaging a sniper in a building, aim at the wall next to the window or fortified position he is firing from. The structure will set off the missile warhead, causing inner spalling of the wall and tremendous heat within the room. If a missile is fired through a window and impacts on a back wall, debris and heat from the explosion will permeate the room.

(2) **Disadvantages.** Some of the employment disadvantages of the Javelin are:

- Overhead wires can impede the missile flight.
  - The missile requires a large overhead clearance from launch point to target.
- e. **Dragon.** The Dragon is a crew-served medium range antiarmor weapon that can be employed to track and engage targets at a range of 1,000 meters, with a 4X day sight or 4X thermal sight.
- (1) **Advantages.** Some of the employment advantages of the Dragon are:
- Will destroy most armored vehicles.
  - Can track and engage targets day or night.
- (2) **Disadvantages.** Some of the employment disadvantages of the Dragon are:
- System is wire guided, which restricts firing from elevated positions where power lines cross the engagement areas.
  - It has noticeable firing signatures that can give away positions.
  - It has dangerous backblast areas that restrict firing inside structures.

### G-39. MILITARY POLICE

Military police operations play a significant role by assisting the battalion in meeting the challenges associated with UO. MPs provide a wide range of diverse support in urban areas, to include area damage control, area security, and EPW operations and non-combatant operations. MP operations require continuous coordination with host nation civilian police to maintain control of the civilian population and to enforce law and order. MPs are not normally placed under the battalion's control, however it is likely that MP squad(s) may be available to assist the battalion when operations are conducted in urban areas. These MP assets may be attached or OPCON to the battalion for the duration of a specific mission and then will be released to the control of the brigade or battalion commander or to their parent unit. Their training in urban operations can be of great assistance for help in crowd control, roadblocks/checkpoints, and EPW control.

a. **Area Damage Control.** MP units take measures to support area damage control operations that are frequently found in urban areas. With the increased possibility of rubble, MP units report, block off affected areas, and re-route movement to alternate road networks.

b. **Area Security.** MP units also secure critical areas, such as communications centers and water and electrical supply sources. These MP assets can assist a battalion that is assigned such a mission. (See Sections V and VI.)

c. **EPW and Noncombatant Operations.** MP units are tasked with EPW and noncombatant operations and must perform them as far forward as possible. MPs operate collecting points and holding areas to briefly retain EPWs and noncombatants. EPW and noncombatant operations are of great importance in urban areas because the rate of capture of EPWs and the presence of noncombatants can be higher than normal. Battalions can use MP assets to assist them in conducting these types of operations.

### G-40. COMMUNICATIONS

One of the biggest challenges for the battalion staff will be to maintain communications with subordinate elements. Buildings and electrical power lines reduce the range of FM radios. Remoting radio sets or placing antennas on rooftops can solve the range problem for CPs and trains. Companies do not have the assets to ensure continuous



communications and the battalion staff will have to plan for continual movement of battalion assets to support company operations.

a. **Wire.** Wire is a more secure and effective means of communications in urban areas. Wire should be laid overhead on existing poles, underground, or through buildings to prevent vehicles from cutting them.

b. **Messengers and Visual Signals.** Messengers and visual signals can also be used in urban areas. Messengers must plan routes that avoid the enemy. Routes and time schedules should be varied to avoid establishing a pattern. Visual signals must be planned so they can be seen from the buildings.

c. **Sound.** Sound signals are normally not effective in urban areas due to the amount of surrounding noise.

d. **Existing Systems.** If existing civil or military communications facilities can be captured intact, they can also be used by the Infantry battalion. An operable civilian phone system, for instance, can provide a reliable, although nonsecure, means of communication. Telephones should not be considered secure. Other civilian media can also be used to broadcast messages to the public. Evacuation notices, evacuation routes, and other emergency notices designed to warn or advise the civilian population must be coordinated at battalion level through the S1 or civil affairs officer. Such notices should be issued by the local civil government through printed or electronic news media. Battalions do not normally release such notices. Use of news media channels in the immediate area of operations for other than emergency communications must also be coordinated through the S1 or civil affairs officer.

#### **G-41. SNIPERS**

Commanders can make effective use of snipers during UO. They should be considered an important combat multiplier, and integrated into the fire plan and scheme of maneuver. Snipers are a precision weapon and must be used as such. If available, the XM107 .50 caliber heavy sniper rifle (HSR) can provide snipers with an antimateriel capability and improve countersniper effectiveness. The HSR is also an excellent weapon for penetrating sandbag barriers and most urban construction materials. Possible targets that can be engaged are:

- Radar systems.
- Missile systems.
- Fuel distribution systems.
- Aircraft (stationary, fixed, or rotary winged).
- Communications equipment.
- Generators.
- Light skinned vehicles.

**Note:** See Appendix E, for more information on sniper employment.

# GLOSSARY

|           |   |        |  |
|-----------|---|--------|--|
| A2C2      | Army airspace command and control               | ANCO   | Advanced Noncommissioned Officers' Course      |
| AA        | assembly area                                   | AO     | area of operations                             |
| AAA       | antiaircraft artillery                          | AP     | armor-piercing                                 |
| AAAD      | all arms for air defense                        | APC    | armored personnel carrier                      |
| AACG      | arrival airfield control group                  | APDS   | armor-piercing discarding sabot                |
| AAR       | after-action review                             | APFSDS | armor-piercing fin-stabilized discarding sabot |
| ABC       | air battle captain                              | API    | armor-piercing incendiary                      |
| ABCCC     | airborne battlefield command and control center | AR     | armor  |
| ACA       | airspace coordination area                      | ARTEP  | Army Training and Evaluation Program           |
| ACE       | armored combat earthmover                       | aslt   | assault  |
| ACL       | allowable cargo load                            | ASOC   | air support operations center                  |
| ACP       | air control point                               | ASP    | ammunition supply point                        |
| ADA       | air defense artillery                           | at     | antitank                                       |
| ADAM      | area denial artillery munition (antipersonnel)  | ATGM   | antitank guided missile                        |
| ADC       | area damage control                             | atk    | attack   |
| ADM       | atomic demolition munition                      | ATM    | advanced trauma management                     |
| admin/log | administrative/logistics                        | ATP    | ammunition transfer point                      |
| ADO       | air defense officer                             | auth   | authorized                                     |
| AF        | Air Force (United States)                       | AVLB   | armored vehicle-launched bridge                |
| AG        | Adjutant General                                | avn    | aviation                                       |
| AGL       | above ground level                              | AWACS  | Airborne Warning and Control System            |
| AH        | attack helicopter                               | AXP    | ambulance exchange point                       |
| aj        | antijamming                                     | az     | azimuth  |
| ALO       | air liaison officer                             | BAE    | battlefield area evaluation                    |
| alt       | alternate                                       | BAI    | battlefield air interdiction                   |
| AM        | amplitude modulated                             | BAS    | battalion aid station                          |
| AMC       | (United States) Army Materiel Command           | BDA    | battle damage assessment                       |
| ANGLICO   | air and naval gunfire liaison company           |        |  |

|        |  |        |                                       |
|--------|--|--------|---------------------------------------|
| BDAR   | battle damage assessment and repair                | cGy    | centigray                             |
| BFV    | Bradley fighting vehicle                           | cGyph  | centigray per hour                    |
| BHL    | battle handover line                               | chem   | chemical                              |
| BHO    | battle handover                                    | CI     | command information                   |
| BICC   | battalion information control center               | CLGP   | cannon-launched guided projectile     |
| BMNT   | beginning morning nautical twilight                | CLOS   | command line of sight                 |
| BMO    | battalion motor officer                            | cm     | centimeter                            |
| BMP    | a Threat fighting vehicle                          | cmd    | command                               |
| BMS    | battalion motor sergeant                           | CMO    | civil-military operations             |
| BMT    | battalion maintenance technician                   | co     | company                               |
| BNCOC  | Basic Noncommissioned Officers' Course             | CO     | commanding officer                    |
| BOMREP | bombing report                                     | COA    | course of action                      |
| BOS    | battlefield operating system                       | COC    | chain of command                      |
| BP     | battle position                                    | COLT   | combat observation and lasing team    |
| BSA    | brigade support area                               | comm   | communication                         |
| BTR    | a Threat personnel carrier                         | COMMEX | communications exercise               |
| btry   | battery  | COMSEC | communications security               |
|        |  | con    | control                               |
| C2     | command and control                                | conc   | concentration                         |
| C3     | command, control, and communications               | coord  | coordination                          |
| C3I    | command, control, communications, and intelligence | COSCOM | corps support command                 |
| CA     | counter air  | CP     | command post                          |
| CARP   | computed air release point                         | CPX    | command post exercise                 |
| CAS    | close air support                                  | CRP    | a Threat combat reconnaissance patrol |
| CAT    | control and assessment team                        | CS     | combat support                        |
| catk   | counterattack                                      | CSM    | Command Sergeant Major                |
| cav    | cavalry  | CSR    | controlled supply rate                |
| cbt    | combat   | CSS    | combat service support                |
| CBU    | cluster bomb unit                                  | CTF    | collective training facility          |
| CCP    | communications checkpoint                          | CW     | continuous wave                       |
| CCT    | combat control team                                | dest   | destroy                               |
| CEV    | combat engineer vehicle                            | det    | detonation (as in detonation cord)    |
| CF     | command fire                                       | DEW    | directed-energy weapon(s)             |
| CFL    | coordinated fire line                              | DF     | direction finding                     |
|        |  | DISCOM | division support command              |
|        |  | div    | division                              |
|        |  | DLIC   | detachment left in contact            |
|        |  | DMD    | digital message device                |

|         |  |         |  |
|---------|--|---------|--|
| DMDG    | digital message device group                   | FAC     | forward air controller                                 |
| DOA     | dead on arrival                                | FASCAM  | family of scatterable mines                            |
| DOD     | Department of Defense                          | FASCO   | Forward Area Support<br>Coordination Officer           |
| DODAC   | Department of Defense<br>ammunition code       | FAST    | forward area support team                              |
| Doppler | of or relating to Doppler radar                | fax     | facsimile  |
| DP      | decision point(s)                              | FCL     | fire coordination line                                 |
| DPICM   | dual-purpose improved<br>conventional munition | FCT     | firepower control team                                 |
| DS      | direct support                                 | FD      | fire direction   |
| DSN     | Defense Switched Network                       | FDC     | fire direction center                                  |
| DST     | decision support template                      | FEBA    | forward edge of the battle area                        |
| DTG     | date-time group                                | FFA     | free fire area   |
| DZ      | drop zone                                      | FFAR    | free-flight aerial rocket(s)                           |
| DZST    | drop zone support team                         | FID     | Foreign Internal Defense                               |
|         |  | FIST    | fire support team                                      |
|         |  | fld     | field  |
| ea      | each   | FLOT    | forward line of own troops                             |
| EA      | engagement area                                | FM      | field manual, frequency<br>modulated                   |
| ECCM    | electronic<br>counter-countermeasures          | FMC     | field medical card                                     |
| ECM     | electronic countermeasures                     | FO      | forward observer                                       |
| EENT    | end-of-evening nautical<br>twilight            | FPF     | final protective fires                                 |
| ELINT   | electronic intelligence                        | FPL     | final protective line                                  |
| ELSEC   | electronic security                            | FRAGO   | fragmentary order                                      |
| EM      | enlisted members                               | FS      | fire support   |
| EMP     | electromagnetic pulse                          | FSA     | fire support area                                      |
| EMT     | emergency medical treatment                    | FSB     | forward support battalions                             |
| enr     | engineer                                       | FSC     | fire support coordination                              |
| EPLRS   | enhanced position-location<br>reporting system | FSCC    | fire support coordination<br>center                    |
| EPUU    | enhanced PLRS user unit                        | FSC     | fire support coordination line                         |
| EPW     | enemy prisoner of war                          | FSCoord | fire support coordinator                               |
| ESM     | electronic warfare support<br>measures         | FSE     | fire support element                                   |
| ETA     | estimated time of arrival                      | FSO     | fire support officer                                   |
| EW      | electronic warfare                             | FSS     | fire support section                                   |
| EZ      | extraction zone                                | ft      | feet   |
|         |  | G2      | Assistant Chief of Staff,<br>G2 (Intelligence)         |
| 1SG     | first sergeant                                 | G3      | Assistant Chief of Staff,<br>G3 (Operations and Plans) |
| FA      | field artillery                                |         |  |

|        |   |        |   |
|--------|---|--------|---|
| GATOR  | (a mine delivered by fixed-wing aircraft)   | IDAD   | internal defense and development            |
| GEMSS  | ground-emplaced mine-scattering system      | IED    | imitative electronic deception              |
| GHz    | gigahertz                                   | IEW    | intelligence and electronic warfare         |
| GL     | grenade launcher                            | IHFR   | improved high frequency radio               |
| GLLD   | ground laser locator designator             | IG     | inspector general                           |
| gp     | group                                       | IHF    | improved high frequency                     |
| GP     | general purpose                             | illum  | illumination                                |
| GPS    | global positioning system                   | IMC    | initial manifest call                       |
| GS     | general support                             | IMINT  | imagery intelligence                        |
| GSA    | General Services Administration             | in     | inch(es)                                    |
| GSR    | ground surveillance radar                   | IN     | Infantry                                    |
| GZ     | ground zero                                 | INS    | inertial navigation system                  |
|        |   | INTSUM | intelligence summary                        |
|        |   | IP     | initial point                               |
|        |   | IPB    | intelligence preparation of the battlefield |
| HB     | (a PSYOP loudspeaker team)                  | IPW    | prisoner of war interrogation               |
| HC     | hexachloroethane                            | IR     | information requirements                    |
| HE     | high explosive                              | ISB    | intermediate staging base                   |
| HEAT   | high-explosive antitank                     | IV     | intravenous                                 |
| HEDP   | high-explosive dual-purpose                 |        |   |
| HEI-T  | high-explosive incendiary—tracer            | JAAT   | joint air attack team                       |
| HEMTT  | heavy expanded-mobility tactical truck      | JAG    | judge advocate general                      |
| HEP    | high-explosive plastic                      | JSEAD  | joint suppression of enemy air defenses     |
| HF     | high frequency                              | JM     | jumpmaster                                  |
| HHC    | headquarters and headquarters company       |        |   |
| HIMS   | HMMWV Interchangeable Mount System          | KIA    | killed in action                            |
| HMMWV  | high-mobility, multipurpose wheeled vehicle | km     | kilometer(s)                                |
| HQ     | headquarters                                | kw     | kilowatt(s)                                 |
| hr     | hour  |        |   |
| HSS    | health service support                      | LAPES  | low-altitude parachute extraction system    |
| HUMINT | human intelligence                          | LAW    | light antitank weapon                       |
|        |   | lb     | pound(s)                                    |
| IAW    | in accordance with                          | LBE    | load-bearing equipment                      |
| ICM    | improved conventional munitions             | LC     | line of contact                             |
|        |   | LD     | line of departure                           |

|         |   |         |   |
|---------|---|---------|---|
| LDF     | light-weight digital facsimile  | MHE     | materials-handling equipment                      |
| ldr     | leader  | MHz     | megahertz   |
| LIC     | low-intensity conflict  | MI      | military intelligence                             |
| LLTV    | low-light level television  | MIA     | missing in action                                 |
| LLVI    | low-level voice intercept   | MICLIC  | mine-clearing line charge                         |
| LO      | liaison officer   | MIJI    | meaconing, intrusion, jamming<br>and interference |
| LOA     | line of advance   | MILES   | multiple-integrated laser<br>engagement system    |
| LOC     | lines of communication  | MILPO   | military personnel office(s)                      |
| log     | logistics   | min     | minute(s)   |
| LOGPAC  | logistics package   | misc    | miscellaneous                                     |
| LOGSTAT | logistical status   | MKT     | mobile kitchen trailer                            |
| LORAN   | long-range navigation   | ML      | moonlight   |
| LOS     | line of sight   | MLC     | minimum load configuration                        |
| LRP     | logistical release point  | MLRS    | multiple-launch rocket system                     |
| lt      | light   | mm      | millimeter(s)                                     |
| LTD     | laser target designator   | MOGAS   | motor gasoline                                    |
| LZ      | landing zone  | MOPMS   | modular-packed mine system                        |
|         |   | MOPP    | mission-oriented protective<br>posture            |
| m       | meter(s)  | MORTREP | mortar bombing report                             |
| MAC     | maintenance allocation chart  | MOS     | military occupational<br>specialty                |
| MANPADS | man-portable air defense<br>system  | MOUT    | military operations on<br>urbanized terrain       |
| MBA     | main battle area  | MP      | military police                                   |
| MC      | Marine Corps (United States)  | mph     | miles per hour                                    |
| MCP     | maintenance collection point  | mps     | meters per second                                 |
| mech    | mechanized  | MPSM    | multipurpose service<br>munition                  |
| MEDEVAC | medical evacuation  | MRB     | motorized rifle battalion                         |
| METL    | mission-essential task list   | MRE     | meal, ready-to-eat                                |
| METT-T  | mission, enemy, terrain, troops,<br>and time available                              | MSB     | main support battalion                            |
| MFAT    | (a minefield seeded with<br>RAAM mines)   | MSC     | Medical Service Corps                             |
| MFGM    | (a minefield of mixed antitank<br>and antipersonnel mines<br>emplaced by the GEMSS) | MSE     | mobile subscriber equipment                       |
| MFH     | (a minefield containing M56<br>mines)   | MSG     | master sergeant                                   |
| MFJ     | (a minefield laid in the<br>standard minefield pattern)                             | MSR     | main supply route                                 |
| MFM     | (a minefield laid by the<br>MOPMS)  | MSRT    | mobile subscriber radio<br>telephone              |
| mg      | machinegun  | MST     | maintenance support team                          |
|         |   | MTOE    | modified table of organization<br>and equipment   |

|        |  |            |  |
|--------|--|------------|--|
| N      | Navy (United States)   | OTAR       | over-the-air rekeying                      |
| NAI    | named areas of interest  |            |  |
| NATO   | North Atlantic Treaty Organization   |            |  |
| NBC    | nuclear, biological, chemical  | PA         | physician's assistant                      |
| NCO    | noncommissioned officer  | PAC        | personnel and administration center        |
| NCOIC  | noncommissioned officer in charge  | PADS       | position and azimuth determining system    |
| NCS    | net control station  | PAO        | public affairs officer                     |
| NFA    | no-fire area   | PD         | point of departure                         |
| NGF    | naval gunfire  | PDM        | pursuit-deterrent munitions                |
| NGLO   | naval gunfire liaison officer  | PDS        | personnel daily summary                    |
| no     | number   | PDY        | present for duty                           |
| NOE    | nap-of-the-earth   | pers       | personnel                                  |
| NOK    | next of kin  | PERSTATREP | personnel status report                    |
| NRI    | net radio interface  | PEWS       | platoon early warning system               |
| nuc    | nuclear  | PIP        | product-improvement program                |
| NUCWAR | nuclear warning  | PIR        | priority intelligence requirement          |
| NVD    | night vision device  |            |  |
| NVG    | night vision goggles   | PL         | phase line                                 |
|        |  | PLD        | probable line of deployment                |
| O&I    | operations and intelligence  | PLL        | prescribed load list                       |
| OB     | order of battle  | plt        | platoon                                    |
| obj    | objective  | PM         | preventive maintenance                     |
| OCOKA  | five military aspects of terrain: obstacles, avenues of approach, key terrain, observation and fields of fire, and cover and concealment | PMCS       | preventive maintenance checks and services |
|        |  | POF        | priority of fire                           |
| OEG    | operational exposure guide   | POL        | petroleum, oils, and lubricants            |
| off    | officer  | POS/NAV    | position/navigation                        |
| OIC    | officer in charge (of)   | PP         | passage point                              |
| O/O    | on order   | PRR        | personnel requirements report              |
| OP     | observation post   | PSC        | Personnel Service Company                  |
| OPCON  | operational control  | psn        | position                                   |
| OPLAN  | operation plan   | PSNCO      | personnel staff noncommissioned officer    |
| OPORD  | operation order  |            |  |
| OPSEC  | operations security  | PSS        | personnel service support                  |
| OPSKED | operational schedule   | PSYOP      | psychological operations                   |
| ord    | ordnance   | PW         | prisoner of war                            |
| org    | organization   | PWP        | plasticized white phosphorus               |
| ORP    | objective rally point  | PZ         | pickup zone                                |

|        |                                 |          |   |
|--------|---------------------------------|----------|---|
| QSS    | quick supply store              | S3       | Operations and Training Officer                   |
|        |                                 | S3       | air assistant S3, air operations                  |
| R&S    | reconnaissance and surveillance | S4       | Supply Officer                                    |
| RAAMS  | remote antiarmor mine system    | SACLOS   | semiactive command line of sight                  |
| RAG    | regimental artillery group      | SALT     | supporting arms liaison team                      |
| RAP    | rear area protection            | SAM      | surface-to-air missile                            |
| RATELO | radiotelephone operator         | SAMS     | Standard Army Maintenance System                  |
| RATT   | radio teletypewriter            | SAR      | search and rescue                                 |
| RCLR   | recoilless rifle                | SARS     | Standard Army Retail Supply System                |
| rd     | round                           | SAT      | sustained airborne training                       |
| recon  | reconnaissance                  | SATCOM   | satellite communication(s)                        |
| REDCON | readiness condition             | SBF      | support by fire                                   |
| REM    | roentgen equivalent man/mammal  | sct      | scout   |
| REMAB  | remote marshaling base          | SEAD     | suppression of enemy air defenses                 |
| REMS   | remotely employed sensor        | sec      | section   |
| rep    | representative                  | SEE      | small emplacement excavator                       |
| repl   | replacement                     | SF       | Special Forces                                    |
| req    | required                        | SIDPERS  | Standard Installation/Division Personnel System   |
| res    | reserve(s)                      | SIGINT   | signals intelligence                              |
| RES    | radiation exposure status       | SIGSEC   | signals security                                  |
| RF     | radio frequency                 | SINCGARS | single channel ground and airborne radio system   |
| RFA    | restrictive fire area           | SITMAP   | situation map                                     |
| RFI    | radio frequency interference    | SITREP   | situation report                                  |
| RFL    | restrictive fire line           | SJA      | Staff Judge Advocate                              |
| RHA    | rolled homogeneous armor        | SL       | starlight   |
| RIF    | reconnaissance in force         | SOC      | special operations command                        |
| ROE    | Rules of Engagement             | SOCCE    | special operations command and control element    |
| RP     | release point (ground traffic)  | SOF      | special operations forces                         |
| RPG    | rocket-propelled grenade        | SOI      | signal operation instructions                     |
| RPM    | revolutions per minute          | SOP      | standing operating procedure                      |
| RS     | radiation status                | SOSR     | suppression, obscuration, security, and reduction |
| RSR    | required supply rate            | SP       | start point                                       |
| RTD    | return to duty                  | spt      | support   |
| rte    | route                           | sqd      | squad   |
| RV     | radius of vulnerability         | SR       | sunrise   |
| RWI    | radio wire integration          |          |   |
| S1     | Adjutant                        |          |   |
| S2     | Intelligence Officer            |          |   |



|           |  |      |   |
|-----------|--|------|---|
| SSB       | single side band   | TOT  | time on target (artillery support)                                  |
| STANAG    | Standardization Agreement                                  | TOW  | tube-launched, optically tracked, wire-guided (refers to a missile) |
| STP       | soldier's training publication                             | TPU  | tank and pump unit  |
| STRIKWARN | strike warning   | TR   | transportation request  |
| T&E       | traversing and elevating                                   | TRP  | target reference point  |
| tac       | tactical   | TSC  | training support center   |
| TAC       | Tactical Air Command                                       | TSOP | tactical standing operating procedure                               |
| TACAIR    | tactical air   | TSR  | tactical surveillance and reconnaissance                            |
| TACAN     | tactical air navigation                                    | TTP  | tactics, techniques, and procedures                                 |
| TACC      | tactical air control center                                | UH   | utility helicopter  |
| TACCS     | Tactical Army Combat Service Support (CSS) Computer System | UHF  | ultra high frequency  |
| TACFIRE   | tactical fire direction system                             | ULC  | unit-level computer   |
| TACP      | tactical air control party                                 | ULLS | unit-level logistics system   |
| TACSAT    | tactical satellite   | UMCP | unit maintenance collection point                                   |
| TACSATCOM | tactical satellite communications                          | UMT  | unit ministry team  |
| TAI       | target areas of interest                                   | UPS  | United Parcel Service   |
| TAMMS     | The Army Maintenance Management System                     | USN  | United States Navy  |
| TAR       | tactical air reconnaissance                                | UTM  | universal transverse mercator (grid)                                |
| TASE      | Tactical Air Support Element                               | VHF  | very high frequency   |
| TBA       | to be activated  | vic  | in the vicinity of  |
| TBD       | to be determined   | VIP  | very important person   |
| TC        | track commander  | VOR  | VHF omnidirectional range   |
| TCF       | tactical combat force                                      | VT   | variable time   |
| TEK       | traffic encryption key                                     | VTOL | vertical take-off/landing   |
| temp      | temperature  | WCS  | weapons control status  |
| TF        | task force   | WFOV | wide field of view  |
| TFW       | (United States Air Force) tactical fighter wing            | WO   | warning order   |
| tgt       | target   | WP   | white phosphorus  |
| TI        | technical inspection                                       | wpn  | weapon  |
| TIC       | troops in contact  | WSO  | Weapons System Officer  |
| TIRP      | terrain index reference point                              |      |   |
| TIRS      | terrain index reference system                             |      |   |
| TLP       | troop-leading procedure                                    |      |   |
| tm        | team   |      |   |
| TOC       | tactical operations center                                 |      |   |
| TOE       | table(s) of organization and equipment                     |      |   |

# REFERENCES

## SOURCES USED

*These are the sources quoted or paraphrased in the publication.*

### *Army Regulations*

AR 310-25. Dictionary of United States Army Terms. 15 October 1983.

### *Field Manuals*

FM 3-5. NBC Decontamination. 24 June 1985.

FM 3-100. NBC Defense, Chemical Warfare, Smoke, and Flame Operations. 23 May 1990.

FM 5-101. Mobility. 3 January 1985.

FM 6-20. Fire Support in the AirLand Battle. 17 May 1988.

FM 7-7. The Mechanized Infantry Platoon and Squad (APC). 15 March 1985.

FM 7-7J. The Mechanized Infantry Platoon and Squad (Bradley). 18 February 1986.

FM 7-8 (HTF). The Infantry Platoon and Squad (Infantry, Airborne, Air Assault, Ranger) (How to Fight). 31 December 1980.

FM 7-10. The Infantry Rifle Company. 14 December 1990.

FM 7-30. Infantry, Airborne and Air Assault Brigade Operations. 24 April 1981.

FM 7-90. Tactical Employment of Mortars. 11 June 1985.

FM 7-91. Tactical Employment of Antiarmor Platoons, Companies, and Battalions. 30 September 1987.

FM 17-15. Tank Platoon. 7 October 1987.

FM 17-95. Cavalry Operations. 14 February 1986.

FM 17-98. Scout Platoon. 7 October 1987.

FM 21-18. Foot Marches. 1 June 1990.

FM 23-27. MK 19, 40-mm Grenade Machine Gun, MOD 3. 27 December 1986.

FM 25-100. Training the Force. 15 November 1988.

FM 34-3. Intelligence Analysis. 15 March 1990.

FM 34-130. Intelligence Preparation of the Battlefield. 23 May 1989.

FM 44-100. US Army Air Defense Operations. 22 November 1988.

FM 71-1. Tank and Mechanized Infantry Company Team. 22 November 1988.

FM 71-2. The Tank and Mechanized Infantry Battalion Task Force. 27 September 1988.

FM 71-3. Armored and Mechanized Infantry Brigade. 11 May 1988.

FM 90-4. Air Assault Operators. 16 March 1987.

FM 90-10 (HTF). Military Operations on Urbanized Terrain (MOUT) (How to Fight). 15 August 1979.

FM 90-10-1 (HTF). An Infantryman's Guide to Urban Combat (How to Fight). 30 September 1982.

FM 90-13-1. Combined Arms Breaching Operations. 28 February 1991.

FM 100-5. Operations. 5 May 1986.

FM 100-20. Military Operations in Low Intensity Conflict. 5 December 1990.

FM 100-27. US Army/US Air Force Doctrine for Joint Airborne and Tactical Airlift Operations. 3 January 1985.

FM 101-5. Staff Organization and Operations. 25 May 1984.

FM 101-5-1. Operational Terms and Symbols. 21 October 1985.

***Joint Publications***

JCS Pub 1-02. Department of Defense  
Dictionary of Military and Associated Terms.  
1 December 1989.

***Standardization Agreements***

STANAG 2082. Relief of Combat Troops.  
STANAG 2029. Method of Describing Ground  
Locations, Areas, and Boundaries.

***Training Circular***

TC 23-14. Sniper Training and Employment.  
14 June 1989.

**DOCUMENTS NEEDED**

*These documents must be available to the intended  
users of this publication.*

***Army Regulations***

AR 140-185. Training and Retirement Point  
Credits and Unit Level Strength Accounting  
Records. 15 September 1979.

***Field Manuals***

FM 3-4. NBC Protection. 21 October 1985.

***DA Forms***

DA Form 1155. Witness Statement on Individual,  
June 1966.  
DA Form 1156. Casualty Feeder Report, June 1966.

DA Form 1380. Record of Individual Performance  
of Reserve Duty Training, February 1975.

**READINGS RECOMMENDED**

*These readings contain relevant supplemental  
information.*

***Field Manuals***

FM 1-113. Assault Helicopter Battalion.  
28 October 1986.  
FM 10-63-1. Graves Registration Handbook.  
17 July 1986.  
FM 19-15. Civil Disturbances. 25 November 1985.  
FM 19-40. Enemy Prisoners of War, Civilian  
Internees and Detained Persons. 27 February  
1976.  
FM 31-71. Northern Operations. 21 June 1971.  
FM 55-2. Division Transportation Operations.  
31 January 1985.  
FM 57-230. Advanced Parachuting Techniques  
and Training. 13 September 1989.  
FM 90-3 (HTF). Desert Operations (How to  
Fight). 19 August 1977.  
FM 90-5 (HTF). Jungle Operations (How to  
Fight). 16 August 1982.  
FM 90-26. Airborne Operations. 18 December  
1990.

# INDEX

- action-reaction-counteraction, 2-18
- actions on contact, 3-23 to 3-24
- Adjutant (S1), B-2
- advance guard, 3-17 (illus)
- air
  - assault task force, 1-4
  - cavalry, 7-13
  - defense artillery, 1-3, 1-4, 3-9, 3-22, 4-10, 5-9, A-32, F-3
- airborne
  - defense support, 7-14, A-3, A-32
  - defense weapon systems, 7-15
  - operations, B-5, D-18
- airdrop, 8-17
- AirLand Battle
  - agility, 1-2
  - depth, 1-2
  - fundamentals, 1-2
  - initiative, 1-2, 1-5, 2-2, 2-3, 2-6
  - synchronization, 1-2
- airland battlefield, 1-1
- alternate command post, 2-1, B-11
- ambulance section, 8-22
- ambush, 1-3, E-8
- analysis
  - METT-T, 2-7, 2-9 (illus)
  - of terrain, 2-9 (illus)
  - of threat, 2-9 (illus)
  - of weather, 2-9 (illus)
- antiarmor, 3-22, 5-8, 7-29, B-5
- antiterrorism, C-9
- approach march technique, 3-15
- area
  - denial, 4-5 to 4-6
  - of operations, 2-8 (illus)
- artillery, 3-1, 3-2, 3-22, 5-8
- assault, 3-32 to 3-33
  - by fire, 1-3
- assembly areas, 2-11, A-3, A-41
- assigned unit, 2-5
- attached unit, 2-5, 2-16
- attack helicopter, 1-3, 5-9, 7-13
- attack of fortified positions and strongpoints, 3-28, 3-29 (illus)
- attacks, 3-24 to 3-35, 4-13
- aviation, 1-4, 3-9, 3-22, 5-9, 7-12, A-3, A-29
- axes of advance, 6-19
- basic loads, 8-12
- battalion
  - functions, 1-3
  - headquarters, 2-5
  - maneuver, 1-4
  - plan, 1-3
  - security area operations, 4-4
  - staff, 2-5
  - tactical standing operating procedure (TSOP), A-1
  - trains, 8-7
- battle
  - damage assessment and repair, 8-15, A-46
  - handover, 4-4 (illus)
  - staff officers, 1-3
- block control, C-20
- breaching operations, 3-9 to 3-11, 7-19
- breakout from encirclement, 6-10 to 6-17 (illus)
- briefbacks, 2-3, 2-10, 2-23
- brigade, 1-4
  - mission, 2-10
  - mission statement, 2-11
  - order, 2-8 (illus), 2-10
- call for fire, 2-6
- camouflage, 1-3
- cannibalization, 8-15
- casualties, A-57

- casualty
  - evacuation, A-14, A-58, F-1, F-2 (illus), F-3
  - locations, F-3
  - reporting, 8-18, 8-21 (illus)
- chain of command, 2-4
- chaplain, B-6
- checkpoints, 6-19, C-26
- civil
  - authorities, support to, C-13
  - disturbances, C-21
  - military cooperation, A-15
- civilian
  - registration, C-19
  - self-defense units, C-21
- classes of supply, 8-3, 8-12 to 8-14
- close
  - air support, 1-3, 3-1 to 3-2, 3-22, 5-9, 7-2, A-45
  - combat, 1-3 to 1-4
- clothing exchange and bath services, 8-17
- combat
  - elements, 1-4
  - medic section, 8-23
  - multipliers, 1-3, 3-4
    - air defense artillery, 1-3
    - attack helicopters, 1-3
    - electronic warfare, 1-3
    - engineers, 1-3, 1-4
  - operations, 2-1, 2-16
  - power, 1-2, 2-3, 2-16, 2-16 (illus), 3-1
  - service support, 1-2, 1-3, 2-10, 2-27, 3-1, 5-9, 8-1, A-15, C-5
    - Adjutant (S1) section, 8-2
    - administrative services, 8-19
    - airdrop, 8-17
    - battalion trains, 8-7
    - clothing exchange and bath, 8-17
    - command and control, 8-10
    - enemy prisoners of war, 8-2, 8-23 (illus)
    - field services, 8-17
    - finance, 8-2, 8-20
    - health services, 8-1, 8-21
    - laundry and renovation, 8-17
    - legal, 8-2, 8-19
    - logistics, 8-6
    - maintenance, 8-4, 8-14
    - medical, 8-3, 8-21
    - mortuary affairs, 8-17
    - operations, 8-12
    - personnel and administration, 8-1, 8-2, 8-18
    - planning, 8-4
    - postal services, 8-2, 8-18
    - public affairs, 8-2, 8-20
    - religious, 8-2, 8-19
    - replacement, 8-18
    - salvage, 8-17
    - soldier's load, 8-6
    - sources, 8-2
    - strength management, 8-18
    - supply, 8-3, 8-8, 8-11
  - support, 1-2, 1-3, 2-10, 2-27, 3-1, 4-14, 5-8, 7-1, 7-27, A-14, C-5
    - air defense, 7-14
    - antiarmor, 7-29
    - aviation, 7-12
    - engineer, 7-16
    - indirect fire, 7-1
    - intelligence and electronic warfare, 7-21
    - MK 19, 7-30
    - nuclear, biological, and chemical, 7-24
    - scouts, 7-27
    - tactical air, 7-10
  - trains, B-11 (illus), B-12 (illus)
  - trains command post, 2-1
- combatting terrorism, C-8
- combined
  - arms force, 1-3
  - operations, 2-6
- command
  - group, 1-2, 2-1, 2-3, B-7
  - post, 2-1, 3-22, A-3
  - relationships, 2-4 to 2-5, 7-5
  - sergeant major, B-2
  - succession, 2-28, A-6
- command and control, 1-2, 2-1 to 2-5, 2-27 to 2-28, 5-7, 6-13, 6-18, 8-10, A-3, A-6, A-29, B-1, C-5
- communications, 2-1, 2-3, 2-11, 2-28, 5-9, 6-9, 6-18, 6-23, 7-7, 8-11
  - elements, 2-1
  - equipment, 2-1
  - facilities, 2-1, B-1, B-6 (illus)
  - organization, 2-11
  - personnel, 2-2

- procedures, 2-2
- process, 2-6
- commander
  - antiarmor company, B-5
  - battalion, B-1
  - headquarters and headquarters company, B-4
- commander's
  - actions, 2-7 (illus)
  - approval, 2-7 (illus)
  - authority, 2-2
  - concept, 2-2 to 2-3, 2-7
  - decision, 2-7 (illus)
  - intent, 1-2, 1-5, 2-3 to 2-4, 2-6, 2-10 to 2-11, 2-27, 2-28, 3-4, 4-5 to 4-6, A-7, A-12
  - leadership, 2-2
  - planning guidance, 2-7 (illus)
  - presence, 2-2
- communications, 2-1, 2-3, 2-11, 2-28, 5-9, 6-9, 6-18, 6-23, 7-7, 8-11, 8-16, A-3, A-20 (illus), C-19, F-2
- concept of operation, 1-2, 2-3, 2-20, 2-27, 2-28, A-12
- conduct of operations, 4-11
- consolidation and reorganization, 2-28, 3-16 3-33 to 3-35 (illus), 4-14 to 4-15, E-3
- contingency
  - operations, 2-6, 2-28, C-12
  - plans, 1-1, 2-3, 5-10, 6-18, 6-23
- control
  - measures, 2-16, 3-6
  - resource, C-21
- controlled exchange, 8-15
- coordinated surface and air-delivered fire, A-3, A-48
- coordinating
  - fire line, 6-19
  - staff, 2-5, B-2
- coordination, 2-2, 2-25
- cordon and search, C-23
- counterair operations, A-13
- counterattack, 1-2, 1-3, 4-12, 7-3
- counterdrug, C-13
- counterinsurgency, C-6
- countermobility, 7-18, 7-20
- counterreconnaissance, 4-7 to 4-11, E-4
- counterterrorism, C-9
- course of action, 2-6
  - analysis, 2-9 (illus), 2-10
  - comparison, 2-9 (illus), 2-10, 2-18, 2-20 (illus)
  - development, 2-9 (illus), 2-10, 2-12, 2-26
  - METT-T factors and, 2-12
  - situation and, 2-12
  - sketch, 2-16
  - statement, 2-16 to 2-18
- cover and concealment, 3-4
- critical events, 2-18
- culminating point, 3-33 to 3-34
- curfews, C-19, C-20 (illus)
- decentralization, 2-3, 2-5
- deception, 1-3, 3-1
- decision-making
  - process, 2-7, 2-8, 2-12
  - techniques, 2-9
  - tools, 2-25
- decision support template, 2-26
- decisive point, 1-2, 2-3, 2-4, 3-4
- decontamination, A-33
- defense
  - against air attack, 4-26
  - against infiltration, 4-26
  - from a battle position, 4-17
  - in sector, 4-16 (illus)
  - linear, 4-24
  - of a sector, 4-15
  - of a strongpoint, 4-25 (illus), 4-27 (illus)
  - perimeter, 4-22, 4-23 (illus)
  - plans, A-27
  - reverse slope, 4-19, 4-21 (illus)
- defensive
  - concept, 4-6
  - framework, 4-2, 4-3 (illus)
  - operations, 2-6, 3-1, 4-1
  - planning and preparation, 4-5 to 4-7
- delay, 2-4, 2-6, 5-2 to 5-11
- deliberate
  - attacks, 3-25 to 3-28, 3-27 (illus), 7-18
  - breach, 3-31 (illus)
- demolitions, 1-4
- demonstrations, C-13
- deployment in depth, 4-15
- direct
  - fires, 1-3, 1-4, 3-1
  - support, 2-5, 7-8
- disaster relief, C-12

- dispersing to search, 3-19 (illus)
- disposition of enemy prisoners of war. See prisoners of war
- distribution of supplies, 8-12
- doctrinal template, 2-26
- drills, 1-2
  
- electronic warfare, 1-3, 7-21, A-13
- elements of command and control, 2-1 to 2-2
- employment in depth, 2-3
- enemy
  - assault, 4-12
  - command post, 2-16
  - forces, 2-11, 2-11 (illus), 6-9
  - main attack, 4-12
  - preparatory fire, 4-12
  - prisoners of war, 8-2, 8-23 (illus)
  - probable course of action, 2-25
  - reconnaissance, 4-12
  - weaknesses and vulnerabilities, 2-16 (illus), 3-2
- engagement
  - areas, 2-16 (illus)
  - options, 4-16
- engineers, 1-4, 3-9, 3-22, 5-9, 7-16, A-3, A-13, A-29, B-5
- envelopment, 3-4, 3-6, 3-7 (illus)
- equipment maintenance, 8-17
- establishment plan, 6-21
- estimate of the situation, 2-9, 2-10, 2-22, 2-26, 3-4
- evacuation
  - medical, A-14, A-58, F-1 (illus), F-3
  - noncombatant, C-13
- event template, 2-26
- exchange of equipment, 6-9
- execution checklist, A-18
- executive officer, 1-4, 2-5, B-1
- exfiltration, 6-23
- exploitation, 2-4, 3-36, 7-18, D-10
  
- facts and assumptions, 2-8 (illus)
- field
  - artillery, 1-3, 4-10, 7-4, A-3, A-44
  - services, 8-17
  - trains command post, 2-1
- final protective fires, 7-3 (illus)
- finance support, 8-20, A-57
- fire
  - direct, 1-3
  - indirect, 1-3
  - planning, top-down, 7-3
  - programmed, 7-4
  - schedules, 7-4
  - support, 1-4, 2-28, 3-8, 6-8, 6-13, 7-2, 7-8, A-3, A-43
  - support matrix, 7-9 (illus)
  - support officer, 7-10, B-5
- fire-control measures, 2-27, 2-28
- firepower, 1-2, 1-3
- fires, A-12
- flanking units, 2-27
- fluid battlefield, 2-3
- follow-and-support operations, 3-36, F-2
- force
  - deployment of, 2-11
  - enemy, 2-11
  - friendly, 2-11
  - preservation, 4-6
  - protection, C-14
- forms of maneuver, 3-4 to 3-8
- fragmentary order, 2-7, 2-22, 2-28, 3-2, A-3, A-19
- framework
  - defensive, 4-2, 4-3 (illus)
  - offensive, 2-26, 3-3,
  - planning, 2-8 (illus)
- fratricide, 1-3, 2-27, 2-28
- friendly forces, 2-11 (illus)
- frontal
  - attack, 3-8
  - movement, 3-4
- functional command post. See command post.
- functions of battalion staff, 2-5
  
- general
  - support, 2-5, 7-8
  - support reinforcing, 2-5
- graphics, A-7
- ground surveillance radar, 1-4, 3-9, 7-22 (illus), F-3
  
- hasty attack, 3-24 to 3-25 (illus), 7-18
- heavy forces, D-1
- heavy/light operations, D-1
- helicopters, 1-4
- hide forces, 6-19

- high-intensity conflict, 1-1
- high-mobility, multipurpose wheeled vehicle (HMMWV), 7-31
- indirect fires, 1-3, 2-28, 3-1
- infiltration, 3-1, 3-4
- inspection, 2-25
- insurgency, C-6
- intelligence, 1-2, 1-4, A-3, A-13, A-49
  - annex OPORD format, A-3, A-50
  - assets
    - infantry patrols, 1-4
    - patrols, 1-4
    - platoon early warning system, 1-4
    - scout platoon, 1-4
  - preparation of the battlefield, 1-2, 2-1, 2-3, 2-8 (illus), 2-25 to 2-27 (illus), 2-28, 3-2, C-4
    - confirmation, 2-8 (illus)
    - quick, 2-8 (illus)
    - support, 7-21
- Intelligence Officer (S2), B-3
- internal defense and development, C-6
- interrogation, 1-4, 7-22
- joint
  - air attack team, 7-12
  - operations, 2-6
- jungle operations, D-18
- key terrain, 2-2, 2-11 (illus), 2-16, 3-4
- key words and phrases, C-5 (illus)
- lanes, single or multiple, 3-6
- lasers, 2-1
- laundry and renovation, 8-17
- leader
  - antiarmor platoon, B-5
  - mortar platoon, B-5
  - scout platoon, B-5
- legal services, 8-19, A-58
- liaison, 6-7
- light/heavy operations, D-1
- limited visibility, 1-1, 3-11 to 3-14, 4-7, 5-10
- line of departure, 3-4
- lines of communication, security of, C-16
- linkup operations, 6-17 to 6-24 (illus), A-3, A-37
- lodgements, 1-1
- logistical estimate, 8-6
- logistics, 2-19, 3-4, 6-18, 8-6, A-3, A-56
- Logistics Officer (S4), B-4
- logistics reports, A-3
- low-intensity conflict, 1-1, C-1, E-7
- low-level voice intercept, 1-4
- machine guns, 3-9
- main
  - attack, 3-2, 3-3 to 3-4
  - battle area operations, 4-4
  - command post, 2-1 to 2-3, B-7, B-8 (illus)
  - effort, 1-2, 2-2 to 2-4, 2-28, 3-1, 3-4
- maintenance
  - collocation with medical assets, F-2
  - platoon/section, 8-4
  - officer, 1-4
  - support, 8-6, 8-15
- maneuver, 1-1 to 1-3, 2-12, A-12, A-13
  - battalion, 1-4
  - elements, 1-4
  - system, 1-4
  - units, 4-9
- masking, A-33
- massing to attack, 3-20 (illus)
- matrix
  - annexes, 2-12 (illus)
  - orders, 2-12 (illus)
- mechanized-armor light forces, D-1
- medical
  - equipment maintenance, 8-16
  - evacuation and hospitalization, A-14, A-58
  - officer, 1-4
  - platoon, 8-3, 8-21
  - support, A-57
  - support matrix, 8-23, F-2
- METT-T
  - analysis, 2-7, 2-9 (illus), 2-12, 5-6, 5-12, 5-22, 6-6, 6-10, E-2
  - factors, 2-12
- mid-intensity conflict, 1-1
- military
  - escorts, C-15
  - intelligence, 1-4
  - operations on urbanized terrain (MOUT), E-6
- minefields, 1-4, 7-19



- mission, 1-3, 2-1, A-12
  - accomplishment, 2-7 (illus), 2-16 (illus)
  - analysis, 2-7 (illus), 2-8 (illus), 2-9 (illus), 2-10 to 2-12, 2-16 (illus), 2-26
  - brigade, 2-10
  - deduction, 2-8 (illus)
  - essential tasks, 2-12, 2-16
  - execution, 2-10
  - issuance, 2-8 (illus)
  - orders, 2-4
  - oriented protective posture, A-34
  - purpose, 2-3, 2-16 (illus)
  - receipt, 2-7 (illus), 2-8 (illus), 2-9 (illus) 2-9 to 2-10
  - restated, 2-7 (illus), 2-10, 2-12
  - statement, 2-11
  - tactics, 2-3 to 2-4, 2-6
  - type orders, 1-5, 2-2, 2-4, 2-6, 3-2
- MK 19, 3-9, 4-9, 7-30
- mobility, 1-2 to 1-3, 7-18, 7-20
- mobility/countermobility/survivability, 1-4, 7-18 to 7-21
- modified table of organization and equipment, 2-1
- mortars, 3-9, 3-22, 5-8, 7-2, 7-5 to 7-8 (illus), F-3
- mortuary affairs, 8-17
- mountain operations, D-18
- mounted attack, E-3
- movement
  - control, 6-9
  - motor, C-17
  - to contact, 3-14 to 3-24, 7-18, A-64, E-3
- mutual support, 1-2
  
- named areas of interest, 2-26
- naval gunfire, 7-8
- night vision devices, 1-1
- nuclear, biological, chemical, 3-1, A-3
  - defense, A-33
  - personnel, B-5
  - reports, A-5
  - weapons, 3-1, 5-9, 7-24
  
- objective, 2-11, 2-16
- observation posts, C-11
- obstacles, 1-4, 2-6, 2-12, 2-26, 6-8, 7-17, 7-19
- occupation, 4-11
- offensive
  - air, A-3, A-45
  - concept development, 3-9
  - framework, 2-26, 3-3
  - operations, 2-6, 3-1, 3-35 to 3-38, D-7, E-3
  - planning, 3-8 to 3-14
- on-order task, 2-3
- operational
  - control, 2-5
  - plan, 1-3, 6-22
  - schedule, A-5, A-63 to A-64
- operation orders, 2-8 (illus), 2-9 (illus), 2-11, A-3, A-11
- operations, 2-6, A-25
  - ambush, 1-3
  - area, 2-8 (illus)
  - deep, 1-1
  - raids, 1-1
  - reports, A-3
  - security, A-52, C-11
  - stay-behind, 1-1
  - sustained, 1-3
  - types, 2-6
- Operations and Training Officer (S3), B-3
- order of movement, 3-30 (illus)
- orders
  - brigade, 2-10
  - confirmatory, 2-8 (illus)
  - development, 2-12
  - fragmentary, 2-7
  - groups, A-7
  - issuance, 2-7 (illus), 2-11
  - matrix, 2-12 (illus)
  - mission-type, 1-2, 1-5
  - operation, 2-3, 2-8 (illus), 2-9 (illus), 2-11, 2-12, 2-23
  - oral, 2-8 (illus), 2-12 (illus)
  - overlay, 2-12 (illus)
  - preparation, 2-7, 2-7 (illus), 2-8 (illus)
  - spectrum, 2-12, 2-12 (illus)
  - update, 2-8 (illus), 2-9 (illus)
  - warning, 2-1 (illus), 2-9 (illus), 2-10
  - written, 2-12 (illus)
- organic units, 2-3, 2-16
- overwatch, E-4
  
- passage
  - of control, 6-9
  - of lines, 6-1 to 6-6 (illus), A-3, A-39

- passive measures, 1-4
- patrols, 1-4, C-11, E-7
- peacekeeping operations, C-10
- peacemaking operations, C-14
- peacetime contingency operations, C-12
- penetration, 3-4, 3-6, 3-7 (illus)
- personal staff, 2-5
- personnel
  - accounting and strength reporting, 8-18
  - reports, A-3
  - support, A-14, A-57
- phase lines, 6-19
- populace control, C-18
- postal operations, 8-18, A-57
- prescribed load lists, 8-12
- preventive medicine, A-58
- principles of war, 2-6
- priority
  - intelligence requirement, 2-10, 2-22, 2-26, A-3, A-54
  - of work, 4-11, A-3, A-26
- prisoners of war, 8-2, 8-23 (illus), A-14, A-57
- public affairs, 8-20
- pursuit, 2-4, 3-36 to 3-38, 7-18
  
- radar, 2-1
- radios, 2-1
- raids, 1-1, E-3, E-7
- rally points, 3-6
- rear area operations, 4-5
- reconnaissance
  - and security, 2-26, 2-28, 3-3, 5-9, 7-27, A-35
  - and surveillance, 1-2, 2-10, 2-22, 2-28, 3-1, 3-2, 5-8, 5-9, 6-8, 7-18, A-35
  - in force, D-10
- registration of civilians, C-19
- rehearsals, 1-2, 2-3, 2-10, 2-23 to 2-24, 2-24 (illus)
- relief operations, 6-6 to 6-10
- reliefs in place, A-3, A-35
- religious support, 8-19, A-58
- remotely employed sensor, 1-4, 7-23
- replacement operations, 8-18 (illus), A-14, A-57
- reports, A-57, A-60 (illus)
- rescue and recovery, C-13
- reserve operations, 3-4, 4-5
- reserves, 3-2, 3-3
- resource control, C-21
  
- restricted areas, C-19
- restrictive
  - fire lines, 6-19
  - terrain, 1-4
- resupply, 8-8
- retirement operations, 5-21 to 5-22
- retrograde operations, 5-1 to 5-2, E-5
- reverse-slope defense, 4-19, E-5
- river crossing, 5-9, D-18, E-7
- roadblocks, C-26, C-27 (illus)
- routes, single or multiple, choosing, 3-6
- Rules of Engagement, A-32, C-3 to C-4 (illus)
  
- safety, 1-3, 2-27, 2-28, D-4, F-3
- salvage, 8-17
- scatterable mines, 7-17 (illus)
- schedule of activities, 2-11
- scheme of maneuver, 2-28, 3-8, 5-7 to 5-8, 6-19, 7-2
- scouts, 1-4, 3-9, 4-9, 5-8, 7-27, F-3
- search-and-attack technique, 3-18 to 3-23, 3-12 (illus)
- searches, C-22, C-24 (illus)
- security, 1-3, 2-28, 3-1, 3-3, 4-9, C-14, C-16 (illus)
  - assistance, C-12
- seizing the objective, 2-11
- sequence of attack, 3-30
- shows of force, C-13
- signal officer, B-5
- situational template, 2-26
- smoke, 7-25, 7-26 (illus)
- sniper employment, E-1
- soldier's load, 8-6
- special operations forces (SOF), D-1, D-18
- special staff, 2-5, B-4
- spoiling attack, 4-13
- staff
  - actions, 2-7 (illus)
  - briefing of commander, 2-12
  - development of order, 2-12
  - elements, 2-5
  - estimates, 2-7, 2-7 (illus), 2-12
  - input, 2-8 (illus)
- standing operating procedure (SOP), 1-2, 2-3, 2-5, 2-11
- static security posts, C-15
- stay-behind operations, 1-1, 6-19

- Stingers, 1-4
- strength, 8-18 (illus)
- strongpoint, E-5
- supplies, 1-4, 2-19
- Supply Officer (S4)
- supply system, 8-11 to 8-14
- support
  - by fire, 1-4, 2-16 (illus), 2-28, 3-8, 6-8, 6-13, 7-2, 7-8, 7-9 (illus)
  - element, 3-9
  - platoon, 1-4, 8-3
  - relationships, 2-5
- supporting
  - arms liaison team (SALT), 7-8
  - attack, 3-3 to 3-4
  - fire, 1-4, 7-9
  - unit, 1-2, 2-3, 2-27
- suppression, 1-3
  - of enemy air defense, 7-11
- surgeon, B-6
- survivability, 7-18, 7-19, 7-21
- sustained operations, 1-3, 2-28
  
- table of organization and equipment, 2-4
- tactical
  - air control parties, 7-10
  - air support, 7-10, 7-11 (illus)
  - operations center, 2-1, B-7, B-9 (illus)
  - support, 3-1
- tactics, 2-6
- tanks, 3-9, 3-22
- target numbering system, A-3, A-47
- task
  - analysis, 2-11
  - organization, 1-2, 2-10, 2-28, 3-8, 5-7, 6-23
  - tasks, 2-6, 2-11
  - terrain retention, 4-6
  - terrain/weather analysis, 2-12, 2-16 (illus), 2-19, 2-26
  - terrorism, C-8
  - thermal sights, 1-4
  - threat integration, 2-9 (illus)
  - top-down fire planning, 7-3
  - treatment squad, 8-22
  - triage, F-3
  - troop-leading procedures, 2-1, 2-7, 2-9 (illus) to 2-25
  - tube-launched, optically tracked, wire-guided (TOW) system, 1-4, 3-9, 4-9, 7-29
  - turning movement, 3-4, 3-8 (illus)
  
  - unit maintenance collection point, 8-15
  - unity
    - of command, 2-4
    - of effort, 2-4, 2-11
  
  - vehicle maintenance, 8-16
  - Vulcans, 1-4
  
  - war games, 2-3, 2-16, 2-18, 2-19 to 2-20, 2-25, 2-26, 3-2
  - warning order, 2-7 (illus), 2-9 (illus), 2-10, 2-28, A-3, A-9
  - weapons
    - control status, A-31
    - maintenance, 8-16
  - weighting significant factors, 2-20
  - withdrawal operations, 2-4, 5-11 to 5-21 (illus)
  - withdrawals, 2-6
  
  - zone of attack, 6-19

By Order of the Secretary of the Army:

GORDON R. SULLIVAN  
General, United States Army  
Chief of Staff

Official:

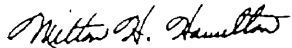

MILTON H. HAMILTON  
*Administrative Assistant to the  
Secretary of the Army*

00848

DISTRIBUTION:

Active Army, USAR, and ARNG: To be distributed in accordance with DA Form 12-11E, requirements for FM 7-20, The Infantry Battalion (Qty rqr block no. 0079).

**PIN: 023646-001**